

FARM
BUILDINGS
WITH
PLANS AND DESCRIPTIONS
SHEARER

ernia
l

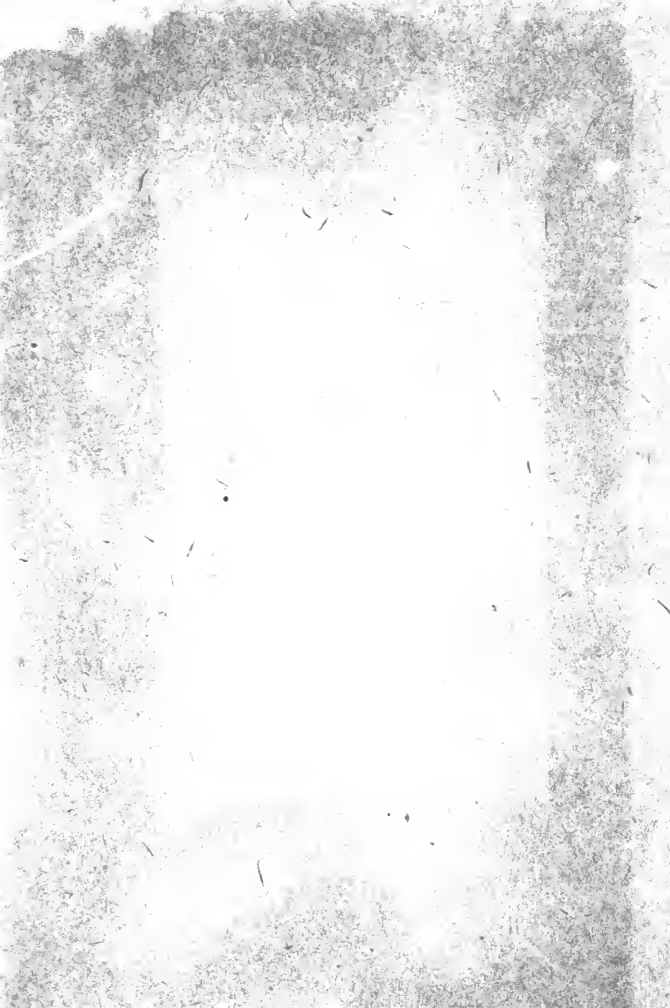

THE LIBRARY
OF
THE UNIVERSITY
OF CALIFORNIA
LOS ANGELES





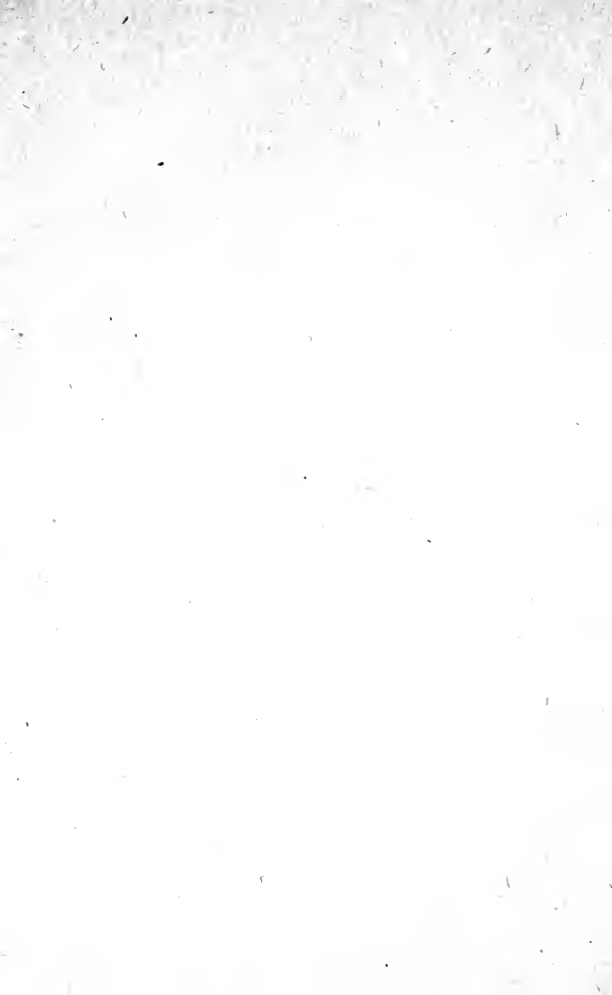



FARM BUILDINGS

WITH PLANS AND
DESCRIPTIONS

BY
HERBERT A. SHEARER
AGRICULTURIST

ILLUSTRATED

CHICAGO
FREDERICK J. DRAKE & CO.
PUBLISHERS

Copyright, 1917
By
FREDERICK J. DRAKE & CO.

Printed in the U. S. A.

TH

4911.

65394

CONTENTS

	PAGE
CHAPTER I	
ECONOMY OF GOOD FARM BUILDINGS.....	7
CHAPTER II	
TWO KINDS OF BARN CONSTRUCTION.....	10
CHAPTER III	
HORSE AND COW BARN.....	16
CHAPTER IV	
ENLARGED DAIRY AND HORSE BARN.....	23
CHAPTER V	
DAIRY BARN FOR TWENTY-EIGHT COWS.....	33
CHAPTER VI	
DAIRY BARN FOR THIRTY COWS.....	43
CHAPTER VII	
MONITOR ROOF DAIRY STABLE.....	49
CHAPTER VIII	
NEW MODELS FOR FARM BARNS.....	62
CHAPTER IX	
MISCELLANEOUS FARM BUILDINGS.....	71
CHAPTER X	
HOG HOUSES FOR WINTER AND SUMMER.....	112

CONTENTS

CHAPTER XI

	PAGE
POULTRY, POULTRY HOUSES AND POULTRY FURNITURE.....	124

CHAPTER XII

CONCRETE ON THE FARM.....	151
---------------------------	-----

CHAPTER XIII

COMFORTABLE FARM HOMES.....	160
-----------------------------	-----

CHAPTER XIV

DICTIONARY OF BUILDINGS AND ARCHITECTURAL TERMS....	236
---	-----

INDEX	253
-------------	-----

FARM BUILDINGS

CHAPTER I

ECONOMY OF GOOD FARM BUILDINGS

The first farmers in the middle west threshed grain and piled it upon the ground because they had no barns, granaries or warehouses. It was hauled to railway tracks and shoveled into box cars at the first opportunity. Box cars were not always available, the weather was uncertain, and the losses always fell on the farmer. There were no cattle to use the straw, so it was burned to get it out of the way. The farmer's life represented years of incessant toil interspersed with every kind of losses that pioneering imposes. The only excuse the early pioneers had for not starving to death was the wonderful productivity of the virgin soil.

To grow a profitable crop, a farmer must devote time, knowledge and experience to the work. It means years of partial failures in the process of learning how. The present crop is produced by days of labor in preparing the land, planting seed, and nursing the crop through to a successful harvest. When the crop is finally secured, large barns are needed to take care of the grain and the straw with the necessary stable room for live stock to make proper use of the grain that is

not sold. To care for domestic animals properly, not only stabling is necessary, but storage for roughage in silos and mows, also rat-proof granaries, ventilated corn cribs, and labor-saving machinery to help with the chores.

Saving the waste makes the profit. In all kinds of manufacturing, the by-products are carefully saved and worked into salable merchandise. Farming is, or should be, a great manufacturing business so carefully conducted that no by-product is permitted to go to waste. The land provides the raw materials and the buildings are the factories where the cheap grains and fodders are changed into high-priced butter, pork, eggs, beef, mutton, etc. Farmers who try to farm without sufficient factory buildings must sell their raw materials and let the next fellow make the profit.

No farmer ever made money by growing grain and burning the straw, although he may have gathered a few dollars by robbing the land. There are instances where straw may be worth more than the grain. In every case it is a valuable by-product, if the farmer has the necessary machinery to work it up.

It does not pay to grow corn, sell the grain and let the weather take the substance out of the stalks. A crop worth growing is worth housing. The stalks are about half the value of the corn crop. When this half is wasted, it is more than half because the cost of growing the whole crop must be charged against the half that is saved. No business except farming could stand such a loss. No farmer can afford to. A manufacturer would have to settle with his creditors, and the merchant caught wasting half his substance would be sent to an asylum for brain treatment.

THE COST OF BUILDING

I am often asked to give the cost of building a house or barn of a given size and plan, but it is impossible to do so, for the following reasons:

In some parts of the country carpenters may be employed at two dollars per day, while in other sections they get seven.

One farmer may have a good gravel pit on his farm so he can haul it to the building site at odd times at little or no extra expense. Another farmer, wishing to put up the same kind of building in another county, would pay two dollars per yard for sand or aggregate at the car and haul it several miles.

Prices of lumber and other building materials also vary in different parts of the country. Therefore any general estimate would prove misleading.

CHAPTER II

TWO KINDS OF BARN CONSTRUCTION

Two ways of building the same kind of barn are shown in Figures 1 and 2. The first is the old style timber frame barn and the other shows the newer plank frame construction.

Both barns are serviceable. Both have stood and protected animals and fodder during the heavy storms

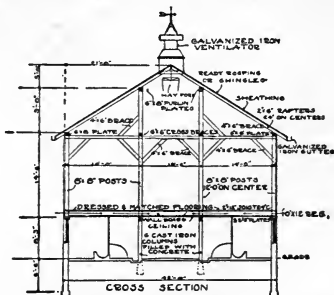

Figure 1.—Cross Section of Old Style Timber Frame Barn, 42 Feet in Width

of winter and summer. It is largely a question of preference when deciding which kind to build.

One farmer, who was preparing to build wrote in this way: "I am interested in barn roofs and I don't

remember having seen the question of stresses in a gambrel-shaped roof fully discussed as to whether it has any advantages over the old style of gable-end roof.”

Probably thousands of farmers have asked the same question since the curb roof became popular, and to

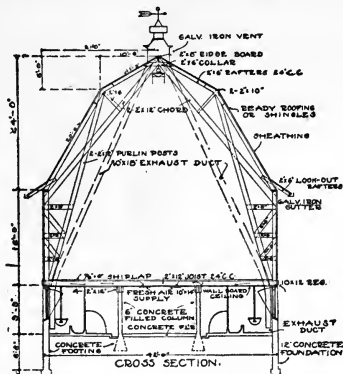

Fig. 2.—Cross Section of Dairy Barn, 42 Feet Wide, Showing Plank Frame Construction Truss. The Building is Wider on Account of the Central Alleyway to Make Room for the Manure Spreader Drawn by Four Horses

answer it fully I have made drawings showing the old and the new and shall give reasons for the change in style and manner of construction.

Probably few carpenters have ever correctly figured the different strains that the roof trusses of a gambrel roof barn are called upon to resist. The combination of different angles connecting at many different points

complicates the problem of calculation beyond the capabilities of ordinary mathematicians. But common practice has settled on certain sizes, angles, proportions, lengths of rafters and braces, sizes of dimension stuff and roof pitches that have stood the tests of wind pressure, rain and heavy loads of snow for fifteen or twenty years.

Figure 1 shows an old fashioned timber frame barn with a straight gable-end roof, built in the usual way. Figure 2 shows the modern plank frame construction with a curb roof.

Both barns are forty-two feet wide to provide room for a wide driveway through the center of the cow stable for the manure spreader drawn by four horses. Figure 3 shows the floor plan.

Because of the extra width the lower rafters of the plank frame barn are longer than usual. When the cows face in, and manure carriers are provided, the width of the barn usually is thirty-six feet.

The storage capacity under a barn roof depends upon the height above the plates. In this timber frame barn we get a height of fourteen feet, while the plank frame barn roof rises twenty-four feet above the plates.

Other advantages of plank frame construction are the ease of building up timbers of any size or strength required by adding planks. Planks are carried in stock by all lumber yards, but timbers often require special orders which cause delays, special trips and extra cost.

The upper roof lies low to catch little wind pressure. This portion of the roof receives less rain water and is short; therefore it may have a low pitch. It dumps

its supply of water onto the steeper slope of the lower roof to be disposed of quickly.

The curb strengthens the roof to the extent of eliminating the purline plates and their supporting posts.

A plank frame barn is built of trusses reaching from one sill to the other, each half truss is opposed to and supports or braces its mate through their connection at the apex, somewhat on the cantilever principle.

Planks are lighter than timbers and more easily handled. They are held at the lumber yards until partly seasoned, so they are easily worked. Less material is required for plank frame construction because the planks are doubled, trebled or used singly, and they vary in width according to the strength required.

A plank barn frame is easily and quickly spiked and bolted together and the work is so simple that any farm hand can follow instruction from the boss carpenter. One skilled mechanic and one or two handy men will do all of the necessary squaring and beveling of plank ends and the spiking and bolting in a short time, and they will do the raising with the aid of an improvised derrick. Plank frame construction has completely discouraged the old fashioned "raisin' bee."

Storage for large quantities of roughage is more of an object than formerly, because live stock is kept in greater numbers. Barn lofts free from center posts and cross timbers may be filled easily by horsepower or engine power, and the fodder may be dug out in winter with the same machinery. Thresher blowers are directed into a hay door to fill one end of the big mow with straw for winter bedding. Hay tipples are

used to dump fork loads or sling loads of hay over against either side of the mow to save hand labor. Hay tipples require a clear space from one end of the barn to the other, and to make them profitable the barn must have both height and width. Another reason for the popularity of curb roof barns is that most farmers like their appearance.

CHAPTER III

HORSE AND COW BARN

The most popular kind of barn on American farms is a combination horse and cow stable with large storage for grain and roughage overhead.

Most farmers keep both horses and cows. When the new barn is planned it sometimes seems best to make it enough longer to also stable the horses, as the expense is likely to be but little more and all the chores may then be done under one roof.

This barn shown in Figure 4 is intended to stable nineteen cows and six horses, in the regular stanchions and stalls, and there is a rather large box stall that may be used for a bull pen or for calves. There may come times when it will be needed as a hospital stall, although as a general thing it is better to remove sick animals to another building.

There are roller doors to shut off the horse stable from the cow department and these doors are kept shut except at stable cleaning time. Dairy rules and some dairy laws require that dairy stables shall be separate from all other departments of the farm. The object is to prevent the milk from being contaminated by harmful bacteria.

There should be no open doorways between the two stables. House flies breed in horse manure and they are the dirtiest and filthiest of all our common insects.

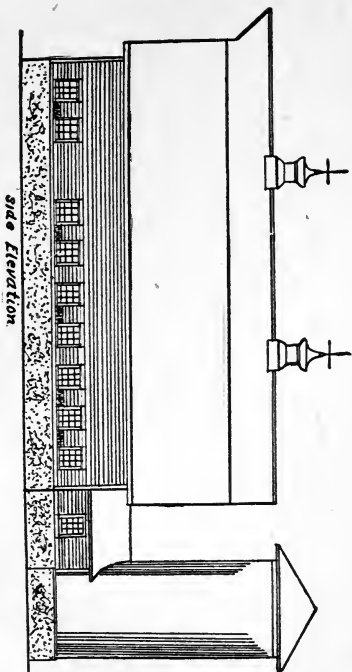

Figure 4.—Side Elevation of Large Dairy Barn, Showing the Manner in Which the Feed Room is Built in Between the Stable and the Silo

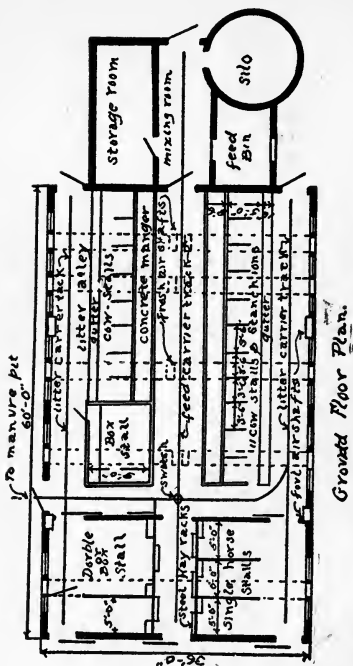
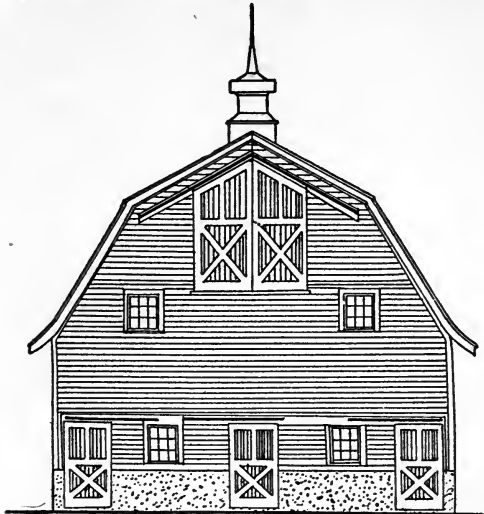

Figure 5.—Floor Plan of Large Dairy and Horse Stable, Showing the Layout of Stalls and Alleyways

Milk inspectors don't like to see house flies floating in a pail of milk. It is an indication of poor management. Ventilation is another sanitary requirement. Old



End Elevation

Figure 6.—End Elevation of a Typical Curb-Roof Dairy Stable and Storage Barn. The Concrete Foundations Extends $3\frac{1}{2}$ Feet Above Grade

timber frame barns boarded up and down are provided with ventilation by the shrinkage of the boards. But a modern air-tight building like this that is built to house pure bred cows comfortably in winter must

have an automatic supply and discharge of air working continuously night and day so long as the stable is occupied.

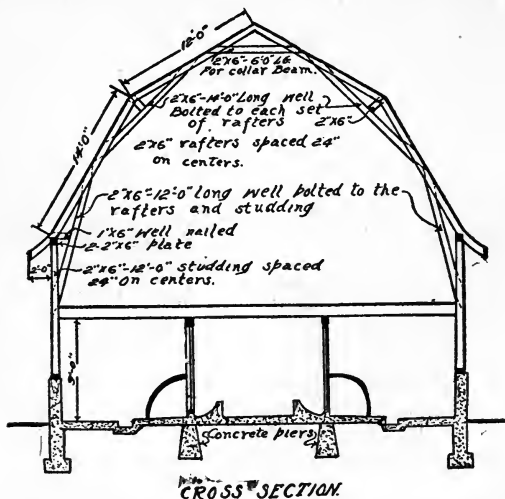

Figure 7.—Cross Section of Curb-Roof Dairy Barn, Showing Rafter Construction and Bracing

In this cow barn the supply of fresh air is taken in through supply pipes placed in the outside walls. Registers placed between the stable windows admit air from the outside and the intake pipes distribute the air at the stable ceiling where it flows out over the cows.

Outlet ventilator pipes also are built into the walls to draw the foul air out and discharge it through the metal ventilator hoods perched on the peak of the roof.

Outlet ventilator pipes when properly proportioned and well made act like chimney flues. The draft depends upon the propensity of warm air to go up. The stable is warmed by the body heat of the animals. Fresh air thus admitted from outdoors loads up with impurities and settles near the floor towards the outer walls where the outlet openings are placed.

It is important that the outlet flues be made tight to prevent leakage of cold air into the pipes, because cold air has a tendency to go down into the stable.

Metal pipes radiate heat in cold weather which interferes with the draft by reducing the temperature. Wooden pipes are better than metal if they are made with tight joints. Wall board is used with success. Wall board is cut in long lengths the right width and is nailed to wooden corner strips two by two inches in diameter. All joints are cemented so there is no opening except the inlet at the bottom and the outlet at the top. Wall board should be made in cylindrical form for such purposes.

Outlet ventilator pipes in a stable of this size should be about twenty inches square, inside measurement, or eighteen inches in diameter if made round.

Inlet ventilators are more numerous and they may be smaller in size. Inlet supply flues do not depend upon temperature to create a draft. The wind will drive through the intakes. For this reason they should be fitted with sliding gates to regulate the openings. It is necessary to regulate the supply of air according to the weather. This is just as important as to regu-

late the supply of feed. If the outlet flues are well made and properly proportioned they will work automatically, but the intakes must be watched.

Some metal ventilator hoods help the draft by directing the wind currents upward to create suction. Aspiration, or the passing of a current of air across the open top of a pipe, also helps to create an upward draft.

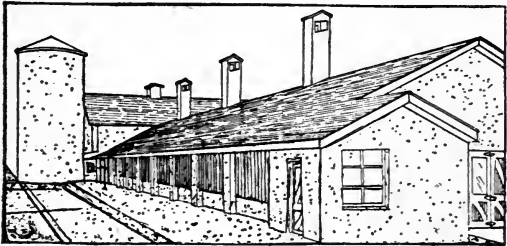

Figure 8.—Concrete Dairy Stable and Concrete Barnyard

The fences are not shown. The barnyard is paved with concrete laid on two levels. A fence confines the cows to the paved yard during muddy weather. There are feed racks to use when needed, and there are open sheds to the left. A good demonstration of the importance of concrete in modern dairy farming.

CHAPTER IV

A LARGE DAIRY AND HORSE BARN

This combination dairy and horse barn is scientifically correct in principle and detail of construction and equipment according to the dictates of modern dairy knowledge and practice.

From the excavations to the peak of the roof, and from the silos at one end of the barn to the manure shed at the other end every detail of plan and elevation has been tried out repeatedly and finally adopted into the barn that is represented by Figures 9, 10, 11, 12 and 13.

Concrete Foundations.—It is easy to make a concrete foundation for a farm building where the materials may be cheaply obtained.

The wall footings are laid deep enough to reach below frost. For this reason climatic conditions are always considered when making a foundation. "Foot-ing" is the builder's term for the wide base of a wall and it means permanency.

When the earth bank is dug square, straight and plumb, the inside wooden form only is necessary up to the surface of the ground. This form is made of material that is afterwards used in the building. Concrete is heavy and it should be tamped, which brings considerable pressure against the form.

A neat finish on the outside of the wall above

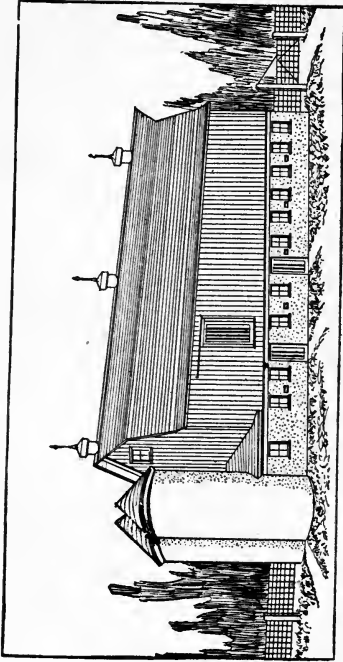
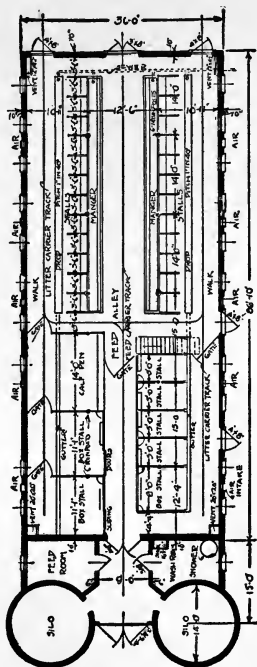
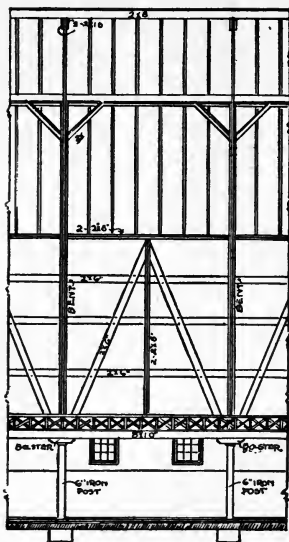

Figure 9.—Perspective View of Large Dairy Barn and Stable with Concrete Basement Wall and Floor

Figure 10.—Floor Plan of Large Dairy Stable, Showing Arrangement of Stalls and the Manner of Connecting the Feed Room with the Two Silos





PANEL BETWEEN TRUSSES

Figure 11.—Detail Showing the Plank Frame Construction of Dairy Barn Shown in Figure 9

ground, whether simply a foundation wall or a basement, means a good deal in the appearance of the building. It costs but little more to set a building up high enough to make a basement. A foundation wall is usually three and a half feet, while a base-

ment wall is about eight feet or eight feet, six inches, according to the use for which the basement is intended. It costs little more to make the inside form high enough for a basement wall. The same may be said of the outside form, because even a foundation wall is carried up above the surface of the ground and

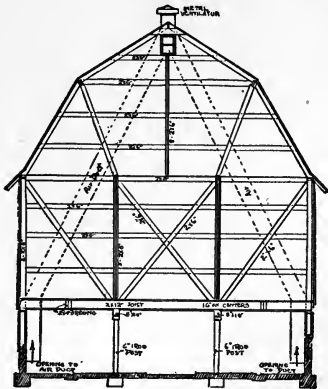

END CONSTRUCTION

Figure 12.—Cross Section

this requires some kind of outside form. Both forms are made level and true on top so that the finished wall is struck off even.

In mixing materials for a basement wall, a great deal of stone should be used. Stone is handled more quickly than concrete, and it makes a stronger wall

when stones are used and well surrounded with thin concrete that fills the crevices and sticks to the stones.

The one rule in mixing concrete that applies in all cases is to use a little more than enough cement to fill the spaces between the grains of sand, and a little more

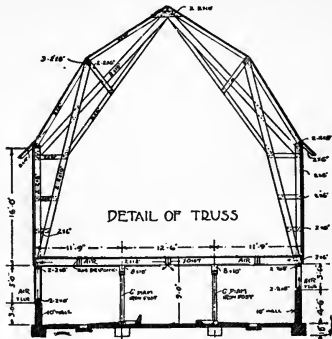

Figure 13.—Detail Showing the Way One of the Main Trusses is Constructed. A Truss Like This is Placed Every 12 Feet in the Length of the Barn to Act as a Stiffener. Between These Trusses the Rafters are Braced in the Ordinary Plank Frame Manner.

than enough sand and cement to fill the spaces between the particles of gravel or aggregate, and lastly, use a wet mixture of cement, sand and aggregate to bind together the larger stones used in the wall.

This is easily and quickly done by first placing a layer of stone to start the bottom of the wall, placing the stones so that they touch each other. Then dump in soft concrete sufficient to fill all the spaces between and to cover the stones with a layer of concrete an

inch deep or more. Then another layer of stones is piled in, and the concrete added as before.

The larger stones, of course, should be selected for the bottom of the wall, where it widens out to make the footing. Each layer of stones and cement should be tamped. If the stones are joggled with the tamper the air is forced out, the cement settles around and adheres to the stones and makes a better wall. Above ground a crow bar is used to pry the stones so that the concrete mortar will make a smooth surface.

Provision is made for placing the basement windows after the inside form is anchored. The easiest way is to mark on the form where the window frame should be placed. When the cement work is up to the bottom of the window sills then the frames are set on the fresh cement and are tacked to the inside form with eight penny nails from the inside.

It is difficult to work the concrete around under the window sill if the frames are put in position too soon. The frames work better if they are made the full thickness of the wall so that they fit between the inside and outside forms. A neat window casing is then easily fitted and nailed against the window frame flush with the surface of the wall.

The outside form is held in place by wires. When the wall is complete the wires are cut close to the wall. To make a neat finish the wall is troweled over with cement mortar. The sooner this is done after the concrete wall has set the better it will stick. Usually it is good practice to embed the sills in fresh cement mortar on top of the wall as soon as the concrete is hard enough. The sills should remain in place undisturbed for a few days before nailing the joists and

studding to them. Fresh concrete is easily injured by pounding.

Plank Frame Construction.—The best and cheapest way to build the superstructure of a barn is to make the frame of two-inch planks.

Plank frame construction was adopted because planks are carried in stock in all lumber yards, but timber must be ordered from a saw mill. Special orders cause delay and add to the expense.

The advantages of these skeleton frames developed with use. Two-inch pieces from two by fours up to the largest planks are easily handled. They are put together in twos, threes, or thicker in the making of strong girders where strength is needed, and they are stretched out singly and opposed in pairs in truss work. Great arches are formed by meeting two trusses together at the apex. Two men are sufficient at a plank frame "raising" unless greater speed is wanted.

Ventilation.—Domestic animals require fresh air every minute, pure water several times a day and food at frequent intervals.

They would die in five minutes without air. With plenty of fresh air they could live a week without water. If supplied with air and water they might live several weeks without food. This means that pure air is of more importance than both food and water. Pure water is of more importance than food. But all three are necessary to promote profitable growth and development.

To provide proper ventilation this barn is fitted with intake air ducts and large outlet ventilators. The intakes are placed along the sides of the building

and the ventilator flues start up from the four corners of the stable.

The system spreads fresh air all through the stable. The body heat of the animals keeps it in motion. As it loads up with carbonic acid gas it becomes heavier and settles near the floor in the coldest corners of the big stable. There is a draft up through the out take flues which carries it out and discharges it through the ventilator hoods on the peak of the roof.

Milking Machinery.—Milking machines are great labor savers. One man can attend to three or four machines and each machine is capable of milking six or eight cows per hour. A battery of three machines will require one horsepower but it is better to provide two horsepower so that additional machines may be added without changing the engine. Milking machines are simple in operation and easily managed but some knowledge of the principles upon which they operate is necessary to keep them in good working order.

Manure Carriers.—Labor saving machinery to handle manure commences by taking the liquids and the solids from behind the cows. The manure is dumped automatically into the spreader from which it is unloaded and spread by horsepower in the field. Great improvement has been made in overhead tracks and cars during recent years. The best makes work easily without binding or unnecessary friction. The same may be said of horse forks, hay carriers and feed carriers.

General Description.—The illustrations show a dairy barn thirty-six feet in width, eighty-six feet in length and fifty feet high from the stable floor to the peak.

The stable is arranged to face the cows in towards a center feed alley. The cow stalls are separated by steel partitions and are fitted with improved stanchions hung to steel manger frames.

The horse stalls are enclosed with steel fences and steel gates. They are fitted with steel hay racks and feed boxes.

There is a stairway leading from the horse department to the floor above, landing in front of the upper side door. This door is for light and ventilation and to admit the blower pipe at threshing time to blow straw into the storage loft.

The horse stable is shut off from the cow stable by a partition and solid doors which are kept shut except when the stables are being cleaned.

There is considerable machinery in the different parts of the barn to save hand labor and to do the chores quickly and better.

The stable ceiling is lined with wall board and is painted to make it air tight and vermin proof.

Between the stable and the silos are two feed rooms and a wash room for the men. In this wash room are lockers for their white milking suits and there is a shower bath and wash bowls with hot and cold running water on tap.

The dairy house is a small separate building at some distance from the stable. It is built according to requirements laid down by pure milk regulations.

CHAPTER V

DAIRY BARN FOR TWENTY-EIGHT COWS

This is a dairy barn thirty-six feet in width by sixty-four feet long. Figure 14.

It is designed to meet the most rigid sanitary requirements as well as to provide the greatest possible amount of cow comfort with the least possible expenditure of labor in attending to their numerous wants.

A labor-saving barn is required to house the cows and the fodder to feed them. There is machinery to pack the feed into the great storage mow in summer and into the silo. There is also machinery to get the feed out in winter and carry it to the mangers as needed.

The foundation is built of concrete from the wall footings up four feet above the concrete stable floor. The footings are shown two feet wide to give them plenty of surface to prevent settling. There is considerable weight on a wall under a building of this size and height and it is supposed to stay exactly as placed.

Great care is taken in starting the floor, as permanency depends upon getting the right start. After the ground is carefully leveled it is wet down to settle it all over alike. In putting down the foundation for the wall, it is necessary to do considerable digging

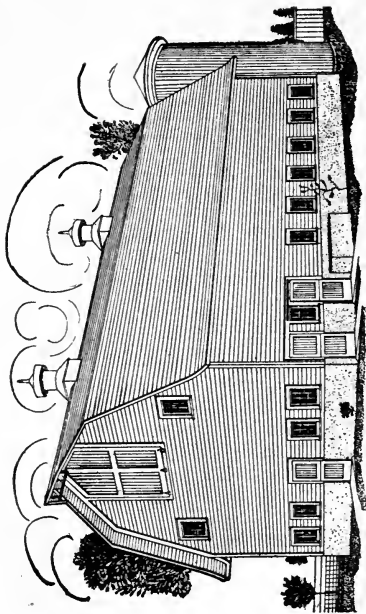

Figure 14.—Perspective View of Another Large Gambrel Roof Dairy Barn and Stable

which loosens the ground in places. Such spots can be packed down hard only with water.

After the earth is settled and leveled it may be laid off into divisions bordered by the manger and gutter forms.

The back of each manger is built against two by six pieces fastened to stakes driven into the ground. The top edges of each of these planks touch the line as shown in the detail floor drawings, Figure 17, so the cement manger is struck off level. The line is carefully leveled and the level mark is snapped against the side-walls with a chalk line so that the line may be quickly stretched crosswise of the stable at any time to test the work by measuring from the line down to different parts of the floor.

The line on the drawing shows a drop of six inches immediately behind the manger and seven inches at the gutter and fifteen inches to the bottom of the gutter, so it is always easy to prove the grading of the floor at any stage during the progress of the work. Likewise horizontal measurements are given which show the cow standing portion of the stable floor to be five feet in width from the center of the back division of the manger to the edge of the gutter.

In doing work of this kind it is always necessary to have a place of beginning to establish grades and measurements. In this stable the proper starting place is the manger.

All cow mangers are placed low down. Cows naturally feed from the ground so it is in keeping with their established habits to eat from the level of their front feet.

Cow stable floors are made the same as sidewalks,

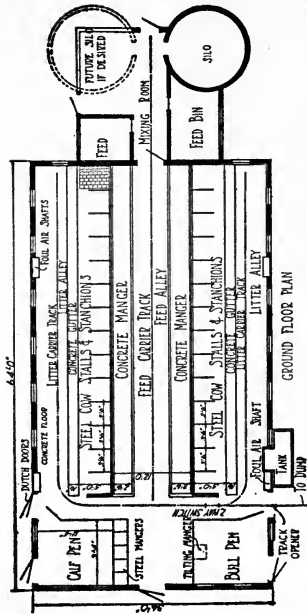

Figure 15.—Floor Plan of Dairy Stable, Showing One Silo Complete and the Other Outlined, to be Built Some Time in Future

by using two by four strips to mark the floor into blocks. The scantlings are spaced and leveled or graded to fit the floor grade and the concrete mortar is struck even with the top edges of the division pieces to bring the floor true to levels and grades.

It is impossible to give a formula for mixing concrete for the stable floor without knowing the quality of the sand and gravel. As a rule it is best not to use sand that contains more than ten per cent of clay or mud. Water in excess of ordinary requirements will sometimes unite poor materials by washing the sand so the impurities will settle. Wet concrete usually makes a better job under ordinary conditions.

After the foundation the most particular part of a cow stable is the surface. It pays to get good sharp sand for the surface coat and to lay it on with a trowel with considerable pressure to make it waterproof. Pressure with the trowel drives out the air and unites the particles of cement and sand so closely that water cannot enter.

After the floor is thoroughly trowled it may be mused over with a stubby broom to rough the surface, so the cows won't slip, but this must be done carefully. The mangers and feed alley floor should be finished smooth and all parts of the floor should be made hard.

The detail floor drawings show the manner of laying prepared blocks into the concrete to make an easy floor that is warmer than concrete. A good deal depends upon the way the cows are bedded.

The big mow overhead is intended for storage for straw as well as hay. Dairymen find it necessary to grow large quantities of grain to feed to their cows.

At threshing time they have many tons of clean bright straw that is valuable if it is properly housed. It is blown from the stacker into one end of the big mow and lifted out in winter time with the horse fork and carried to the mangers in the feed carrier.

Cows will eat a good deal of straw along towards noon. They like to pick it over and munch the chaff and finer parts. Then in the afternoon when the stables are cleaned the mused over straw in the mangers is forked back into the stalls for bedding. It is also a good liquid manure absorbent as it gradually works back into the gutters.

This already makes three uses for clean, bright straw, but the most valuable use is when it is taken in the manure spreaders while it is soaked full of liquid phosphoric acid and ammonia and is spread out on the land to grow big crops of corn and small grain to be followed by clover and other legumes.

A splendidly well made stable floor is in this way made first aid to the manufacture of a very valuable by-product of the dairy. Stable manure from grain-fed cows, made and handled in this way, is valued at thirty dollars per year for each 1,000 pound cow. This great value depends upon the proper use of the manure after it is made as well as upon the way it is made and handled. Under scientific management the manure from thirty cows may be made to pay for the barn.

Wall board is specified for lining this stable above the concrete wall for the reason that wall board may be made air tight. An air tight stable may be ventilated easier and better than when there are many cracks to admit air. Wall board may be butted to-

gether to bring the joints on the joists. These joints are then easily filled with putty and the whole surface covered with two coats of good white lead and oil.

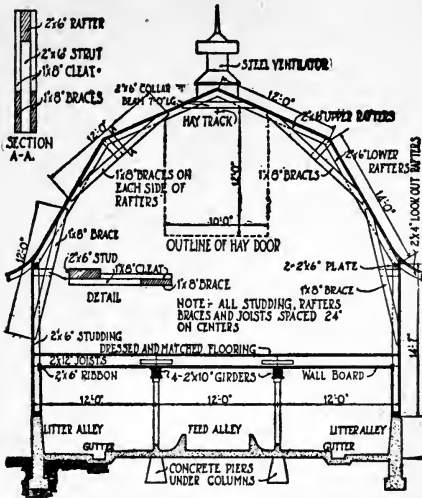

Figure 16.—Cross Section Showing Detail of Construction

When walls and ceilings are made in this way there is no harbor for disease-breeding bacteria. The walls may be brushed with long handled brushes to remove the little floating dust that finds a lodgment which goes a long way towards keeping the stable in a sanitary condition.

For the same reason all stall partitions and stanchions are made of iron and coated with smooth enamel that may be washed or wiped with damp cloths to remove all bacteria-laden dust and dirt.

The supporting columns that carry the weight of the girders are of wrought iron filled with concrete.

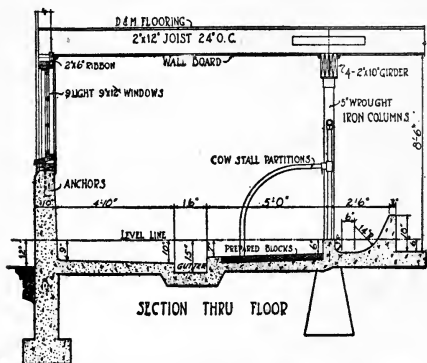

Figure 17.—Cross Section Showing the Manner of Constructing the Concrete Floor and Wall and Stable Window

This makes a stiff solid support that may be smooth finished to correspond with the manger and stall partitions.

Each column stands in cement in the back line of the manger which really is a continuous wall with ample footings to support the overhead load. When the big mow is filled and settled and filled to the peak it will hold more than 100 tons of hay, so it behooves

the owner to provide considerable under pinning to prevent settling.

It will be noticed that the spacing works out right for three lengths of twelve foot joists to splice on the girders. The joists are two by twelves placed twenty-four inches apart on centers and well bridged to make a solid floor.

The stable is lighted by twenty windows glazed with nine by twelve lights, nine lights to a window. This gives 135 square feet of glass, or about four and a half feet to each animal in the stable. It is impossible to keep a dark stable clean.

The silo is sixteen feet in diameter and thirty-six feet high. It will hold about 140 tons of silage, which will equal 280 days feeding, allowing each cow thirty-five pounds of silage per day.

Another silo is provided for in the plan to be built sometime in the future as the herd grows in numbers. Herds always do increase when a sanitary dairy is once started because it pays.

Plank frame construction is used above the concrete wall. Planks are used in different widths from two by fours to two by tens for girders and two by twelves for floor joists. The girders are built up by bolting four planks together. They are selected according to the way the grain runs and are placed side by side, breaking the splicing in such a way as to make continuous girders the whole length of the barn.

The roof construction is self supporting on the cantilever truss principle. Each pair of rafters forms an independent truss reaching from one wall to the other. Placing such trusses three feet apart makes a strong roof and a great mow that is free from obstructions

so the hay fork and hay tipple may work freely from one end of the barn to the other.

Ventilation pipes are arranged to carry out Professor King's system of ventilating dairy stables. There are inlet pipes that admit fresh air from outside and deliver it over the cows.

The outlet pipes take the foul air from near the floor behind the cows and carry it up to the peak of the roof. The ventilating flues are connected at the peak with metal ventilator hoods that regulate the draft so the flow of air through the pipes is constant regardless of the direction of the wind.

CHAPTER VI

DAIRY BARN FOR THIRTY COWS

This barn shown in Figure 18, is thirty-six feet in width, which is a few feet wider than older dairy stables, to make room for wide alleys behind the cows and a feed alley of sufficient width to accommodate a feed carrier suspended from an overhead track.

A similar track is fitted into the ceiling over the rear alleys to support a manure carrier. This track extends the full length of both manure gutters and clear around both silos, where the ground is supposed to be low enough to drive the manure spreader under the carrier to dump the load. This is a very important feature, and one that is well worth figuring on before the building is started.

Between the two silos and the end of the stable is a feed room with a low roof. It is easier to build it low, as we avoid the barn cornice. This feed room is divided into three parts to make storage for different kinds of grains.

The litter carrier track runs underneath a shute that is built in front of the silo doors, so that the silage may be forked into the shute above and fall directly into the carrier. When two men are doing the feeding this arrangement saves one handling. The man in the silo gets the feed ready while the man with the carrier is dumping the load. When he returns

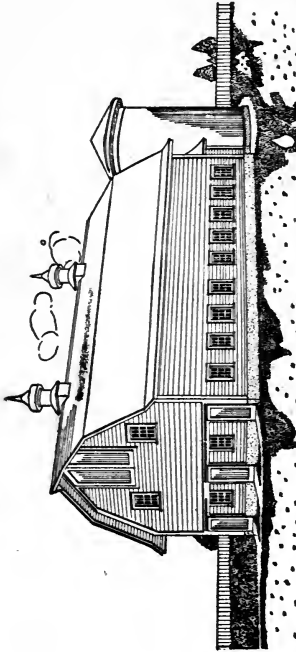

Figure 18.—Perspective View of Dairy Barn with Large Storage Overhead. The Manure Carriers are a Special Feature of This Stable

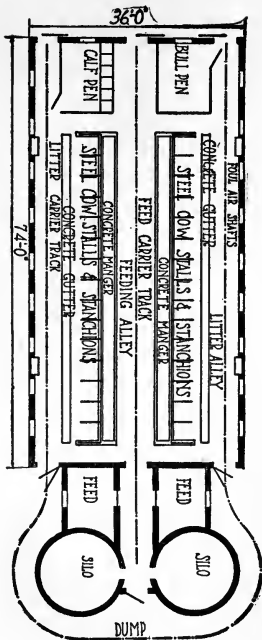

Figure 19.—Floor Plan, Showing Stabling for Thirty Cows, Besides Two Pens for Other Animals

with the carrier it is filled almost instantly by the man in the silo.

Likewise the bedding is forked down a similar chute from the storage mow into the litter carrier and is run through the stable to the different stalls. All overhead tracks are alike, so the litter carrier may be run through any of the alleys.

A good ventilating system is provided through steel air shafts placed in the walls. There are four of these ventilating flues, which follow the walls to the plates, then follow the rafters to the peak, where they are topped with ventilators to secure a steady upward draft.

The silos are fourteen feet in diameter by thirty-two feet in height. The capacity of two silos of this size is rather more than necessary to feed thirty cows during the regular silo feeding season, but silage is being used for summer feed as well as winter feed, also the number of animals on a dairy farm where silage is fed, increase rapidly. It is seldom that any silage is wasted.

It is such a valuable feed that some use is found for it some time during the year. For this reason it is advisable to provide plenty of silage capacity. Two small silos are better than one large one, as the silage may be kept fresher.

Above the stable is the large storage mow which, owing to the construction of the roof, is free from cross timbers,—so the hay fork may be run directly through from one end of the barn to the other. The height of the peak and the shape of the roof is especially designed to give large capacity for hay and straw.

It is customary to put more windows in cow stables than formerly. This stable is designed for a little more than four square feet of glass per cow. The windows being placed behind the cows give plenty of light at milking time.

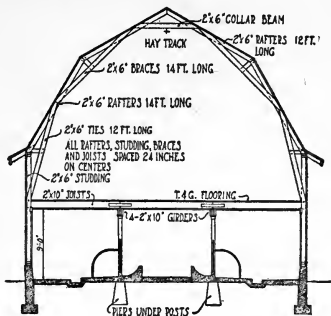

Figure 20.—Cross Section Showing Detail of the Stable Floor, Barn Floor and Plank Frame Roof Construction

Steel stall partitions separate the cows, and the steel frame over the manger forms a hanger for the light swinging stanchions. This steel frame also provides places for the record sheet for keeping daily account of the milk that each cow produces.

Inside the stable the walls are made as smooth as possible to prevent lodgment of dust. Dust harbors bacteria, and bacteria make trouble for dairymen. That is one great advantage of using iron stall partitions—there is little room for the lodgment of dust. They are easily dusted or washed or wiped with a

damp cloth. Dairymen are becoming very particular in regard to the manner in which the stable is kept. It is impossible to keep a stable clean unless it is designed and built for cleanliness.

CHAPTER VII

MONITOR ROOF DAIRY STABLE

For ventilation in summer a monitor roof is better than other forms of dairy stable construction. Where the hot weather continues through the spring, summer and fall, dairymen are looking for the coolest way possible to build their dairy stables.

The stable shown in Figure 21 has all the sanitary stable fixtures required by the most rigid inspection rules. These rules by the way, are not unreasonable when they are rightly understood. Sometimes inspectors are too aggressive, some are too ignorant to know right from wrong, but taking inspection as it embraces the whole country it is working splendidly for the benefit of honest dairymen.

Particular consumers are demanding cleaner milk. They are beginning to understand that it costs money to be clean and they are learning to pay the price. Many city people realize that it is cheaper to pay an extra cent or two per quart for milk than to pay more money to the doctors and to lose time while convalescing.

Like all good dairy stables this manner of building requires a good solid foundation of concrete which includes the dairy floor. The outside concrete walls and the supporting piers under the mangers are built first and carefully leveled on top. The ground between the walls is then wet down and made solid.

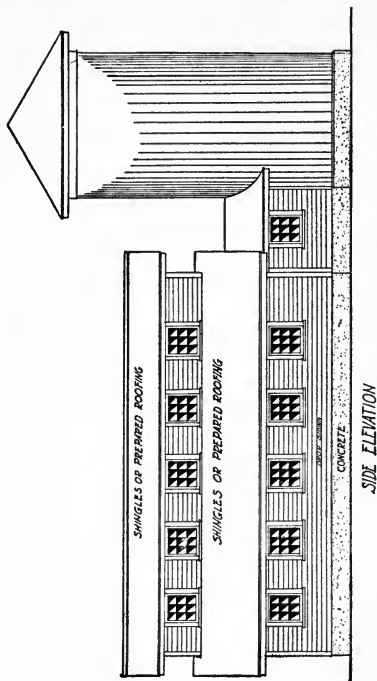

Figure 21.—Side Elevation Showing a Monitor Roof Dairy Stable with Large Silo

Stable floors usually are level from end to end except the bottom of the gutters behind the cows. Gutters are given a fall of about one inch to twenty feet on the bottom to drain out at the end of the building when the gutters are washed with the hose.

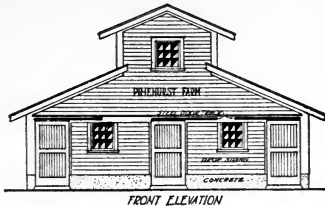

Figure 22.—Showing End View of Monitor Roof Stable

Grading the ground crossways of the building calls for measurements to bring the mangers up to grade and the gutters down to their proper places. One way to test the work as it proceeds is to make two templates, one as a guide, between the outside wall and the center piers and the other template to reach across the mangers and feed alley from each center pier to its opposite mate.

These templates are built up by using narrow strips of wood having straight edges. The points of contact for the templates are the top surface of the finished foundation walls and the tops of the center piers.

The lines followed are the face surface lines of the finished floor. From the inside of the foundation walls of the manure alley, the floor should slope to the edges of the gutters. From the backs of the

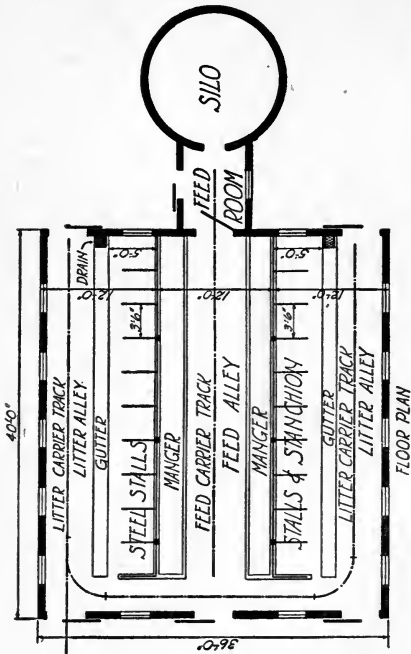

Figure 23.--Floor Plan of Monitor Roof Stable Showing Large Silo Opposite a Central Feed Alley

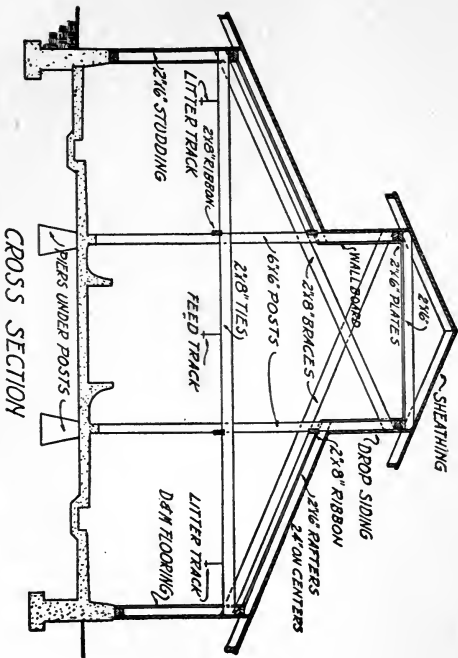

Figure 24.—Cross Section Through Monitor Roof Dairy Stable

mangers the standing, or stall floors, slope back to the gutters. The center alley floor and the bottom of the mangers are on a level with each other.

These templates are first used to grade the ground, afterwards they are used to set the stakes and forms for the concrete floor. The top edges of the two by fours used for forms are placed to touch the bottom edges of the templates, when the soft cement floor surface is struck off with a straight edge even with the tops of the two by four forms; then the finished floor conforms to the floor line as shown in the cross section drawing, Figure 24.

The floor plan, Figure 23, shows the stable to be thirty-six feet in width and forty feet in length. The width has been worked out carefully and may be considered standard.

The manure alleys are supposed to be kept clean at milking time and there are manure carriers and hose sprinklers and scrubbing brushes to assist in the cleansing operations. The space between the cows and the outside wall as shown is sufficient to operate these different mechanical labor savers to advantage.

There are windows enough to light this part of the stable effectively, partly to reveal any dirt and partly because considerable light is wanted at milking time. Cows do better in a bright stable.

Modern dairy stables are built not only to furnish a comfortable feeding and milking shelter, but to supply conditons that are favorable to the use of dairy machinery including milking machines.

Labor saving dairy machinery has done away with so much drudgery that a large herd of milking cows

may be better cared for with less expenditure of hand labor than a small dairy demanded a few years ago.

The length of this stable is sufficient to hold twenty cows. It may be extended to twice or three times the length if that much room is needed. The same width is maintained, but lengthwise the plan is extremely elastic.

If fifty or more cows are stabled, however, it will be necessary to build another silo. Silage is the best and cheapest cow feed and the handiest to store and deliver.

It is a good plan to have silage enough to feed at milking time the year around. A full day's silage ration for a cow weighing 1,000 pounds is reckoned at forty pounds, but when silage is fed only at milking time to keep the cows quiet and contented, probably an average of twenty or twenty-five pounds will be sufficient. A great deal depends upon the way the cows are cared for between milking periods.

This plan provides for a covered passage way which connects the stable with the silo. The silo delivery chute comes down into this feed room and the feed carrier track extends to within a few feet of the silos, so it is easy to load the carrier directly from the bottom of the chute and to run it clear through the feed alley, dumping the necessary amount before each cow as it goes along.

The new feed carriers are much larger than the old ones and they have hinged sides that may be lowered to slide the feed into the cow mangers. The width of the car with the wings extended should fit the space between the mangers so that feed will drop into them and not fall short nor shoot over.

If the stable is made extra long and feed carriers of greater capacity are needed, then the feed carrier cars may be made longer, but the proper width should be maintained.

The silo chute may be fitted at the bottom with a hopper to hold the silage up from the floor. The feed carrier may then be run under the hopper and loaded by pulling a slide to let the silage fall through.

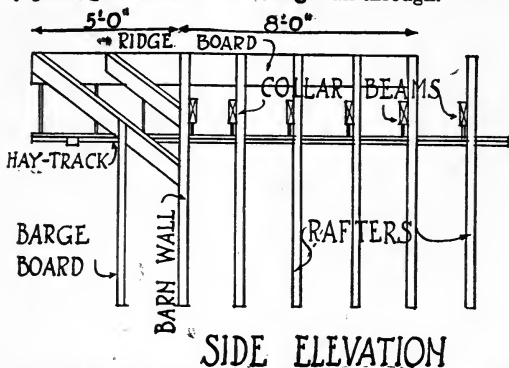

Figure 25.—Side View Showing Plan for Building a Hayfork Hood to Project from Peak of a Storage Barn. The Jack-Rafters form a Brace to Support the End of the Hay-Track Beam

HAYFORK HOOD.

It is easy to frame a hayfork hood extension to a barn roof by extending the ridgeboard five feet beyond the wall rafter. The ridgeboard is supported by two pairs of jack-rafters as shown in Figures 25 and 26. The outer jacks carry the barge board effect around

the point of the hood. The hay-track is hung by long bolts reaching down from the ridgeboard extension.

BUILDING SCAFFOLD BRACKET

Two pieces of two by four, four feet long each, halved and bolted together at the corner, makes the

RIDGE BOARD SHOULD EXTEND BACK INTO BARN 8 FEET.

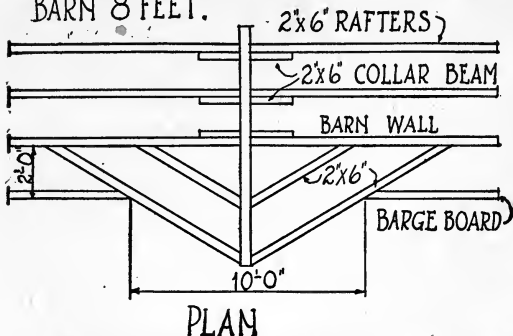

Figure 26.—Top View of the Hay-Track Roof Extension Showing the Ridgeboard and Supporting Jack-Rafters

cheapest, safest and most convenient scaffold bracket. There are four braces of one by four nailed to the two by four pieces, as shown in Figure 27. Either a two by four or a four by four is used for the leg, according to the height of the scaffold. The leg is not fastened. It fits snugly between the four side braces and takes any slant necessary to raise the scaffold to the proper height.

DAIRY STALL AND MANGER

Figure 28 shows a cross section through a dairy stall and manger and gutter. The dimensions are marked. Cork brick are sometimes used for the

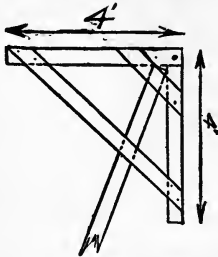

Figure 27.—Building Bracket Made of 2x4 Pieces Put Together at Right Angles with Diagonal Braces. The Supporting Leg Fits Between the Four Diagonal Braces

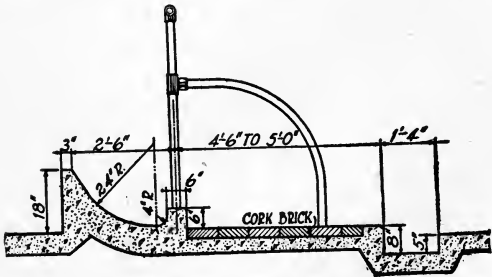

Figure 28.—Detail of Dairy Stable Floor and Stall Construction. In this Cross Section Cork Brick are Shown as a Cushion Intended for Animals Which Remain in the Stable Long Hours.

standing floor for cows because cork is warmer and it is more pliable or springy. Cork brick should be carefully laid in asphaltum to prevent filth from accumulating in the cracks between. This kind of stall floor is somewhat expensive, but for a valuable animal the extra cost may be justified.

A MODERN DAIRY BARN

Figure 29 shows a cross section through a modern dairy barn thirty-six feet wide. The lettering and figures on the drawing give sizes of planks used in the

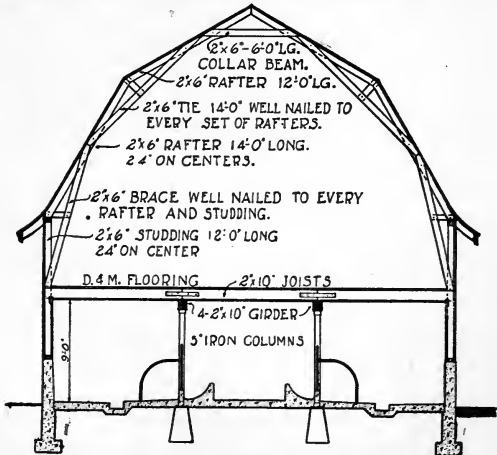

Figure 29.—Cross Section Showing Complete Detail of Concrete Stable Floor Construction with Footings and Center Piers. Also Heavy Girders, Side Walls and Rafter Trusses.

upper works. The stable is made air tight and bacteria proof according to the best dairy practice. This type of gambrel roof is much used.

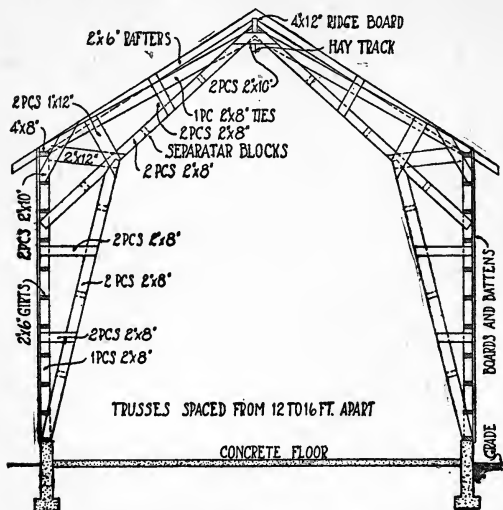

Figure 30.—Section Through a Large Storage Barn Designed for a Farm Where Considerable Alfalfa is Grown. These Trusses are Placed from 12 to 16 Feet Apart, According to the Size of the Barn

CROSS SECTION OF STORAGE BARN SHOWING THE BRACING

Such a barn may be constructed of light material, but it is necessary to place a braced bent about every sixteen feet, as shown in Figure 30. This plan shows

up and down boarding, with or without battons. Battons add to the appearance but sometimes ventilation is of more account. The good appearance of a farm building should never be neglected to save a little expense at time of building. The illustration shows a barn truss thirty-six feet in width and forty feet high to the peak.

CHAPTER VIII

NEW MODELS FOR FARM BARNs

ROUND CURB-ROOF BARN.—ELLIPTICAL OR EGG-SHAPED BARN.—AUDITORIUM BARN.—SHEEP BARN.

ROUND CURB-ROOF BARN

To build a round barn, take a silo and put a barn around it. Formerly silos were square or rectangular; they are all made round today. Some barns are made around some silos. Usually such barns are built with expensive curb-roofs.

ELLIPTICAL OF EGG-SHAPED BARN

A new round barn is to be rounded elliptically, from sill to apex, as well as to be circular; made egg-shape with the small end at the top and the big end smashed down hard on the ground to make it sit up straight, as shown in Figure 31.

The silo is made of two by six studding boarded around with thin boards sprung into place. Two thicknesses of boards are used, breaking joints with building paper between. The hay tipple runs half way around the silo in both directions and dumps the hay where it is wanted. The hay-track takes the same upward curve as the roof and the fork drops the hay on the center of the tipple. This plan saves running a circular hay-track around under the roof. Filling the silo requires a silage carrier instead of a blower pipe.

Round barns may be built cheaper than barns with corners having the same capacity because a circle includes a greater area than any possible combination of straight lines. The saving in building a round, or rounded, barn as compared with a rectangular barn

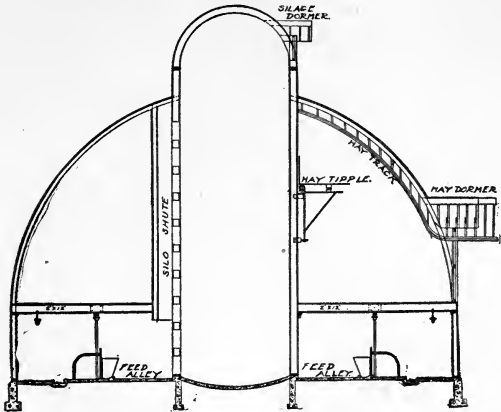

Figure 31.—Round Barn with Silo in Center. The Hay Tipple is Supported by a Track which Runs Nearly Around the Silo So the Tipple May Travel in Either Direction. Hay is Taken in Through the Lower Dormer. The Silo is Filled Through the Upper Dormer Window

of the same cubic foot capacity should be from twenty to thirty-five per cent. The saving in the material alone has been figured at a higher percentage. Something depends upon the size and height in each case.

Forty cows may be stabled in a round barn sixty feet in diameter and leave room for a silo and a circular feed room in the center.

A round barn with a round silo in the center is simply one cylinder inside of another, both supporting each other.

Round or rounded barns are so new that proportions have not been thoroughly tested out, but on general principles, it is thought best not to raise the point of the roof more than two-thirds the diameter of the barn. That is, a sixty-foot barn would be forty feet in height, which is high enough for a good silo. It is not thought desirable to make a round barn more than ninety feet in diameter on the self-supporting curb-roof plan. No builder has yet shown sufficient nerve to build an egg-shaped barn of any capacity.

The term, "self supporting roof," is a misnomer in a way, because the silo makes the best kind of support in the center, although some builders claim that a roof made in this way is plenty stiff enough to withstand the strongest winds without any support other than the round shell of the building itself.

The form of the rounded or elliptical roof takes advantage of the tensile strain of timbers which is a hundred times greater than the bending strain. Resistance to a side strain on a stick of timber is not very great, but it is difficult to imagine a straight pull sufficient to tear apart sound pieces of building timber.

The egg-shape so far as the roof is concerned, offers resistance from every direction. The sill is built up of small segments, or bent strips, to form an immense hoop. All of the different strips of siding and each

continuous roof board are parts of other hoops which hold the barn together.

To appreciate a rounded bulgy construction of this kind, it is only necessary to consider the strength of a barrel that is well hooped.

In regard to the cubic space enclosed, the dairy department of the University of Illinois worked out the economy of building a round barn for a twenty-acre dairy farm showing a saving over a rectangular barn of the same capacity amounting to twenty-two per cent in wall construction and thirty-four per cent in cost of material for the barn.

The Illinois barn, however, is not egg-shaped. It is built with a curb or gambrel in the roof and with rafters terminating at the eaves as in a curb-roofed rectangular barn.

Figures 32 and 33 give many details of construction for an egg-shaped barn. The ideas shown have not all been actually built into a barn or any other building, but they are theoretically correct. The advantages of this style of construction are economy of material and strength to resist strain from either the inside or the outside better than any other that has been invented.

AUDITORIUM BARN

Wagon bows have been used for a hundred years to support the roofs of "prairie schooners." The same mechanical principle applies to the building of town halls and larger auditoriums. And now farmers are using giant wagon bows in the building of large storage barns.

The foundation is made of concrete in the usual

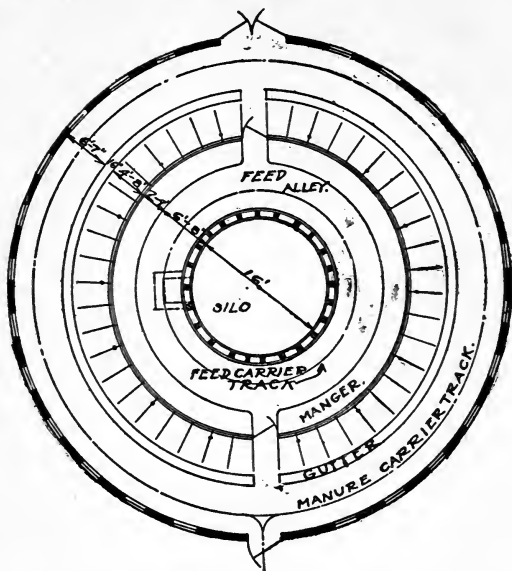

Figure 32.—Floor Plan of Round Barn, Showing Silo in the Center and the Feed-Alley Between the Silo and the Manger. A Manure Carrier Track Encircles the Stalls as Shown.

way with one exception. The outside walls are made thicker to receive the ends of the bows, or, sometimes iron wall sockets are used. Sometimes wooden sills are embedded in soft concrete on top of the walls and the feet of the bows are bolted to the sill.

Whatever method is used the bows should be well anchored at the bottom.

The bows or arches are usually built up out of boards bent to a scribed circle so they are all exactly alike. Sometimes the lower ends or legs of the bows are made straight for several feet to lift the roof higher without making the barn too wide.

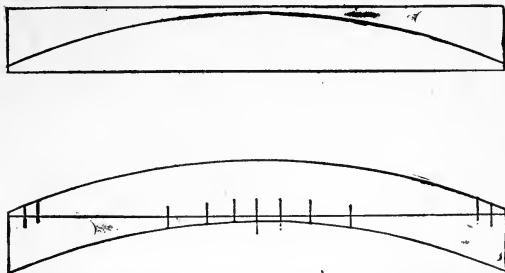

Figure 33.—Diagram Showing How to Cut a Plank on a Band-Saw to Form a Curved Rafter. The Two Pieces of the Plank are Spiked Together as Shown in the Lower Drawing. This Makes a Curved Rafter Without Waste of Material.

The barn is stronger when built without an eave projection, as the boarding may then be put on continuously without a break.

If the concrete wall is built up high enough to allow for a basement, then the gutter is attached to the lower boarding at the top of the wall.

If roll roofing is used the roof boards should be matched with tongue and groove and put on smoothly to give proper support to the roofing. Matched roof boards are worth all they cost just for extra stiffness regardless of the kind of roofing they are covered with.

SHEEP BARNS

Sheep are the worst fresh-air cranks among domestic animals. For this reason a good sheep barn differs from all other farm buildings.

Sheep are covered with warm wool in the winter time sufficient to protect them from severe cold weather so long as the atmosphere remains dry. But when the rains come this same fleece of wool acts like a sponge to absorb and hold moisture.

When the wool is wet it must be dried by evaporation induced by the body heat of the sheep. Evaporation is a cooling process so the sheep is required to eat more heat-forming food, otherwise it must draw upon its stored up fat to dry its wool. In either case there is an economic waste and the vitality of the sheep is impaired.

A sheep barn should provide shelter from rains and protection against cold north and west winds. It should also contain sufficient roughage to feed the flock all winter, which means that the main part of the building should be high and broad, if many sheep are kept, and it should have wings in the shape of feeding sheds open to the south and east.

There may be a silo for the sheep alone, or silage may be brought by overhead carrier from the cattle department. Silage is just as good for sheep as it is for cows or beef cattle. It is the cheapest roughage, and, with the exception of roots, it is the most succulent of winter feeding materials for farm live stock.

Silage in connection with alfalfa or clover hay will bring ewes through to yeaning time in good condition with little or no grain.

An eight-sided sheep barn with shelter sheds and yeanning pens is shown in Figure 34. The posts are set in concrete. The outside posts support the plates and the inside posts support purlin plates. The roof

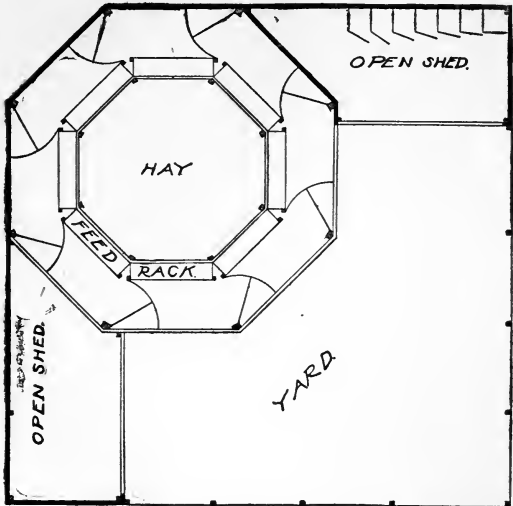

Figure 34.—Sheep Barn with Hay in the Center. There is an Open Yard with Open Sheds Protected from the Cold Winds.

is hipped from each outside post to the apex. A hay dormer is built into the most convenient side of the roof and the hay-track runs the hay-carrier to the center. Hay is dumped on the ground and is stacked

up to the roof. Feed racks are built around the hay. Feed is pitched down from above and is guided into the feed racks by shutes attached to posts, one shute to two feed racks. Gates are hinged to the outside posts for the purpose of dividing the barn into small pens when the lambs are young. Double gates, or doors, are shown under one shed. These doors are hinged to fold back upon each other when not in use. It is a convenient way to have individual pens for one ewe and lamb.

CHAPTER IX

MISCELLANEOUS FARM BUILDINGS

GARAGE AND POWER HOUSE

It is perfectly natural that both power and light should radiate from the farm garage. Farming is rapidly becoming a power proposition. Farmers own more automobiles than city people; farm trucks are becoming popular, and the demand for small farm tractors is greater than the factories can supply.

The coming farm garage will combine storage for these locomotors together with a power plant and machine shop. There will be a dynamo driven at odd times by the engine of the farm tractor. The electricity so developed will be stored in batteries and paid out as needed to drive all the stationary machines on the farm and to light every building. There will be a small electric motor stationed in each building driven by electricity which will be carried by wire from the central power house.

The garage and power house should be a well ventilated fireproof building made of concrete up to the plates. See Figure 35.

Fireproof roofs are rather more expensive than the lower part of the building, so that some figuring on the cost of fireproof roofing materials may be necessary before deciding.

The roof trusses must span the space from one side wall to the other because no posts are wanted in a garage. Either king trusses or queen trusses, or a modification of these principles, will be required to support the roof according to the width of the building and the materials used.

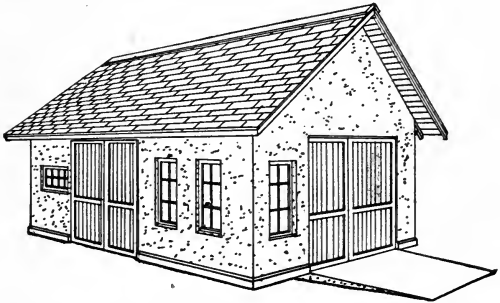

Figure 35.—Concrete Farm Garage, Showing Both Front and Side Doors

The floor is the most important part of a farm power house. It should be solid, level, smooth, waterproof and well drained.

Power on a large farm means tractor, truck, and automobile, together with dynamo and several small motors to drive stationary machines such as cream separator, fanning mill, grindstone, churn, sewing machine, washing machine and other light work. Heavy driving such as pumping, feed grinding, corn shelling, cutting silage, etc., will be done by direct belt or tumbling rod.

The power house on such a farm should be large enough to hold the three mobile machines and a dynamo properly placed to be driven by belt from the tractor. And there should be a forge, drill press and vise bench, and possibly a separate bench for cutting and threading gas pipe.

A building twenty by thirty feet could be used to advantage. There should be two large doors and a

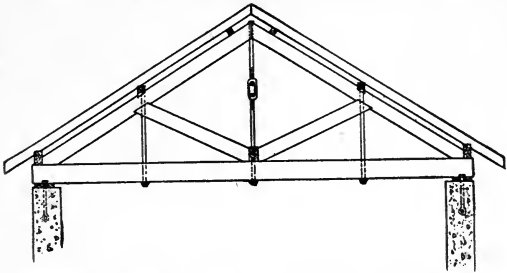

Figure 36.—Design of Roof Truss Intended to Span a Farm Garage

small door, and plenty of windows for light so that repair work may be done in any part of the room.

There is light on all sides of a farm building. Windows are not much more expensive than the same surface of solid wall.

Two forms of roof trusses are shown, either of which will support the roof over a span of twenty feet. Figures 36 and 37. From three to five trusses are needed to properly support the roof. The number of trusses and the size of timbers both are specified after the size of the garage and the width of span is decided

upon. On general principles, six by six is heavy enough for the main timber and the upper timbers may be lighter.

It is intended that the tractor shall have a permanent place near the right-hand wall where it will

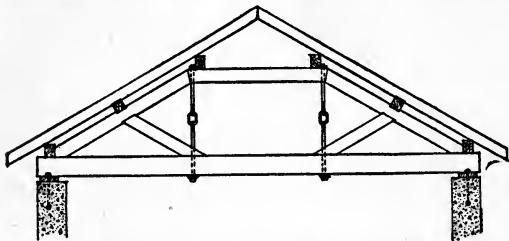

Figure 37.—Another Style of Roof Truss Built Strong Enough to Support the Roof of a Farm Garage Without Center Posts

belt directly to the dynamo. There will be a concrete wheel block to stop the tractor the proper belting distance from the dynamo. The truck belongs at the left where it may remain until wanted.

This arrangement leaves the center of the garage for the automobile which is likely to be brought in at the front door and taken out through the side door several times a day.

The back end of the room is the machine shop, but it is not shut off by a partition. A farm garage differs from the machinery shed because the garage is active while the shed is intended for storage. The garage is all in use and it should be well lighted, ventilated, heated in winter and made comfortable to work in the year round.

A tarpaulin may be dropped from one of the ceiling truss beams at the shop end when the weather is extremely cold, but a permanent partition is too much in the way.

There should be a good wash floor with a slight depression and a good drain trap. Car washing facilities may be provided either inside or outside of the garage.

SMALL FARM GARAGE

A small garage fourteen feet wide and twenty feet deep is shown as a separate building in Figures 38 and 39. Some farmers object to using gasoline, or storing it, near the main buildings. In all cases it is better to

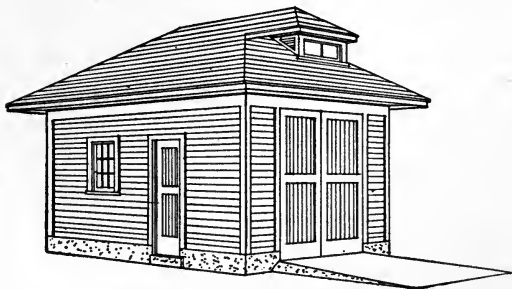

Figure 38.—Farm Garage Built of Wood with Concrete Wall and Floor

keep the supply of gasoline underground for safety first, also to prevent evaporation. This little building has a solid concrete foundation and floor with a drain in the center to carry off the wash water. There are

two small work benches in the corners of the room for light tinker work, but the main repairs are supposed to be done in the farm blacksmith shop. A small dormer in the roof helps with ventilation which is

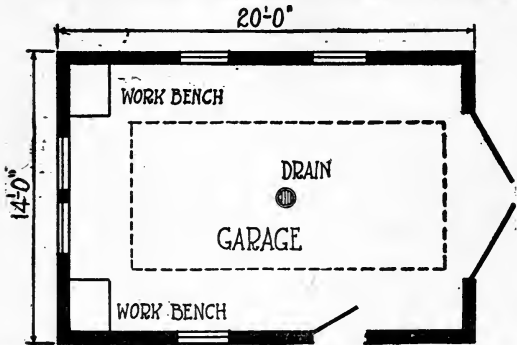

Figure 39.—Floor Plan of Farm Garage 14 Feet in Width by 20 Feet in Length

quite important in winter when the doors and windows are shut. Many deaths have been caused by running an automobile engine in a tightly closed garage. Combustion uses all of the oxygen out of the air and the attendant dies from suffocation.

ADVANTAGES OF THE TWO-STORY CORN CRIB

In combination with the farm granary, the new building makes a safe storage for both corn and small grains. When properly constructed it is easily made rat-proof. Because such a building usually is isolated from other buildings, and, as there is no accumulation

of straw or other inflammable material about, it is considered comparatively safe from fire.

Two-story corn cribs and grain houses utilize space to advantage because one foundation and one roof

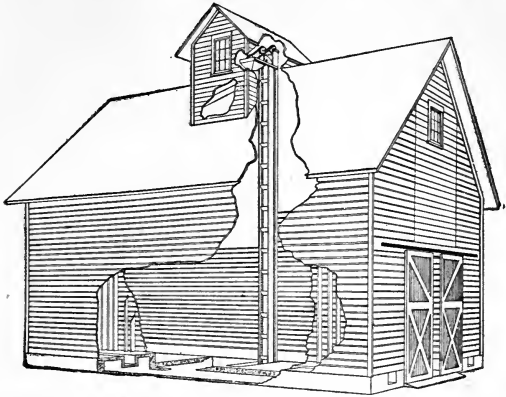

Figure 40.—Perspective View of Two-Story Corn Crib. The Side of the Building is Cut Away to Show the Elevating Machinery

does double duty. The height and size of a grain house is governed only by the requirements of the farm, but the deeper the grain bins the more material is required to make them sufficiently strong. Commercial grain elevators sometimes are carried up a hundred feet, but the construction is expensive. A well built two-story farm corn crib and grain house is an ornament and a valuable asset. See Figures 40 and 41.

Cleaning and Grading Grain.—A two-story corn crib and granary has a central driveway which is closed at both ends by doors and is used in fall and winter to clean and grade grain before selling or seeding. There are down spouts and elevating buckets to do the shoveling and lifting and carrying.

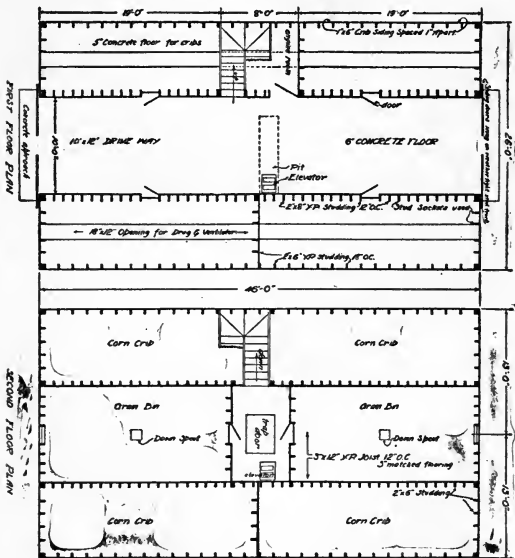

Figure 41.—Floor Plans of Two-Story Corn Crib. The First Floor Shows the Driveway with Corn Cribs at the Sides and the Second Floor Shows the Grain Bins Over the Center Driveway, with Location of the Downspouts, Stairway, etc.

A good fanning mill separates salable or plantable seeds from noxious weed seed and blows out all of the light, shrunken kernels. The great advantage of planting pure seeds is well understood by progressive farmers. The splendid work of Burbank and other scientists has shown that all grains may be improved by planting only the full sized perfect specimens.

A two-story grain house stores all of the small grains on the second floor, where they may be spouted down by gravity to the fanning mill. The fanning mill is run by power from a gasoline or kerosene engine so that a steady motion is maintained at the right speed. Men who turn the crank of a fanning mill hour after hour to clean grain are anxious to see the hopper emptied as quickly as possible. The result is that the work often is hurried and inferior seed is planted, but with a gasoline or kerosene engine doing the work, there is no temptation to hurry the grain through too fast because no one is being over-worked.

The customary price for husking and shoveling ear corn into the crib is four cents per bushel. Where machinery is used to do the shoveling, three cents is considered sufficient to make wages.

Shelling and Storing Corn.—Corn may be shelled and stored in bins overhead the same as other grains. There always is danger of heating, but with elevating machinery it may be handled so easily and transferred from one bin to another that the heating loses its old-time significance.

The corn sheller is placed in the center driveway and the shelled corn is elevated at once into one of the upper bins. The cobs are carried by the sheller

carriers into wagon boxes or hog racks to be hauled over to the wood shed to use for summer fuel and winter kindling when the cook wants a quick hot fire.

By way of precaution the shelled corn is spouted down in a few days' time and is again carried up by the elevator. If there is any danger of heating the trouble is discovered before the corn is damaged. Farmers who have tried to air hot corn by shoveling know exactly how to appreciate the luxury of doing it by engine power.

Grinding Feed.—With different kinds of grains stored in the bins overhead it is easy to bring a mixture to the feed grinder. It comes through the different spouts in small steady streams to feed the grinder to its full capacity without choking. Corn and cob may be brought from the cribs and dumped with other grains to be mixed and ground and carried up to the feed bin to be fed out as needed.

Such mixtures are sometimes necessary when careless help is employed. They can be trusted to use so many measures of certain mixtures, but could not be relied upon to make the mixtures themselves.

Foundation and Floor of a Two-Story Granary.—The foundation walls should be either stone or concrete. Because of the weight of the grain bins, it is necessary to have four walls running lengthwise of the building. The outside or corn crib walls are lighter than the grain part of the building, but they go deeper into the ground to ensure against heaving by frost in winter. The inside walls are somewhat protected.

The two center foundation walls should be twelve inches in thickness and have substantial footings to sus-

tain the weight of the grain bins. No definite rule can be given for the depth of such walls. Frost penetrates deeper in some soils and localities than others where the winter temperature may be about the same. Local custom usually establishes the depth of excavation for foundation walls.

There should be light concrete floors in the corn cribs and a heavy concrete floor in the driveway through the center of the building to stand the wear of horses and the weight of heavy loads of grain. The floors should be made in blocks, like sidewalks, to permit of expansion and contraction from heat and cold.

There should be a pit near the center of the floor in the driveway for the elevator boot. The dimensions of this pit will conform to the size and shape of the particular kind of elevator to be used. The manufacturer of the elevator will give the necessary figures.

The Superstructure.—The central part of a two-story grain house is built solid and strong. Usually two by twelve studding, twenty-four feet long, are spaced twelve inches apart on centers, each side of the driveway. This studding supports the grain bins and the roof purlines.

The joists which carry the grain bins are two by twelve inch selected planks placed twelve inches on centers. They are spiked and bolted to the studding and are supported by two by ten girders gained into the uprights. The joists are further supported by plank posts in the nature of pilaster reinforcements to the studding. Both the joists and studding are thoroughly well bridged.

Grain bins are made strong for the following rea-

sons: on account of the weight of grains, as a cubic foot of wheat or rye weighs forty-nine pounds; corn, forty-four pounds; oats, twenty-eight, and peas, fifty pounds.

The grain bins are ten feet wide and fourteen feet deep. When filled with wheat the weight on the floor of the bin would be 686 pounds per square foot of floor surface.

As wheat in a bin is liquid in character the pressure on the sides of the bin is practically the same as the dead weight at the same depth.

The floor of the grain bins may be of heavy matched narrow flooring carefully blind nailed to the joists, or, a rough floor may be laid diagonally and strongly nailed to the joists and a lighter floor of seven-eighths inch narrow matched flooring laid over it. The tongue and grooved flooring should be laid at right angles to the joists and thoroughly blind-nailed at each cross-section with extra long finishing nails.

After the floor is laid the sides of the grain bins and the partitions between are built up. As the heavy studding reaches to the roof the sides of the bins may be of matched stuff nailed to the studding. But provision must be made for the cross partitions between the bins.

Cleats will not hold cross partitions in grain bins fourteen feet deep, the pressure is too great. But the ends of some of the planks may pass through the sides. These planks are bolted to the heavy studding which acts as cross ties to hold the sides from spreading.

In some of these two-story grain houses the bins are built up in grain warehouse fashion. They are sup-

ported in the same way over the center driveway, but are practically separate from the timbers of the building.

The best way to make the sides of the grain bins, and the partitions between, is to use two by fours laid flatways with locked corners. Each two by four is well spiked before the next one is laid. At each corner every alternate two by four laps past and is spiked into the abutting partition with slim wire nails four and one-half inches long. This makes dovetailed corners, which is the strongest practical way of joining two wooden partitions at right angles.

It may not be necessary to carry this extra strong construction clear up to the tops of the bins because the outward pressure is much less towards the top. Two by fours turned on edge make strong partitions when the corners are locked. Boards seven-eighths inch thick may be used near the top, if they are well fastened in place, but a farmer feels much more comfortable when the bins are made solid beyond the possibility of collapse.

Ventilation.—Eight feet in diameter is about the limit for ear corn in the crib. The atmosphere is much dryer some seasons than others, but we should provide against the soft corn years.

Allowing eight feet for each corn crib and ten feet for the center driveway, we have a building twenty-six feet in width. When the end doors are left open there is circulation of air on both sides of each crib.

Ventilation is improved by using corn wire inside of the studding to keep the ears from lying lengthwise in the openings between the wooden slats. The wooden

slats protect the corn from driving storms, and they help out in looks, but the corn keeps better when the cribs are lined with wire.

The cupola also is a ventilator which is continually letting out damp air as it follows up the slant of the roof from the corn cribs.

The Roof.—A steep pitch gable end roof is best for a two-story grain house and corn crib. The rafters and cross ties which reach across the building from one plate to the other form triangles. Rafters put up in this way brace each other and brace every part of the building.

The steep pitch is necessary to get sufficient elevation for the grain hopper so the shutes will carry to the farthest bins.

Each rafter makes one side of two triangles, which reach from the peak to the plates and are tied back to the long studding which supports the grain bins. These uprights are tied together by the heavy floor joists of the grain bins, and the cross ties in the bins, so that the upper part of the building is a continuation of trusses, reaching from one plate to the other by way of the peak.

FARM IMPLEMENT SHED

Diversified farming of the modern type calls for a great many special farm implements and machines to save hand labor. The growing of five acres of potatoes, for instance, requires a potato cutter, planter, sprayer, digger and sorter. Plows, harrows, cultivators, etc., also are necessary, but they are not classed as special crop tools.

A complete list of implements, tools and machinery

used on farms has never been compiled, but any well-managed farm has enough to pay for a special building to protect them from the weather when not in use. Upkeep, depreciation and overhead charges are new

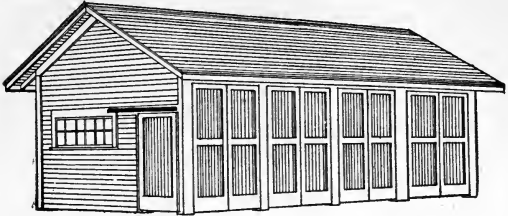

Figure 42.—Perspective View of Farm Implement Shed and Workshop

terms in farm bookkeeping, but they are here to be juggled with.

The implement shed shown in Figure 42 is forty-eight feet wide by sixteen feet in depth. It is built in twelve-foot sections or bents with a foundation wall across each end and along the back. The front is mostly double doors hinged to the posts in such a way as to shut together in pairs so they open the full width.

The building is twelve feet high to the plates to give plenty of head room for the highest farm implement. Door openings are all about fifteen feet in width in the clear, which is sufficient to enter a spring tooth horse rake or a binder in field condition.

One section may be extended back if necessary to hold one of the new jumbo truck wagons, but this implement shed is intended for moderate ambitions in regard to power farming.

Such a building is not easily braced in front so it is better to set the front posts in concrete. It is easily done by digging holes about two feet square and three feet deep.

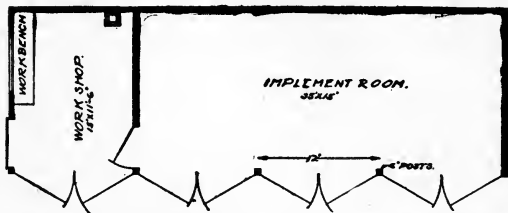

Figure 43.—Floor Plan of Farm Implement Shed, Showing the Workshop in One End of the Building, Handy to the Implement Storage Room.

The foot of the post is set on a small stone in the bottom of the hole, to keep it off the ground. It is carefully lined and plumbed and stay lathed, then filled around with a thin mixture of concrete up to the surface of the ground. If the shed is to be floored with concrete, these front posts are set in a wall trench instead of post holes.

The floor plan, Figure 43, shows a work shop in one end which should be supplied with a blacksmith kit and a good many carpenter tools. A wide window is shown in the end of the building which is intended to light the iron work bench.

No one has yet found a place for the wood-working bench. The shavings are sadly in the way in the blacksmith shop and there is no other place where the farm carpenter is welcome.

SMALL SEPARATE DAIRY HOUSE

A dairy house separate from the stable is shown in Figures 44, 45 and 46. It is only twelve by fourteen feet in size, but it is big enough to handle the milk of a large dairy when the cream is sold and the milk is fed warm to calves and small pigs as it should be.

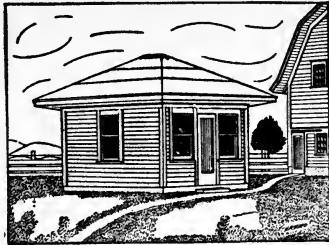

Figure 44.—Separate Farm Dairy House

One of the principal reasons for having a dairy house is to provide facilities for disposing of the skim milk at a profit.

When fresh milk, warm from the cows, is passed through the separator and the skim milk fed quickly to pure bred young stock in clean metallic pails or troughs that have been properly sterilized, it often brings more money than the cream.

Separator milk fed cold in bacteria-lined troughs to scrub animals is quite another proposition.

The construction of this little house commences with a good concrete foundation wall and floor. The wall reaches down below frost and the floor is carefully

surfaced with rich cement mortar troweled on to make it waterproof and smooth for easy cleaning.

A two by four sill is set in soft concrete mortar on top of the foundation wall and two by four studding are toe nailed into the sill in the usual way.

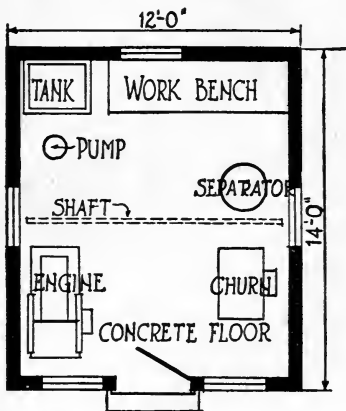

Figure 45.—Floor Plan of Separate Farm Dairy House, Showing How the Engine, Pump, Churn and Separator are Placed

Outside is a covering of building paper and drop siding finished at the plate and eaves with a box cornice having a level plancier.

A hip roof built of matched sheathing and roll roofing with the proper eave gutters together with the box cornice gives the little dairy house a neat, attractive appearance when it is nicely painted. Always

a couple of coats of good paint are necessary to dress a frame or wooden building ready for inspection.

Inside, this little dairy house is a model of perfection.

The wall and ceiling are made smooth with matched, tongued and grooved ceiling over building paper.

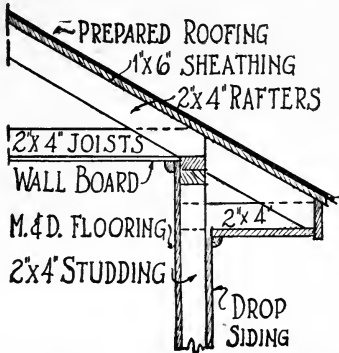

Figure 46.—Detail Showing Cornice Construction of the Small Dairy House

There is no beading and the joints are carefully filled with putty and painted with three coats of white lead and oil with a dash of Prussian blue to make it look white. An inside finish made in this way may be washed to keep it in sanitary condition.

The only insulation is the hollow wall with building paper outside and inside and a filling of mineral wool over the ceiling between the ceiling joists.

There is a cement-lined concrete water tank to cool

the cream cans. This tank is fitted with a hollow overflow plug that drains away the running water as fast as it reaches the proper level.

All machinery and other stationary appurtenances are indicated on the floor plan.

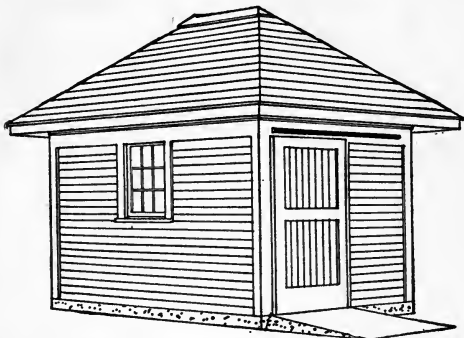

Figure 47.—Perspective View of Another Small Dairy and Pump House, 10 Feet by 14 Feet in Size

All milk utensils are washed with cold water at the sink, which has a properly trapped waste pipe that is connected with the drain.

There is no provision inside the dairy house for scalding the cans or other utensils because the one room dairy cannot be kept warm and cold at the same time.

A rack is provided outside against the south side of the dairy house to drain the cans and expose them to the sun. Under and in front of this rack is a concrete

floor where the tins are scalded with boiling water brought by the farm cart,

Milk tins should always be washed first with cold water or water that has been slightly warmed, as hot water will cook the drainage milk and stick it fast to

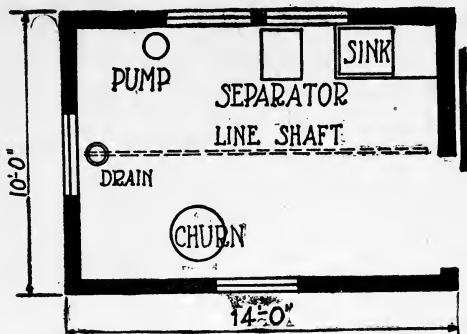

Figure 48.—Floor Plan of Pump House, Showing the Placing of the Churn, Pump, Separator, Lineshaft, Drain, etc.

the tins, thus sealing over the bacteria, to be soaked loose with the next warm filling of milk.

PUMP HOUSE

A small farm pump house and dairy house ten by fourteen feet, is shown in Figures 47 and 48. It has a concrete floor with an open drain running through the center of the floor leading out at the back end of the building. A power line shaft runs lengthwise of the building supported by hangers from the ceiling. Belts from the drive pulleys on the line shaft run the pump,

separator and churn. The most important machinery is arranged in front of the windows; also the sink is placed in a very light corner. The building itself is of wood on a concrete foundation. It is covered with a hip roof over an insulated ceiling to keep the dairy

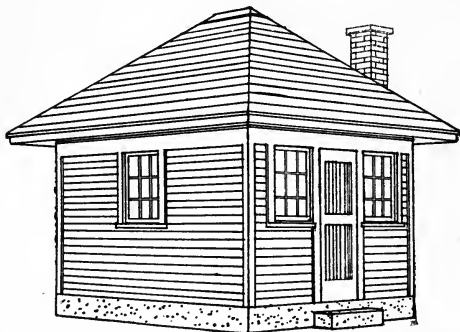

Figure 49.—Perspective View of Small Dairy House for Making Butter

house cool. An important feature of the building is a wide sliding entrance door with a sloping concrete approach which is intended for the easy entrance of a farm cart containing the milk cans. The farm cart also takes the skim milk from the separator immediately out for feeding warm to young pigs, calves, etc.

BUTTER DAIRY

A dairy house on a farm where butter is made is shown in Figures 49 and 50. It is twelve by fourteen feet in size. The utensils are: *A*, Ice Box. *B*, Butter

Worker. *C*, Stove. *D*, Sink. *E*, Can Rack. *F*, Cream Separator. *G*, Cooler. *H*, Cream Vat. *I*, Churn.

CONCRETE DAIRY HOUSE WITH WATER-TANK OVERHEAD

This milk house is built of solid concrete with walls twelve inches thick. The building is eight feet wide

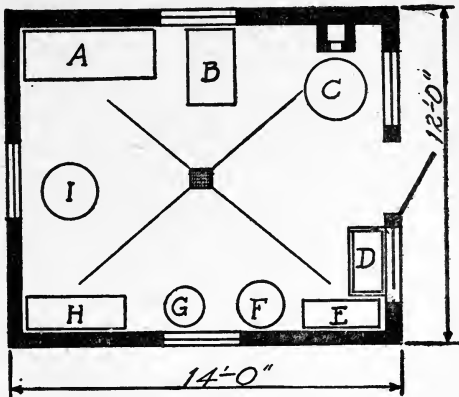

Figure 50.—Floor Plan of Butter Dairy

by twelve feet in depth, outside dimensions, and it is twelve feet high. There is a reinforced concrete tank floor seven feet up, leaving about four feet above the floor for the water tank. See Figures 51 and 52. The floor of the water tank and the roof of the building, which also is the roof of the tank, are built of reinforced concrete. All inside surfaces are finished smooth and waterproofed. The water tank is made

water tight by cement mortar made rich and put on with a trowel. The milk room floor also is concrete with water proof surface made in the same way, but the sides and ceiling of the milk room are painted with cement water proofing paint. The idea of building

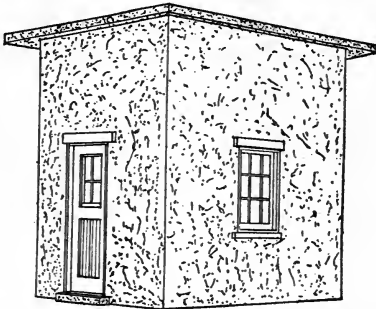

Figure 51.—Perspective View of a Reinforced Concrete Dairy House with Water Tank in the Top

the dairy house in this way is to keep it as cool as possible without the use of ice, also to supply tap water under pressure. A gasoline engine furnishes power to fill the tank and to run the separator. It makes a solid, satisfactory milk house for a small dairy when cream is sold and milk is fed on the farm to young stock.

STABLE MILK RECORD SHEET

The illustration, Figure 53, shows a frame with two panes of glass fitted into grooves. The frame is made slate-frame fashion except that there are two grooves

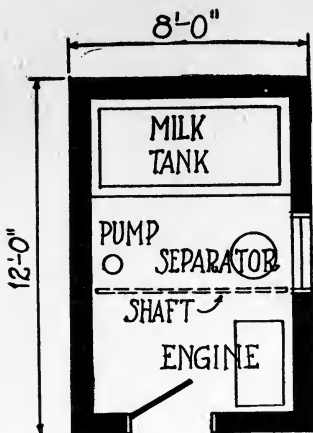

Figure 52.—Floor Plan of Concrete Dairy Tank House, 8 Feet by 12 Feet

instead of one. The record card slides in between the two lights of glass so that it may be read without being removed. The frame may be hung with chains or wires suspended from the ceiling.



Figure 53.—Frame for Holding Record Sheets in a Dairy Stable

CALF FEEDER

The drawing, Figure 54, shows a simple contrivance to hold calves steady while getting their milk rations. Every dairyman recognizes the importance of preventing calves from reaching each others' ears after giving

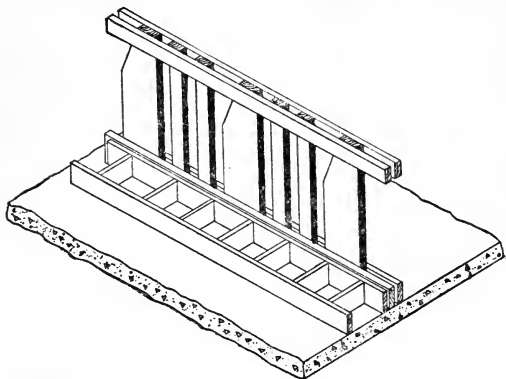

Figure 54.—Stanchions for Holding Calves at Feeding Time

them their supply of milk. If they are confined in stanchions far enough apart, until their mouths become dry or they lose the taste of milk, they will eat clover heads and meal instead of sucking each others' ears. In front of the stanchions is a wooden rack divided into squares like a ladder. These squares are just the right size to hold the pail from upsetting and they are spaced so the openings come opposite the calves.

Calves should be fed in sterilized pails. It is impos-

sible to clean a trough properly, and it soon becomes foul and dangerous. A growing calf is an energetic little animal, and he will upset a pail unless it is firmly held. The rack is independent of the floor so it may be removed and the floor scrubbed. The rack itself is a convenience for holding dry feed so the calves can get it without pushing it too far away. The stanchions are two feet apart and the openings in the ladder rack, which come opposite the stanchions, are from twelve to fifteen inches in diameter, according to the size of pails used for feeding. The openings between may be of any size to bring the feeding pails in front of the stanchions, as these between openings are intended for spaces to keep the feeding pails far enough apart.

FARM ICE HOUSE

The ice house shown in Figure 55 is fourteen feet square on the ground and sixteen feet high to the plates. The foundation is of concrete made into one solid wall extending all the way around. Above the wall the house is built of wood, using studding, matched boards and drop siding. Next to the studding, both outside and inside, is one thickness of building paper, then matched ceiling boards are blind nailed on the inside and drop siding is used for the outside boarding, leaving a four-inch dead air space between. It is a mistake to pack this space with sawdust, because the sawdust holds dampness and rots down at the bottom and settles in spots.

To preserve stored ice from melting, the first attention should be given to drainage. It is absolutely necessary that the water should get away from the

bottom. If ice rests in water it melts away rapidly. It is a good plan to first tile drain the ground.

The space between the concrete foundation walls under the ice is filled with cinders pounded down.

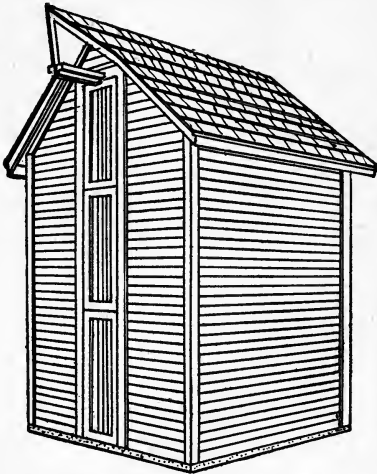

Figure 55.—Farm Ice House with Continuous Doors Reaching from Bottom to Top

Above the cinders is a slanting floor of concrete, then a layer of sawdust a foot deep. This makes the very best foundation for ice in a farm ice house. There are other methods of keeping ice in large commercial storage plants, but what interests farmers is a cheap, practical way of preserving ice for home use.

There also is a drainage system inside of the ice house consisting of grooves in the slanting concrete floor under the ice. These grooves or gutters empty into a cross gutter or drain which leads the drip water into the tile drain.

The ice house doors reach from the sill almost to the peak, making one continuous opening, so that the ice can be put in or taken out at any level as the house is being filled or emptied.

A handy way to lift the cakes of ice is with a hay fork toggle and a pair of heavy ice tongs. A single rope is attached to the tongs and passed over the hoisting pulley in the track carriage at the top and run through a single shieve at the bottom, so that a horse can quickly lift a cake of ice to any height necessary.

The cakes of ice are built into a solid mass in the center of the house usually by breaking joints the same as in brick work, leaving a space of twelve inches all around the outside. It is much better to do the filling and packing in the coldest weather, and to sprinkle the ice with a hose or throw pails of water over each layer to freeze the cakes of ice together into a solid body as near as possible. Sawdust enough is needed to pack all around the ice and for a layer eighteen inches or two feet deep over the top.

Where sawdust cannot be obtained, clean straw or hay that has been run through the cutting box will answer the purpose, and if carefully handled will keep the ice in a very satisfactory manner. However, sawdust is much to be preferred, and when figuring the cost it is well to remember that the same sawdust may be used for several years by taking good care of it to

keep it clean and to dry it out in summer. Sawdust from pitch pine logs is the best.

The principle of keeping ice on a farm is a little different from the commercial proposition where ice is stored in winter to sell out in summer. The farmer usually fills his own ice house. He does the work in the winter time when help and horses would otherwise be practically idle. A little extra ice under the circumstances costs the farmer nothing, so that he does not figure it as a real loss if the meltage is considerable. On the other hand, if it keeps extra well and he has a surplus, there is always sale for it in August and September.

It is better to clear the sawdust out, before the cold nights of November, to give the ice house a chance to dry out before being refilled. When considerable ice is left over, it is a temptation to put new ice on top of the old, but this is a mistake. The ice house should be cleaned out clear down to the bottom every year. This gives an opportunity to examine the drainage and to start right with the next filling. The management of an ice house is simple, but there are a few little things to remember. When you fill an ice house you want to do it in such a way that most of the ice will stay in the house until you are ready to take it out.

Figure 56 shows a concrete ice house which is built to last. It is sixteen by twenty-four feet in size on the ground and twenty feet high. A solid building like this is a great asset to the farm.

MANURE SHED

The name "manure pit" suggests a foul-smelling hole requiring a great deal of disagreeable hand labor

in filling and emptying the pit. But some provision must be made for storing stable manure when the weather is too stormy to haul it to the field. Also the liquids must be saved and applied to the land in a decent, self-respecting manner.

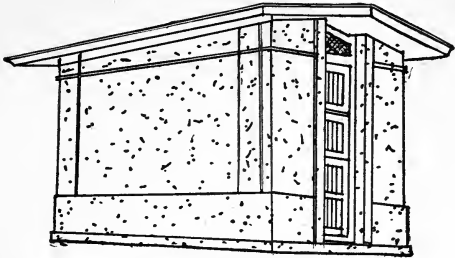

Figure 56.—Concrete Farm Ice House with Flat Roof Made of Asphalt

A manure shed properly constructed is a unit in the general system of handling stable manure. It also provides convenient storage and protection for the manure spreader.

Machinery is necessary for the economic handling of manure. Manure contains more value when it is fresh. The dairy stable and horse stable manure should be carefully spread each day at stable cleaning time. To prevent leaching in winter there should be a rooted crop such as rye, wheat or winter oats on the ground to catch and hold the liquids and fine particles from disappearing in the wash caused by melting snow and winter rains.

The manure from a well fed dairy cow is worth

about twenty-five dollars per year. To save and utilize this valuable by-product it is necessary to have a system and sufficient discipline to carry the system into effect.

Manure is at its best when taken fresh from the stable and spread immediately and evenly by machinery upon the land. The beneficial bacteria in fresh manure are lively and vigorous and ready to prepare plant food for the growing crop.

The reason why hand spreading does not produce the same results is because it is not even. Too many bacteria are planted in one spot, while other patches of ground are left without any. Hand spreading is too expensive. Horsepower is cheaper as well as better.

The best practice is to prepare land in the fall and seed it to rye. Rye is equal to wheat as food for man or beast. Rye is the coolest growing crop we have. It will grow late in fall and start again early in spring. In many localities there are days during the winter when rye will make some growth.

Rye holds snow and rain water until it soaks into the ground instead of running in streams down the inclines to carry fertility into the low places. Water stored in the soil in winter is worth a rain in summer. It is better because such moisture contains plant food in solution.

Fall plowing destroys different kinds of destructive insects such as chinch bugs, grasshoppers, white grubs, corn root worms, timothy bill bugs and many other pests that hibernate in the ground or under trash and emerge in the spring to work mischief.

Fall plowing helps to hold moisture, adds humus

and bacteria and it works the soil into better physical condition.

Rye, under this system, is not grown for crop but to turn under in the spring together with the manure collected during the winter. If rye is sown early it will make some winter and a good deal of spring pasture. It puts the ground in splendid condition to work into a good early seed bed for spring crop.

This system provides conditions under which stable manure may be profitably disposed of as fast as it accumulates. There is no serious objection to sinking the spreader wheels deep in the soft ground when the rye is to be plowed in the spring. Four horses may be necessary, but farm horses are not overworked in winter.

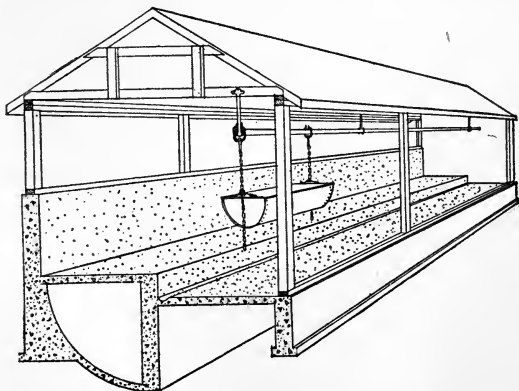

Figure 57.—Manure Shed with Pit for Liquid Manure

One great advantage is the possibility of keeping the stables and yards clean so there are no breeding places for house flies and other harmful disease-breeding insects. Stable cleanliness also deprives harmful bacteria of their propagating places.

A manure shed and shelter for the spreader is shown in Figure 57. The building is sixteen feet wide and twenty-four feet long, made of concrete and covered with a light framework of wood with a corrugated iron roof. The driveway on the right hand side is eight feet wide and has a solid concrete floor with a drain gutter as shown. This gutter is an extension of the stable gutter drain which conducts the liquid manure into the manure sink. The platform to the left is for dumping solid stable manure on stormy days. There is a switch track which runs the carrier over this manure platform after the spreader is

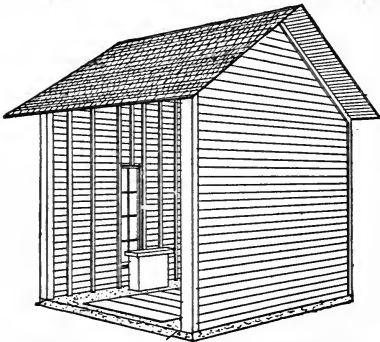

Figure 58.—Farm Scale House with Concrete Foundation and Scale Pit

loaded. A pump and short hose is used to lift the liquid manure and pour it over the loads of solid manure so the spreader disposes of both. The stable and manure shed are both washed down with the hose and this wash water drains into the liquid manure sink. The spreader is driven in at one end and out at the other to save turning or backing.

SCALE HOUSE

The scale house protects the farm scale from the weather. See Figure 58. It is fourteen feet wide and sixteen feet long, with an overhanging roof to keep out the rain and snow. The little house is open both front and back to drive through. The four corner

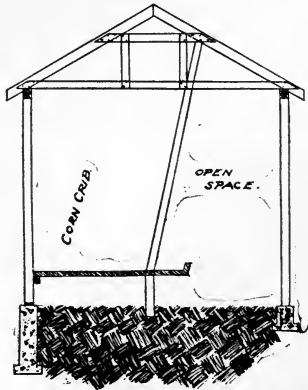

Figure 59.—Section Through Winter Feeding Shed for Cattle. There is a Feeder Corn Crib with Trough at the Side, 2 Feet Above the Ground Level

posts are set in concrete because there is no other way of bracing them.

CORN CRIB WITH OPEN FEEDER TROUGH

Figure 59 shows a corn crib with open feeder trough at the side. The roof is extended to make a stock shed. The bottom corn slat is left off so the corn may be worked out with a handspike or crow bar.

THE COST OF FARM FENCING

One dollar per rod is the easiest unit to use in figuring the cost of farm fencing. If the job is well done the fence will be worth a dollar a rod.

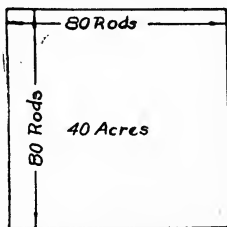

Figure 60.—Showing the Amount of Fencing Required to Enclose Forty Acres

It takes 320 rods of fencing to enclose forty acres in one square field. At one dollar per rod the fence would cost eight dollars per acre.

To fence two forties together into two forty-acre square fields would require 560 rods. This means seven dollars, or one dollar less per acre, because the one cross fence answers for both fields.

When three forties are fenced together, 800 rods of fencing is required, or a little more than six and one-half rods per acre, or six and one-half dollars per acre.

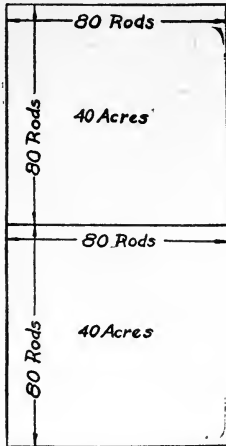

Figure 61.—Diagram Showing Fencing Required to Fence
80 Acres

When four forties or 160 acres are fenced into forty-acre square fields, 960 rods of fence will do the job, which is only six rods per acre, or six dollars per acre, according to the dollar a rod price. On 160 acres the division fences effect a saving of two dollars per acre as compared with fencing one forty-acre field alone. These figures mean that a farmer owning 160 acres must have \$960 worth of fence for the large fields and

that the smaller fields and yards are extra, which may be estimated at \$1,200, including paddocks, yard entrance gates, etc. Figuring upkeep and depreciation at twelve per cent per year, we have an annual fencing cost of \$144, or about one dollar per acre for the tillable land.

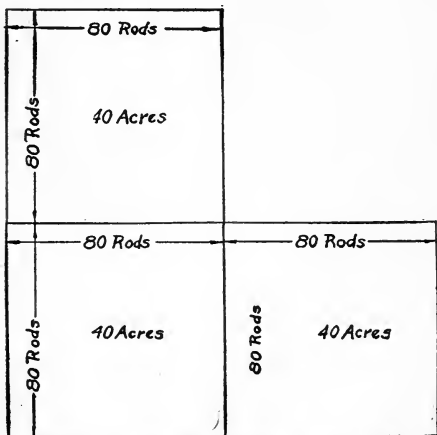

Figure 62.—Fencing Necessary for 120 Acres

FIELD GATE FOR OCCASIONAL USE

It is not necessary to have hinge gates in all fields. The kind shown in Figures 64 and 65 is useful and convenient and not expensive. The saving is not so much in the gate as in the supporting posts. Ordinary

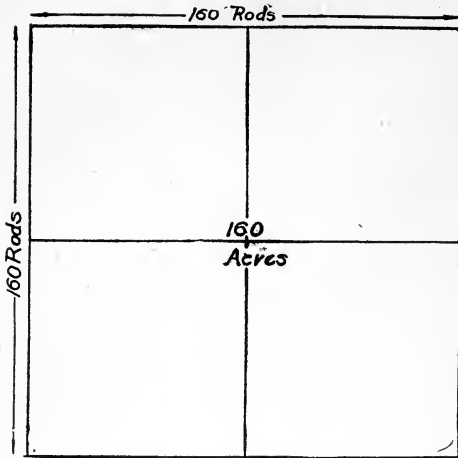

Figure 63.—Amount of Fencing Required to Fence 160 Acres in 4 Fields of 40 Acres Each

fence posts are heavy enough, but they should be well set in the ground and the three posts at each end of the gate should be connected by fence wire and by



Figure 64.—Farm Gate Intended for Grain Fields and Pasture Fields at a Distance from the Farm Buildings

wooden cross pieces bolted through. Nails will not hold the weight of the gate and the racking caused

by sliding the gate open and shut. Farm gates should be a little higher than the fence because breachy animals try the gate first.



Figure 65.—Plan Showing Fence, Fence Posts and Field Gate. The Posts Should Be So Placed as to Permit the Gate to Open At Right Angles to the Fence

STOCK HURDLE

The stock hurdle, shown in Figure 66, is used for driving or separating hogs or sheep. It is made light and strong by using thin boards of tough hard wood,

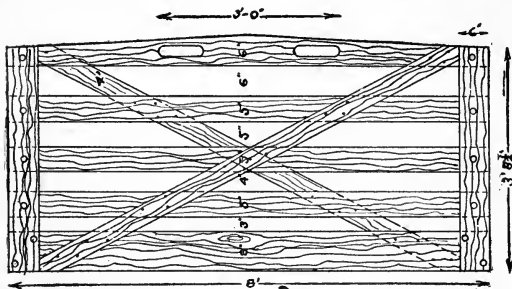

Figure 66.—Stock Hurdle Used for Separating Sheep or Hogs

bolted through at the crossings of the end pieces and also at the crossings of the cater-cornered braces. One-quarter inch carriage bolts are used.

HARROW SLED

This sled is used for moving harrows from the implement shed to the field or from one field to another. A large harrow may be eighteen feet wide and only six or eight feet long, which makes it awk-

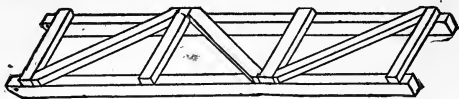

Figure 67.—Harrow Sled Long Enough to Hold a Four-Section Harrow

ward to drag through gates and farm lanes. Lanes should be grassy and the grass should be protected. A sled like this is useful at such times.

CHAPTER X

HOG HOUSES FOR WINTER AND SUMMER

WINTER HOG HOUSE

A hog house that is designed especially for breeding stock in the winter, is shown in Figure 68. There are two sets of windows so placed that the sun shines on the hog nests in the middle of the day during the farrowing season in late winter. This special plan is for latitude 42 or thereabouts. Modifications have been worked out for locations farther north. The solid concrete floor has a waterproof upper surface made of rich cement mortar laid on with a trowel and pressed water tight. The house is divided into pens six by nine feet in size. Each pen is provided with a movable wooden nest floor to keep the hogs up from the cold concrete. The alleyway through the center is arranged for convenient feeding and there are doorways and gates to facilitate the driving of hogs in any direction. See Figure 69.

“This is our fourth year in the pure bred hog business,” said a farmer after he had built such a house. “We have not yet established a reputation for high-priced breeding stock, but we are enjoying the confidence of our neighbors and have made a few good sales.

“The fact came home to us the first winter that

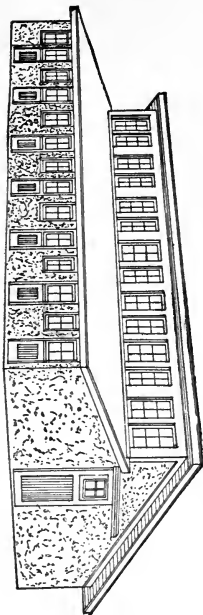

Figure 68.—Winter Hog House Built of Concrete

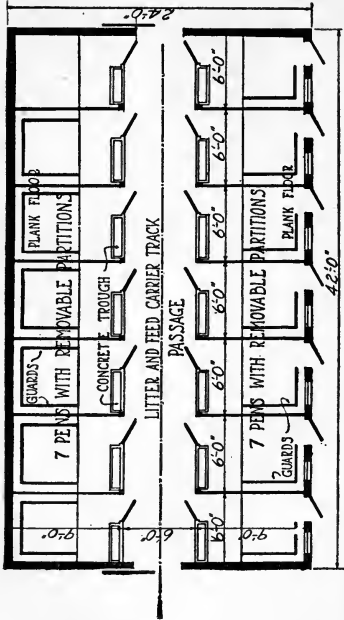

Figure 69.—Floor Plan of Winter Hog House, Showing the Arrangement of Pens and Gates

pure bred hogs require pure bred care in feeding and housing. Scrubs may rustle around the barnyard because they don't know any better, but quick maturing hogs that have been educated for generations to make satisfactory gains in winter demand all of the comforts of a good home.

“Two years ago we built this winter hog house especially for the breeding stock. It is twenty-four by forty-two feet in size and contains fourteen pens arranged on both sides of a center alley. Each pen is six by nine feet, a size we have found to be just large enough to hold one sow and her litter of small pigs and leave the little fellows some room to root among the sods that we supply for their entertainment and exercise.

“The building has a concrete foundation and floor. See Figure 70. The outside wall was footed deep enough to reach below frost and it extends up in the rear to the plate, which is about six feet above the floor. In front or on the sunny side of the building, the wall is low enough to place the windows down near the nests. The plan was made to let the sun shine through the windows into the hog nests for the longest possible period each day during the months of March and April, the time when most of the spring pigs are farrowed.

“Ventilation is provided for by a system of levers which operate the upper windows and hold them in any desired position. It often happens that the days are warm enough towards spring to have most of these windows open. When the house is well occupied, considerable ventilation is needed even in cold weather.

“Towards the north the house is made solid and

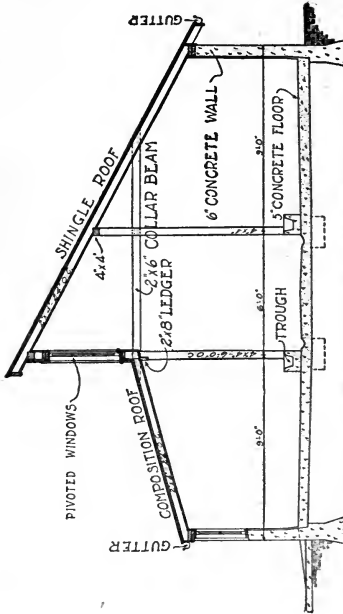

Figure 70.—Section Through Winter Hog House Designed for Latitude 42°

wind proof. There are no doors or openings of any kind to create a draft from this direction. There are plenty of inside doors and outside doors opening to the south, so that the pigs may be transferred from one pen to another or separated or turned out of doors as required.

“The floor is solid concrete surface finished with well made cement mortar to make it waterproof. The feeding troughs are made of high grade cement mortar cast in molds so the troughs are separate from the floor, but are so heavy that they are not easily upset or moved. Each pen is provided with a wooden nesting floor to keep the pigs up from the cold cement. These nesting floors are made as light as possible to be easily moved about when the pens are being cleaned. During mild weather the pens are cleaned frequently with the hose and we are very particular to see that each pen is liberally supplied with fresh bedding every day. We have valuable hogs and we find that it pays well to take first class care of them.”

PORTABLE HOG HOUSE

Hogs on pasture need a house for protection against the hot sun in the middle of the day in summer. They also need a shelter against cold rain storms and early snow storms in the fall. Again in the spring, when the wheat or rye fields need pasturing, a nearby shelter comes in handy.

Figure 71 shows a portable hog house that is easily and quickly made of light materials. It should be well braced inside to prevent racking while being moved.

Some farmers build these houses with floors and

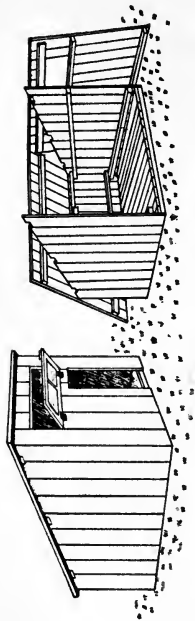

Figure 71.—Portable Hog House Made So It May be Taken Apart and Stored Away When Not Required for Use

others bed them with straw. In either case they should be banked around with earth to prevent the wind from blowing under. Ventilation is provided by leaving the door open, also by means of the small ventilator door in the front side of the house near the roof. Ground that is high and dry is always selected, either in the pasture or nearby, preferably in the farm lane near the pasture fields.

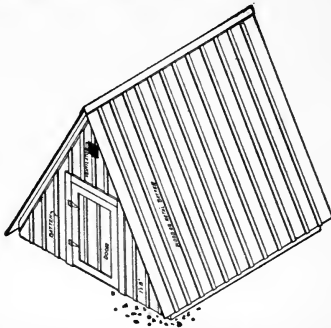

Figure 72.—A-Shaped Portable Hog House for Use in the Fields or Distant Feed Lots

These portable hog houses should be about eight by twelve feet in size with a low partition or two across the middle to prevent the hogs from piling up to keep warm when the nights are cold.

A two by eight reaching across from one sill to the other makes a good protection for the smaller shoats. The top edge of the plank should be about a foot above the ground.

A-SHAPED HOG COT

At the price, there is nothing better than the A-shaped hog cots. They are handy for sows at farrowing time and they help out at other times. See Figures 72, 73 and 74.

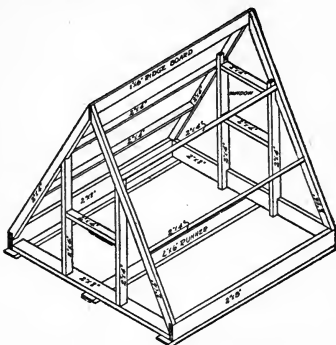

Figure 73.—Showing How the A-Shaped Portable Hog House Is Framed

The commonest size of A-shaped hog cots is eight by eight feet for both bottom and sides. That is, the bottom is eight feet square and each side is eight feet square. Sixteen-foot boards are used in making them. The boards are cut across in the middle so that there is no waste.

The mud sills usually are rounded up at one end sleigh runner fashion for easy moving. This is desirable because the ground in front of a hog cot soon gets muddy.

Bill of Lumber for the A-Shaped Hog Cot.—Thir-

teen pieces, one inch by eight inches, sixteen feet long. Twelve wooden battens sixteen feet long; or twenty-four metal battens eight feet long for roof.

Ten boards one by eight, fourteen feet long, for ends. Also seven battens fourteen feet long. Seventy

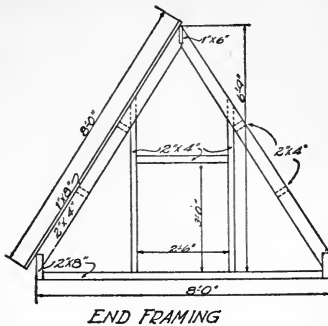

Figure 74.—Cross Section Through A-Shaped Portable Hog House

feet of flooring in sixteen-foot lengths. Two pieces for ridgeboards one by six by eight feet. Three pieces two by eight by sixteen feet for sills. Four pieces two by four by sixteen feet long. Two pieces two by four by ten feet. Three pieces two by six inches, eight feet long, for mud sills or runners. One sash complete with four lights of ten by twelve glass. One piece one by three by sixteen feet for window and door casings.

AUTOMATIC HOG COT DOOR FOR WINTER

It is easy to make an automatic hog door that will fall back into place every time a hog passes through.

The door is a gunny sack nailed over the opening. It is weighted down by about two pounds of earth in the bottom of the sack. The door works better if the opening is about an inch wider than the sack, but some farmers prefer to have the sack lap past the sides of the doorway an inch on each side.

The hogs soon learn to open the door either way. When the gunny sack is wider than the opening one edge of the sack will flop inside sometimes, while the

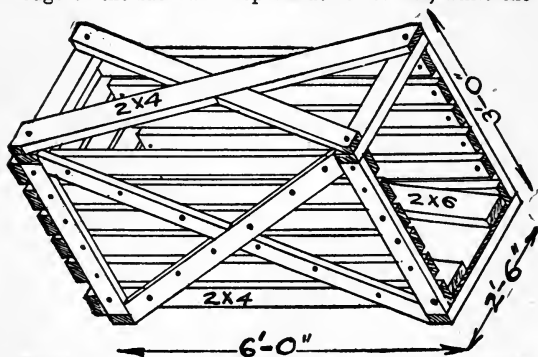

Figure 75.—Breeding Crate for Hogs. The Illustration Shows the Manner of Construction

outer edge remains outside, which looks untidy, but it lets in fresh air which may be greatly needed. If the doorway is wider than the canvas door, then the curtain drops straight down and hangs in the doorway, leaving two cracks for ventilation. The doorway fronts the south. In cold weather it may be further protected by placing the hog cot near a building, high board fence, or some other wind shield.

HOG BREEDING CRATE

Pure bred boars sometimes grow to weigh 700 pounds. A breeding crate is necessary when young sows are mated to such heavy hogs.

Figure 75 shows a good way to make a breeding crate to use for such purposes. It is made of two by four scantling put together with bolts. The bolts are pointed out and the ends are cut off even with the outside of the nuts and are filed smooth. The crate is thoroughly well cross braced to prevent racking when it is loaded or unloaded from a wagon.

HOG LOADING SHUTE

A portable hog shute is a great convenience on a livestock farm. The one shown in Figure 76 is six-

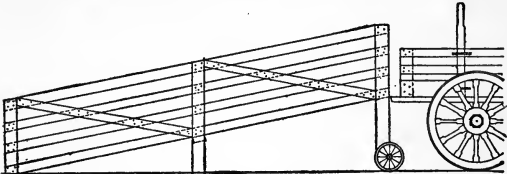

Figure 76.—Loading Shute for Hogs. This Loading Shute is Made Portable and May Be Moved Like a Wheelbarrow

teen feet long and the same width as the wagon box. If inch boards are used for the bottom of the shute it will be necessary to use five or seven cross pieces under the floor. Planks are heavy. The shute is used occasionally, sometimes for light hogs, sometimes for heavy ones. If made of light material and well braced, a shute like this should last a dozen years or more.

CHAPTER XI

POULTRY, POULTRY HOUSES AND POULTRY FURNITURE

Breeds of Domestic Fowls.—There are about twenty-four breeds of domestic fowls, known as follows: Ancona, Black Spanish, Black Sumatra, Blue Andalusian, Brahma, Buckeye, Cochin, Cornish, Dominique, Dorking, Game, Hamburg, Houdan, Java, Langshan, Leghorn, Minorca, Orpington, Plymouth Rock, Polish, Red Cap, Red Malay, Rhode Island Red, Wyandotte.

Most of these breeds are subdivided into varieties; for instance, there are three varieties of dorkings, the white, the silver grey and the colored. There are eight varieties of leghorn, two varieties of Rhode Island reds, etc. Bantams are dwarfs selected and bred down from the regular breeds.

Poultry Breeding Terms.—

Fowl.—Hen or rooster more than a year old.

Cockerel.—Male bird less than a year old.

Cock.—Mature male fowl. A rooster fully developed.

Hen.—Mature female having attained full vigor is considered in the breeding class after molting.

Pullet.—Female less than a year old.

Broiler.—A young bird weighing less than two pounds dressed weight.

Roaster.—A young fowl weighing four pounds or more when dressed. Old fowls are fit only for stewing.

Capon.—Male bird emasculated. It is done to increase the size and quality of the flesh.

Trio.—Two hens and a cock bird mated for breeding.

Trapnested.—Means that the hen has a trap nest egg record.

Setting of Eggs.—Thirteen.

Poult.—A pin feather turkey, male or female, less than a year old.

POULTRY A-HOUSE

One of the homely adjuncts to the poultry business is the A-shaped coop. See Figure 77. The most convenient size for hen and chickens is two feet square on the ground and about eighteen inches high. The

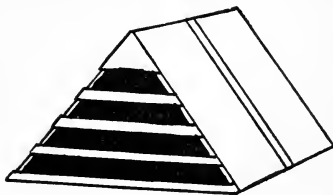

Figure 77.—A-Shaped Protection for Hen and Chickens

boards should be cut two feet long. The back end is boarded solid and the slatted end is faced towards the sun and away from the wind. When these A-shaped coops are made for turkey hens they should be about three feet square on the bottom and two feet six inches high.

SIZE OF THE POULTRY HOUSE

The size of a poultry house should be sufficient to give about three square feet of floor space to a full grown hen. If extra large fowls are kept this allowance should be somewhat increased.

The height of the ceiling does not figure with fowls. A ceiling three feet high for laying hens corresponds to a house ceiling sixteen or seventeen feet high for human beings. No poultry keeper would want a poultry house as low as three feet, because it would be very difficult to keep the house clean, so a compromise must be made and a medium decided upon.

A shed roof poultry house is the cheapest and the easiest to arrange because the back may be low down and the front high enough for the attendant to stand upright. A shed roof is all straight work and may be quickly made. If the roof boards are cut even with the back wall, without eave projection, roll roofing may be carried down the roof and down the back of the house to the ground in one continuous strip.

POULTRY FOODS FOR WINTER

To obtain eggs in the winter time it is necessary first to have a sanitary, well built poultry house, then to supply considerable protein food. A very satisfactory condensed form of protein and phosphorus may be obtained from the home butcher in the form of bones and small particles of meat that adhere to the bones. To obtain eggs of good flavor the scrap must be fresh and free from taint.

A good bone grinder is a great help in preparing

such poultry food. It must be fed in small quantities with the full understanding that it is a very rich food, and that poultry are sometimes ravenous unless fed regularly.

The feeding of meat scrap and ground bone supplies the food elements necessary for laying hens and prevents the feather eating and egg eating habits. When laying hens are closely confined for weeks together they often suffer for the variety that they are accustomed to finding outdoors in summer.

A hen feeding in the orchard or pasture field will pick up a blade of grass, chase a grasshopper, gather a few small insects, and hunt weed seeds, and occasionally pick up a fat, juicy grub, so that she manages to mix a balanced ration to supply her own body necessities and to manufacture eggs from the surplus. Poultry in confinement keeps the poultry man or poultry woman busy inventing ways of supplying all the different ingredients necessary for a well balanced ration. Grains, greens, grit and gumption have been mentioned as the four g's that are essential in keeping poultry in a house in the winter time.

Good winter feeding requires that part of the ration shall be composed of grains. A daily supply of vegetable matter is needed for condimental and laxative reasons. No fowl can be thrifty without grit. Grit is necessary to grind the grains and other foods in their crops. The term gumption is an inelegant expression meaning common sense which is applied to every branch of every successful poultry business. Lime also is needed for bones and egg shells. Protein to build up muscle and green bone to supply phosphorus.

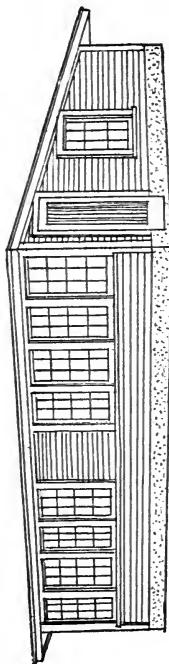

Figure 78.—Winter Poultry House with Shed Roof

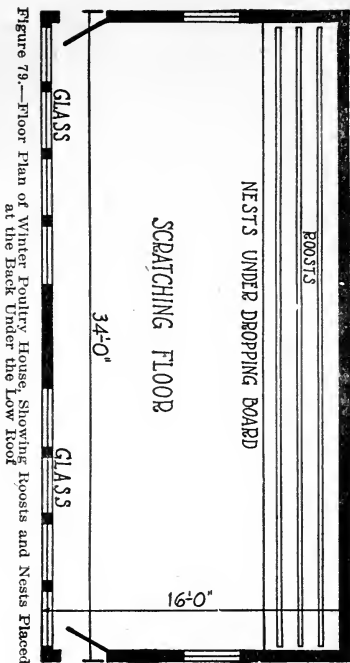

Figure 79.—Floor Plan of Winter Poultry House, Showing Roosts and Nests Placed at the Back Under the Low Roof

NEW YORK POULTRY HOUSE

Organized poultrymen in New York worked a long time trying to build a poultry house that would provide winter comfort and healthful exercise for the fowls, together with ventilation and other sanitary requirements.

Specifications demanded that the cost should come within the means of any farm boy or village girl having sufficient energy and determination to follow directions.

The result was a plain shed roof poultry house of one room, preferably sixteen feet square, placed high side to the south and made wind proof with building paper.

Ventilation was secured by using thin cheese cloth over the window openings.

The fowls are exercised by inducing them to scratch for hidden grain in straw several inches or a foot deep.

The original plan was built sixteen feet square, but it may be built double, as shown in Figures 78 and 79, with a partition in the center, making two compartments sixteen feet square each. It is covered with a straight shed roof which slopes down, from a front that is eight feet high, to a low back wall.

The advantage of a shed roof on a poultry house is to admit plenty of light and air by placing the high side to the south and to shut out the cold that comes from the north. The sun shining against the high side of a building during the day makes the poultry house bright and cheerful. The protection of the low roof at the back keeps the poultry snug and comfortable at night while on the roosts.

Figure 80 shows the advantage of a shed roof for a poultry house in the winter time. This illustration also is a cross section through the New York poultry house. It shows the concrete floor made solid with

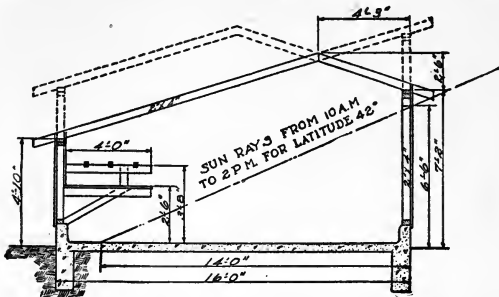

Figure 80.—Diagram Showing Different Designs for Poultry House Roof

the walls, and it shows the way the droppings board and roosting poles are placed up near the roof, thus leaving the floor clear for scratching litter underneath.

COMBINED PORTABLE BROODER AND SMALL POULTRY HOUSE

A small house twelve feet by eight feet in size is convenient to use as a laying house in winter and a brooder house in early spring. See Figures 81, 82 and 83. In figuring the size of a house it is customary to provide from two square feet to five square feet of floor space per fowl. The difference between two feet and five feet is considerable. It is accounted for by the different kinds of poultry, some of which are

much larger than others; also different poultrymen have different ideas in regard to the amount of room that poultry should have.

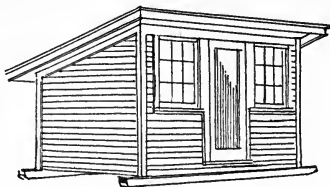
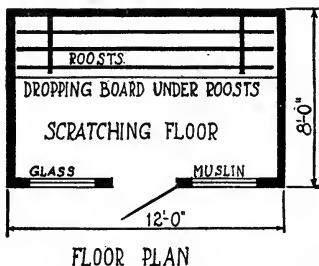

Figure 81.—Portable Poultry House

It depends somewhat on the length of time they are to be confined. The more crowded the house the more work is necessary to keep the place clean and



FLOOR PLAN

Figure 82.—Floor Plan of Portable Poultry House

sanitary. Also the time of year has an influence on the capacity of the house. In spring, when poultry may run outdoors during the greater part of the day

the house may accommodate more poultry than when they are cooped up all day and all night in the winter time.

This poultry house contains ninety-six square feet of floor space, which, allowing four square feet per fowl, has a capacity of twenty-four laying hens.

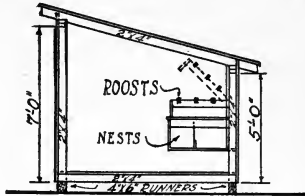

CROSS SECTION

Figure 83.—Cross Section of Portable Poultry House, Showing Roosts and Nest Boxes

Two dozen Plymouth Rock hens would require about twelve lineal feet of perch, or three roosting poles four feet long. This is figuring the whole floor space, so the chicken furniture would be all suspended from the roof or hung against the side walls, thus leaving the whole floor covered with straw for scratching.

Cubic air space does not count in poultry houses, because there is always an excess of cubic capacity as compared with the floor space. The reason is that the roofs of poultry houses are always pushed up to give headroom enough for the attendants. Chickens do not require very much headroom. They would be better off in much lower houses.

Ventilation is closely connected with the size of

the house, the height of the roof and the number of poultry housed. There is only one way to ventilate a poultry house, and that is by the use of thin cotton cloth or muslin. Some poultry writers make the mistake of calling it canvas. Canvas means an air-tight, almost water-tight, substance. The opening might as well be covered with boards as to be blocked shut with canvas. The object of ventilation is to ventilate. The necessity of putting thin cloth covers over a ventilator opening is to prevent the wind from blowing in.

It is almost impossible to ventilate poultry houses by the methods used to ventilate cow stables, because birds are so much smaller that their body heat is less in comparison to the volume of air in the building, so that the principle of the circulation of warm air by changing the temperature of a large quantity of stale air is not possible. But when twenty or thirty hens are crowded together on a roost in a small poultry house at night, it may be noticed that they develop considerable body heat and that the air in a small poultry house that is well built is continually moving. The cold air comes in through the cotton covered openings and circulates around the droppings board and finds its way up to the roosts. From the roosts the natural way out is up along the roof to the nearest opening. For this reason it is a good plan to have two cotton ventilators, one near the ground and one near the roof.

Small portable poultry houses always face the south or southeast in winter and spring. A good exposure is south with the door in the east end, so that the north side and west end is made tight to prevent draughts. This is the best arrangement in sections where the

prevailing cold winds come from the north, northwest and west.

The plan of this little poultry house shows the whole surface of the floor free from encumbrances, so that it may be covered a foot deep with fresh straw every day to allow the poultry full freedom for exercising their muscles by kicking the straw about.

HILLSIDE CHICKEN HOUSE

Probably the most successful scratching shed ever designed for the use of laying hens is shown in Figure 84. Litter from the barn is thrown into the

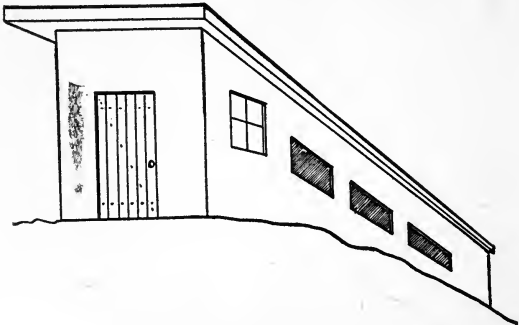

Figure 84.—Hillside Poultry House

scratching shed just inside of the door at the upper end. The incline is such that the hens work the straw down to the lower end of the house. When it gets there, it is broken up so fine that it is ready to go out into the manure heap.

In this plan advantage is taken of the disposition of hens to face uphill when using their feet and claws for scratching purposes. Inside this scratching shed twenty or fifty hens will be seen busy at work kicking the litter downhill. It is built in connection with the winter chicken house and is intended to be just large enough to accommodate one pen of layers. They are required to go into their regular roosting places at night, but the small doors are left open so that they can come through at the first peep of daylight to commence work on the straw pile which the attendant pitched in after dark, the night before. A little grain is scattered through the straw to add interest to the performance. Some poultry men keep sheaves of wheat or other grain or loose straw that has not been threshed. A sheaf of oats is unbound and the straw mixed with the other litter. A forkful of buckwheat straw unthreshed also helps the variety.

The upper end of the building is on level ground, so the floor in this part is level. The roof takes the slope of the hill and is shaped as shown in one straight slab reaching from the front end of the poultry house proper to the lower end of the scratching shed. The window openings are covered with screen wire and thin muslin. The building is twelve feet wide and may be thirty feet long. The upper end is made warm for winter comfort.

FOUR-STORY POULTRY HOUSE

Boys on the farm, and girls, too, like to make pets of well bred poultry. Play houses for poultry may be made practical. Such houses are divided into compartments in such a way as to induce the hens to dis-

built smaller on the ground and higher to give the necessary room. See Figure 85. And they may be tribute themselves all through the house. It is done in the following way:

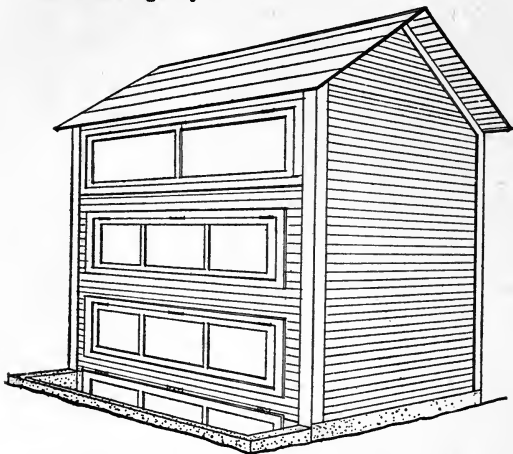

Figure 85.—Perspective of Four-Story Poultry House

The basement is used for scratching purposes only. If the poultry yard is well drained the basement may be partially built under ground. An excavation two or three feet deep is sufficient. It must not be deep enough to be dark or damp. Sunlight and dry air are both essential for success in keeping poultry. See Figure 86.

If the basement is made with a damp proof cement

wall with a window reaching clear across the south side, the little basement may be made comfortable in winter. It is necessary to have wide doors across

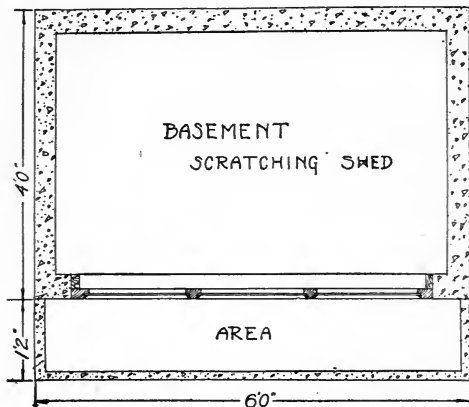

Figure 86.—Basement of Small Poultry House

the front for light, for ventilation and for cleaning. Every part of the poultry house must be kept clean, otherwise there is sure to be trouble.

Above the basement wall the little house is built of studding, building paper and thin boarding both inside and outside of the studding. This makes a hollow wall. The first floor, Figure 87, is intended for a feeding floor. Feed hoppers for ground oyster shell, grit and charcoal are hung to the sides of this room and a removable porcelain or metal trough for feed-

ing mashes is placed within easy reach of the door opening. There is a drinking fountain on this floor and another one is hung in the basement.

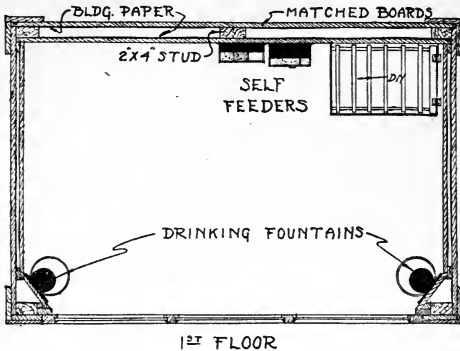

Figure 87.—First Floor of Small Poultry House

The size of this little poultry house is only six by four feet on the ground. It is so small that the attendant never goes inside, but he can reach in through the different window doors to attend to the wants of the poultry, and he has scrapers and brushes to use for cleaning purposes. A hinged window reaches clear across the front of the little building at each floor.

The second floor, Figure 88, is made dark and is used for laying purposes. The nest boxes or bottomless racks are placed on the floor and are made easily removable so they may be lifted out for cleaning.

2ND FLOOR

Figure 88.—Second Floor of Small Poultry House

3RD FLOOR

Figure 89.—Third Floor of Small Poultry House

The top floor, Figure 89, is the attic and is used for roosting. The only perches in the house are in the attic. The attic is not lighted in the usual way, but there is an opening for ventilation. This opening is covered with thin cotton so that sufficient light is admitted. The opening extends clear across the front of the house and is closed by a door frame that hinges at the top and is covered with wire netting on one side and cotton on the other. The sill under this door is on a level with the floor inside and extends out several inches beyond the front boarding of the house door.

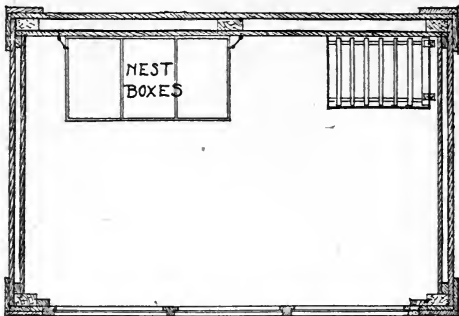
There is a metal droppings pan which covers this floor all but the stairway, or it may be made in two pans if necessary. It consists of a sheet of galvanized iron turned up about half an inch at the edges. This pan is easily removable at cleaning time.

The roosts are supported on low trestles about eight inches high. The trestles stand on the metal droppings pan and are lifted off for cleaning.

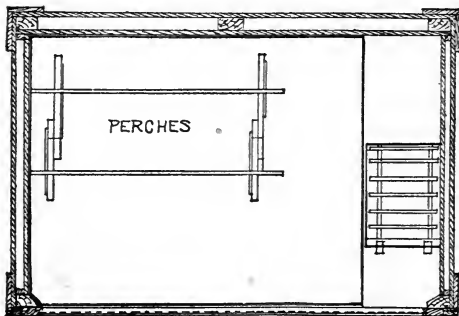
At the east end of the house there are three stairways, one over the other, each hinged at the top to close like so many trap doors at house cleaning time.

In practice it is noticed that the hens occupy the whole house, according to their moods and fancies. In the morning when the sun shines they will be found down in the basement scratching among the litter for scattered grains. They are continually going up and down to the second floor to pick lime, gravel, charcoal or condiments from the supply hoppers, and they always climb up to the attic when they want to go to roost.

The third floor is a quiet place and the hens sneak off

into this room for laying. Occasionally a brooding hen takes a fancy to the third floor for solitude. Upon the whole, it is a satisfactory small poultry house that will accommodate from a dozen to twenty or thirty hens, according to size, and it is so built that it is easily kept sanitary and warm enough, and it is well ventilated to keep the poultry comfortable and in good health.

Cleanliness is the main requirement. Good feeding comes next. But both depend upon the way in which the poultry house is built.

POULTRY FEED HOPPERS

A feed hopper is used for dry feed such as small grains, bran, etc. A hopper should deliver all of the feed; otherwise what remains in the corners of the hopper will become old and musty and unfit for use.

Figure 90 shows the proper design for a feed hopper. It may be any size, according to the size of the chickens to be fed. The same principle holds for a small chicken feeder or large feeder for laying hens. For larger birds the hopper is hung well up above the floor and it is better to slant the cover so the chickens will slide off when they try to roost there. The incline forming the front and the lower part of the hopper-back should deliver the last particle of feed where it may be reached.

In the summer when chickens are running out they get bits of gravel and lime and weed seeds, which together with insects make up a natural ration. In the winter time when the ground is covered with snow and the insects are all hibernating, poultry often suffer because they do not have access to nature's condi-

ments which are required to keep them in good physical condition.

Such substances as ground oyster shell, or some other form of lime, and small gravel stones for grit,

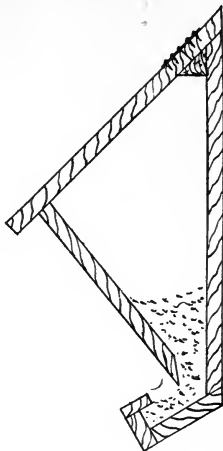

Figure 90.—Section Through Poultry Feed Hopper Designed to Hang Against a Wall. These Feed Hoppers May Be Made Any Length and Divided by Partitions to Hold the Different Kinds of Poultry Hopper Feeds, Grit, Charcoal, etc.

are best kept in hoppers. Another substance that may be constantly kept before poultry in one compartment of the hopper is charcoal.

Wheat bran is another hopper food. Different kinds of grains may be kept in the hoppers, but a good many poultrymen prefer to scatter grains in the straw

to encourage the chickens to dig for it. The digging and the hunting around amongst the straw, six inches or a foot in depth all over the floor, will induce the chickens to take the necessary exercise to keep their blood in circulation.

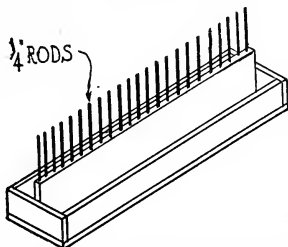

Figure 91.—Double Poultry Feeding Trough with Partition in the Center

The accompanying diagrams, Figures 90, 91, 92 and 93, show several styles of feed hoppers that are well calculated to keep the different kinds of dry substances clean and within reach at all times.

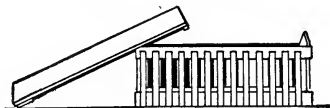

Figure 92.—Poultry Feeder with Metal or Crockery Receptacle

Keeping poultry supplies around poultry houses in open boxes on the ground is wasteful of good food and floor space. The advantage of hoppers is that besides keeping the different substances clean and

preventing waste, they are hung up out of the way. The different hoppers should be placed just high enough so the poultry may easily reach the feeder troughs.

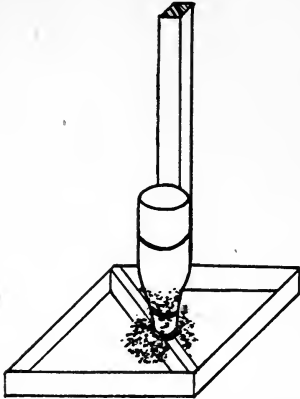

Figure 93.—Poultry Fountain Feeder for Grain

It will be noticed that each delivery trough has a ledge or guard at the front that projects in. The purpose of this is to prevent chickens from throwing the materials out with their beaks. Chickens are never satisfied to pick what lies on top. Their nature is to eat from the bottom. If they cannot scratch the stuff away, they try to throw it towards them with their beaks. Sometimes these guards are hinged so that they may be turned back for cleaning.

Generally speaking, however, these hoppers always are kept dry. The materials are dry and the hoppers are hung against the wall in a dry place, so that they do not require cleaning very often, but on general principles, everything that belongs to a poultry house should be so arranged that every corner and crevice may be examined for accumulations of dirt. Dirt harbors vermin and vermin is the great source of loss amongst poultry.

A double hopper to feed from both sides with a top that slants in two directions leaves a ridge that the fowls are quick to appropriate as a perch. It is perfectly natural for chickens to utilize any ledge that offers support for their feet.

Like all other rules in regard to poultry, there is a reason for this one. The shape of a chicken's foot and the toe muscles are intended by nature to grasp the limb of a tree. When a chicken sits down, the muscles contract to draw the toes around the limb. This is the reason why a chicken can sit all night on a swinging limb in windy weather. The toes grasp the limb automatically and hold the sleeping chicken in an upright position.

Following out this principle, it is easily understood why poultry object to standing on a hard level floor. The toes are extended and the tendons are strained. This peculiarity of the formation of a chicken's foot also accounts for its scratching proclivities to a certain extent. A chicken scratches to unearth food until it becomes a fixed habit. The act of scratching also relieves the tension of the toe tendons which urges the fowl to increased activity.

If all poultrymen understood the peculiarities of

the feet of fowls, more straw would be provided for their comfort in the poultry houses. Also plenty of roosts properly built and easy of access would be arranged for their comfort and convenience when not feeding. Chickens enjoy standing in straw because they can close their toes and relieve the muscle tension.

SANITARY POULTRY FEED TROUGH

When chickens are fed warm mash in an ordinary trough, they fight each other in their eagerness to get what they consider their proper share.

The illustration, Figure 91, shows a feeding trough with an upright partition in the center. This partition is bored with one-quarter inch holes an inch apart, and one-quarter inch rods, twelve inches long, are driven into these holes, so that they stand upright. It is the only device ever invented that will prevent chickens from standing on the side of the trough or perching on the top of the division board when the trough is made double.

It is better to smooth the top ends of the quarter-inch rods to prevent injury to the poultry in their attempts to plant themselves on the top of these spindles. Chickens soon learn that the trick cannot be successfully performed. They seldom make more than one or two attempts.

The center division board should be several inches higher than the sides of the trough, but four inches is wide enough for each trough. The length may be from four to eight feet for easy handling and cleaning.

Troughs for feeding wet mash must be kept clean. Poultrymen who object to mash, and say that mash is injurious, are the fellows who neglect to clean

the troughs. There is nothing injurious about a fresh mash mixed with wholesome foods and given to the poultry in clean troughs before fermentation has an opportunity to make mischief.

A self feeder for poultry that keeps the feed clean is made one foot wide and long enough to accommodate the number of chickens to be fed. Figure 92. The cover is made with a ridge in the center and slopes down to each side. The cover is made steep enough to slide the chickens off when they attempt to perch on it.

For mashes there must be a tin pan made to fit inside. This is taken out and cleaned and scalded each day to prevent disease. A floor is not necessary. It is more easily cleaned without a floor.

Figure 93 shows a bottle grain feeder for poultry. A shallow box is fitted with a piece of wood extending diagonally across from one corner to the other. A common milk bottle is fitted into two wire staples attached to an upright post as shown in the cut. The bottle is filled with small grain and is inverted over the wooden strip. The grain runs out as fast as it is eaten by the chickens.

POULTRY CATCHING HOOK, OR HOW TO BREAK A CHICKEN'S LEG

A catcher for poultry is easily made by bending a number ten wire the shape shown in Figure 94. The straight end of the wire is driven into the end of a short stick. By reaching out quickly while the flock is feeding the wire may be hooked over the chicken's lower leg just above the foot. It must be used with considerable care to prevent the chicken

from turning over. It is easy to break a leg when a chicken is flapping or floundering with its foot caught fast. The loop on the outer end of the hook is to prevent catching and tearing the chicken's skin.



Figure 94.—Poultry Catching Hook

A CHICKEN OILER

Some poultrymen adopt the plan of hanging a tin can with a lamp wick drawn through the bottom over

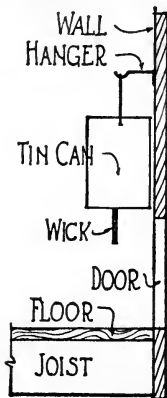

Figure 95.—Poultry Oiling Device for Coal Oil

the little doorway that the chickens pass through. See Figure 95.

Any tin can that will hold water will answer the purpose. A cold chisel is driven through the bottom and a lamp wick is drawn tight into the cut made by the cold chisel. Coal oil is then put into the can and it is hung over the little chicken doorway just high enough so that the wick touches the feathers as the hens pass through. The wick should be wet with coal oil but not wet enough to drip. Two or three trials may be necessary to make the cut just right, so that the wick will pull through tight enough to prevent leaking. Lice will not settle on a hen when the feathers are wet with coal oil. This remedy, however, must be applied with caution and common sense. Like many other contrivances invented for the benefit of the poultry, it may be a good thing if carefully managed and not worked too hard.

CHAPTER XII

CONCRETE ON THE FARM

CONCRETE BARNYARDS, PIERS, FLOORS, WALKS, WATER TANKS, POSTS AND GENERAL FARM REPAIR WORK

Portland cement has been used on American farms for more than a hundred years, but concrete in its various forms only recently came into general farm use.

Portland cement mortar was used by our grandfathers to plaster cisterns and to lay up brick walls in damp places. It was made the same as we make it now when we have particular work to do—by mixing together one of cement and two of sand. And our ancestors were particular about the kind of sand even as we are.

One of their old cisterns may be seen near the town of Spencer, Indiana. It is shaped like a jug, about sixteen feet deep and is still in a good state of preservation with several feet of water in it. The old house was burned many years ago and the land has grown up with trees.

Concrete on the farm is a very different proposition from concrete in a twenty-story city skyscraper. Farmers have their own ideas in regard to the most satisfactory way to use cement on the farm and they are based on economic principles. This statement does not mean

that cheap or careless methods prevail, but farmers have repeatedly proved that it is not necessary to spend a dollar a square foot in making a concrete feeding floor for hogs or a clean foot path to the dairy house. Farmers know that puddling the bottom of a hog wallow will hold water, but a mixture of sand and cement will add dignity and durability. Farmers also know that a small amount of cement if well mixed with clean sand and quickly applied will stick rough stones together to make a rat proof foundation wall good enough to support a chicken house or other light building.

Graduate engineers may not always agree with farm methods, but they are not familiar with farm limita-

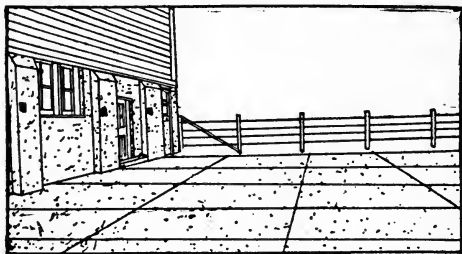

Figure 96.—Concrete Barnyard, Laid in Blocks Like a Sidewalk

tions. There were no concrete engineers when the Indiana cistern was plastered against the clay sides of a hole in the ground.

At the same time farmers are well aware of the progress in concrete building construction and they

are waiting patiently for architects to invent sensible artistic designs for concrete parts of farm buildings.

The idea of constructing a whole building of concrete never interested farmers because of the cold lifeless tombstone effect. Such a building makes a poor companion piece to a herd of warm blooded Holsteins in a setting of green fields and leafy shade trees.

Paved Barnyard.—Figure 96 shows a paved barnyard. The blocks are about five by seven feet with

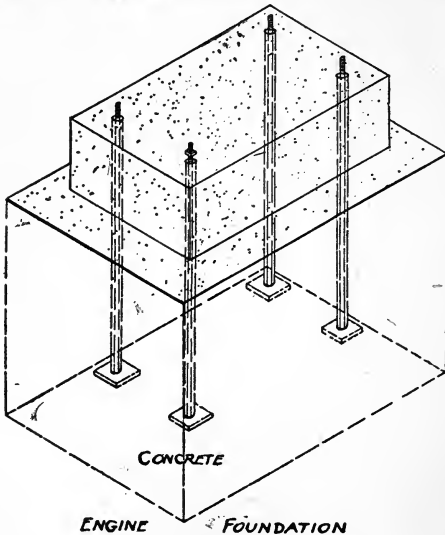

Figure 97.—Concrete Engine Pier

hot asphalt pitch run into the joints. The floor slopes away from the stable with a fall of about one inch to the rod. It is bordered by a concrete curb along the edges to make a neat finish and to protect the floor from rooting hogs.

Figure 97 shows a concrete engine pier. The farm engine works better when it has solid footing. Concrete work subject to vibration requires a mixture of one part cement, two parts sand and four parts gravel. Screen the materials carefully, measure accurately, use clean water, mix first dry to a uniform color, then mix wet to a quaky consistency and fill into the form quickly. Use no large stones. Be particular. The size of an engine pier should be about a foot larger each way than the engine bed, which allows for a six inch projection all around. It is a good plan to avoid sharp corners and edges by fitting triangular pieces into all corners of the mould. The illustration shows how the bolts are embedded. To properly place the bolts make a template with holes to correspond with the bolt holes in the engine bed.

Concrete Scale Pit.—Figure 98 shows a concrete scale pit. Farm scales never were properly set until they were set in concrete. The drawing shows a 6,000 pound farm scale in a water proof concrete pit. There

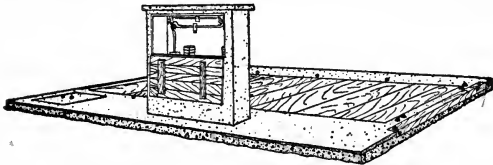

Figure 98.—Concrete Farm Scale Base and Pit

are eye-bolts along the sides. Stock panels are hooked to these eye-bolts when farm animals are weighed. Bumper strips of hard wood are shown at the ends of the concrete to take the jar from wagon wheels. The weighing platform is made of two-inch plank.

Concrete Hog Wallow.—Figure 99 shows a hog wallow which should be about twelve or fourteen inches deep. It may be any size across and almost any shape, but it is better to have several small wallows

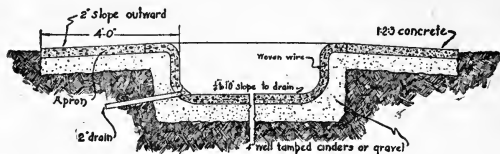

Figure 99.—Concrete Hog Wallow, Showing Drain Pipe

rather than only a single large one. It is not necessary to put much expense on a hog wallow. The drawing shows a permanent foundation for ground that may become wet in cold weather. Heaving or breaking by freezing is thus guarded against, but, it is better to dig a hole and plaster the concrete directly on the earth than to let the hogs go without a wallow because of the extra expense of making it right. This is one of the concrete structures that may be slighted in the making without serious results. If it breaks with the frost it may be patched. The two-inch drain pipe should project out at the side of the bank or raise of ground selected for the wallow. This pipe may then be punched through with a stick or iron rod when it chokes full of mud.

Figure 100 shows two ways of reinforcing a concrete trough. One cut represents a hog trough reinforced with poultry netting, the other is reinforced with quarter inch round steel or iron rods. There

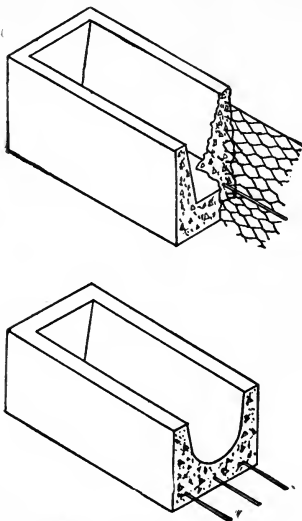

Figure 100.—Showing Two Ways to Reinforce a Concrete Feeding Trough

should be two rods in each side in addition to the bottom rods shown in the cut. Concrete troughs are cast upside down in the mould and the soft concrete is struck off even to shape the trough bottom. A mix-

ture of 1:1½ is used for troughs. The cement must be fresh and lively and the sand fine and clean. Pure water is essential.

Concrete Hog House Alley.—The center alley in a winter hog house should be well rounded in the center with two well defined gutters. See Figure 101. Hogs

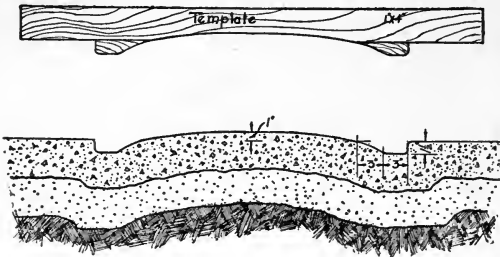

Figure 101.—Concrete Center Alley for Hog House. The Upper Illustration Represents the Wooden Template Used to Form the Center of the Hog House Floor

do not slip and hurt themselves on wet concrete like larger animals. They are not in the center alley often so it is better to build the alley and the floors to be easily cleaned with the hose. The floors of the pens slope towards the alley with a fall of about one inch in ten feet to keep back ends of the pens dry. The wooden template shapes the center of the alley and both gutters at the same time.

Permanent Mail Box.—Figure 102 shows a copper mail box and concrete post. The post may stand out alone at the side of the road or it may be part of the entrance gateway. It must be easy of access. Bolts

are embedded into the concrete to hold the mail box in place.

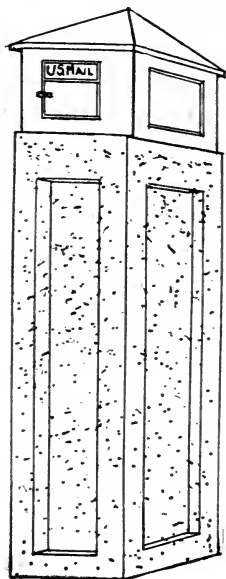

Figure 102.—Farm Gate Post with Copper Mail Box

Clothes Line Reel.—Figure 103 shows a clothes line reel set on a concrete post. The reinforcing rods are threaded and project above the post. The bottom of the reel box is bored to fit the rods and the nuts are

screwed down to hold the box firmly in place. The top is covered with felt roofing.

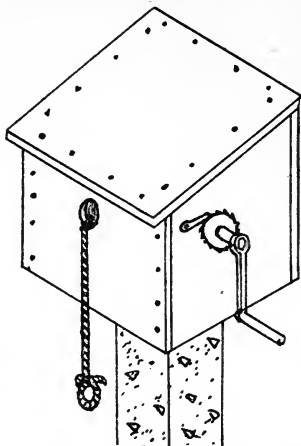

Figure 103.—Concrete Post Supporting a Waterproof Clothes Line Reel Box

CHAPTER XIII

COMFORTABLE FARM HOMES

SHOWING FARM HOUSE PLANS WITH HOT AND COLD
RUNNING WATER, DRAINAGE, HEAT,
LIGHT AND POWER.

FOUNDATIONS FOR FARM BUILDINGS

Different Kinds of Basement Walls.—A well built house or barn must have a solid foundation, which commences with the footings of the walls and center piers. The width of the footings will depend somewhat on the character and weight of the building. In every case the footings of walls and piers should be wide enough to positively prevent settling. A little extra expense when building is saved in after repairs. If walls or center piers settle, the floors are pitched out of level, the doors stick either at top or bottom and cracks break across the plastered walls, window and door casings open at the joints and unnatural strains are put upon the frame work.

Staking the Cellar.—First set one corner stake where it properly belongs. Then stretch a line, 100 feet or more in length, parallel with the road, or, set a stake some distance away to sight to. It may be necessary to stake the road for half a mile or so to get the true line. The diagram shows how the stakes and lines look when the staking is finished. The first

corner is made square by the "rule of six, eight and ten." After setting the first two stakes, usually across the front of the proposed building, then one side line is stretched and squared first by using a carpenter's steel square against the lines at the first corner. This squaring will not be accurate but it will be near

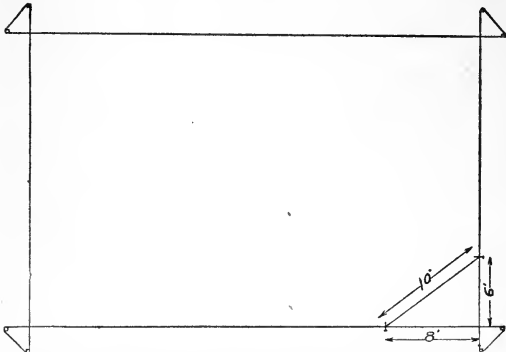

Figure 104.—Diagram Showing How to Stake the Foundation of a Farm Building so the Excavation Can Be Made Clear Out to the Corners without Undermining the Stakes

enough to set the temporary stakes while making the preliminary measurements. Before the stakes are driven solid, measure accurately six feet from the first corner and stick a pin through the line. Then measure eight feet on the other line, from the same corner and stick a pin. If the ten foot pole proves that the pins are exactly ten feet apart at the places where they intersect the two lines then the corner is square. With this double arrangement the excava-

tion may be dug square into each corner without disturbing the stakes.

House foundations are built differently in each building section. Concrete probably is the most universal material used for house walls, but the cost of concrete varies according to the price of local materials. Sometimes gravel banks at home may be tapped that furnish both sand and gravel, and it may be used for foundation walls and piers without screening or the addition of any material except cement and water. Farmers who have access to such a bank are fortunate. They may make the excavations and build a wall right up to the first floor, giving the regulation seven and one-half foot farm basement headroom at a minimum of expense.

There are other places, however, where concrete walls are desirable, but the materials are shipped in from a distance. Usually sand and aggregate that pay freight are selected with considerable care. The sand is clean and the aggregate is rough and clean, so that a thin wall may be constructed stronger than a thicker wall of course bank gravel and sand of nature's mixing.

In some localities where wall material is expensive, it is customary to build a cellar wall up to and a little above the surface of the ground. The space between the top of this low wall and the sill that supports the joists of the first floor is filled in with short uprights of two by fours or two by sixes, or two by eights, according to the weight and the general character of the house. When cellar wall material is expensive this so-called "false work" effects a saving in expense, and for ordinary house construction

it is considered almost as good. It offers the advantage of building a plain straight foundation wall on four sides of the house without a break, as the windows are above and the wall is level and smooth on top. If the work is well done it makes a foundation that cannot settle or crack.

Sometimes such walls are waterproofed either outside or inside, or both. If outside waterproofing is deemed necessary, because of a saturated soil at certain times during the year, the excavation must be enough larger to permit the use of a trowel outside of the wall. If cement waterproofing is put on by a spray machine or with a brush, the space required will be about the same.

There are building sites, otherwise desirable, that give trouble in the spring when the snow is melting and the frost is going out of the ground. Many cellars are flooded at this time of year that are dry enough at all other times. Building sites vary a great deal in this respect. There may be a springy spot on one lot while the ground is as dry as a bone on all the adjacent lots. These peculiarities are not discovered until the excavations are made, and not then if the hole is dug at a dry time. Sometimes it has been found necessary to dig a trench all around a cellar and trowel the whole wall with a rich cement mortar. To make a thorough job, it is better to put a line of tile outside of the wall as near the footings as possible. A little below the footing is even better if the proper outlet may be secured.

Because the whole wall is footed at the same time the work apparently is of more importance and it receives better consideration than the piers. It is a

man's job to lay footings of walls, but according to the ideas of some builders any boy can build a pier. At the same time the eye of the owner may be beneficial in starting the wall.

When walls are built up of concrete it is customary to make the earth answer in place of an outside form in which case it is necessary to dig the cellar carefully to line and plumb. The inside form is built of wood in the usual way and substantially braced across the excavation to the opposite form. Concrete, stone and aggregate is then dumped in to fill the space and the wall is kept level all around as it rises between the wood frame and the earth.

If broken stone or small boulders may be picked up about the place then the cheapest way to lay up a wall is to put in a layer of stone and pour in thin concrete cement mortar to fill the spaces between the stones. In order to secure a good bond, the stones must be wet before they are thrown in, or sprinkled with water in the trench. To bind a wall all solid together, so there will be no cracks or breaks in it, requires that the work shall be well done, but not necessarily rich in cement. An ordinary cellar wall may be rather poor in cement if plenty of water is used together with the right proportions of cement, sand and aggregate. It is important that the mortar be handled quickly. A great deal depends on the quality of the sand and aggregate. Ten per cent of clay or mud should be the limit. Clay gets between the cement and the aggregate and prevents proper adhesion.

Wall Materials.—Cellar walls may be made of stone laid up as masonry, hard burned brick, concrete blocks, solid concrete, or a combination of stone and

poured concrete or a combination of hard burned brick bats and poured concrete.

In fact, there are many ways of making cellar walls. Local custom has a good deal to do with determining the manner in which a wall should be built. Local materials usually are selected because they are cheaper. Sometimes a good quality of mixed sand and gravel may be made in gravel banks near at hand, while in other places, sand, gravel or other aggregate must be shipped long distances at considerable expense. Sometimes there is no gravel or stone, but a good home brick yard can supply a hard grade of brick at low prices that will work into a cellar wall to good advantage.

In many parts of the country cellar walls are made of hard burned brick, made specially for underground work. In other places, stone is abundant, so that stone walls are cheaper than any other good cellar wall material. When all cellar wall materials are scarce or expensive, and wood is cheaper, then it is customary to build the foundation wall up to the level of the ground only and a superstructure of wood is built up between the top of the cellar wall and the joists of the main floor.

Where stones are abundant and skilled masons are scarce, it is easy to lay up a stone wall between forms by throwing in a layer of stone, then pouring in enough thin grout cement mortar to work around the layer of stones. Walls built in this way should have the stones laid flat and the cement mortar should be thin enough to work in well around the stones. The mortar sticks to the stones much better if the stones are wet before the cement reaches them. The stones

may be sprinkled in the forms but are better soaked in water before being dropped into the forms. It is difficult or impossible to drown cement with water so long as the "soup" is confined so the cement is not carried away with the wash.

When the wall is low and the house is small, a light house frame of two by four studding is toenailed into a double two by four sill, set in soft cement mortar on top of the wall. Girts are ganged into the studding one-half inch at the right height to support the floor joists. This girt is thoroughly well spiked to each upright, and the ends of the joists are spiked to the studding at every opportunity. It may not be necessary to space all of the joists to come against the studding. The weight and importance of the building will decide the distance apart for the timbers.

Hard Brick for Walls.—In some localities brick walls are used extensively under houses. The reason is that bricks are made locally and the materials for concrete work are scarce.

Good hard burned bricks when properly laid into a cellar wall give good satisfaction. The best brick wall, however, is not nearly so valuable as a thoroughly well built concrete wall of the same thickness. Bricks may be waterproofed by painting the outside of the wall or by plastering it with cement mortar.

In sections of the country where it is necessary to ship in bricks for walls, also sand and aggregate to make concrete, the preference should be given to concrete construction. Freight is expensive in both cases, but concrete is more valuable. There is such variation in prices that it is impossible to make estimates in the

cost of building that will apply satisfactorily in different localities.

Center Piers.—Most houses that have stood for a year or two have settled in places sufficient to crack the plaster or to prevent doors from shutting properly. The trouble may be in one or more of the side walls, or it may be confined to the center partitions.

There are piers under the center of most houses, and very often these piers are so carelessly constructed that they settle at one side or one corner. It is a common practice in cheap houses to put in small concrete piers or to lay stones on the cellar bottom to support the timber posts that reach up to the girders. Some of the more expensive houses are treated in the same way.

Builders are not particular enough to provide good solid supports under the middle of a house. Too often they do not realize the great weight that such supports have to carry year after year. The fact is a great portion of the weight of the house rests on the center beams and posts, which are supported by the center piers. The wall has a bearing the whole length, but a pier has a small surface in comparison. The footings of house piers are all out of proportion to the footings of the walls.

Sometimes good solid foundation piers are made, but the upright wooden posts are too small and the upper end of the posts will sink into the soft wood girder half an inch. If house builders appreciated the strain on house center piers and upright supports, we would see them much larger and better built.

The proper way to build a center pier is to dig

down at least eighteen inches below the cellar floor. The size, of course, depends on the size and weight of the house, as well as the number of piers built in to support the weight. But it is better to make a pier too large than too small. No pier should be smaller than twenty-four inches in diameter at the base and eighteen inches deep to the top of the cellar floor. It is better to build a pier several inches above the floor, but this upper part may be smaller. Sometimes if the pier is carried up the full size a foot or eighteen inches above the floor, the space around the posts comes in handy as a ledge or shelf.

When the excavation for a pier is made the hole should be a little larger at the bottom. Usually piers are made of broken stone and cement mortar. The cheapest and easiest way to start the pier is to put in a layer of larger stones five or six inches deep and then pour in very thin grout mortar. The stones should be first wet with water so the grout mortar will adhere readily.

It is a good plan to use a small stick like a lath to churn the thin mortar around the stones to expel air, and to effect a good bond. Above this foundation the pier is built in the usual way. Such work is out of sight after the hole is filled to the top, so that the temptation to slight the piers is very great, especially on contract work, for all contractors are drivers, otherwise they fail to make fair profits.

In making specifications it is well to have all such details carefully enumerated, so that both parties know what to expect. Then the owner must either depend on the architect to see that the specifications are car-

ried out properly or he must superintend the work himself.

The cheapest house construction above the wall is made by extending the studding from the top of the wall to the bottom of the plate, instead of framing false work to fill in between the basement wall and the joists of the main floor. It saves material and labor.

The framework of a house may be stiffened materially by carefully bridging the joists at proper intervals between the partitions, also by carefully planning partitions as supports to the upper framework and the roof.

In building a house with an attic that is not needed at present, it is a good plan to put in a few roof supports in line with the partitions that may be put in later. Usually in planning attic rooms to use the floor space to the best advantage, the partitions naturally come about right to support the roof at the weakest places, so that future partition studding may be put in place at the time of building. These studs are the permanent rafter supports.

Roofs that are supported by partitions may be constructed of two by four rafters, placed twenty-four inches on centers, fitted and spiked into place. Collar beams are placed in regular order high enough for an eight-foot ceiling.

It is better to floor the attic at the time of building, although it may be used only for storage. The floor is worth all it costs to keep the lower rooms comfortable. An attic floor carefully laid protects the lower rooms against heat or cold. Also a floor is an advan-

tage in putting in future partition studding to support the roof, the value of which will be appreciated in the stability of the house.

Roofs supported in this way cannot settle. When roofs settle the rafters push the plates out and the house is weakened. A swayback peak or broken backed roof is the result and it is difficult to remedy.

PLANK FLOOR CONSTRUCTION

The difficulty of securing timber for buildings was mother to the invention of what is generally termed "plank frame construction." The knowledge that two-inch planks could be built up by spiking them or bolting them together to make any size and strength of timber led to experiments in truss work to support the different parts of a building by carrying the strains on struts and ties.

Builders of houses are not worried about floor loads, because of the partitions which support the upper joists. Cellar girders are built up of two by ten or two by twelve plank, according to the size of the house and the weight the girder is intended to sustain. These girders are supported on posts or pillars, and the posts are set on concrete foundations. There is a great deal of weight on these posts and foundations even in a small house.

GRADE CELLAR ENTRANCE

One of the neatest inventions in house building that has ever been worked out is a grade entrance and the combination stair leading to the cellar and to the kitchen. These grade entrances are familiar to all builders, but they are not always appreciated to their

full value by house owners. Not every house plan lends itself conveniently to the grade entrance proposition, but certain kinds of plans are incomplete without it.

When properly constructed a grade entrance to a cellar consists of a doorway with the sill on a level with the walk that leads to the back of the house. There is an inside platform three or four feet in width and there are six or seven steps to go down into the cellar. The entrance to the kitchen is across the same platform with five or six steps to go up into the kitchen. It makes a very convenient way of getting into the cellar with supplies or to remove ashes from the furnace.

Usually the laundry is in the cellar, and this grade entrance gives easy access to the laundry and out to the clothes-line on wash days.

It often happens that a grade entrance to the kitchen is roomy enough to hold the refrigerator, so that ice may be put in without entering the kitchen.

SILLS

House sills are made of timber or by spiking together planks of the necessary width. It depends a good deal on the stock in the local lumber yards. Generally two-inch planks are available, but the ordering of timbers sometimes causes delay.

Planks may be dodged so as to make a continuous sill dove-tailed at the corner, which saves making mortises and tenons. Sills laid on top of a concrete wall need not be very large, in fact, the superstructure above good concrete walls is well supported when a single wooden strip that is thick enough to toe nail

the bottom of the studding is used. Sometimes wall sockets are set into the fresh concrete, doing away with all horizontal sill woodwork and the studding is stepped into the wall sockets on top of the cement wall.

READING BUILDING PLANS

There is an old saying: "The house that is a building looks not as the house that is built." This means that the imagination of the owner is not sufficiently prophetic to build in his or her mind a correct picture of the coming castle. It also means that after the house is started that the surrounding chaos of rubbish and lumber, excavations and brick bats is a poor indication of future beauty and comfort. It also suggests that house plans in miniature drawn to scale mean little more than a headache to the man or woman unaccustomed to reading architectural drawings.

A young married couple about to venture upon the interesting and important task of building themselves a home became confused studying plans of the different floors in miniature. One-quarter inch scale was a foreign expression to them. Skeleton cross sections were like toys and they failed to comprehend that a partition could not be moved without interfering with the room next behind. At my suggestion they finally ordered two loads of bricks delivered on the building site. They carried the bricks and made rows of them on the ground, thereby making full size plans of the house, including the cellar walls and the outside walls and inside partitions of the first floor and the second floor. The different floors were laid out in

separate plans according to the measurements of the different rooms. Openings were left the actual width of the doors and pieces of board, cut to represent the exact width of the different windows, were laid on the brick walls where the windows were to be placed in the building. They could then walk around through the rooms and doorways the same as after the house is built. And they could stand before each window and look out at the view. After making a few trips to these full size plans they suggested a few minor changes and the result was a house they have felt satisfied with ever since.

A SIX-ROOM FARM HOUSE

Economy of cubic space and the careful arrangement of rooms for convenience and comfort is the object of presenting the plan shown in Figures 105, 106, 107 and 108. It is a small story-and-a-half house twenty-five feet six inches by thirty feet in size, exclusive of front porch.

The cellar is eight feet longer than the house proper to include the wall under the front veranda. There is a cross cellar wall under the front house wall to support the weight and to make a cold cellar under the veranda for the storage of apples and vegetables.

The inside of the concrete cellar wall is treated with a coating of cement mortar to make it waterproof. The mortar for this purpose is made rich with cement and thin by adding water until it is almost sloppy.

A mixture of one part cement to two parts sharp sand works well. It is put on with a trowel immediately after removing the inside forms, while the wall is still damp, so that the mortar will stick well and

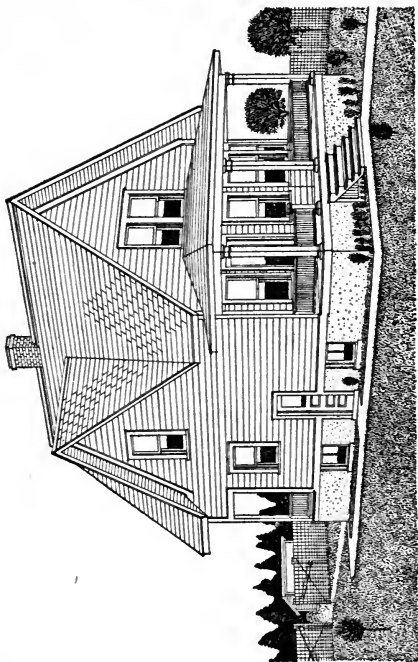

Figure 105.—Farm House with Gabled Roof and Side Cellar Entrance

run in to fill all the openings whether they are little or big.

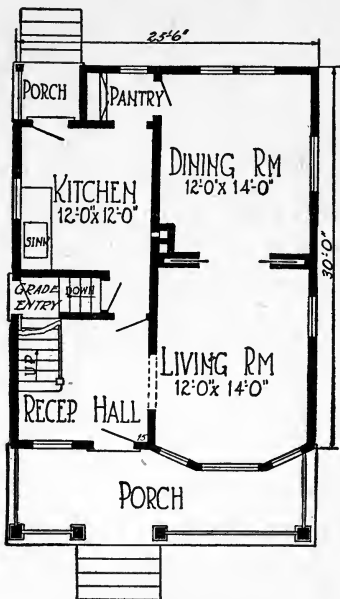

Figure 106—First Floor Plan

Pressing thin cement mortar with a trowel expels the air and closes all the voids and makes it waterproof and dampproof.

Mixing hydrated lime into cement mortar helps to

make it waterproof but the quality of the mortar is not quite so good. Hydrated lime is burned lime that has been slaked and allowed to absorb a certain amount of moisture.

Floors and Siding.—There is only one way to build

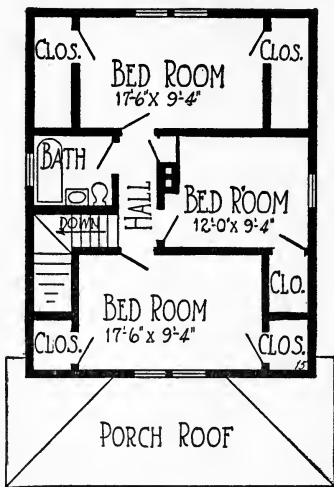

Figure 107.—Second Floor Plan

a frame house in any climate and that is to build it so as to shed the weather. A house built so that it will keep out the cold in winter will keep the heat out in summer.

Use seven-eighths inch lumber, dressed one side for boarding, all over the house, to cover the outside studding, floor joists and rafters. The roof boards are better if matched. Wide widths nail on faster and make a stiffer outer wall, floor, or roof. Put the floor and studding sheathing on diagonally. A forty-five

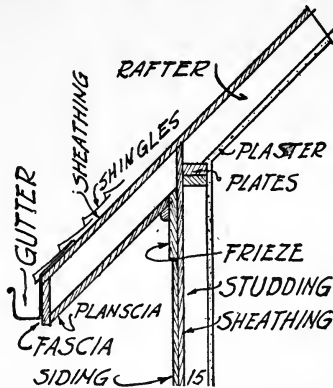

Figure 108.—Detail Showing Side Wall, Eave Projection and Roof

degree angle cuts so that the boards may be turned over to fit to make the joints come right.

Cover this rough boarding with the best quality of hard building paper, carefully worked around all of the door and window frames, then put on the clap boards. The best grade of building paper is a good thing to put on the roof boards under the shingles,

and it works well between the rough floor and the thin matched flooring of hard wood.

The plan of this house has been worked out very carefully to make good use of all the floor space. This plan provides a grade entrance with a combination stairway which reaches down five steps into the cellar and up six steps into the kitchen. There is a square platform inside the cellar door to start from. The cellar stair is under the front stair that steps up from the front hall. It makes a combination that takes up very little room in proportion to its usefulness.

The chimney is in the center of the house. It has a good foundation below the cellar bottom to prevent it from settling. It has two flues, one for the warm air furnace and one for the kitchen range, both flues are reached by short smoke pipes.

There are three rooms besides front hall and pantry on the first floor. The rooms are well arranged and large enough for comfort and they are all well lighted.

There are large windows and plenty of them. Even the cellar is well lighted with two light windows, in single sash, hinged at the top and arranged to hook up against the floor joists for ventilation.

Upstairs there are three bed rooms and a bath room with plenty of closets for storage of household things not in use at all times. The front and back bed rooms are large and are well lighted by double windows built into double frames in the large gables. The side bed room and the bath room are lighted by single two-sash windows in smaller gables. A short hallway connects the stairway with all the upper rooms. There is just enough hall wall space to hold the doors and to make room for the stairway and the chimney.

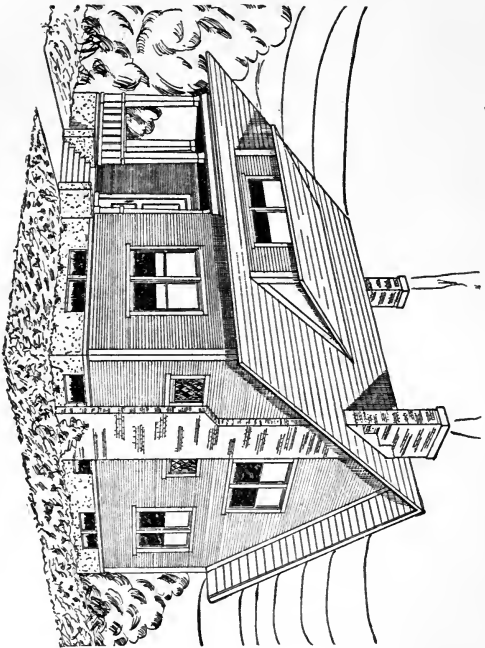
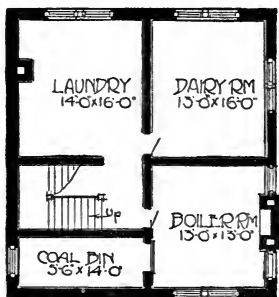

Figure 109.—Perspective View of a Five-Room Farm House

A FIVE-ROOM HOUSE

Small houses containing five rooms meet the requirements of a great many families. The design illustrated in Figures 109, 110, 111 and 112 shows a style of house ordinarily described as a story and a half. It is thirty by thirty-two feet, in size, and contains a splendid large living room and a good kitchen on the first floor and three bed rooms and a bath room on the second floor together with the necessary clothes closets.



- BASEMENT PLAN -

Figure 110

The basement is enclosed with solid concrete walls based on wide footings to prevent settling. The walls extend up to the main house floor, giving a height of basement ceiling a little higher than seven and one-half feet.

The basement is well lighted by four double windows and three single windows. The windows of the workroom side of the house are deeper than the windows in the front. The reason for this is that considerable work is done in a good farm house basement like this so that plenty of light and air are necessary to make the workroom comfortable.

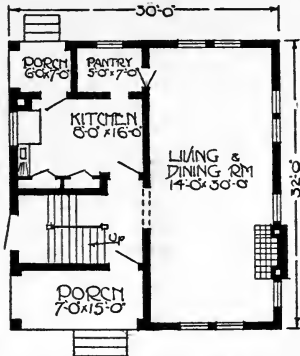

- FIRST FLOOR PLAN -

Figure 111

The forms for the concrete walls are made out of joists and cheap lumber that is afterwards used in the upper structure of the house. The outside boarding and the floor linings work in just right for forms for the concrete wall. The only loss in using lumber joists and studding for the basement forms is in the splitting of the boards when trying to get the nails

out. This difficulty is overcome by using six penny nails, which pull easily. The boarding for the forms is tacked to the uprights on the inside, so that the pressure comes against the uprights and no nail strength is required except to hold the forms together until the concrete is filled in.

In making and placing forms have them level and true on top so that when the forms are filled full and

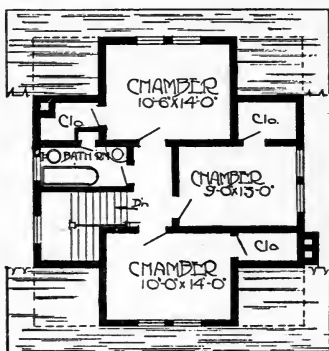

~SECOND FLOOR PLAN~

Figure 112

struck off true with the top then the foundation for the sills is level and true, straight and square, so that the sills may go on the concrete and the superstructure be carried up square and plumb without chinking up under the sills, or any other adjustment that takes time and looks bad after the house is finished.

Have the sills and the window frames made the full thickness of the wall so that they fit in between the outside and inside wall forms, and the concrete may be filled around to make a tight joint quickly.

If an eight-inch wall is wanted then the basement window frames are made eight inches wide from one face to the other. They are lightly tacked to the boarding of the forms so that the boards will pull away without loosening the frames. The frames should be worked around with two stops so that the wet concrete will run in between the stops to hold the frame firmly in place and to prevent currents of air from passing through between the frame and concrete wall openings. The basement requires ventilation, but not through cracks that are accidentally made at the time of construction.

An interesting feature of this house is the grade entrance and the way in which the stairway is built. The doorway at the side of the house is built in the concrete wall at the level of the ground so that the door sill and cement walk come on a level with each other.

Inside the house at the grade entrance is a platform about four feet square. The stair leads down into the basement from this platform and also from this platform other steps lead up into the kitchen. There are six steps down and seven steps up so that the entrance is easy both to the basement and to the kitchen.

The same stairway reaches from the basement floor to the upper story, so that in the building of one stairway over the other little room is taken up when the amount of stairway is considered. The stairway

is lighted by a window placed on a level with the upper floor.

The main floor of the house is planned for simple elegance. The large living room fourteen by thirty feet is unusual in a house of this size. The fashion for large rooms has probably come to stay. It is much easier to furnish a large room than several small ones and the large rooms are much more comfortable. They are light and airy and there are corners to fit all kinds of weather. A large fireplace, like the one shown, helps greatly in furnishing a room of this kind. It is also very pleasant during cool evenings, when a little fire is comfortable, and it furnishes ventilation at all times. The ventilation through a chimney is much more rapid when the fire is burning, but a good flue will carry off the foul air from a room in a steady stream all day and all night. A fireplace is worth all it costs for ventilation alone. It is also an economy in the spring and fall when the days are warm and the nights are cool and a little open fire makes the house comfortable and saves firing up the large heating apparatus.

The further end of this room is intended for a dining room and also for a parlor and sitting room. When not in use the dining table is pushed into the corner and the chairs used for other purposes. When you come to think about it, there is little furniture in the ordinary dining room. The dining table and half a dozen chairs are all that are necessary for a small family, and in many houses the dining room is shut up twenty-two hours out of the twenty-four, simply to accommodate seven pieces of furniture, most of which are quite small.

There is just one suggestion for an improvement in this plan, and that is to build a back porch big enough and to hold the pantry.

A kitchen eight by sixteen feet makes a comfortable cozy little room to work in, but it is rather small for a farm house during the busy season. There is a constant controversy in regard to kitchens; whether they should be large or small. A large kitchen requires a great deal of traveling back and forth while the small kitchen has everything within reach.

In this plan, as it stands, there are two cupboards to hold all sorts of kitchen utensils. One of the cupboards is especially designed to hold the ironing board, vacuum cleaner, brooms, mop sticks, with a hook on the wall for the dust pan. In addition to the convenience for the tools mentioned this little cupboard has a trap door in the floor to let the soiled linen down into the laundry where it accumulates in a big clothes basket for wash day. Formerly such laundry shutes were built of wood, but a better practice is to leave a hole through the floor and have iron hooks to hold the big laundry basket underneath. A laundry shute, after months of use, becomes odorous so that when the trap door is opened the odor comes up into the rooms above. But there is no objection to a trap door in a cupboard like this with a basket suspended underneath.

The upper story in this house is divided into three bed rooms and a bath room. It will be noticed that every square foot of space is occupied, except the extreme corners where the roof comes down too low to give sufficient head room. There are three clothes

closets besides a small linen closet, opening off from the bath room.

Little room is taken up in the hallway. There is just about wall space enough to hold the different doors and leave an opening for the stairway. It would be difficult to design an upstairs in a house of this size on any other plan that would give so much room and comfort.

AN ATTRACTIVE COUNTRY HOME

Beautiful country homes naturally belong to some farms because the owners want beautiful homes. There really is not much difference in the cost. It is principally in management. Beautiful homes are not necessarily large nor expensive.

The house illustrated in Figures 113, 114, 115 and 116 is thirty-four by thirty feet in size. It presents an attractive appearance because of its well balanced proportions.

The basement is enclosed by a well made concrete wall eight feet high including the footings.

The basement contains a laundry, a furnace room with coal bin, a splendidly lighted dairy room seventeen by eighteen feet and a wash room for the men.

There is a grade entrance at the side of the house and there is a combination stairway which leads down to the cellar and up to the kitchen. The short stair leading down to the cellar is built under the front stair, which gives the necessary headroom and saves space.

The living room is twenty-eight by thirteen feet. It is well lighted with three side windows and two windows at the end.



Figure 113.—Attractive Country Home

In furnishing such a grand big room a davenport of the largest size is needed to place in the middle of the room facing the open fire. An overtufted davenport, four feet wide and about nine feet long so placed, taken in conjunction with the open fire, suggests solid comfort.

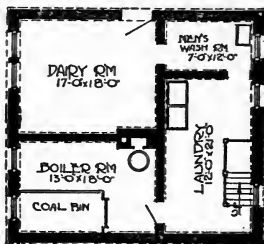

Figure 114.—Basement Plan

Besides the big davenport such a room requires several wide heavy armed chairs placed sociably in pairs or trios in the corners before the windows and along the wall spaces.

The dining room is twelve by sixteen feet with a window extension to hold a heavy but plain, factory-made, built in sideboard and double china cabinet. The sideboard is built across the window at the height of the window sill. The rounded glass fronts of the china closets commence at the top of the sideboard and extend up as high as a woman can reach to place the ornaments to show to advantage on top.

The window casing and wood work of the china cabinets and sideboard is all built together and the wood work corresponds with the finish of the room. In fact, the cornice of the china cabinets merges into the plate rail that is carried all the way around the room. The base board and crown moulding at the ceiling are made to correspond. The wood work in the living room and the dining room corresponds in every way except the plate rail.

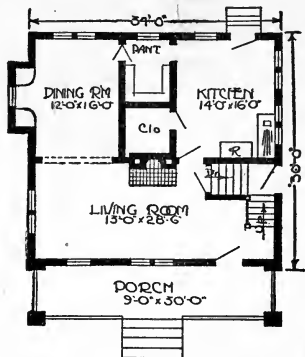

Figure 115.—First Floor Plan

All of the wood work is made plain and rather heavy. Simple elegance rather than fancy machine work is the keynote in modern house wood work. Straight lines, smooth satiny finish and soft tones are evidences of good taste in the finish in living rooms and dining rooms.

The kitchen in this house was designed especially for farm conditions where it is necessary to provide meals for extra farm helpers during haying and harvest and at other busy seasons.

In the first place there are two entrances to the basement, and there is a wash room down there for the men, and lockers where they may keep their working clothes. On fine days they will use the outside entrances to the kitchen and dairy room. In stormy

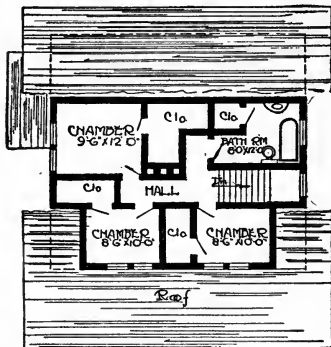

Figure 116.—Chamber and Roof Plan

weather they will use the inside cellar steps when going from the wash room to the kitchen for meals.

At such times the kitchen is intended for both kitchen and dining room. For this reason the range and sink are placed in one end of the room and a small dining table occupies a place near the outside door. This arrangement leaves the line of travel free

between the pantry, the stove, the sink, the store room and the cellar stairway.

The kitchen wood work is basswood finished in white enamel with plain white walls and ceiling. The floor is white maple, unvarnished. The white finish together with the light from five windows makes a very bright pleasant work room. The usual kitchen porch or veranda is left out of the plan to have the windows all free from obstruction for both light and air.

A back veranda is not really necessary in this plan because of the two outside cellar and kitchen entrances. Double storm doors in winter may be hung in place of the summer screen doors. The outside dairy entrance steps may be covered with a double door placed on an incline as a protection against storms.

The upstairs of this house is divided into three bed rooms and a bath room with plenty of closet room. The stairway is wide and well lighted by a large window that sheds light clear across the hall on the upper floor.

All plumbing pipes are confined to one corner of the house which makes for economy because the pipes are shorter. Commencing at the sewer in the laundry, the water supply pipes and the waste pipes are all bunched into one system and are exposed in such a way as to be easy of access in case repairs are needed.

ONE-STORY FARM HOUSE

In the house plan shown in Figures 117, 118 and 119 the cellar walls divide the basement into rooms to correspond with the rooms on the main floor so that the main outside walls and the principal inside partitions extend from the basement to the roof.

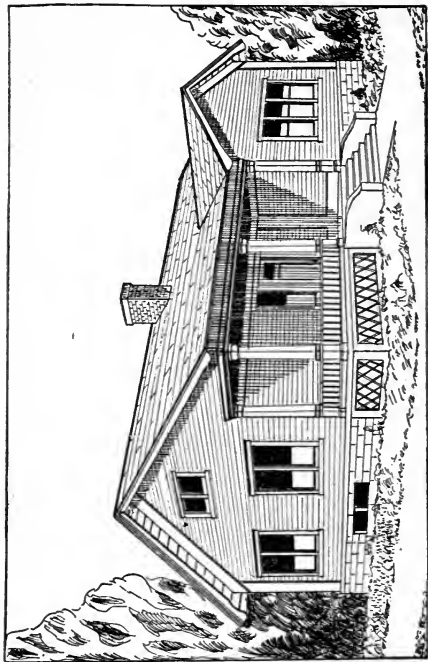

Figure 117.—One-Story Farm House

The basement is divided into three large rooms,—laundry, vegetable cellar, and furnace room. There also is a good wash room for the men.

Storage is provided both in the vegetable cellar and in the boiler room. Vegetables and fruit are kept cold

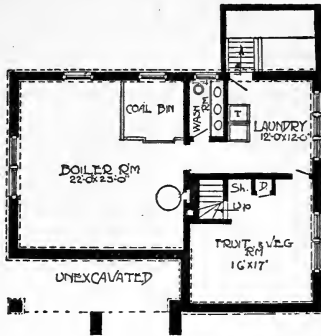

Figure 118.—Basement Plan

but the boiler room is warm enough in winter to be used for a farm shop. It is also large enough to furnish considerable room for the storage of such things as the best harness, saddles and extra horse trappings, binding twine, grain sacks, rope, hay slings, paints and oils and varnishes and many other things needed on a farm.

A farm cellar is made much more comfortable and slightly by pointing the walls on the inside and keeping them coated with whitewash. Also the ceiling should be lathed and plastered and kept white and

clean. Finishing the basement ceiling also makes the upper rooms more comfortable.

In this house the basement and the kitchen are connected by two stairways, one outside and one inside. An outside entrance is convenient and necessary when

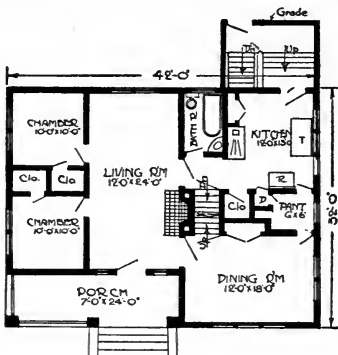

Figure 119.—Floor Plan

the basement is built for business as it should be. It is easy to provide a straight, wide concrete stairway into this basement and have it protected from the weather by building a shed instead of the usual back porch. The shed floor is on a level with the ground outside so that about six or eight steps will reach down into the basement and about four or six steps will reach up to the level of the kitchen floor.

The kitchen is twelve by thirteen feet in size and

there are two storage closets and a dumb waiter besides a good pantry, which is built in between the kitchen and dining room.

The dumb waiter saves many steps between the kitchen and the cellar. It is built with shelves to hold butter, lard, milk, bread, salt, pepper, left over cooking from the previous meal and many other small things needed instantly when a woman is busy working over the range getting meals.

The cage of the dumb waiter is built two feet square and six feet high. It is hung by a rope that runs over a pulley above and is counter poised by a weight so that it moves easily up and down.

There is a square hole through the floor half an inch larger each way than the cage. There is a projecting top to the cage which rests on the floor when the cage is down to prevent cold air from the fruit cellar escaping into the pantry or kitchen.

The plumbing in this house is confined to a small space so that the supply pipes and waste pipes may be all short. It is but a few feet from the bath room and kitchen sink to the laundry tubs and the men's wash room in the basement. There is economy in bunching the plumbing pipes all close together and so placing the bunch that it may be easily protected from frost.

A fine big living room extends through the house from front to back. This room is lighted by windows at both ends and it is brightened by a splendid fireplace that is decorated with a tiled hearth and a heavy wooden mantle.

The two bed rooms are ten by ten feet each with

good clothes closets between. There is wall space in each bed room to turn the beds two ways. Two bed rooms would not be sufficient on a farm, but there is a big attic in this house with two gables and these may be made useful when extra help is needed.

The stairway leading up from the dining room is, in this plan, closed by a door at the bottom. If, in after years, it should become necessary to raise the roof and make the attic into sleeping rooms, then the front entrance should be changed and a small vestibule taken from that side of the dining room. Part of the present pantry would then be worked into the dining room and the kitchen would be enlarged by moving the bath room upstairs. Few houses lend themselves so well to expansion ideas.

A study of the plan will show that the floor space is all utilized to the best advantage. All the rooms are well lighted by large windows rightly placed. Doors are made to open back against solid walls whenever possible. The chimney is large and is built in the center of the house. Windows are made large and in multiple where much light is needed.

This house should front towards the north, if possible, for several reasons. The large living room is much more pleasant when light and sunshine come in freely through the two duplicate windows. Both bed rooms would then look to the east to catch the early morning sun. The back entrance to the kitchen and cellar is protected from strong west winds by the shed. The west kitchen windows may be opened to the cooling west breezes when weather conditions are favorable.

BUSINESS FARM HOUSE

The modern tendency is to make farm houses small, compact and convenient rather than large and imposing. There are no old fashioned parlors in modern houses, furnished too nice for use. Instead, there is one big living room designed and upholstered for everyday comfort.

Small bed rooms with proper ventilation are more healthful than big rooms that have to be closed tight in winter to keep from freezing.

A good bath room with hot and cold water on tap costs less than the fancy roof ornaments on some houses.

Instead of low-headed, dark, dingy cellars, modern farm houses have well lighted basements divided into rooms designed for special purposes.

Stairways are built to save labor. They are the product of evolution, the study of which takes the reader through volumes of development that is fully as interesting and important as the growth of any other modern invention.

Hard wood floors have taken the place of carpets because they are more sanitary, easy to clean and are more attractive in appearance.

Builders of new farm houses have returned to pioneer simplicity in the enjoyment of an open fireplace during the evenings of fall and the chilly periods in spring. But they have extended the mild fireplace weather inside of the house to include the long winter evenings. They have done this by the aid of the modern warm air furnace installed in one room in the basement.

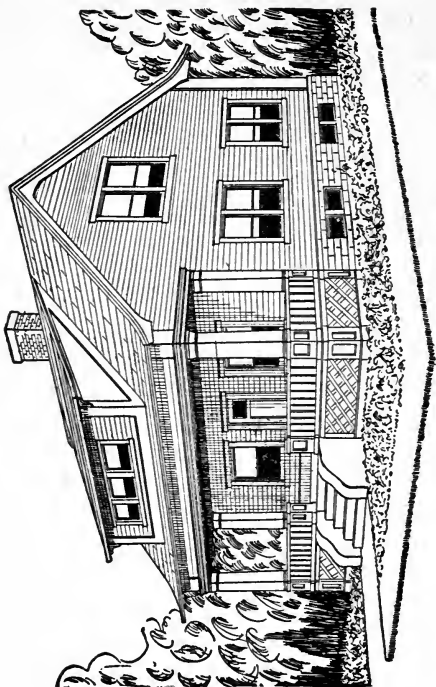

Figure 120.—Business Farm House

Farm kitchens in the newer houses are smaller and more convenient. If the modern kitchen be made large, a dining table can be placed in one corner or along one side. Such kitchens have several windows

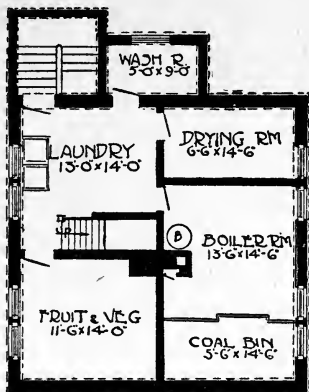

Figure 121.—Basement Plan

for light and ventilation. The room is carefully planned to save labor by bunching the necessary working utensils all within arm's reach as nearly as possible. Modern kitchens are planned and built with the same care as the front hall or living room. The kitchen is recognized as being the most important

room in the house and often is shown to visitors with as much pride as any other feature of the new home.

The house, shown in Figures 120, 121, 122 and 123, is small, only twenty-eight feet square on the ground,

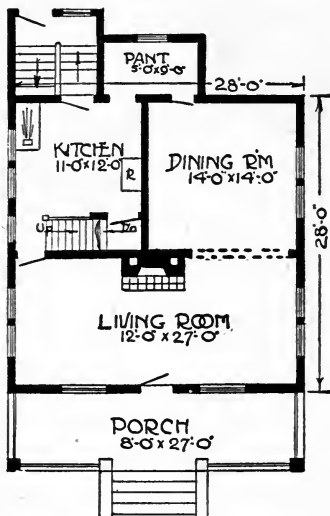

Figure 122.—First Floor

and the roof is low towards the eaves, but it contains three rooms on each floor and more in the basement. They are good sized rooms. The secret is in making good use of the attic and in the way the rooms are

huddled close together. There is little space devoted to hallways or stairways and the two dormer windows help. One chimney is cheaper than two and better when it is built where this one is, in the middle of the

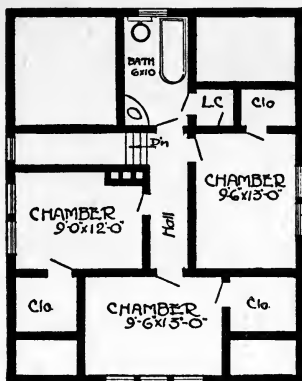

Figure 123.—Second Floor

house. The upper hall is not dark. It is lighted by a large window in the open stairway.

The working parts of this house deserve close attention. The kitchen is connected with the basement by two stairways. Going upstairs or down into the laundry from the kitchen is made as easy as possible. The inside stairway to the basement is for the women, the outside stairway is for the men. Both stairways are made roomy with easy steps. The outside steps to the cellar are made of solid concrete ten-inch tread with

seven-inch risers and are four feet in width. The outside steps leading up to the kitchen are made in the same way. The balance of the shed is covered with a concrete floor on a level with the concrete walk outside and there is no door sill to make an obstruction.

SQUARE FARM HOUSE

Theoretically, a square house is the cheapest to build and the cheapest to live in. Practically, it depends upon how it is planned and constructed whether it is either cheaper or better.

A full two-story house of small dimensions blocks off into square sensible rooms to advantage, and the upper rooms are warmed by some of the heat that would otherwise go to waste.

To take advantage of the mechanical principles of house construction and the thermic principles of house heating in this type of house the building must be small, not larger than thirty-six feet square. The plan shown in Figures 124, 125, 126 and 127, is only thirty by thirty-two feet on the ground, so it comes well within the specified economic bounds. Eighteen-foot studding are needed to allow for the joists and floors and then an eight-foot ceiling upstairs.

A square built house calls for a hip roof. The roof looks better and is cheaper if the pitch is low, say one-quarter or one-third pitch. The same pitch and hip design should cover the verandas and porches. A low pitch requires a rather wide projection, say three feet on a house of this size and height. No house looks well with a stingy eave projection. A heavy looking box cornice gives the house a solid appearance.

The basement of this house is planned and con-

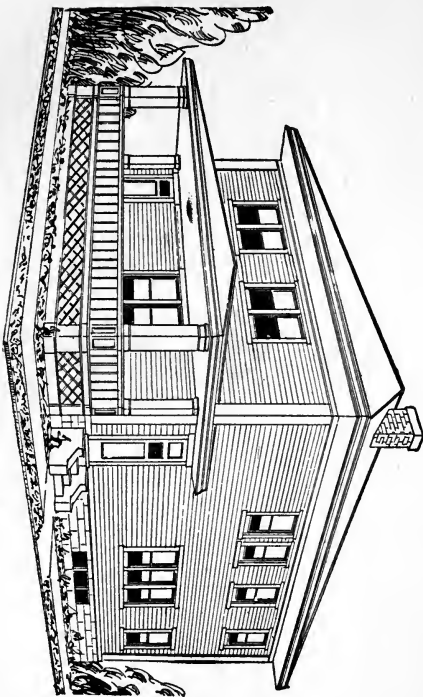

Figure 124.—Square-Built Farm House

structed in true farm house style to meet farm requirements. It contains a cold storage room for fruits and vegetables. The furnace room is partitioned away from the other basement divisions to confine the heat and dust to one section. This furnace room is easily reached by stairway from the kitchen or from the back cellar entrance through the laundry.

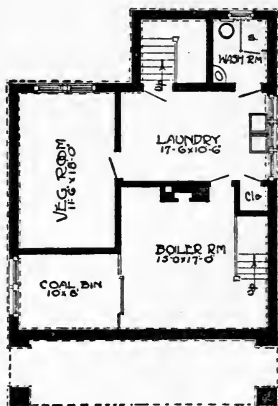

Figure 125.—Basement Plan

The laundry has all of the big and little inventions that help to whitewash all of the "blue Mondays" and to make wash day pleasant and agreeable. Opening off from the laundry is a wash room for the men, which includes a shower bath. There is a depression in the concrete floor with a drain strainer which con-

nects with the house sewer system. A small water pipe with pin holes in it is bent in the form of a circle. Hot and cold water pipes are connected with the circle pipe by a double globe valve arrangement which regulates the temperature of the water. Five dollars will buy the materials to make a shower bath

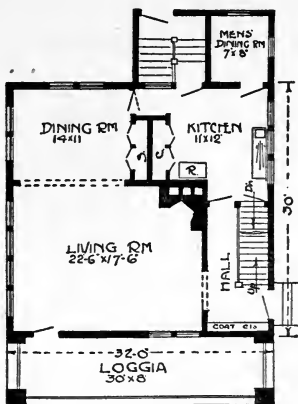

Figure 126.—First Floor Plan

and a handy tinker can easily put them together. Such a small room may be heated by a coal oil stove to make it warm enough in winter.

Another comfortable arrangement for the men is the porch dining room at the rear of the kitchen. From the wash room the men go up the outside steps to the porch dining room through the end of the

kitchen not used by the cook. If this little dining porch is used in winter the coal oil heater is brought up from the basement bath room at meal time. In summer the windows are left open.

The business end of the kitchen contains all of the working essentials within a small space. The range

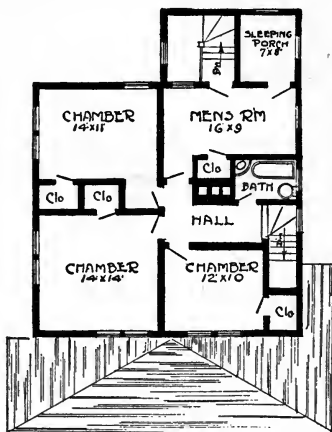

Figure 127.—Second Floor Plan

stands between the large kitchen cupboard and the sink and stairway to the cellar.

Upstairs, in the men's quarters, there is wall space for two single beds in the one bed room and there is room for two cots in the sleeping porch. The family is provided for by the three front bed rooms.

STORY AND A-HALF FARM HOUSE

Instead of waiting to accumulate money enough to build a big imposing house, farmers are now studying how to build small comfortable homes. The new idea is to gather together in a small space enough of the so-called modern conveniences to supply each member of the family with warmth, light, fresh air and the facilities for keeping themselves clean.

Modern inventions were slow to penetrate into the interior of farm homes, principally because such improvements depend upon plumbing and so long as lead pipes and joint wiping were necessary the expense seemed prohibitive. In recent years, however, standard sizes and duplicate parts of plumbing materials and fittings have been adopted by the different manufacturers and are being made in great quantities by machinery. The result is that plumbing is better done at one-quarter of the former cost.

A very respectable looking and serviceable bath room equipment may now be had for thirty dollars or less, which price includes all of the attachments necessary to connect with the supply pipes, waste pipes and atmospheric ventilators. An ordinary mechanic can fit the different pieces in place and make nearly all of the connections with a combination pipe and monkey wrench. The job is neither difficult nor of long duration. The same may be said of kitchen and laundry plumbing and of the whole water supply system.

Wooden houses are more common on the farm than houses of any other material. This is because lumber for wooden houses may be had in every farming com-

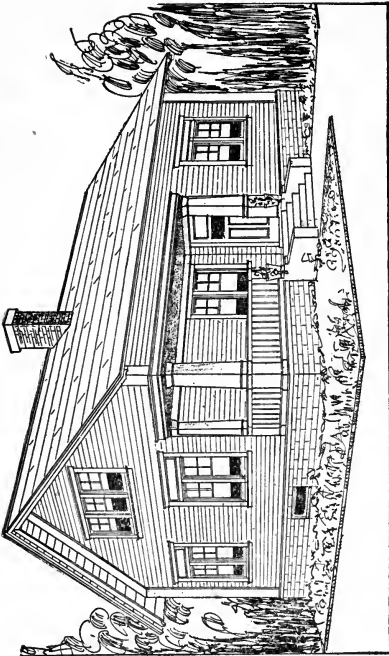

Figure 128.—Story and A-Half Farm House

munity and because the construction of wooden houses is better understood. There are men within easy reach who understand and who have the tools for putting wooden materials together to make a good house and their work usually is satisfactory.

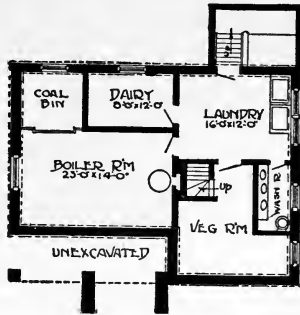

Figure 129.—Basement Plan

The accompanying illustrations, Figures 128, 129, 130 and 131, show a plain house that has square corners without any fancy crooks or ornaments.

In the first place there is a good basement. The wall is of concrete up to the surface of the ground. Ventilated or hollow concrete blocks are used to carry the wall up about three feet higher. There are several good reasons for so doing. It is easy to make an inside form for the concrete wall and to use the ground for the outside form. Also from the grade line up it is easier to lay concrete blocks than to construct a double form to make a solid wall.

Concrete block machines have been very much improved in the last five years so that good concrete block work may be done right on the building site.

It is easier to set the window frames between the blocks than it is to fit them into the forms when making a solid wall. There is still another advantage.

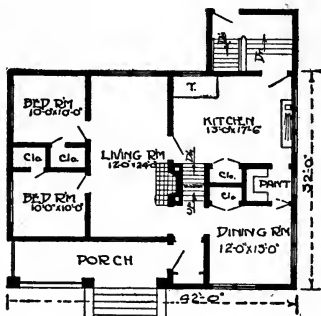

Figure 130.—First Floor Plan

When hollow blocks or ventilated blocks are used the air spaces in the blocks are non-conductors of heat, cold and moisture.

This design shows a story and a-half house. The main part of the house consists of the basement and the main floor. Two good bed rooms and a bath room **are built into the attic** space under the roof. These rooms are lighted by multiple windows in the large gables.

The house is forty-two by thirty-two feet on the

ground; the first floor is the same size, but upstairs is smaller on account of the low roof at the sides. Storage for fruit and vegetables is under the front part of the house.

The dairy room and laundry are close together under the kitchen and bath room so that the plumb-

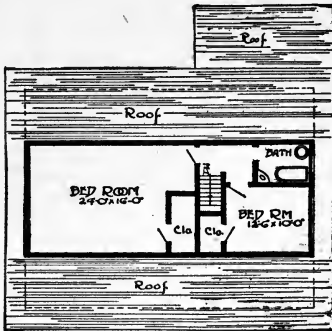

Figure 131.—Second Floor Plan

ing is bunched into one corner of the building. From the bath room down through the kitchen to the laundry and dairy is but a short distance so that all of these rooms may be supplied by the same water pipes and waste pipes.

The back entrance to the cellar and to the kitchen is a great comfort and convenience. The cement steps lead straight down into the cellar without any turn, which is important because the steps are used so many

times every day. The other set of steps leading up to the kitchen also are wide, roomy and easy.

There is an addition to the building which extends around these two sets of steps, thus forming a shed over the kitchen and cellar doors.

The kitchen in this farm house is arranged for convenience in doing the work. There is room for a good sized dining room table without interfering with the working end of the kitchen. The sink, cellar way, pot cupboard and pantry are all within easy reach.

There is a small dining room in the front part of the house which will be used a great deal when the family is alone, but during busy times the dining table in the kitchen will be found much more convenient.

The large living room twelve by twenty-four feet is built for solid comfort. It is lighted from both ends by large windows and there is a large handsome brick fireplace which is intended for heating as well as for ornament. The chimney flue is large enough and is placed properly to give a good draught so that the room may be warmed comfortably during mild weather while it is made cheery with the open fire. Such a fine large living room adds a great deal to the appearance of the interior of a farm house when it is furnished with large easy chairs and a davenport.

The plan provides for four bed rooms, two down stairs and two upstairs, which arrangement is about right for the average farm. There are many small conveniences about the house such as closets both on the ground floor and the upper floor. There is also plenty of shelf room in the pantry and there is a coat cupboard handy to the front door. The windows are mostly of the multiple style to admit plenty of light.

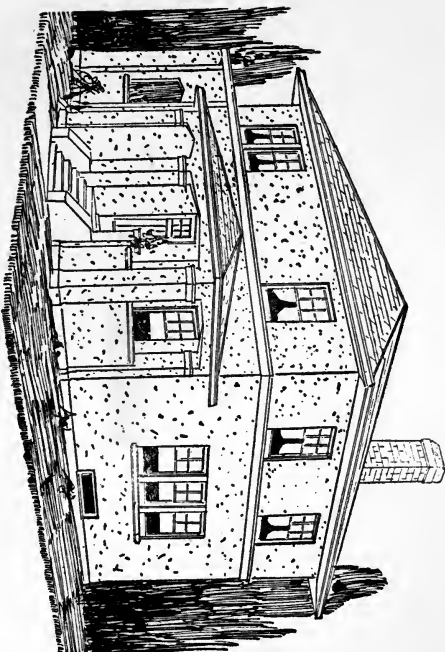

Figure 132.—Another Square-Built Full Two-Story House

ANOTHER SQUARE TWO-STORY HOUSE

The house shown in Figures 132, 133, 134 and 135 covers a space twenty-eight by thirty-two feet on the ground. The house contains four rooms and a wash room in the basement, three rooms on the first floor and four bed rooms and a bath room on the

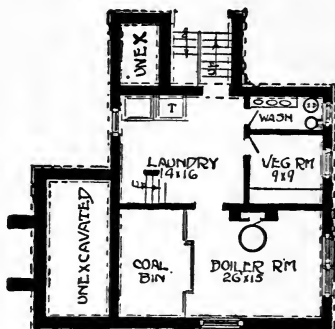

Figure 133.—Basement Plan

second floor. It also has an attic for storage purposes.

There is a concrete basement wall which extends up about a foot above grade. The construction of the house from the wall up is of two by fours for studding and rafters, with two by eights for joists. On the outside the studding is covered with boards dressed to an even thickness. They are better put on diagonally, especially in a windy country, because every board is then a brace to make the frame stronger.

Outside of the boarding is metal lath and cement

stucco. The only objection to metal lath is a tendency to rust. However, if the metal lath be thick and galvanized and the stucco well made and troweled on, it will last for a good many years. Stucco finish is somewhat cheaper than other kinds of veneer and looks well.

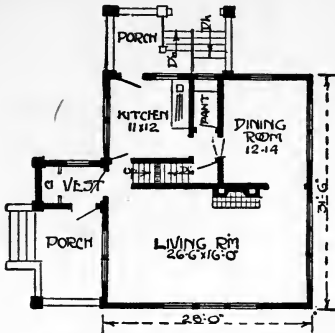

Figure 134.—First Floor Plan

Inside, the house is finished with lath and plaster in the usual way, but a thickness of high grade building paper is put in between the studding and the plaster by using furring strips to separate the plaster from the building paper. The best quality of building paper should be used. It is a good protection against heat or cold in any climate and the expense is not great. If poison-treated it is a protection against mice.

In cold climates special attention is given to window and door frames. They are made the right width to

allow the stucco to come flush with the outside edge of the frame so that the casing fits flat against the stucco. Sometimes when a specially tight window is wanted fresh stucco is plastered with a trowel around the edge of the frame and the casing nailed against the fresh mortar.

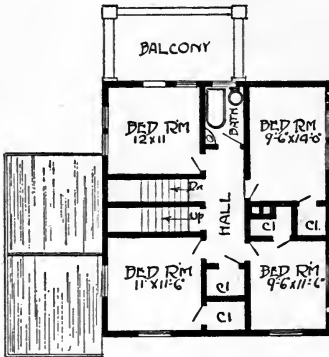

Figure 135.—Second Floor Plan

The front porch is built in keeping with the general appearance of the house, and like the house top, the porch is covered with a hip roof. It makes a very attractive front, or side entrance, according to which side of the house is built towards the road. The plan offers a choice without making any changes.

The general plan of the house is arranged for comfort in every room. Commencing with the basement, there is a roomy outside stair leading down from the

ground level at the rear. This stair is made of concrete built all solid together with the cellar walls. Cement steps also reach from grade up to the back porch.

The cellar or basement is divided into furnace room, laundry, cold storage for fruit and vegetables and a wash room for the men. In the corner of this wash room is a shower bath that is greatly appreciated. A drain in the floor carries off the superfluous water and discharges it into the septic tank along with the other house sewage.

On the first floor is the living room, dining room and kitchen. The living room is twenty-six by sixteen feet, with three triple windows and one double window, and there is a fireplace

The kitchen is nearly square. It is well lighted and conveniently arranged. Entrance to the cellar, both by the inside and outside steps, is convenient to the kitchen. This plan works out splendidly when there are extra men about as they make good use of the wash room in the basement and come up the outside cellar way to meals.

The rear porch in one house of this general design was fitted with sash and used as a men's dining room. It is no farther from the kitchen to the back porch than it is from the kitchen to the dining room.

Placing the front porch around the corner leaves the front of the house free from obstructions so that there is an uninterrupted view from the living room.

The plan of taking the vestibule from the end of the porch leaves the inside of the house free from jogs and corners and it provides room for a good sized coat cupboard outside of the house proper. It also places

the outside entrance directly in front of the stairway so that one can enter the living room or kitchen or go directly upstairs.

The second floor is divided into four bed rooms and a bath room with an extra stairway leading up into the attic. There is a clothes closet for each bed room and a linen closet in the hall. The clothes closet in the large bed room is not marked on the plan. It belongs over the stairway.

By referring to the floor plans it will be noticed that the doorways are all conveniently placed and that the doors open back against solid partitions. This is a comparatively small consideration, but it should not be overlooked in building a house.

Another desirable feature is the wall space provided for the placing of furniture. The new pieces of furniture are larger and more comfortable than ever before and more room is required in a house to place them for comfort in regard to light as well as for looks.

TWO-FAMILY FARM HOUSE

The design and plan shown by Figures 136, 137, 138 and 139 is a combination house that may be used for one or two families. Sometimes a valuable farm hand would like to get married and live on the farm; possibly a son or daughter would prefer to spend the first years of their married life in a separate apartment under the parental roof. The expense is less than to provide two separate houses.

If the upper rooms are not wanted for housekeeping purposes the bed rooms will come in handy for extra farm help or for the children as they grow older.

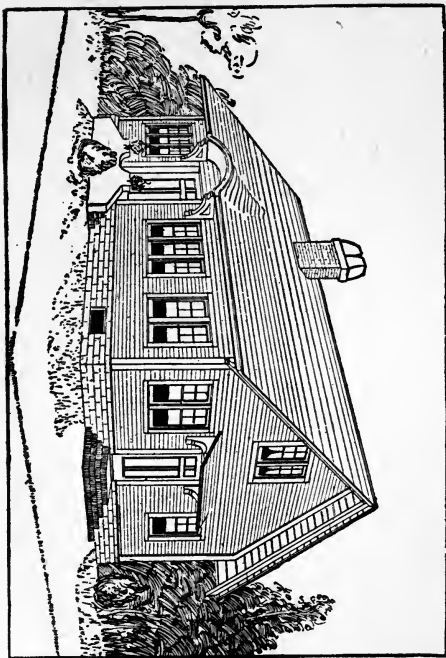

Figure 136.—Two-Family Farm House

The plans show a concrete basement divided into rooms that may be kept at different temperatures. There is a question whether it is advisable to have the dairy in the basement of the house. But there can be no serious objection if the room is light and has good drainage and is otherwise sanitary. It is cooler than a separate dairy house and the cost is less when the dairy is made as shown in this arrangement.

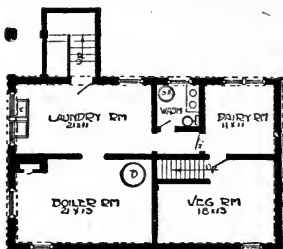

Figure 137.—Basement Plan

The house is planned for hot and cold running water on all floors. There are two bath rooms and a wash room in the basement fitted with a shower bath. All plumbing is connected with the septic tank by a line of four-inch vitrified sewer pipe with leaded joints.

Pumping engines are becoming so universal on farms that home water works only call for the additional fixtures and piping to carry the water where it is wanted.

If this house is well built by using building paper and double boarding, it may be heated with one fire in a good warm air furnace. An eight-room house

usually is considered the limit for hot air, and this house has ten rooms, but the heat pipes may be short, which is one of the main considerations.

There is no objection to using hot water heat in a house as large as this. Many prefer hot water as the heat is more even. A hot water heating plant costs more than a warm air heater, but it is cheaper to run, that is, you get better value for the coal consumed

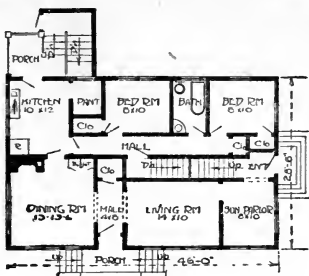

Figure 138.—First Floor Plan

which counter balances the extra interest on the first cost.

Inside wood work should be plain, no beading whatever and very few curves. The most expensive rooms are finished with plain, straight bands of wood instead of mouldings. From the baseboard to the crown moulding at the ceiling, including window casings, door casings, platerail and the finish of built in sideboards and book cases, all are straight and plain with square or slightly rounded corners.

The idea is to make the insides of the different

rooms smooth for easy cleaning, both to save labor and to prevent the accumulation of dust.

There are three outside entrances to this house. There may be four if the back steps are carried up to the second floor. A good pantry may be built on the second floor if another window is built in the gable end.

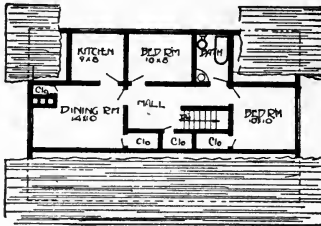

Figure 139.—Second Floor Plan

The old fashioned porches are different from the ordinary. The porch roofs may be extended out far enough to protect the steps by making strong brackets. There should be no porch pillars.

SMALL FARM COTTAGE

This comfortable, artistic little home with all of its modern conveniences may be built for less money than some of the very plain looking houses we see in some farming communities. It is just as easy to build a house with some style as to copy a poor old habitation that was built in the dark ages when window glass was a real luxury. See Figures 140, 141, 142 and 143.

This house is only twenty-seven by twenty-four feet

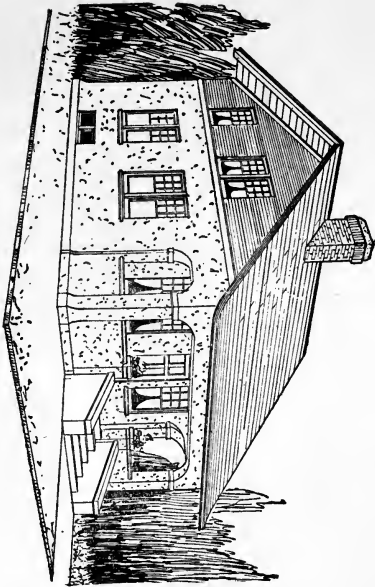

Figure 140.—Small Farm Cottage

in size on the ground and it is less than two stories high, but it contains three living rooms, two bed rooms and a bath room. And it has a cellar that is divided into departments the same as a large farm house.

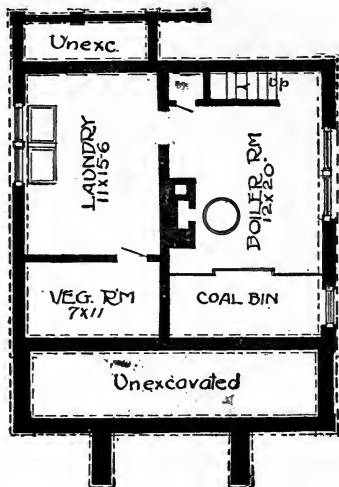

Figure 141.—Basement Plan

The construction above the cellar wall is a light framework of two by fours covered with wide boards and good building paper and metal lath and cement stucco. The roof is made in the same way except that roll roofing is used instead of stucco.

Inside, the walls are made of plaster board put on in wide panels carefully butted together to avoid open joints. Good quality plaster board will finish with paint or white enamel as well as wood. It is a good

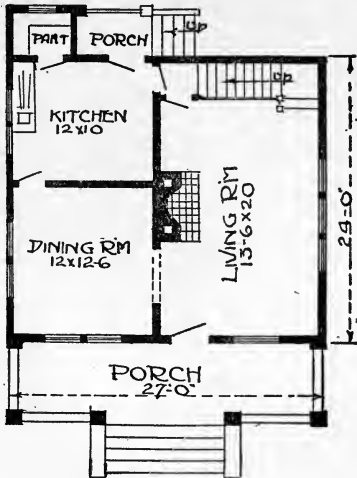

Figure 142.—First Floor Plan

plan to use a high baseboard to protect the plaster board near the floor, and there should be a smooth backing of boards in rooms that are not wainscoted. This backing should extend up about three feet.

The house is well planned for convenience, comfort

and economy. A small furnace of the warm air variety will easily keep the house warm, even in zero weather, because it is small, compact and well built.

The stairway is a model combination of front stair, cellar stair and double door entrance between the living room and kitchen. The pantry really is part of the back porch and there could be an ice door to let the ice in from the outside.

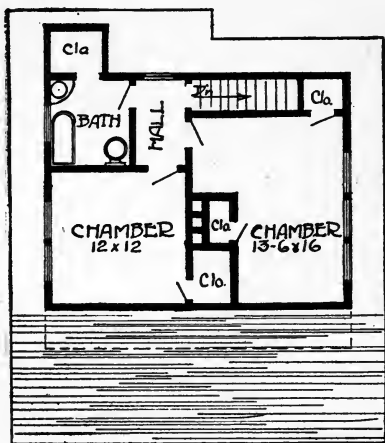

Figure 143.—Second Floor Plan

Rough-faced dark red or brown brick are used for the large fireplace. The wide mantle and chimney from floor to ceiling also is faced with rough brick.

A SPLENDID COUNTRY HOME

This model farm house, shown in Figures 144, 145, 146 and 147, is intended to combine the business of farming with the comforts of a real country home. The farm "office" in this house plan is in the dairy room where the farmer has a large roll top desk in



Figure 144.—Splendid Country Home

front of the double window near the rear entrance to the basement.

There is an electric motor in the partition between the dairy and the laundry. It is belted to the cream separator and to the electric light dynamo and to the washing machine in the laundry.

The hot water heater and boiler have capacity sufficient to supply 300 gallons of hot water which is piped to the dairy, kitchen sink and the two bath rooms and the laundry tubs.

The perspective view shows a small ravine at the back of the house which slopes away gently to the southeast. The house sewer follows along the east bank of this depression about 100 yards to the septic

tank. From the tank discharge the waste water is carried to connect with the title drainage system.

Some grading and planting are needed to complete the front of the house—terrace work which will extend

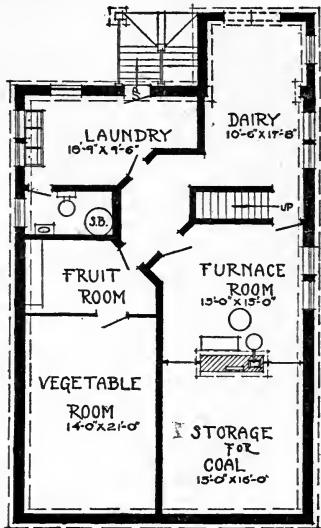

Figure 145.—Basement Plan

from the front corner of the veranda to the living room jog. From this point the ground slopes back to the rear of the house and is planted with hardy perennial flowers and bulbs.

The general type of window follows closely the multiple design used along the lower front, but single windows, doubles and triplets in different parts of the house are made to harmonize while varying in size and shape to avoid monotony.

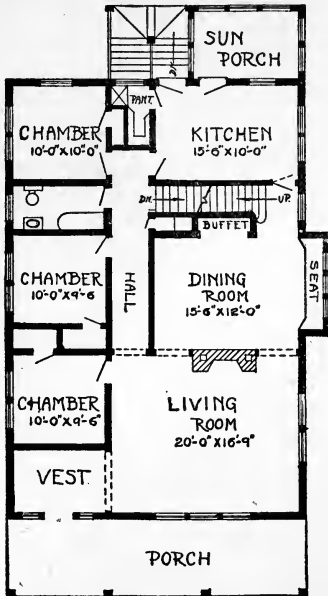

Figure 146.—First Floor Plan

The different floor plans show an interesting arrangement of rooms and household conveniences.

The kitchen dining table is in the sun porch, where it is out of the way of the kitchen workers. The fam-

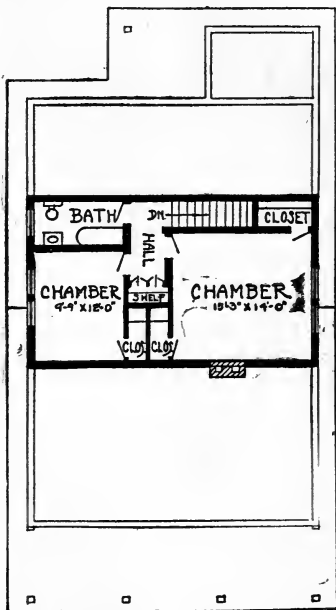

Figure 147.—Second Floor Plan

ily dining room is likely to be neglected during the busy season.

There is a dumb waiter which settles of its own weight and hangs from the ceiling into the dairy room in the cellar. It is lifted easily by turning a windlass.

FARM SEPTIC TANK

A septic tank provides a scientific means of rendering sewerage harmless. See Figure 148. It consists of two or three underground water-tight boxes connected together by U-pipes in the form of syphons. When an underground sewer tank consists of only one compartment it is called a catch basin and should be connected with a regular sewer system.

Two kinds of bacteria work in a septic tank, aerobic bacteria work in the first compartment and anaerobic bacteria work in the second compartment.

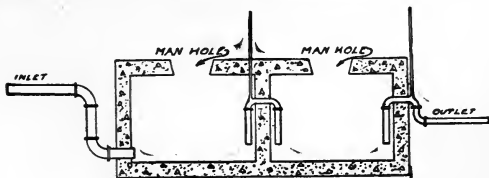

Figure 148.—Farm Septic Tank

Aerobic bacteria are so named because they require a certain amount of air in order to live and carry on their work of destruction, while anaerobic bacteria live and work without air. The two kinds are necessary to liquidize the solids in sewerage.

The first box or compartment of the septic tank is

open to the atmosphere by means of small ventilators, usually holes through the cover of the manhole. Also air is carried into this first compartment with the sewerage from the house by the intermittent charges which enter the compartment several inches below the surface of the liquid in the tank, thus forcing air into the liquid.

When the first compartment or tank fills then part of the contents runs over into the second tank in such a way that the liquid also enters the second tank several inches below the surface, but little or no air is carried over with it. The reason for, or necessity for these submerged inlets is that the work of the bacteria, in destroying offensive matter, is carried on principally under cover of the scum that forms at the surface. The perfect working of the tank requires that the scum shall not be broken. Bacterial action also depends to a certain extent upon the intermittent manner in which the different charges of sewerage are interjected into the tank.

The size of the septic tank varies according to the amount of sewerage to be disposed of. The capacity of the first box or compartment should be sufficient to hold two days' or three days' sewerage before it runs over into the second compartment. The second compartment should be about the size of the first.

The amount of sewerage usually is estimated according to the number of persons living in the house. About seventy gallons of water in twenty-four hours is figured for each person, so that each compartment of the septic tank should hold about 400 gallons for a family of four or five persons. This estimate includes a little extra as a margin of safety.

All supply pipes and all waste pipes within the walls of the house should be of iron.

The sewer pipes should be vitrified with all joints carefully and thoroughly cemented or leaded. The sewer between the house and tank should be four inches in diameter laid with a fall of about one inch in ten feet.

The syphon pipes and outlet pipes also should be three or four inches in diameter according to the size of the tank. They are set so as to prevent the liquid in the tank from rising to its level in the house sewer pipe regardless of the size or depth of the septic tank.

The best material used for the construction of a septic tank is concrete. The walls of the tank may be made of a very coarse mixture, but the lining should be a rich cement mortar made with fine sand and pressed smoothly with a trowel to make it water tight.

The tops, or covers of the tanks require reinforcing. This may be done with iron or steel rods, but a cheaper way is to use heavy woven wire fencing. What is ordinarily sold as heavy "hog wire," is very good for the purpose. Any old iron bars may be thrown in to get rid of them, but the hog wire will reinforce the cover sufficiently.

In making the cover, manholes must be provided. When the cover of the tank is being made, a tapering box placed on the false wood work answers as a mold for the manhole opening. If the box be made deep enough the same box may be used to cast the cover by using the bottom of the box for the hole and the top of the box for the cover. This gives the cover the same mitre as the hole so that when it is put into position it fits perfectly. Any mold for casting cement

must be greased to prevent the cement from sticking fast. The mold for the manhole cover must be made true and the partition floor placed in the box at the right height so the cover will settle down into the opening in the tank top about even.

A heavy chain is cast into the cover reaching clear through. An ordinary eye-bolt is not sufficient. If the cover sticks and a pry is used the eye-bolt may be loosened, but a few links of chain that reach clear though the cover rarely give trouble.

The depth of the tank must be governed by the depth of the cellar from which the sewer pipe is taken. In all cases the sewer pipe should be below frost and the septic tank should be some distance from the house; fifty feet or more.

Generally speaking, the bottom of the septic tank should be at least three feet lower than the bottom of the cellar. Four feet is better.

The final discharge from the septic tank is supposed to be inoffensive but it is generally recommended to discharge into four-inch drain tile so that the water can percolate away. The ground in this case will act as a purifier.

The amount of drain tile should be sufficient to hold as much liquid as one compartment of the septic tank; generally it will amount to a great deal more than that because the overflow would naturally be carried away for some distance. It may be connected with the farm drainage system.

It is usually figured that one length of four-inch tile would hold one gallon of liquid discharge, which calculation would require about 400 tiles.

One precaution should be taken in regard to per-

mitting kitchen grease to flow into the septic tank. Grease gradually accumulates on the pipes and may cause trouble in time. It is better not to let much grease get into the kitchen sink.

A septic tank properly made and kept free from grease may not require cleaning out for a number of years; however, it is better to open a tank after it has been used for six months or a year, to make sure that everything is working all right.

CHAPTER XIV

DICTIONARY OF BUILDING AND ARCHITECTURAL TERMS TOGETHER WITH NAMES OF MANY DIFFERENT KINDS OF BUILDING MATERIAL

Abacus.—The upper corbels overtopping a column, next under the architrave.

Abutting Joint.—Where the end of a piece is joined to the side of another piece so that the grain of the wood is placed one at an angle to the other.

Acanthus.—A leaf ornament at the top of a column.

Acropolis.—The upper part of a fortified citadel.

Acroterium.—Any angle of a pediment or gable, usually the upper or pitch angle. An ornament or statue place at the point of a pediment angle. The ornamental prow or stern of a classical galley.

Aeolian Harp.—A box fitted with keys and strings tuned to chords or harmonics. It is placed in a partially open window so the wind plays with the strings.

Alinement.—(Sometimes spelled *alignment*). To place in line as per plan.

Ambulatory.—A place to walk. A promenade. Formerly in a cloister. See *Portico*.

Amphiprostyle.—Having columns at each end, but not at the sides.

Andiron.—One of a pair of metal fuel supporters used in fireplaces. Fire dog.

Angle.—The approach of two straight lines to a converging point.

Angle Bead.—Rounded beaded corner of an angle piece used to protect the outer corner of a wall.

Angle Iron.—Rolled iron or steel, the cross section of which forms an angle. Usually a right angle.

Annulet.—A ring moulding. Often worked on a corner block used to join door casings and window casings.

Anta.—A pilaster with capital and base, usually formed by thickening the wall.

Arcade.—A series of arches together with the columns or piers which support them, open, or with openings on one or both sides and with an open clear passage running lengthwise. There may be a railing in front or at the back with no railing in front, or it may be open between the columns in every direction.

Arch.—Segment of an ellipse or circle. An upward curve.

Architrave.—That part of a structure next above the abacus or upper corbel above a column. The lower division of the entablature, consisting of the upper fascia and lower fascia. Also a set of mouldings running across over a square doorway. A decorated beam spanning the distance between two or more posts.

Archivolt.—The front or outside surface of an arch, the mouldings forming the ornamental voussoir curve.

Area.—When a cellar is deep the windows reach down below the surface of the ground. The earth is removed and the space is boxed around with brick or concrete. The opening is called an area.

Atlantes.—Half figures of men to support an entablature (see *Telamones* and *Caryatides*).

Axis.—A central guiding line used in the preparation of architectural drawings.

Balcony.—A projecting platform, cage, or short gallery, resting on brackets or consoles enclosed by a parapet.

Baldachin.—A canopy supported by pillars. It may stand on the floor, hang from the roof or project from the wall. It is generally placed over an altar.

Baluster.—A spindle to support the rail of an open staircase. A baluster is sometimes incorrectly called banister.

Balustrade.—A rail with a row of balusters to support it to protect an open parapet, balcony or bridge.

Barge Board. See *Verge Board*.

Barge Course.—Projecting bricks forming a continuous projection capping a gable wall.

Bascule Bridge.—A lift bridge operated by a lever which is pivoted in the center and weighted at one end. The outer end of the bridge is lifted. As it rises it closes the inner approach like a door. A draw bridge to a castle. Also used to bridge canals at street crossings.

Base Board.—A plinth, usually having a moulded upper edge. Used around a room as a finish to the lower part of the walls.

Batten.—Also spelled *batton*. A narrow strip of wood or metal used to cover a crack.

Beam.—A stick of timber of considerable size.

Belfry.—A bell tower. A cupola with supports to swing a bell.

Belly.—The belly of a timber is the outward or downward curve. See *Camber*.

Bin.—A small room or box partitioned off in a granary or barn. It may or may not have sloping sides or bottom, with or without carrying shutes. Hopper bin. Grain bin.

Bird's Mouth.—A v-shaped opening in the end of a piece of timber. Sometimes it is made ornamental.

Blinds.—There are both inside and outside window blinds, both made of wood. Inside blinds fold back into recesses in the box window frame. Outside blinds usually are made in pairs and swing out and back against the side of the building. Both kinds are slatted.

Block House.—A log fort. The upper story projects beyond the first story on all sides.

Board Measure.—Lumber measure. Formerly 144 cubic inches constituted a foot of lumber, but 144 square inches now passes for a foot when the boards are one inch or less in thickness.

Bond.—In a stone wall the bonding stone reaches across to bind together the stones facing either side of the wall.

Booth.—A small house with one or more open sides. A stall in a market house. A stand for selling at a bazaar or fair.

Boudoir.—Small reception room. A private sitting room.

Bourse.—Money exchange. A meeting place, room or building, to make transfers in a mercantile way.

Box Office.—Booth for selling theatre tickets. An office with a selling window that is accessible to the public.

Brace.—A prop to prevent two timbers from coming

together. In modern plank frame construction a brace may also be a tie.

Bracket.—A triangular brace reaching out to support something.

Bridging.—Short pieces of scantling with beveled ends nailed between joists to stiffen the floor. These blocks reach from the bottom edge of one joist to the top edge of the next.

Bridgeboard.—A stair stringer.

Building Paper.—Used to cover the sides of wooden buildings. It is placed between two thicknesses of boards.

Camber.—Concavity of the under side of a beam. A vessel's deck is said to be built with a camber, because it curves upward. The term is sometimes applied to road-building. To curve or bend upward.

Canopy.—An ornamental projection over a door, window or niche. A roof-like covering.

Cantilever.—Also spelled *cantilever*. From *cant*, an external angle, and *lever*, a roof supporter. A bracket projecting out to support a balcony or the upper part of a cornice.

Caryatides.—Draped female figures supporting an entablature. See corresponding male figures, *Atlantes*, *Telamones* and *Persians*.

Cella of a Temple.—An enclosure between walls behind a portico.

Cement.—A mixture of lime, clay and other substances.

Portland Cement gets its name from Portland, England, where it was found as a natural deposit in the earth. It is now manufactured in many large factories.

Cement Mortar. A mixture usually consisting of one part cement and two parts clean sand, first thoroughly mixed dry, then thoroughly mixed wet. The fineness of the sand determines the fineness of the mortar.

Citadel.—Fortress. Fort. Fortification. Final strength in resistance. A citadel may be near a city or inside a fortified city. The heavily protected magazine section of a battleship.

Clap-Board.—Narrow weather boarding placed horizontally, each board overlapping the one next below. Clap-boards usually are about one-quarter of an inch thick at the upper edge and half an inch thick at the lower edge. This allows for saw cut and the ripping of two clap-boards from a rough board an inch thick.

Colonnade.—A series or range of columns placed at regular intervals with entablature, stylobate, roof, etc. If placed by itself it is sometimes called a peristyle. If attached to a building, a portico.

Column.—A cylindrical post more or less elaborate, usually with base, shaft and capital. A pillar, used to support some part of the superstructure.

Concrete.—Spontaneous union of cement and sand and small particles of rock into a solid mass.

Conductor Pipe.—Down spout. Usually a three-inch pipe made of tin or galvanized iron to conduct rain water from the roof gutter to the sewer.

Console.—A bracket twice the height of its width, used to support a cornice or other projection.

Coping.—The top course in stone or brick walls. The covering course. Generally overlapping with provision for protecting the wall from rain water. Also called *copping*.

Corbel.—An upright series of bricks either in layers or single, each one overlaying the one below it, built up to support a projecting ledge, like a shelf mantle over a fireplace. A fancy carved bracket. Overlaying stone supports.

Cornice.—Projection, usually moulded. Finish under the shingles of a projecting roof.

Corps.—A small part of a building projecting beyond the general outline.

Cottage Roof.—Sloping from the ridge to the eaves at the ends as well as at the sides of the building. See *Hip Roof*.

Counter Brace.—Supplementary brace in truss work.

Cove.—An arch or concave.

Cove Moulding.—A moulding cut with a hollow circle, used in corners and between a ceiling and the wall.

Cupola.—An inverted cup or tub. A small dome-shaped roof. An ornament on the top of a tower in lantern style.

Curb.—The border at the side of a street. The gambrel in a roof.

Curb Roof.—Also called a gambrel roof. It has two pitches. The lower part, reaching downward from the curb to the eaves, is much steeper than the upper section, which reaches upward from the curb to the peak.

D & M.—In building specifications means dressed and matched. Planed and grooved or tongue and groove.

Dimension Stuff.—Building materials of wood in sizes as specified.

Dropsiding.—A trade name for weather boards that have been shaped in a sticker.

Dressed.—The rough saw surface planed off.

Extrados.—Same as *intrados*, taken collectively.

Expanded Metal Lath.—Sheet metal cut through with numerous slits and the openings spread.

Equerry.—Sometimes spelled *equery*, a stable for horses, presided over by a royal officer.

Ecurie.—See *Equerry*. A stable.

Fascia.—A broad fillet or flat band. In American house building the part of the finish under the roof projection that lies flat against the side of the building is called the fascia.

Fennestration.—Proportioned for windows or with windows in series.

Fire Dog.—An andiron.

Flashing.—Small sheets of tin inserted between shingles, or bricks, to turn rain water.

Flawn.—A court or part of a street marked off for some specific purpose.

Flyer, Fliers.—Steps in a straight stairway. Parallel stair steps.

Footing.—The side base of a wall or pier.

Gabion.—A cylinder of coarse basket work, without a bottom, to be filled with sand. A crib to be filled with stones and sunk in the water.

Gable.—The part of a building under the projecting end of a roof and above the level of the eaves. Gables usually are vertical and triangular in shape. The recessed triangular surface space is called the pediment.

Gallery.—A long, narrow floor with a low balustrade along the front side. It often is built to increase the

seating capacity of churches, halls, etc. Sometimes the gallery is too narrow for seats, but is used to connect two parts of a building. Galleries are supported by columns or brackets.

Gambrel Roof.—A roof that is pentagonal in cross section, having two pitches breaking at the curb, the lower pitch being steeper than the upper one. Same as curb roof.

Gargoyle.—A fancy water spout. On expensive buildings roof gutter outlets sometimes are fashioned in grotesque figures representing men or animals. Also spelled *gargyle*, *gurgoyle* and *gargle*.

Girder.—A heavy beam to support floor joists. A compound girder to support rafters is built of several pieces in the form of a truss.

Graywacke.—A term used to describe a mass of rocky material that has been partially cemented together by nature. In building it has been used to denote rubblestone masonry.

Grill Work.—Open work of light wood or metal to form a screen or partition.

GUILLOCHE.—Ornamental scroll work woven about round centers, originally a carving.

Gutter.—Rain trough at or near the eave.

Hair.—Usually means cows' hair collected from hides at the tannery. Hair is used to mix with plastering mortar and with stucco to help bind it together and hold it to the lath.

Hay Doorway.—A large opening for the hay fork. It should be six or eight feet wide and eight or ten feet in height.

Hay Fork Hood.—The roof projection built out over the hay door to protect the hay track extension.

Hermes.—A sculptured boundary stone showing a human head. A corner or boundary stone or post.

Hip Rafter.—The corner rafter in a hip roof reaching from the plate to the ridge at the corner of a building.

Hip Roof.—Sloping from the plate to the peak from the sides and ends of the building. See *Cottage Roof*.

Intrado.—The convex or interior surface of an arch stone or voussoir.

Jack Rafter.—A short rafter reaching from the eave to the hip rafter.

Joists.—Supports for both floor and ceiling. Joists usually are two inches thick and from six inches to a foot in width.

Key Stone.—A wedge shaped stone forming the apex of an arch.

King Post.—A brace post in a compound girder extending from the center of the tie timber to the ridge.

Lintel.—The horizontal top of a door frame or archway.

Loggia.—An enclosed veranda. More a part of a house than a porch. Usually not the entrance way. An outdoor room opening into a parlor or living room.

Log Scale.—Logs are measured, or scaled, across the small end with a rule marked for quick reading.

Lower.—Slanting boards closing a tower from rain. In a belfry tower to exclude the rain but permitting the sound to escape.

Mausoleum.—Sepulchre above ground.

Metal Lath.—Sheet metal slotted and expanded.

Minaret.—An open tower top of lantern or light-house or turret design. A slim tower attached to the

corner of a mosque, having projecting balconies, used to call the worshippers.

Molding.—Also spelled *moulding*. A strip of wood shaped to some graceful or fancy form.

Moncharaby.—A projecting latticed balcony supported by brackets or corbels. An oriel.

Monitor Roof.—A raised projection in the form of a turret, usually with slats for ventilation. Modern farm monitor roofs usually have windows on both sides of the monitor.

Mortise.—A hole, square or rectangular in shape, made to receive a tenon.

Mud Sill.—A log or stick of timber resting on the ground to support some part of a building.

Mullion.—See *Stile*. An upright division bar between lights of glass. Also written *munnion*, *munтин* and *munting*.

Multifoil.—An architectural ornament consisting of more than five divisions. The scalloped inner edge of a circle.

Narthex.—The outer court or atrium in church architecture. The term is used in connection with ambulatories. The narthex is used as a vestibule or lobby leading to the nave.

Oriel.—A bay window corbeled out.

Parapet.—A low wall to protect the edge of a platform, roof or porch.

Parvis.—The upper story of a porch.

Patio.—A Spanish word meaning a court in the rear and in connection with a building. The buildings form three sides of the inclosure, there may be a building or a high fence across the rear end.

Peak.—The summit or ridge of a roof.

Pediment.—The triangular surface space in the gable end of a building enclosed by the end projection of a simple roof. See *Tympanum*, also *Gable*.

Pentastyle.—A portico having five columns in front.

Pergola.—Also spelled *pergula*. Similar to a peristyle but usually is not connected with a building. An arbor with columns built of open work, usually of timbers. A vine covered arbor. It may be straight or curved.

Peristyle.—A complete set of columns with entablature in circular or elliptical form, usually placed around a court to connect two parts of a building or two separate buildings.

Piazza.—A gallery, roofed in arcade style. Longer than a portico.

Pier.—Usually of stone, concrete or brick, built solid with footings firmly imbedded in the ground.

Pitch.—The angle or rise of a roof.

Pilaster.—A pier projecting from a wall about one-third of its width, having capital, shaft and base to correspond with columns.

Pillar.—May be either pier or column. A symbol of strength.

Plancier.—The underside of the cornice projection. The ceiling that is nailed to the under edges of the rafters outside of the building.

Plate.—The upper horizontal timber in the frame of the side of a building. The lower support of the rafters.

Plate Rail.—A narrow shelf extending around the dining room. It is placed about five feet six inches above the floor.

Plank.—Thicker than a board. Planks are from

one and one-fourth inches to three inches in thickness.

Plaza.—A public square; a term borrowed from the Spanish.

Portico.—A covered ambulatory of colonnade form usually at the entrance of a building and usually in classical style. See *Ambulatory*.

Portico-Chaise.—A porch over a driveway for carriages to pass through. An elevated floor on the house side is placed at the proper level to step into or out of the carriages easily.

Post.—An upright support.

Prostyle.—A building having columns in front.

Purlin or *Purlin Plate*.—Used in pair in roof construction. Purlins extend horizontally of the building and support the rafters between the plate and the peak.

Quadra.—The lowest base of a pedestal. A water table, podium, listel, fillet.

Queen Posts.—Are used in pair in roof construction. Instead of one center king post two queen posts are placed, extending from the tie beam up to the purlins.

Quirk Moulding.—A corner moulding with a square inside corner and a bead worked on the outside corner. Used to protect the outside exposed corner of a wall.

Rafter.—Scantling or small timber reaching from the eaves to, or towards, the peak or top of the roof.

Rail.—The upper part of a balustrade.

Railing.—See *Rail*.

Ramp.—A concave cap overtopping a concave descending or ascending wall or path border. The rampart walls built at the sides of the steps leading up to a porch or veranda.

Renaissance.—Means rehabilitating an old style or design.

Resaw.—Planks are sometimes split with a resaw to make thin boards.

Ridge.—The top of the roof where the two sides meet.

Ridge Board.—A board set on edge between the ends of two opposite sets of rafters.

Ridgepole.—A round pole used to support the high center of a tent.

Riser.—The vertical face board connecting two stair steps is called a riser.

Roofs.—Hip roof, also called cottage roof. Curb roof, also called gambrel roof. Gable roof. Gothic roof.

Rubblestone.—Stone used in masonry in its rough natural state for filling between wall facings. Also cobble-stone wall, pier and chimney work. Sometimes called graywacke.

Sanitation.—Means cleanliness. Clean air, clean water and clean food for both man and beast. New farm buildings are designed along these lines.

Scantling.—Smaller than timber. Small dimension stuff.

Shakes.—Thicker and longer than shingles. A barrel stave. Shakes are rived out of timber bolts with a froe.

Sheathing.—Roof boards. Also boards used to side up a house before applying building paper and siding.

Shingles.—May be of wood, metal or asphalt. Slate shingles are called tile.

Shiplap.—Used for outside boarding.

Sill.—The lower timber in the frame of a building.

Sleeper.—A valley rafter. The valley flashings follow the sleeper down to the eave gutter or eave trough.

Stanchion.—Used to mean rigid stocks to fasten a cow in her stall. Modern stanchions are not rigid, but they still retain the name.

Stay Lath.—A temporary brace.

Stile.—In framework the upright pieces are called stiles and the cross pieces are rails. Smaller uprights to divide the framework into sections are called mullions. Stiles carry mortises, rails are tenoned into them.

Stilted Arch.—An arch on high posts.

Stoop.—A wide step in front of an entrance door, large enough to hold a seat, with steps leading to the ground. It may have a roof cover.

Stringer.—A horizontal sleeper. A timber to connect two or more upright posts. A longitudinal or lengthwise bed piece. A bridge timber to support a railway track. When a stick of timber lies crosswise of the track it is called a cross sleeper.

Strut.—Stretching piece. To hold apart. A brace placed at an angle between two parallel timbers. Used in truss work from or to a king or queen post.

Stucco.—Formerly an inside plaster made of sand and powdered marble and other ingredients. The name is now used to denote an outside plaster finish which usually contains cement and hair.

Studding.—Upright scantlings in house walls and partitions.

Stylobate.—A continuous flat band coping, or pavement for the base support of colonnade columns.

Superstructure.—The lighter or upper part of a building above the foundation walls.

T & G.—When used in house specifications means tongue and groove.

Tenon.—The end of a rail with shoulder or shoulders made to fit a corresponding mortise.

Threshold.—The stone or timber placed under an entrance door. A thin beveled strip of wood fitted across any doorway to meet up close against the bottom of a door.

Tie.—To hold together. The opposite of strut. It may be an iron rod or a stick of timber.

Tile.—Sewer tile is vitrified. Drain tile is burned in a kiln like brick. Drain tile also is made of concrete. Roof tile when well burned makes the most lasting roof.

Timber.—A straight stick of wood larger than four inches square.

Timber Measure.—Same as lumber, that is, 144 cubic inches make one foot.

Tread.—The top or surface of a stair step is called the tread.

Turret.—A revolving tower in which guns are mounted.

Turret Roof.—A term sometimes applied to the raised portion of a railway coach roof in which are the ventilators.

Tympanum.—The space between a smaller arch and a larger arch placed over it, or the space in the upper part of an arch above a lintel. The face of a pediment recessed, in an arch or gable.

Valley.—The junction of two roofs connected at right angles to each other.

Valley Flashing.—Sheet metal inserted between the shingles to make the valley gutter water-tight.

Ventilators.—Stable ventilation depends upon intake flues, outlet pipes, metal ventilator hoods and special windows.

Veranda.—A roofed gallery in front of a house with columns or pillars in front.

Verge Board.—An edgewise perpendicular border board suspended from the end of the roof on the gable end of a building. Also called barge board.

Vaulted Roof.—Concave arch. An arch continuous from side to side of a room.

Voussoir.—A wedge-shaped arch stone.

Wall Board.—A hard plaster composition rolled into sheets. It is sold in different widths and is used instead of lath and plaster.

Wall Sockets.—Iron sockets are made to hold the bottom ends of studding. The sockets are built into the top of the concrete wall so that no wooden sill is required.

Window Stool.—The inside finishing piece at the bottom of the sash.

INDEX

	PAGE
Architectural terms.....	236
A-shaped hog cot.....	120
Auditorium barn.....	65
Barn construction.....	10
Basement walls, different kinds of.....	160
Breeds of fowls.....	124
Brick for walls.....	166
Building bracket.....	58
Building material, names of different kinds of.....	236
Building plans, reading	172
Building terms	236
Business farm house.....	197
Butter dairy	92
Calf feeder	96
Center piers	167
Chicken oiler.....	149
Clothesline reel.....	159
Concrete barnyard	22, 152
Concrete dairy house with water tank overhead.....	94
Concrete dairy stable	22
Concrete engine foundation	153
Concrete garage	72
Concrete scale base and pit.....	154
Concrete feeding trough	156
Concrete foundations	23
Concrete ice house	101
Concrete mixing	28, 37
Concrete on the farm.....	151
Corn crib, two-story.....	76
Corn crib with open feeder trough.....	106
Corn crib, shelling and storing.....	79
Cost of building.....	9

	PAGE
Country home, a splendid	227
Country home, attractive	186
Curb-roof dairy stable.....	19
Curved rafters, how to form.....	67
Dairy and horse barn	23
Dairy and pump house	90
Dairy barn for thirty cows	43
Dairy barn for twenty-eight cows	33
Dairy house, small, separate.....	87
Dairy stable with wide center alley.....	13
Dairy stall and manger.....	58
Dictionary of building and architectural terms.....	236
Economy of farm buildings.....	7
Egg-shaped barn	62
Elliptical barn	62
Engine foundation, concrete.....	153
Farm buildings, miscellaneous.....	71
Farm homes	160
Feed hoppers, poultry.....	142
Feeding trough, concrete.....	156
Feed trough, sanitary poultry.....	147
Fencing, cost of.....	106
Five-room house.....	180
Floors and siding.....	176
Floors for stables.....	35
Foundations for farm buildings.....	160
Four-story poultry house.....	136
Garage	71
Gate, field	108
Grade cellar entrance.....	170
Grain, cleaning and grading.....	78
Grinding feed	80
Harrow sled	111
Hayfork hood	56
Hillside poultry house.....	135
Hog breeding crate.....	123
Hog house alley, concrete.....	157
Hog house, portable	117
Hog house, winter	112

	PAGE
Hog loading chute	123
Hog wallow, concrete	155
Hook for catching poultry.....	148
Horse and cow barn.....	16
Ice house	97
Ice house, concrete.....	101
Implement shed.....	84
Labor saving dairy machinery.....	54
Mail box, permanent.....	157
Manure carriers.....	31
Manure shed	100
Milking machinery	31
Milk record sheet.....	94
Monitor roof dairy stable.....	49
New York poultry house.....	130
One-story farm house.....	191
Paved barnyard.....	153
Plank floor construction.....	170
Plank frame construction.....	11, 26, 30
Portable brooder and small poultry house combined....	131
Portable hog house	117
Portable poultry house	132
Poultry	124
Poultry A-house	125
Poultry breeding terms	124
Poultry catching hook	148
Poultry feed hoppers.....	142
Poultry foods for winter.....	126
Poultry furniture	124
Poultry house	124
Poultry house, four-story	136
Poultry house, size of	126
Power house	71
Pump house	91
Reading building plans.....	172
Roof construction	41
Round barn	63

	PAGE
Round barn, floor plan of.....	66
Round curb-roof barn	62
Sanitary poultry feed trough.....	147
Scale house	104
Septic tank	231
Sheep barn, eight-sided	69
Sheep barns	68
Siding	176
Silage	68
Silage, use of.....	55
Sills	171
Silo	36, 46
Six-room farm house.....	173
Small farm cottage	222
Small farm garage	75
Square farm house	202
Square two-story house	214
Stable floors	51
Stable manure	38
Staking the cellar.....	160
Steel stall partitions.....	47
Stock hurdle	110
Storage barn showing bracing.....	60
Story-and-a-half farm house.....	207
Straw as feed.....	38
Two-family farm house.....	218
Two-story corn crib	76
Two-story granary, foundation and floor of.....	80
Ventilating system	46
Ventilation	30, 83
Ventilation for barns.....	20
Ventilation of poultry houses.....	134
Wall materials	164
Windows in stables.....	47



University of California
SOUTHERN REGIONAL LIBRARY FACILITY
405 Hilgard Avenue, Los Angeles, CA 90024-1388
Return this material to the library
from which it was borrowed.

NON-RENEWABLE

NOV 01 1993

ILL/KSC
DUE 2 WKS FROM DATE RECEIVED

REC'D LD-URL

DEC 09 1993

UCLA-AUPL
TH 4911 S539f



L 005 862 602 9

UC SOUTHERN REGIONAL LIBRARY FACILITY



A 001 219 326 4

Univ
So
I