

495
L3

UC-NRLF



SB 69 193

**FARM CROPS LABORATORY
MANUAL AND NOTE BOOK
F. W. LATHROP**

YC 59234

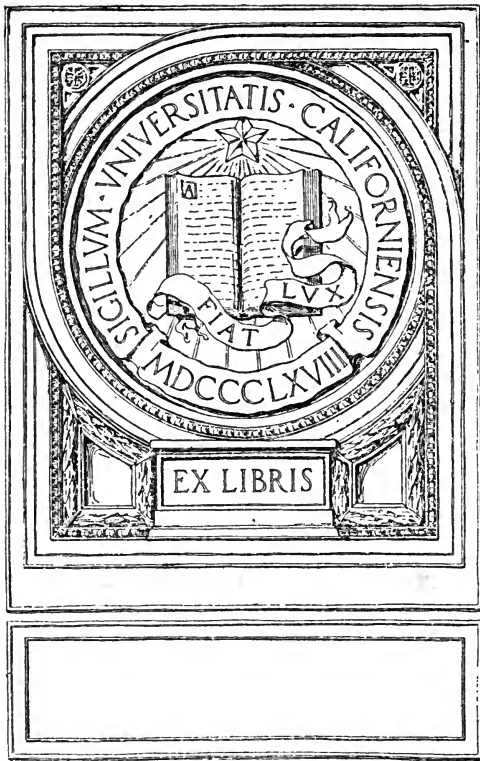

**FARM CROPS LABORATORY
MANUAL AND NOTE BOOK**

F. W. LATHROP, A.B., M.S.A.

LIPPINCOTT'S FARM MANUALS

Edited by K. C. DAVIS, Ph.D., Knapp School of Country Life, Nashville, Tenn.

- PRODUCTIVE SWINE HUSBANDRY 1915
By GEORGE E. DAY, B.S.A.
- PRODUCTIVE POULTRY HUSBANDRY 1919
By HARRY R. LEWIS, B.S.
- PRODUCTIVE HORSE HUSBANDRY 1920
By CARL W. GAY, D.V.M., B.S.A.
- PRODUCTIVE ORCHARDING 1917
By FRED C. SEARS, M.S.
- PRODUCTIVE VEGETABLE GROWING 1918
By JOHN W. LLOYD, M.S.A.
- PRODUCTIVE FEEDING OF FARM ANIMALS 1916
By F. W. WOLL, Ph.D.
- COMMON DISEASES OF FARM ANIMALS 1919
By R. A. CRAIG, D.V.M.
- PRODUCTIVE FARM CROPS 1918
By E. G. MONTGOMERY, M.A.
- PRODUCTIVE BEE KEEPING 1918
By FRANK C. PELLETT
- PRODUCTIVE DAIRYING 1919
By R. M. WASHBURN, M.S.A.
- INJURIOUS INSECTS AND USEFUL BIRDS 1918
By F. L. WASHBURN, M.A.
- PRODUCTIVE SHEEP HUSBANDRY 1918
By WALTER C. COFFEY, M.S.
- PRODUCTIVE SMALL FRUIT CULTURE 1920
By FRED C. SEARS, M.S.
- PRODUCTIVE SOILS 1920
By WILBERT W. WEIR, M.S.
- LIPPINCOTT'S COLLEGE TEXTS**
- SOIL PHYSICS AND MANAGEMENT 1919
By J. G. MOSIER, B.S., A. F. GUSTAFSON, M.S.
- FARM LIFE TEXT SERIES**
- APPLIED ECONOMIC BOTANY 1919
By MELVILLE T. COOK, Ph.D.
- PRODUCTIVE PLANT HUSBANDRY 1918
By KARY C. DAVIS
- HORTICULTURE FOR HIGH SCHOOLS 1919
By KARY C. DAVIS
- PRODUCTIVE SOILS Abridged Edition 1920
By WILBERT W. WEIR, M.S.
- LABORATORY MANUALS AND NOTEBOOKS**
ON THE FOLLOWING SUBJECTS
- SOILS, By J. F. EASTMAN and K. C. DAVIS 1915 POULTRY, By H. R. LEWIS 1918
DAIRYING, By E. L. ANTHONY 1917 FEEDING, By F. W. WOLL 1917 FARM CROPS, By F. W. LATHROP 1920

FARM CROPS LABORATORY MANUAL AND NOTE BOOK

F. W. LATHROP, A.B., M.S.A.

FORMERLY INSTRUCTOR IN AGRONOMY AND FARM MANAGEMENT,
SCHOHARIE STATE SCHOOL OF AGRICULTURE, COBLESKILL, N. Y.

44 ILLUSTRATIONS IN THE TEXT

Div. of
California



PHILADELPHIA AND LONDON
J. B. LIPPINCOTT COMPANY

L 113
L 2

4

COPYRIGHT, 1920
By J. B. LIPPINCOTT COMPANY

no visit
arranged

LIBRARY-AGRICULTURE DEPT.

*Electrotyped and Printed by J. B. Lippincott Company
The Washington Square Press, Philadelphia, U. S. A.*

CONTENTS

	PAGE
INTRODUCTORY NOTES.....	7
EXERCISE	
1. TO MAKE A BRIEF SURVEY OF THE FARM CROPS IN THE LOCALITY.....	12
2. TO CHART THE MARKET PRICE OF SOME CROP FOR A SCHOOL YEAR.....	13
3. TO UNDERSTAND THE FLOWER AND ITS PARTS.....	15
4. TO UNDERSTAND SEEDS AND SEEDLINGS AND THEIR PARTS.....	17
5. TO UNDERSTAND THE TYPES OF CREEPING AND UNDERGROUND PARTS OF PLANTS.....	19
6. TO LEARN THE CHARACTERISTICS OF THE GRASS FAMILY.....	23
7. TO SHOW THE CLASS THE BEST TYPE OF CORN PLANT TO BREED FROM AND GIVE EACH STUDENT PRACTICE IN FIELD SELECTION.....	27
8. TO LEARN TO RECOGNIZE THE IMPORTANT TYPES AND VARIETIES OF CORN.....	28
9. TO SCORE AND JUDGE CORN.....	30
10. TO DETERMINE WHICH EARS WILL GERMINATE STRONGLY.....	33
11. TO LEARN THE MOST IMPORTANT TYPES OF OATS.....	38
12. TO LEARN TO JUDGE OATS ON THE BASIS OF THEIR VALUE FOR FEED.....	40
13. TO LEARN TO CONTROL OAT SMUT.....	43
14. TO LEARN THE MOST IMPORTANT TYPES OF WHEAT.....	47
15. TO LEARN HOW TO JUDGE WHEAT.....	50
16. TO LEARN THE IMPORTANT TYPES OF BARLEY.....	53
17. TO LEARN TO IDENTIFY SOME COMMON GRASS PLANTS.....	55
18. TO LEARN TO IDENTIFY GRASS SEEDS.....	59
19. TO LEARN TO IDENTIFY CLOVER AND ALFALFA PLANTS.....	62
20. TO LEARN TO IDENTIFY CLOVER AND ALFALFA SEEDS.....	63
21. TO STUDY ALFALFA IN THE FIELD.....	65
22. TO ANALYZE CLOVER, ALFALFA, MILLET OR TIMOTHY SEED FOR PURITY.....	69
23. TO TEST SMALL SEEDS FOR GERMINATION.....	71
24. TO LEARN COMMON MEADOW AND PASTURE MIXTURES.....	72
25. TO STUDY THE MORPHOLOGY AND COMPOSITION OF THE POTATO TUBER.....	73
26. TO HARVEST SEED POTATOES BY THE HILL SELECTION METHOD.....	75
27. TO BECOME FAMILIAR WITH VARIETIES AND VARIETY GROUPS OF POTATOES..	77
28. TO LEARN HOW TO JUDGE POTATOES.....	81
29. TO LEARN THE IMPORTANT TYPES OF TOBACCO.....	83
30. TO STUDY TOBACCO GROWING BY THE SURVEY METHOD.....	85

CONTENTS

31. TO STUDY THE STRUCTURE OF THE COTTON PLANT.....	88
32. TO STUDY VARIETIES REPRESENTING DIFFERENT TYPES OF COTTON.....	91
33. TO STUDY THE SELECTION OF SEED BEANS.....	93
34. TO LEARN THE TYPES OF FIELD BEANS..	94
35. TO BECOME FAMILIAR WITH THE WEEDS IN THE VICINITY OF THE SCHOOL AND THEIR CONTROL.....	95
36. TO IDENTIFY SOME IMPORTANT WEED SEEDS.....	97
37. TO LEARN TO IDENTIFY SEEDS OF MISCELLANEOUS CROPS AND TO REVIEW SEEDS STUDIED BY MEANS OF AN IDENTIFICATION CONTEST.....	101
38. TO LEARN THE PRINCIPLES UNDERLYING THE ROTATION OF CROPS.....	103
39. TO LEARN HOW TO MAKE A BIBLIOGRAPHY AND TO BECOME ACQUAINTED WITH THE LITERATURE OF FARM CROPS.....	106
HOME PROJECTS IN FARM CROPS	108
CROP GROWING PROJECTS	110
WITH CORN, 1 TO 4	110
WITH POTATOES, 5 TO 9	111
WITH OATS, 10 TO 13.....	112
WITH ALFALFA, 14 TO 18	113
WITH TIMOTHY AND CLOVER, 19 TO 23.....	114
WITH COTTON, 24 TO 29	115
WITH TOBACCO, 30 TO 36.....	117
WITH PEANUTS, 37 TO 40 ..	118

INTRODUCTORY NOTES

These notes are written to suggest some of the methods of teaching farm crops and also to suggest to the instructor how he may use the exercises in this manual most effectively. The plan is to discuss some of the more important types of laboratory exercises used in teaching farm crops.

1. **Identification of Plants and Seeds.**—Several methods may be used in order to fix the identity of plants and seeds in the student's mind.

(a) *Drawing.*—Drawing seeds and plants necessitates the observation of certain characters which might otherwise escape attention. In the case of seeds a minimum size or standard should be set because the natural tendency of the student is to make the drawings too small. Correct labeling is essential.

(b) *The Use of a Key.*—Keys are in printed form for the identification of such crops as oats, barley, grasses and clovers. Many of these keys should be simplified for use in secondary schools.

(c) *Descriptive Outlines.*—Describing specimens according to a set outline is a useful method but has serious limitations. The student should have a set of definite descriptive terms of which he knows the meaning. This method should always be supplemented by one of the other methods in order to bring out the differences in the specimens described. When literature on variety or type description is available it may be used to supplement the study of the specimens at first hand.

(d) *The Identification of Numbered Specimens Unlabeled.*—This method is valuable because of the interest it arouses. Its purpose, however, is not to teach but to test and drill. The student should know what mistakes he has made and should correct them.

(e) *Class Discussion.*—Contrasts between specimens may be brought out by class discussion.

2. **Judging.**—The most common error in judging exercises consists of scoring and judging by the student before he has a real acquaintance with the score card. To avoid this error and for the sake of thoroughness judging work may well consist of three steps.

Step 1.—Let the instructor explain the score card. Then have the student examine specimens which illustrate the score card points as in Exercise 9.

Step 2.—In the case of potatoes, for example, have the student take several samples which are later to be judged and place them in the order of

merit in respect to each point on the score card. In judging corn take a five-ear sample and place the ears in the order of merit in respect to each point.

Step 3.—Score and judge the exhibits. After the judging is completed discuss the placings and clear up anything not understood.

It is well to have one or two exhibits which will score high. The other samples should show clearly most of the strengths and weaknesses indicated by the score card. The instructor needs a large amount of material to select from. In judging grains it is well to have at least one quart of each sample to be judged. More than one student may then work with a sample and the weight per bushel may be figured with fair accuracy.

A corn or potato show will nicely supplement judging work in these crops. The show should include a judging demonstration and a program to create interest in crop improvement.

3. Field Trips.—The following notes are taken from a lecture by Professor W. F. Lusk of Cornell University.

(a) Field trips should be considered as a necessary outgrowth of teaching and should not be organized merely for the sake of having a field trip.

(b) A field trip should have a definite aim.

(c) The number of field trips should depend upon the need and what the community has to offer.

(d) The teacher should have in mind the means of realizing his aim and the preparation on his part should be made with the same care as for inside laboratory work. He should go over the ground first. Failure to make careful preparation will be more fatal to success than with inside laboratory work.

(e) The class should be prepared by the presentation of specific information which will enable the students to appreciate the points presented on the trip. The teacher should raise questions which the field trip will answer.

(f) Do not attempt to do a job lot of teaching which has accumulated or dissipate the energy of the class over other subjects at the expense of the main aim.

(g) It is well to use the question and answer method to bring out the points of the lesson on the trip. As far as possible make the students think out the points.

(h) The lesson of the trip should be summarized by a later class discussion and generally by means of a notebook.

Diseases and Insects Affecting Farm Crops.—In a majority of cases, the entire newness of the subjects of plant pathology and entomology to the student and the lack of training for these subjects on the part of the instructor makes it impractical to go far into these subjects. In many schools the in-

structor can arrange that a part of the work can be given in the biology course.

He must, however, have a working knowledge of the terminology of plant diseases and insects. A special study of insects and diseases by the instructor is worth while because a large proportion of questions asked by farmers deals with these subjects.

The student must know enough terms so that he can understand (1) the life cycle, (2) the description (so that identification is possible), and (3) control measures for the most common diseases. Which diseases shall be studied, is for the most part a local problem.

The following references will be found useful:

Cook, M. T., Applied Economic Botany (LIPPINCOTT).

Percival, J., 1915, Agricultural Botany (Holt), Chapters 46 and 47.

Duggar, B. M., Fungous Diseases of Plants (Ginn).

The students should understand the terminology of entomology well enough to learn the life cycle, description and control of the important crop insects. Useful references are:

Washburn, F. R., Injurious Insects and Useful Birds (LIPPINCOTT).

Sanderson, E. D., and Peairs, L. M. School Entomology (Wiley).

Directions for Collection and Preservation of Insects, U. S. National Museum, Bul. 67.

Plant Physiology.—It is best to arrange for the student to get his plant physiology in his botany course previous to studying farm crops. Where this is not possible the suggested plan is that a series of demonstrations be prepared by the instructor and given at the beginning or end of the first seven or eight recitations. The students may be required to make note of each demonstration according to a regular outline.

By this method the student should get the necessary principles of plant physiology. The average student lacks skill in setting up well the necessary apparatus to demonstrate these things for himself in the laboratory and the returns for time spent are small.

Material.—A large and varied supply of plant and seed specimens is essential for teaching farm crops. Several supply houses can furnish this material but the instructor can secure the bulk of it at no cost from farms in his locality, commercial houses dealing in certain crop products, fairs and other exhibits. The students can obtain many specimens from their own and adjoining farms.

Equipment.—Farm crops can be taught with less equipment than most other subjects and part of it can be made in the school shop. The following is a suggested list for ten students:

10 small microscopes, tripod type.

Mouseproof and ratproof box, drawer or compartment for storing grain and head samples.

Seed corn tree, rack or other device for storing.

Sawdust box corn germinator and cloths.

4 dozen perforated blotter germinators for small seeds (Fig. 1).

10 glass squares.

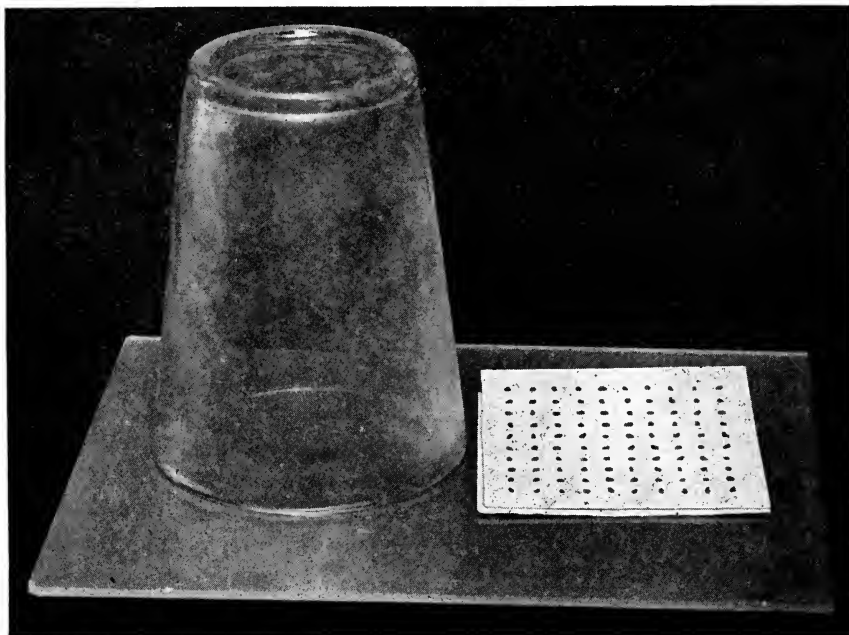

FIG. 1.—A method of germinating small seeds. The glass fits over the blotter. The upper blotter contains 100 perforations into which the seeds fit. The under blotter is a moisture reservoir.

10 large glasses to set over the blotters on the squares (Fig. 1).

2 dozen 2-ounce screw top vials.

1 gross small vials and corks.

3 dozen 16-ounce white flint wide mouth bottles and corks.

1 dozen 32-ounce white flint wide mouth bottles and corks.

Collection of 100 weed seeds commonly found in commercial seeds.

School set of economic seeds.

(The above two collections may sometimes be secured from the Seed Laboratory, Bureau of Plant Industry, U. S. Dept. of Agriculture, Washington, D. C., but they are not always available).

10 cardboard weed seed holders.

Beaver board or other stiff card on which to fasten specimens, diagrams, photographs, etc.

2 plant presses (may be made of carpet lining and rough, thin, absorbent paper).
100 botany mounting cards.
Insect killing bottle.
Hand sprayer.
Potato fork or hook.
Corn knife.
1 family scale, 24 pounds.
1 peck measure.
10 flower pots.
Trowels.

Grade.....

Date.....

EXERCISE 1
CROP SURVEY

Object.—To make a brief survey of the crops in the locality.

Directions.—Each student should ask three farmers for the information necessary to fill out the following outline for each. The figures should be for the crops of the previous year.

Name of Crop	Variety	Acres	Average Yield	Total Yield	Use
Orchard.....					
Pasture.....					
Woods.....					
Miscellaneous..					

What is the rotation?

All the records taken by the class should be combined in summary.

Summary of all Records Taken by the Class

Crop	Total Acres	Average Yield	Total Yield	Average Yield of State (Census)	Per Cent of Area	Most Important Three Varieties	Most Important Use
Orchard....							
Pasture....							
Woods....							
Miscellaneous							
					100		

What is the most common rotation?

Grade.....

Date.....

EXERCISE 2

CROP PRICES

Object.—To chart the market price of some crop for a school year.

Directions.—On the price chart the vertical lines show the prices, and the horizontal lines show the dates. Each student should choose a crop and a grade thereof as designated in the market reports. Select the publication which will be preferably a weekly agricultural paper, from which you will get your prices.

A duplicate of the chart in the manual should be kept. These duplicates can all be posted together in the laboratory and can be discussed from time to time.

Name of Crop	Grade	Publication	Day of Issue

SUMMARY OF PRICE CHANGES DURING THE YEAR AND THE PROBABLE REASONS

EXERCISE 2 (Continued)

Dates

A large grid for data entry, consisting of 20 columns and 30 rows. The grid is empty and intended for recording data for Exercise 2.

Prices

Grade.....

Date.....

EXERCISE 3

FLOWER PARTS

Object.—To understand the flower and its parts.

Definitions.—Taking any simple flower such as the nasturtium, geranium, or morning glory, the instructor should point out the location and uses of the following parts: Sepals, petals, stamens, carpels, pistil, filament, anther, ovary, style, stigma, receptacle (Fig. 2).

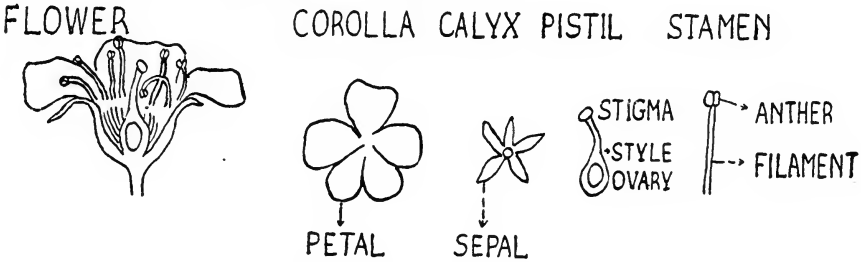

FIG. 2.—Parts of a complete flower.

Drawings.—Parts should be labelled by ruling a line from the part to the name of the part in the column at the right. Draw all parts large.

1. Carefully pull away the petals. *Draw a petal.*
2. Pull off the sepals, leaving only stamens and pistils. *Draw sepal.*
3. Take off the stamens. *Draw a stamen showing filament, anther and anther lobes.*
4. Only the pistil remains. *Draw this showing ovary, style and stigma.*

Application.—1. How is a grain or pod related to the parts of a flower?
2. What is a cross-fertilized flower? A self-fertilized flower? What crops belong to each class?

3. What effect do the relative positions of the stigma and anthers have on fertilization?

4. Describe the corn flower. Why are certain rows of corn sometimes detasseled?

5. How do insects help in the production of seeds?

Reference.—Percival, J., 1915, *Agricultural Botany* (Holt), 78–88. Cook, M. F., 1919, *Applied Economic Botany* (LIPPINCOTT).

EXERCISE 3 (Continued)

LABELS

EXERCISE 4

SEEDS AND SEEDLINGS

Object.—To understand seeds and seedlings and their parts.

Material.—Corn and bean plants two weeks old, corn and beans which have germinated, and corn and beans which have been soaked over night.

Directions.—All drawings for this exercise should be five times natural size. Seeds may be divided into two groups according to the way food is stored.

A. Food Stored in Cotyledons, or first two leaves. Example, the bean.

1. Take a soaked bean, remove the seed coat and separate the cotyledons. Make a drawing showing the embryo (little plant). Label cotyledon, plumule radicle.

2. Draw a germinated bean, labelling all parts.

3. Draw a plant two weeks old, labelling all parts.

B. Food Stored in Endosperm.—Example, corn.

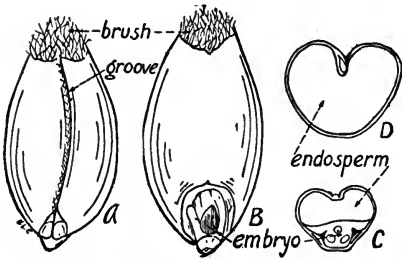

FIG. 4.—A wheat seedling. (Robbins' Botany of Crop Plants, P. Blakiston, Son & Co.)

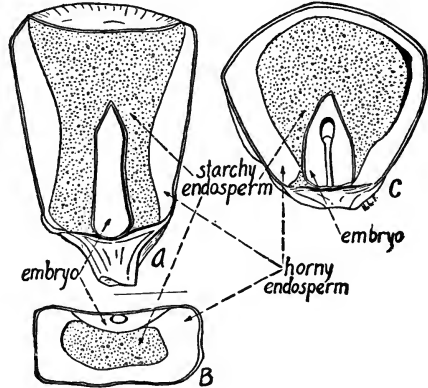

FIG. 3.—Cross section of a kernel of corn. (Robbins' Botany of Crop Plants, P. Blakiston, Son & Co.)

1. Shave down, on the germ side, a kernel of corn so that the germ is fully exposed. Make a drawing, labelling endosperm, embryo, scutellum, plumule, radicle. (Fig. 3.)

2. Draw a kernel of germinated corn labelling all parts.

3. Draw a corn plant two weeks old, labelling all parts.

Application.—1. Why is it that the bean seedling has difficulty in breaking

through a crust? Compare with wheat and corn.

2. What are the food values of the different parts of the corn kernel?

3. What are hominy, corn starch, and corn oil cake in relation to the seed parts?

4. How are germs in corn kernels killed and how do they appear when dead?

EXERCISE 4 (Continued)

LABELS

EXERCISE 5

CREEPING AND UNDERGROUND PARTS

Object.—To know the types of creeping and underground parts of plants.

1. **Parts of a Root.**—Obtain corn and bean seedlings which were grown for the previous exercise. Note that the primary root of the bean is strongly developed and secondary roots branch from it. The primary root of corn is



FIG. 5.—A fibrous-root as shown by a grass plant. (Cook's Applied Economic Botany.)

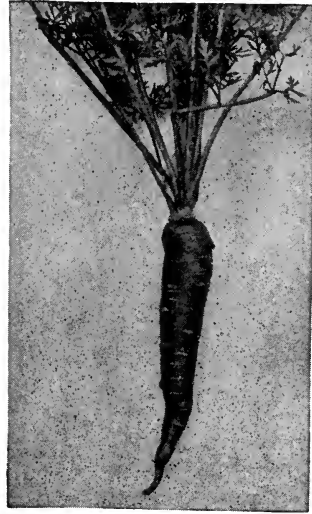

FIG. 6.—A fleshy root as shown by a carrot. (Cook's Applied Economic Botany.)

succeeded by others which do not arise as branches upon the primary one but spring from the stem a certain distance below the ground. The roots of common grasses and cereals form in this way. Note the fine root hairs which form just back of the root tips. Through these the plant obtains food from the soil.

2. **Types of Creeping and Underground Parts of Plants.**—Draw an example of each type to scale so that all five drawings may occupy one page. Do not draw the potato tuber since this will be done in a later exercise.

A. *Fibrous Root.*—Examples: Timothy, wheat, oats, barley (Fig. 5).

B. *Tap Root.*—Examples: Alfalfa, red clover.

C. *Fleshy Root.*—Examples: Carrot, turnip, beet (Fig. 6).

D. *Stolon.*—Examples: Strawberry, orange hawkweed.

EXERCISE 5 (Continued)

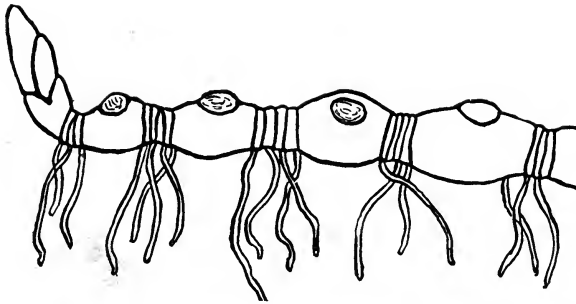

FIG. 7.—A rhizome. The underground stem of Solomon's seal. (Cook's Applied Economic Botany.)

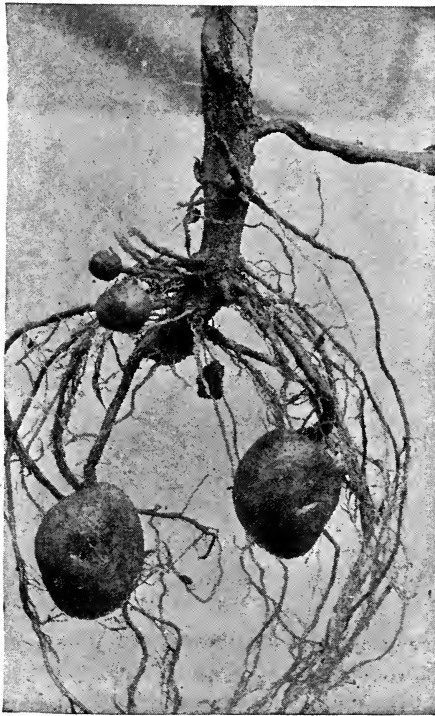

FIG. 8.—A tuber as shown by the potato. (Cook's Applied Economic Botany.)

E. *Rhizome* (underground stem).—Examples: Kentucky blue grass, Canada thistle, quack grass (Fig. 7).

F. *Tuber*.—Example: Potato (Fig. 8).

EXERCISE 5 (Continued)

3. **Further Examples.**—Place the names of the common plants in your locality in the table below as they fall in one or more of the six groups. For example, a plant may have both rhizomes and fibrous roots.

Fibrous Root	Tap Root	Fleshy Root	Stolon	Rhizome	Tuber

Application.—1. Compare the root systems of timothy and clover. Give one reason why they grow well together.

2. Why should an alfalfa field have a supply of lime in the subsoil?

3. Can you control quack grass and orange hawkweed by preventing seed formation?

4. What does a grass sod consist of?

5. Why does a wild carrot not produce seed the first year?

EXERCISE 5 (Continued)

LABELS

Grade.....

Date.....

EXERCISE 6

GRASS FAMILY

Object.—To learn the characteristics of the Gramineæ (Grass Family).

Materials.—Corn and oat plants, wheat and barley spikes.

Explanation.—Both the cereals and the grasses belong to the Family Gramineæ, the members of which are similar in structure. Agriculturally, this family is more important than any other.

Roots.—The Gramineæ have fibrous roots. See Exercise 5.

Stems.—The typical stem of the Gramineæ is hollow, is circular or flattened in section and is divided by nodes.

Drawing I.—Draw the transverse section of a corn stem.

Drawing II.—Draw the longitudinal section of a short piece of corn stem which includes a node.

Drawing III.—Draw a longitudinal section of a sheath ring on oats. Be careful to show the relation of the ring to the node. This ring occurs on oats, bent grasses and fescue grasses.

Leaf.—The leaves of the Gramineæ are arranged in two rows alternating up the stem. The leaf consists of a sheath and a blade.

Drawing IV.—Draw the junction of the leaf and the blade on a corn leaf. Show sheath, ligule, auricle and blade.

Spikelets.—The spikelets of the Gramineæ have (1) a pair of outer glumes; (2) a flowering glume and palea surrounding each kernel; (3) an undeveloped flower represented by the axis and empty glumes.

Drawing V.—Arrange the oat spikelet parts in the order in which they occur. Draw ($\times 3$) and label them carefully.

Drawing VI.—Draw a wheat spikelet in the same manner.

Drawing VII.—Draw the barley spikelet. Note that three spikelets occur at a node instead of one as in oats and wheat.

Observation.—1. The class should observe a corn ear (Fig. 9) and tassel and note the similarity in structure to the three spikelets drawn.

2. Observe resemblance between spikelets drawn and spikelets of timothy, rye grass or one of the other grasses.

Discussion.—After reading Sargent, F. L., *Corn Plants*, pages 11–34, Cambridge, 1899, the instructor should discuss with the class the ways in which the structure of the Gramineæ enables them to cope with their environment.

EXERCISE 6 (Continued)

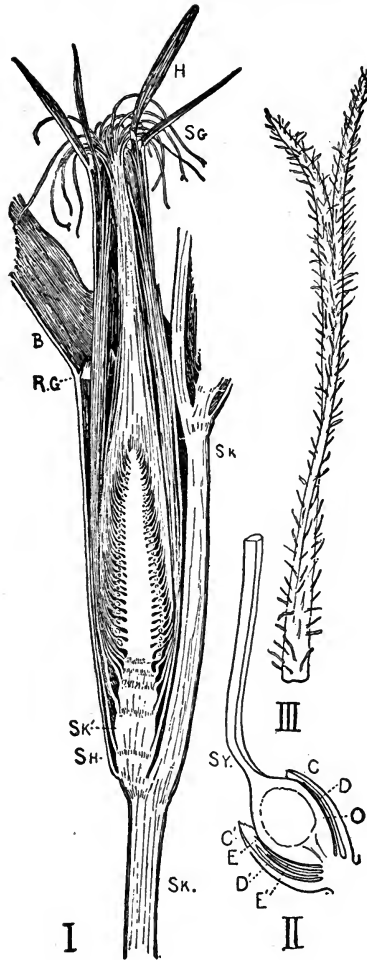

FIG. 9.—The Structure of an Ear of Corn. I. A young ear cut through the middle lengthwise. Sk, the main stalk; Sk', a short branch which bears the ear; Sh, sheathing of lower part of the leaf which enfolds the whole ear and its husks; B, blade of the same leaf; R. G., rain-guard which keeps the rain from running into the sheath and promoting decay; H, the "husks" or large, leaf-like bracts around the ear; Sg, stigmas (the "silk") protruding beyond the husks. About one-third natural size. II. A spikelet of the same ear, showing the bracts (C, C', D, D', E, E'), and the ovary (O) and the lower part of the style (SY) of the single pistil. Enlarged. III. Upper part of the stigma of the same, showing the delicate hairs that cover it. Enlarged. (Sargent.)

References.—Carrier, Lyman. U.S.Dept. Agr. Bul., No.461. Ward, H. M., 1908, Grasses (Cambridge University Press). Sargent, F.L., 1899, Corn Plants (Houghton Mifflin). Hitchcock, A. S., 1914, Text-book of Grasses (Macmillan).

EXERCISE 6 (Continued)

LABELS

EXERCISE 6 (Continued)

LABELS

EXERCISE 7

FIELD SELECTION OF CORN

Object.—To show the class the best type of corn plant from which to breed, and to give each student practice in field selection.

Step 1.—The class should decide on the desired type and the instructor should illustrate each desirable and undesirable character in the field.

Consider the following characters:

1. *A vigorous plant.* Such a plant should be stocky at the base, straight, average or slightly above average in height.

2. *One ear to the plant.* Unless in an average season on average ground one can grow two ears per plant it is better to select plants having one good ear.

3. *Ear located one-third to one-half the distance from the base to the tassel and moderately drooping.*

A low ear does not blow off so easily, is easier to husk and ripens earlier. A drooping ear is protected from moisture.

4. *A mature ear.* Maturity indicates good adaptation.

Step 2.—Each student should take one or more rows and should select good and poor plants in respect to the four characters listed above. When these plants are brought to the end of the row the class may decide which plant best illustrates each character. Then the class should search for plants which are strong in all four characters.

Reference.—Bussell, F. P., Cornell University. Improving the Corn Crop, Reading Course Lesson 129. Read in any good text on field crops, methods of storing seed corn (Fig. 10).

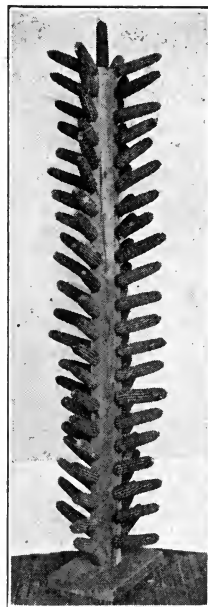

FIG. 10.—A seed corn tree. Field Crops (Wilson and Warburton)

Grade.....

Date.....

EXERCISE 8

TYPES OF CORN

Object.—To learn to recognize the important types and varieties of corn.

Materials.—Ears representing the four main types of corn (Fig. 11),

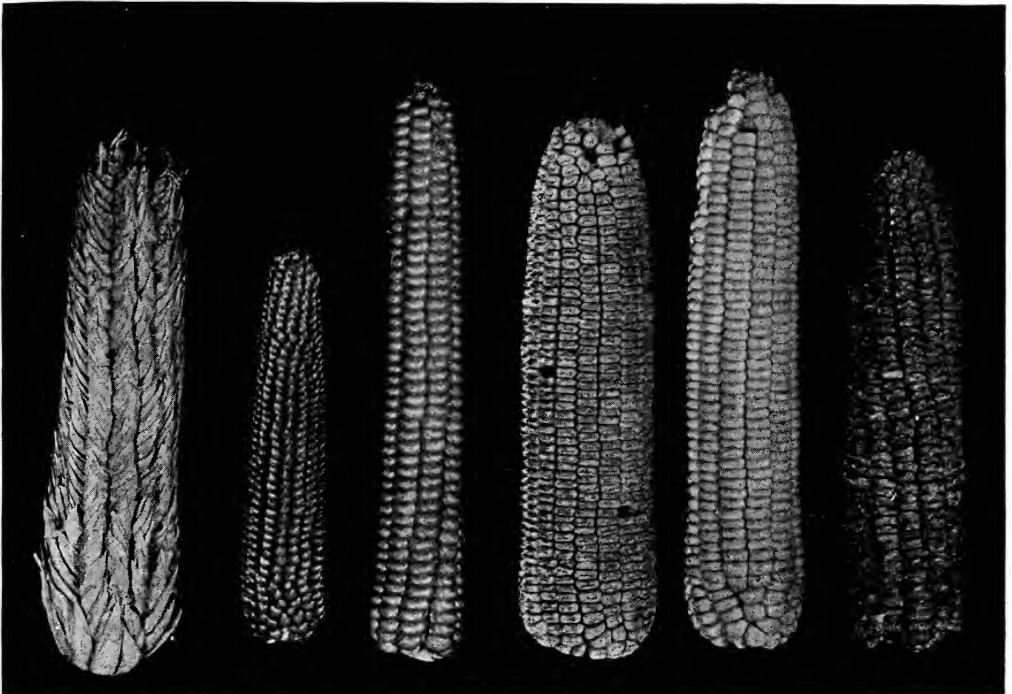

FIG. 11.—Types of corn. From left to right, pod corn, pop-corn, flint corn, dent corn, flour corn and sweet corn. (Productive Farm Crops, Courtesy Macmillan Pub. Co.)

dent, flint, pop and sweet; also grains of each that have been prepared by soaking 24 hours.

Drawings.—With a sharp knife shave the germ side of a kernel of each type, exposing the germ. Make drawings of each showing relative proportion of (1) hard starch, (2) soft starch, (3) germ. Use the following system in sketching these parts: Hard starch, parallel lines. Soft starch, blank. Germ, solid penciling.

Description.—Describe an ear of each type. Use the descriptive terms in Productive Farm Crops, pages 98–99.

EXERCISE 8 (Continued)

Outline for Describing Corn

Type				
<i>Ear:</i>				
Color				
Shape				
Proportions . . .				
Tips				
Butts				
<i>Rows:</i>				
Spacing				
Arrangement . .				
Number				
<i>Kernels:</i>				
Shape, broad . .				
Shape, edge . . .				
Crown				
Depth				
<i>Shank:</i>				
Size				

Local Varieties.—Every school teaching agriculture should have a collection of the varieties of corn grown in the locality. The students can add to this collection, also the exhibitors at the local fair. Let the class describe these varieties according to the above outline and also bear in mind the time it takes each variety to mature. If there is time, number each variety, let the students identify and place the name of each opposite its number on a sheet of paper.

Reference.—Sturtevant, E. L., 1899, Varieties of Corn. U. S. D. A. Expt. Station Bul. 57.

Grade.....

Date.....

EXERCISE 9

CORN JUDGING

Object.—To score and judge corn.

Material.—A set of ears to illustrate the points on the score card, some five-ear samples to illustrate the points under uniformity and at least three ten-ear samples to score and judge.

Step 1.—Learning the Points on the Score Card.—Students should fill in blanks.

Fancy Points:

Shape and Proportions of Ears.—Compare Nos. — and —. No. — is cylindrical, No. — is tapering. Compare Nos. — and —. No. — is poorly proportioned, No. — is well proportioned.

Tip of Ears.—Compare Nos. — and — No. — has crooked irregular rows, No. — has straight, regular rows. Compare Nos. — and —. No. — has small depth of tip kernel. No. — has good depth of tip kernel. Compare Nos. — and —. No. — has exposure of cob, No. — has no exposure of cob.

Butts of Ears.—Compare Nos. — and —. No. — has irregular rows. No. — has regular rows. Compare Nos. — and —. No. — has poor depth and shape of butt kernel. No. — has good depth and shape of kernel. Compare Nos. —, —, —, —. Flat butt, No. —; expanded butt, No. —; contracted butt, No. —; well rounded butt, No. —.

Spacing of Rows.—Compare Nos. — and —. No. — has poorly fitting rows, No. — has well fitting rows.

Shape of Kernels.—See Productive Farm Crops, Fig. 36. Remember that eastern grown dent kernels will not be as deep as the western grown but should be shaped so that no space is wasted between rows.

Uniformity.—Size.—Compare samples — and —. Sample — has poor size uniformity. Sample — has good size uniformity.

Shape.—Compare samples — and —. Sample — has poor shape uniformity. Sample — has good shape uniformity.

Indentation.—Compare samples — and —. Sample — has poor indentation uniformity. Sample — has good indentation uniformity.

Kernel.—Compare samples — and —. Sample — has poor kernel uniformity. Sample — has good kernel uniformity.

EXERCISE 9 (Continued)

Practical Points:

Maturity.—Compare Nos. —, —, —, —, —. No. — can be twisted, No. — has discolored tips, No. — is blistered, No. — is pinched at the top of the kernel, No. — has good maturity.

Plumpness of Kernel.—Compare Nos. — and —. No. — has a shrunken tip; No. — has a plump tip.

Color or Luster of Kernel.—Compare Nos. — and —. The kernels of No. — have dull color; the kernels of No. — have bright color.

Quality of Germ.—Compare Nos. —, —, —. No. — has a discolored germ. No. — has a shrunken germ, No. — has a bright, plump germ.

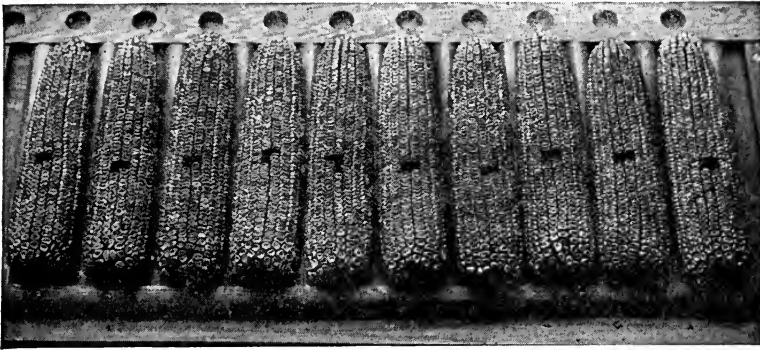

FIG. 12.—A good ten-ear sample of Reid's Yellow Dent. (Agriculture and Life.)

Size of Shank.—Compare Nos. —, —, —. The shank of No. — is too large, the shank of No. — is too small, the shank of No. — is of desirable size.

Step 2.—Placing Single Ears.

A. With a five-ear exhibit for practice, pick out the ear that is best in “shape and proportion.” Next pick out the poorest, then arrange the five ears in order of merit when this point only is considered.

B. Take the next point on the score card and arrange the ears according to tips, and so on through all the points.

C. Pick the best ear when fancy points only are considered.

D. Pick the best ear when practical points only are considered.

E. Pick the best ear, all points considered.

F. Repeat with other five-ear exhibits.

EXERCISE 9 (Continued)

Step 3.—Scoring and Placing Ten-Ear Exhibits (Fig. 12).

After adding scores the student should consider whether he has scored highest the sample he believes to be best. If his scoring and opinion do not agree he should go over the score card again. At the close of the period the placings should be discussed and the principles of corn judging summarized.

Reference.—Montgomery, E. G., 1916, *Productive Farm Crops* (Lippincott), Chapter XIV.

Score Card for Corn

Number of Sample or Ear	Points	1	2	3	4	5
Fancy points indicating trueness to type (55):						
1. Shape and proportions of ear...	10					
2. Tips.....	5					
3. Butts.....	5					
4. Spacing of rows.....	5					
5. Shape of kernels.....	10					
6. Uniformity of ear (20):						
(a) Size.....	5					
(b) Shape.....	5					
(c) Indentation.....	5					
(d) Kernel.....	5					
Practical points indicating adaptation and viability (45):						
7. Maturity.....	10					
8. Plumpness of kernel.....	10					
9. Color of kernel.....	10					
10. Quality of germ.....	10					
11. Size of shank.....	5					
	100					

Grade.....

Date.....

EXERCISE 10

GOOD GERMINATION

Object.—To determine which ears will germinate strongly.

Material.—Germination box, cloths, sawdust, ten ears of corn for each student.

Indications of Germinating Power.—Let each student take ten ears; the instructor should see that students have both poor and good ears. Ears should be numbered 1–100. Describe each ear, using the descriptive terms in *Productive Farm Crops*, page 65.

Number of ear										
<i>Grain:</i>										
Appearance										
Discolored										
Shape of tip										
General texture										
<i>Germ:</i>										
Covering										
Texture										
Air space										
Color										

Preparing Germination Box.—See directions in *Productive Farm Crops*, Chapter VIII. (Fig. 13.)

Starting the Test.—Let each student take six kernels from each of his ten ears. In removing kernels take two from near the butt on opposite sides of the ear, two from the middle, two from near the tip, turning the ear enough so as not to take two kernels out of the same row. Place the kernels from each ear in the square having the same number. If the box is kept in a warm room, results follow in 5 or 6 days, if proper moisture is maintained.

Results of the Test.—The first three columns in the following table should be filled out when the test starts; the remaining four columns at the conclusion of the test.

EXERCISE 10 (Continued)

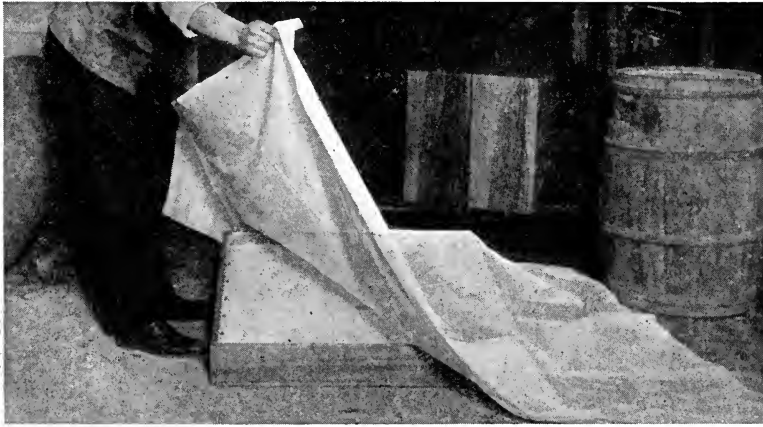

FIG. 14.—Laying on the Top Cloth. The cloth should be several inches larger than the germination box.

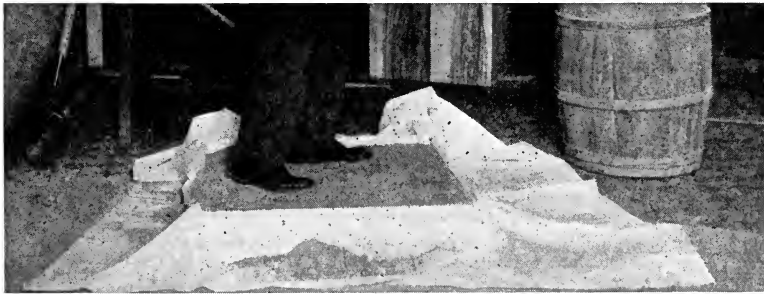

FIG. 15.—Packing Sawdust. The box should now be filled with one inch of warm moist sawdust and packed down carefully.



FIG. 16.—This shows how the cloth should be folded. (International Harvester Co.)

EXERCISE 10 (Continued)

Conduct an exercise by this method and note results as before. The same samples may be tested by the two methods, either by the same students or by different students.

Reference.—Holden, P. G. and Waggoner, J. E. Seed Corn. (Published by Agricultural Extension Department, International Harvester Co., Chicago, Ill.)



FIG. 17.—The Rag Doll Tester. Lay out the corn to be tested on the table. The cloth should be dipped in warm water and spread as shown. Straighten out the kernels with their points all toward one side of the cloth, and the germ side up. The tester should be put in the pail with the points of the kernels down.

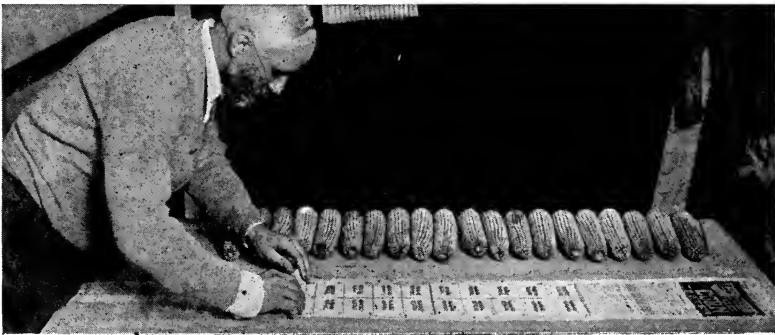

FIG. 18.—Rolling up the Tester. After the squares have all been filled, roll up the tester, tie a string or put a rubber band around the center just tight enough to hold the kernels in place.

EXERCISE 10 (Continued)

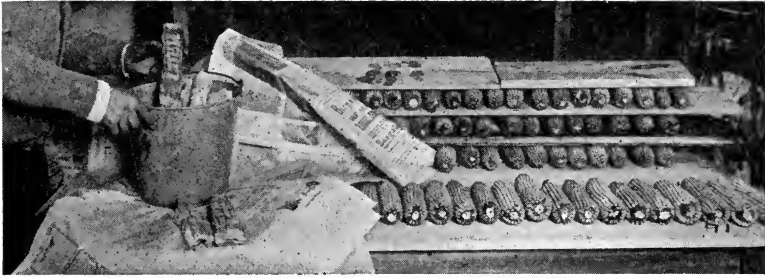

FIG. 19.—Putting Tester in Pail. Put the testers in a pail. Do not put more than ten or twelve in a ten-quart pail.



FIG. 20.—Wrapping up Pail. Fill the pail with lukewarm water, wrap up carefully and soak for five or six hours. Drain off water, lay a wet cloth over the top of the rolls and let stand for two days. Then soak again five or ten minutes, drain the pail and set away five or six days. Read test when sprouts are about two inches long. When the cloth is unrolled, the ears must be arranged as at the start of the test so that they are opposite the squares which represent them. (International Harvester Co.)

Grade

Date.....

EXERCISE 11

TYPES OF OATS

Object.—To learn the most important types of oats.

Material.—Head and grain samples of white, yellow, black and red varieties. Samples of early and late, side and paniced oats should also be included (Fig. 21).

Explanation.—Oats belong to the family of Gramineæ, the genus *Avena*, and species *sativa*.

They differ from wheat and rye mainly in having the grain borne in a panicle rather than in a spike.

Oats are classified into types largely on the basis of shape of the panicle. Thus we have three main types of oats:

1. Paniced (branches of panicle diverging broadly from central axis).
2. Compressed (branches closely adjacent to the central spike).
3. Side (branches all inclined toward one side of the central axis).

Directions.—Describe samples according to the outline. See *Productive Farm Crops*, Chap. XX, for descriptive terms for oats. To find the per cent

Outline for Describing Oats

Name of Variety					
A. <i>Panicle:</i>					
1. Shape.....					
2. Structure.....					
3. Awns.....					
B. <i>Spikelet:</i>					
4. Color.....					
5. Width.....					
6. Number grains.....					
C. <i>Grain:</i>					
7. Color.....					
8. Shape.....					
9. Crease.....					
10. Tip.....					
11. Per cent hull.....					
12. Per cent kernel.....					

EXERCISE 11 (Continued)

of hull and kernel weigh 100 grains taking them as they run. Remove hulls and weigh kernels. Weight of hulls will equal weight of grain minus weight of kernels. From this data percentages can be figured. Each student should make enough hull tests so that the class may have duplicate results for each variety.



FIG. 21.—Two types of oats, panicle and side. (Field Crops Wilson and Warburton.)

Questions.—1. Which have the larger percentage of kernel, side or panicle varieties?

2. Do early or late varieties produce the most straw?

3. What is the geography of white, yellow, black and red varieties?

References.—Montgomery, E. G., 1916, *Productive Farm Crops* (LIPPINCOTT), Chap. XX. Etheridge, W. C., 1916. *A Classification of the Varieties of Cultivated Oats*. Cornell University Agr. Expt. Sta. Memoir 10.

Date

Grade

EXERCISE 12

JUDGING OATS

Object.—To learn to judge oats on the basis of their value for feed.

Materials.—Threshed samples of oats of different varieties and types. If peck samples cannot be obtained, quart samples may be used.

Method of Analysis.—Mix each sample thoroughly and dip out about a heaping teaspoonful. First, analyze the samples, filling out the report card, then score samples from this data.

Explanation of Score Card.—In this score card oats are judged entirely from the feeder's standpoint. It is not possible to make a score card by which a sample of oats could be judged at the same time from the feeder's and the miller's standpoint, and also judge the grain for seed. Different points would be used in each case and different values given them.

Uniformity in color and size is of only minor importance to the feeder. Divide the sample according to the color of grain. Let the class having the largest number determine the color. Cut one point for each two per cent of other colors.

Uniformity in Size.—Divide the sample into two parts according to size of grain. Estimate per cent of small grains by count. Cut one point for each four per cent of small grains.

Weight per bushel is a very important consideration in estimating the value of oats for feeding purposes. A heavy weight indicates that the grain was well matured and filled out. In the same variety a heavy lot usually has a less percentage of hull, and, consequently, a higher feeding value than a light lot. The best oats should weigh 38 pounds per bushel. Cut one point for every pound light down to 32 pounds per bushel, and two points for every pound light below this.

Soundness and Dirt.—Sprouted and decayed grains have little more value than so much trash, and may be regarded as such for judging purposes. Separate all unsound grains and dirt, estimate the per cent by weight, and cut two points for each one per cent. This cut is not limited to ten points but may be indefinite.

Size of Grain.—Size varies greatly with varieties but 100 grains of heavy oats should weigh 3 grams. Cut one point for every two-tenths of a gram less.

Must and Smut.—If must and smut are very apparent the sample should be cut 10 points.

Percentage of Hull.—The percentage varies with varieties, the locality in which the oat is grown and also depends on how perfectly the grain

EXERCISE 12 (Continued)

Report Card on Threshed Oats

(Express data in per cent)

Name of Sample						
Color.....						
Size:						
Large.....						
Small.....						
Weight per bushel.....						
Soundness and purity:						
Damaged grain.....						
Foreign matter.....						
Size of grain.....						
Must, smut, etc.....						
Per cent of hull.....						

Score Card for Oats

Number of Sample						
Uniformity, 20 per cent:						
(a) In color..... 10						
(b) In size..... 10						
Quality, 80 per cent:						
(a) Weight per bushel..... 25						
(b) Soundness and dirt..... 10						
(c) Per cent of hull..... 25						
(d) Size of grain..... 10						
(e) Must, smut..... 10						
TOTAL.....100						

was matured. In growth the hull and bran develop first, and the starch is deposited last. However, if from any cause, such as dry weather, poor soil, injury from insects, etc., the grain is prevented from maturing perfectly,

EXERCISE 12 (Continued)

the development of the starch is somewhat curtailed and, consequently, the percentage of hull is higher. A good oat may have as high as 30 per cent hull. Cut two points for every per cent of hull above this.

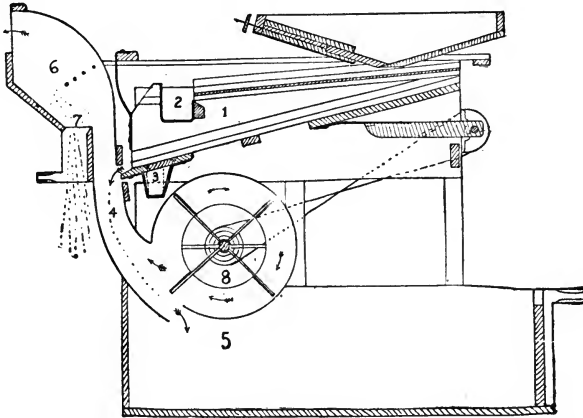

FIG. 22.—A hand power seed cleaner. The seed is sifted through screen as far as 1, the straw, particles, etc., being eliminated at 2. As the seeds slide down over the screen above 3, the sand and fine seeds drop through and are eliminated. The good seed passes into the air shaft at 4, the air moving upward forced by the rotary fan at 8. The perfect seeds being heavier fall and pass out at 5. The remaining dust, chaff, etc., are discharged through the dust hood at 6. Light, imperfect and foreign seeds fall into the opening at 7. (Courtesy A. T. Ferrell & Co., Saginaw, Michigan.)

Note.—If one is careful to mix each sample thoroughly and to take the grains strictly as they come, it is possible to use 100-grain samples instead of heaping teaspoonfuls. In this way the percentage figuring is simplified and much time is saved on the hulling.

Use of Seed Cleaner.—If a seed cleaner (Fig. 22) is available, weigh a bushel of oats and then clean it. Weigh the products resulting.

Grade.....

Date.....

EXERCISE 13

OAT SMUT

Object.—To learn to control oat smut.

Material.—Grain scoops, sprinkling cans, 50 gallon barrel, grain bags and one pint of 40 per cent formaldehyde solution (formalin) for every 40

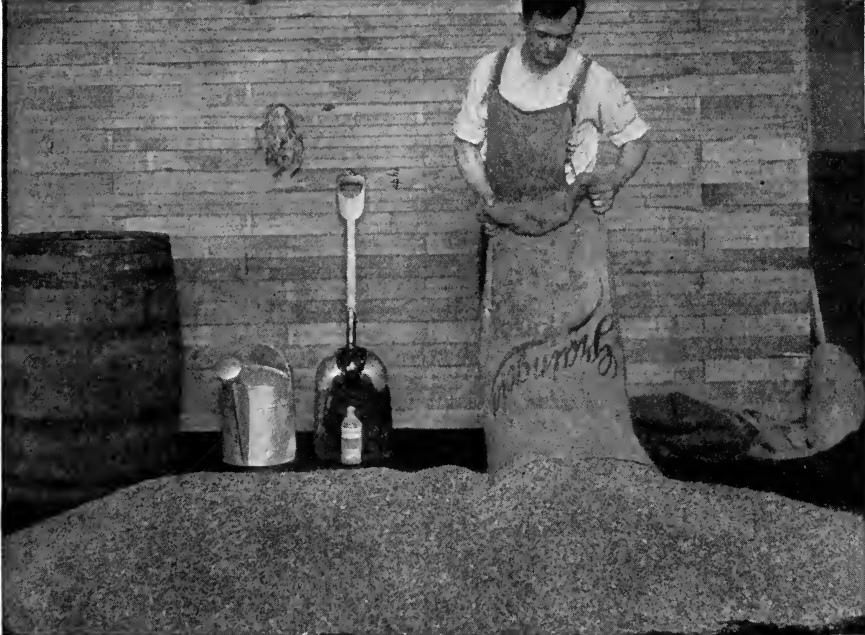

TREATING OATS FOR SMUT

FIG. 23.—First Step—Spread the oats to be treated on the barn floor. Have barrel, scoop shovel, sprinkling can and bottle of formalin ready. One pint of formalin will treat forty or fifty bushels of oats.

bushels of oats to be treated. The exercise may best be conducted in the barn of a neighboring farmer who wishes to have his oats treated.

Directions.—The students should work in pairs, each student to alternate sprinkling and shoveling (Figs. 23 to 28).

1. Dump the oats after cleaning with a fanning mill on a clean floor or canvas.

2. Pour forty gallons of water and one pint of formalin in the barrel. This amount will treat 50 to 60 bushels. Fill the sprinklers from this barrel.

EXERCISE 13 (Continued)

3. Let one student sprinkle the formalin on the oats as the other shovels them over. After being mixed thoroughly, shovel them into a pile and cover with bags or other covering which has been wet with the solution.



FIG. 24.—Second Step—Put forty gallons of water in the barrel. Pour the formalin in the water and mix thoroughly. Do not open formalin or put in the water until the oats are ready to treat.

4. Leave a few hours or over night; then take off the covering and dry out by spreading in a thin layer, stirring frequently.

Precautions.—1. Treat all bags with which the oats will come in contact, also the drill.

2. If sown by hand before drying, allow one peck of oats per acre extra.

EXERCISE 13 (Continued)



FIG. 25.—Third Step—Sprinkle the formalin solution on the oats and shovel the oats thoroughly in order to be sure that all the oats are moistened. Work fast so that little of the formalin gas escapes in the air.



FIG. 26.—Fourth Step—Shovel the oats in a pile so they can be easily covered.

EXERCISE 13 (Continued)

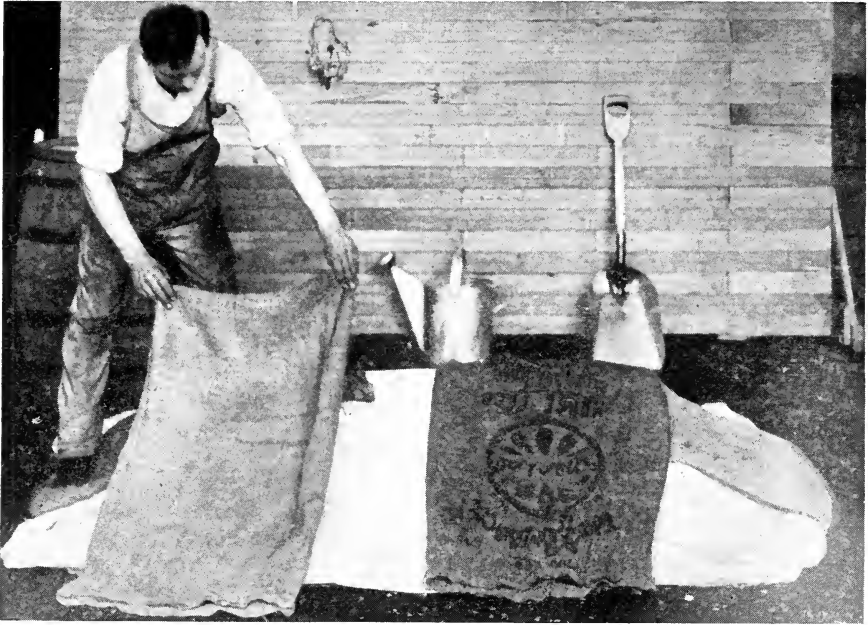

FIG. 27.—Fifth Step—Cover the oats with canvas, blankets or gunny sacks in order to retain formalin gas. Leave covered for eight or ten hours or over night.

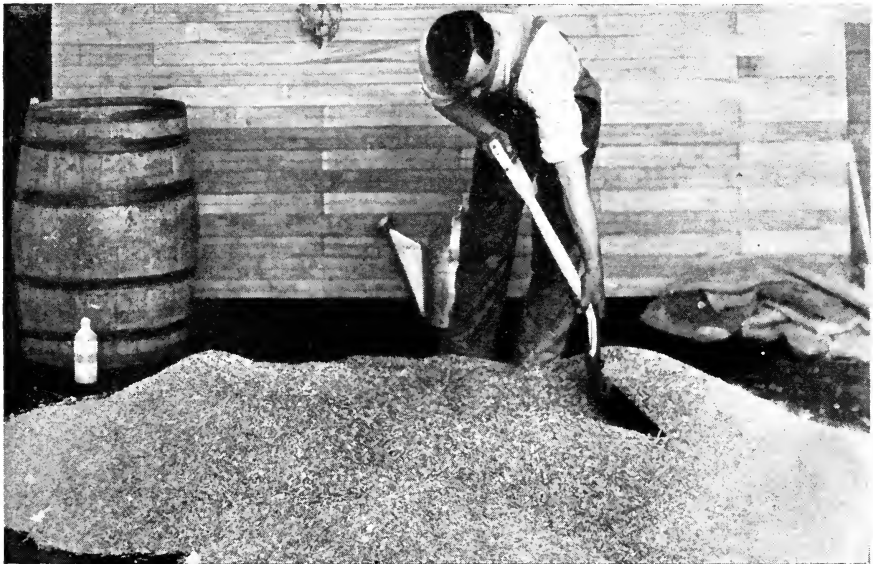

FIG. 28.—Sixth Step—Uncover the oats and spread them out to dry. They can be sown as soon as they are dry. Set the seeder one peck per acre more to allow for swollen grain. (International Harvester Co.)

Grade.....

Date.. ..

EXERCISE 14

TYPES OF WHEAT

Object.—To acquaint the student sufficiently with the different types of wheat so that they will be readily recognized, either when seen in the head or as threshed grain.

Material.—Specimens of einkorn, emmer, spelt, macaroni, Polish, common smooth and common bearded wheat. Include local varieties of wheat.

Drawing.—Lay out the heads of the seven types of wheat in the order above mentioned from left to right. Sketch each of these in order.

2. Lay out kernels of each in same order and examine. Draw a cross-section of each kernel, leaving the white starch blank, but indicating vitreous portions by shading with a pencil. Draw four times natural size.

Description.—Certain technical terms are used in describing wheat. Look over the specimens, study the descriptive terms in Productive Farm Crops, Chapter XVI and describe the heads, filling out the following table.

Descriptive Form for Wheat

Name							
A. <i>Spike:</i>							
1. Beards.....							
2. Shape.....							
3. Cross-section.....							
4. Spacing of spikelets.....							
B. <i>Spikelet:</i>							
1. Width.....							
2. Number of kernels.....							
3. Glumes.....							
4. Color of chaff.....							
C. <i>Kernels:</i>							
1. Color.....							
2. Hardness.....							
3. Texture.....							

EXERCISE 14 (Continued)

Resume.—Fix in mind the types by the following methods:

1. Identify the types unlabeled.
2. Discuss the use of each type.
3. Place local varieties in the proper group.

References.—Montgomery, E. G., 1916, *Productive Farm Crops* (LIPPINCOTT), Chapter XVI.

LABELS

EXERCISE 14 (Continued)

LABELS

Grade.....

Date.....

EXERCISE 15

WHEAT JUDGING

Object.—To learn how to judge threshed wheat.

Material.—Threshed lots of wheats representing hard winter, hard spring, red wheat, white wheat and durum wheat; also local samples.

Method of Analysis.—Mix each sample thoroughly and dip out about a teaspoonful. If the student is very particular to take the kernels as they come 100-grain samples may be used.

Weight per Bushel.—In measuring grain pour it into container loosely, fill level full and stroke with a straight edge. A one- or two-quart sample is sufficient to determine the weight per bushel.

Purity and Soundness.—Foreign matter and broken or injured seeds may be classed together, as they must all be removed to find net weight of good grain.

Injured grains are of four classes: 1. Bin burnt and stack burnt means wheat overheated in bin or stack, causing oil to exude and giving a dark appearance to the germ end.

2. Sprouted grain. Generally shows dried sprout.

3. Broken grain.

4. Shriveled grain, due to arrested development in growth, from such causes as disease, insects or unfavorable weather.

(Having discarded impurities and unsound grain, use sound sample for the rest of the exercise.)

Texture and Hardness.—In general the wheats from the drier regions are classed as “hard” wheats while those from the humid regions are classed as “soft” wheats. There is a large intermediate class, known on the market as “red” wheats. In general the harder wheats are darker in color (the durum wheat is an exception) and higher in protein content. The hard wheats make a “strong” flour adapted to light bread making, while the soft wheats produce a “short” and “weak” flour adapted to biscuits or cracker making.

Color of Kernels.—As already explained, color is related to hardness. The “amber” and “clear red” wheats are those with a glassy translucent appearance when broken, and hard texture. Most hard wheats are clear red in color but the durum wheats are an exception, being “light amber.” The “dull red” wheats, known as “red” on the market, are medium hard, but white and starchy when broken. There are two causes of redness in wheat. In the hard red wheats the redness is due to the hard vitreous endosperm.

EXERCISE 15 (Continued)

The dull red wheats which are medium hard owe their redness to red pericarp. The white wheats are softer and pure white inside when broken.

Size of Kernels.—This is arbitrary, but is determined by comparison with various samples of wheat of types representing the various sized kernels.

Report on Wheat Samples
(Express data in per cent)

Name of Sample							
<i>Weight per bushel:</i>							
<i>Purity and soundness:</i>							
Foreign matter							
Broken grains							
Shriveled grains							
Otherwise damaged							
<i>Texture and hardness:</i>							
Hard and vitreous							
Medium							
Soft and starchy							
<i>Color of kernels:</i>							
Light amber							
Clear red							
Dull red							
Whitish							
<i>Size of kernels:</i>							
Large							
Medium							
Small							

Explanation of Cuts in Scoring Samples

1. *Weight Per Bushel*—30.—Good wheat should weigh 60 pounds per bushel. Cut 2 points for each pound below this.

2. *Purity and Soundness*—30.—Cut two points for each per cent of foreign matter or broken or unsound kernels.

EXERCISE 15 (Continued)

3. *Uniformity in Color*—10.—Let the bulk of the sample determine the color. Cut 2 points for each per cent of other colors.

4. *Uniformity of Texture*—25.—Cut 2 points for each per cent of texture not uniform with the bulk of sample.

5. *Uniformity in Size*—5.—Cut 1 point for each per cent of small sized grains.

Score Card for Wheat

Name of Sample									
Weight per bushel.....	30								
Purity and soundness.....	30								
Uniformity in Color.....	10								
Texture.....	25								
Size of kernel.....	5								
TOTAL.....									

Note.—In localities where wheat is a main crop and samples of the different grades may be easily obtained, an exercise on the description and identification of grades may well be substituted for the judging exercise. A description of the grades of wheat can be found in *Productive Farm Crops*, Appendix III.

EXERCISE 16

TYPES OF BARLEY

Object.—To learn the important types of barley.

Explanation.—Barley differs from wheat and rye in having three flowers at a joint of the rachis, and but one grain per spikelet. In the six-row barleys all three flowers are fertile and bear grains. In the two-row barleys the lateral flowers are sterile (undeveloped). It will be observed that the outer or empty glumes are very narrow in barley while in wheat and oats they are broad, enclosing the flower. Read carefully Chapter XXIII in Productive Farm Crops before starting this exercise.

Materials.—Head and grain samples of:

1. Six-row barley (*Hordeum hexastichum*).
2. Common six-row, lateral grains overlapping, sometimes called four-row (*Hordeum vulgare*).
3. Two-row barley, slender heads (*Hordeum distichum*).
4. Two-row barley, broad heads (*Hordeum zeocrithum*).
5. Hulless barley (hooded type).
6. Hulless barley (awnless type).

Outline for Describing Barleys

Type and Variety					
<i>A. Spike:</i>					
1. Rows.....					
2. Type.....					
3. Cross-section.....					
4. Awns.....					
<i>B. Spikelet:</i>					
5. Fertile.....					
6. Sterile.....					
7. Color.....					
<i>C. Grains:</i>					
8. Glumes.....					
9. Color of kernel.....					
10. Shape.....					
11. Texture.....					

EXERCISE 16 (Continued)

Directions.—Describe the types according to the outline on the preceding page. For descriptive terms see Productive Farm Crops, end of Chapter XXIII.

II. Lay out spikes of six-row, common six-row and two-row barleys. Lay a brace of spikelets from each type just below the respective types. Draw each brace (enlarged $\times 3$), showing (1) relative size of the three spikelets in a brace in the six-row types, (2) straightness of the grains, (3) length of the grains, (4) prominence of the two nerves on the back of the spikelet. After making these drawings answer the following questions:

1. How may we distinguish erect six-row (hexastichum) barley in the threshed sample?
2. How may we distinguish the common nodding six-row (vulgare) in the threshed sample?
3. How may we distinguish two-row barley (distichum) in the threshed sample?
4. How may we distinguish two-row barley (zeocritum) in the threshed sample.

Reference.—Harlan, H. V.: United States Department of Agriculture, Bulletin 622. Montgomery, E. G., 1916, Productive Farm Crops (LIPPINCOTT), Chap. XXIII. Carleton, M. A., 1916, The Small Grains (Macmillan).

LABELS

Grade.....

Date.....

EXERCISE 17

GRASS PLANTS

Object.—To learn to identify and know the characteristics of some common grass plants (Figs. 29 to 35).

A. Draw head specimens of timothy, redtop, orchard grass, Kentucky blue grass, Canada blue grass and other grasses of local importance. Make drawings about twice natural size.

B. Identify numbered but unlabeled specimens.

No. 1.....

No. 6.....

No. 2.....

No. 7.....

No. 3.....

No. 8.....

No. 4.....

No. 9.....

No. 5.....

No. 10.....

C. A field trip to study grass plants will nicely supplement this exercise.

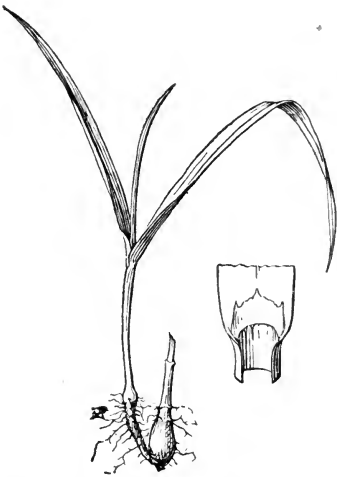

FIG. 29.—Juncture of sheath and blade.
Timothy.

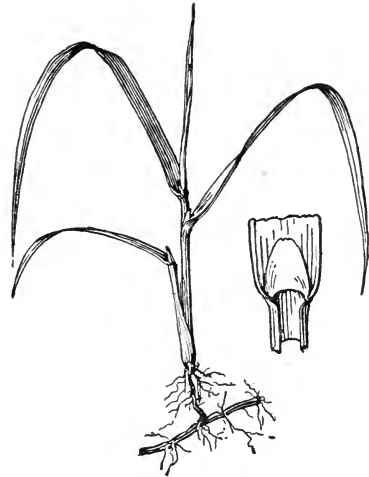

FIG. 30.—Juncture of sheath and blade.
Redtop.

EXERCISE 17 (Continued)

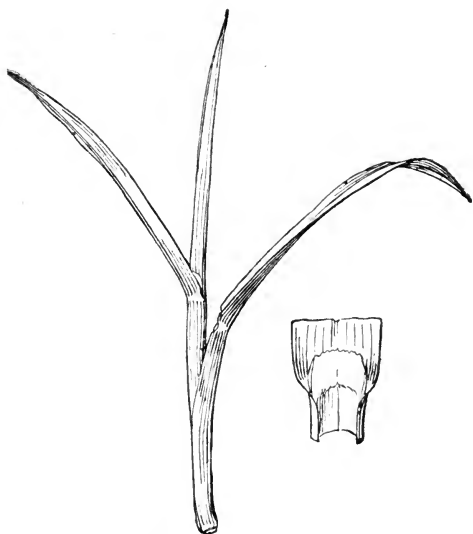

FIG. 31.—Juncture of sheath and blade.
Orchard grass.

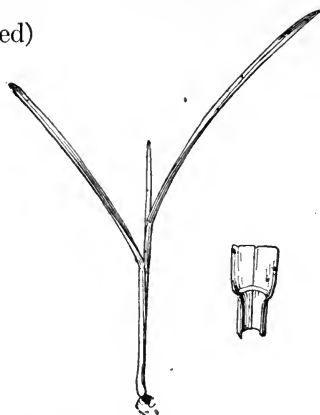

FIG. 33.—Juncture of sheath and blade.
Kentucky blue grass.

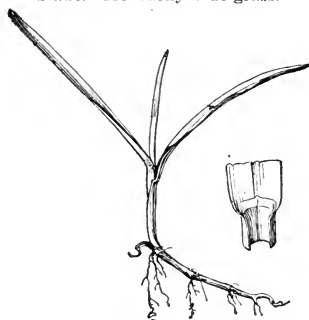

FIG. 34.—Juncture of sheath and blade.
Canada blue grass.

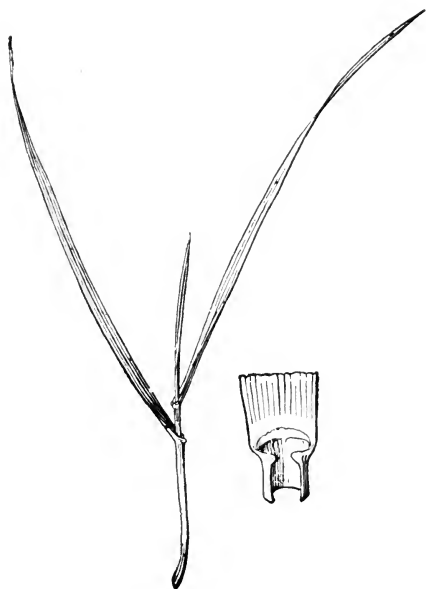

FIG. 32.—Juncture of sheath and blade.
Meadow fescue.

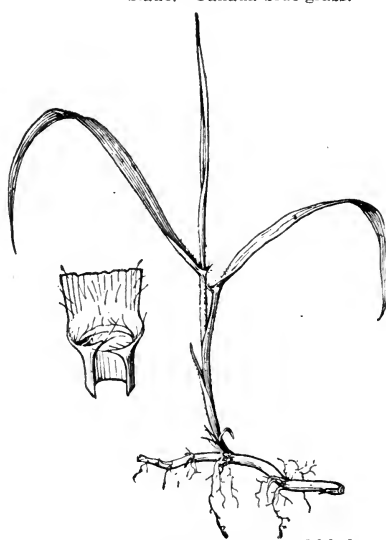

FIG. 35.—Juncture of sheath and blade.
Quack grass.

EXERCISE 17 (Continued)

LABELS

EXERCISE 17 (Continued)

LABELS

Grade.....

Date.....

EXERCISE 18

GRASS SEED

Object.—To learn to identify and know the characteristics of some common grass seeds (Figs. 36 and 37).

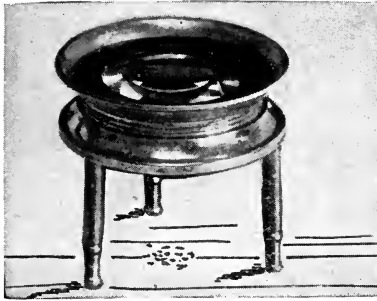

FIG. 36.—Tripod lens. For seed testing this lens is satisfactory and inexpensive. (Productive Plant Husbandry.)

A. By means of the key for the identification of grass seeds in *Productive Farms Crops* by E. G. Montgomery, Chapter XXXV, identify numbered but unlabeled seed samples of timothy, redtop, orchard grass, Kentucky blue grass, Canada blue grass and other grasses of local importance.

- | | |
|------------|------------|
| No. 1..... | No. 4..... |
| No. 2..... | No. 5..... |
| No. 3..... | No. 6..... |

B. Draw the same seeds. Make the largest seed one inch the long way and the others in proportion.

C. Identify the contents of numbered but unlabeled mixtures.

- | | |
|-----------------|-----------------|
| Mixture 1. | Mixture 5. |
| Mixture 2..... | Mixture 6..... |
| Mixture 3..... | Mixture 7..... |
| Mixture 4..... | Mixture 8..... |

EXERCISE 18 (Continued)

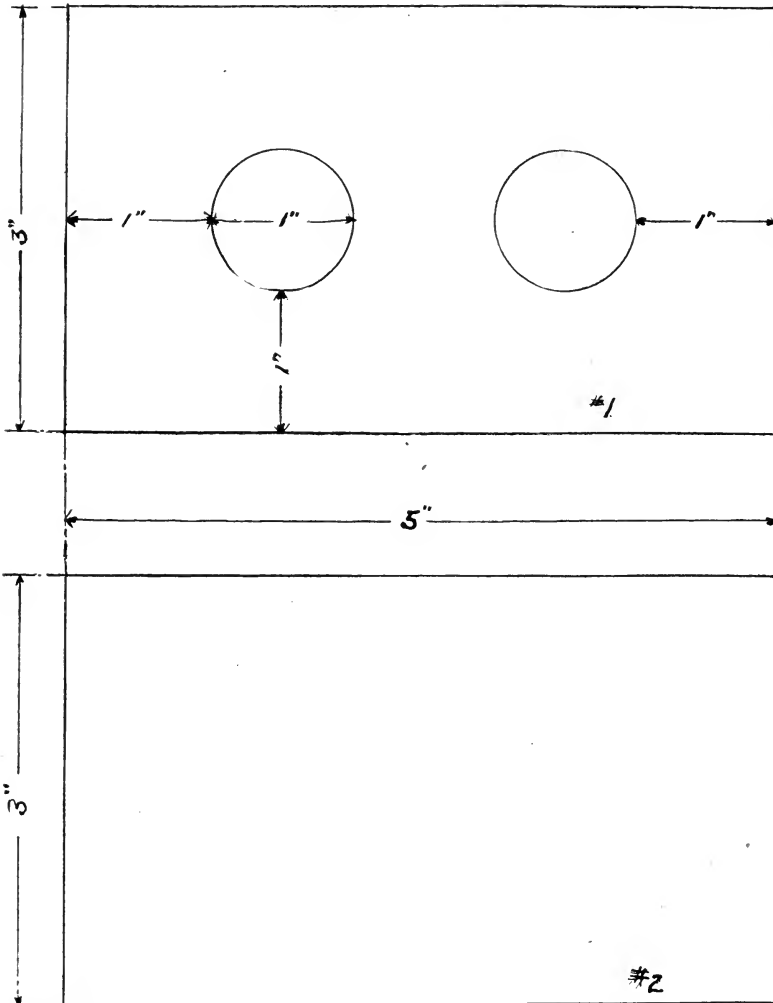

FIG. 37.—A weed seed holder. This device can be made from two layers of thick cardboard by means of a shotgun wad cutter.

References.—Montgomery, E. G. 1916 *Productive Farm Crops* (LIPPINCOTT), Chap. XXXV. Ward, H. M., 1908, *Grasses* (Cambridge University Press). *Testing Farm Seeds in the Home and Rural School*, U. S. D. A. Farmers' Bul. 428. Hitchcock, A. S., 1914, *Text-book of Grasses* (Macmillan).

EXERCISE 18 (Continued)

LABELS

Grade.....

Date.....

EXERCISE 19

CLOVER AND ALFALFA PLANTS

Object.—To learn to identify and know the characteristics of clover and alfalfa plants.

A. Describe plants according to outline.

	Red Clover	White Clover	Alsike Clover	Sweet Clover	Alfalfa
Color of blossom.....					
Habit of growth.....					
Trace outline of leaf showing markings...					
Length of life.....					
Character of roots....					

B. Identify numbered but unlabeled specimens.

No. 1..... No. 5..... No. 9.....

No. 2..... No. 6..... No. 10.....

No. 3..... No. 7.....

No. 4..... No. 8.....

Grade.....

Date.....

EXERCISE 20

CLOVER AND ALFALFA SEEDS

Object.—To learn to identify and know the characteristics of clover and alfalfa seeds.

A. By means of the key for the identification of clover and alfalfa seeds in *Productive Farm Crops* by E. G. Montgomery, Chapter XXXV, identify numbered but unlabeled seed samples of red clover, white clover, alsike clover, sweet clover and alfalfa.

No. 1..... No. 3..... No. 5.....

No. 2..... No. 4..... No. 6.....

B. Draw these seeds. Make the largest seed one inch the long way and the others in proportion.

C. Identify the contents of the numbered but unlabeled mixtures.

Mixture 1..... Mixture 5.....

Mixture 2..... Mixture 6.....

Mixture 3..... Mixture 7.....

Mixture 4..... Mixture 8.....

References.—Montgomery, E. G., 1916, *Productive Farm Crops* (LIPPINCOTT), Chap. XXXV. Testing Farm Seeds in the Home and Rural School, U. S. D. A. Farmers' Bul. 428.

EXERCISE 20 (Continued)

LABELS

Grade.....

Date.....

EXERCISE 21.

STUDY OF ALFALFA

Object.—To study alfalfa in the field.

Explanation.—It is not expected that all the aims of this field trip can be realized except under very favorable conditions. The number of aims is somewhat large for this reason. It is suggested that the student make rough notes in the field and copy answers into this manual later on page 68.

Aim 1.—To examine the parts of the alfalfa plant and the manner of growth.

Aim 2.—To show when alfalfa should be cut.

Aim 3.—To show the difference between common alfalfa and the variegated varieties.

Aim 4.—To show the effect of poor drainage.

Aim 5.—To show the effect of soil acidity.

Aim 6.—To observe whatever diseases, insects and serious weeds may be found.

Aim 7.—To discuss alfalfa culture with an alfalfa grower.

Aim 1—(a) What is the length of the longest root you find?

(b) What kind of a root has alfalfa? (See Exercise 5.)

(c) Draw part of an alfalfa root showing the nodules (Fig. 38). The digging must be careful or the nodules will be shaken off.

(d) Find the largest alfalfa plant you can. How many stems arise from the crown?

(e) Early in the season alfalfa may be confused with sweet clover. Draw a leaf of each showing how they may be distinguished.

Aim 2—(a) Draw the crown of an alfalfa plant which is ready to cut. Indicate the length of the shoots.

Aim 3.—(a) Dig plants of common and variegated alfalfa. Examine blossoms. How do they differ?

Aim 4.—(a) Find a wet spot in the field of alfalfa. What is the effect on the alfalfa?

Aim 5.—(a) Find a spot (not wet) where alfalfa does not thrive and such weeds are found as sheep sorrel, daisy, paintbrush and plantain. Make a litmus paper test of the soil and subsoil. Describe result.

Aim 6.—Make a list of the alfalfa diseases and insects, also of the weeds found in any quantity.

EXERCISE 21 (Continued)

Aim 7.—Discuss with one of the alfalfa growers whom you visit such questions as:

- (1) The use of nurse crops.
- (2) Time of planting.
- (3) Amount of seed per acre.
- (4) Number of cuttings per season and date of last cutting.
- (5) Winter killing.
- (6) Inoculation.
- (7) Liming.
- (8) Cultivation.
- (9) Making hay.
- (10) Pasturing.

Reference.—Montgomery, E. G., *Productive Farm Crops* (LIPPINCOTT), Chap. XLI.

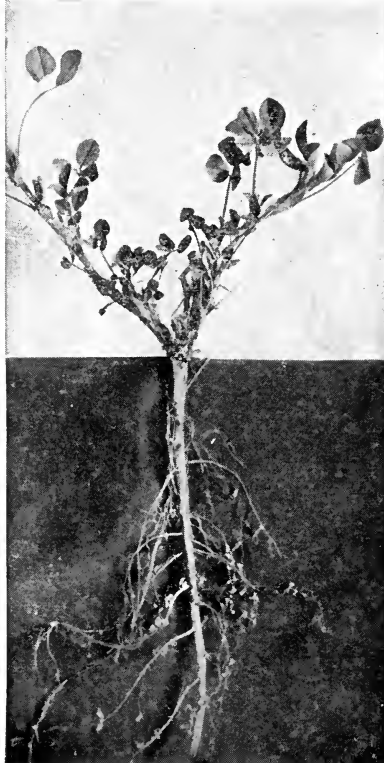

FIG. 38.—Root system of alfalfa showing crown and nodules. The long tap root may extend to a depth of many feet. (U. S. D. A.)

EXERCISE 21 (Continued)

LABELS

EXERCISE 21 (Continued)

Grade.....

Date.....

EXERCISE 22

SEED ANALYSIS

Object.—To analyze clover, alfalfa, millet or timothy seed for purity.

Directions.—Dip out a rounded teaspoonful* from the sample which you test for germination. Spread this out on a sheet of white paper and with the aid of a hand lens place the whole, plump seed in one pile and the foreign matter, which includes shriveled seed, broken seed, dirt, weed seeds and other trash in other piles. Count each kind of seed, if there are more than two or three, and by using the "Table of Weed Seed Weights" figure, the percentage of each kind of weed seed and write percentages into the analysis. Add percentages to get **total** percentage of weed seeds. Estimate and write in percentage of dirt, inert matter and poor seeds. Subtract these percentages from 100 to get the percentage of pure seed.

Note.—The instructor may put into the samples any weeds or other foreign matter with which he wishes the class to become familiar.

References.—Testing Farm Seeds in the Home and Rural School. U. S. D. A. Farmers' Bul. 428. Cunningham, J. C. and Lancelot, W. H., 1915, Soils and Plant Life (Macmillan) 261-266.

*Table of Weed Seed Weights***

In the first column of numbers below is given the number of seeds of each of the common weeds, required to make *one per cent* of a rounded teaspoonful of clover or alfalfa seed; in the second column are the numbers of seeds of the respective weeds required to make one per cent of a sample of the same size of timothy or millet seed:

Velvet leaf.....	5	4	Peppergrass.....	125	100
Quack grass.....	20	16	Tickle grass.....	125	100
Tumbleweed.....	135	110	Bracted plantain.....	36	28
Small ragweed.....	20	16	Buckhorn.....	57	46
Wild mustard.....	24	19	Plantain.....	111	89
Black mustard.....	62	48	Black bindweed.....	11	9
Lambsquarter.....	72	57	Pennsylvania smartweed.....	10	8
Canada thistle.....	45	36	Sheep sorrel.....	10	8
Wild carrot.....	63	50	Curled dock.....	36	29
Smooth crab grass.....	192	155	Russian thistle.....	65	53
Crab grass.....	185	142	Yellow foxtail.....	39	32
Barnyard grass.....	62	48	Green foxtail.....	63	52
Morning glory.....	2	1.6	Vervain.....	24	20

* A rounded teaspoonful of clover or alfalfa weighs 5 grams. A rounded teaspoonful of timothy or millet weighs 4 grams.

**From Weeds of the Farm and Garden. L. H. Pammel.

EXERCISE 22 (Continued)

Record of Seed Analysis

Kind of Seed Secured from

Kinds and percentages of weed seed present:

Buckhorn

Dock

Pigweed

.....

.....

.....

Total percentage of weed seeds

Percentage of broken and shriveled seeds

Percentage of dirt and inert matter

Percentage of pure seed

100

EXERCISE 23

SEED TESTING

Object.—To test small seeds for germination.

Directions.—1. This exercise should be given in connection with the preceding exercise. The same sample of seed is to be tested in this exercise for germination and in the preceding exercise for purity.

2. Secure pieces of blotting paper about $2\frac{1}{2}$ inches square. Make 100 perforations in each blotter (Fig. 1). Cut other pieces of blotting paper the same size with no perforations. These are to be used as bases under the perforated blotters to conduct and store moisture.

Moisten the blotter and base and place a seed in each perforation. Two of these perforated blotters should be used for each sample of seed, *i.e.*, make each test in duplicate.

3. Place each perforated blotter and base on a piece of glass and cover with a large drinking glass. By this method the students can better keep watch of the test. The blotter may be placed between two pie tins the lower of which may contain wet sawdust.

4. The proper temperature is 50–80° F. The seeds may be taken from the blotter as they germinate or a count may be made about 6 to 7 days from the start of the test.

5. Find the germination percentage and average the counts of the duplicate tests. In testing clovers and vetch count one-half of the hard seeds as germinating. If grass seed tests poorly it is well to give it a second test before passing judgement.

6. Write the counts into the Record.

Germination Record

	Test 1	Test 2	Average
Percentage of germinable seeds.
Percentage of non-germinable seeds.
	100	100	100

Grade.....

Date.....

EXERCISE 24

GRASS MIXTURES

Object.—First, to learn common meadow and pasture mixtures and second, to review identification of grass and clover seeds.

Directions.—The six numbered bottles are meadow and pasture mixtures given in Productive Farm Crops, Chapter XXXV. (a) Identify contents of mixtures and record in the second column. (b) Looking in the text, decide which each mixture is and fill out the remainder of the table. The last column will be a correction of the second, and in addition the amount per acre of each grass or clover will be given.

Mixture number	Ingredients	Pasture or meadow	Conditions	Mixture and amounts

EXERCISE 25

STUDY OF POTATO

Object.—To study the morphology and composition of the potato tuber.

Explanation.—The potato tuber is part of the system of lateral underground stems, and corresponds largely in its morphology to aerial stems. It serves as a storage part to the underground stem and enables the plant to live over from one year to another.

Part I.—(a) Draw a tuber natural size showing the correct arrangement of eyes. Label stem end, bud end, eyes, and eyebrows. (b) Show on your drawing by dotted lines how the tuber should be cut for seed purposes.

Part II.—(a) Make with a sharp knife a thin longitudinal and a thin transverse section of a tuber cutting through one or more eyes in each case. Rinse in water and examine. (b) Draw natural size in both longitudinal and transverse section a tuber showing in proper proportion: (1) internal medullary area; (2) external medullary area; (3) cortex; (4) epidermis.

Part III.—(a) Treat the thin longitudinal section with dilute iodine, rinse in water in a pie tin and observe the portion of greatest starch concentration. Indicate concentrations by labeling the drawing in Part II.

Reference.—Montgomery, E. G., *Productive Farm Crops* (LIPPINCOTT), Chap. XXX.

EXERCISE 25 (Continued)

LABELS

Grade.....

Date.....

EXERCISE 26

SELECTING SEED POTATOES

Object.—To harvest seed potatoes by the hill selection method.

Explanation.—The value of seed potatoes depends on the performance of the parent tuber. Therefore we must make certain that our seed comes from good hills (Figs. 39 and 40).

Directions.—The exercise should be given in a potato field. Let each student choose a group of ten consecutive hills.

Step 1.—Score the vigor and growth habit of the plant. The haulms should be stocky. Short haulmed, upright, heavy leafed tops are not as susceptible to disease as the prostrate types. The prostrate types, however, prevent evaporation of moisture more than the upright types. Early potatoes grow upright. Your scoring will depend on whether disease resistance or moisture conservation is more important in your locality. Score the best plant 20 points and the others accordingly.

Step 2.—Dig the hills and weigh separately the marketable tubers in each hill. Score the best yielding hill 50 points and the others accordingly.

Step 3.—Inspect each hill for variety characters, as color, shape and eyes. If preferred, score for conformity to market demand. Such tubers are round, flat, or oval flat with few and shallow eyes. Score the best hill 15 points and the others accordingly.

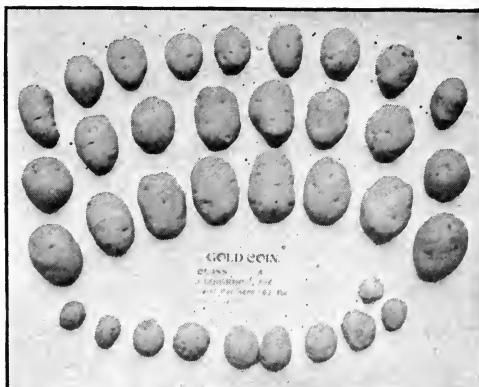

FIG. 39.—Product of a single tuber cut in four pieces, each piece planted in a hill. Yielded at the rate of 163 bu. per acre.

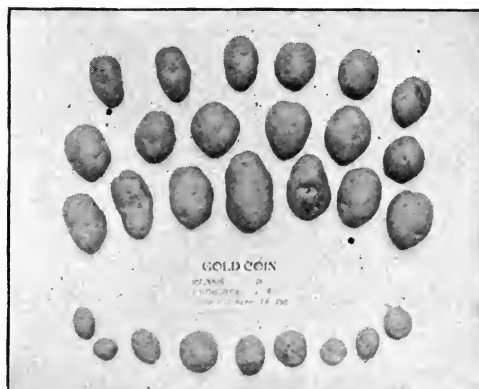

FIG. 40.—Product of a tuber which yielded at the rate of 96 bu. per acre. From field of H. B. Sweet, Utica, N. Y. (Schoharie Co., N. Y. Farm Bureau News.)

EXERCISE 26 (Continued)

Step 4.—Examine tubers in each hill for blemishes and diseases, especially scab and rhizoctonia. Score the best hill 15 points and the others in proportion.

Step 5.—Add scores. Show the instructor how you have placed the hills.

Number of Hill	Points	1	2	3	4	5	6	7	8	9	10
Yield of marketable potatoes	50										
Vigor and growth habit of plant.....	20										
Variety characters.....	15										
Blemishes and diseases.....	15										
	<u>100</u>										

Reference.—Gilbert, A. W., 1917, *The Potato* (Macmillan) 47-76.

EXERCISE 27 (Continued)

internal and external medullary areas. Rank these, sections as to quality, indicated by a smaller inner medullary area.

- | | | |
|----|----|----|
| 1. | 4. | 7. |
| 2. | 5. | 8. |
| 3. | 6. | 9. |

Identification.—Identify the following numbered specimens as to variety group.

- | | | |
|----|----|-----|
| 1. | 5. | 9. |
| 2. | 6. | 10. |
| 3. | 7. | 11. |
| 4. | 8. | 12. |

References.—Stuart, Wm., United States Department of Agriculture, Bulletin 176. Montgomery, E. G., 1916, Productive Farm Crops (LIPPINCOTT), Chap. XXX.

LABELS

EXERCISE 27 (Continued)

LABELS

EXERCISE 27 (Continued)

LABELS

Grade.....

Date.....

EXERCISE 28

POTATO JUDGING

Object.—To learn how to judge potatoes.

Material.—Two common potato varieties, five plates of each, five potatoes on a plate. Number the ten plates consecutively.

Step 1.—See explanation of the score card. Examine all the ten plates. Fill in the following blanks.

	Plate No.		Plate No.
Most uniform.....	—	Best quality of flesh.....	—
Least uniform.....	—	Poorest quality of flesh.....	—
Least blemishes and disease....	—	Least depth and frequency of eyes	—
Most blemishes and disease.....	—	Greatest depth and frequency of	
Best variety shape.....	—	eyes.....	—
Best market shape.....	—	Best color and skin texture.....	—
Best size.....	—	Poorest color and skin texture....	—

Step 2.—Score all plates and place them within each variety.

Number of plate.....	Points																		
Uniformity.....	20																		
Blemishes and disease.....	20																		
Shape.....	15																		
Size.....	15																		
Quality of flesh.....	10																		
Depth and frequency of eyes..	10																		
Color and texture of skin....	10																		
TOTAL.....	100																		

Explanation of Score Card.—*Uniformity.*—The tubers should be the same size, shape, color and texture of skin, depth and frequency of eyes on any one plate.

EXERCISE 28 (Continued)

Blemishes and Disease.—Should be no evidence of blight, rot, grubs, scab, rhizoetonia, sunburn or injury from rough handling.

Shape.—Should be typical of the variety. Market demands a moderately oval flat or round flat shape.

Size.—Should be typical of the variety. Market demands a medium sized potato, about 8 ounces.

Quality of Flesh.—Should be typical of the variety. Market requires a fine textured flesh of light color, free from excess moisture, and from hollow or dark spots.

Depth and Frequency of Eyes.—Should be typical of the variety. Market demands few and shallow eyes.

Color and Texture of Skin.—Should be typical of the variety. Market demands a thin smooth skin. White skinned varieties are preferable in most markets.

Reference.—Gilbert, A. W., 1917, *The Potato* (Macmillan), 48-54.

EXERCISE 29

TYPES OF TOBACCO

Object.—To learn the important types of tobacco.

Material.—Leaves of the following types:

Cigar Tobacco:

- (a) Broadleaf or seedleaf type.
- (b) Havana seed type.
- (c) Cuban type.

Manufacturing Tobacco:

- (a) Plug (dark heavy type).
- (b) Smoking (light colored type).
- (c) Plug and smoking (as White Burley).

Directions.—Describe the types, using the following descriptive terms and outline.

A. *Economic:*

- 1. Grown where?
- 2. Use: Wrapper, binder, filler, plug, smoking, plug and smoking.

B. *Leaf:*

- 3. Thickness: Thin, medium, thick.
- 4. Color: Dark, medium, light.

C. *Curing:*

- 5. Method: Air, open fire, flue.

References.—Duggar, J. F., 1918, *Southern Field Crops* (Macmillan), Chap. XXX. Montgomery, E. G., *Productive Farm Crops* (LIPPINCOTT), Chap. XLV.

EXERCISE 29 (Continued)

Outline for Describing Tobacco

Variety.....						
Type.....						
<i>Economic:</i>						
1. Grown where.						
2. Use.....						
<i>Leaf:</i>						
3. Thickness....						
4. Color.....						
<i>Curing:</i>						
5. Method.....						
Other characters...						

Identify numbered but unlabeled leaves, placing them in the proper type.

Variety	Type
1.	
2.	
3.	
4.	
5.	
6.	
7.	
8.	
9.	
10.	

Grade.....

Date.....

EXERCISE 30

TOBACCO SURVEY

Object.—To study tobacco growing by the survey method.

Directions.—Each student should obtain from a tobacco grower answers to the following questions in regard to the last crop grown.

1. How many acres did you grow?	
2. What was your total yield in pounds?	
3. What variety of tobacco did you raise?	
4. For what was it used?	
5. Of what texture is your soil?	
6. What is your rotation?	
7. What kind of fertilizer did you use?	
8. How much fertilizer per acre?	
9. Where did you obtain your seed?	
10. What was your rate of seeding per 100 square feet?	
11. At what date did you start your plant bed?	
12. How did you fertilize it?	
13. Did you sterilize it?	
14. Did you cover your plant bed with cloth or other material?	
15. At what date did you plow your main tobacco field?	
16. How many times did you harrow?	
17. At what date did you set your plants?	
18. Did you transplant by hand or by machine?	

EXERCISE 30 (Continued)

19. How wide were your rows?	
20. How far apart were the plants in the row?	
21. How many times did you cultivate?	
22. At what stage of the plant's growth did you practice topping?	
23. How many leaves did you retain?	
24. Did you sucker your plants?	
25. Did you harvest by priming or by cutting the whole stalk?	
26. How did you cure the crop?	

Summary of the Questions.—The class should put their results together in the form of a summary.

In summarizing questions concerning acreages and yields give the totals for all growers and find average acreage and yield.

In summarizing questions concerning dates, fertilizer per acre, rate of seeding, times harrowed, thickness of transplanting, times cultivated, and number of leaves retained, give highest and lowest figures and earliest and latest dates and in addition quote the figures and dates given by a majority of the growers, if possible.

In summarizing all other questions quote answer given by a majority of the growers.

Outline for Summary

1. Acreage.	
2. Yield.	
3. Variety.	
4. Use.	
5. Texture of soil.	
6. Rotation	

EXERCISE 30 (Continued)

Outline for Summary (Continued)

7. Kind of fertilizer.	
8. Amount of fertilizer.	
9. Source of seed.	
10. Rate of seeding.	
11. Date of starting plant bed.	
12. Method of fertilizing.	
13. Sterilization.	
14. Covering plant bed.	
15. Date of plowing.	
16. Times harrowed.	
17. Date of setting plants.	
18. Method of transplanting.	
19. Width of rows.	
20. Distance in row.	
21. Times cultivated.	
22. Topping stage.	
23. Number leaves retained.	
24. Suckering.	
25. Method of harvesting.	
26. Method of curing.	

Make a special study of the methods of the growers who obtained the best yields and try to find reasons.

References.—Montgomery, E. G. *Productive Farm Crops* (LIPPINCOTT), Chap. XLV. Duggar, J. F., 1918, *Southern Field Crops* (Macmillan), Chap. XXX.

Grade.....

Date.....

EXERCISE 31

THE COTTON PLANT

Object.—To study the structure of the cotton plant.

Material.—Cotton plants.

Directions.—1. *Root.*—(a) Examine the root. What kind of a root is it according to Exercise 5? _____

2. *Stem.*—(a) Drawing No. 1. A node of the cotton plant showing a fruiting and an undeveloped sterile branch.

(b) Examine a short jointed plant. What is the average length of the three lowest internodes? _____ inches.

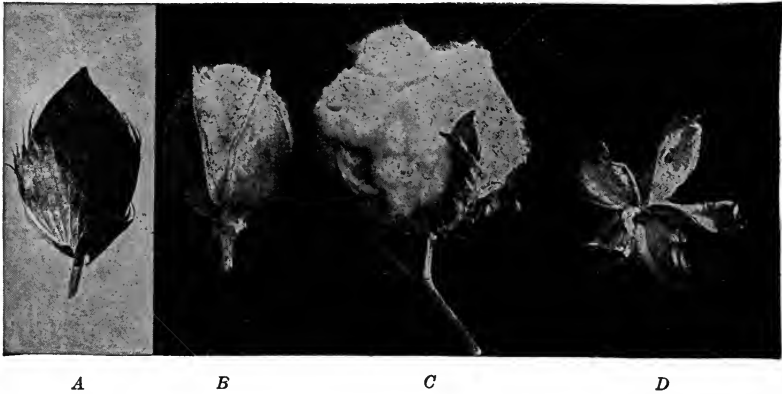

FIG. 41.—A cotton boll and how it develops. A, the unopened boll; B, boll partly opened; C, boll fully opened showing locks of fibre; D, the empty pod after the lock cotton has been gathered. (Productive Farm Crops.)

Examine a long jointed plant. What is the average length of the three lowest internodes? _____ inches.

3. *Leaf.*—(a) Drawing No. 2. A leaf, showing shape of lobes and veins.

4. *Boll.*—(a) Drawing No. 3 (Fig. 41). A storm resistant boll and a non-resistant boll. Label carefully showing the differences.

(b) Label the locks in Drawing No. 3.

5. *Fiber.*—(a) Examine ripe and unripe fibers under the microscope. Note the flattened twisted form of the ripe fibers.

Drawing No. 4. Ripe and unripe fibers. Draw large.

(b) Examine bolls of a long and a short staple variety.

EXERCISE 31 (Continued)

Average length of long staples in inches. _____

Average length of short staples in inches. _____

Which has the stronger fiber? _____

6. *Seed*.—(a) Split a cotton seed. Drawing No. 5, draw seed; label all parts.

Reference.—Duggar, J. F., 1918, *Southern Field Crops* (Macmillan), Chap. XIV.

LABELS

EXERCISE 31 (Continued)

LABELS

Grade.....

Date.....

EXERCISE 32

TYPES OF COTTON

Object.—To study varieties representing different types of cotton.

Material.—Plants representing as many of the following types as possible.

- Group 1. Cluster type.
- Group 2. Semicluster type.
- Group 3. Rio Grande type. Example, Peterkin.
- Group 4. Early varieties of the King type.
- Group 5. Big boll type.
- Group 6. Long limbed type.
- Group 7. Intermediate varieties.
- Group 8. Long stapled upland varieties.

Directions.—Describe each plant using the following descriptive terms.

- Terms for Describing Cotton.**—A. *Plant*.—1. Shape: Cone shaped, sugar loaf shaped, slender, with long basal limbs.
- 2. Size: Small (less than 3 feet), medium (3–5 feet), large (5 feet or more).
 - 3. Internodes: Short, medium, long.
- B. *Bolls*.—4. Shape: Slender, medium, rounded.
- 5. Size: Small, medium, large.
 - 6. Arrangement: Clustered, semiclustered, separate.
- C. *Fiber*.—7. Length: Short ($\frac{3}{4}$ – $1\frac{1}{8}$ inches), long ($1\frac{1}{4}$ – $1\frac{5}{8}$ inches).
- D. *Seed*.—8. Color.
- 9. Pubescence: Hairy, mixed, smooth.
- E. *Leaf*.—10. Size: Small, medium, large.
- 11. Shape of lobe: Short, broad, medium, long pointed.
- F. *Maturity*.—12. Season: Early, medium, late.
- G. *Other Characters*.

Outline for Describing Cotton

Variety and Type						
A. <i>Plant</i> :						
1. Shape						
2. Size						
3. Internodes ..						

EXERCISE 32 (Continued)

B. <i>Bolls:</i>						
4. Shape						
5. Size						
6. Arrangement						
C. <i>Fiber:</i>						
7. Length						
D. <i>Seed:</i>						
8. Color						
9. Pubescence						
E. <i>Leaf:</i>						
10. Size						
11. Shape of lobe						
F. <i>Maturity:</i>						
12. Season						
G. <i>Other characters.</i>						

Discussion.—Bring out the differences between these varieties and identify unlabeled specimens.

References.—Duggar, J. F., 1918, *Southern Field Crops* (Macmillan), Chapters XVI and XVII.

Grade.....

Date.....

EXERCISE 34

TYPES OF BEANS

Object.—To learn the types of field beans.

Materials.—Samples representing each of the following types of field beans, kidney, marrow, medium and pea.

Directions.—Draw each type (enlarged $\times 3$), showing very carefully the relative sizes and shapes.

By means of class discussion compare these types as to (1) yield in your locality, (2) soil fertility required, (3) disease susceptibility, (4) market price.

Reference.—Sevey, G. C., Bean Culture (Orange Judd).

LABELS

Grade.....

Date.....

EXERCISE 35

WEEDS

Object.—To become familiar with the weeds in vicinity of the school, and their control.

Material.—Each member of the class should be required to collect ten weeds before this exercise is given (Fig. 42). Each specimen should include the root, stem, leaves and either the flower or seeds or both. By mounting the best of these specimens the school may obtain a valuable collection. This collection may be supplemented by conducting a field trip for the purpose of identifying and collecting weeds. Save the weed seeds for later use.

Directions—Each student should describe each of his ten weeds according to the following outline. After describing his own he should describe weeds collected by other students. Thus each student may make a fairly complete inventory of the weeds in the locality of the school.



FIG. 42.—Some common weeds. Left to right: Jimson, ragweed, lamb's quarter, jointweed, rough pigweed.

The Weed Club.—A weed club has been successful in some schools. The object of such a club is to rid a locality of weeds. Each member of the club chooses an important weed and agrees to destroy a certain number each day of the growing season. The club may also spread control information and may add to the school weed collection.

Weed Contest.—The object of a weed contest is to determine how many students can identify unlabeled seed mounts in the school collection.

References.—Georgia, A. E., 1914, *Manual of Weeds* (Macmillan). Pammel, L. H., *Weeds of the Farm and Garden* (Orange Judd). Percival, J., 1915, *Agricultural Botany* (Holt).

Grade.....

Date.....

EXERCISE 36

WEED SEEDS

Object.—To identify some important weed seeds (Fig. 43).

Material.—About twenty (or more if time is available) important weed seeds. Part of these should be chosen because of their prevalence in the locality and part of them because of their prevalence in commercial seed.

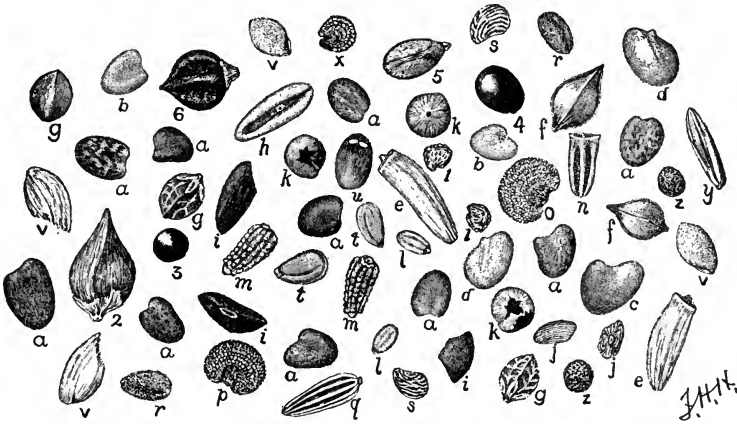

FIG. 43.—Mixture of weed seeds commonly found in low grade alsike clover seed: *a*, alsike clover; *b*, white clover; *c*, red clover; *d*, yellow trefoil; *e*, Canada thistle; *f*, dock; *g*, sorrell; *h*, buckhorn; *i*, rat-tail plantain; *k*, lamb's quarter; *l*, shepherd's purse; *m*, mayweed; *n*, scentless camomile; *o*, white campion; *p*, night-flowering catchfly; *q*, oxeye daisy; *r*, small fruited false flax; *s*, cinquefoil; *t*, two kinds of pepper-grass; *u*, catmint; *v*, timothy; *x*, chickweed; *y*, Canada blue grass; *z*, clover dodder; *1*, mouse-ear chickweed; *2*, knot grass; *3*, tumbling amaranth; *4*, rough amaranth; *5*, heal all; *6*, lady's thumb. Enlarged (U. S. D. A.)

Drawings.—Draw each seed under the low power microscope and make each drawing one inch the longest way. This rule will overcome the tendency of many students to draw seeds natural size. If it is desired to indicate relative size of the seeds, the class may number the largest seed No. 1, the second largest No. 2, etc. Weed seed holders as shown in figure 37 are convenient.

Identification.—Examine numbered but unlabeled mixtures of the weed seeds drawn above. Each mixture should contain three or four kinds of seeds.

EXERCISE 36 (Continued)

	Student's Identification	Corrected Identification
Mixture No. 1.....		
Mixture No. 2.....		
Mixture No. 3.....		
Mixture No. 4.....		
Mixture No. 5.....		
Mixture No. 6.....		
Mixture No. 7.....		
Mixture No. 8.....		
Mixture No. 9.....		
Mixture No. 10.....		

Students should examine again the mixtures which they have written incorrectly.

References.—The Seed of Red Clover and Its Impurities, U. S. D. A., Farmers' Bul. 260. Testing Farm Seeds in the Home and Rural School, U. S. D. A., Farmers' Bul. 428.

EXERCISE 36 (Continued)

LABELS

EXERCISE 36 (Continued)

LABELS

EXERCISE 37

Object.—To learn to identify some of the seeds of crops which have not been studied and to review these and all other seeds studied to date by means of an identification contest.

Material.—*Group 1.*—Seed samples of rye, silver hull buckwheat, Japanese buckwheat, flax, sorghum (Kafir, Durra and broom corn types) millet (common, barnyard, broom corn and pearl types), cowpeas, soybeans, field peas, winter and spring vetch (Fig. 44).



FIG. 44.—School set of one hundred economic seeds supplied by the United States Department of Agriculture, for cost of case, bottles, corks and labels. (Productive Plant Husbandry.)

Group 2.—Samples of all the seeds which have been studied to date.

Directions.—*Part I.*—Draw the seeds in Group 1 and compare them with similar seeds with a view to future identification. Make drawings one inch the longest way.

Part II.—**Identification Contest.**—Place numbered vials of the seeds of Groups 1 and 2 before the class. The object of the contest is to identify correctly the largest number of seeds.

Number of Vial	Name of Seed	Corrected Name

EXERCISE 38 (Continued)

Part III.—To Criticise a Rotation.—The following are eight requirements of a good rotation. State opposite each requirement how your rotation meets it.

1. *Plant Food.*—The crops in a rotation should have different plant food requirements.
2. *Roots.*—A rotation should include deep rooted and shallow rooted crops. The roots of certain crops such as grass, millet, buckwheat and barley, have a beneficial effect on the structure, especially of heavy soils.
3. *Organic Matter.*—Sods, stubbles, or green manure crops should be plowed under; or all of these.
4. *Legumes.*—Nitrogen from the air is obtained by these plants. A rotation should include one or more of them.
5. *Weeds.*—Rotation should control weeds usually by means of cultivated crops.
6. *Unoccupied Land.*—The ground should not be left bare during part of the year so that the soil may wash or the weeds get a foothold.
7. *Diseases and Insects.*—A rotation should be able or adjustable to control diseases, as potato scab, which live over in the soil and insects like the wireworm, which thrives in sod left down too long.
8. *Labor Distribution.*—A good rotation should distribute work as evenly as possible through the season.

EXERCISE 38 (Continued)

Part IV.—To Name and Discuss Common Local Rotations.—The class should name at least three rotations common locally and discuss according to the requirements named in Part III.

1.

2.

3.

References.—Rotation of Farm Crops. Cornell University, Reading Course Bul., 24. Lyon, T. L., 1917, Soils and Fertilizers (Macmillan), 242-247.

Grade.....

Date.....

EXERCISE 39

BIBLIOGRAPHY

Objects.—1. To learn to make a bibliography.

2. To become acquainted with literature of farm crops.

Directions.—The instructor should submit to the class a list of subjects dealing with farm crops. Each student should choose a subject and break it up into key words. For example, in the subject potato breeding the key words are potato and breeding. Look up both these words when going through an index. References should first be written on a separate sheet of paper and copied into the manual when approved by the instructor.

The following are sources to examine. Group the references cited under these five headings.

1. Textbooks (including encyclopedias).

Example

Author	Chapter Title	Title of Book (Including Volume)	Pages	Year
Gilbert, A. W.	Potato Breeding	The Potato	47-85	1917

2. Government Publications (including Yearbooks).

Example

Name of Series	Number	Pages	Year
Farmers' Bulletin Yearbook	464 —	Entire 221-238	1911 1913

3. State Experiment Station publications.

Example

Name of Station	Series	Number	Pages	Year
Michigan Agr. College	Extension Series	9	Entire	1917

4. Current Literature.

Example

Author	Title of Article	Publication	Volume	Number	Year
Sanders, J. G.	Potato Wart Disease	<i>The Potato Magazine</i>	1	6	1918

5. Miscellaneous.

Record as much as is given of the following and in the order given. Author, Title of Article, Publisher, Series, Number, Pages, Year.

Subject Assigned _____

EXERCISE 39 (Continued)

BIBLIOGRAPHY (Continued)

HOME PROJECTS IN FARM CROPS

A home project in farm crops conducted by a student of high school grade consists of a crop enterprise at home accompanied by class and individual instruction relating to the enterprise both of which are under the supervision of a trained instructor in agriculture.

The essentials of a home project are given by the Federal Board for Vocational Education as follows:

"1. A carefully drawn plan covering a considerable extent of time, with a definite aim, including some problems new to the pupil and outlining with sufficient detail the methods to be employed. This plan should be written and should be an exhibit in connection with the second essential.

"2. An agreement between parent, pupil and teacher based upon the plan already prepared and so prepared as to eliminate later disagreements. The boy's financial privileges should be clearly stated.

"3. Instruction in the school both in regular course and special individual study to the end that the project work may be done intelligently and that the home may furnish the kind of laboratory practice best adapted to the school work. .

"4. Detailed records of method, time, cost, income and other important factors to be summarized in —

"5. A report including both a story and a complete accounting for the entire project period.

"6. Supervision by a competent instructor of such a nature as to help the student to succeed in his project, to encourage him at times when difficulties arise and to hold him to his agreement; incidentally to impart instruction supplementing that of the class-room."

For further information concerning home projects the reader is referred to Bulletin 21, Agricultural Series No. 3 issued by the Federal Board for Vocational Education, Washington, D. C.

Use the records and report blanks adopted by your state educational authorities in charge of vocational education.

SUGGESTIONS ON KEEPING PROJECT NOTE BOOKS

The list of references at the end of each project outline is not complete. The student should add any material published by his state agricultural college and experiment station, new books, agricultural periodicals, lectures, information from practical growers and all other possible sources. Be continually on the lookout for further references.

Before reading references the student should decide what questions need to be answered by his reading in order to plan his project. He should write out these questions and submit them to the instructor for suggestions and approval.

Having answered the questions in written form, he should also go over these with the instructor and then copy them into his project note book. Give the reference for each point brought out.

This project note book should be of permanent value. It should be well organized into headings and sub-headings, indexed and space should be left after each subject so that material may be added later. Clippings and photographs may well be added.

CROP GROWING PROJECTS

1. Growing a Field of Corn for Profit.

Project Work Plan	Study Involved
Select a variety.....	Important varieties and their characters. Home grown <i>vs.</i> foreign seed.
Select seed ears in your father's or a neighbor's field	Corn improvement. Qualities of best plants from which to select ears. Field trip.
Store seed.....	Principles of seed storage. Devices for storing seed corn.
Select ground.....	Corn soils. Effect of poor drainage on corn. Signs of good and poor drainage. Rotations which include corn. Nearness to other corn fields.
Manure and plow (fall).....	Use of farm manure. Rate of manuring. Mechanics and adjustment of plows. Fall <i>vs.</i> spring plowing. Depth of plowing.
Test ears for germination.....	The sawdust box and rag doll methods. Signs of good and poor germination. Effect of poor ears on yield. (Compute.)
Select fertilizer.....	Computing fertilizers. Corn fertilizers. Rate of fertilizing.
Fit the ground.....	Tilth and tillage. The fitting program. Tools to be used and their effects.
Plant.....	Planting machinery. Method, time, depth and rate. Grading seed.
Fertilizing.....	Methods of applying. When seeding and later.
Cultivate.....	Cultivation program. Weeds which infest corn. Depth and frequency of cultivation.
Select and store seed as at the beginning of the project	
Harvest.....	Harvesting machinery. Handling corn fodder.
Husk and weigh up ears. Select exhibit ears while husking	Corn judging.
Sell or store crop.....	Prevailing prices of seed corn. Value of fodder. Shrinkage of corn in storage. Grades of corn.
Compute costs and profit.....	Farm accounts.
Summarize project.	

Demonstrations with Projects in Corn Growing

2. Grow several promising varieties of corn and compare them as to yield and maturity.
3. In a corn-growing project try, on several rows each, a different fertilizer. These may vary in amounts or in the relative amounts of nitrogen or phosphate, or potash.
4. Make trials in like manner to compare the results with and without barnyard manure or green manure.

References on Corn Growing

- Montgomery, Productive Farm Crops (LIPPINCOTT).
 Montgomery, The Corn Crops (Macmillan).
 Duggar, Southern Field Crops (Macmillan).
 Bowman and Crossley, Corn. (Published by authors, Ames, Iowa.)
 Holden and Waggoner, Seed Corn, (International Harvester Co., Chicago).
 Bussell, Improving the Corn Crop, Cornell Reading Course Lesson 129.
 Burlison and White, Selection and Storage of Seed Corn. Illinois Circular, 225.

5. Growing a Field of Potatoes for Profit.

Project Work Plan	Study Involved
Select ground.....	Potato soils. Potato rotations.
Plow (or plowing may be delayed till spring)	Mechanics and adjustment of plows. Fall vs. spring plowing. Depth of plowing.
Select variety.....	Principal variety groups and their importance. Important varieties in your locality. Market demand.
Hill select seed in father's or neighbor's field	Principles of hill selection. The degeneration of varieties.
Store seed.....	Principles of potato storage. Types of storage.
Treat seed.....	Scab, rhizoctonia, blackleg. Corrosive sublimate treatment.
Sprout seed.....	Method of sprouting. Greening seed.
Fit ground.....	Tilth and tillage. The fitting program. Tools to be used and their effect on the soil.
Select fertilizer.....	Computing fertilizers. Potato fertilizers. Rate of fertilizing. Methods of applying fertilizer. Fertilizer guarantees.
Cut seed.....	Whole vs. cut seed. Method and time of cutting. Size of seed piece.
Put in 25 tuber units.....	Principles of the tuber unit method. Potato improvement.
Plant remainder of seed.....	Planting machinery. Rate, depth and time of planting. Hill vs. drill planting. Level or ridged cultivation.
Cultivate.....	Cultivation program. Tools for cultivation.
Spray.....	Important potato diseases and insects. Spray materials. Spraying machinery. Spraying program.
Hill select for next year. Harvest. Weigh up units and save the better units	Harvesting machinery.
Weigh up yield.....	Average and maximum yields in other states and other countries.
Grade.....	Potato graders. Cost and returns from grading. Grades of potatoes.
Store or sell.....	Prevailing prices of seed stock. Other prices. Losses in storage.
Compute costs and profit.....	Farm accounts. Cost of growing potatoes.
Summarize project.	

Demonstrations with Projects in Potato Growing

6. Compare the dusting methods with spraying to fight potato beetles. Leave a row untreated as a check.
7. Compare yields from selected and unselected seed; or from small and large pieces with two eyes each; or from lots grow from lots of one-eye, two-eye, and many-eye pieces.
8. Compare results from different kinds and amounts of fertilizers.
9. Compare results with different methods of tillage, as extreme ridging with rather level culture.

References on Potato Growing

- Montgomery, Productive Farm Crops (LIPPINCOTT).
 Gilbert, The Potato (Macmillan).
 Fraser, The Potato (Orange Judd).
 Classification of Varieties, U. S. D. A. Bulletin, 176. Potato Breeding and Selection, U. S. D. A. Bulletin, 195. Potato Storage and Storage Houses, Farmers' Bulletin, 847. Good Seed Potatoes and How to Produce Them, Farmers' Bulletin, 533. How to Increase the Potato Crop by Spraying, Farmers' Bulletin, 868. Commercial Handling, Grading and Marketing of Potatoes, Farmers' Bulletin, 753.

10. Growing a Field of Seed Oats for Profit.

Project Work Plan	Study Involved
Select ground.	Oat soils. Rotations which include oats. The causes of lodging.
Select variety.	Variety groups and their distinguishing characters. Important varieties in your locality.
Select and test seed for germination and purity	Oat judging. Seed analysis.
Select fertilizer or manure.	Computing fertilizers. Fertilizers for oats. Rate of fertilizing oats. Use of manure on oats. Fertilizer guarantees.
Plow.	Mechanics and adjustment of plows. Depth of plowing.
Fit ground.	Tilth and tillage. The fitting program. Tools to be used and effects on soil.
Treat seed.	Oat smut. Treatment.
Drill.	Grain drills. Rate, time and depth of sowing.
Prevent harmful weeds.	Weeds infesting oats. Methods of eradicating.
Certify crop.	Rules of nearest crop improvement association.
Harvest.	Harvesting machinery. Curing oats. Time to cut. Avoiding mixture with other oats in same field.
Thresh.	Avoiding contamination by threshing machine.
Weigh up.	Average weights elsewhere.
Market or store crop.	Prevailing prices of seed oats. Storage of grain. Advertising.
Compute costs and profit.	Farm accounts.
Summarize project.	

Demonstrations with Projects in the Growing of Small Grains

11. Make a comparison of several important varieties as to yield, earliness, weight per bushel, feeding qualities, etc.
12. Compare results under different rates of seeding.
13. Measure yields on two equal areas—one fitted with special care and the other with ordinary care.

NOTE.—Very similar projects could be conducted using barley, rye or wheat.

References on Growing Oats

- Montgomery, *Productive Farm Crops* (LIPPINCOTT).
 Carleton, *The Small Grains* (Macmillan).
 Spring Oat Production, *Farmers' Bulletin*, 892. A Classification of the Varieties of Cultivated Oats, *Cornell Memoir* 10. Methods of Breeding Oats, *Cornell Reading Course* 44.

14. Growing a Field of Alfalfa for Profit and for Soil Improvement.

Project Work Plan	Study Involved
Select a variety.	Classification of alfalfa varieties. Varieties used locally.
Buy and test seed.	Sources of seed. Seed analysis. Adulterations and impurities.
Select ground.	Alfalfa soil, lime requirements, drainage, texture. Working alfalfa into rotations.
Manure and plow.	Response of manure to alfalfa. Rate of application.
Select fertilizer and lime.	Fertilizer. Kind, rate of application local markets. Lime. Response of alfalfa to lime, kinds of lime, rate, method and time of application.
Fit the ground.	Relation of fertilizer and lime to nurse crops. The fitting program. Tillth and tillage. Importance and method of cleaning the field of weed seeds.
Inoculate the seed.	Methods of inoculation of seed and field.
Plant.	Methods, time and rate of sowing. Nurse crops for alfalfa. Advisability, kinds, management.
Care for the crop.	Disease, insect and other pests. Clipping. Winter care.
Harvest.	The time of cutting. Methods of curing and handling. Management in mow or stack. Pasturing alfalfa. Number of cuttings per season. Time of last cutting.
Weigh up yields.	
Dispose of crop.	Uses of alfalfa. Food value. Markets for alfalfa. Grades.
Compute costs and profit.	Farm accounts.
Summarize project.	

Demonstrations with Projects in Alfalfa Growing

15. Important varieties may be compared.
16. Make a comparison of results on limed and unlimed portions of a field.
17. Make comparison of areas sown with and without nurse crops.
18. Compare a small plot on the field not inoculated with a like area of the field where inoculation is good.

NOTE.—This project may well continue three or four years. At the conclusion the field will commonly be capable of more cuttings. This equity and the increased fertility of the field should be credited to the project.

References on Alfalfa Growing

Montgomery, *Productive Farm Crops* (LIPPINCOTT).
 Wing, *Alfalfa in America* (Sanders Pub. Co.).
 Coburn, *Book of Alfalfa* (Orange Judd)
 Piper, *Forage Crops* (Macmillan)
 Graber, *Alfalfa* (Alfalfa Order, Madison, Wisconsin).
 Farmers' Bulletin 339, *Alfalfa*; 194, *Alfalfa seed*; 382, *Adulteration of forage plant seeds*; 306,
 Dodder in relation to Farm Seeds. *Studies in Alfalfa*, International Harvester Company, Agr. Ext. Dpt.,
 Chicago, Ill.

19. Growing a Field of Timothy and Clover for Profit and Soil Improvement.

Project Work Plan	Study Involved
Select ground.....	Soils for timothy and clover, texture, drainage, acidity. Rotations.
Select mixture.....	Kinds of clover. Grasses supplementary to timothy. Best mixture for project, ingredients and proportions.
Test seed.....	Analyzing germination and purity of grass seed.
Manure and plow.....	Response of timothy and clover and nurse crop to manure. Rate of application. Fall vs. spring plowing. Mechanics of the plow.
Select fertilizer and lime.....	Fertilizers. Kind, rate of application, local markets. Lime. Effect of lime on grasses and clovers. Kinds of lime, rate, method and time of application. Relation of fertilizer and lime to the nurse crop.
Fit the ground.....	The fitting program. Tilth and tillage.
Plant.....	Methods, time and rate of sowing. Kinds and management of nurse crop. Fall and spring grains as nurse crops. Care of new seeding.
Harvest.....	Time of cutting. Methods of curing and handling. Management in the mow.
Weigh up yields.	
Dispose of crop.....	Markets for hay. Grades. Pressing hay.
Compute costs and profit.....	Farm accounts.
Summarize project.	

NOTE.—This project may well continue two or three years. At the conclusion this field may be capable of more cuttings. This equity and the increased fertility of the field should be credited to the project.

Demonstrations with Projects in the Growing of Timothy and Clover

20. Grow them with different nurse crops, as barley, oats, wheat and rye—compare the results.
21. On the second year's growth of timothy apply fertilizer on part of the field and compare the yield with that not fertilized.
22. Make a comparison of the results on limed and unlimed portions of the clover and timothy.
23. Demonstrate the increase in yield by adding seed of redtop, alsike clover and other hay plants.

References on the Growing of Timothy and Clover

- Montgomery, *Productive Farm Crops* (LIPPINCOTT).
 Wilson and Warburton, *Field Crops* (Webb).
 Piper, *Forage Crops* (Macmillan).
 Spillman, *Farm Grasses of U. S.* (Orange Judd).
 Wing, *Meadows and Pastures* (Sanders Pub. Co.).
 Hitchcock, *Textbook of Grasses* (Macmillan).
 U. S. Farmers' Bulletins, 990, Timothy; 455, Red Clover; 260, The Seeds of Red Clover and Its Impurities; 508, Market Hay; 943, Haymaking; 936, Curing Hay on Trucks; 977, Hay Caps; 987, Labor Saving Practice in Haymaking.

24. Growing a Field of Cotton for Profit. *

Project Work Plan	Study Involved
Select a variety.....	Species and types of cotton. Varieties for various soils and climatic conditions.
Select seed bolls at first picking in field	Improvement by selection. Indications of best qualities in plants. Storm resistance. Length and weight of lint. Crossing to improve. The seed patch. Prices of seed for planting.
Gin field-selected seed separately. . . .	Visit gin and study methods.
Dry and store seed.....	Prevention of mold and injury from enemies.
Select field.....	Soil requirements. Needs of fertility. What crop should precede cotton. Rotations with legumes.
Manure, double disk, harrow, and sow to cover crop	Suitable amounts of manure. Ways of spreading. Value of cover crop; kinds of cover crop for this purpose.
Test sample of seeds.....	Methods of testing compared. Reasons for testing.
Choose suitable fertilizers for home mixing	Best ingredients for cotton. Probable needs of your field. Make formulas for home mixing and compute costs. Rates of application.
Plow and fit the soil for planting. . . .	Best time to turn under cover crop. Values of a bare fallow period before planting. Steps in fitting soil. Implements and their effects. Best methods.
Plant the crop.....	Methods of planting. Time to plant. Distances. Depths for different methods. Amount of seed.
Fertilize.....	Applying fertilizer when planting and later. Differences in availability. Effects of time of applying. Reasons for rapid forcing of crop.
Cultivate.....	Purpose of intertillage. How best to maintain a dust mulch without injuring crop. Kinds of weeds. Their control. Need of early rapid growth under weevil conditions.
Thin the chop.....	Need for thick planting and subsequent thinning. Other special reasons for chopping out rows. How to avoid it.
Subsequent cultivation.....	Kinds of cultivation tools. Their special effects and uses. Fighting weevils by tillage. How to "lay-by" cotton, for sowing cover crop and without.
Inter-plant with corn.....	Control of boll-worm (corn ear worm) with use of corn a strap crop. Times to plant the corn. Uses of the corn. Other means of control of worms.
Select next year's seed.....	Review seed selection and score card for bolls and plants.
Pick the main crop.....	Methods of picking; cost; new machines.
Gin and bale.....	Calculate yields of seed and lint. Determine percentage of seed to lint; compare with others and with other years. Study mechanism of gins, balers, compressors. Get samples of cotton of all types at the gin or warehouse.
Sell or store cotton.....	Price fluctuations and charts. Profits from storing. Cotton grades and grading. Practice scoring and grading. Types of warehouses; damage during storage. Need of compressing. Insurance.
Make second picking; gin and store..	Nature of blossoming and fruiting of cotton plant. Need of second picking. Character of yield. Effect of boll weevil on late crop.
Sell, store, or have seed crop pressed	Composition, value, products of seeds and their uses. Feeding cottonseed hulls and meal.
Pasture the stalk field.....	Value and uses of cotton stalks. Danger from weevils where not pastured nor turned under.
Turn under and sow to rye or other cover crop	Effects of all plowing on weevils and boll-worms. Review values of cover crops.
Compute costs and profits.....	Cost accounting; record forms; farm accounts. Compare with other crops.
Summarize project in narrative style	

*Outlined by K. C. Davis, George Peabody College for Teachers, Nashville, Tenn.

Demonstrations with Projects in Cotton Growing

25. Partial trials with different forms and amounts of fertilizer.
26. With and without green manure or barnyard manure.
27. Compare commercial fertilizers with barnyard manure and with green manure.
28. Compare ridge planting and culture with level methods.
29. Compare late and early varieties or any two promising varieties.

References on Cotton Growing

- Montgomery, Productive Farm Crops (LIPPINCOTT).
Duggar, Southern Field Crops (Macmillan).
Bailey's Cyc. of Agr. Vol. II.
Brooks, Cotton, New York.
Burkett and Poe, Cotton, New York.
Robinson, Classing Cotton, Stillwater, Okla.
U. S. D. A. Yearbook, 1902. Farmers' Bulletins 286, 501, 591, 601. U. S. Office Exp. Sta. Bull. 33,
Bur. Plant, Ind. Bull. 163.

Write the stations of each of the Cotton states for all available bulletins on cotton.

30. Growing a Field of Tobacco for Profit.*

Project Work Plan	Study Involved
Select the type and variety you want and secure seed	Types suited to the region. Yields, values and purposes of various types. How seed is selected and improved. Amount seed needed.
Select field.....	Soils for tobacco. Rotations with tobacco.
Manure, disk, and sow cover crop...	Effects of manure and green manure. Benefits of cover crops.
Build curing house.....	Types of houses. Methods of curing. Probable capacity required. Cost of buildings.
Plan bed and select site.....	Size of bed needed for field chosen. Methods of making bed. Materials needed. Suitable sites.
Make bed and plant seeds.....	Sterilizing soils. Best time to start beds. Care and management of beds when started.
Plow and prepare field for setting plants	Best time and depth for plowing. Steps in preparation of soil for setting. Level vs. ridge setting.
Set plants in field.....	Methods of setting. Modern machines. Carrying plants to place. Methods of watering. Distances for setting. Number of plants per acre. Suitable weather conditions.
Fertilize.....	Best time to fertilize; amounts; kinds; methods of applying; special effects; weather conditions.
Cultivate, weed, and sucker.....	Importance of thrifty growth. Thorough cultivation. Mulch. Freedom from weeds. Need of suckering. Tillage implements.
Destroy worms and other enemies. . .	Methods of control of tobacco worms and other enemies. Picking compared with spraying. Poisons compared.
Topping and selection of seed plants	Choice of good seed plants. Disease resistance. Signs of health and disease. Need of topping. Number of seed plants to save.
Priming.....	Economy and saving due to priming. Control of disease by priming.
Harvest crop and hang in curing house	Different methods of harvesting for different types of tobacco. Tools, wagons, other equipment. Cost of harvesting. Space required in shed per acre of crop. Weather conditions.
Cure crop.....	Care in curing to produce best results. Steps in curing. Judging conditions of leaf and weather.
Sell or store crop.....	Methods of marketing, grading, storing, handling, warehouses. Insurance. Price variations. Profits and losses.
Compute Profits.....	Farm accounts.
Write account of project.	

Demonstrations with Projects in Tobacco Growing

31. Make a comparison by growing part of the crop with, and part without green manure.
32. In like manner demonstrate the effects of barnyard manure.
33. Compare different formulas of commercial fertilizers.
34. Compare two very promising types or varieties, both probably suited to the soil and region. Both should be suited to your type of house and methods of curing.
35. Compare two methods of curing if your facilities will permit, and if the type of tobacco is suited to both, as curing with open fires and air curing. If there are three types of houses in the region compare all the different methods of curing.
36. Methods of harvesting may be compared if both will suit the type of tobacco—priming all the leaves and cutting the stalks.

* Outlined by K. C. Davis, George Peabody College for Teachers, Nashville, Tenn.

References on Tobacco Growing

Montgomery, Productive Field Crops (LIPPINCOTT).
 Duggar, Southern Field Crops (Macmillan).
 Killebrew and Myrick, The Tobacco Leaf (Orange Judd Co.).
 Bailey's Cyc. Agr. Vol. II. Tobacco Soils, etc., U. S. Bur. Soil, Bulletins 11, 27, 37. U. S. D. A. Reports, 59, 62, 63. Farmers' Bulletins, 60, 120, 343, 416, 523, 511. Bur. Plant Ind. Bulletins 91, 96. U. S. Farmers' Institute Illustrated Lecture No. 9.

Write to the Stations of the leading tobacco growing states for their available bulletins on the subject.

37. Growing a Field of Peanuts for Profit.*

Project Work Plan	Study Involved
Select variety.....	Classification of varieties according to use. Classification of varieties according to season. Varieties grown in community.
Select seed.....	Value of selected seed. Characteristics of good seed: (a) brightness, (b) effect of storage, (c) maturity.
Select ground.....	Peanut soils: (a) effect of habit of growth, (b) acidity. Rotations.
Select fertilizer.....	Plant food elements needed. Manure: (a) effect on peanut crop, (b) rate and method of application. Commercial fertilizers: (a) kind needed, (b) local markets, (c) method and rate of application. Lime: (a) effect on peanut crop, (b) kind; method and rate of application.
Fit the ground.....	Tilth and tillage. Fall or spring plowing. Mechanics of the plow. Fitting program.
Plant.....	Preparation of seed. Method of planting. Variety and rate of planting. Time of planting. Effect of (a) variety, (b) season, (c) soil condition, (d) use.
Care for crop.....	Cultivation: (a) time to start, (b) frequency, (c) implements. Insects and diseases. Pegging.
Harvest.....	Seed selection. Time of harvesting. Methods. Handling in field. Amount of poles needed. Method of stacking. Curing.
Picking.....	Hand or machine picking. Kinds of pickers.
Storing.....	Methods. Advantages of storing.
Market the crop.....	Market from picker to car. Improving the grade.
Compute costs and profit.....	Farm accounts
Summarize projects.	

* Adapted from Georgia Vocational Bulletin 5.

Demonstrations with Projects in the Growing of Peanuts

38. Grow and compare several important varieties of peanuts.
39. Try different amounts and kinds of fertilizers.
40. Compare results with selected and unselected seed.

References on Peanut Growing

Montgomery, E. G., Productive Farm Crops (LIPPINCOTT).
 Dugan, J. F., Southern Field Crops (Macmillan).
 Morgan, Field Crops for the Cotton Belt (Macmillan).
 U. S. Farmers' Bulletins 431, The Peanut; 509, Forage Crops in the Cotton Region; 751, Peanut Oil; Bureau of Plant Industry Cir. 88, Picking and Handling Peanuts; Bureau of Plant Industry, Cir. 98, Peanut Butter; U. S. D. A. Yearbook (1917), Peanut Industry; U. S. D. A. Yearbook (1917), Peanut as Food.



465339

S495
L3

UNIVERSITY OF CALIFORNIA LIBRARY

