

Historic, archived document

Do not assume content reflects current scientific knowledge, policies, or practices.

62.37

FARM AND
GARDEN SUPPLIES



GRIFFITH
AND TURNER CO.

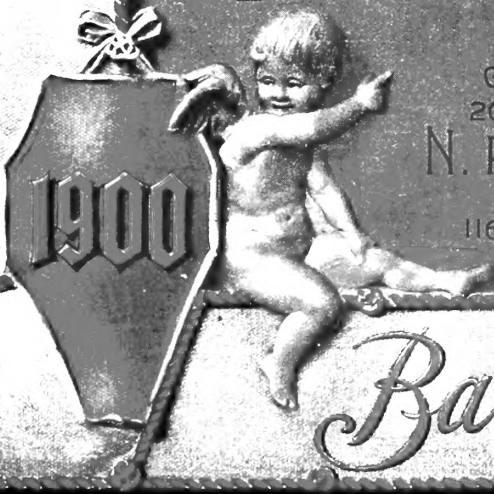

GENERAL OFFICES
205-207-209 & 213
N. PACA STREET
BRANCH
116 & 118 LIGHT ST.

Baltimore

SEED TABLET.

THE QUANTITY OF SEED USUALLY SOWN TO AN ACRE.

Asparagus..... 5 lbs.	Grass, blue, alone..... 28 lbs.	Potato, cut tubers, in drills..... 8 bush.
Barley, broadcast..... 2 to 3 bush.	Grass, Hungarian..... 1 bush.	Radish, in drills..... 6 to 8 lbs.
Beans, dwarf, in drills..... 1 to 1½ bush.	Grass, lawn..... 3 to 4 bush.	Radish, broadcast..... 10 lbs.
Beans, pole, in hills..... 8 to 10 qts.	Grass, orchard..... 28 lbs.	Rye, broadcast..... 1 bush.
Beet, in drills..... 4 to 6 lbs.	Grass, red top..... 28 lbs.	Salsify, in drills..... 6 to 8 lbs.
Broom Corn, in hills..... 4 to 6 qts.	Grass, R. I. Bent..... 3 bush.	Sorghum..... 10 to 12 lbs.
Buckwheat, broadcast..... ¾ bush.	Timothy..... 3 bush.	Squash (bush varieties), in hills..... 4 to 6 lbs.
Cabbage, in beds, to transplant..... ¾ lb.	Kale..... 4 to 6 lbs.	Squash (running varieties), in hills..... 3 to 4 lbs.
Carrot, in drills..... 2 to 3 lbs.	Millet..... 1 bush.	Turnip, in drills..... 1 lb.
Celery, to transplant..... ½ lb.	Melon, musk..... ½ to 2 lbs.	Turnip, broadcast..... 2 to 3 lbs.
Corn, in hills..... 8 qts.	Melon, water..... 2 to 3 lbs.	Tomato, to transplant..... ¾ lb.
Corn, for soiling..... 2 to 3 bush.	Mustard, broadcast..... 12 to 16 qts.	Vetches broadcast..... 2 to 3 bush.
Clover, Alsike..... 12 lbs.	Mangold, Wurzel..... 4 to 6 lbs.	Wheat, broadcast..... 1½ to 2 bush.
Clover, red, alone..... 15 lbs.	Oats, broadcast..... 2 to 2½ bush.	Wheat, in drills..... 1 bush.
Clover, white, alone..... 12 lbs.	Onions, in drills, to make large onions..... 6 to 8 lbs.	
Clover, white, with other seeds..... 4 lbs.	Onion Seeds, for small sets..... 40 to 60 lbs.	
Clover, Luzerne, alone..... 15 lbs.	Parsnip, in drills..... 4 to 6 lbs.	
Clover, scarlet..... 15 lbs.	Peas, early, in drills..... 1 bush.	
Cucumber, in hills..... 2 lbs.	Peas, Marrowfat, in drills..... 1½ bush.	
Flax, broadcast..... 1 to 2 bush.	Peas, broadcast..... 2 to 3 bush.	

Clover } Together for 1 acre. { 8 lbs. Clover.
 Timothy } { 10 lbs. Timothy.
 Red Top } { 14 lbs. Red Top.

QUANTITY OF SEEDS REQUIRED FOR A GIVEN NUMBER OF PLANTS, NUMBER OF HILLS, OR LENGTH OF DRILLS.

Asparagus..... 1 oz. to 50 ft. drill.	Radish..... 2 oz. to 100 ft. drill.	Pumpkin..... 1 oz. to 40 hills.
Beet..... 1 oz. to 50 ft. drill.	Salsify..... 1 oz. to 70 ft. drill.	Early Squash..... 1 oz. to 50 hills.
Celery..... 1 oz. to 100 ft. drill.	Spinach..... 2 oz. to 100 ft. drill.	Marrow Squash..... 1 oz. to 16 hills.
Carrot..... 1 oz. to 100 ft. drill.	Turnip..... 1 oz. to 150 ft. drill.	
Endive..... 1 oz. to 150 ft. drill.	Peas..... 1 qt. to 100 ft. drill.	
Egg Plant..... 1 oz. to 300 ft. drill.	Dwarf Beans..... 1 qt. to 100 ft. drill.	
Lettuce..... 1 oz. to 150 ft. drill.	Leek..... 1 oz. to 100 ft. drill.	Cabbage..... 1 oz. of seed will produce 2,000 plants.
Okra..... 4 oz. to 100 ft. drill.	Pole Beans..... 1 qt. to 150 hills.	Cauliflower..... 1 oz. of seed will produce 2,000 plants.
Onion..... 1 oz. to 100 ft. drill.	Corn..... 1 qt. to 200 hills.	Celery..... 1 oz. of seed will produce 3,000 plants.
Onion Sets, small..... 1 qt. to 100 ft. drill.	Cucumber..... 1 oz. to 50 hills.	Egg Plant..... 1 oz. of seed will produce 1,000 plants.
Parsley..... 1 oz. to 150 ft. drill.	Watermelon..... 1 oz. to 30 hills.	Lettuce..... 1 oz. of seed will produce 3,000 plants.
Parsnip..... 3 oz. to 100 ft. drill.	Muskmelon..... 1 oz. to 60 hills.	Pepper..... 1 oz. of seed will produce 1,000 plants.
		Tomato..... 1 oz. of seed will produce 1,500 plants.

See Back Cover Page for Instructions When to Sow Seed.

... PRICES ... TO MARKET GARDENERS.

Market Gardeners and all other purchasers of Seeds, in large quantities, should send for our Special prices.

Quality of Seeds. We do not sell the cheapest seeds, but make **LOWEST PRICES** consistent with quality. They will please you.

On Every Order Be sure to sign your name and give your address plainly, as we frequently receive orders lacking either or both; also give full shipping instructions.

Notice. The greatest care is taken to supply every article true to name and of the very best quality; at the same time it is mutually understood that we do not warrant our seeds, and that we are not in any respect responsible for any loss or damage arising from any failure thereof.

Orders from unknown correspondents must be accompanied with the cash

**PRICES
SUBJECT TO CHANGE
WITHOUT NOTICE.**



FILLING ORDERS.

Every order is filled and forwarded as promptly as possible, but if not duly received, please notify us and we will make every effort to trace it without delay. Do not fail to sign your name and give full address.

Packing and Shipping. We make no charge for boxes or packing of retail orders, and deliver all goods to any railroad or steamboat free of charge. We charge for cotton bags as follows: Peck and ½ bushel, 10 cents each; 1 bushel, 15 cents each; 2 bushels, 20 cents each.

How to Remit. Remittances should be made by Draft, Express Money Order, P. O. Money Order, or Registered Letter.

All Vegetable and Flower Seeds, By the Packet, Ounce or Quarter Pound. On quantities over quarter pound the purchaser pays the postage at the rate of 8 cents per pound. On Beans, Peas and Corn, 8 cents per pint or 15 cents per quart should be added to Catalogue Price to pay the postage.

To Our Patrons.

By a careful examination of the following pages you will find represented one of the largest and best selected stocks of goods carried by any house of its kind in the country. Our constant care in purchasing this immense stock has been to secure the lines of goods best adapted to the needs of those sections of the country throughout which our trade is distributed. Since we conduct both a wholesale and retail business, we are obliged to buy very large quantities of goods, and are prepared to offer our customers advantages which we do not think can be obtained elsewhere. To meet the demands of our wholesale and retail trade, we carry a great variety of goods, which enables our patrons to buy more of ONE HOUSE, thus securing for themselves the benefits and discounts gained by large purchasing. We claim that, since each year finds us with a larger wholesale and retail trade, in addition to a constantly increasing mail order business, which now covers most every State in the Union, we are prepared to give our customers better goods for the same money and prompter service, by virtue of our varied stocks, than any competing house.

Trusting that you will give us an opportunity to demonstrate and establish the foregoing facts, we remain,

Yours Respectfully,

JOHN M. GRIFFITH,
President.
M. S. GRIFFITH,
Vice-President.

Griffith & Turner Company,

JOHN L. TURNER,
Treasurer.
GEORGE W. HOBBS,
Secretary.

Branch House, 116 and 118 Light Street,

205 TO 209 N. PACA ST.,

Cable Address, "Griffturn, Baltimore."

BALTIMORE.

GRIFFITH & TURNER CO'S.

GENERAL LIST OF VEGETABLE SEEDS

Premiums to every purchaser of Seeds in Packets. . . . The purchaser may select 60c. worth of Seeds for 50c., and anyone sending us \$1.00 can select SEEDS IN PACKETS amounting to \$1.25; for \$2.00, seeds in packets to the value of \$2.50.

TESTED and RELIABLE

ASPARAGUS. German, Spargel.

THIS is one of the earliest spring vegetables, and should be in universal use. Many persons think it is difficult to grow, but we consider this a mistake, and believe it can be produced as cheaply and easily as any on the list. Sow the seed in the seed bed late in the fall or in the early spring, as soon as the ground can be worked, in drills one foot apart, covering the seed about one inch deep. When the plants are four to five inches high, great care should be taken to keep the bed free of weeds. One ounce of seed will sow forty feet of row. Thin to nine inches in the row.

MAMMOTH WHITE ASPARAGUS.

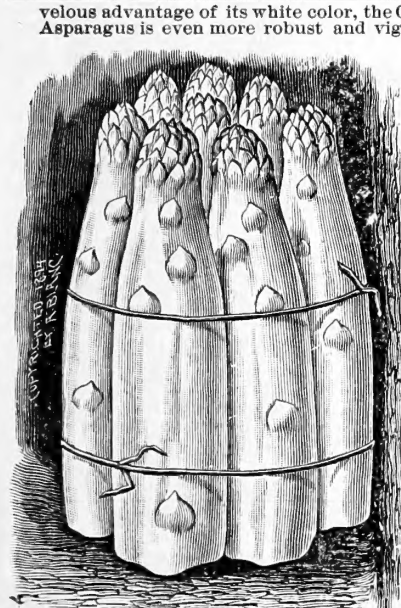

In addition to the marvelous advantage of its white color, the Columbian Mammoth White Asparagus is even more robust and vigorous in habit and throws larger shoots, and fully as many of them, as the Conover's Colossal. When we add to these the immense advantage of its needing no earthing up in order to furnish the white shoots so much sought after, we think it evident that it is superior to any sort now in cultivation, and that no asparagus grower can afford to plant seed of any other kind. Market gardeners, growers for canners and amateurs should give this great acquisition a thorough trial.

Pkt. 5c. Oz. 10c.
1-4 lb. 20c. Lb. 60c.

BARR'S MAMMOTH.

This splendid variety, highly recommended for its many good qualities, is very productive and about ten days earlier than Conover's Colossal. The stalks are very large and retain their thickness completely up to the top of the shoots; very tender and succulent; of delicious flavor. Grow very quickly and are light in color.

Pkt. 5c. Oz. 10c. 1-4 lb. 20c. Lb. 50c.

PALMETTO ASPARAGUS.

This Asparagus, said to have originated in South Carolina, is now quite extensively grown by Southern gardeners for New York and Philadelphia markets, where it sells at very high prices, owing to its mammoth size and regularity. An average bunch of fifteen shoots will measure thirteen to fourteen inches in circumference. For several seasons this asparagus has reached Northern markets ten days ahead of all other varieties, and sold at fabulous prices.

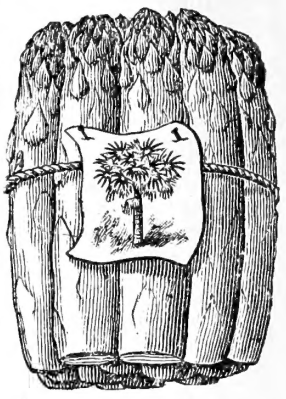

Pkt. 5c. Oz. 10c.
1-4 lb. 20c. Lb. 50c.
CONOVER'S COLOSSAL.—The old and well-known variety.
Pkt. 5c. Oz. 10c.
1-4 lb. 15c. Lb. 40c. †

Asparagus Roots.

A saving of one to two years is effected by planting roots. A bed 12 x 40 feet, requiring about 100 roots, should give a sufficient supply for an ordinary family. 7,260 roots will plant an acre. Select good, loamy soil, plough deep, put in good quantity of manure, and 100 lbs. kainit to 1,000 square feet of bed. Incorporate thoroughly, make a trench 8 inches deep, set plants 9 inches apart. In field culture rows are placed 4 feet apart.

BARR'S MAMMOTH.—Per 100, 70c. By mail, \$1. Per 1000, \$4.00.
PALMETTO.—Per 100, 60c. By mail, 90c. Per 1000, \$3.50.
COLOSSAL.—Per 100, 60c. By mail, 90c. Per 1000, \$3.50. †
MAMMOTH WHITE.—Per 100, 75c. By mail, \$1. Per 1000, \$5.00.

BEST ASPARAGUS BUNCHER.—\$1.50.
ASPARAGUS KNIVES.—25c. By mail, 35c.



DWARF BEANS.

One quart will plant 100 feet of drill. †
Add 8c. per pint, or 15c. per quart, on all Beans if to be sent by mail.

Select light, warm soil, and plant when danger from frost is past in the spring, in drills 2 to 2½ feet apart, dropping the beans about 2 inches apart in the drills, and cover 2 inches deep. A succession of sowings can be made from the first week in May until August.

WHITE MARROWFAT.—Extensively grown for sale as a dry bean for winter use. Qt. 20c. Pk. 75c. Bu. \$2.50.

WHITE NAVY.—A well-known variety for field culture, very prolific. Qt. 20c. Pk. 60c. Bu. \$2.00.

ARTICHOKES.

This is a very nice vegetable to eat. Some prefer it cooked like asparagus, that is, take the flower head before it begins to open and cook much the same way as asparagus. The tubers roasted, or boiled, served with butter, salt and pepper, makes a dish some think superior to potatoes. They are most excellent feed for cows and will cause an increase in quantity and quality of milk.

LARGE GREEN GLOBE.—Pkt. 10c. Oz. 30c.
JERUSALEM.—Pk. \$1.00. Bu. \$2.50.

ALL PRICES SUBJECT TO CHANGE WITHOUT NOTICE.

BEANS.

DWARF, BUSH OR SNAP.

Dwarf Green Podded.

EARLIEST MARKET.—This is well named, being the earliest Bean in existence, and therefore very profitable to the market gardener, and desirable to the private gardener as well. The pods are long, broad, green and very showy, reaching maturity in thirty days from germination, and the habit of vine very productive. **Qt. 30c. Pk. \$2.00.**

TRIUMPH OF THE FRAME.—This variety is particularly adapted for forcing. Very dwarf, prolific and tender. **Pt. 25c. Qt. 50c.**

EXTRA EARLY REFUGEE.—It is similar in every respect to the ordinary Refugee, but is nearly two weeks earlier. It is enormously prolific, and from its earliness is almost certain to produce a crop, no matter how unfavorable the season. Is rapidly becoming a favorite sort as it matures equally early with the Red Valentine, and has that beautiful silvery green color in the pods that is so much desired. **Qt. 30c. Pk. \$2.00.**

EARLY REFUGEE, or BROWN VALENTINE.—Resembles the Red Valentine, but two weeks late, very productive. **Qt. 30c. Pk. \$1.75.**

EARLY MOHAWK.—**Qt. 30c. Pk. \$1.75.**

DWARF HORTICULTURAL.—A very fine green podded sort, used as a Shell Bean, and for this purpose is one of the finest in general use; long a favorite with those who use a Shell Bean in a green state. **Pt. 15c. Qt. 30c. Pk. \$1.75.**

BEST OF ALL.—One of the most valuable green podded sorts for family or market use. The pods are six inches long, very fleshy, succulent, stringless, and of rich flavor; they are produced early and abundantly. **Qt. 30c. Pk. \$2.00.**

EMPEROR WILLIAM.—An extra early white variety of good quality. **Pkt. 15c. Qt. 30c. Pk. \$1.75.**

LONG YELLOW SIX WEEKS.—Very early, hardy bean. **Qt. 30c. Pk. \$1.75.**

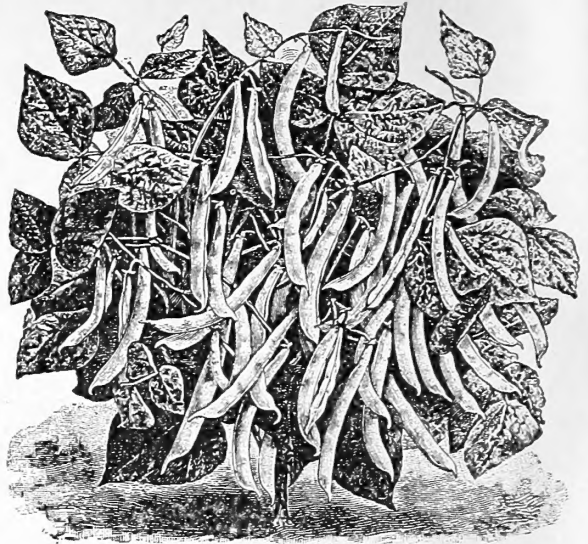

EARLIEST RED VALENTINE.—Ten days earlier than the ordinary Red Valentine Bean, and therefore the best for truckers and market gardeners. It is without doubt the very best and earliest green Snap Short Bean. The habit of the vine is dwarfed and very uniform. Color of pods light green, round, curved, succulent, prolific, continuing long in edible condition. **Qt. 35c. Pk. \$2.00.**

NEW STRINGLESS GREEN POD.—One of the earliest varieties, pods round and full, absolutely stringless and of beautiful fleshy appearance, quality excellent. The only green pod Bean, of which the pods never develop any strings. **Qt. 35c. Pk. \$2.00. Bu. \$7.50.**

Dwarf Wax Podded.

NEW GOLDEN-EYED WAX.—This fine new Bush Bean is very early; the vine grows vigorously about one and a half feet high, holding the pods off the ground. The pods are handsome, long, straight, and flat, remarkably free from rust, and keeps well. **Qt. 25c. Pk. \$1.75**

CURRIE'S RUST-PROOF BLACK WAX.—For earliness and freedom from rust it is at the head of the Wax Bean family. Habit, upright and robust, holding the pods well from the ground. Pods, long, straight, flat and very meaty, of a beautiful golden color; quality not surpassed and for productiveness unequalled. **Qt. 30c. Pk. \$2.00**

KENTON'S RUSTLESS GOLDEN WAX (New).—A strong-growing bush variety of remarkable vigor and freedom from rust. It sends out short tendrils, on which pods are formed in addition to those near the central stalk of the plant, which accounts for its wonderful productiveness. The pods are meaty and well filled; thick-flat when young, and semi-round later; of rich yellow color and fine quality; and entirely stringless throughout, even when old enough to shell. **Pt. 15c. Qt. 25c. Pk. \$1.75.**

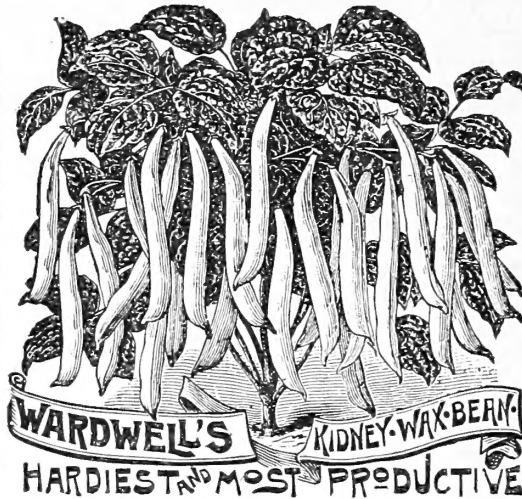

WARDWELL'S KIDNEY WAX BEAN.—This is one of the best of the wax sorts. The vines are remarkably vigorous, hardy and productive. The pods are very large, smooth, showy, tender, perfectly stringless, and of unusually fine quality. **Qt. 30c. Pk. \$2.00.**

DAVIS' KIDNEY WHITE WAX.—The best White Wax Bean known. Vigorous grower, bears abundantly long white handsome pods, which are very crisp and tender. **Qt. 30c. Pk. \$2.00.**

IMPROVED RUST-PROOF GOLDEN WAX. This is the earliest, handsomest and hardiest of all the Wax Beans. The pods are straight, long and thicker than the ordinary Golden Wax, much superior in quality, absolutely rust-proof, and sure to become the favorite Wax Bean; in fact, it has already gained great popularity with growers. **Qt. 30c. Pk. \$1.50. Bu. \$5.50.**

DETROIT WAX.—Pods straight, flat, but thick to edge; broader than Golden Wax; beautiful wax color and as nearly rust-proof as any. **Qt. 30c. Pk. \$1.50. Bu. \$5.00.**

DWARF PROLIFIC BLACK WAX.—Yellow pod; a very superior snap short, ripening among the first earlies, and having the best characteristics. Very tender. **Pt. 15c. Qt. 30c. Pk. \$2.00.**

Pole Beans

four healthy plants when they are up. They require the same soil and treatment as the dwarf varieties, with the exception that they crave stronger soil and do best in a sheltered location.

CREASE-BACK, or FAT HORSE.—A well-known and many-esteemed Southern variety. Very productive. Forms very full, round pods, very fleshy, entirely stringless and distinctly creased along the back; hence its name. This variety is especially valuable for its extreme earliness and its habit of perfecting all of its pods at the same time. **Qt. 30c. Pk. \$1.75.**

SOUTHERN PROLIFIC.—A splendid, vigorous, and productive variety. Pods in clusters, succulent and delicious; matures quite early and continuous, bearing until frost. **Qt. 20c. Pk. \$1.25.**

SPECKLED CUT-SHORT, or CORN-HILL.—An old variety, very popular for planting among corn, and will give a good crop, without the use of poles; vines medium, with dark-colored, smooth leaves; pods short, cylindrical and tender. **Pt. 15c. Qt. 30c. Pk. \$1.75.**

Set the poles three or four feet apart, and plant six to eight beans, with the eyes downward, around each pole, thinning to

DUTCH CASE KNIFE.—Vines moderately vigorous, climbing well, but not twining so tightly as some, and so may be used for a corn hill bean. Leaves large, crumpled; blossoms white; pods very long, flat, irregular, green, but becoming cream white; beans broad, kidney shaped, flat, clear white, and of excellent quality. green or dry. **Pt. 15c. Qt. 40c. Pk. \$1.75.**

MARYLAND WHITE.—This new White Pole Bean is destined to take its place as one of the best Beans ever grown for general purposes. Its thick, meaty green pods are very tender, rich in flavor, and produced in great abundance. It is equally valuable as a snap or shell bean. It has been grown in Maryland to a very limited extent for a few years, and those who have grown it once want it again. **Pt. 15c. Qt. 30c. Pk. \$1.75.**

SPECKLED HORTICULTURAL, or WREN'S EGG.—An old favorite for both snap-shorts and dry beans. **Qt. 30c. Pk. \$1.75.**

WHITE CHERRY.—Great favorite; used with or without pods. **Pt. 15c. Qt. 25c. Pk. \$1.75.**

LAZY WIFE.—Large, pale green pods, very thick meated, stringless, rich, tender and buttery; ripens early; clings well to the pole; enormously productive; splendid either as a snap or shell bean; retains its exquisite flavor until nearly ripe. **Pt. 15c. Qt. 30c. Pk. \$1.75.**

BUSH LIMA BEANS.



The Bush Lima Beans are rapidly gaining friends and have evidently come to stay.

Burpee's Bush Lima.—The bushes grow 18 to 20 in. high, stout growth and always erect, yet branching so vigorously that each plant develops into a magnificent circular bush, from two feet to three feet in diameter. The bush character is thoroughly established, not one plant in a thousand showing any disposition "to run." It is an immense yielder, each bush bearing from 50 to 200 of the handsome large pods, well filled with very large beans, which are identical in size and luscious flavor to the well-known large pole limas. By the introduction of this most valuable novelty, the largest and best lima beans can now be raised in quantity at small cost, without the expense and labor attached to the use of poles.

Pt. 15c. Qt. 30c.
By mail, 15c. per qt.
extra. Pk. \$1.85.
Bu. \$6.50.

DREER'S BUSH LIMA.—A dwarf variety of the Dreer's Improved Lima, which has been fixed in its character of a bush bean; it is very prolific, single plants often producing from 150 to 200 pods. Equal in quality and tenderness to Dreer's Pole Lima.

Pt. 15c. Qt. 30c. Pk. \$2.00.

HENDERSON'S DWARF LIMA.—These are valuable because they do not need poles, and being so dwarf can be planted close together. They are very early and prolific, continuing to bear until frost.

Qt. 30c. Pk. \$1.75.

BROAD WINDSOR.—Matures in 50 days after germination. Should be planted very early.

Qt. 30c.

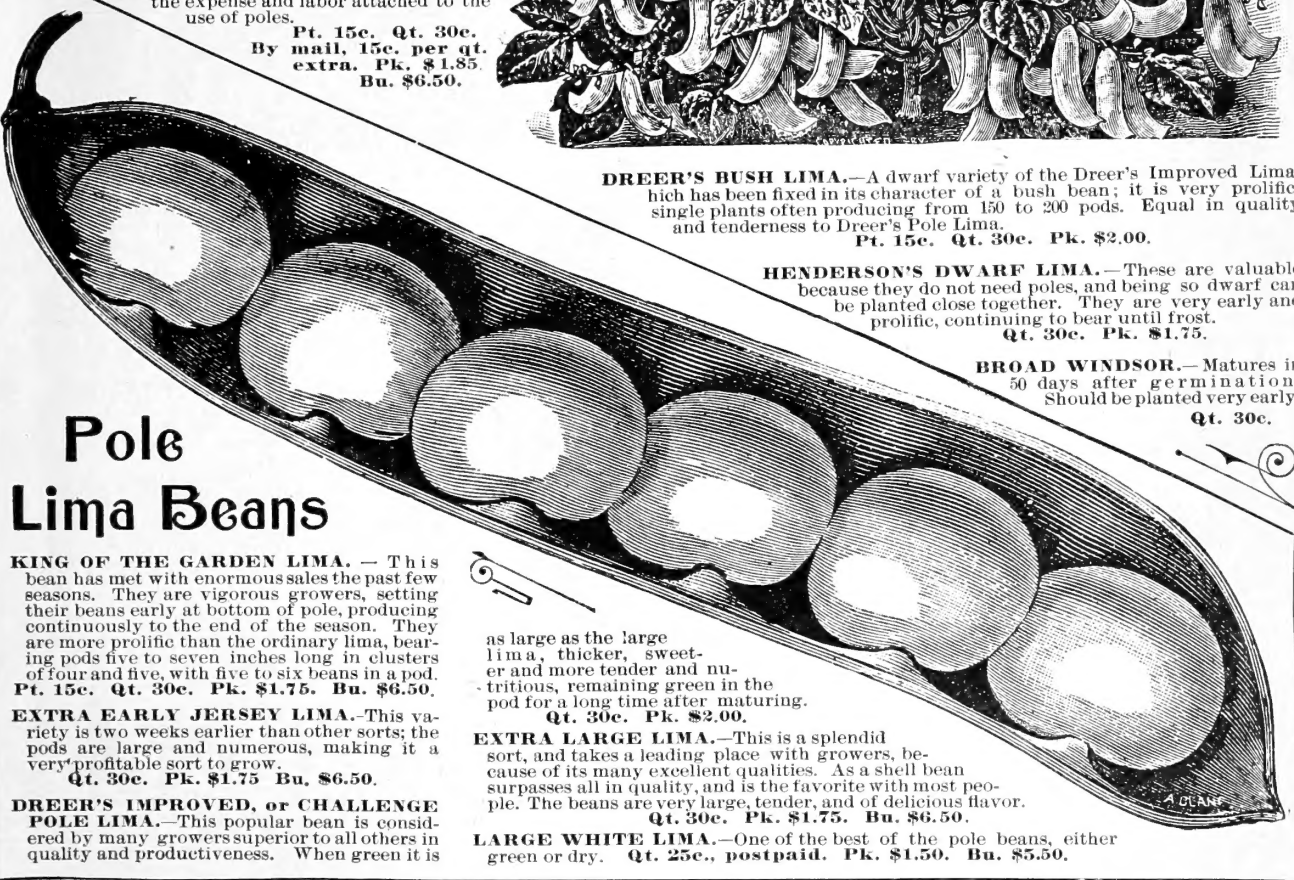

Pole Lima Beans

KING OF THE GARDEN LIMA.—This bean has met with enormous sales the past few seasons. They are vigorous growers, setting their beans early at bottom of pole, producing continuously to the end of the season. They are more prolific than the ordinary lima, bearing pods five to seven inches long in clusters of four and five, with five to six beans in a pod.

Pt. 15c. Qt. 30c. Pk. \$1.75. Bu. \$6.50.
EXTRA EARLY JERSEY LIMA.—This variety is two weeks earlier than other sorts; the pods are large and numerous, making it a very profitable sort to grow.

Qt. 30c. Pk. \$1.75 Bu. \$6.50.
DREER'S IMPROVED, or CHALLENGE POLE LIMA.—This popular bean is considered by many growers superior to all others in quality and productiveness. When green it is

as large as the large lima, thicker, sweeter and more tender and nutritious, remaining green in the pod for a long time after maturing.

Qt. 30c. Pk. \$2.00.
EXTRA LARGE LIMA.—This is a splendid sort, and takes a leading place with growers, because of its many excellent qualities. As a shell bean surpasses all in quality, and is the favorite with most people. The beans are very large, tender, and of delicious flavor.

Qt. 30c. Pk. \$1.75. Bu. \$6.50.
LARGE WHITE LIMA.—One of the best of the pole beans, either green or dry. Qt. 25c., postpaid. Pk. \$1.50. Bu. \$5.50.

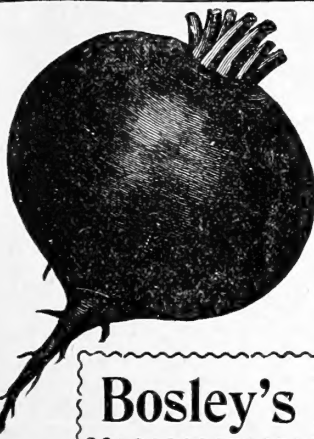

BEETS.

CROSBY'S IMPROVED EGYPTIAN BEET.—A very superior strain of the well-known Egyptian, carefully selected, deep blood color, quick, rapid growth. The shape is very desirable, as shown in the accompanying photograph, being not quite so flat as the ordinary Egyptian, nor so round as the Eclipse. Once used, it is preferred to Egyptian or Eclipse for forcing in frames or for first sowing outside, and being a rapid grower, it may be sown outside as late as July.

Pkt. 5c. Oz. 10c. 1-4 lb. 15c. Lb. 40c.
LARGE LONG BLOOD.—A large and desirable late variety of deep red color.

Pkt. 5c. Oz. 10c. 1-4 lb. 15c. Lb. 40c.

EDMOND'S RED TURNIP.—The most uniform of all turnip beets. It is of handsome round shape, good marketable size, and deep blood color. It has a small top, and may be planted close.

Pkt. 5c. Oz. 10c. 1-4 lb. 15c. Lb. 40c.
SWISS CHARD.—Oz. 10c. 1-4 lb. 25c.
BASSANO, or EXTRA EARLY TURNIP.—Flesh white and rose, very sweet and tender.

Pkt. 5c. Oz. 10c. 1-4 lb. 15c. Lb. 40c.
EXTRA EARLY EGYPTIAN.—This is a flat beet, very early and deep red color. Owing to the small top it can be planted very close.

Pkts. 5c. and 10c. 1-4 lb. 15c. Lb. 35c.

Bosley's Poultry Powders

IS AN EGG PRODUCER.—Sure cure for Cholera, Roup, Gaps, Bowel Disease and all Poultry Diseases. Price, 25 cents per package.

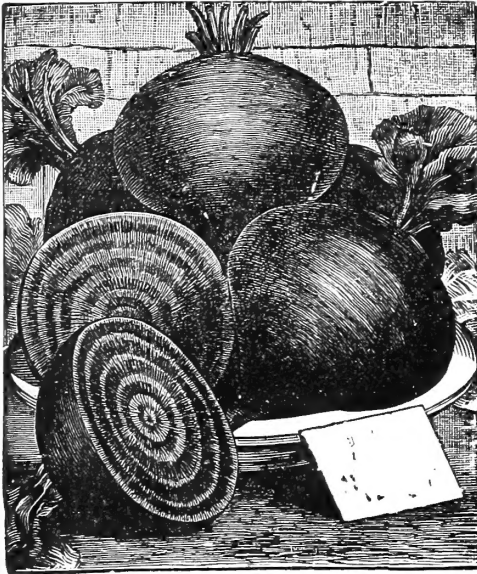

EARLY BLOOD TURNIP BEET. —

G. & T. CO.'S.—Grown specially for us from selected roots. In shape like a turnip, deep red color, and best for general use. We have been selling this stock of Beet for a number of years, and it has given unqualified satisfaction.

Pkt. 5c. Oz. 10c. 1-4 lb. 15c. Lb. 40c.

DETROIT DARK RED TURNIP BEET.

It will be found on investigation that this is one of the finest formed and handsomest colored Beets on the market. It is unsurpassed in the uniformity and beauty of the crop. It is exceedingly early and produces more marketable specimens on the same acreage than any other variety. Pkt. 5c. Oz. 10c. ¼ lb. 20c. Lb. 50c.

BALTIMORE EARLY MARKET BEET

—Its qualities are extra early; dark red color; fineness of shape and small top. It is earlier than Crosby's Egyptian; darker and much resembling it in shape. One of the most attractive varieties grown and is specially desirable for hot beds on account of its small top and close growing habit. It certainly will take first place among early Beets.

Pkt. 5c. Oz. 10c. 1-4 lb. 20c. Lb. 50c.

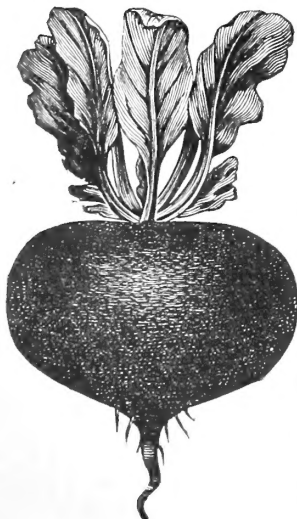

BALTIMORE EARLY.

BEETS

CONTINUED.

(One ounce of seed will sow one hundred feet of drill.)

SELECT a deep, rich, sandy loam, and manure with well decomposed compost or a good chemical fertilizer. Sow in drills, fourteen to sixteen inches apart, and cover one inch deep. When the young plants appear, thin to four or five inches apart. For early use, sow as soon as the ground can be worked in the Spring; for Autumn use, about the middle of May; and for Winter use, during June or July, according to the variety—the long varieties requiring more time to mature than the round early kinds.

BEETS FOR STOCK FEEDING

Sow 4 pounds
to the acre.

STOCK BEETS grow larger than other Beets, and hence require more room. They should be sown from April to June, in drills two and a half feet apart, and the plants thinned to twelve to fifteen inches in the row. The attention of farmers to the growing of Beets for stock feeding has rapidly increased, but it should be grown more generally and will show the results in the health and condition of the stock. It supplies good, rich food for cattle during the winter.

GOLDEN TANKARD MANGOLD.—The best type of Mangold—small top, smooth rich skin, broad shoulders, very solid fleshed, golden stemmed, heavy producer. It has already taken the lead of other varieties in England, and is relished by milch cows and sheep.
1-4 lb. 15c. Lb. 30c. Five lbs. \$1.00.

CHAMPION YELLOW INTERMEDIATE, or GATE-POST MANGOLD.—One of the very finest Mangolds ever introduced, giving unbounded satisfaction wherever grown. The crop is very uniform and the roots heavy, handsome and clean, with sin, gle tap root. In flavor they are wonderfully rich and nutritious. With good cultivation will crop at the rate of 200 bushels per acre.
1-4 lb. 15c. Lb. 40c. Four lbs. \$1.00.

LONG RED MANGOLD WURZEL.—The well-known, large, long variety, grows well out of ground; color light red. Very productive.
1-4 lb. 15c. Lb. 30c. Five lbs. \$1.00.

WHITE SUGAR BEET.—A large growing sort, and used for feeding stock.
1-4 lb. 15c. Lb. 30c. Four lbs. \$1.00.

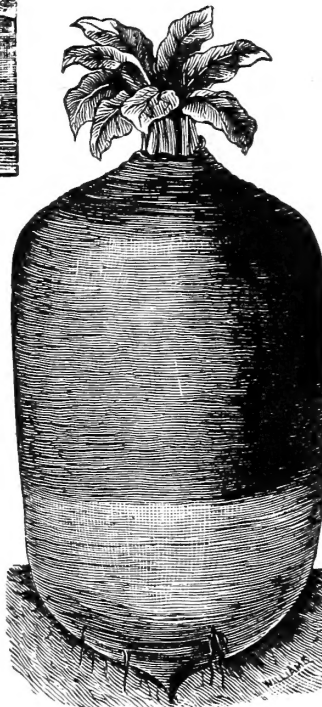

GOLDEN TANKARD MANGOLD.

ECLIPSE BEET. This new extra early Beet is remarkable for its fine quality and rapid growth, is of deep red color and handsome shape; as an early market sort it is unrivaled. It is, to a large extent, superseding the Egyptian, being earlier in development, more attractive in appearance, and of superior quality for the table. We have never known a market gardener to try it but who wanted it again.

Pkts. 5c. and 10c. 1-4 lb. 15c. Lb. 40c.

BRUSSELS SPROUTS German, Kopfkohl

Grüner.—(One ounce of seed to 100 yards of row.) A class of plants allied to the Cabbage family, producing a great number of small heads for sprouts on the main stem of the plant, which are used and prepared as greens. It is a delicious vegetable, especially after being exposed to the frost. Plant in rich soil, in hills two feet apart each way.

Pkt. 10c. Oz. 20c. 1-4 lb. 60c.

BROCCOLI.—German, Spargel Kohl.—(One ounce of seed to 100 yards of row.) The Broccoli are closely allied to the Cauliflower family. They require similar cultivation and treatment to Cauliflower.

EARLY PURPLE CAPE.—Large, compact.

Pkt. 10c. Oz. 40c.

LARGE EARLY WHITE.—Head white, like Cauliflower; the best. Pkt. 10c. Oz. 40c.

BORECOLE. This is often called Broccoli by market gardeners, but belongs to the Kale family. Very spreading in habit, and beautifully curled.

Pkts. 5c. and 10c. Oz. 15c. ¼ lb. 25c. Lb. 75c.

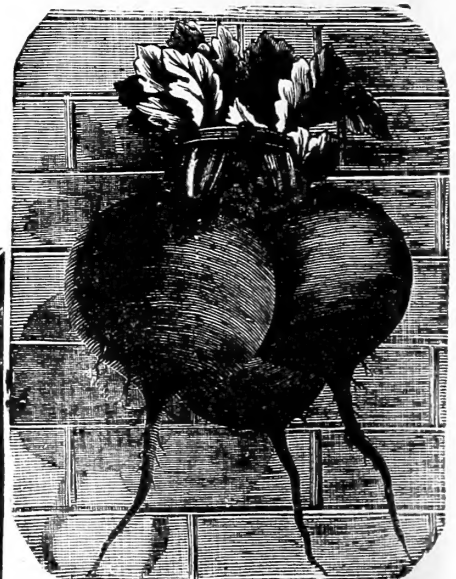

ECLIPSE BEET.

ALL PRICES SUBJECT TO CHANGE WITHOUT NOTICE.

CABBAGE.

One Ounce of Seed to 100 yards of row.

GERMAN, KOPFKOHL.

Early Cabbages.

CABBAGE will thrive on any good corn land, though the stronger the soil the better they will develop. New land is preferable. Plow deep and manure very liberally, as cabbage is a strong feeder and will repay for the care bestowed upon it. The early sorts bear planting from eighteen inches to two feet apart in the rows, with the rows from two to two and a half feet apart. The larger varieties to be from two to four feet apart in the rows, with the rows from two and a half to four feet apart, the distance varying with the size. It does not pay to buy cheap cabbage seed. Ours is American grown, and from the best stock in the country. For early use, sow in a hot-bed in February or March, and transplant to a cold-frame as soon as large enough. In April the plants may be set out in the rows. For late crop, sow in nursery bed in May or June, and transplant as soon as the plants are five or six inches high. The ground should be thoroughly cultivated every week until the plants meet in the rows.

KING OF EARLIES.—An excellent early sort. Heads formed like a Wakefield, but ten days earlier. Habit vigorous, short stem, and proof against sun.
Pkts. 5c. and 10c. Oz. 20c. 1-4 lb. 65c. Lb. \$2.25.

EARLY WINNINGSTADT.—Head large, cone-shaped and solid. An old and popular sort.
Pkts. 5c. and 10c. Oz. 15c. 1-4 lb. 40c. Lb. \$1.25.

Charleston, or Large Wakefield.

This is now a very popular market cabbage, fully meeting the demand for a cabbage having all the characteristics of the Jersey Wakefield, but larger. It is five to six days later than Early Jersey Wakefield. The heads are fully one-half larger, and quite solid. It is very compact in growth, and can be easily planted in rows two feet apart and twenty inches in rows. One great advantage is, it does not burst open when ripe, like many other early sorts, and consequently can be left standing on the ground a long while without injury, until a favorable opportunity for cutting. No market or private gardener desiring a cabbage of this kind should fail to plant this valuable sort.

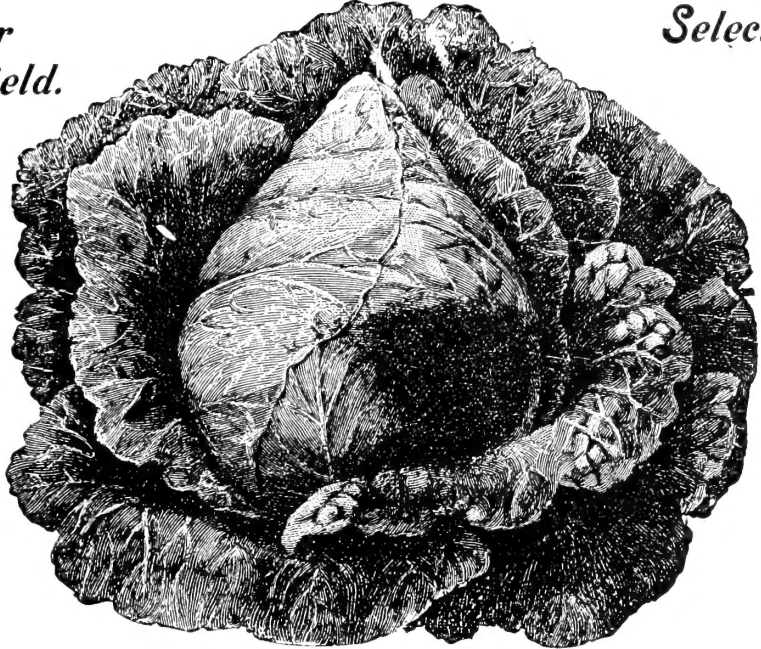

Pkts. 5c. and 10c. Oz. 25c. 1-4 lb. 90c. Lb. \$3.00.

CHARLESTON, OR LARGE WAKEFIELD.



SELECT EARLY JERSEY WAKEFIELD.

Select Early Jersey Wakefield.

The very best early cabbage, and grown more extensively by market gardeners than any other variety. It is early, the heads are pyramidal in shape, very large and solid, and having but few outside leaves, the plants can be set close together. We secured our seed from a grower of the best Wakefield cabbage in the country, and it is giving good results wherever it is used, so much so that our sales of this sort are rapidly increasing each year. The demand for this sort has brought on the market inferior stock at a low price, but when select stock, such as we offer, is used, it cannot fail to give satisfaction.

Pkts. 5c. and 10c. Oz. 25c. 1-4 lb. 90c. Lb. \$3.00.

LARGE EARLY YORK. One of the earliest. Forms a medium size, pointed head.

Pkts. 5c. and 10c. Oz. 15c. 1-4 lb. 50c. Lb. \$1.50.

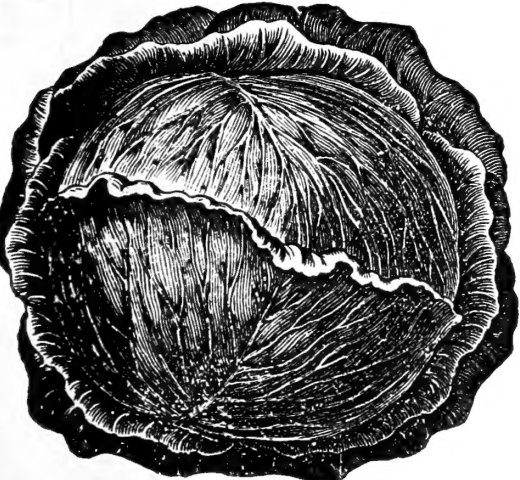

NEW EARLY.

EARLY DWARF FLAT DUTCH. An old standard variety which stands the sun and produces fine large heads, coming in soon after the Wakefield.

Pkts. 5c. and 10c. Oz. 15c. 1-4 lb. 50c. Lb. \$1.50.

LARGE EARLY SUMMER.—One of the earliest of the summer varieties. Heads large and flat; short stemmed, few outside leaves, uniform in character, and about ten days later than the Wakefield. It is very popular with the truckers.

Pkts. 5c. and 10c. Oz. 15c. 1-4 lb. 65c. Lb. \$2.00

New Early.—This is one of the finest large early cabbages grown. Forms solid, compact heads and leaves grow close to the head, thus allowing many more cabbages to be grown on the acre than any other sort. One of its most striking features is its earliness. It heads so rapidly that the worms can't hurt it.

Pkts. 5c. and 10c. Oz. 25c. 1-4 lb. 75c. Lb. \$2.50.

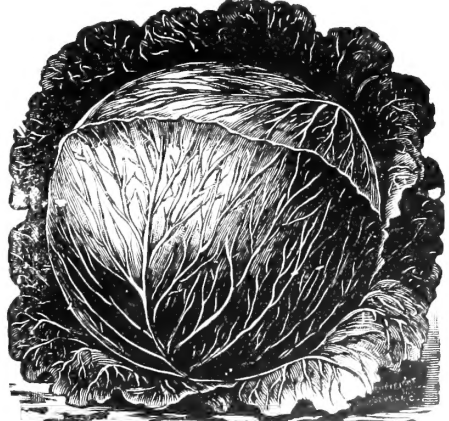

Early Spring.—An extra early round-headed cabbage of the early summer type.
Pkt. 10c. Oz. 30c. 1-4 lb. \$1.25.



SUCCESSION CABBAGE.

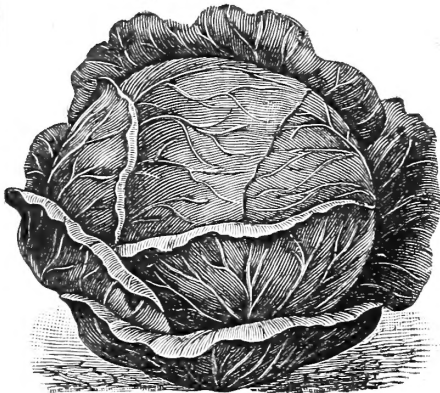

DANISH BALL HEAD CABBAGE.



ALL-HEAD EARLY CABBAGE.



PREMIUM LARGE FLAT DUTCH—LATE CABBAGE.

CABBAGE. —CONTINUED.

MEDIUM EARLY VARIETIES.

THE SUCCESSION CABBAGE is one of the most valuable contributions to horticulture. It would be classed as a second early variety, coming in a few days later than Early Summer, but it is immeasurably superior to that variety; it is nearly double the size, and is absolutely true to its type under all conditions. In addition to this, it has no tendency whatever to run to seed. It is one of the finest sorts in existence to-day; whether for medium early, main crop or late use, it has no superior. It is so finely bred and so true to type that in a field of twenty acres every head appears alike. We can recommend it either for the market gardener, trucker or private planter, as it is a perfect Cabbage in every respect, not only being of the largest size, but of handsome color and of the finest quality. It is probably the safest variety for an amateur to plant as it does well at all seasons, and one is almost sure of getting a crop, no matter when it is planted. **Pkts. 5c. and 10c. Oz. 20c. 1-4 lb. 75c. Lb. \$2.50.**

DANISH BALL HEAD.—This most excellent variety of Cabbage, coming from Denmark, has grown very rapidly into favor with both market and private gardeners. It is a large, round, solid heading, medium early variety; a very sure header, having few loose leaves, consequently can be planted very close together. Although a medium early, can also be grown for a fall and winter crop, being one of the best keepers. Very popular in the Philadelphia, New York and Boston markets. **Pkt. 10c. Oz. 20c. 1-4 lb. 75c. Lb. \$2.25.**

THE LUPTON.—This will mature earlier than Flat Dutch, keeps well, and is a good header. **Pkts. 5c. and 10c. Oz. 20c. 1-4 lb. 65c. Lb. \$2.00.**

ALL-HEAD EARLY CABBAGE—This is the earliest of all Cabbages, fully one-third larger than the Early Summer, therefore more profitable to the market gardener. It is the nearest approach to a thoroughbred Cabbage of any variety, both in size and uniform development. As the All-Head comes in quicker than any of the other Flat Cabbages, it is consequently more tender. It is also valuable for a late or winter cabbage.

Pkts. 5c. and 10c. Oz. 20c. 1-4 lb. 75c. Lb. \$2.25.

LOUISVILLE DRUMHEAD.—This is the most popular intermediate or second early with market gardeners around Louisville and the South-west. It comes off medium early, withstands heat to a remarkable extent, heads large, solid and uniform in size and color. We can recommend this sort very highly for the Southern and Middle States.

Pkt. 10c. Oz. 15c. 1-4 lb. 50c. Lb. \$1.50

SUREHEAD.—This popular Cabbage is rightfully named Surehead, as it never fails to make a fine, large, solid head, with few outer leaves. It is a strong, vigorous grower, and very uniform in size and color. Always brings the highest price in our markets. **Pkts. 5c. and 10c. Oz. 20c. 1-4 lb. 50c. Lb. \$1.75.**

ALL SEASONS.—This forms a fine, large head, of superior quality, nearly as early as the Early Summer. Suitable for planting at any season. **Pkts. 5c. and 10c. Oz. 25c. 1-4 lb. 65c. Lb. \$2.00.**

**SPECIAL PRICES TO GARDENERS
AND FARMERS, IN LARGE
QUANTITIES.**

Late or Autumn Cabbages.

PREMIUM LARGE LATE FLAT DUTCH CABBAGE.—Large and excellent for winter, very extensively grown. The head is broad, thick and flat, well covered in by leaves lapping across the centre, outside leaves feathered to the base of the leaf stem. **Pkts. 5c. and 10c. Oz. 15c. 1-4 lb. 40c. Lb. \$1.25.**

BOSS FLAT DUTCH CABBAGE.—In again calling the attention of market gardeners and truckers to this magnificent Cabbage, we would say that it has fully met the claims we made for it upon its introduction. When we ask our customers how they like it, their answer is "splendid" or "elegant," everything heads; "you can scarcely find any that don't head." The heads are large, hard, thick and flat, the leaves lapping across the centre, making it the most desirable winter variety in cultivation. Try it and be convinced of its superior quality.

Pkts. 5c. and 10c. Oz. 20c. 1-4 lb. 50c. Lb. \$1.75.

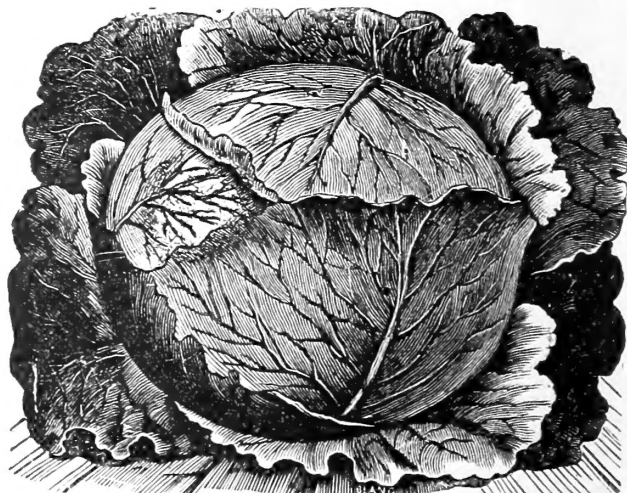

BOSS FLAT DUTCH—LATE CABBAGE

ALL PRICES SUBJECT TO CHANGE WITHOUT NOTICE.

LATE CABBAGES. Continued.

Perfection Drumhead Savoy.—

This is without any exception the finest stock of Savoy cabbage to be found anywhere. The heads are large and solid, the leaves beautifully curled, and in tenderness and flavor it is almost equal to cauliflower, while its keeping quality is first-class. To say that our market gardeners are pleased with it, is putting it mild; they are enthusiastic over it, as they find it so much superior to the old-time Savoy. It is specially adapted to private use, as when grown in the fall and allowed to be touched by frost, it is one of the most delicious of all vegetables.

Pkts. 5c. and 10c. Oz. 15c. 1-4 lb. 40c. Lb. \$1.25.

LARGE LATE AMERICAN DRUMHEAD.—One of the largest, most solid and best keeping late varieties. This variety seldom fails to head, and is of good quality.

Pkts. 5c. and 10c. Oz. 15c. 1-4 lb. 40c. Lb. \$1.25.

RED DUTCH.—The head is large, round, solid and a deep red color, the best of the red cabbages.

Pkts. 5c. and 10c. Oz. 20c. 1-4 lb. 50c. Lb. \$1.50.

WORLD-BEATER, or AUTUMN KING.—This is a very superior late cabbage. The large, broad heads are very thick through, slightly rounded at the top, fine grained and tender, has a short stalk, green color, and one of the best keepers we know, and is a rapid grower.

Pkts. 5c. and 10c. Oz. 20c. 1-4 lb. 65c. Lb. \$2.25.

Georgia Collards.—Called the Cabbage Collard on account of its close bunching growth. The plant produces centre leaves generally perfectly white, though sometimes dashed with pink. It is a very delicate vegetable and of the first quality.

Pkt. 10c. 1-4 lb. 20c. Lb. 50c.

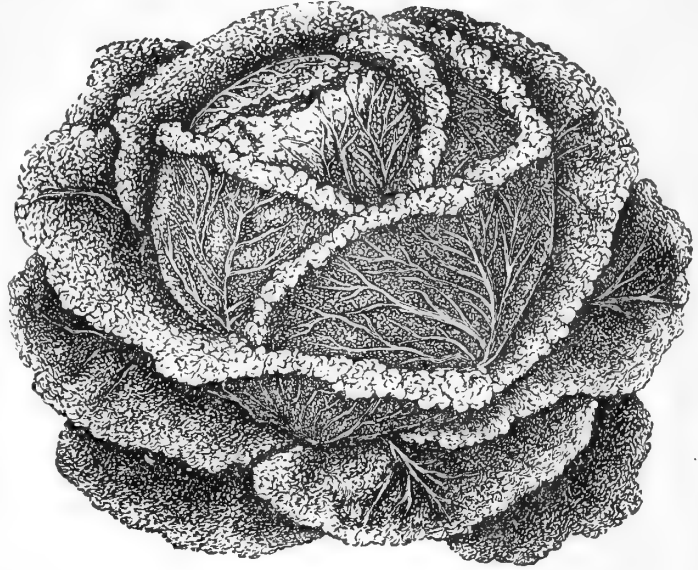

G. & T. Co.'s Snowball Cauliflower.

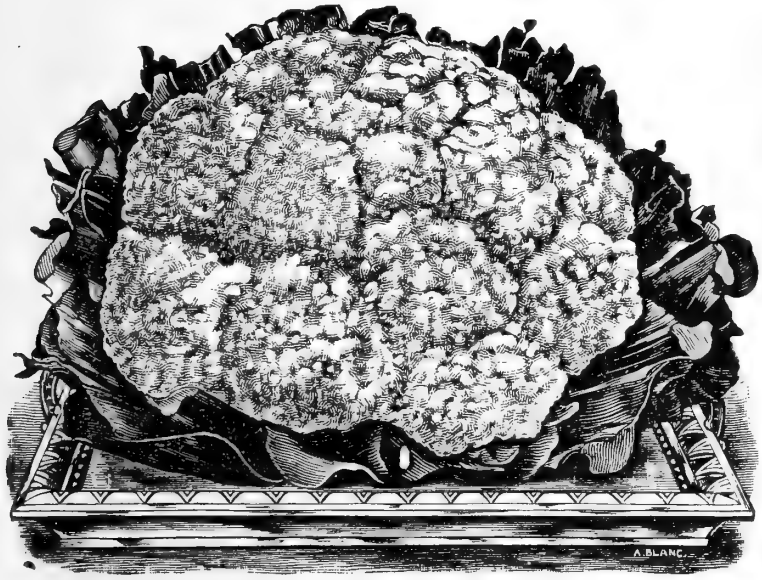

One Ounce of seed will produce 2,000 Plants.

MANY amateurs make the mistake of sowing the seed too early for late crop. It should not be sown before May, as when sown earlier they begin to head before the hot weather is over, and are a failure. Cauliflower can only be grown on rich, well-tilled and well-watered soil. The most delicious of all the cabbage family, and requiring the same culture and treatment, but being more delicate. The good culture and richness of the soil recommended for cabbage is absolutely necessary for the cauliflower. For early crop, sow in hot-bed or cold-frame in February or March. For late crop sow and treat like late cabbage.

Our Gilt Edge Snowball Cauliflower.

—Is without exception one of the finest sorts now in cultivation. It is very early. Nearly every plant will, under proper cultivation, form a perfect snow white head, and its close growing, compact habit enables the grower to plant one-third more on the same space of ground than other varieties. In fact, it is, and deserves to be, the standard with the market gardener and amateur.

Pkts. 25c. and 50c. 1-4 oz. 75c. Oz. \$2.00.

SELECT EARLY DWARF ERFURT.—Long the standard of highest excellence, and still holding its own with a great many people.

Pkts. 25c. and 50c. 1-4 oz. 50c. Oz. \$1.75.

EARLY PARIS.—An excellent sort for early or late use.

Pkt. 10c. Oz. 50c.

Cress, or Pepper Grass.

Used as a small salad. Sow very thickly in shallow drills, on a smooth surface, at short intervals throughout the season.

CURLED.—Pkt. 5c. Oz. 10c. 1-4 lb. 20c. Lb. 60c.

WATER CRESS.—Water Cress may be grown along the margin of running streams, ditches or ponds, and has a ready sale in the hotels and markets.

Pkt. 10c. Oz. 30c.



Corn Salad.

Three ounces of seed to 100 feet of row.

A favorite salad plant, and very hardy. Sow in August or September, and protect with leaves during the winter; it can be gathered in the spring very early. Sown in April, it is soon ready for use. The leaves are sometimes boiled and served as spinach.

Pkt. 5c. 1-4 lb. 15c. Lb. 40c.

G. & T. CO.'S CARROTS.

One ounce of seed to 100 feet of row.

CARROTS thrive best in rather a light, rich loam. The ground should be well manured with fine, well-rotted or composted manure, and be thoroughly worked quite deep. Sow from middle of April to middle of May, in rows 14 inches apart, and thin the plants to 5 or 6 inches in the row. For late crops sow in June or July. An important point is to tread the rows firmly after sowing. For field culture, carrots should be sown in drills 3 to 3½ feet apart, so as to cultivate with horse.

Improved Long Orange.

—Deep orange color, long, smooth, fine for either garden or field culture. All who have cattle should raise a surplus of this carrot for feeding milch cows during winter. It increases the flow of milk and imparts to the butter a delicious flavor and a rich, golden color.

Pkt. 5c.
Oz. 10c.
1-4 lb. 20c.
Lb. 60c.
By mail, 70c.

IMPROVED LONG ORANGE.

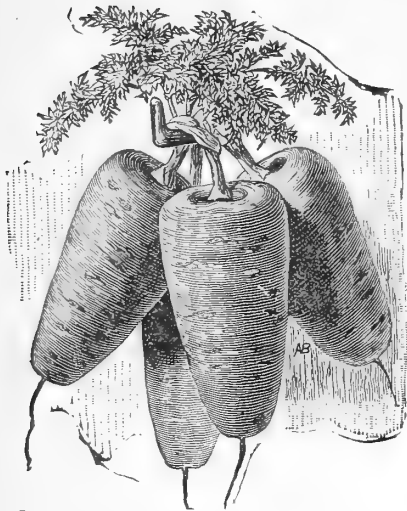

Ghantenay.—Very productive; has an extra large shoulder, is easily dug, and is in every way desirable. It is very smooth, fine in texture, and of a beautiful, rich orange color. Well worthy of a thorough trial.

Pkt. 5c. Oz. 10c. 1-4 lb. 20c.
Lb. 60c. By mail, 70c.

EARLY SCARLET HORN.—Blunt rooted, early, good. Favorite sort for early crop.

Pkt. 5c. Oz. 10c. 1-4 lb. 20c. Lb. 60c.

Guerande, or Ox Heart.—A new French variety, intermediate in length, of fine quality; excellent table sort. The shape is nearly oval, and the color and quality all that can be desired. No market gardener should be without it.

Pkts. 5c. and 10c. 1-4 lb. 20c. Lb. 60c. By mail, 70c.

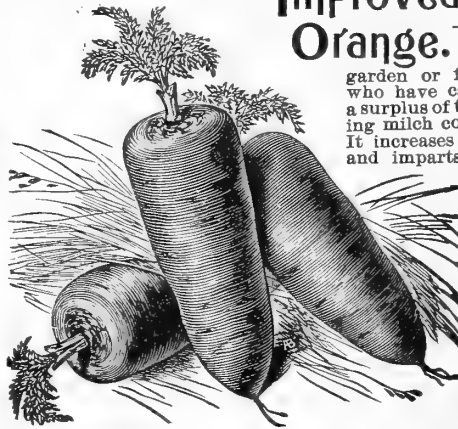

Danvers.—A decided acquisition of the half-long type, broad-shouldered, cylindrical, admirable in color, fixed in habit, a wonderful producer. It is a first-class carrot for all soils.

Pkt. 5c. Oz. 10c.
1-4 lb. 20c. Lb. 60c. By mail, 70c.

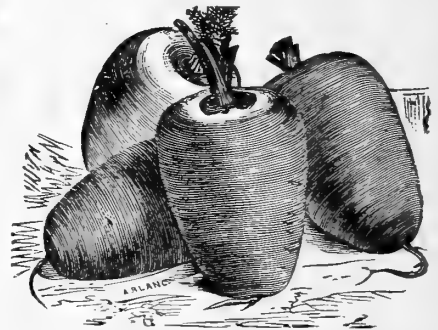

GUERANDE, OR OX HEART.

One Ounce will produce 2,000 Plants.

CELERY. German, Celerie.

PLANT seed in hot-bed or very early in open ground. Transplant four inches apart when three inches high, in rich soil, finely pulverized; water and protect until well rooted. In June or July transplant into rows three to four feet apart, either on surface or well-manured trenches a foot in depth, half filled with well-rotted manure. Set the plants from six to eight inches apart. To blanch, draw earth around the plants from time to time, taking care not to cover the top of the centre shoots.

Golden Heart, or GOLDEN DWARF CELERY.—This old standard variety still holds a high place in the estimation of market gardeners, and is largely used, always giving satisfaction. A showy sort, solid, of fine flavor and a good keeper.

Pkts. 5c. and 10c. Oz. 15c. 1-4 lb. 40c. Lb. \$1.25.

EARLY ARLINGTON. This new celery is an improved selection of the well-known Boston Market Celery, made by an Arlington market gardener. It is very early, coming in quite three weeks in advance of the Boston Market, and its superiority over that variety is in the fact that it is earlier, of larger size and more vigorous growth, and bleaches easily and more quickly.

Pkt. 10c. Oz. 20c. 1-4 lb. 50c. Lb. \$1.50.

NEW ROSE.—In England, the Pink or Red Celeries are much more largely used than the white varieties, and we wonder they are not more grown in this country. They possess many advantages over the white, being hardier, more solid and better keepers.

Pkt. 10c. Oz. 20c. 1-4 lb. 50c. Lb. \$1.75.

WHITE SOLID.—A large, standard sort. One of the best of the large growing sorts.

Pkts. 5c. and 10c. Oz. 15c. 1-4 lb. 40c. Lb. \$1.50.

CELERY SEED FOR FLAVORING.—This seed is used for flavoring pickles, soups, etc.

Pkt. 5c. 1-4 lb. 10c. 1-2 lb. 15c. Lb. 25c.

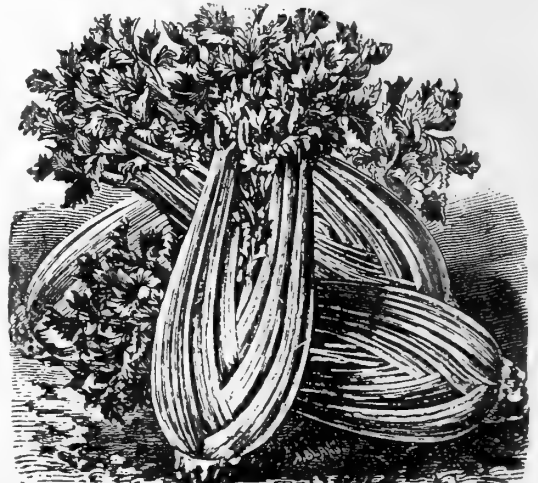

GOLDEN HEART.

ALL PRICES SUBJECT TO CHANGE WITHOUT NOTICE.

CELERY. — CONTINUED.

PARIS GOLDEN SELF-BLANCHING CELERY.—(French Stock).—This recommended, as after being thoroughly tested it has fulfilled all that has been claimed for it. It is decidedly the very best and most profitable Celery in cultivation; it is very early and entirely self-blanching. The beautiful appearance of the plant, its close habit, compact growth, straight, vigorous stalks, solid, crisp, brittle ribs, fine quality and delicious flavor commend it to all lovers of Celery. No variety can surpass, if, indeed, equal the Paris Golden Self-Blanching in its striking appearance and delicious flavor. Our stock of this variety has been giving the market gardeners the very best results for several years.

Pkts. 5c. and 10c. Oz. 30c. 1-4 lb. 90c. Lb. \$3.25.

PARIS GOLDEN CELERY (American Stock).—This is a selection from the French Stock grown here, and is a favorite sort with market gardeners, being very largely used. **Pkts. 5c. and 10c. Oz. 20c. 1-4 lb. 60c. Lb. \$2.00.**

PINK PLUME.—This is identical with the White Plume, but with the added merit of the stalks being exquisitely suffused with pink, and possessing the crispness, rich, nutty flavor and long-keeping qualities for which red celeries are noted.

Pkt. 10c. Oz. 25c. 1-4 lb. 75c.

PERLE LE GRAND. The new Perle beautiful, full golden heart, and rich, nutty flavor; on the market stall it is extremely showy and salable, a single plant making a good-sized bunch and surpassing all other sorts in weight. It is not only a good early Celery, being among the first fit to use, but as a winter keeper, remaining when properly trenched, in perfect condition a way into the spring.

Pkt. 10c. Oz. 20c. 1-4 lb. 50c. Lb. \$1.50.

IMPROVED BOSTON MARKET.—This is a decided improvement on the old Boston Market, being earlier, larger in size, and of more vigorous growth.

Pkts. 5c. and 10c. Oz. 15c. ¼-lb. 40c. Lb. \$1.50.

GIANT PASCAL.

A selection from the well-known Self-Blanching Celery. It partakes of the best qualities of that variety, is somewhat larger, and an excellent keeper. It is of a fine, nutty flavor, being entirely free from any bitter taste. It grows about two feet high; the stalks are very broad, thick and crisp; the width and thickness of these are distinctive features of this variety.

Pkts. 5c. and 10c. Oz. 15c. ¼-lb. 40c. Lb. \$1.25.



GIANT PASCAL

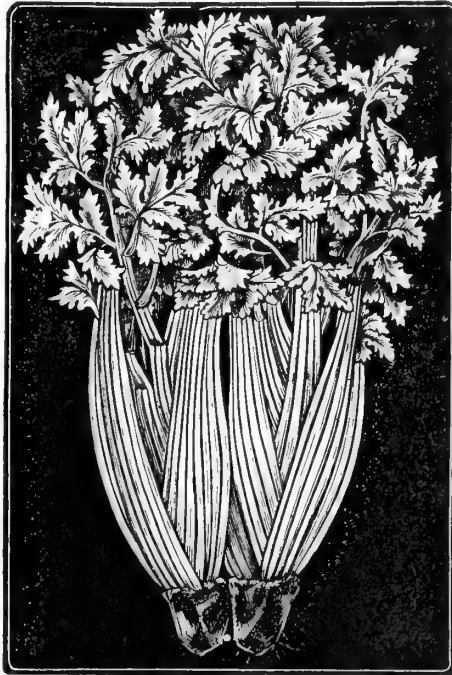

WHITE PLUME.

WHITE PLUME.—An early, handsome, self-blanching variety, growing in popularity every year. Like the Golden Self-Blanching, it requires very little earthing up to blanch it, and as a Celery for fall and early winter use it is unsurpassed. **Pkts. 5c. and 10c. Oz. 20c. 1-4 lb. 50c. Lb. \$1.50.**

CELERIAC

OR TURNIP ROOTED CELERY.

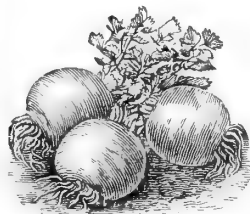

LARGE SMOOTH PRAGUE.—The largest, smoothest and best of the Celeriacs. **Pkts. 5c. and 10c. Oz. 20c. ¼ lb. 50c. Lb. \$1.50.**

NEW APPLE SHAPE.—Small foliage, large, round, smooth. **Pkts. 5c. and 10c. Oz. 20c. ¼ lb. 50c. Lb. \$1.50.**

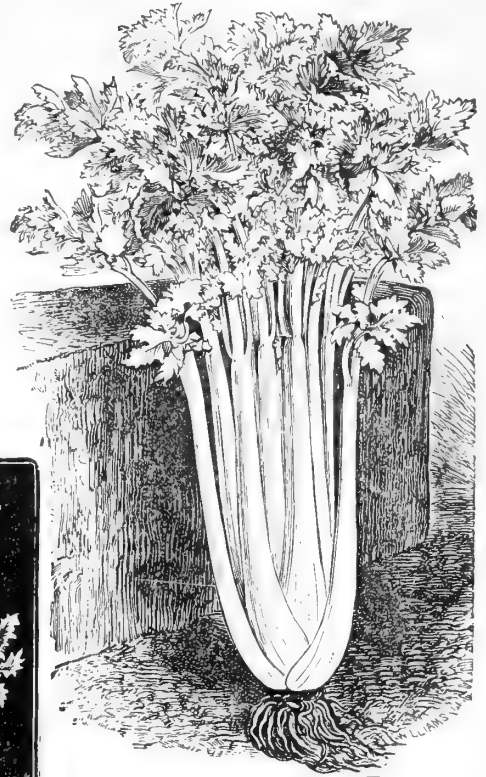

PARIS GOLDEN SELF-BLANCHING CELERY!



PERLE LE GRAND.

Sweet or Sugar Corn.

FOR TABLE USE.

German Heischhorn.

When Corn is wanted by mail, add 8 cents per pint to pay postage.

CULTURE.—Sugar Corn may be planted in rows three to four feet apart, and the seeds placed about eight inches apart in the rows, or planted in hills three to four feet apart each way, according to variety grown or richness of soil. Do not let more than three plants remain in each hill. It can be planted in this vicinity from first of May to last of July for succession of crop. By planting every two weeks, a family may have good corn throughout the whole season.

EXTRA EARLY ADAMS.—Ear 5c. Doz. 25c. Pt. 10c. Qt. 15c. Pk. 50c. Bu. \$1.75.

EARLY ADAMS.—A favorite in the South.

Ear 5c. Doz. 25c. Pt. 10c. Qt. 15c. Pk. 50c. Bu. \$1.75.

EARLY BURLINGTON HYBRID.—We introduced this variety in this market five years ago, and our sales have grown each year. Not a true sugar corn, but a hybrid or mixture between the sugar corn and the Adams Early, being as early as Adams, with an ear about the size of Stowell's Evergreen, and more productive than either. The husk, blade and ear, when green resemble the sugar corn. Those who have tried it want it again.

Doz. 25c. Qt. 15c. Pk. 65c. Bu. \$1.75.

CROSBY'S EXTRA EARLY.—An early market variety, very productive, ears rather short and rich, sugary flavor.

Qt. 20c. Pk. 75c. Bu. \$2.50.

EARLY MINNESOTA SUGAR.—One of the first early among sugar corn.

Qt. 20c. Pk. 75c. Bu. \$2.50.

BLACK MEXICAN SUGAR.—The Black Corn is especially rich in sugary qualities. Qt. 20c. Pk. 75c.

WHITE CORY.—An extra early variety, with good-sized ears and large kernels. Qt. 20c. Pk. 75c. Bu. \$2.50.

EXTRA EARLY BALTIMORE.—The hardiest and earliest variety for table use; it can be planted earlier than any other, but is not a sweet corn; white indented grains and short ears.

Ear 5c. Doz. 30c. Qt. 15c. Pk. 75c. Bu. \$2.25.

EARLY MAMMOTH.—A splendid market sort, producing large, handsome ears, grain large, white and sweet. Fills out well at the end.

Ear 5c. Doz. 30c. Qt. 15c. Pk. 75c. Bu. \$2.25.

LATE MAMMOTH.—The largest variety grown; very fine for market purposes.

Ear 5c. Doz. 50c. Qt. 15c. Pk. 75c. Bu. \$2.50.

STOWELL'S EVERGREEN.—So well known that it scarcely needs description. Excellent; keeps green till cold weather; ears large. One of the best.

Ear 5c. Doz. 30c. Qt. 15c. Pk. 75c. Bu. \$2.25.

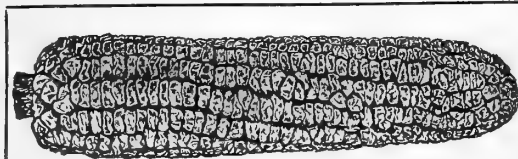

TRUCKERS' EARLY SUGAR CORN.

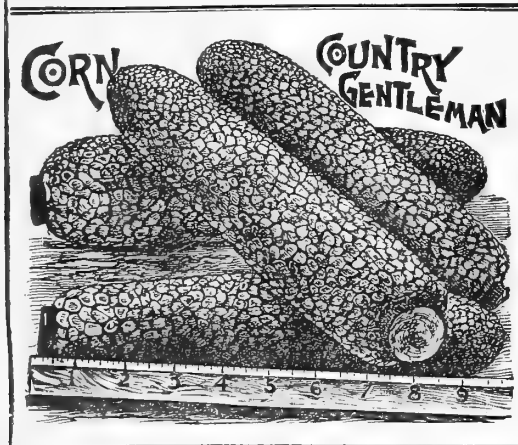

TRUCKERS' EARLY SUGAR CORN.—This is the most desirable variety of sugar corn for truckers and gardeners to plant early. As its many excellent qualities are becoming generally known, it has come to be one of the standard sorts. It is ten days earlier than Evergreen, very productive, growing two to four ears to the stalk. The ears set low, are large and well filled, the grain long and narrow, similar to Evergreen, but smaller. It is one of the most productive varieties in cultivation.

Qt. 20c. Pk. 90c. Bu. \$3.00.

KENDALL'S EARLY GIANT.—The largest early sweet corn known; comes in just after the Cory, and is very productive.

Pt. 15c. Qt. 25c. Pk. \$1.00. Bu. \$3.00.

FIRST OF ALL.—A selection from the Cory, the ears about the same size as Cory, lighter in color and earlier.

Qt. 20c. Pk. 75c. Bu. \$2.50.

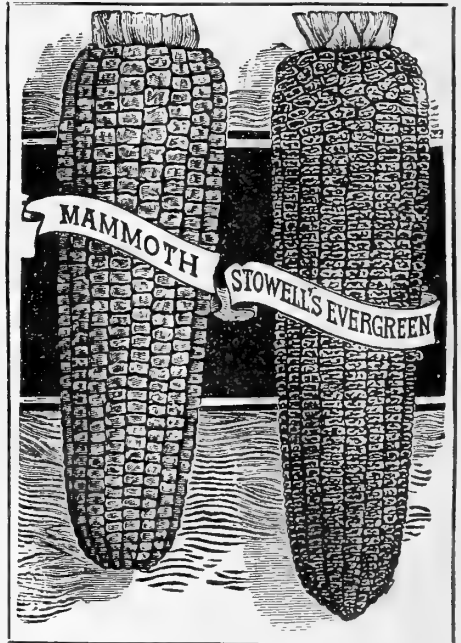

COUNTRY GENTLEMAN CORN.—This is the sweetest and most deliciously flavored of all sugar corn. It is the finest variety for the table, and will delight the most fastidious epicure. It produces three to four ears to the stalk, and retains its greenness longer than other sorts.

Qt. 20c. Pk. \$1.00. Bu. \$3.00

STABLER'S EARLY.—Of larger size than usual for the early kinds. It is remarkable for the fine flavor, sweetness and earliness, and is a desirable gardeners' and canning variety.

Pt. 10c. Qt. 20c. Pk. 75c. Bu. \$2.50.

HICKOX.—A very handsome and excellent variety of sugar corn; large, white grain and sweet.

Ear 5c. Doz. 40c. Qt. 20c. Pk. 75c. Bu. \$2.25.

EGYPTIAN, or WASHINGTON MARKET.—A large variety, somewhat resembling the Evergreen; flavor peculiarly rich and sweet, and of superior quality; fine for market.

Ear 5c. Doz. 40c. Qt. 20c. Pk. 75c. Bu. \$2.25.

IMPROVED NE PLUS ULTRA.—Early, good-sized ears and deep grain. Very productive, some stalks yielding four ears and an average crop running as high as three ears to the stalk.

Qt. 25c. Pk. \$1.00. Bu. \$3.00

ZIGZAG EVERGREEN.—This is one of the sweetest and best late sweet corns, not even excepting the celebrated Country Gentleman and Shoe Peg. The ears resemble Stowell's Evergreen in size and shape, except that the kernels are placed irregularly or zigzag upon the cob, which is always an indication of great sweetness in any variety of sugar corn.

Pt. 10c. Qt. 20c. Pk. 75c. Bu. \$2.50.

90-DAY CORN (Red Cob).—This is an elegant corn for truckers and market gardeners, as it is a good seller as green corn, and if not used as green corn, makes a good variety for feeding purposes. It may be planted for early crop and at intervals until the middle of July. Many truckers use it for their late planting, as it produces a very sure crop.

Qt. 10c. Pk. 50c. Bu. \$1.50.

SUGAR CORN.—For fodder. Write for Prices.

POP CORN.—For popping. 1 lb. by mail, 15c.

TESTIMONIALS.

Hudgins, Va., May 10, '99.
I like your seed, they always come up.

N. E. MILLER, J. P.

Markham, Va., July 24, '99.
Your seed gave entire satisfaction.

F. M. TRIPLETT.

ALL PRICES SUBJECT TO CHANGE WITHOUT NOTICE.

CUCUMBER, GERMAN, GURKE.

CULTURE.

(One ounce will plant 50 hills; two lbs. will plant one acre.)

For very early Cucumbers sow the first of April in a hot-bed, upon pieces of sod (grass side down), so that they can be readily transplanted to the open ground, in rich soil, when danger of frost is over, or protect by hand-glasses. The vines require a warm location for early Cucumbers. Plant after the ground has become warm, in hills four feet apart for the smaller varieties, and five feet for the larger sorts. For pickling sow from middle of June to last of July. Manure with ashes, fertilizer or some well-rotted compost, working the manure just under the surface. Sprinkle the vines with slug-shot, plaster or air-slacked lime, to protect from bugs. The Cucumbers should be gathered when large enough for use, whether required or not; if left to ripen, it destroys their productiveness.



EVER-BEARING CUCUMBERS.



This variety is unique, and will prove valuable both for the table and for pickling. It is of small size, very early, enormously productive, and extremely valuable as a green pickler. The peculiar merit of this new cucumber is that the vines continue to flower and produce fruit until killed by frost, whether the ripe cucumbers are picked off or not, in which respect it differs from all other sorts in cultivation.

Pkt. 5c. Oz. 10c. 1-4 lb. 20c. Lb. 50c.

IMPROVED LONG GREEN.

LONG GREEN.—Has long been a favorite with growers; dark green, firm and crisp. Superior for pickles and for market.

Pkt. 5c. Oz. 10c. 1-4 lb. 20c. Lb. 40c.

LONG GREEN TURKEY.—A very showy and excellent sort.

Pkt. 5c. Oz. 10c. 1-4 lb. 20c. Lb. 50c.

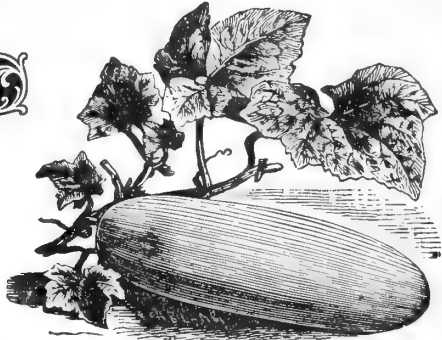

WHITE WONDER CUCUMBER.

The White Wonder surpasses the White Pearl both in handsome appearance and fine quality, while its strong, vigorous, extremely healthy habit of growth enables the vines to produce a large crop of perfect fruit, even under adverse conditions. Its strong constitution is exceptional. The Cucumbers are thickly set throughout the length of the vine, and are remarkably uniform in color, shape and size.

Pkt. 5c. Oz. 10c. 1-4 lb. 30c. Lb. \$1.00.



Baltimore White Spine Cucumber.

This is the best Cucumber for early planting, because it will retain its green color longer than any other sort. It is of good size and shape, and the popular variety with truckers around Baltimore and Norfolk, as well as the growers from Virginia to Florida.

Pkt. 5c. Oz. 10c. 1-4 lb. 20c. Lb. 50c.

ARLINGTON WHITE SPINE.—A favorite extra early variety, of desirable size, handsome shape, dark green color, holding its color longer than most others. Good shipper and sells well.

Pkt. 5c. Oz. 10c. 1-4 lb. 15c. Lb. 40c.

EARLY GREEN.—Early, short, prolific. Quality of fruit good.

Pkt. 5c. Oz. 10c. 1-4 lb. 15c. Lb. 40c.

EXTRA EARLY WHITE SPINE. A strain of White Spine which has been improved through careful selection, with a view to use for forcing in hot-houses and frames; also elegant for field culture. Our stock produces handsome, dark-colored fruits, which retain their color longer than other sorts.

Pkt. 5c. Oz. 10c. 1-4 lb. 15c. Lb. 40c.

COOL AND CRISP. This is the earliest and one of the most prolific pickling Cucumbers. The Cucumbers are straight, long, even and slim, and of a dark color; it is very tender and crisp.

Pkt. 5c. Oz. 10c. 1-4 lb. 15c. Lb. 40c.

EARLY CLUSTER. A short, prickly variety, bearing in clusters near the root. A great bearer.

Pkt. 5c. Oz. 10c. 1-4 lb. 15c. Lb. 40c.

GHERKIN, or Burr. Used for pickles only.

Pkt. 5c. Oz. 15c. 1-4 lb. 35c.

JAPANESE CLIMBING CUCUMBER. It bears abundantly throughout the season, while the climbing habit enables the hanging fruit to grow perfectly straight; from 12 to 16 inches in length, the Cucumbers are thick tender, and of delicate flavor; flesh white, skin dark green, turning to brown and netted when ripe.

Pkt. 5c. Oz. 10c. 1-4 lb. 20c. Lb. 65c.

ENGLISH FORCING CUCUMBERS Should be grown in hot-beds, where the temperature does not fall below 65 degrees at night.

TELEGRAPH is the best. 25c. Packet.

JERSEY PICKLING.

This is the most popular sort with the market gardeners around Baltimore and Philadelphia for pickling. Said to green better than any other variety.

Pkt. 5c. Oz. 10c. 1-4 lb. 15c. Lb. 40c.

CHICAGO PICKLING.

Very Popular With Chicago Market Gardeners, and Extensively Grown in that Vicinity.

Fruit medium length, pointed at each end, with very large and prominent spines; color deep green.

Pkt. 5c. Oz. 10c. 1-4 lb. 20c. Lb. 50c.

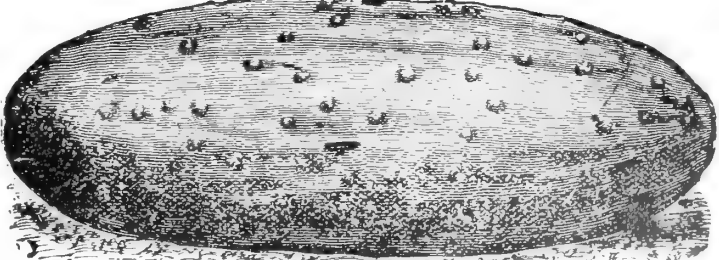

Egg Plant

GERMAN.
Eierpflanze.

(One ounce will produce about 1,000 plants.)

CULTURE.—Sow the seed in hot-beds early in March. When three inches high pot the young plants, using small pots, and plunge them in the same bed, so that the plants may become stocky. They can be planted, out, from the pots, when the season becomes sufficiently warm, in May or June; or they can be transplanted into a second bed to make them strong, until the weather is warm enough to transplant, about three feet apart each way, in thoroughly worked and well enriched soil. Draw the earth up to the stems when about a foot high. Egg Plant seed will not vegetate freely without a strong, uniform heat, and if the plants get the least chilled in the earlier stages of growth they seldom recover. Therefore repeated sowings are sometimes necessary. Care should be observed in cutting the fruit so as not to disturb the roots of the plants.



BALTIMORE EGG PLANT.—WHEN ONCE USED, TAKES THE LEAD.

THIS is decidedly the best and most profitable Egg Plant in cultivation; it is large, thornless, of beautiful shape and handsome purple color. We have never seen finer specimens of Egg Plant than those grown from our seed. When inspecting the field of Egg Plants growing for seed, we were surprised at the regular size and uniform, handsome color of the fruit all over the field. Packet, 10c. Oz. 30c. 1-4 lb. 65c. Lb. \$2.00.

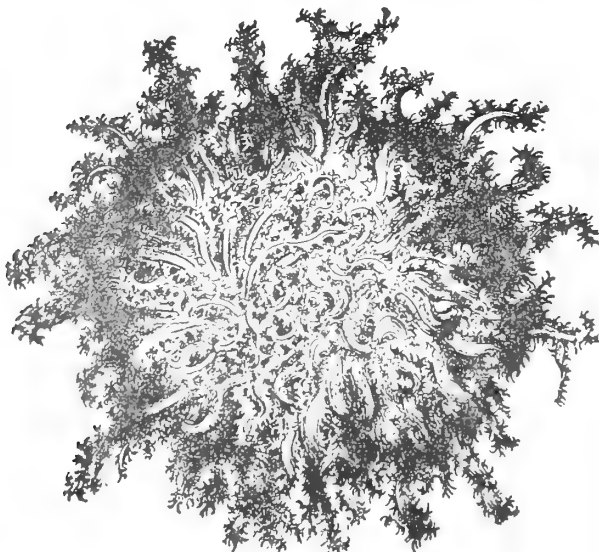

Endive. GERMAN. Endivien

IS ONE OF THE BEST SALADS FOR FALL AND WINTER USE.
(One ounce of seed to 150 feet of row.)

FOR early use, sow as soon as the ground can be worked in the spring, in drills fifteen inches apart, and thin plants to six or eight inches in the row. To blanch the leaves, gather them carefully together when perfectly dry, and tie with matting or soft fibrous material. Another method is to invert flower pots over the plant. The leaves are very highly esteemed for use as salads.

GREEN CURLED.—The best sort in use. Useful as a salad, and also used for garnishing. Pkt. 5c. Oz. 15c. 1-4 lb. 40c. Lb. \$1.25.

MARKHAM, VA.,
July 24th, 1899.
Your seed gave entire satisfaction.
F. M. TRIPLETT.

HUDGINS, VA.,
May, 5th, 1899.
I like your seed, they always come up.
N. E. MILLER, J. P.

BALTO. CO., MD.,
July 3rd, 1899.

As to the condition of your seeds, I can only speak praise as they are first-class and reliable.

FRANK COLITZ,
Gardener and Florist.

KALE. GERMAN, BLATTER-KOHL.

ONE OUNCE OF SEED WILL SOW A DRILL OF ABOUT TWO HUNDRED FEET.

THE Kales are more hardy than Cabbage, and make excellent greens for winter and spring use, and are improved by frost. For early spring use, sow broadcast in September, and protect during winter. It must also be sown in April or May for later use.

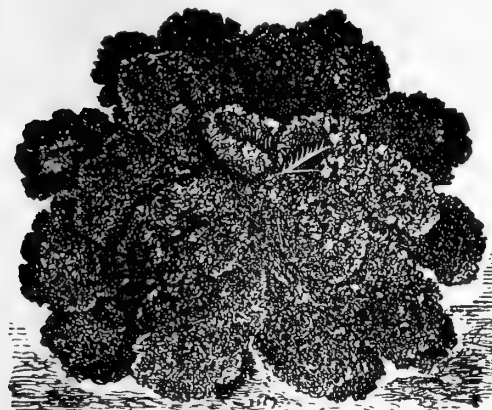

EXTRA CURLED NEW AMERICAN KALE.

THIS is an extra curled, long-standing variety of a beautiful green color; stands the winter well, and will stand longer in the spring before going to seed than any other variety.

Pkt. 5c. 1-4 lb. 20c. Lb. 60c.

DWARF GERMAN GREENS.—This variety sow in September broadcast, and gather in early spring like spinach. It may also be sown early in the spring for later use.

Pkt. 5c. 1-4 lb. 20c. Lb. 50c.

NORFOLK.—A variety used by the truckers of Norfolk for shipment North. Light green color and leaves much curled.

Pkt. 5c. Oz. 10c. 1-4 lb. 30c. Lb. \$1.00.

KOHL RABI.

ONE OUNCE OF SEED TO ONE HUNDRED YARDS OF ROW.

WHITE VIENNA.—

BULB LIGHT GREEN,

FLESH WHITE, VERY RAPID IN GROWTH,

EARLY MATURITY,

FINE IN TEXTURE, and

SYMMETRICAL IN FORM.

SUPERIOR.

Pkts. 5c. and 10c. Oz. 20c. 1-4 lb. 50c. Lb. \$1.50.



LEEK. * *

GERMAN, LAUCH.

ONE OUNCE OF SEED TO 150 FEET OF ROW.

SELECT good Onion soil, manure liberally, plant in April in drills six to eight inches deep, and eighteen inches apart, and thin to nine inches apart in the drill. Gradually draw the earth around the plants until the drills are filled level with the surface. Draw for use in October. To be used in soups or boiled as Asparagus.

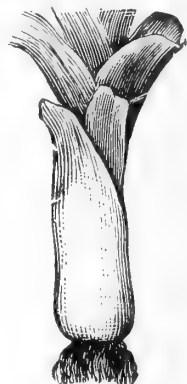

EXTRA LARGE.—A large and strong plant; hardy. The best variety for general culture.

Pkt. 5c. Oz. 10c. 1-4 lb. 40c. Lb. \$1.25.

MUSSELBAUGH.—Oz. 20c. 1-4 lb. \$1.25.

LARGE ROUEN.—Pkts. 5c. and 10c. Oz. 20c. 1-4 lb. 50c. Lb. \$1.50.

LETTUCE.

GERMAN, LATTICH.

(ONE OUNCE OF SEED TO ONE HUNDRED AND FIFTY FEET OF ROW.)

LETTUCE requires a rich and rather moist soil. The rows should be about twelve inches apart, and the plants thinned to ten or twelve inches apart for the leading varieties. The more rapid the growth the better the quality. Some varieties are peculiarly adapted for early culture, others for summer growth.

G. & T. CO.'S SUMMER LETTUCE (Black Seed).

—This Lettuce is becoming very popular among gardeners and bids fair to eclipse all others for summer use. It produces a splendid, large, solid head, of the cabbage type, remaining a long time in prime condition without going to seed; in fact, it is often necessary for the seed growers to slit open the head in order to allow the seed stalk a chance to develop. It is of a light green color, fine quality, crisp, tender, and nearly every plant will make a fine, solid head in the hottest, weather, when other varieties refuse even to grow. Pkts. 5c. and 10c. Oz. 15c. 1-4 lb. 30c. Lb. \$1.00.

G. & T. CO.'S WHITE SEED SUMMER LETTUCE.

—Having heard of this superior Lettuce, we secured some of the seed, and introduced it last season. The result exceeded our expectation. Those who purchased it, were delighted with their crops and came back for more seed. This Lettuce will stand the summer heat better than most sorts, and makes magnificent heads. We expect this sort to grow in favor wherever known. It has a beautiful green color; head solid; light cream; leaves nicely crinkled; very tender and of most excellent flavor. Pkt. 5c. Oz. 20c. 1-4 lb. 50c. Lb. \$1.50.

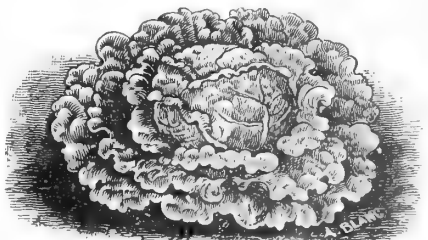

EARLY WHITE CABBAGE, or BUTTER.—A broad leaved, vigorous heading sort; white, showy, and desirable.

Pkt. 5c. Oz. 10c. 1-4 lb. 35c. Lb. \$1.00.

EARLY CURLED SIMPSON.—Black seed. Very early; excellent for salads; forms a compact mass of leaves.

Pkts. 5c. and 10c. Oz. 15c. 1-4 lb. 30c. Lb. \$1.00.

TENNIS BALL.—Black seed. A favorite forcing variety; a very hard head.

Pkts. 5c. and 10c. Oz. 15c. 1-4 lb. 30c. Lb. \$1.00.

ALL PRICES SUBJECT TO CHANGE WITHOUT NOTICE.

LETTUCE

CONTINUED.

Baltimore Cabbage Lettuce,

G. & T. CO.'S TRUE STOCK.

Large heads, beautiful heads, solid heads, stands heat well.
Best of all for Fall Planting.

THIS new Lettuce, which we introduced a few years ago, and claimed to be one of the best ever put on the market, and which produced such a sensation among the large growers who tried it, still holds a high place among Lettuce. As soon as the growers discovered its merits they came for more seed, and recommended it to all their friends; these in turn, were delighted with their crops, as the result more than justified all we claimed for it. A grower at Gardenville, Maryland, says: "I had three thousand heads of your Baltimore Cabbage Lettuce, and they all headed but one; they are slow to run to seed." The heads are large and solid, color, pretty light green, and very slow to seed. In fact, it is just what the truckers and gardeners want. A large trucker in New Jersey writes: "The Baltimore Cabbage Lettuce I had of you was certainly very fine."

Pkts. 5c. and 10c. Oz. 20c. 1-4 lb. 40c. Lb. \$1.25.

BALTIMORE OAK LEAF.—This Lettuce will resist the heat of summer, and stand longer before running to seed than any variety we have ever known. It makes a large, solid head, and is very popular with those who know it.

Pkts. 5c. and 10c. Oz. 15c. 1-4 lb. 30c. Lb. \$1.00.

GRAND RAPIDS.—This variety is largely grown for shipment, and is considered by many the best loose-headed Lettuce for forcing under glass. Leaves medium size, of light, yellowish green color, much crimped and frilled, thin, but of very upright growth; crisp, tender and of good quality. Owing to its upright habit, it may be planted very closely. It is of extremely rapid growth; very little liable to rot; will stand without spoiling a week to ten days after it is fit to cut, and retains its freshness a long time after cutting.

Pkt. 5c. Oz. 10c. 1-4 lb. 30c. Lb. \$1.00.

PARIS WHITE COS.—Differs entirely in shape from the other varieties, the head being elongated and of conical form, eight or nine inches in height and five or six inches in diameter. The outer coloring of this variety is yellowish green. It is very hardy and of good flavor. To blanch perfectly it must be tied up.

Pkt. 5c. Oz. 15c. 1-4 lb. 35c. Lb. \$1.00.

BIG BOSTON.—The same in color, shape and general appearance as the Boston Market, but double the size. A most desirable sort either for forcing in cold frames or planting in open ground. Is popular with truckers, as it makes large, solid, salable heads. Very highly recommended by those who have tried it.

Pkts. 5c. and 10c. Oz. 15c. 1-4 lb. 40c. Lb. \$1.25.

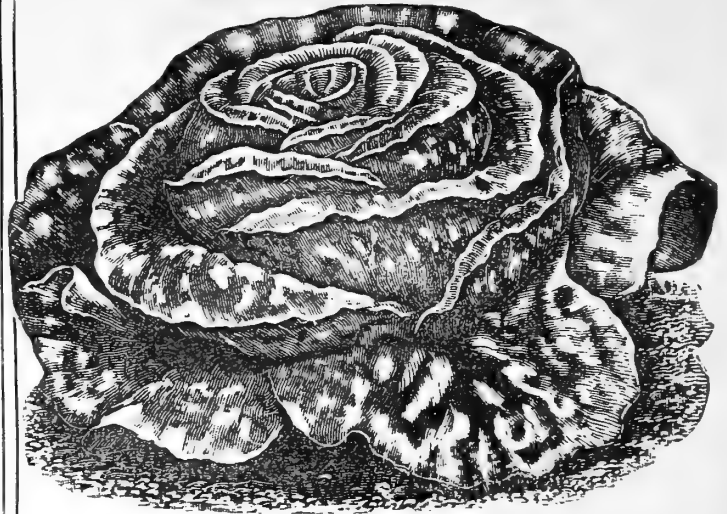

BALTIMORE CABBAGE LETTUCE.

BIG HEAD LETTUCE.—The "Big Head" is certain to please market gardeners and truckers, because it always produces large salable heads. It is very solid and crisp, of tender quality, which makes it attractive. Packets, 5c. and 10c. Oz. 15c. 1-4 lb. 40c. Lb. \$1.25.

BOSTON MARKET.—White seed. A celebrated variety in New England, of good heading habit; small, early and compact; quite desirable. Pkts. 5c. and 10c. Oz. 15c. 1-4 lb. 30c. Lb. \$1.00.

NEW YORK LETTUCE.—Very large, solid, Cabbage heads; slow to run to seed; crisp tender and of nice flavor. Pkt. 5c. Oz. 15c. 1-4 lb. 30c. Lb. \$1.00.

CREAM BUTTER LETTUCE (Black Seed).—This is fairly well-known and has given good results with the growers. Pkt. 5c. Oz. 10c. 1-4 lb. 30c. Lb. \$1.00.

HANSON.—A variation of the India, forming a half-closed head. Pkts. 5c. and 10c. Oz. 15c. 1-4 lb. 30c. Lb. \$1.00.

SALAMANDER (Black Seed).—An excellent sort for spring or summer use, forms good-sized heads of excellent quality. Pkt. 5c. Oz. 10c. 1-4 lb. 30c. Lb. \$1.00.

DEFIANCE.—Stands summer heat better than any other variety; one of the finest large growing varieties. It forms very large, solid heads, so firm they have to be cut open to allow the flower heads to come through.

Pkt. 5c. Oz. 10c. 1-4 lb. 30c. Lb. \$1.00.

Large Loaf Lettuce.

THIS is so well-known to truckers and gardeners around Baltimore and Norfolk that for them it scarcely needs description. For the benefit of those who are not acquainted with it, would say it makes large, compact heads, is of beautiful light green color, very tender and crisp. This is unsurpassed for frame use, and is also an excellent outdoor Lettuce for fall or early spring.

Pkt. 5c. Oz. 10c. 1-4 lb. 30c. Lb. \$1.00.

MARKET GARDENERS

are asked to look carefully over our list; notice our attractive prices, and send us at least a

TRIAL ORDER.

For years we have given special attention to the selection and growing of

SEEDS

and therefore can offer first-class stocks at moderate prices.

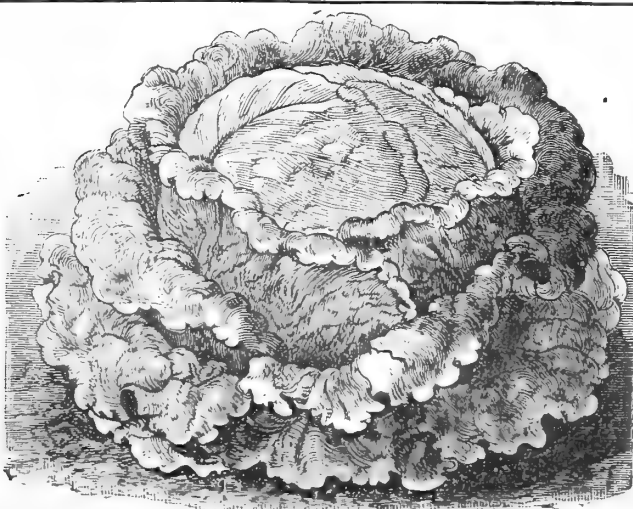

LARGE LOAF LETTUCE.

ALL PRICES SUBJECT TO CHANGE WITHOUT NOTICE.

Musk Melon

German, Melone.

Rocky Ford Musk Melon or Cantaloupe.

—This has become one of the most popular of small or basket melons, largely owing to the fact that growers in the Rocky Ford region pack and ship their fruit in a most attractive manner. The fruit is oval, slightly ribbed, densely covered with coarse netting. Flesh thick, green, very sweet and high flavored. We offer an exceptionally fine stock of this sort, the fruit being wonderfully uniform in shape and quality.

**Pkt. 5c. Oz. 10c. 1-4 lb. 20c.
Lb. 60c. 5 lbs. \$2.75.**

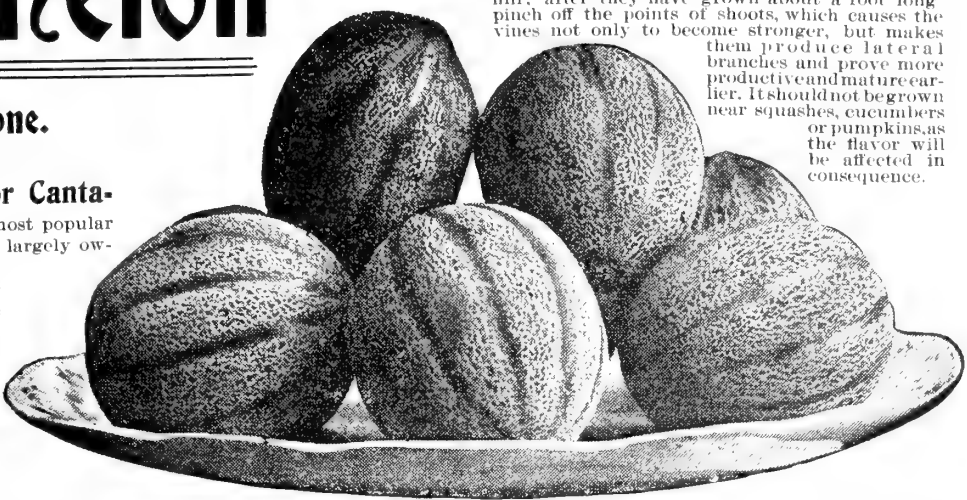

CULTURE.—One ounce of seed to 50 hills. Sow about the last of spring or first of summer, in hills of light, rich, sandy soil, four feet apart, allowing but three plants to grow in each hill; after they have grown about a foot long pinch off the points of shoots, which causes the vines not only to become stronger, but makes them produce lateral branches and prove more productive and mature earlier. It should not be grown near squashes, cucumbers or pumpkins, as the flavor will be affected in consequence.

Baltimore Nutmeg Cantaloupe.

—The cut below is from a photograph taken from a sample lot of BALTIMORE NUTMEG CANTALOUPEs gathered from the field where our seed was grown, and is a fair representation of the whole crop. The stock seed of this splendid melon was secured from a trucker who enjoys the reputation for raising the finest cantaloupes that come to the Baltimore market. In passing through the fields inspecting the crops we were surprised at the uniformity in the shape and size of the fruit. The writer also tested the fruit, and found it to be of excellent flavor. It is green fleshed and the rind is handsomely netted. It is well known and popular with the truckers and market gardeners of Baltimore, Washington, Norfolk and other places; in fact, it is a leading sort all over the country.

Pkt. 5c. Oz. 10c. 1-4 lb. 15c. Lb. 40c. 5 lbs. \$1.50.

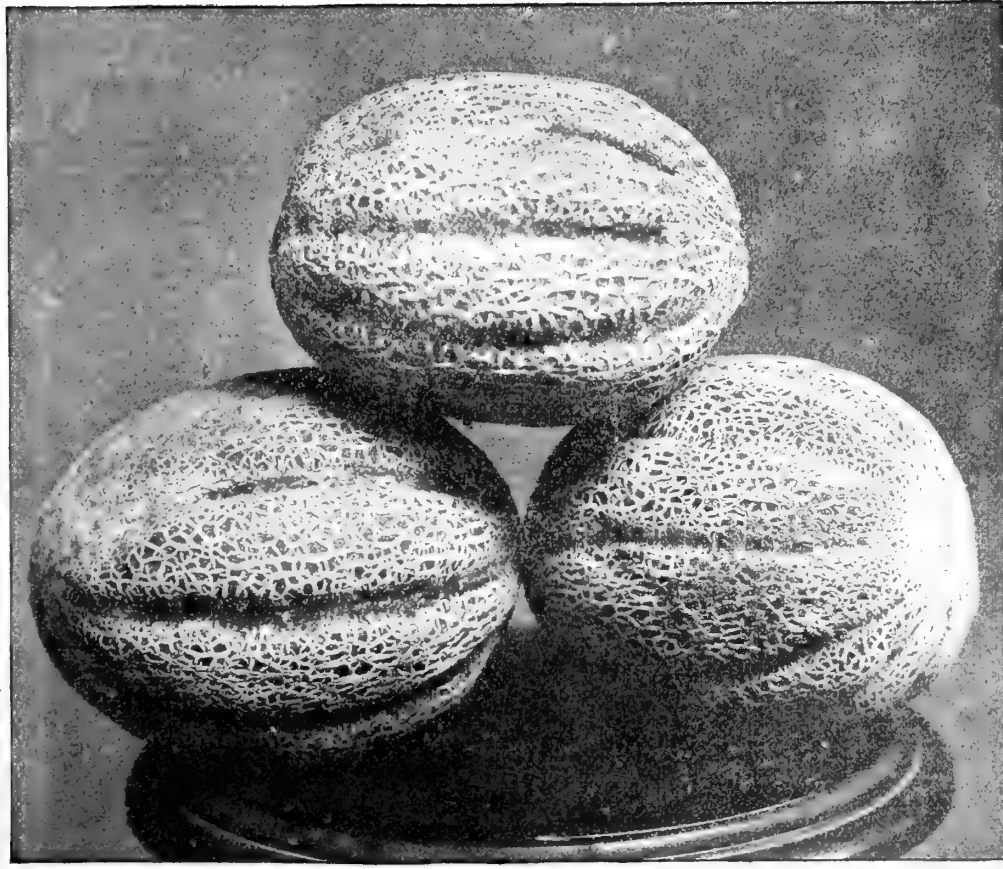

BALTIMORE NUTMEG CANTALOUPE.

THE STOCK SEED OF THIS SPLENDID MELON WAS SECURED FROM A TRUCKER WHO ENJOYS THE REPUTATION FOR RAISING THE FINEST CANTALOUPEs THAT COME TO THE BALTIMORE MARKET.

EMERALD GEM—Meat salmon color, exceedingly sweet and delicious; very early and prolific. One of the best for family use. Its appearance is not attractive, but try it and you will want it again.

**Pkt. 5c. Oz. 10c.
1-4 lb. 15c. Lb. 40c.**

OSAGE—MILLER'S CREAM. Most delicious. The flesh is a rich salmon color, very thick, sweet and rich; rind very thin and finely netted.

**Pkt. 5c. Oz. 10c.
1-4 lb. 15c. Lb. 40c.**

EARLY NETTED GEM.—Extensively grown, and many prefer it to all others for table use. Shape almost a perfect globe, and grows remarkably uniform; thick meat; flesh light green in color and of fine, luscious flavor; skin green, regularly ribbed and thickly netted; very productive and extra early in ripening; will keep for nearly a week after picking, and is especially suited for shipping in baskets or crates.

**Pkts. 5c. and 10c.
1-4 lb. 15c. Lb. 40c.**

IMPROVED JENNY LIND.—A small, early variety of surpassing good quality, highly recommended for family garden. We consider this the most delicious cantaloupe we have ever eaten, and while the fruit is small, it is an abundant bearer. A market gardener having this sort for sale would in a short time have no difficulty in disposing of all he could raise.

**Pkt. 5c. Oz. 10c.
1-4 lb. 15c. Lb. 40c.**

MUSK MELONS.—Continued.

Paul Rose.

—This variety originated with one of the most successful melon growers in the country who reports that when planted for market the fruit has brought him nearly twice as much per acre as he realized from any other sort. In this new sort are combined all the good qualities of the Netted Gem and the Osage, the varieties from which it originated. The fruit is oval, about 5 inches in diameter, and in shape and general appearance similar to the well known Netted Gem or Rocky Ford. The firm flesh is a rich orange red color, like that of the Osage, but even sweeter and higher flavored, retaining its good qualities quite to the rind. We have found the fruit the most uniformly good of any musk melon we have ever grown, every one of the hundreds tested being sweet and rich flavored. It is rare that a musk melon of such superlative quality is a good market or shipping sort, but the firm, solid flesh and thin but strong rind of this sort make it the best shipper we know of, while it is just the size for hotel and table use. We think it really has no equal as a market melon for professional melon growers and it is one of the very best sorts for the home garden.

Pkt. 5c. Oz. 10c. 1-4 lb. 25c. Lb. 75c. 5 lbs. \$3.00.

PERFECTED—DELMONICO.—This is one of the best of the red flesh sort; the flesh is a deep, rich orange color of very fine grain and of delicate and delightful flavor. **Pkt. 5c. Oz. 10c. 1-4 lb. 20c. Lb. 50c.**

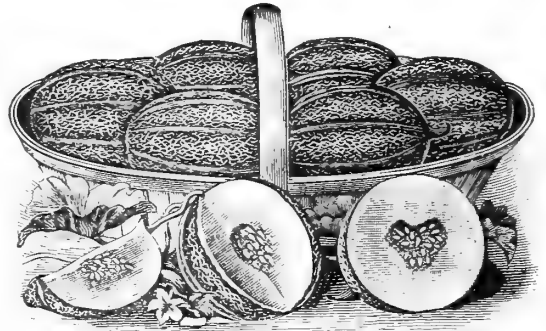

Anne-Arundel Cantaloupe.

(ORIGINAL STOCK.)

The cut represents a sample of our stock photographed from fruit taken from the growing seed crop. It is very large, nearly round, deeply netted, and of good flavor. A wagon load of them at once attracts the buyers' attention, and when piled up on a market stall they are irresistible. No large grower's stock is complete without this superb melon.

This handsome melon, introduced by us several years ago, was for years a special favorite with a number of the leading growers of Anne Arundel County, Maryland. Knowing its value, we selected the stock and placed it before our customers. It has met every promise we made for it upon its introduction.

One grower says: "It is in all respects one of the best of melons."

Another says:
"Portsmouth, Va.
Dear Sirs: The Anne-Arundel Cantaloupe was perfectly satisfactory, just what it is claimed to be—it proved to be early, of good size, and gave me a large yield."

**Pkts. 5c. and 10c.
1-4 lb. 15c. Lb. 40c.**

SOUTHERN BEAUTY CANTALOUPE

The Musk Melon for the South.

The Grower says: "It is the finest Cantaloupe I have ever planted, particularly suited to the Southern climate. It is remarkably free from rot of all sorts, caused by damp or rainy weather, and will hold up a long time after they have ripened, the outer rind remaining firm and sound for at least ten days after the melon first ripens." Again he says: "I shipped these cantaloupes from this point to Chicago, Illinois, Cleveland and Cincinnati, O., by freight, where they arrived in perfect condition, and brought fancy prices."

**Pkt. 5c. Oz. 10c.
1-4 lb. 20c. Lb. 65c.
5 lbs. \$2.75.**

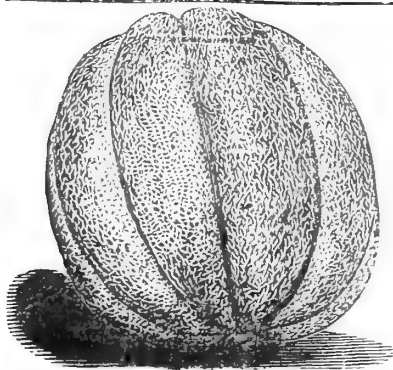

EXTRA EARLY HACKENSACK.—Netted, green flesh and excellent; very showy market variety and an excellent keeper; ten days earlier than the Old Hackensack. **Pkts. 5c. and 10c. 1-4 lb. 15c. Lb. 40c.**

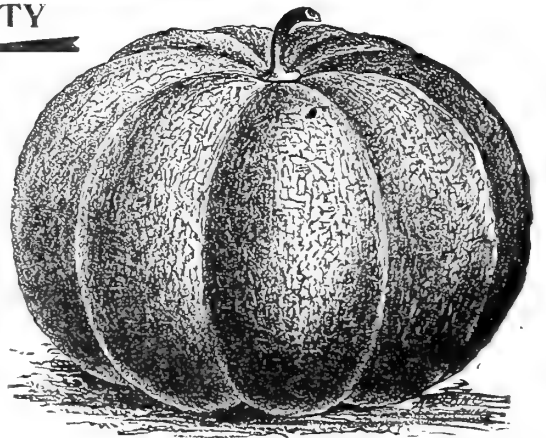

WATER-MELONS

GERMAN, Wasser-Melone.

CULTURE.—One ounce of seed to thirty hills. Watermelons require a rich, sandy soil for best development. Cultivate the same as for Cantaloupes, except that the hills should be eight to ten feet apart.

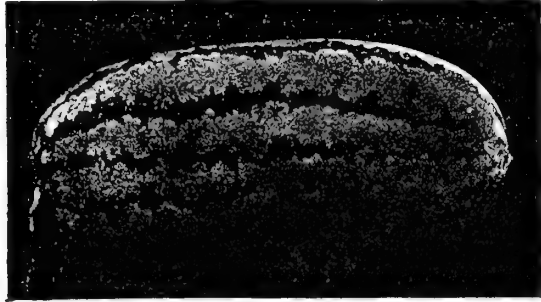

Florida Favorite.

This we consider the richest and sweetest flavored melon grown, of medium size and prolific. The best of all for family garden. It is now very popular with the truckers and melon growers of Maryland and Virginia, and sells readily in the Baltimore market. Pkt. 5c. Oz. 10c. ¼-lb. 15c. Lb. 40c. Five lbs. \$1.75.

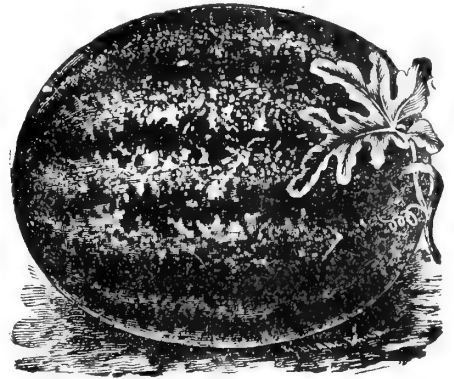

KOLB'S GEM.

This is one of the largest, most productive, best keeping and best shipping water-melon grown. Sells readily at the highest market price. In fact, it is so well-known that it speaks for itself. Our stock of this comes direct from the original grower. Special prices on large quantities. Pkt. 5c. Oz. 10c. ¼-lb. 15c. Lb. 30c. Five lbs. \$1.25.

TRIUMPH WATER-MELON

Six specimens weighing 420 pounds.

THIS new melon, as a market sort and for shipment, is the best we have ever introduced. It is very prolific, very early, and of uniformly large size. It is a cross between the Duke Jones and Kolb Gem; has the fine, handsome appearance of the former and the fine shipping qualities of the latter. The rind, like the Duke Jones, is of dark green color, the seed exactly the same color as those of the Kolb Gem. The average size of the melon is very large. Our stock of this seed is very limited.

Pkt. 5c. Oz. 10c.
¼-lb. 20c.
Lb. 50c. Five lbs. \$2.00

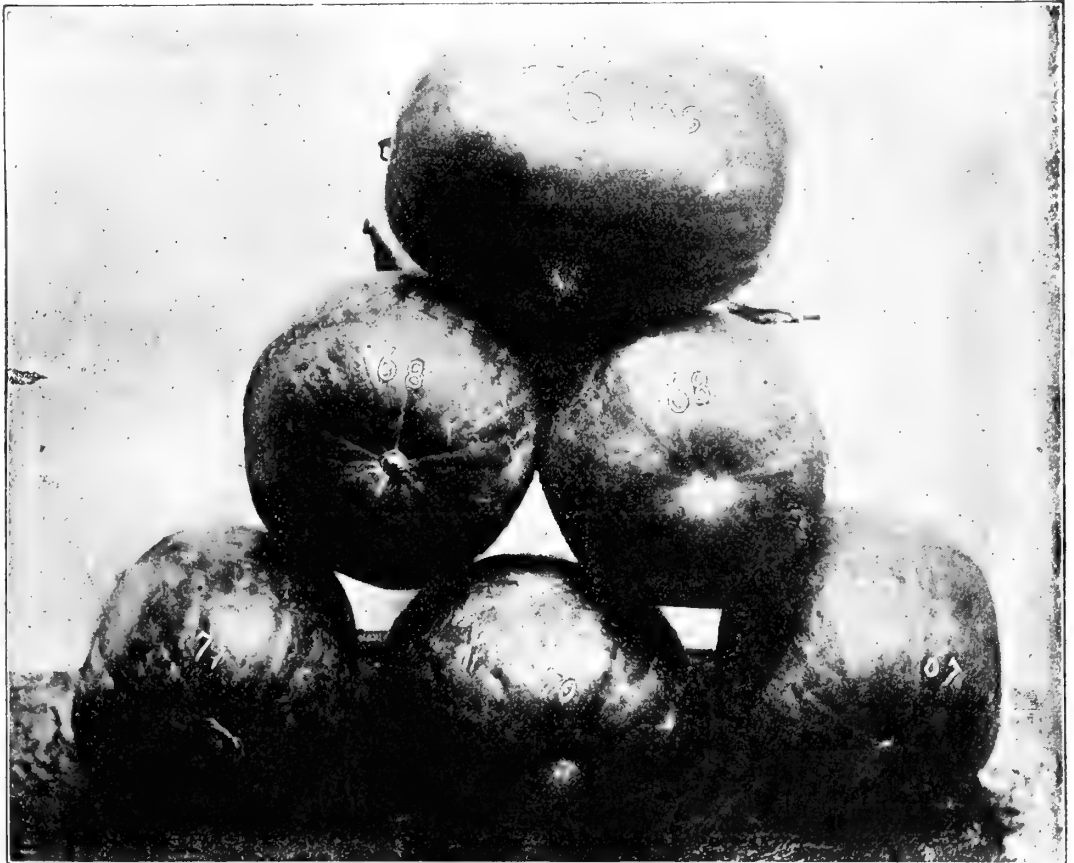

RATTLESNAKE WATER-MELON.—Large, oblong, striped and mottled; flesh bright red; a good shipper; a favorite variety in the South. Pkts. 5c. and 10c. 1-4 lb. 15c. Lb. 40c.

CITRON

FOR PRESERVES.—Fruit round, handsome and small; used in making preserves only. Pkt. 5c. Oz. 10c. 1-4 lb. 20c. Lb. 60c.

Bosley's Poultry Powders

IS AN EGG PRODUCER.—Sure cure for Cholera, Roup, Gaps, Bowel Disease and all Poultry Diseases. Price, 25 cents per package.

WATER-MELONS. Continued.

DUKE JONES WATERMELON.—

In shape the "Duke Jones" resembles very closely the Kolb Gem. The rind is darker green in color, with indistinct, irregular stripes of dark and light green alternating; in general appearance it is a dark green melon. It averages very large in size, comparatively no small melons, is very productive; it is also very early in maturing, ripe melons being plucked from the vine just 67 days from the date of planting. Its chief claim for popularity is its delicious flavor. The flesh is crisp and very sweet, firm, but not tough, no hard middles, but ripens evenly throughout; flesh deep crimson in color. The "Duke Jones" is the largest of melons, but has no superior in its delicious flavor.

Pkt. 5c. Oz. 10c. 1-4 lb. 15c. Lb. 40c. 5 lbs. \$1.75.

GRAY MONARCH or LONG WHITE ICING.—This distinct melon is without doubt one of the largest of all, frequently attaining a weight of seventy pounds and over. The skin is a mottled gray color, shape long, flesh bright crimson and of sweet, delicious flavor. It is also a fine shipper, carrying well long distances, and bringing very high prices.

Pkt. 5c. Oz. 10c. 1-4 lb. 20c. Lb. 40c.

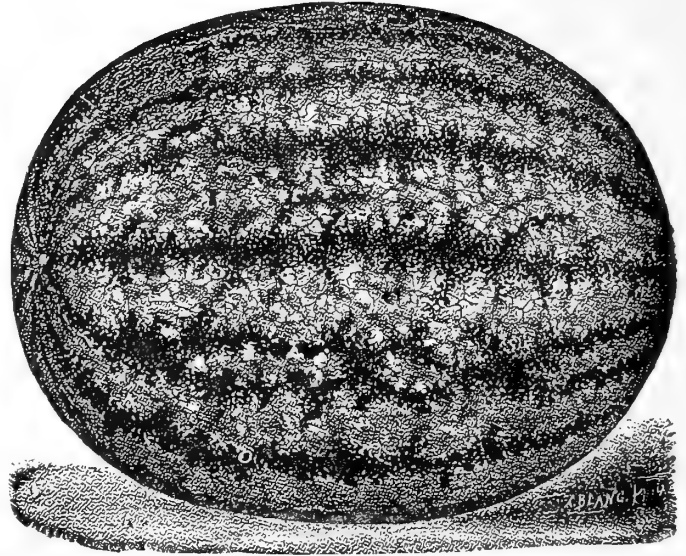

DIXIE.—It is earlier and larger than the well known and popular Kolb Gem, and in color a darker green, with beautiful stripes, making it one of the handsomest melons on the market. Flesh deep red, sugary and melting.

Pkts. 5c. and 10c. 1-4 lb. 15c. Lb. 40c.

SWEET HEART.—An entirely distinct and handsome new watermelon. Vine vigorous and productive, ripening early. Fruit large, oval, very heavy, uniformly mottled light and dark green. Flesh bright red, solid and very sweet.

Pkt. 5c. Oz. 10c. 1-4 lb. 20c. Lb. 50c.

BLUE GEM.—This splendid melon resembles the Kolb Gem in shape, and is of a dark bluish color, with small grayish stripes. It is one of the best shippers, and as a table melon much superior to the Kolb Gem. Very productive and is handsome and showy. A grower in Dixie, Georgia, says: "If you want a shipper that will go around the world, you can safely select the BLUE GEM."

Pkts. 5c. and 10c. 1-4 lb. 20c. Lb. 40c. 5 lbs. \$1.75.

MEIVER'S SUGAR WATERMELON.—In outward appearance it somewhat resembles the old Rattlesnake. The quality, however, is so much superior that it is an injustice to mention the Rattlesnake on the same page with it, as it even surpasses such excellent varieties as Florida Favorite and Icing. It is also an extremely productive and hardy variety

Pkt. 5c. Oz. 10c. 1-4 lb. 20c. Lb. 50c.

LORD BALTIMORE WATERMELON.—

We wish to call special attention to this splendid and delicious melon. It is early, very large, of oblong shape, and the flesh is of handsome crimson color, deliciously sweet, and extending close up to the rind. It has a thin, hard rind, beautifully mottled light and dark green. Its perfect shape, faultless color, fine texture and excellent flavor combine to make it one of the very best melons that grows. It is a good shipper, and beats all others as a seller.

**Pkt. 5c. Oz. 10c. 1-4 lb. 20c.
Lb. 50c. 5 lbs. \$2.00.**



ALL PRICES SUBJECT TO CHANGE WITHOUT NOTICE.

ENGLISH MILLTRACK MUSHROOM SPAWN.

Lb. 12c. By mail, 25c. lb. 10 lbs. \$1.00. 100 lbs. \$8.00.

CULTIVATION.

THE cultivation of the Mushroom is a very simple matter, and requires only ordinary intelligence and care. The materials needed are fresh horse manure, good soil and live spawn. The manure should not be too short, as it does not combine the necessary qualities. Long, strawy litter, plentifully mixed with short manure, makes by far the best beds, as it does not heat too violently, decomposes slowly and retains its heat for a long period. Put in a heap and turn every three or four days to permit the escape of noxious gases and prevent burning. When ready for use it should be as hot as can be borne comfortably by the hand, and should also be moist. Make the beds three feet wide at the base, two and a half feet high, and of any desired length. The manure, when in proper condition, should be quickly handled to prevent the loss of heat and be beaten down to make the heap firm and compact, and cover with long litter. The bed should within a few days warm to a temperature of 110 to 120 degrees. Never spawn a bed when the heat is rising, but always on the decline and under 90 degrees. Have a ground thermometer, and keep it plunged in the bed; by pulling it out and looking at it you can ascertain exactly the temperature of the bed; should the temperature not exceed 100 or 110 degrees no alarm should be felt,

for if the manure was fresh it will likely produce a good crop. Where the heat has decreased to 90 degrees the bed is ready to receive the spawn, which is done by raising the manure with the hand and inserting pieces of spawn two inches square and nine inches apart each way. At the expiration of a few days the

bed may be covered with soil to the depth of about two inches. If in a closed cellar or mushroom house, wait about ten days, but if in open shed five days will do. If the soil is poor add a liberal quantity of bone meal. It requires a period of five to seven weeks before they are ready for use.
Two pounds of Spawn is sufficient for a bed 3 feet by 6 feet.

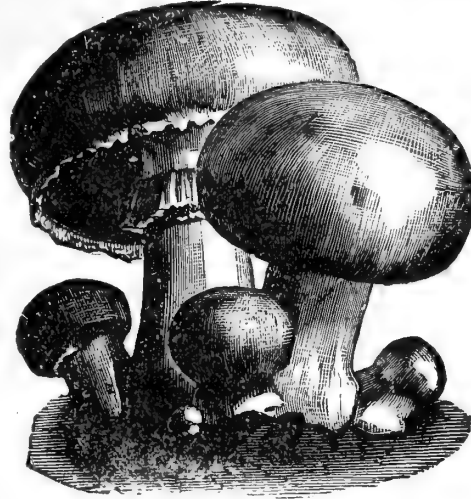

Mushrooms can be readily grown in cellars, stables, sheds or pits. Many are successfully grown on a shelf in an ordinary cellar, and yield sufficient crops to compensate the grower for his effort. The space under greenhouse benches or stagings will suit them exactly, using materials in same manner as described.

MUSHROOM ON PASTURE LAND OR LAWN
—About the first of June, take pieces of Spawn an inch square and lift the sod with a trowel or spade just sufficient to get a Spawn under it and then press the soil down hard. Set the spawn one to two feet apart. In a favorable season a crop may be expected in three or four months from the time of planting.

MUSTARD SEED

Pkt. 5c. 1-4 lb. 10c. Lb. 25c.

NASTURTIUM.

Plant in May, the climbing varieties to cover arbor or fence, and the Dwarf for beds or hanging baskets. The leaves are used for salad, and the seeds, when soft enough to be penetrated by the nail, for pickles.

TALL.—Pkt. 5c. Oz. 10c. 1-4 lb. 25c. Lb. 75c. DWARF.—Pkt. 5c. Oz. 15c. 1-4 lb. 30c. Lb. \$1.00.

ONION SEED

CULTIVATION

TO GROW LARGE ONIONS FROM SEED—The seed should be sown as early as possible in the spring, as they grow much better during the cool weather, and should make most of their growth before the hot weather sets in. Sow five pounds of seed to the acre for large onions.

THE NEW ONION CULTURE—Sow the seed in hot-bed, and transplant as early as possible to open ground; they can be grown very successfully by this plan.

FOR SETS—Have a clean and very rich soil, which should be thoroughly cultivated, or it will not do well enough to pay for



the trouble. The most successful growers work their ground several times in the fall to kill out the weeds, and get ground in nice condition. Use well-rotted manure freely, and be sure to get the seeds in as early as possible in the spring, no matter if it is ever so cold or unpleasant, and keep the soil mellow and clear of weeds, and if seed is good you will have a large crop of onion sets. On no other condition can you hope for success. Disturb the roots of the Onion as little as possible, either in thinning or hoeing, and never hoe earth toward them to cover or hill, as we do most other things.
Sow the seed in drills about 12 inches apart. It will require from 40 to 60 pounds to sow an acre.

White Pearl Onion.

—Earliest of all, growing with all the rapidity of a summer radish. Pearly white, waxy and transparent. Form flat and broad, flavor very mild, and it can be eaten raw almost like an apple. On rich soil it will grow very large. This is an elegant sort to sow for large Onions, because of its rapid growth and fine quality.

Pkt. 5c. Oz. 15c. 1-4 lb. 50c. Lb. \$1.50.

WHITE SILVERSKIN or PORTUGAL

—A good variety for family use; skin and flesh pure white, mild flavor and flat shape. The best white Onion to grow largely for sets.

Pkts. 5c. and 10c. Oz. 20c. 1-4 lb. 75c. Lb. \$2.50.

WETHERSFIELD LARGE RED.

—A well-known and favorite sort. A large yielder and good keeper.

Pkt. 5c. Oz. 10c. 1-4 lb. 35c. Lb. \$1.15

ONION SEED. CONTINUED.

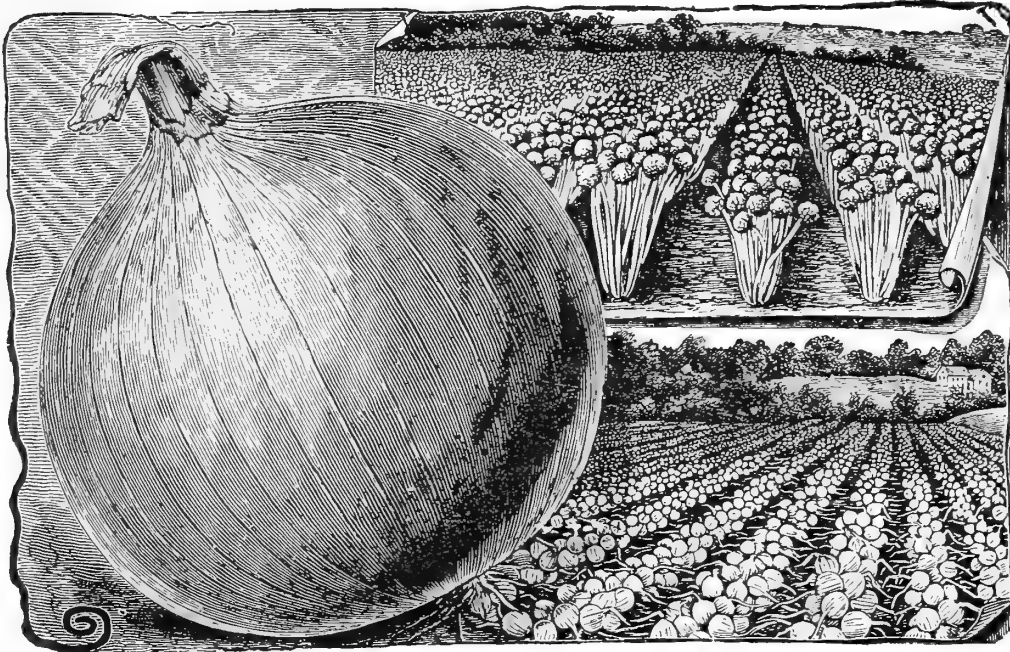

THIS CUT REPRESENTS A FIELD OF YELLOW GLOBE DANVERS.

Yellow Globe Danvers.—A very handsome round, yellow onion, a large grower all over the country. We unhesitatingly recommend it for growing either sets or large onions.

Pkt. 5c. Oz. 15c. 1-4 lb. 35c. Lb. \$1.10.

YELLOW FLAT DANVERS.—Oz. 10c. 1-4 lb. 30c. Lb. \$1.00.

LARGE YELLOW DUTCH, or STRASBURG.—Very fine; a good keeper. The kind used very largely by those who grow onion sets for market. Pkt. 5c. Oz. 15c. 1-4 lb. 30c. Lb. \$1.00.

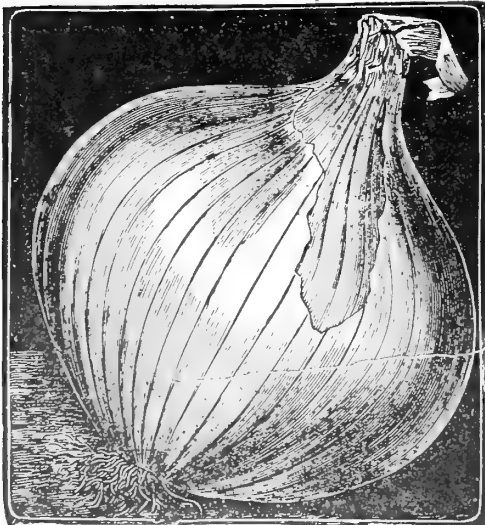

PRIZETAKER.—(American Grown.) This is the large, beautiful onion that is seen every fall offered for sale at the fruit stores in Baltimore and other large cities. They are a rich straw color, and of enormous size. Although of such large size, it is very hardy and an excellent keeper. The flavor is mild and delicate, making the Prizetaker a favorite variety for salads. By sowing this sort early, you can raise a crop of large onions the first season with very little trouble. All that is necessary is good ground, proper cultivation and not to have them too thick. Those of our growers who have tried them have had remarkably fine success. Pkt. 5c. Oz. 15c. 1-4 lb. 35c. Lb. \$1.25. 5 lbs. \$5.75.

EXTRA EARLY RED.—Onions of a good size may be raised from the black seed the first season.

Pkts. 5c. and 10c.
Oz. 15c. 1-4 lb. 40c.
Lb. \$1.25.

Bermuda Varieties

They are of a mild and delicate flavor and keep longer than any foreign variety. Like the Italian varieties, it produces full-grown onions from seed the same season. In the South, seed sown in the fall will produce fine, large onions for market in early spring.

RED BERMUDA.—Pkt. 10c. Oz. 25c. 1-4 lb. 75c. Lb. \$2.25.

WHITE BERMUDA.—Pkt. 10c. Oz. 25c. 1-4 lb. 75c. Lb. \$2.25.



ONION SETS.

WHITE.—Qt. 25c. By mail, 40c.
YELLOW.—Qt. 20c. By mail, 30c.
Write us for quotations by the bushel.

OKRA, or GUMBO.

Select warm location and rich soil, and plant when the ground becomes warm, in rows three feet apart, thinning plants a foot apart in the row. As the seed are liable to rot in cool weather, they should be sown thickly. The pods are used to thicken soup, being gathered when young. It is one of the most wholesome vegetables in use.

DWARF PROLIFIC.—This is the preferred kind with the growers; is of dwarf habit and very productive.

Pkts. 5c. and 10c. 1-4 lb. 15c. Lb. 40c.

WHITE VELVET.—It is very distinct and the pods are perfectly round, smooth, of an attractive white velvet appearance, and of superior flavor and tenderness. The pods are of extra large size, and produced in great abundance.

Pkt. 5c. Oz. 10c. 1-4 lb. 15c. Lb. 40c.





Parsnip

The Parsnip will flourish best and give the longest, largest and smoothest roots in a very deep, rich soil—one that has been made rich from manure the previous year. Fresh manure makes the roots somewhat ill-shaped. Sow as early in the spring as the ground can be made ready, pretty thickly in drills from 12 to 18 inches apart, and about an inch deep. Thin the plants to 5 or 6 inches apart.

Hollow Crown or Sugar.

The Hollow Crown is superior in quality to all other varieties, and the preferred kind with Baltimore gardeners; the roots are smooth, tender, handsome shape and early. We have the finest stock of Hollow Crown Parsnips that we know of in this country.

Pkt. 5 and 10c. 1-4 lb. 15c. Lb. 40c.

PARSLEY

Select rich soil; sow the seed in drills one foot apart, covering half an inch deep. It would be well to firm the soil with the foot after sowing the seed. As the seed is usually from 15 to 25 days in vegetating, it will be necessary to sow early. Thin plants to four inches apart when two inches high. The beauty of the plant may be increased by several successive transplantings. It is used principally for flavoring soups, etc., and for garnishing in its natural state.

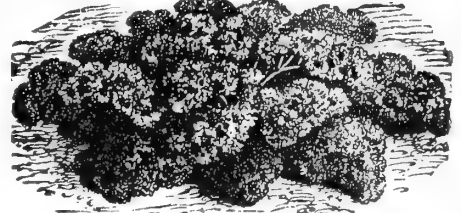

TRIPLE CURLED.—

The most beautiful and valuable variety in use. Of a handsome, bright green color, finely crimped and beautifully curled. Pkt. 5c. Oz. 10c. 1-4 lb. 20c. Lb. 50c.

MOSS CURLED.—A very select crimped variety. Pkt. 5c. Oz. 10c. 1-4 lb. 20c. Lb. 60c.

Pepper

as the soil is warm. Transplant when three or four inches high, in rows eighteen inches apart.

CAYENNE.—Small, long and tapering, very hot; best for seasoning pickles. Pkts. 5c. and 10c. Oz. 20c. 1-4 lb. 65c.

LARGE SWEET.—Very large and excellent for Mangoes or Stuffed Pickles. Pkts. 5c. and 10c. Oz. 20c. 1-4 lb. 50c.

BULL NOSE, or BELL.—Good for pickling; very hot. Pkts. 5c. and 10c. Oz. 20c. 1-4 lb. 50c.

RUBY KING.—An excellent sort of large size and mild flavor. Pkts. 5c. and 10c. Oz. 20c. 1-4 lb. 60c.

GOLDEN QUEEN.—In shape and size similar to Bull Nose, and of mild flavor; color, yellow. Pkts. 5c. and 10c. Oz. 25c.

RED CHERRY.—Pkts. 5c. and 10c. Oz. 20c.

RED CHILI.—Pkts. 5c. and 10c. Oz. 20c.

or CAPSICUM, is cultivated mainly for Pickles: It is used as a seasoning in many ways, and sometimes medicinally. Sow the seed early in a hot-bed, if possible; if not, select a warm place in the garden for the seed bed, and sow as soon

PEAS.

NOTICE.—In ordering Peas to be sent by mail, please add 8 cents per package to pay postage.

The dwarf varieties should be liberally manured; the tall sorts will run too much to vine if heavily manured, it being better to depend on the richness of the land that was previously in a good condition. Plant the dwarf in rows two feet apart. Those varieties attaining the height of from two to three feet, in rows three feet apart, and the rows of the tallest sort four feet apart. Bushing the tall kind when six inches high, on poles set every six or eight feet, with twine fastened to them about four inches apart will answer finely.

G.&T.Co.'s First Early

(In sealed bags, thoroughly rogued and hand picked.)

This is the earliest of all, and the most profitable early-market Pea, because of its early maturity, uniformity of growth and ripening, and its productiveness. It ripens up so evenly as only to require about two pickings to secure the crop. It is grown from selected stock, under our own supervision, and the greatest care is exercised to keep it up to the highest standard of quality. It is a great favorite with the truckers, and is largely used by private families. Our sales of this sort increase annually.

Pt. 15c. Qt. 25c. Pk. 90c.
Bu. \$3.00.

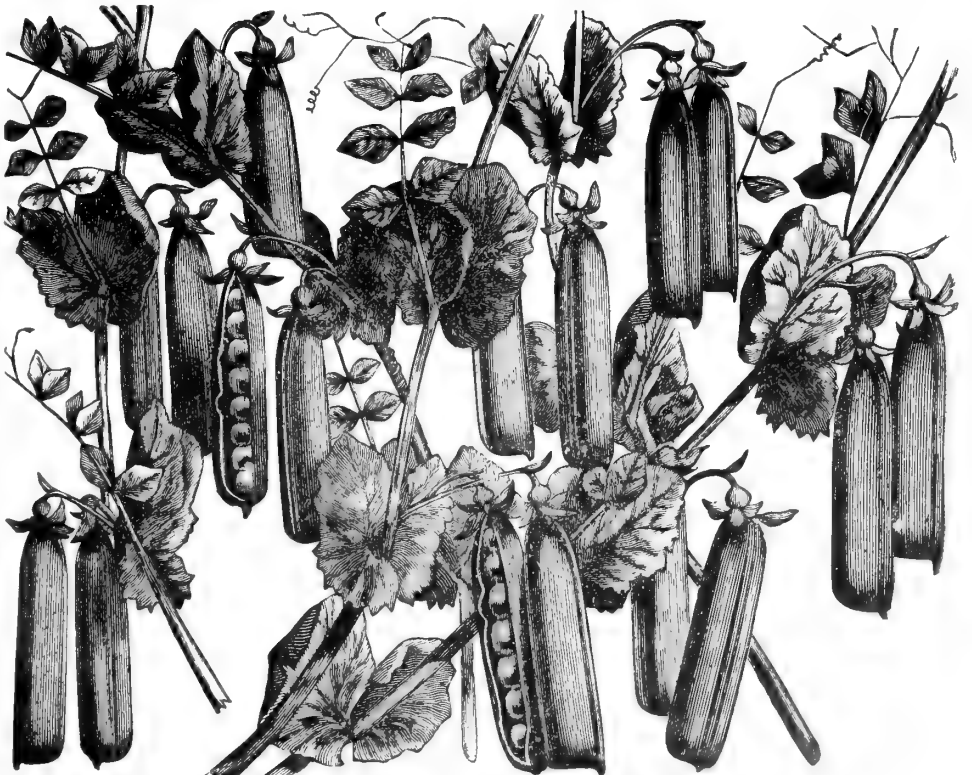

PEAS. Continued.

EXTRA EARLY DWARF.

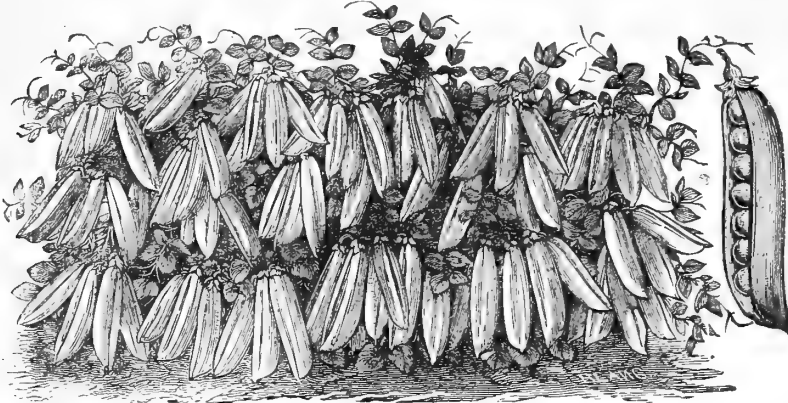

Nott's Excelsior.—Is the best dwarf wrinkled extra early of recent introduction. The vines are larger and more vigorous than the American Wonder, while the pods are fully one-third larger, containing six to eight fine, large peas, packed so closely together in the pods that the peas are always more square than round. The pods are always well filled with peas, which in sweetness and quality have no superior.

Pt. 15c. Qt. 25c. Pk. \$1.15 Bu. \$4.00

American Wonder.—Very luscious in flavor. Try it. Height 12 inches. The earliest wrinkled pea; very productive and sweet. Better suited to the private than to the market garden.

Qt. 20c. Pk. \$1.15. Bu. \$4.00.

Premium Gem.—Height 15 inches. An improvement upon the Little Gem. A splendid wrinkled dwarf pea, very luscious in flavor.

Qt. 20c. Pk. \$1.00 Bu. \$3.75.

Blue Peter (or BLUE TOM THUMB.)

One of the earliest and hardiest of the dwarf varieties; blue seed, dark green pods; large peas of excellent quality; much superior to the White Tom Thumb.

Pt. 10c. Qt. 20c. Pk. \$1.00. Bu. \$3.75.

Rural New Yorker.—Height 2½ feet. In maturity it is among the first early.

Qt. 20c. Pk. 75c. Bu. \$2.75

First and Best.—Height 2½ feet. Grown with special care; one of the early varieties.

Qt. 20c. Pk. 75c. Bu. \$2.50.



Gardener's Favorite.—Height 30 to 36 inches.

A wrinkled variety named and introduced by us, and which is constantly gaining friends; of most delicious flavor, prolific bearer, specially suited for the market garden trade. It is also attracting considerable attention with some of our leading canners, as when packed they find the quality to be superior to any other sort.

Pt. 10c. Qt. 20c. Pk. \$1.00. Bu. \$3.75.

Pride of the Market.—A medium early dwarf and very productive. The pods are large, of a medium green color, and contain 7 to 9 peas of fine quality; 14 feet. Pt. 15c. Qt. 25c. Pk. \$1.15. Bu. \$4.50.

Yorkshire Hero.—Height 2½ feet. A wrinkled variety, productive, and of very superior flavor.

Qt. 20c. Pk. 90c. Bu. \$3.25.

Advancer.—Height 2½ feet. A green wrinkled variety, introduced some years ago, and has always given satisfaction.

Qt. 20c. Pk. 90c. Bu. \$3.25.

Abundance.—Height 30 to 36 inches. An excellent half-dwarf, medium early, wrinkled variety, pods 3½ inches long, containing 6 to 8 large peas of excellent quality.

Qt. 20c. Pk. \$1.00. Bu. \$3.50.

Everbearing.—Vines about 2 feet high, of a branching character, forming as many as ten stalks from a single root stalk. Peas large and of fine quality.

Qt. 20. Pk. \$1.00. Bu. \$3.50.

Admiral.—A very desirable new variety; medium early and very productive, and of good flavor.

Qt. 20c. Pk. 75c. Bu. \$2.25

Alaska.—Our best rogued and hand-picked stock. Height 26 inches. The earliest Blue Pea; very uniform in growth and time of ripening; the dark green color of pods make this a most desirable sort for canners and shippers, as it can be carried long distances without losing color.

Qt. 20c. Pk. \$1.00 Bu. \$3.75.

Dexter. (Genuine Stock.)—Thoroughly rogued and hand picked.

Qt. 20c. Pk. 75c. Bu. \$2.50.

Triumph.—Qt. 20c. Pk. 75c. Bu. \$2.50.

Philadelphia.—Extra early. Qt. 20c. Pk. 75c. Bu. \$2.50.

MEDIUM AND LATE PEAS.

Griffith's Canning.—Medium early, with a vigorous vine, bearing a great profusion of pods closely packed with peas of excellent flavor.

Qt. 20c. Pk. 90c. Bu. \$3.00

Gradus.—The most attractive novelty of recent years. Large, handsome pods, well filled, ripening with the earliest, and of vigorous habit.

Pt. 20c. Qt. 35c. Pk. \$2.25.

Heroine Pea.—A medium early green wrinkled pea, and one of the best of recent introduction; large, recurved, showy pods; an immense cropper; peas of finest quality; height 2 to 2½ feet.

Pt. 10c. Qt. 20c. Pk. \$1.00. Bu. \$3.50.

Shropshire Hero.—A grand new second early wrinkled pea, producing long, handsome, well-filled pods in great abundance. Height 2½ feet.

Pt. 10c. Qt. 20c. Pk. \$1.00. Bu. \$3.50.

Dwarf Green Wrinkled Marrow.—An excellent new wrinkled variety; large pods and very productive.

Qt. 20c. Pk. \$1.00. Bu. \$3.50.

Long Island Marrow.—Very popular in some sections with market gardeners who want a large, handsome pod of deep green color.

Qt. 20c. Pk. \$1.00. Bu. \$4.00.

Improved Stratagem.—Height 2½ feet. A large wrinkled blue pea of excellent quality; very long, large filled pods. More regular in its growth than the ordinary Stratagem, and every way superior.

Qt. 20c. Pk. \$1.25 \$4.50

Horsford's Market Garden.—

Height 2½ feet. A medium early wrinkled variety, highly recommended.

Qt. 20c. Pk. \$1.00. Bu. \$3.25.

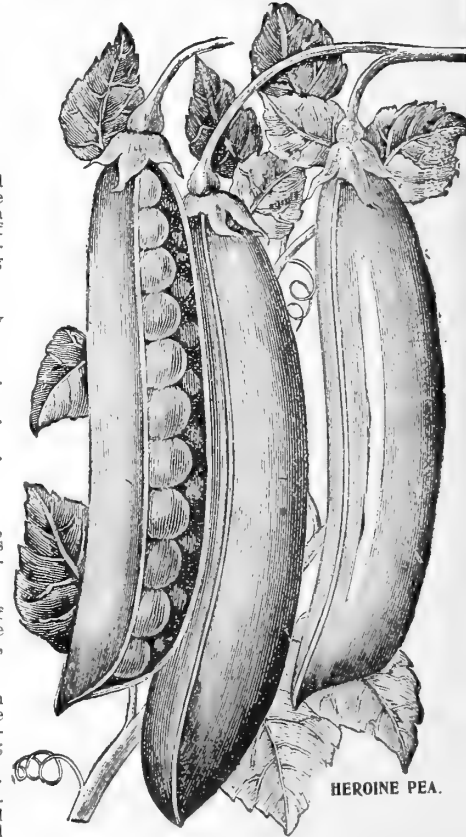

HEROINE PEA.

Edible . . . SUGAR PEAS

Melting Sugar.—Edible Pods.—This variety is ahead of all other sugar peas, not only in size of pod and prolific bearing, but also for its delicious flavor. It grows to the height of 5 feet, bears a profusion of very large, broad, handsome light green pods, and are so brittle that they snap without any strings.

Pt. 15c. Qt. 25c. Pk. \$1.25.

Tall Gray Sugar.—Edible pods; same as Snap Beans.

Pt. 15c. Qt. 25c. Pk. \$1.50.

Dwarf Gray Sugar.—Edible pods; quite a favorite.

Pt. 15c. Qt. 25c.

PEAS-Continued.

CHAMPION OF ENGLAND.—Height, 4 feet. An old favorite, rich flavored and very productive.
 Qt. 20c. Pk. 75c. Bu. \$2.50

FORTY FOLD.—An improvement on the Champion of England.
 Qt. 20c. Pk. 75c. Bu. \$2.50.

TELEPHONE.—Height, 3 to 4 feet. Large wrinkled seeds; pods large and well filled.
 Qt. 20c. Pk. \$1.00. Bu. \$3.50.

TELEGRAPH.—Resembles the Telephone in every respect, except they are a deeper shade of green. Pods are very attractive in appearance.
 Qt. 20c. Pk. \$1.00. Bu. \$3.50.

DWARF WHITE MARROWFAT.—Best stock. Height, 3½ to 4 feet. Standard market variety.
 Pt. 10c. Qt. 15c. Pk. 50c. Bu. \$1.75.

SUGAR MARROWS.—Height, 3½ feet. Grows a strong vine, bears in abundance large, filled pods. The truckers' favorite.
 Qt. 20c. Pk. 75c. Bu. \$2.75.

FRENCH CANNER.—Height, 3½ feet. The celebrated pea used in France by the canners. It is wonderfully prolific, bearing an abundance of long pods containing seven to nine peas of excellent flavor.
 Qt. 20c. Pk. 50c. Bu. \$1.75.

FIELD PEAS.

SEE PAGE 31.

❁ PUMPKIN ❁

Plant in May, in hills 8 feet apart. Allot ten seeds to each hill, as bugs often destroy the young plants, but only allow two or three healthy plants to remain in each hill. They are usually planted in fields with corn or potatoes.

MARYLAND SWEET POTATO.—This is the best table pumpkin in cultivation. In shape and size it somewhat resembles the Cashaw, but much more beautiful in color, being a handsome green and white stripe. The flesh is a rich yellow color, solid, fine grained, very thick, flavor delicious.
 Pkt. 5c. Oz. 10c. 1-4 lb. 20c. Lb. 65c.

TENNESSEE SWEET POTATO.—A splendid pie and cooking pumpkin. They grow pear-shaped of medium size, slightly ribbed; skin is a creamy white, lightly striped with green; flesh very thick, creamy white, dry and fine grained, keeping well until late in the spring. When cooked resembles sweet potatoes, but much more delicious in taste.
 Pkt. 5c. Oz. 10c. 1-4 lb. 15c. Lb. 40c.

LARGE CHEESE.—Skin reddish orange, flesh thick, fine and sweet.
 Pkt. 5c. Oz. 10c. 1-4 lb. 15c. Lb. 40c.

CASHAW, or CROOKNECK.—Solid flesh, fine and sweet; keeps well.
 Pkt. 5c. Oz. 10c. 1-4 lb. 20c. Lb. 50c.

CONNECTICUT FIELD.—Very productive and grown for feeding stock. It is so well known that it does not need description.
 Pt. 10c. Qt. 15c. Lb. 20c. Five lbs. 75c.



Maryland Sweet Potato.

== RADISHES ==

FOR an early supply sow in hot-bed, in February. For a successive supply sow from middle of March to September. Radishes thrive best in a light, rich, sandy loam.

The radish must make a rapid growth to be fit for use; it will then be crisp and tender and of a mild flavor. If it grows slowly, it will be hard, fibrous and disagreeably pungent.

LARGE WHITE SUMMER.—This is the most popular white radish for summer use with the gardeners around Baltimore, because of its handsome appearance and ready sale, and its well-known quality of being slow to run to seed.
 Pkt. 5c. Oz. 10c.
 1-4 lb. 15c. Lb. 35c.

GOLDEN GLOBE.—An excellent summer radish. Slow to run to seed, shape globular, bright yellow color, and mild flavor.
 Pkt. 5c. Oz. 10c.
 1-4 lb. 15c. Lb. 40c.

WHITE BOX.—Perfectly round, smooth skin, pure white, free from any sharpness or bitterness. A remarkably quick grower, with small top; for forcing it is in every way superior.
 Pkt. 5c. Oz. 10c. 1-4 lb. 20c. Lb. 50c.

EARLY WHITE TIPPED SCARLET.—An excellent variety for forcing with very short leaves, bright scarlet in color, with a white tip.
 Pkt. 5c. Oz. 10c. 1-4 lb. 15c. Lb. 40c.



Large White Summer

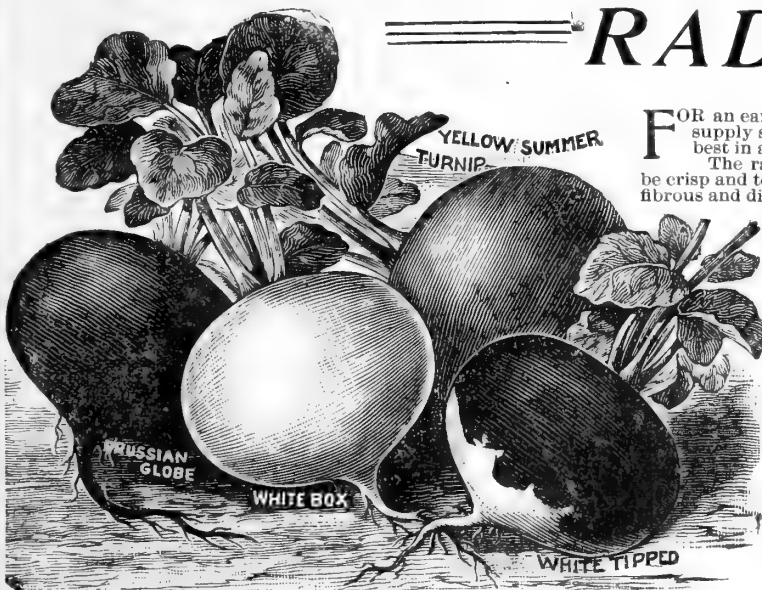

EARLY SCARLET, or PRUSSIAN GLOBE RADISH.—This is the very best forcing variety; is sown largely by market gardeners and truckers, and they are delighted with it. It is of globular shape and brilliant, beautiful crimson color, short top and will stand a large amount of heat without becoming pithy.
 Pkt. 5c. Oz. 10c. 1-4 lb. 20c. Lb. 50c.

ALL PRICES SUBJECT TO CHANGE WITHOUT NOTICE.

RADISHES

CONTINUED.

WHITE DELICACY.—This excellent Radish introduced by us last year, has proved itself all that has been claimed for it. It has become a great favorite with the Truckers and market gardeners around Baltimore. Succulent, crisp, delicate, smooth and clean. Among the earliest spring varieties, an improvement on the White Strasburg which it resembles, being more evenly shaped and smaller topped, grows into full size and perfection during the hottest months.
Pkt. 5c. Oz. 10c. 1-4 lb. 20c. Lb. 50c.

WHITE OLIVE.—Quite saleable in market. Pkt. 5c. Oz. 10c. 1-4 lb. 20c. Lb. 50c.

SCARLET OLIVE-SHAPED.—A showy half-long variety of pretty shape, and bunches beautifully. Pkt. 5c. Oz. 10c. 1-4 lb. 20c. Lb. 50c.

CHINESE ROSE WINTER.—Remarkably fine for winter use. The best of the winter sorts. Pkt. 5c. Oz. 10c. 1-4 lb. 20c. Lb. 50c.

WHITE CHINESE WINTER.—An excellent White Winter Radish; a good keeper. Pkt. 5c. Oz. 10c. 1-4 lb. 20c. Lb. 50c.

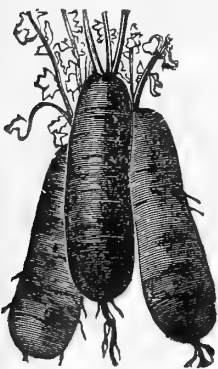

SPANISH RADISH.

LONG BLACK SPANISH.—A large winter variety; one of the hardiest, with dark green leaves, firm in texture; keeping until spring. Pkt. 5c. Oz. 10c. 1-4 lb. 20c. Lb. 50c.

LARGE WHITE SPANISH, Winter.—Fine keeping quality. Pkt. 5c. Oz. 10c. 1/4-lb. 20c. Lb. 50c.

ROUND WHITE SPANISH.—A good fall or winter variety. Pkt. 5c. Oz. 10c. 1/4-lb. 20c. Lb. 50c.

ROUND BLACK SPANISH.—A fine globe-shaped Radish, very popular with the Germans, known as Rettig; good quality. Pkt. 5c. Oz. 10c. 1-4 lb. 20c. Lb. 50c.



WHITE DELICACY.

WHITE STRASBURG.—This is becoming one of the most popular summer sorts, it is of handsome tapering shape, skin pure white, very tender. Pkt. 5c. Oz. 10c. 1-4 lb. 15c. Lb. 40c.

GIANT STUTTGART.—A splendid new variety, of excellent quality; withstands summer heat. Pkt. 5c. Oz. 10c. 1-4 lb. 15c. Lb. 40c.

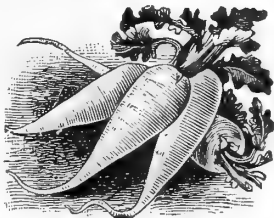

WHITE STRASBURG.



TRIUMPH RADISH.

TRIUMPH RADISH—(Striped, Red and White).—This is a beautiful and odd radish, which when mixed in the bunch with Scarlet Radishes makes a pleasing contrast. The radishes are globe shape and strikingly handsome, having bright scarlet stripes on a white ground. It is a splendid forcing variety, with short top, small leaves, and matures quickly. The warmth of the hot-bed makes its peculiar colorings quite prominent. It can also be grown in the open ground, and is of mild, pleasing flavor. It is very ornamental for table use.
Per pkt. 10c.
Oz. 25c. 1/4-lb. 75c.

WHITE VIENNA, or LADY FINGER.—This is unquestionably the finest long white radish. Of most handsome shape; color, a beautiful snow white. It is of very rapid growth, and remarkably crisp brittle and tender, equally desirable for the market or home garden. Pkt. 5c. Oz. 10c. 1/4 lb. 15c. Lb. 40c.

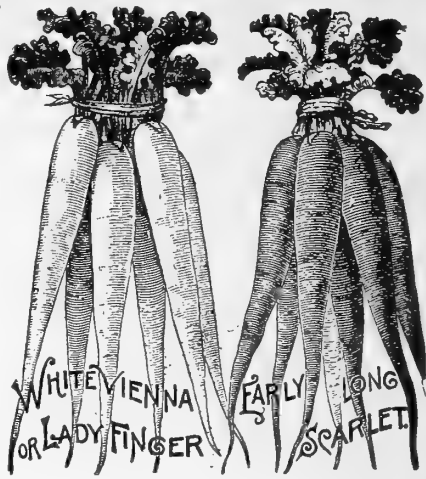

LONG SCARLET.—(American grown.)—Very attractive and sells readily. Owing to its handsome shape brilliant color and fine qualities, it commands a higher price and more ready sale than the imported Long Scarlet, as generally sold. Pkt. 5c. Oz. 10c. 1/4-lb. 15c. Lb. 35c.

CHARTIER.—A good variety for private or market garden purposes stands long before going to seed, and is tender and crisp. Pkt. 5c. Oz. 10c. 1-4 lb. 20c. Lb. 50c.



EARLIEST WHITE TURNIP.—For forcing. This and the Red Turnip bunch together very nicely. Pkt. 5c. Oz. 10c. 1-4 lb. 15c. Lb. 40c.

EARLIEST RED TURNIP.—Turnip shaped, skin red; for forcing. Pkt. 5c. 1-4 lb. 15c. Lb. 40c.

FRENCH BREAKFAST.—Of oval form, color scarlet, white tipped. Pkt. 5c. Oz. 10c. 1-4 lb. 15c. Lb. 40c.

Rhubarb or PIE PLANT.

Sow in April, in drills one inch deep and one foot apart. When plants are large enough, thin to ten inches apart, and cultivate. In the fall or following spring, transplant into deep rich soil three feet apart each way.

Pkt. 10c. Oz. 15c. 1-4 lb. 50c. Lb. \$1.50.

SALSIFY or VEGETABLE OYSTER.

SOW in early spring on light, rich soil in drills fourteen inches apart, and thin the plants to six inches in the row. The roots will be ready for use in October, and will sustain no injury by being left in the ground during the winter. When cooked the flavor somewhat resembles the oyster, and is a good substitute for it.

SANDWICH ISLAND MAMMOTH.—This new Salsify grows fully twice the size of the old sort, and is superior in quality. Invaluable to market gardeners. Pkt. 5c. Oz. 10c. 1/4-lb. 25c. Lb. 80c.

LARGE WHITE.—The old well-known variety. Pkt. 5c. and 10c. 1-4 lb. 25c. Lb. 75c.



Salsify.

POTATOES FOR SEED. (German) Kartoffel.

THE soil best suited to the potato is a rich, sandy loam, but it seems to thrive in almost any soil or climate. The potato being a gross feeder, requires a liberal application of manure; if stable manure is to be used, it should be well rotted, and not allowed to come in contact with the tubers. On no other crop are the results from the use of phosphates so manifest as on the potato; almost invariably the tubers are smoother, brighter and freer from rust and the destructive influence of wire worms. GRIFFITH & TURNER CO.'s PLANT FOOD is especially adapted for potatoes, as it promotes growth and at the same time prevents disease. Plant as early in the spring as the ground can be thoroughly worked in rows three to four feet apart and one foot in the rows; covering in light, warm soil about four inches, and in cold, wet ground three inches deep; draw the earth to the plants as they advance in growth. If an early crop is desired sprout the tubers, or cut potatoes, in a light, warm room, from four to six weeks before planting, then lift carefully and plant out; by this process sprouts are obtained that, as soon as planted out in the open ground, will send out shoots, and grow more rapidly than if treated in the ordinary way. The soil should be constantly stirred through the season to prevent the surface from baking.

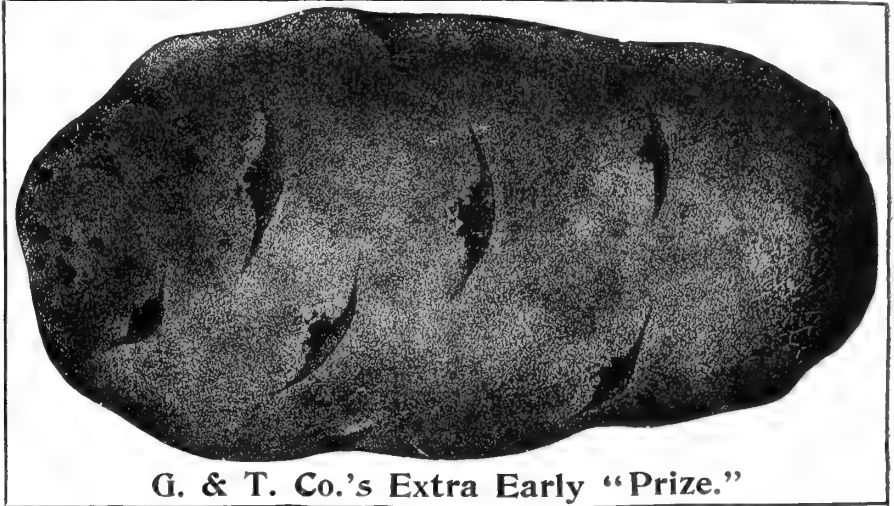

G. & T. Co.'s Extra Early "Prize."

BLISS TRIUMPH.—This beautiful variety combines the wonderful productiveness of the Peerless with all the good qualities of the Early Rose, is much more productive, and matures its crop at least a week in advance of the Early Rose. Tubers are of medium size, round and uniform in shape, with but a very few small ones; eyes slightly depressed; color a beautiful light red. Its great beauty, productiveness and fine quality make it one of the best market varieties.
Peck, 50c. Bus. \$1.60 Bbl. \$4.00

G. & T. Co.'s Extra Early Prize.—This potato is in all respects a very superior early sort. It proved to be the earliest and most productive of any we tried; also found its eating qualities first-class. We consider it the best early potato on the market today.
Peck 50c. Bus. \$1.60 Bbl. \$4.00

MAINE, or HOULTON EARLY ROSE.—The Early Rose led the list for over thirty years, and is today one of the best early market potatoes. Our stock of this is grown on new land, near Houlton, Maine, is rugged and pure, and produces as good crops as those which made the Early Rose famous in its early years. Remember that this stock is not to be confounded with the old run-out Rose, grown in other sections.
Peck 50c. Bus. \$1.50 Bbl. \$3.25

NEW YORK EARLY ROSE.—A leading variety for earliness, quality and productiveness.
Peck 50c. Bus. \$1.50 Bbl. \$3.00

IRISH COBBLER (A New Sort).—Very productive, matures ahead of the Early Ohio. Shape chunky, eyes strong and deeply set, skin netted, flesh white, quality very superior. The writer's attention was called to this variety while on a tour of inspection, and we concluded to place it in our collection. We believe it is something extra. Don't fail to get it.
Peck 75c. Bus. \$2.25 Bbl. \$6.00

EARLY OHIO.—This is very early and productive, of fine quality, and an excellent keeper.
Peck 50c. Bus. \$1.50 Bbl. \$4.00

EARLY NORTHER.—This superb potato originated at Caribou, Maine. It resembles the Early Rose in shape and color, matures earlier than the Rose, and is much more productive. Under our own observation the past season it yielded more than the Rose, matured earlier, and was in all respects superior.
Peck 50c. Bus. \$1.50 Bbl. \$3.25

RURAL NEW YORKER, NO. 2.—A valuable variety of large size, very smooth and a great cropper; in quality unexcelled. This variety is yearly becoming more popular as the best late long keeper, and we can recommend it highly.
Peck 50c. Bus. \$1.25 Bbl. \$2.75

BURBANK.—This is an old and reliable variety, and is A No. 1 for a late, large-yielding, good-keeping potato, and for table use, after January 1st, is one of the best.
Peck 40c. Bus. \$1.25 Bbl. \$2.75

NEW QUEEN.—A grand potato of recent introduction, closely resembling Beauty of Hebron in appearance, color, size and shape, but is seven to ten days earlier, and a heavy yielder. Our seed of this variety comes from Maine, where it originated, and is pure and true to name.
Peck 50c. Bus. \$1.50 Bbl. \$3.25
Prices subject to market changes.

SWEET POTATOES.

Choice Jersey Sweets at market prices during season. Write us for quotations.

SECOND CROP SEED POTATOES

THE advantage derived from Second Seed over First crop is that they do not sprout or shrivel, or lose any of their vigor through the winter, having been checked by frost before maturity; they lie dormant, ready to grow vigorously when planted.

They rarely send up more than one sprout; this may divide into several branches, the consequence is all the growth goes into the tubers; they do not form as many to the hill as matured seed and they grow full marketable size twelve to fifteen days earlier than ordinary seed.

The following varieties are grown from second crop seed:

CROWN JEWEL.—This is a seedling of the Early Ohio. Skin white, with a flesh tint, meat white and floury, cooking evenly through. A very early bearer, and its keeping qualities are equal to the best.
Peck 50c. Bus. \$1.50 Bbl. \$3.50

EARLY ROSE.—See above.

BLISS TRIUMPH.—See above.

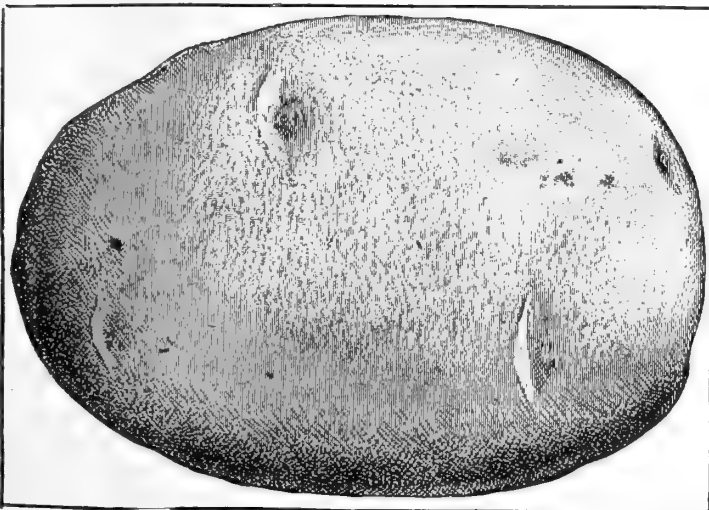

SPINACH.

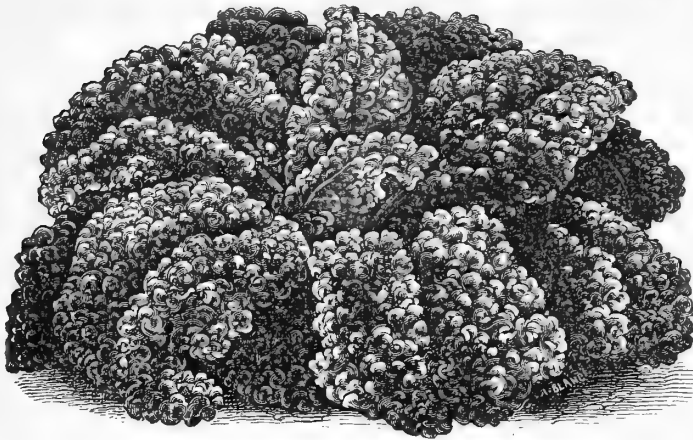

THIS is quite an important crop with market gardeners, and one easily managed.

For summer use, sow early in spring, in drills eight inches to one foot apart, covering the seed one inch deep. Select rich soil and manure liberally. A succession may be obtained by sowing at intervals of two weeks through the season. For very early spring use sow in August, and protect the plants through the winter by a thick covering of clean straw or some similar light covering. Spinach is used principally as greens for boiling, and is very highly esteemed for this purpose.

LARGE ROUND-LEAVED VIROFLAY.—A new sort, with very large, thick leaves.
Pkt. 5c. 1-4 lb. 10c. Lb. 20c.

LONG STANDING.—Best for spring sowing, as it is very slow to seed. The leaves are large, round, unusually thick, curled and of dark green color.
Pkt. 5c. 1-4 lb. 10c. Lb. 20c.

CURLED SAVOY, or BLOOMSDALE.—The leaves are fine, curled, large, thick and heavy, and are produced in great numbers.
Pkt. 5c. 1-4 lb. 10c. Lb. 20c.



G. T. & CO.'S EXTRA CURLED AMERICAN GROWN SAVOY SPINACH.—This is grown specially for us, and is without exception the best type of Savoy Spinach in existence. It is beautifully curled and wrinkled, the leaves large, thick and heavy, produced in great numbers, and stands handling and transportation better than any other sort; in fact, we hardly think we could say too much about this valuable acquisition to the spinach family. Sold only in sealed bags.

Pkt. 5c. 1-4 lb. 10c. Lb. 25c.

VICTORIA SPINACH.—This new spinach comes to us with the highest recommendations from the growers. The foliage is heavy, the broad, dark green leaves being of the true Savoy appearance, and of the finest quality, but the most remarkable feature that will make it of special value, both for market and family gardens is the fact that it is in prime condition from two weeks to three weeks after all other varieties of spinach have run to seed.

Pkt. 5c. 1-4 lb. 10c. Lb. 20c.

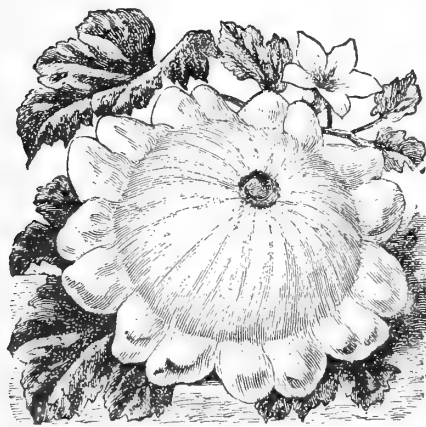

EARLY WHITE BUSH SCALLOP.—A desirable and marketable sort. Best known and most productive of all the summer sorts.

Pkt. 5c. Oz. 10c. 1-4 lb. 15c.
Lb. 40c.

EARLY YELLOW BUSH SCALLOP.—An early, flat scallop shaped variety; color yellow, flesh pale yellow and well flavored, very productive; used when young and tender.

Pkt. 5c. Oz. 10c. 1-4 lb. 20c.
Lb. 50c.

VEGETABLE MARROW.—A delicious English sort; skin greenish white, flesh white, soft, and of a rich flavor; a heavy cropper, quite distinct from the other sorts. We think every family should plant a package of this squash.

Pkt. 5c. Oz. 10c.

SQUASH.

THE Squashes are all quite tender, and therefore no progress can be made in starting them until the weather becomes somewhat warm and settled. Plant in hills five feet apart each way for the bush varieties, and eight feet for the running varieties; put eight seeds to the hill, but don't allow over three to stand.

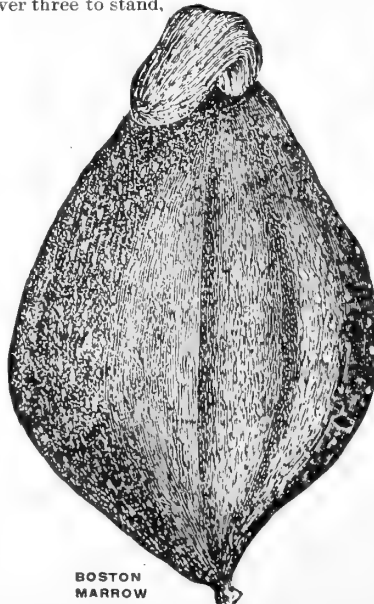

BOSTON
MALLOW



SUMMER CROOK NECK (Early).—Fine flavor; a desirable table sort.

Pkt. 5c. Oz. 10c. 1-4 lb. 15c. Lb. 40c.

WINTER CROOK NECK.—Flesh red, fine flavor; largely grown for winter use.

Pkt. 5c. Oz. 10c. 1-4 lb. 15c. Lb. 40c.

HUBBARD.—Fine and desirable for winter use.

Pkt. 5c. Oz. 10c. 1-4 lb. 15c. Lb. 40c.

BOSTON MARROW.—A fall and winter variety, very popular in the Boston market. Of oval form, skin thin, when ripe, bright orange mottled with light cream color, flesh rich salmon yellow, fine grained, and for sweetness and excellence unsurpassed, but not as dry as the Hubbard. Fine for pies or baking.

Pkt. 5c. Oz. 10c. 1/4-lb. 15c. Lb. 40c.

Tomato

GRIFFITH & TURNER CO.'S WORLD'S FAIR TOMATO.

**THE GREAT
CANNER.**

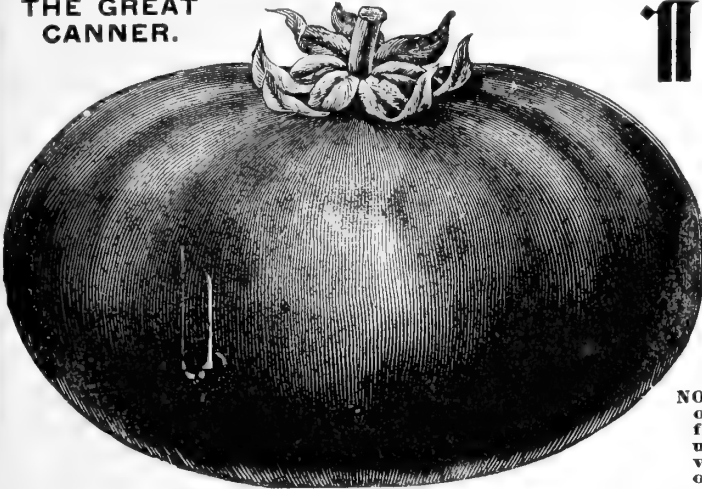

It is scarcely necessary to speak of this **Great Tomato** among those who have used it, because they have become our best advertisers, constantly praising, and persuading others to use it. Our sales of seed of this sort have increased each year far beyond our expectation. It is without exception one of the best for Canners, Market Gardeners or private use, because of its solidity, symmetrical shape, handsome bright red color, uniformity of ripening and freedom from rot. Its shipping and keeping qualities are unexcelled. The gentlemen who superintends the growing of this seed for us says: "I desire to call especial attention to this stock; it is particularly solid and of fine flavor, the fruit is good size, smooth and certainly attractive. I venture to say without fear of contradiction, that your Tomato will bear off the palm for quality and flavor in the hands of impartial judges. Parties around here who saw some of the fruit said they had never seen any better Tomato. We could get any number of testimonials to bear us out in all we say about this excellent Tomato."

Pkt. 5c. and 10c. Oz. 20c. 1-4 lb. 50c. Lb. \$1.50.

NOTICE.—Because of the well-known superior quality of this splendid Tomato, and the increasing demand for the seed, other parties are cataloguing a Tomato under the same name. In order to protect those who want the pure article WE GIVE NOTICE that we shall only sell the **WORLD'S FAIR TOMATO** in sealed packages.

Beware of cheap tomato seeds, saved in canning houses, as it is sure to be a mixture of different sorts. We take special care in growing our Tomato seeds. We have the seed stocks selected carefully each year, and the crops are inspected by us during the period of growth and maturity of fruit, and we are thus prepared to offer our customers seed of the first quality.

FOR EARLY FRUIT sow the seed March or April, in the hot-bed or in pots in a sunny exposure in the house. When the plants are about three or four inches high they should be set out four or five inches apart in another hot-bed or cold-frame, or removed into small pots, allowing a single plant to a pot. Expose to the air as much as possible to harden, and about the middle of May, set the

plants in the open ground, at a distance of four or five feet each way. Water freely at the time of transplanting, and shelter from the sun for a few days until the plants are established. Sufficient plants for a small garden may be had by sowing a few seeds in a shallow box or flower pot, and placing in a sunny window in the house. Cultivate thoroughly as long as the vines will permit.

Tomatoes will admit of training to stakes or trellis of various kinds, and the fruit is very much improved both in appearance and quality. This mode of cultivation is now quite common among gardeners who grow for early market. The usual method is to set one strong plant to a stake, using stakes five to seven feet in height, tying the plants up with wool or other strong, soft twine, pruning out quite freely as the vines advance in growth. By adopting this method the plants may be set much closer than in the ordinary way.

GOLDEN QUEEN, or SUNRISE. — Pkts. 5c. and 10c. Oz. 20c. 1-4 lb. 75c.

PEAR-SHAPED RED. — Pkts. 5c. and 10c. Oz. 20c. 1-4 lb. 75c.

DWARF CHAMPION. — Plant grows stiff and upright, and may be planted closer than other varieties; bears throughout the entire season. The fruit resembles the Acme, and is smooth and attractive in appearance. Pkts. 5c. and 10c. Oz. 20c. 1-4 lb. 50c. Lb. \$1.75.

PONDEROSA.—A remarkably large and heavy fruited Tomato, deep red in color; flesh very thick, solid and of excellent quality. Pkt. 10c. Oz. 35c. 1-4 lb. \$1.00.

IMPERIAL.—This new variety is highly recommended by leading growers. The originator claims it to be much earlier than any other; a beautiful, symmetrical and meaty Tomato. Pkt. 10c. Oz. 20c. 1-4 lb. 50c. Lb. \$1.75.

CRIMSON CUSHION. — In shape and size this resembles the Ponderosa; color is deep red. Pkt. 10c. Oz. 35c. 1-4 lb. \$1.00.

PEAR-SHAPED YELLOW. —Used for preserves and pickles. Pkts. 5c. and 10c. Oz. 20c. 1-4 lb. 60c.

YELLOW PLUM. — Color bright yellow; excellent for preserving. Pkt. 5c. Oz. 25c. 1-4 lb. 75c.

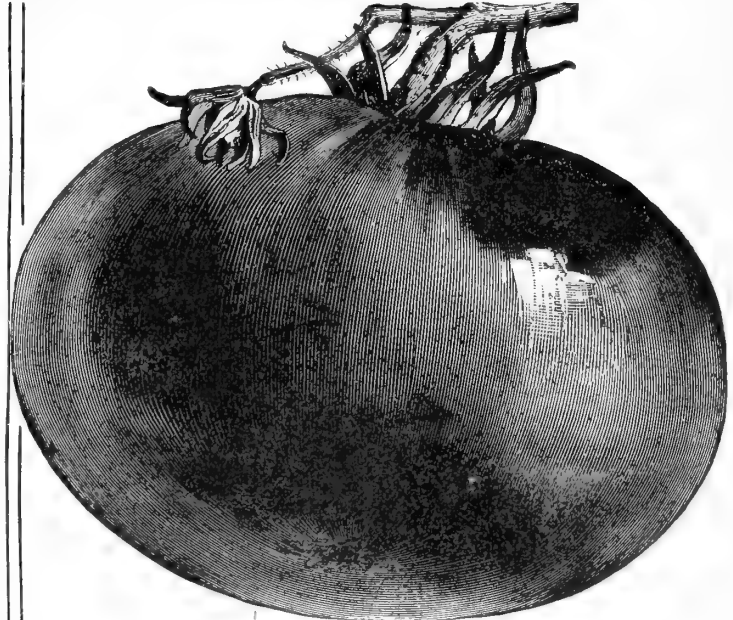

B. B. TOMATO.

B. B. TOMATO (Brinton's Best). — We have secured Headquarters' stock of this excellent and popular new variety; it is one of the leading sorts for second early and late use; the fruit is large, handsome, and a splendid keeper. A great favorite with Canners and Truckers. Pkts. 5c. and 10c. Oz. 20c. 1-4 lb. 50c. Lb. \$1.50.

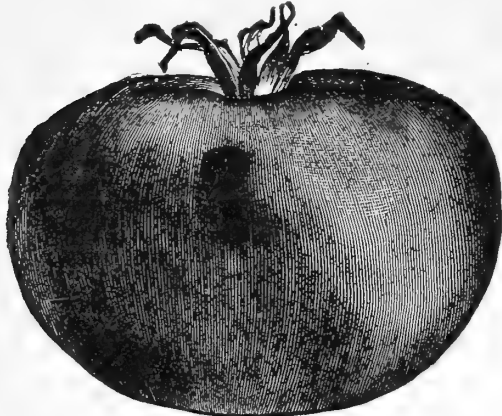

TOMATOES.-Continued.

ATLANTIC PRIZE.—An excellent extra early red tomato, and while it does not run as regularly smooth as the Paragon, it ripens very evenly.

Pkts. 5c. and 10c. Oz. 20c.
1-4 lb. 50c. Lb. \$1.50.

FAVORITE.—This is a large, perfect-shaped tomato. One of the best for either canning or market purposes.

Pkts. 5c. and 10c. Oz. 20c.
1-4 lb. 40c. Lb. \$1.25.

ACME.—Of superlative merit, early, medium size, shape, slightly oval, smooth, and of a pink-purplish color.

Pkts. 5c. and 10c. Oz. 20c.
1-4 lb. 40c. Lb. \$1.25.

PARAGON.—Here we have a variety—the perfection of a tomato—large, solid, smooth and handsome, deep red color. It is superb. No praise can be too high.

Pkts. 5c. and 10c. Oz. 20c.
1-4 lb. 40c. Lb. \$1.25.

ROYAL RED.—A new tomato, much resembling the Favorite in form and color. A good main crop variety.

Pkts. 5c. and 10c. Oz. 20c.
1-4 lb. 40c. Lb. \$1.25.

PRIZETAKER.—A very desirable early sort, large, of handsome shape, and deep crimson color, with a light tinge of purple.

Pkts. 5c. and 10c. Oz. 20c.
1-4 lb. 40c. Lb. \$1.25.

PRIZEWINNER TOMATO.

In this new sort we have the prince of market tomatoes. In color somewhat resembling the Beauty, but much larger, very solid, ripens early, and with us was one of the best keepers we have seen. As an early tomato it is first-class, selling for the highest market price. It is also well adapted for a late crop. It is smooth and uniform in shape, and in quality it cannot be surpassed.

Pkts. 5c. and 10c.
Oz. 20c. 1-4 lb. 40c.
Lb. \$1.25.

Beauty—For early market and shipping this cannot be excelled, because of its solidity and toughness of skin. Color is a rich, glossy crimson, with a slight tinge of purple. It is well known and very largely used by our gardeners.

Pkts. 5c. and 10c. Oz. 20c. 1-4 lb. 40c.
Lb. \$1.25.

Tobacco.

These varieties are well adapted to Maryland and Virginia soils.

WHITE BURLEY.—Especially desirable for the manufacture of cigars, as the leaf of this kind readily absorbs a large quantity of manufacturing material.

Pkt. 10c.

CONNECTICUT SEED LEAF.—An old well-known variety.

Pkt. 10c. Oz. 20c. 1-4 lb. 60c.
Lb. \$2.00.

HAVANA.—Grown from seed imported from the district of VUELTA DE ABAJO.

Pkt. 10c. Oz. 35c.



Stone—The New Stone Tomato ripens for main crop;

is very large and of bright scarlet color, very smooth, with occasionally a specimen very slightly octagon shaped, ripening evenly to the stem without a crack; exceedingly solid and firm fleshed (as its

name indicates). It is an excellent shipper; fine for canning; a good keeper; not subject to rot.

Pkts. 5c. and 10c. Oz. 20c. 1-4 lb. 40c.
Lb. \$1.25.

SEEDS of Sweet, Pot and Medicinal Herbs

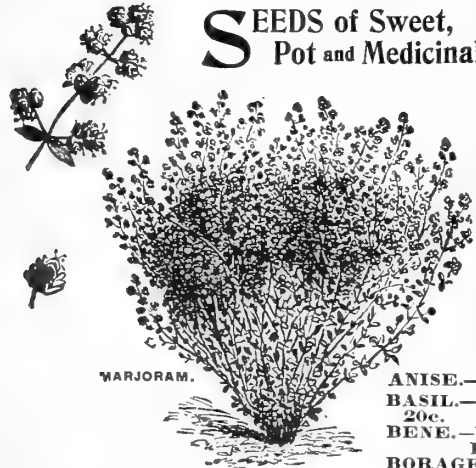

A little collection of Sweet Herbs is a treasure to the cook and nurse. A small place in the garden will give all the herbs needed in any family, and care should be taken to harvest them properly. This should be done on a dry day before they come into full bloom, then dried quickly and packed closely, entirely excluded from the air. Sow in spring in shallow drills, one foot apart, and when well up, thin out or transplant to a proper distance apart.

ANISE.—Pkt. 5c. Oz. 20c.
BASIL.—Pkts. 5c. and 10c. Oz. 20c.
BENE.—Used medicinally.
Pkt. 5c. Oz. 20c.
BORAGE.—Excellent for Bees.
Pkt. 5c. Oz. 15c.

CARAWAY.—Pkt. 5c. Oz. 15c.
CHERVIL.—Pkt. 5c. Oz. 25c.
CHICKORY.—Pkt. 5c. Oz. 10c.
CORIANDER.—Pkts. 5c. and 10c. Oz. 15c.
DILL.—Pkt. 5c. Oz. 10c. 1-4 lb. 20c. Lb. 70c.
LAVENDER.—Pkt. 5c. Oz. 20c.
MARJORAM.—Pkt. 5c. Oz. 20c. 1-4 lb. 50c.
FENNEL (Sweet).—Pkt. 5c. Oz. 10c. 1-4 lb. 25c.
ROSEMARY.—An Aromatic Herb. Pkt. 5c. Oz. 30c.
SAGE (Americann).—Pkts. 5c. and 10c. Oz. 20c. 1-4 lb. 60c. Lb. \$2.00.
SUMMER SAVORY.—Pkts. 5c. and 10c. Oz. 15c.
THYME (Broad-leaved English).—Pkts. 5c. and 10c. Oz. 25c. 1-4 lb. 75c.

TOMATO HONOR BRIGHT.—We believe this to be a grand acquisition to the list of tomatoes. Its chief peculiarities are its solidity, and changes of color the fruit undergoes during development; first it is light green, then an attractive waxy white, then lemon, changing to red. It is one of the longest keeping varieties and of excellent quality. If picked in the early stage they can be stored in a cool place and will keep from one to four weeks.

Pkt. 10c. Oz. 30c.

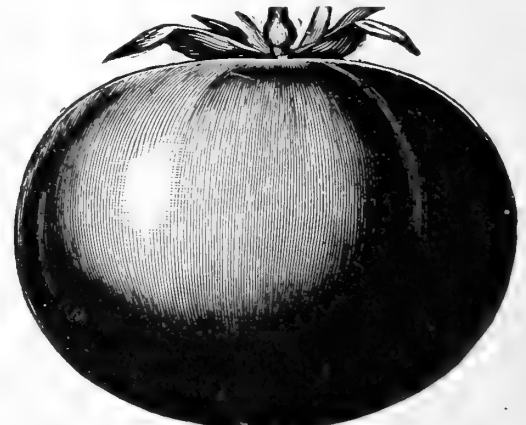

Queen—Fruit somewhat resembles Paragon in appearance. This sort is well known and a favorite among canners, but it is not as deep red in color nor as weighty and solid as our WORLD'S FAIR.

Pkts. 5c. and 10c. Oz. 20c. 1-4 lb. 40c.
Lb. \$1.25.

Turnip

FOR early use, sow the small sorts as soon as the ground can be worked in the spring, in drills fourteen inches apart, the Rutabagas thirty inches. As the seed is very fine, it should be covered but slightly, excepting in very dry weather. Select light, and if possible, new soil, and manure with plaster and ashes, or phosphates. Should the young plants be troubled with insects, a sprinkling of slug shot will be beneficial. For fall and winter use the early kinds should be sown, from the middle of July to the middle of August; and the Rutabagas from the middle of June to the first of July, using from one to one and a half pounds of seed to the acre.

LARGE EARLY RED TOP GLOBE. A variety of recent introduction. Of large size, rapid growth, unusually attractive. Approved and admired by all who have seen it. A very much heavier producer than either of the Flat varieties and quite as early as the Flat Red Top. Very few market gardeners will have any other kind.

Pkt. 5c. 1-4 lb. 10c. Lb. 30c.

YELLOW ABERDEEN, or SCOTCH YELLOW. This a highly approved CATTLE TURNIP, attaining a large size. It is solid, nutritious, a good keeper, and in every respect reliable.

Pkt. 5c. 1-4 lb. 10c. Lb. 30c.

LARGE AMBER, or YELLOW GLOBE.—Grows to a large size, flesh yellow, firm and fine grained. Excellent for either table use or feeding stock.

Pkt. 5c. 1-4 lb. 10c. Lb. 30c.

Ruta Bagas or Swedes.

THE Swede Turnips, or Rutabagas, grow much larger in size, and are of greater value for stock feeding than ordinary turnips. Every farmer and stock raiser should grow Rutabagas and Stock Beets for winter feeding.

GRIFFITH & TURNER CO.'S IMPROVED PURPLE TOP.

Yellow fleshed. A standard field variety for stock, and fine for family use. This splendid Swede is the hardest, most productive, and most nutritious variety in cultivation.

Pkt. 5c. 1-4 lb. 10c. Lb. 30c.

YELLOW RUTABAGA.—1-4 lb. 10c. Lb. 25c. (If Turnip is wanted by mail, add 10c. per lb. for postage.)

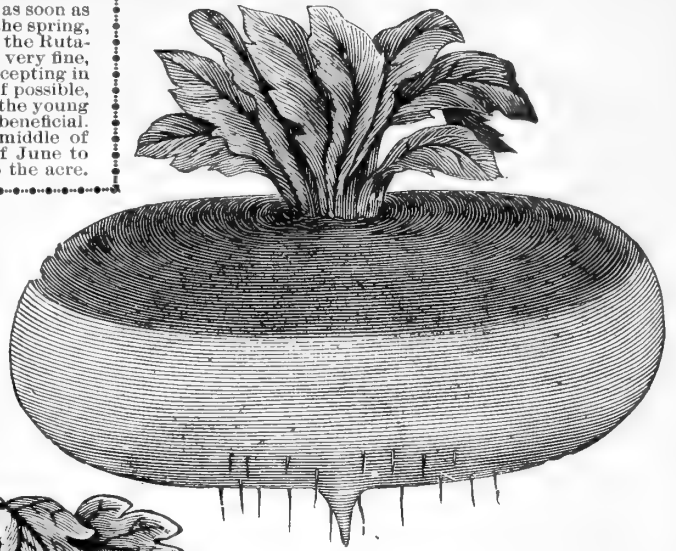

EARLY RED TOP FLAT.—Fine, sweet, mild; rapid grower; very early and popular.

Pkt. 5c. 1-4 lb. 10c. Lb. 30c.

EXTRA EARLY PURPLE TOP MILAN.—The earliest and handsomest Flat Turnip in cultivation; none equal to it for spring sowing.

Pkt. 5c. 1-4 lb. 20c. Lb. 50c.

WHITE FLAT (Strap Leaf).—Differs from Red Top only in color.

Pkt. 5c. 1-4 lb. 10c. Lb. 30c.

EARLY WHITE EGG.—A new variety of rapid growth; egg-shaped and white, as its name indicates.

Pkt. 5c. 1-4 lb. 15c. Lb. 40c.

COW-HORN (Large Cropper).—This variety is pure white, excepting a dash of green at the crown, and in shape is long like the carrot.

Oz. 5c. 1-4 lb. 15c.

SEVEN TOP.—For greens and salads. Used largely in the Southern States.

Pkt. 5c. 1-4 lb. 10c. Lb. 30c.

SOUTHERN PRIZE.—True strain of the favorite Turnip for Greens in Virginia and the Carolinas. Valued also for its bulb.

Oz. 5c.

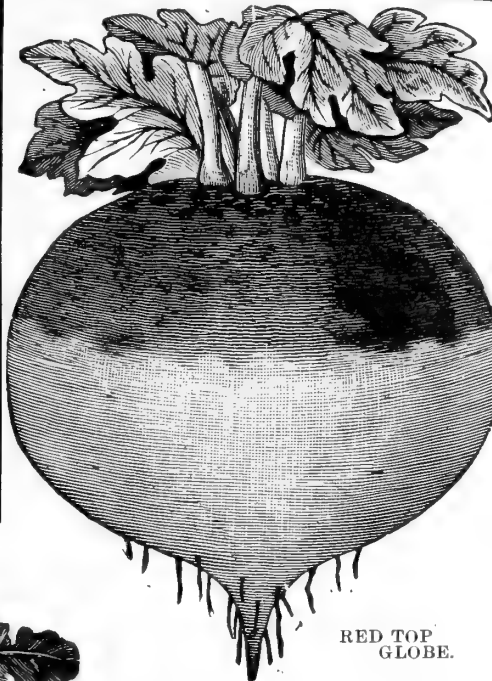

RED TOP GLOBE.



RUTA BAGA.

Vegetable Roots.

ASPARAGUS ROOTS.—(See page 1).

ARTICHOKES (Jerusalem).—Pk. \$1.00. Bu. \$2.50. For further information see page 1.

HORSE RADISH ROOTS.—Doz. 20c. Per 100, 75c. Per 1,000, \$6.00

RHUBARB ROOTS.—15c. each. Doz. \$1.50.

Plants.

CASH WITH ORDER.

☞ We will not ship Plants C. O. D. Shipments at purchaser's risk.

CABBAGE.—40c. per 100. 500 for \$1.25. \$2.00 for 1000.

TOMATO.—40c. per 100. 500 for \$1.25. \$1.75 for 1000.

CELERY.—50c. per 100. 500 for \$1.25. \$2.00 for 1000.

EGG PLANTS, PEPPER, Etc.

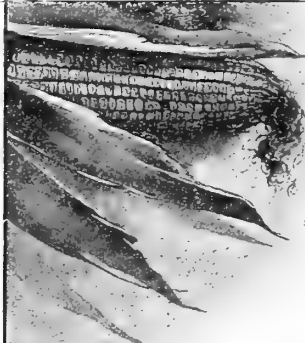

FARM SEEDS

CORN, WHEAT, OATS, &c.

White Varieties.

IMPROVED WHITE PROLIFIC.—This corn is specially adapted for strong ground, exceedingly prolific, very showy, large ears, deep grain, slightly wrinkled, frequently grows two ears to the stalk. Produces heavy fodder; decidedly the best paying corn for strong land.
Qt. 10c. Pk. 40c. Bu. \$1.25.
5 bu. \$5.00.

MARYLAND WHITE.—This is an excellent white corn, grows good-sized ears, and makes splendid meal. Produces better crops on average land than most any other variety.
Qt. 10c. Pk. 40c. Bu. \$1.25 5 bu. \$5.00

BLUNT'S PROLIFIC.—Remarkably prolific, producing from three to five good-sized ears on a stalk and growing very large fodder; is frequently used for ensilage.
Qt. 10c. Pk. 40c. Bu. \$1.25. 5 bu. \$5.00.

SNOWFLAKE.—A well-known and very popular corn through the South. Suitable for meal or feeding purposes; the best white corn for poor land.
Qt. 10c. Pk. 40c. Bu. \$1.25. 5 bu. \$5.00.

90-DAY CORN (Red Cob).—This is an elegant corn for truckers and market gardeners, as it is a good seller as green corn. Is suitable for either early or late crop.
Qt. 10c. Pk. 50c. Bu. \$1.50.

WHEAT AND RYE.

Write us August 1st for special prices on Seed Wheat and Rye for Fall Sowing.

Winter Oats.

These are quite distinct from Spring oats, and are now being quite largely grown in Southern Pennsylvania, New Jersey, Delaware, Maryland and Virginia. They are sown in the Fall.

At Market Prices.

OATS.

(Thirty-two pounds to the bushel.)
CLYDESDALE.—A very early and productive variety of extraordinary weight.
Per bu. (32 lbs.) \$1.00.

WHITE RUSSIAN.—Per bu. 90c.

WELCOME.—An excellent variety, very productive and heavy. Per bu. (32 lbs.) 80c.

CHOICE BLACK OATS.—Per bu. (32 lbs.) 75c.

GOOD SEED OATS.—Unnamed varieties.
At Market Prices.

SEED BUCKWHEAT.

JAPANESE.—The plants are large and vigorous, maturing their seed early, and resisting drought and blight remarkably well, while the grain is much larger and at the same time has a thinner hull than the common or the Silver Hull. Owing to its branching character, only one-half the seed is required per acre, while the straw is much stiffer and stands up better. We recommend this especially for well-drained or sandy land, and the dry climate of the Western plains.
At Market Prices.

SILVERHULL.—This improved variety is much better than the old sort. It is in bloom longer; matures sooner and yields double the quantity per acre. The husk is thinner, the corners less prominent, and the grain of a beautiful light grey color. At Market Prices.

BARLEY.

MANSHURY SPRING BARLEY.—This is the most productive variety we know, and, having grown it ourselves, can recommend it.
By Express or Freight—Pk. 50c. Bu. \$1.25.

NEW BEARDLESS SPRING BARLEY.—The earliest barley known. If sown about the 20th of March, will ripen about the 28th of June. The straw is about the height of the common barley, but better, and will stand up on any land. Sow as early as you can; frost does not hurt it. Being beardless, it handles as easy as oats, and makes a stronger feed.
By Express or Freight—Pk. 40c. Bu. \$1.25. Bags 20c.

Yellow Varieties.

IMPROVED MARYLAND YELLOW DENT.—Our Maryland Dent Corn has taken first premium over all other field corn where exhibited. The grains are unusually deep, ears large, stalks grow from 7 to 10 feet high, does not exhaust soil so much, and will stand drought better than a large stalk, and will yield five to ten bushels per acre more than any other corn generally planted.
Qt. 10c. Pk. 40c. Bu. \$1.25.
5 bu. \$5.00.

EARLY LEAMING.—An early selected variety of yellow corn, small grain, weighty and productive. Highly esteemed in Maryland and Pennsylvania. One of the earliest varieties of yellow corn in cultivation.
Qt. 10c. Pk. 40c. Bu. \$1.25.

GOLDEN BEAUTY.—A large, broad-grained yellow corn, with ears of perfect shape and very small cob. The richness of color and the quality of the grain make it a very superior variety.
Qt. 10c. Pk. 40c. Bu. \$1.25.
5 bu. \$5.00.

EARLY WESTERN YELLOW.—This is an excellent sort, and may be planted after peas are taken off, and make a good crop.
Pk. 40c. Bu. \$1.25.

POP CORN.—The best kind for popping.
Lb. 10c. 4 lbs. 25c.
By mail, 20c. per lb.

THE 100-DAY BRISTOL.—The largest eared, earliest Yellow Dent Corn in cultivation. Since its introduction this corn has grown in popularity each season, and is now planted largely, both in the Northern and Southern states. The grain is a light golden yellow, large and broad; the cob is small considering the size of the ear. The ears grow an average of about a foot in length, and the growth of fodder is immense.
Qt. 10c. Pk. 40c. Bu. \$1.25.
5 bu. \$5.00.

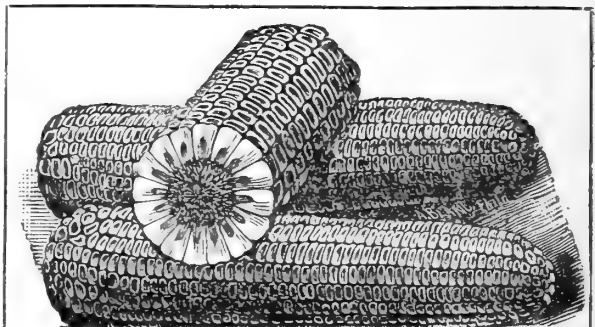

IMPROVED MARYLAND YELLOW DENT.

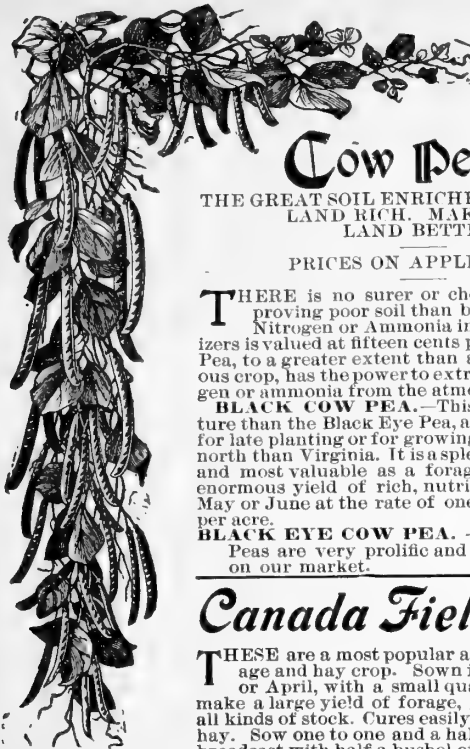

Clover and Forage Seeds

Cow Peas.

THE GREAT SOIL ENRICHER. MAKES POOR LAND RICH. MAKES GOOD LAND BETTER.

PRICES ON APPLICATION.

THERE is no surer or cheaper means of improving poor soil than by sowing Cow Peas. Nitrogen or Ammonia in commercial fertilizers is valued at fifteen cents per pound. The Cow Pea, to a greater extent than any other leguminous crop, has the power to extract this costly nitrogen or ammonia from the atmosphere.

BLACK COW PEA.—This is quicker to mature than the Black Eye Pea, and is better adapted for late planting or for growing in districts further north than Virginia. It is a splendid land improver and most valuable as a forage crop, making an enormous yield of rich, nutritious feed. Sow in May or June at the rate of one and a half bushels per acre.

BLACK EYE COW PEA.—The Black Eye Peas are very prolific and bring a good price on our market.

Canada Field Peas.

THESE are a most popular and satisfactory forage and hay crop. Sown in February, March or April, with a small quantity of oats, they make a large yield of forage, greatly relished by all kinds of stock. Cures easily, making a splendid hay. Sow one to one and a half bushels per acre broadcast with half a bushel of oats. Cut for hay before the Peas mature. Per peck, 40 cents; bushel, about \$1.25. Write for special prices if a quantity is required.

Dwarf Essex Rape.



DWARF ESSEX RAPE is considered indispensable by the sheep and cattle farmers of Great Britain, and is fast coming into use in this country on account of its rapid growth, being ready to feed in ten weeks from sowing, and producing twenty-five to thirty tons of green forage to the acre. It grows to a height of three feet and covers the surface so densely as to smother out all weeds and to kill quack and other objectionable grasses. It can be sown all through the season, being perfectly hardy, withstands drought, and will produce a crop in any soil by sowing broadcast at the rate of five pounds to the acre, or in drills or rows two feet apart at the rate of three pounds per acre. While unequaled as a pasture for sheep, as a fattening food for all kinds of live stock it is without a rival in point

of cheapness or effectiveness. **Lb., by mail, 20c. By express or freight, 5 lbs., 50c. 50 lbs. and over, 7c. per lb. If wanted by mail, add 8c. per lb. for postage.**

Broom Corn.

IMPROVED EVERGREEN.—This is the favorite sort; has a fine brush, yields well, and keeps green. Height, 8 to 9 feet. **Qt. 20c. Pk. 75c. Bu. \$2.50.**

Early Amber Sugar Cane.

THE saccharine matter of this early and productive variety is of the first quality, and produces a fine sugar or syrup. It grows ten or twelve feet high and yields large crops of fodder, which is relished by all kinds of stock. It will produce two cuttings during the summer. Culture same as corn. Sow three or four quarts per acre.

10c. Lb., by mail, 20c. Bu. (56 lbs.) \$2.00.

Kaffir Corn.

(Red or White).

ONE of the best things offered of late years for a forage plant. The heads contain small white seeds, which make an excellent flour. They are greedily eaten by horses and cattle, and make excellent food for poultry, either fed in the grain or ground and cooked. Use four to five pounds to acre.

Lb. 10c. 15 lbs. 75c. 100 lbs. \$4.00.

Crimson Clover.

THE GREAT NITROGEN GATHERER.

THE best crop for Hay, Silage and green manuring—all winter and spring pasturage. For Hay it must be cut before it comes into full bloom, as otherwise it may cause hair-balls to form in the animal's

stomach. This popular Clover Seed is grown successfully in Delaware, Maryland and Virginia. The yield of fodder is immense. Its growth is very rapid and luxuriant, and, therefore, it is valuable as a fertilizer to turn under. It is fast becoming a popular crop in the Middle States and the South, and is finding its way into Pennsylvania and the West. It is used on poor and rich land. It is seeded in this country in June, July, August, September and October, and will produce an enormous crop early in the following spring suitable either for consumption as green food or for hay. Ten or fifteen pounds should be sown to the acre, according to quality of ground. **10c. per lb. By mail, 20c. Per 100 lbs. \$8.50.**

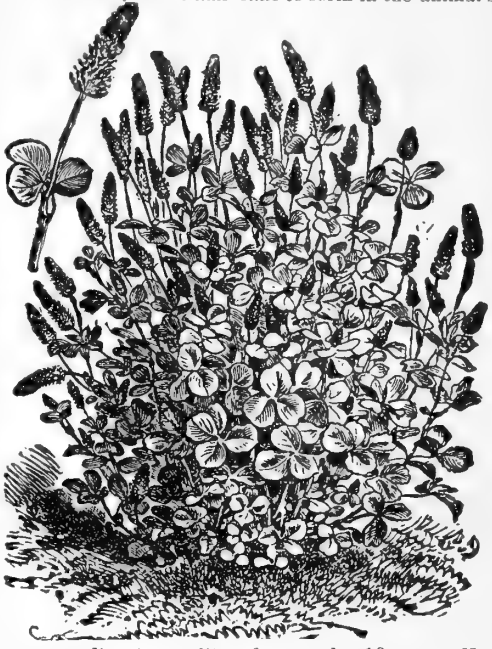

Recleaned Red Clover.

WE TAKE great pains to supply an extra quality of Red Clover at a reasonable price. Farmers should not sow a poor quality of Clover Seed. We have, however, cheaper grades for those who wish them. Market prices.

Lucerne Clover.

ONE of the most valuable among Clovers, resisting drought and remaining green when other sorts are dried up. Sow on rich, moist loam or sandy soil. Prepare the land thoroughly and sow 15 pounds to the acre. **Lb. 15c. By mail, 25c. 7 lbs. \$1.00. In quantities at market price.**



Alsike or Swedish Clover. (Trifolium Hybridum).

HARDEST of all the Clovers, and on rich, moist soils yields an enormous quantity of hay or pasturage. Valuable for sowing with other Clovers or Grasses, as it forms a thick bottom and increases the yield of hay. Sow 6 pounds per acre when used alone. **Lb. 15c. By mail, 25c. 7 lbs. \$1.00. In quantities at market price.**

White Dutch Clover.

THRIVES most everywhere. The best to sow with lawn grass, and valuable to sow with Blue Grass for permanent pastures. **1-4 lb. 10c. 1b. 25c. By mail, 1b. 35c. 5 lbs. for \$1.00. 100 lbs., \$18.**

Russian Sunflower.

GROWING to double the size of the common Sunflower, and the yield of seed is twice as great. It is highly recommended for poultry—the best egg-producing food known. The leaves make splendid fodder, much relished by all kinds of stock. The seed is good feed for horses, and yields a fine quality of oil. **Lb., 10c. By mail, 18c. 4 lbs., 25c.**

**OUR
PERMANENT
HAY
AND PASTURE
GRASS**

is prepared especially to meet the demand for a mixture that will be desirable either for cutting for Hay or to use for Pasture, and contains such grasses as are best adapted for these purposes. In ordering, please state whether you want a mixture for upland or low ground.

MIXTURE FOR UPLAND.
14 lbs. to the bu., 2 bu. to the acre. Per bu. \$2.00, 10 bu. for \$17.50.

MIXTURE FOR LOWLAND
14 lbs. to the bu., 2 bu. to the acre. Per bu. \$2.00, 10 bu. for \$17.50.

**OUR SPECIAL GRASS MIXTURE
FOR HAY AND PERMANENT PASTURES.**

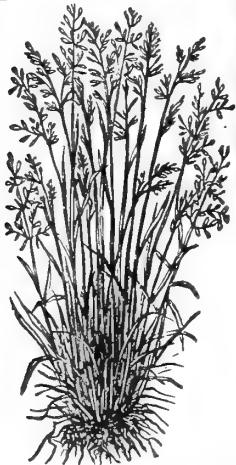

RED TOP GRASS.

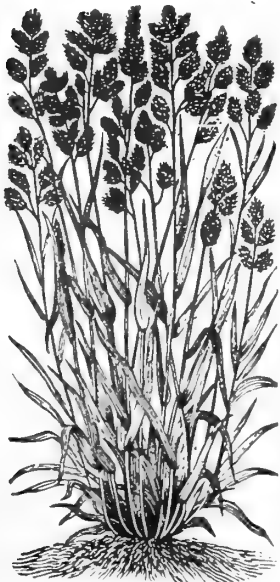

ORCHARD GRASS.

Grass Seed.

CREeping BENT GRASS (Agrostis Stolonifera).—Succeeds in nearly any situation, and is good for lawns or pastures; best adapted for moist situations. About 20 lbs. to the bushel; 2½ bushels to the acre. Per lb. 35c. postpaid. Per bu. \$3.75.

ENGLISH RYE GRASS.—A nutritious permanent grass for meadows and pastures. Qt. 20c. Bu. (24 lbs.) \$2.00.

MEADOW FOXTAIL (Alopecurus pratensis).—An excellent early grass for permanent pasture; medium moist or dry land is best. Lb. 35c.

WOOD MEADOW (Poe's nemoralis).—An early nutritive grass; thrives well under trees. Lb. 35c.

CRESTED DOG'S TAIL (Cynosurus cristatus).—Valuable for dry hard soils and hills. Two to three bushels to the acre. Lb. 35c.

SHEEP FESCUE (Festuca Ovina).—A grazing grass for dry, sandy and rocky situations. Two to three bushels to the acre. Lb. 25c. Bu. (12 lbs.) \$2.00.

HERD, or RED TOP GRASS (Agrostis vulgaris).—A valuable native permanent grass, as a mixture in meadows, pastures or lawns, grows best in moist situation. 10 lbs. to the bushel; 2½ bushels to the acre. As usually sold, per bushel, 75c. Choice Extra Heavy Seed, per bushel, \$1.00. Fancy Clean Seed, very choice, 8 lbs. \$1.00. 100 lbs. \$12.00.

KENTUCKY BLUE GRASS.—It is rather sensitive to heat, but not so to cold weather, and on this account does its best in the fall, winter and spring. It grows slowly at first, forms a very compact turf, making a fine pasturage when once established. It is much the best, however to combine other grasses with it, for either lawn or pasturage. Sow in the spring or fall. Fancy, triple-cleaned, bu. (14 lbs.) \$1.50. Notice.—Beware of cheap Canada Blue Grass, as it is full of Thistle.

ORCHARD GRASS (Dactylis Glomerata).—One of the most desirable grasses for pastures. Sow under orchards or in shady places. It grows rapidly, thrives in sandy land, and does not suffer from close feeding. Choice Western seed. Not to be confounded with the cheap grasses mixed with rye grass. Bu. (14 lbs.) Fancy Re-cleaned Seed, \$1.50 bu.

TIMOTHY.—The best quality of Timothy Seed at market prices.

IMPORTANT.—It does not pay the farmer to buy cheap Grass Seeds, as it is liable to be either old seed or full of weeds.

Millet.

GERMAN, or GOLDEN MILLET.—An improved variety, medium early, growing three to five feet high. The heads are closely condensed, though the spikes are very numerous. This is the best and most productive Millet to grow. Weight, per bushel, 50 pounds. Market Prices.

HUNGARIAN MILLET (Panicum Germanicum).—Early and productive, growing two to three feet high, with an abundance of foliage and slender heads. Weight, per bu. 48 lbs. Market Prices.

COMMON MILLET.—Weight, per bushel, 50 pounds. Market Prices.

Tares.

TARES, or SPRING VETCHES (Vicia sativa).—Closely associated with peas in character. Highly valuable for soiling or for green manuring. Sometimes grown with oats, for mowing and feeding to stock. Use two or three bushels to acre. Sow in spring, while ground is cool and moist, or in early autumn.

Bushel of 60 pounds. Write for Prices.

TARES, or WINTER VETCHES (Vicia villosa).—Also called Sand Vetch, or Hairy Vetch. Recommended for fall sowing with rye, as in many localities in the North it is hardy, remaining green all winter. A valuable food for stock in early Spring. Use one to two bushels per acre.

Bushel of 60 pounds. Write for Prices.

Flax Seed.

FLAX SEED.—Lb. 10c. 6 lbs. 25c. Bu. \$2.00.

FLAX-SEED MEAL.—For horses and cattle. 10 cts. per pound. 6 lbs. 25c. In quantities at market prices.



GROUNDS OF BALTIMORE COUNTRY CLUB.



THE view herewith, taken from the September issue of "GOLF," represents a portion of the beautiful golf grounds of the Baltimore Country Club, sown with Griffith & Turner Co.'s Special Grasses. These grounds have been the admiration of thousands of visitors. There being a growing demand for a Grass Mixture suitable for Golf and Cricket grounds, we have made a study of the grasses best adapted to these purposes, and have them mixed in proper proportions to give desired results.



Sown with G. & T. Co.'s Special Grasses

Griffith & Turner Co.'s Golf Link Mixture. Bushel, \$2.50. 10 Bushel Lots, \$2.25
PUTTING GREEN MIXTURE: Peck, \$1.25. Bushel, \$4.50

CRESCENT LAWN SPRINKLER.

WORKS BEAUTIFULLY.

THIS Sprinkler is compactly and strongly made with PHOSPHOR BRONZE BEARING, and will cover a surface of 48 feet in diameter. As it has a free and unobstructed channel, there is no danger of clogging with dirty water, and therefore it fills the requirements of users of such articles better than the more expensive and larger sprinklers, and will accomplish the same results. The top and arms are brass, full nickel-plated standard; the base and legs are iron, handsomely japanned.

Price, 12 in. high, - - -	\$1.50
" 24 " " 4 arms, - - -	2.00
" 36 " " 4 " - - -	2.50

Eclipse Sprinkler.

This is the cheapest and one of the most effective sprinklers made. The distribution of water is perfect.
 Price, 20c., by mail, 30c.

The Mystic Lawn Fountain.

Throws either whole or half circle by simply turning thumb piece. The sled enables the sprinkler to be moved about the lawn by the hose. The wings will not choke or clog, and revolve with very little pressure.

Price, - - - 75c.

Lyons' Automatic Lawn Feeder.

It is a neat device attached to the hose nozzle, which dissolves a stick of concentrated fertilizer, diffusing it through as much water as will pass through garden hose in about one hour. Complete outfit, consisting of one holder and 12 of the food cartridges, prepaid, to any address on receipt of \$1.00.

EXTRA FOOD CARTRIDGES, in boxes of 24, for 50c. or prepaid for 75c.

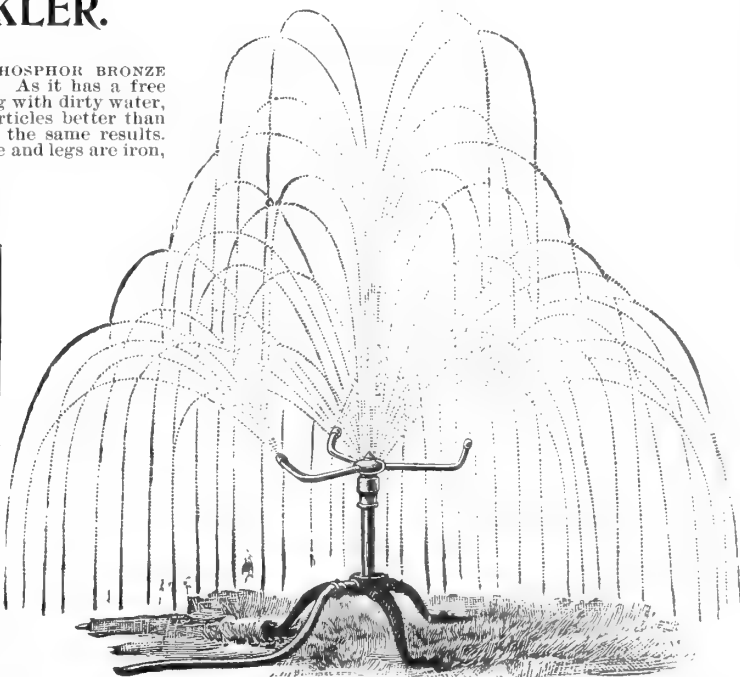

THE CRESCENT LAWN SPRINKLER.

ALL PRICES SUBJECT TO CHANGE WITHOUT NOTICE.

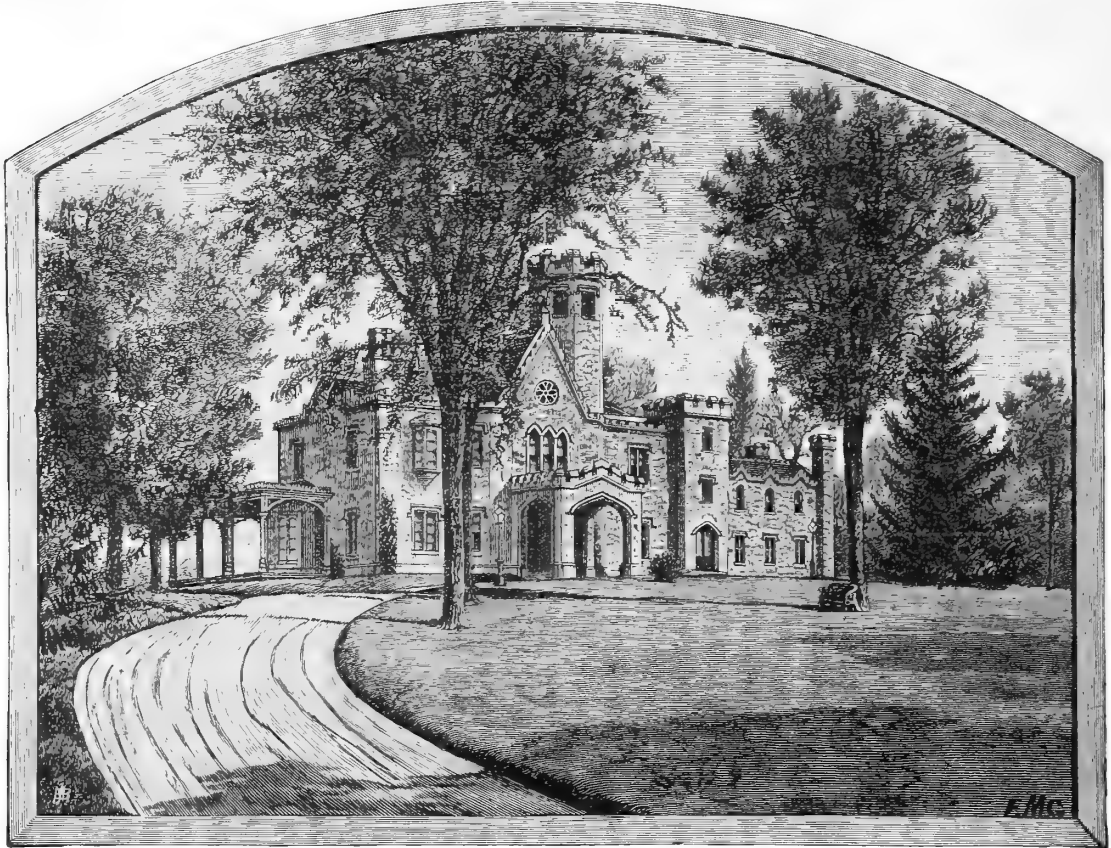

GRIFFITH & TURNER CO.'S EVERGREEN LAWN GRASS.

THIS is a first-class mixture prepared by ourselves, and containing nothing but choice seeds—just the thing for tennis, croquet and ball grounds, remaining green and fresh during the hot summer months. Widely known and extensively used on the finest private and public grounds around Baltimore, Washington and elsewhere with the most satisfactory results.

Nothing adds to the attractiveness of a suburban home more than a well kept, closely cut, velvety lawn; hence the importance of securing the best seeds. This we offer in our selected Evergreen Lawn Mixture, containing different varieties, that grow and flourish at different months of the year, so that a rich green, velvety lawn is constantly maintained. It is also adapted to the small grass plots of city homes. **Pint, 10c.; quart, 20c.; half peck, 75c.; peck, \$1.15; bushel of 20 pounds, \$4.00.**

. . Preparation and Care of Lawns . .

The ground should be thoroughly drained and well enriched before sowing. Work the soil until well pulverized, and have the surface as level as possible, so that the grass may present an even appearance. After sowing, cover seed lightly and follow with roller. The best results are obtained by using plenty of seed—four bushels to the acre being about the right quantity. One quart is sufficient for 300 square feet. Let the grass obtain a good start before cutting, and then it should be trimmed with a lawn mower about every ten days. Old lawns may be improved and renewed by the application of fertilizers and seeding about half the quantity of seed required for new lawns. This should be done whenever they show any thin places.



White Dutch Clover

(*Trifolium repens*.)

The best variety for lawns, as it forms a close herbage and remains green throughout the season. It is also valuable when mixed with grass seeds for pasture. Sow in spring at the rate of 6 pounds per acre when sown alone, half the quantity when sown with other grasses.

Pound	\$.25
5 pounds.....	1.00
100 "	18.00

OUR LAWN GRASS should not be confounded with the cheap, chaffy grasses offered at less prices.

**Park . . .
Lawn Grass**

This mixture does not contain so much of the high-priced grasses as our Evergreen Lawn Grass, but it is superior to many of the cheap grades offered, and will make a very nice lawn.

Quart, 20c.	Peck, \$1.00
Bushel of 16 lbs.,	\$3.00

RUBBER HOSE.

Armored or Wired Hose, in 25 and 50-ft. lengths, $\frac{1}{2}$ inch, 16c. per foot.
G. & T. Co.'s Extra 4 ply, in 25 and 50 ft. lengths, 15c. per foot.
G. & T. Co.'s Extra 3 ply, in 25 and 50 ft. lengths, 10c. per foot.
G. & T. Co.'s Standard 3 ply, in 25 and 50 ft. lengths, 9c. per foot.

Gem Hose Nozzles.

The best in use. For throwing fine or coarse spray or straight stream.

Hose Menders.

Couplers.

Brass, for $\frac{1}{2}$ inch hose, per pair 15c.

HOSE REELS, \$3.50

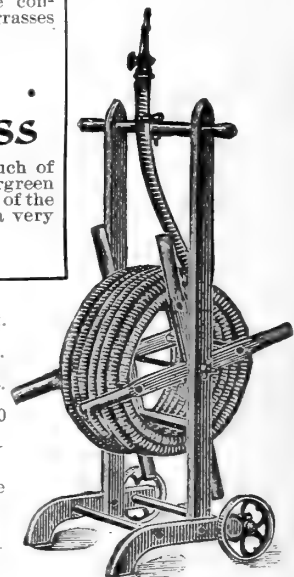



ORDER BY NUMBER.

Ten 5c. Papers for 25c., or Four 10c. Papers for 25c.

1. AGERATUM, MIXED.—Suitable for beds, and especially nice for cut flowers and bouquets.
Packet, 5c.

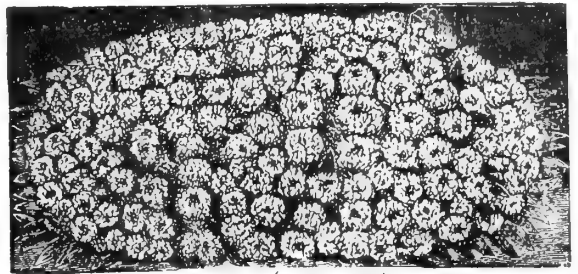

ALYSSUM (TOM THUMB).



ALYSSUM.

10. ALYSSUM.—The Sweet Alyssum has pretty little white flowers, useful in making small bouquets, and its fragrance, while sufficiently pronounced, is very delicate. The Alyssum grows freely from seed; blooms the whole season.
Oz. 25c. Packet, 5c.

11. ALYSSUM (Tom Thumb).—Of dwarf, compact habit, each plant covering a circle from 15 to 30 inches. It will bloom when small and remain covered with bloom from spring to autumn.
Oz. 40c. Packet, 5c.

20. AMARANTHUS, MIXED.—Showy blooming plants, with long racemes of curious looking flowers and brilliant foliage; half hardy annuals.
Packet, 5c.

21. AMARANTHUS, TRI-COLOR (Joseph's Coat).—Red, yellow and green foliage; 2 feet.
Packet, 5c.

22. AMARANTHUS, CAUDATUS (Love Lies Bleeding).—Graceful and handsome flowers of blood red hue.
Packet, 5c.

25. ASTER.—Choice mixed varieties. Well-known and beautiful flowers; should be in every garden.
Packet, 5c.

26. ASTER, GERMAN.—All colors and shades of the best German sorts. Sow Seed early and transplant to rich soil.
Packet, 5c.

27. ASTER, TRUFFAUT'S PERFECTION.—A very favorite class; thrifty, upright growers; flowers large, almost perfectly round, with incurved petals. The florists' preference; 1½ to 2 feet.
Packet, 10c.

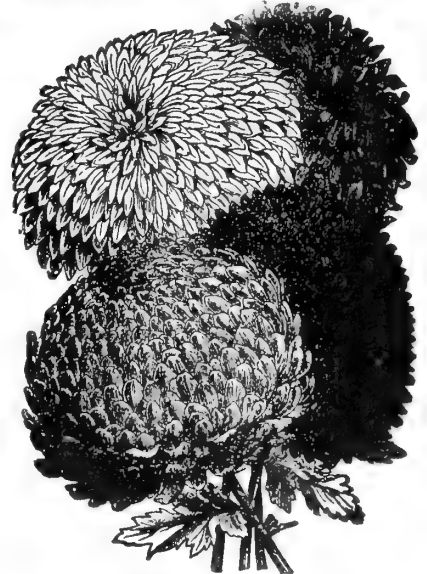

PRINCESS SNOWBALL ASTE

28. PRINCESS SNOWBALL.—This is an entirely distinct variety of Aster. The flowers are pure white, and are formed of short, thickly set imbricated petals, there being about 25 to 30 on a plant.
Packet, 10c.

geous shades. Very double and 4 inches across; height 15 to 18 inches.
Packet, 10c.

29. MIGNON ASTER.—A splendid new class of Asters. The plants are semi-dwarf and bear in profusion flowers of a very double nature, the petals overlapping each other.
Packet, 10c.

31. COMET ASTER.—This class of Asters have long, slender and curled petals, forming loose, yet dense flowers, of semi-globe shape, 3½ to 4½ inches in diameter, which resemble the Japanese Chrysanthemum.
Packet, 10c.

30. VICTORIA ASTER.—The most beautiful of all Asters, bearing flowers of all colors and shades; the colors include many extremely delicate and gor-

32. DWARF CHRYSANTHEMUM FLOWERED ASTER.—Grow 9 inches high; surpass all the dwarf varieties in size of flowers.
Packet, 10c.



COMET ASTER.



LOVE LIES BLEEDING.



VICTORIA ASTER.

FLOWER SEEDS THAT GROW.

TEN 5c. PAPERS MAILED FOR 25c., or FOUR 10c. PAPERS FOR 25c.

33. SEMPLE'S BRANCHING ASTER.
A choice strain of American-grown Asters, which has, by careful selection, been brought to a high degree of excellence. **Mixed Colors, 10c.**

34. SEMPLE'S BRANCHING ASTER (White).—Very choice. **Packet, 10c.**

35. BACHELOR'S BUTTON, or BLUE BOTTLE (Centaurea Cyanus).—A very old favorite garden annual, with handsome flowers of various colors. It does best if sown in a hot-bed; half-hardy annuals; two feet. **Packet, 5c.**

40. DOUBLE BALSAMS, CAMELIA FLOWERED (Lady Slipper, or Forget-Me-Not).—The well-known Balsams are one of the finest summer blooming annuals, free bloomers and highly colored. By transplanting them once or twice, the flowers are apt to be more double. **Packet, 5c.**

41. BALSAM, PERFECTION WHITE. This resembles the mixed Balsams in shape, but the flowers are of a pure white, and is the variety usually grown by florists. **Packet, 10c.**

45. CANDYTUFT MIXED.—Well-known favorite, hardy annuals; very pretty in beds or masses; useful for bouquets. Seeds may be sown in the fall for early flowering. **Packet, 5c.**

46. CANDYTUFT, WHITE.—Treated and used same as the mixed. **Packet, 5c.**

50. CALCEOLARIA DWARF.—This is a magnificent ornamental plant for green-house or conservatory, bearing in profusion pocket-shaped flowers of all colors, spotted and blotched in the most fanciful fashion. **Packet, 25c.**

53. CALENDULA, DOUBLE.—Very profuse dwarf bushy annuals, blooming continuously and profusely until frost; of easy culture, and suitable for summer garden or for growing in pots in winter. **Packet, 5c.**

55. CANNA, MIXED (Extra Choice).—The Cannas are desirable not only for the beauty of their spikes of scarlet flowers, but for their highly ornamental leaves. They make superb beds for the lawn. Soak the seeds thoroughly before planting, and keep in a warm spot. Very slow to germinate. **Packet, 5c.**

60. CANTERBURY BELLS, SINGLE MIXED (Campanula).—A highly attractive class of plants, combining richness of color with stately growth; valuable for beds and borders. Sow early, and transplant in light, rich soil. **Packet, 5c.**

61. CANTERBURY BELLS, DOUBLE MIXED. **Packet, 5c.**

CARNATION.—(See Pinks).

65. CASTOR OIL BEAN (Ricinus). Ornamental plants of stately growth and picturesque foliage; fine for lawns massing or centre plants for ribbon beds; half hardy annuals. **Packet, 5c.**

68a. CENTAUREA GYMNOCARPA. Fine cut silver-gray foliage; 1½ feet. **Packet, 5c. 1-4 oz. 25c.**

68. CENTAUREA CANDIDISSIMA. Silver white; leaves broadly cut. **Packet, 5c. 1-4 oz. 25c.**

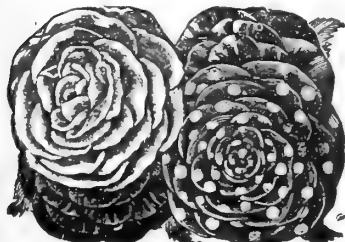

40.—DOUBLE BALSAMS.



33.—SEMPLE'S BRANCHING.



85. COCKSCOMB.

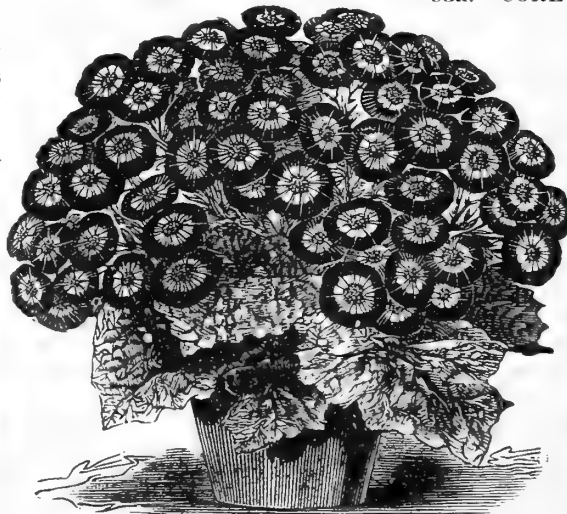

76.—CINERARIA HYBRIDA.

69. CENTROSEMA GRANDIFLORA. A perfectly hardy perennial vine of rare beauty, which blooms in July from seed sown in April, and bears in great profusion inverted pea-shaped flowers of various colors. **Packet, 5c.**

70. CHRYSANTHEMUMS, SINGLE, MIXED.—Showy and effective garden favorites extensively grown for cut flowers. The hardy annuals are summer flowering border plants; good for pot culture and quite distinct from the autumn flowering varieties. **Packet, 5c.**

71. CHRYSANTHEMUM FRUTESCENS (The Marguerite, or Paris Daisy).—Immense quantities are grown by French florists, and find a ready sale. It produces freely its white star-like flowers under the most favorable conditions. **Packet, 10c.**

75. CINERARIA (Dusty Miller).—Fine for bedding, ribbon beds and margins; prized for their beautiful downy silvery foliage; half hardy perennials; two feet. **Packet, 5c.**

76. CINERARIA HYBRIDA.—Large flowered prize varieties; very attractive, free blooming plants, producing large and brilliant flowers. **Packet, 25c. 5 for \$1.00.**

77. CINERARIA HYBRIDADWARF—Large flowered, dwarf prize varieties; splendid strain. **Packet, 25c. 5 for \$1.00.**

80. CLARKIA, MIXED.—An old favorite hardy annual plant, growing in any garden soil, and producing freely its cheerful flowers early in the season; 1½ feet. **Packet, 5c.**

85. COCKSCOMBS (Celosia Cristata).—Very popular annuals of the easiest culture, highly ornamental for decoration of the green-house, drawing-room and garden. Half hardy annuals. **Packet, 5c.**

86. COCKSCOMBS, GLASGOW PRIZE.—Immense showy dark crimson combs. **10c.**

88. COWSLIP.—**Packet, 10c.**

89. COLEUS.—Very choice plants with richly colored foliage of maroon, green, crimson, yellow, etc. **Packet, 25c.**

90. CONVULVULUS, TRI-COLOR MINOR (Dwarf Morning Glory).—A beautiful class of hardy annuals, affording a large, showy mass of flowers from July to October. **Packet, 5c.**

93. COREOPSIS (Calliopsis).—Very handsome and showy plants, with numerous flowers of brilliant colors, and of long duration in bloom.

93a. COREOPSIS LANCEOLATA—IMPROVED (California Sunbeams).—This is one of the finest of hardy plants, with large, showy, bright golden-yellow flowers, freely produced on long stalks, from June till frost; excellent for cutting; will thrive in almost any situation. **Packet, 5c. 1-4 oz. 40c.**



50.—CALCEOLARIA, DWARF.

ALL PRICES SUBJECT TO CHANGE WITHOUT NOTICE.

SELECTED FLOWER SEEDS || TEN 5c. papers mailed for 25c. OR FOUR 10c. papers for 25c.

Cosmos Large flowering. Sow early in spring, and transplant when danger from frost is past. The flowers are borne profusely, and present a charming appearance when in full bloom, being covered through the autumn months with hundreds of showy blossoms. They are very easily raised and make a grand display.

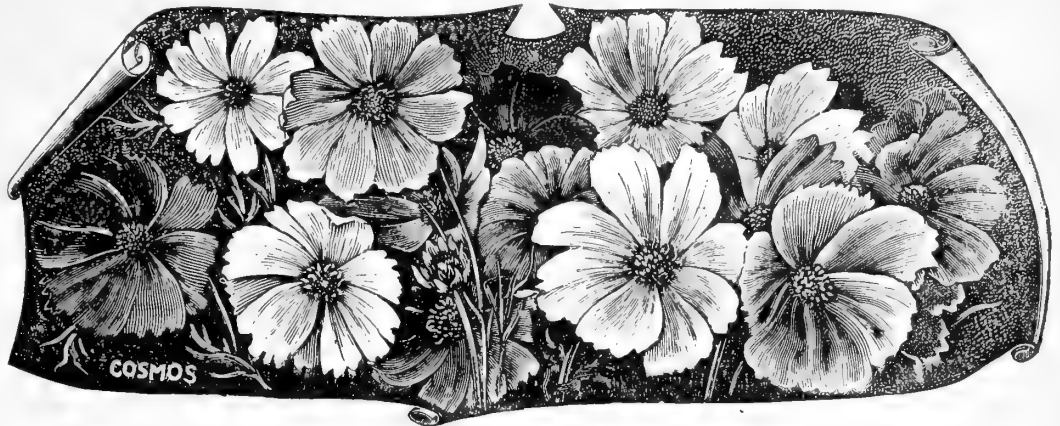

- 94. TINTS OF DAWN COSMOS.—This new variety comes into full bloom in July and continues a mass of bloom until cut down by severe frost. In addition to this it is of dwarf growth, and large flowers. Pkt, 10c. 1-4 oz. 50c.
- 95. COSMOS, Mixed.—5c. 1-4 oz. 20 cts. Oz. 50c.
- 95a. COSMOS, Pink.—5c.
- 95b. COSMOS, White.—5c.
- 95c. COSMOS, CRIMSON.—5c.
- 95d. NEW MARGUERITE COSMOS.—One of the prettiest and faintest varieties imaginable. Packet, 10c.
- DIANTHUS.—(See Pinks).
- 96. CYCLAMEN—PERSICUM—GIGANTEUM, MIXED.—Charming plants with beautiful foliage and rich colored fragrant flowers. Packet, 25c. 5 for \$1.00

- 97. DAISY, MIXED.—Well-known favorites, admirably adapted for edgings, borders and low beds, and it is also suited for growing in pots. Although they are perennials, they will flower the same season if seed is sown early in the house. Packet, 10c.
- 98. DAISY LONGFELLOW.—This is a very pretty large double pink variety. Packet, 10c.
- 99. DAISY SNOWBALL.—An unusually large flowered variety, and produces very double, pure white flowers. Packet, 10c.

Dahlia—One of our best autumnal flowering plants. Blooms until killed by frost; tuberous-rooted, half-hardy perennials; blooming the first year from seed, if sown early.

- 100. SINGLE MIXED.—Large showy single flowers. Packet, 5c.
- 100a. CACTUS DAHLIA.—A most curious and desirable variety of many colors. Packet, 5c.
- 100½. DIANTHUS—ORIENTAL BEAUTIES.—A magnificent strain of new large flowering Dianthus, from Japan. The colorings and markings are rich beyond description; very dainty and pretty with their charming ruffles and frills. Hardy and perpetual bloomers. Packet, 10c.
- 101. ETERNAL FLOWER (Helichrysum).—These are very popular and desirable for winter decoration, bouquets, wreaths, etc. They should be cut when they come into full bloom, tied into bunches, and dried in the shade with their heads downward. Packet, 5c.

- 103. FEVERFEW (GOLDEN FEATHER) (Pyrethum Aureum).—A highly ornamental golden yellow foliage plant, unexcelled for bedding. Hardy perennial 1½ ft. Packet, 5c.
- 105. FORGET-ME-NOT (Myosotis).—Neat and beautiful little plants with star-like flowers, succeeding best in a shady, moist situation; half-hardy perennials; blooming the first year from seed, if sown early. Packet, 5c.
- 106. FOXGLOVE (Digitalis).—A handsome and highly ornamental, hardy perennial plant of stately growth; fine for shrubberies and other half-hardy places; 3 feet.
- 107. GERANIUM (New Zonale).—A grand strain of Geraniums, containing all shades of colors. Packet, 10c.



DAISY.



HELIOTROPE.

FOUR O'CLOCK

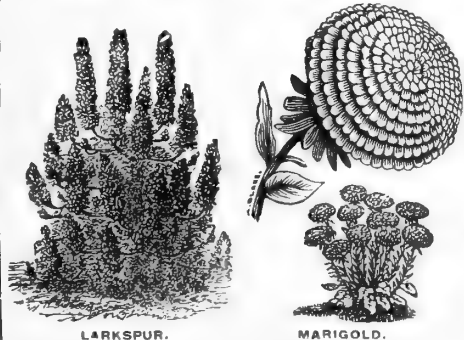

LARKSPUR.

MARIGOLD.

- 109. GAILLARDIA.—Very attractive plants, producing a profusion of bloom the entire summer and autumn. Half-hardy annuals. Packet, 5c.
- 110. GILIA, MIXED.—Very pretty dwarf plants, early, free blooming, fine for massing and rock work. Hardy annuals. Packet, 5c.
- 111. GLOXINIA.—Produces in great profusion large bell-shaped flowers of the richest variety of colors. Packet, 25c.

- 112. HELIOTROPE.—These are deliciously fragrant flowers, remaining in bloom a long time; fine for pot culture or bedding; half-hardy annuals. Packet, 5c.
- 115. HOLLYHOCK, MIXED (Althen Rosea).—This is one of the oldest inhabitants of our gardens; now ranks as one of the finest autumn flowers. Packet, 5c.
- 116. HOLLYHOCK, DOUBLE WHITE.—Largely used by florists. Packet, 10c.
- 120. LARKSPUR (Delphinium).—One of our most showy and useful plants, possessing almost every requisite for adornment of the garden. Packet, 5c.
- 121. LARKSPUR EMPEROR.—Of symmetrical bushy habit, with a profusion of brilliant dark-blue, red-striped and tri-colored flowers. Packet, 5c.

LOBELIA—A beautiful and popular flower, very desirable for pot culture, beds or hanging baskets, because of its trailing habits. Grows easily and does well in beds and rockeries. Bears a profusion of blue and white flowers. Annuals.

- 122. MIXED VARIETIES.—5c.
- 123. CRYSTAL PALACE COMPACTA.—Rich deep blue. The finest for bedding. Packet, 10c.
- 125. MARIGOLD, DOUBLE AFRICAN.—A well-known free flowering plant, of easy culture, with rich and beautiful double various colored flowers. Packet, 5c.
- 126. MARIGOLD, DOUBLE FRENCH.—Of compact habit, with numerous bright, showy flowers. Very fine. Packet, 5c.
- 130. MARVEL OF PERU, or FOUR O'CLOCK (Mirabilis Jalapa).—Very pretty annual of vigorous growth. The flowers are brilliant, singularly mixed and varied on the same plant. 2 feet. Packet, 5c.
- 133. MESEMBRYANTHEMUM CHIRYS-TALINUM (Ice Plant).—Dwarf spreading plants of great beauty, blooming the entire summer, succeeding best in dry, sandy or loamy soil, and in a warm locality. It belongs to the half-hardy annuals. Packet, 5c.

FLOWER SEEDS THAT GROW

Ten 5c. Papers mailed for 25c.,

or Four 10c. Papers for 25c.

Mignonette

135. **MIGNONETTE—SWEET** (*Reseda Odorata*)—A well-known and universal garden favorite, and one that requires no extra instructions for growing. Hardy annuals. **Packet, 5c. Oz. 15c.**
136. **MIGNONETTE—PYRAMIDAL.**—(Large flowered.)—The largest flowered of all Mignonettes. Annual. **Packet 5c. Oz. 15c.**
137. **MACHET MIGNONETTE.**—Well adapted for pot culture; dwarf pyramidal growth; bearing numerous flower stalks; one of the best. **Packet, 10c. 1-4 oz. 20c. Oz. 50c.**
138. **MIGNONETTE VICTORIA.**—A splendid, new, compact, growing variety of dense pyramidal habit, growing about six inches high. The flowers are of a brilliant red, and are suitable for pot or garden. **Packet, 10c.**
139. **ALLEN'S DEFIANCE.**—When grown under favorable conditions and with proper care, spikes will not only be of remarkable size— from 12 to 15 inches long— but deliciously fragrant; much more so than any other variety. **Packet, 10c. 1-4 oz. 25c. Oz. 75c.**
140. **GOLDEN MACHET MIGNONETTE.**—Distinct new variety of the well-known Machet, of the same compact and robust habit, but differing from the type by its massive spikes of golden yellow blossoms. **Packet, 5c. 1-4 oz. 20c. Oz. 50c.**



DEFIANCE MIGNONETTE.

147. **DWARF NASTURTIUM** (*King of Tom Thumbs*).—Brilliant yellow flowers, blotched with maroon, measuring three inches across. **Packet, 5c. Oz. 15c.**
148. **DWARF NASTURTIUM.**—Ruby King.—Light ruby red. **Packet, 5c. Oz. 15c.**
149. **DWARF NASTURTIUM.**—(*Cloth of Gold*).—Golden yellow foliage, light scarlet flowers. **Packet, 5c. Oz. 20c.**
150. **KING THEODORE.**—**DWARF.**—Black brown foliage. **Packet, 5c. Oz. 15c.**
151. **CRYSTAL PALACE GEM.**—Sulphur, maroon, spot. **Packet, 5c. Oz. 15c.**
- TALL NASTURTIUM.**—(See 310).

Oxalis

153. **OXALIS.**—Pretty little half-trailing annuals for hanging baskets. Mixed annual sorts. **Packet, 10c.**

Nasturtium

142. **NASTURTIUM—DWARF.**—The dwarf variety of Nasturtium is among the most useful and beautiful of annuals for bedding, massing, etc., owing to their compact growth, richness of color and profusion of bloom; mixed colors. **Packet, 5c. Oz. 10c.**
143. **DWARF NASTURTIUM—AURORA.**—Blush white and salmon, blotched with garnet. **Packet, 5c. Oz. 15c.**
144. **DWARF NASTURTIUM—BEAUTY.**—Bright scarlet, striped with yellow. **Packet, 5c. Oz. 15c.**
145. **DWARF NASTURTIUM** (*Empress of India*).—Very dark foliage, with deep crimson flowers. **Packet, 5c. Oz. 25c.**
146. **DWARF NASTURTIUM** (*Golden King*).—Brilliant yellow. **Packet, 5c. Oz. 15c.**



NASTURTIUM.

Pansies

155. **PANSY, HEARTSEASE.**—(*Viola Tricolor*).—Choice mixed. An old but universally admired plant, producing an endless variety of color, marking and texture. They may be treated as annuals, as they flower the first season from seed; six inches. **Packet, 5c. 1-8 oz. 75c.**
156. **PANSY, GIANT TRIMARDEAU.**—Remarkable for the extra large size of the flower and an endless variety of beautiful shades. **Packet, 10c. 1-8 oz. 75c.**
157. **PANSY, G. & T. CO.'S EXTRA MIXED.**—This mixture containing the finest blotched varieties, is grown and selected with special care, and has given the most satisfactory results to both florists and amateurs for the past two years. **Packet, 15c. Two pkts. 25c. 1-8 oz. 75c.**
158. **PANSY** (*Bugnot's Superb Blotched*).—A celebrated strain of extra large size, beautiful colors, with handsome broad blotches, and finely penciled with stripes of delicate hue. The ground colors are generally dark, which, with light penciling and blotches, make a magnificent flower. They are a small seeder. **Packet, 25c.**

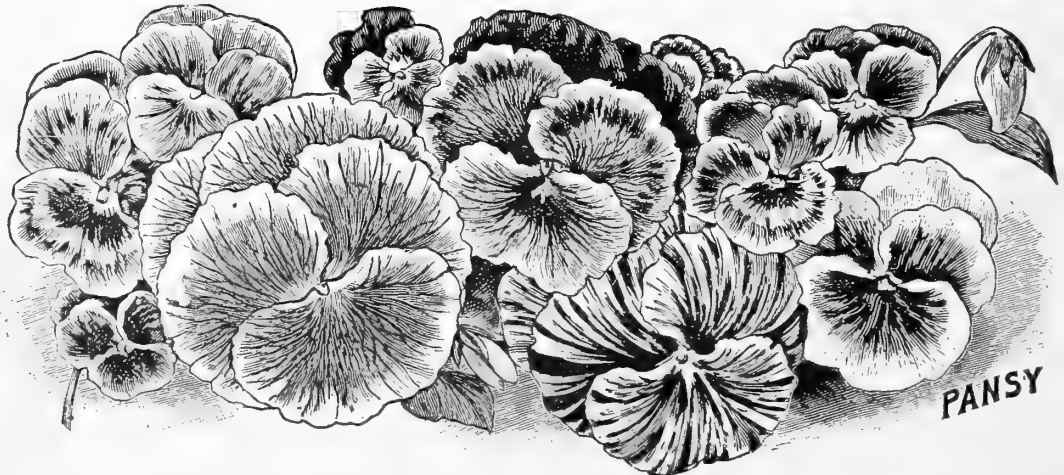

PANSY

GRIFFITH, & TURNER CO.'S EXTRA MIXED PANSIES.

ALL PRICES SUBJECT TO CHANGE WITHOUT NOTICE.

THE BEST FLOWER SEEDS

Ten 5 cent Papers, mailed, for 25 cents, or Four 10 cent Papers for 25 cents.



PETUNIAS

165. **PETUNIA.**—Favorite, half hardy perennials, succeeding well in any rich soil. For the brilliancy and variety of the colors and the long duration of their blooming period, they are indispensable in any garden. Packet, 5 cents.

166. **SINGLE-FRINGED MIXED PETUNIA.**—Large flowers, four to five inches across, of every hue, each flower being beautifully fringed. Packet, 25 cents.

167. **DOUBLE PETUNIA.**—About thirty per cent. will produce double flowers. Packet, 25 cents.

168. **PETUNIA. — Double-Fringed Mixed.**—The flowers of this sort being double, together with being fringed, are very beautiful. Packet, 25 cents.

PHLOX DRUMMONDII

175. **PHLOX DRUMMONDII.**—A most brilliant and beautiful hardy annual, about one foot high, well adapted for bedding, making a dazzling show through the whole season. It succeeds well on almost any soil. Packet, 5 cents.

176. **PHLOX DRUMMONDII. — (Nana Compacta).**—Very fine mixed. This new strain is of dwarf, compact habit, and makes desirable pot plants; also excellent for ribbon lines and massing. Packet, 10 cents.

PINKS

180. **PINK-CARNATION or PICOTEE.**—Choicest Double Mixed (*Dianthus Caryophyllus.*)—Carnation and Picotee Pinks are generally favorites for their delicious fragrance, richness of colors, and profuse bloom. Perennial. Packet, 10 cents.

181. **PINK, CARNATION** (*Riviera Market, or Gillaud.*)—This is the only variety that will produce yellow flowers the first season. The mixture we offer contains a magnificent variety of colors and shades, having among them flowers of canary yellow, and also striped yellow. They will thrive either in open ground or pots. Packet, 25 cents.



PINK-CHINA.



PINK-CARNATION.

182. **PINK-CARNATION** (*Marguerite.*)—Will produce flowers in a few weeks from seed. Profuse bloomers, producing very double flowers of all shades of red, pink, white and variegated. Will bloom all summer until frost, or will bloom indoors in winter in pots. Packet, 10 cents.

185. **PINK-CHINA** (*Dianthus Chinensis.*)—Free bloomers, and a general favorite for bouquets; also a useful bedding plant. Packet, 5 cents.

188. **PINK-HEDDEWIGII**—Beautiful double flowers in a great variety of colors, with fringed white edges. Packet, 5 cents.

189. **PINK-JAPAN**—Beautiful double flowers, mixed, of various colors, with the outer edges fringed and nearly white. Packet, 10 cents.

195. **PORTULACA** (*Mexican Rose.*) One of our finest hardy annual plants, of easy culture, thriving best in rather rich, light loam or sandy soil; the single flowering varieties are large and brilliant, of the richest shades of color, and produced throughout the summer in great profusion; fine for massing in beds, or edgings of rock work. Packet, 5 cents.

196. **DOUBLE PORTULACA.**—Packet, 10 cents.

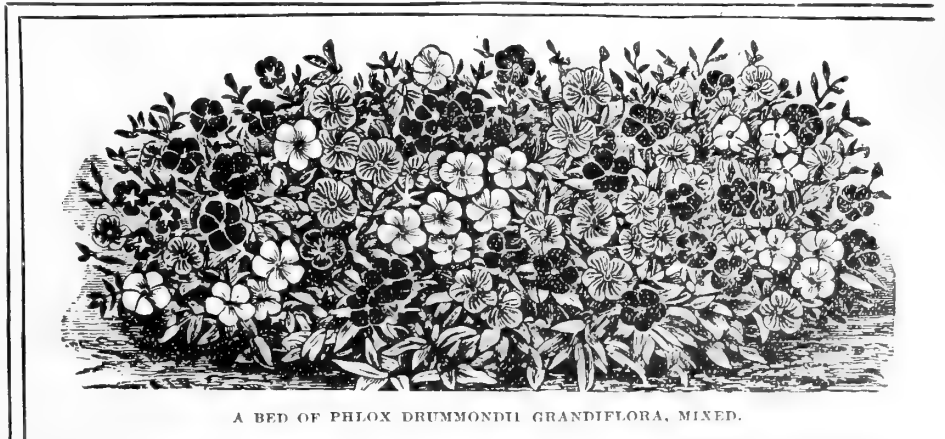

A BED OF PHLOX DRUMMONDII GRANDIFLORA, MIXED.

The Best Flower Seeds.

Ten 5c. Papers Mailed
for 25c., or Four 10c.
Papers for 25c.

200. POPPY-CARNATION (Papaver).—A showy and easily cultivated hardy annual, with large brilliant colored flowers, growing freely in any garden soil.

Packet, 5c.

201. POPPY-PEONY FLOWERED.—A magnificent species, large, showy, double globular flowers, resembling Peonies in shape.

Packet, 5c.

202. SHIRLEY POPPY.—These beautiful Poppies are generally single or semi-double. The colors, extending from one extreme to the other, are so varied that scarcely two are alike, while many are striped and blotched. The blooms, if cut when young, will stand for two or three days.

Packet, 5c.

203. TULIP POPPY.—A magnificent species from Armenia. The plants attain a height of 14 to 16 inches, and produce from about 50 to 60 flowers of the brightest scarlet.

Packet, 5c.

204. ICELAND POPPIES, MIXED.—Although hardy perennials, these Poppies bloom the first season from spring-sown seed. The fragrant, elegant, crushed satin-like flowers are produced in never-ceasing succession from the beginning of June to October.

Packet, 5c.

205. POPPY-IRRÉSISTIBLE.—A rare and beautiful Poppy, with immense flowers. Color, an exquisite rose.

Packet, 5c.

210. ENGLISH PRIMROSE (Primula Vulgaris).—No collection of spring flowers is complete without a few of these charming little plants. A little covering in the late fall will protect them from the severe weather of winter, and the great number of flowers produced will more than repay you the extra trouble. They are not as generally grown as they should be.

Packet, 10c.



SWEET WILLIAM.

211. CHINESE PRIMROSE (Primula Fringed).—This variety is much prettier than the English, being fringed and of the most beautiful colors. They differ from each other like the double and single Petunias.

Packet, 25c.

213. SCABIOSA-GRANDIFLORA.—A wonderful improvement over the old variety; bears beautifully formed flowers three inches in diameter.

Packet, 10c.

215. SCARLET SAGE (Salvia Splendens).—A favorite greenhouse and bedding plant, bearing long spikes of flowers in great profusion, from July to October; half hardy perennial, blooming the first year from seed. Three feet.

Packet, 5c. 1-4 oz. 75c.

216. SCARLET SAGE-CLARA BEDMAN (Bonfire).—The finest Salvia ever introduced.

Packet, 5c. 1-4 oz. 75c.



CHINESE PRIMROSE.

220. SENSITIVE PLANT (Mimosa).

Curious and interesting plants, with pinkish white flowers; the leaves close in and droop when touched or shaken; tender annual.

Packet, 5c.

225. SNAPDRAGON (Antirrhinum).

One of our most useful and showy border plants. The recently improved varieties have large, finely shaped flowers of brilliant colors. Perennial.

Packet, 5c.

230. TEN WEEKS' STOCKS (Gill-flower).—A world-wide favorite, brilliant and varied in color, equally well adapted for massing, bedding, edging or pot culture. Very profuse bloomers. Should be grown in rich soil.

Packet, 5c.



TULIP POPPY.

231. STOCKS - SNOWFLAKE IMPROVED.—A beautiful dwarf-growing variety; very large, double, snow-white flowers. Our seed of this variety is grown by a specialist, and will produce a large percentage of double flowers.

Packet, 15c.

235. SUNFLOWER (Helianthus).—Remarkable for the stately growth, size and brilliancy of their flowers, making a very good effect among shrubbery and for screens. The seed is also good for feeding poultry.

Packet, 5c.

237. SWEET ROCKET (Hesperis).—Very pleasing, early spring flowering, profuse blooming plants, with fragrant flowers, growing freely in any light, rich soil.

Packet, 5c.

240. SWEET WILLIAM (Dianthus Barbatus).—A well-known, free flowering, popular favorite; the great improvements upon the old varieties made within the last few years have rendered it still more desirable. Hardy perennial.

Packet, 5c.

243. SWEET VIOLET.—Deservedly much in demand, because of their profusion of bloom and delicate sweet odor.

Packet, 10c.



SCARLET SAGE.

Choice Flower Seeds

Ten 5c. Papers mailed for 25c. or Four 10c. Papers for 25c.



MAMMOTH VERBENA.

- 245. **MAMMOTH VERBENA.**—One of the most popular and useful bedding plants. Verbenas delight in sunny situation, rich soil and thorough cultivation. **Packet, 5c.**
- 247. **VINCA.**—Small bushy plants, producing in quantities round single flowers the first season, if sown early. They may be potted and kept all winter.
- 250. **VINCA ROSA.**—Rose with dark eye. **Packet, 5c.**

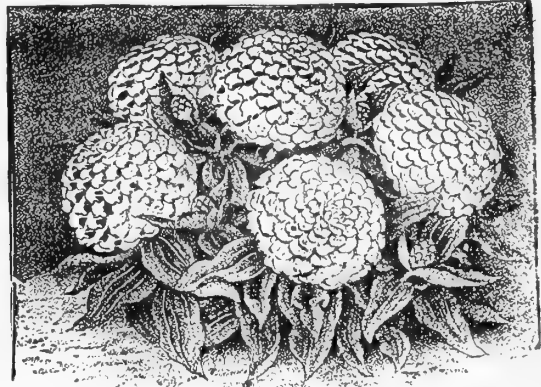

ZINNIAS.

- 251. **VINCA ALBA.**—White, with crimson eye. **Packet, 5c.**
- 255. **WALLFLOWER, DOUBLE.**—Well-known, deliciously fragrant plants, with large spikes of double flowers, similar to the Gilliflower. Succeed in light, rich soil, in a moist atmosphere. Perennials. **Packet, 10c.**
- 258. **ZINNIA ELEGANS (Youth and Old Age).**—This is one of the most brilliant of annuals, and has long been a general favorite. The flowers are large, finely formed, in great variety of colors, and continue to bloom the entire season. Half-hardy annuals. **Packet, 5c.**
- 259. **ZINNIAS CURLED AND CRESTED.**—New, odd and superb. Petals twisted, curled and crested into fantastic contortions and graceful forms. A magnificent variety of colors. **Packet, 5c.**
- 260. **ZINNIA—DOUBLE POMPON.**—Long cone-shaped flowers, very fine. **Packet, 5c.**

General List of Climbers.

- 270. **BALSAM APPLE (Momordica).**—Very curious trailing vines, with ornamental foliage, fruit golden yellow; when ripe, opens, showing the seeds and its brilliant carmine interior. **Packet, 5c.**
- 272. **BALLOON VINE (Love in a Puff).**—A rapid growing plant; succeeds best in a light soil and warm situation; flowers white; half-hardy annual. **Packet, 5c.**
- 275. **CANARY BIRD FLOWER (Peregrinum).**—With yellow, canary-like flowers; very ornamental and beautiful foliage; half-hardy annual. **Packet, 5c.**
- 276. **COBEA SCANDENS.**—A beautiful, rapid growing climber, with handsome foliage and large bell-shaped flowers; blue; half-hardy perennial; grows twenty to thirty feet high. **Packet, 10c. Oz. 40c.**
- 278. **CYPRESS VINE, RED (Ipomea Quamoelit).**—One of our most popular vines, with very delicate, fern-like foliage, and masses of beautiful, small, star-shaped flowers. Sow last of May; fifteen feet. **Packet, 5c.**
- 279. **CYPRESS VINE, WHITE.**—Usually grown with the red, making a handsome effect. **Packet, 5c.**
- 282. **MAURANDIA (Barclayana).**—These charming climbers cannot be too highly praised for their beautiful flowers and foliage; they are admirably adapted for hanging baskets, vases or trellis work. **Packet, 5c.**
- 285. **MIXED GOURD (Cucurbita).**—Rapid growing, interesting plants, with ornamental foliage and varieties of singular shaped fruit; annual. **Packet, 5c.**
- 286. **NEST EGG GOURD.**—White fruit, shaped like an egg. Used as a substitute for nest eggs. **Packet, 5c.**
- 287. **DISH CLOTH GOURD.**—**Packet, 5c.**
- 288. **DIPPER GOURD.**—**Packet, 5c.**
- 290. **MOCK ORANGE.**—Fruit shaped like an orange. **Packet, 5c.**
- 295. **HEAVENLY BLUE IPOMEA.**—The flowers are in large airy clusters and of that lovely blue so rarely seen. Flowers four to five inches across. **Packet, 5c.**



BALSAM APPLE.



MIXED GOURDS.

CHOICE FLOWER SEEDS.

Climbers, continued.

300. MORNING GLORY (Convolvulus Major).—One of the most free flowering and rapid growing plants in cultivation, thriving in almost any situation. The beauty and delicacy of their brilliant flowers are unsurpassed; hardy annuals.
Packet, 5c.

301. NEW BRAZILIAN MORNING GLORY.—Packet, 5c.

302. GIANT JAPANESE MORNING GLORY.—This plant has been developed to such a state of perfection that it now produces flowers of immense size and almost endless variety of color and markings. Some of the flowers are brilliant red, or rich blue self colored; others are equally brilliant with broad margins of clear white. Some blossoms are striped and dotted with blue or red on white or lemon yellow ground, others clouded with blue and red; in fact, one may expect to find some new and exquisitely beautiful markings every morning. Not only are the flowers varied, but the foliage is equally so; some of it comes plain green, and part is mottled with white and shades of yellow or yellowish green. Vines grow 30 to 40 feet high.
Packet, 10c.

305. MOON FLOWER (Ipomaea noctiflora).—Charming and popular blooming climbers, of rapid growth and showy effects; warm, rich soil, with a sunny exposure, suits them.
Packet, 5c.

310. TALL NASTURTIUM (Tropaelum Major).—Elegant, profuse flowering plants, constantly growing in favor for verandas, trellis, etc. The seed pods can be gathered while green and tender for pickling.
Packet, 5c. Oz. 10c.

320. SCARLET RUNNERS.—Very handsome, climbing Beans, with bright scarlet flowers.
Packet, 5c.

326. SMILAX.—Charming climber for greenhouse or window gardens.
Packet, 5c.



JAPANESE MORNING GLORY.

No lover of flowers should be without a bed of . . . Sweet Peas.

Our List comprises the . . . Best Varieties.

Sweet Peas

Ten 5c. papers mailed for 25c., or Four 10c. papers for 25c.

SWEET PEAS still hold a place in the first rank among flowering plants. But few plants are grown more easily, and grown in masses of separate colors or in mixture their beauty and fragrance cannot be surpassed. We offer in our list an assortment of the choicest varieties.

CULTURE.—Sweet Peas should be sown in drills as early as possible in spring, in rich, friable soil. Prepare the bed thoroughly, working in a quantity of well-rotted manure, if it can be done, making a furrow 4 to 6 inches deep. In this sow the seed and cover 2 inches deep. As soon as the plants begin to show through, fill in the furrow. This will secure a deep planting without the bad effect of deep covering of the seed at first, and so enable the plant to bloom continuously through the heat of summer. As fast as the flowers come into full bloom or fade they should be cut off, for if the pods are allowed to form the plants will stop blooming.

CLASSIFIED VARIETIES AS TO COLOR.

If you want **WHITE**, select from numbers 356, 373, 387, 402. **PINKS** 350, 371, 391, 420, 427. **ORANGE** and **SALMON**, 395, 406. **SCARLET**, 377, 386. **MAROON**, 360, 423. **YELLOW**, 400. **STRIPED VARIETIES**, 352, 411, 424. **PINK** or **RED**, with **White Wings**, 351, 358.

350. ALICE ECKFORD.—Standard, rich creamy, tinted pale pink, Wings pure white.
Pkt. 5c. Oz. 10c. 1-4 lb. 20c.

351. APPLE BLOSSOM.—Bright rose and pink; beautiful.
Pkt. 5c. Oz. 10c. 1-4 lb. 20c.

352. AURORA.—The color effect is gorgeous, both standard and wings are flaked and striped on a white ground with bright orange salmon.
Pkt. 5c. Oz. 10c. 1-4 lb. 25c.

356. BLANCHE BURPEE.—Pure white; very large flower.
Pkt. 5c. Oz. 10c. 1-4 lb. 25c.

357. BLANCHE FERRY.—Popular color standard brightest pink; keel and wings white. Pkt. 5c. Oz. 10c. 1-4 lb. 20c.

358. BLANCHE FERRY.—Extra Early.—10 days earlier.
Pkt. 5c. Oz. 10c. 1-4 lb. 20c.

359. BLUSHING BEAUTY.—Flowers of largest expanded form, perfect in shape, and of very good substance. Color a delicate, soft pink.
Pkt. 5c. Oz. 10c. 1-4 lb. 20c.

360. BOREATTON.—A very fine dark pea, with bold, stout flowers color deep maroon. Pkt. 5c. Oz. 10c. 1-4 lb. 20c.

361. BUTTERFLY.—New, and ranks among the very best of this unrivaled class of plants. Color lavender blue, shading into white on the lower petals. Pkt. 5c. Oz. 10c. 1-4 lb. 20c.

366. COUNTESS OF RADNOR.—Delicate lavender, wings delicately striped with rose. Pkt. 5c. Oz. 10c. 1-4 lb. 20c.

371. ELIZA ECKFORD.—Standard, rose, wings delicately striped with rose. Pkt. 5c. Oz. 10c. 1-4 lb. 20c.

372. EMILY ECKFORD.—Standard heliotrope, suffused with blue; wings deep blue. Pkt. 5c. Oz. 10c. 1-4 lb. 20c.

373. EMILY HENDERSON.—Very early; color pure white; fragrance most delicious. The plants are robust, branchy, of compact habit; flowers, large, broad and round, and its abundance of bloom is phenomenal. Pkt. 5c. Oz. 10c. 1-4 lb. 20c.

374. FIREFLY.—Intense, glowing crimson.
Pkt. 5c. Oz. 10c. 1-4 lb. 20c.

381. GAIETY.—Standards white, striped and flaked with rosy lilac; wings delicate blush. Pkt. 5c. Oz. 10c. 1-4 lb. 20c.

382. HER MAJESTY.—Beautiful, soft rosy pink.
Pkt. 5c. Oz. 10c. 1-4 lb. 20c.

385. INDIGO KING.—A dark maroon standard and clear indigo blue wings. Pkt. 5c. Oz. 10c. 1-4 lb. 20c.

386. INVINCIBLE SCARLET.—Flowers of intense and brilliant scarlet pink, of the largest size.
Pkt. 5c. Oz. 10c. 1-4 lb. 20c.

391. KATHERINE TRACEY.—Soft, brilliant pink.
Pkt. 5c. Oz. 10c. 1-4 lb. 20c.

394. LADY BEACONSFIELD.—The standards are of light salmon pink, wings pale primrose yellow.
Pkt. 5c. Oz. 10c. 1-4 lb. 20c.

395. LADY PENZANCE.—One of the most beautiful of Eckford's introductions. The standard is a beautiful laced pink, touching orange, while the wings are a darker and purer pink.
Pkt. 5c. Oz. 10c. 1-4 lb. 20c.

396. LOTTIE ECKFORD.—New and a free bloomer, color lavender, shaded with pink and white. Very handsome.
Pkt. 5c. Oz. 10c. 1-4 lb. 20c.

ALL PRICES SUBJECT TO CHANGE WITHOUT NOTICE.



409. **PRIMROSE.**—Distinct, as the nearest approach to yellow in Sweet Peas. Standard and wings of pale primrose yellow color. Pkt. 5c. Oz. 10c. 1-4 lb. 20c.
410. **PRINCESS BEATRICE.**—Flowers of a clear and beautiful carmine rose, slightly shaded. Pkt. 5c. Oz. 10c. 1-4 lb. 20c.
411. **PRINCESS OF WALES.**—Color, white ground, shaded and tinged with mauve. Pkt. 5c. Oz. 10c. 1-4 lb. 20c.
412. **PRINCESS VICTORIA.**—Standard, dark cherry; wings, mauve pink, and slight lines of rose. Pkt. 5c. Oz. 10c. 1-4 lb. 20c.
416. **QUEEN OF THE ISLES.**—Scarlet mottled and flaked with purple and white. Pkt. 5c. Oz. 10c. 1-4 lb. 20c.
419. **RED RIDING HOOD.**—Standard and wings are a rosy pink, shading to bluish white at the calyx. Pkt. 5c. Oz. 10c. 1-4 lb. 25c.
420. **ROYAL ROBE.**—Standards a rich but delicate pink, wings a soft bluish pink. Pkt. 5c. Oz. 10c. 1-4 lb. 20c.
423. **STANLEY, or BLACK KNIGHT.**—A deep maroon; a large and very handsome flower of the finest form and abundance. Pkt. 5c. Oz. 10c. 1-4 lb. 20c.
424. **THE SENATOR.**—Large flowers, shaded chocolate and bright brown, and striped on a creamy-white ground-color; mottled and blotched in every conceivable manner. Pkt. 5c. Oz. 10c. 1-4 lb. 20c.
427. **VENUS.**—Salmon buff; the standards delicately shaded with rosy pink. Pkt. 5c. Oz. 10c. 1-4 lb. 20c.
430. **G. & T. CO.'S EXTRA-FINE MIXED.**—This is a splendid mixture of our own, which includes nearly all the above varieties. Pkt. 5c. Oz. 10c. ¼ lb. 15c. Lb. 40c.
- ECKFORD'S LARGE FLOWERING MIXED SWEET PEAS.**—Contains some of each of our entire list of Eckford's varieties. Pkt. 5c. Oz. 10c. ¼-lb. 15c. Lb. 40c.

Sweet Peas

—Continued.

Ten 5c. Papers mailed for 25c.
or Four 10c. Papers for 25c.

397. **LOTTIE HUTCHINS.**—Daintily flaked with pink on cream ground making a rich and lovely effect. The flowers are of well-expanded grandiflora type, large in size and finely formed, borne on heavy, substantial stems. Pkt. 10c. Oz. 25c.
400. **MRS. ECKFORD.**—Color a peculiarly delicate shaded primrose yellow. Decidedly pretty. Pkt. 5c. Oz. 10c. 1-4 lb. 20c.
401. **MRS. GLADSTONE.**—On opening, the flowers are buff and soft pink, changing to a beautiful pale bluish. Standard pink, deepening in color at the base, and wings flesh tinted. Pkt. 5c. Oz. 10c. 1-4 lb. 20c.
402. **MRS. SANKEY.**—Black seeded. Large white flower, changing to bluish. Pkt. 5c. Oz. 10c. 1-4 lb. 20c.
406. **ORANGE PRINCE.**—Bright orange pink, flush scarlet; wings of rich rose, veined with pink. Pkt. 5c. Oz. 10c. 1-4 lb. 20c.

Cupid Dwarf Sweet Peas.

CUPID DWARF SWEET PEAS for edgings, low beds and for pot culture are unique and wonderfully pretty.

WHITE CUPID.—Standard bright rose pink; wings either pure white or bluish. The seed is black and germinates readily; a thrifty grower and continuous bloomer. Pkt. 5c. 1-2 oz. 25c. Oz. 40c.

PINK CUPID.—Pure white flowers. Packet, 5c. Oz. 20c.

Pæonies.

These noble plants are exceedingly effective; the profusion and duration of bloom, combined with handsome massive foliage, accommodating habit, and easy culture, render them one of the most popular hardy plants grown for lawn and garden decoration, or for mingling with shrubs or herbaceous plants in borders and wild gardens.

- Double White, each 25c. Doz. \$2.00.
 - Double Rose, each 25c. Doz. \$2.00.
 - Double Crimson, each 25c. Doz. \$2.00.
- Postage extra, 5c. each, if wanted by mail.

Double Violets.

LADY HUME CAMPBELL.—Its excellent merit is its strong, healthy constitution. Light purple flowers.

SWANLY WHITE.—The best double white Violet.

Good plants of either of the above varieties at \$1.00 per dozen, or \$6.00 per 100.

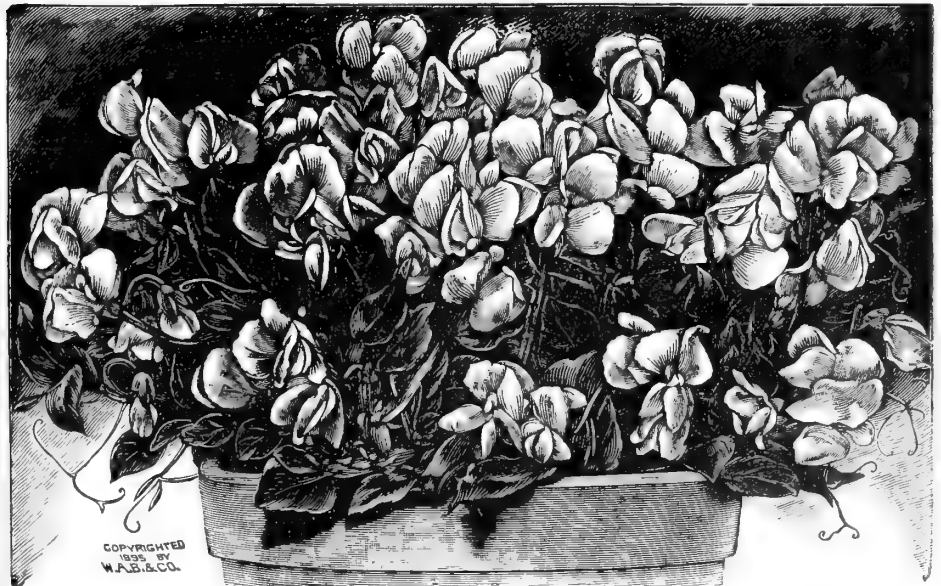

A Single Plant of Cupid.—Grown in a pot, engraved from a photograph.



Fifteen cents each. Four for 50 cents. \$1.25 per dozen.

AUGUSTA VICTORIA.—One of the most desirable Roses of recent introduction. The flowers are produced in the greatest profusion, are of large size, of a creamy white color, shading deeper towards the center. It is a strong, healthy grower, with fine foliage, and will undoubtedly become popular both as a bedding variety and for forcing under glass.

AMERICAN BEAUTY.—Beautiful crimson; very double and fragrant.

LA FRANCE.—Splendid satiny Rose; very large, full, fine form; a constant bloomer.

MADAME CAMILLE.—Pale flesh, changing to salmon Rose, shaded with carmine.

METEOR.—A rich, dark, velvety crimson, Hybrid Tea; a free bloomer and vigorous grower.

MARIE GUILLOT.—Pure white; a fine bedding Rose.

MARECHAL NEIL.—Large golden yellow.

NIPHETOS.—The White Rose par excellence, large pointed buds; very free flowering. Particularly valuable for winter forcing and summer blooming.

PAPA GONTIER.—This is one of the most fashionable of our winter flowering Roses, but is equally useful for summer bedding. Color, a glowing carmine crimson.

PERLE DES JARDINS.—No Rose of its color is more valuable than this. Its color is a rich shade of yellow; large size and perfect form. Tea fragrance; a healthy, free grower, and unequalled in profusion of bloom.

SAFRANO.—Saffron yellow, beautiful in the buds; a well-known favorite.



BRIDE.—The Bride is pure white of large size and most perfect form. This variety has a most delicious fragrance, and is a strong growing, free blooming rose, either for summer or winter flowering.

BRIDESMAID.—This beautiful new rose is a sport from Catherine Mermet, possessing all the good qualities of that popular variety, but surpassing it in color, being of a darker, richer color, a deep, rich pink. A most desirable acquisition, and invaluable for winter forcing.

GEN. JACQUEMINOT.—Well known and popular.

CORNELIA COOK.—Perhaps the finest white rose; flowers very large.

GOLDEN GATE.—Creamy white, tinted yellow; petals edged with rose.

HERMOSA.—Pink. A grand bedding rose, prolific in blooming, and almost entirely hardy, having lived for years in the New York cemeteries.

AGRIPPINA.—Crimson. Second only to "Hermosa" in hardiness and profusion of bloom. Color, rich shade of crimson.



Augusta Victoria.

HARDY MEMORIAL ROSE.—(Rosa Wichuraiana)—FOR USE IN CEMETERIES.—It is difficult to conceive anything more appropriate, beautiful and enduring for covering graves and plots in cemeteries than the Hardy Memorial Rose. It creeps along the ground almost as closely as Ivy, growing ten feet in one season, and forming a dense mat of very dark green, lustrous foliage.

PRICE.—15 cts. each. 4 for 50 cts. \$1.25 per dozen.

ALL PRICES SUBJECT TO CHANGE WITHOUT NOTICE.

Climbing HARDY Roses

HARDY CLIMBING ROSES.

15c. each. 4 for 50c.
\$1.25 per dozen.

CRIMSON RAMBLER.—This Rose has already made an impression as one of the grandest garden varieties introduced for years. It is of Japanese origin, and quite hardy, with strong shoots, that climb high in a season, or may be cut back into handsome bush form. The foliage is noticeably distinct and handsome, light glossy green, thick and leathery. The flowers are produced in great pyramidal panicles of brilliant crimson. As a decorative pot plant it is also strikingly effective.

YELLOW RAMBLER.—The hardiest yellow climbing Rose yet introduced. A worthy companion to the Crimson Rambler, White Rambler and Pink Rambler.

BALTIMORE BELLE.—Pale blush, shading to rose color; very double flowers in large clusters.

GREVILLEA or SEVEN SISTERS.—Flowers in clusters, opening a light rose color, changing to pure white.

PRAIRIE QUEEN.—Bright carmine pink; full globular flowers of fine size. A fine rose for all sections.

TENNESSEE BELLE.—Blush of good size, flowers in clusters.

CHAMPNEY, PRIDE OF WASHINGTON, RUSSELLS COTTAGE, SUPERBA.

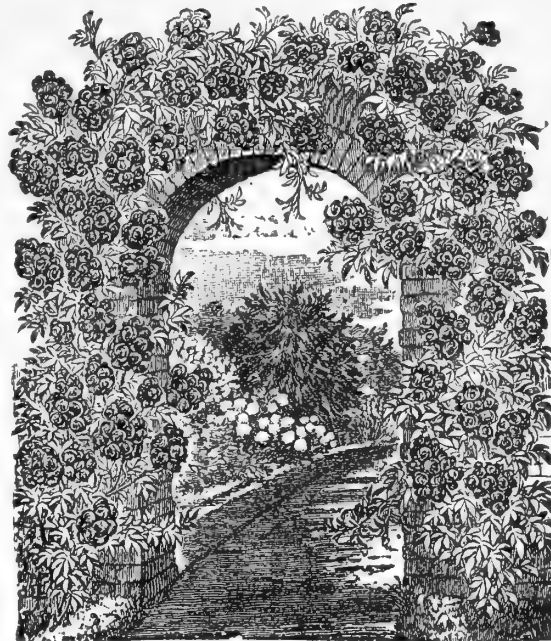

CRIMSON RAMBLER

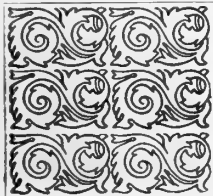

Chrysanthemums



LARGE SHOW VARIETIES } PRICE, 15c. each; 5 for 50c.; \$1.00 per dozen; \$5.00 per 100; one each of the 24 varieties for \$1.75.

- BELLE OF CASTLEWOOD.**—A pleasing shade of shell pink.
- COL. WM. B. SMITH.**—A grand, deep yellow, of finest form and size.
- CALLINGFORDI.**—A fine shade of crimson.
- EUGENE DAILLEDOUZE.**—Bright, clear, yellow; extra.
- GLORY OF THE PACIFIC.**—A magnificent extra early pink.
- GOLDEN WEDDING.**—The grandest golden yellow ever introduced.
- IVORY.**—Snowy white; perfect form and early.
- J. H. WOODFORD.**—Shell or Mermaid Pink, strong stem, fine foliage.
- LIBERTY.**—Of beautiful form; color a clear rich yellow.
- MAJOR BONNAFFON.**—One of the best yellow.
- MRS. F. BERGMAN.**—One of the earliest and best whites.
- MRS. J. T. WHILDIN.**—A handsome light yellow.
- MAUD DEAN.**—An extra large flowered variety; color, pink, almost rose.
- MINERVA.**—Large, vivid golden yellow.
- MRS. S. T. MURDOCK.**—Large, deep pink, one of the latest.
- MRS. JOHN GLESSNER.**—Large, light yellow, incurved, late.
- MRS. FERRIN.**—Rose pink, globular, incurved.
- MRS. O. P. BASSETT.**—Japanese incurved, clear light yellow.
- MRS. H. WEEKS.**—Japanese incurved, snow white.
- MODESTO.**—One of the largest and prettiest yellow varieties.
- NIVEWS.**—A grand snow white variety.
- THE QUEEN.**—Excels all in pure whiteness.
- V. H. HALLOCK.**—Rosy pearl of a waxy texture.
- WM. H. LINCOLN.**—A magnificent golden yellow variety.

HARDY POMPON VARIETIES } We have a fine assortment of these and offer a collection of 25 named sorts at \$5.00 per 100, or one each of the 25 for \$1.75. \$1.00 per dozen.

ALL PRICES SUBJECT TO CHANGE WITHOUT NOTICE.

BULBS and ROOTS

FOR SPRING PLANTING

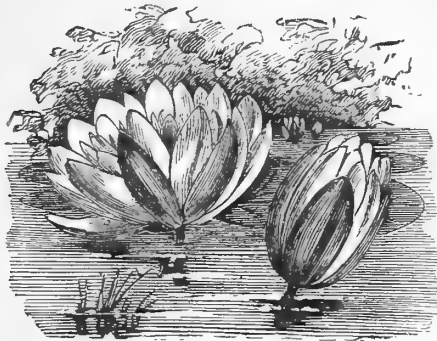

Hardy Water Lilies

NYMPHAEA ODORATA.—The well-known, fragrant pond lily. Its lovely pure white flowers, so common in some localities, is worthy of a place among the choicest varieties where cultivated.

15c. each. Four for 50c. \$1.25 per doz.

NYMPHAEA ODORATA GIGANTEA.—This is a superb variety, and should be in every collection. Similar in all respects to *Nymphaea odorata* but the flower is very large and full.

15c. each. Four for 50c. \$1.25 per doz.

NYMPHAEA ODORATA MINOR.—A pretty little variety of our native pond lily, equally as hardy and fragrant, but the flowers and leaves are much smaller.

15c. each. Four for 50c. \$1.25 per doz.

•• CANNAS ••

FEW flowering plants combine so many fine qualities as the modern *Canna*—a race of subtropical bulbous plants, of most easy culture, rapid reproduction, and good keeping qualities. The floral world has been astonished by their luxuriance of foliage and gracefulness of bloom, which is of immense size, borne in large masses and trusses, combining in color the brightest and richest shades of yellow, red, orange and scarlet, bringing them to the front as the finest ornamental plant in commerce. Useful for the garden, greenhouse or sitting-room.

ALPHONSE BOUVIER.—This is probably the grandest and most effective *Crimson Canna* grown. Height, 6 feet.

Each, 5c. By mail, 10c. Dozen, 50c.

PAUL MARQUANT.—One of the most pleasing on account of its large size and entirely distinct color, a bright salmon scarlet, passing to a rosy carmine, with a peculiar silvery lustre, which lights up the salmon very brightly. 3 to 3½ feet in height.

Each, 5c. By mail, 10c. Dozen, 50c.

ADMIRAL COURBET.—Flowers large, light yellow, spotted with crimson.

Each, 5c. By mail, 10c. Dozen, 50c.

FLORENCE VAUGHAN.—The finest yellow spotted variety yet sent out. The foliage is massive and of a rich green color.

Each, 5c. By mail, 10c. Dozen, 50c.

QUEEN CHARLOTTE.—This new German sort is one of the handsomest scarlet varieties ever introduced, having a distinct golden belt around each petal.

Each, 5c. By mail, 10c. Dozen, 50c.

DWARF MIXED VARIETIES.—Containing the leading sorts in mixture.

Each, 5c. Dozen, 35c.

TALL MIXED VARIETIES.—Red or green foliage.

Each, 8c. Dozen, 75c.

If *Cannas* are wanted by mail, send 5c. additional for postage on each, or 15c. for a dozen.

•• Iris •• Kaempferi

JAPANESE IRIS.—These magnificent Japanese Iris are among the most beautiful of our summer flowering plants, and are destined to become great favorites. They commence flowering early in July, and continue in bloom for five or six weeks if plentifully supplied with water while growing and flowering. Many of these flowers measure from ten to twelve inches in diameter, and almost rival the orchids in their rich colorings and markings.

Each 15c. Four for 50c.

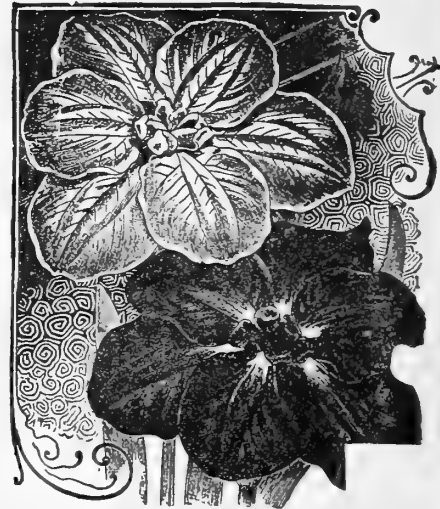

MADAME CROZY.—Flowers of dazzling crimson scarlet, bordered with golden yellow. A marvelous and rich combination of colors. The plant is of vigorous growth, yet very dwarf in habit, rarely exceeding four feet in height.

Each, 5c. By mail, 10c. Dozen, 50c.

AUSTRIA is a counterpart of *Italia* except in the color of its flowers, which are of a pure canary yellow, with but a few traces of small reddish-brown spots in the centre of the two inside petals.

Each, 10c. Dozen, 75c.



Canna Italia

ITALIA is of a bright orange scarlet with a very broad golden yellow border. The flowers, which are produced on massive stems, about sixteen inches long, are set well above the foliage, which is large and heavy, similar to that of the *Musa Ensete*.

Each, 10c. Dozen, 75c.

ALL PRICES SUBJECT TO CHANGE WITHOUT NOTICE.

Begonias TUBEROUS ROOTED . .

The Tuberous-Rooted Begonias are among the handsomest of our summer flowering bulbs. They are not grown to the extent they should be; they require no more care than Geraniums; have as fine a range of color, and will bloom continuously throughout the summer, even when Geraniums droop through lack of moisture and fail to unfold their flowers. Planted either in the rocky or flower border, they rival the Geraniums with their rich and varied colors, ranging from the most delicate shade of yellow and salmon to the most striking crimson and scarlet.

MIXED SINGLE, 10c. each. \$1.00 per dozen.
MIXED DOUBLE, 25c. each. \$2.50 per dozen.

Tuberoses

One of the most fragrant and popular of the summer flowering bulbs. May be started early in hot beds or pots, or planted in open ground after first day of May.

Each, 5c. Dozen, 25c. \$1.00 per 100.
By mail, 35c. dozen.

Madeira Vine Roots.

5c. each, 30c. dozen.



GLADIOLUS

IF WANTED BY MAIL, ADD 10c. PER DOZEN FOR POSTAGE.

The cultivation of the Gladiolus is very simple as they will thrive in any good garden soil, but will amply repay one for careful cultivation. A succession of bloom may be had from July to September by planting at intervals from April to June.

OUR GLADIOLUS are from one of the largest growers in the country, and one who has the finest assortment to be had either in this country or Europe; therefore we claim them to be unexcelled as to quality.

MIXED (All Colors.)—Dozen, 25c. \$1.25 per hundred.

WHITE AND LIGHT COLORS.—Dozen, 30c. \$1.75 per hundred.

EXTRA WHITE AND LIGHT VARIETIES.—All first-class varieties, made up largely from best-named sorts, including ten per cent. of Snow White.
10c. each, 50c. per dozen. \$3.50 per hundred.

CHILDSI MIXED.—Extra large and fine. 50c. dozen. \$3.25 per hundred.

BEDDING PLANTS.

COLEUS.—Good Varieties. 10c. each. 6 for 50c. 75c. per dozen.

GERANIUMS.—10 Named Varieties. 15c. each, 5 for 50c. \$1.00 per dozen.

HELIOTROPE.—Good Varieties. 10c. each. 6 for 50c. 85c. per dozen.

PANSIES.—Good Varieties. 10c. each. 6 for 50c. 75c. per dozen.

SALVIAS.—“Scarlet Sage.” 10c. each, 6 for 50c. 85c. per dozen.

VERBENAS.—10 Named Varieties. 10c. each. 6 for 50c. 80c. per dozen.

HARDY PHLOXES.—10 Named Varieties. 15c. each. 6 for 50c. 10 for 85c.



Gladiolus.

CARNATIONS. STANDARD . SORTS .

LIZZIE MCGOWAN.—One of the best white varieties.

NEW YORK.—Bright, cerise pink, a fine flower.

PORTIA.—Brilliant scarlet. Still the leading scarlet.

SCOTT.—Flowers large and non-bursting, of a deep pink; stems long, of good strength. Everybody's Pink.

15c. each. 5 for 50c. \$1.00 per doz.

CALADIUMS ELEPHANT'S . EAR .

The Caladium Esculentum is one of the handsomest of the ornamental leaved plants. It will grow in any good garden soil, and is of the easiest culture. To gain the best result it should be planted where it will obtain plenty of water, and an abundance of rich compost. Roots planted in the spring will make good growth in the summer, and in the fall they should be taken up and stored in a cellar. Leaves three feet or more in length and nearly as broad. There is nothing so good as this Caladium for a grand bed of foliage in the garden.

FIRST SIZE BULBS.—5c. each. By mail, 10c. 50c. per dozen.

EXTRA LARGE BULBS.—10c. each. By mail, 15c. \$1.00 per doz.

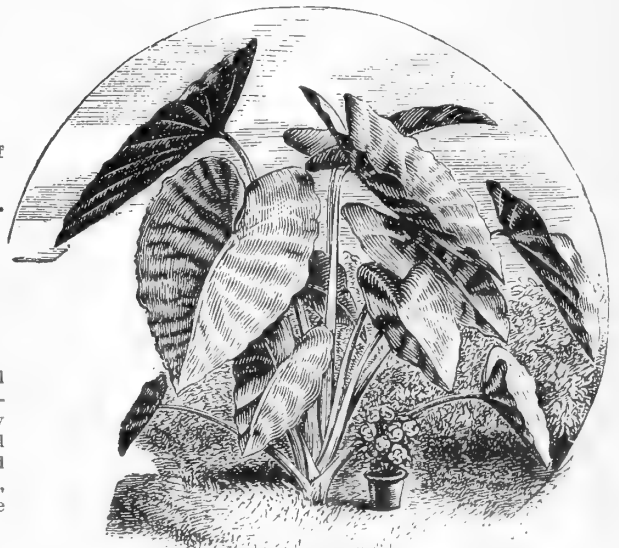

Caladium Esculentum.

ALL PRICES SUBJECT TO CHANGE WITHOUT NOTICE.



LILIUM AURATUM.

LILIES. ♣

AURATUM (The Gold-Banded Lily of Japan).—Immense white flowers, each petal marked with a wide gold band and spotted with maroon; very sweet fragrance and free blooming. It is considered by many the finest lily in cultivation.

Large bulbs, 15c. each. \$1.00 per dozen.
Extra large bulbs, 15c. each. \$1.25 per dozen.
Mailed free.

LILIUM SPECIOSUM RUBRUM.—White with rose centre.
Each, 15c. \$1.00 per dozen.

LILIUM SPECIOSUM ALBUM.—Pure white.
Each, 15c. \$1.50 per dozen. Mailed free.

WHITE CALLA—(Ready in July).—The White Calla or Lily of the Nile is a well-known plant of easy culture, and in winter is one of our best winter plants. To aid profuse blooming, keep them dormant from the middle of June to last of August, re-pot in good rich soil, using a four to six-inch pot. Give water, light and heat in abundance, and the result will be most satisfactory.

Large bulbs, 10c. each. By mail, 15c.
Extra large bulbs, 15c. By mail, 25c.



Dahlias==Pot Grown.

LARGE FLOWERING.

- ARABELLA.**—Primrose tip and shaded lavender.
- DANDY.**—Pure pink, striped jet black.
- FORGET-ME-NOT.**—Variegated.
- KING OF YELLOW.**—Pure, clear yellow.
- LA PHARE.**—Brilliant scarlet.
- A. D. LIVONI.**—Beautiful soft pink, with quilled petals.
- MADAME ZELLER.**—Yellow tip, shaded red.
- MRS. DEXTER.**—Salmon
- PRINCE BISMARCK.**—Rich purple.
- PENELOPE.**—Pure white, flaked lavender.
- PERILE.**—Clear white.
- RUBY QUEEN.**—Clear ruby red.
15c. each. Five for 50c. \$1.00 per dozen.

TWELVE SELECT CACTUS DAHLIAS for \$1.00.

- BRONZE.**—Buff yellow, overlaid bronze.
- CLIFFORD W. BRUTON.**—The best yellow Cactus Dahlia; a clear rich yellow.
- LYNDHURST.**—Deep glowing scarlet; large and full.
- FIRE BALL.**—Clear yellow, tipped red-dish pink.
- MISS JENNINGS.**—Combination of yellow, salmon and pink.
- NYMPHAE.**—A beautiful delicate pink, shading to blush at centre.
- ORIENTAL.**—Rich pale salmon.
- ORANGE KING.**—Yellow orange.
- RED AND BLACK.**—Deep wine, red margin black.
- SUNLIGHT.**—Soft pale lemon. Very fine.

Dahlia Roots. Choice named sorts, 10c. each, \$1.00 per dozen.

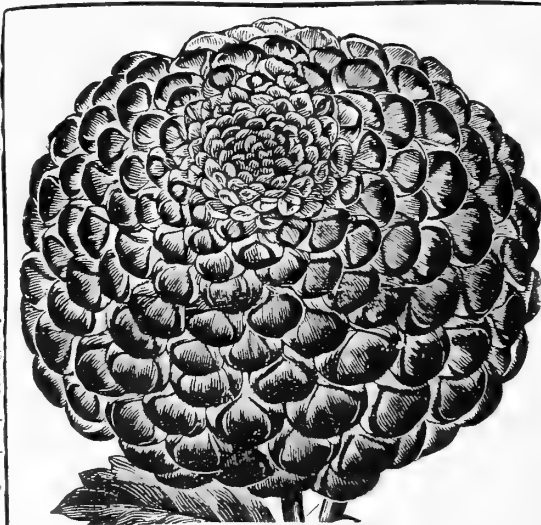

GRAND DUKE ALEXIS.—Large, massive flowers, ivory white, with a faint tinge of rose at the extremities of the petals. 15c. each. 5 for 50c.

- TRUE MODEL.**—Buff, overlaid with reddish bronze.
- UNIQUE.**—Pure yellow, tipped with red and blue.
- WILLIAM AGNEW.**—The grandest red Cactus Dahlia ever produced; color, rich shade of red.
15c. each. Five for 50c. \$1.00 per dozen.

POMPONE DAHLIAS.

- AILLET'S IMPERIAL.**—Suffused pink, tipped purple.
- CRIMSON.**—A beauty. Rich crimson.
- ELFIN.**—Pale primrose, changing to cream white.
- ELEGANTA.**—Soft pink, tipped deep pink.
- FAIRY QUEEN.**—Light sulphur yellow, edged with deep pink. One of the most beautiful and profuse bloomers. Fine for cutting.
- GOLDFINCH.**—Clear yellow, tipped with scarlet.
- LELIA.**—Flesh mottled, deep crimson.
- LITTLE BESSIE.**—Quilled creamy white.
- LITTLE PRINCE.**—Red tipped, mottled deep crimson.
- LITTLE DIAVOLA.**—Light pink, tipped with dark maroon.
- LITTLE HELEN.**—Pure white.
- LITTLE PET.**—Soft pink, shaded with crimson.
- LITTLE MASTER.**—Deep maroon.
- SNOW-CLAD.**—Unquestionably the finest white.
- VIVID.**—Intense scarlet.
15c. each. 5 for 50c. \$1.00 per doz.

FLOWER TUBS.



No. 1.—PLAIN.		
12 in. diameter by 11 in. high	each	\$1.00
15 " " " 14 " "	"	1.50
18 " " " 16 " "	"	2.00
21 " " " 18 " "	"	2.50
24 " " " 20 " "	"	3.00

U. S. FLOWER TUBS.

Cypress, Painted Green; Iron Feet and Iron Bound.

No. 1—13 x 11	each	\$.75
No. 2—14½ x 13	"	1.25
No. 3—16 x 15	"	1.75
No. 4—20 x 18	"	2.25
No. 5—24 x 21	"	2.75



ALL PRICES SUBJECT TO CHANGE WITHOUT NOTICE.

STRAWBERRY PLANTS.

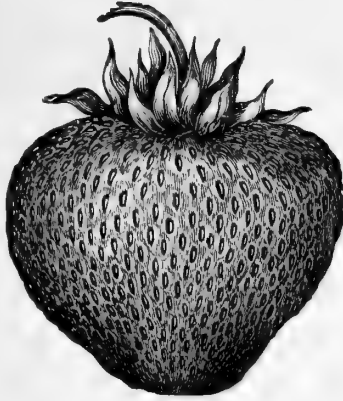

Varieties marked "P" should have another perfect flowering sort near them.

We offer a nice stock of Strawberry Plants of all the leading varieties, and at low prices, considering the quality of the stock. We can supply them at short notice, freshly dug and shipped direct from the nursery.

JESSIE.—Mid-season; good size and productive.

RIO.—A recent berry that is very highly recommended. Rich, glossy color, medium size and very prolific.

HAVERLAND (P.)—Early in season.

MICHEL'S EARLY.—Very early.

TIMBRELL (P.)—Very large, bright red color.

BRANDYWINE—Very late, strong grower, productive.

MARSHALL.—Medium to late in season.

BEDERWOOD.—Early and of medium size.

DAYTON.—Early, unexcelled.

GREENVILLE (P.)—Mid-season.

H. W. BEECHER (P.)—Mid-season.

SHUSTER'S GEM.—Mid-season, medium size.

WOOLVERTON.—Mid-season, should be in every collection.

CLYDE.—Among new varieties, possessing points of excellence, Clyde stands first on the list. Fruit large, firm and of light scarlet color.

NEW LADY FINGER.—A very long berry of beautiful appearance and very valuable because of its habit of holding good size to the end of the season. In season from medium to very late.

WM. BELT.—The fruit is exceptionally large, of brilliant red color, and of extra fine quality. It is a good shipper.

MEEK'S EARLY.—Very early.

TENN. PROLIFIC.—Large, sweet, firm.

BUBACH (P.)—Medium to late.

GANDY.—Late. Fine for canning.

LADY THOMPSON.—Medium to late.

SHARPLESS.—Old reliable.

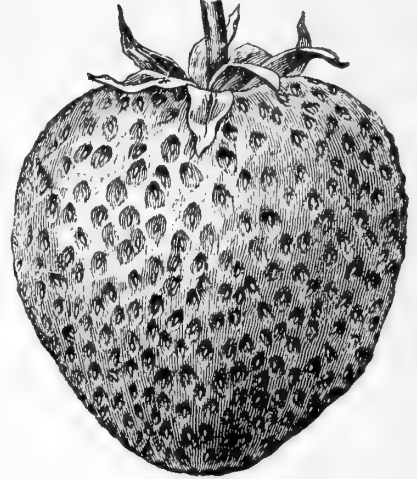

GLEN MARY NEW.—A very large variety; larger than Sharpless or any other berry. In quality it is equal to the best, and surpasses even the Crescent for productiveness in quarts of berries. At its home, in Chester county, Pa., it begins to ripen about May 28th. Everyone should try this excellent variety.

PARKER EARLE.—This is a large sort, of wonderful productiveness. Late.

Price: Any of the above Varieties, Strong, Healthy Layers, 25 Cts. per Doz.; 75 Cts. per 100; \$4.00 per 1,000.

POT GROWN PLANTS will be ready for delivery after August 1st. Prices for pot-grown plants are from \$2.50 to \$4.00 per hundred, according to variety.

Blackberries.

WILSON, Jr.—Very early.

KITTATINY.—Medium.

ERIE.—Early.

LUCRETIA (Dowberry).—As early as Early Harvest and as large as Wilson. Shiny jet black, melting and delicious quality, devoid of core. Plant is entirely hardy, healthy, strong grower and very productive.

Any of the above, 50 cts. doz., \$2.00 per 100, by express.

Gooseberries.

DOWNING.—

Two-year old, 50 cts. per half doz., \$1.00 per doz., \$5.00 per 100, by express.

HOUGHTON'S SEEDLING.—

Price, 50 cts. per half doz., 75 cts. per doz., \$4.00 per 100, by express.

Japan Wineberries.

This fruit is but little known, but should be in every garden. It is wonderfully productive. At this date, June 20th, our beds are one solid mass, about three feet high, and covered all over the top with fruit as thick as clover in blossom.

Price, \$1.50 per dozen, by express.

Raspberries.

BLACK PROGRESS (Pioneer).—Early.

GOLDEN QUEEN.

CUTHBERT, GREGG, OHIO AND SOUEGAN.

Any of the above, 50 cts. per dozen, \$2.00 per 100, by express.

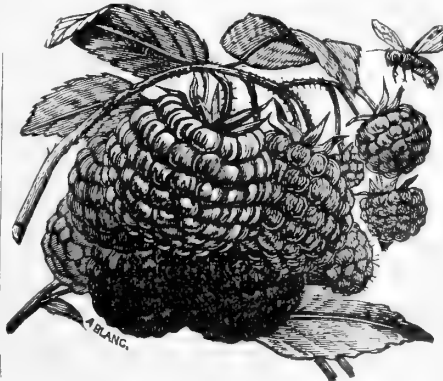

Currants.

CHERRY.

Price, 60 cts. per half dozen, \$1.00 per doz., \$5.00 per 100, by express.

FAY'S PROLIFIC.—The best red currant. Strong grower, wonderfully productive, and comes to bearing young; fruit large, bright red, and good quality.

Price, 75 cts. per half doz., \$1.25 per doz., by express.

WHITE GRAPE.—

Price, 60 cts. per half doz., \$1.00 per doz., by express.

Juneberry.

IMPROVED DWARF.—

The fruit is borne in clusters, reddish purple in color, changing to bluish black. In flavor it is mild, rich sub-acid; excellent as a dessert fruit or canned. It is extremely hardy. In habit it is similar to the currant, the bushes attaining the same size. The blossoms are quite large and composed of fine white petals, which, with its bright, glossy, dark green foliage, renders it one of the handsomest of ornamental shrubs.

Price, 15 cts. each, \$1.25 per 100

SPECIAL PRICES TO GARDENERS AND FARMERS IN LARGE QUANTITIES.

ALL PRICES SUBJECT TO CHANGE WITHOUT NOTICE.

Nursery Department

- FRUIT -

SUMMER APPLES.

YELLOW TRANSPARENT.—Ripens among the earliest. July, 50 cents each. \$4.80 per dozen. \$18.00 per 100.
EARLY HARVEST.—June and July. 50 cents each. \$4.80 per dozen. \$18.00 per 100.

AUTUMN APPLES.

GRAVENSTEIN.—August. 50 cents each. \$4.80 per dozen. \$18.00 per 100.
OLDENBURG (Duchess of Oldenburg).—August. 50 cents each. \$4.80 per dozen. \$18.00 per 100.

WINTER APPLES.

LANKFORD'S SEEDLING.—A popular sort for late winter use. 50 cents each. \$4.80 per dozen. \$18.00 per 100.
YORK IMPERIAL or JOHNSON'S FINE WINTER. 50 cents each. \$4.80 per dozen. \$18.00 per 100.

ADDITIONAL VARIETIES.

("S" means Summer. "A" Autumn. "W" Winter.)
Red Astrachan, S. Carolina Red June, S. Tetofsky, S. Fall Pippin, A. Smokehouse, A. Ben Davis, W. Bentley's Sweet, W. Berry Red, W. Fallwater, A. Winesap, W. Nansmond Beauty, W. Rome Beauty, W.

25 cents each. \$2.50 per dozen. \$15.00 per 100.

CRAB APPLES.—60 cents each. \$6.00 per dozen.

PEARS.

KOONCE.—The fruit is medium to large, very handsome; surface yellow, one side covered with a bright carmine, containing brown dots; stem meaty and short; quality very good, spicy, juicy and sweet. The Koonce is a vigorous grower, free from blight, heavy and productive, and an annual bearer. 50 cents each. Three for \$1.25.

VERMONT BEAUTY.—In color it is a rich yellow, with a beautiful bright carmine cheek. The fruit is of medium size, and the flesh is of the finest quality, being rich, juicy and aromatic. The tree is a fine grower, of very thrifty habit and perfectly hardy. Its season of ripening, which is after the Seckel and before the winter pears are ripe, makes it particularly valuable. 50 cents each, three for \$1.25.

GARBER.—September and October. 40 cents each. \$4.00 per dozen. \$25.00 per 100.

KEIFFER.—The old, well known, reliable and paying variety. 40 cents each. \$4.00 per dozen. \$30.00 per 100.

FLEMISH BEAUTY, BARTLETT, SECKEL.—25 cents each. \$2.50 per dozen. \$20.00 per 100.

PEACHES.

CROSBY (Excelsior, Frost Proof).—Ripens between Early and Late Crawford. 20 cents each. \$2.00 per dozen. \$12.00 per 100.

CHAMPION.—July. 20 cts. each. \$2.00 per doz. \$12.00 per 100.

Alexander, Louise, Yellow St. John, Mountain Rose, Early Silver, Crawford Early, Wheatland, Crawford Late, Chairs Choice, Family Favorite, Chinese Cling, Old Mixon, Reeves Favorite, Christiana, Smock Free, Globe, Ringgold Cling. 18 cents each. \$1.75 per dozen. \$10.00 per 100.

JAPANESE OR ORIENTAL PLUMS.

HALE.—Most vigorous tree of all the Japans. Fruit large; bright orange, mottled with cherry red. Superb in quality. Ripens middle of September. Price, \$1.00. Three for \$2.50.

WILLARD.—Earliest of all Japan Plums, and hence very valuable for market. 50 cents each. Three for \$1.25.

WICKSON.—Pit small; flesh tender, sweet and delicious. Season just following the Burbank Plum. 50 cents each. Three for \$1.25.

Will sell one of each of above in one order for \$1.50.

BOTAN or ABUNDANCE.—First of August.

BURBANK.—September 1st.

The two above-named varieties 60 cents each. Three for \$1.50. Six for \$2.75. \$4.50 per dozen.

ADDITIONAL FRENCH AND AMERICAN VARIETIES, INCLUDING SHROPSHIRE DAMSON.—35 cents each. \$3.50 per doz.

CHERRIES.

HEART—Black Tartarian, Gov. Wood, Napoleon Bigreau, Florence, Early Purple.
DUKE AND MORELLO—Dye House, Belle Magnifique, Early Richmond, Montmorency.
 Price, 25 cents each. \$2.50 per dozen.

APRICOTS.

APRICOTS (Russian Varieties)—Nectarines—Quinces, consisting of Meech Prolific, Rea and Champion.
 Price, 25 cents each. \$2.50 per dozen.

NUT-BEARING TREES.

Spanish Chestnut, English Walnut, Paper Shell Pecan, Filberts, Shell Barks, Hard and Soft Shell Almonds.
 Price, 40 cents to 50 cents each, according to variety.
JAPAN CHESTNUT.—\$1.00 each. \$10.00 per dozen.

GRAPES.

The following list contains the best known sorts of hardy American varieties:

Ohio, Black.—One of the very best sorts. 50 cts. each. \$5.00 doz. Two years' old.
Brighton, Red—Concord, Black—Delaware, Red—Martha, White—Worden, Black, Two years' old. 25 cts. each. Six for \$1.00. Twelve for \$2.00.
Moore's Early, Black—Niagara, White—Pocklington, White—Vergennes, Red—Champion, Black. 30 cents each. Six for \$1.50. Twelve for \$2.00.

SELECT QUINCES.

CHAMPION.—Three to four feet, 25 cents each. \$2.50 per dozen.
CHAMPION.—Two to three feet, 20 cents each. \$2.00 per dozen.
MEECH PROLIFIC.—Three to four ft., 25 cts. each. \$2.25 per doz.
MEECH PROLIFIC.—Two to three ft., 20 cts. each. \$2.00 per doz.

ORNAMENTALS.

Deciduous Trees.

Can furnish any of the Deciduous Trees at 50 cents to 75 cents each, and larger quantities in proportion.

Evergreens.

SPRUCE.—Two to two and a half feet, 50 cents each. \$5.00 per doz
FIRS.—Two to two and a half feet, 75 cents each. \$7.50 per doz.
 Other varieties in proportion.

Shrubby.

JAPAN MAPLES.—Mostly dwarf habit; several kinds weeping and cut-leaved, with brightly colored foliage, red, purple, etc. These are indeed remarkable for beauty, and wherever planted give perfect satisfaction. \$1.50 each.

DEUTZIA GRACILIS.—35 cents each. \$3.00 per dozen.

DEUTZIA CRENATA.—35 cents each. \$3.00 per dozen.

LILAC (White and Blue).—35 cents each. \$3.00 per dozen.

SPIREA RIEVESII.—35 cents each. \$3.00 per dozen.

SPIREA BUNALDO.—35 cents each. \$3.00 per dozen.

SPIREA CALGSA ALBA.—35 cents each. \$3.00 per dozen.

HYDRANGEA, PANICULATA GRAND.—35 cents each. \$3.00 per dozen.

GRAPE MYRTLE.—50 cents each.

Vines.

AKEBIA QUINATA.—25 cents each. \$2.50 per dozen.

AMPELOPSIS VEITCHII.—25 cents each. \$2.50 per dozen.

ENGLISH IVY.—25 cents each. \$2.50 per dozen.

WISTARIA PURPURA.—50 cents each. \$5.00 per dozen.

WISTARIA ALBA.—50 cents each. \$5.00 per dozen.

CLEMATIS (Large Flowering).—50 cents each. \$5.00 per dozen.

CLEMATIS (Small Flowering).—30 cents each. \$3.00 per dozen.

Hedge Plants.

CALIFORNIA PRIVET.—One year, \$3.00 per 100. \$25.00 per 1,000

CALIFORNIA PRIVET.—Two years, \$4.00 per 100. \$35.00 per 1,000.

OSAGE ORANGE.—One year, 75 cents per 100.

OSAGE ORANGE.—Two years, \$1.25 per 100.

AMERICAN ARBORVITAE.—Twelve to eighteen inches, \$12.50 per 100. Two to three feet, \$22.50.

PRAIRIE STATE INCUBATORS AND BROODERS.

PRICES ON PRAIRIE STATE INCUBATORS AND BROODERS have been considerably reduced. We honestly believe that we are to-day offering the public the best line of Incubators and Brooders ever put upon the market at the price which we are now selling them. Every machine is constructed of the very best material, finely finished, self-regulating, having automatic turning tray which is a very strong feature, and all machines are built over the same pattern. One machine will do just as good work as another, and no one need hesitate to send us an order for any style or size that the Company manufacture. We warrant the machines first-class in every respect, and if the purchaser finds they are not as we advertise, they are at liberty to return them and we will refund the money. We want no person's money unless we give them value received for the same.

PRICE LIST OF INCUBATORS AND BROODERS.

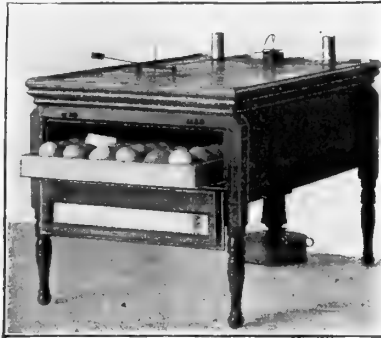

No. 2 Baby Incubator.

Incubators.

	Capacity.	Weight, Crated.	Price.
No. 1, Baby,	50 Eggs,	45 lbs.	\$6.00
No. 2,	100 "	70 "	10.00
No. 1, Style A	150 "	170 "	20.00
No. 2,	" A 210 "	215 "	26.00
No. 3,	" A 300 "	260 "	32.00
No. 1,	" B 150 "	150 "	15.00
No. 2,	" B 210 "	195 "	22.00
No. 3,	" B 300 "	240 "	25.00
Special Duck	200 "	260 "	32.00

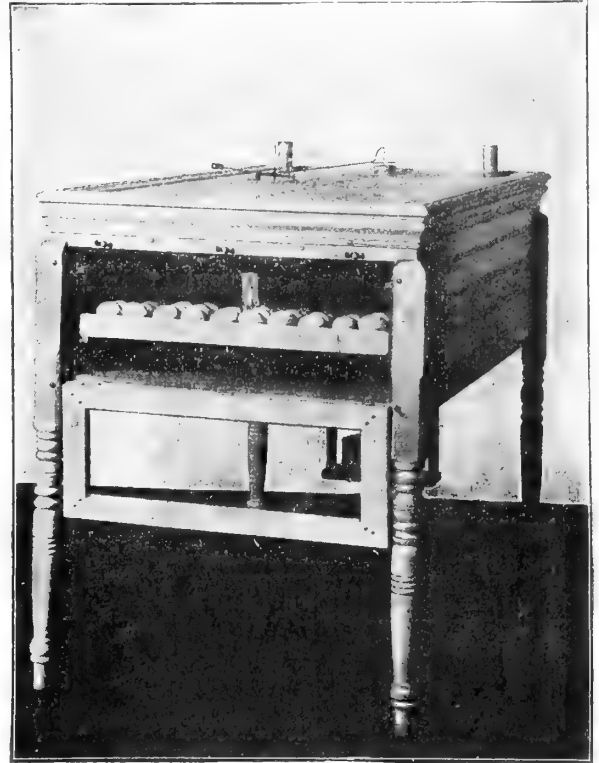

Style A. Incubator.

Brooders.



Style D, Hot-Air Indoor Brooder.

The simplest and cheapest on the market.
 Capacity. Weight, Crated. Price.
 No. 1, - - - - 80 Chicks, - - - - 60 lbs., - - - - \$7.00

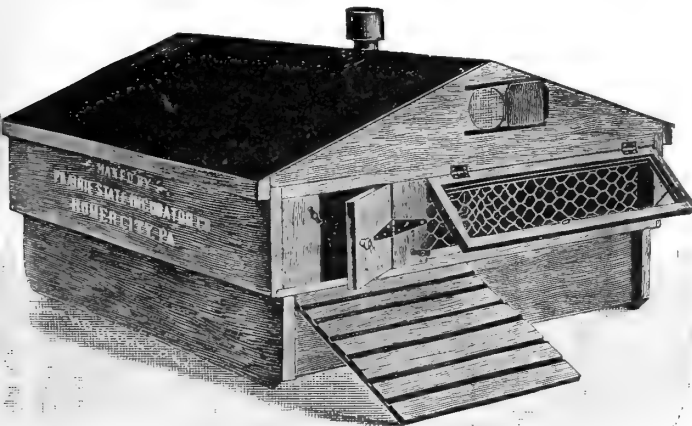

Style C, Hot-Air Outdoor Brooder.

Has all the convenience of the Hot-Water Brooder. Is rat, rain and storm proof.
 Capacity. Weight, Crated. Price.
 No. 1, - - - - 100 Chicks, - - - - 125 lbs., - - - - \$12.00
 No. 2, - - - - 150 " - - - - 185 " - - - - 16.00

EXTRAS. Special tested Thermometers, Metal, 75 cts.; 10 cts. extra for mailing each. Burners for No. 1 Incubator Lamp, 25 cts., postpaid; for Nos. 2 and 3 Lamps, 35 cts., postpaid. Lamps for No. 1 Incubators, 65 cts.; for No. 2, 75 cts. Extra Trays for Incubators, 40 cts. each. Egg Tester, 35 cts., postpaid.

HAND CORN SHELLERS FOR POULTRYMEN, see page 100.

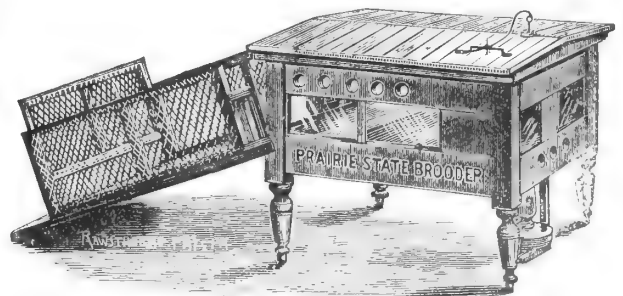

Style A, Hot-Air Brooder, with Runs.

(Self-regulating Top and Bottom Heat.)
 This Brooder is intended for indoor work only. They will do the work satisfactorily, and as they are well made and finely finished, can be placed in any building, or moved from one place to another.

	Capacity.	Weight, Crated.	Price.
No. 1,	100 Chicks,	100 lbs.,	\$13.50
No. 2,	200 "	120 "	18.00

ALL PRICES SUBJECT TO CHANGE WITHOUT NOTICE.

POULTRY SUPPLIES

POULTRY NETTING, for enclosing Poultry Yards.

The Wire we offer is all No. 19 and 20 double twist, 2 inch mesh, thoroughly galvanized after weaving. Sold in bales of 150 running feet.

PRICES TWO-INCH MESH.							
No.	In. Wide.	Sq. Ft.	Per Bale.	No.	In. Wide.	Sq. Ft.	Per bale.
No. 19,	12	150	\$1.12	No. 19,	48	600	\$4.50
No. 19,	18	225	1.69	No. 19,	60	750	5.63
No. 19,	24	300	2.25	No. 19,	72	900	6.75
No. 19,	36	450	3.38	For prices on No. 20 Wire see page 107.			

Price 1 cent per square foot in less than bale lots.
Staples for fastening, 10 cents per pound.

FRENCH POULTRY KILLING KNIFE.



The most expeditious and humane way of killing and dressing poultry is by the French method. These knives are made of the finest steel.

Price, with instructions 50c. each.

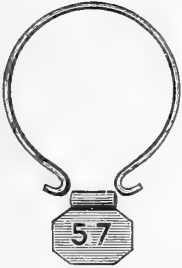

CLIMAX LEG BANDS.

Made of spring brass and so made that the tag acts as a clasp, holding them securely in place. Price per doz., 25 cents; per 50, 75 cents; per 100, \$1.25.

WIRE HEN'S NESTS.

15 cts., each; 4 for 50 cts.; \$1.25 per dozen.

PORCELAIN NEST EGGS.

The best and cleanest nest egg used. Each, 5 c.; dozen, 25c.; by mail, 50c.



POULTRY MARKER.

This little instrument is used for marking young and old chickens. It is invaluable to breeders and farmers. They are made in two sizes for large or small chicks, nickel-plated, have steel cutter and spring, and are made small and neat to carry in the vest pocket. Sent by mail on receipt of price. 25c. each.

RUST'S HAVENS' CLIMAX CONDITION POWDER

FOR ANIMALS AND POULTRY
SURE CURE FOR GAPES AND FOWL CHOLERA

CLIMAX CONDITION POWDERS FOR STOCK AND POULTRY.

The only positive preventive and cure for Gapes and Poultry Cholera, and a most excellent medicine for young Turkeys that have been exposed to the weather; also an excellent medicine for Horses, Cattle, Sheep and Hogs. All who have used Haven's Climax Condition powders once, will have it again.
13 oz. packages, 25c.; by mail 40c.
32 oz. packages, 50c.; 5 lb. box, \$1.00.

HAVEN'S ROUP PILLS.

For the cure of Roup, Catarrh, Colds, etc. Box 25c.

YOU CAN RAKE IN DOLLARS WHILE USING RUST'S EGG PRODUCER COSTS ONLY 20 CENTS A YEAR TO FEED IT.

Eggs at all Seasons by Using RUST'S EGG PRODUCER.

TRADE

THE HEN PERSUADER.

MARK.

This has given our customers universal satisfaction. It supplies those substances which produce Egg growth and development. So moderate in price, it should be used winter and summer.

1 lb. package 25c.
2 1/2 lb. package 50c.
6 lb. box \$1.00
If to be sent by mail, add 16 cents per lb. to prepay postage.

SHERIDAN'S CONDITION POWDER.

Strictly a medicine, to be given in the food, once daily, in small doses. Prevents and cures all diseases of hens. Worth its weight in gold when hens are moulting. Price, small packages, 25 cents, 5 for \$1.00; large packages, \$1.00, by mail, \$1.25; 6 large packages, by express, \$5.50.

GROUND CHARCOAL.

A little ground charcoal, mixed with the soft feed in the morning, once or twice a week, is an excellent corrective for the fowls, and keeps them healthy.
1lb., 10c.; 5 lbs., 30c.; 10 lbs., 50c.; 25 lbs., \$1.00; 100 lbs., \$3.50.

PIONEER CLOVER MEAL.

By all odds the best and most economical way of feeding clover. Can be fed in mash with other food.
50 lb., bag \$1.25
100 lb., bag 2.00



Nos. 1, 2 and 3.

CAST IRON POULTRY TROUGHS.

Same shape as Hog Troughs. This is an indispensable article for parties raising poultry. It is readily cleaned, and no leaking.
No. 0, 8 inches long, 3 1/4 inches wide at top, 1 1/2 inches deep 20c.
No. 1, 20 inches long, 4 inches wide at top, 1 1/2 inches deep 40c.
No. 2, 23 inches long, 7 inches wide at top, 3 inches deep 50c.



18 inch \$1.00
27 inch 1.25

GROUND BEEF SCRAPS.

Our ground beef scraps are specially prepared. Feed three times a week at the rate of about a handful to every three birds in the morning meal of hot food. During warm weather the scraps need not be fed more than once a week.
5 lbs., 25c.; 10 lbs., 40c.; 50 lbs., \$1.25; 100 lbs., \$2.25.

MEAT MEAL.

This is a true egg-producing, flesh and bone-forming food, and supplies just what laying hens and growing chicks require. It is not a medicine. It is fed with other foods. Fed to small chicks about three times a week will promote health, growth and vigor.
5 lbs., 25c.; 10 lbs., 40c.; 25 lbs., 75c.; 50 lbs., \$1.25; 100 lbs., \$2.25.

CRACKED POULTRY BONE.

This article is manufactured from fresh, clean bones, and is perfectly pure and sweet. The bones are extra selected, being first boiled to remove the meat, and then ground. No chemicals whatever are applied to them in the course of manufacture, so that they are turned out green and pure. Should be fed to the poultry daily, about a handful to every five fowls, like grain or any other feed. An excellent bone and egg producer, keeping the fowls strong on their legs and largely increasing their laying qualities.
5 lbs., 25c.; 10 lbs., 40c.; 35 lbs., \$1.00; 100 lbs., \$2.00.

BONE FLOUR FOR POULTRY.

For mixing once a day with soft feed this is unsurpassed. Laying hens and young chickens, whose digestive powers are not strong, are much benefited by this, especially during the winter months, or where closely confined in yards. This is exactly the same as the cracked bone described above, only it is ground much finer.
5 lbs., 25c.; 10 lbs., 40c.; 35 lbs., \$1.00; 100 lbs., \$2.25.

CRUSHED OYSTER SHELLS.

This is a most important article for the poultry yard through the winter, and should be liberally supplied to the fowls. In summer, when left to run at large, they can find their own shell-making material, but when everything is frozen or covered with snow, they must be helped out if eggs are wanted.
5 lbs., 10c.; 100 lb. bag, 50c.; 500 lbs., \$2.25.

MANN'S GRANITE AND MICA CRYSTAL GRIT.

To aid digestion it is necessary to feed some gritty material. These supply this want better than any other article known.
5 lbs., 15c.; 100 lbs., \$1.00; 200 lbs., \$1.75; 500 lbs., \$3.75.

SUNFLOWER SEED.

Highly recommended for poultry as one of the best egg-producing foods known, keeping them in good condition.
Quart, 10c.; peck, 60c.; bushel, \$1.75.

DEATH TO LICE.

A DISINFECTANT INSECT POWDER.
This powder is unrivalled as an insecticide; handy to use, cheap to buy, and does the work quick.

15 oz. package \$ 25 Postpaid \$ 40
48 oz. package 50 Postpaid 1.00
100 oz. package 1.00 Express paid 1.50

PIGEON FOOD.

Canada Field Peas—Quart, 10c.; peck, 40c.; bushel, \$1.25. Buckwheat—Quart, 10c.; peck, 40c. Hemp Seed—Pound, 8c.; 4 pounds, 25c.

INSECT DESTROYERS, ETC.



SLUG SHOT.

A non-poisonous powder, and a very popular insecticide—it requires no further mixing or preparation—easily applied, and not injurious or dangerous to animals, the person applying it, or fruits and vegetables treated. Very effectual in destroying potato bugs and beetles, green and black fly, slugs, worms, caterpillars, etc.

It will be necessary, however, to apply it occasionally, for it does not kill the eggs or prevent them from hatching. The best time to apply it is early in the morning, particularly for potato bugs, as they do not feed during the night.

Apply with duster, bellows or gun. Ten to forty pounds is sufficient for an acre.

5 pound packages, 25 cents; 10 pound packages, each, 45 cents; 25 pounds, \$1.00.

PERSIAN POWDER OR BUHACH.

A most effective non-poisonous impalpable powder—so fine that it penetrates the innermost crevices—for worms, flies, aphids, and almost all kinds of insects. It is very effectual, suffocating them by filling up the breathing pores.

Price, per pound, 40 cents, or by mail, 55 cents per pound. ¼ lb., 15 cents.

DRY.—Blow on with a bellows or gun.

SOLUTION.—Dissolve 1 ounce to 3 gallons of water, and apply with syringe or pump.

GRAY MINERAL ASH.

Kills all kinds of insects—potato bugs, squash bugs, red spider, caterpillars, bed bugs, ants, roaches—and yet not injurious to those who use it.

DIRECTIONS.—Do not put the Ash in cold water. Take half pound, sift in one gallon boiling water, stirring all the time; keep it boiling ten minutes longer, then pour into four gallons cold water. This solution is strong enough for potato vines.

1 pound can, 15 cents; 2 pounds, 25 cents; 5 pounds, 50 cents; 10 pounds, 85 cents.



BORDEAUX MIXTURE.

A valuable and indispensable fungicide for grape growers, thereby insuring larger crops and finer grapes, and preventing failure. A sure cure and preventive for black rot, mildew and rust; also of great value for other plants with kindred diseases.

Per gallon can, \$1.25.

By express or freight only. Mix one part of this to 50 parts of water.

POWELL'S BORDEAUX MIXTURE.

Ready for use by simply adding water.

1 lb. box, price 15 cents, makes 5 gallons spray.

5 lb. box, price 60 cents, makes 25 gallons spray.

10 lb. box, price \$1.00, makes 50 gallons spray.

KEROSENE EMULSION (a Paste.)

Ready for use by simply adding water.

1 lb can, price 15 cents, makes 10 gallons spray.

5 lb. can, price 60 cents, makes 50 gallons spray.

25 lb. can, price \$2.50, makes 250 gallons spray.

This is strictly an insecticide for plant lice of all kinds, rose bugs, cabbage bugs, melon insects, fowl, human and animal lice, caterpillars, tobacco flies, peach lice, red spiders, green fly and all sucking insects.

PURE WHITE HELLEBORE.

The cheapest and best preparation for destroying rose slugs, currant worms, etc.

Quarter pound, 10 cents; pound, 30 cents. By mail, 45 cents per lb.

LEMON OIL.

This well known insecticide has had for some time a marvelous success in England; perfectly safe and harmless to the tenderest foliage and roots. It effectually destroys mealy bug by syringing or dipping. It also destroys scale, thrip, red spider, black and green fly, caterpillar, American blight, mildew, etc. Dilute with 50 parts water.

Half pint, 25 cents; pint, 40 cents; quart, 75 cents; half gallon, \$1.25; gallon, \$2.00.

TOUGH ON FLIES.

One application instantly and positively relieves horses and cattle from all annoyance from green heads, the dreaded Texas heel fly, as well as other flies, gnats and insects of every description for at least twenty-four hours. It improves the coat of the animal and abolishes the use of fly nets.

Price, quart, 50 cents; half gallon, 90 cents; gallon, \$1.50.



LAUREL GREEN.

A combined Insecticide and Fungicide.
15 cents per pound; \$1.25 per dozen.

FLOWERS OF SULPHUR.

For the prevention and destruction of mildew on roses and other plants. Apply with bellows or gun. Pound, 10 cents; 5 lbs., 40 cents, 10 lbs., 60 cents.

N. B.—If by mail, add 15 cents per pound for postage.

PARIS GREEN.

Quarter pound, 10 cents; pound, 25 cents. By mail, 40 cents.

NIKOTEEN.

Is the most powerful known insecticide, and will be found more economical and convenient than weak tobacco extracts.

Price, pint cans, \$1.50; 5 cans, \$7.00.

Vaporizing pans, for above, 50 cents; irons, 50 cents; 3 pans, 3 irons and 1 hook, \$3.00.

THYMO-CRESOL or SHEEP DIP.

In cans, per gallon, \$1.75; half gallon, \$1.00; quart, 65 cents; pint, 45 cents.

LONDON PURPLE.

Very poisonous and equally as efficacious as Paris Green, and more soluble in water. Use in the same way as Paris Green.

1 pound, 20 cents; by mail, 35 cents.

WHALE OIL SOAP.

Makes an excellent wash for trees and plants where insects and eggs affect the bark, and for smearing on the trunks of trees to prevent worms from crawling up.

Price, cake, 10c.; 15 cents per lb.; 5 lbs., 60 cents; 9 lbs., \$1.00. Large quantities at special prices.

For insects on plants, dissolve ½ lb. to a gallon of water; apply with syringe or spraying pump. For bark insects, etc., dilute with water to consistency of thick paint, and apply with brush.

PINNER'S TOBACCO SOAP.

Pound, 45 cents; by mail, 55 cents.

TOBACCO DUST, FINE.

For green and black aphids, fleas, beetles, etc. Splendid fertilizer and preventive for insects in the ground and around roots.

Price, 5 lbs., 20 cents; 20 lbs., 50 cents; 100 lbs., \$1.00; 200 lbs., \$1.75; 500 lbs., \$3.75.

For insects on plants, apply with powder duster or bellows. For worms or grubs in the soil, apply liberally to the surface and rake in, or strew thickly in the drills before planting.

TOBACCO STEMS.

Indispensable for fumigating greenhouses and conservatories for the destruction of green and black aphid and other insects.

5 cents pound; large quantities, 3 cents pound. Dampen thoroughly a few hours before using, place about a half pound over a handful of shavings in a fumigator, and light.

FUMIGATORS.

Eureka, No. 2, height, 16 in., for a house 12x40 ft., \$1.75.

Eureka, No. 3, height, 20 in., for a house 15x100 ft., \$2.25.





FOR THE

FARM

FERTILIZERS

LAWN AND GARDEN

167 lbs.

GRIFFITH & TURNER CO'S

ANIMAL

BONE

PHOSPHATE

BALTIMORE

The application of Fertilizers has been a topic much discussed among farmers generally. The quality and requirements of the soil are so varied, some lands being deficient in Potash, Phosphoric Acid or some other chemical ingredient, that it is frequently very difficult for the farmer to determine just what mixture he needs. We give below a line of fertilizers best adapted to the various soils and crops.

ANIMAL BONE PHOSPHATE.

Made principally from Animal Bone, Potash and Ammoniates in proper proportion. A complete manure always gives good results. Specially adapted to the growth of Peas, Cabbage, Wheat and Grass—it contains all of the ingredients necessary to supply what may be lacking in the soil for almost any crop.

Price, \$28.00 per ton.

AMMONIATED ALKALINE PLANT FOOD.

Our old stand-by for summer crops is used largely on Potatoes, Corn, Tobacco and other summer crops, stands the hot, dry weather particularly well.

Price, \$22.50 per ton.

AMMONIATED BUTCHERS BONE PHOSPHATE.

Is made largely from slaughter-house stock; used principally for Wheat and Grass, as well as by growers of Corn and Tomatoes for canning purposes; a good article at a low price.

Price, \$22.50 per ton.

SOFT GROUND BONE.

Made from softer material than the regular "Ground Bone," and contains some little meat and blood. The great objection to the use of Pure Bone (the price) no longer prevents its use by anyone wanting to restore worn-out land. Try it and be convinced.

Price, \$27.00 per ton.

DISSOLVED BONE.

Made from stock containing some meat, thoroughly dissolved, and in fine drilling condition. Farmers wishing a Fertilizer for immediate action will find in this brand a reliable manure of good value, and one whose good effect can be seen for a long time.

Price, \$27.00 per ton.

AMMONIATED SOLUBLE BONE.

Made for our Pennsylvania trade exclusively, where it is well and favorably known.

Price, \$20.00 per ton.

SOLUBLE BONE PHOSPHATE.

A good cheap Fertilizer. Quite a number of chemists claim that Ammonia adds very much to the cost of Fertilizers without being of much agricultural value; that is, sufficient Ammonia can be obtained from the atmosphere, etc., etc. Whether or not this theory is correct, quite a number of people have used our Soluble Bone with very satisfactory results. To supply such a trade we offer the above.

Price, \$16.00 per ton.

TOBACCO BED FERTILIZER.

This brand is specially well adapted for use on tobacco beds, containing 10 per cent. of Ammonia and a large percentage of Potash and Phosphoric Acid. A most excellent substitute for Peruvian Guano. In bags, 167 lbs.

\$4.00 per bag, \$45.00 per ton.

SPECIAL MIXTURE.

A new brand introduced by us this year; a complete Fertilizer, containing Ammonia, Potash and available Phosphoric Acid in proper proportions.

Price, \$17.00 per ton.

PERUVIAN GUANO.

10 per cent. goods. In bags of 167 pounds.

Prices on application.

HIGH GRADE ACID PHOSPHATE.

Best grade of S. C. Phosphate, thoroughly dissolved and in good, dry condition.

Prices on application.

KAINIT.

Containing about 25 per cent. Sulphate of Potash. In bags of 200 pounds each.

Prices on application.

MURIATE OF POTASH.

Contains about 80 per cent. of Muriate; is specially adapted for rejuvenating old, worn-out soils, which, when used in connection with other ingredients, makes a good Potato Fertilizer.

Prices on application.

NITRATE OF SODA.

Is very quick in its action, and forces from ten days to two weeks. Should be used after plants have gotten good start; is very soluble, and 200 to 250 pounds to the acre is a good dressing; application should be made in connection with plaster or some similar article.

Prices on application.

LAND PLASTER.

In bags 200 pounds each.

90c. per bag. \$7.50 per ton.

FINE GROUND FISH.

Contains a large percentage of Ammonia. A very desirable form, quick in action.

Prices on application.

GROUND TANKAGE.

In good, dry condition, and ground fine.

Prices on application.

PULVERIZED SHEEP MANURE.

This is purely a natural and most nutritious plant food, clean to handle, and its effect is immediate and lasting. There is nothing better to mix with soil for potting plants. Florists who use it extensively advise mixing about one-seventh manure and six-sevenths soil. As a top dressing for lawns, it is unequalled.

5 lbs. 25c.; 10 lbs., 40c.; 30 lbs. \$1.00; 50 lbs. \$1.50; 100 lbs. \$2.50

BONE FLOUR.

Made especially for Florists and Gardeners. This flour is passed through a 30-mesh screen, and is consequently exceedingly fine, and in addition to this, it is the Pure Bone, containing no foreign matter at all. Write for sample.

Price, \$4.00 per bag of 167 lbs.

JADOO FIBRE.

A new material in which every plant thrives without earth.

5 lbs. 30c.; 10 lbs. 50c.; 25 lbs. \$1.10; bags of 120 to 130 lbs. 3c. per lb.

- - FLORIST AND GARDEN SUPPLIES - -

Mastica Glazing Machine.
Price.....\$1.00

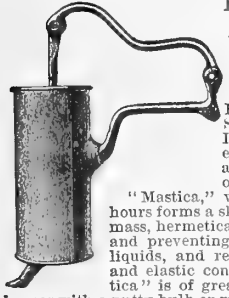

Mastica,
For Glazing Greenhouses, Sashes, etc., new and old. It is elastic, adhesive and easily applied; it is not affected by dampness, heat or cold.

"Mastica," when applied, in a few hours forms a skin or film on the entire mass, hermetically sealing the substance and preventing the evaporation of the liquids, and remains in a soft, pliable and elastic condition for years. "Mastica" is of great value in going over old houses with a putty bulb or machine on the outside of sash, as it makes it perfectly tight and saves the expense of relaying the glass.
Price, 1/2-gal..... \$.75
1-gal..... 1.25
5-gal..... 5.75

Unglazed Hot-Bed Sash.

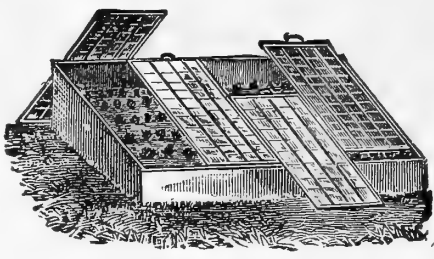

Price, 75 cents.

Hot-Bed Mats.



Made of strong Burlap, interlined with wool, 40 x 76 in. Price 75c. each. \$8.50 per dozen.

VanReyper's Glazing Points.

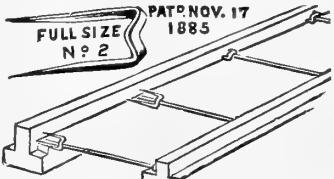

The finest glazing points on the market; the glass cannot slip; they are quickly and easily put in with special pincers; no "rights" and "lefts" to bother with. Price, per box of 1,000, 60c., or by mail, 75c. " in lots of 5,000, by express, 55c. per 1,000. Pincers, price per pair, 50c., or by mail 60c.

Rattan Hot-Bed Mats.

These are the most durable yet introduced, and will probably supersede all others when their merits are known. Size 72 x 74 in., covering two frames.
Price, \$2.00 each. \$21.00 per doz.

Brass Garden Syringes.
OUR SYRINGES ARE THE BEST MADE.

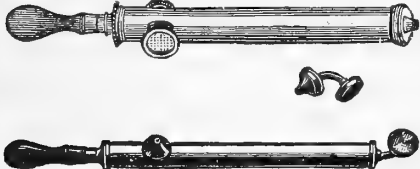

Barrel 16 in. x 1 1/2 in. diameter.

- No. A, Barrel 12-in. long, 1 spray and 1 stream rose..... \$2.25
- " 12, Barrel 13-in. long, 1 coarse and 1 fine spray and 1 stream rose..... 3.75
- " 2, 2 sprays, roses and jet, 14 1/2 x 15-16 in..... 4.25
- " 10, Barrel 18-in. long, 1 coarse and 1 fine spray and 1 stream rose with patent valves and elbow joint..... 6.00
- " 1, 1 stream, 2 sprays, 15 x 1 1/4 in..... 2.50

Plant Bed Cloth.

A cheap substitute for glass, and will keep out many degrees of frost. Also useful for shading material. Samples mailed on application.

Light grade, 4c. yd.; piece of about 65 yds., 3 1/2 c. yd.
Medium " 8c. " " " 60 " 7c. " "
Heavy " 11c. " " " 40 " 10c. "

Ironlad Watering Pots.



WITH ADJUSTABLE NOZZLES.

- 4-quart..... \$.50
- 6 "65
- 8 "75
- 10 "90
- 12 " 1.10
- 16 " 1.25

WORTHESPOON MAKE.

- 6-quart..... \$1.75
- 8 " 2.00

Plant Sprinklers.



For sprinkling cut flowers, seedlings, plants, clothes, etc:
Medium size..... \$.60
Large size..... 85c. and 1.00
By mail, 10c. extra.

Garden Boxes.

Price..... .20, 25 and 30c. each.

Raffia.

The best material for tying plants, vines, etc.
Per lb., 20c. 10 lbs., \$1.50.
SILKALINE, spool..... 20c.

Sphagnum Moss.

For packing growing orchids, plants, trees, etc.
Per barrel..... \$ 1.25
Per bale..... 2.50

Stable Brooms.

For stables, lawns and walks.
Price, with handle..... 60c.

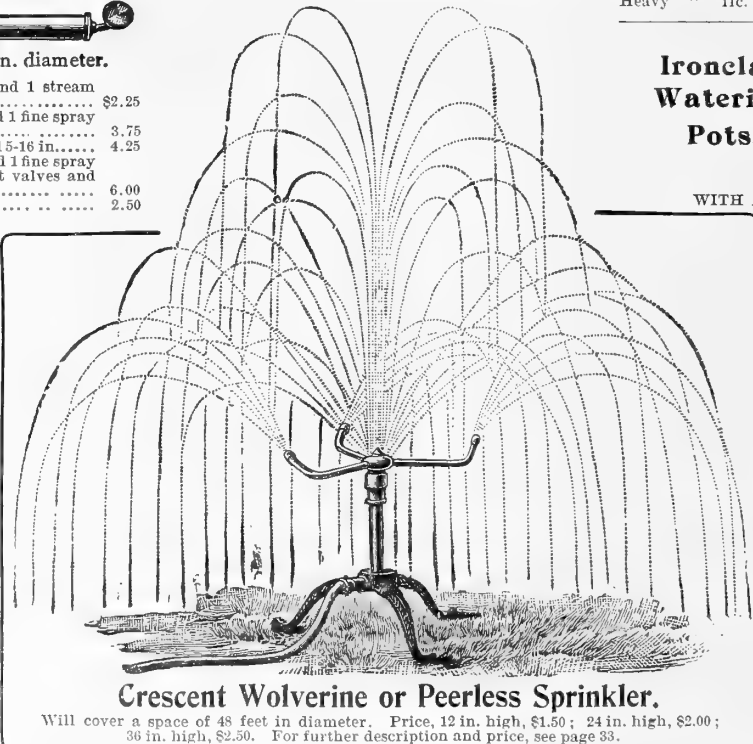

Crescent Wolverine or Peerless Sprinkler.

Will cover a space of 48 feet in diameter. Price, 12 in. high, \$1.50; 24 in. high, \$2.00; 36 in. high, \$2.50. For further description and price, see page 33.



Putty Bulbs.

Price..... \$.90
Price by mail..... 1.00

Grafting Wax.

- 1/2-lb..... 10c.
- 1-lb..... 20c.
- 1-lb..... 35c.

Acme Powder Gun.



Is a simple, practical instrument for exterminating all kinds of insects, bugs, flies, etc. It will handle all insecticides in the dry state—Pure Paris Green, Hellebore, Persian Insect Powder, etc. It is very effective in the destruction of potato bugs, currant worms, and all like pests, and for the wholesale destruction of house flies, using freshly ground insect powder, cannot be excelled.

Price..... 75c.

Liquid Atomizer.

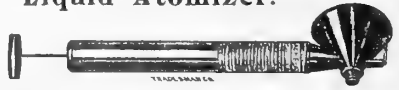

For spraying Paris Green and other insecticides on potato plants, shrubs, small trees, house plants, live stock and poultry. For potatoes: put one rounding tablespoonful of poison into the can, fill with water and thoroughly agitate. Should action of valve become weakened from wear, take out the two screws at end of tube; draw out plunger and wrap twine around bevel edge of wood washer, spreading leather with fingers; keep plunger well oiled; funnel is for filling only.

- Price, Brass Tank, Double..... \$1.00
- " " Single..... .70
- " Tin "50

FLORIST AND GARDEN SUPPLIES.

CONTINUED.

THERMOMETERS.

Tin, Japanned, 7 inch.....	\$.15
10 Inch Distance Reading Thermometer.....	.25
Boxwood, fine finish, red spirit.....	1.00
Plain metal, brass finished.....	.50
Dairy or hot-bed, glass, floating.....	.25
Glass, floating, large.....	.50
Eight-inch Dairy, stands boiling water.....	.50
Mushroom bed, or hot-bed, with brass end.....	1.00
Mushroom bed, or hot-bed, with brass end, extra good.....	1.50
Porcelain scale, red spirits.....	1.00
New Incubator Thermometer.....	.75
Stands in tray between the eggs and can be read without opening drawer.	
By mail, add 5 cents each.	

LIGHT PLANT STAKES.

	Each.	Per doz.	Per 100.
1½ feet.....	\$.02	\$.15	\$.80
2 feet.....	.03	.25	1.40
2½ feet.....	.05	.38	2.00
3 feet.....	.05	.46	2.75

HEAVY OR DAHLIA STAKES.

	Each.	Per doz.	Per 100.
3 feet.....	\$.06	\$.67	\$3.85
4 feet.....	.08	.88	5.15
5 feet.....	.10	1.10	6.40

CANE STAKES.

5 to 7 feet long.....	Per 100, \$1.00.	Per 1,000, \$7.00
-----------------------	------------------	-------------------

POT LABELS.

	Plain.	Painted.
3½ inch, per 1,000.....	\$.45	\$.60
4 " " ".....	.50	.65
4½ " " ".....	.55	.70
5 " " ".....	.65	.90
6 " " ".....	.75	1.00
12 inch, per 100.....	50 cents.	

PAINTED TREE LABELS.

3½ inch, Notched or Pierced.....65 cents per 1,000.

OUT OF SIGHT MOLE TRAP.

Considered to be one of the best and cheapest Mole Traps on the market. Especially valuable for hot-beds and frames on account of its convenient size. Price.....\$1.25



Showing Position of Trap When Set, With Mole Approaching.

THE MODEL MOLE TRAP.



This, while possessing all the good qualities of other traps is especially adapted for setting under glass. Price, \$1.75

OUR NEW MOLE TRAP.

This is a good Mole Trap for the money. Price, \$1.00

UNPAINTED STAKES OR DOWELS.

Long.	Diameter.	Per Doz.	Per 100.	Per 1,000.
36 inch.....	¼ inch.....	\$.15	\$.75	\$4.50
42 inch.....	½ inch.....	.20	.85	5.00
44 inch.....	¾ inch.....	.25	1.00	6.00

CALVANIZED HARD STEEL PLANT STAKES.

These are a great improvement over wooden stakes for Carnation and Rose beds, as they are durable, neat and strong.

	Per 100.	Per 1,000.
2½ feet long.....	\$.60	\$5.00
3 feet long.....	.75	5.50
3½ feet long.....	.90	7.00
4 feet long.....	1.00	8.50
5 feet long.....	1.15	10.00

HORTICULTURAL TOOLS.



This cut represents one of the best Trowels ever offered to the trade. It is made of forged steel, strong and durable. English, 6 inch, 40 cts.; 7 inch, 50 cts. American, No. 3090, 35 cents. Cheap wood handle Trowels, 5 and 10c. each. If trowels are wanted by mail, send 10 cents additional for postage.

CLEVES' TROWEL.



THE NEW GARDEN IMPLEMENT.
No. 1—Standard, 8-inch blade, 25c.; mailed, 35c. each.
No. 2—Medium, 7-inch blade, 20c.; mailed, 30c. each.
No. 3—Daisy, 5-inch blade, 15c.; mailed, 20c. each.

ALL STEEL TROWEL.



Very strong and durable, Price, 15c. Full Tinned Malleable Trowel, 10c. Mail, 10c. extra.

EUREKA HAND WEEDER.



A very handy and useful little instrument. Short handle, 25c. Long handle, 35c.

DIBBLE.



Dibble.

For transferring plants. By far the best thing for the purpose ever introduced.

Straight, made of Tubular Steel..... 1.00
Right-angle Shape, Steel Polished, Wood Handle. ... 40

GARDEN REELS.



Small size.....\$.75
Large size..... 1.00

LARGE HAND WEEDER.



Large size..... 15c.
Small size..... 10c.
By mail, 10c. extra.

EXCELSIOR WEEDER.



Price, 10c.; Mailed, 15c.

FRUIT PICKER.

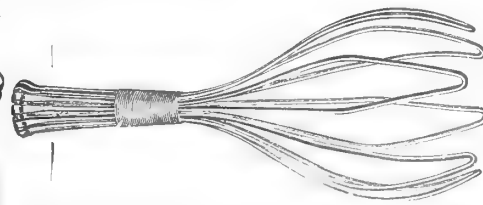

First class for picking fruit, particularly when wishing to select ripest without interfering with immature specimens. Price.....50 cents.



NOVELTY LIFTING WEEDER.

A Chisel Blade cuts off the weeds; the trigger holds them so they can be pulled out. Each, \$1.00.

ALL PRICES SUBJECT TO CHANGE WITHOUT NOTICE.

HORTICULTURAL TOOLS.

CONTINUED.

ASPARAGUS KNIFE.—Fig. 1.

Made of solid steel.....30c. By mail.....45c.

ASPARAGUS BUNCHER.

Price.....\$1.50

BUDDING KNIVES.—Fig. 4.

Price.....No. 12, 75c.; No. 10, \$1.00

EDGING KNIVES.—Fig. 12.

9 in. American.....\$ 50	9 in. Eng., all Bright.....\$1.50
8 in. Eng. Blk.....1.10	10 in. Eng. Blk.....1.50
8 in. Eng., all Bright.....1.25	10 in. Eng., all Bright.....1.75
9 in. Eng. Blk.....1.25	

FLOWER AND GRAPE SCISSORS.—Fig. 11.

Flower Scissors.....75c. Grape Scissors.....65c.
5 cents extra for postage.

GRASS HOOKS.—Fig. 2.

American.....25c.
German, No. 6, 20c.; No. 1, 25c.; No. 2, 35c.
Best Eng. Grass, No. 2, 40c.; No. 3, 50c.
Best Eng. Hedge Hooks, No. 4.....60c.
Best Eng. Hedge Hooks, No. 5.....75c.

GRASS EDGER.—Fig. 5.

Price, without wheel.....\$2.25
Price, with wheel.....2.75

GRASS SHEARS.—Fig. 10A

Bent Handle, No. 360.....35c.
Trowel Handle, No. 460.....85c.
Mail, add each 15c.

HORSE RADISH CRATER.—Fig. 14.

Price, with perforated tin cylinder \$7.00
Price, with steel pin.....8.00
Machine for power.....14.00

HORSE OR DOG CLIPPERS.—Fig. 9.

Very handy about a horse; also for Clipping Dogs.

Mascot Clipper.....\$1.00
Nickel plated, each.....1.75
Bottom plate.....1.00
Stewart Clipper.....\$1.00
Top plate, each......75
Spring......15

HORSE SCISSORS.

No. 9162.....\$1.25
Mail, add 15c.

HORSE SHEARS.—Fig. 19.

Bent Handle, No. 1087.....50c.
Curved Handle, No. 1090.....60c.
By mail, add 15c.

LAWN SHEARS.—Fig. 6.

2 wheels, 8 in. blade, for cutting on narrow borders, under fences and shrubs.....\$2.75

HAY KNIVES.

Lightning.....\$1.25
American Sickle Edge.....1.50

HEDGE SHEARS.—Fig. 3.

8 inch.....\$1.25 10 inch.....\$1.75
9 inch.....1.50 12 inch.....2.25
With Notch 25 cents extra.

LOPPING SHEARS.—Fig. 7.

Balto. Draw Cut Lopping Shears.....\$2.50
American Shears, No. 1......90
American Shears, No. 2.....1.25
American Shears, No. 5.....1.00

PRUNING SHEARS.—Fig. 8.

No. 1, Malleable Pruning Shears, with steel blade.....50c.
No. 2, Malleable Pruning Shears, with steel blade.....60c.
9 in. Solid Steel Pruning Shears.....\$1.25
Full polished pruning shears.....1.00
6 in. nickel plated Ladies Flower Shears.....75c.

NEW VINEYARD PRUNING SHEARS.

These have been recently introduced among the vineyardists and have met with great favor. Price.....\$1.25

PRUNING KNIVES.—Fig. 4.

Prices.....No. 126, 50c.; No. 2173, 65c.

PRUNING SAWS.—Fig. 18.

16 in.....70c.
18 in.....80c.
20 in.....90c.
Saw and chisel, combined.....\$1.10

SCUFFLE HOES.—Fig. 15.

4 inches.....50c.
6 inches.....60c.
8 inches.....70c.
10 inches.....80c.

SCYTHES.

American.....\$ 60
Best American.....75
Bush or Brier Scythes.....65
English T. Waldron.....36 in. \$1.35; 38 in. \$1.40; 40 in. 1.45
American Grain.....1.00
English Waldron Grain.....50 in. \$1.75; 52 in. \$1.90; 54 in. 1.90

SCYTHE STONES.—Fig. 16.

No. 1—Willoughby Creek.....10c. each, \$1.00 per doz.
No. 2—White Mountain.....10c. each, 1.00 per doz.
These are far superior to Darby Creek and not so easily broken
No. 3—Green Mountain.....8c. each, 75c. doz.
No. 4—Indian Pond No. 2, (red end).....5c. each, 50c. doz.
No. 5—Moving Machine (beveled).....10 c. each.
No. 6—Darby Creek.....10c. each, \$1.00 doz.
Cigar Emory.....10c. each, \$1.00 doz.
No. 7—Imported English Talacre.....20c. each.
None genuine unless labeled Sir Fyers Mostyn, Talacre Quarries.

TELEGRAPH TREE PRUNERS.

Price, without pole.....\$1.15
Extra blades.....25c.
Little Giant Pruning Hook and Saw.....1.75
Extra springs.....25c.

WATERS' TREE PRUNERS.—Fig. 17.

4 feet long.....\$ 75
6 feet long.....85
8 feet long.....95
10 feet long.....1.00
12 feet long.....1.10
Extra knives, 20 cents.

WIRE PLIERS.

Combination Wire pliers.....\$1.50
Fence wire cutters, 8 in. 50c.; 10 in. 75c.
SHEEP SHEARS.—Fig. 10.
No. 3749.....\$ 75
No. 3755.....1.00
By mail, add 15 cents.



Fig. 2.

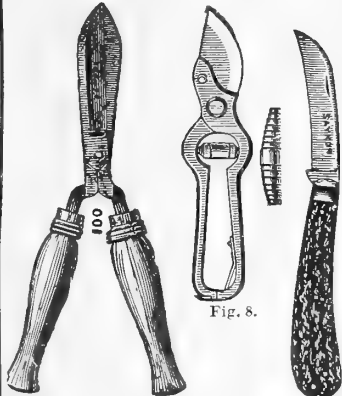

Fig. 8.

Fig. 4.

Fig. 3.



Fig. 5.

Fig. 6.

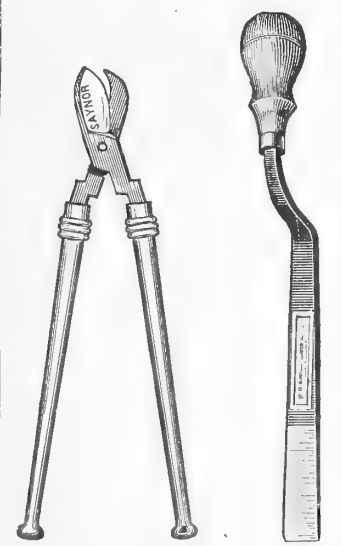

Fig. 7.

Fig. 1.

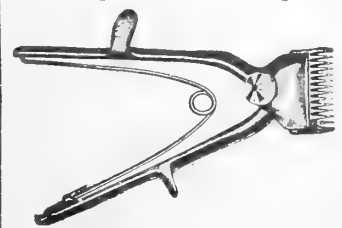

Fig. 9.

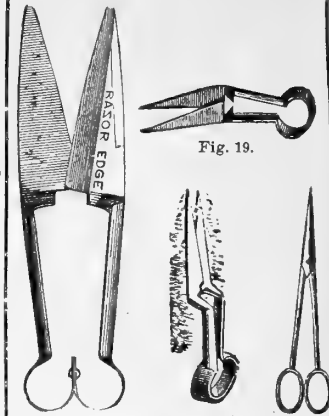

Fig. 19.

Fig. 10.

Fig. 10 A.

Fig. 11.

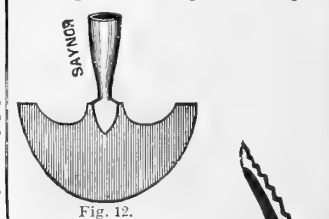

Fig. 12.

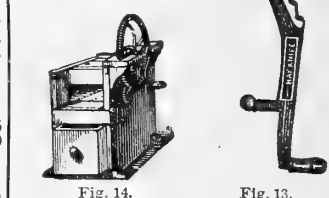

Fig. 14.

Fig. 13.

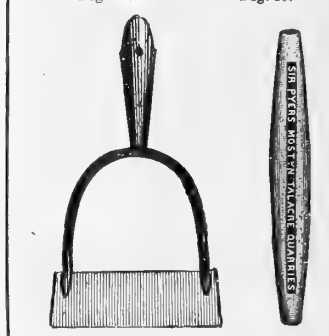

Fig. 15.

Fig. 16.



Fig. 17.



Fig. 18.

SPRAY PUMPS, NOZZLES, ETC.



No. 327

LITTLE GIANT.

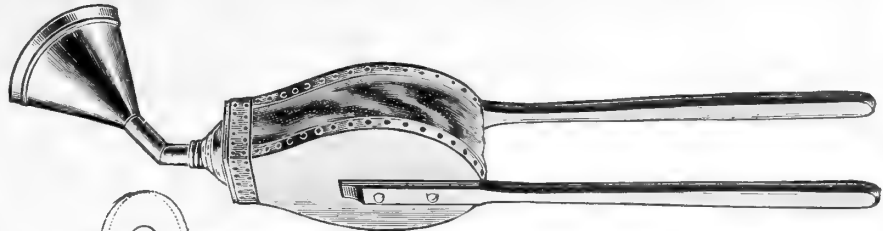

No. 334



Nos. 332 & 333



Nos. 332 & 333

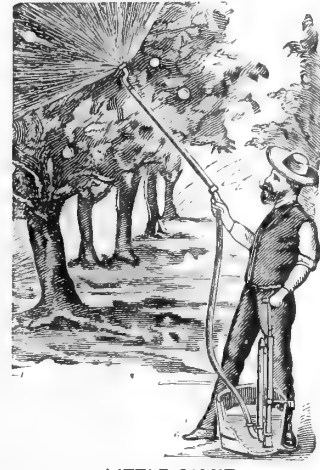

LITTLE GIANT

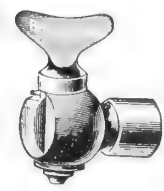

BORDEAUX No. 336

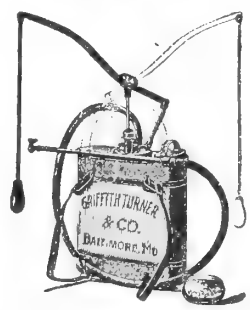

Nos. 330 & 331



No. 335

Little Giant Bucket Brass Spray Pump and Fire Extinguisher, with Agitator.

This Spray Pump is constructed entirely of brass, a material that is not affected by the poisonous arsenites used in different formulas for spraying fruit trees, vines and shrubbery. It is so arranged that the labor of pumping is all done on the downward stroke of the piston and nothing on the up.

It is provided with a large air chamber, and has a ball valve at the bottom between the cylinder and the air chamber, whereby the pressure is held uniformly in the air chamber and on the hose so that the nozzle throws a continuous spray, and is not affected by the movement of the plunger. The operator is enabled to keep a constant pressure on the nozzle of from 50 to 100 pounds with very ordinary exertion. It will throw a solid stream 50 feet and is of unusual value for washing windows, buggies, and extinguishing fires, sprinkling lawns, flowers, etc. For spraying it is arranged so as to discharge a fine jet in the bottom of the bucket and keep the solution thoroughly mixed and agitated, a feature peculiar to this pump only, and a very necessary feature to a spray pump. The pump is also provided with a sprinkler for flowers.

PRICE LIST OF PUMP SHOWN:

	Retail Price.	List Price.
No. 327 1/2 Bucket Brass Spray Pump with Agitator, complete with hose and combination fine, coarse spray and solid stream nozzle.....	\$2.75	\$5.00
No. 328 Bucket Brass Spray Pump with Agitator, complete with hose and combination fine, coarse spray and solid stream nozzle and an 8-ft. pipe extension.....	3.10	5.50
Vermorel or Bordeaux nozzles, each.....	.60	1.00

No. 334, Acme Powder Gun

Will handle all insecticides in the dry state—Pure Paris Green, Hellebore, Persian Insect Powder, etc. It is very effective in the destruction of Potato Bugs, Currant Worms, House Flies, etc..... Price, 75c.

No. 335, Liquid Atomizer.

For spraying Paris Green and other insecticides on potato plants, shrubs, small trees, house plants, live stock and poultry. A great labor-saver on every farm, and in every garden, barn, greenhouse, orchard and henery. It will apply the finest possible spray on any object desired, and exterminate any kind of insect life. Will not corrode. Easily filled, easily emptied. One can full will poison bugs on 600 to 800 hills of potatoes.

Price, Tin Atomizer.....	\$.50	Price, Brass Gauze, single..	\$.70
" Galvanized, single.....	.55	" " double.....	1.00
" double.....	.65	All brass single and double on application.	

Knapsack Spray Pumps.

The tank holds five gallons, is fitted with lid and strainer, which can be removed. This pump has lever, large air chamber, ball valves, solid plunger and agitator. It is so arranged that no water can drip on the operator. The pump can be easily removed and is fitted with handle so the operator can use it the same as our tank with bucket pump.

	Retail Price.	List Price.
No. 330, Fitted with five feet of 1/2-inch hose, pipe extension and Bordeaux spray nozzle, which can be graduated from a fine mist to a solid stream, or shut off entirely.....	\$6.00	\$10.00
Any other nozzle furnished with these pumps when ordered.		

The Perfect Knapsack Spray Pump.

Is identically the same as No. 330, with the exception that the tank is constructed entirely of copper.

	Retail Price.	List Price.
No. 331, complete with hose, stop cock, pipe extension, and Bordeaux nozzle.....	\$9.00	\$16.00
A first-class outfit at a reasonable price.		

The Fountain Spray Pump.

The above illustrations Nos. 332 and 333 represent the FOUNTAIN KNAPSACK, which is constructed of first-quality galvanized iron, with round corners, built precisely the same as the regular Knapsack with REMOVABLE STRAINER and tight lid. It is fitted with adjustable straps so as to be carried on the back, or it can be carried by bail as shown by dotted lines.

It is tapped at both right and left hand lower corners and fitted with brass female ends to which hose is attached, either one or two strings of which may be used at one time. When one hose only is used the other opening is closed with a metal plug furnished for that purpose.

The HOSE and BULB are made of the best white rubber and wired at end. The VALVES are made of brass and will not corrode; have large openings which permit the free flow of water and shut off instantly when under pressure.

The NOZZLE is made of brass, nickel-plated; has fifty small openings, and throws a spray six feet wide at a distance of twelve feet.

The pump is operated by grasping the bulb in the hand and compressing it, which causes a spray to be thrown any distance from three to fifteen feet, as desired; on relaxing the pressure on the bulb it expands, refilling instantly, when the same operation can be repeated. To shut off flow of water entirely, use valve on hose for that purpose.

We furnish this hose and fixtures to be attached to a barrel or tank placed on a wagon. This is desirable when spraying large fields of cotton or potatoes.

CAUTION.—ALWAYS MIX PARIS GREEN OR LONDON PURPLE IN A SEPARATE VESSEL, FORMING INTO A PASTE BEFORE ADDING THE WATER. In this way everything will be dissolved and will not need to be agitated.

	Retail Price.	List Price.
No. 332, Fountain Knapsack Spray Pump, with one tube, rubber bulb and rose.....	\$3.25	\$5.00
No. 333, Fountain Knapsack Spray Pump, with two tubes, rubber bulbs and roses, to work with both hands.....	4.25	7.00
Extra tube, rubber bulb and rose.....	1.25	2.00

Daisy Force Pump and Sprayer.

For Farmers, Gardeners, Nurserymen, Fruit Growers and Housekeepers. It is indispensable for killing bugs and insects on vines, vegetables, and fruit trees, showering windows, carriages and various other uses. It is double acting, having an air chamber and throwing a constant stream; works with a lever; easy to operate. Has rubber hose. The spray nozzle simple and effective, and when taken off a solid stream is produced. Not liable to get out of order. Plunger is of iron and oiled wood, and valves perfect. Will throw solid stream on ordinary high windows and roofs. Always ready for use.

Price.....	\$1.00
------------	--------

No. 336, Spray Nozzles, Etc.

	Retail price.	List price.
THE BORDEAUX.....	\$.75	\$ 1.00
THE VERMOREL.....	.75	1.00
Combination Nozzles and Hose Coupling.....		15 cents.

The "Advance Age" KEROSENE SPRAYERS.



The Peerless Kerosene Sprayer.

COPPER TANK AND BRASS PUMP.

This outfit has been designed for use in orchard spraying with kerosene for the destruction of scale insects and plant lice. Our Peerless Kerosene Sprayers will accomplish this much needed work of destroying the scale insects easily, cheaply and speedily. The work may be done at any season of the year, and is accomplished in the same manner as in ordinary orchard spraying. An extra suction pipe and our mechanical agitator are furnished with this outfit, so that the kerosene tank, suction pipe, etc., may be removed and the extra suction pipe and agitator used. The outfit then becomes the Peerless Barrel Sprayer for use in the application of the Bordeaux mixture and the arsenites. This outfit is furnished with either iron or brass air chamber, as listed below.

Figure 529.

	Iron Air Chamber— List. Retail.	Brass Air Chamber— List. Retail.
Fig. 529, Pump only.....	\$26.00 \$17.25	\$31.00 \$20.75
Outfit A—Pump with 12½ feet of ½-inch hose and Bordeaux nozzle, with pole connection.....	30.50 20.25	35.50 23.75
Outfit B—Pump with two 12½ feet sections of hose, Bordeaux nozzles and pole connections.....	35.00 23.25	40.00 28.50

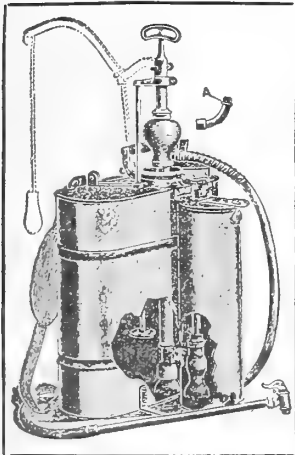

The Weed Kerosene Sprayer.

In this figure we show the outfit as a Bucket Sprayer, the dotted lines showing the handle and lever when in position, when used as a knapsack. It is in effect a Bucket, a Knapsack and a Kerosene Sprayer in one. The kerosene tank is readily detached from main tank and a cap is furnished with which to close the oil inlet. Very simple. Complete with under Sprayer and Agitator.

List.....	\$18.00
Retail.....	14.50

Figure 676.

TO OBVIATE THE OBJECTIONS to the more extended use of kerosene as an insecticide, for several years past the manufacturers have been at work in perfecting some sprayers whereby the kerosene may be mechanically mixed with water during the process of pumping. The kerosene is placed in a separate tank connecting with the pump cylinder by means of a suction pipe. A suction pipe also connects with the water reservoir, so that both kerosene and water are forced through the pump at each stroke of the plunger. The mixing of the liquids takes place partially in the pump, but more largely in the nozzle, where they are divided into the very finest particles in the shape of a mist-like spray. The proportion of oil is controlled by means of a valve in the kerosene tank. This valve is connected with the indicator on the top of the tank by means of a rod.

The figures on the gauge indicate the per cent. of oil to the entire mixture which will be pumped when the indicator is placed at the different per cent. marks. Thus when the indicator points to 0 the valve in the kerosene tank is closed so that pure water will be pumped. By turning the indicator a certain amount, the check valve controlling the oil is allowed to raise a definite height, thus allowing a definite amount of oil to pass into the pump cylinder. The proportion of oil does not vary except as the oil indicator is turned.

EXAMPLE:—To make a mixture containing 15 per cent. oil (the proportion we recommend for general use), it is only necessary to fill the main tank with water and the smaller one with kerosene; turn the indicator to the 15 per cent. mark, and the apparatus is ready for use. A new proportion of oil may be obtained by simply changing the position of the indicator. When the position of the indicator is changed, however, the new proportion will not be obtained until a few strokes have cleared the mixture already in the pump.

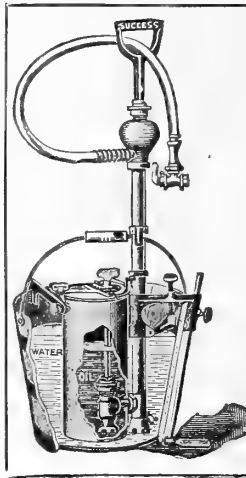

The Success Kerosene Sprayer.

WITH REMOVABLE KEROSENE TANK.

IMPROVED COMBINATION FOOT REST AND BUCKET CLAMP.

The Success Kerosene Sprayer consists of our G. & T. Prize Sprayer with a kerosene attachment. The oil tank may be readily removed and a cap, which we furnish, placed on the oil inlet. The outfit then becomes the same as the G. & T. Prize Bucket Sprayer.

The operation and uses of the kerosene sprayers have already been explained, which read carefully. The Success Kerosene Sprayer makes a most convenient article for general use in spraying shade trees, poultry houses and flowers.

Figure 649 has four feet of discharge hose with Bordeaux nozzle.

	Price List.	List. Retail.
Fig. 649, complete, as in cut, Seven-foot section of hose, and couplings, with pole connections.....	\$10.00	\$7.50 1.50 1.25

Figure 649.

TABLE SHOWING USES OF KEROSENE SPRAYERS AND PER CENT. OF OIL REQUIRED.

Position of Indicator showing per cent. of oil.	Uses of the different proportions of oil.
0.....	Pure water will be pumped when the oil valve is closed.
5.....	Seldom used.
10.....	Mealy bugs, scale insects and plant lice on tender plants. Horn flies on Cattle. <i>Will not injure the foliage on tender plants.</i>
15.....	Scale insects and plant lice of all kinds, except on tender hot-house plants. All caterpillars exposed on leaves, cabbage worms, ants, chinch bugs on corn. <i>Will not injure ordinary foliage.</i>
20.....	Scale insects and plant lice not killed by 15 per cent. of oil. Lice on cattle, dogs, horses and poultry. Mites in poultry houses. <i>Will rarely injure ordinary foliage.</i>
30.....	Lice on hogs. Fleas on cats, dogs, etc. <i>Cannot be used on foliage without injury.</i>
40.....	Ticks on cattle.
50.....	For the winter treatment of scale insects.

The Field Sprayer.

For spraying Potato Plants, Strawberry and Cotton Plants, Small Nursery Stock, etc.

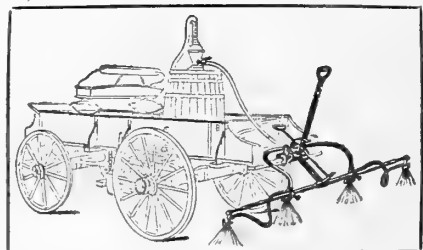

THE Potato Spraying Appliance shown in the accompanying cut is intended to be attached to any Barrel Sprayer. The outfit may be placed on the end of a wagon or truck, and the two sections of hose connected with the spray pump. The four Bordeaux Nozzles are adjustable for any width of rows, from 30 to 40 inches, and may be raised or lowered as desired. The nozzles should be directly over the rows to be sprayed. The nozzle holders may be brought together so that the wagon can pass through any gate.

The machine has a long arm, used for setting the row of nozzles at a higher or lower point, the small rod, with handle, being for the purpose of turning the nozzles at a different angle with the ground. Will spray backward or forward at an angle of 45 degrees, having a movable radius of 90 degrees, the entire change being controlled from the wagon.

Attachable to any Wagon and Barrel Sprayer.

Price, Retail, \$10.50.

Water Carts or Trucks, and Combinations.

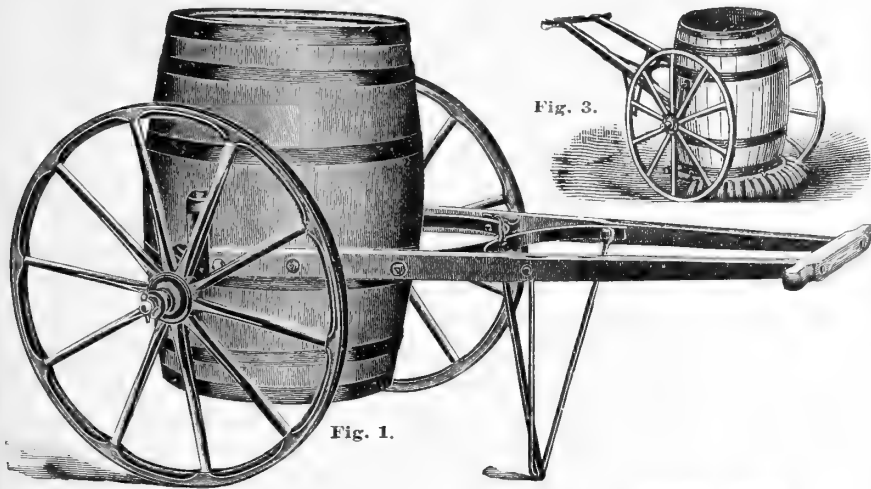

Fig. 1.

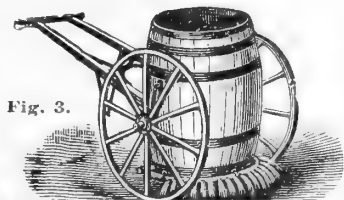

Fig. 3.

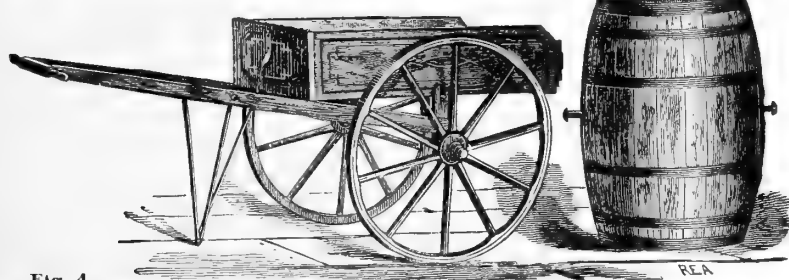

Fig. 4.



Fig. 2.



Fig. 6.

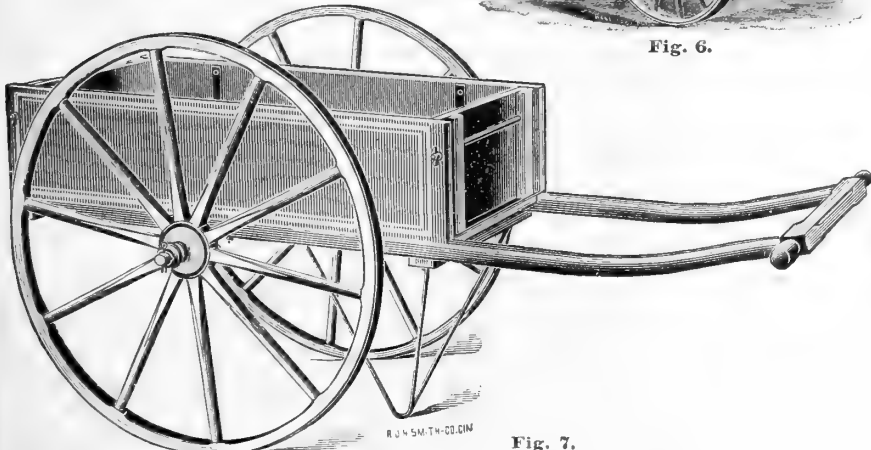

Fig. 7.

Fig. 1 shows Truck and Barrel.
 Fig. 2 shows Truck with Leaf Rack Attachment.
 Fig. 3 shows Truck and Barrel with Sprinkler Attachment.
 Fig. 4 shows Truck and Box.
 Fig. 5 shows Gem Spray Pump.

PRICE LIST.

	List.	Retail.
Water Truck.....	\$10.00	\$6.00
Water Truck and Barrel.....	13.60	8.25
Water Truck and Box.....	13.60	8.25
Water Truck, Barrel and Box.....	17.20	10.50
Gem Spray Pump Attachment.....	9.00	5.00
Sprinkling Attachment.....	4.00	3.00
Leaf Racks.....	7.00	4.00
New Barrels.....	3.60	2.25
Box.....	3.60	2.25

Trunnions, per pair, 50c.
 For 2 1/2 in tires on trucks, add to the above price Retail, \$1.00. List, \$1.50.
 For 4 in. tires on trucks add to the above price Retail, \$1.50. List, \$2.00.

EXTRA TRUCK WHEELS.

	List.	Retail.
Regular Tire.....	\$3.00	\$2.00
2 1/2 inch Tire.....	4.00	2.50
4 inch Tire.....	4.50	2.75

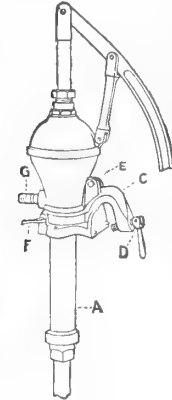

Fig. 1.— This Fig. represents our Barrel Cart, to which can be attached the "Gem" Brass Spray Pump (Fig 5.) This is a convenient combination, and may be found useful in various ways, such as watering gardens, spraying fruit trees, etc.
 The Barrel Cart and Pump may be ordered separately and arranged together to suit the purchaser. The Barrel Cart may be wheeled about when filled with water, to supply sprinkling cans for watering flowers and vegetable gardens. When the running gear or truck is ordered without barrel, the trunnions may easily be fastened to any good water-tight barrel by any person with ordinary mechanical ability.

Key to Detail Engraving of Gem Spray Pump.

- A—Brass Cylinder of Pump.
- B—Suction Pipe and Strainer.
- C—Main part of Barrel Clamp.
- D—Wrench or Clamping Screw.
- E—Bolt holding Clamp to Pump.
- F—Thumb Screw holding Pump in Barrel Clamp.
- G—Discharge of Pump.

Fig. 5. Gem Spray Pump.

The Miller Junior Sprinkling Carts.

Fig. 6.— This Cart is adapted for use in cemeteries, parks, private grounds, flower and truck gardens, and can be used for sprinkling or for carrying water. The barrel holds 160 gallons, and is mounted on two wheels with 4 inch tires. The wheels are 4 feet 6 inches center to center, and 4 feet 6 inches high. The axle is of solid steel, 1 1/2 inches thick. The Sprinklers are brass, and controlled by the driver, he being able to throw to the right or left or both sides at the same time, and the Sprinklers are so arranged that the spray can be made very wide or very narrow and of any desired width. The water issues from an adjustable slot, and will pass such small obstructions as may be found in manure water. The barrel is fitted with a faucet, to which 3/4 inch garden hose can be attached. The cart is in every way first-class.

Prices: f 875.00 f. o. b. factory.
 f 85.00 f. o. b. Baltimore.
 (Prices for Street Sprinklers furnished on application.)

Baltimore Push Cart.

Fig. 7.— For the merchant, printer, farmer, etc., to have one of these carts on his premises it will be found a most useful vehicle. There are so many purposes for which they can be employed—carrying bundles, printers' forms, farmers tools and light implements, etc. It is never out of place, and always ready to pick up short notice. They are nicely finished; higher wheel better ironed and altogether superior to anything its kind on the market. There is now an immense demand for these carts, but notwithstanding placed the price f w

Prices: f Retail..... \$ 7.50
 f List..... 13.50

Matthews' *New Universal* Garden Drill.

ONE OF THE STANDARD DRILLS OF AMERICA.

SIMPLE IN CONSTRUCTION. NEAT IN DESIGN. EFFICIENT IN OPERATION. NONE BETTER CAN BE PROCURED.

Medals and testimonials confirming the superiority of the "Matthews" have been repeatedly bestowed upon it from all quarters, and as it has been improved from time to time it has always been acknowledged **one of the most perfect drills made.** The present form is the neatest and simplest yet produced, and cannot fail of proving an even more popular modification of this reliable drill.

Our retail price \$ 6.50 List price..... \$ 8.00

The Seeding Device.

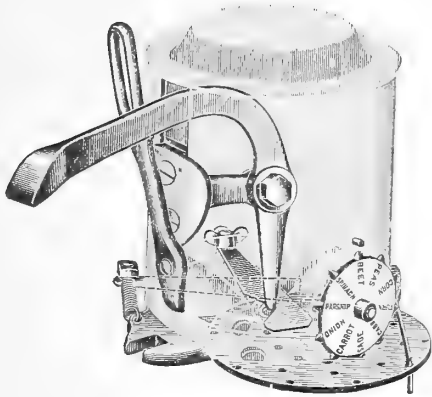

PATENT SEED INDICATOR USED ON ALL GENUINE DRILLS.

Seeding can be regulated to exact quantity desired.



The Seeding device employed on all Matthews' Seeders is set forth in the accompanying illustration, showing transparently the solid wall of the seed box. The indicator, which is also shown above, has the names of the various seeds plainly marked upon it. The dial has a separate hole for each kind of seed, which registers in the centre of the hole in bottom of seed box. The hole in the dial may be gauged to a nicety by means of the regulator, held by a thumb screw. To lead the seed to the central opening there is provided a corrugated and shouldered bottom, which admits of dropping any quantity of seed, even to a **single paper.** The feed is practically a force feed. No other device ever met with the success of the agitator. Principally for dropping all the small garden seeds. The seed is not bruised or damaged by the agitator. The manual cut off indicated in the illustration by the dotted lines, with its spiral spring connection, is worked from the handle by a wire, and the flow of seed may thus be instantly checked. No seed need be wasted in turning rows.

Matthews' *New Universal* Model Hill and Drill Seeder.

This implement is the same in style and working qualities as the one just described, but is arranged so as to drop the seed continuously in drills or at distance of 4, 8, 12, 16, 24 and 48 inches apart. The adjustment from drills to hills is made by one screw in attaching a brass cut-off to the agitator. The distance apart is regulated by the number of cogs on the driving wheel against which the agitator strikes. The seed cannot drop except when the hole in the bottom of seed box is opened by the agitator striking a cog on the wheel, and it immediately closes again as the agitator drops. This saves seed, as no more need be dropped at a time than is desired, no matter what the distance may be. There are no parts to wear or get out of order. If this implement is wanted be sure and order the "Hill and Drill Seeder," as the regular garden drill cannot be fitted with the attachments. Our retail price, \$7.25. List price, \$9.00.

The manufacturers of this line do not make a Hill and Drill Seeder with cultivating attachments, and we would recommend as far preferable, one of the above separate drills and a separate single wheel hoe complete, with all the attachments, for which our retail price covering the two separate implements is only, \$11.75.

Matthews' *New Universal* Combination Drill.

WITH HOE, CULTIVATOR, PLOW AND RAKE ATTACHMENTS.

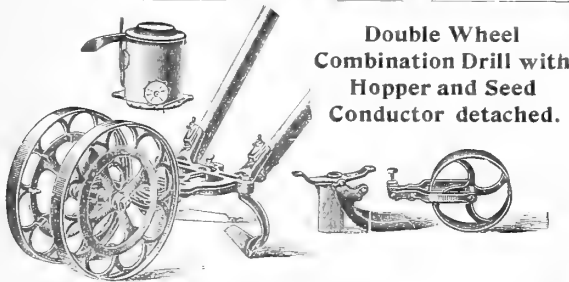

Double Wheel Combination Drill with Hopper and Seed Conductor detached.

Can be used as a
ONE WHEEL } Seeder, Cultivator,
 or } Hoe, Plow,
TWO WHEEL } Rake, Marker

Loosening one thumb screw removes all Seeder Attachments, leaving frame clear for Cultivating Attachments.

Retail Price, \$ 8.50
 List Price, : 10.50



This is not only a desirable combination of the Garden Drill already described with the New Universal Cultivating attachment, but it has the advantage of having either a double wheel or single wheel implement at will, the change from one to the other being readily made.

The use of a one wheel seed sower insures the nicer work, as if two wheels are used an obstruction under one wheel or the other has a tendency to crook the rows, and this makes after cultivation harder. The operator always has a one wheel seeder under full control, and in addition the single wheel follows in the mark made when planting the previous row and presents a sight to keep the rows straight.

The two wheels are desirable, however, when used as a cultivator or wheel hoe, as in this way the rows of young plants may be straddled and the cultivating done on both sides of the row at one passing. The seeding and covering attachments can be readily removed when the implement is used for cultivating. It is not necessary to remove the seed box, but it can be taken off if desired. The combination is one which cannot fail of recommending itself to all. The attachments are—

- ONE (1) PAIR HOES. FIVE (5) CULTIVATOR TEETH. ONE (1) PAIR RAKES. ONE (1) PAIR PLOWS.

Extracts from Prof. S. B. Green's report in Bulletin No. 38 of Minnesota Experiment Station, as published in the "Market Garden" for March, 1895.

"During the past year I have made a special study of garden implements best adapted for garden use. The (New Universal) Combination Drill and Cultivator is arranged to use either one or two wheels. The indicator is very simple in construction and easily handled. The agitator is sure to keep the seed moving through constantly. The depth of sowing can easily be regulated. The marker is well adapted for giving a clean track for successive rows, and is easily changed to different widths. A convenient cut-off is provided to use when turning at the ends of the rows to prevent loss of seed. The change from the drill to the cultivator can be made very quickly. For working the soil it has hoes, plows, rakes and cultivator teeth of good shape and size. It can be used successfully to open or close furrows. The machine is adapted to working on both sides of a single row with two wheels or between the rows. The manufacturers recommend for market gardeners instead of this combined implement, separate implements to save the time of changes.

"The New Universal hand double wheel hoe, cultivator and plow is an implement of recent introduction having all the latest improvements. It contains a handy feature in the adjustable arch by which the depth of the cultivator teeth may be regulated. It may be used to work between the rows or to straddle one row."

Our Retail Price, \$8.50. List Price, \$10.50.

Send for Special Implement Catalogue Containing full description of all New Universal and Matthews Tools.

ALL PRICES SUBJECT TO CHANGE WITHOUT NOTICE.

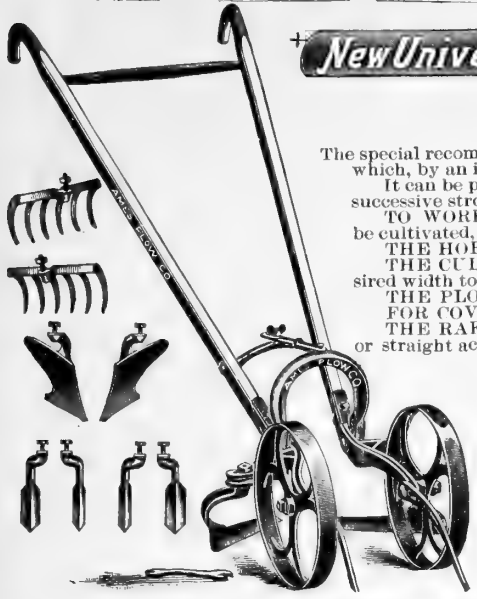

**New Universal Hand Double Wheel Hoe, Cultivator
Plow and Rake.**

The special recommendation is the Adjustable Arch, by which not only the depth of work can be gauged, but which, by an ingenious device, enables the teeth to be pitched at any angle desired.
 It can be pushed straight ahead, but better results are obtained by using it same as a scuffle hoe, with successive strokes of length to suit the nature of soil and crop.
TO WORK BOTH SIDES of a row at one passing, the attachments can be set to suit width of crop to be cultivated, keeping row midway between wheels.
THE HOE BLADES can be set to turn in or out, as desired by the operator.
THE CULTIVATOR TEETH.—Four are furnished with each. Two cultivator teeth can be used at desired width to mark out rows.
THE PLOWS.—For furrowing they can be set close together and turn outward.
FOR COVERING, set to width desired, and turn inward.
THE RAKES.—For fine cultivation and other uses of an ordinary rake. They can be set angling or straight across.

The depth can be regulated by adjusting wheel arms in the three holes provided on each side of Arch. The depth can also be regulated by pitching the Arch by means of the Arch Brace and the Thumb Bolt, where it connects, to lower Handle Brace.
THE LEAF GUARDS are to prevent wheels from injuring large, spreading foliage.

THE ATTACHMENTS ARE

- | | |
|---------------|----------------------------|
| 1 Pair Hoes. | 1 Pair Narrow Cultivators. |
| 1 Pair Plows. | 1 Pair Wide Cultivators. |
| 1 Pair Rakes. | 1 Pair Vine Guards. |

Specially designed for working both sides of the row at one passing.

Our Retail Price, \$5.25
 List Price, 6.50

New Universal Expansion Double Wheel Hoe, Cultivator Rake and Plow.

This Implement has the same attachments as the Double Wheel Hoe already described, but has Steel Arch and Rocking Adjustment same as HIGH ARCH HOE illustrated below.

Retail Price, \$6.50 List Price, \$7.50

New Universal High Arch Expansion Wheel Hoe, Cultivator, Rake and Plow.

In this new implement the manufacturers have practically reproduced dimensions and purpose of their first attempt at a "Straddle-Row" Weeder. The wheels are 12 inches in diameter, and the arch high enough to cultivate over plants 20 inches or more in height. The Double Wheel Hoe meets all requirements, but we here present if possible a more complete implement of larger size.
 The Adjustable Arch affords means for regulating depth, and for setting pitch of teeth, a very valuable feature in using the Hoe Blades. It also admits of use of implement by either man or boy.
 Expansion Pads or Tooth Holders, are provided so any width of cultivation may be attained, from the narrowest up to 20 inches wide.
 One wheel is preferred by many when in use as a "between row" cultivator, and for this purpose is provided the CENTRE ATTACHMENT, consisting of Wheel Scraper and Tooth Holder.

The Attachments for HIGH ARCH WHEEL HOE are:

- 1 Pair Long Bladed Hoes.
- 1 Pair Short Bladed Hoes.
- 1 Pair Narrow Cultivators.
- 1 Pair Wide Cultivators.
- 1 Centre Cultivator.
- 1 Pair Plows.
- 1 Pair Rakes.
- 1 Pair Vine Guards.
- 1 Centre Tooth Holder.

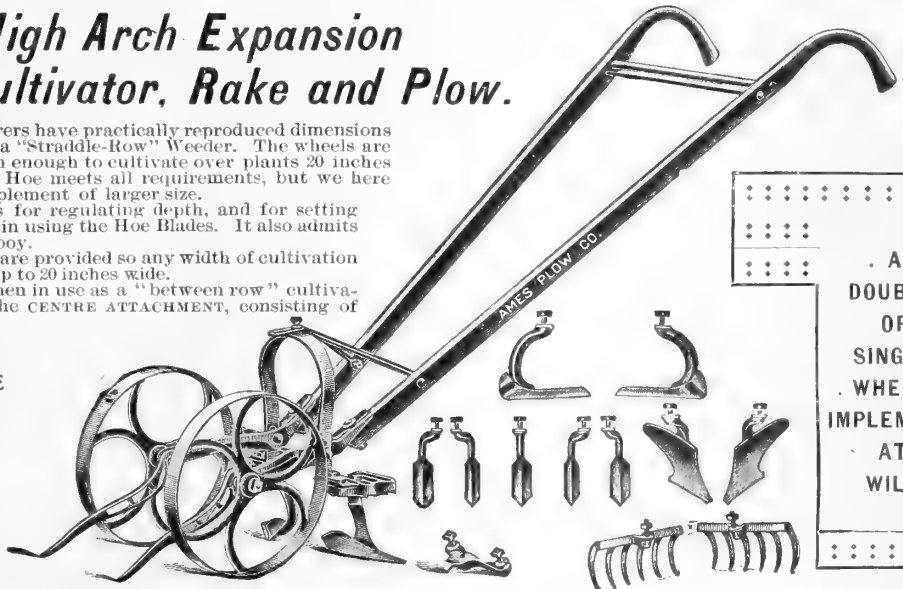

A DOUBLE OR SINGLE WHEEL IMPLEMENT AT WILL

Retail Price, \$8.00 List Price, \$9.50 With Hoe Blades only, Retail, \$5.25 List, \$6.00.

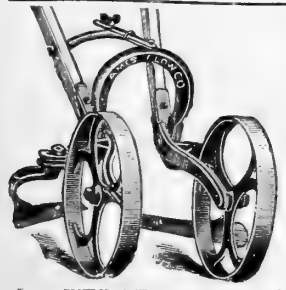

New Universal Hand Double Wheel Hoe, WITH HOE BLADES ONLY.

As seen in the cut, this is the same implement as above, but without the extra attachments for those who have no occasion for more than the blade attachments.

Retail Price, \$3.50 List Price, \$4.25

EXPANSION DOUBLE WHEEL HOE, with Hoe Blades only, same as above, except it has the Steel Arch..... Retail Price, \$4.50 List Price, \$5.25

SEND FOR SPECIAL IMPLEMENT CATALOGUE CONTAINING FULL DESCRIPTION OF ALL NEW UNIVERSAL AND MATTHEWS TOOLS.

ALL PRICES SUBJECT TO CHANGE WITHOUT NOTICE.

New Universal Model Gem Seed Drill.

This has been perfected to meet the demand for a low-priced drill. This is not only accomplished in this design, but we here offer a drill with all the essential qualities of the Matthews principle, even to embodying seed dial and indicator, from exactly same patterns as those used on the larger and more expensive drills. It also has a new seed regulator for gauging the exact flow of seed required; seed cut-off for stopping the flow while turning at the ends of rows, and marker adjuster for remarking the rows at any desired distance apart. We do not recommend it for use instead of the larger drills, but we are sure that all in want of such a drill as we represent will find this to be a very valuable implement.

Retail Price, \$5.00 List Price, \$6.25

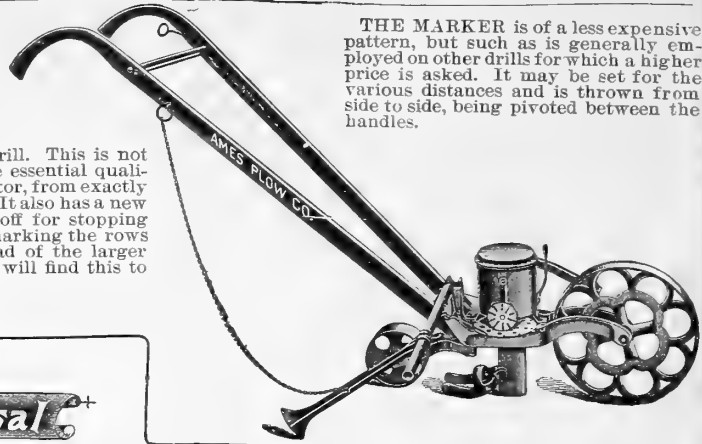

THE MARKER is of a less expensive pattern, but such as is generally employed on other drills for which a higher price is asked. It may be set for the various distances and is thrown from side to side, being pivoted between the handles.

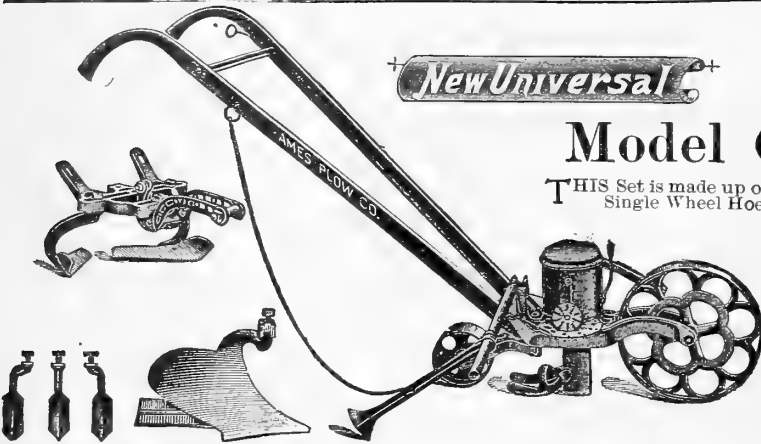

New Universal Model Gem Gardening Set.

THIS Set is made up of one of the Gem Drills already described and one of the No. 2 Single Wheel Hoes, with Cultivator and Plow Attachments.

The extremely low price is made by furnishing the one wheel, and one pair of handles for use with both implements. The change is readily made, as one bolt attaches the wheel, and the handles are held by thumb bolts. A more convenient set certainly cannot be obtained, and the price at which it is offered is one that may be afforded by anyone who plants a kitchen garden.

The Attachments are as per Illustration :

- 1 Pair Hoes. 1 Pair Cultivators. 1 Centre Cultivator.
- 1 Large Plow. 1 Marker.

We furnish all the pieces shown in illustration when this set is ordered.

Retail Price, \$8.00 List Price, \$10.00

New Universal Hand Single Wheel Hoe, Cultivator, Plow and Rake.

AS with the Double Wheel Hoe described, this can be used either between or astride the rows, although it is really intended for between row cultivation. For straddle cultivation the wheel can be set to one side, so as to bring the row of young plants under centre of frame. Later cultivation must be done between rows.

The Attachments are :

- 1 Pair Hoes. 5 Cultivator Teeth. 1 Pair Plows.
- 1 Pair Rakes. 1 Vine or Leaf Guard.

Retail Price, \$4.50 List Price, \$5.75

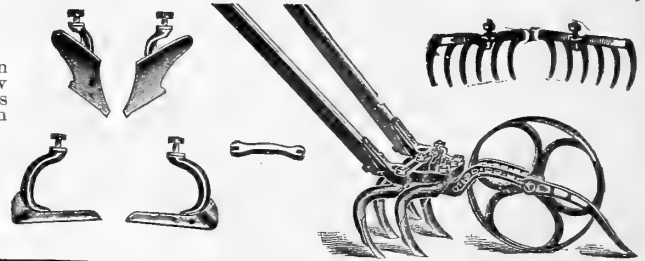

New Universal "Flier" Hand Single Wheel Hoe, Cultivator and Plow No. 2.

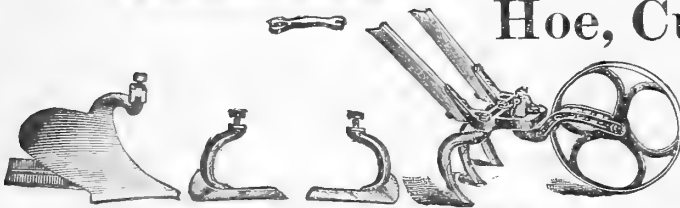

THIS Implement is same as our regular Single Wheel Hoe, except that at this price fewer attachments are furnished. They are :

- 1 Pair Hoes.
- 3 Cultivator Teeth.
- 1 Large Plow.

—If this style is wanted, be sure and order the "FLIER."—

Retail Price, \$4.00 List Price, \$5.00

New Universal Hand Wheel Plow.



This can be used to prepare the ground, to furrow out, to cover and to cultivate. The mould board is of steel, polished and tempered.

Retail Price, \$2.00 List Price, 2.50

New Universal Draw Plow.

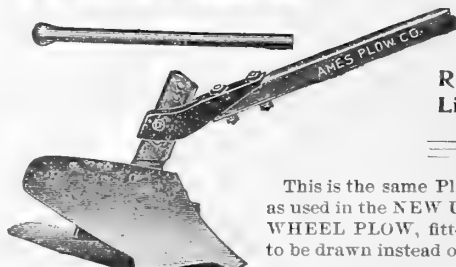

Retail Price, \$1.50 List Price, - - 2.00

This is the same Plow, and is standard, as used in the NEW UNIVERSAL HAND WHEEL PLOW, fitted with long handle, to be drawn instead of being pushed.

Send for Special Implement Catalogue containing Full Description of all New Universal and Matthews Tools.

ALL PRICES SUBJECT TO CHANGE WITHOUT NOTICE.

“IRON AGE” WHEEL HOES AND DRILLS.

Price, \$10.50

The “Iron Age” Combined Seed Drill and Wheel Hoe.



THE cut shows it to be a whole tool house of itself. It is a seed drill, a double wheel hoe, a single wheel hoe, a cultivator, plow and rake. It is converted into a perfect seeder by the drill attachment, which is quickly and easily placed in position, and which is simple in operation, having no gearing, screws or springs to get out of order. The adjustment for various seeds is perfect, the cam index allowing the seed slide to be instantly adjusted to the slightest variation desired. The following cuts showing this same tool in its various operations, gives an idea of its great value in the field and garden.

The “Iron Age” Hill and Drill Seeder.

THE WHEEL is 16 inches high, made of steel, with a two-inch tread. The OPENING PLOW is clog-proof, and can be instantly adjusted. The HOPPER is low, therefore, the delivery of the seed is close to the ground, thus making possible accurate spacing. Capacity, four quarts. The AGITATOR is a revolving bush, which makes it a sure feed, and sows absolutely all of the seed accurately, and without injury. The distance of spacing the seed can be instantly changed by simply removing a small wheel at the side of the hopper and reversing it, or by putting on another. It will drop at 4, 6, 9, 12, 18, 36 inches apart. The change from a Hill Dropper to a Row Drill can be instantly made, or vice versa. The amount of seed can be minutely adjusted by our patented cam index, one feature which has made the New Model so famous. The COVERERS are firmly held in place by a spring, thus avoiding all danger of not covering. The wheel rolls and packs the soil. The flow of seed can be instantly stopped or started by a convenient finger latch on the handle. Our patented marker can be changed in width by inches, and when not in use can be thrown up out of the way.

Price,

\$12.00

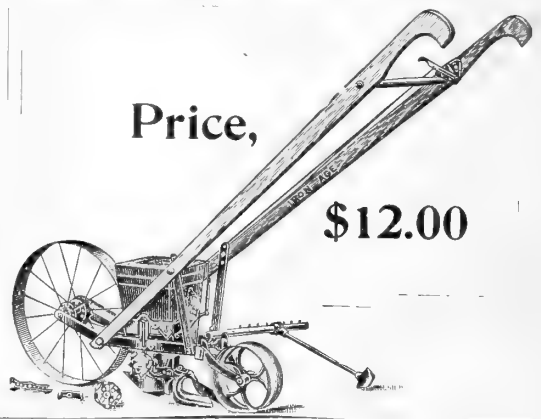

The “Iron Age” No. 5 Seed Drill only

We offer the “Iron Age” as a Seed Drill only, as shown in cut. This is the same tool as the combined “Iron Age” with no attachments, and with but one wheel. The same remarks apply concerning its construction and operation.

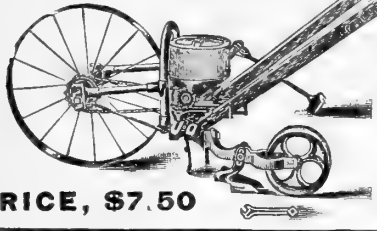

PRICE, \$7.50

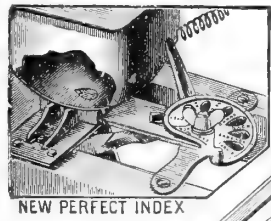

NEW PERFECT INDEX

New Model Seed Drill.

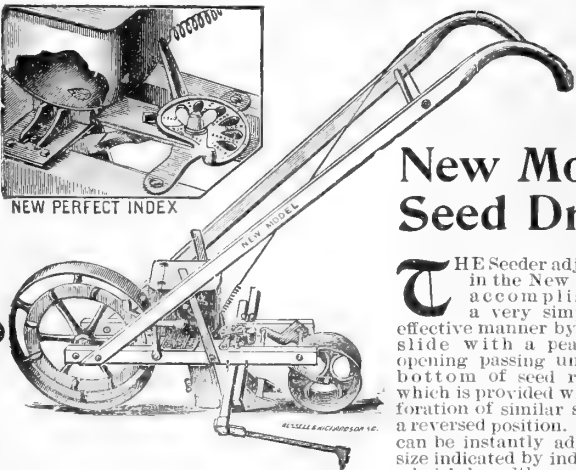

THE Seeder adjustment in the New Model is accomplished in a very simple and effective manner by use of a slide with a pear-shaped opening passing under the bottom of seed reservoir, which is provided with a perforation of similar shape, in a reversed position. This size can be instantly adjusted to size indicated by index, or to a hair's breadth variation.

This index or indicator is plain, convenient and reliable. It is placed in open sight, and can be quickly adjusted to the slightest variation desired. The names of the principal seeds are plainly shown on the index. The flow of seed can be instantly stopped by a swinging cut-off, conveniently operated by a cord and ring on handle. This cut-off prevents all loss of seed at end of rows, and its swinging or gravity form will be found far preferable to one that slides under, as it cannot be jammed by the falling seed. Each drill is crated and carefully packed for shipment. Packed weight, about 40 pounds.

The “Iron Age” Double Wheel Hoe.

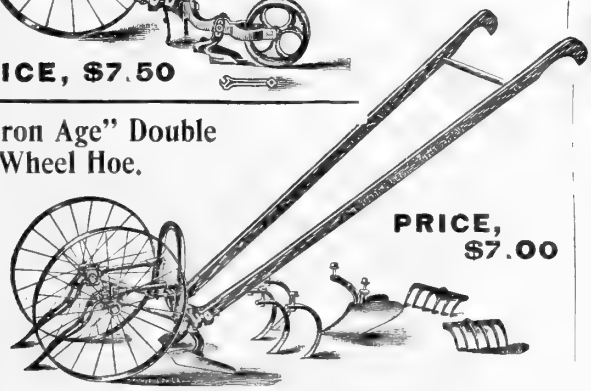

PRICE, \$7.00

In cultivating onions, beets, turnips, radishes, etc., it is invaluable—saves hours of hard labor, and does the work better than several men could do in the same time. One great advantage which this double wheel hoe possesses is that it can be made into a practical single wheel hoe in a moment's time. An axle is sent with every double wheel hoe for this purpose. The wheels are 16 inches high, enabling the wheel hoe to run easy and without yielding to the depressions of the soil. The frame being made of tubing, coupled to malleable castings, gives great strength, together with lightness. All the tools shown in the cut go with the machine.

Price, Retail, \$7.00 List, \$8.00

The “Iron Age” Plain Double Wheel Hoe.

In order to accommodate those who have only use for the Wheel Hoe for hoeing, we offer the machine described opposite with **\$4.25.**

"IRON AGE" WHEEL HOES AND DRILLS, FOR FIELD AND GARDEN.

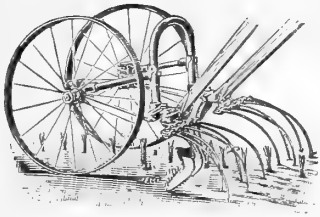

Side Hoe and Weeder.

The "Iron Age" Double Wheel Hoe, showing Weeder Attachment.

For perfect work, every farmer using a wheel hoe should have a pair of Weeder attachments. They may be used with or without the side hoes. Where used in connection with the side hoes, as shown in cut, they thoroughly pulverize the soil and break up the lumps which follow the side hoes, and at the same time keep the land perfectly level, so the plant is not left to stand on a ridge to be dried out by the sun's rays. Price of Weeder attachments, per pair, \$1.00.

The "Iron Age" Double Wheel Hoe, Landside Plow Attachment.

The Landside Plow may be attached to the machine while it is either a double wheel or single wheel hoe—oftener used with a single wheel for convenience of working. Oftentimes it is convenient to have a Landside Plow in connection with a double wheel, as with this attachment the ground can be broken and the machine used for a greater variety of work. Poultry keepers will find this plow of great value in turning under the droppings in their poultry yard. Price of Plow Attachment, only \$1.00.

THE "IRON AGE" SINGLE WHEEL HOE, CULTIVATOR, PLOW AND RAKE.

THIS tool is, in regard to the work done, almost a counterpart of the Double Wheel Hoe and the same remarks as to its construction, extreme lightness and ease of operation, will apply with equal force. In addition, its lower price, less weight and increased steadiness, given by a single wheel, make strong arguments in favor of this tool. For the small kitchen garden, we consider the single wheel hoe, with these points of merit, as being very valuable. The work is done principally between the rows, although plants of small growth can be hoed on both sides at once by placing the wheel on the left side. With this single wheel tool, spaces of exceedingly narrow width can be worked, even using but one cultivator tooth. With the large plow attachment, deep furrows can be opened or closed; potatoes, celery and other crops hilled.

PRICE, - - - - \$5.50.

We also have a Weeder attachment for this tool similar to the one used on the Double Wheel Hoe. Price, 75c.

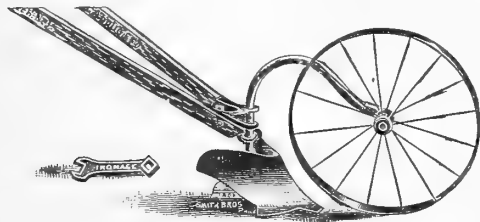
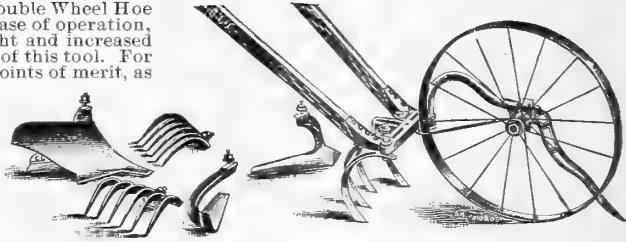

THE "IRON AGE" WHEEL PLOW.

Following out the idea of bicycle construction, as shown in the preceding tools, we offer also a wheel plow constructed in same manner. Packed weight, 15 pounds.

PRICE, - - - - \$2.50.

THE GEM WHEEL HOE.—Thousands in use giving perfect satisfaction. Price, \$4.75.

JEWEL DOUBLE WHEEL HOE, CULTIVATOR AND PLOW COMBINED.—So well known, so thoroughly introduced and so entirely satisfactory that further description is useless. Price, \$5.50.

THE BALTIMORE DOUBLE WHEEL CULTIVATOR.

This Cultivator has a new device for expanding and contracting, which permits the operator to set the machine instantly to any desired width. It is furnished with various attachments used for harrowing, furrowing and covering.

Price, without Rakes, \$5.00
Price, with Rakes, \$5.40

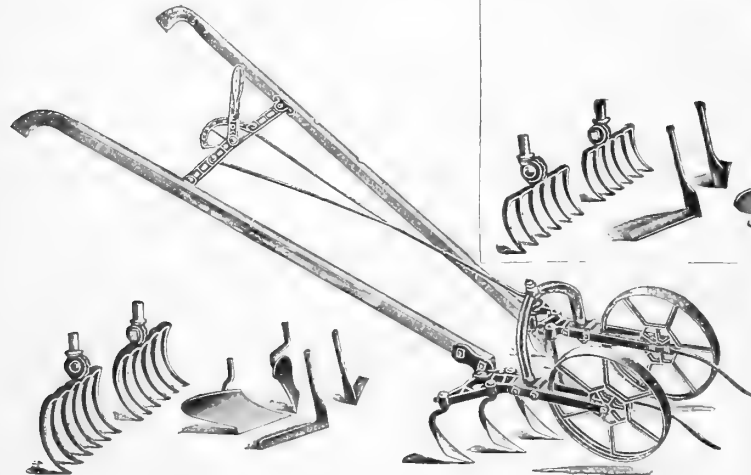

THE BALTIMORE SINGLE WHEEL GARDEN CULTIVATOR.

THIS Cultivator has an entirely new arrangement of frame which is strong, neat and compact, and with the aid of the different attachments, can be used for hilling, furrowing or covering. The hilling attachments or weed cutters can be arranged to hoe in or out and to or from the plants and can be set at any angle desired. Wheel and handles are both adjustable.

Price, without Rakes, \$3.70
Price, with Rakes, \$4.10



THE ATTACHMENTS SHOWN IN THE ANNEXED CUTS OF THE BALTIMORE CULTIVATORS, EXCEPT THE RAKES, ARE FURNISHED WITH EACH IMPLEMENT AT THE PRICES NAMED.

ARCTIC

THREE SIZES

AS A SWING.

Affords the most comfortable lounging place you can think of. The backs of the chairs are adjustable, and can be set up as straight, or inclined at as great an angle as you wish.

AS A RECLINING CHAIR.

For out-door use it is without an equal. By dropping the back of the chair and raising one end of the foot rest, attaching it under the seat it makes an excellent and comfortable reclining chair.

AS A HAMMOCK.

By raising the foot platform to a level with the seats and reclining backs of chairs you have a most comfortable hammock.

HOW OPERATED.

A slight pressure of the feet on the platform regulates and controls the swing. A child able to sit alone can operate it.

HOW MADE.

Our swings are smoothly made of the very best hardwood lumber, and entirely put together with bolts and screws.

FINISH.

All swings are painted a handsome shade of deep red and nicely varnished. WRITE for PRICES on SUN SHADES or AWNINGS.

LAWN SWING AND HAMMOCK

We illustrate the "ARCTIC" Swing and Hammock with Sun Shade or Awning Attachment. It will be seen that the awnings are over each individual seat. They are adjustable and independent, and in consequence are always directly over each seat, whether the swing is in motion or at rest. They may be slanted at different angles to obstruct the sun's rays or lessen the glare of light while reading. These are features of excellence and comfort not offered by others. No trouble to attach the Awnings. Bolts with thumb nuts and awning supports are furnished with each pair. If you already have an "Arctic" swing, and wish the Awning Attachment, a 3/8-in. hole should be bored at proper height (usually 36 inches from the seat arm) and the Awning put in place and held in place by bolt and thumb nut.

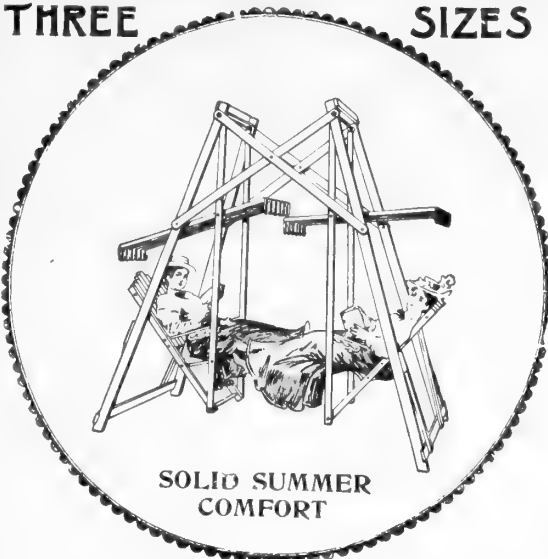

SOLID SUMMER COMFORT

PRICE - - \$7.00
WITHOUT AWNINGS.

THE ARCTIC SWINGING CHAIR.

THE LATEST DESIGN FOR A SWINGING CHAIR AND HAMMOCK YET PRODUCED

It occupies on the porch floor a space about six feet long by three feet wide and about six feet high. It is made of the most substantial material, the best of dry hard wood, with steel arms and braces, and arch of steel tubing. It is provided with a foot rest, adjustable for children or adults, is nicely painted and varnished and has durable canvas back. It weighs about forty-five pounds, folds up easily like a jack-knife, and is readily moved from place to place. It is better and cooler than any hammock, and occupies less space. It is shipped entirely set up and ready for use by the simple adjustment of the thumb nuts and two bolts.

PRICE, \$4.00.



The most comfortable Lawn Seat is illustrated herewith. It is attractive and gives plenty of room to rest the tired body. Just the thing for Parks, Porches, Hotels, Picnic Grounds, Cemeteries, etc. Painted bright red and varnished. Weight No. 6, sixty-five pounds.

Write for prices.



THE NEW IDEA SEED SOWER.

THIS IS A NEW IDEA, and we regret to say it came to hand too late for proper classification. As can be seen from the cut the gearing works in a worm shaft with only one cog wheel which gives the nearest approach to a ball bearing movement possible to construct. Equipped with agitator and accurate seed gauge. We have laid in a large stock of these and the Perfection, shown in the other cut, because we know they must sell. The price is such that it comes within the reach of all, especially in these times of advancing prices. It is wonderful that a geared machine can be made so cheap and yet do its work so perfectly. Will sow accurately any kind of seed, also plaster, fertilizer, ashes, salt, etc.

Price, - - - \$1.50

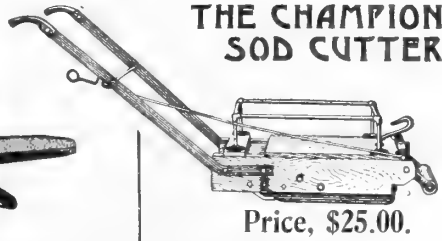

THE CHAMPION SOD CUTTER

Price, \$25.00.

THE PERFECTION HAND SEED SOWER.

This is practically the same machine as the New Idea, and does its work equally as well, the only difference being in the gearing which can be seen in cut. The large cog wheel is 7 inches diameter and drives the distributor by a small cog wheel which is part of the distributor. It sows accurately any kind of seed that can be sown by the "New Idea." Either of these machines will sow at a round, from 20 to 50 feet according to the weight of seed.

Price, \$1.25

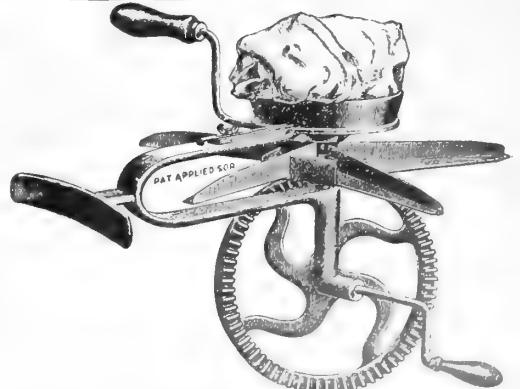

	Retail.	List.
14 inch.....	\$ 7.80	\$17.00
16 inch.....	8.70	19.00
18 inch.....	9.60	21.00
20 inch.....	10.50	23.00
25 inch.....	16.00	30.00

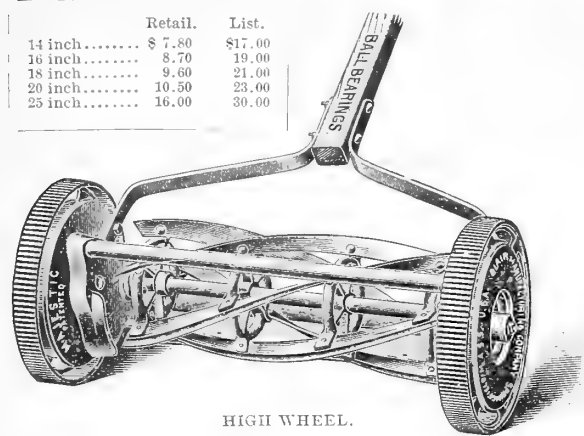

HIGH WHEEL.

“Druid” Ball Bearing Lawn Mower.

WITH FOUR REVOLVING KNIVES, DRIVING WHEELS 10 INCHES IN DIAMETER.

The superiority of BALL BEARINGS is now universally conceded, combining EASE OF DRAFT with the least possible FRICTION.

The only requirement being that they must be thoroughly made and perfectly hardened. In the “**DRUID**” Lawn Mower we offer a machine that in every respect is equal in workmanship to the highest grade bicycle.

The Revolving Knives run on twenty-eight 3/4 in. cast steel Balls, 14 at each end.

The Ball Races and Adjusting Cones are also made from cast steel, and perfectly hardened and ground. As a result, the Mower runs easily, remains in adjustment, and does better work than is possible with parallel bearings which tend to wear out of true and allow “lost motion” to the knives.

The use of Ball Bearings in a Lawn Mower makes necessary a rigid frame.

The frame of the “**DRUID**” is constructed with the greatest possible care, and is warranted to hold the cutting edges true and in alignment, though subjected to the hardest use.

In short, the “**DRUID**” **LAWN MOWER** is designed for a machine of higher grade than has heretofore been attempted, and is offered as the perfection of Lawn Mowing Machines.

THE BALTIMORE HIGH WHEEL MOWER

DRIVING WHEELS, 9 INCHES DIAMETER. CUTTING CYLINDER, 6 INCHES DIAMETER, WITH FOUR KNIVES.

For extreme EASE OF OPERATION, SIMPLICITY, DURABILITY, DESIGN AND FINISH **THE BALTIMORE HIGH WHEEL MOWER** is unsurpassed.

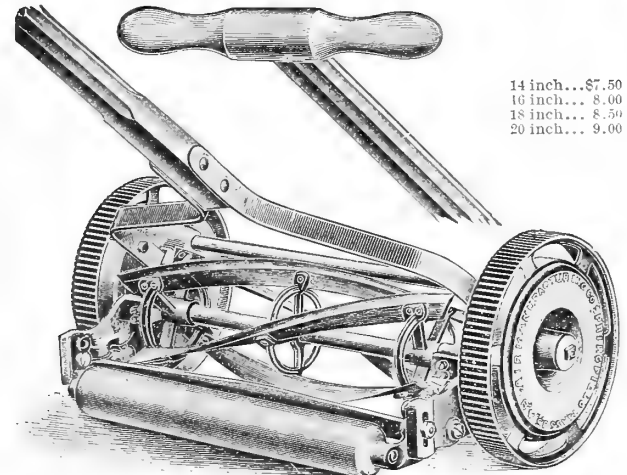

14 inch...	\$7.50
16 inch...	8.00
18 inch...	8.50
20 inch...	9.00

All of the essential features in best lawn mower construction have been incorporated in the **BALTIMORE**. It has the Patent Rocker Adjusting Journals for the cutting cylinder, compensating for wear upon all sides of the shaft; patent double-bearing, double-toothed Ratchet and Pawl connection, which positively avoid all friction while the Mower is in operation, and thereby causing it to run much easier than any other machines, (with one exception, the “**DRUID**”). It is made of first-class material and workmanship, and will do the most perfect work.

THE Maryland Regular Mowers, No. 1.

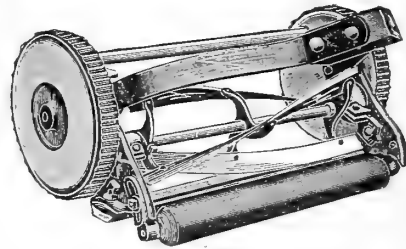

The Ratchet on this machine is simple and positive, having for a pawl a Solid Steel Ball, which works in a pocket in the pinion when the machine is not in motion, and by the action of the pinion when in motion this ball is thrown into a corresponding pocket, in the back cap, which locks the two together, thus driving the reel. The **CUTTER BAR** is of solid steel and has no cast iron parts. The adjustment is from the reel, and is perfectly simple. It is not necessary to turn the mower upside down to adjust it. Having a reel adjustment, the Cutter Bar is bolted firmly to the machine, and therefore holds the mower firmly in line. The Cutter Bar adds strength to the mower instead of weakening it.

All parts are interchangeable, and in case of wear or breakage, can be at once duplicated. Diameter of Traction Wheel, 8 1/4 inches. Diameter of Wheel, 5 1/2 inches. Made in 12, 14, 16 and 18 inch sizes. Painted in Red and Green and decorated in Gold.

12 inch.....	\$2.75	16 inch.....	\$3.25
14 inch.....	3.00	18 inch.....	3.50

MARYLAND HIGH-WHEEL MOWER.

The cutter-bar and boxes for reel shaft are **ADJUSTABLE** to **COMPENSATE FOR WEAR**. Bronze boxing for reel shafts. Adjustment of handle is an important feature, being arranged at lower end, so that it is instantly adjustable for a child or grown person. The reel and cutter-bar knives are made of crucible steel.

Retail price: 14 inch.....	\$6.00	16 inch.....	\$6.50	18 inch.....	\$7.00
----------------------------	--------	--------------	--------	--------------	--------

THE SCOTCH GOLF LAWN MOWER.

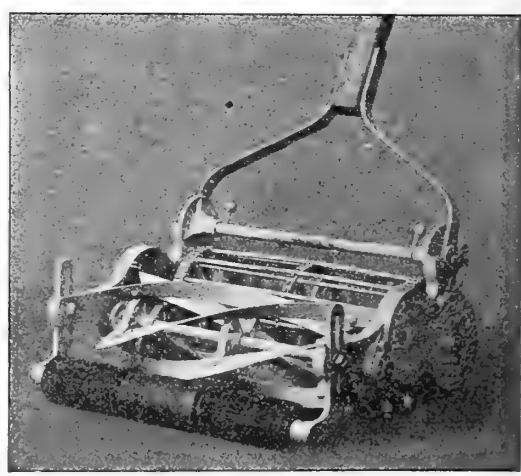

Is made from patterns which have been used in England for the past twenty years, and has the approval of the most exacting golf clubs of that country. It has five revolving knives, running at high speed, and will cut the lawn as close and smooth as a carpet.

PRICES: { 14 inch.....	\$ 8.00	18 inch.....	\$11.00	24 inch cut for two men.....	\$15.00
16 inch.....	10.00	20 inch.....	12.00		

BALTIMORE REGULAR MOWER No. 1.

8 in. Wheels. 3 Blades.

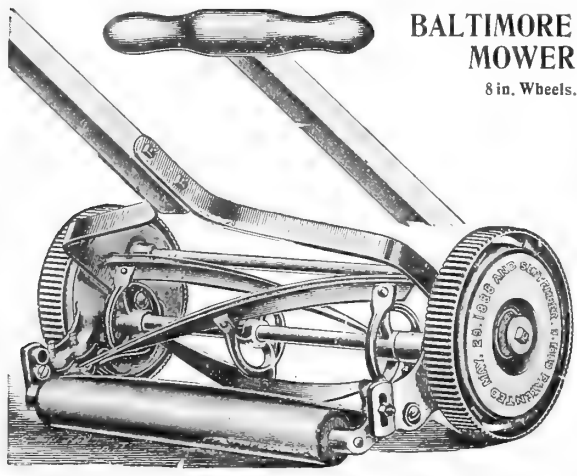

An open cylinder machine, strong and durable, made of the best material; nicely finished, and is first-class in every respect. Though a moderate priced Mower is by no means a cheap one, for all realize that cheap goods are dear at any price. This Mower is built on the same lines as the Baltimore High Wheel, but has three blades; is lighter in weight, and has an 8-inch, instead of a 9-inch, hence the difference in price.

10 inch.....	\$3.25
12 inch.....	3.75
14 inch.....	4.25
16 inch.....	4.75

**"THE BALTIMORE"
HORSE LAWN MOWER**

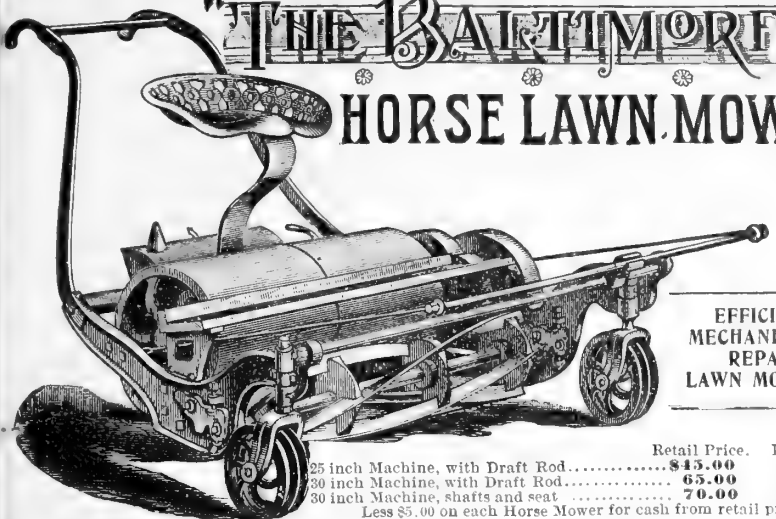

**EFFICIENT
MECHANICS TO
REPAIR
LAWN MOWERS.**

25 inch Machine, with Draft Rod.....	\$45.00	\$65.00
30 inch Machine, with Draft Rod.....	65.00	100.00
30 inch Machine, shafts and seat.....	70.00	110.00
Less \$5.00 on each Horse Mower for cash from retail price.		

The Baltimore Horse Lawn Mower is guaranteed to be equal to any machine made; in order to appreciate its good points, it is necessary to see it at work on the lawn, where it performs in a most satisfactory manner.

NOTICE.
We make a specialty of repairing lawn mowers, for which purpose we employ efficient mechanics, and in this way become thoroughly acquainted with the construction of all machines on the market. When you buy a lawn mower be sure to select one for which you can get repairs. The Baltimore is just such a machine.

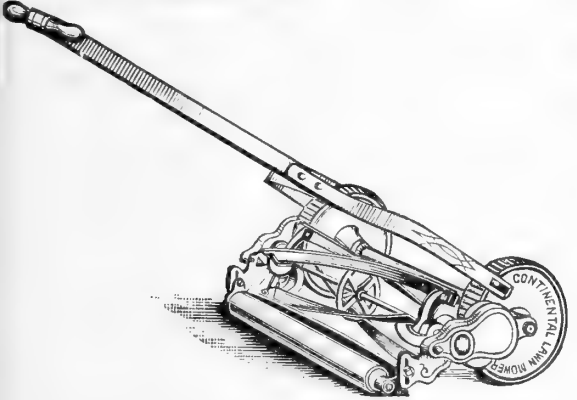

THE CONTINENTAL HIGH WHEEL MOWER.

A distinct type of machine in popular favor. Owing to the demand for a High Wheel Mower for uneven lawns, we have secured what we consider one of the best machines of the kind made. Every customer is more than satisfied with the Continental. In use at Patterson Park, and on the lawns of Messrs. Robert Garrett, William H. Whitridge, R. B. Smith, German H. Hunt, Edward A. Griffith, at Church Home, the Woman's College of Baltimore City, and many others. Splendidly built. A full stock of machines and repairs always on hand.
Retail prices, 15 in. \$10.75 17 in. \$12.25 19 in. \$13.50 21 in. \$15.00
List prices, 15 in. 25.00 17 in. 28.00 19 in. 31.00 21 in. 34.00



THE I. X. L. PHILADELPHIA PONY AND HORSE MOWER.

Prices of 30, 35 and 40 inch sizes include the Draft Rod Seats and Shafts. All parts are lettered and interchangeable, and every mower will give perfect satisfaction. Are made from the best materials and finished by the latest approved methods of manufacture.
Retail prices, 30 in. \$ 65.00 35 in. \$ 82.50 40 in. \$100.00
List prices, 30 in. 100.00 35 in. 125.00 40 in. 150.00

THE OLD STYLE PHILADELPHIA HORSE LAWN MOWER.

With Draft Rod.
These Mowers are being used extensively in different sections of the country, and in this city they are giving entire satisfaction, in the public parks and large lawns.
Retail price, 30 in. \$70.00 List price, 30 in. \$100.00

PHILADELPHIA LAWN MOWER.

STYLE C.
Medium High Wheel, Open Wiper, Four Blades.
Retail prices, 14 in. \$6.80 16 in. \$7.60 18 in. \$8.40 20 in. \$9.20
List prices, 14 in. 17.00 16 in. 19.00 18 in. 21.00 20 in. 23.00

UNIVERSAL GRASS CATCHER.

A Grass Catcher that will fit any mower. Canvas body, blacked sheet, steel bottom. Two sizes, No. 1 will fit 10, 12, 14 and 16 inch mower, and No. 2 will fit 16, 18 and 20 inch. Price, \$1.00.

THE CANVAS GRASS CATCHER.

Instantly self adjustable. Instantly self attachable.
Price, \$1.00.

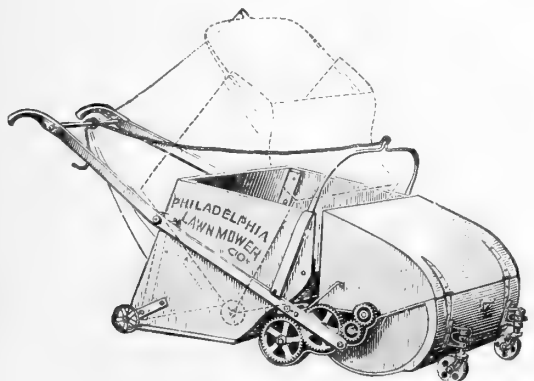
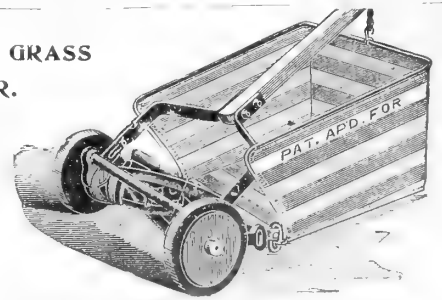

HORSE LAWN SWEEPER.

It is very simple in construction. A revolving brush is placed directly in front, sweeps the sod clean and throws the sweepings backward into a large box in the rear of the roller. This box can be dumped without stopping.
40 inches wide, \$56.00. List, \$70.00.



HORSE BOOTS—For use on lawn.

For those who desire a well kept lawn. Made of heavy leather bottoms and will fit any horse's feet.
Price, per set.....

ALL PRICES SUBJECT TO CHANGE WITHOUT NOTICE.

Cahoon Patent Broad-Cast Seed Sower.

FOR SEWING CLOVER, TIMOTHY, MILLET, OATS, WHEAT, HEMP, BARLEY, RYE, RICE, BUCKWHEAT, ETC.
A MODEL FOR ACCURACY AND DURABILITY.

Price, - - \$3.50

Sows from 4 to 8 acres per hour at an ordinary walking gait, throwing wheat about 40 feet wide. A saving of four-fifths of the labor and one-third of the seed is effected by the use of this machine, and a person entirely unused to sowing by hand can use it with perfect success.

TO SOW THICKER OR THINNER WITHOUT CHANGING THE SLIDE.—Having set the index to the desired quantity per acre—taking the average of the field—the operator can easily sow a little thicker upon those places where the soil is richer, by taking shorter steps and thus not going so fast, and upon the poorer spots of ground it can be sown thinner by taking longer steps, and consequently passing more rapidly forward.

ABOUT SOWING IN THE WIND.—Any one familiar with the use of the machine can sow satisfactorily in a much stronger wind than will admit of sowing well by hand; but as the ordinary work of a day can easily be done with the sower in two or three hours, that time may be chosen early in the morning or late in the evening, when it is usually calm or nearly so.

FOR SOWING IN STANDING CORN the machine will be found of the greatest utility—nothing can ever equal it for this purpose—but will not sow as wide as on fallow ground, in consequence of the obstruction which the corn offers to the seed. A broader lap is therefore required, by making the passages nearer together. (See directions.)

The breadth of the cast will be according to the weight of the seed.	{	Wheat and Rye, 30 to 36 feet.	Oats, 21 to 25 feet.
		Barley, 27 to 33 feet.	Clover, Millet, Hungarian Seed, 20 to 24 feet.
		Hemp, 27 to 30 feet.	Timothy, 15 to 18 feet.

DIRECTIONS FOR GAUGING THE MACHINE.

The large gate is to be used when sowing grain and the small gate in the larger one for grass seed only. First, close the slide or gate tight, then fix the lower edge of the index point against the scale of inches on the slide for the different seeds as follows:

FOR WHEAT AND RYE.—To sow two bushels to the acre, at 1 inch. To sow one and a half bushels to the acre, at $\frac{3}{4}$ of an inch.

FOR BARLEY.—To sow two bushels to the acre, at 1 inch. To sow one and one-eighth bushels to the acre, at $\frac{3}{4}$ of an inch.

FOR HEMP.—To sow one bushel to the acre, at $\frac{1}{2}$ an inch. To sow one and a quarter bushels to the acre, at $\frac{3}{8}$ of an inch.

FOR OATS.—To sow two bushels to the acre, at $1\frac{1}{2}$ inches. To sow one and a half bushels to the acre, at $1\frac{1}{4}$ inches.

When ready to sow, first commence turning, and with the left hand raise the slide until the nib on the slide comes against the index point. Be careful to walk and turn, as above directed. To close the slide, do it with a quick pressure of the left hand. To sow wheat or rye in standing corn, two bushels to the acre, set the index at $\frac{3}{8}$ of an inch, and sow five or six rows at a time, according as they are wide or narrow.

FOR GRASS SEED.—To sow one peck of grass seed to the acre, raise, the small gate $\frac{3}{8}$ of an inch; half a bushel, $\frac{3}{8}$ of an inch.



Thompson's Clover and Grass Seeder.

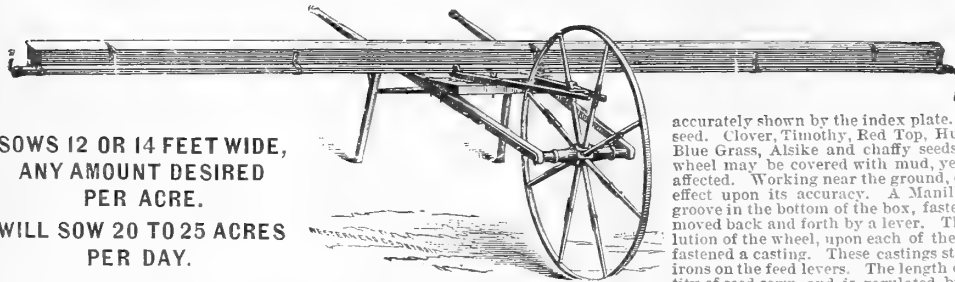

SOWS 12 OR 14 FEET WIDE,
ANY AMOUNT DESIRED
PER ACRE.
WILL SOW 20 TO 25 ACRES
PER DAY.

fulcrum at any distance desired from the driving point. The plate for this pin if accurately marked in figures, indicating the quantity of seed sown per acre. By use of a thumb screw the lever can be thrown out of connection, when all sowing stops, the feed rope covering the holes in the bottom of the hopper, through which, when at work, it forces the seed. Manilla rope is used because it is better than wire or any substitute. It does not wear the groove, bruise the seed, or fail in its work—wire rope will. Being scorched and chemically treated, our rope is weather proof. It is provided with an iron wedge at one end of the feed rod, so that it may be loosened when not in use.

This Grass Seeder is simple, without gearing, cams or intricate machinery. It cannot get out of order. It is strong, yet weighs but 40 pounds. Perfection feed is attained in making it absolutely positive, yet a non-leaking carrier when thrown out of connection. The quantity of seed to the acre is accurately shown by the index plate. You place the pin, the machine measures the seed. Clover, Timothy, Red Top, Hungarian, Millet, Flax, Orchard Grass, Fancy Blue Grass, Alsike and chaffy seeds are alike sown by it. It cannot clog. The wheel may be covered with mud, yet its working will not be affected. Working near the ground, even strong winds have no effect upon its accuracy. A Manilla rope passes through a groove in the bottom of the box, fastened at the ends to a rod moved back and forth by a lever. This is operated by the revolution of the wheel, upon each of the eight spokes of which is fastened a casting. These castings strike alternately V-shaped irons on the feed levers. The length of stroke governs the quantity of seed sown, and is regulated by the pin, which forms a

It cannot clog. The wheel may be covered with mud, yet its working will not be affected. Working near the ground, even strong winds have no effect upon its accuracy. A Manilla rope passes through a groove in the bottom of the box, fastened at the ends to a rod moved back and forth by a lever. This is operated by the revolution of the wheel, upon each of the eight spokes of which is fastened a casting. These castings strike alternately V-shaped irons on the feed levers. The length of stroke governs the quantity of seed sown, and is regulated by the pin, which forms a

- No. 1—Complete Clover and Grass Seeder, the most popular style. \$6.50
- No. 2—Complete Seeder, with Double Hopper for Red Top, Orchard Grass, Blue Grass, Lawn Grass, as well as Clover. \$ 8.00



The Cyclone Hand Broad-Cast Seed Sower

This Seeder is accurate, strong, light and durable. The best medium price machine of its kind on the market.
Price \$2.00



Chicago Seeder.

A good Seeder, at a very low price. This is the most satisfactory Bow Seeder made.
Price \$1.50

Champion Jr. Seeder.
A MODERATE PRICE MACHINE.

The accompanying illustration shows our **Champion Jr. Seeder**, a moderate price machine.
GUARANTEED equal to any other make on the market.
Price \$1.25

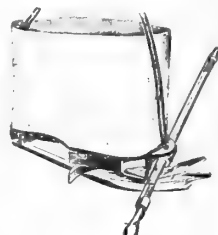

THE Gordon Automatic Hand Corn Planter

ITS ROTARY SLIDE has a motion TWO ways—back and forth. It prevents skips. No matter how short the stroke, the pocket is pushed into the corn and back into the conveyor tube. This motion is positive. It breaks up all bridging, and fills the pocket uniformly—it counts the kernels for each drop. THE IRON STRIPPER will not wear out nor break. It prevents an over-dose of corn, and will not crack a kernel. The entire dropping device is made of iron, held together by 3 bolts. All parts are easily accessible and readily adjusted. THE HOPPER IS IN LINE WITH THE CENTRE, there is a double-coil spring on each side, and the planter hangs well in the hand. The material is all the best. The Planter is finished with a selected hardwood frame, finished bright, a brilliantly painted hopper, and all parts varnished.
Price \$1.50

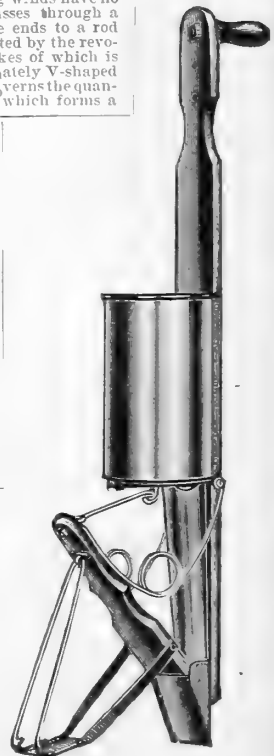

FOR OTHER BROAD CAST SEED SOWERS, SEE PAGE 67.

ALL PRICES SUBJECT TO CHANGE WITHOUT NOTICE.

The Evans Steel Frame Intermittent Drop Planter.

Plain Planter, \$ 30.00
 Planter, with Fertilizer At-
 tachment 40.00
 Check Rower, 11.00

THIS Machine is a continuous intermittent rotary drop Planter, made to drop the entire hill at one time. It does not, however, destroy the usefulness of a combined machine, and it can be used as such by simply changing from thick to thin plate, and by putting on or taking off the drive chain. Using the machine as a drill, it can be changed to drop 10, 12, 14 or 16 inches apart by changing the chain to a different sprocket wheel on the shaft. It will plant in hills with the drill drop, from two to six grains, by changing the chain to different sprockets, dropping from 2 to 3, 3 to 4, 4 to 5 grains in a hill. Four sets of thin feed plates for different size corn are used with drill crop, either for drilling or hilling. Each of our thin feed plates has eight sets of holes varying in size from one-half to eleven-sixteenths of an inch. By having four sets of feed plates with different size seed holes and different cone sprockets, we get 16 changes. This is equal to 32 feed plates, as compared to Planters using thin feed plates, with different number of feed holes in them and without the use of cone sprockets for driving the feed.

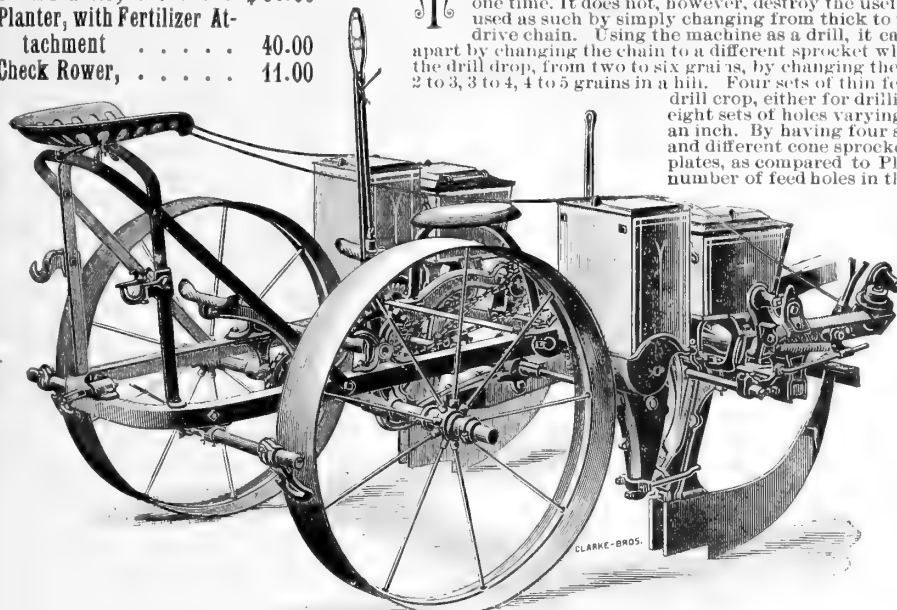

THE CHECK ROWER is fastened on the beam of the Planter front, and is connected with the valve rod which operates the dropping device. The check-rower head has a long adjustment, so as to bring the corn in check under the knot on the wire. It is made with the fewest number of parts possible, and has an upright fork to catch the wire, which is a great advantage over forks which operate sideways.

POSITIVE WIRE THROW-OFF.—See cut herewith for same. The check-rower pulleys and forks are so pivoted that, when the machine is at the end of the field, it is only necessary for the driver to pull the small cord, and the lower pulleys and forks tip and release the wire, throwing it from the machine automatically without stopping the team; a great improvement over other check-rowers which have only part of the check-rower to tip.

SIMPLICITY OF ADJUSTMENT.—There is but one place on each head to adjust the check-rower, that being the threaded rod running to the valve crank, which it is only necessary to lengthen or shorten as the check-rower head is moved backward or forward, to bring the corn under the button.

FERTILIZER ATTACHMENT.—We have a perfect fertilizer attachment for this machine, which we guarantee in every particular to work equally as well with wire check-rower as without. It will drop the fertilizer in a continuous stream when hilling or drilling, or at intervals with the hill of corn, as desired. This is the only successful fertilizer attachment on the market.

Sunflower Corn Planter,

WITH DISC MARKER.

To meet the demand for a lower-priced planter, we show in the adjoining cut the **SUNFLOWER** style, with Disc Marker and Check-Rower. We do not carry this make in stock, but can supply the demand F. O. B. factory. This machine can be changed to drop 12, 16 or 19 inches apart, with the use of the different sprockets, furnished with each drill attachment.

Price, with Check-Rower Attachment, \$38.00

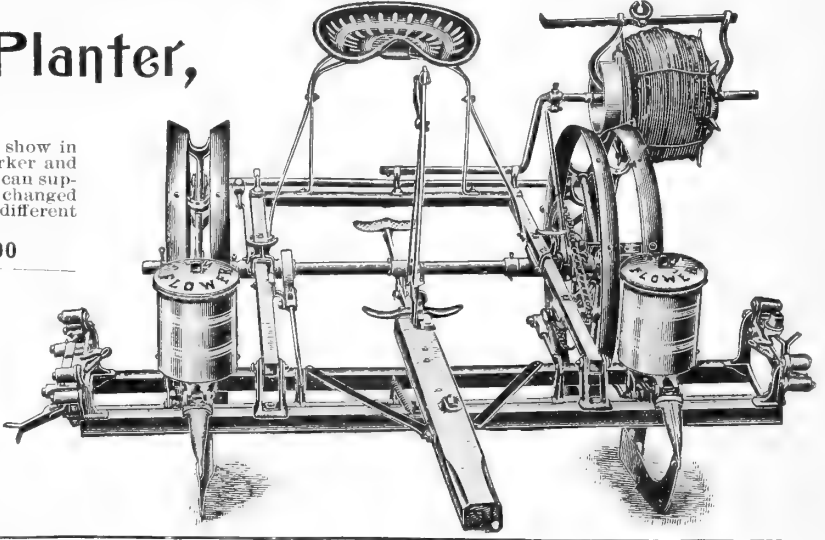

Corn Planter Runner,

For all leading makes of Corn Planters.

\$3.50 per pair.

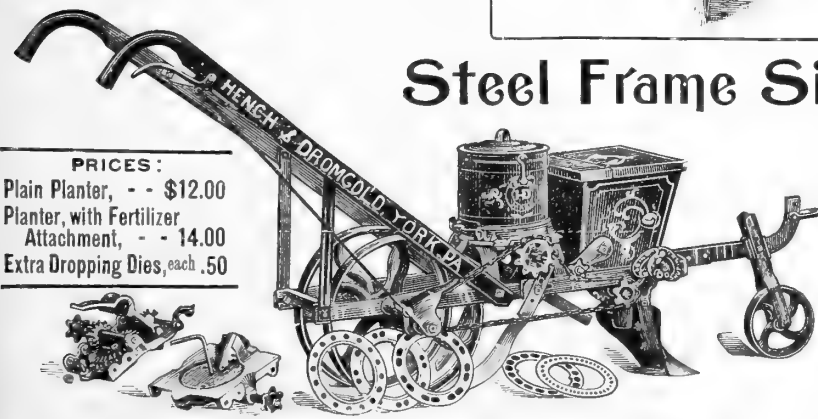

Steel Frame Single Row Planter.

Made in three styles—first, as shown in cut, with double wheel in rear; secondly, with concave wheel in rear; thirdly, with concave wheel in rear and runner in front. All can be furnished with or without fertilizer attachment.

The Corn-Dropping Arrangement is very simple and positive in action.

The Fertilizer Sower has an agitator which prevents the fertilizer from arching in the box, and will sow regularly any quantity from 100 to 400 lbs. per acre.

Four Rings or dropping dies are furnished with each planter, two with small and two with large holes, dropping one grain at a place an equal distance apart, and two with large and two with small holes for dropping two grains in a hill.

Three Chain Wheels are furnished with plain planter and four with fertilizer. The six-point chain wheel drops one grain 13 inches, or two grains 26 inches apart. The seven-point drops one grain 15 inches, or two grains 30 inches apart. The nine-point wheel drops one grain 19 inches, or two grains 38 inches apart. We can also furnish rings for planting Peas, Beans, Ensilage, Corn or any kind of seeds, and by using the different chain wheels can plant any desired amount.

PRICES:
 Plain Planter, - - \$12.00
 Planter, with Fertilizer
 Attachment, - - 14.00
 Extra Dropping Dies, each .50

ALL PRICES SUBJECT TO CHANGE WITHOUT NOTICE.

The York Force Feed Grain and Fertilizer Drill.

THERE are certain points of superiority about these drills that are well worth considering, viz: **SIMPLICITY OF GEARING; CHANGING THE QUANTITY OF SEED OR FERTILIZER PER ACRE, AND THE FERTILIZER FEED,** shown in cut below. Both the grain and fertilizer sowers are positive Force Feeds, and will sow with absolute regularity any kind of grain or fertilizer in good condition. The grass seeder (shown in cut) is also a force feed and can be used either in front or rear of the hoes; also the quantity can be changed to any amount necessary. It is fastened on the frame and very low down, thus preventing the wind from blowing the seed away before reaching the ground.

Two levers are used on this drill — one for grain feed and one for fertilizer feed, and by simply moving them either back or forward the indicators, in plain view, will guide the operator, and enable him to accurately sow the desired quantity per acre; but bear in mind, in using the fertilizer feed the operator must be governed by the condition of the material. The quantity of grain to be sowed can by this means be varied from the smallest to the greatest amount desired, varying as little as a half to a pint at each change. The fertilizer feed can be stopped or started at any time while the drill is in motion, which makes it convenient in case the operator does not wish to sow fertilizer while going over good ground.

The **HOISTING and HOE SHIFTING LEVER** attachments are the simplest and latest improved on the market. Simply pulling down lever at right hand end of drill, making a quarter circle, forming a dead centre lock, raises the hoes and simply touching the lever with one finger releases the hoes. The shifting, or zig-zag lever, is on the left-hand end of box and is very easily operated, having three different changes, one-half of the hoes moving backward and one-half forward. Both wheels are drivers, and have ratchets in hubs. Each having Two pawls in the hub, instead of one, as in other drills; there is no lost motion, so that immediately the drill moves, it begins feeding. When going in a circle the outside wheel does the driving. The land measure has two hands, one making a revolution for each acre and the other for every twelve acres. We furnish these drills in both spring and pin hole. Either plain or fertilizer drills furnished as ordered.

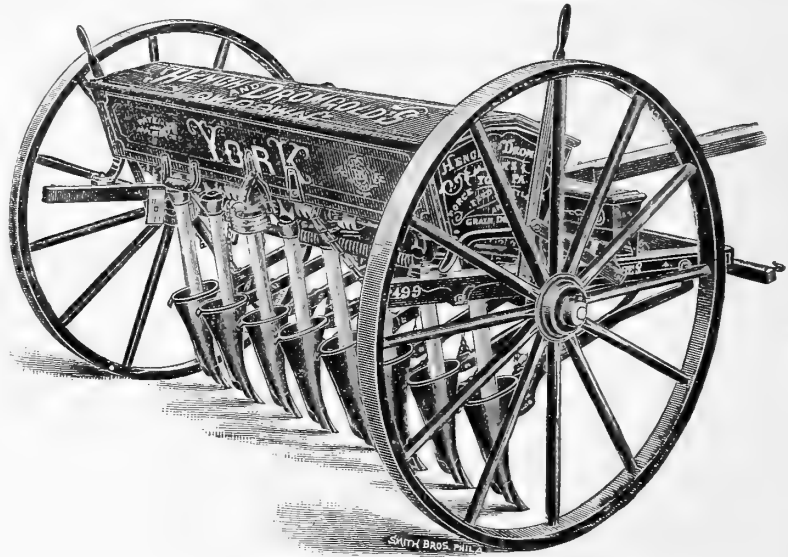

8-Hoe Pin	\$65.00	10-Hoe Pin.....	\$71.00	8-Hoe Spring.....	\$70.00	10-Hoe Spring.....	\$76.00
9-Hoe Pin	68.00	11-Hoe Pin.....	74.00	9-Hoe Spring.....	73.00	11-Hoe Spring.....	79.00

SPECIAL DISCOUNT FOR CASH.

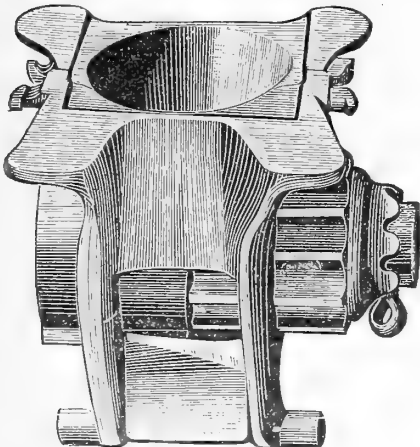

GRAIN FORCE FEED.

It will sow any kind of grain accurately. The agitator for sowing oats is furnished with every drill and will make it sow oats regularly, which many other makes of drills will not do. It is a positive force feed.

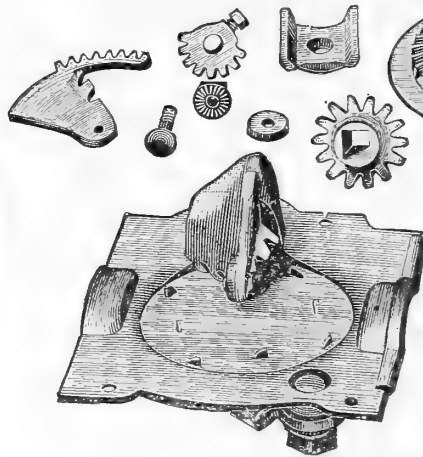

THE FERTILIZER FEED.

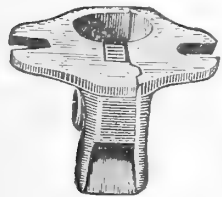
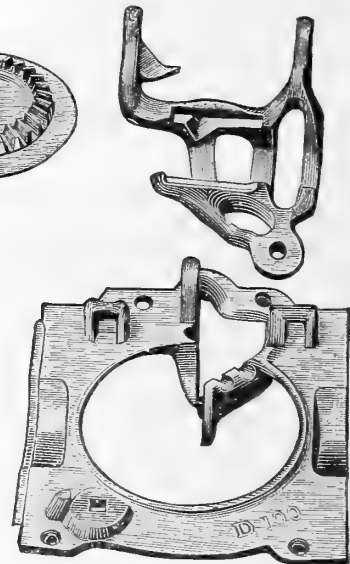

Timothy Seed Force Feed will sow 2, 3, 4, 4½ or 5 quarts or double the amount by changing two wheels as per directions.

GRAIN DRILL TUBES AND POINTS.

For all leading Grain Drills, including York, Superior, Pennsylvania, Bickford & Hoffman, Buckeye, Hoosier, Indiana, Champion, Empire, McSherry, Hagstownton, Greencastle, etc. Tubes, 25 cents each; points 12½ cents each.

LAWN AND FIELD ROLLERS.

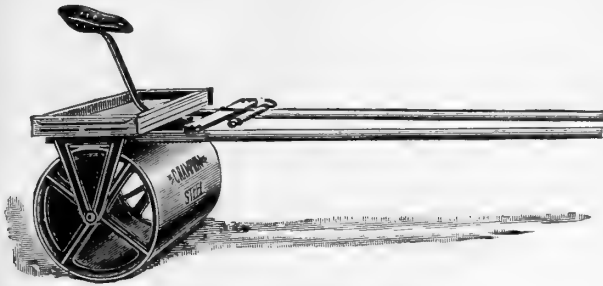

THE BALTIMORE HORSE LAWN ROLLER.

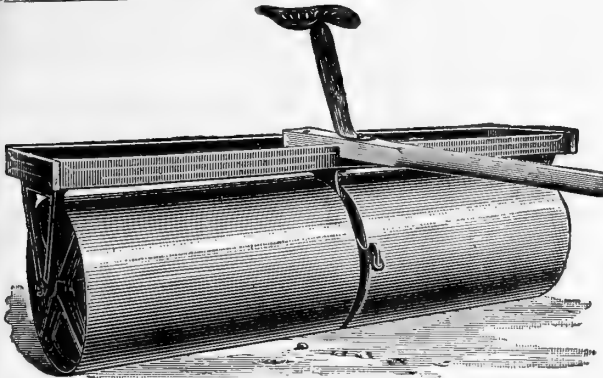

THE BALTIMORE STEEL TWO-HORSE ROLLER, No. 2.

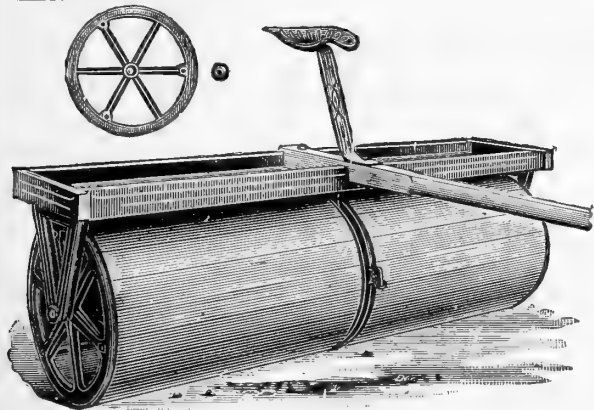

BALTIMORE WOOD FIELD ROLLER, No. 1.

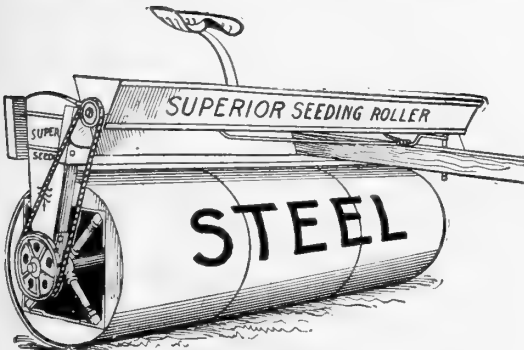

SUPERIOR STEEL FIELD ROLLER, No. 3.

The Baltimore Hand Lawn Roller.

CAST IRON.

EVERY person who wishes a smooth well kept lawn realizes the fact that a good lawn roller is one of the necessities. So we add to our list the "Baltimore" making our line the most complete for all purposes to be found anywhere. These rollers are specially desirable, they will not dent; wet grass and dirt do not cling to them, owing to their highly polished surface and rivetless ends. Have counter balance which holds up the handle and makes it very easy to push.

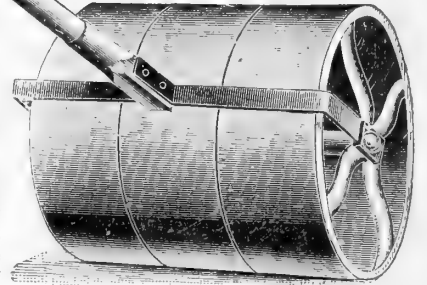

No.	No. Sec.	Width of face.	Diam. Sec.	Total length.	Weight.	Price.
3	1	20 in.	20 in.	20 in.	250 lbs.	\$11.00
4	3	8 in.	20 in.	24 in.	300 lbs.	13.50
5	3	8 in.	24 in.	24 in.	400 lbs.	18.00

Superior Steel Rollers.

No.	Section.	Track.	Diameter.	Av. wt.	List Price.	Retail Price.
A	1	20 in.	20 in.	250 lbs.	\$14.00	\$12.75
C	2	20 in.	20 in.	275 lbs.	15.00	13.50
F	2	24 in.	24 in.	400 lbs.	21.00	19.00

The Baltimore Horse Lawn Roller.

This Roller is furnished with seat. We furnish this Roller in two sizes, No. 16 and 17. No. 16 (see cut) has 26-inch steel rim, 4 feet, one section, one-horse; weight, 375 pounds. No. 17, has 26-inch steel rim, 4 feet, two sections, one horse; weight, 425 pounds.

No. 16.....	\$20.00
No. 17.....	22.50

2-L. Horse Lawn Mower.

Two sections, 4 ft. long, 24 in. diameter, average weight, 500 pounds. Price, \$25.00

O. L. Horse Lawn Roller.

Three sections, 5 feet, average weight, 550 pounds. Price, \$30.00.

The Baltimore Steel Two-Horse Roller No. 2.

TWO sections; 8 foot; 26-inch steel rim; weight, 700 lbs.; with neck yoke and whiffletrees. These Rollers are made with steel drums of special high carbon steel, riveted to two cast iron heads. The rolls revolve on a 1 1/2 inch round shaft, held stationary and in place with a set screw in each end hanger, making it strong and firm. Our Removable Chilled Bearing is worth your careful attention. It can be replaced at the small price of 25 cents. No roller is complete without it. Price, \$27.50

Baltimore Wood Field Rollers, No. 1.

(With Neck Yoke and Whiffletrees.)

This Roller is made of all Oak Staves, let into a mortise or groove in casting, and held together by three long bolts, running lengthwise inside of roll to clamp the two castings together, instead of being bolted as most all Rollers are made. 27 inches diameter, 2 sections, each 3 ft., 9 in. Weight, 700 pounds. Price, \$20.00

Superior Steel Field Rollers, No. 3.

THESE are the same make of goods as seen at top of page, only this Roller has three sections of two feet each, six feet long; diameter, 24 inches; average weight, 550 pounds. Has no neck yoke or whiffletrees. They have a substantial hardwood weightbox, which can also be used as a convenient way for clearing fields of loose stone. Price, \$30.00

Lawn and Field Cast Iron Rollers.

Full assortment of sizes, prices on application.

ALL PRICES SUBJECT TO CHANGE WITHOUT NOTICE.

The "Improved-Robbins" Potato Planter.

Price of Planter with Fertilizer Attachment, \$65.00. Special Discount for Cash.

THE opening plow is a small double mould board plow, preceded by a thin steel runner to prevent clogging with trash, and which divides the soil for the plow. This runner or shield also prevents injury to the machine. In striking a "fast" rock, the blow is gradual, thereby warning the driver to release the lever and enable him to pass over the rock. The plow throws out on each side a free furrow of loose soil, with no packing or wedging to crowd the future growth of the crop. It now has an independent adjustment by which its position can be changed so as to suit different depths of furrowing in different soils. Immediately following the plow comes the deposit of fertilizer (if used) in a broad stream across the bottom of the furrow.

DROPPING SEED.—Then follows the drill tube through which the seed is dropped, this tube being provided with a small shoe which opens a narrow groove in the bottom of the furrow, and into which falls the seed. The small shoe also divides the fertilizer, preventing it from coming in direct contact with the seed, and mixes it with the soil in passing. Then immediately following come a pair of large steel discs which cover the seed with light, loose soil, all in a nice, moist state, just the right condition for starting a vigorous growth of the potato sprout.

DISTANCE APART.—The speed of the dropper is regulated by a simple change of sprocket wheels, those sent out with planter dropping at distances of about 12, 14, 15½, 17, 18½ or 20 inches.

SIMPLE AND EASY.—The handling of the planter is exceedingly simple and easy, the movement of one lever stopping both potato and fertilizer feed, and at the same time raising the entire gang of opening plow, potato tube and covering discs entirely free from the ground.

A PERFECT FERTILIZER DISTRIBUTER.—We wish to speak particularly of the Fertilizer Distributer of the Improved Robbins, as we believe it to be, beyond any doubt, one of the best methods of distributing fertilizer yet adopted. The fertilizer is placed in a round hopper of galvanized iron, holding about one hundred pounds, and is fed downward through a central opening formed by a straight agitator shaft; the capacity of the distributor is up to a ton per acre, depending largely upon the condition of the fertilizer. The amount sown is quickly and easily regulated by the adjustment of gate or change of sprocket wheels.

Particular attention is called to the planter as being adapted to the planting of Peas, a large acreage having been sown with the most satisfactory results, and with a very decided advantage over all other methods. The planter has been sold for this purpose exclusively. Also, as another attachment, we have the Leveler, for leveling and smoothing the row.

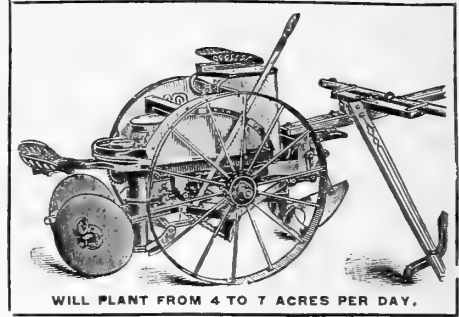

WILL PLANT FROM 4 TO 7 ACRES PER DAY.

Prices of Attachments for Planter : **Pea, Bean and Corn Sower Attachment, - \$5.00**
Leveler Attachment, - - - - - 1.25

The L. C. Evans Potato Planter, No. 55.

This machine will plant from seven to ten acres per day.

NO Adjustment necessary to suit size of pieces of Potato.

THE FEED.—This is the most important part in seeding machines, and especially so in potato planters. It is a force feed, and is positive in its action, and its operation is controlled by the machine, instead of by the size of the seed potatoes.

TO CHANGE THE DISTANCES APART IN DROPPING.—The machine will drop the potatoes in drills 10, 12, 14, 16, 18, 20, 28 or 36 inches apart. The change for the different distances apart is accomplished by putting on more or fewer picker arms. The number of arms to be used is shown in plain figures on the disc to which the picker arms are attached, so there can be no mistake made in changing the machine to plant the proper distance.

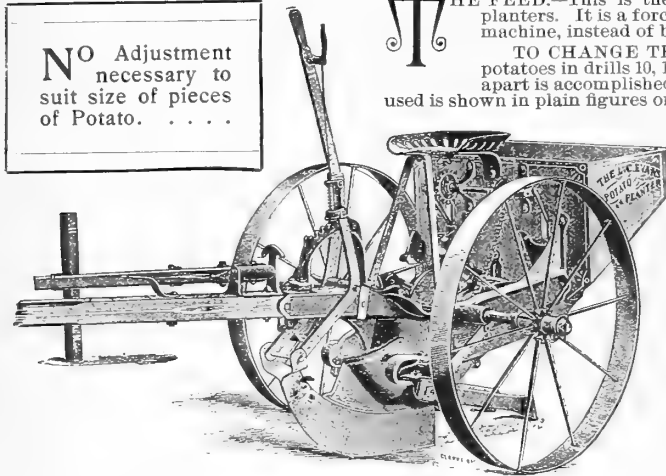

VIBRATING FEED HOPPER BOTTOM.—The bottom of the hopper is constructed with two feeding channels, which vibrate from the top of the hopper down to the bottom of the concaves, thus insuring an even and steady flow of potatoes.

THE Driver can see the Potatoes dropping. . .

THE DRIVE WHEELS.—The wheels are 36 inches in diameter, with 3½ inch tire, which makes the machine run easily, and does not allow the wheels to bury themselves in soft and sandy soil.

THE HAND LEVER.—This machine is controlled by a simple and effective hand lever, which governs the depth of planting and covering, and is readily changed by the operator, without leaving his seat. The covering shovels are supported on a flat U-shaped spring, which is connected to the furrow runner, and the shovels are raised or lowered by the hand lever. The U-shaped springs make the covering shovels flexible, allowing them to yield to the uneven surface of the ground, causing them to cover much better than shovels attached without springs. The hand lever is also used for raising the furrow runner when turning round, which is a great advantage over machines having no hand lever.

upright position when turning round, is readily operated by the hand catch, and cannot fall when turning on hilly ground. The marker is arranged with a sliding marker-head, so that the machine will plant the rows any distance apart desired.

WIDTH OF THE MACHINE.—The machine is 36 inches wide, from the centre of one drive wheel to the centre of the other, which is quite an advantage over narrow-tread machines, which easily upset on hilly ground.

FERTILIZER ATTACHMENT.—This machine can be furnished with a Fertilizer Attachment when desired. It is made on the same principle as those on the Evans Corn Planters.

WITH FERTILIZER ATTACHMENT, \$50.00 Special Discount for Cash.

PRAIRIE CITY POTATO CUTTER Price - - \$ 2.50

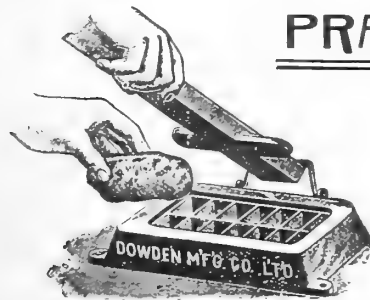

The Prairie City Potato Cutter will cut potatoes for seed faster than seven or eight men can by hand.

- - Directions for Using the Prairie City Potato Cutter. - -

Fasten the cutter by rear bolt to a barrel or box, with a space sufficiently large to let the pieces of potatoes fall through. Place a potato on knives with one hand, and with the other press it through, while reaching for another potato with the first hand. Cut one potato at a time. The more careful you are to place the potatoes, the better the eyes will be distributed. You can by changing knives, cut the pieces any desired size, and if desired you can place a division beneath, so as to collect all the seed ends in one pile separate from the rest. If the lever suggests some other way, you can, by two screws, take it off and change

— POTATOES.—

Number of Pieces per acre.	
APART.	PLANTS.
12 in. x 2½ ft.	18,640
12 " x 3 "	15,532
12 " x 3½ "	13,289
14 " x 2½ "	16,000
14 " x 3 "	13,314
14 " x 3½ "	11,405
16 " x 2½ "	12,434
16 " x 3 "	10,355
16 " x 3½ "	8,874

it by making it longer, or by making the paddle smaller or larger, if desired, or you can leave it off and use a wooden mallet. Be careful not to press or strike harder than sufficient to drive the potato down—a little experience will determine the force required. To enable rapid work, a small feed table placed close to the operator will be found very convenient.

ALL PRICES SUBJECT TO CHANGE WITHOUT NOTICE.

Advance Pea and Fertilizer Drill.

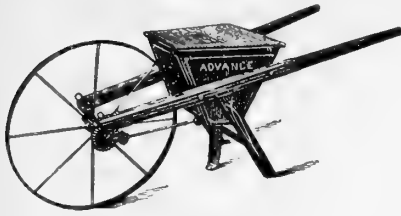

THE agitator is new, being of steel in the form of two knife-shaped arms sweeping around under the mass of the fertilizer and throwing it upon the revolving disc below. A shut-off has lately been added, whereby the waste of fertilizer is stopped when turning at ends of rows. As shown in cut, loops are bolted to frame for the purpose of attaching a horse. We cannot too strongly recommend this Drill to pea growers as being one of the very best tools for sowing peas. The same can be said of it in regard to sowing fodder corn or ensilage.

Price, ----- \$6.00

Single Row Fertilizer Distributer.

THIS fertilizer distributor will sow any kind of fertilizer evenly. We use the same feed that we use on the planter with fertilizer (except that it is much larger), which has given entire satisfaction. The fertilizer bottom and feed is composed of only five pieces, viz: the bottom, the cap, the crown-wheel pinion and the agitator. The Agitator is connected on the shaft, standing perpendicular, which prevents the fertilizer from arching. Under the planter is a funnel-shaped iron which scatters the fertilizer as desired. Three chain wheels are furnished with each machine. It will sow or distribute evenly any kind of commercial fertilizer and in any quantity desired, from the smallest to the largest amount required per acre.

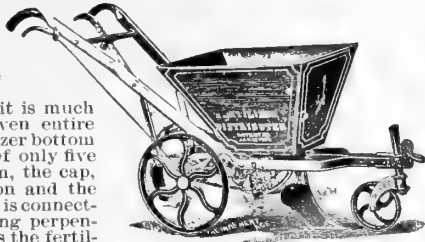

Price, with furrowing out and rear shovels complete, \$14.00

THE LATEST IMPROVED PEACH AND POTATO SORTER.

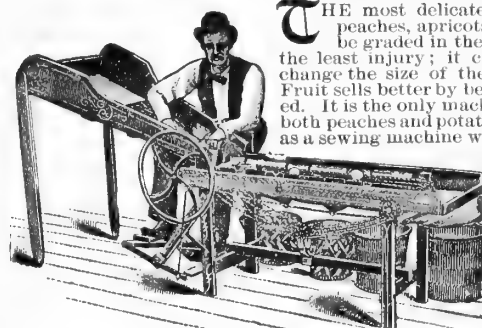

THE most delicate, ripe and softest peaches, apricots, plums, etc., can be graded in the machine without the least injury; it can be adjusted to change the size of the grades required. Fruit sells better by being properly sorted. It is the only machine that will sort both peaches and potatoes; it runs as light as a sewing machine with foot treadle; it is easily operated, and fruit growers cannot afford to be without it. All machines fully warranted.

Retail Price:
No. 1. — Capacity 2,000 bushels per day, \$25.00

Weight, 300 pounds. Shireman's Patent.

Hench & Dromgold's Potato Digger.

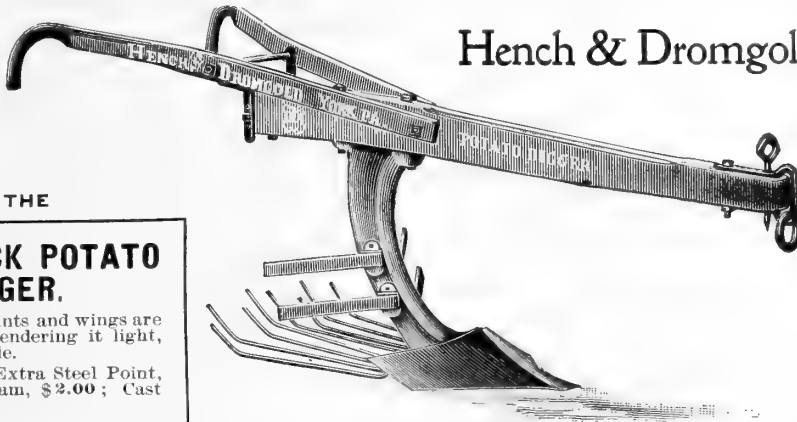

THIS cut illustrates our new and improved Potato Digger. The standards are made of cast iron, having on a highly polished steel share. The side or wing pieces to the standard are bolted with a ratchet, by which they can be adjusted to stand up or down as desired. The fingers extending back from the standard are made in a zig-zag form, instead of straight as shown in cut, on account of which they separate the potatoes from the ground better than straight ones. They are made of spring steel, and are very elastic and durable.

Our retail price, \$8.00

WE ALSO CARRY THE

HITCHCOCK POTATO DIGGER.

The fingers, points and wings are made of steel, rendering it light, strong and durable.

Price, \$8.00; Extra Steel Point, 60 c.; Extra Beam, \$2.00; Cast Head, \$1.00.

Hench & Dromgold's Low Down Broadcast Fertilizer, Lime and Ash Distributer.

THIS cut gives a description of our Broadcast Fertilizer Distributer showing how it will sow, evenly, Fertilizer, Paris Green, etc. The machine is easily operated. The lever on the rear throws the machine in and out of gear. The lever on the left side changes the feed to a small quantity for sowing, even Paris Green, and will sow as much as 8,000 lbs. of fertilizer per acre.

Price: No. 1, Distributer, \$35.00
No. 2, Distributer, 42.50
No. 3, Distributer, 50.00

Those persons who use unsifted lime can order extra screen, which is a little larger than the box. Price, \$2.50.

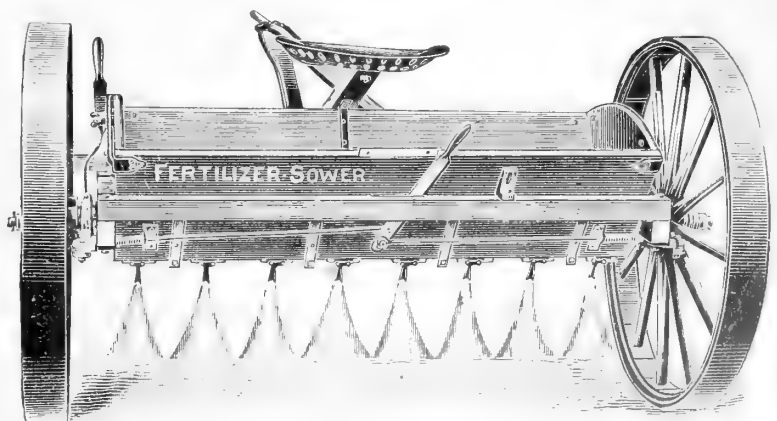

Genuine "Malta" Single and Double Shovel Plows.

Malta Double Shovel Plow, \$2.75

THE "Genuine Malta" Double Shovel Plow, as it is now made, consists of two solid pieces of iron—milled especially—made extra heavy in the shank, and tapered at the point, giving strength where it is most needed. It is provided with Malleable Adjustable Clevis Hook and Handle Braces. Blades are of the best of Open-hearth Steel, full weight and any desired width. We desire to call particular attention to the "Two Hole" feature in the shank—the most simple, sensible and substantial method yet devised for giving adjustment and long life to the blades. When the blades are new and long, they should be bolted in the upper hole. But after they become worn off at the point, and do not have the proper pitch or angle, they should be dropped to the lower hole. The point of the blade is thereby thrown forward and given the same pitch or angle as when new.



THE FARMERS' FAVORITE SINGLE, DOUBLE AND TRIPLE SHOVEL PLOWS.

THESE Shovel Plows, which were introduced by us some years ago, are rapidly growing into favor. The cost of these goods is not so much in the finish as in the construction and material, that being the principal requisite in an implement.

We wish to call your special attention to the Triple Shovel Plow, or 3-shovel Drag. They are particularly well adapted to hill side work, at the same time doing excellent work on level land, cover more ground and leave the land level and well plowed.

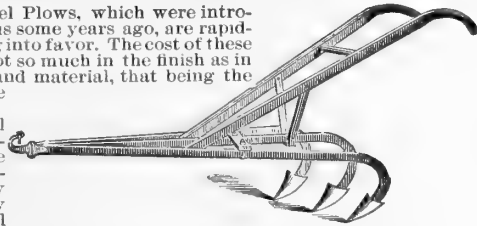

Farmers' Favorite, Single Shovel, \$2.25
 Farmers' Favorite, Double Shovel, 2.50
 Farmers' Favorite, Triple Shovel, 3.00

MALTA IRON BEAM SINGLE SHOVEL PLOW.

This plow is extensively used throughout the Middle and Southern States. The "Malta" Single Shovel Plow consists of one solid Iron Bar, rolled in such a manner as to give it great strength, is extra heavy in the curve, and tapered at the point or front end, to which is attached our Adjustable Clevis Hook. Blades are attached to beam with two bolts, and vary in width from six to sixteen inches. In ordering, always specify width of blade. Blades from twelve to sixteen inches wide are special sizes, and will not be furnished on plows without additional cost.



Malta Single Shovel Plow, \$2.50
 Malta Double Shovel Plow, 2.75

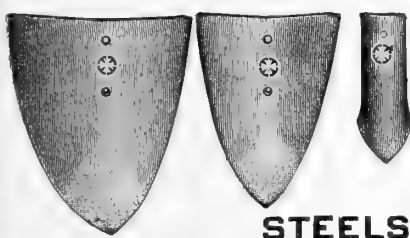

STEELS

FOR SINGLE AND DOUBLE SHOVEL PLOWS.

Full and complete line of polished steels for single and double shovel plows, made in both one and two hole styles.

- 5 1/2 & 6 in. D. S. blades, per pair, 40c.
- 7 in. D. S. blades, per pair, 50c.
- 8 in. D. S. blades, per pair, 60c.
- Bull Tongues, per pair, 40c.
- 10 in. single shovel blades, ea., 45c.
- 12 in. single shovel blades, ea., 65c.
- 14 in. single shovel blades, ea., 75c.
- 16 in. single shovel blades, ea., 85c.
- Triple Shovel plates, per set of three, 50c.

Steel Beam Georgia Stock, No. 1.

FOR the purpose of attaching shovel blades or steels of any kind used on shovel plows. These are a new invention and are the best on the market. The beam is made of a plate of steel, formed in the shape of a U bar, the front end being arranged with an adjustable clevis, dispensing with the need of a lap ring. The rear part of the beam forms a Steel Box for the plow handles, thus making it impossible to split the handles. Regular Georgia Stock Plow Handles will fit these plow stocks. Price, \$1.25.



Extra Heavy Steel Beam Georgia Stock, No. 3.

with adjustable landside and rudder. This plow stock has an extra long and very strong beam and heavy foot. The construction of this Steel Beam makes this the best and strongest plow stock on the market. Price, \$1.60.

Gold Medal Sub-Soil Plow.

THIS is a very superior implement, combining lightness of draft, economy and perfection of work. The one-horse plow will reach a depth of 15 inches, and two-horses 20 inches.



GOLD MEDAL SUB-SOIL SHOVEL PLOW.

\$8.00

SHOVEL PLOW FENDER,
 Price, each, 35c.

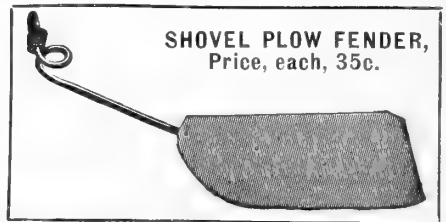

PLOW HANDLES.

- 1 1/4 x 2 inches, 5 feet long, per pair, 35c.
- 1 1/4 x 2 1/4 inches, 5 feet long, per pair, 40c.

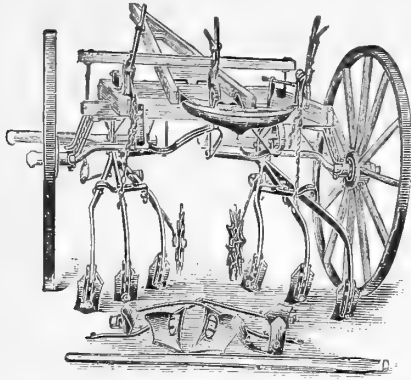

Hench Improved Riding and Walking Cultivator.

THIS CULTIVATOR HAS MANY ADVANTAGES, AS FOLLOWS :

- 1st.—It has the improved movable spindle by which the operator guides the machine to the right or left at will; can be managed by any boy who can drive a team; has double tongue, giving full view of the corn row.
- 2d.—Each beam or drag bar has lever by which it can be raised independently, and by changing a bolt, both drag bars can be raised or lowered by one lever, and each has an independent spring pressure.
- 3d.—It has also a center adjusting lever for setting the shovels closer to or from the corn row.
- 4th.—The drag bars couple in front with ball and socket bearings, by which all lost motion and wear can be taken up.
- 5th.—The single tree rods are connected to the shovel beams and serve as a pressure on the shovels while cultivating, and also assist the operator in raising the shovel beams. They are made with either pin-hoe or spring-hoe attachments.
- 6th.—Two centre beams and shovels are furnished with each machine, making an eight-shovel cultivator for fallow cultivating. The three shovel beams on either side can be set closer together or wider apart, and either one can be set to run deeper than the other. They can also be spaced six inches farther apart from front shovel or rear shovel.

Steels for Riding and Walking Cultivators.

For Hench and Dromgold Riding Cultivator and Champion Walking Cultivators.

2x10 inch plain shovel, without revolving back, at.....	15c.
3½x10½ inch new style shovels, with revolving back.....	25c.
3½x10½ inch old style shovels, without revolving back.....	20c.
6x11 blade, with revolving backs for four shovel cultivators.....	40c.
Hilling Shovels, each.....	50c.

Pin-Hoe Cultivators.....	\$27.50
Spring-Hoe Cultivators.....	32.00
Extra Beam for Cultivating Orchards.....	2.50
SPECIAL PRICE FOR CASH.	

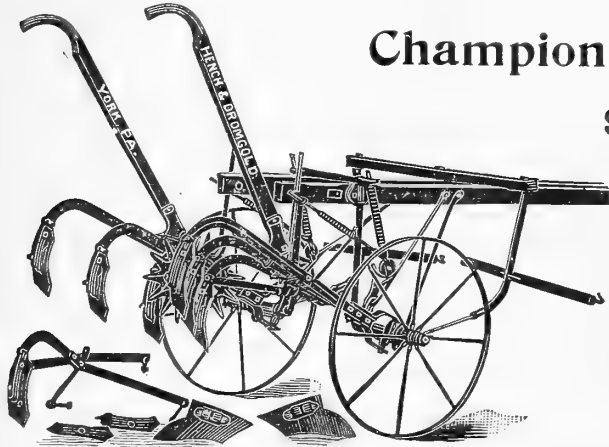

Champion Steel Walking Cultivator.

SPECIAL PRICE FOR CASH.

In the annexed is seen our six-shovel Corn and Fallow Cultivator, with seventh or middle shovel.

Perfect spring pressure and hoisting device for regulating the shovel beams or drag bars for deep or shallow cultivating.

The high arch permits its use in high corn, and being firmly braced gives it great strength.

We furnish the same patent Spring Hoe that is used on our riding cultivators for rocky or stumpy land, at small extra cost.

PRICE.

Six Shovel Cultivator, Pin Hoe, with two Bull Tongues and Two Hilling Shovels.....	\$17.50
Seventh or Middle Shovel, extra.....	1.75
Six-Shovel Cultivator, Spring Hoe.....	22.00
Seventh or Middle Shovel.....	2.60

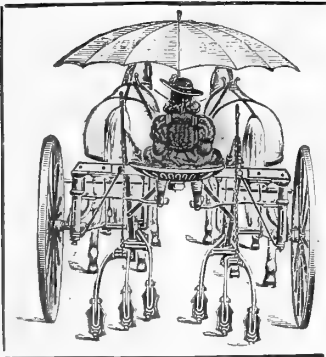

THE BALTIMORE PIVOT-AXLE RIDING CULTIVATOR. SIX BEAM PIN TRIP.

THE beams are guided by pressure on the foot levers, connected with the pivoted axles, moving with the wheels, and responds readily and easily to the will of the operator. The adjustment of beams, as to distance apart and depth of shovels can be almost instantly changed and shovels set to any desired depth; whether ground be HARD or SOFT, and they will STAY where set. It is first class for cultivating HILLSIDES.

Price, 6 Beam Pin Trip..... \$30.00

Baltimore Walking Cultivator, Steel Beam. SIX SHOVEL.

The growing demand for a six shovel cultivator is the result of a better condition of the ground, and being adapted to cultivating corn as well as plowing fallow ground, seeding Wheat, Rye, Oats, etc., makes it very desirable. Can be changed to a FOUR SHOVEL Cultivator by unbolting and removing centre beams. The price complete with Fenders and Steel or Wood Wheels..... \$20.00

The "Iron Age," as a Fixed Wheel Riding Cultivator.

Complete with One Pair of Plows, Shields and Fallow Tooth Attachment.

FOR a Riding Cultivator needed in very close work we offer the "Iron Age," No. 2, as being particularly adapted to the cultivation of peas, beans, and all close-grown crops. Its wheels close up to 35 inches and widen to 43 inches.

We take pleasure in recommending these implements to all those who have not used Riding Cultivators, owing to the fact that they work satisfactorily in close rows, and feel confident the market gardener will find them well suited to his needs.

Price, \$30.00

SPECIAL PRICE FOR CASH.

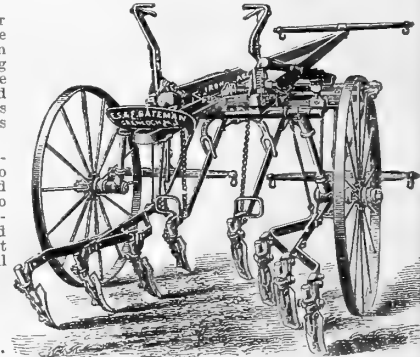

The "Iron Age," as a Pivot Wheel Cultivator. Price, \$30.00.

Complete with One Pair of Plows, Shields and Fallow Tooth Attachment.

Steels for Iron Age Riding Cultivators.

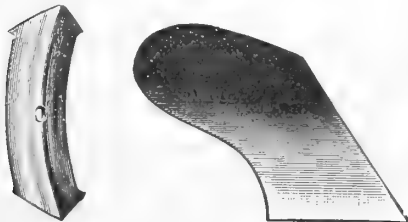

Cultivator Blades for Malta, Brown and similar styles Walking and Riding Cultivators.

Furnished blank without holes, to be fitted.
 Price, each..... 40c.
 Malta Riding Cultivator Blades, complete with Back and Bolts..... 75c.
 Malta Riding Cultivator Calf Tongues, complete with Backs and Bolts..... 60c.

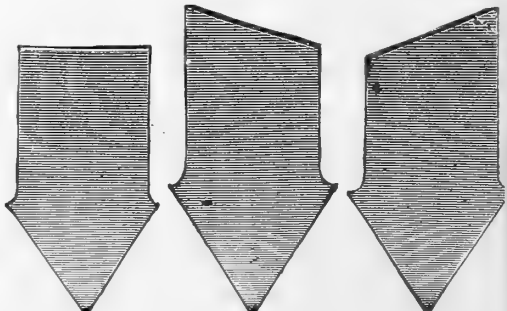

No. 90, Plates, each.....	\$.18
No. 91, " ".....	.20
No. 92, Steels, each.....	1.00

ALL PRICES SUBJECT TO CHANGE WITHOUT NOTICE.

WOODEN AND STEEL WHIFFLETREES.

Tubular Steel Whiffletrees.

These goods are tapered from centre to end and flattened, giving great strength. Practically speaking, indestructible. We can furnish this pattern for heavy contractors' work, with or without staple centre of evener; evener has hole in centre instead of hook. Made in three sizes. Also furnish same for use on wagons, hole in centre, but without staple in centre of evener. Made in 4 sizes.

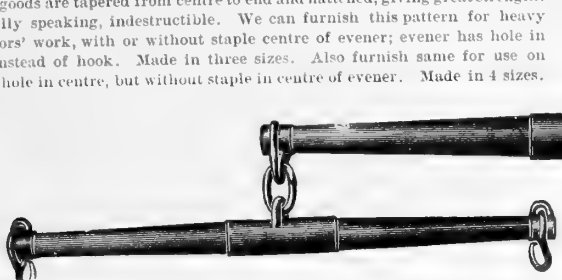

Plow Doubletrees in Sets, Complete—Pattern No. 90.

	Capacity.	Length.	Price per Set.
No. 0—For light plowing.....	2,000 lbs.	33 x 28 inches.	\$2.50
No. 1—For ordinary plowing.....	3,000 lbs.	36 x 30 inches.	3.00
No. 2—For extra heavy plowing.....	4,000 lbs.	36 x 31½ inches.	3.85

In ordering, please state length of bar, also length of singletrees and if rings or cock eye hooks are required for trace attachment.



Contractors' Double Tree—Chicago Pattern No. 54.

	Capacity.	Evener.	Singletree.	Price per Set.
No. 1—4,000 to 5,000 lbs.		41 inches long.	32 inches long.	\$6.50
No. 2—6,000 to 8,000 lbs.		43 inches long.	34 inches long.	7.00
No. 3—8,000 to 10,000 lbs.		43 to 45 inches long.	34 to 36 inches long.	7.50

In ordering please state length of evener, also whether rings or cock eye hooks are required for trace attachment.

Farm Wagon Doubletrees—Pattern No. 89.

	Capacity.	Evener.	Singletree.	Price per Set.
No. 1—2,500 lbs.		43 inches long.	33 inches long.	\$4.66
No. 2—4,000 lbs.		43 to 45 inches long.	34 inches long.	5.00

In ordering, please state length of evener, also whether rings or cock eye hooks are required for trace attachment.

Southern Plow Singletrees—Pattern No. 91.

No. 0—20, 22, 24 and 26 inches long.
Price each \$0.50



Southern Plow Singletrees—Pattern No. 92.

No. 1—28 & 30 inches long.
Price each \$0.70

- 36 inch Southern Double Trees... \$.75
- 36 inch Heavy Double Trees... 1.00
- 40 inch Heavy Double Trees... 1.10
- Extra Heavy Triple Trees... 2.00

Oval Lap or Open Rings, 10c. each.
Chain Repair Links, 30c. per doz.

Single, Double and Triple Trees. IRONED, COMPLETE.

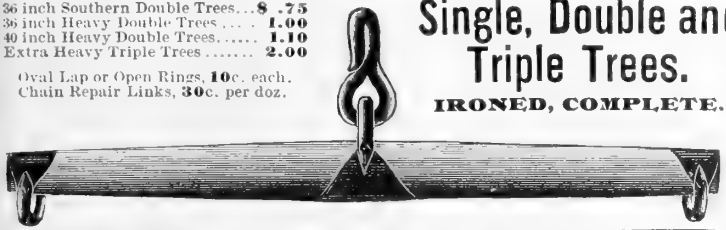

26 inch Southern Single Trees.....	25c.
28 inch Extra Nailed Single Trees.....	40c.
30 inch Heavy Single Tree.....	50c.
32 inch Heavy Single Tree.....	60c.
34 inch Heavy Single Tree.....	60c.
36 inch Heavy Single Tree.....	75c.

WOODEN NECK YOKES No. 6. IRONED COMPLETE.

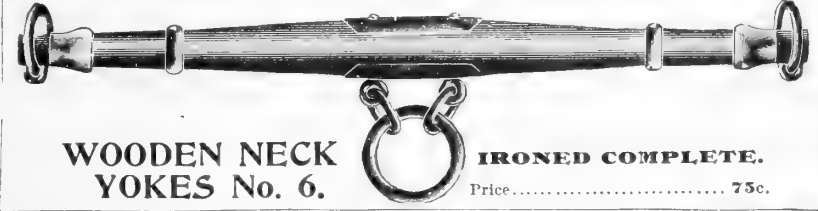

Price 75c.



Steel Neck Yokes—Pattern No. 55.

This cut represents our No. 2 Neck Yoke, which is very suitable for Farm Wagons and Similar work.
No. 2 Neck Yoke, 42 inches long..... Price each, \$2.00



Neck Yokes—Pattern No. 96.

This represents our No. 1 Neck Yoke, which is very suitable for Reaper, Mower and Grain Drill use.
No. 1 Neck Yoke, 36 inches long..... Price each, \$1.00



SETS OF WELDED CLIPS.

FOR SINGLE TREES.

	Price per Set.	Doz. Sets.
No. 26—One Centre ½ inch Clip, welded and two ½ inch End Clips, welded, with 5-16 inch hooks as used on our 28 inch Single Trees.....	.20	\$2.00
No. 30—One Centre 9-16 inch Clip, welded, and two 7-16 inch End Clips, welded, with ½ inch hooks as used on our 30 and 32 inch Heavy Single Trees.....	.25	2.50
No. 34—One Centre ¾ inch Clip, welded, and two 7-16 inch End Clips, welded, with ¾ inch hooks as used on our 34 and 36 inch Heavy Single Trees.....	.30	3.00

FOR DOUBLE TREES.

	Price per Set.	Doz. Sets.
No. 36—Southern, one ¾ inch Centre Clip and Hook, welded, with ½ inch Hook and two ½ inch End Clips, welded, as used on our 36 inch Southern Double Trees.....	.25	\$2.50
Nos. 36 and 40—Pennsylvania, one ¾ inch Centre Clip and Hook, welded, with ¾ inch Hook and two 9-16 inch End Clips, welded, as used on our 36 and 40 inch Heavy Pennsylvania Double Trees.....	.40	4.00

ALL PRICES SUBJECT TO CHANGE WITHOUT NOTICE.

Genuine Oliver Chilled Plows and Repairs.

DONT forget to look
for the
Oliver Trade Mark
on all Oliver Goods. None
genuine without it.

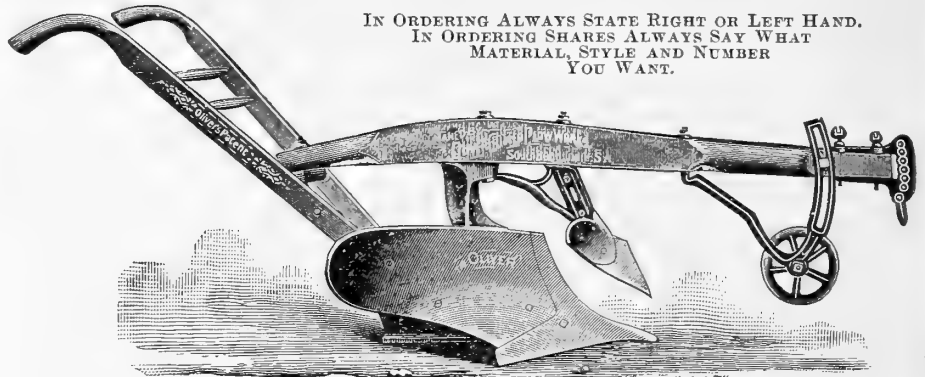

IN ORDERING ALWAYS STATE RIGHT OR LEFT HAND.
IN ORDERING SHARES ALWAYS SAY WHAT
MATERIAL, STYLE AND NUMBER
YOU WANT.

PLOWS—PRICES.

No. A-1 and A-2.....	\$4.75	No. 22, Iron Beam	\$12.00
" B.....	6.50	" 40	10.00
" B Vineyard, right hand		" E-1	10.00
only.....	8.00	" 14-A Steel Mouldboard	
No. 10-0.....	7.50	and Landside, Cast Share	
" 13.....	8.50	and Shoe, right hand	
" 19.....	9.00	only.....	12.00
" 20.....	9.50	No. 40, XX O. C. Plow.....	11.00

OLIVER SPECIAL PLOWS.

No. 1—Road and Grading Plow, all Steel, with Standing Coulter and Gauge Iron or Wheel.....	\$33.00
The Oliver Sub-Soiler, best of its kind, with Wheel.....	14.50

OLIVER HILLSIDE PLOWS.

They are made in two sizes—the smallest, No. 52, for one horse, and the largest, No. 53, for two horses. It is made with steel mouldboard and cast point, and is well equipped in all respects for first-class work. In addition to its excellent qualities as a hillside plow, it also works admirably in level ground, and having been thoroughly tried we do not hesitate to recommend it highly.

No. 52, Steel Mouldboard, Cast Share.....	\$11.00
No. 53, Steel Mouldboard, Cast Share.....	12.00

NOTE.—A Clevis, Wrench, and an extra share are included in above prices for plows fitted with cast shares, but wheels and jointers are not.

OLIVER COMBINATION PLOWS.

WOOD BEAM, RIGHT AND LEFT HAND.

No. 130—All Chilled, only.....	\$10.00
" 140—All Chilled, only.....	10.50

OLIVER REPAIRS.

MOULDBOARDS.

No. A-1 and A-2.....	\$1.25	No. E.....	\$3.00
" B and B. Vineyard.....	1.75	" 14 A, Steel.....	5.00
" 10-0.....	2.00	" 98.....	2.75
" 13 and 13 Vineyard.....	2.25	" 99.....	3.00
" 19.....	2.50	" 119.....	2.50
" 20.....	2.75	" 120.....	2.75
" 22.....	3.00	" 140.....	3.00
" 40.....	3.00		

STANDARDS.

No. A.....	\$1.25	No. 20.....	\$2.25
" B.....	1.50	" 40.....	2.50
" B. Vineyard.....	2.00	" E.....	2.50
" 10-0.....	2.00	" 119.....	2.75
" 13.....	2.25	" 120.....	2.75
" 19.....	2.25	" 140.....	2.75

SHARES.

Numbers.	Cutter Shares.	Plain Shares.	Cutter Slip-Nose Shares.	Plain Slip-Nose Shares.	Reversible Shares.	Cast Reversible Slip.
A	25c.	20c.		25c.		
B	30c.	25c.		30c.		10c.
B, Vin.		25c.				
10-0	50c.		40c.			10c.
13	30c.		40c.			10c.
19	35c.		45c.			10c.
20	35c.		45c.			10c.
22	40c.	35c.		45c.		10c.
30	40c.	35c.				10c.
40	40c.		55c.			10c.
E	40c.		55c.			10c.
14-A	40c.	35c.		45c.		10c.
98	65c.				30c.	20c.
99	65c.				30c.	20c.
119					35c.	25c.
120					35c.	25c.
140					35c.	25c.

LANDSIDES.

No. A.....	\$.45	No. E.....	\$1.00
" B and B. Vineyard.....	.65	" 14-A, Cast.....	.70
" 10-0.....	.70	" 14-A, Steel.....	1.25
" 13 and 13 Vineyard.....	.75	" 98.....	1.00
" 19.....	1.00	" 99.....	1.00
" 20.....	1.00	" 119.....	1.00
" 22.....	1.00	" 120.....	1.00
" 30.....	1.00	" 140.....	1.00
" 40.....	1.00		

HANDLE BRACES.

No. A.....	25 cents.
" B-10-13-13 Vineyard, B Vineyard.....	30 "
All other Handle Braces.....	50 "

HANDLES.

COMPLETE.		PER SET.	
No. A-B-10-0.....	\$1.25	No. B Vineyard.....	\$2.00
" 22, complete, less rod.....	1.25	" 98-99-119-120 and 140.....	1.85
" 14-A and rod.....	1.50	" 113.....	1.60
" 13.....	1.50	" 19-20-E and 40.....	1.75

HANDLES.

PER PAIR AND SINGLE.

All numbers, per pair, loose.....	\$1.00
" single, each.....	.50
Rounds, per pair.....	.10
L. S. Handle Plates, each.....	.10

CLEVISES.

Clevises Marked "A," for One-Horse Plows.....	\$.20
" Marked "B," for Two-Horse Plows.....	.30
" Marked "D," for Three-Horse Plows.....	.50
" Shackles.....	.15
" Wrenches.....	.00
" Guide Pins.....	.03
" Shackle.....	.05
" Links, Two-Horse.....	.05
" Rings, One-Horse.....	.05

BEAMS.

No. A-B-B Vineyard and 10.....	\$1.00
All other numbers, Wood.....	1.50
No. 22, Iron.....	4.25

All Polished Points, each, add extra 10 cents.
Non-Reversible Shares and Slips same as Reversible.
Bowers' Slips same as other Slips.

ALL PRICES SUBJECT TO CHANGE WITHOUT NOTICE.

OLIVER REPAIRS--Continued.

ROLLING COULTERS.

We have Rolling Coulters to fit every kind of Oliver Plows upon which they may be required. See prices below.

11-inch, for One-Horse Plows, complete.....\$3.00
 13-inch, for Two or Three Horse Plows, complete..... 3.50

COMBINATION PLOW REPAIRS.

Numbers.	Mouldboard Lugs.	Handle Lugs.	Mouldboard and Landside Braces.	Shins.	Lever.	Springs.	Landside Plates.
98	20c.	20c.	40c.	20c.	5c.	5c.
99	20c.	20c.	40c.	20c.	5c.	5c.
119	20c.	20c.	40c.	20c.	20c.	5c.
120	20c.	20c.	40c.	20c.	20c.	5c.
140	20c.	20c.	40c.	20c.	20c.	5c.

HANGING COULTERS.

These are made to any of our Jointer Holders, and take the place of the Jointer where their use is desired.

All other numbers, complete, Two-Horse.....\$2.00
 All numbers, complete, One-Horse..... 1.50
 Holders, same as for Jointers..... 1.00

HILL-SIDE PLOW REPAIRS.

Plow Nos.	Steel Mouldboard.	Standards.	Landsides.	Cast Shares.	Set Handles.	Beams.	Clevises.	Wrenches.	Wheels.	Jointers.
52	\$3.00	\$2.75	\$.75	\$.50	\$1.75	\$1.00	\$.20	\$.15	\$.75
53	3.50	3.00	.75	.50	1.75	1.25	.30	.15	.75
55	4.50	3.25	1.00	.55	2.00	1.00	.35	.15	1.25	\$2.00

NOTE.—Where blank spaces occur, parts are not made, hence prices are not given.

No. 55, Malleable Beams.....	\$4.00
" 54, Jointer Standards, Wrought.....	1.00
" 55, Jointer Standards, Wrought.....	1.00
" 54, Jointer Mouldboard and Point.....	.50
" 55, Jointer Mouldboard and Point.....	.50
" 54, Wheel Standard.....	.50
" 54, Wheel Standard Block.....	.25

No. 55, Wheel Standard, Double.....	\$.75
" 55, Wheel Standard, Yoke.....	.50
" 52-C, Hook Holder.....	.30
" 52-D-M, B. Foot.....	1.00
" 52-F-M, B. Brace.....	.60
" 52-H, Lever.....	1.00
" 52-I, Handle Part.....	.30

WHEELS.

Their use is strongly recommended in wet or mellow ground. Can be furnished for nearly all our patterns. See prices below.

Straight Standard, One Horse, complete.....	\$.75
Brace, Standard, Two-Horse, complete.....	1.00
Standards, One-Horse, Straight.....	.40
Standards, Two-Horse, all kinds.....	.50
Wheels only, One-Horse.....	.40

Wheels, only, Two-Horse.....	\$.50
Hubs.....	.10
Centre Pins or Hub Bolts.....	.10
Wheel Caps or Sand Bands.....	.05

NOTE.—In ordering Wheels, say if for Right Hand or Left Hand, Wood or Steel Beam Plows.

JOINTERS.

Decidedly the most important of all plow attachments, and can be used on most of our plows. The plowman who once uses a Jointer will never want to do without it.

No. D, Chilled, for One-Horse Plows.....	\$1.50
" 140, Chilled, for Nos. 120, 125 and 140 Plows.....	2.00
" 2, for Two and Three-Horse Plows.....	2.00
Jointer Points, Chilled, all numbers.....	.20
Jointer Mouldboards, Chilled, all numbers.....	.40

One-Horse Jointer Holders.....	\$.75
Two-Horse Jointer Holders.....	1.00
One-Horse Jointer Standards.....	.50
Two-Horse Jointer Standards.....	.50

NOTE.—In ordering say whether for Wood or Steel Beam Plows.

Plow, Machine and Carriage Bolts and Nuts.

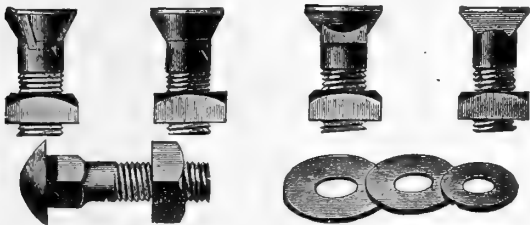

PLOW CLEVISES.

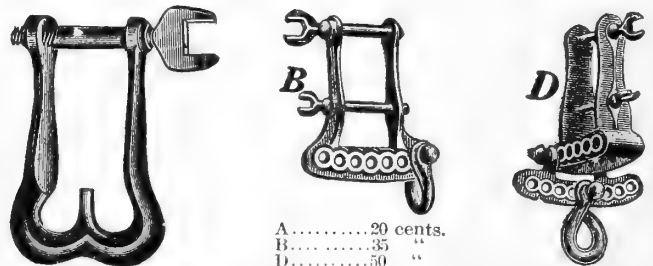

A.....20 cents.
 B.....35 "
 D.....50 "

Extras furnished for most of the other Chilled and Cast Plows used throughout this section, including South Bend, Roland, Syracuse, Bissell, Ward, etc. Also keep on hand full stock of Clevises for Minor & Horton, Farmers' Friend, Girl Champion, Boy Dixie, and other Southern Cast Plows, and a full supply of plow, cultivator and machine bolts.

CAST PLOWS.

Minor & Horton High Standard Plows. {	No. 18.....\$3.00	No. 19.....\$4.00	} Plain Castings per lb.
	No. 18½..... 3.50	No. 19½..... 5.00	

Girl Champion.
 Casting by weight.

No 'Girl'.....\$3.00 No. A.....\$3.25
 No. AA.....\$3.50

"Boy" Dixie Plow.

"Boy" Dixie.....\$1.75
 No. X..... 2.00
 " I..... 2.10
 " II..... 4.00

Genuine Farmers' Friend Plow.

No. 1½...\$2.10 No. 8, with clevis,\$5.65
 No. 5.... 2.10 No. 8, with rod, 6.35
 No. 7½.. 4.35 Casting by weight.

ALL PRICES SUBJECT TO CHANGE WITHOUT NOTICE.

•• Climax Steel Plows ••

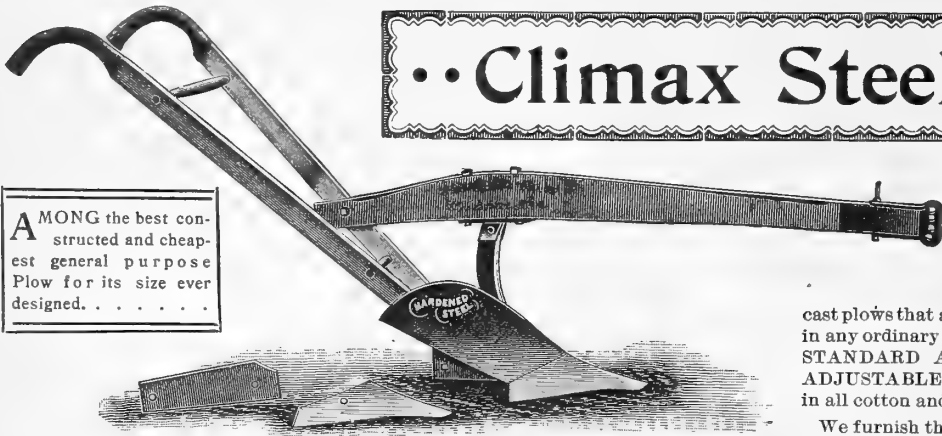

AMONG the best constructed and cheapest general purpose Plow for its size ever designed.

THESE Plows have a wide reputation for superiority in quality and finish, and for lightness, because steel being tougher than cast iron, can be made thinner. They take on a much higher degree of earth polish than is ordinarily found in cast plows that are not chilled, and consequently will scour in any ordinary clay soil. They are all made with **STEEL STANDARD AND CAP, SLOPING LANDSIDE AND ADJUSTABLE SLIP HEEL**, and will do superior work in all cotton and corn lands.

- We furnish them in the following numbers and sizes:
- Pony—Light one-horse, 7-inch cut, wood beam. Very popular. Price, with our extra steel point... **\$3.25**
 - A. O.—One-horse, 8-inch cut, wood beam. Price, with extra steel point **3.75**
 - B. O.—One-horse or light two-horse, 9-inch cut, wood beam. Designed for either stubble or light sod, doing both kinds of work in the most satisfactory manner. Very light draft. Price, with extra steel point..... **4.25**
 - C. O.—Two-horse, 10-inch cut, wood beam. Price, with extra steel share..... **6.00**
 - D. O.—Two-horse, 11-inch cut, wood beam. It turns its furrow slice perfectly. Price, with extra steel point..... **7.25**

Pony Series Frogs or Saddles.-Steel.

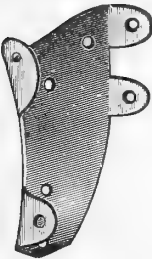

THESE cuts show our Pony series Solid Steel Frogs which are forged from a solid piece of steel. By the use of this, the strength of the plow is increased and the draft made lighter. **THIS STEEL FROG IS PRACTICALLY INDESTRUCTIBLE.** The adjustable heel is intended to take up the wear at heel of landside, and as long as it lasts it is practically a new landside. A great improvement.

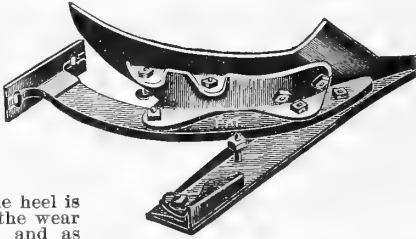

Cast Plows The Hampton Plows

Hampton No. 1, C or Jersey & Attachments.

HAS adjustable handles, beam and brace rod. Extras are ground. There are several improvements on this implement. We confidently offer it now as one of the best truck plows made, and with the several attachments that go with it the farmer may feel that little more is to be desired for the plowing and proper cultivation of all his crops. First class work can be done on all kinds of soil. One of the strongest features is its length of landside, causing it to run perfectly level. The beam is provided with both a vertical and lateral adjustment, which is easily effected, as there are no mortices in the beam. All repairs are polished, which prevents sticking and insures easy running.

Find below description of repairs and extra attachments:

With every Hampton No. 1 C Plow is sent 3 extra moulds and one extra share and wrench, as follows:

- No. 1 B, Fig. 3 in cut—A regular one horse mould board used on all regular No. 1 Plows.
- Cabbage, Fig. 2 in cut, smaller than No. 1 B—Particularly adapted to the second cultivation of ALL CROPS.
- Truck, Fig. 1 in cut—A small mould board suitable for the early cultivation of all truck.
- No. 1 C—Illustrated on plow is a large one horse mould board turning a strong furrow.

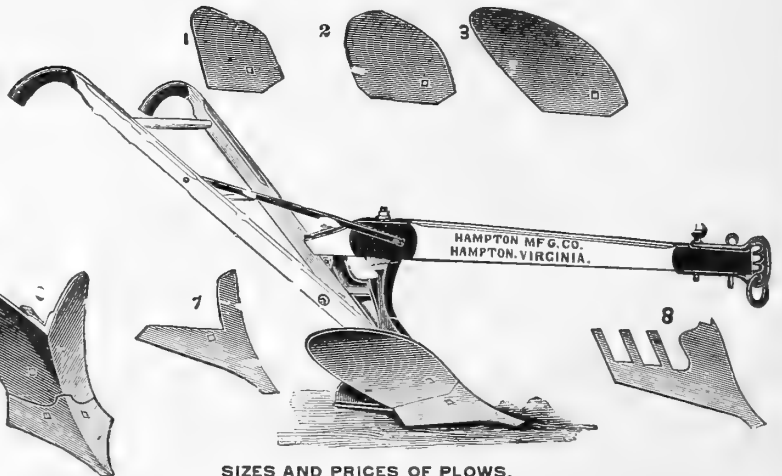

SIZES AND PRICES OF PLOWS.

All of the above are included in the price..... **\$4.00**

The following attachments are sold extra:

The double mould board and point (Fig. 6 in cut) is used for opening furrows and hilling up, and can be attached to the standard by removing the point and mould board. The sweep point is same as No. 8, but without the fingers. A splendid weeder.

Fig. 7 in cut is a cutter or sod land point. Very popular.

Fig 8 in cut is a potato digging attachment. Very effective for the purpose.

HAMPTON BOY.

Similar in size and shape to Boy Dixie and Boy Clipper, but has a higher standard, which makes it less liable to choke. Its beam adjustment is simple and complete. It can be quickly changed from a light truck plow to a medium, and even a large one-horse plow, by using the large moulds. Scraper and Potato Points are also fitted to this plow, thus covering almost every detail of farm work. The wood work is handsomely painted, lettered and varnished.

Price with truck mould board, wrench and point..... **\$2.50**

HAMPTON No. 1 REGULAR.

This style is similar to the Boy, but larger. Attachments are: truck mould board, point and wrench.

Price complete..... **\$3 00**

HAMPTON No. 5.

This is a medium two horse plow, very light draft, and scours thoroughly. Front wheel and jointers furnished when desired, extra. Price, plain plow..... **\$5.75**

LIBERAL DISCOUNT TO THE TRADE.

— LIBERAL DISCOUNT TO THE TRADE. —
Casting on all Hampton Plows..... Price, plain 4c.; polished 5c.

The Bell's Center-Cut Overlapping Disc Harrow.

THE IMPORTANCE OF THIS SURE CULTIVATION TO AN EVEN DEPTH and leaving no ground uncultivated can not be overestimated. There will be no hard ridge. There will be no row of weeds between the grain. This Harrow is made of steel angles and platform and high test steel discs. No wood about it except poles and hitch. Harrows will always be furnished with Round Discs, unless especially ordered otherwise. Polygon or cut discs furnished at small extra cost, when especially ordered.

No. 1. Bell's Centre-Cut Harrow, with 13 discs, steel frame neck yoke and 3-horse eveners..... **\$27.00**

THERE is no farming tool that covers and cultivates so much ground as a good disc harrow, but they are all so made that a little uncut ridge of ground is left in the center. How to reach that ridge and cultivate an even surface has been the problem. It is now solved by "BELL'S CENTER CUT" This is the first and only successful overlapping center-cut disc harrow. This harrow cultivates the ridge and pulverizes the ground from outside to outside, leaving a smooth surface behind it. Farmers who broadcast seed or grain will have no other machine after once trying this center-cutting harrow.



This Harrow is unquestionably the neatest, the simplest in construction, the lightest running, and at the same time the strongest and most durable harrow made, with the single exception of the "Centre-Cut."

"Druid" Disc Harrow.

GOOD CULTIVATION.

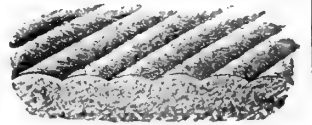

Cut showing soil as pulverized by the Bell's Center-Cut when the gangs overlap, leaving no part uncultivated, and leaving a perfect seed bed.



Cut showing soil as pulverized with old style Harrow, when the gangs abut, but do not overlap, showing a center row of weeds and soil uncultivated.

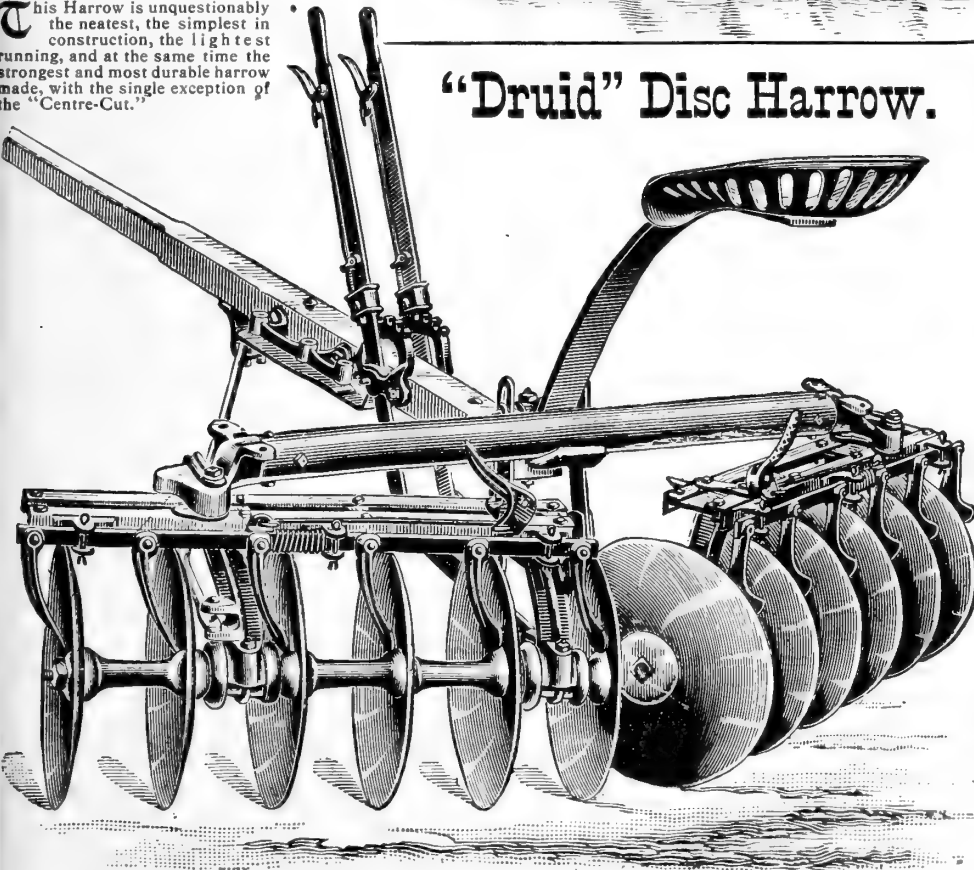

THIS Harrow is made of steel angles, extra heavy crossbeam of steel-tubing. No wood about it but the tongue and the hitch. It has many advantages over the wood frame Harrow, and, in addition, will last longer. While almost any disc harrow will do fair work under the most favorable circumstances, only the BEST will stand the test at all times and under all the various conditions of soil. The cut shows the Harrow up in excellent shape, giving the construction in detail, including the most perfect set of gang scrapers made. Furnished with neck yoke and whiffletrees.

No.	Disc.	Inches.	Ft. of Cut.	Price.
00	8	16	4	\$23.00
0	10	16	5	24.00
1	12	16	6	25.00

Can also furnish a cheaper line of Disc Harrows

ALL PRICES SUBJECT TO CHANGE WITHOUT NOTICE.

Hench & Dromgold Improved Walking or Riding Spring Tooth Lever Harrow, on Wheels.

IT is an established fact that land prepared by a Spring Tooth Harrow for wheat, is the most acceptable and common-sense method, but the complaint of some has been heavy draft. Now, to meet that objection, a set of wheels has been added; consequently the draft is lessened almost one-half a horse less than on the float spring tooth harrow; fifteen inches can be worn off the teeth by the use of the lever and the ratchets; the slat can be removed in a second; the lever can be attached to the middle rollers, if so desired, when used altogether for riding; and the wheels, when the teeth are set the desired depth, prevent its going deeper than required by the operator, and consequently it cuts the same depth in case soft or hard ground is encountered alternately. The front wheels are pivoted and the eveners is attached to the pivoted wheels, so that the harrow will draw at ease after the horses, causing it to draw straight, each tooth cutting its own course or way. It is also admirably adapted to putting corn land in condition for seeding wheat, as the depth is easily and immediately regulated by the lever. It is pivoted in the centre, and can be uncoupled in a moment without the use of bolts or split keys, and can then be used as a one-horse harrow, which makes it quite convenient, either half being adjusted with perfect ease.

SPECIAL DISCOUNT FOR CASH.

Fifteen Tooth Harrow, without seat	\$17.50
Seventeen Tooth Harrow, without seat	18.50
Nineteen Tooth Harrow, without seat	19.75
Twenty-one Tooth Harrow, without seat	21.25

(If seat is wanted, price will be 75 cents extra.)



Hench & Dromgold All Steel Frame Spring Tooth Harrow.

SPECIAL DISCOUNT FOR CASH.

14 Tooth Harrow	\$13.50
16 Tooth Harrow	14.00
18 Tooth Harrow	15.00
20 Tooth Harrow	16.00
22 Tooth Harrow	17.00

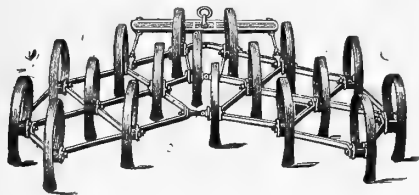

In the Ratchet Tooth Holder, as shown in the cut, the tooth is securely clamped between two malleable ratchet clips, which engage with the ratchet frame clip, and is held firmly and securely by one bolt to each tooth, on which it rotates as on a pivot. By this arrangement, if the teeth are worn off or cut off as much as fifteen inches, they can be set to run as deep as when new. It is so hinged that either side can be raised straight up or at right angles, for passing stumps or trees.

Daisy Cultivator on Wheels.

THIS Style of Cultivator is precisely the same as either half of the regular Spring Tooth Wheel Harrow, with the addition of handles. It is an admirable implement for use with one horse in working crops in rows. We can furnish anyone having the regular harrow a set of handles and braces, and they can be attached to either half. The front wheel is pivoted, and will draw with ease after the horse, causing it to draw straight. The wheels guide it and cause it to run steady, and each tooth will cut its own way. For turning at the ends the teeth can be raised by the use of the lever, and is very easy to operate. The frame is made of "I" Beam steel; the rollers or bars are also of steel, the castings being malleable, and the best steel used in our teeth, makes it one of the most durable and complete cultivators or small harrows ever offered to the public. We solicit your patronage.



RETAIL PRICE.

7 tooth	\$8.75	10 tooth	\$10.25
8 tooth	9.25	11 tooth	10.75
9 tooth	9.75		

Perry Wood Frame Harrow—Iron Clad.

THIS is, without doubt, one of the best Float Harrows on the market, and our very large sales during the season just passed testify to this fact. It is particularly desirable in cloddy ground, as it combines a clod crusher and spring-tooth harrow, the frame being iron-plated underneath and in front, so that it crushes the clods at the same time the teeth stir up the ground, and the frame prevents it sinking too deep. Bolt heads fully protected. Teeth cannot get loose. Simplicity itself, and very strong.



14 and 16 Tooth Harrows. \$10.50	18 Tooth Harrows. \$11.50
20 Tooth Harrows. 12.50	22 Tooth Harrows. 13.50

SPECIAL DISCOUNT FOR CASH.

"Daisy" Cultivator.

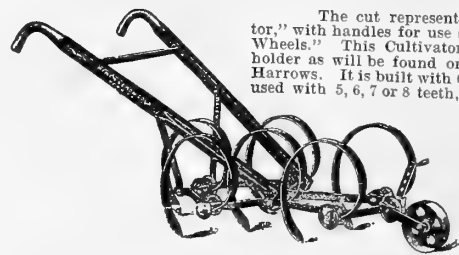

The cut represents the "Daisy Cultivator," with handles for use similar to the "Daisy on Wheels." This Cultivator has the same ratchet holder as will be found on all of this make of Harrows. It is built with 6 or 8 teeth, but can be used with 5, 6, 7 or 8 teeth, as desired. By simply unbolting the two outside teeth of the 6 tooth Cultivator, it can be used with 4 teeth, and by taking out the middle tooth on the right hand side, and setting the rear tooth in the centre, it makes a 5-tooth Cultivator.

Price of 6-tooth Cultivator, with wheel.....	\$5.50
Price of 8-tooth Cultivator, with wheel.....	6.50
Price of 10-tooth Cultivator, with wheel.....	8.00

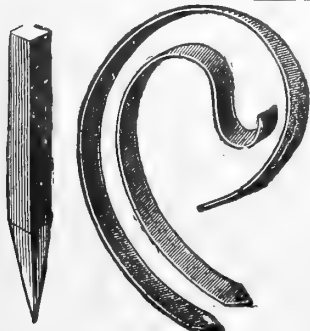

Spring Harrow Teeth.

For Leading Harrows including
Hench & Dromgold,
Stevens, Perry, Childs, U. T. K.,
Tiger, Buffalo, Pitts,
etc., etc.

PRICE, 40 CENTS EACH.

When taken in full sets a special price.

SPIKE HARROW TEETH AT LOWEST PRICES.

Whipple's Supplementary Adjustable Harrow Tooth Points.

Old Harrows made as good as new at small expense.

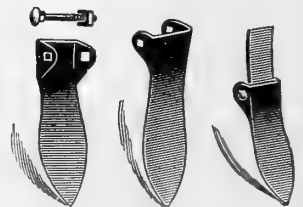

These points are made of a high grade of steel and will outwear the original points. The ears extend back and the point being made of spring metal, allows the ears to be drawn together, clamping the shank firmly, and if the old teeth are out of line, the points, being adjustable, can be lined up, so that every tooth will rest on the ground. These points will fit any of the old Spring Teeth on the market.

Price, point, 15 cents each.

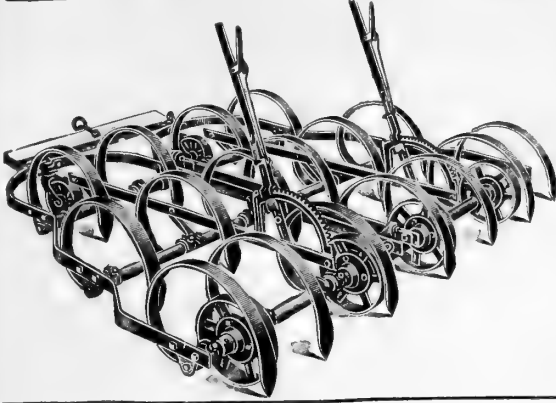

BALTIMORE SPRING TOOTH LEVER WHEEL HARROW.

THIS HARROW is constructed with five pipe bars, to which are attached the Improved Self-Sharpening Teeth. These teeth are serrated a distance back from the point, which allows the tooth after being worn to a certain point to assume a new cutting edge. The illustration shows the method of attaching the tooth to the bar. The strain comes directly against the side of the bolt, lessening the liability of breakage. The tooth is held securely in position by the Malleable Friction Clamp, which also prevents the loosening of the nut. The slotted hole allows an adjustment of four inches at the point of the tooth. In this manner of fastening the liability of breakage of teeth is reduced to a minimum, as the strain of the teeth simply increases or decreases the curve or circle without damage.

The wheels on the rear end of the frame revolve on journals around the cross bar, while those on the front are castor wheels. The CHILLED BOXES and JOURNALS of these wheels are renewable.

- 15 Tooth, 2 Sections, complete.....\$17.50
- 17 Tooth, 2 Sections, complete.....\$18.50

STEVENS' SPRING TOOTH HARROWS.

Perfect Tooth Clip. Pitch Changed by loosening one bolt. Clears itself. Cannot clog. Folds compactly.

PRICES :

- Fourteen and Sixteen Tooth Harrows..... \$13.00
- Eighteen Tooth Harrows..... 14.00
- Twenty Tooth Harrows..... 15.00
- Twenty-two Tooth Harrows... 16.00

Special discount for cash.

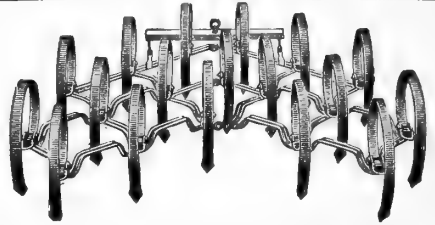

STEVENS' ARCHED FRAME.

STEEL "U" BAR LEVER HARROW.

SO ARRANGED THAT THE TEETH CANNOT TRACK.

THIS is a "U" Bar Steel Harrow, with five "U" bars to each section. The teeth are so fastened by a malleable tooth holder secured by a bolt that may be easily removed for sharpening, or so

they may be adjusted to make them cut deep or shallow, as desired. The levers permit the teeth to be lowered for smoothing or set forward at an angle to make them do more work and run more steady, and also allow the operator to unload trash without stopping his

team. It is strong and durable; made of high carbon steel. It is finished nicely, painted and varnished. The heads of the teeth are swedged to prevent losing them, which makes a much more economical and satisfactory harrow for the farmer to own and the dealer to sell.

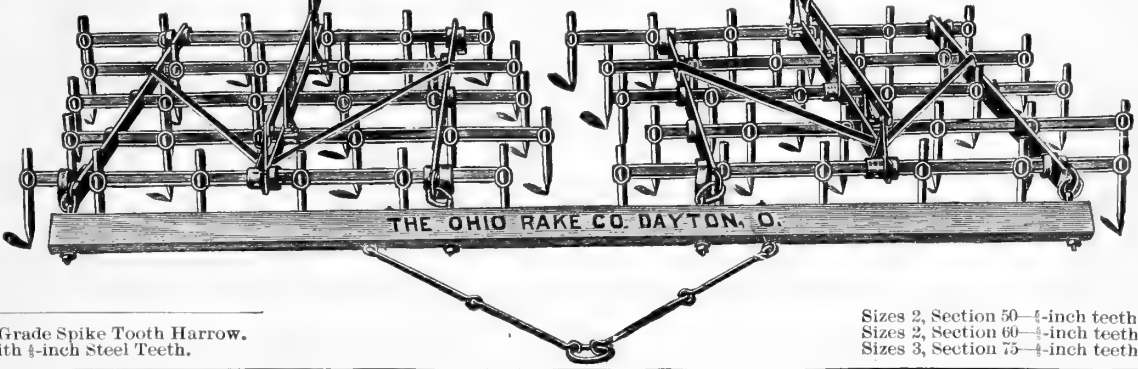

A High Grade Spike Tooth Harrow. With 1/2-inch Steel Teeth.

- Sizes 2, Section 50—4-inch teeth, \$11.00
- Sizes 2, Section 60—4-inch teeth, 12.25
- Sizes 3, Section 75—4-inch teeth, 16.50

ADJUSTABLE TUBULAR FRAME LEVER HARROW.

THIS HARROW can be used as a straight-tooth pulverizing Harrow, or a straight-tooth smoothing Harrow. By means of the Lever the teeth can be set straight or to any desired slant. The beams are made of iron tubes and the teeth pass through the same and are threaded and held firmly in place by a tap. If stalks and trash accumulate on the teeth when used as a straight-tooth Harrow, the teeth can be changed in a moment, by means of a Lever, to a standing position, for clearing off the same. As a smoothing Harrow it never clogs, all rubbish being cut in two or passing down and off the ends of the teeth and completely buried. For cultivating young corn in its early stage it is admirably adapted. Specially adapted to cultivating wheat in the spring.

- Price, with 50 Teeth.....\$11.50. Special discount for cash.

GARDENER'S HARROW.

THIS Harrow is similar to the Baltimore Double-Hinge Harrow, only it is made in one section instead of two. It is just the thing for small, hilly farms, or for market gardeners. It is designed to be used by one horse, and is the essence of convenience in handling and getting around in small garden plots, etc. We furnish this Harrow with 30 teeth, which cuts 4 feet 6 inches wide, and with 24 teeth, cutting 3 feet 8 inches wide.

- Price, with 24 teeth.....\$5.50.
- With 30 teeth..... 6.25. Special discount for cash.

Baltimore Double-Hinge Harrow.

THIS is a two section, wood frame, spike-tooth Harrow. It is so coupled that each section has a vibratory motion, independent of the other. It is simple and durable. The frame is of hard wood, nicely finished and painted. The runners, as seen in the cut, are intended to be used in carrying the Harrow from one field to another; the value of this feature any good farmer will appreciate. It cuts 6 feet 6 inches, and contains 40 teeth. Price, \$9.00. Special discount for cash.

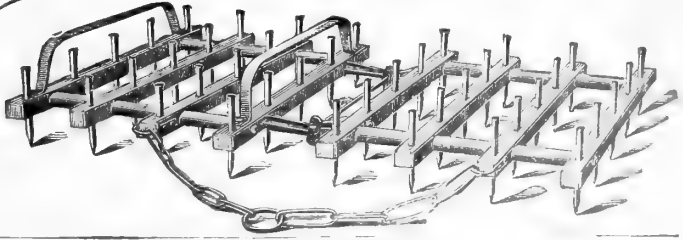

ALL PRICES SUBJECT TO CHANGE WITHOUT NOTICE.

= = HORTICULTURAL TOOLS. = =



Figure 1.

SILVER POLISH TROWEL TEMPER.



Figure 2.

The 'VICTOR' Garden Cultivator



Figure 8.

The "Crescent" Cultivator Hoe.

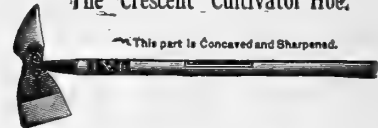

Figure 2.—Two Hoes on One Handle.

Gibbs' Post Hole Digger.



Figure 9.



Figure 3.



Figure 4.

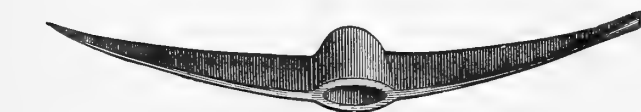

Figure 5.



Figure 6.



Figure 7.

FIGURE 1.—Kretsinger Cut-Easy Hoe, Price 55c. each; \$6.00 per dozen. This is the finest hoe made. Cuts easy, sells easy. Try it.

FIGURE 2.—Retail Price—Each.
 No. G, 02, Solid Steel Garden Socket Hoe, XXX Handle.....45 cents.
 " G, 2, " " Shank Hoe XXX Handle.....40 "
 " 25, Riveted Garden Socket Hoe.....30 "
 " 10, Solid Steel Lady's Shank Hoe, XX Handle.....35 "
 " P, 7, Heavy Handied Planter Shank Hoe, 7-inch blade...45 "
 " P, 7 1/2, " " " " " 7 1/2-inch blade...45 "
 " P, 8, " " " " " 8-inch blade...50 "
 " 64 1/2, " " Sprouting Hoe, 4 1/2-inch blade, special temper.....60 "
 " 75, Heavy Handied Mattock Hoe, special temper.....60 "
 " 66, Crescent Cultivator Hoe, 6-inch.....50 "
 " 2, Two-point, Solid Steel Weed Hoe.....30 "
 " R-1 Sharp Point, Steel Blade Weed Hoe.....25 "
 " 84, Brace or Shank Scuffle Hoe, 8-in. Steel Blade, with Handle 50
 Six-inch Corn Stalk Cutter Hoes, Heavy, Solid, Steel Shank, 30-inch Handles.....40 "

We carry also many other sizes and shapes of Hoes.

FIGURE 3.—Retail.
 No. 2—D. Handle, Square Point, Griffith Warranted Steel Spade...\$1.00
 " 2— " " Hill's or Rowland's Steel Spade... .90
 " 2—Long Handle, Square Point, Hill's or Rowland's Steel Spade .90

FIGURE 4.—Retail.
 " 2—Long Handle, Round Point, Griffith Steel Warranted Shovel, 1.00
 " 2— " " " " Rowland's " " " " .90
 " 2— " " " " Steel Socket Shovels..... .90
 " 2— " " " " Riveted Shovels..... .80

Scoop Shovels of all sizes always on hand. Wood and Wire Potato Scoops, different styles, in stock.

Retail Price
 No. 2—D. Handle, Square Point, Griffith Warranted Steel Shovel... \$1.00
 " 2— " " Solid Socket, Steel Shovel..... .90
 " 2— " " Rowland's..... .90
 Many other sizes and styles always on hand.

FIGURE 5.—Retail. List.
 No. 1—6 to 7 lbs. Best Quality Warranted Steel R. R. Picks. 50c.
 " 2—6 to 7 lbs. Best Refined Iron R.R.Picks (Steel Points), 70c. \$13.00

FIGURE 6.—Retail.
 No. 1—5 lb. Best Quality Warranted Steel Mattocks..... 90c.
 " 1—6 lb. " " " " \$1.00
 " 2—5 and 6 lb. Best Refined Iron Mattocks (Steel Cutters), 75c. \$16.00
 " 1 and 2, Warranted Steel Grub Hoes..... 65c.
 " 1—3 1/2 lb. Best Refined Iron Grub Hoes (Steel Bit)..... 50c. 11.00
 " 2—4 lb. Best Refined Iron Grub Hoes (Steel Bit)..... 60c. 11.50

FIGURE 7.—PICK AND MATTOCK HANDLES. Retail.
 No. XX Best Quality, Selected, Second Growth Hickory Pick Hdls, 25c.
 " 1—Good Quality White Hickory Pick Handles..... 20c.
 " 2—Mixed White and Red " " " " 15c.
 Also Ash Handles, different grades.

FIGURE 8.—THE VICTOR is popular because it is made of best material. The Shanks and Blades are extra good stock and are easily adjusted. No. 90—Complete, on 5-foot handle, with 3x5 Blades, each \$1 00.

FIGURE 9.—GIBBS' POST HOLE DIGGER. Digs faster, works easier than any other on the market. All wearing parts have steel pins. Makes a hole of any desired diameter. First class for tree planting. Price, \$1.75.

STEEL HOLLOW HANDLE POST SPADE. Flattened at one end like a spade. The other end is sharpened and can be used as a crowbar. Light, durable, effective, cheap. Price, \$2.00.

ALL PRICES SUBJECT TO CHANGE WITHOUT NOTICE.



Fig. 2.

STEEL RAKES.

No.	Description	Retail Price.
No. 14	Fig. 1—Prize Bow, Braced Rake, Solid Steel, 14 teeth	...65c. each.
No. 16	" 1—" " " " " " "	...70c. each.
No. 110	Fig. 2—"Peerless" Shank " " " " " "	...45c. each.
No. 112	Fig. 2—" " " " " " "	...50c. each.
No. 114	Fig. 2—" " " " " " "	...55c. each.
No. 116	Fig. 2—" " " " " " "	...60c. each.

Each rake is made of **one piece** of solid steel; no iron, no welding. They are hardened, oil tempered and beautifully finished.



Fig. 1.

MALLEABLE RAKES.

No.	Description	Retail Price.	No.	Description	Retail Price.
No. 010	Heavy Single Shank, Malleable Rake	20c. each.	No. 0014	Heavy Braced Shank, Malleable Rake	35c. each.
No. 012	" " " "	25c. each.	No. 0016	" " " "	35c. each.
No. 014	" " " "	30c. each.	No. 1	Solid Steel Turf Edger	50c. each.
No. 016	" " " "	30c. each.	No. 30	Steel Thistle Dock Cutter	50c. each.
No. 0012	Braced Shank, " " " "	30c. each.			

POTATO AND MANURE HOOKS.

No. F 04	Flat Oval Four Tine, Solid Steel Potato Hook	Retail price, 50c. each.
No. J M 4	Extra Heavy, Four Angular Tine, Jumbo Potato Hooks	65c. each.
No. S M 4	Oval, Four Tine Manure Hook or Drag	60c. each.
Regular Pattern Corn Hooks, not adjustable, 20c. each.		Pat. Folding Corn Hooks, with serrated edge, 35c. each.
Garden Sets, 3 pieces, 5-T Rake, Shovel and Hoe, \$1.00 set.		Clipper Corn Knives, 30c. each.

THE BOSS GARDEN RAKE.

(Strong, All Steel, Tinned, Cheap.)
 Fig. 3—No. 18—15 $\frac{3}{4}$ inch Head, 18 Steel-pointed Teeth.....40c.
 Boss 6-Tooth Weeder.....25c.

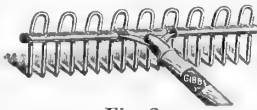

Fig. 3.

QUEEN STEEL GARDEN RAKE.

Neat, Strong and Durable. Bright Finished, Twisted Teeth.
 Fig. 4—14 Teeth.....35c.
 16 Teeth.....49c.

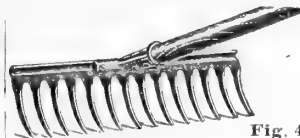

Fig. 4.

QUEEN ALL-STEEL LAWN RAKE.

Reversible, Heavily Tinned.

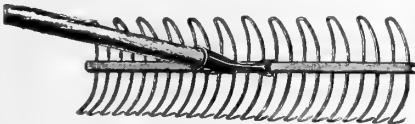

Fig. 5.

width in the line of strain, which is the stiffest form possible, and, being closed, will not collect dirt in the head. The teeth being bent at the points, makes the Rake run smooth, and will not tear the soil. By reversing, the double teeth are used for leaves and rubbish.

21 inch head, 24 teeth.....50c.

Fig. 5.—In this Rake there is no opening in front or back of head in which to collect dirt. As can be seen by the shape of the teeth, they run smooth and will not dig in the sod. The steel head of this Rake is in the form of an egg-shaped tube, with the greatest

AUTOMATIC SELF-CLEANING RAKES.

LAWN RAKES.

Fig. 6.—A backward motion of the Rake from the operator will clean all the teeth at once, thus avoiding the disagreeable task of cleaning the teeth with the fingers. The teeth are made of the best hickory, and will not tear the sod or grass.

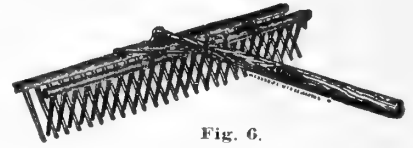

Fig. 6.

With 22 teeth.....60c.
 With 26 teeth.....70c.
 Lawn King Rake, with 22 teeth.....40c.

We carry the Iowa Farming Tool Co.'s line of **Celebrated Steel Goods**, embracing a full assortment of Hoes, Forks, Rakes, etc. They are well known for their superior quality and finish, and beauty of design. All made of best material obtainable, and severely tested.

"Champion," Silver Polish.



Fig. 8.

Damascus Temper.

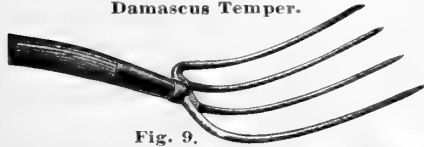

Fig. 9.

Silver Polish, Damascus Temper.

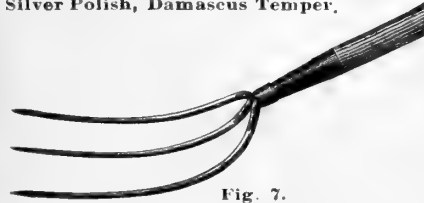
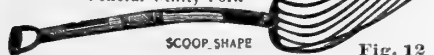

Fig. 7.

THE IOWA FARMING TOOL CO.
 FORT MADISON, IOWA.

General Utility Fork



SCOOP SHAPE

Fig. 12.

HAY FORKS.

No.	Description	Retail Price.
No. 026	Two tine Hay Strap Ferrule, straight handle	50c. each.
No. 26	Two tine Hay, common or plain, straight handle	45c. each.
No. 035 $\frac{1}{2}$	Fig. 7, Three tine Hay, strap, straight handle	60c. each.
No. 35 $\frac{1}{2}$	Three tine Hay, common or plain, straight handle	50c. each.

MANURE FORKS.

No.	Description	Retail Price.
No. C 04 $\frac{1}{2}$	Fig. 8—"Champion" Four tine Manure, long handle strap ferrule	70c. each.
No. C 04 D	"Champion" Four tine Manure, Mall. D handle strap ferrule	70c. each.
No. 404 $\frac{1}{2}$	Fig. 9—Four tine Manure, long handle, strap ferrule	70c. each.
No. C 44 $\frac{1}{2}$	Four Tine Manure	55c. each.
No. 44 $\frac{1}{2}$	Four tine Manure, long handle, common ferrule	50c. each.
No. 40 D	Four tine Manure, Mall. D handle, strap ferrule	75c. each.

We carry some special heavy Manure Forks not listed here.

SPADING FORKS.

No.	Description	Retail Price.
No. 8 D	Fig. 10—"Columbia" Solid Socket, ang. tine, heavy Mall. D handle	\$1.00 each.
No. J. O. W.	Fig. 11—"Jumbo" extra heavy ang. tine wood D handle strap Ferrule	1.00 each.
No. L $\frac{1}{2}$ O D	Medium weight, ang. tine Mall. D handle, strap ferrule	80c. each.
No. B 4	Boys' four tine	50c. each.
No. S 10	Fig. 12—Ten tine, Scoop Shape, Mall. D handle, strap ferrule	1.50 each.

Especially for handling Beets Onions, Apples, Corn, etc. Tine points are flattened and rounded, so as not to injure Potatoes, etc.

No. 44	Coke Forks, 14 tine, D handle, strap ferrule	\$2.00 each.
No. 101	Ten tine, D handle stone forks	1.75 each.

Special Prices in Quantities.

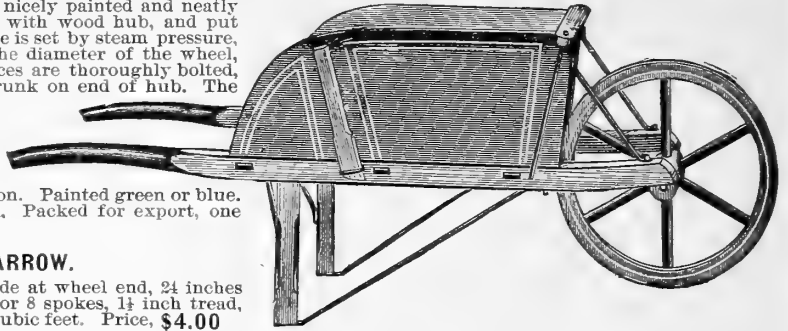

Fig. 10.

Fig. 11.

BALTIMORE GARDEN BARROW.

THESE are the best Garden Barrows that we make, nicely painted and neatly finished in every respect. The wheels are of wood, with wood hub, and put together in the strongest possible manner. The tire is set by steam pressure, which shortens the iron in the tire, and reduces the diameter of the wheel, bringing the spokes up tight in every joint. Iron leg braces are thoroughly bolted, not held by screws. The wheels have iron bands shrunk on end of hub. The spokes, maple or beech, shaped, not turned.



No. 4 MEDIUM SIZE or MAN'S BARROW.

Inside measurement of box: 26½ inches long, 18½ inches at wheel end, 23 inches wide at handle end, 12 inches deep. Has 20 inch wheel, 6 or 8 spokes, 1½ inch tread, ½ inch gudgeon. Painted green or blue. Bottoms matched and glued. Nicely painted and striped. Packed for export, one dozen measure 45 cubic feet. Price, \$3.75.

No. 5, LARGE SIZE or MAN'S BARROW.

Inside measurement of box, 28 inches long, 20 inches wide at wheel end, 24 inches wide at handle end, 12 inches deep. Has 22 inch wheel, 6 or 8 spokes, 1½ inch tread, ½ inch gudgeon. Finished as above. Packed, measure 50 cubic feet. Price, \$4.00

MARYLAND GARDEN BARROW.

This style, though very popular in this section, is used extensively in the South and West. The measurements of these Barrows range from 45 to 55 cubic feet per dozen when packed for export. In general construction these Barrows are put together like the Baltimore, with the exception of brace between the handles and the regular handle bars, distinctions that are readily seen in the cuts.

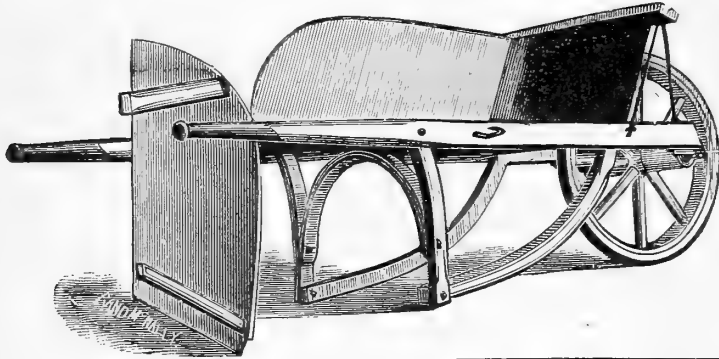

No. 3, MEDIUM SIZE.

Inside measurement, 28 inches long, 17 inches wide at wheel end, 22 inches wide at handle end, 11 inches deep, 18 inch wheel. Bottoms matched and glued. Painted green or red; striped and varnished. Price, \$3.25.

No. 2, MEDIUM LARGE SIZE.

Inside measurement of box, 30 inches long, 19 inches wide at wheel end, 24 inches wide at handle end, 12 inches deep, 20 inch wheel. Bottoms matched and glued. Nicely painted, blue, green or red, or oiled, varnished and striped. Price, \$3.50.

No. 1, LARGE SIZE.

Inside measurement of box, 32 inches long, 22 inches wide at wheel end, 27 inches wide at handle end, 12 inches deep, 20 inch wheel. Bottoms matched and glued. Nicely painted and striped. Price, \$4.00.

The Baltimore Canal Barrows.

THESE are, without exception, the strongest and best made Barrows for the purpose on the market. Full sized tray, edges shared, bolted to legs, and well bolted and braced in front. Handles and legs of selected hard wood; wheels painted. We carry two kinds—"The Baltimore" and "Plain Bolted." Furnished in both wood and steel wheel.

Price, wood wheel.....\$2.25
Price, steel wheel..... 2.50

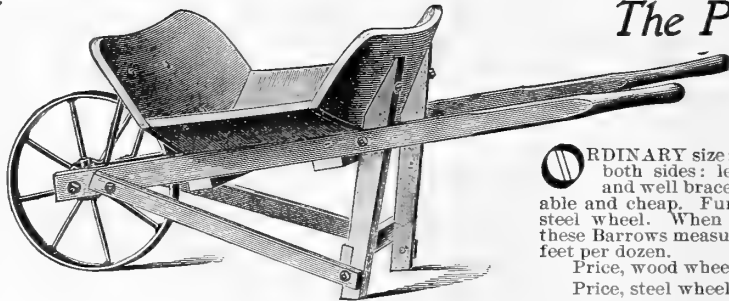

The Plain Bolted Canal Barrows.

ORDINARY size; belt tray: planed on both sides; legs bolted to handles and well braced. Very strong, durable and cheap. Furnished with wood or steel wheel. When packed for export, these Barrows measure from 28 to 33 cubic feet per dozen.

Price, wood wheel.....\$1.75
Price, steel wheel..... 2.00

THE BALTIMORE CANAL BARROW.

COAL AND MORTAR BARROW.

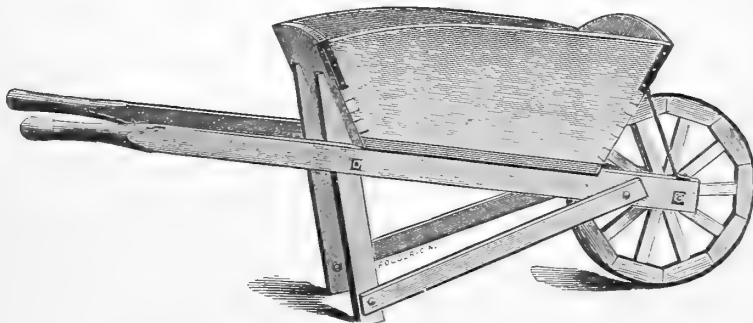

Top is iron banded, strongly braced and bolted; has large capacity. Price, wood wheel,.....\$3.50
Price, steel wheel..... 3.75

THERE are so many uses to which Barrows are put, that in order to stand the test they must be strong, and made of good, well seasoned timber. A barrow that will stand the rough handling to which it is subjected, requires stronger wheels and stouter rims that are ordinarily found in this class of goods. These Barrows are made in such a substantial manner that they will withstand this treatment, and, being strong enough for city uses, they will certainly meet all requirements of the farm or garden. Our trade extends all through the South, a large portion of the West, and the New England States. This fact testifies to the superiority of these goods.

ALL PRICES SUBJECT TO CHANGE WITHOUT NOTICE.

TUBULAR FRAME SOLID PRESSED, STEEL TRAY BARROW.



HANDLES are bent so as to form braces on front end of tray, and a fulcrum when dumping barrow over wheel. Prevents tray striking on corner when barrow is dumped sidewise. Will not run back on wheels. Handles are joined under tray by two cross bars with loops on ends, and are securely clamped by bolts that pass through the tray and cross bars. The full strength of the handles is retained, having no holes drilled through. Legs and braces are very strong. The trays are pressed from a single piece of steel, very smooth, free from rivets, seams, crimps and overlaps; have a narrow flange around edges, giving strength and adding to appearance. Trays, wheels and frames pack very conveniently in one-quarter, one-half and one dozen bundles.

A 1—Tray 16 gauge, steel; capacity 3 cubic feet; weight 58 pounds; wheel, 17 in. diameter; tire, 1 1/2 in., eight 1/2 in. spokes, shouldered and riveted; axle, 1/2 in. For moving earth, ashes and light work. Price **\$6.00**
B 2—Tray, 14 gauge, steel; capacity, 5 cubic feet; weight, 75 pounds; mounted on same frame and wheel as A 1. For general purposes and light running. It will stand hard usage. Price **\$6.50**

SPECIAL DISCOUNT FOR CASH.

WOOD FRAME SOLID PRESSED, STEEL TRAY BARROW.

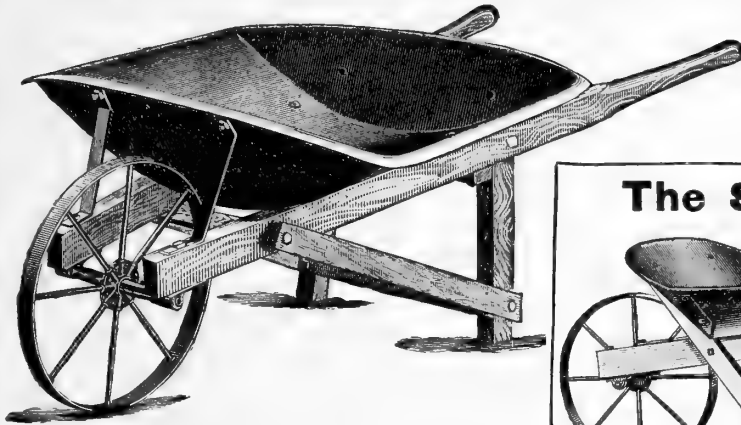

THIS Barrow, similar to the Tubular Frame, except in shape, and has a wood frame, is very desirable on account of lightness. The frame is planed smooth on all sides, of selected lumber, and painted. The wheel is 17 in. diameter; eight 7-16 spokes, shouldered and riveted; tire, 1 1/2 in.; axle, 9-16 in., and runs in an iron bearing. It is well braced throughout. The brace on leg extends around the bottom or base, and prevents splitting. Weight, 50 pounds.

PRICE OF WOOD FRAME SOLID PRESSED, STEEL TRAY BARROW.....**\$4.50**

The Southern Steel Tray.

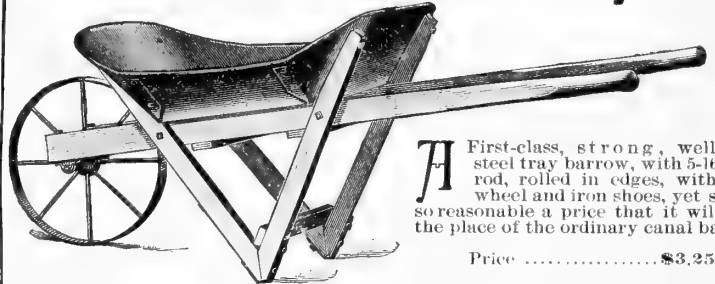

A First-class, strong, well-made steel tray barrow, with 5-16 steel rod, rolled in edges, with steel wheel and iron shoes, yet sold at so reasonable a price that it will take the place of the ordinary canal barrow.

Price **\$3.25**

HASLUP PATENT WHEEL SCRAPER. - - IT LEADS - -

THERE are some very strong points about this Scraper—facts that are indisputable. It measures the amount of work done. The lifting lever is very powerful; working parts, of steel, are few and simple; automatic yet free from springs or cumbersome traps. The adjustable hooks that prevent scraper from dumping while filling, are on the pan, out of the way of obstructions. The hooks on the hounds are very heavy. Positive action of hooks on hounds upon those on side of pan; no slipping; no dumping while filling. High axle; spindles thoroughly protected from sand and dirt; snatch rod extends back to double-tree, practically taking weight off horses' necks. The trouble heretofore with wheel scrapers has been the breaking, twisting and bending of hounds on tongue, throwing working parts out of line, thereby preventing satisfactory work. All this is obviated in this scraper. Following are some of the points of improvement: Hounds are doubled on tongue, strengthened by a system of braces and supports. The double hounds, joined by heavy piece of steel, set edgewise, passing through strong loop, extending around end of tongue, preventing twisting or sagging, permitting no failure of hooks on hounds catching on adjustable hooks on side of pan when lever is thrown forward for filling. Stationary hooks on hounds are strong and heavy, well braced and securely riveted.

SUGGESTIONS AND DIRECTIONS FOR USING WHEELER.

Always raise the Scraper out of the ground while the team is in motion. See that all the bolts on the Scraper are drawn up tight and all the bearings kept well oiled.

An ordinary team can work No. 2 size. The No. 3 size can be worked with one team, but to fill the Scraper well it needs an extra team in filling, and each No. 3 Wheeler is complete with a snatch rod. The snatch rod is placed under the double tree, practically taking all weight off the horses' necks.

To load, hold the lever in an upright position until the foot piece on the end of the lifting device comes in contact with the lug on the hounds. Raise on the handles of the scraper box until the point catches in the ground. The scraper will run perfectly level and regulate the depth itself. When the scraper is full, bear down on the lever until the hook catches on the back of the pan.

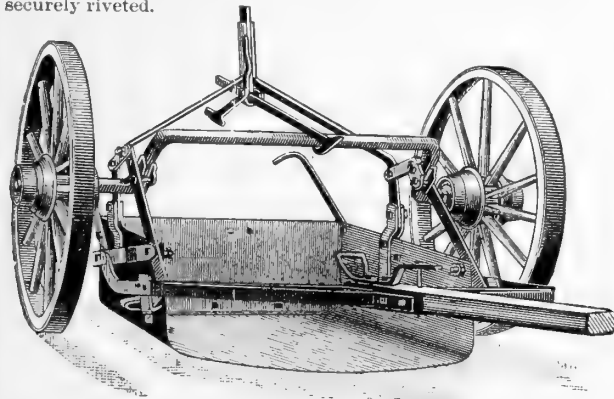

ORDER BY NUMBER ONLY. WE MAKE THREE SIZES.

No. 1—Capacity 9 cubic feet, weight 375 pounds...	Price, \$30.00
" 2— " 13 " " " 500 " " "	37.50
" 3— " 17 " " " 650 " " "	44.00

SPECIAL DISCOUNT FOR CASH.

HASLUP ROUND BACK, SOLID PRESSED DRAG SCRAPER.

No. 1—carries 7 feet of earth, weight 90 pounds....	\$6.50
No. 2—carries 5 feet of earth, weight 80 pounds....	6.25
No. 3—carries 3 1/2 feet of earth weight 70 pounds....	6.00

Special Discount for Cash. Special Prices in Quantities.



STORE TRUCKS.

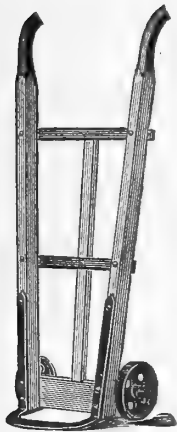

BALTIMORE STORE TRUCK.



NEW YORK PATTERN.

BALTIMORE STORE TRUCK.

BEST LIGHT TRUCK MADE FOR THE MONEY.

List Price.....\$4.00
Retail Price..... 2.00

NEW YORK PATTERN.

HALF STRAPPED.

No.	List Price.	Retail Price.
No. 0....	\$ 4.40	\$ 2.60
" 1....	4.60	2.70
" 2....	6.10	3.65
" 3....	8.00	4.80
" 4....	9.50	6.00
" 5....	11.50	6.90

FULL STRAPPED.

No.	List Price.	Retail Price.
No. 0....	\$ 5.15	\$ 3.10
" 1....	5.35	3.80
" 2....	7.10	4.25
" 3....	9.00	5.40
" 4....	11.00	6.60
" 5....	13.50	8.10

NEW YORK PATTERN.

No.	Length Handles.	Width Nose.	Width at Upper Bar.	Diameter Wheels.	Weight.
No. 1	4' 0"	12 1/2"	18"	8"	42 lbs.
" 2	4' 5"	14"	19 1/2"	9 1/2"	44 "
" 3	4' 8"	15"	21"	9 1/2"	72 "
" 4	5' 0"	16"	22 1/2"	11"	85 "
" 5	5' 3"	17"	24"	11"	90 "
" 6	5' 9"	20"	23 1/2"	12"	125 "



COTTON TRUCK.



NEW YORK BARREL TRUCK.

COTTON TRUCKS.

No.	Length of Handles.	Width of Nose.	Width at Upper Bar.	Diam. of Wheels.	Weight in Pounds.
No. 3	4' 10"	15 1/2"	21"	9 1/2"	74
" 4	5' 0"	16"	23"	11"	104
" 5	5' 3"	18"	22"	10"	95
" 6	5' 9"	20"	23 1/2"	12"	125

NEW YORK BARREL TRUCKS.

No.	Length of Handles.	Width of Nose.	Width at Upper Bar.	Diam. of Wheels.	Weight in Pounds.
No. 1	4' 0"	12"	17 1/2"	7"	42
" 2	4' 6"	14"	18 1/2"	8"	53
" 3	4' 7"	15"	20"	9"	76
" 4	5' 0"	16"	21"	9 1/2"	95
" 5	5' 3"	18"	22"	10"	125

DIMENSIONS AND PRICES CAST IRON TRUCK WHEELS.

No.	Pounds Weight.	Height Inches.	Face Inches.	Hub Inches.	Bore Inches.	Retail Price, Each.	List Price, Each.
No. 0	4 1/2	6 1/2	1 1/2	2 1/2	1 x 1 1/2	\$.27	\$.36
No. 1 and 2	7 1/2	8	2	2 1/2	1 1/2 x 1 1/2	.44	.58
No. 3	12 1/2	9 1/2	2 1/2	3 1/2	1 x 1 1/2	.76	1.02
No. 4 and 5	17 1/2	11	3	3 1/2	1 x 1 1/2	1.05	1.40
Heavy	25	12	3	3 1/2	1 x 1 1/2	1.50	2.00

FOUR WHEEL PLATFORM TRUCK.

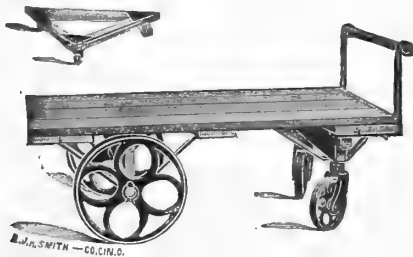

For Canning House, Railroad Stations and Warehouse. Cheap, strong and well made.

Size Platform.	Diam. Wheels.	Diam. Castor.	Weight.	List.	Retail.
No. 1-2x4 feet	12 in.	6 in.	120 lbs.	\$20.00	\$15.00
" 21-3x5 feet	18 in.	9 in.	200 lbs.	28.00	21.00

PLAIN PLATFORM TRUCK.

Size of Platform.	Weight.	Diam. Wheels.	List.	Retail.
No. 82-2 ft. 4 in. by 3 ft. 4 in.	100 lbs.	7 1/2 in.	\$14.00	\$10.50
" 83-2 ft. 6 in. by 3 ft. 6 in.	115 lbs.	7 1/2 in.	15.00	11.25
" 84-3 ft. by 4 feet	125 lbs.	8 1/2 in.	17.00	12.75

We are prepared to quote special prices on Trucks of every description. If you want anything special write us for prices.

CAN FURNISH SPECIAL TRUCKS AT LOWEST POSSIBLE PRICES. ALSO TRUCK WHEELS.

Prices on application.



Luther's "Success" Sickle Grinder.



AS A SICKLE GRINDER.
THE BEVELED EMERY WHEEL gives the proper bevel to insure the greatest service to the sickle. After the first grinding, establishing this bevel, the work may be done in 10 minutes. Price, \$3.50

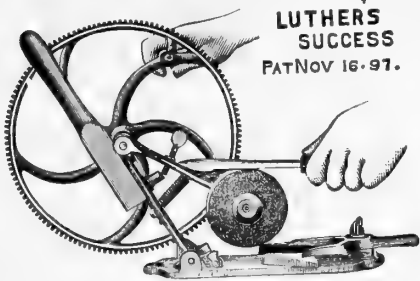

LUTHER'S SUCCESS PAT. NOV. 16-97.

AS A TOOL GRINDER.

THE annexed cut shows the machine we sold last year, but the Grinder described below is an improvement. We could not secure the electrotype in time for this issue. By an oscillating device, the stone is driven back and forth over the sickle, while a steel spring allows of the proper pressure. In this way it is automatic in its workings. Tapered adjusting nuts lift the stone from the heel and point of the sickle at any place desired. A large tool grinding emery stone, is furnished with each machine, suitable for grinding axes, cultivator points, shovel plow steels, tools, etc. No water is required on emery stones but may be used if desired. Full instructions furnished with each machine.

PRICE, \$4.50.

GRINDSTONES MOUNTED.

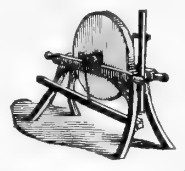

- No. 1.....\$3.50
- " 2.....3.25
- " 3.....3.00

SCHOFIELD STEEL FRAME BI-TREADLE GRINDSTONE.

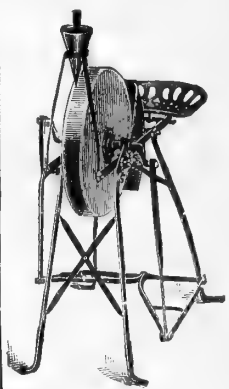

This is without doubt one of the handiest implements on the farm. No necessity to call a boy to turn the stone, the work being done with both feet, as its name indicates. It has also a self-watering attachment.

Price, Stone and Frame complete, \$5.25.

STABLE FORKS.



- Three-Prong Ash Bonner..... 55c.
- Three-Prong Oak Wood Stable Forks, Bonner... 60c.
- Four-Prong Oak Wood Stable Forks..... 75c.

HAND-MADE GRAIN CRADLES.

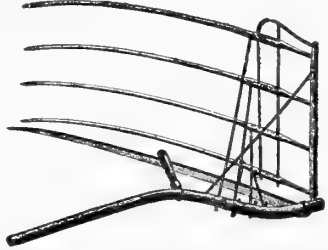

MADE FROM THE BEST MATERIAL WITH ENGLISH AND AMERICAN BLADES.

- Hand-Made Schwab Cradle, with English Waldron Blade, retail..... \$4.50
- Hand-Made Schwab Cradle, with American Blade, retail..... 3.25
- Factory-Made Cradle, American Blade, five fingers complete with Scythe..... 3.00
- Factory-Made Cradle, American Blade, six fingers complete with Scythe..... 3.10



SCYTHES.

- American..... \$1.00
- Best American..... 1.10
- Bush or Brier Scythes..... 1.00
- English T. Waldron, 36 inches..... 1.35
- " " 38 "..... 1.40
- " " 40 "..... 1.45
- American Grain Scythes..... 1.50
- English Waldron Grain Scythes 50 inches..... 1.75
- " " 52 "..... 1.80
- " " 54 "..... 1.90

HARTMAN IMPROVED HITCHING POST.

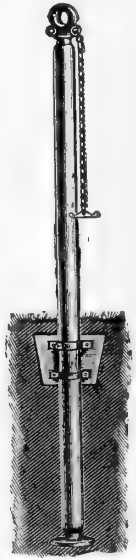

Cannot be broken or pulled out. Made of tubular steel, thoroughly painted.

Anchored at the bottom and at the ground level.

These Posts furnished with Welding Steel Chain and Spring Snap complete.

Price, complete, \$2.25.

SCYTHE SNATHS.



- No. 80—Ring Fastening Socket, iron trimmed, retail price..... 55c. List price..... \$9.50.
- No. 55—Patent Loop, Solid Plate, Iron Trimmed, "..... 65c. "..... 11.50.
- No. 100—Two Rings, Bush Snath, "..... 70c. "..... 12.50.

DARNELL'S IMPROVED PATENT FURROWER AND MARKER.

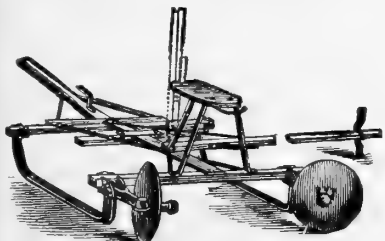

Strong, light and durable. A half dozen tools in one, and each worth the purchase price.

Runs steadily and cannot be choked. Adjustable throughout. Gauge self-adjusting to all inequalities of ground. Every part well made of good material, and no end to its wear and usefulness. Broad runners of wrought T angle iron with rib to prevent sliding on side hill. Revolving discs or furrowers, fifteen inches in diameter, with chilled hub and steel axle, cutting a clean, straight furrow. Shipping weight, 140 pounds.

PRICE..... \$20.00.

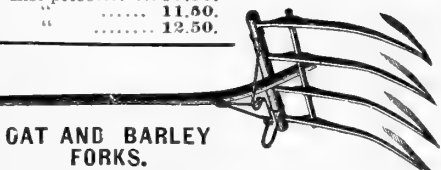

CAT AND BARLEY FORKS.

Price..... 75c.

- SCYTHE STONES. No. 1.—Willoughby Creek, 10c., \$1.00 doz.
- No. 2.—White Mountain, 10c., \$1.00 doz.
- These are far superior to Darby Creek and not so easily broken.
- No. 3.—Green Mountain..... 8c., 75c. doz.
- No. 4.—Ind. Pond No. 2 (red end) 5c., 50c. doz.
- No. 5.—Mowing Machine (beveled), 10c. each.
- No. 6.—Darby Creek..... 10c., \$1.00 doz.
- No. 7.—Imported English Talacre, 20c. each. None genuine unless labeled Sir Pycers Mostyn, Talacre Quarries.
- Cigar Emery..... 10c. each.

ALL PRICES SUBJECT TO CHANGE WITHOUT NOTICE.

Hay Track Carriers and Fixtures.

Ney's Patent Improved Swivel Reversible Hay Carrier.

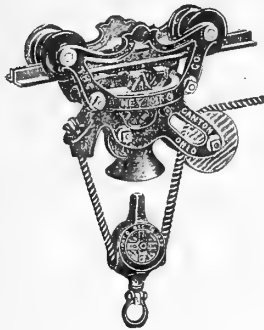

FOR DOUBLE ANGLE STEEL TRACK.

THIS Carrier possesses the following advantages: It will not pass the bumper or trip block while in operation. The lock is positive and cannot fail to work perfectly. It is entirely independent of the rope, automatic in its movements, and has neither springs, clutches nor lugs to break, wear out or get out of order. Track travelers and rope pulleys revolve on turned iron bushing.

Price, - - \$4.50

The Haymaker Carrier for Steel Track.

THIS Carrier is known as a combination machine, or a swivel and reversible both in one. It is constructed with straight flanged wheels, bored on lathe, so as to run true, which revolve on a 1/2-in. turned steel axle. It has a Positive Force Lock with no springs. Stop is clamped to Top of Track. Hanging Hook is malleable iron composed of two parts. The Track is solid steel. 1-beam, 2 1-16 inches wide by 1 1/4 inches deep.

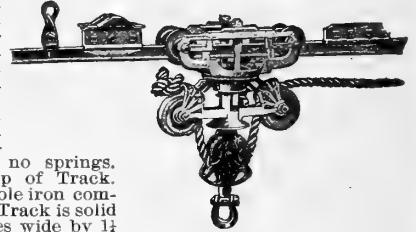

Price, - - - \$4.50

HAY CAR IN USE.

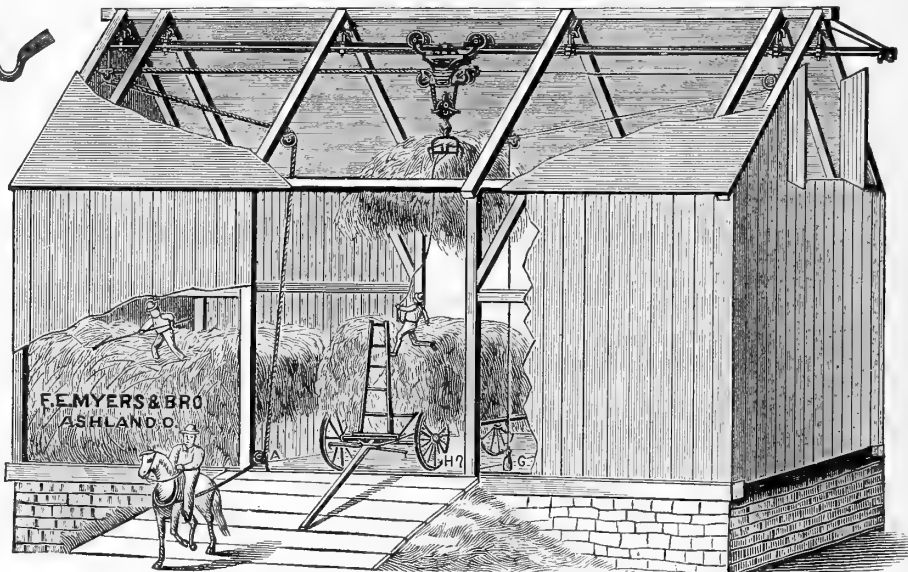

Price of Track for Steel Carrier, 12 1/2 c. per foot.

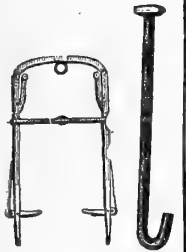

Fig. 1



Fig. 2

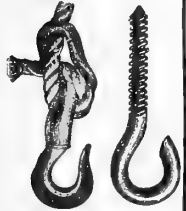

Fig. 3



Fig. 4



Fig. 5



Fig. 6



Fig. 7

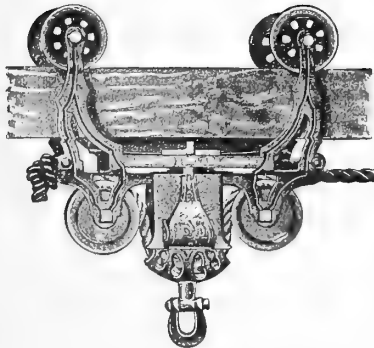

Fig. 8



Fig. 9

Meyers' Double Lock Reversible Carrier.



AN examination of the working parts of this Carrier will show that it is a **DOUBLE LOCK CARRIER**. The stop has a notch on each side and Carrier also either will hold it in, while elevating fork full of hay. Has 3-in. track wheels, which revolve on 1/2-in. turned steel axles. All rope wheels are fitted with large bushings. Unquestionably one of the simplest, most durable and reliable Carriers made.

Price, - - \$4.25

NEY'S PATENT WOOD TRACK CARRIER.

THIS cut shows the Swivel Reversible Carrier for Wood Track. In construction it is the same as the steel track car (reverses the same way), except that it is made to run on 4 x 4 in. wood track. The best swivel wood track car made.

Price, - - - \$4.25

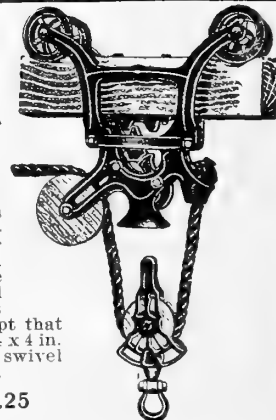

WRITE FOR SPECIAL DISCOUNT FROM THESE PRICES.

HAY TOOL SUPPLIES.

Price—Fig. 1—Double Harpoon Hay Fork	\$1.25
" 2—Hanging Hook for Wood Track08
" 3—Patent Rope Hitch25
" 4—Floor Hook08
" 5—Rafter Bracket06
" 6—Rafter Grapples60

Price, Extra Trips or Stops for Cars	\$.75
Fig. 7—Maple Sheave Pulley25
" 8—Iron Strapped Pulley30
" 9—Knot Passing Pulley35
" Plain Iron Pulleys30
" Steel Track, per foot12 1/2

WRITE FOR SPECIAL CASH DISCOUNT FROM THESE PRICES.

ALL PRICES SUBJECT TO CHANGE WITHOUT NOTICE.

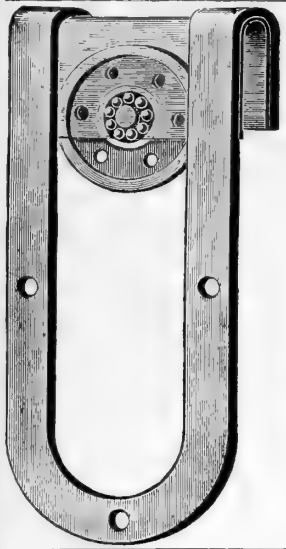

THE NEY ANTI-FRICTION BARNDOOR HANGER No. 2.

THIS Hanger is ANTI-FRICTION, containing roller bearings, which cause the wheel to roll easily and prevent wear. The frame is made of special open hearth steel, and the strength is fully sufficient for the heaviest doors, and has hood protecting the wheel from snow and ice. The wheel is 4 inches in diameter, and of standard tread, therefore can be used on other tracks. Finished in black baking japan, and packed one dozen pairs in a crate.

Price per pair, - - - - - 75c.

THE NEY STEEL BARNDOOR TRACK.

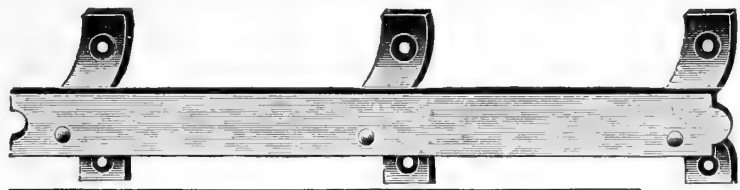

THIS Track is made of SPECIAL CARBON OPEN HEARTH STEEL, 1x3-16 stock, and has heavy brackets well and substantially riveted to it at every 12 inches. The ends are made with tongue and groove to match. The track is made in 4, 6, 8 and 10 ft. lengths.

It is easily erected, and requires no roofing or covering of any kind.

STAY ROLLERS.

For use on Barn Door Hangers.

Price, each, - - - - - 15c.

Price per 100 ft. - - \$5.00

THE CANTON HOIST.

Can be used to advantage in factories of all kinds, foundries, quarries, mills and warehouses; also by contractors, carpenters, stonemasons and all classes of mechanics, as well as farmers. They are indispensable on the farm.

Special farm size, No. 37, capacity 800 pounds. One man can lift 400 pounds.

Price, - - - - - \$4.00

BENT RUNG STEP LADDERS, EXTENSION and SINGLE LADDERS.



A 16-foot Single Ladder only weighs from 21 to 25 pounds. By drawing out a small rod at top of step-ladder, it can be converted into two separate ladders. These goods are made nearly altogether by hand, and are very much superior to factory ladders. No holes are bored in the side pieces, thus making them the strongest and lightest ladders made. The rungs are made of toughest hickory. A slight groove in the side pieces, in which the rungs are set, acts as a brace and aids to stiffen the ladder.

SINGLE LADDERS.

Less 30 per cent. from the following prices:

5 feet.....\$1.25	12 feet.....\$3.10	19 feet.....\$5.25
6 ".....1.50	13 ".....3.40	20 ".....5.60
7 ".....1.75	14 ".....3.70	21 ".....6.00
8 ".....2.00	15 ".....4.00	22 ".....6.40
9 ".....2.25	16 ".....4.30	23 ".....6.90
10 ".....2.50	17 ".....4.60	24 ".....7.50
11 ".....2.80	18 ".....4.90	

STEP LADDERS.

Less 40 per cent. from following prices:

4 feet.....\$3.00	6 feet.....\$4.00	9 feet.....\$5.50
5 ".....3.50	7 ".....4.50	10 ".....6.00
	8 ".....5.00	

We also carry a first-class step-ladder, which we sell at 15c. per foot, net.

EXTENSION LADDERS.

Less 35 per cent. from the following prices:

TWO LADDERS.			TWO LADDERS.		
Each.	Extended.	Price.	Each.	Extended.	Price.
10 feet.....	17 feet.....	\$7.40	18 feet.....	33 feet.....	\$14.40
11 ".....	19 ".....	8.15	19 ".....	35 ".....	15.20
12 ".....	21 ".....	8.90	20 ".....	37 ".....	16.00
13 ".....	23 ".....	9.60	21 ".....	39 ".....	17.20
14 ".....	25 ".....	10.40	22 ".....	41 ".....	18.50
15 ".....	27 ".....	11.20	23 ".....	43 ".....	19.80
16 ".....	29 ".....	12.20	24 ".....	45 ".....	21.20
17 ".....	31 ".....	13.60			

Our IMPROVED TILLEY STEP and EXTENSION LADDERS.

EUREKA—well adapted to any use for which step-ladders are put. It has a special style of hinge, connecting front and back, bolted on, rodged, and well braced with iron. Some prefer the open back, detached, as it admits of using a plank to make a platform more readily.

Prices, with Pail Rest :

6 foot	-	-	\$2.50
8 "	-	-	3.00
10 "	-	-	3.50

Other sizes on application.



Our Improved Tilley Extension Ladders.

THESE Ladders are stiff, strong and well built. Have Improved Patent Spring Locks attached to traveling section, and are automatic in action. These locks are fastened securely to the inner sides of upper section, and made of the best malleable iron. They are also provided with a durable spring, which keeps the hook thrown forward and grasps each round of the stationary ladder as the traveling ladder passes upward. A tripper forces the hook back, allowing it to pass the rounds when descending.

PRICES

24 ft.,—2 12-ft. sections, extends 21 ft.....	\$6.00
28 "—2 14-ft. " " 25 ".....	7.00
32 "—2 16-ft. " " 29 ".....	8.00
36 "—2 18-ft. " " 33 ".....	9.00
40 "—2 20-ft. " " 36 ".....	10.00

OTHER LENGTHS GIVEN ON APPLICATION.

Also furnish single ladders, made of Spruce, with hand shaved Oak rounds, first-class in every particular. 12, 14, 16, 18 feet. Price, 15c. per foot. Ladders over 18 feet, 2c. per foot extra.

IMPROVED STEEL BINDER.

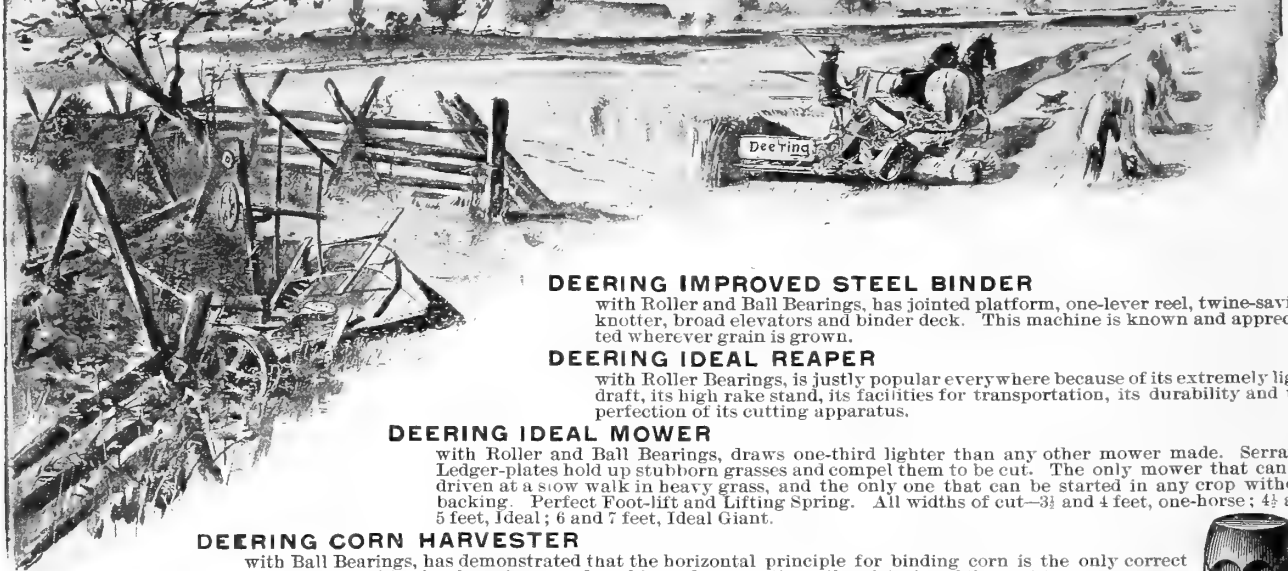

DEERING IMPROVED STEEL BINDER

with Roller and Ball Bearings, has jointed platform, one-lever reel, twine-saving knoter, broad elevators and binder deck. This machine is known and appreciated wherever grain is grown.

DEERING IDEAL REAPER

with Roller Bearings, is justly popular every where because of its extremely light draft, its high rake stand, its facilities for transportation, its durability and the perfection of its cutting apparatus.

DEERING IDEAL MOWER

with Roller and Ball Bearings, draws one-third lighter than any other mower made. Serrated Ledger-plates hold up stubborn grasses and compel them to be cut. The only mower that can be driven at a slow walk in heavy grass, and the only one that can be started in any crop without backing. Perfect Foot-lift and Lifting Spring. All widths of cut—3/4 and 1 feet, one-horse; 4 1/2 and 5 feet, Ideal; 6 and 7 feet, Ideal Giant.

DEERING CORN HARVESTER

with Ball Bearings, has demonstrated that the horizontal principle for binding corn is the only correct one. This machine has been improved, and is ready to continue the victories of the past two seasons.

SEND FOR CATALOGUE "FORTY HARVEST SEASONS."

IMPORTANT.

WE ARE HEADQUARTERS for KNIVES, SECTIONS, GUARDS, RIVETS, KNIFE HEADS, COTTERS, STEEL PUNCHES, COLD CHISELS, etc., for all leading machines on the market; also furnish Thresher Teeth, with or without nuts. It is frequently the case that farmers are located where there is no stock of sections, etc., carried. We are headquarters for a full line of these goods, enumerated above and if you will write us for prices, can doubtless supply you with what you need at very low prices. As a rule the above are not ordered until needed for immediate use, now if you will only take up the matter with us early in the season we are confident we can save you both money and annoyance. This not only holds good for this class of goods, but Grain Drill Points and Tubes and other extras. Look over your Plows, Cultivators, Grain Drills, Mowers, Binders, Feed Cutters, etc., make out your list and let us have it early.

BEST GOODS AT LOW PRICES.—In ordering the above repairs always bring or send the part you wish duplicated, or a drawing, also always give the name of machine and number of part. Write us for prices and terms.

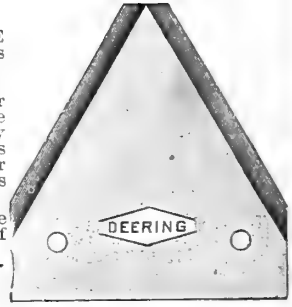
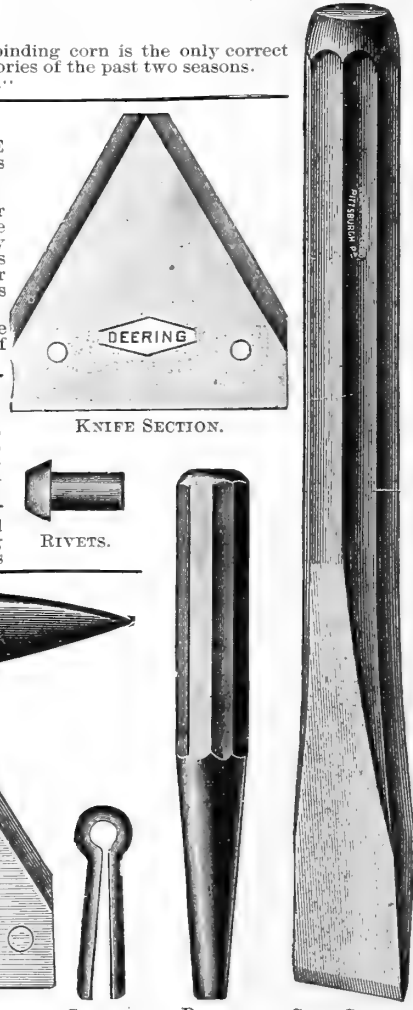

KNIFE SECTION.



RIVETS.



COTTER.

PUNCH.

COLD CHISEL.



WROUGHT SCREW AGRICULTURAL WRENCHES.

	6-in.	8-in.	10 in.	12-in.	15-in.
Retail price, each,	\$.25	\$.35	\$.50	\$.60	\$.75
List price, per doz.	9.00	10.00	12.00	14.00	24.00

LINK CHAIN BELTING

for use on Mowers, Reapers, Binders, Corn and Wheat Drills, Corn Shellers, Straw Stackers, Feed Cutters, Traction Engines, etc. Other attachments will be furnished at special prices.

WE are prepared to furnish Binder and Conveyor canvases for the leading machines at comparatively low prices



KNIFE HEAD.



GUARD.

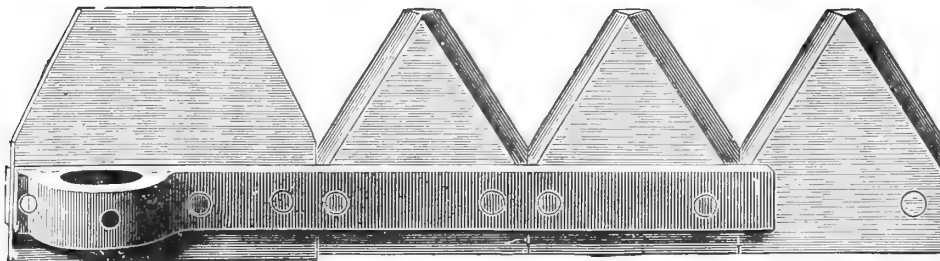

SECTIONS AND KNIFE HEAD.

ALL PRICES SUBJECT TO CHANGE WITHOUT NOTICE.



DEERING BINDER TWINE

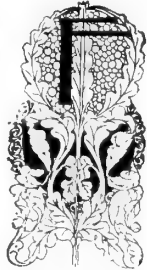

On the benefit of those who have been using binder twine for a number of years we append a short account of the growth and manufacture of the article, and you will find contiguous cuts of the Manila and Sisal plants which will give an idea of their growth. We are headquarters for binder twine, which consists of the best at lowest prices, and can supply in any quantity desired, such as Sisal, Standard, Standard Manila, Manila and Pure Manila.



SISAL PLANT.



MANILA PLANT.

The preparation of Manila fibre, while possessing much in common with that of Sisal, is still more arduous and expensive. The fibre is obtained from the fully developed leaves of a species of plantain or banana tree, which grows best in the Philippine Islands and takes its commercial name from the chief city of the Island of Luzon, the largest of the group. The Manila tree, after a growth of three years, is shorn of its long, graceful leaves, which, though of considerable bulk, yield scarcely two-thirds of a pound of fibre to the tree. It is not surprising then, that a bale of 270 pounds' weight represents three years' production of over 400 trees and requires the labor of one man for about 22½ days to gather and prepare it for market. Every pound of finished twine is weighed, tested and measured. It is baled, tagged and packed in neat, portable fifty-pound bales and sent to the farmer with a guarantee that every bale is "just what the tag says it is." Sisal fibre is obtained from the leaves of a species of Central American agave, similar to the century plant, which flourishes in the hard, calcareous soil of Yucatan. Five years after planting the leaves may be cut. Natives gather them and with crude machinery scrape the pulp away. The fibre is then hung on long lines and dried, leaving it in its raw state. It is then twisted in big skeins, baled and shipped to the Deering Harvester Co.'s mills for the final process of manufacture. For those who are interested in further details of the manufacture of this important product we will mail an illustrated booklet free on application.



ON ACCOUNT OF THE GREAT FLUCTUATION OF THE MARKET WE CANNOT QUOTE PRICES HERE, BUT SAME WILL BE FURNISHED ON APPLICATION.



ROPE, FODDER YARN AND BINDER TWINE.

We keep a full line of Manila, Sisal and Cotton Ropes, including all sizes from 5-16 up. We make a specialty of ¼, 13-16 and ½ Hay Fork Rope.

Complete line of Twines and Fodder Yarn always on hand.

We make a specialty of BINDER TWINE and carry a large stock of all grades in season. Prices quoted on application.

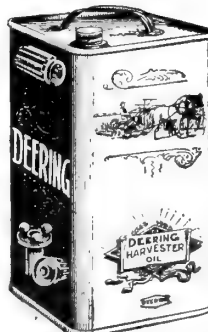

Deering Harvester Oil possesses all the elements which fit it for use in harvesting machinery. It is always uniform, unexcelled as a lubricant. It is not a mixture in any sense of the word, being a straight-run product. It can never gum, no matter what the temperature or climate. Its usefulness is not confined to harvesting machinery alone, and thousands of other machines owe their smooth and frictionless action to its use. Dust and grit are much in evidence in the harvest-field, and the greater the consistency of an oil, the more effective it is in withstanding these evils. Deering oil will never thicken, even to the very last drop, whether exposed to the air or not. The best testimonial to its worth is, that once used it is always used.

BALTIMORE SELF-DUMP RAKE.

This is the Old Reliable Horse-Dump Rake, with Combined Shafts, for use of one or two horses.

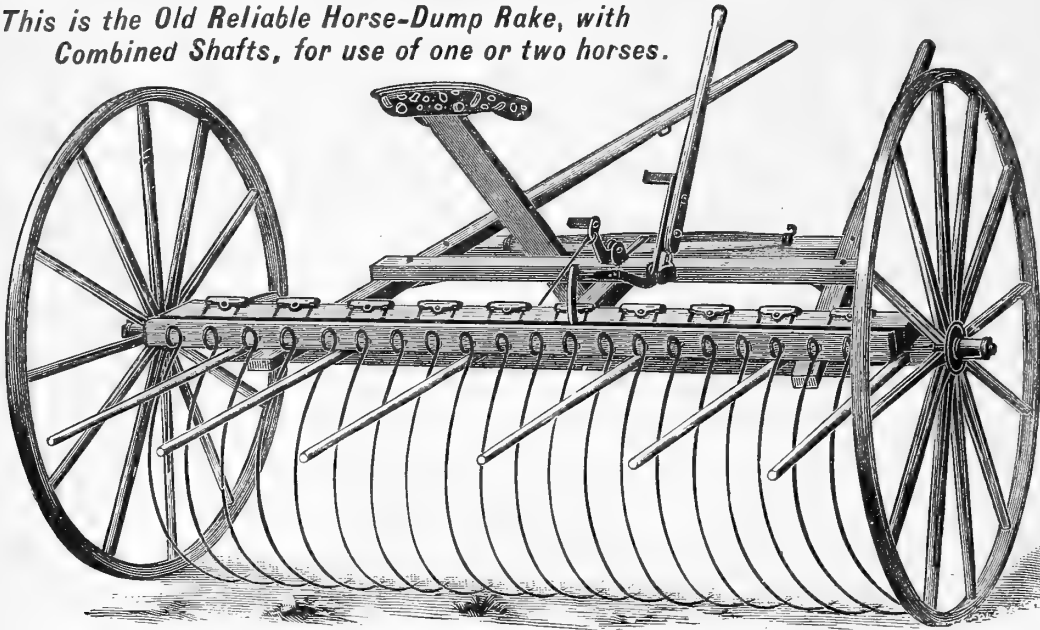

Made in either Wood or Steel. Disengages noiselessly and without jar or strain. We claim for it greater strength because the parts are united securely to the steel axle and the wood rake-head, and because there is less wear and tear than on other rakes. It has steel teeth, made from the best crucible steel, and tempered in oil.

The lever remains stationary when the load is discharged.

PRICE,
BALTIMORE SELF-DUMP RAKE,
Wood, - - \$21.00
Steel, - - \$22.50

• Baltimore • Hand-Dump Rake

MADE IN
EITHER WOOD OR STEEL.

This Rake is made of thoroughly seasoned hardwood. The axle arms are 1½-inch round iron, securely bolted to the wood axle head. It has 20 teeth of spring steel, same as above. Every tooth independent. The seat is adjustable and can be raised or lowered for man or boy.

The Steel Hand-Dump Rake is similar in all respects excepting in material used.

PRICE,
BALTIMORE HAND-DUMP RAKE,
Wood, - - \$17.50
Steel, - - 19.00

Hay Tedder Forks



Always on hand, stock of Forks for leading styles of Hay Tedders.

Price, - 25cts.
SPECIAL PRICES IN QUANTITIES.

MADE IN EITHER WOOD OR STEEL.

BALTIMORE HAY TEDDERS.

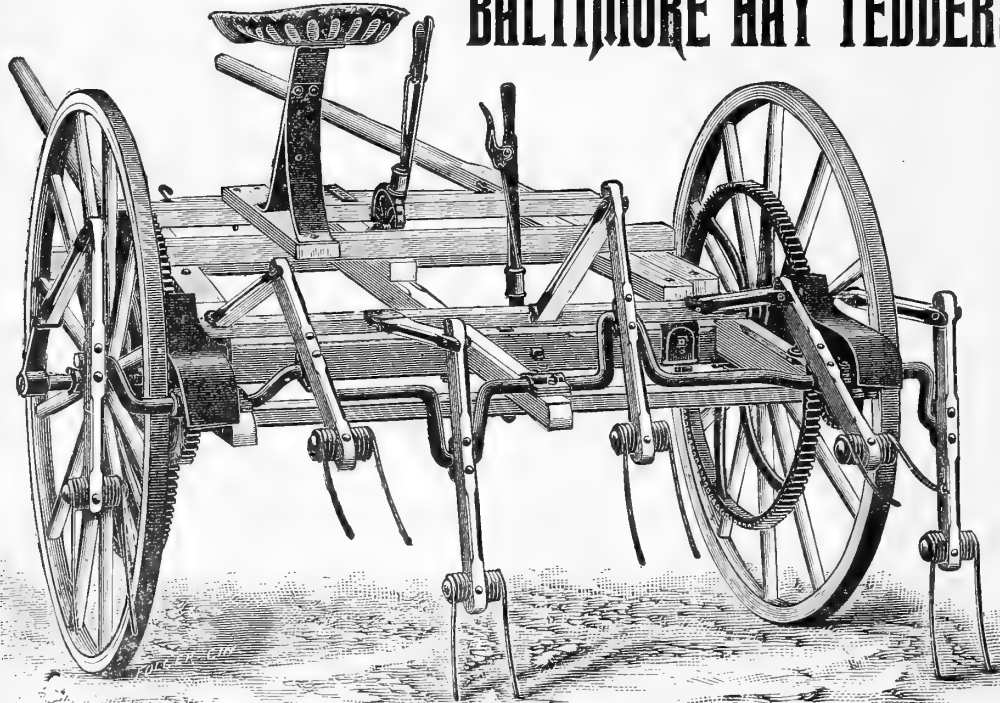

The Best Wood Frame Tedder for Heavy Grass or Fallen Grain.

Combination shafts and tongue, without side fork and shields over gearing. The Baltimore has new bent shifting lever which makes a complete lock. Also is provided with a most comfortable spring seat, levers for raising and lowering, and throwing in or out of gear, within easy reach of the driver. Combined pole and shafts, quickly and easily changed from a one to a two-horse machine. One of the simplest and most comprehensive tedders on the market.

— PRICE: —
BALTIMORE TEDDER, Wood, - - - - \$28.00
" " " Steel, - - - - 30.00

Thomas Royal Tedders, WOOD..... \$30.00
STEEL..... 32.00
THOMAS IMPERIAL, Wood 30.00

RAKE

TEETH

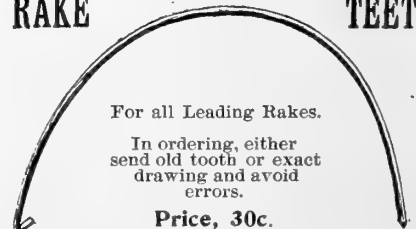

For all Leading Rakes.

In ordering, either send old tooth or exact drawing and avoid errors.

Price, 30c.

Dederich's Steel Case Reversible Press.



Size bale chamber 17x22. Patent steel case press, with bale chamber, friction adjustment, loose reversible horse lever with patent adjustment, short movement, double acting power, bumpers and friction rebound stop, condensing hopper, folder roller scaffold, truck, doubletrees, neck yoke, two wrenches and oil can.

Price complete.....**\$300.00.** Less special discount, f. o. b. factory.
 Patent wood frame, iron and steel press, 17x22, with same attachments as above with the exception of adjustable short movement and patent bumper attachments. Price complete.....**\$275.00**
 The same as above with tray hopper, as used on all other presses. Price complete.....**\$250.00**
 Less special discount, f. o. b. factory.

All orders understood to mean with condensing hopper unless otherwise stated.

Dederich's Steel Frame Full Circle Press.

Size bale chamber 14x18. With patent bale chamber, friction adjustment, double stroke power, pipe connection, condensing hopper, automatic feeder, folder roller, feidng partitions, scaffold, truck, doubletrees, neck yoke, two wrenches and oil can.
 Price complete.....**\$350.00.** 17x22 or any other size bale....**\$375.00.**
 Less special discount f. o. b. factory.

Dederich's Toggle Link Hand Press.

For Hay, Straw, Broom Corn, Hemp, Hops, Rag, Moss, Husk, Cotton, Wool, Hair, Manure, etc.

Five feet depth of box; bale 3 feet 10 inches long, 25x25, price.....**\$100.00**
 Same press, bale 34x16x16 inches, price.....**100.00**
 Special discount f. o. b. factory from these prices.

Dederich Portable Baling Presses for Steam Power.

These presses are made with either steel or wood case.

The wood frame press is constructed from the best seasoned hard wood, strongly rodded and ironed and the entire press case and bale chamber is lined with steel. Both the Steel Case and Wood Frame Belt Presses are provided with a New Automatic Partition Dropping Device, which is simple, positive and durable.

Steel Case Size Bale, 14x18, friction adjustment, power safety power regular, feeder, shipping device, condensing hopper, folder roller, scaffold, truck, doubletrees, neck yoke, two wrenches and oil can.

Price complete.... **\$500.00** Price 17x22 complete.....**\$550.00**
 Less special discount f. o. b. factory.
 Wood frame iron and steel press with same attachments as above. Price complete 14x18 size.....**\$400.00**
 Price complete 17x22 size.....**450.00**
 Less special discount f. o. b. factory.

BALING TIES.

The cost of Bale Ties is from 40 to 60 cents per ton of hay. We have spared no expense to secure the BEST methods and the most efficient machinery. To get the length of tie required add 3 inches to the measure around the bale when under pressure. We keep in stock only the standard size, No. 15, 8½ feet long, but can furnish any of the other sizes and lengths on order at lowest prices. Retail price on application.



ANNEALED BALING WIRE. Nos. 11, 12, 13, 14 and 16 always on hand at lowest market prices on application.

BALTIMORE LITTLE GIANT THRESHER.

Illustrating our Two-Horse Threshing Outfit.

PRICES ON APPLICATION.

This machine is made in two sizes, as follows: The No. 1 Little Giant for two and three-horse level-tread powers, or six-horse engine. The cylinder of this machine is 17x30 inches; the machine weighs 1700 lbs.

The No. 2 Little Giant is made for two-horse level tread power, or four-horse engine. The cylinder of this machine is 17x26 inches; the machine weighs 1425 pounds. Both machines are so constructed that they can be run from either side, the change being made easily and quickly.

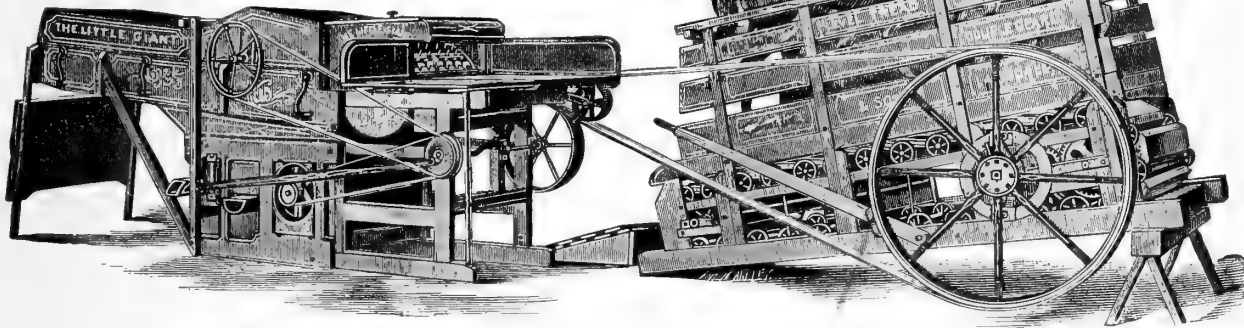

We furnish a two-horse direct geared power with the No. 2 Giant, if preferred. The machine has a capacity of from 200 to 500 bushels per day, the quantity being determined by the weight of the team, the length of the straw, the condition the straw is in, (whether dry or damp,) the yield of grain per acre, etc. Estimates as to the capacity of the threshers are based on wheat. There is no occasion to clean the grain a second time for the machine will do the work nicely. All who use the Little Giant take their grain directly from the machine to market.

The Shaker or Separator.

The upper bottom is of galvanized sheet steel, perforated with half round holes, through which the grain and chaff falls as quickly as separated from the straw a series of beater forks are used to beat the straw from the under side, as it passes out of the machine, and the separation is thus made complete. After the grain passes through the upper or perforated bottom, it falls upon the under bottom, made of sheet steel, and is conducted to the sieves.

Revolving Apron.

The Patent Revolving Apron has been in use for several years past and is known and appreciated by all who have had our latest improved machines.

Patent Duster.

The Little Giant is provided with a patent duster which carries the dust off with the straw, at the rear end of the machine. No parts are added to accomplish this and there is no loss of power, as the suction is caused by the ingenious construction of the top, bottom and sides of the thresher, enabling us to utilize the blast of wind caused by the motion of the cylinder. Besides carrying the dust out of the machine the "sucker" helps to carry off the straw.

The Wind Regulator.

That the fan may do its work perfectly, and clean the grain ready for market, we furnish with each machine, a self-adjusting wind regulator. Speed increases when the cylinder is empty and at such times there should be less wind on the sieves for there is less chaff and grain there; when so much grain is run through the cylinder as to retard its motion it is important that there be more wind on the sieves, as there will be more chaff and grain coming down to the fan. With our self-adjusting regulator the wind "comes" and "goes" just as though it were hidden.

The Concave Strong and Safe.

As it is important that the concave be very strong we use a solid iron bed plate, into which a wood bolster, 2 inches thick, is fitted. The teeth have square shoulders and pass through square holes in the iron bed plate and then through the wood bolster, being made secure by strong nuts under each of which a washer is placed. The bolster gives a longer bearing for the teeth and increases the strength of the concave. When any hard substance gets into the machine the concave will rise, being so made that it can do this, and thus prevent breakage which otherwise would be sure to occur. The concave can be raised and lowered while the machine is in operation by means of a hand screw which is easily turned, and is within reach of the person who feeds the grain into the machine.

PENNSYLVANIA THRESHER.

ONE-HORSE THRESHING OUTFIT.

The Pennsylvania has steel bar cylinder, with steel teeth, the same as the Little Giant, except that the cylinder is only 21 inches long. It has the patent dust sucker; the concave is like that made for the Little Giant; the revolving apron is used; the fan is adjusted to different rates of speed. It will thresh and clean from 75 to 125 bushels of wheat per day, with our one-horse powers, and will do the work as well as it can be done by any large machine.

ALL PRICES SUBJECT TO CHANGE WITHOUT NOTICE.

Fodder and Ensilage Cutter and Shredder Department.

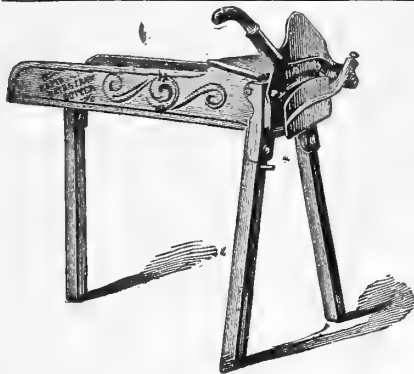

Maryland Lever Cutter.

STRONG, CHEAP and DURABLE.

Price..... \$3.50

There are a number of cheaper Lever Cutters on the market which we do not carry in stock, but can furnish at lowest market prices.

Our Baltimore Pony Cutter.

THIS Cutter, the Baltimore Pony, is for hand use only; strong and light running. Adapted to cutting hay, straw and corn fodder, and is suitable for persons keeping from one to four or five animals.

There is only one size, and it is made so it can be knocked down and packed for shipment, thus securing lower freight rate. Has 14-in. knife, and by very simple changes makes four lengths of cut. A great improvement in this machine—the feed roller stops when the knife is cutting, making it easier on the operator, and consequently avoids the pressing against the knife so common in other cutters. Weight, K. D. packed for shipment, 160 pounds. Pony Cutter, 14-inch Knife. Retail price.....\$10.50

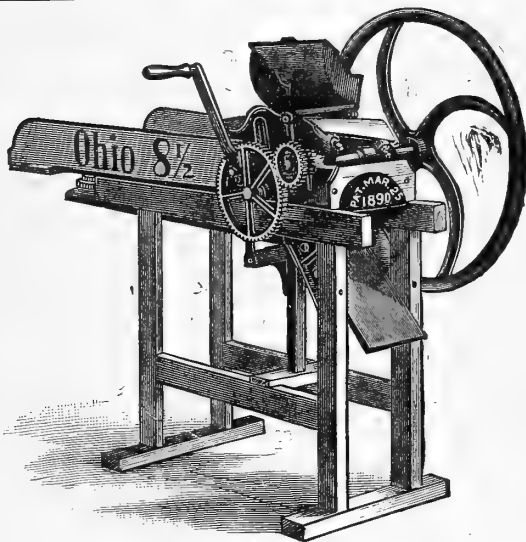
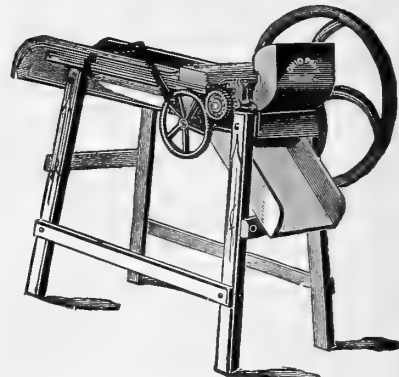

“Ohio” Hand-Feed Cutter.

MADE IN TWO SIZES, Nos. 8½ and 10½, THE NUMBERS CORRESPONDING WITH THE LENGTH OF KNIVES IN INCHES.

THESE MACHINES are light, but very strong and serviceable, and have large capacity. The frames are solid and substantial, and all sizes are adapted to cutting hay, straw and all kinds of fodder, green or dry. They are especially adapted to the requirements of those keeping from two to six animals, and also livery stables and like places, where all of the cutting is done by hand.

We recommend the use of two-knife machines, for the reason that double the quantity of feed may be cut a given length.

We always send two-knife machines, unless otherwise ordered.

Price..... \$20.00.

Less 30 per cent. retail.

“Ohio” Standard Feed and Ensilage Cutter.

SHOWING RIGHT-ANGLE PLAIN CARRIER ATTACHED.

NEW SOLID KNIFE HEAD. — Knives adjusted easily by means of Set Screws firmly bolted on the Knife Heads.

THE SAFETY FLY-WHEEL (arranged with a frictional device in connection with the hub) prevents accidents from over-feeding; or, in case any hard substance should pass in with the material while being fed, the knives will stop and the momentum of the fly-wheel will be arrested gradually by friction against the hub, thus preventing breakage of the machine and insuring safety to the operator. Safety Fly-Wheels furnished with all power machines.

THE LEVER FOR STOPPING THE FEED ROLLERS assists also in changing the lengths of cut. In connection with the Safety Fly-Wheel, it is an additional safeguard against accidents. The four lengths of cut are made with but one detached gear.

THE KNIFE SHAFT is made long enough to attach the pulley or fly-wheel to either end of the same on all sizes above No. 9. This will often save delay in locating the engine or horse-power.

ANGLE CARRIERS for our Power Cutters are made reversible, i. e., they can be set to deliver straight, to the right or to the left of the machine, as the case may require.

THESE MACHINES HAVE LARGER THROAT, in proportion to length of knives, than any other cutter, which, in point of capacity, makes them superior to any similar machine with equal cutting surface.

Ohio Standard Feed and Ensilage Cutters and Carriers.

LIST PRICE OF CUTTERS WITHOUT CARRIERS.

Knives. Fly Wheel.	Two Knives.	Four Knives.
Length. Cut. Price.	Length. Cut. Price.	Length. Cut. Price.
No. 9—9 in. Safety.....	1, 1½, 2 in. \$35.00	1, 1½, 2 in. \$40.00
No. 11—11 in. Safety.....	1, 1½, 2 in. 40.00	1, 1½, 2 in. 45.00
No. 13—13 in. Safety.....	1, 1½, 2 in. 60.00	1, 1½, 2 in. 65.00

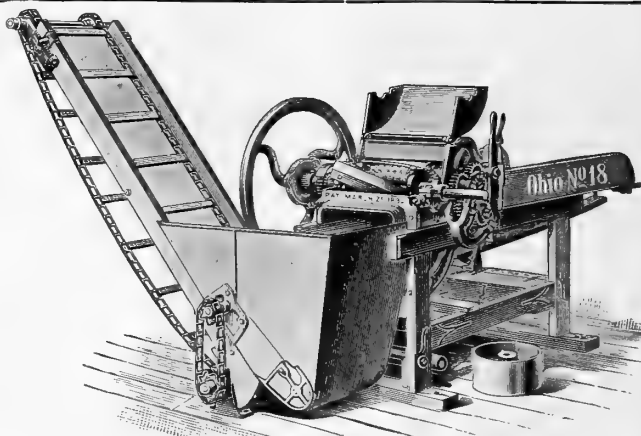

FOUR KNIVES.	Length.	Cut.	Price.
No. 16—16 in. Safety.....	1, 1½, 2 in.	1 in.	\$90.00
No. 18—18 in. Safety.....	1, 1½, 2 in.	1 in.	120.00
No. 20—20 in. Safety.....	1, 1½, 2 in.	1 in.	200.00
No. 24—24 in. Safety.....	1, 1½, 2 in.	1 in.	250.00

Less 30 per cent. retail.

LIST PRICE OF CARRIERS.

PLAIN SLAT CARRIERS WITH ANGLE DELIVERY ATTACHMENTS.	Price.
For No. 11 Cutter, 12-foot.....	\$33.75
For No. 13)	
For No. 16) Cutters, 12 foot.....	37.00
For No. 18)	
Each additional foot.....	1.70
Same size Carriers for each machine.	
For No. 20 Cutter, 12-foot.....	45.00
For No. 24 Cutter, 12-foot.....	45.00
For No. 26 Cutter, 12-foot.....	50.00
Each additional foot.....	2.25
Same without Angle Delivery Attachments, deduct \$3.50 List from Nos. 11, 13, 16 and 18; \$5.60 from Nos. 20 and 24, and \$11.25 from No. 26.	
Less 30 per cent. retail.	

ALL PRICES SUBJECT TO CHANGE WITHOUT NOTICE.

A GREAT INVENTION.

"Ohio" Standard Self-Feed Ensilage Cutter
WITH EXTENDED TABLE AND TRAVELING FEED APRON.

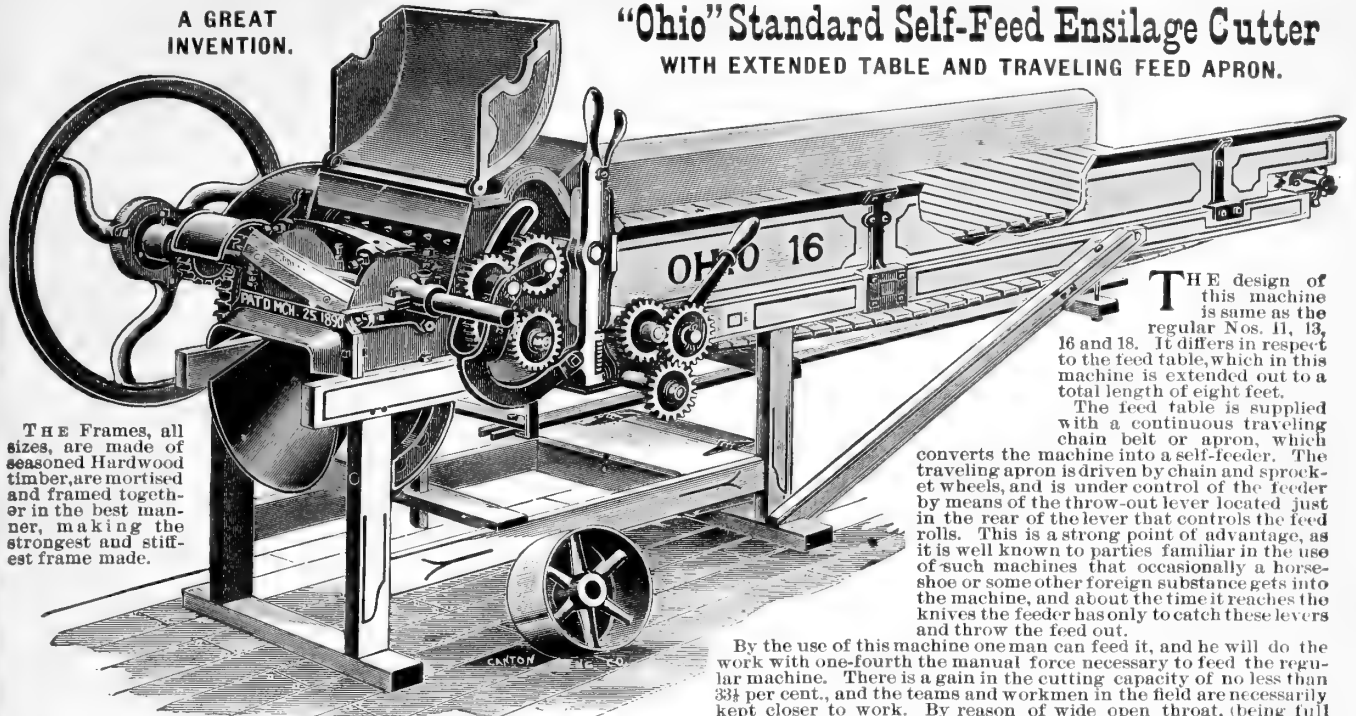

The Frames, all sizes, are made of seasoned Hardwood timber, are mortised and framed together in the best manner, making the strongest and stiffest frame made.

THE design of this machine is same as the regular Nos. 11, 13, 16 and 18. It differs in respect to the feed table, which in this machine is extended out to a total length of eight feet.

The feed table is supplied with a continuous traveling chain belt or apron, which converts the machine into a self-feeder. The traveling apron is driven by chain and sprocket wheels, and is under control of the feeder by means of the throw-out lever located just in the rear of the lever that controls the feed rolls. This is a strong point of advantage, as it is well known to parties familiar in the use of such machines that occasionally a horse-shoe or some other foreign substance gets into the machine, and about the time it reaches the knives the feeder has only to catch these levers and throw the feed out.

By the use of this machine one man can feed it, and he will do the work with one-fourth the manual force necessary to feed the regular machine. There is a gain in the cutting capacity of no less than 33 1/2 per cent., and the teams and workmen in the field are necessarily kept closer to work. By reason of wide open throat, (being full width of cutting surface, all sizes,) and improved patented feeding device, they have larger capacity than others. The Knife Shafts are large and heavy, and babbitted with high-grade metal. The knives are secured to our Solid Knife Heads by bolts with Lock Nuts, to prevent working loose, and backed up by set screws, as shown, to hold them securely in place. Nos. 13, 16 and 18 are our medium-priced Ensilage and General Purpose Power Machines, all very large capacity, and by far the most serviceable machines made. All sizes are adapted to cutting hay, straw and corn fodder, with or without ears, and green or dry. All sizes are extensively used for Ensilage, and also for tobacco, rags and other materials.

PRICE LIST.

No. 13—With four knives 13 inches long, four lengths cut.....	\$ 95.00	No. 20—With four knives 20 inches long, four lengths cut.....	\$250.00
No. 16—With four knives 16 inches long, four lengths cut.....	120.00	No. 24—With four knives 24 inches long, four lengths cut.....	300.00
No. 18—With four knives 18 inches long, four lengths cut.....	155.00		Less 30 per cent. retail.

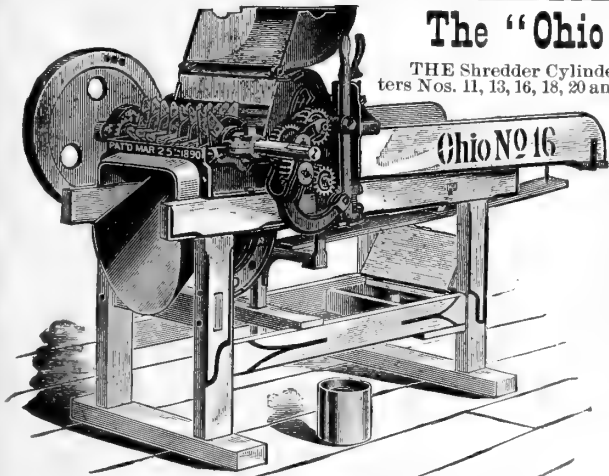

The "Ohio" DRY FODDER SHREDDER Complete.

THE Shredder Cylinders are for dry corn fodder. We can furnish Shredder Cylinders for "Ohio" Cutters Nos. 11, 13, 16, 18, 20 and 24. The shredder head consists of a steel shaft same diameter as in the Ohio Cutters, cast iron heads, steel shredder teeth, new fly-wheel and pulley. The cast iron heads interlock with each other, and the outer ones are securely keyed to the shaft. Each head has six steel shredder teeth, which are fitted into sockets and securely riveted to the heads. The fly-wheel is solid, as shown, and is about 20 inches diameter and perfectly balanced. The pulley is 6 inches diameter, which will enable the user to attain a high rate of speed. The teeth are set so that when they pass the cutter bar there is one-eighth inch clearance between them, and they cover the entire length of the cutter bar. From the description it will be seen that the shredder head is made up of a number of parts; therefore, in case of breakage, the necessary parts can be furnished at a trifling cost, and the cylinder is not entirely destroyed, as is the case with some other makes. The shredder teeth are not sharp like knives, as the fodder is to be torn apart and not cut. We are told by farmers that shredded fodder has advantages over cut fodder, inasmuch as cattle will eat it better and it can be handled to better advantage than cut fodder.

The shredder head can be removed and the knife cylinder attached instead, in case the machine is wanted for hay or ensilage cutting. In order to reap the best results in shredding, the machine must be speeded up to ten or twelve hundred revolutions per minute; for that reason we use the fly-wheel seen in the cut, instead of the open wheel in the Ohio Cutter.

No. 11—With Solid Fly-Wheel and Six-Inch Pulley.....	\$ 45.00
No. 13—With Solid Fly-Wheel and Six-Inch Pulley.....	65.00
No. 16—With Solid Fly-Wheel and Six-Inch Pulley.....	90.00
No. 18—With Solid Fly-Wheel and Six-Inch Pulley.....	120.00
No. 20—With Regular Fly-Wheel, Small Pulley.....	200.00
No. 24—With Regular Fly-Wheel, Small Pulley.....	250.00

Less 30 per cent. retail.

SHREDDER CYLINDERS ONLY.

For No. 11, including Fly-Wheel and Pulley.....	\$25.00	For No. 18, including Fly-Wheel and Pulley.....	\$32.00
For No. 13, including Fly-Wheel and Pulley.....	28.00	For No. 20, including Pulley, no Fly-Wheel.....	50.00
For No. 16, including Fly-Wheel and Pulley.....	30.00	For No. 24, including Pulley, no Fly-Wheel.....	55.00

Less 30 per cent. retail.

RUBBER BELTING.

WITH SMOOTH, METALLIC RUBBER SURFACE.
FOR AGRICULTURAL AND OTHER MACHINERY.

Three and Four Ply, Sizes, 3, 3 1/2, 4, 4 1/2, 5 and 6 Inches. Prices on application.

ALL PRICES SUBJECT TO CHANGE WITHOUT NOTICE.



Baltimore Shellers

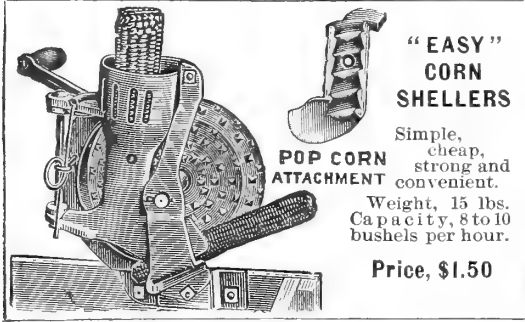

**"EASY"
CORN
SHELLERS**

**POP CORN
ATTACHMENT**

Simple,
cheap,
strong and
convenient.
Weight, 15 lbs.
Capacity, 8 to 10
bushels per hour.

Price, \$1.50

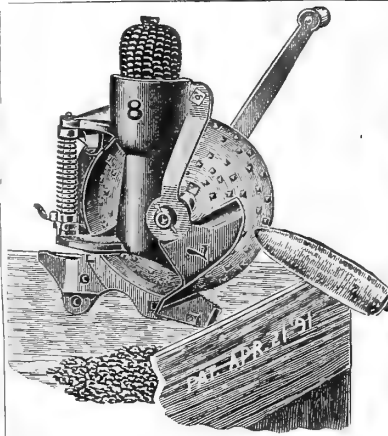

"CYCLONE" CORN SHELLER.

One of the best of its kind. No
clogging or choking.

Price, \$2.00.

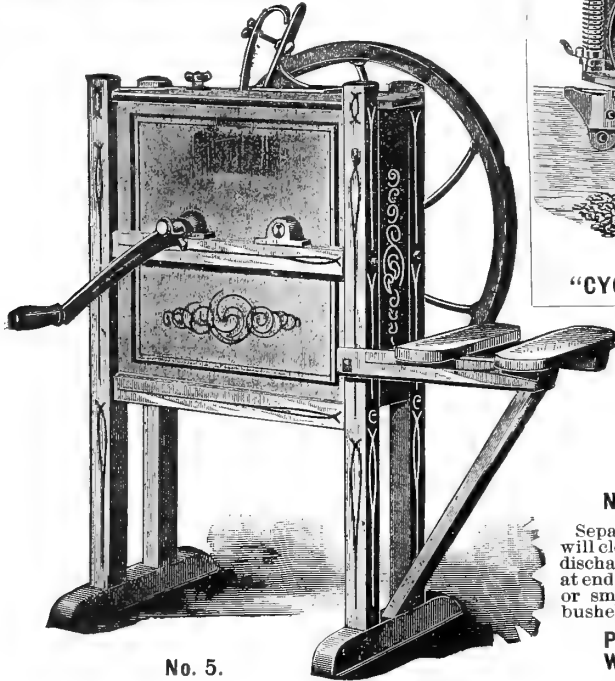

No. 5.

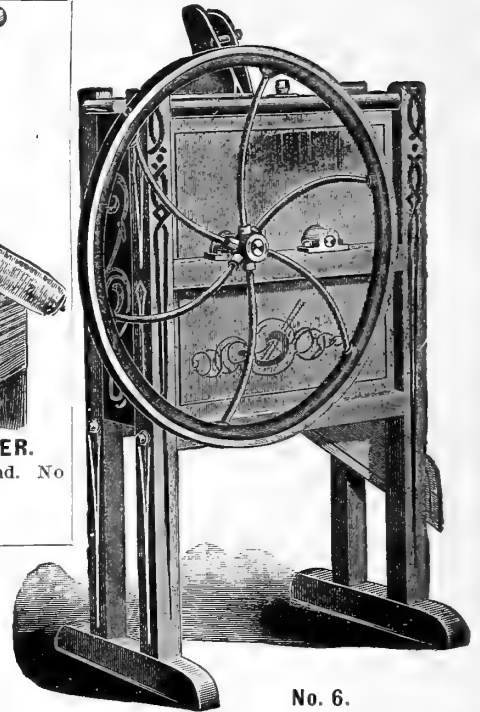

No. 6.

No. 3, Single Spout.

Separates corn and cob. Fan
will clean corn for market. Corn
discharged beneath Sheller, cobs
at end. Easily adjusted for large
or small ears. Capacity, 125
bushels a day.

**Plain, - - - - \$6.50
With Fan, - - 7.00**

No. 4, Single Spout.

Screens corn; side delivery;
light-running; strong steel
shafts. Capacity, 125 bushels a
day.

Plain, - - - - \$6.50

No. 5.

Capacity, 125 bushels per day;
single spout; left hand.

**Without basket holder, \$6.00
Basket holder, extra, 60**

No. 6.

Single spout; corn and cob
together. Capacity, 125 bushels
per day.

Price, - - - - \$5.50

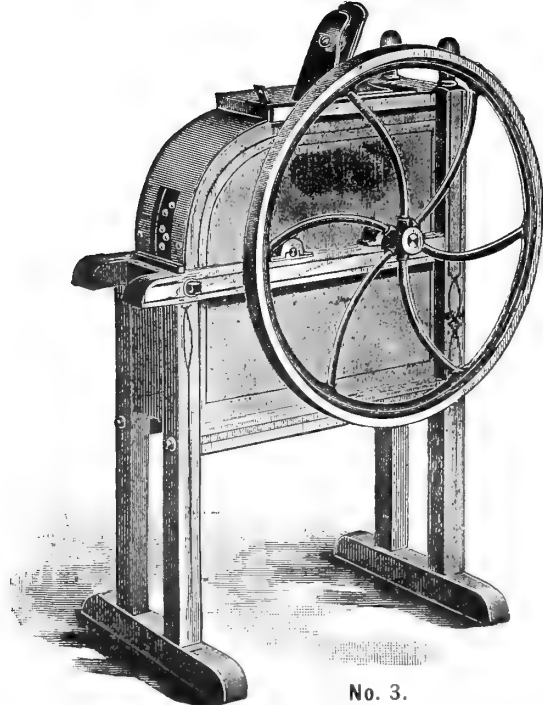

No. 3.

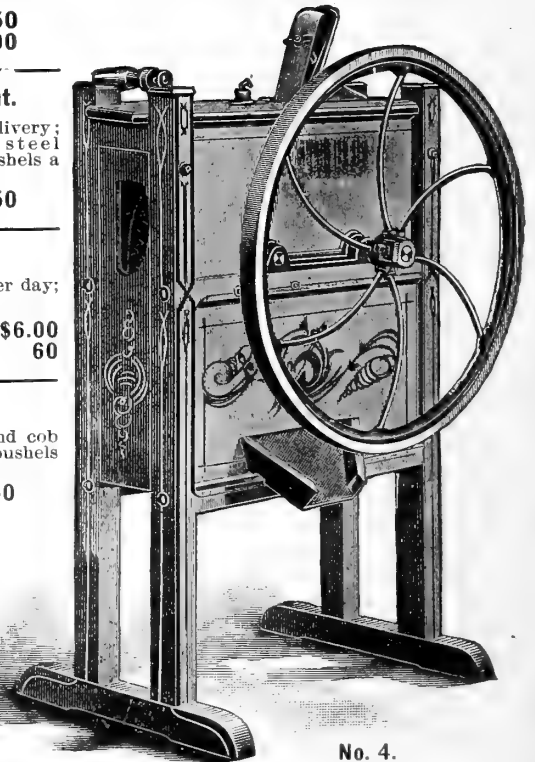

No. 4.



CORN SHELLERS AND POWERS, Etc.

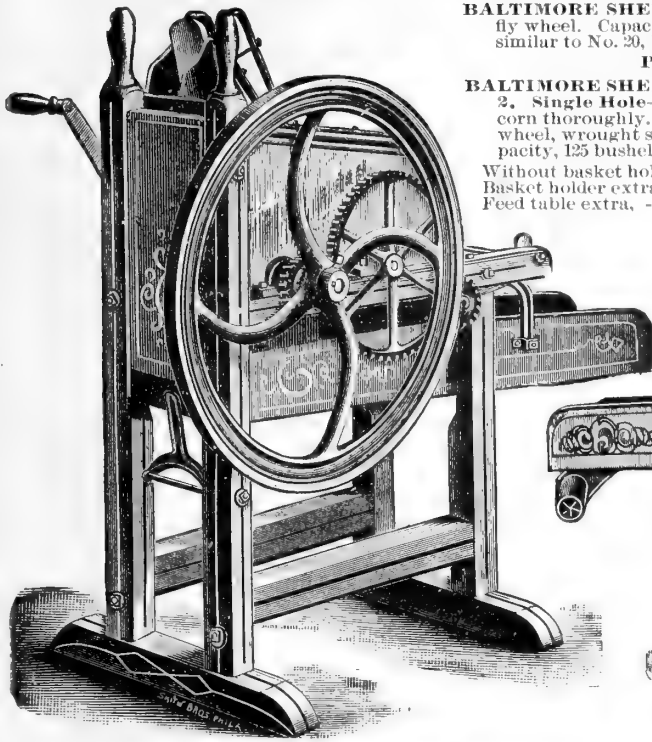

No. 20.

BALTIMORE SHELLER, No. 20, Double Spout. — Hand and Power, with shaker belt and fly wheel. Capacity, 200 bushels per day. Capacity by power, 500 to 600 bushels, Number 18 similar to No. 20, but without shaker and with screen at bottom to take out dust or dirt.

PRICE, No. 20, with shaker, \$16.00 No. 18, \$15.00

BALTIMORE SHELLER, No. 2, Single Hole—Cleans the corn thoroughly. Heavy fly wheel, wrought spokes. Capacity, 125 bushels per day.
Without basket holder, \$8.50
Basket holder extra,60
Feed table extra,1.00

THE BALTIMORE SHELLERS

Are all made with heavy fly wheels and steel shafts. Finely finished. Easy running and in every way classed among the best shellers on the market. The gears are all made inside and no danger to operator, can adjust to large or or small ears of corn.

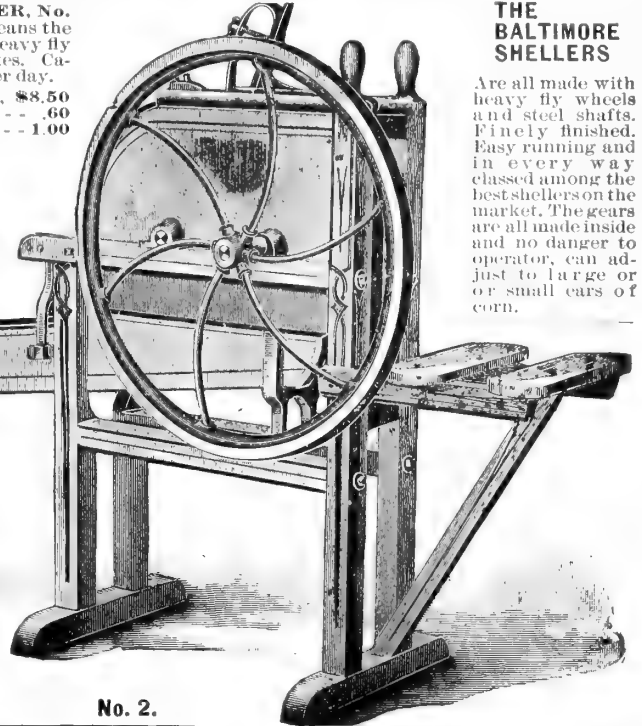

No. 2.

Scientific Triple-Geared Two-horse Sweep Power.

Is intended for one or two horses, and to run our two-hole Sheller. Can also be used with wood saws, feed cutters and other machinery. The tumbling rod makes 60 revolutions to one round of horse. We furnish with the power one lever, one 12-foot tumbling rod, two knuckles and one rod rest. Price of power complete, \$40.00

We also have a heavier Power similar to above which is strong enough for four horses and can easily be operated with two. The gearing is the same as used on our Double Action Mill. Price for this two and four horse power with two levers, tumbling rod, knuckles and rod rest, \$50.00.

Our eight-horse power is made with special reference to the requirements of Grinding Mills. The castings and timbers are all heavy and strong, carefully put together, so as to insure the least possible friction. It will run so light that two horses can readily work it where no more power is required, and it is sufficiently strong for any work requiring 8 horses. The tumbling rod makes 45 revolutions to 1 round of horses. Price, with 4 levers, 2 lengths of tumbling rods, knuckles, etc. List, \$95.00 Retail, \$76.00

	LIST.	RETAIL.
Two-horse Power,	\$50.00	\$40.00
Four-horse Power,	60.00	50.00

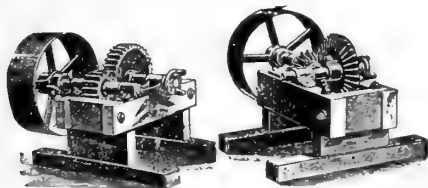
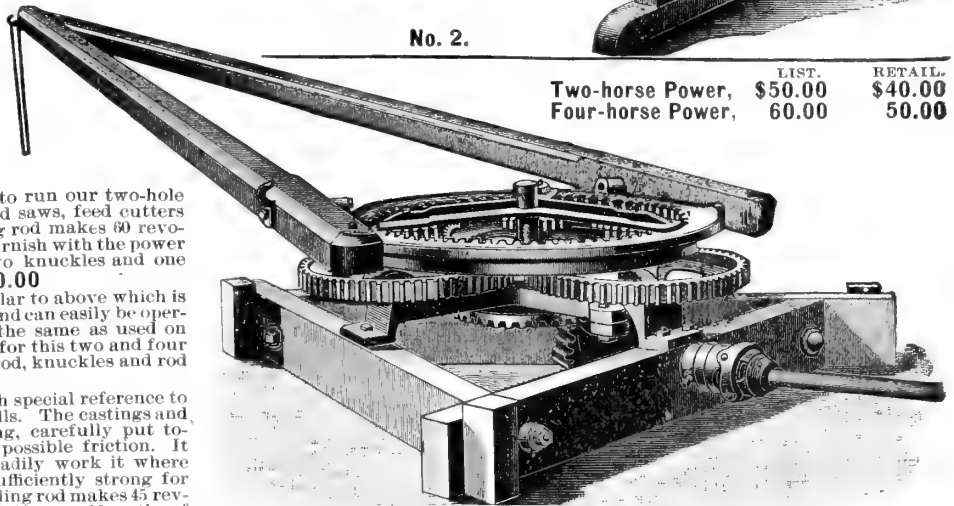

Spur and Bevel Gear Jacks.

This machine is intended to increase speed and transmit power by belt. The spur gear transmits the motion at a right angle with the tumbling rod, and the Bevel Gear transmits it in a line with tumbling rod. For 2-horse power pulley revolves 2 1/2 times to one revolution of tumbling rod. List, \$10.00

For 4-horse power, 2 1/2 times, List, \$18.00

Write for Special Retail Prices.

Circular Saw

WITH SWINGING TABLE.

FARMERS and others who use saws can at once appreciate the great convenience of this machine. It has a swing table, which is the best style for cutting cord wood. One man can do the work with this saw as readily as two men on the regular style. In this machine the draft is direct from the power to the saw, consequently it takes less power to drive it.

List price, with 20 inch Saw, \$40.00

Write for Special discounts.

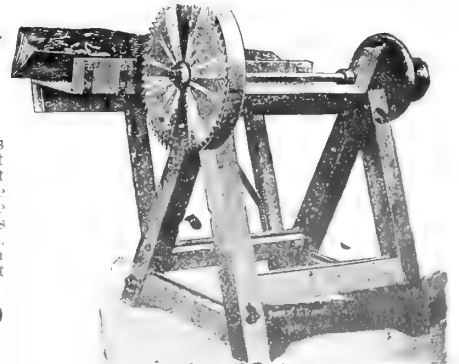

The Scientific, Double Action, MILL Triple-Gear'd and Power Combined

BOTH PLATES REVOLVE, ONE IN OPPOSITE DIRECTION FROM THE OTHER.

THE GRINDING PLATES

Are of the same peculiar hard metal which have given our mills their unequalled record for durability, and are so dressed as to give them the greatest capacity and at the same time do an excellent quality of work, cutting oats and rye into fine feed, not merely mashing these grains, or letting most of the product pass through untouched, as is the case with most other mills of this class.

FOR grinding corn and cob or shelled grain. Can also be used as a separate horse power for running other machinery. The combination of Feed Mill and a Horse Power in one makes a great reduction in cost, and yet furnishes a light run'ng machine.

THE sweeps or levers are attached to a large internal geared master wheel, into the teeth of which three strong pinions mesh, and through these pinions motion is imparted to the three large gear wheels, the teeth of which engage a heavy, strong pinion on one end of the shaft, which carries one of the grinding plates; the other, resting in a casting, is attached to the master wheel, and makes one revolution with each round of the horses, while the other makes thirty in a contrary direction; in consequence we get greater speed without increase of power and greater capacity. The utmost care is taken to insure the least possible draft.

Two levers or tongues are furnished so two, three or even four horses can be used. We also furnish two baskets with each mill, which set on rests, as shown. A cut-off is used to change the discharge to the empty basket, avoiding the necessity of stopping the team; no loss of time or waste of feed.

Capacity of mill on small grain, 12 to 18 bushels per hour; ear corn, 10 to 15 bushels.

Write for special descriptive catalogue.

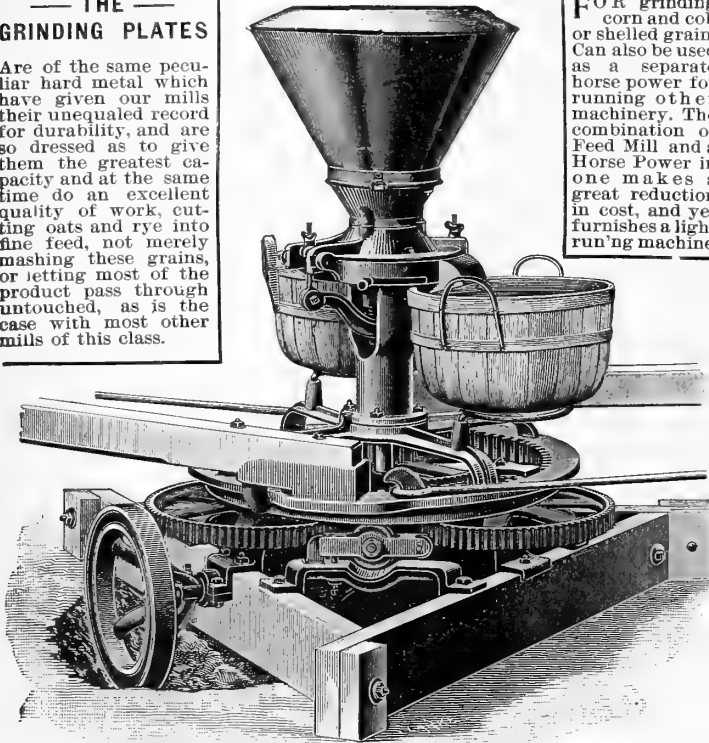

PRICES.

Double Action Mill and Power, complete, with two Levers.....	\$65.00
Double Action Mill and Power, complete, with two Levers, but without Tumbling Rod Attachment....	60.00
Single Action Mill and Power, complete, with two Levers.....	60.00
Single Action Mill and Power, complete, with two Levers, but without Tumbling Rod Attachment....	55.00

Special allowance for cash on any of above machines.

TESTIMONIAL.

MARYLAND AGRICULTURAL COLLEGE, }
OFFICE OF THE PRESIDENT.
COLLEGE PARK P. O., MD.

GRIFFITH & TURNER CO., BALTIMORE, MD.:

GENTLEMEN.—I can now say that the mill has been tested, and has given us every satisfaction. I regard it as fully filling every guarantee that you gave for it. Very truly yours,

R. W. SYLVESTER, PRESIDENT.

THE SCIENTIFIC SWEEP FEED MILL.

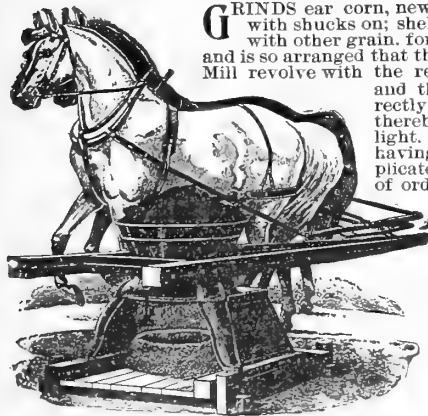

GRINDS ear corn, new, dry or damp, but not with shucks on; shell corn alone or mixed with other grain, for chopped feed, oats, etc., and is so arranged that the interior parts of the Mill revolve with the revolutions of the team, and the power is applied directly to the grinding parts, thereby making the draft very light. It is extremely simple, having no cog gearing or complicated machinery to get out of order. Our Grinding Rings or Burrs have a peculiar dress by means of which the broken pieces of cobs and whole grains are gradually reduced to the fineness desired. This breaking device, in connection with grinding rings, enables it to grind new ear corn just husked from the shock, as well as damp or wet corn.

The lower part of the mill is enclosed, making a large box for feed, which is discharged, all around the plates, and can be shoveled out at leisure. Weight of Mill, 625 pounds. Capacity, 8 to 15 bushels per hour, according to quality of work. Price of Mill, complete, with Platform and one set of Plates, \$25.00.

SIZES AND PRICES.

600 Pounds—Size of Platform, 10x23.....	\$12.50
800 Pounds.....	14.50

Special discount for cash.

WAGON SCALE.



One of the best Farm and Stock Scales made. Strong, accurate and durable.

Five Tons Capacity. Platform, 14 Feet Long, 8 Feet Wide. Iron Levers, Steel Pivots, Brass Beam, Sliding Poises and Beam Box. Price.....\$65.00.

PORTABLE SCALE.



They are carefully adjusted by competent workmen, and are guaranteed accurate United States Standard Scales.

The material throughout is of the same quality as is used in the highest priced goods. The brass work is highly polished, the iron work is japanned in black, and the wood work is finished in its natural color, making a very attractive combination.

They are carefully packed for shipment and can be set in position ready for use in a few minutes.

THE SCIENTIFIC CORN AND COB MILLS

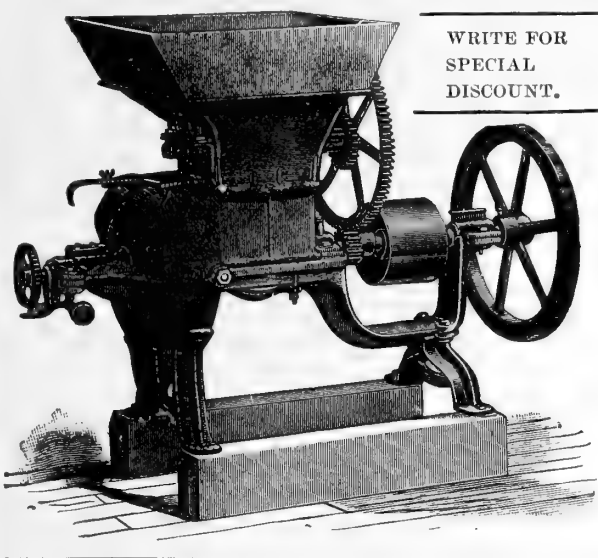

WRITE FOR SPECIAL DISCOUNT.

Style H. No. 1. Has Double Breakers, Partition Hopper, Pin Breaker and Safety Bottom. It grinds ear corn without shucks, shelled corn, oats, rye, barley, cheat screenings, or any and all kinds of small grain, separately, or any two or more mixed, for feed.

DIMENSIONS AND WEIGHT.—3 feet 10 inches long, 2 feet 8 inches wide and 3 feet 7 inches high. Weighs 508 pounds. Weight of fly wheel, 40 pounds. **SHAFT.**—1½ inches in diameter, cold rolled steel.

GRINDING PLATES.—10 inches in diameter. These plates are unlike those in the other mills, and run only in one direction—to the right. Can furnish left hand if desired. Will furnish an extra set free in this style of mill, but in no other, as all others are reversible.

POWER.—4 to 8-horse to sweep power, or 4 to 6-horse steam power.

PULLEY.—Furnish an 8-inch diameter, 6½-inch face pulley, unless special size is ordered, which can be furnished without extra charge.

SPEED.—800 to 1,000 revolutions per minute for horses; 1,000 to 1,200 for steam.

CAPACITY.—Ear corn, with shucks off, 8 to 18 bushels. If corn is new or wet, the work can be done but not so fast. Shelled corn, 8 to 20 bushels per hour. All kinds of small grains separately, or corn and oats or other grains mixed, 6 to 15 bushels per hour.

Price of this mill, complete, with extra set of plates, \$65.00. Extra plates, per set, \$2.00.

Style L. No. 1. Has Double Breakers, with partition Hopper, Pin Breaker and Safety Bottom. It grinds ear corn with or without shucks on, shelled corn, oats, rye, barley, cheat screenings, or any kind of small grain separately, or any two or more mixed, for feed.

DIMENSIONS AND WEIGHT.—4 feet 2 inches long, 2 feet 3 inches wide, and 3 feet 2 inches high. Weight of mill, 560 pounds; weight of fly wheel, 55 pounds. **SHAFT.**—1½ inch; cold rolled steel.

GRINDING PLATES.—12 inches in diameter, of extremely hard metal, and very durable. Are reversible and self-sharpening, having double the capacity of non-reversible plates.

POWER.—8 to 12 horses to sweep power; 6 to 10 horse steam power.

PULLEY.—8 inches in diameter, 6½-inch face, but can furnish larger, if desired, without extra charge.

SPEED.—1,000 to 1,200 revolutions per minute for steam power. 800 to 1,000 revolutions per minute for horse power.

CAPACITY.—Ear corn with shucks on, 10 to 20 bushels per hour; with shucks off, 15 to 30 bushels. If corn is new, wet or frozen, the work can be done equally as well, but not so fast. Shelled corn, 25 to 40 bushels per hour. All other small grains separately, or corn and oats or other grains mixed, 15 to 30 bushels per hour.

Price, \$75.00. Extra plates, \$4.00. Write for Mill Catalogue. Prices on Power Mills subject to special discount.

Style N. No. 1. This is similar in general make-up to the style L, the only difference being in dimensions, power and capacity.

DIMENSIONS AND WEIGHT.—4 feet 9 inches long, 2 feet 5 inches wide, and 3 feet 5 inches high. Weight of mill, 625 pounds; weight of fly wheel, 100 pounds.

SIZE OF SHAFT.—4 feet 9 inches long by 1½ inches in diameter; cold rolled steel. **POWER REQUIRED.**—10 to 15-horse steam power.

SPEED.—900 to 1,000 revolutions per minute.

PULLEY.—Unless otherwise ordered, we put on this mill, a pulley 10 inches in diameter, 8½-inch face, but can furnish any size up to and including 14 inches in diameter, 8½-inch face, without extra charge.

CAPACITY.—Ear corn, with shucks on, 15 to 25 bushels per hour; with shucks off, 20 to 50 bushels per hour. If corn is new, wet or frozen, the work can be done equally as well, but not so fast. Shelled corn, 20 to 65 bushels per hour. All other small grains, separately or mixed, 20 to 60 bushels per hour.

Price of N. No. 1 Mill, complete, on cars here, \$95. Extra grinding plates, per set, \$5.00.

Write for Mill Catalogue. Prices subject to special discount.

TESTIMONIALS.

MESSRS. GRIFFITH & TURNER CO., BALTIMORE, MD.

GENTLEMEN.—It gives me pleasure to state that I have erected several Scientific Mills, and in every instance they have given entire satisfaction. Yours very truly JOHN B. ADT, 332 to 342 Holiday St.

FREEDOM, CARROLL CO., MD.

GRIFFITH & TURNER CO., BALTIMORE, MD.

GENTLEMEN.—This is to certify that I have been using one of the Double-Acting Mills bought from you in the spring of 1897 in grinding grain, crushing corn on cob, etc., and am much pleased with the work it does. It is entirely satisfactory, and is all that you claimed for it when I bought it. Not only is it endorsed by myself, but also by those who have seen it at work. Such being the case, I can recommend it to anyone who has stock to feed. Yours respectfully, J. OLIVER WADLOW.

STRAUB'S VERTICAL FRENCH BURR MILLS.

WE BELIEVE these Burr Stone Mills are the best ever offered to the public. Strong, well and substantially built. The cut, which represents the "Export, is designed both for export and domestic trade. It has been thoroughly tested and is an entire success. For grinding corn and feed, mineral paints, cement, plaster, shells, bones, spices, graham and buckwheat flour, etc.

'EXPORT.'

Size of Mill	Horse P. Required	Capac'y per hr.	Speed per Min.	Floor Space	Height.	Pulley.	Shipping Wt.	Price. List.	Retail.
No. 15-15 in.	2 to 5	8 to 15	1,000	42x25	37 inches.	10x 6½	600 lbs.	\$150.00	\$90.00
No. 18-18 in.	6 to 10	15 to 30	1,000	46x28	40 inches.	12x 7½	900 lbs.	170.00	102.00
No. 24-24 in.	8 to 12	20 to 50	800	56x38	54 inches.	16x10	1,500 lbs.	275.00	165.00

"EXPORT, Jr."

The next mill is the "Export, Jr." following the same general principles of the above, but is lighter and has been found perfectly satisfactory for grinding corn, wheat, rye, oats, buckwheat, rice, coffee, spices, or in fact anything that can be ground upon our larger French Burr Mills. It can be operated by light motors or engines, wind mills, sweep or tread powers.

Size of Mill, 9 inch. Power required, one-half to 2-horse power. Capacity per hour, 2 to 8 bushels. Revolutions, 800-1,200. Size of pulley, 6x3½. Net weight, 225 lbs. Boxed weight, 275 lbs. Height, 32 inches. Floor space, 30x18 inches. Retail price, \$45.00. List price, \$70.00.

"GEM OF THE SOUTH."

The "Gem of the South," another of these celebrated mills, will be found exceedingly well adapted for farmers' purposes generally. Is claimed by thousands of users to be the best vertical mill on the market for grinding corn and feed, mineral paints, cement, plaster, shells, bones, spices, graham and buckwheat flour, etc. We only furnish this mill is one size, the 12-inch standard.

Size of Mill, 12 inches. Power required, 2 to 4 horse power. Capacity per hour, 4 to 8 bushels. Speed per minute, 1,000 to 14,000. Diameter of pulley, 7 inches. Size of belt, 4 inches. Size on floor, 20x14 inches. Weight, 300 lbs. Price, List, \$107.50. Retail, \$64.50.

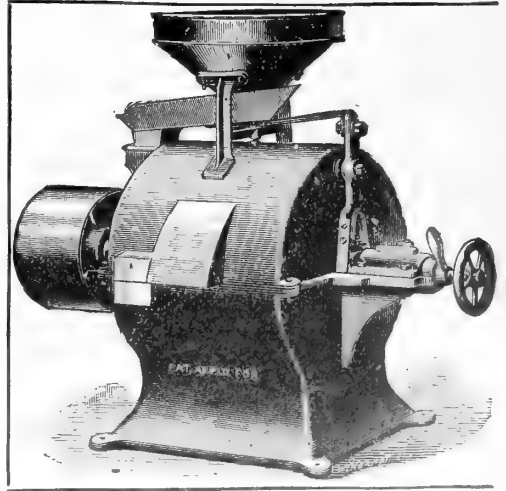

ALL PRICES SUBJECT TO CHANGE WITHOUT NOTICE.

THE OWENS' FANNING MILLS.

WE INTRODUCED this Fanning Mill last year feeling confident that we had at last secured a machine that would take cockle from wheat and all other grains; separate mustard and all foul seeds from flax, etc. It also cleans Oats, Barley, Peas, Beans, Clover, Timothy, Millet, alfalfa and cheat out of wheat.

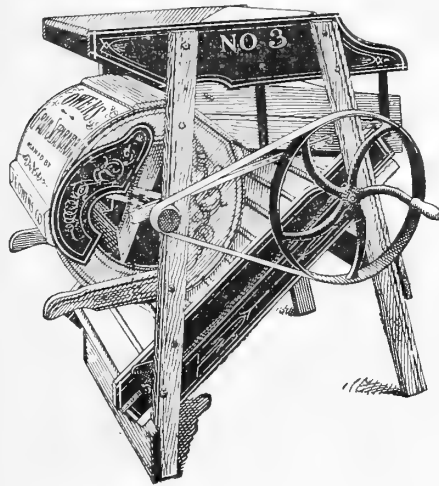

Never before have the sales for Fanning Mills been so great in any one year in the history of the business. The reason is obvious; it has been considered impossible to effectually separate cockle and other foreign seeds from wheat, and the farmer has been satisfied with the old styles, which clean grain well enough for flour. These mills actually do all that is claimed for them by the manufacturers. It is no longer considered an experiment but an established fact. You need only read our testimonials given on this page to become convinced, the signatures of those testifying carry conviction. The reports of our sales through

Pennsylvania and Delaware, as well as Maryland, have been of the most flattering character.

We furnish the Owens' Automatic Force Feeder with all mills. All of these Mills are end shake with the exception of No. 20, which is Side Shake.

It will be noticed that in all other mills they depend entirely upon blast to clean the grain. While we have an equal amount of blast, we also have, in addition to it, a Cockle Separator, which removes all foul seeds perfectly. The Cockle Separator is constructed in such a manner as to allow the grain to pass over an inclined stationary sieve of proper mesh, the grain being kept in a horizontal direction by means of slats on a revolving canvas. By having the screen stationary, we are enabled to use a sieve of much coarser mesh than can be used in other mills, and for this reason we are able to remove large foul seed from the small wheat. As can readily be seen, the grain is constantly kept parallel with the slats and a revolving motion imparted to it, so that all of the grain is brought in contact with the screen, and all foul seeds smaller than a kernel of wheat lengthways will fall through the screen, while the clean grain passes over and falls in front of the mill. By the same means the screen is kept constantly clean.

No. 3 FARM MILL.

Capacity, 30 to 40 bushels per hour. This Mill separates all foul seeds from wheat, oats and barley, especially mustard. Will also clean flax from all foul seeds, as well as clean all kinds of grass seed. **\$18.50.**

No. 3½ FARM MILL.

Capacity, 40 to 60 bushels per hour. Has all the merits of the No. 3, but has greater capacity and easier to operate, owing to its being made lower. It will also separate oats from wheat better than any other make of mills. Price, **\$21.50.**

No. 5 FARM MILL.

Capacity, 60 to 80 bushels per hour. This Mill is larger than No. 3 and requires more power. Price, **\$24.50.**

A FEW TESTIMONIALS FROM PERSONS USING THE OWENS' FAN.

MESSRS. GRIFFITH & TURNER CO.:

GENTLEMEN—We are handling your Owens' Grain Fan No. 20, and for removing cockle and cheat from wheat we do not think they can be surpassed. Yours very truly,

ISAAC ROBINSON.

CHESAPEAKE CITY, MD., Nov. 29th.

BALTIMORE, MD., Nov. 1st.

MESSRS. GRIFFITH & TURNER CO.:

GENTLEMEN—Having used your Owens' Fanning Mill this fall for cleaning seed wheat,

OWENS' LEADER No. 1.

SEED, GRAIN and BEAN CLEANER. SEPARATOR OF COCKLE, BUCKWHEAT AND MUSTARD.

THE sieves are made of best zinc, and screens of best steel pressed wire, furnished with Force Feed End Shake, and the best vertical Blast ever constructed. It works in all kinds of grains and seeds without any attachments. It has an adjustable Blast Shaft, so as to increase or diminish the force of the blast without increasing or diminishing the speed of the fan.

MADE IN
FOUR SIZES
FOR
HAND AND
POWER.

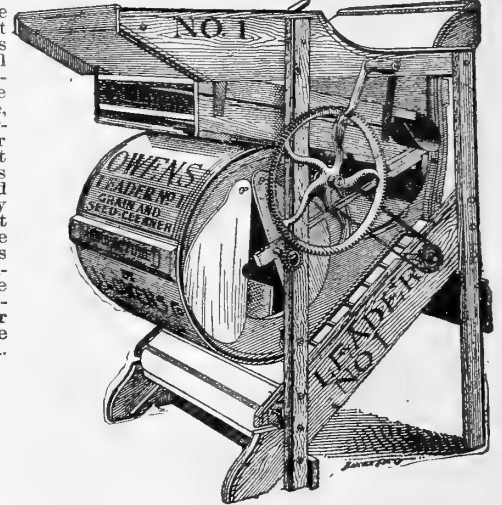

CAPACITY, 40 TO 50 BUSHELS PER HOUR.

Price.....\$28.50.

OWENS' FANNING MILL.

No. 20—SIDE SHAKE.

THIS MILL IS MUCH LARGER THAN THE OTHERS, AND IS USED MORE ESPECIALLY FOR WAREHOUSE PURPOSES. IT HAS THE SLATTED CANVAS PRINCIPLE OF THE OTHER STYLES.

CAPACITY, 80 TO 100 BUSHELS PER HOUR.

Price.....\$27.50.

— THE — BALTIMORE IMPROVED GRAIN FAN.

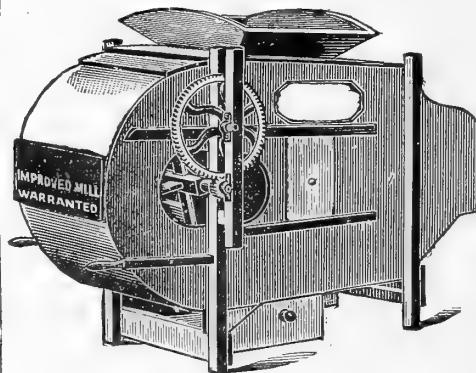

Good General Purpose Mill. Side Shake.

Will clean from 60 to 100 bushels per hour. Made of best material and finished in a neat and tasty manner.

Price, **\$18.09.** Special price for cash.

it gives us pleasure to state that it is a most excellent machine for that purpose, and has done for us all you claim.

Yours very truly, DUDLEY & CARPENTER.

EARLVILLE, MD., Sept. 29th.

MESSRS. GRIFFITH & TURNER CO.:

GENTLEMEN—I have operated and sold quite a number of the Owens' Grain Fans this fall, and they have given satisfaction to all purchasers, especially for grading and cleaning seed wheat. Yours very truly,

WM. J. DUHAMEL.

FEDERALSBURG, MD.

MESSRS. GRIFFITH & TURNER CO.:

GENTLEMEN—We have tried the Owens' Fan and find it first class for cleaning grain. Yours very truly, J. M. WRIGHT.

QUEEN ANNE, MD., Oct. 14th.

MESSRS. GRIFFITH & TURNER CO.:

GENTLEMEN—The Owens' Fanning Mill has more than met our expectations for cleaning seed wheat. It has no competition from the fact that the screens are kept clean automatically, thus insuring a perfect separation at all times, which other mills fail to do.

Very truly, HACKETT & JUMP.

ALL PRICES SUBJECT TO CHANGE WITHOUT NOTICE.

CIDER MILLS AND PRESSES.

The "Baby" Wine and Cider Mill.



THIS is a very handy little mill for making a small quantity of cider, five or ten gallons at a time. All of the juice of the apples can be gotten out, but not so rapidly. It is really intended more for grinding grapes and other small fruit for wine, and is so constructed as not to crack the seed.

No. 0—Single Cage Mill.. \$9.50
1— " " " " " " " " " " " " " " 10.50

IXL Lard and Fruit Press.

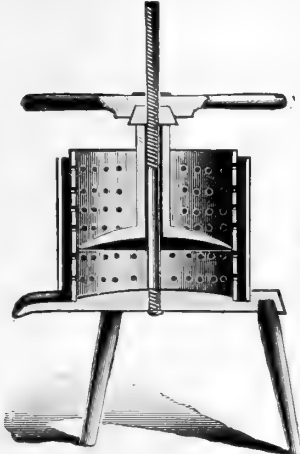

WE desire to call your attention to the I X L Lard and Fruit Press, a cut and description of which is given herewith. Best simplest and cheapest. It is substantial and won't get out of order, and very easy to clean. A boy ten to twelve years old can operate it. By its use enough lard is saved in one season to pay for it. Good for pressing berries and small fruits. It will last a life-time, as all parts are made of heavy cast iron, while bowls are of the best galvanized steel. Whole height of press, 3 feet; size of bowl or drum, 10 inches in diameter; weight, 45 pounds.

Price \$4.00
We also handle the ENTERPRISE Presses.



THES E MILLS are first-class in every particular, special pains being taken in the selection of materials. **HARD WOOD FRAMES, HEAVY CAST IRON BEAMS and SET SCREWS,** are unsurpassed in quality, durability and capacity.

The grinding apparatus is of the most satisfactory and latest improved pattern, and is made adjustable so as to grind both small and large fruit equally well.

The pomace is not left in lumps, but all the cells are crushed, consequently ALL the JUICE can be extracted by the press.



"Senior" Hand and Power Cider Mill.

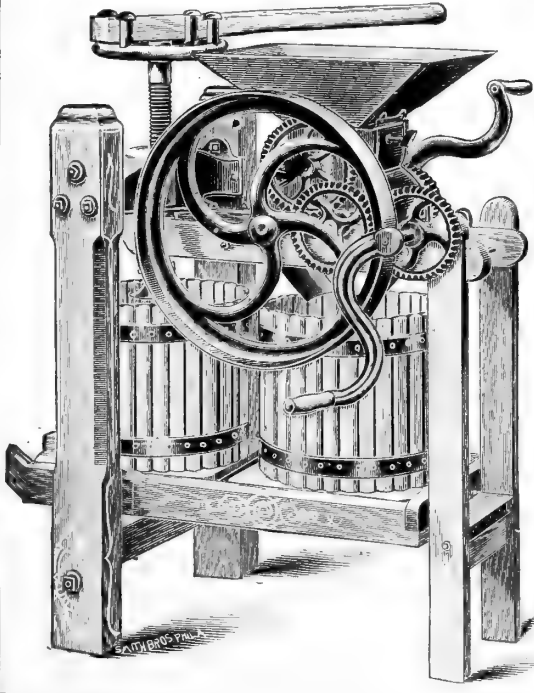

THIS is our largest sized mill, adapted for hand or power, with a detachable handle on either side. The top set of rolls first mash the fruit fine, and the bottom set grinds it, thoroughly breaking all the cells, so that the cider is entirely extracted. These mills produce more cider to a given quantity of apples than any other mill on the market.

Price.....\$22.50

Medium and "Junior" Hand Cider Mill.

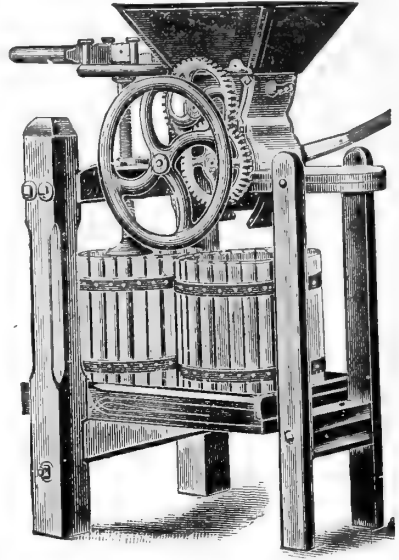

THES E Mills are almost identical with the "Senior," except they are smaller, and have only one handle. In the preparation of the pomace for cider, they are the same in all their parts.

Price, Junior.....\$15.00
" " " " " " " " " " " " " " 18.00

Berry Press.

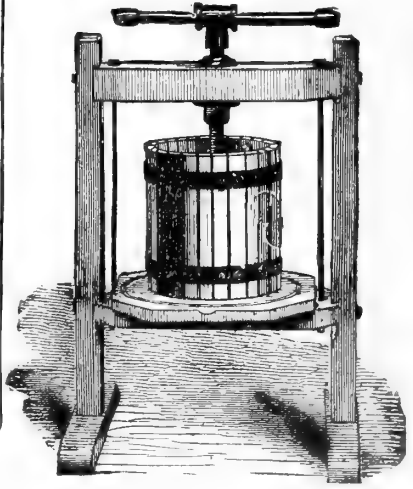

THIS little press is for the purpose of expressing the juice of grapes and other small fruits, for wine making. Strong and substantial. Made of oak staves, securely bound with a rivet in each stave. Frame of oak and securely ironed, and will stand great pressure.

Berry Presses No. 1.....\$5.00
" " " " " " " " " " " " " " 5.50
" " " " " " " " " " " " " " 7.25

THE BANNER ROOT CUTTER.

Built in three sizes for both Hand and Power.

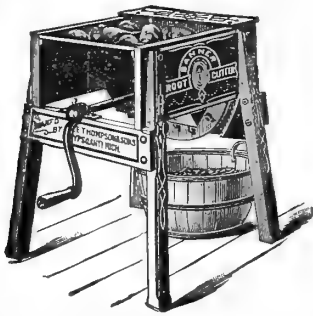

Simple in construction. Easy to operate. Has a self-feeder. Separates dirt from cut feed. Cuts with a clean cut. Does not crush, grind and tear the feed.

The No. 20—For Hand Use.

Has a capacity of 30 to 50 bushels per hour.
List Price.....**\$12.00**
Retail Price.....**9.00**

The No. 15—Hand and Power Cutter.

Same size as No. 20. It is arranged with Band Wheel for light power, such as wind mill, etc. Capacity by power, 1 to 1½ bushels per minute.
Our Retail Price.....**\$10.00**

The No. 16—Small Power Cutter.

With Fly Wheel and Band Wheel. Supplied with crank also for hand use. Capacity by hand, 30 to 50 bushels per hour. Capacity by power, 2 to 3 bushels per minute.
Our Retail Price.....**\$15.00**

REGULAR 3 KNIFE KRAUT CUTTER, with Sliding Box, 8x26 inches, Price, \$1.25.



Thompson's Junior Banner Cutter, No. 7.

Suitable for a Flock of 50 to 1000 fowls.

This cutter is adapted especially for poultry men and farmers or for suburban residents keeping a couple of cows. Cuts roots and vegetables into fine chicken feed. Capacity, one bushel in about five minutes. Price, **\$5.00.**

Balto. Feed Cooker, Style No. 1.

The furnace, door frame, hearth and grates of this cooker are made of the best cast iron linings, and sides of sheet steel plates. The steel linings prevent burning or warping where the furnace is concerned, and the air between the furnace and outside sheet passes into the fire box and out through the smoke stack, this increases heating capacity and hence saves fuel. The boiler is made of galvanized steel, and will not corrode nor rust.

We can also furnish a tight fitting galvanized steel cover with every boiler. A faucet for drawing off liquid can be attached to the boiler, for \$1.00 extra. All furnaces are furnished with one length (24 inches) of 6 inch stove pipe, extra lengths for 25 cents. The steel cover is for the purpose of converting the furnace into a stove by taking off the boiler. The hearth in this furnace extends back under the grates, so as to form an ash receiver. The furnace can be set up in any building or on the ground without danger of fire.

Style, No. 1, 25 gal., 21x25x13, wt. 115 lbs.....	\$12.00
" 2, 40 " 21x35x13, " 130 "	14.00
" 3, 50 " 21x37x13, " 142 "	16.00
" 4, 65 " 21x47x13, " 160 "	18.00
" 5, 100 " 21x61x13, " 240 "	22.00
Plate for Style, No. 1.....	2.50
" " " 2.....	2.90
" " " 3.....	3.35

EMPIRE STATE COOKER, similar in construction to the above but lighter and cheaper. Special prices on application.

Electric Corrugated Boiler and Feed Cooker.



PATENTS PENDING.

The kettles are made of finest grades of cast iron. They are mounted on a very heavy CORRUGATED STEEL JACKET, which provides for EXPANSION and CONTRACTION of the metal so that it will not buckle or break when exposed to a high degree of heat. A HEAVY STEEL BAND extends around the jacket at both TOP and BOTTOM making it an EXCEEDINGLY DURABLE FURNACE.

This boiler is designed to set on the ground or brick foundation. A CAST IRON FLUE is fastened to the inside of the Jacket which retards the draft and causes the heat to be retained, and applied to the whole exterior surface of the kettle, before passing out, making it very economical in the consumption of fuel. Cast iron fixtures for hard or soft coal furnished when required.

MADE IN THREE SIZES.

No. Size.	Usual Rating.	Shipping Weight.	List.
4	1 bbl. 40 gals.	175 lbs.	\$14.50
5	1½ " 60 " "	200 " "	16.00
6	2 " 70 " "	225 " "	18.00
Cast Iron Fire Pot for Coal.....			3.50

SPECIAL DISCOUNT FOR CASH.

ALL PRICES SUBJECT TO CHANGE WITHOUT NOTICE.

...THE...

Ohio Butchering Derrick.

THE GREAT LABOR SAVER.

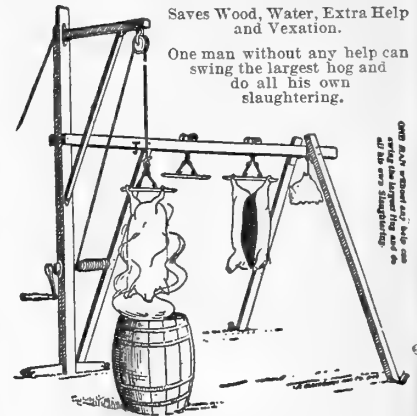

Saves Wood, Water, Extra Help and Vexation.

One man without any help can swing the largest hog and do all his own slaughtering.

The Derrick is made of first-class hardwood, finished in oil and varnished. Strong enough to swing up the largest hog, and room enough on it for four or more. It can be taken apart, and put together within a few minutes; can be folded up closely and packed away in the hay loft during the summer. The hot water barrel may be placed within easy distance, and the whole pig ducked at once and as long as may be necessary. Strong, durable, always ready for business.

DESCRIPTION—From the pulley to the ground, 9 ft.; length of derrick, 9 ft. 6 in.; track, 6 ft. 9 in. from the ground; braces, 6 ft. 6 in. wide at the bottom. Each Derrick furnished with four gammon sticks, four pulleys, four head hooks, twenty feet manilla rope, malleable iron stay rings, a windlass of easy sweep. Thoroughly well braced with proper cast iron supports to the crane. Weight 150 lbs.

Price.....**\$10.50**

Horse Radish Grater.

Price, with Perforated Tin Cylinder.....**\$ 7.00**
Price with Steel Pin..... **8.00**
Machine for Power..... **14.00**

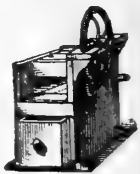

DECARBONIZED METAL FARM BELLS.



No.	Diameter of Bell.	Weight Complete.	List Price.	Retail Price.
No. 1.....	15	40 lbs.	\$1.00	\$2.00
No. 2.....	17	50 " "	5.00	2.50
No. 3.....	19	75 " "	7.50	3.75
No. 4.....	20	100 " "	10.00	5.00

Above prices include bell and hangings complete.

WAUKEGAN BARBED WIRE.
PRICES ON APPLICATION.



IOWA FOUR POINT BARBED WIRE.
PRICES ON APPLICATION.

PLAIN TWISTED TWO STRAND WIRE.
PRICES ON APPLICATION.



PLAIN RIBBON WIRE.
PRICES ON APPLICATION.



PLAIN GALVANIZED WIRE.
PRICES ON APPLICATION.

PLAIN ANNEALED WIRE.
PRICES ON APPLICATION.

TRUSS AND CABLE FENCE WIRE.

It is composed of six galvanized spring steel wires of superior quality and is about 1 1/2 in. wide. Its strength is equal to the combined tensile strength of all the wires, and its construction is such as to allow for the expansion and contraction of heat and cold without stretching.

PRICES ON APPLICATION.

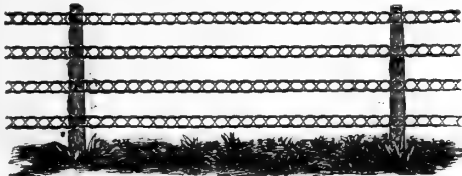

WIRE STRETCHER.



The person stretching the wire can nail it to the post without assistance. The only true principle for a Wire Stretcher.

Price, 75 cents.

FARM POST. Fig. 67.

Shows the "Hartman" Farm Post slotted for our Stockade Fence. It is used for ANY KIND of fence or fence wire, and is slotted to order without extra charge. Price \$1.20.

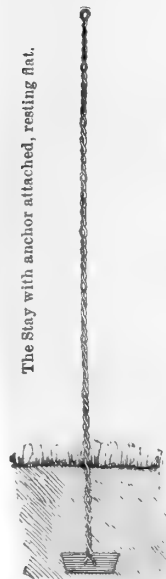

The Stay with anchor attached, resting flat.

THE "HARTMAN" ANCHORED FENCE STAY.

For bracing farm fences.

This simple device is a means of adding much strength to farm fences, at the same time lessening the cost.

The Stay consists of heavy galvanized twisted STEEL RODS, about 3/4 inch in diameter, to which the horizontal wires of ANY farm fence are fastened by means of short pieces of small wire. At the end is an anchor that is attached to the stay and set from 8 inches to 12 inches in the ground. The STAYS are placed ONE ROD APART (or 2 in 50 ft.) and serve to strengthen the fence between posts, which may be of any desired material—wood or steel.

They effect a LARGE SAVING in cost by LESSENING the NUMBER of posts REQUIRED.

They make it impossible for the fence to be LIFTED UP or PULLED DOWN and brace it sidewise.

48 ins. high, per 100, List \$29.50; Retail, 25 cents each.
60 ins. high, per 100, List \$33.25; Retail, 28 cents each.

THE "HARTMAN" STEEL TREE GUARD.

Is Ornamental, Strong, Durable and Cheap.

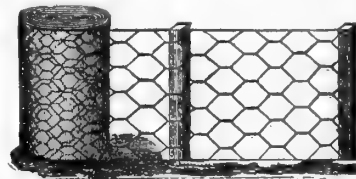

Fig. 18.

We can make this guard for any size of tree, 9 inches diameter, 5 feet 8 inches high, \$2.00 each.

POULTRY NETTING—
For Enclosing Poultry Yards.

The Wire we offer is all No. 19 and 20 double twist, 2 in. mesh, thoroughly galvanized after weaving. Sold in bales of 150 running feet.



PRICES TWO INCH MESH.

No.	19.	in. wide.	sq. ft.	per bale.	No. 20.	in. wide.	sq. ft.	per bale.
"	12	150		\$1.12	"	12	150	\$1.02
"	18	225		1.69	"	18	225	1.52
"	24	300		2.25	"	24	300	2.03
"	36	450		3.38	"	36	450	3.04
"	48	600		4.50	"	48	600	4.05
"	60	750		5.63	"	60	750	5.36
"	72	900		6.75	"	72	900	6.08

Price 1 cent per sq. ft. in less than bale lots. Staples for fastening, 10 cents per pound.

HARTMAN "STOCKADE" WOVEN WIRE FENCE.

Strong, Durable, Cheap, Ornamental, Convenient, because easy to handle, quickly put up. The "Y" steel posts are used in the erection of this fence. (See cut, 67).

THE BEST FENCE MADE.

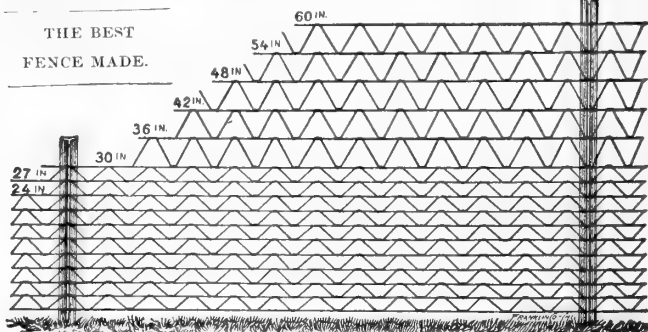

The ingenuity of the most successful inventors has contrived no better fence than our "Stockade," and in some important respects it is absolutely unrivaled.

This fence, made in various heights for hogs, sheep, cattle and horses, is composed of horizontal strands of gauge 13 galvanized steel wire (except top and bottom wires, which are of gauge 10), braced by intersecting strands of gauge 13 wire. It is made with horizontal wires 3 inches apart, below 24 inches; above that distance, 6 inches apart.

The nature of the construction indicates its remarkable strength. It contains much more material than fences more cheaply constructed, consequently is proof against chickens as well as the heaviest stock.

Ample provision made for expansion and contraction. It will not sag, properly erected and stretched, as do all "coil spring" and "corrugated" fences.

For use on the farm, ranch, pasture, plantation, corral, and for general field use it is usually erected on posts of wood, placed from 10 to 16 feet apart, with braced terminal corner and gate posts. Some fence users place posts greater distances apart with mere wood braces fastened to fence and resting on the ground at convenient intervals. We are able, however, to supply our steel posts and braces at a first cost but little advanced over wood, which is more than met by their durability.

The cut shows the different heights of "Stockade" Fence. It is put up in standard rolls 20 rods each, or in special lengths when ordered.

NOTE.—In the 60-inch height only the horizontal wires are 3 inches apart up to 30 inches, while in all other heights up to 24 inches.

PRICE WITHOUT STEEL POST. Fig. 67.
4 ft. high, per rod, Retail, 72c. List, \$1.22. 5 ft. high, per rod, Retail, 88c. List, \$1.46. Steel Posts, each \$1.20 WRITE FOR SPECIAL PRICES.

Having laid in quite a large stock of this fencing before the advance in price, we are prepared to furnish the same, in reasonable quantities, at a special discount. Nothing equals our Steel Picket Fence for Cemetery lots.

SINGLE WALK GATES. (Enamelled Black.)

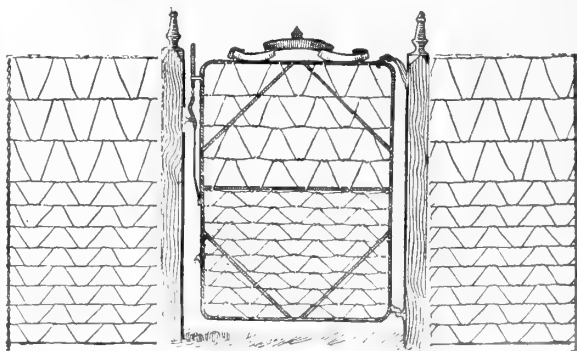

List Price. Retail Price.
48 inches high by 3 1/2 feet wide \$1.30 83.44
60 inches high by 3 1/2 feet wide 1.65 3.72
Above prices of Gates include the hinges, latch and screws.

DOUBLE DRIVE GATES. (Enamelled Black.)

List Price. Retail Price.
9 feet wide by 48 inches high, each \$9.50 87.60
9 feet wide by 60 inches high, each 9.50 7.60
Above prices include hinges, latch, plate and screws.

THE BALTIMORE PUMP.
WITH AND WITHOUT PORCELAIN CYLINDER.
PRICES OF PUMPS FITTED COMPLETE.

	6 x 6 UNLINED.		6 x 6 LINED.		7 x 7 LINED.	
	LIST.	RETAIL.	LIST.	RETAIL.	LIST.	RETAIL.
For 6 foot well.....	\$6.25	\$4.70	\$ 7.75	\$ 5.85	\$ 9.00	\$ 6.75
" 8	6.60	5.00	8.10	6.10	9.35	7.00
" 10	6.90	5.20	8.40	6.30	9.70	7.30
" 12	7.25	5.50	8.75	6.60	10.10	7.60
" 14	7.60	5.75	9.10	6.85	10.45	7.85
" 16	8.00	6.00	9.50	7.15	10.80	8.10
" 18	8.75	6.60	10.25	7.75	11.15	8.40
" 20	9.10	6.85	10.60	8.00	11.50	8.65
" 22	9.50	7.25	11.00	8.25	11.85	8.90
" 24			12.00	9.00	13.15	9.90
" 26			13.00	9.75	14.35	10.80
" 28			14.00	10.50	15.55	11.95
" 30			14.75	11.10	16.30	12.25
" 32			15.50	11.65	17.05	12.80
" 33			15.85	11.90	17.40	13.00
" 35			16.60	12.45	18.15	13.65
" 36			17.00	12.75	18.50	13.90
" 38			17.75	13.35	19.25	14.45
" 40			18.50	13.90	20.00	15.00
" 42			20.25	15.20	21.75	16.35
" 45			22.00	16.50	23.50	17.65

—THE—
IXL GALVANIZED
STEEL CURB.

It will not rust, being made out of No. 24 Gauge Galvanized Steel.

It will not rot or accumulate filth, and leaves the water clear and pure.

It is anti-freezing, as the reservoir piece, has a small hole in same, which allows the water to run out.

It can be used in wells as deep as 40 feet.

Prices.

Galvanized Curb.....	\$3.25
Tubing, per foot.....	.07
Coupling.....	.16
Rubber Buckets.....	.08
Iron Platform.....	4.00

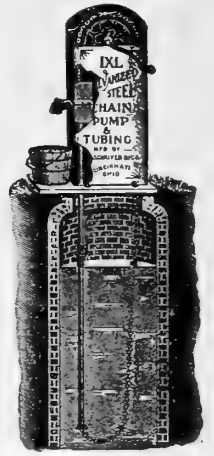

STANDARD LIST PRICES

Wood Pumps, Tubing and Extras,
Adopted December 8, 1892.

PUMPS FOR DRIVE WELLS.—To Fit 1 1-4, 1 1-2 or 2 in. Iron Pipe.

No. 1—House, 6 ft. long, Iron Cylinder.....\$6.75
No. 1—House, 6 ft. long, Porcelain Lined Cylinder..... 7.50

IRON PIPE.

Connections to connect plain pump to drive well pump..... 75 cts.

"No. 0" STOCK PUMP.—7. in. Square, 4 in. Bore.

	Porcelain Lined.
6 ft. long, in one piece.....	\$7.80
7 " " " ".....	8.50
8 " " " ".....	9.10
10 " " " ".....	10.30
12 " " " ".....	11.50
10 " Extension Cylinder.....	9.55
12 " " " ".....	10.25
15 " " " ".....	11.30
20 " " " ".....	13.05
25 " " " ".....	14.80
30 " " " ".....	16.85
C " in one piece, without Lining.....	6.20

"No. 1" FAVORITE HOUSE PUMP.—6 in. Square, 3 1-2 in. Bore.

	Porcelain Lined.	Porcelain Lined.	
6 ft. long, in one piece.....	\$ 6.50	12 ft. long, Extension Cylinder.....	8.75
7 " " " ".....	7.00	15 " " " ".....	\$ 9.80
8 " " " ".....	7.50	20 " " " ".....	11.55
10 " " " ".....	8.50	25 " " " ".....	13.30
12 " " " ".....	9.50	30 " " " ".....	15.05
10 " Extension Cylinder.....	8.05	6 " in one piece, without Lining...	5.00

TUBING, COUPLINGS, ETC.

No. 1 or 4 x 4 Tubing, 12 ft. and under, per ft.....	\$0.15	Extra Buckets, Leathers, per doz.....	\$3.50
No. 1 or 4 x 4 Tubing, over 12 ft., per ft.....	.17	Extra Handles, each.....	.30
6 x 6 Extension Tubing, per ft.....	.35	Extra Handles, Links, each.....	.25
Couplings for 4 x 4 Tubing, with Bands.....	.40	Extra Bands, each.....	.10
Extra Iron Spouts, Japanned, each.....	.30	Extra Check Valves, per doz.....	1.50
Extra Wood Spouts, each.....	.15	Extra Splice Straps, pair, with bolts.....	.25
Braces for Wood Spouts, each.....	.15	Extra Iron Pipe Connections, each.....	.75
Iron Brackets, each.....	.40	Extra Cork Lined Frost Faucets, each.....	.40
Extra Buckets, 3 1/2 inch, each.....	.80	Plunger Rod, per foot.....	.03
Extra Buckets, Woods, per doz.....	3.00		

VICTOR EXPANSION RUBBER BUCKET.



For Chain Pumps. Anti-Freezing.
Price..... **10 cts.**

IXL RUBBER BUCKET.

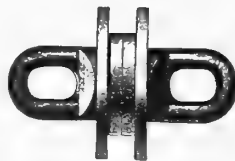

Price..... **8 cts.**

THE QUEEN.



Price..... **8 cts.**

CROSBY SWIVEL LINK.



Price..... **10 cts.**

BRASS JACKET DRIVE WELL POINTS.

Numbers.	Diameter of Pipe.	Length Jacket.	Length Pipe.	Number Holes.	No. 60 Gauge per doz. List.	Retail Price each.
90	1 1/4	18 inches.	24 inches.	100	Price \$36.00	\$1.05
94	1 1/4	24 inches.	30 inches.	130	Price 46.00	1.36
98	1 1/4	30 inches.	36 inches.	165	Price 56.00	1.63
102	1 1/4	42 inches.	48 inches.	270	Price 76.00	2.21
136	1 1/2	18 inches.	24 inches.	120	Price 48.00	1.40
140	1 1/2	24 inches.	30 inches.	162	Price 60.00	1.75
144	1 1/2	30 inches.	36 inches.	198	Price 72.00	2.10
148	1 1/2	42 inches.	48 inches.	276	Price 96.00	2.80

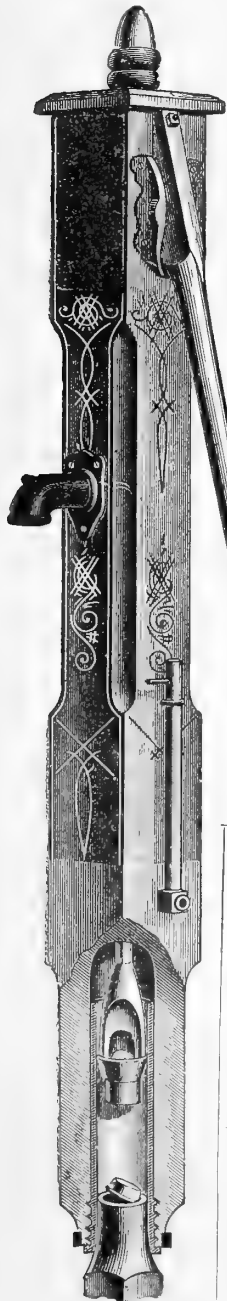

NATIONAL
CHAIN
PUMPS.

This Wood Curb Chain Pump is first-class in every respect; nicely finished; nicely painted and striped.

Prices.

Chain Pump Curbs, each, \$2.00.

Chain Pump Tubing, per foot, 5 cts.

Chain (running 4 to 4 1/2 feet to pound), per pound, 7 cts.



Anti-Freezing Well Lift Pumps.

WITH WROUGHT IRON CONNECTING PIPE AND PATENT SAND VALVE.

Fig. 1018 represents our latest design in Anti-Freezing Well Lift Pumps, with wrought iron connecting pipe, for out-door cisterns and shallow wells—dug, drilled or driven—where the water is not more than 25 feet below the ground line. Pump has revolving top, recessed or cupped, to admit priming if necessary.

FIG. 1018. SIZE, PRICE, & C.

No.	Diam. Cyl.	Stroke.	Capacity per Stroke.	Suction.	Lift.	Price.
4	3 in.	6 in.	.18 gal.	1½ in. pipe.	30 ft.	List, \$8.00 Retail, 5.00

Fig. 1153 illustrates our new Lift and Force Pump, with adjustable base and brace, syphon spout and revolving bearer top. The principal feature of these new pumps is the wrought iron pipe stock with base and brace, which can be adjusted to meet any requirements of height of lever or spout. Under the base is a heavy malleable pipe nut connecting standard with set length. This permits extension of set length with the least possible trouble. We list pumps with outside attachment iron cylinders. Base to bottom of cylinder, 4 feet.

FIG. 1153. SIZE, PRICE, & C.

No.	Diam. Cyl.	Stroke.	Capacity per Stroke.	Suction.	Disch'ge	Lift & Force.	Price.
4	3 in.	6 in.	18 gal.	1½ in. pipe.	½ in. hose	40 ft.	List, \$9.50 Retail, 7.00

Fig. 1146 illustrates our Single Pipe Double-Acting Well Force Pump with common top for hand power, as adapted for shallow or deep wells—open, driven, drilled or cased. It is constructed with brass lined or brass body cylinder as ordered, both having inside attachments, provided with metal lower valve and brass valve seat.

FIG. 1146. SIZES, PRICES, & C.

No.	Diameter Lower Cylinder.	Stroke.	Brass Body Cylinder.	
			Retail.	List.
2	2½ in.	5 in.	\$12.50	\$15.50
4	3 in.	5 in.	13.00	16.00

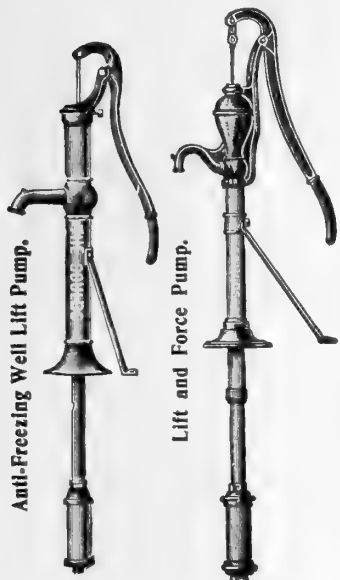

FIG. 1018

FIG. 1153

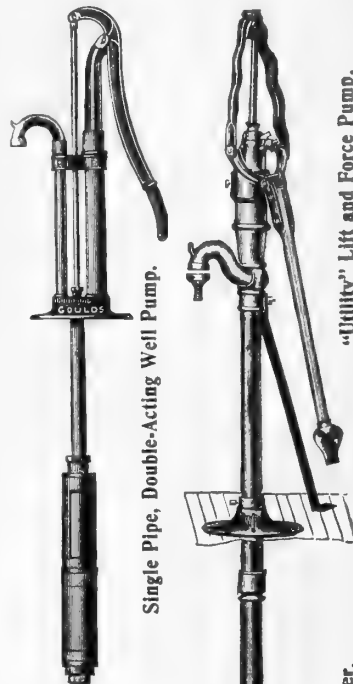
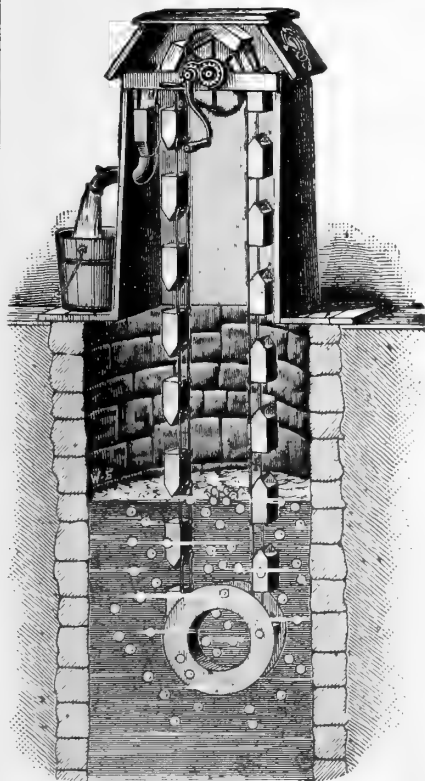

FIG. 1146

FIG. 1111

WATER ELEVATOR AND PURIFIER.



Purifies water by means of oxygen forced into water. Strength, durability, workmanship cannot be surpassed. Pumps are carefully inspected before leaving factory.

Price—Elevator, with 25 ft. Chain and Japanned Bottom Wheel.....\$6.50
Extra Chain, 15 cents per foot.

"Utility" Lift and Force Pump.

A SINGLE PUMP FOR A VARIETY OF SERVICES.

Fig. 1111. A Combined Lift and Force Pump, with Brass Cylinder, of suitable capacity for any ordinary purpose. For shallow or deep well. Reversible handle properly balanced. Notice the handle attachment—it allows no side wear. Stroke is long and direct. Top is tight. Base and brace both adjustable. Galvanized set length. Large air chamber provided with pet cock, making it either a Lift or Force Pump at will. It has a drip hole or waste way, making it perfectly anti-freezing. Lever closes tight against standard, rendering it safe for shipment and less liable to breakage. Hose connection and strainer furnished free.

This Pump by its construction is especially adapted for drive wells. In many cases it is difficult to cut off the pipe in the well the exact length wanted. By its adjustable base this bother is done away with, together with the necessary raising or lowering of the platform.

For ordinary pumping always open the air cock, it will work easier. When used as a force pump, air cock should be closed, when the stream will be strong and steady. Pump is offered in two sizes, No. 2 and No. 4.

FIG. 1111. SIZES, PRICES, & C.

No.	Diam. Cyl.	Stroke.	Suction.	Discharge.	Brass Cylinder.
2	2½ inch.	9½ inch.	1½ inch pipe.	½ inch hose.	List, \$17.00 Retail, 12.50

Pitcher Pump.

Fig. 150 is the Improved Closed Top Pitcher Pump for inside kitchen use, where a substantial cistern pump is wanted. Arm on bearer is high, giving plunger full stroke. Thread on base is cut iron pipe thread, so in case of breakage a 1½ inch by 1½ inch reducing coupling can be used. All parts are numbered.

	LIST.	RETAIL.
Fig. 150—No. 1, size cylinder 2½ inches, fitted for 1 inch pipe, stroke 4 inches, iron.....	\$4.25	\$1.40
Fig. 150—No. 2, size cylinder 3 inches, fitted for 1½ inch pipe, stroke 4 inches, iron.....	4.75	1.60
Fig. 150—No. 3, size cylinder 3½ inches, fitted for 1½ inch pipe, stroke 4 inches, iron.....	5.25	1.80

PITCHER PUMP LEATHERS.

No. 1—Valve and Plunger Leathers.....	each, 5c.
" 2— " " ".....	" 8c.
" 3— " " ".....	" 10c.



FIG. 150

CHAINS, AXES, OIL CANS, ETC.



Fig. 1.

Fig. 2.



Fig. 4.

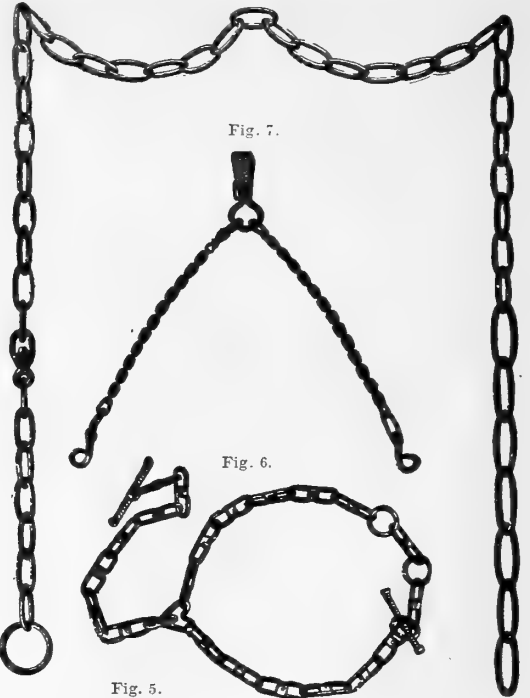

Fig. 7.

Fig. 6.



Fig. 3.

Figs. 2 and 4—Triumph Chains, very light; possess great strength; all links have equal strength. Do not kink; no welds to give way; no sharp edges.

No. 3-0—Triumph Cow Tie (Ohio pattern).....	Each	\$.30
No. 4-0—Triumph Cow Tie (Ohio pattern).....	Each	.35
No. 3-0—4½ ft. Triumph Halter Chain.....	Each	.30
No. 3-0—6 ft. Triumph Halter Chain.....	Each	.35
No. 5-0—7 ft. Triumph Trace Chains.....	Each	.70
No. 6-0—7 ft. Triumph Trace Chain.....	Each	.80
No. 5-0—3½ ft. Triumph Butt Chain.....	Each	.45
No. 6-0—3½ ft. Triumph Butt Chain.....	Each	.50
No. 2—6 ft. Triumph Kennel Chain.....	Each	.40
No. 1—20 ft. Triumph Tethering Chain.....	Each	.90
No. 0—20 ft. Triumph Tethering Chain, heavy.....	Each	1.00

Fig. 7.—Regular Iron Traces.	
Retail Price.	
7, 8, 2.....	\$.50
7, 10, 2.....	.60
7, 12, 2.....	.70
7, 14, 2.....	.80
7, 16, 2.....	.90

Fig. 3—Breast Chains.	
Double Stiff, 5-16.....	Pair \$1.25
Double Stiff, ¾.....	Pair 1.20
Double Slack.....	Pair \$.80
Single Slack.....	Pair .60

Fig. 5—Patent Sleeve Chain. It is made from steel wire with the ends of the metal inserted into a closely fitting malleable iron sleeve. As these ends abut against the continuous portion of the link, they form a cross-bar, and the more strain placed on the link the tighter the ends are forced together. This chain is the only patented chain which has no Unprotected Ends, and is free from obstructions and projections. We offer same in Cow Tie and Long and Short Traces, No. 6 size.

Cow Ties.....	Each	30c.
Fig. 6—No. 71—Spreader Chains, Pennsylvania Pattern, black or self color, Stiff.....	Doz.	\$3.25
No. 73—Repair Links, polished.....	Doz.	.15
No. 75—Open Side Links, polished.....	Each	.10
No. 58—Long Link Log or Ox Chain, 12 x ¾.....		1.75
14 x ¾.....		2.00
14 x ½.....		2.50
14 x ¼.....		3.00
No. 46—Cart Tug Chains.....	Per pair	.30

AXLE GREASE, OILS AND OIL CANS.

Per box.....	Royal.....	\$.05	Mica, 10 lb. pails.....	\$.75
15 lbs. in pails.....	".....	.75	Mica, 15 lb. pails.....	1.00
25 lbs. in pails.....	".....	1.00	Mica, 25 lb. pails.....	1.25
Mica, in wood.....	Per box, 10c., 3 for 25c.			

We are headquarters for a full line of Lubricating Oils. **No. 1 Castor Oil, price 75c. per gallon.** Special prices in barrel and half-barrel lots.

Deering Harvester Oil.

Five Gallon Can.....	\$2.25	One Gallon Can.....	\$.60
Three Gallon Can.....	1.50	One-half Gallon Can.....	.40

Special prices on one-half barrel and barrels.
Separator Oil, for Cream Separator, gallon can, \$1.00, 5 gallon can, \$4.00.

Oil Cans.

We carry in stock a full line of Oil Cans for all kinds of farm machinery, including the Oval, Round, Dome and Chase styles.

No. 699—Bent or Straight Stem, Oval.....	10c.
No. 698—Bent or Straight Stem, Round.....	10c.
No. 700—Dome.....	10c.
No. 3—Chase.....	15c.

AXES.

In Axes we carry the best lines only. We aim to sell only those we know to be first-class in every respect and that have an established reputation.

Retail Price Each.	
Wm. Mann's Celebrated Red Warrior Axes.....	75c.
W. Stewart's Superior Steel Axes.....	75c.
Robt. Mann's Superior Steel Axes, Extra Steel.....	70c.
Marshall Bro's Superior Steel Axes.....	65c.
Hatchets, Half Pattern and No. 2 Shingling.....	25 to 60c.

AXE HANDLES.

No. X—Extra Selected 2nd Growth all White Hickory Axe Handles, each.....	25c.
No. 1—Selected White Hickory Axe Handles.....	20c.
No. 2—White and Red Hickory Axe Handles.....	15c.
No. 3—White and Red Hickory Axe Handles.....	12c.



Fig. 698.

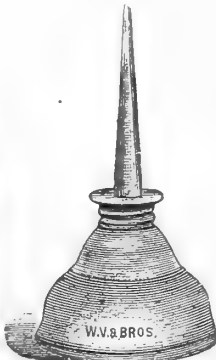

Fig. 3—CHASE.



BALTIMORE JERSEY PATTERN.

ALL PRICES SUBJECT TO CHANGE WITHOUT NOTICE.

SUPERIOR DAIRY GOODS.

THE BALTIMORE CHURN.

Patented July 5, 1891.

It is made of thoroughly seasoned material. It is finished smooth inside as well as outside. The iron ring head is strong and not liable to break.

The balls are fastened to the iron ring, where they need to be fastened.

PRICES.

List price. Retail price.

No. 0, 5 gallon to churn 2 gallons....	\$ 8.00	\$ 5.00
1, 10 " " " 5 " "	8.50	5.25
2, 15 " " " 7 " "	9.00	5.50
3, 20 " " " 10 " "	10.00	6.25
4, 25 " " " 12 " "	12.00	7.50
5, 35 " " " 17 " "	16.00	10.00
6, 60 " " " 30 " "	26.00	16.00
7, 75 " " " 37 " "	30.00	18.50
8, 90 " " " 45 " "	35.00	22.00

We furnish Fulcrums for power. Prices extra, according to size desired. Directions for using in each Churn. Write for Special Discount for Cash.

IMPROVED CEDAR CYLINDER CHURNS.

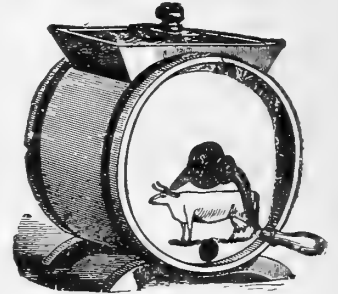

There are a number of Cylinder Churns on the market sold at a lower price, but they are made of pine or other inferior wood, while these are all of selected Cedar, free of knots.

	Retail price.	List price.
No. 1, 2 1/2 gallons	\$2.00	\$2.50
" 2, 4 " " " "	2.50	3.00
" 3, 7 " " " "	3.00	3.50
" 4, 10 1/2 " " " "	3.50	4.00



STODDARD CREAMERY.

With or without special refrigerator, thorough in construction, simple in operation, accurate in its working.

Family Class. Each can holds 2 1/2 gallons.

No.	No. of Cans.	No. of Cows.	Plain Creamery.	With Special Refrigerator.
2.....	2.....	2.....	\$20.00.....
3.....	3.....	3 to 4.....	26.00.....	\$31.00
4.....	4.....	5 to 6.....	32.00.....	37.00

Dairy Class. Each can holds 5 gallons.

No.	No. of Cans.	No. of Cows.	Plain Creamery.	With Special Refrigerator.
2.....	2.....	5 to 6.....	\$25.00.....
3.....	3.....	7 to 9.....	31.00.....	\$36.00
4.....	4.....	10 to 12.....	37.00.....	42.00
5.....	5.....	13 to 15.....	43.00.....	48.00
6.....	6.....	15 to 18.....	49.00.....	54.00
8.....	8.....	20 to 24.....	61.00.....	66.00
10.....	10.....	25 to 30.....	73.00.....	78.00
12.....	12.....	30 to 35.....	85.00.....	90.00

Subject to special discount.

No. 2 Family Class and No. 2 Dairy Class are not made with the separate refrigerator compartment unless so ordered.

The above prices do not include partitions, nor more than one water faucet. If partitions or extra water faucet is wanted, they will be furnished at \$1 each.

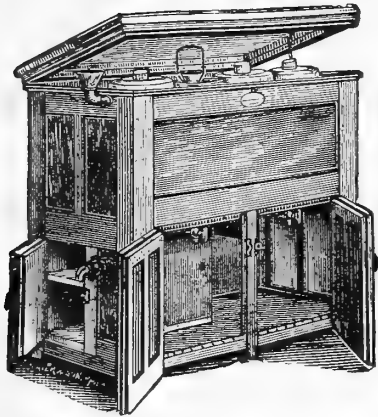

Rice's Calf Weaners.

Also prevents cows from sucking themselves.

No. 1, for Calves, 30c.; by mail, 35c. No. 2, for Heifers, 50c.; by mail, 56c. No. 3, for Cows, 75c.; by mail, 85c.

Floating Glass Thermometers.

Price, 25 Cents each.



Eight inch Dairy Thermometer, stands boiling water, Price, 50 cents each.

The Keystone Dehorning Clippers.

The practice of dehorning cattle is coming more and more into vogue. It is a mercy to the animals. Prevents going. Does not crush the horns. No twisting motion or second cut on horn. Parts are all interchangeable, and can be replaced at any time. It is approved by veterinary surgeons and leading dairymen. "The horns must go, and they cannot go too soon."



PRICE.

Clipper, with Leader and Rope, extra Blades and Screw, fully warranted....	\$12.00
Clipper alone.....	10.00

We furnish a cheaper Clipper than the above that is superior to any of the cheap Clippers made, but do not recommend it as broadly as the Keystone, which has no equal. Price.....\$8.00

SPAIN'S PATENT CHURN.

Prices Furnished on Application.

Perfection Calf Dehorner.



ANY ONE CAN OPERATE IT.

This takes the place of acids and is cheaper, is not painful, no more so than extracting a loose tooth, as the young horns are not firmly set in the head.

PRICE LIST.

Perfection Calf Dehorners, including sample box of Perfection Cream and full instructions for operating, etc.

Net, Plain	\$3.50
Net, Nickel Plated,	5.00
Perfection Cream, per pound.....	.50
Discount on five pound orders.	

GUARANTEE.

The Calf Deborner is fully guaranteed for one year, and if from any defect it breaks or gives out during this time, duplicate parts will be furnished free of cost, by sending us the part broken.

DESCRIPTION.

The perfection Calf Deborner is formed by two curved blades, which cut with a shear cut. The one is stationary and has a "U" shape edge, which draws into the flesh and holds the instrument in position, and is adjustable to the other by a wedge which is inserted next to the frame. The other, which does most of the cutting, is hinged in such a position that cuts with a down and then an up cut, which scoops out the horn. It has a lever which moves one blade, and is hinged to the frame. There are two handles so that it can be held firmly to the head. It will dehorn calves from two weeks to three months old. It is 16 1/2 inches long; weight, 2 1/2 lbs., and opens 1 1/2 inches. The frame and lever are malleable iron; the blades are of the best steel.

Sharples' Cream Separators

THE W H S HAND SEPARATOR

Capacity, 300 Pounds of New Milk Per Hour, Price \$75, is Furnished Complete, as Shown in Cut, Without Legs or Table.



THIS machine is designed to meet the demand for a strictly reliable Hand-power Separator of lowest possible first cost. It must be understood, however, that though low in price it is in no sense a cheap or second-rate separator. The materials entering into its construction are the best obtainable. The work is done by the same workmen and subjected to rigid inspection, just as in our higher-priced No. 1 Safety Hand Separators.

In clean skimming and in the quality of cream and butter the W H S SEPARATOR is exactly on a par with the No. 1 Safety.

As a matter of fact there is not on the market a Hand-power Separator selling for less than \$100 that will equal the W H S Separator in quality, work and general satisfaction.

In considering the first cost of a Separator count up the gain which we absolutely guarantee by its use, and see if it will not amount to at least fifty per cent. or one hundred per cent. per year on the investment.

If the first cost of a Separator seems high for a farm implement, please consider, for a moment, that it is an all-the-year-round machine, Sundays included, and not like nearly all other agricultural machinery—only intended for use a few days in a year.

Remember, in estimating the cost, that a Separator must have a con-

stitution like a man who never gets sick, for it won't do to have the machine break down for a single day. For that and other reasons a Separator must be built like a watch, and not like a corn sheller.

Every spindle in a Sharples' Separator is gauged to a limit of less than one one-thousandth part of an inch, and the material used in its spindles is the finest crucible steel. The bowl can be put on an anvil and hammered for an hour with a sledge, but will not show the slightest crack.

IT TURNS EASILY.—The bowls are lighter than any others of same capacity, while all the bearings are of hard steel and of exceptional truth and roundness. This, together with the fact that the gearing is of an improved design and very accurately cut, explains the reasons for very easy-running hand machines.

THE BOWL IS SIMPLE AND EASY TO CLEAN.—Not over four or five minutes are required in which to thoroughly wash and cleanse a bowl. First washing must be done with cold water. Every part is open and accessible, and no corners for dirt or milk to lodge in unseen.

Power Machines are described in a little booklet which we will be glad to forward free on application.

PRICE.

W H S HAND SEPARATOR,	- - -	\$ 75.00
No. 1 SAFETY HAND SEPARATOR,	- - -	100.00
SEPARATOR OIL, per gallon can,	- - -	1.00
SEPARATOR OIL, five gallons,	- - -	4.00

PURITY OF PRODUCT.

There is no subject receiving more attention at present among bacteriologists than disease germs existing in milk; especially is this true of the tubercular or consumptive germs. The appalling increase of tuberculosis has caused many of the State Legislatures to take up the subject.

It is a recognized fact that in milk set by the gravity system, all of the bacteria matter or filth, if you wish to term it so, is left in the milk or cream. Any one who has not seen the parts of a machine cleansed after separating, would be amazed at the quantity of dirty, slimy, sickening matter that is washed off the parts. Especially may this fact be noted with the SHARPLES' SEPARATORS.

Contained in this filth are the disease germs that one has been pouring into his system, unconsciously bringing disease and death on himself, his family or his friends. Some physicians are advocating separator milk as preferable to mother's milk for young babies.

We can furnish a smaller Separator, adapted for use in small dairies of from two to six or eight cows. This is a most excellent machine and does its work better than any other make of same size and capacity.

PRICE, - - - - - \$50.00

STAR MILK COOLERS.

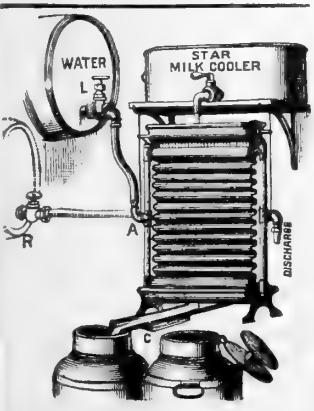

THESE are thorough aerators, because the water flowing upwards inside the sheets of copper becomes heated by the warm milk flowing down over the outside, this brings warm milk and warm water together at the top of the cooler; the milk being gradually cooled as it descends, leaves the Cooler within two degrees of the temperature of water run through it.

In the smallest size every drop of milk is compelled to flow over forty inches of surface, all on outside of machine. Will cool milk as fast as it can be milked; no ice required.

These Coolers are constructed of Copper Sheet and Brass Castings, heavily tinned, and have surface enough to do the work claimed in hot weather. Will not rust; last a life time.

PRICE.

No. 1 STAR COOLER, 60 gallons per hour,	-	\$25.00
No. 2 STAR COOLER, 90 " " "	-	27.50

STANDARD AERATOR AND COOLER.

THE Standard will aerate and cool fifty gallons of milk per hour to within two degrees of the temperature of the water used. All of the milk flows down over forty inches of cold surface, and by the time it reaches the bottom it is cold.

PRICE.

Plain Cooler, as used with Separator,	- - -	\$5.00
Cooler, including 18-qt. Milk Tank, Milk Flow Regulator, Brackets, Screws and Hose,	- - -	6.00
Barrel Connections, extra,	- - -	75c.
Syphons,	- - -	\$6.00

LANTERNS.

THIS Lantern has the Lift Wire Attachments and Guard, and is desirable for hand service. Made in Bright Tin, Brass or Copper. Can be filled, lighted, regulated and extinguished without removing globe. Price, 50 cents.

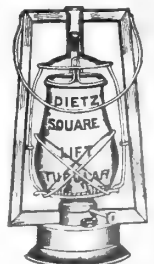

DASH BOARD LANTERN, Price 90c.

DAIRY GOODS.

REID'S BUTTER WORKER.

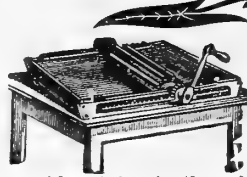

THIS machine will work a batch of butter in from three to five minutes, according to the condition of the butter, working out the buttermilk and thoroughly mixing in the salt, doing the work far quicker and better than it can be done by hand. It consists of a tray and a roller with paddles, which is turned by a crank and traverses from end to end of tray. It acts on the butter on precisely the same principle as a ladle in the hands of a person, but with perfect uniformity and without injuring the grain.

INSIDE MEASUREMENT.	CAPACITY.	WEIGHT.	LIST PRICE.	RETAIL PRICE.
No. 1—23x36x2½ inches.....	30 lbs.	45 lbs.	\$10.00	\$8.00
No. 2—20x36x2½ ".....	50 "	29 "	8.00	6.40
No. 3—17x27x2½ ".....	20 "	25 "	7.00	5.60
No. 4—14x23x2½ ".....	10 "	20 "	6.00	4.80

Three pounds can be worked in any of the above machines, as well as a larger quantity. In buying a machine you should choose a size that will work the largest quantity that you will be likely to want to work at a time.

Larger sizes, specially designed for mixing, re-working and coloring, or for creamery use.

INSIDE MEASUREMENT.	CAPACITY.	WEIGHT.	PRICE.
No. 0—23x37x3 inches.....	75 lbs.	60 lbs.	\$12 50
No. 00—23x56x3 ".....	112 "	80 "	15.00
No.000—23x72x3 ".....	150 "	100 "	18.00

When desired, we can send legs along with any size machine, for \$4.00 extra, which can be set up after arrival at destination.

BUTTER PRINTS AND MOLDS.

All sizes and styles. Round, 15 and 35 cts.; square, 60 cts.; square and extra hand-made, \$1.00, \$1.50 & \$1.75 each.

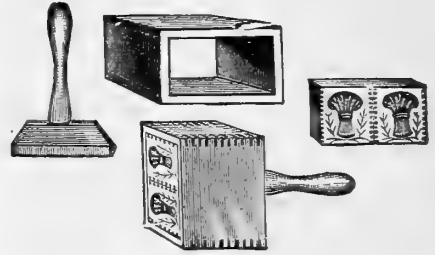

MOORE'S PYRAMIDAL MILK STRAINER.

With Rest, \$1.50; without Rest, \$1.35.

WELLS, RICHARDSON & CO.'S BUTTER COLOR.—Will not color the Buttermilk. Price, 25 and 50 cents per bottle.

REID'S SELF-GAUGING BUTTER PRINTER.



PRINTS BUTTER VERY NEATLY AND QUICKLY.

WEIGHS INTO POUNDS OR HALF POUNDS, AS DESIRED.

DOES IT IN ONE QUARTER THE TIME IT CAN BE DONE BY HAND.

MAKING PRINTS OF UNIFORM WEIGHT.

MOLDS ARE SQUARE.

— PRICE. —

Either pound or half pound. \$10.00
Both pound and half pound combined..... 13.50
Extra for initials or monograms..... 1.50

BUTTER BOXES.



Are made of well-seasoned lumber, iron-bound at the edges and capped at the corners. Malleable iron detachable hinges and corner plates combined. The trays for the butter are let down into the box, one upon another, and may be put in or lifted out with the butter in them. A movable ice-box is placed in the centre, when this is not used, a strip provided for the purpose may be placed in the bottom of each tray to fill up the space. The four sides of the trays are surrounded by a non-

conducting airspace. Malleable iron chest handles are well secured to the sides of the box. These boxes are specially suited for square or oblong prints.

Capacity, 20-lb. Prints.....	\$3.75	Capacity, 120-lb. Prints.....	\$6.00
" 30-lb. ".....	4.25	" 36-lb. ".....	4.50
" 40-lb. ".....	4.75	" 64-lb. ".....	5.25
" 56-lb. ".....	5.00	" 80-lb. ".....	5.50
" 80-lb. ".....	5.50	" 100-lb. ".....	6.00
" 96-lb. ".....	5.75	" 140-lb. ".....	7.00

PARCHMENT BUTTER PAPER.

IS AIR PROOF, tasteless and odorless. Does not stick to the butter, and prevents shrinkage. Is purer, neater, cleaner and cheaper than cloth. In Sheets 24x36, or can furnish the paper cut in the following sizes without extra charge—6x9 for half pounds, 9x12 for one pounds and 10x15 for two pounds. Price, 20c. per pound; by mail, 35c.; six pounds, \$1.00.

BUTTER LADLES—Price..... 15 and 25c. each.
PADDLES—Price..... 10c. each.

REFRIGERATORS.

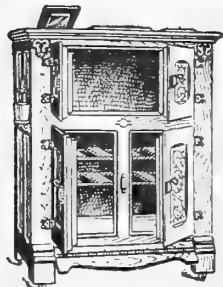

INTENDING TO DISCONTINUE THE SALE OF REFRIGERATORS, WE OFFER A FEW SIZES AND STYLES

AT A BARGAIN

— TO CLOSE OUT STOCK. —

SEND FOR PRICES.

LA FAYETTE BUTTER PRINTER.

THIS IS ALSO SELF-GAUGING, INTENDED FOR USE IN CREAMERIES, BUT MORE ESPECIALLY FOR RE-PRINTING.

Very simple & handy. Either pound or half pound, with table, \$15.00. Either pound or half pound, without table, \$10.00.

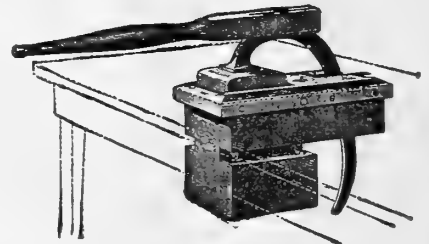

THE IMPROVED MILK CAN.

Made of the very best material.



PRICES ON APPLICATION.

MILK PAIL.

Made of Best Tin.

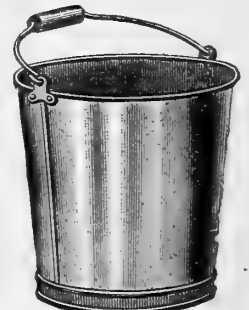

Holds five gallons.

— PRICE. —

Three Gallons.....45c. each.
Three and a half gals..50c. each.

DEPARTMENT OF HARNESS.

No. 700—SINGLE BUGGY HARNESS.

Bridles, 5/8 inch; Traces, 1 inch; Saddle, 2 1/2 inches; Breast Collar and Breeching, single leather; Flat Lines, with Web Hand-Parts; X-C Mounting. Price, with Collar and Hames, \$6.50; with Breast Collar, \$6.00.

No. 603.—SINGLE BUGGY HARNESS.

Bridle, 5/8 inch; Traces, 1 1/2 inches; Saddle, 3 inches, with Nickel Hook and Terrets; Breast Collar and Breeching, folded, with Straight Lay; Flat Lines; X-C Mounting; Imitation Hand Stitched. Price, with Collar and Hames, \$10.00; with Breast Collar, \$9.75.

No. 4—SINGLE BUGGY HARNESS.

Bridle, 5/8 inch; Traces, 1 1/2 inches; Saddle, 3 inches; Breast Collar and Breeching, folded with Straight Lay; Flat Lines; X-C Mounting, with Nickel Hook and Terrets; Imitation Hand Stitched. Price, with Collar and Hames, \$10.75; with Breast Collar, \$10.00.

No. 93—SINGLE CARRIAGE HARNESS.

Bridle, 5/8 inch; Traces, 1 1/2 inches; Saddle, 3 1/2 inches; Breast Collar and Breeching, folded with Straight Lay; Flat Lines; X-C Mounting; Imitation Hand Stitched. Price, with Collar and Hames, \$12.00; with Breast Collar, \$11.00.

No. 94—SINGLE CARRIAGE HARNESS.

Bridle, 3/4 inch, Chain Front; Traces, 1 1/4 inches; Saddle, 4 inches; Breast Collar and Breeching, folded with Straight Lay; Flat Lines; Nickel Hook and Terrets, and balance of Mounting X-C; Imitation Hand Stitched. Price, with Collar and Hames, \$12.75; with Breast Collar, \$11.75.

No. 354.—SINGLE CARRIAGE HARNESS.

Bridle, 5/8 inch Front; Traces, 1 1/2 inches; Saddle, 3 inches, Hand Laced. Leather Lined; Breast Collar and Breeching, folded with Wave Lay; Flat Lines; Full Nickel or Imitation Rubber Mounting; Imitation Hand Stitched. Price, with Collar and Hames, \$13.75; with Breast Collar, \$11.75.

No. A—HAND-MADE SINGLE BUGGY HARNESS.

Bridle, 5/8 inch; Traces, 1 1/2 inches; Saddle, 3 inches, Hand Laced. Leather Lined; Breast Collar and Breeching, folded with Wave Lay; Flat Lines; Full Nickel or Imitation Rubber Mounting; Hand Stitched. Price, with Collar and Hames, \$20.00; with Breast Collar, \$18.00.

Single Buggy Harness.

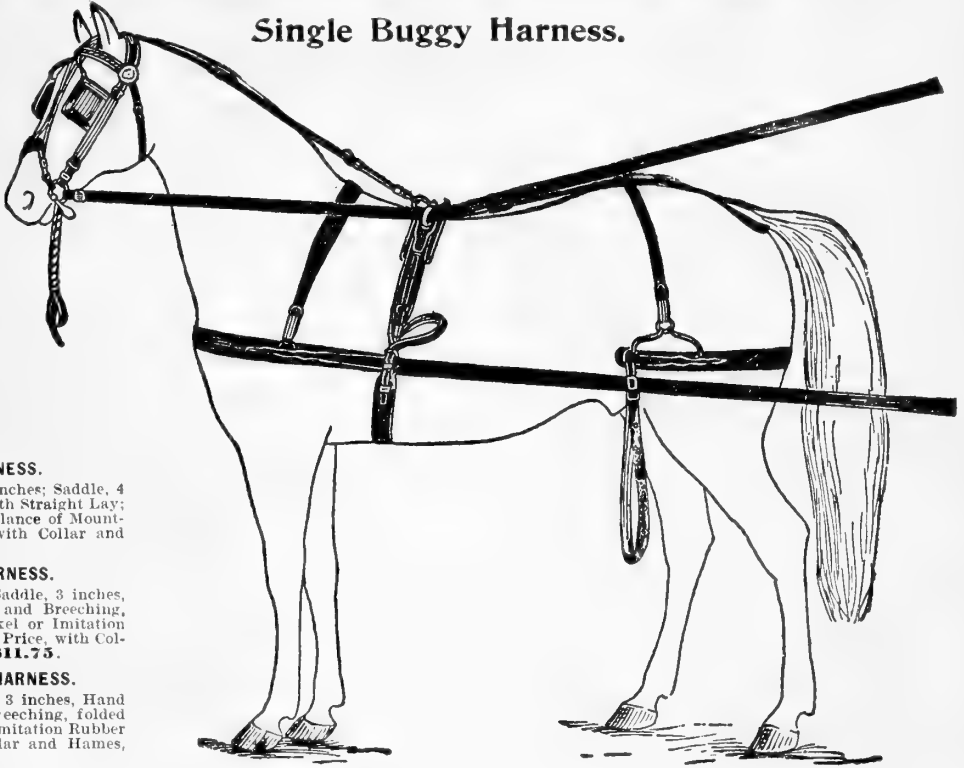

Double Buggy Harness.

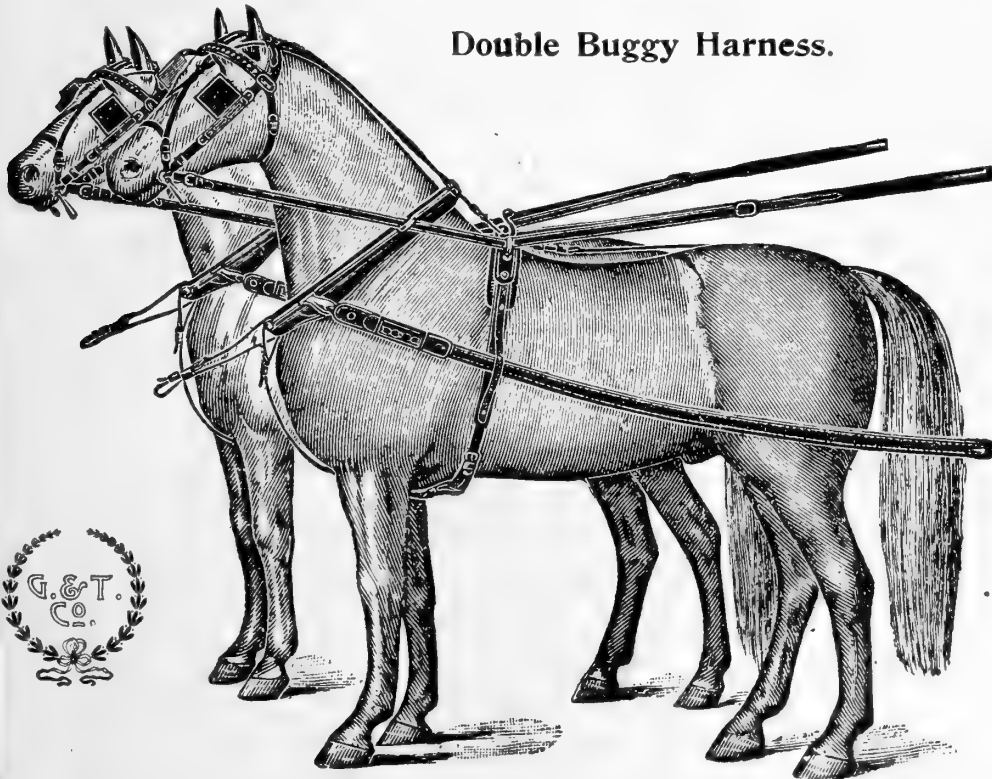

No. 29—DOUBLE BUGGY HARNESS

Bridles, 5/8 inch; Traces, 1 inch; Fancy Bound Pads; 1 1/4 inch Side Pieces and Folded Bellybands; Turnbacks, 3/4 inch; Hip Strap, 5/8 inch, with Patent Leather Drops; Flat Lines; Kip Collars; X-C Mounting.

Price \$17.50



No. 19—DOUBLE BUGGY HARNESS.

Bridles, 5/8 inch; Imitation Chain Front; Traces, 1 1/2 inches; Fancy Bound Pads under same; 1 1/4 inch Side Pieces and Folded Bellybands; Turnback, 3/4 inch; no Hip Strap; Flat Lines; Patent Leather Collars; Full Nickel or Imitation Rubber Mounting; Imitation Hand Stitched.

Price..... \$22.50



No. 35—DOUBLE BUGGY HARNESS.

Bridles, 5/8 inch; Traces, 1 1/2 inches; Plain Pads, with Leather Housings under same; 1 1/2 inch Side Pieces; Folded Bellybands; Turnback 3/4 inch, waved; Flat Lines; Patent Leather Collars; Nickel or Imitation Rubber Mounting; Imitation Hand Stitched. Nicely finished.

Price \$26.75



STABLE REQUISITES

CURRY COMBS AND BRUSHES.

No. 183.



All steel, close back, 8 bars, plain knocker, lacquered, enameled handle, brass ferrule, oval face, shank running through handle and riveted. Packed one dozen in box. Cases made for 24 dozens. Price 20c. each.

8 Bars, Hand Riveted.

PATENT APPLIED FOR.



No. 480.

No. 480—Columbia—Lacquered..... 25c. each.
Packed one dozen in box. Cases are made for 24 dozens.

EIGHT BARS, EXTRA HEAVY.
No. 490—All steel shank runs through handle and is riveted, 25c. each.
Packed one dozen in box. Cases are made for 24 dozens.

All Steel, Close Back.

No. 800.



All steel, close back, lacquered, extra size, oval face, curved knockers, braced shank extending through handle and riveted, enameled handle, brass ferrule, 8 bars.
Packed 1 doz. in box. Cases made for 24 dozens. Price 25c. each.

All Steel, Open Back.

No. 083.

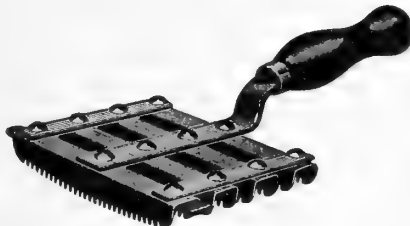

All steel, open back, 8 bars, plain knocker, japanned, carmine handle, steel ferrule, oval face, shank running through handle and riveted. Packed one dozen in box. Cases made for 24 dozens. Each 15c.

Leather Back Brushes.

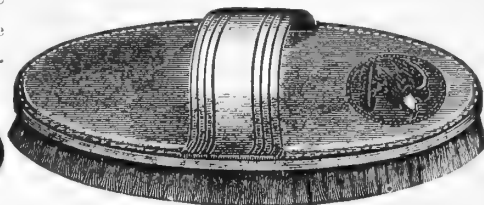

- | | |
|--|------------|
| No. 35—Patent Leather Back | Each, 40c. |
| “ 123—Yellow Leather Back | “ 50c. |
| “ 400—Yellow Leather Back | “ 60c. |
| “ 999—Russet Leather Back | “ 90c. |
| “ 80—All Bristle, Russet Leather, Flexible Back, Army | “ \$1.25 |
| “ 445—All Bristle, Russet Leather, Flexible Back, Army | “ 1.50 |
| “ 100—London, warranted all white Bristle | “ 2.00 |

Dandy Brushes.

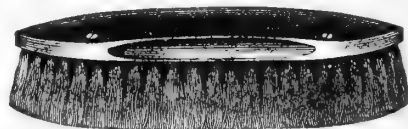

- | | |
|--|------------|
| No. 10—Dandy | Each, 25c. |
| “ 20 Dandy | “ 30c. |
| “ XX—Palmetto Dandy | “ 40c. |
| “ 940—Dandy | “ 45c. |
| “ 7000—Dandy, made of selected fine root | “ 60c. |

All of above are packed six in a box.

No. 707—Grenelle Brushes, extra fine, each, 60c.

No. 699.

Adjustable Web Halters.

Continuous piece solid color No. 1 extra quality web, folded through metal corners. Adjustable buckle. Leather chin piece with buckle. Rope lead, leather latch, snap. Price 40c.

Rope Halters.

- | | |
|---|------|
| No. 688—One-half inch XX Sisal Rope, Price..... | 20c. |
| No. 690—One-half inch Manilla Rope, Price..... | 40c. |

All of our Rope Goods are of best quality, standard size and full length.
Order by number for any kind of Halter.



No. 238.

No. 238 Cyclone Leather Halters.

One and a quarter inch with 1/4 inch Leather Lead, price \$1.35.
No. 242—1/4 inch with 1/4 inch Leather Lead, price \$1.25.

Fancy Striped Halters. No. 696.

Corners bound with leather riveted to ring loops. Leather chin piece. Rope lead, leather latch, snap. Price, 30 cents.

Fancy Striped Extra Heavy No. 1 Halters. No. 698.

Corners bound with leather, riveted to ring loops. Leather chin piece with buckle. Rope lead, leather latch and snap. Price, 35c.

Rope Cattle Ties.

- | | |
|--|-------------|
| No. 652—1/2 inch Manilla Rope, eight feet long. | Price, 30c. |
| No. 655—1/2 inch XX Sisal Rope, eight feet long. | Price, 20c. |

Rope Horse Ties.

- | | |
|--|-------------|
| No. 664—1/2 inch Manilla, ten feet long, (two snaps). | Price, 35c. |
| No. 667—1/2 inch XX Sisal, ten feet long, (two snaps). | Price, 28c. |

No. 1 Web Halters. No. 694.

Continuous piece, solid color both sides, No. 1 Web through metal corners. Leather chin piece. Rope lead, leather latch, with snap. Price..... 25c.

Horse Collars.



- | | |
|---|---------|
| No. 190—Draft Collars, split leather back and rim, Duck face, price | 90c. |
| No. 1101—Team do., heavy, price, | \$1.25. |
| No. 186—Kip Team, sheep faced, price, | \$1.75. |
| No. 155—Scotch, kip, back and rim tick face, price | \$2.20. |
| No. 760—Heavy kip team, sheep faced, price, | \$2.00. |



“Sel-Wel”
(TRADE MARK)

Sweat Pads.

Made only in one combination of drill, brown white. With one kind of stuffing, composite. With four hooks. The fourth hook can be removed, if not wanted, but it will not be taken off. Five rows quilting. With hooks always set in the same position.

Each pad will be so branded that a dealer can tell at once to what size collar it is best adapted.

To illustrate—Sixteen for either 15 or 16 inch collar. Eighteen for either 17 or 18 inch collar, etc. A 10, 10 in. wide, 35c. A 12, 12 in. wide, 40c.

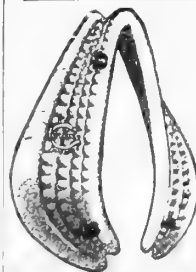

Sweat Pads.

“Kurine,” and “Felt Less” Brands.

- | | |
|--------------------------|------|
| “Kurine”—9 in., each | 30c. |
| Brown and white drill. | |
| “Kurine”—11 in., each | 35c. |
| Brown and white drill. | |
| “Felt Less”—10 in., each | 50c. |
| Old gold drill. | |
- This line of “Kurine” brand presents more attractive features than any similar line of medium-priced sweat collars on the market.

CARRIAGE AND BUGGY DEPARTMENT.

No. 39.

SKELETON CART

SARVEN WHEELS,
ONE-INCH AXLE,
SEMI-ELLIPTIC SPRINGS,
PAINTING DARK WINE.

— o —
PRICE.

List \$26.00
Retail 15.00

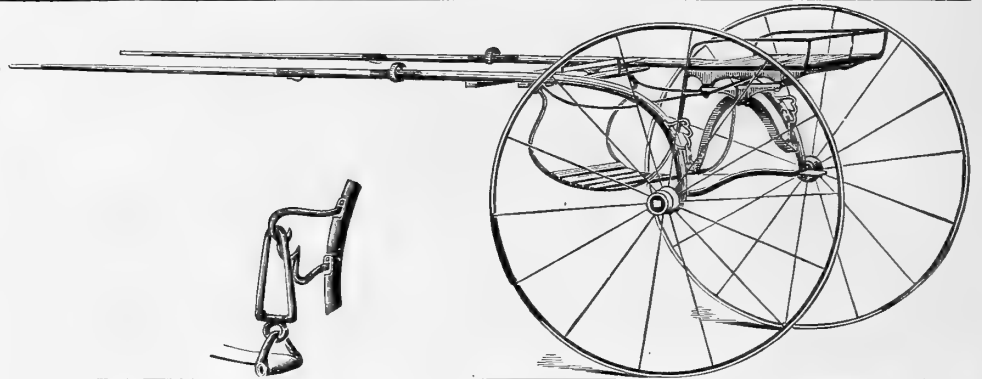

THERE have been eliminated in this all the objectionable features generally found in Road Carts. Notably among them are the horse motion and back step. In this, as seen in cut, the step is in front, rendering it a very easy matter for ladies to mount, and the springs are so arranged that the only motion felt is in that of a buggy. No horse motion whatever. This can readily be seen by examining the cut.

Wheels, Sarven patent, four feet high; 1 inch tread. Gear double collar, steel axle, 1 in., coaxed; double bend shafts, admitting of entering from front; four-leaf springs, combined with small coil springs; adjusting irons for raising or lowering body. Body, 27 inches wide; seat, 30 inches wide, with box underneath, 24x11x6 ins. Trimmings, imitation leather; spring cushion. Painting, body black; gear, Brewster green, nicely striped.
List, \$42.00. Retail, \$25.00.

No. 35. Body Cart.

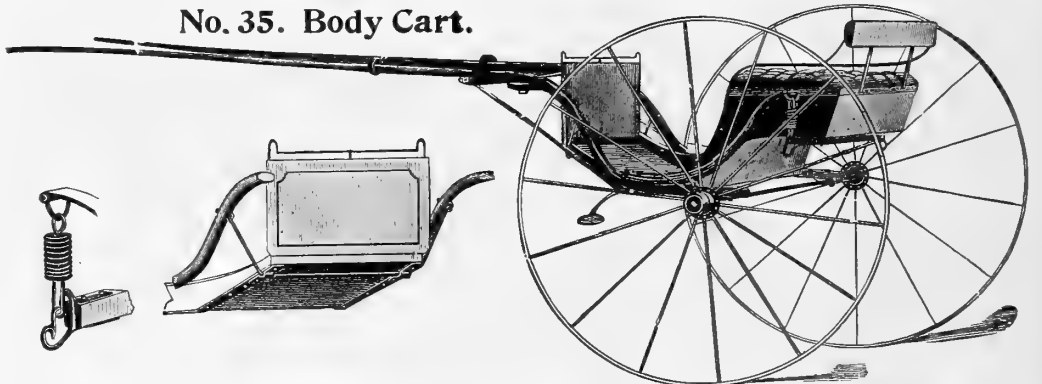

No. 15 CART.

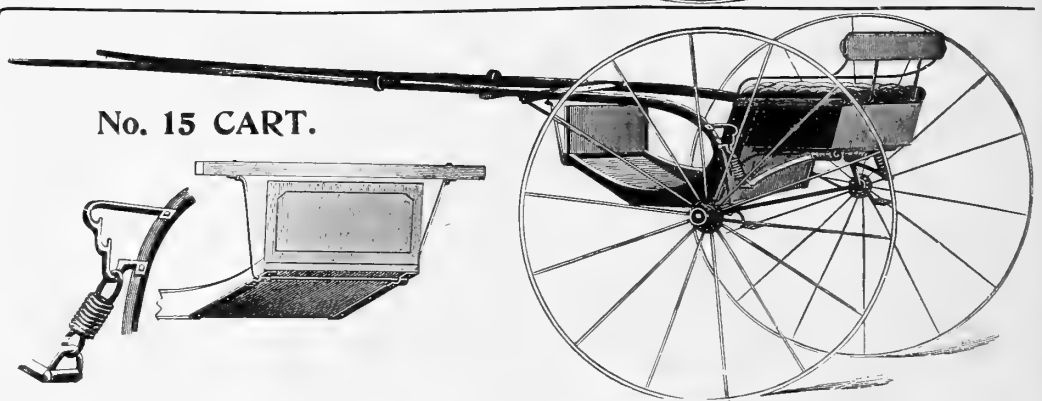

WHEELS, Sarven patent; four feet high, one inch tread. Gear—Double collar steel axle, one inch; coaxed; combination of large and small coil springs; adjusting irons for raising and lowering body to suit load. Body and Seat—Body, 27 inches wide; seat, 30 inches wide, with box underneath for holding parcels; size of parcel box, 24x14x5 inches. Trimmings—Imitation of leather; cushion and back. Painting—Body, black; gear, Brewster green.
List, \$37.00. Retail, \$22.50.

THREE-SPRING Delivery Wagon.

WHEELS, Warner or Sarven, one inch tread; round edge steel tires; one inch double collar steel axles. Springs—Oil tempered. Body—6 feet 3 inches by 35 inches, 9 inches high inside. Painting—Gear, red or yellow; body, black. Capacity—800 lbs.

Also made with 1 1/4 inch axles and gear.
List price, \$75.00. Retail price, \$42.00.
Can also furnish same with flaring sides.
List, \$80.00. Retail, \$45.00.

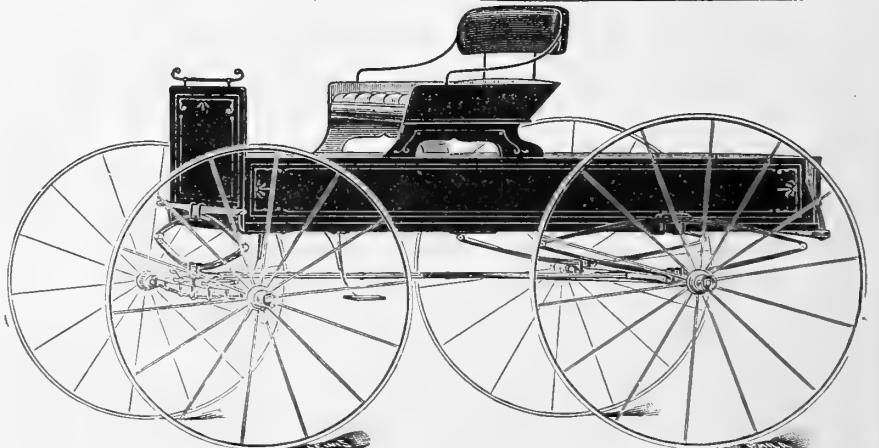

ALL PRICES SUBJECT TO CHANGE WITHOUT NOTICE.

CARRIAGE AND BUGGY DEPARTMENT.

CONTINUED.

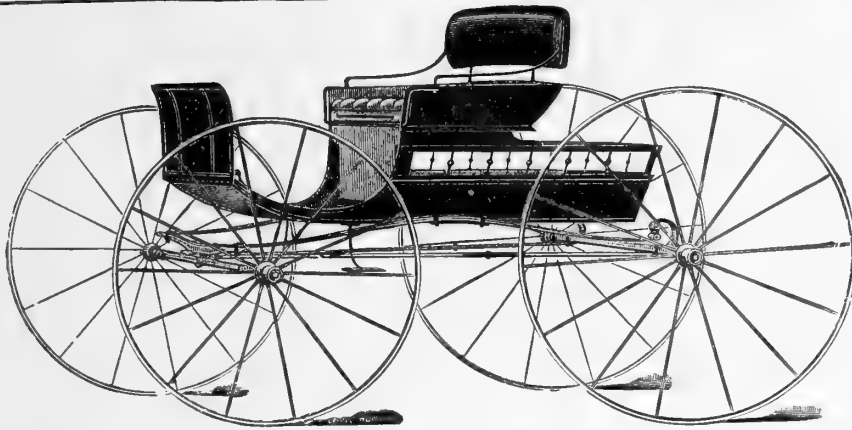

No. 00 ROAD WAGON.

15-16 in. Double Collar, Steel Axles, Warner or Sarven Wheels, $\frac{3}{4}$ or $\frac{3}{4}$ Tread, Upholstered in Corduroy or Drill, Gear Dark Green or Imitation Carmine, Body Black, Oil Tempered Springs.

List, \$50.00. Retail, \$30.00.

No. 00 $\frac{1}{2}$ ROAD WAGON.

THIS is the same as 00 (see cut) except it has a Canvas Top.

List, \$65.00 Retail, \$37.50

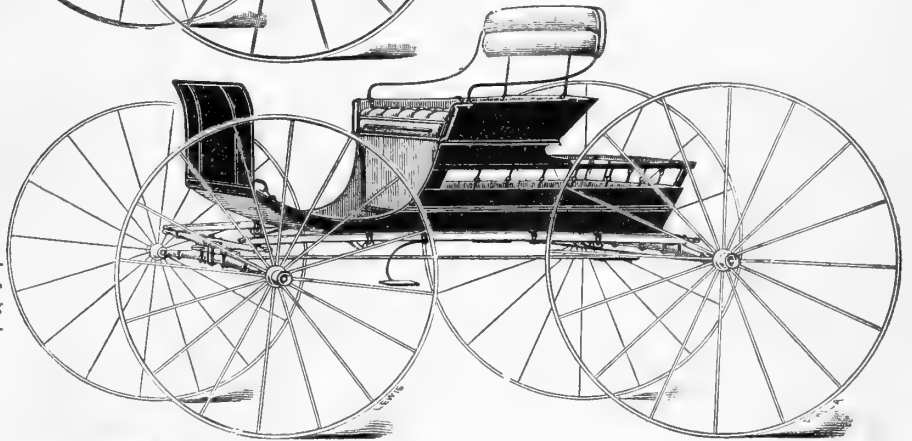

No. 35 ROAD WAGON.

THIS Wagon is made of Warner Wheels exclusively, unless specially ordered otherwise— $\frac{3}{8}$ -inch tread, hung on either Brewster, King or Coil Springs. A nicely finished and an exceedingly fine job for the money.

List, \$60.00. Retail, \$35.00.

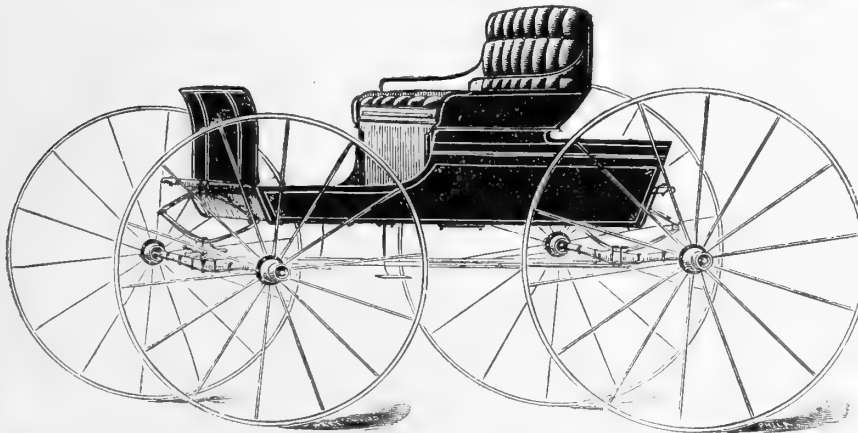

No. 4 Road Wagon.

WHEELS—Sarven patent; $\frac{3}{8}$ tread, with round edge steel tire. Gear—Double Collar Steel Axle; 15-16 inch; fantail and swedged; three-leaf 34-inch spring; axles bedded and reaches ironed. Body—Size, 49x24 inches on bottom; round corners and concave seat risers; steel body loops. Seat—Size, 16x27 inches, with detachable panel back. Trimmings—Leather dash; carpet in bottom; cushion and back green cloth or imitation of leather. Painting—Body, black; gear, Brewster green; both neatly striped.

List, \$65.00. Retail, \$37.50.

No. 66 Driving Wagon

List... \$100.00.
Retail, 60.00.

WHEELS—Extra selected hickory; Sarven patent or compressed band; $\frac{3}{4}$ tread, with round edge steel tire, bolted between every spoke. Gear—Double Collar Steel Axle, 15-16 inch; fantail and swedged; 36-inch four-leaf graded steel springs; gear woods best black hickory, with axle beds cemented to axles; wrought derby fifth wheel, with taper clip king bolt; bent reaches mortised in head block and ironed full length. Body—Ash sills and poplar panels, nicely molded with shutter work on sides; round corners; size, 26x50 in.; full length steel body loops; wrought step with rubber pads. Bottom boards put in from the bottom, giving additional leg room.

Seat—Size, 16x28 inches on bottom, with extra high back and Stanhope pillars; nicely molded. Trimmings—Fancy dash; full length velvet carpet; cushion and back, whipcord or leather; leather extra. Painting—Body black, with molding deep body green or French carmine; gear, Brewster green or carmine, neatly striped.

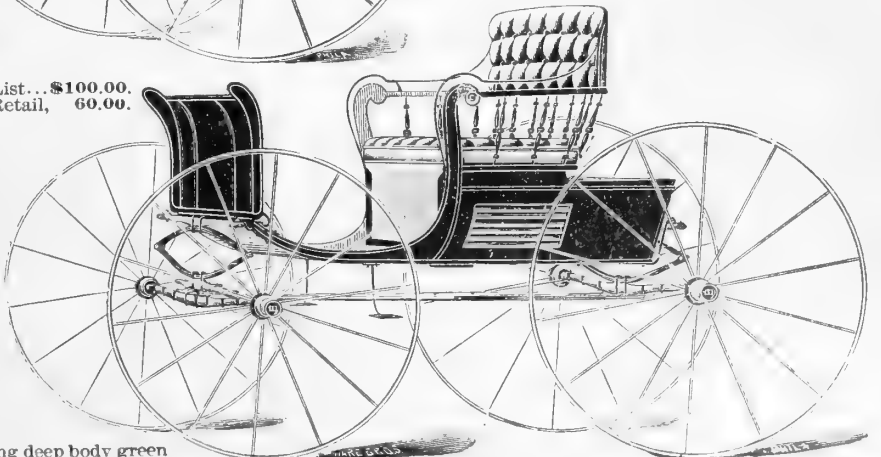

ALL PRICES SUBJECT TO CHANGE WITHOUT NOTICE.

CARRIAGE AND BUGGY DEPARTMENT.

CONTINUED.

— No. 3 —

DRIVING WAGON.

Wheels—Extra selected hickory; Sarven patent or compressed band; 3/4 inch round edge steel tire, bolted at every spoke. Gear—Double Collar Steel Axle, 15-16 inch, fantail and swedged; 36-inch four-leaf graded steel springs; gear woods best black hickory, with axle beds cemented to axles; wrought derby fifth wheel, with taper clip king bolt; bent reaches mortised in head block and ironed full length. Body—Ash sills and poplar panels, with round corners, swelled sides, convex panels, with oval edge irons and concave seat risers; size, 24x54 inches; full length steel body loops; wrought steps, with rubber pads; bottom boards put in from the bottom, giving additional leg room. Seat—Size of bottom, 17x28 inches; polished beveled edged back. Trimmings—Leather dash; full length tapestry carpet; cushion and back, whipcord or leather; leather extra. Painting—Body, black; gear, Brewster green or carmine; neatly striped. List, \$95.00. Retail, \$55.00.



— No. 52 —

Brewster Spring Buggy.

Seven-eighths Double Collar Swaged Steel Axles; shell band or Warner wheels, No. 1 quality; 3/4 or 7/8 inch tread; steel tire bolted between every spoke; body 22 inches wide; seat regular width, upholstered in green or blue broadcloth or leather; cushions on back are plaited; seat lined; a neatly trimmed job; 28-ounce rubber top. Nickel fasteners on stays; body hung low. It is nicely finished and style is exceedingly good.

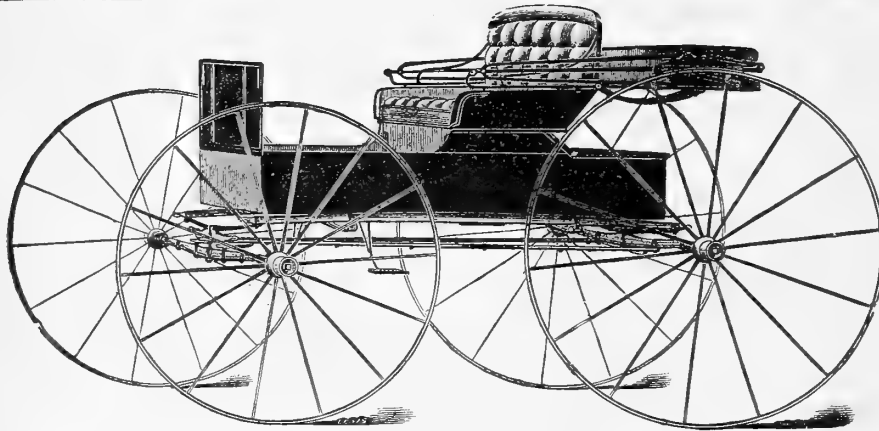

Rubber Top—List, \$105.00.	Retail, \$57.50
Lea. Quarter—List, \$110.00.	Retail, 60.00
Lea. Top and Rubber Sides—List, \$120.00.	Retail, 65.00
Full Lea. Top—List, \$130.00.	Retail, 75.00
Nickel Rail.....	Retail, 65c. List, \$1.10.
Rim Sleeve Bands—Retail, 85c.	List, \$1.50.
Nickel Cap	Retail, 85c. List, \$1.50.

No. 40 SIDE BAR BUGGY--Piano Body.

Wheels, No. 1 grade, 3 feet 9 inches and 3 feet 5 inches high; Warner or shell band, 3/4x3-16 steel tire bolted between every spoke, double perch; well ironed; 15-16 inch double collar, steel axle; springs all clipped on axle; Brewstersprings; body black; gear green; black or natural wood finish; can hang on other springs on sufficient notice.

Rubber Top.....	List, \$86.00	Retail, \$48.00	Lea. Top and Rubber Sides.....	List, \$100.00	Retail, \$55.00
Lea. Quarter.....	90.00	50.00	Full Lea. Top.	105.00	57.50

WITH END SPRING, SAME PRICE.

Baltimore Single Leaf End Spring Buggy.

THE CUT does not show the single leaf feature of the spring, as it could not be obtained in time for this issue, but in every other respect it is the same. This is rather a new departure, but a most excellent arrangement; for ease of riding and general comfort it is not excelled by any other style. Axles 3/4 double collar steel; Warner or shell band; wheels No. 1 quality; 3/4 or 7/8 inch tread; tire bolted between every spoke; body 22 inches wide; seat regular width; nickel hub bands; nickel prop nuts; trimmed in leather same as No. 52. A great favorite in the South.

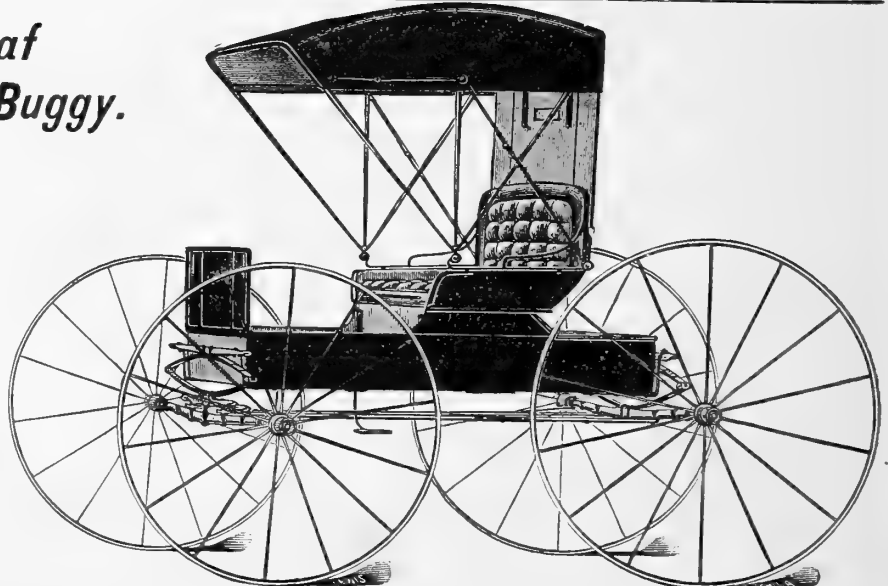

PRICE.

Rubber Top—List, \$105.00	Retail, \$57.50
Lea. Quarter— " 110.00	" 60.00
Lea. Top and Rubber Sides, " 120.00	" 65.00
Full Lea. Top, " 130.00	" 75.00

ALL PRICES SUBJECT TO CHANGE WITHOUT NOTICE.

CARRIAGE AND BUGGY DEPARTMENT.

CONTINUED.

No. 4 Dayton.

Length of body 5 feet 10 inches, width 2 feet 10½ inches, frame and seats best white ash; panels, best No. 1 poplar; wheels 3 feet 9 inches and 3 feet 5 inches high; 1 1-16 inch spoke; Warner or shell band; 1x¼ inch steel tire; 11-16 inch steel axle front spring, 1½ inch 4 ply; two back springs 1¼ inch 4 ply, oil tempered, gear best white hickory; cushions trimmed either leather or cloth; curtains 24 ounces, green back, gum; finished natural wood or painted as desired. Hung on Brewster springs.

— PRICE. —

List..... \$110.00
Retail..... 60.00

Can also furnish in duplex or side bar at same price.

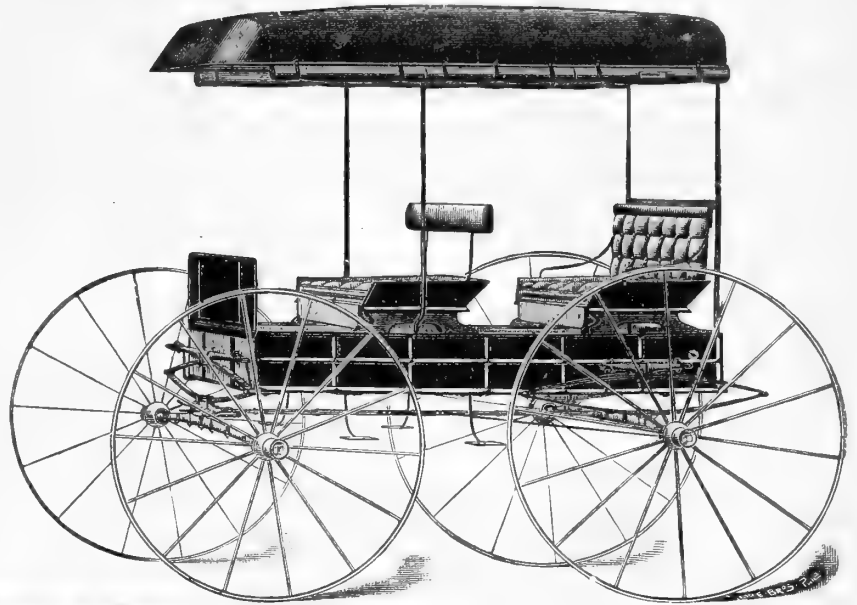

No. 75 Extension Top Surrey.

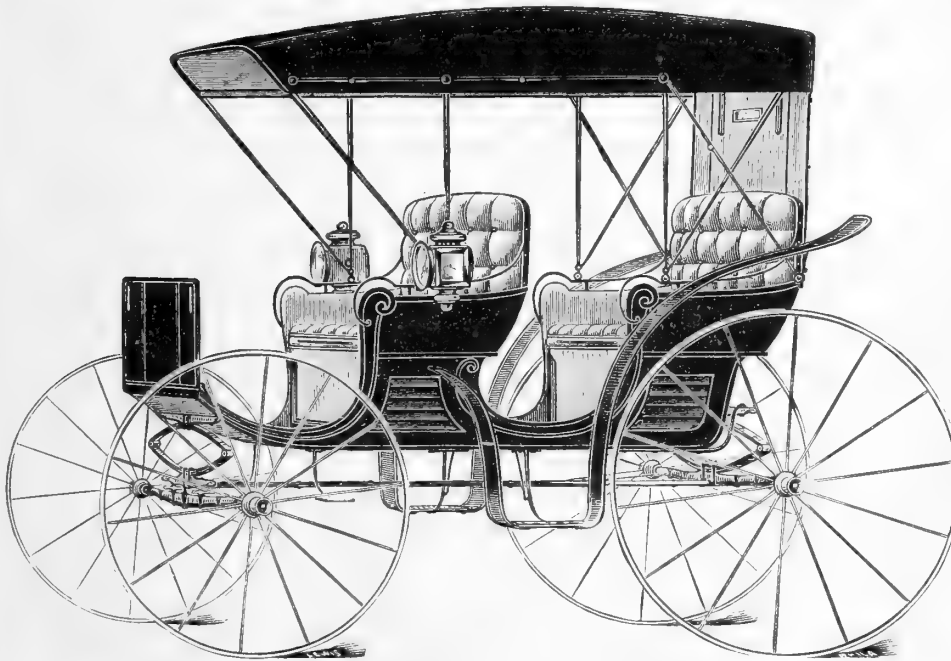

Wheels—¾ or 1 inch tread; Warner, Sarven or shell band; steel tires; bolted between every spoke. Axles—1-16 in. double collar steel. Springs—Oil tempered elliptic. Trimming—Cloth or imitation leather; spring cushions and backs. Painting—Gear, Brewster green, imitation carmine or any other color desired.

We make this job in rubber top, leather stay and quarter, or full leather. We mean by full leather all leather except the two front side curtains which will be charged extra if wanted in leather. Also mount this job on Brewster springs if wanted.

In ordering give width of track.

Rubber Top—List \$165.00
Retail..... 90.00
Lea Stay and quarter—List 175.00
Retail..... 95.00
Lea Top—List..... 182.50
Retail..... 100.00

“Model” Ironed Carriage Pole.

Is WELL ironed with wrought iron tees; double or single hammer strap; heavy drop-forged stay irons. In every way suitable for medium grade work.
Prices are for Pole Complete, which include Neck Yoke, Double and Single Trees and Check Straps. List.... \$10.00. Retail.... \$7.00.

No. 1 Patent Shifting or Adjustable Pole.

SHIFTS to fit any Carriage or Sleigh. Best selected timber; ironed with Norway iron. List....\$18.00 Retail... \$9.00

Buggy Tops Canvas,	List.	Retail.	Buggy Wheels Finished—	List,	Retail,
Rubber.....	\$18.00	\$10.00	No. 57.....	\$22.00	\$12.50
	23.00	12.75	No. 52.....	24.00	15.00



ALL PRICES SUBJECT TO CHANGE WITHOUT NOTICE.

The Griffith & Turner One-Horse Wagon.

THE GRIFFITH & TURNER ONE-HORSE WAGON has adjustable reach, front hounds, patent wheels, double box, spring seat, and gear or body brake. It is substantially made and especially adapted for general use. It has an excellent finish and gives satisfaction.



CAN BE FURNISHED WITH OR WITHOUT BRAKE.

PRICE:

Without brake.....	\$30 00
With gear brake.....	33 00
Gear only, without brake.....	27 00
Gear only, with brake.....	30 00
Tongue.....	5 00
Bodies.....	7 50



The Griffith & Turner Solid Steel Axle Wagons.

These wagons are all heavily ironed and braced, and for use in rough and hilly country, they are specially adapted, being exceptionally strong. The wheels are dipped in **Boiling Oil** and the round edge tire is used for the protection of felloes and paint. They are one of the lightest running wagons made. There is an increasing demand in sandy countries for steel axle wagons and our trade in this style has grown immensely.

Prices include Whiffletrees, Wrench, Stay Chains, Tongue Chains' Box, Top Box, Spring Seat and Gear.

All Wagons will be arranged with Shafts, for one horse instead of Tongue, when ordered at same price. Note prices on brakes.

Nos.	Size of Steel Axle.	Size of Tub'lr Axles.	Size of tires.	Height of Wheels		Dimensions of Body.				Wght.	Capacity.	Wagon complete no brakes.	Wagon complete with brakes.	Gears only with brakes.	Gears only, no brakes.
				Front.	Hind.	Length.	Width.	Depth.							
								Box.	Running Gear.						
22	1 3/4	2 1/4 x 8	2 x 1 1/4	3 ft. 6 in.	4 ft. 2 in.	10 ft. 6 in.	3 ft. 6 in.	12	6 in.	900	2500 to 3000	\$58 50	\$63 00	\$57 00	\$52 50
23	1 3/4	2 3/4 x 9	2 x 3/4	3 ft. 6 in.	4 ft. 2 in.	10 ft. 6 in.	3 ft. 6 in.	12	8 in.	1000	3000 to 3500	60 50	64 50	58 50	53 50
24	2	2 3/4 x 11	2 x 3/4	3 ft. 6 in.	4 ft. 2 in.	10 ft. 6 in.	3 ft. 6 in.	14	8 in.	1200	4000 to 4500	65 50	70 50	63 00	59 50
25	2 1/4	2 3/4 x 11	3 x 3/4	3 ft. 6 in.	4 ft. 2 in.		Running Gear.			1200	6000	68 50	84 50	68 50	74 00
26	2 1/2	3 1/8 x 12	3 x 3/4	3 ft. 6 in.	4 ft. 2 in.		Running Gear.				8000	84 50	80 00

For tires wider than above on Nos. 22 and 23, add \$4.50; on Nos. 24, 25 and 26, add \$5.50. Rear brake, extra, \$4.50.

The National Tubular Axle Farm Wagon.

To meet the demand for a tubular axle we can furnish the "National Tubular Self Oiling Axle" acknowledged by all to be the best on the market. See cut annexed.

For Prices on Tubular Axles see table above.

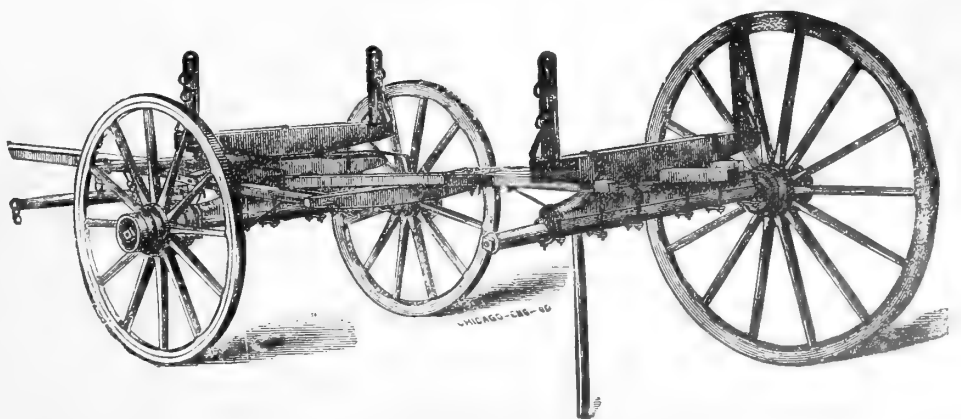

ALL PRICES SUBJECT TO CHANGE WITHOUT NOTICE.

The Lansing Wagon.

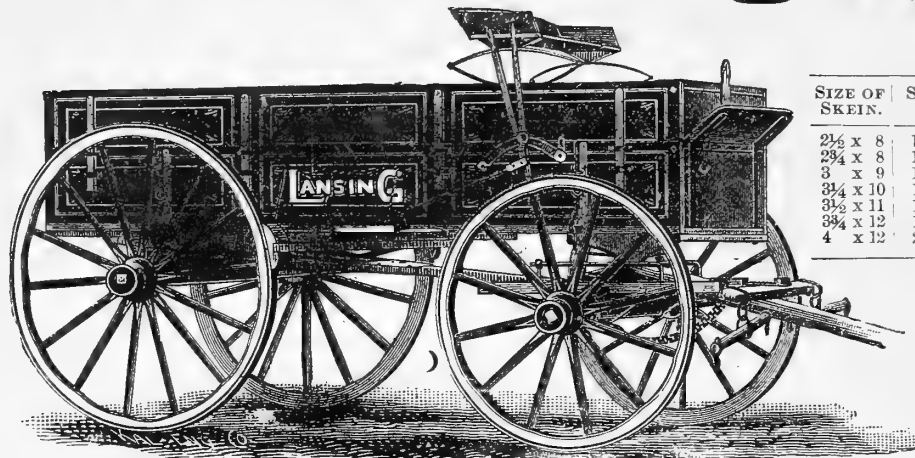

RETAIL PRICES.

SIZE OF SKEIN.	SIZE OF TIRE.	CAPACITY.	BRAKE	PRICE WITH GEAR BRAKE.
2½ x 8	1½ x ¼	2000 Cast Skein	Gear.	\$59 00
2¾ x 8	1½ x ½	2500 " "	" "	60 00
3 x 9	1½ x ½	3000 " "	" "	61 50
3¼ x 10	1½ x 9-16	3500 " "	" "	62 50
3½ x 11	1½ x 5/8	5000 Steel	" "	71 00
3¾ x 12	1¾ x 5/8	6000 " "	" "	75 00
4 x 12	2 x ¾	8000 " "	" "	81 00

Above prices include Double Box, Seat, Whiffletrees and Gear Brake top of hounds.

If gear only is wanted, deduct \$10.00 from above prices.

For Wide Tire add prices on Wagons as follows:

For 2 x 5/8 inch Tire, add.....	\$3 00
" 2½ x 5/8 inch Tire, add.....	4 50
" 3 x 5/8 inch Tire, add.....	6 00
" 4 x ¾ inch Tire, add.....	13 00
" 4 x 7/8 inch Tire, add.....	14 50

Lower Box, no seat.....	\$ 9 00
8 inch or 10 inch Top Box.....	1 50
Spring Seat.....	3 00
Gear Brake, complete.....	5 50
Rear Brake Attachment.....	4 00

LIST PRICES ON LANSING WAGONS COMPLETE.

SIZE OF SKEIN.	SIZE OF TIRE.	PRICE WITH CAST SKEINS.			PRICE WITH STEEL SKEINS.		
		CAPACITY.	PRICE, WITHOUT GEAR BRAKE.	PRICE, WITH GEAR BRAKE.	CAPACITY.	PRICE, WITHOUT GEAR BRAKE.	PRICE, WITH GEAR BRAKE.
2½ x 8	1½ x ¼	2000	\$90 00	\$98 00	2500	\$96 00	104 00
2¾ x 8	1½ x ½	2500	92 00	100 00	3000	98 00	106 00
3 x 9	1½ x ½	3000	94 00	102 00	3500	102 00	110 00
3¼ x 10	1½ x 9-16	3500	96 00	104 00	4000	106 00	114 00
3½ x 11	1½ x 5/8	4000	100 00	108 00	5000	110 00	118 00
3¾ x 12	1¾ x 5/8	5000	106 00	114 00	6000	116 00	124 00
4 x 12	2 x ¾	6000	112 00	120 00	8000	126 00	134 00

~ If Gear only is wanted, deduct for Lower Box, \$12.00; Top Box, \$2.00; Seat, \$4.00 from above list prices.

LIST PRICES ON EXTRAS.

Gear Brake, complete, \$8.00; Rear Brake Attachments, \$6.00; Body Brake, complete, \$5.00. When wanted with wide Tire, add as follows:

Thickness.	2'' wide.	2½'' wide.	3'' wide.	3½'' wide.	4'' wide.	Thickness.	2'' wide.	2½'' wide.	3'' wide.	3½'' wide.	4'' wide.
¼ inch.						¾ inch.					
½ "						7/8 "					
5/8 "						1 "					

At the time this catalogue was issued the list prices on extra width of tire had not been determined upon by the factory.

THE COMMON SENSE BOLSTER SPRING.

To carry 1000 lbs.,... \$4.00	To carry 4000 lbs.,... \$ 9.00
" 1500 " .. 4.50	" 5000 " .. 10.00
" 2000 " .. 5.00	" 6000 " .. 11.00
" 2500 " .. 5.50	" 8000 " .. 12.00
" 3000 " .. 8.00	" 10000 " .. 13.00



North Patent Adjustable Bolster Springs.

Wagon will last longer, will carry load in much better condition, particularly fruit or produce that is likely to become bruised, etc., and will make the load run much easier to the horses.



SHOWS CENTRE SPRING IN POSITION FOR LIGHT LOAD.

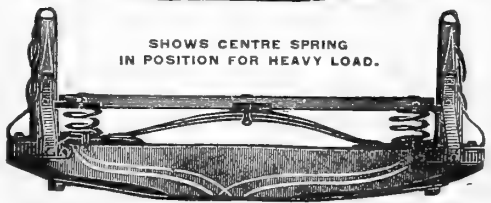

SHOWS CENTRE SPRING IN POSITION FOR HEAVY LOAD.

To carry 1000 lbs.,... \$4 00	To carry 4000 lbs.,... \$10 00
1500 " .. 5 00	5000 " .. 11 00
2000 " .. 6 00	6000 " .. 12 00
2500 " .. 7 00	" .. 8 00
3000 " .. 8 00	

Miller's Improved Wagon Jack.

IT IS MADE IN THREE SIZES.

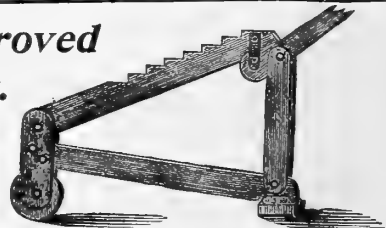

No. 1—Adapted for buggies or light work, capacity 2,000 lbs.	\$1.25
No. 2—For heavy wagons, transfer wagons, trucks, etc., capacity from 3,000 to 5,000 lbs.	1.50
No. 3.	2.25

It is made of selected ash wood, put together with bolts. Its weight is respectively nine and fourteen pounds each for Nos. 1 and 2. They are very strong and durable, as the strain comes parallel with the grain of the wood, the weight is shared throughout the entire machine. Some of the advantages of this Jack over all others on the market are: It is so constructed that you do not have to make any adjustments for different height axles, as this is regulated by the notch bar.

We also have a cheap Jack, very simple in construction, but one which is easily handled, and which is all right for light work. Price, 50 cents.

FARM AND CONTRACTOR'S CART

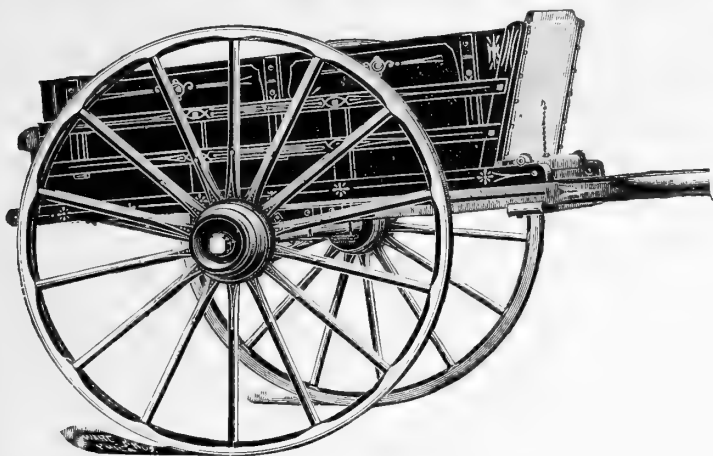

THESE carts are very strong, heavily ironed, nicely painted, striped and varnished. They are specially adapted for use by Farmers and Contractors. Incorporated in these carts are all of the best features of the old style farm cart, even to the trap stick which we retain, considering it far ahead of any of the patent devices. In consequence of these points we have now unquestionably the best article of its kind ever introduced. We have sold these carts more or less extensively throughout Maryland, Virginia, Pennsylvania, New York, New Jersey, North Carolina, and other parts of the South, and judging from our largely increasing trade, we are prepared to say that it is just the Cart needed. It has been our sole aim to have nothing but the best.

Size of Axle.	Size of Tires.	Diameter of Wheels.	Price.
1 3/8 inches	2 inches.	4 ft., 10 in.	\$32.50
1 1/2 inches.	3 inches.	4 ft., 10 in.	35.00
2 inches.	2 inches.	4 ft., 10 in.	37.50
2 inches.	3 inches.	4 ft., 10 in.	40.00

Baltimore Truckers' Wagon.

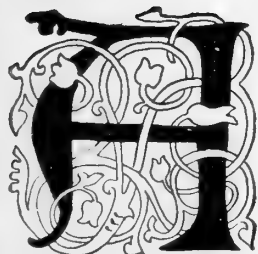
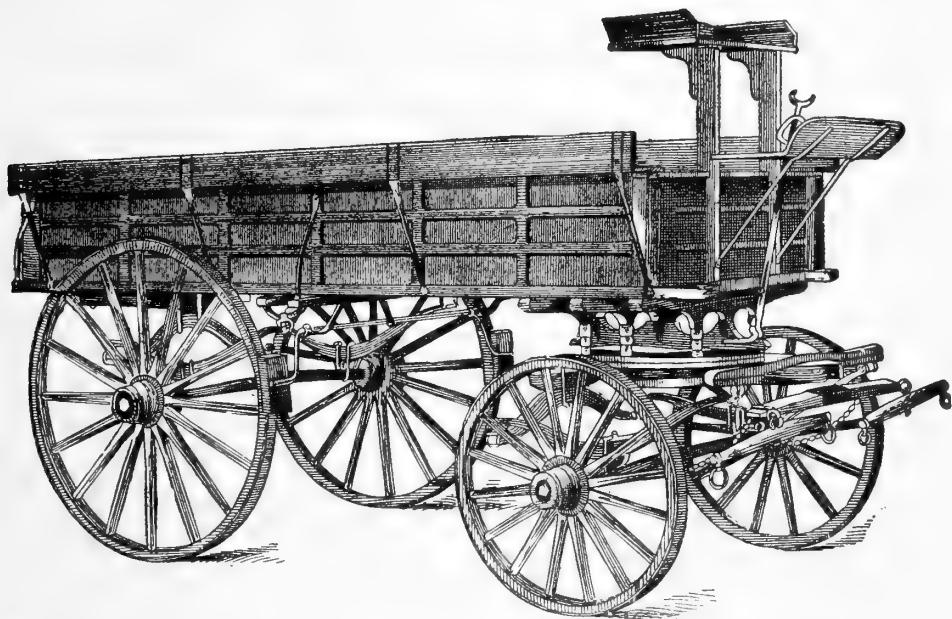

AMONG the different classes of people who use heavy wagons there is none more particular and exacting than the Trucker. He must have things just so. His crates must be loaded in a certain manner in order that he may carry a large quantity; the rear axle must be heavier than the front; the lee boards must be fashioned in a peculiar way. In fact a Trucker's wagon, is his freight car; his carry-all. He goes to market with his truck and takes back a load of pickers, etc., etc. Now we are in a better position to understand the trucker's wants than even the wagon manufacturer, as we come in direct contact with him.

Having a keen knowledge of all the points that go to make up a first-class Truckers' Wagon, we have had constructed for us a vehicle, as per cut, that has embodied in it all the latest improvements, and we can confidently assert that it is the best braced, the best finished, the best proportioned wagon for the purpose on the market to-day. The body has two rails on the side, studs 7/8x1 inch, solid corner posts, hardwood end gate, tires 2 1/2x3/8 inches, and axles 2 inches in the rear and 1 1/4 inches front.

WRITE FOR PRICES.

ALL PRICES SUBJECT TO CHANGE WITHOUT NOTICE.

A Great Problem.

THE constant advance in prices on all classes of goods we handle made the compilation of this Catalogue, in the matter of quotations, one of the greatest problems we ever encountered. We can even now give no assurance of their stability. It was therefore necessary for us to frequently state that all prices are subject to change without notice.

Complete Outfits.—We make a specialty of quoting prices on complete outfits; and by a careful examination of this catalogue, it will be seen that we carry a full line of standard goods for which repairs can be obtained in all sections of the country. Therefore persons living in isolated sections will save money by corresponding with us. If your local dealer cannot furnish repairs for machinery which you have in use, write to us.

A Fine Opportunity.—We know of many persons who are making money by soliciting orders for Garden and Flower Seed; we here offer such a chance to any one having a little leisure time. Send us your name and address, stating you wish to enter upon the work, and we will be pleased to name terms that will make it profitable for you to accept.

Read the Catalogue.—If persons receiving this Catalogue will carefully read it, they will find many questions fully answered.

Please Remember, When wishing us to duplicate any part of a machine, tool or vehicle, always send us the number of the part, but if it is not obtainable, send the part itself, **prepaying express charges.** By observing the above instructions it will be a mutual saving of an immense amount of time and patience.

Repairing Lawn Mowers.—Send us your mowers early in the season, if you wish them repaired or sharpened. We employ competent mechanics for the purpose.

Mail Orders.—Always be sure to write your name and address plainly, as well as shipping address. It will avoid disagreeable delay.

Read notice on page 128; it will answer important questions.

GOULD'S "KEROWATER" SPRAYER.

For Emulsifying and Spraying Kerosene and Water.

This Kerosene Sprayer came to hand too late for classification.

It consists of two pumps, one for water and one for the oil, but having one common exit at the hose. Both pumps are contained within the barrel. Instead of mixing the oil and water at the suction, the emulsion is made at the discharge. Kerosene is poured into the oil tank through a marked filling hole, and water into the barrel. The amount of oil used is controlled by the proportionate stroke of the pumps. In the end of the lever are drilled a number of holes (see top of cut), into one of which is inserted a coupling pin. By removing the pin from one set of holes to another the percentage of oil can be graded from 5 per cent. to 25 per cent. easily and quickly. Figures near each hole indicate the percentage of oil the pin working in that hole will supply. The mixture is positively accurate. A brass shut-off is seen near the top, attached to the hose, to prevent pure oil from being thrown at any time.

Barrel is furnished with outfits shown below.

FIG. 1187. SIZES, PRICES, ETC.

	LIST PRICE.	RETAIL PRICE.
Pump only. —Diameter of Plunger, 2 in.; Stroke of Plunger, 4 in.; Discharge, ½ in. Hose.....	\$21.00	\$17.20
Outfit A, for Single Spray. —"Kerowater" Sprayer, with one lead 10 ft.; ½ in. discharge hose, with "Seneca" (or Vermorel) Spray Nozzle.....	23.75	19.00
Outfit B, for Double Spray. —"Kerowater" Sprayer with two leads 10 ft. each; ½ in. discharge hose, with "Seneca" (or Vermorel) Spray Nozzle.....	26.50	21.25

Before contracting with the Company, we understood that Prof. Johnson, of the Maryland Agricultural College and Experiment Station, endorsed the "Kerowater" Sprayer, and we sent our representative to interview him, and he very kindly gave us the following letter:

"DEPT. OF ECTOMOLOGY, MARYLAND AGRICULTURAL COLLEGE & EXPERIMENT STATION,

GRIFFITH & TURNER Co.,
205 Paca St., Baltimore, Md. College Park, Md., Dec. 19, 1899.

GENTLEMEN: Your Mr. Hall was here on Saturday last, and made inquiry about our experience with the Gould 'Kerowater' Sprayer. In reply would say we thoroughly tested the Gould 'Kerowater' Sprayer (Fig. 1187) when it was first put upon the market, and found it a reliable, all-round outfit for general orchard work against the San Jose and other scale insects. We have, therefore, not failed to recommend it where such a pump was needed, and have continued to use it in our State work.

Very truly yours, W. G. JOHNSON.

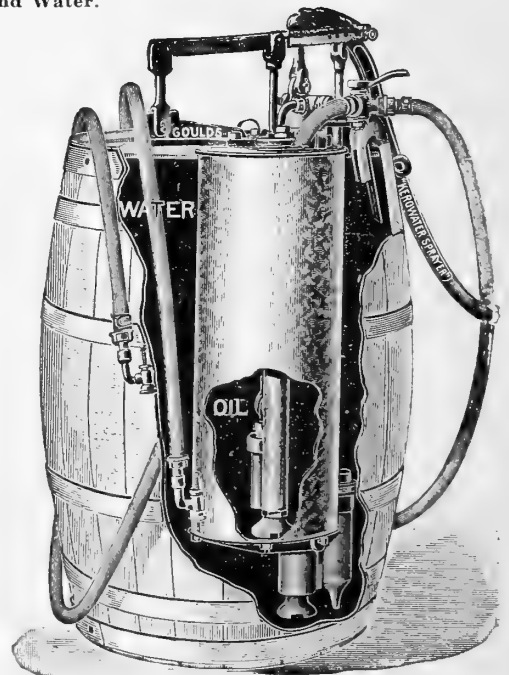

FIG. 1187

ALL PRICES SUBJECT TO CHANGE WITHOUT NOTICE.

Cyclone Corn Husker and Shredder Combined.

A MACHINE that will successfully husk your corn; place in your wagon box; cut and elevate your fodder where you want it, thereby saving it out of the weather; is of incalculable value. Too much fodder has been allowed to go to waste in the fields in shocks. The machine will do the work and do it clean. There is no wrapping around the cylinder because the fodder is cut short and torn into shreds.

The table is on an incline, (see Fig. 2), so the stalks, will slide down into the hopper, where they are caught by the rollers passing through the upper end, stripping off the ears; beneath the rollers you will see the cutter and shredder head, which cuts and shreds the stalks into the finest kind of fodder, and also the husks which are stripped off by the rollers will slide down into the blower fan where they are elevated to a receptacle by an air draft through a seven inch pipe, to a distance of twenty to fifty feet and more, wet or dry. If the fodder is to be elevated at different directions, a curve is made by an elbow. When the ears of corn are stripped from the stalk they continue sliding downward on the rollers, thereby being stripped off the husks and drop into a basket, or can be elevated into a wagon box by the corn elevator.

PRICE.
 Plain, . . . \$145.00
 Elevator, . . . 15.00
 Trucks, . . . 20.00

Subject to Special Discount.

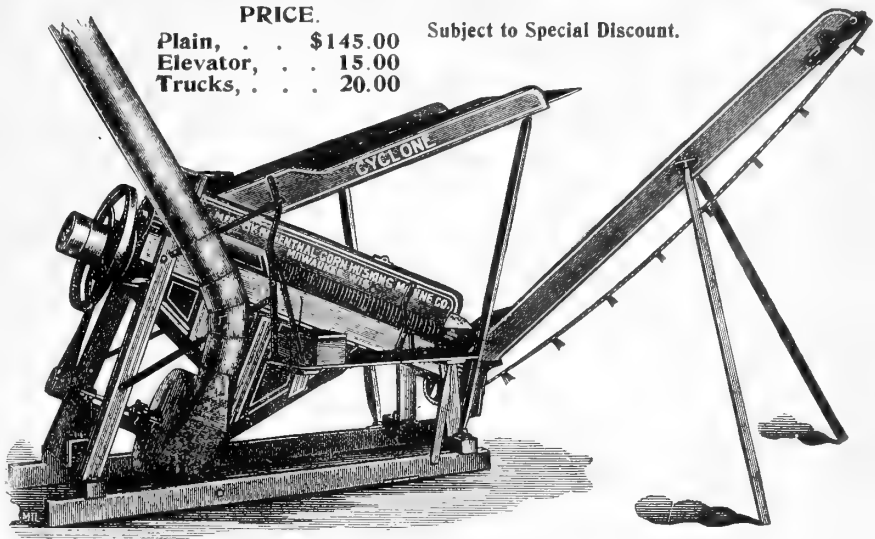

Fig. 2. - WITH CORN ELEVATOR.

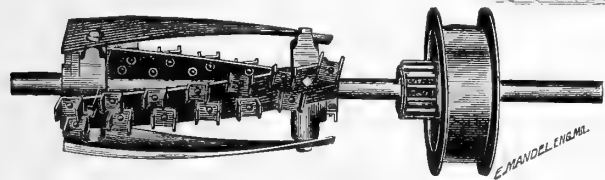

Fig 4.-CUTTER AND SHREDDER HEAD.

The Capacity is from twenty to sixty bushel baskets of ear corn per hour, depending upon the power the machine is run; also upon the condition and quality of the corn.

It requires from two to three men to operate the machine and is especially adapted for a farmer's own use.

The Fodder is cut in about two-inch lengths, shredded and split at the same time into the finest kind of fodder, which has proved to be far superior to all shredded or all cut fodder.

A combined Cutter and Shredder Head as used in our machines has to run only from 800 to 900 revolutions per minute, where a complete Saw Shredder head has to run from 1200 to 1400 revolutions per minute in order to keep from winding when the fodder is damp. Running only 800 to 900 revolutions it will naturally last longer and take less power to run it.

We sold one of these machines to Mr. H. C. Snavely of Sparrow's Point, Md., and append his testimonial: "I cannot speak too highly of the Cyclone Husker, it does the work perfectly, even better than you lead me to believe. It will pay for itself. Yours truly, H. C. SNAVELY."

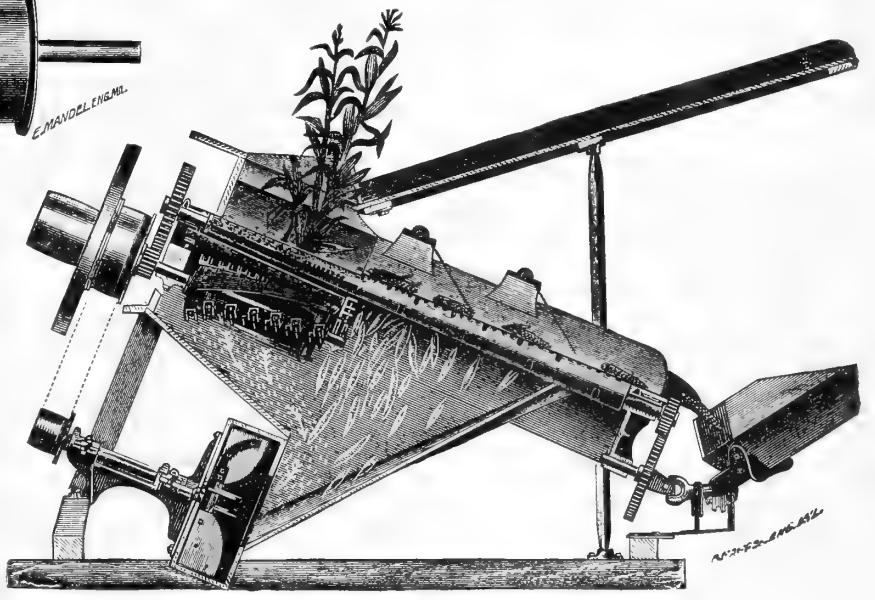
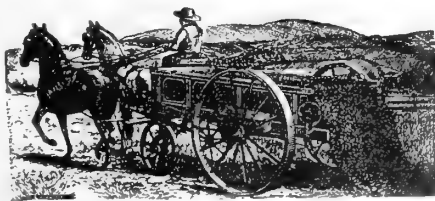

Fig. 5.-SHOWING INSIDE OF MACHINE.

Kemp Manure Spreader.

As a labor and material saver this is one of the most economical implements used on a farm. It will spread just the quantity desired and do it evenly, covering every square inch with finely pulverized manure in one-tenth the time required with shovels and forks. Drill attachment can be changed to lime hood, by removing the chutes and adding the lime board.

PRICES:
 Size No. 1, capacity 30 bushels \$100.00
 Size No. 2, capacity 40 bushels 105.00
 Size No. 3, capacity 50 bushels 110.00



Drill attachment for leaving manure in rows, extra \$8.00
 Wind brake, or lime hood for windy weather, extra 5.00
 Brake or lock for hilly sections, extra 5.00
 Three-horse evener, extra 5.00
 Slow feed, for lime, ashes, etc., extra, Lugs, per set of 28 for use in frosty weather 2.25
 Whiffletrees, neck yoke and two-horse evener furnished free.
 Size No. 2 comes nearer to general wants than any other.

SPECIAL DISCOUNT FROM THESE PRICES.

ALL PRICES SUBJECT TO CHANGE WITHOUT NOTICE.

IMPORTANT NOTICE TO PURCHASERS OF SEEDS.

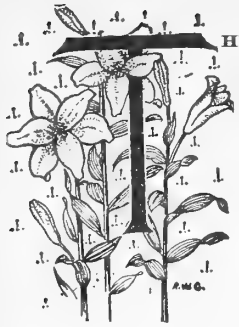

THE question is often asked by some of our Northern correspondents, "Will your seeds give satisfaction in the North?" We can very readily understand how certain advertisements have misled the buyer, and the reasonableness of this question.

To those who are undecided on this account as to where to place their orders, we wish to make the following statement, viz: The locality of the seedsmen does not in any way determine the section in which he grows his seeds: we as well as any other first-class seed house grow each variety of seed in that part of the country best adapted to that particular variety; consequently it makes no difference whether you buy from Baltimore, New York or Boston, so you make your purchases from a reliable house.

Our seeds are now used by farmers and gardeners in nearly every State in the Union with the most satisfactory results.

Read remarks on page 126.

WHY IT WILL PAY YOU TO PLACE YOUR ORDERS WITH US.

First:—We handle a complete line of Farm, Garden, Florists, Dairy and Poultry supplies, consequently we have some work to keep our entire force busy during the year.

Second: It is a known fact that it costs less money to conduct business in Baltimore than some of the other large cities, and we will give you the benefit of same.

It will pay you to correspond with us before placing your order elsewhere. Trusting that you will give us an opportunity to demonstrate this fact, we are,

Very respectfully yours,

GRIFFITH & TURNER COMPANY.

INDEX

	Page.		Page.		Page.
Vegetable Seeds	1 to 29	Cow Ties.....	110	Hame Strings.....	116
Nursery Dept	50	Creamery.....	112	Hampton Plows.....	82
Small Fruits	49	Crescent Cultivator.....	86	Hand Corn Planter.....	73
Florist and Garden Supplies	56, 57	Crescent Lawn Sprinkler.....	33, 56	Hand Weeders.....	57
Clover and Forage Seeds	31	Cultivators and Harrow combined.....	76	Harness.....	115, 116
Farm Seeds	30	Cultivators, Baltimore and Old Dominion.....	76	Harness Menders.....	116
Flower Seeds	35 to 43	Cultivators, Riding and Walking.....	76	Hartman Stockade Fence.....	107
Roses.....	41, 45	Cultivator Points and Steels.....	78	Harrows, Spring Tooth.....	84, 85
Bulbs, Roots and Flowering Plants.....	46, 47, 48	Curry Combs.....	117	Harrows, Spike Tooth.....	85
Grass Seeds	32	Cut Easy Hoe.....	86	Harrows, Disc.....	83
Lawn Seeds	34	Dairy Cultivator.....	84	Harrow Teeth.....	84
Sun Flower	31	Dairy Supplies.....	112, 113, 114	Hay Carriers.....	92
Broom Corn	32	Dehorners.....	118	Hay Knives.....	58
Millet	32	Delivery Wagons.....	118	Hay Presses.....	97
Flax Seed	32	Dibbles.....	57	Hay Rakes.....	95
Insect Destroyers	54	Disc Harrows.....	83	Hay Rake Teeth.....	96
Poultry Supplies	52	Dock Cutters.....	57, 87	Hay Tedders.....	96
Dairy Supplies, 112 to 114		Drag Scraper.....	89	Hay Tedder Forks.....	96
Implements, Vehicles, Etc., Etc.		Drills, Grain.....	72	Hay Tool Supplies.....	92, 93
Acorn Powder Gun.....	56, 59	Drills, Seed.....	62, 64, 65	Hedge Shears.....	58
Ash Spreader.....	75	Drive Well Points.....	108	Hitching Post.....	91
Asparagus Knife.....	58	Drill Points and Tubes.....	72	Hoes, Garden.....	86
Asparagus Buncher.....	58	Drinking Fountains.....	53	Hollow Idle, Post Spade.....	86
Atomizer Liquid.....	56, 89	Edging Knives.....	58	Hog Trough.....	111
Axes and Handles.....	110	Farm Mills.....	102, 103	Horse Powers.....	101
Axle Grease.....	110	Farm Bells.....	106	Horse Powders.....	52
Back Bands.....	116	Farm Carts.....	125	Horse Boots.....	59
Baling Ties.....	97	Farm Posts.....	107	Horse Hoes.....	58, 26
Baling Wire.....	97	Farm Wagons.....	122 to 126	Horse Clippers.....	76
Barn Door Hanger.....	93	Farm Cookers.....	108	Horse Shears.....	58
Barn Door Track.....	93	Fence Stay.....	107	Horse Scissors.....	58
Barbed Wire.....	107	Fence Post.....	107	Hose.....	34
Barrows.....	88, 89	Fertilizer.....	55	Hose Reels.....	34
Belting, Rubber.....	99	Fertilizer Distributors.....	75	Hose Menders.....	34
Belting Link Chain.....	94	Field Sprayer.....	60	Horticultural Tools.....	57, 58
Bells, Farm.....	106	Field Rollers.....	73	Hot Bed Mats.....	56
Berry Presses.....	94	Flower Tubes.....	48	Hot Bed Sash.....	56
Binders, Deering.....	94	Fodder Carrier.....	98	How and When to Spray.....	3d cover page
Binder Twine.....	95	Fodder Cutters.....	98, 99	Incubators.....	54
Bolster Springs.....	124	Fodder Yarn.....	95	Iron Age Garden Tools.....	65, 66
Bone Mills.....	53	Fodder Shredder.....	99	Iron Hoes.....	58
Bolts and Nuts.....	81	Food Cartridges.....	33	Iron Troughs.....	111
Brooms, Stable.....	56	Force Pumps.....	109	Insect Destroyers.....	54
Brooders.....	51	Forks, Oat and Barley.....	91	Kerosene Sprayers.....	60, 126
Brushes, Horse.....	117	Forks, Stable.....	91	Kerowater Sprayer.....	126
Budding Knives.....	58	Forks, Regular.....	87	Knife Grinders.....	91
Buggies.....	120	French Burr Mills.....	103	Knife Sections.....	94
Buggy Poles.....	121	Fruit Pickers.....	57	Knives for Binders.....	94
Buggy Wheels and Tops.....	121	Fumigators.....	57	Knives Budding.....	58
Buff Mills.....	103	Galvanized Pipe.....	108	Knives, Edging.....	58
Butchering Derrick.....	106	Galvanized Couplings.....	108	Knife Head.....	94
Butter Requisites.....	112 to 114	Galvanized Pump Rod.....	108	Labels, Tree.....	57
Calf Dehorners.....	112	Gape Extractor.....	53	Ladders.....	93
Calf Weaners.....	112	Garden Hoes.....	86	Lanterns.....	113
Canton Hoist.....	93	Garden Rakes.....	87	Lard Presses.....	105
Caponizing Tools.....	53	Garden Boxes.....	56	Lawn Fountain.....	33, 56
Carts, Farm.....	125	Garden Drills and Plows.....	62 to 66	Lawn Feeder.....	33
Carts, Sprinkling.....	61	Garden Reels.....	57	Lawn Mowers.....	68, 69
Carts, Push.....	61	Garden Syringes.....	56	Lawn Rakes.....	87
Cast Plows.....	81	Gates, Single and Double Drive.....	107	Lawn Rollers.....	73
Chains.....	110	Georgia Stocks.....	107	Lawn Shears.....	58
Corn Planters.....	70, 71	Glazing Points.....	56	Lawn Swings.....	67
Corn Planter Runners.....	71	Grafting Wax.....	56	Lawn Seat.....	67
Corn Shellers.....	100, 101	Grain Radles.....	91	Lawn Sprinkler.....	33, 56
Cotters.....	94	Grain Fans.....	104	Lawn Sweeper.....	69
Couplers, Hose.....	34	Grain Mills.....	72	Leaf Rakes.....	52
		Grain Drills.....	102	Leg Band.....	52
		Grain and Timothy Force Feeds.....	72	Line Spreader.....	75
		Granite Grit.....	53	Link Chain Belting.....	94
		Grape Scissors.....	58	Liquid Atomizer.....	59
		Grass Catchers.....	69	Lopping Shears.....	58
		Grass Edger.....	58	Malta Single and Double Shovel Plows.....	77
		Grass Hooks.....	58	Mangers.....	111
		Grass Shears.....	58	Manure Hooks.....	87
		Grindstones.....	91	Manure Spreader.....	127
		Grinding Mills.....	102, 103	Mastic.....	56
		Grain Hoers.....	86	Mastic Machine.....	56
		Guards.....	86	Matts and Handles.....	86
		Halters.....	117	Mills, Feed.....	102, 103
		Hames.....	116	Milk Coolers.....	113
				Mole Traps.....	57
				Monkey Wrenches.....	94
				Mowers, Deering.....	91
				Mowers, Lawn.....	68, 69
				Mower Repairs.....	94
				Neck Yokes.....	79
				Nest Eggs.....	52
				Nozzles, Hose.....	34
				Notches.....	126, 128
				Oats Forks.....	91
				Oils and Oil Cans.....	95, 110
				Oliver Plows and Repairs.....	80, 81
				Open Bings.....	79
				Open Links.....	79
				Ox Yokes.....	116
				Peach Sorter.....	75
				Pea Drills.....	75
				Picks.....	88
				Pick Handles.....	86
				Pitcher Pumps.....	109
				Plant Stakes.....	57
				Plant Bed Cloth.....	56
				Plant Sprinkler.....	56
				Platform Trucks.....	90
				Plow Clevises.....	81
				Plow Handles.....	77
				Plows and Repairs.....	80, 81
				Post Hole Digger.....	86
				Post Labels.....	57
				Potato Cutter.....	74
				Potato Digger.....	75
				Potato Hooks.....	87
				Potato Planter.....	78
				Potato Sorter.....	75
				Poultry Knife.....	52
				Poultry Netting.....	52, 107
				Poultry Marker.....	52
				Poultry Supplies.....	52
				Poultry Trough.....	52, 111
				Powder Gun.....	56, 59
				Pruning Knives.....	58
				Pruning Saws.....	58
				Pruning Shears.....	58
				Pumps.....	108, 109
				Pump Buckets.....	108
				Punch.....	94
				Push Cart.....	61
				Putty Bulbs.....	87
				Raffia.....	56
				Rakes.....	87
				Reaper, Deering.....	94
				Refrigerators.....	114
				Repair Links.....	79
				Riding Cultivators.....	78
				Rivets.....	94
				Rivet Punch.....	116
				Road Carts.....	113
				Road Wagons.....	119, 120
				Rope.....	95
				Root Cutters.....	106
				Row Marker.....	91
				Rubber Belting.....	99
				Rubber Buckets.....	108
				Rubber Hose.....	34
				Saws, Circular.....	101
				Scales.....	102
				Scissors, Flower and Grape.....	58
				Scraper.....	77
				Scuffle Hoes.....	58
				Scythes.....	58, 91
				Scythe Snathes.....	91
				Scythe Stones.....	58, 91
				Seed Table.....	2d page cover
				Seed Sowers.....	67, 70
				Sections.....	94
				Separators.....	113
				Separator Oil.....	110
				Shears.....	58
				Sheep Shears.....	58
				Shovel Plow Steels.....	77
				Shovel Plows.....	77
				Shovel Plow Fenders.....	77
				Shovels.....	86
				Shovel Plows.....	77
				Shredders.....	99
				Shredder Cylinders.....	99
				Sickle Grinders.....	91
				Silkline.....	56
				Singletrees.....	79
				Snaths.....	91
				Soil Cutter.....	67
				Spades.....	86
				Sphagnum Moss.....	56
				Spray Pumps and Nozzles.....	59



TIME FOR SOWING IN THE OPEN GROUND.

These Directions Apply to the Vicinity of Baltimore and Philadelphia; South of This They Should be Sown Earlier, and North, Later.

- BEANS.**—From 1st of May till August.
BEETS.—Soon as ground can be worked in Spring.
CABBAGE.—For early use sow in hot-bed in February and transplant in April to open ground; for late use, sow in May or June.
CAULIFLOWER.—Sow about the same time as cabbage. For late crop sow in June, and they will head up in cool weather and escape injury from the heat.
CARROT.—For early sow, from 1st of April to middle of May, and for late crop in June or July.
CELERY.—Sow as soon as ground is open in Spring and transplant in July.
CUCUMBER.—Sow about the 1st of May for early, and for pickling in July.
LETTUCE.—Sow soon as ground can be worked in Spring, and at intervals as desired.
MELONS.—Sow in May and June.
ONION.—Sow early as possible in Spring.
PARSNIP.—Soon as ground can be worked.
PEAS.—Sow in March and at intervals through the season, as desired.
PUMPKIN.—Plant in May or June.
RADISH.—Soon as ground is ready, and all through the season, at intervals.
SQUASH.—Soon as ground is warm.
TOMATO.—Sow in hot-bed in March and transplant about middle of May.
TURNIP.—For early use in April; for main crop, July and August.

See front cover page for seed table giving full instructions as to quantity of seed required per acre, drills or hills, etc.

COUNTRY MERCHANTS

Send for Our

WHOLESALE TRADE PRICE LIST FOR 1900.

Prices Subject to Change Without Notice.

Orders Accepted Subject to Being Unsold.

PREMIUMS To every purchaser of Seeds in Packets. The purchaser may select 25 cents worth extra for each one dollar sent us. Thus, any one sending us \$1.00 can select Seeds in Packets amounting to \$1.25; for \$2.00 Seeds in Packets to the value of \$2.50, and so on.

HOW AND WHEN TO SPRAY.

PLANT.	FIRST APPLICATION.	SECOND APPLICATION.	THIRD APPLICATION.	FOURTH APPLICATION.	FIFTH APPLICATION.
Apple. —(Canker worm, codling moth, bud moth, scab.)	Spray before buds start, using copper sulphate solution.	After the blossoms have formed, but before they open, Bordeaux and Paris green.*	Within a week after blossoms have fallen, Bordeaux and Paris Green.	10 to 14 days later, repeat.	10 to 14 days later, Bordeaux or weak copper sulphate.
Bean. —(Anthracnose.)	When blossoms appear, spray with Bordeaux.	10 days later, repeat.	10 to 14 days later, weak copper sulphate solution.	Repeat last, if necessary.	
Cabbage. —(Worms, aphid.)	When worms first appear, kerosene emulsion, or Paris green.	If worms or aphides are present, repeat if plants are not heading, using emulsion for aphid.	If aphides persist or if worms reappear, use kerosene emulsion, if plants are not heading.	After heads form, use saltpetre for worms, a teaspoonful to a gallon of water; emulsion for aphides.	Repeat if necessary.
Carnation. —(Rust and other fungous diseases.)	When planted out, dip in Bordeaux.	7 to 12 days later, spray plants with Bordeaux.	Repeat at intervals of a week or ten days until blossoms open.	While in bloom, spray every week with the dilute copper sulphate solution.	
Cherry. —(Rot, aphid, curculio and slug.)	Before buds start, use copper sulphate solution. For aphid, kerosene emulsion.	When fruit has set, Bordeaux and Paris green.*	10 to 12 days later, if signs of rot appear, repeat.	10 to 12 days later copper sulphate solution, weak.	Repeat if necessary.
Current. —(Worms, mildew.)	As soon as worms are seen, Paris green.	If they reappear, repeat, adding Bordeaux for mildew.†	If worms still trouble, pyrethrum or hellebore.†		
Gooseberry. —(Mildew, worms.)	As leaves open, Bordeaux and Paris green.	In 10 to 14 days, repeat with both.	10 to 14 days later sulphide of potassium on English varieties.	10 to 14 days later, repeat if necessary.	If mildew persists after crop is gathered, Bordeaux.
Grape. —(Flee-beetle, fungous diseases.)	Before buds burst, copper sulphate solution and Paris green.	When first leaves are half grown, Bordeaux and Paris green.	As soon as fruit has set, repeat.*	10 to 14 days later, Bordeaux mixture, if disease is present.	If necessary, very weak copper sulphate solution.
Nursery Stock. —(Fungous diseases.)	When buds burst, Bordeaux.	Repeat at intervals.	of 10 to 14 days.		
Peach, Apricot. —(Leaf-curl, curculio, mildew and rot.)	Before bud swell, copper sulphate solution.	As soon as fruit has set, Bordeaux and Paris green.*	10 to 12 days later, repeat.	10 to 12 days later, repeat.	If rot persists, use very weak copper sulphate solution every 5 to 7 days.†
Pear. —(Leaf-blight, scab, psylla and codling moth.)	Before buds start, copper sulphate solution.	Within a week after blossoms fall, Bordeaux and Paris green.	10 to 12 days later, repeat.	10 to 16 days later, Bordeaux.	10 to 16 days later, Bordeaux.†
Plum. —(Black knot, rot and all fungous diseases, curculio.)	As buds start copper sulphate solution. Cut out knot and burn.	When fruit has set, Bordeaux and Paris green.	10 to 12 days later, repeat.	10 to 20 days later, Bordeaux.	Weak copper sulphate solution, as is necessary.
Potato. —(Beetles, scab, blight.)	For scab soak seed in corrosive sublimate solution (2 oz. in 16 gallons of water for 90 minutes.)	When beetles or their larvae appear, Paris green (1 pound to 100 pounds of plaster.)	Repeat whenever necessary.	When blight of the leaves is accompanied by rot of the tubers, Bordeaux.	Repeat if necessary.
Quince. —(Leaf and fruit spot, rot.)	Before buds start, copper sulphate solution.	When fruit has set, Bordeaux and Paris green.*	10 to 12 days later, repeat.	10 to 20 days later, Bordeaux.	Bordeaux or copper sulphate sol., as is necessary.
Raspberry, Black-berry. —(Anthracnose, rust.)	Cut out badly diseased canes. Spray with copper sulphate solution before growth starts.	When new canes are one foot high spray with Bordeaux mixture.	10 to 14 days later, weak copper sulphate solution.	When crop is gathered, remove old canes thin new ones and spray with Bordeaux mixture.	
Rose. —(Mildew, black spot, red spider, aphid.)	Mildew: Keep heating pipes painted with equal parts lime and sulphur mixed with water to a paste	Black spot: Spray plants once a week with weak copper sulphate.	Red spider: Kerosene emulsion to under side of foliage.	Aphid: Kerosene emulsion.	
Strawberry. —(Rust.)	Just before blossoms open, Bordeaux and Paris green.	When fruit has set, Bordeaux* or weak copper sulphate solution.	As soon as berries are harvested, Bordeaux (if to be kept longer)		
Tomato. —(Rot and blight, worms.)	When first fruits have set, Bordeaux.	If disease appears, repeat* or use weak copper sulphate solution.	If necessary, spray with weak copper sulphate solution.		
Violet. —(Blight, red spider.)	When blight is first seen, weak copper sulphate. Kerosene emulsion for insects.	Repeat at intervals of 10 to 20 days, as necessary for blight.	NOTE.—Use kerosene emulsion, very weak.		

SPECIAL NOTES.

For BLACK KNOT on cherries and plums, cut out and destroy by burning the diseased parts as soon as discovered.

For APHIS on all plants use kerosene emulsion.

If RED RUST appears the entire stools affected should be cut out and burned.

YOUNG PLANTS should be sprayed with Bordeaux mixture at the time of the first and third applications to bearing plants.

EXPLANATION.—WHENEVER AN ASTERISK (*) IS USED IT CAUTIONS AGAINST SPRAYING WITH POISONS WHILE THE PLANTS ARE IN BLOSSOM. A DAGGER (†) INDICATES THAT THERE IS DANGER OF MAKING AN APPLICATION WITHIN THREE WEEKS OF THE TIME THE FRUIT IS TO BE USED AS FOOD. While the number of applications recommended will be found desirable in seasons when the fungi are particularly troublesome, a smaller number may often suffice.

FUNGICIDES.

COPPER SULPHATE SOLUTION.

Copper Sulphate.....1 lb.
Water.....25 gals.

For use ONLY BEFORE THE BUDS OPEN. It is ready for use as soon as dissolved in water.

BORDEAUX MIXTURE.

Copper Sulphate.....4 lbs.
Quick Lime.....4 lbs.
Paris Green (for leaf-eating insects).....4 oz.
Water (1 barrel).....40-50 gals.

To prevent potato rot, 6 lbs. of copper sulphate is used instead of 4.

AMMONIACAL COPPER CARBONATE.

Copper Carbonate.....5 oz.
Ammonia.....2 qts.
Water (1 barrel).....40-50 gals.

For use late in season when Bordeaux mixture may stain the fruit. It is also best adapted for green-house spraying.

INSECTICIDES.

KEROSENE EMULSION.

Kerosene (coal oil).....
Rain Water.....
Soap.....

To be diluted before use sucking insects.

Paris
I



BALTIMORE HIGH WHEEL
LAWN MOWER

*Keller & Co.
Pittsboro.*