

Historic, archived document

Do not assume content reflects current scientific knowledge, policies, or practices.

Fig. 1 Garden Phlox

FARQUHAR'S Catalogue

Spring
1904

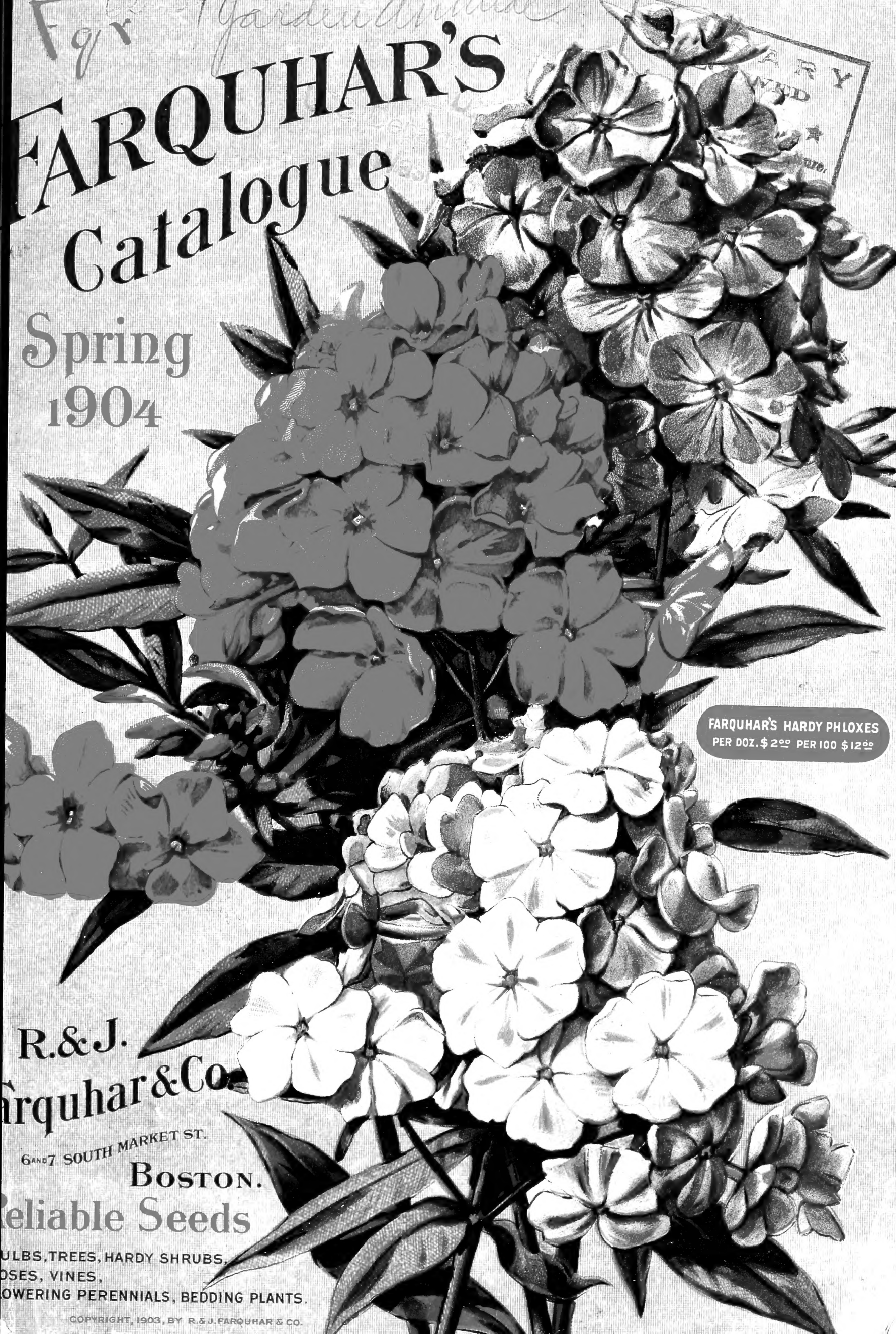

FARQUHAR'S HARDY PHLOXES
PER DOZ. \$ 2.00 PER 100 \$ 12.00

R. & J.
Farquhar & Co.

6 AND 7 SOUTH MARKET ST.

BOSTON.

Reliable Seeds

BULBS, TREES, HARDY SHRUBS,
ROSES, VINES,
FLOWERING PERENNIALS, BEDDING PLANTS.

1904.

R. & J. FARQUHAR & CO.

(Established 1884.)

ANNUAL SPRING CATALOGUE

OF

Reliable Seeds, Bulbs, and Plants.

QUALITY OUR FIRST CONSIDERATION.

Index, page 144.

SEEDS POST-PAID BY MAIL. We send seeds *free of postage* to any part of the United States, at ounce or packet prices. All heavy seeds, such as peas, beans, corn, clover, roots, tubers, etc., we do not send free, as such are quoted at net prices at our store. If these are desired by mail, purchasers should remit an additional sum for postage at the rate of *eight cents per pound, or fifteen cents per quart.*

POSTAGE ON SEEDS TO CANADA. We send flower seeds at packet prices, **FREE OF POSTAGE**, to any post-office in Canada. On seeds by weight or measure, and Vegetable Seeds in packets, the postage is *sixteen cents per pound*, which the purchaser should remit.

PLANTS BY EXPRESS. Plants are now carried by the leading express companies at a discount of twenty per cent. from the regular merchandise rates. It is, therefore, much better to send them by express than by mail; better specimens can usually be sent.

ORDER EARLY. It is very important that you send your orders as early as possible on receipt of this catalogue. We aim to ship all orders the same or next day after receipt, but during the busy season it is almost impossible, hence the importance of ordering early.

PRICES AND TERMS. The prices quoted are those ruling at this date, and are **SUBJECT TO FLUCTUATION** without notice; they do not include transit except where so stated. Our terms of payment are net cash.

Quotations with samples will be cheerfully given for such variable articles as Grass and Clover Seeds.

LIBERAL PREMIUM ON SEEDS IN PACKETS. When the order is accompanied by the money, purchasers of seeds in packets at catalogue prices may select **25 CENTS' WORTH EXTRA PACKETS FOR EACH \$1.00 SENT.** Thus, any one enclosing **\$1.00 MAY ORDER SEEDS IN PACKETS AMOUNTING TO \$1.25.** Two dollars sent us with the order will pay for seeds **IN PACKETS** amounting to \$2.50, and so on. This offer does **NOT** include seeds in collections, by weight or measure, bulbs, plants, or anything excepting seeds in packets.

SEEDS BY WEIGHT AND MEASURE. Except where otherwise priced, one-fourth bushel will be sold at bushel rates; one-half pound at pound rates. The smallest quantity of seeds we weigh is 10 cents' value, but 5-cent *packets* of almost all common varieties can be had.

BAGS AND PACKING. No charge for boxes or packing, nor for delivery to Freight Depots or Express Offices. Two Bushel Cotton Bags only we charge for at 20 cents each, and if returned in good condition free of expense, they will be credited as charged.

NAME AND ADDRESS. We frequently receive orders without the name of the sender or with insufficient address. Customers should be particular to give the full **NAME, POST-OFFICE, COUNTY, AND STATE**, number of street or P. O. Box, and the **NEAREST EXPRESS OFFICE.**

GARDENERS AND FARMERS. Parties requiring the services of reliable men, married or single, should consult with us, as we have the names of a number on our register, thoroughly experienced in every branch of the business. We have the largest acquaintance among gardeners of any firm in New England, and it is seldom that any one who applies to us fails of getting the right party. No fee.

NON-WARRANTY.

R. & J. Farquhar & Co. give no warranty, express or implied, as to description, quality, productiveness, or any other matter of any seeds, bulbs, or plants they send out, and they will not be in any way responsible for the crop. If the purchaser does not accept the goods on these terms, they are at once to be returned.

R. J. Farquhar & Co.

BOSTON, JANUARY 1, 1904.



Farquhar's Reliable Vegetable Seeds

ARTICHOKE.

✓ LARGE GREEN GLOBE.

A most delicious vegetable, which will become more popular when better known. The large Green Globe variety is of better quality and gives more edible part than the common sort. The edible part is the undeveloped flower head, which may be eaten raw or used as a salad. Plants set out in April or May 3 ft. x 3 ft. will produce heads in July and continue to do so until the end of October. It will only produce a partial crop the first season, but being a perennial, will remain in bearing for years in the same bed. As soon as the head is taken off, the stalk should be cut down close to the main stock or root. Succeeds best in a very rich, light, moist soil. Should have protection in winter in our northern climate.

PLANTS, .20 each; \$2.00 per dozen.

SEEDS, .10 pkt.; .35 oz.; \$3.50 per lb.

✓ LARGE GLOBE OR PARIS. The best of all Artichokes; .15 pkt.; .75 oz.

✓ JERUSALEM ARTICHOKE. (*Helianthus tuberosus*.) Cultivated for its tubers; .20 qt.; qt. by mail, .35; \$1.00 peck.

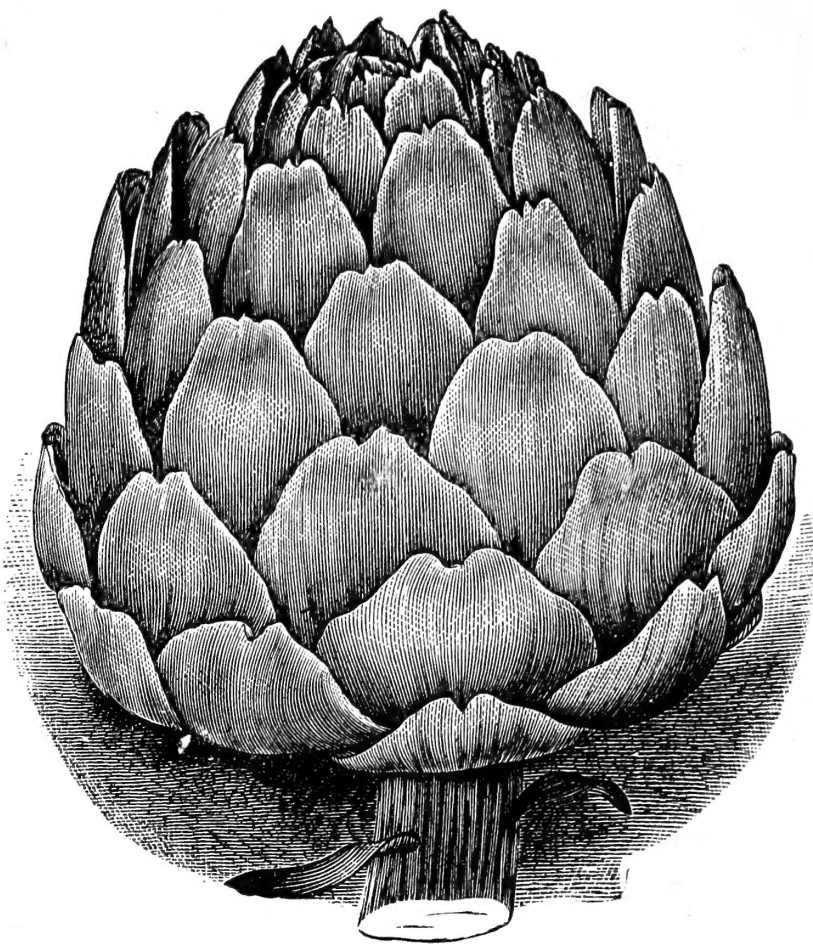

Artichoke, Large Green Globe.

ASPARAGUS. (*Spargel*.)

This is one of our most delicious vegetables, and when proper care is taken in making the beds and setting the plants, they will continue productive for many years.

CULTURE. The permanent bed should be trenched or ploughed very deeply, and well manured with rich, thoroughly decayed manure. Wide drills should then be made three feet apart, and deep enough to admit of the top of the plants being covered six inches. Plants two years old may be purchased in spring, or may be produced from seed sown in drills one inch deep and a foot apart. Set the plants eighteen inches apart in the rows, carefully spreading out and separating the roots. For the sake of convenience, one drill should be made at a time, and the planting and covering completed before another is commenced. In November the plants should have their annual top dressing of manure after the stalks have been cleared away. The dressing should be forked in as soon as the ground can be worked in spring, and the bed neatly raked. *One ounce of seed sows sixty feet of drill.*

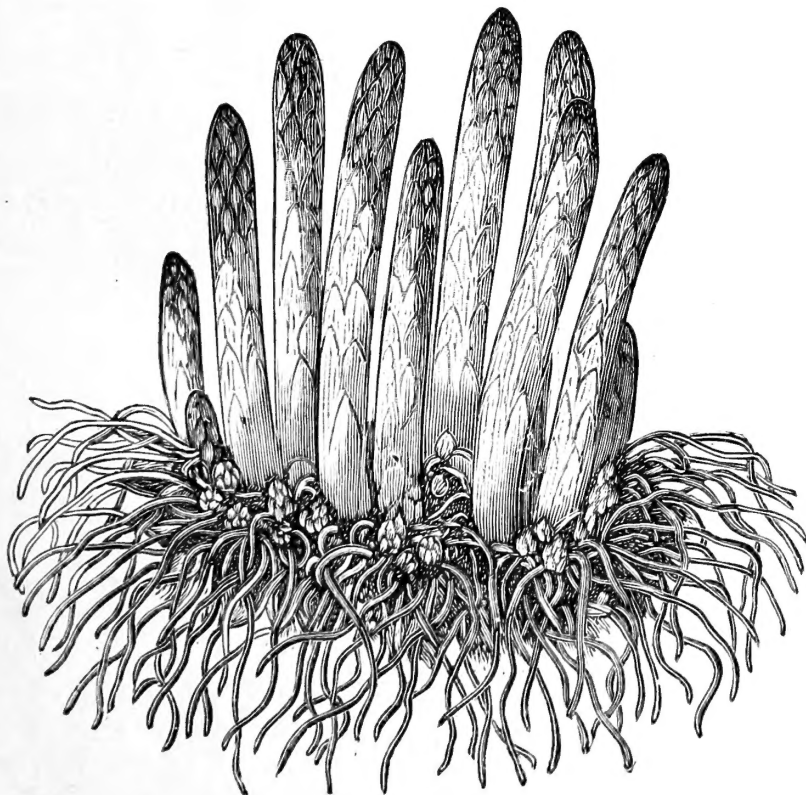

Asparagus.

	Pkt.	Oz.	¼ lb.	Lb.
✓ CONOVER'S COLOSSAL. A standard sort; early; large, and very prolific05	.10	.25	\$0.75
✓ COLUMBIAN MAMMOTH WHITE. Stalks clear white; large; distinct05	.10	.30	1.00

ASPARAGUS ROOTS. — APRIL DELIVERY.

✓ CONOVER'S COLOSSAL	Two years, per 100, \$1.00; per 1,000, \$7.00
✓ COLUMBIAN MAMMOTH WHITE	" " 1.25 " 7.50

BEANS, ENGLISH. (*Faba*.)

Plant six inches deep as early in spring as the ground can be worked. The rows should be three feet apart and the seed deposited four inches apart in the rows.

	Pkt.	Qt.	½ pk.	Pk.
✓ BROAD WINDSOR. The best variety; very hardy; height three feet10	.30	\$1.00	\$1.75

POLE BEANS.

	As Pkt.	Qt.	Peck.
✓ WORCESTER POLE. The best Pole Bean in cultivation; very early and remarkably productive. The long, beautifully-colored pods, striped and splashed brilliant crimson, hang in rich clusters. an early Shell Bean it is unequalled for tenderness and delicious flavor10	.35	\$2.00
✓ HORTICULTURAL, OR SPECKLED CRANBERRY. Similar in character to Worcester Pole, but smaller in every way, pods short, broad, pale green, but becoming streaked with bright red10	.30	1.75
✓ OLD HOMESTEAD. One of the best; pods yellow; extremely early and productive10	.35	2.00
✓ ARLINGTON RED CRANBERRY. Large, tender, stringless pods; very productive10	.30	1.75
✓ INDIAN CHIEF, OR WAX. Very tender stringless snap bean with yellow pods10	.35	2.00
✓ MONT D'OR, OR GOLDEN BUTTER. Early; yellow pods six to eight inches long10	.35	2.00
✓ LAZY WIFE. An excellent White Bean of good quality; long green pods10	.40	2.25
✓ DREER'S GOLDEN CLUSTER. Pods golden, very long, broad and succulent; early and delicious10	.40	2.25
✓ LARGE WHITE LIMA. One of the finest-flavored shell beans; late10	.35	2.00
✓ CHALLENGER LIMA. Thick and productive; one of the best; early10	.40	2.25
✓ KING OF THE GARDEN LIMA. Pods and beans large; productive and delicious10	.40	2.25
✓ DREER'S IMPROVED LIMA. Fine and productive; short, broad pods10	.40	2.25
✓ JERSEY EXTRA EARLY LIMA. The earliest of the large Limas10	.40	2.25
✓ SEIBERT'S EARLY LIMA. Recognized as the best of all Limas10	.40	2.50
✓ SIEVA, OR SMALL LIMA. Earlier and hardier than the large Lima10	.35	2.00
✓ DUTCH CASEKNIFE. Early; productive; good for string or shell10	.30	1.75
✓ WHITE RUNNER. Productive, early and hardy10	.40	2.00
✓ SCARLET RUNNER. Flavor excellent; very ornamental; flowers dazzling scarlet10	.40	2.00
✓ YARD LONG POD. Pods often 30 to 36 inches long; a curious and interesting variety10; 1/2 pint	.25	

BEET. (*Runkel Rube.*)

A sowing for an early supply should be made as soon as the ground can be worked in spring. For main crop, sow early in May, and for winter beets from the first to the third week in June. Sow in drills fifteen inches apart, and cover the seed one inch. Thin out the plants to six inches apart. The soil should be deeply manured and well cultivated. *One ounce of seed to fifty feet of drill; six pounds to one acre.*

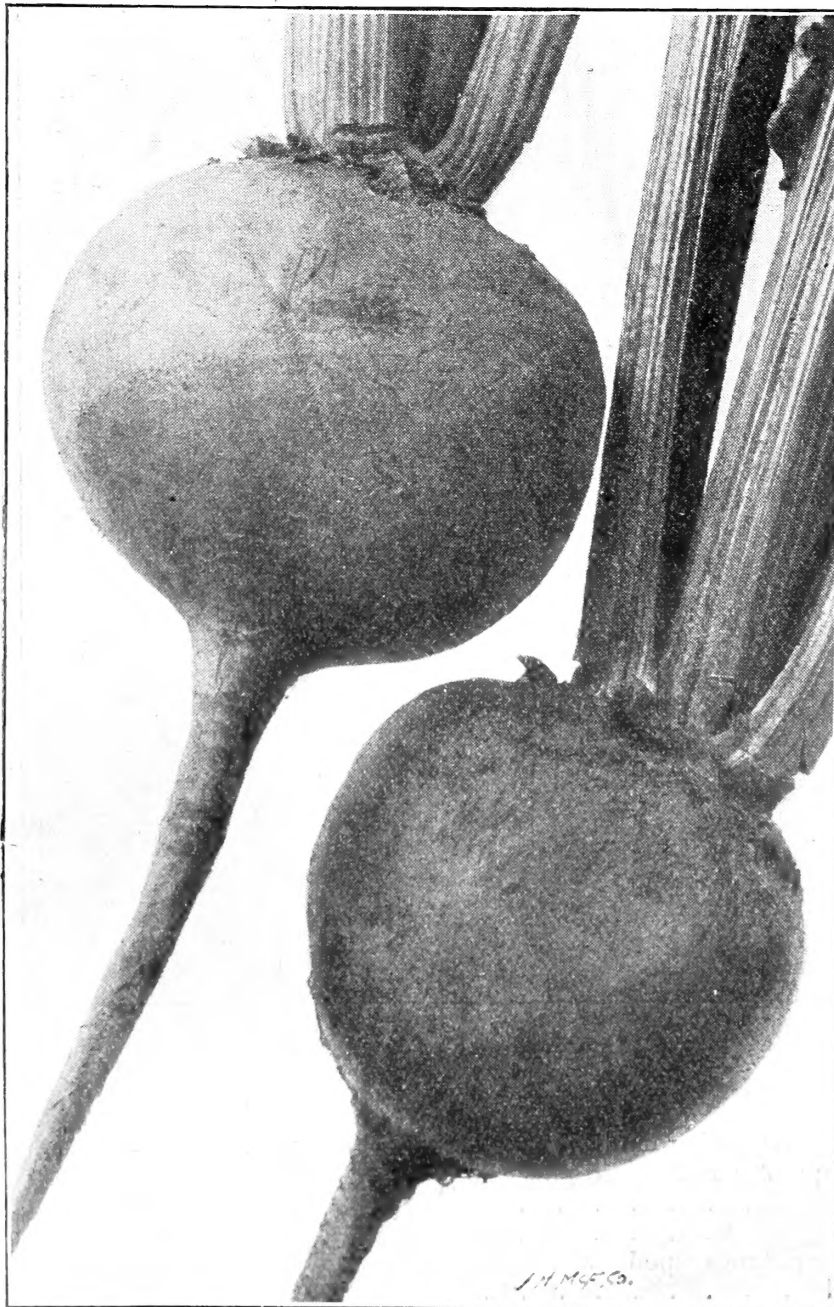

Early Eclipse Beet.

- ✓ IMPROVED EARLY EGYPTIAN. Remarkably smooth and fine-grain; dark; turnip-shaped; small top, small tap-root. Pkt., .05; oz., .10; 1/4 lb., .20; lb., .60.
- ✓ CROSBY'S EGYPTIAN. A very early and carefully selected strain of the original Egyptian. Pkt., .05; oz., .10; 1/4 lb., .30; lb., \$1.00.
- ✓ ARLINGTON FAVORITE. In form, flavor, and color unsurpassed for main crop. Pkt., .05; oz., .10; 1/4 lb., .25; lb., .75.
- ✓ BASTIAN'S EARLY. Of quick and large growth; bright red color. Pkt., .05; oz., .10; 1/4 lb., .15; lb., .50.
- ✓ EARLY BASSANO. Very early and tender; color light. Pkt., .05; oz., .10; 1/4 lb., .15; lb., .50.
- ✓ EDMANDS' EARLY TURNIP BLOOD. Beautiful round form and good size; flesh dark-red and of finest quality; a splendid keeper. Our stock is the purest and finest obtainable. Pkt., .05; oz., .10; 1/4 lb., .20; lb., .60.
- ✓ EARLY ECLIPSE. Very early; globe-shaped; flesh dark and tender. Pkt., .05; oz., .10; 1/4 lb., .20; lb., .60.
- ✓ CRIMSON GLOBE. Globular shaped Beet, with smooth surface; flesh deep crimson, excellent quality. Pkt., .05; oz., .10; 1/4 lb., .20; lb., .60.
- ✓ DEWING'S EARLY BLOOD TURNIP. Good color; medium size; smooth and handsome. Sweet and popular for main crop. Pkt., .05; oz., .10; 1/4 lb., .20; lb., .50.
- ✓ DETROIT RED. Round, of medium size and finest quality; very dark. Pkt., .05; oz., .10; 1/4 lb., .20; lb., .60.
- ✓ LONG SMOOTH BLOOD. Excellent dark-fleshed late sort; stands drought well. Pkt., .05; oz., .10; 1/4 lb., .20; lb., .50.
- ✓ PERPETUAL SPINACH. The leaves are delicious when cooked as "greens." Pkt., .05; oz., .10; 1/4 lb., .25; lb., .75.
- ✓ SWISS CHARD. Used as "greens;" the leaf stalks used as Asparagus. Pkt., .05; oz., .10; 1/4 lb., .25; lb., .75.
- ✓ BEET FOR GREENS. The small plants make delicious greens. Pkt., .05; oz., .10; 1/4 lb., .15; lb., .50.
- ✓ DELL'S BLACK LEAVED. Pkt., .05; oz., .15; 1/4 lb., .35; lb., \$1.25.

MANGEL WURZEL.

An invaluable crop for stock feeding. Highly relished by cattle, resulting in improved health and condition, increasing the yield of milch cows. Sow from April to June on well cultivated, deep, rich soil, in drills 24 to 30 inches apart. Six to 8 lbs. of seed are required per acre. Price of all varieties, .10 per oz.; .15 per $\frac{1}{4}$ lb.; .35 per lb.; 10 lbs. and upwards at .25 per lb. If by mail, add .08 per lb. extra for postage.

✓ MAMMOTH LONG RED.

The largest and heaviest cropper of all the long red sorts. It grows well out of the ground, and is easily harvested. Color blood red; a most valuable and distinct variety, and very popular on account of its nutritious and milk-producing qualities. Our seed is produced from the largest selected roots and is a most superior strain.

✓ GOLDEN TANKARD.

A greater weight per acre may be obtained from this variety than all other large growing sorts, being an excellent shape and of very neat habit. Flesh bright golden yellow, differing in this respect from all other varieties which cut white. Rich in saccharine matter and feeding properties.

✓ YELLOW GLOBE.

This variety has a very fine top and single tap root, adapted for growing in shallow soils. A less expensive sort to lift than the larger-growing varieties. Skin smooth, good size, and of excellent quality.

✓ RED GLOBE.

Very similar to Yellow Globe, but differing in color.

SUGAR BEET.

One of the best paying crops for stock feeding. When fed to milch cows will increase the flow and quality of the milk. They keep well throughout the winter. They are not such heavy yielders as Mangel Wurzel, but are of superior quality and rich in saccharine matter. Oz., .10; $\frac{1}{4}$ lb., .15; lb., .40. If by mail, add .08 per lb. extra for postage. 10 lbs. and upwards, .30 per lb.

✓ KLEIN WANZELEBEN.

The most popular variety; root conical, straight, and even; large shoulder, rapidly tapering to a point. Heavy yielder, remarkably rich in sugar.

✓ LANE'S IMPROVED.

An old standard sort, one of the most valuable for stock feeding. Hardy and productive.



Mangel Wurzel. Mammoth Long Red.

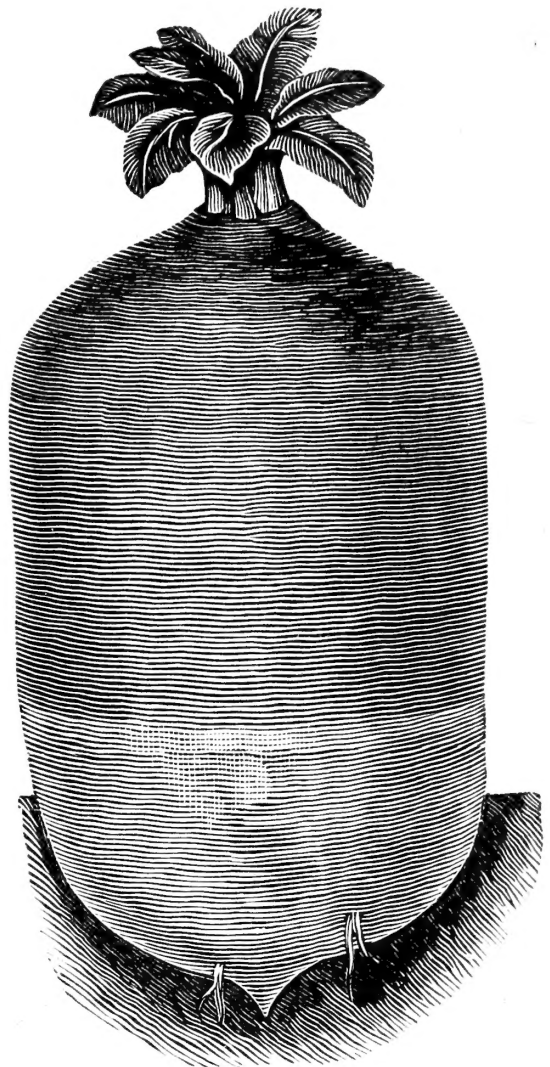

Mangel Wurzel. Golden Tankard.

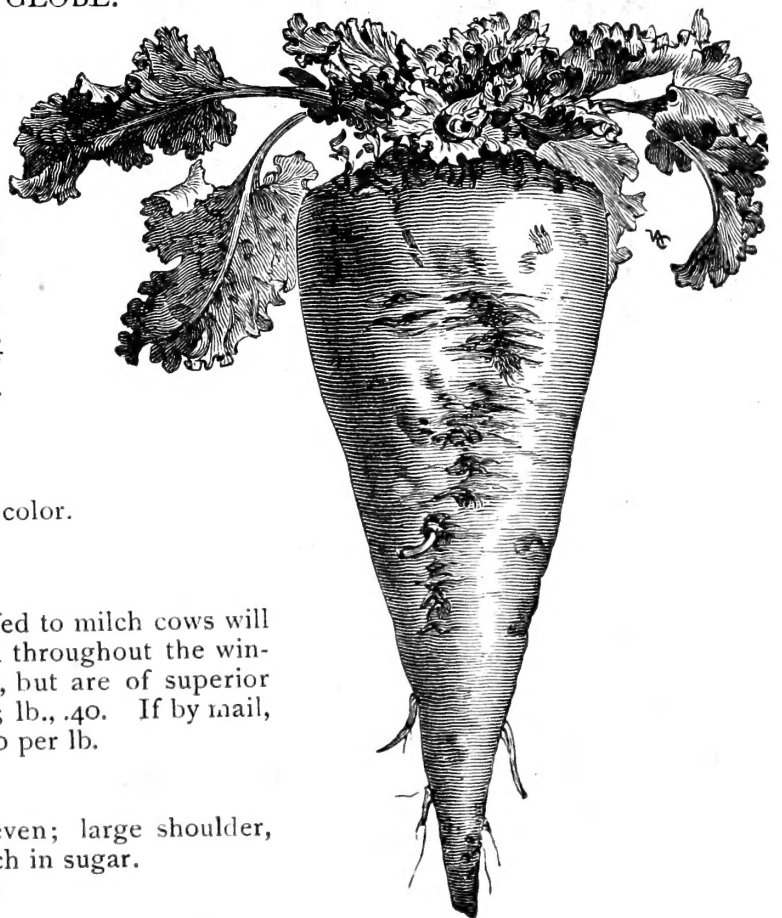

Sugar Beet. Klein Wanzeleben.

BROCCOLI. (*Spargel Kohl.*)

This vegetable resembles the Cauliflower, but is hardier.

✓ **WHITE CAPE.** Heads white, close, and compact; a standard sort.
Pkt., .10; oz., .40; ¼ lb., \$1.25; lb., \$4.00.

BRUSSELS SPROUTS. (*Sprossen Kohl.*)

Cultivate like Cabbage. It is ready for use late in autumn after the early frosts. *One ounce of seed produces about fifteen hundred plants.*

	Pkt.	Oz.	¼ lb.	Lb.
✓ AIGBÜRTH. The finest variety. In a trial of 33 sorts at Chiswick this sprout was placed first .	.05	.25	.75	\$2.50
✓ PARIS MARKET. Half-dwarf05	.20	.50	1.75
✓ SELECTED ENGLISH. Tender and rich05	.20	.60	2.00
✓ SCRYMGER'S GIANT. Large, compact sprouts05	.20	.50	1.75

CARDOON. (*Kardon.*)

Grown for the mid-ribs of the leaves, which are blanched in the same manner as Celery . . . Pkt., .05; oz., .25; ¼ lb., .75; lb., \$2.50

CARROT. (*Mochre.*)

Sow in April and May, in drills about half an inch deep and a foot apart. Thin out, leaving the plants from three to eight inches apart, according to variety. *One ounce of seed is sufficient for one hundred feet of drill; three to four pounds for an acre.*

✓ EARLIEST SCARLET FRENCH FORCING. For forcing; small, round, and tender	Pkt., .05; oz., .20; ¼ lb., .50; lb., \$1.75
✓ EARLY SCARLET HORN. Thick roots of medium size and fine color. Pkt., .05; oz., .15; ¼ lb., .40; lb., \$1.25	
✓ GUERANDE, OR OX HEART. Short; thick; much larger than Early Horn	Pkt., .05; oz., .15; ¼ lb., .40; lb., \$1.25
✓ CHANTENAY. Form half long; stump-rooted; fine-grained; small core. Pkt., .05; oz., .15; ¼ lb., .40; lb., \$1.25	
✓ DANVERS HALF-LONG. Selected. Best main crop variety; fine form and color; half-long with small tap-root; productive and keeps well	Pkt., .05; oz., .10; ¼ lb., .30; lb., \$1.00
✓ IMPROVED LONG ORANGE. Roots large and long; enormous yielder. Splendid for stock. Pkt., .05; oz., .10; ¼ lb., .30; lb., \$1.00	
✓ WHITE BELGIAN. Large, long-rooted variety; valuable for stock	Pkt., .05; oz., .10; ¼ lb., .20; lb., .60



Scrymger's Giant Brussels Sprouts.

Pkt., .05; oz., .15; ¼ lb., .50; lb., \$1.50
Splendid for stock.
Pkt., .05; oz., .10; ¼ lb., .30; lb., \$1.00
Pkt., .05; oz., .10; ¼ lb., .20; lb., .60

CELERIAC.

✓ **CELERIAC, ERFURT GIANT.** (Turnip rooted.) The round, solid heads are used as a salad when boiled and sliced. Pkt., .05; oz., .20; ¼ lb., .60; lb., \$2.00

CHERVIL. (*Gartenkerbel.*)

✓ **CURLED CHERVIL.** The young plants are used for flavoring . Pkt., .05; oz., .10; ¼ lb., .30; lb., \$1.00

CRESS, OR PEPPERGRASS.

(*Kresse.*) Used as salads and for garnishing.

✓ EXTRA CURLED. Excellent for salads; sow in shallow drills one foot apart and make successive sowings every ten days. Pkt., .05; oz., .10; ¼ lb., .20; lb., .50
✓ UPLAND. A perennial variety, similar in taste to the Water Cress. Pkt., .05; oz., .10; ¼ lb., .25; lb., .75
✓ WATER. Sow in damp soil or by the side of a pond or stream of water . Pkt., .10; oz., .50; ¼ lb., \$1.25

CHICORY. (*Cichorien.*)

The young leaves, when blanched, are used for salads.
Pkt., .05; oz., .10; ¼ lb., .30; lb., \$1.00

CHIVES.

Grown for their tops, which are used wherever the flavor of onion is required. Perfectly hardy, and should be in every garden.

✓ CHIVES; ROOTS. Per bunch, .15; 6 bunches, .75; 12 bunches, \$1.25. By mail, add 5 cents each extra.
✓ CHIVES, SEED. Pkt., .20; oz., .75; ¼ lb., \$2.50; lb., \$7.50

CORN SALAD. (*Ackersalat.*)

✓ **ROUND-LEAVED.** Used as a salad.
Pkt., .05; oz., .10; ¼ lb., .20; lb., .50

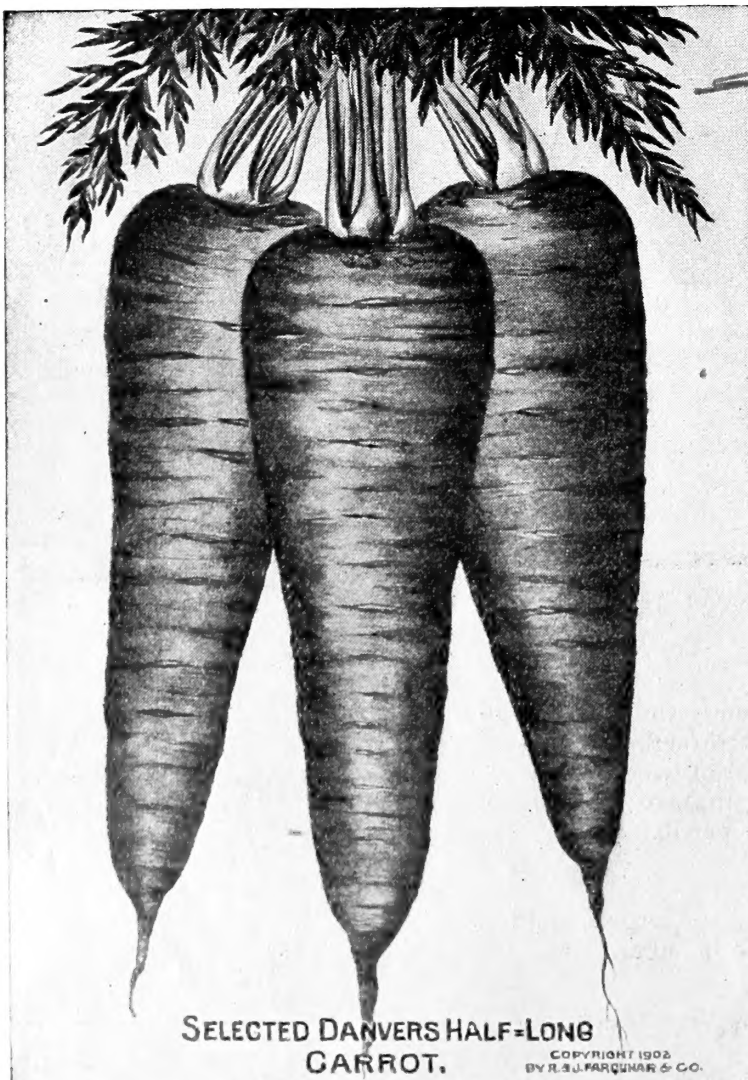

SELECTED DANVERS HALF-LONG
CARROT.

COPYRIGHT 1902
BY R. J. FARQUHAR & CO.

CABBAGE. (*Kopfkohl.*)

CULTURE. For very early use sow in January or February in hot-beds, prick out when the plants are strong enough into other hot-beds, or sow in cold frames in March. Transplant to the open ground when danger from killing frosts has passed, in rows two feet apart and eighteen inches from plant to plant. For succession, sow in the open ground the last of March or early in April. Plants which have been sown in the autumn and wintered over in cold frames are usually set out from the middle of March to the middle of April, in rows about two feet apart and the plants eighteen inches apart. The autumn and winter varieties may be sown in April or early in May in shallow drills three or four inches apart; transplant early in July, making the rows about two and a half feet apart, and setting the plants two feet apart in the rows. Cabbage succeeds best in a fresh, rich soil, well manured and deeply dug or plowed. The late plants are subject to attacks of the cabbage fly, which destroys them as fast as they appear above ground. To preserve the plants, sprinkle them early in the morning while they are wet with dew, with slug-shot or tobacco dust. Dalmatian Insect Powder sprinkled on the plants will keep off the cabbage worms. *One ounce of seed produces about thirty five hundred plants.*

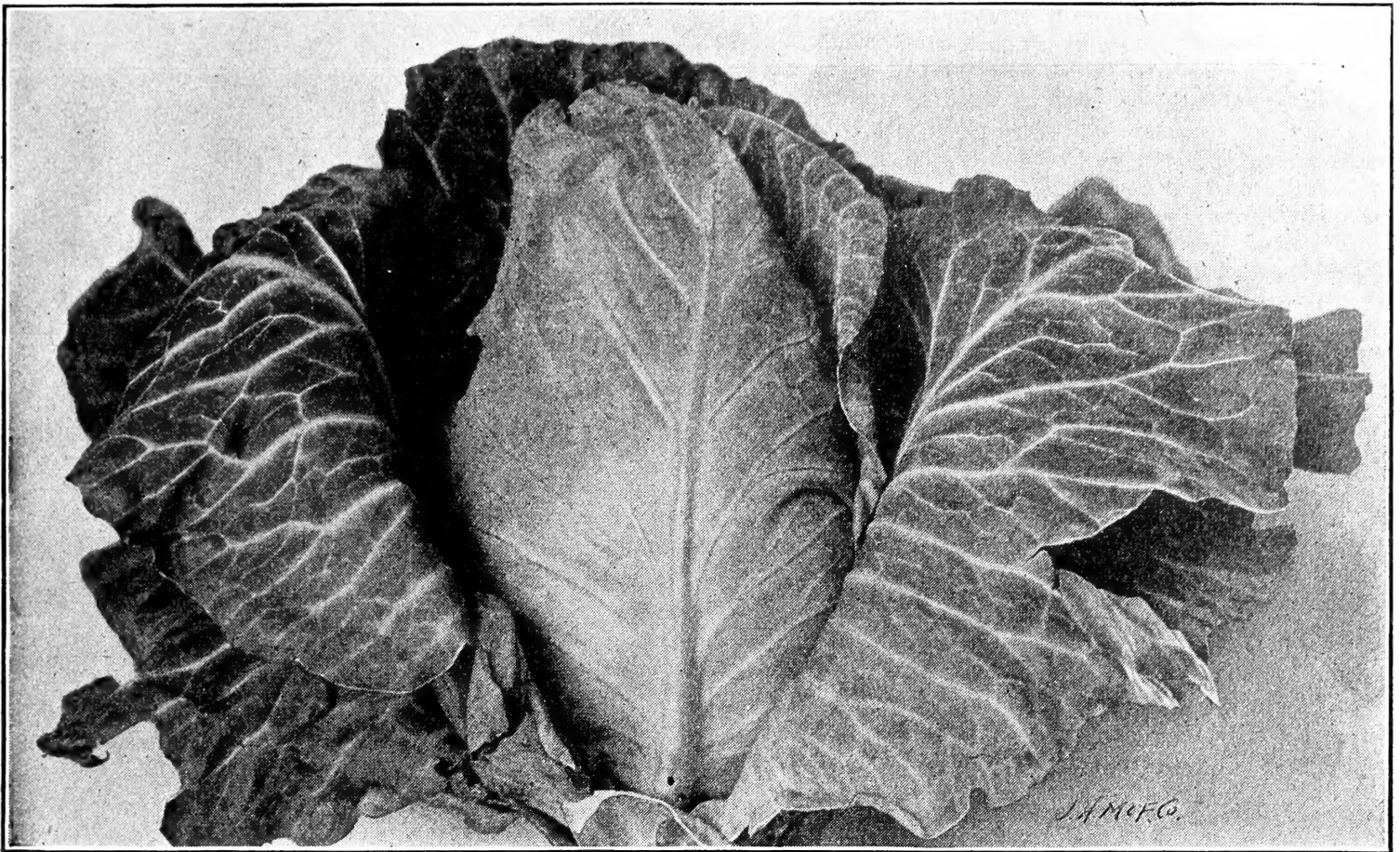

Early Jersey Wakefield Cabbage.

	Pkt.	Oz.	¼ lb.	Lb.
✓ EARLY SPRING. A round, flat-headed, extra early variety, coming in with the <i>Wakefield</i> . The heads are exceedingly uniform and very solid, even when quite young10	.40	\$1.25	\$4.00
✓ EXPRESS EXTRA EARLY. The earliest; medium sized solid heads; tender and delicious05	.20	.60	2.00
✓ VERY EARLY ETAMPES. Solid, pointed head; very dwarf; may be planted close05	.20	.60	2.00
✓ WINNIGSTADT. Pointed head, adapted for light soils; medium early05	.20	.60	2.00
✓ EARLY YORK. Solid and very early; a standard old sort; small05	.15	.50	1.50
✓ EARLY JERSEY WAKEFIELD. Early and sure-heading; pyramidal shape05	.25	.75	2.50
✓ CHARLESTON WAKEFIELD. A large strain of the foregoing10	.30	.85	3.00
✓ EARLY SUMMER. The best second-early sort; large and solid heads05	.20	.60	2.00
✓ SUCCESSION. Very fine for second-early or late crops05	.25	.75	2.50
✓ ALL SEASONS; SELECTED. Excellent for main crop; large; reliable header05	.20	.60	2.00
✓ ALL-HEAD. Earliest of the large cabbages; heads uniformly solid. Splendid sort10	.30	1.00	3.00
✓ FOTTLER'S IMPROVED BRUNSWICK. Our stock of this useful main crop cabbage is unsurpassed, the heads often weighing twenty to thirty pounds; large, very solid and tender when cooked; stem short and small; reliable header10	.30	1.00	3.00
✓ WARREN'S STONE-MASON. A greatly improved type of Stone-Mason, being earlier, rounder, and more solid10	.35	1.00	3.50
✓ STONE-MASON DRUMHEAD. A standard late sort; heads very solid; fine keeper10	.35	1.00	3.50
✓ PREMIUM FLAT DUTCH. Well known late sort with large flattened heads05	.20	.60	2.00
✓ AUTUMN KING. One of the largest and finest winter cabbages05	.25	.75	2.50
✓ MARBLEHEAD MAMMOTH. Late; the largest cabbage grown; solid; excellent keeper05	.25	.75	2.50
✓ PERFECTION SAVOY. Large and finely curled heads; compact grower; excellent keeper05	.20	.50	1.75
✓ IMPROVED AMERICAN SAVOY. Finely curled, solid, round heads; fine flavor05	.20	.60	2.00
✓ DRUMHEAD CURLED SAVOY. The largest of the Savoys; fine keeper05	.25	.75	2.50
✓ EARLY DARK RED DUTCH. Remarkably solid; beautiful dark color; fine texture10	.30	.85	3.00
✓ DARK RED DRUMHEAD. Heads very dark red, round and solid; choice stock10	.30	.85	3.00
✓ MAMMOTH ROCK RED. The largest red, very solid, color deep10	.35	1.00	3.50
✓ DANISH BALLHEAD. The favorite winter cabbage. One of the hardiest Cabbages in cultivation, and endures both frost and drought that would destroy other varieties. The hardest heading cabbage we know of and of the very best quality10	.35	1.00	3.50
✓ PET-SAI, OR CHINESE CABBAGE. This plant bears a loose, lettuce-like head of crisp leaves with pure white stalks, which are used like cabbage10	.35		

CABBAGE PLANTS. READY IN JUNE. .20 per doz.; \$2.00 per 100.

Early Jersey Wakefield, Early Summer, Fottler's Brunswick, and Stone Mason.

CAULIFLOWER. (*Blumen Kohl.*)

The Cauliflower is the most delicious of all *Brassicas*, and succeeds well in any soil where Cabbages will grow. It delights in a rich soil and abundance of water. By sowing the early varieties in a hot-bed in February or March, or later in a cold frame, fine heads can be obtained quite early. For a later supply, sow seed in a prepared bed in May, choosing a cool, moist place. When large enough, transplant, making the rows about two and a half feet apart and eighteen inches between the plants. Transplanting should be done in moist weather. In dry seasons the crop must be watered. The young plants are frequently attacked by a little black beetle; its ravages may be stopped by frequent applications of plaster in the morning while the dew is on. For the cabbage-worm, apply Dalmatian Insect Powder. *One ounce of seed produces about three thousand plants.*

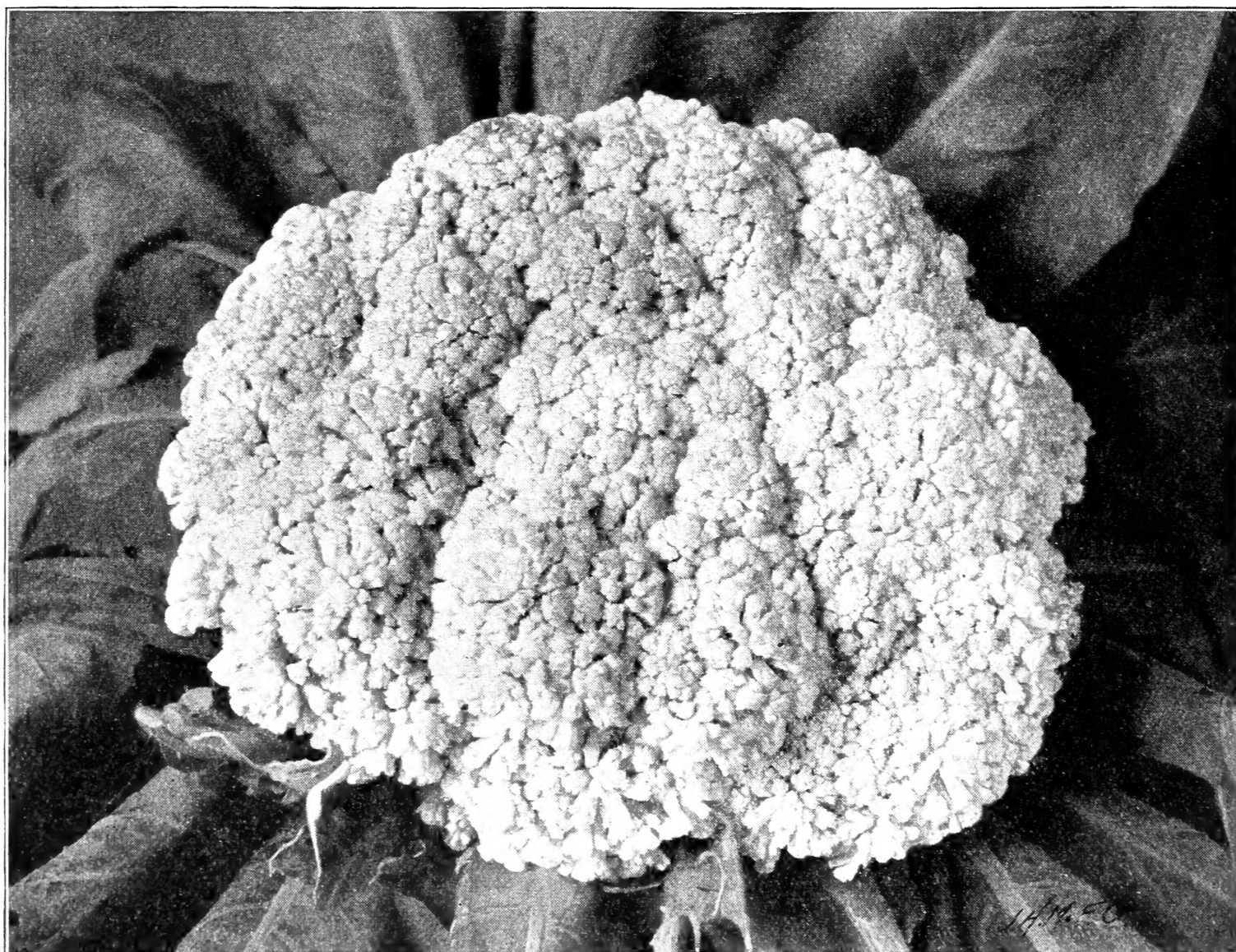

✓ FARQUHAR'S EARLIEST DWARF ERFURT CAULIFLOWER.

BEST FOR EARLY, BEST FOR LATE, BEST FOR FORCING, AND THE SUREST HEADER OF ALL.

This strain is grown especially for us, by the most reliable grower in Northern Europe, where the finest type and quality of Cauliflower is grown. The trade we have for Cauliflower Seed is large. Our customers consist of private and market gardeners and large growers. Every effort is made to secure the best there is in Cauliflower as well as in all other seeds. Good seed is absolutely necessary for success in growing Cauliflower. Our seed is most carefully grown, and with reasonable care every plant will produce a fine head

	Pkt.	¼ oz.	Oz.	¼ lb.
✓ KRONK'S PERFECTION DWARF ERFURT. A very early, carefully selected strain with large, solid, and beautiful heads; one of the most reliable croppers25	\$1.00	\$3.00	\$10.00
✓ ERFURT EARLIEST DWARF. A very early, reliable sort, almost every plant producing a fine, large, white head; plants are low with small leaves20	.75	2.50	7.50
✓ EARLY SNOWBALL. Of dwarf habit; heads white and solid; largely grown for early crops.20	.85	3.00	10.00
✓ AUTUMN GIANT. The finest late variety in cultivation. Vigorous and very large05	.15	.35	1.00

TILDEN BROS., Scituate, Mass., write, January 18:

"The Cauliflower Seed we bought of you last spring did remarkably well, the best in Scituate, and were considered as good by good judges as any on the street in Boston market. Pulsifer, Savage & Co. handle a good many of them."

W. H. TEELE, West Acton, Mass., writes, October 30:

"I grow my best Cauliflower year after year from your seed. This year again your seed was the best I had and I took the special Cauliflower Prize, also the first prize at the Exhibitions of the Mass. Horticultural Society."

CAULIFLOWER PLANTS. Ready in June. .25 per dozen; \$1.50 per 100.

CELERY. (*Seleri.*)

Sow the seeds in March or April in a hot-bed or cold frame. As soon as the plants are three inches high, transplant into a prepared border, setting them four inches apart. When grown six inches, and fine stockv plants, set in richly manured, deep soil, in rows three and a half feet apart, and about nine inches from plant to plant. Water, if dry weather follows transplanting. During the next two months all the attention required is to keep down weeds. Afterwards earth up a little, and continue doing so at intervals until only the tops of the leaves are visible late in autumn. Never hoe or earth up when the plants are wet. *One ounce of seed produces about four thousand plants.*

Pkt. Oz. ¼ lb.

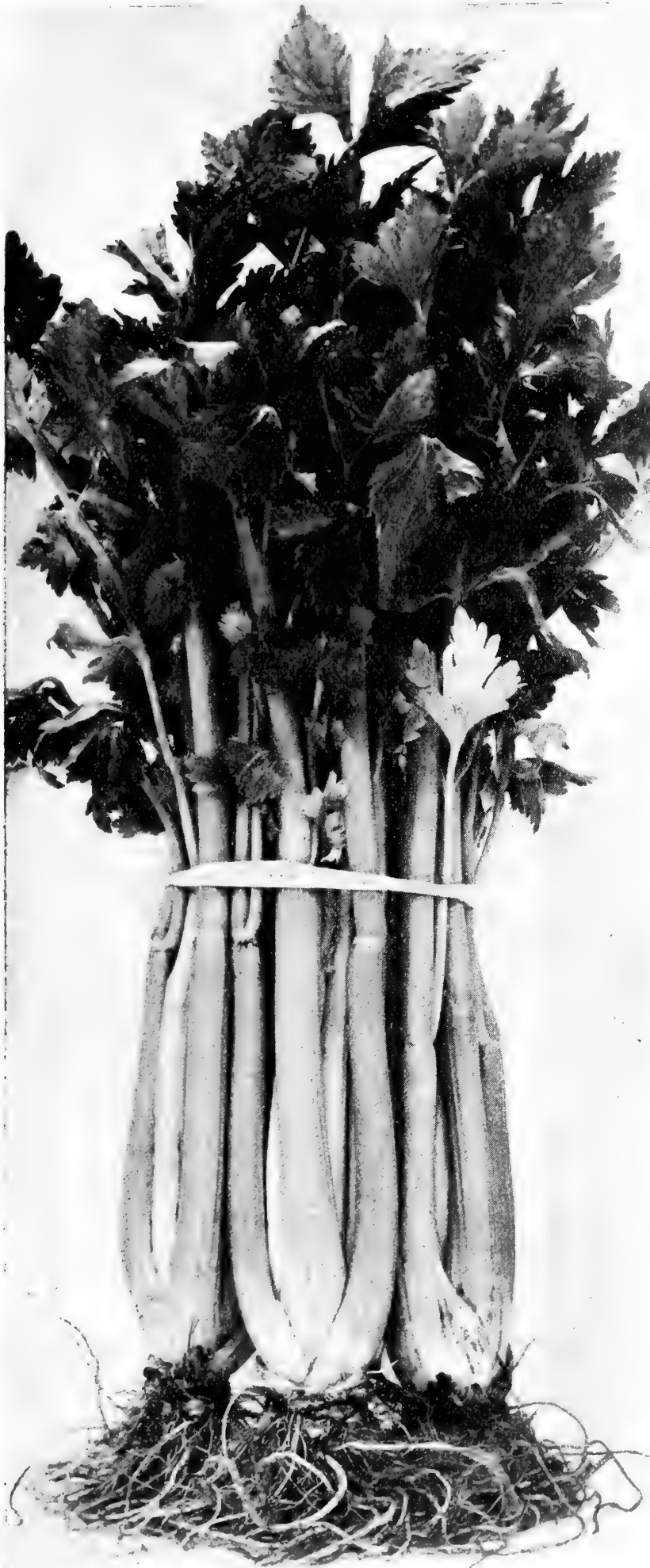

COPYRIGHT 1902 BY R. & J. FARQUHAR & CO.

Crosby's Original Boston Market Celery.

Engraved from a photograph.

✓ CROSBY'S ORIGINAL BOSTON MARKET. The finest-flavored variety in cultivation; solid, crisp, and of excellent, nutty flavor; dwarf, branching habit; blanches perfectly white; a splendid keeper; fine home-grown seed.

The purity and quality of our seed may be relied upon. Celery is an important crop; and as an ounce of seed produces several thousand plants, this, the best, will prove to be the cheapest

- ✓ PERFECTED WHITE PLUME. Best for early use; the stalks and portions of the leaves, being naturally white, are fit for table early in the season; fine stock . . .15 .75 \$2.00
- ✓ PARIS GOLDEN SELF-BLANCHING. (Large Solid Yellow.) One of the finest in cultivation; very early, very solid; crisp, with fine nutty flavor. Imported originator's seed of best quality . . .10 .50 1.50
- ✓ ROSE RIBBED PARIS GOLDEN SELF-BLANCHING. A Celery of very high quality, in character resembling the previous variety: Color rich yellow with rose-tinted ribs. Stalks almost stringless; very tender, crisp, and of good flavor . . .10 .35 1.00
- ✓ GIANT PASCAL. An easily-blanched and fine-keeping sort of excellent flavor. It grows about two feet high, the stalks being broad, thick, crisp, and stringless. It is of wonderful keeping qualities and almost entirely rust-proof. Highly recommended . . .05 .20 .50
- ✓ CARTER'S DWARF CRIMSON. Crisp, tender, and delicious; stalks beautifully rose-tipped . . .10 .35 1.00

CELERY PLANTS.

READY IN JUNE.

BOSTON MARKET, WHITE PLUME, GOLDEN SELF-BLANCHING.

.20 per doz.; \$1.00 per 100; \$7.50 per 1,000.

Messrs. R. & J. Farquhar & Co.:

Gentlemen: I have seen Celery that was purchased from different firms, and all who have seen mine and bought plants of me pronounce yours the cleanest and truest to name.

White Plume and Golden Self-Blanching were extra good: the two varieties mostly grown here.

Brattleboro, Vt., Feb. 21st.

D. MCGILLIVRAY.

NEW SWEET CORN "PEEP O' DAY."

TEN DAYS EARLIER THAN ANY OTHER VARIETY.

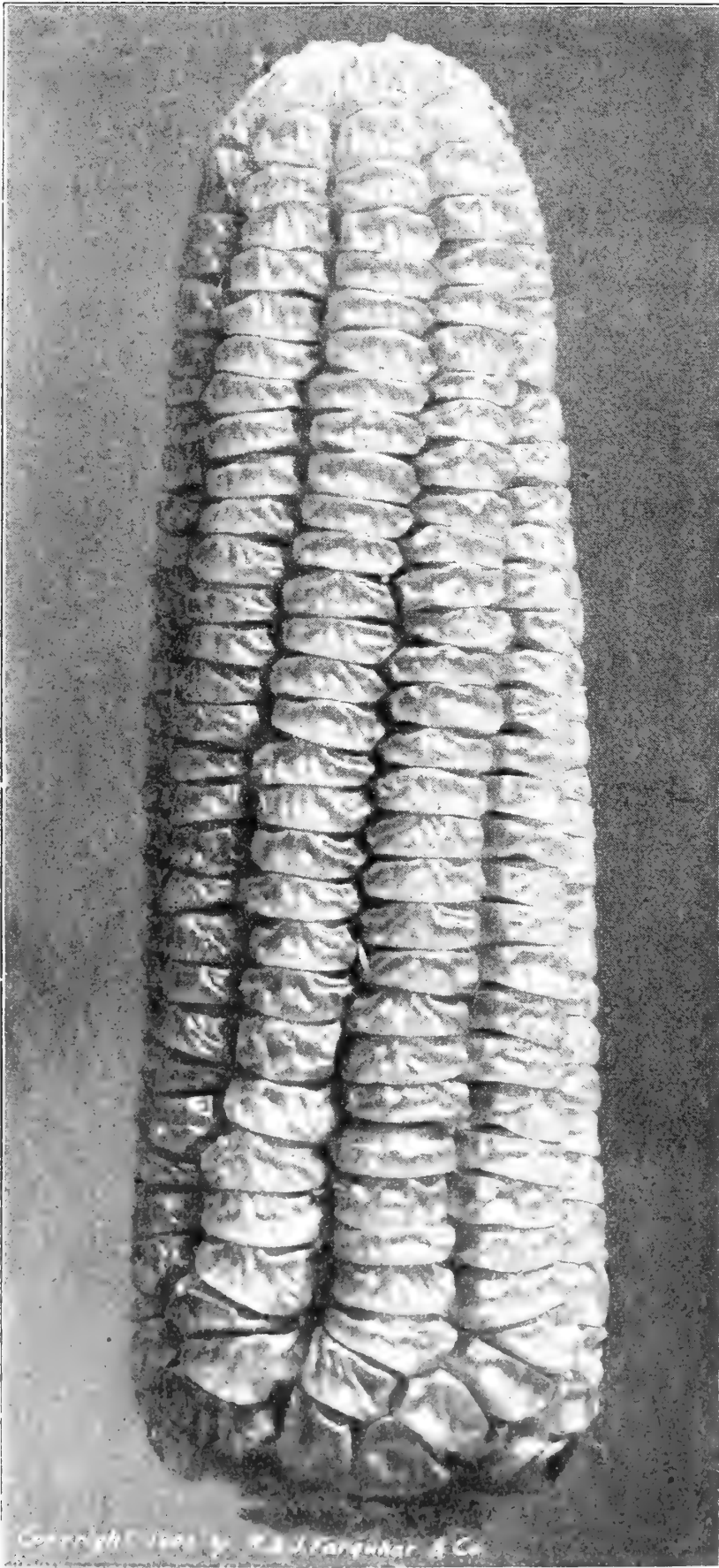

Peep o' Day Sweet Corn.

What product of the garden is so eagerly awaited as the first Sweet Corn of the season? — not the tasteless, discouraged, premature corn, shipped from long distances, worthless when picked and unfit for food when it arrives, but the real, tender, juicy Sweet Corn ready for use before the summer has really commenced. Such a Sweet Corn is Peep o' Day.

Other characteristics of the Peep o' Day in addition to its extreme earliness are its tenderness and sweetness, surpassing in these particulars any other early Sweet Corn.

DESCRIPTION AND CULTIVATION.

The ears of Peep o' Day corn average about 6 inches in length and are perfect in form. In habit of growth Peep o' Day is very distinct. The stalks grow from 3 to 4 feet in height, 3 to 5 ears on the stalk. The stalks being so small they may be allowed to stand very closely together. The seed may be planted either in hills or in rows. If the former, plant 6 or 7 kernels in a hill, later thinning out so as to leave 4 plants to each hill. If in rows and not in hills, drop the seed about 6 inches apart and (if planted early) cover about 1 inch deep. Later plantings should be put in deeper. Eight to 10 quarts will plant an acre.

PRICE, Packet, 10 cts.; Selected Ears, 10 cts. each; pint, .25 cts.; quart, .40 cts.; ½ peck, \$1.25; peck, \$2.00; bushel, \$7.00.

If by mail add 8 cts. per pint, and 15 cts. per quart extra for postage.

Peep o' Day Sweet Corn gave me good ears of the best flavored and sweetest very early corn that I have ever been able to get. I shall plant it again. It is far ahead of the Cory in earliness and sweetness.

ROBT. W. CURTIS,
Stratford, Conn.

Peep o' Day Sweet Corn was the earliest corn of the year; ahead of either Cory or White Cob Cory, and sweet. The cob is white, kernels pearly white, ears averaging six inches in length, exceptionally good for early market or home consumers.

REV. J. R. LAWRENCE,
(Eden Trial Grounds), Lanesboro, Mass.

We think Peep o' Day Sweet Corn very fine, and we had it earlier than our neighbors. We call it about 10 days earlier than any other corn.

MRS. GRANT CURRIE,
Currie, N.Y.

Maxwell's Court, Rockville, Conn., Nov. 16, 1903.

R. & J. Farquhar & Co.:

Gentlemen: I have purchased from you for the last two years quite a quantity of your Farquhar's Evergreen Lawn Grass Seed, which has been very satisfactory. It has produced a splendid sward with rich green color, free from weeds, and has been admired by all who have seen it. Your seeds have given me the best results during my twenty-two years' experience in this country as gardener. Your Grass Mixture for growing under trees and shady places cannot be surpassed.

Yours very truly,

GEORGE PECK,
Gardener to F. T. Maxwell, Esq.

CORN, SWEET. (*Welschkorn.*)

CULTURE. Select a warm soil, if possible, especially for the earlier varieties, which should not be planted before the middle of May. Successive plantings should be made every two weeks till July. Plant in hills three or four feet apart, in thoroughly manured soil. *One quart to two hundred hills; ten quarts to an acre. See page 35 for Field Corn.*

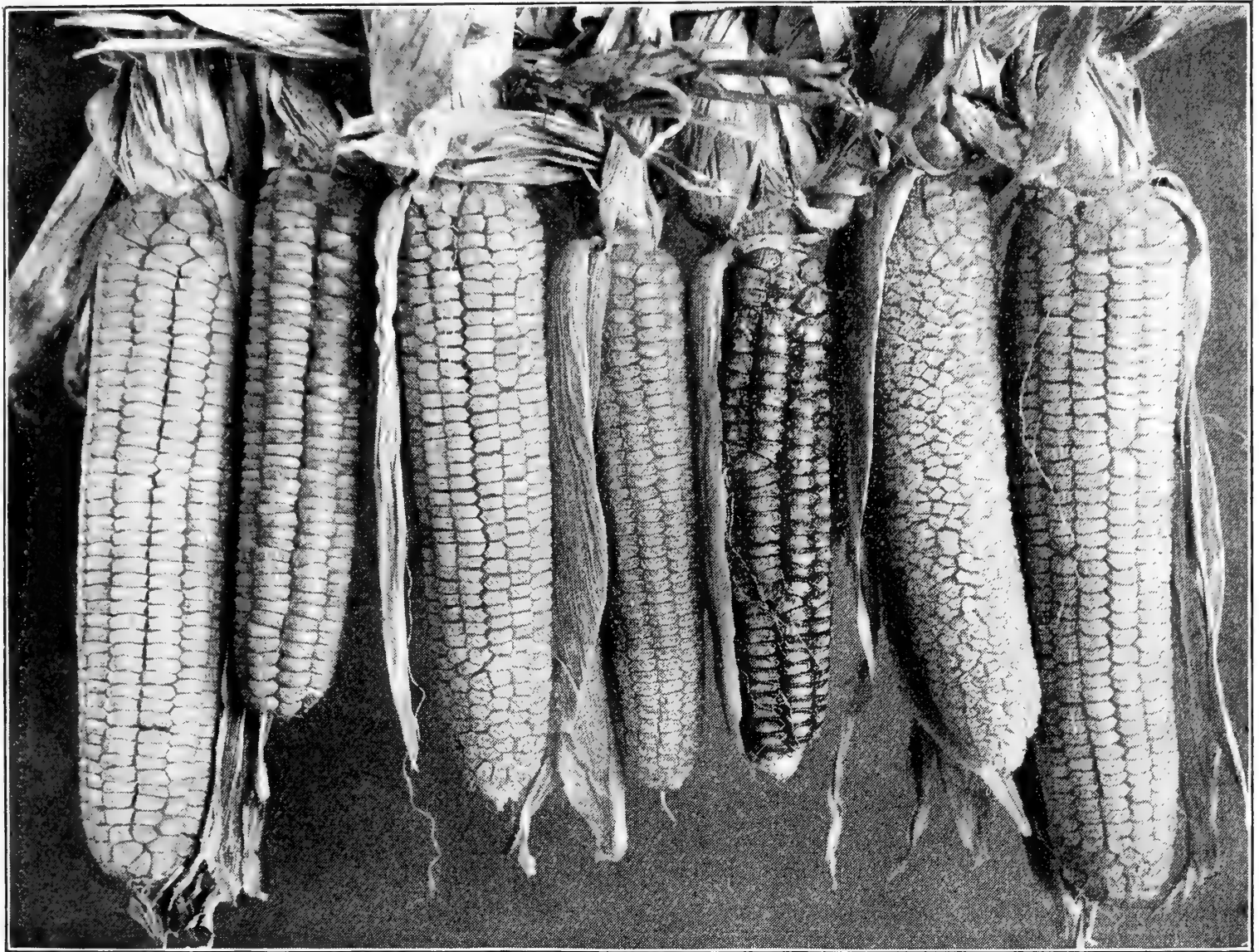

Hickox Improved. First Crop. Potter's Excelsior. Crosby. Cory. Banana. Stowell's Evergreen.

	Pint.	Qt.	Peck.	Bush.
EARLY.				
✓ FARQUHAR'S FIRST CROP SUGAR. The best early. White cob, eight rowed, quality superior to all others and very much sweeter20	.35	\$2.00	\$7.00
✓ EARLY CROSBY. Dwarf, remarkably sweet, usually 12 rowed20	.30	1.75	6.00
✓ METROPOLITAN. Ears average 9 inches, 10 to 12 rowed, tender and rich15	.25	1.75	6.00
✓ CORY. Kernels large and reddish, red cob, early dwarf15	.25	1.75	6.00
✓ EARLY MINNESOTA. Eight rowed, kernels broad, sweet, and tender15	.25	1.50	5.50
✓ NEW EXTRA EARLY WHITE CORY. Grain sweet and tender; 8 rowed20	.30	1.75	6.50
✓ MAMMOTH WHITE CORY. Handsome ears, 12 rowed, grain very white, broad20	.30	1.75	6.50
MEDIUM.				
✓ EARLY EVERGREEN. Similar to Stowell's Evergreen, but one to two weeks earlier20	.30	1.75	6.00
✓ OLD COLONY. A fine variety, handsome ears with 12 or more rows15	.25	1.50	5.50
✓ POTTER'S EXCELSIOR (Original). Unsurpassed in sweetness and tenderness, 12 rowed, the best main crop variety on the list20	.30	1.75	6.00
✓ EARLY CONCORD. Fourteen rowed, of good quality, splendid keeper20	.30	1.75	6.00
✓ EARLY CHAMPION. Very large, 12 rowed, of the very best quality15	.25	1.50	5.00
✓ PERRY'S HYBRID. Large, 12 to 14 rowed sort, medium-grain, very white and rich,15	.25	1.50	5.00
✓ WASHINGTON. Ears large, 16 to 18 irregular rows, and of the richest flavor15	.30	1.75	6.50
✓ HICKOX IMPROVED. Long, attractive ear, sweet and very productive20	.30	1.75	6.00
LATE.				
✓ STOWELL'S EVERGREEN. The finest late variety; ears large, 12 to 16 rowed; remains fit for use longer than any other variety. Hardy and productive20	.30	1.75	6.00
✓ MAMMOTH. The largest ears of any sort, and of excellent quality20	.30	2.00	7.50
✓ FARQUHAR'S BANANA. The most delicious Table Corn in cultivation20	.30	2.00	7.50
✓ COUNTRY GENTLEMAN. Cob small, irregular rowed, long, slender, white grains20	.30	2.00	7.00
✓ BLACK MEXICAN. Very tender, bluish-black when ripe, cooking almost white20	.30	1.75	6.00
✓ EGYPTIAN. Ears large, uniform, and of good quality20	.30	1.75	6.00

SELECTED EARS OF THE FOLLOWING VARIETIES AT .10 EACH; .75 PER DOZ.

- ✓ FARQUHAR'S FIRST CROP SUGAR. MAMMOTH. STOWELL'S EVERGREEN. POTTER'S EXCELSIOR (Original).
- ✓ EARLY CROSBY. BLACK MEXICAN. COUNTRY GENTLEMAN. FARQUHAR'S BANANA.

Packets of all varieties, 10 cts. each, postpaid.

CUCUMBER. (*Gurke.*)

For very early use, seed may be started in heat and the plants set out in May. Pieces of inverted sod are an excellent medium for starting and growing early Cucumber plants, as they can be readily lifted from the hot-bed to the garden without disturbing the young plants growing upon them. For main crop, plant in hills four feet apart, in the end of May. Keep the young plants safe from the striped bug by dusting with dry plaster or powdered hellebore. Leave four strong plants to each hill. *One ounce to fifty hills; two to three pounds to one acre.*



FARQUHAR'S PERFECTION FORCING CUCUMBER.

	Pkt.	Oz.	¼lb.	Lb.
✓ FARQUHAR'S PERFECTION FORCING. An excellent and much-improved strain of White Spine. Remarkably smooth and perfect in outline; and longer than any of the old White Spines. Our illustration is from a photograph and shows well its splendid form. Color a clear rich green, bright and permanent. Very robust and quick in growth, being about ten days earlier than the old strains; and in productiveness it ranks first. Flesh thick, exceedingly crisp and of excellent flavor. One of the best sorts for outdoor culture and unequalled for forcing in frames or hothouses. We offer carefully selected seed of our own growing . . .	\$0.25	\$1.00	\$3.00	\$10.00
✓ CUMBERLAND. A distinct variety; handsome, dark green fruit covered with numerous white spines. Exceptionally straight and symmetrical, thus being as choice as a slicing variety as it is for pickles. Flesh firm and crisp. Vine hardy, vigorous,10	.25	.75	2.50
✓ EARLY RUSSIAN. Short and very early; valuable for small pickles05	.20	.60	2.00
✓ IMPROVED WHITE SPINE. Early and good for table use or for pickling; of medium length, dark green color, and flesh crisp and excellent05	.20	.60	2.00
✓ ARLINGTON WHITE SPINE. Extra selected. Very productive; fruit even in size and of beautiful cylindrical form, dark green, excels in crispness and flavor10	.25	.75	2.50
✓ EARLY FRAME, OR SHORT GREEN. Early and productive, dark green05	.20	.50	1.75
✓ EARLY CLUSTER. Prolific, tender and crisp; about five inches long, good color05	.20	.50	1.75
✓ COOL AND CRISP. A strain of White Spine, flesh peculiarly crisp and tender05	.20	.60	2.00
✓ GREEN PROLIFIC. Dark green; medium length; very free bearer05	.20	.50	1.75
✓ NICHOLS' MEDIUM GREEN. Medium size, always straight and smooth. Color dark green, flesh crisp and tender. Splendid table variety05	.20	.50	1.75
✓ BOSTON MARKET FORCING. This variety is a selection of the best form of White Spine, very dark green in color, fine in size, straight, and of beautiful form,10	.30	1.00	3.00
✓ BOSTON PICKLING. Fine stock. The finest variety for pickles; fruit short, straight,05	.20	.50	1.75
✓ LONG GREEN. Fruit about twelve inches long, tender and excellent05	.20	.60	2.00
✓ WHITE PEARL. A small, even, delicious white sort05	.10	.40	1.25
✓ WEST INDIA GHERKIN. Used only for pickles; the smallest of all varieties10	.25	.75	2.50

ENGLISH FRAME CUCUMBERS.

FOR FRAME OR HOTHOUSE CULTURE. Each, per packet, 25 cents. TELEGRAPH, TENDER AND TRUE, THE ROCHFORD.

DANDELION. (*Lowenzahn.*)

Used as early spring "greens" and considered very healthful. The seed should be sown in May or June, in drills half an inch deep and fifteen inches apart. The crop will be ready for use next spring. A moist, heavy soil is preferable. *One ounce of seed is sufficient for two hundred feet of drill.*

	Pkt.	Oz.	¼ lb.	Lb.
IMPROVED LARGE-LEAVED. The finest variety; home-grown seed10	.50	\$1.50	\$5.00

EGG PLANT. (*Eierpflanze.*)

For perfection of growth, a very rich soil, plenty of moisture, and warm weather are required, with the addition of frequent hoeings. Sow in a gentle heat about the first of April. Transplant about the middle of June, setting the plants three feet apart. *One ounce to fifteen hundred plants.*

	Pkt.	Oz.	¼ lb.	Lb.
✓ BLACK PEKIN. Very fine, large, globular fruit, of a dark, glossy purple color; early, solid10	30	1.00	\$3.00
✓ NEW YORK IMPROVED. Purple; the best variety; very large, oval, heavy fruit10	.40	1.25	3.75
✓ EARLY LONG PURPLE. Fruit longer and smaller than the above sorts; hardy, productive10	.25	.75	2.50
✓ EGG PLANTS. Black Pekin, New York Improved. Ready in June. \$1.00 per dozen; \$6.00 per 100.				

ENDIVE. (*Endivien.*)

One of our best salad plants. For a first crop, sow about the middle of April; for succession, small sowings may be made every month till August, when the main planting is made. Set out the plants one foot apart, in rows, and when well grown, effect blanching by folding the leaves in their natural position around the heart, and tying the outer leaves together by their tips in cone form. *One ounce of seed for seventy-five feet of drill.*

	Pkt.	Oz.	¼ lb.	Lb.
✓ DE RUFFEC. A large green curled variety. Outer leaves well cut and of a beautiful deep green color. Very hardy, making it a desirable variety for fall and winter05	.20	.60	\$2.00
✓ GREEN CURLED. Hardy, finely curled; easily blanched; one of the best05	.15	.50	1.50
✓ FRENCH MOSS-CURLED. Very finely curled, with close, dense leaves05	.20	.60	2.00
✓ WHITE CURLED. Blanches rapidly; excellent, and very tender05	.15	.50	1.50
✓ BROAD-LEAVED BATAVIAN. (<i>Escarolle.</i>) Leaves long and broad, thick and succulent05	.15	.50	1.50

HORSE RADISH.

Grown from small pieces of the roots. Plant the sets fifteen inches apart in rows two-and-a-half feet apart. SMALL SETS. Per dozen, 15 cents; per 100, 75 cents; per 1,000, \$5.00.

KALE, OR BORECOLE. (*Blatter Kohl.*)

The Kales are the most tender and delicate of all the Cabbage family, and are improved in flavor after frost. For fall use, sow early in May, in a prepared bed, transplant in June, and treat in the same manner as Cabbages. *One ounce of seed produces about fifteen hundred plants.*

	Pkt.	Oz.	¼ lb.	Lb.
✓ DWARF GREEN-CURLED. Leaves bright green and beautifully curled05	.10	.30	\$1.00
✓ WINTER, OR GERMAN GREENS. (<i>Sprouts.</i>) Sow in the end of August and treat as Spinach; excellent as spring greens05	.10	.25	.75

KOHL-RABI.

Sow in May or June, in rows eighteen inches apart. Any ordinary soil, moderately rich, will answer. The bulbs, when about half grown, are boiled and served like turnips.

- ✓ EARLY WHITE VIENNA. The best for early and main crop; flesh white. Pkt., .05; oz., .25; ¼ lb., .75; lb., \$2.50.
- ✓ EARLY PURPLE VIENNA. Bluish purple outside; flesh white. Pkt., .10; oz., .30; ¼ lb., .85; lb., \$3.00.

LEEK. (*Lauch.*)

The Leek is generally considered superior to the Onion for soups; it is very hardy, and easily cultivated. Sow in drills, a foot apart, in April, and transplant in July, in rows fifteen inches apart, and six inches from plant to plant. Plants should be set five inches deep in rich, moist soil. *One ounce will produce about 1,000 plants.*

- ✓ MUSSELBURGH, OR SCOTCH. Of large size and extra fine quality. Pkt., .05; oz., .30; ¼ lb., .75; lb., \$2.00.
- ✓ GIANT CARENTAN. Of mammoth size; hardy and excellent. Pkt., .05; oz., .30; ¼ lb., .75; lb., \$2.50.
- ✓ LONDON FLAG. Leaves broad with short, very large stem. Pkt., .05; oz., .25; ¼ lb., .60; lb., \$2.00.



Kohl-Rabi. Early White Vienna.

LETTUCE.

(*Lattich Salat.*)

The Lettuce is the best vegetable of the salad kind grown in the open air. It thrives best in a light, very rich, moist soil, with a dry substratum, but does well in a common garden soil enriched with rotted manure. For first crop sow in gentle heat in February, and transplant to ten inches apart. For a summer supply, sow thinly in shallow drills, eighteen inches apart, and transplant, or thin out, leaving a foot between the plants. Sowings may be made from April to the end of August. *One ounce of seed gives about four thousand plants.*

We make a specialty of the varieties of Lettuce grown in the vicinity of Boston, and the seed of these we offer is all home-grown, and saved with the utmost care.



COPYRIGHT 1902
BY R. & J. FARQUHAR & CO.

Boston Forcing Tennisball Lettuce.

	Pkt.	Oz.	¼ lb.	Lb.
✓ BOSTON FORCING TENNISBALL; WHITE-SEEDED. Forms fine, perfect heads very rapidly; crisp and very tender. Our seed is of the finest growth and from perfect heads10	.40	\$1.25	\$4.00
✓ HITTINGER'S BELMONT FORCING. Larger than the above and almost as early; of excellent quality and highly recommended for forcing10	.40	1.25	4.00
✓ CRUMPLED LEAF. A fine, large, solid head, leaves dark green, slightly ruffled or crumpled, tender, flavor unsurpassed. For so large a variety it is a quick grower, and sure to head10	.40	1.25	4.00
✓ GRAND RAPIDS FORCING. Crisp and tender; leaves frilled; heads of fair size05	.15	.50	1.25
✓ FARQUHAR'S LONG-STANDING. Earliest and finest head Lettuce for summer crops; every plant produces fine, large, firm head; flavor excellent; tender and free from all bitterness10	.50	1.50	
✓ BLACK-SEEDED TENNISBALL. Excellent; forms a very fine head; compact, crisp, tender05	.15	.30	1.00
✓ WHITE-SEEDED TENNISBALL. Early, tender, and free from bitterness05	.15	.30	1.00
✓ MAMMOTH BLACK-SEEDED BUTTER. A very large Cabbage Lettuce, solid, smooth leaved. The outer leaves are thick and brittle; the inner ones becoming very white and tender05	.15	.50	1.50
✓ WONDERFUL. Solid head, crisp, tender. The largest and best of all Cabbage Lettuce05	.15	.50	1.50
✓ TOM THUMB. A favorite for pot culture and hot-bed use. One of the earliest to mature, forming compact heads, crisp and free from coarseness10	.20	.50	1.50
✓ BOSTON FINE CURLED. Attractive on table and of good quality when young05	.15	.50	1.50
✓ DENVER MARKET. Large heads, sweet and tender; leaves crumpled05	.10	.30	1.00
✓ ALL THE YEAR ROUND. Hardy, compact, close-heading Cabbage variety05	.10	.30	1.00
✓ HANSON. An excellent summer Lettuce with very large heads05	.15	.50	1.25
✓ BLONDE BLOCKHEAD. Heads of immense size; one of the finest05	.20	.60	2.00
✓ BURPEE'S PRIZE-HEAD. Handsome and very early-heading05	.15	.50	1.50
✓ BLACK-SEEDED SIMPSON. A superior variety; large and compact heads05	.15	.30	1.00
✓ EARLY CURLED SIMPSON. A leading early sort; very tender05	.15	.30	1.00
✓ DEFIANCE. A large Cabbage Lettuce; crisp and tender05	.15	.50	1.50
✓ TOMHANNOCK. Leaves almost white, upright and loose; very handsome05	.15	.50	1.50
✓ SALAMANDER HEAD. Popular summer variety; very crisp and fine05	.20	.60	2.00
✓ DEACON. Heads large, compact, inner leaves tender; one of the best05	.20	.60	1.75
✓ NEW YORK. Of unusual size and solidity; crisp and tender05	.15	.50	1.50
✓ FROUT, OR SPOTTED. Most tender Lettuce on the list; spotted leaves05	.20	.60	2.00
✓ BROWN DUTCH. The hardiest Lettuce grown; best for very early out-of-doors crop05	.15	.50	1.50
✓ BLOOD RED. Very productive, with red leaves; heads of good size05	.20	.75	2.00
✓ TRIANON SELF-CLOSING COS. Upright in growth. Leaves long, narrow, forming close heads,05	.20	.60	2.00
✓ PARIS WHITE COS, OR ROMAINE. Very early, requires tying to blanch05	.20	.60	2.00
✓ MAXIMUM. A large, solid head variety of excellent quality05	.15	.50	1.50
✓ MIGNONETTE. Small head, long standing, hardy, great drought resister05	.15	.50	1.50
✓ ICEBERG. A handsome head variety, very tender05	.15	.50	1.50
✓ CALIFORNIA CREAM BUTTER. Large, solid head; tinged brown, white inside05	.15	.30	1.00

MELON, MUSK. (*Melone.*)

A light, rich soil is the most suitable for Melons of all kinds. In very rich soils the hills should be six feet apart; in poor soil about five feet. Before planting the seed mix a peck of rotted manure with the soil in each hill. About the middle of May, plant the seeds half an inch deep — six or eight in each hill. When the plants are well up, thin out, leaving three to a hill. *One ounce of seed for sixty hills; two to three pounds for an acre.*

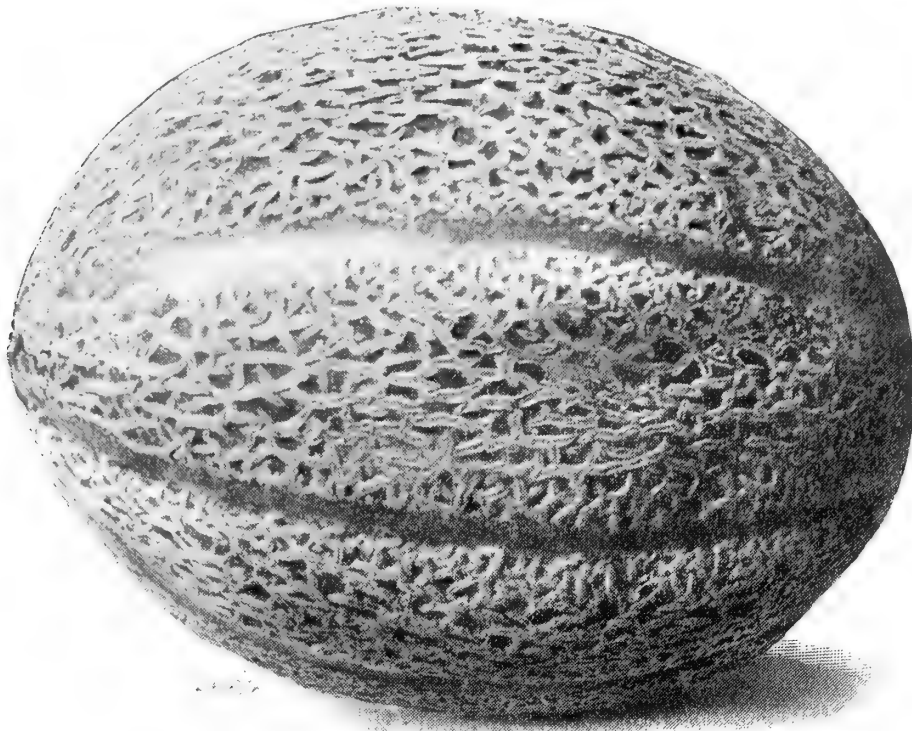

Rocky Ford Melon.

- ✓ FARQUHAR'S HONEY-DROP. For earliness and delicious flavor this splendid Melon is without a rival, and for table use it is unquestionably the sweetest and best. It is of beautiful form, good size, and very productive. The flesh is very thick, delicious and melting, and of a deep orange yellow color. Pkt., .15; oz., .50.
- ✓ HACKENSACK. Early, of large size, round shape, and deeply ribbed; flesh green; very sweet. Pkt., .05; oz., .15; lb., \$1.25.
- ✓ EARLY GREEN NUTMEG. Green flesh; very sweet and early. Pkt., .05; oz., .10; lb., \$1.00.
- ✓ EARLY CHRISTIANA. Yellow-fleshed; very rich; melting flavor. Pkt., .05; oz., .20; lb., \$2.00.
- ✓ ARLINGTON NUTMEG. A favorite in Boston market; early and delicious. Pkt., .05; oz., .15; lb., \$1.25.
- ✓ MONTREAL NUTMEG. Early, large, handsome, and excellent. Pkt., .05; oz., .20; lb., \$2.00.
- ✓ EMERALD GEM. Small, extra early and very sweet; flesh orange. Pkt., .05; oz., .20; lb., \$1.75.
- ✓ LONG ISLAND BEAUTY. Round; one of the earliest and finest. Pkt., .10; oz., .20; lb., \$1.75.
- ✓ PETOSKEY OR PAUL ROSE. In this sort are combined all the good qualities of the Netted Gem and the Osage, the varieties from which it originated. The fruit is oval, about five inches in diameter; flesh is firm

- and is a rich orange-red color like Osage, but sweeter and more highly flavored. Pkt., .05; oz., .15; lb., \$1.25.
- ✓ ROCKY FORD. One of the best second early Melons. The type is similar to the oval Netted Gem; but more oblong in shape, and possessing much better shipping and keeping qualities. Flesh thick, green, sweet, and highly flavored. Fruit small, uniform, and a good basket size. Pkt., .05; oz., .10; 1/4 lb., .30; lb., \$1.00.
- ✓ DELMONICO, PERFECTED. Round, flesh deep rich orange and of highest quality; a strong, hardy grower and very productive. Pkt., .05; oz., .10; lb., .75.
- ✓ ACME, OR BALTIMORE. Oblong; green flesh; finest quality. Pkt., .05; oz., .10; lb., \$1.00.
- ✓ MILLER'S CREAM, OR OSAGE. Most delicious; flesh salmon-color; very thick. Pkt., .05; oz., .10; lb., \$1.00.

MELONS FOR FORCING.

✓ ROYAL SOVEREIGN.

The fruit will average in weight about five pounds, occasionally rising to eight pounds and over, and is of a beautiful golden color, slightly netted, flesh white, faintly tinged with green, and very deep, rind very thin. Grand variety for the exhibition table. Pkt., .50.

✓ INVINCIBLE SCARLET.

Form globular; skin orange-red when perfectly ripe, finely and evenly netted; thick bright scarlet flesh, of exquisite flavor. Sets very freely. Scarlet Invincible is a first-class Melon for frame or hot-house culture, an easy setter, and good flavored fruit. Weighs about four pounds each, beautifully netted. Pkt., .25.

✓ BLENHEIM ORANGE.

Well known handsome scarlet-fleshed variety; of delicious flavor and beautifully netted. Sets well and is very prolific. Pkt., .25.

✓ ROYAL FAVORITE, FROGMORE SCARLET, NE PLUS ULTRA, .25 per packet.

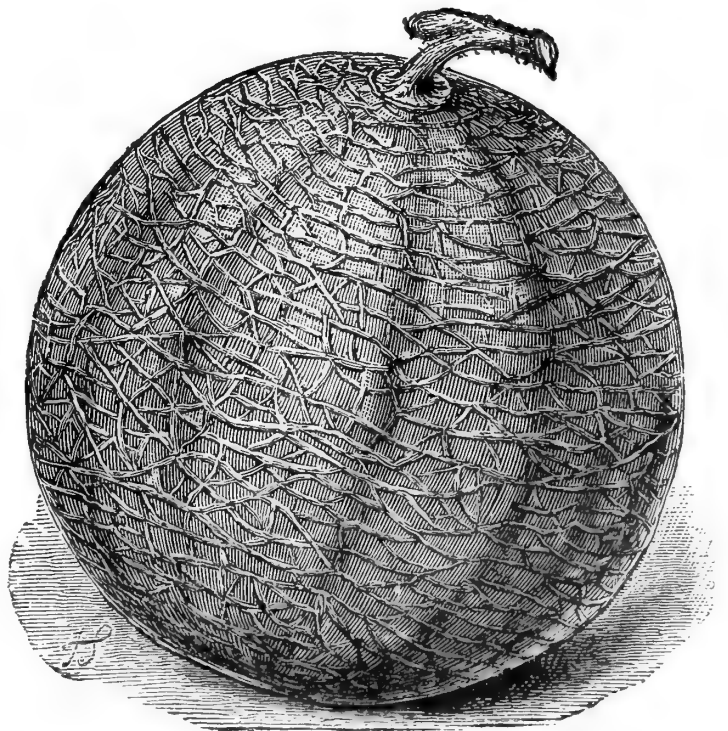

Blenheim Orange Melon.

MELON, WATER. (*Wassermelone.*)

Treat the same as Musk Melon, but plant eight to ten feet apart.

	Pkt.	Oz.	Lb.
✓ VICK'S EARLY. Very early, long, smooth, with bright pink flesh; fine	.05	.10	.75
✓ PHINNEY'S EARLY. Early, productive, and fine flavor; rich flesh	.05	.10	.75
✓ HUNGARIAN HONEY. One of the earliest; fine for northern latitudes	.05	.10	1.00
✓ EARLY FORDHOOK. The earliest of all. Outer color uniform green, flesh bright red, very sweet	.05	.10	.70
✓ ICE CREAM. Nearly round; flesh scarlet, solid, crisp, and delicious	.05	.10	.75
✓ MAMMOTH IRONCLAD. Of large size and great weight; solid and delicious	.05	.10	.75
✓ MOUNTAIN SWEET. Oblong, with green skin; flesh solid and sweet	.05	.10	.60
✓ BLACK SPANISH. Round, very dark green; flesh scarlet; very sweet	.05	.10	.85
✓ CITRON, FOR PRESERVING. Used only for preserves; round; productive and hardy	.05	.10	.60

ONION. (*Zwiebel.*)

The Onion has been cultivated as an article of food from the earliest times, and is perhaps at the present day more universally grown than any other vegetable. A good crop is impossible unless the soil is very rich and kept clean. Use well-rotted manure freely, and get the crop in as early as possible in spring, even though the weather be cold and unpleasant. Sow in drills one foot apart and cover about one-third of an inch, treading or rolling after sowing so that the hot, dry atmosphere may not destroy the sprouting seed. When three inches high thin to two inches apart. Stir the ground freely without disturbing the young plants and keep free from weeds. *One ounce of seed to one hundred feet of drill; four to five pounds an acre.*

Our Onion Seed is grown from bulbs carefully selected by hand, and is of most superior quality.



Farquhar's Yellow Globe Danvers Onion.

✓ FARQUHAR'S YELLOW GLOBE DANVERS. Saved from selected onions exclusively and home-grown; early; round with very small neck; ripens uniformly; onions of good size, fine quality, and excellent keeping properties. The best variety for general crop. Our strain will meet the demands of the most critical10	.25	.75	\$2.50
✓ YELLOW GLOBE DANVERS. Eastern grown; fine, but not our own growth of seed05	.15	.40	1.25
✓ SOUTHPORT YELLOW GLOBE. Handsome, with mild flavor; one of the best05	.15	.50	1.50
✓ EARLY YELLOW FLAT, OR CRACKER. Earliest yellow variety; excellent and keeps well05	.25	.75	2.50
✓ RED GLOBE. Of beautiful shape; splendid quality, and an excellent keeper05	.20	.60	2.00
✓ EARLY RED. Very early and of most excellent flavor; good keeper05	.20	.60	2.00
✓ LARGE RED WETHERSFIELD. Of finest flavor, large and hardy; keeps well05	.15	.40	1.25
✓ WHITE PORTUGAL, OR AMERICAN SILVER SKIN. Splendid when young as a Salad Onion and for pickles. Early; mild flavored, and excellent for first crop05	.20	.60	2.00
✓ WHITE GLOBE. A handsome Onion. Flesh firm, fine grained, mild. Our strain is excellent05	.20	.60	2.00
✓ QUEEN. One of the best for very early crop; grows rapidly, beautiful white skin; fine flavor and a good keeper. Especially valuable for pickling05	.25	.75	2.50
✓ GIANT ROCCA. An enormous globe-shaped variety; mild and sweet05	.15	.50	1.50
✓ AUSTRALIAN BROWN. An early variety, medium size, color amber brown, unequalled for keeping qualities05	.15	.40	1.25

ONION — *continued.*



COPYRIGHT 1902
BY R. & J. FARQUHAR & CO.

White Globe Onion.

	Pkt.	Oz.	¼ lb.	Lb.
✓ GIANT WHITE TRIPOLI. Excellent; of quick growth and mild flavor05	.20	.60	\$2.00
✓ ADRIATIC BARLETTA. The earliest of all; a small white Italian sort10	.25	.75	2.50
✓ SILVER KING. Enormous size; skin silvery white; mild and pleasant flavor05	.25	.75	2.50
✓ PRIZE-TAKER. Color yellow, flesh white; globular; of immense size; medium early, mild05	.20	.60	2.00



COPYRIGHT 1902
BY R. & J. FARQUHAR & CO.

White Sets.

Potato Onion Sets.

Yellow Sets.

ONION-SETS. PRICES VARIABLE.

These are small Onions grown the previous year, ripened off and taken up when mere bulblets. They produce a very early crop, and grow in any good soil. Set them four inches apart in rows one foot apart.

	Qt.	Pk.	Bush.		Qt.	Pk.	Bush.
WHITE SETS25	\$1.50	\$4.50	WHITE MULTIPLIER SETS30	\$1.50	\$4.50
YELLOW SETS20	1.25	3.50	SHALLOTS30	1.50	4.50
POTATO ONION SETS20	1.25	4.00	GARLIC	Bunch, .25		

OKRA, OR GUMBO. (*Essbarren Hibiscus.*)

The young pods are used to thicken soups and stews. Sow in spring in rows three feet apart and two inches deep; thin, so that the plants stand about one foot apart. *One ounce to forty feet of drill.*

	Pkt.	Oz.	¼ lb.	Lb.
WHITE VELVET. Pods used to thicken soups, etc., large and smooth05	.10	.20	.50
DWARF GEEEN. Produces large, tender pods; very productive05	.10	.20	.50

PARSLEY. (*Petersilie.*)

Sow as early as possible in spring, first soaking the seed three hours in water; cover lightly, raking the soil fine and level on top. The drills should be about fifteen inches apart. The plants appear in two to four weeks. Thin to three inches apart. *One ounce of seed to one hundred and fifty feet of drill.*

- ✓ **FARQUHAR'S TRIPLE CURLED. DWARF EXTRA.** Dwarf dark green, densely curled, excellent for table and edgings. Pkt., .05; oz., .10; ¼ lb., .30; lb., \$1.00.
- ✓ **CHAMPION MOSS.** An English variety; fine habit; mossy and beautiful. Pkt., .05; oz., .10; ¼ lb., .25; lb., .75.
- ✓ **DOBBIE'S SELECTED.** The standard exhibition sort. Pkt., .05; oz., .10; ¼ lb., .25; lb., .75.

- ✓ **FERN-LEAVED.** Very ornamental for table decoration; mossy-curved. Pkt., .05; oz., .10; ¼ lb., .25; lb., .75.
- ✓ **TURNIP-ROOTED, OR HAMBURG.** Edible roots, suitable for flavoring soups, etc. Pkt., .05; oz., .10; ¼ lb., .20; lb., .60.

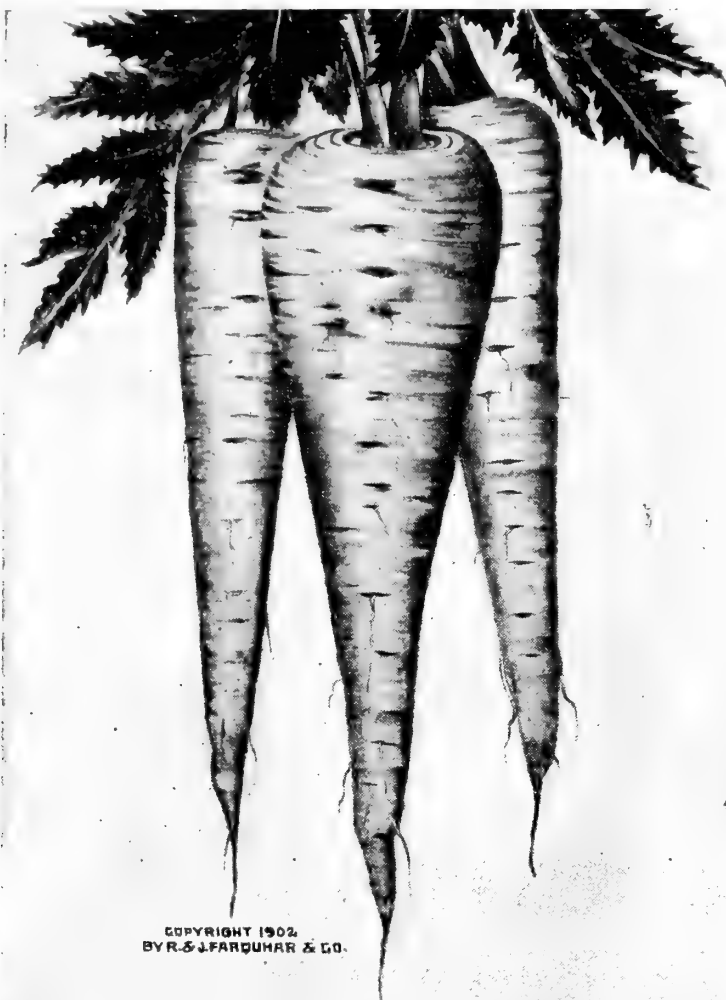

COPYRIGHT 1902 BY R. & J. FARQUHAR & CO.

**FARQUHAR'S MARKET MODEL
PARSNIP.**

PARSNIP. (*Pastinake.*)

Sow in rich soil, in drills about eighteen inches apart as early in the spring as the ground can be worked. *One ounce will sow one hundred and twenty feet of drill; five pounds an acre.*

- ✓ **FARQUHAR'S MARKET MODEL.** The finest in cultivation; very heavy cropper; average length of root eighteen to twenty-four inches; remarkably smooth, handsome, and clean in appearance; of most superior flavor. Pkt., .05; oz., .15; ¼ lb., .30; lb., \$1.00.
- ✓ **STUDENT.** A favorite English variety; smooth; tender. Pkt., .05; oz., .10; ¼ lb., .25; lb., .75.
- ✓ **HOLLOW CROWN.** Fair, smooth skin; fine quality. Pkt., .05; oz., .10; ¼ lb., .20; lb., .60.
- ✓ **LONG SMOOTH WHITE.** Straight, smooth, and handsome. Pkt., .05; oz., .10; ¼ lb., .20; lb., .60.
- ✓ **EARLY ROUND.** Pkt., .05; oz., .10; ¼ lb., .25; lb., .75.

PEPPER. (*Spanischer Pfeffer.*)

Sow in March or April, in a hot-bed, or in the open ground when the weather becomes quite warm. Transplant when three inches high.

- ✓ **CHINESE GIANT.** The largest and finest mild Red Pepper. Pkt., .10; oz., .50; ¼ lb., \$1.75; lb., \$5.00.
- ✓ **SQUASH, OR PICKLING.** Best for pickling; tomato shaped; medium size; thick. Pkt., .10; oz., .50; ¼ lb., \$1.50; lb., \$4.50.
- ✓ **SWEET MOUNTAIN MAMMOTH, OR IMPROVED BULL NOSE.** The most popular and desirable sort; color bright red when ripe; fruit large with thick mild flesh. Pkt., .05; oz., .25; ¼ lb., .75; lb., \$2.50.
- ✓ **PROCOPP'S GIANT.** Very long and large; fine scarlet; flesh thick. Pkt., .10; oz., .30; ¼ lb., .85; lb., \$3.00.

- ✓ **RUBY KING.** Long, about five inches; very thick; fine, mild flavor. Pkt., .10; oz., .30; ¼ lb., .85; lb., \$3.00.
- ✓ **LONG RED CAYENNE.** Long, slender, and very pungent; beautiful color. Pkt., .05; oz., .25; ¼ lb., .75; lb., \$2.50.
- ✓ **GOLDEN DAWN.** Golden yellow; thick and fine. Pkt., .10; oz., .30; ¼ lb., .85; lb., \$3.00.
- ✓ **CELESTIAL.** Very early and profuse bearer; vivid scarlet when ripe. Pkt., .05; oz., .25; ¼ lb., .75; lb., \$2.50.
- ✓ **RED CHERRY.** Small round, smooth; glossy scarlet fruit. Pkt., .10; oz., .30; ¼ lb., .85; lb., \$3.00.
- ✓ **CORAL GEM BOUQUET.** Productive and wonderfully handsome, covered with small, bright coral red fruits which are quite hot and splendid seasoning. Pkt., .10; oz., .35; ¼ lb., \$1.00; lb., \$3.50.
- ✓ **CHILI.** The best for Pepper sauce; small, narrow, bright scarlet pods. Pkt., .05; oz., .25; ¼ lb., .75; lb., \$2.50.

PUMPKIN. (*Curbis.*)

- ✓ **MAMMOTH.** Saved from specimens weighing over 100 pounds. Pkt., .10; oz., .25; ¼ lb., .75; lb., \$2.50.
- ✓ **CONNECTICUT FIELD.** Excellent for stock. Pkt., .05; oz., .10; ¼ lb., .15; lb., .50.
- ✓ **SUGAR, OR SWEET.** Fine grained; sweet and prolific; excellent for pies. Pkt., .05; oz., .10; ¼ lb., .25; lb., .75.
- ✓ **CHEESE.** Flat; one of the best for family use. Pkt., .05; oz., .10; ¼ lb., .20; lb., .75.
- ✓ **NANTUCKET, OR NEGRO.** Small, dark shell, warted; fine flavor; the variety from which the old-fashioned Pumpkin pies were made. Pkt., .05; oz., .10; ¼ lb., .30; lb., \$1.00.
- ✓ **WINTER LUXURY.** A round Pumpkin with smooth yellow skin, finely netted; flesh very thick, sweet and of excellent flavor; the best variety for pies. Pkt., .05; oz., .10; ¼ lb., .30; lb., \$1.00.



COPYRIGHT 1902 BY R. & J. FARQUHAR & CO.

Connecticut Field Pumpkin.

PEAS. (*Erbse.*)

A light soil, moderately rich, should be selected for the early varieties, and old, decomposed manure or leaf-mold should be scattered along the bottom of the drill and covered lightly with fine earth, so that the seed may not come in direct contact with the fertilizer. The earliest Peas are very hardy, and should be sown as early as possible in spring; later sowings of the fine, sweet, wrinkled varieties should follow. Sow in drills and cover not less than four inches. *One quart to one hundred feet of drill; one and one-half bushels sows one acre in drills.*

Large packet of all varieties, 10 cents each, post-paid. If larger quantities are desired by mail please add 8 cents per pint, and 15 cents per quart extra for postage.

EXTRA EARLY AND EARLY PEAS.

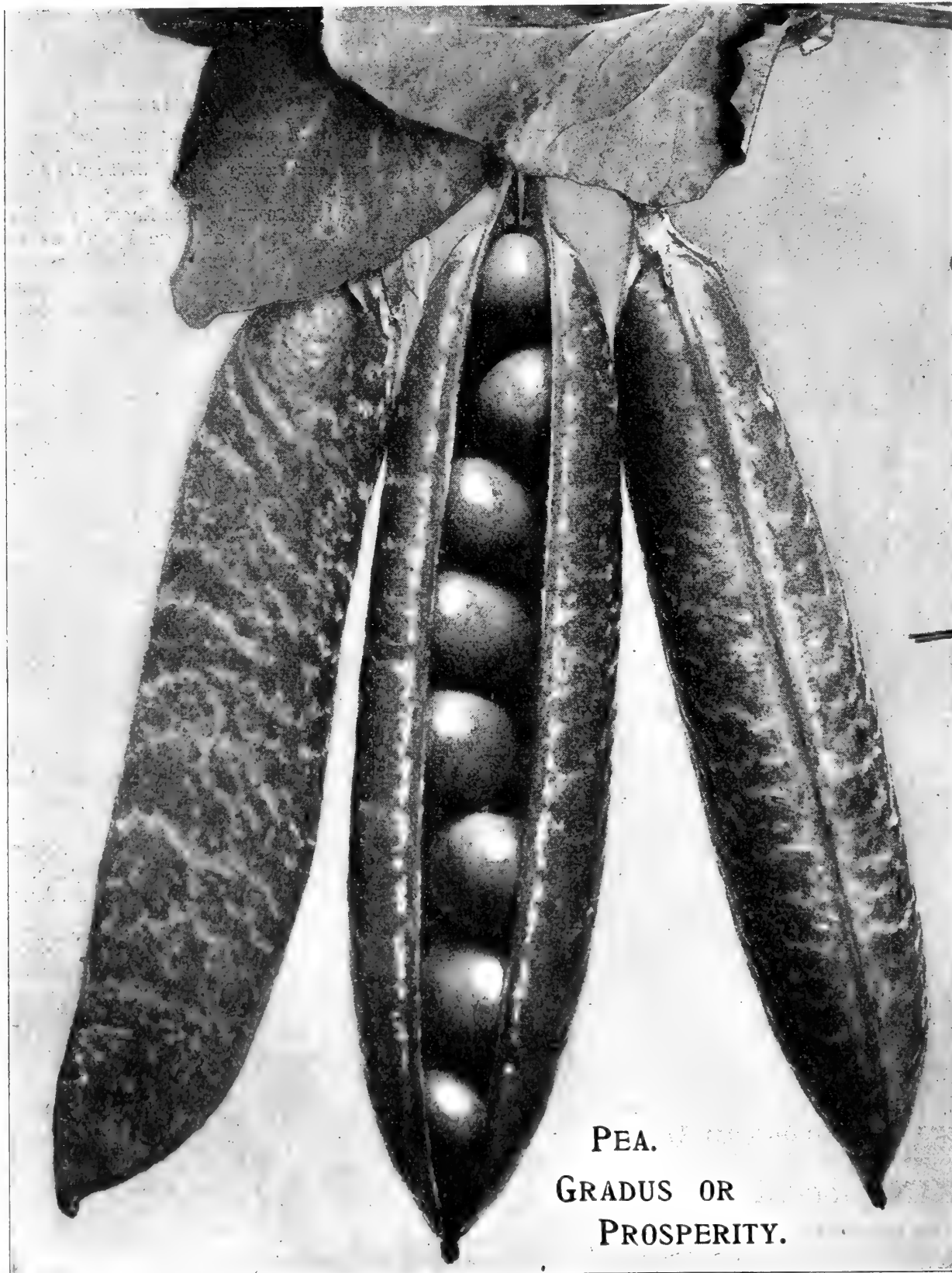

PEA.
GRADUS OR
PROSPERITY.

✓ EARLIEST OF ALL, OR ALASKA. Large, full, dark green pods; peas of good size, sweet and juicy. The hardiest extra early. Pint, .15; quart, .25; peck, \$1.50; bushel, \$5.50.

✓ FIRST AND BEST. Our stock of this pea is selected with a view to earliness, length of pod, size of pea, even-ripening and productiveness. One of the best of the earlies. Height about 2½ ft. Pint, .15; quart, .25; peck, \$1.50; bushel, \$5.50.

→ FARQUHAR'S PROLIFIC EARLY. The largest podded of all extra early varieties. Superior to First and Best in length of pod, number of peas in the pod and number of pods to the vine. Pint, .20; qt., .35; peck, \$2.00; bushel, \$7.00

✓ SURPRISE. Resembling in vine, size and shape of the pod, and ripening with Maud S. and Alaska; tender quality and delicate flavor. Seed small, green, wrinkled, height 2 ft. Pint, .20; qt., .35; peck, \$2.00; bushel, \$7.00.

✓ SUTTON'S EXCELSIOR. A dwarf, early Marrowfat Pea, growing about 16 to 18 inches high. Vine is very similar to Stratagem, pod is large and well filled with delicious flavored peas. Ready for picking with Nott's Excelsior. A Pea of decided merit. Pint, .25; qt., .40; peck, \$2.25; bush., \$8.00.

✓ GRADUS OR PROSPERITY. Large, handsome pods resembling Telephone in size and shape, well filled with large peas, ripening with the earliest. Ripening very quickly, the pods must be picked as soon as fit for the table. Habit vigorous, very quick to germinate and push to maturity; foliage large, pale green in color; pods long, straight, slightly rounded at the point. The best extra early wrinkled variety ever introduced, and by far the most desirable variety for the home garden. Height, 3 ft. Pint, .30; qt., .50; peck, \$3.00; bush., \$10.00.

✓ THOMAS LAXTON. (New.) Very similar to Gradus, being a cross between that variety and one of the extra earlies. In our trial ground we found it several days later than Gradus, but harder and fully more prolific. Peas are wrinkled and quality the best. Pods are very large and contain on an average eight to ten peas. Pint, .30; qt., .50; peck, \$3.50; bush., \$12.00.

EXTRA EARLY AND EARLY PEAS.

- ✓ **NOTT'S EXCELSIOR.** The best dwarf wrinkled pea. It is so hardy and vigorous that it may be safely planted nearly or quite as early in spring as the smooth varieties, and will mature almost as soon; and the superior flavor of a wrinkled pea to a smooth pea needs no comment. It is frequently ready for the table in 45 days from sowing. Pods are square and chunky, containing from 7 to 9 large peas, packed so closely that they are more nearly square than round. The peas are at all times tender and of fine flavor. *In sweetness and quality this variety is unsurpassed.* The vines grow to a uniform height of about 1 foot. Pint, .25; qt., .40; peck, \$2.50; bush., \$8.00.
- ✓ **AMERICAN WONDER.** A very dwarf and remarkably fine wrinkled variety, extra early, producing a multitude of large, very closely filled pods; flavor delicious; height about nine inches. Pint, .25; qt., .40; peck, \$2.25; bush., \$8.00.
- ✓ **MCLEAN'S LITTLE GEM.** A dwarf green wrinkled pea; rich and sugary; very early, and every way excellent; height about 1 foot. Pint, .20; qt., .35; peck, \$2.00; bush., \$7.00.
- ✓ **PREMIUM GEM.** Seed green, wrinkled, hardy and prolific. Pint, .20; qt., .35; peck, \$2.00; bush., \$7.00.
- ✓ **PETIT POIS, OR SMALL EARLY FRENCH.** Pick when young; 4 ft. Pint, .20; qt., .30; peck, \$1.75; bush., \$6.50.
- ✓ **CARTER'S DAISY OR DWARF TELEPHONE.** A dwarf sort, bearing handsome peas of the best quality; pod frequently 5 inches long; remarkably well filled, often containing 10 peas. Pint, .20; qt., .35; peck, \$2.00; bush., \$7.50.
- ✓ **DUKE OF YORK.** Height, 2½ feet, bearing handsome pods of superior quality. Two or three weeks earlier than Champion of England. Pint, .20; qt., .35, peck, \$2.00; bush., \$7.00.

MEDIUM PEAS.

- ✓ **MCLEAN'S ADVANCER.** Our stock of this invaluable Pea is of unsurpassed excellence; its fine characteristics being retained by careful selection. A dwarf, green, wrinkled marrow pea, with numerous long, well-filled pods. Height, 2 ft. Pint, .15; qt., .25; peck, \$1.50; bush., \$5.00.
- ✓ **HORSFORD'S MARKET GARDEN.** On the style of Advancer; very productive and even cropper; pods large and numerous; delicious flavor. Pint, .15; qt., .25; peck, \$1.50; bush., \$5.00.
- ✓ **EVERBEARING.** Habit branching; should be sown thin; excellent variety; pods fully three inches long. Pint, .15; qt., .25; peck, \$1.50; bush., \$5.00.
- ✓ **ABUNDANCE.** Of dwarf bushy habit; pods are full and numerous; quality excellent; height, 2 ft. Pint, .15; qt., .25; peck, \$1.50; bush., \$5.00.
- ✓ **HEROINE.** Green, wrinkled variety; peas very tender, rich, sugary flavor; height 2½ ft. Pint, .20; qt., .30; peck, \$1.75; bush., \$6.00.
- ✓ **JUNO.** Pods thick; filled from stem to tip; wrinkled; delicious; 2 ft. Pint, .20; qt., .30; peck, \$1.75; bush., \$6.00.
- ✓ **MELTING SUGAR; EDIBLE-PODDED.** The pods when cooked are eaten like Snap Beans and are very sweet and tender; height, 2½ ft. Pint, .20; qt., .30; peck, \$1.75; bush., \$6.00.

MAIN AND LATE-CROP PEAS.

- ✓ **CHAMPION OF ENGLAND.** We place this superior old variety at the head of this section, as it is unsurpassed in flavor, sweetness, and general excellence; our stock is maintained pure by careful selection and is unexcelled; vines over 4 ft. high. Pint, .15; qt., .25; peck, \$1.25; bush., \$4.50.
- ✓ **STRATAGEM, COX'S IMPROVED.** Carefully selected stock. A Pea of extraordinary merit; habit branching and stocky; the vines are covered with full pods of great size; flavor melting and delicious; one of the best; height 2 ft. Pint, .20; qt., .30; peck, \$1.75; bush., \$6.00.
- ✓ **TELEPHONE.** A tall and very robust grower, bearing pods closely filled and of unusual length; remarkably productive. Pint, .20; qt., .30; peck, \$1.75; bush., \$6.50.
- ✓ **RELIANCE.** A superior variety, Superb flavor and tender. Pint, .20; qt., .35; peck, \$2.00; bush., \$7.00.
- ✓ **DUKE OF ALBANY. (AMERICAN CHAMPION.)** Very large, well filled pods; of vigorous growth and a remarkable cropper; height, 5 ft. Pint, .20; qt., .30; peck, \$1.75; bush., \$6.50.
- ✓ **PRIDE OF THE MARKET.** Wrinkled, robust; enormous yielder; 2 ft. Pint, .15; qt., .25; peck, \$1.75; bush., \$6.00.
- ✓ **SHARPE'S QUEEN.** Of vigorous branching habit, it needs to be sown thinly. Pods long, slightly curved, well filled with large peas of most delicious flavor. Its beauty, productiveness, and fine quality combined make it exceedingly popular. Height, 2½ ft.; seed dark green, wrinkled. Pint, .15; qt., .25; peck, \$1.50; bush., \$5.00.
- ✓ **YORKSHIRE HERO.** A hardy, productive Pea about 20 inches high. Peas of good quality, remaining a long time in condition for use. Pint, .15; qt., .25; peck, \$1.50; bush., \$5.00.
- ✓ **SHROPSHIRE HERO.** Vines average 20 to 30 inches long, bearing a great abundance of large, handsome pods well filled with Peas of superior flavor. Pint, .15; qt., .25; peck, \$1.50; bush., \$5.00.
- ✓ **WHITE MARROWFAT.** An old sort; very hardy. Pint, .15; qt., .25; peck, \$1.25; bush., \$4.00.
- ✓ **BLACK-EYED MARROWFAT.** Very popular and hardy; 3 ft. Pint, .15; qt., .25; peck, \$1.25; bush., \$4.00.

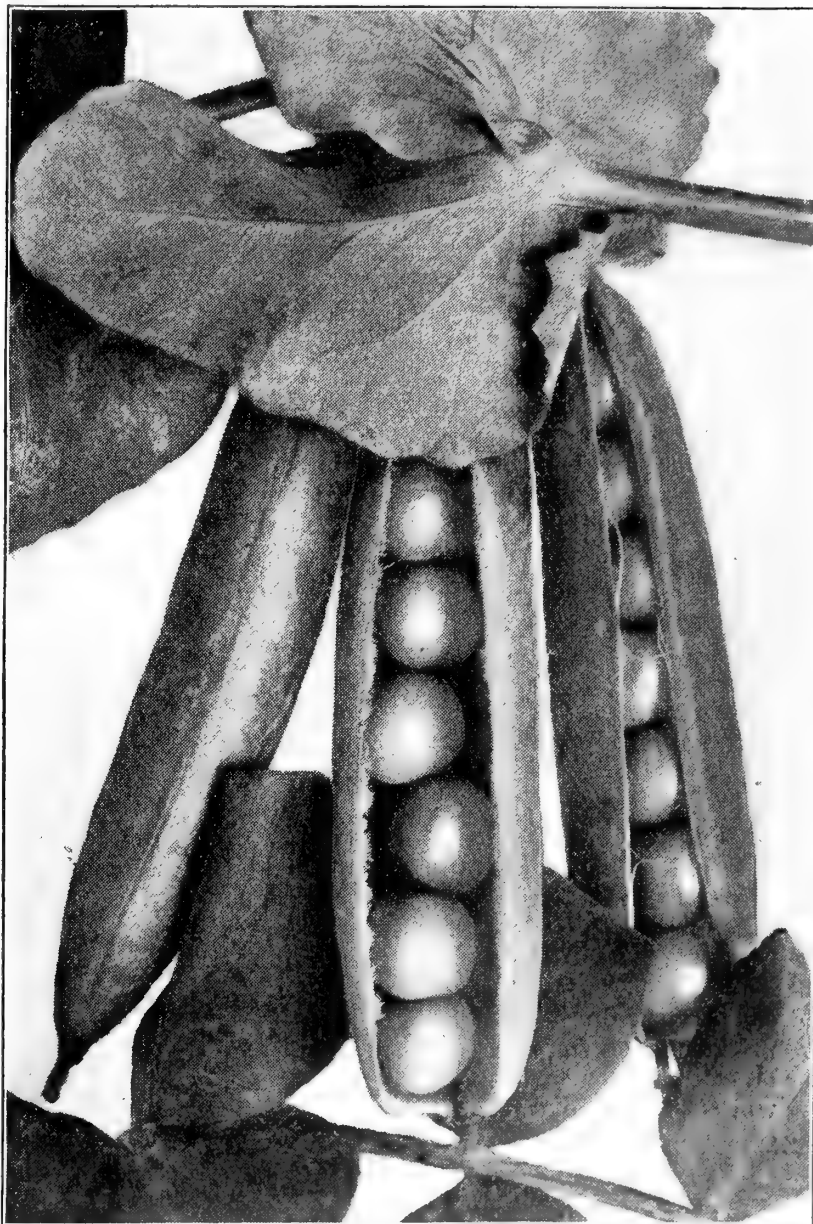

Pea. Nott's Excelsior.

Large packets of all varieties, 10 cts. each postpaid.

POTATOES.

PRICES SUBJECT TO VARIATIONS OF THE MARKET.

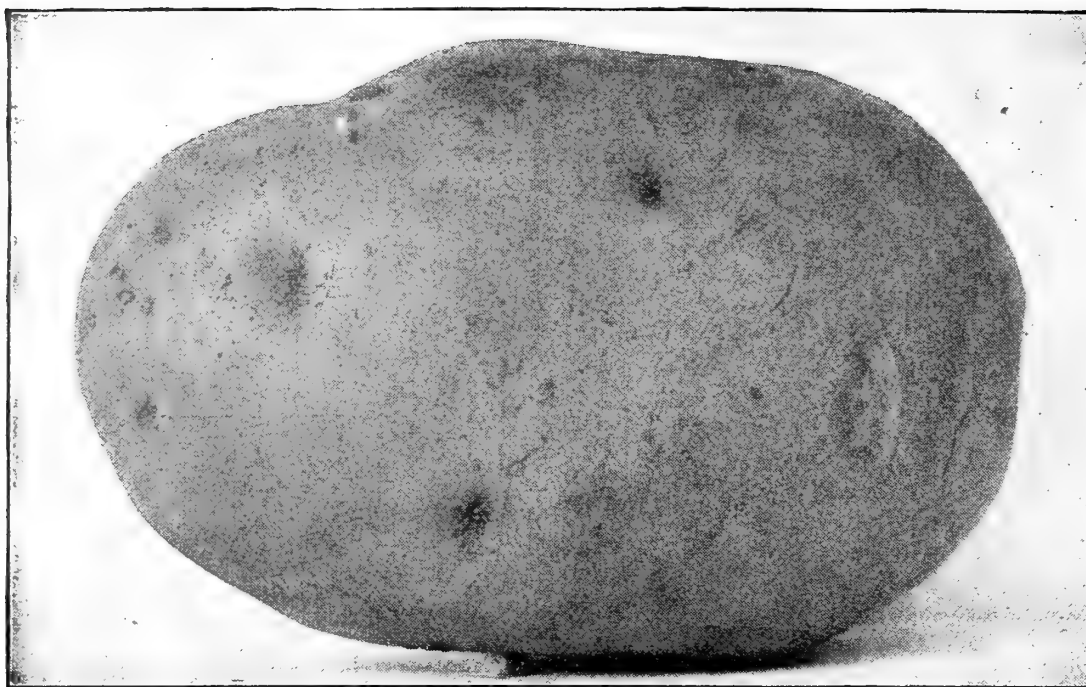

Early Rose.

A good, sandy loam produces the best potatoes, but they can be grown on all kinds of soil. New or pasture land, with the turf freshly turned, produces the finest crop. Make furrows of good depth, three feet apart. Scatter a liberal dressing of phosphate or decayed stable manure along the drill, and set the seed about ten inches apart in the rows. Cover with about two inches of soil, and begin to cultivate when the plants are well up. At each successive hoeing, bring additional soil about the plants. A change of seed is the best antidote for disease. *Four barrels are sufficient to plant one acre in drills.*

EARLY.

	Peck.	Bush.	Bbl.
EARLY ROSE. The standard variety for earliness, productiveness, and good quality60	\$1.75	\$4.00
BEAUTY OF HEBRON. Early potato of excellent quality and handsome appearance. It can safely be classified with the heaviest yielders. Its keeping qualities for an early kind are unexcelled. .60	1.75	4.00	
BOVEE. It is of the Early Hebron type. Vine growth dwarf and stocky. Potatoes have a pink skin, are smooth, handsome, fine quality and yield heavily75	2.00	4.75
NEW QUEEN. Seedling from the old Beauty of Hebron, which it closely resembles in color and form; a vigorous grower, producing large crops with but few small potatoes; earlier than the Rose, and a good general cropper60	1.75	4.00

MEDIUM EARLY.

IMPROVED GREEN MOUNTAIN. One of the best yielders, free from blight and rot, keeps well in cellars; color white; form round or oval; smooth skinned, shallow eye, a grand field cropper. .50	\$1.75	\$4.25	
--	--------	--------	--

LATE.

CARMAN NO. 3. The handsomest large round potato ever produced; every potato perfect in form. It ranks with the best for yield and table use. It has no dark spots, or hollow hearts, .60	\$1.75	\$4.00	
RURAL NEW YORKER NO. 2. Always produces a large crop of good potatoes; pure white skin and flesh. Eyes few and shallow. Heavy yielder60	1.75	4.25

SIR WALTER RALEIGH.
 Too much cannot be said in its favor; it yields practically no small potatoes. Few eyes; flesh white, fine grained, exceeding in quality many of the early varieties,
 Peck. Bush. Bbl.
 .60 \$1.75 \$4.25

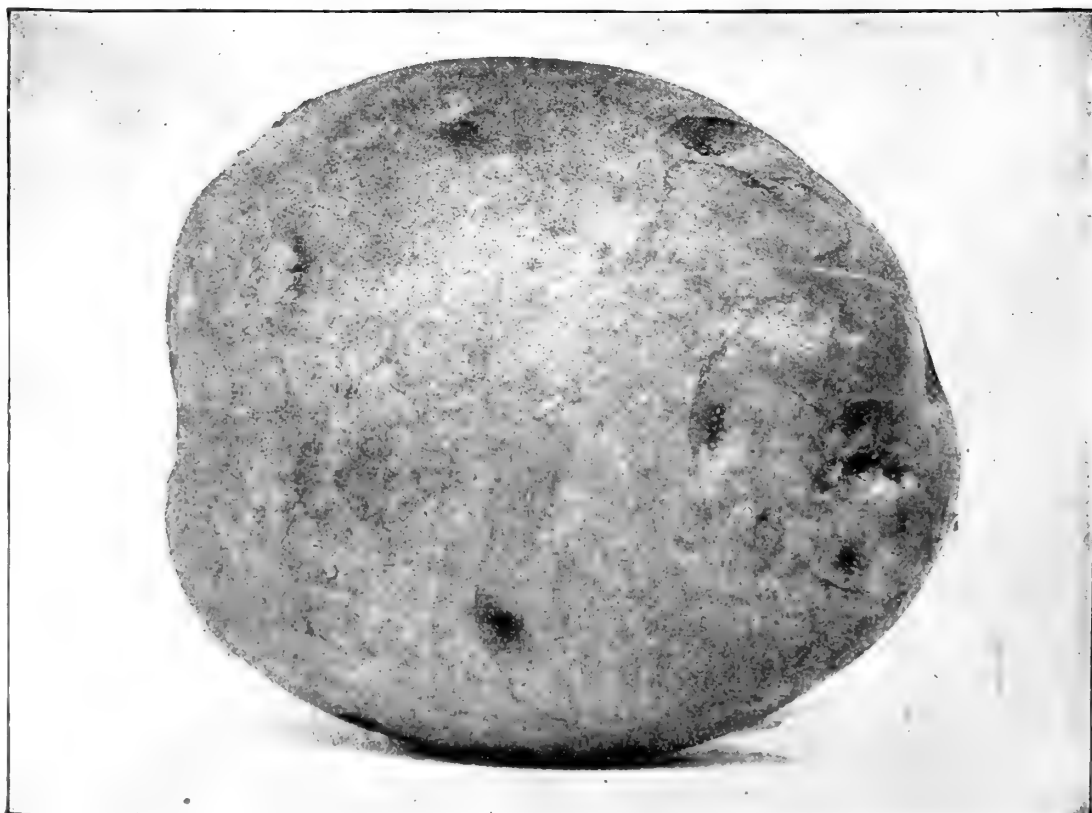

Rural New Yorker No. 2.

SWEET POTATOES.

ROOTED SLIPS READY IN MAY.

The young plants should be set in May in hills about four feet apart, and five inches above the ground level. A light soil and sunny location is preferable.

YELLOW NANSEMOND.
 Early; productive; the best for general culture. Price per 100, 75 cents. By mail, \$1.00.

RADISH. (*Rettig.*)

Radishes require a light, loamy soil, moderately fertile, which should be deeply dug and well pulverized. The situation should be warm and sheltered. For an early supply sow in January or February in hot-beds, keeping well ventilated. In May they may be sown out of doors. Successive sowings should be made every two weeks. Radishes to be crisp and tender should make a rapid growth. *One ounce of seed to one hundred feet of drill; ten pounds an acre.*

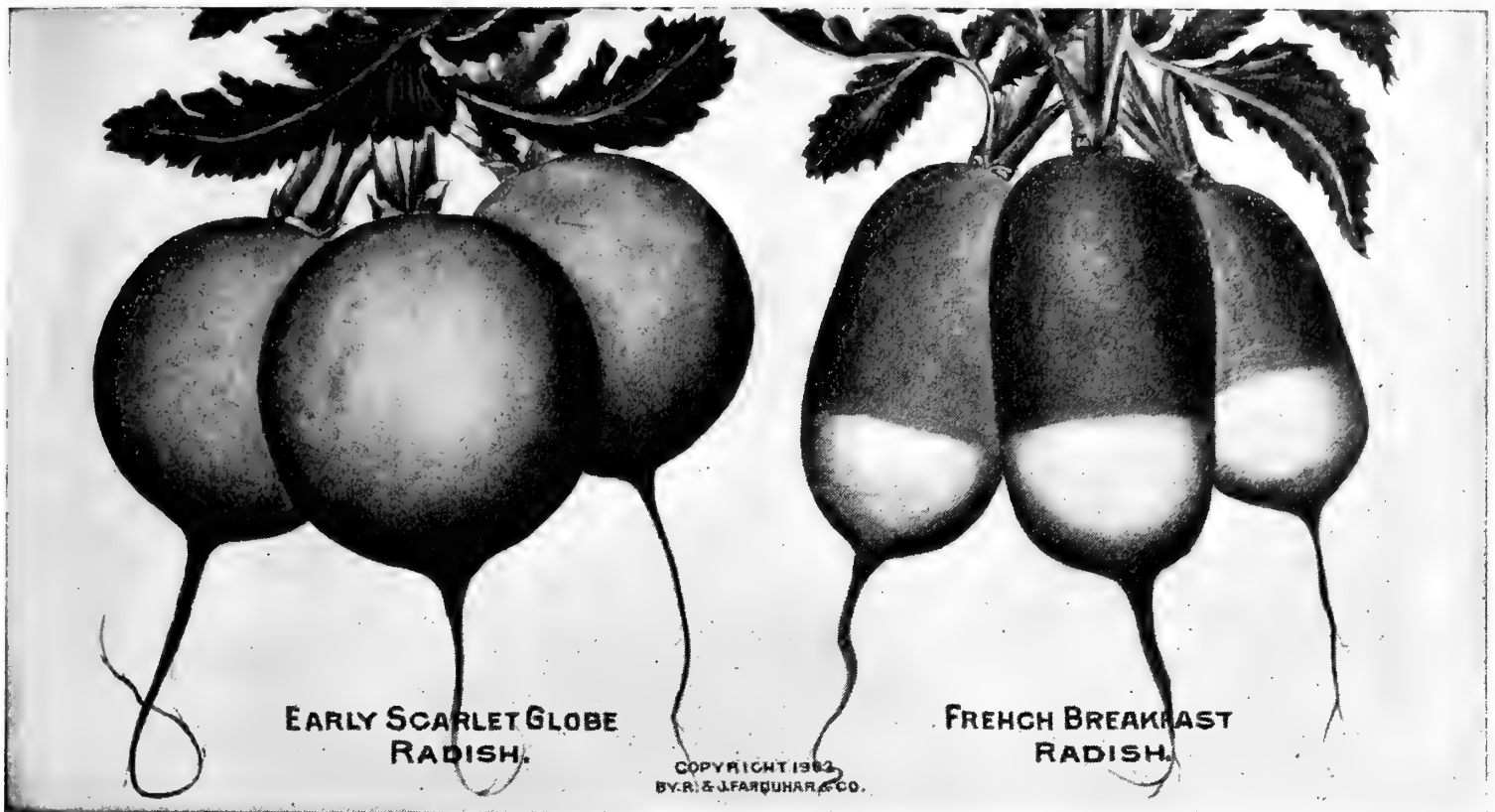

	Pkt.	Oz.	¼ lb.	Lb.
✓ EARLY DEEP SCARLET, OLIVE-SHAPED, SHORT LEAF. One of the most desirable varieties for forcing. The skin is a very deep bright red color; flesh crisp, tender, and of good quality. Leaves few, short, and small.05	.10	.25	.75
✓ EARLIEST SCARLET FRENCH FORCING TURNIP-ROOTED. NON PLUS ULTRA. The earliest of all; fit for use in about twenty days; short-leaved; brilliant red; excellent for forcing.05	.10	.25	.85
✓ EARLIEST FORCING DEEP SCARLET TURNIP-ROOTED. Similar to the above but darker.05	.10	.20	.75
✓ EARLY SCARLET GLOBE. Very attractive and beautiful; admirable for forcing or out-of-door culture; fine globe form with small top; color rich deep scarlet; flesh white and tender.05	.10	.30	1.00
✓ EARLY SCARLET TURNIP-ROOTED. Very early, crisp, and beautiful05	.10	.20	.65
✓ EARLY SCARLET TURNIP, WHITE-TIPPED. Very early; for frames or out-of-doors05	.10	.20	.70
✓ EARLY WHITE TURNIP, OR BOX. Suitable for forcing; pure white; sweet05	.10	.25	.85
✓ EARLY FRENCH BREAKFAST. Handsome oval form; color beautiful scarlet with white tip; excellent quality; quick in growth and small top. A splendid variety05	.10	.20	.70
✓ EARLY OLIVE SHAPED. Scarlet; very early; for frames or out-of-doors05	.10	.20	.65
✓ EARLY LONG SCARLET, SHORT TOP. Very long and crisp; for frames or open ground05	.10	.20	.60
✓ LONG BRIGHTEST SCARLET, WHITE TIP. The most beautiful colored scarlet radish in existence. Matures in twenty-five days from time of planting, and continues to be of good quality until full grown. Small top. A variety sure to give satisfaction05	.10	.25	.75
✓ BECKERT'S CHARTIER. Clear rose with white point; grows very even; crisp and tender05	.10	.25	.75
✓ WOOD'S FRAME. An early Half-Long Scarlet. Much used for forcing; handsome05	.10	.25	.85
✓ LONG BLACK WINTER, OR SPANISH. A popular winter sort05	.10	.25	.75
✓ ROUND BLACK WINTER, OR SPANISH. Fine keeper during winter05	.10	.20	.65
✓ WHITE GIANT STUTTGART WINTER. The finest white winter variety05	.10	.25	.75

SPINACH. (*Spinat.*)

This is best developed and most tender and succulent when grown in very rich soil. For summer use sow early in spring in drills fifteen inches apart, and make successive sowings every two weeks. For spring use sow in September, and cover lightly in November with light litter. *One ounce will sow 100 feet of drill; 10 to 12 lbs. an acre.*

	Pkt.	Oz.	¼ lb.	Lb.
✓ ROUND THICK-LEAVED. A standard sort; equally good for early spring or fall sowing; leaves are thick, succulent, and tender05	.10	.15	.35
✓ LONG-STANDING. Of delicious, tender quality; dark green05	.10	.15	.35
✓ SAVOY-LEAVED, OR BLOOMSDALE. Large, tender, curled leaves; fine05	.10	.15	.35
✓ VICTORIA. A new variety with thick dark green leaves. The best long standing Spinach.05	.10	.15	.35
✓ LETTUCE-LEAVED. A popular variety; very tender05	.10	.15	.35
✓ PRICKLY SEEDED. Very hardy and vigorous; leaves arrow-shaped05	.10	.15	.35
✓ NEW ZEALAND. Makes a low spreading plant from which delicious, tender greens can be gathered the entire summer. May be started in a hot-bed and transplanted or sown out-of-doors when the ground is warm, allowing two feet between the plants05	.15	.30	1.00

SQUASH. (*Speise Kurbiss.*)

Being somewhat tender, Squashes should not be planted till all danger from frost has passed. They delight in a warm, thoroughly pulverized, very rich soil. Plant in hills in May, mixing with the soil in each hill a shovelful or two of rotted manure. For bush varieties the hills should be from five to six feet apart, for running sorts ten feet apart. Put eight or ten seeds in each hill, and when well grown, thin, leaving two or three of the strongest plants in each hill. *Small seeded sorts, one ounce to fifty hills; large seeded sorts, one ounce to fifteen hills.*



COPYRIGHT 1902
BY R. & J. FARQUHAR & CO.

Hubbard.

Bay State.

✓ THE DELICIOUS. A new variety, surpassing all others. Its color is almost uniformly of a green shade, with occasionally a blue specimen, it being just about as pure in this respect as was the original Hubbard. In size it also closely follows the original Hubbard, which weighed between five and ten pounds. In thickness of flesh it surpasses nearly every variety, the color being a dark orange. For table use no squash compares with it in its remarkable combination of fineness and compactness of grain, dryness, sweetness, and exceeding richness of flavor. It is a fall and winter squash, being excellent at all seasons, but like the old Hubbard, though at any time excellent, does not acquire its best quality until winter

	Pkt.	Oz.	¼ lb.	Lb.
THE DELICIOUS. A new variety, surpassing all others. Its color is almost uniformly of a green shade, with occasionally a blue specimen, it being just about as pure in this respect as was the original Hubbard. In size it also closely follows the original Hubbard, which weighed between five and ten pounds. In thickness of flesh it surpasses nearly every variety, the color being a dark orange. For table use no squash compares with it in its remarkable combination of fineness and compactness of grain, dryness, sweetness, and exceeding richness of flavor. It is a fall and winter squash, being excellent at all seasons, but like the old Hubbard, though at any time excellent, does not acquire its best quality until winter10	.35	\$1.00	\$3.50
✓ EARLY MAMMOTH WHITE BUSH. The best early scalloped summer sort05	.10	.30	1.00
✓ EARLY GOLDEN CUSTARD. Scalloped, early; golden yellow; excellent05	.10	.30	1.00
✓ EARLY SUMMER CROOKNECK OR WARTED. The best flavored of the early bush Squashes; long; bright yellow in color05	.10	.30	1.00
✓ STRICKLER BUSH. A large growing type of summer Crookneck; fine quality05	.15	.35	1.25
✓ EARLY PROLIFIC, OR ORANGE MARROW. The earliest and most productive fall and winter Squash; color bright orange; flesh dry and sweet. A true marrow05	.15	.40	1.25
✓ BOSTON MARROW. Larger and somewhat later than the preceding; good keeper and of excellent flavor05	.15	.40	1.25
✓ ESSEX HARD-SHELL TURBAN, OR HYBRID. Productive, with very hard shell; a solid, heavy thick-fleshed sort; of excellent flavor, and keeps admirably10	.20	.60	2.00
✓ AMERICAN TURBAN. Flesh thick and sweet; a superior fall sort10	.20	.60	2.00
✓ THE WARREN. Very solid and heavy Turban Squash with rich deep color; very deep flesh and of excellent quality; fine winter sort10	.20	.60	2.00
✓ THE GOLDEN BRONZE. Size averaging from eight to ten pounds; color, a dark, grayish green; flesh an exceedingly bright golden yellow; fine grained, very sweet, and of delicious flavor. Easy in maturing, a good keeper, and yielding largely of squashes of very uniform size and appearance. A squash combining the qualities desired for the table and pies05	.20	.50	1.75
✓ HUBBARD. The standard winter Squash; more highly esteemed than any variety for dryness, flavor, productiveness, and fine keeping qualities; shell dark green, very hard; flesh very thick and of fine flavor05	.20	.60	1.75
✓ CHICAGO WARTED HUBBARD. This squash has warty knobs all over it; flesh thick and rich. Splendid keeper05	.20	.60	2.00
✓ BAY STATE. Blue, very hard shell; for fall and winter05	.15	.40	1.25
✓ MARBLEHEAD. Resembles the Hubbard, but has gray skin; excellent05	.10	.30	1.00
✓ SIBLEY, OR PIKE'S PEAK. Of superior flavor and very dry; shell pale green, very hard; productive and keeps well05	.10	.30	1.00
✓ CANADA CROOKNECK. Small, well-known winter sort; green skin05	.10	.30	1.00
✓ WINTER CROOKNECK. Good keeper; bugs or borers rarely trouble the two latter sorts05	.10	.30	1.00
✓ YELLOW MAMMOTH. Grows to an enormous size, often weighing nearly two hundred pounds; requires high cultivation10	.25	.75	2.50
✓ VEGETABLE MARROW. For summer use; favorite English bush squash; cream color, white flesh10	.30	.75	2.50

TOMATO. (*Liebes Apfel*.)

Sow thinly about the first week in March in a hot-bed, greenhouse, window, or sitting room, where the temperature is never below 60°. When two inches high set out the plants in boxes, about four inches apart, or pot singly. About the first of June they may be transferred to the open ground. Set them deeply, four feet apart, and a shovelful of rotted manure should be mixed in the earth of each hill. If the vines are trained on trellis the fruit will be finer and larger.

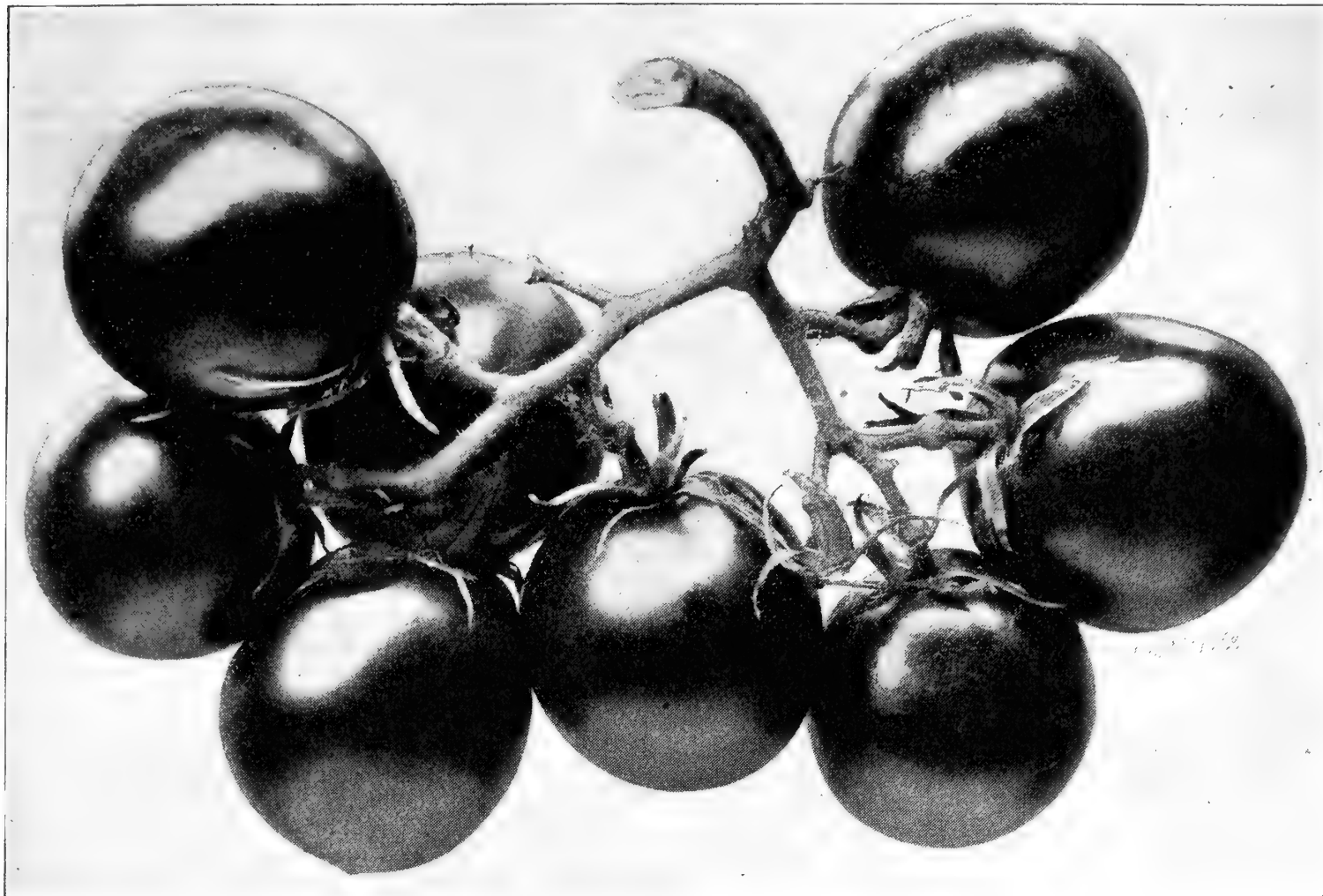

Tomato, Stirling Castle.

	Pkt.	Oz.	¼ lb.	Lb.
✓ STIRLING CASTLE. We have a specially selected stock of this variety. The best cropping sort of all the round fruited varieties. Excellent for forcing as well as out-door culture. Fruit is of medium size, reddish scarlet in color, and of very delicious flavor. A variety which sets very freely, and one we can thoroughly recommend25			
✓ THE ROCHFORD. A grand forcing Tomato, combining great productiveness with excellent form and splendid quality. The fruit is round, perfectly smooth, medium size, and of a deep rich scarlet color. Flesh very solid, something of much importance in a forcing Tomato. The fruit is produced on bunches which average six to ten fruit each15	.50	\$1.50	
✓ SPARK'S EARLIANA. The earliest and most prolific large Tomato. Color a beautiful red, handsome, uniform, remarkably solid and productive10	.75	2.00	
✓ CHALK'S EARLY JEWELL. An early deep fruited sort, hardy and very solid. Color brightest scarlet, flesh scarlet with few seeds and of very sweet flavor, skin thin15	\$1.25		
✓ FARQUHAR'S FAULTLESS EARLY. The standard early Tomato. Uniformly medium size; handsome, perfectly round fruit of great density; incomparable; superior to all other varieties for early and main crop10	.35	1.00	\$3.50
✓ MAY'S FAVORITE. One of the finest in every respect; very early; smooth and uniform10	.30	.85	3.00
✓ DWARF CHAMPION. Quite distinct and very early; stem upright, with few branches; beautiful solid fruit close to the stem10	.35	1.00	3.50
✓ FREEDOM. An extra early; bright scarlet, smooth, round, and handsome05	.25	.75	2.50
✓ FROGMORE. One of the best early scarlet Tomatoes for early forcing or outdoor culture. Free setter, heavy cropper, medium, uniform, and smooth10	.40	1.25	4.00
✓ SUTTON'S BEST OF ALL. An excellent sort for forcing, or early outdoor crop. Sets freely and an immense cropper. Color, deep scarlet15	.50	1.50	
✓ LIVINGSTONE'S MAGNUS. Unsurpassed in quality and in the production of fine, large fruits. The form is perfect, uniform, large, and attractive; flesh very firm; heavy cropper10	.40	1.25	4.00
✓ PRESIDENT CLEVELAND. Excelling all others in solidity, smoothness, and fine quality; evenly large; ripens clear up to the stem, and first class in every respect; wonderfully productive05	.25	.75	2.50
✓ STONE. Livingstone. Large, perfectly smooth, scarlet; one of the best05	.25	.75	2.50
✓ BEAUTY. Livingstone. Pinkish red; large, smooth, thick flesh05	.25	.75	2.50
✓ FAVORITE. Livingstone. One of the handsomest; very smooth05	.25	.75	2.50
✓ PERFECTION. Livingstone. Early; evenly large, and very productive05	.25	.75	2.50
✓ LORILLARD. Early; bright glossy red, fine flavor05	.25	.75	2.50
✓ ACME. Medium; red, smooth, and very fine05	.25	.75	2.50
✓ TROPHY. Large; very solid, productive, and keeps well05	.25	.75	2.50
✓ PONDEROSA. Late and very large; remarkably solid; not smooth10	.50	1.50	5.00
✓ GOLDEN QUEEN. Yellow; medium size; fine; remarkably attractive10	.30	1.00	3.00
✓ PEACH. Resembles the Peach in color; small; good for preserves10	.30	1.00	3.00
✓ PLUM. Yellow, oval, small size; used for preserves10	.30	1.00	3.00
✓ PEAR, OR FIG. Bright red, pear-shape, small; for preserves10	.30	1.00	3.00
✓ RED CHERRY. Used for preserves; small, round fruit10	.30	1.00	3.00
✓ CURRENT, OR GRAPE. Very small, bright red fruit in clusters10	.50	1.50	4.50
✓ STRAWBERRY, OR GROUND CHERRY. Physalis alkekengi. The fruit, which grows in a husk, will keep all winter; makes an excellent preserve10	.40	1.25	4.00

TOMATO PLANTS. .30 per doz.; \$2.00 per 100. Ready in June. DWARF CHAMPION, PERFECTION, AND STONE.

TARRAGON PLANTS.

FRENCH ESTRAGON. Plants of our own growing of the genuine French Tarragon. The leaves impart a delicious flavor to salads, soups, pickles, etc. Plants, well established, 25 cents each; dozen, \$2 50. By mail, 5 cents each extra.

TURNIP. (*Rube.*)

For early Turnips, sow as soon as the ground is dry enough. Fall Turnips may be sown from the first week in July to the end of September. Ruta-bagas should be sown in June or early in July, in drills eighteen inches apart. Turnips should be thinned when large enough, six to nine inches apart in the drills, according to size. Sowings should be done before rain, if possible. The soil should be rich and well worked. *One ounce will sow one hundred and fifty feet of drill; two pounds will sow an acre in drills; one pound will sow an acre broadcast.*

- ✓ **PURPLE TOP WHITE FLAT, STRAP-LEAF.** A popular sort for early and fall sowing; flesh white, tender, and very sweet. Pkt., .05; oz., .10; 1/4 lb., .20; lb., .50.
- ✓ **WHITE TOP FLAT.** Early, smooth, white, fine. Pkt., .05; oz., .10; 1/4 lb., .20; lb., .50.
- ✓ **EXTRA EARLY WHITE MILAN.** The most beautiful white variety in cultivation and one of the earliest to mature. The roots are very smooth; small tops; flesh tender and sweet. Adapted for growing in cold frames. Pkt., .05; oz., .10; 1/4 lb., .30; lb., \$1.00.
- ✓ **PURPLE TOP MILAN.** The earliest and best of the Flat Turnips; white with purple top; delicious quality; small, compact strap leaves. Pkt., .05; oz., .10; 1/4 lb., .25; lb., .75.
- ✓ **WHITE EGG.** Oval; remarkably handsome; sweet. Pkt., .05; oz., .10; 1/4 lb., .25; lb., .75.

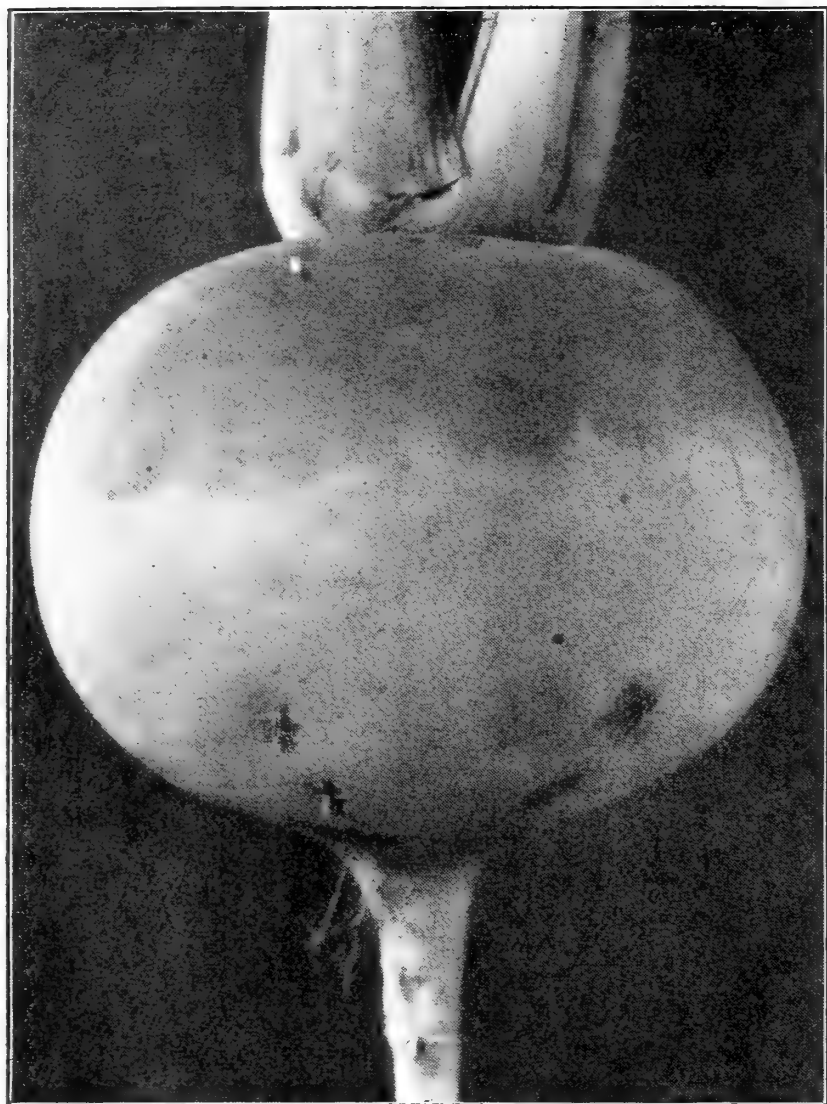

Purple Top White Globe Turnip.

- ✓ **PURPLE TOP WHITE GLOBE.** Very early; very fine grained; beautiful in appearance; tender and delicious. Pkt., .05; oz., .10; 1/4 lb., .20; lb., .50.
- ✓ **WHITE GLOBE.** Large English white variety; quick grower. Pkt., .05; oz., .10; 1/4 lb., .20; lb., .50.
- ✓ **YELLOW ABERDEEN.** Yellow; solid; fine quality; keeps well. Pkt., .05; oz., .10; 1/4 lb., .20; lb., .50.
- ✓ **YELLOW STONE, OR GLOBE.** Of large size; flesh yellow; fine fall sort. Pkt., .05; oz., .10; 1/4 lb., .20; lb., .50.
- ✓ **COWHORN, OR LONG WHITE.** Form oblong; flesh white; early and very good. Pkt., .05; oz., .10; 1/4 lb., .25; lb., .75.

RUTA-BAGA, OR SWEDISH TURNIP.

- ✓ **AMERICAN PURPLE TOP.** A strain of purple top yellow. The roots grow to a large size and are of the finest quality, short neck and small top. Pkt., .05; oz., .10; 1/4 lb., .20; lb., .60.
- ✓ **BUDLONG'S WHITE SWEDE.** Grown from selected roots, the best of this section; very sweet; excellent flavor and keeps well. Pkt., .05; oz., .10; 1/4 lb., .20; lb., .50.
- ✓ **SWEET GERMAN.** White flesh; sweet, and fine flavor; good keeper. Pkt., .05; oz., .10; 1/4 lb., .20; lb., .50.
- ✓ **WHITE FRENCH.** Similar to Sweet German, but larger. Pkt., .05; oz., .10; 1/4 lb., .20; lb., .50.
- ✓ **SHAMROCK.** Yellow flesh; solid as a rock; remarkably fine flavor; neck short; a very heavy cropper and one of the best. Pkt., .05; oz., .10; 1/4 lb., .20; lb., .50.

BOOKS ON VEGETABLE GARDENING.

Postpaid at prices quoted.

- Gardening for Profit. Henderson. \$1.50.
- Success in Market Gardening. Rawson. \$1.00.
- Principles of Vegetable Gardening. Bailey. \$1.25.
- Vegetable Gardening. Green. \$1.00.
- Kitchen Garden Planting Table, mailed upon application.

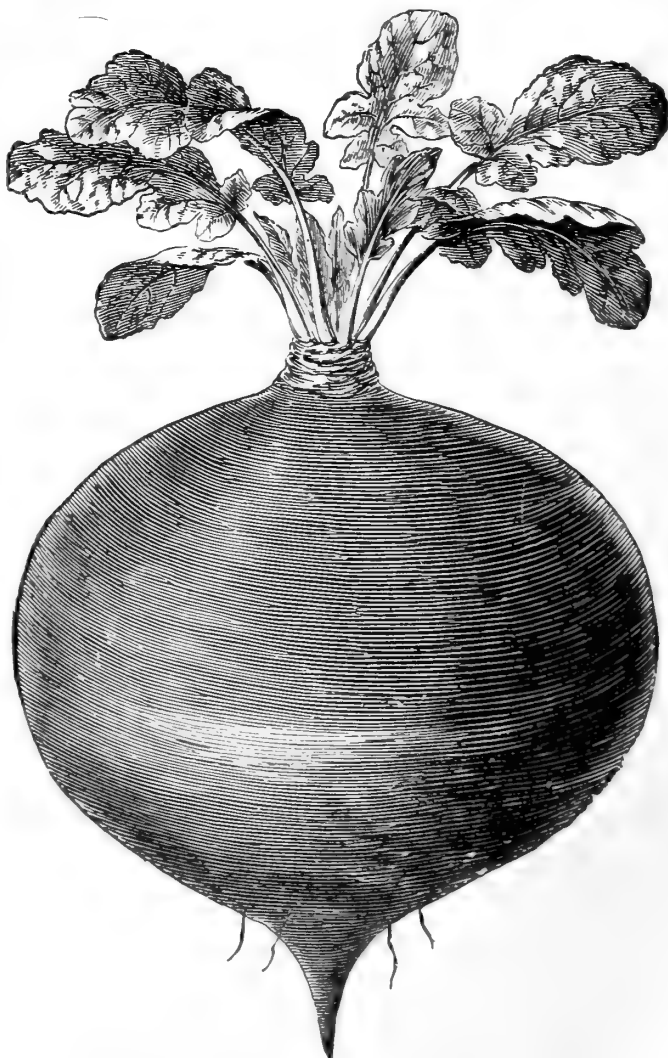

Improved American Purple Top Ruta-Baga.

RHUBARB. (*Rhabarber.*)

A deep, rich soil, trenched to the depth of two feet, is best for Rhubarb. It is usually propagated from plants.

		Pkt.	Oz.	¼ lb.	Lb.	Each.	Doz.	100.
✓ LINNÆUS.	Early, large, tender05	.20	.50	\$1.75	.25	\$2.50	\$15.00
✓ VICTORIA.	Large, late, good old sort05	.20	.50	1.75	.25	2.50	15.00
✓ MONARCH.	The best sort; very tender05	.25	.75	2.00	.35	3.50	20.00

SALSIFY, OR OYSTER PLANT. (*Haferwurz.*)

A most delicious vegetable. It is used stewed, boiled, or fried, and sometimes as a salad. When cooked it has an oyster flavor. Cultivation the same as for Carrots or Parsnips. *An ounce will sow fifty feet.*

		Pkt.	Oz.	¼ lb.	Lb.
✓ MAMMOTH SANDWICH ISLAND.	True. Large and superior; very fine flavor05	.15	.50	\$1.50
✓ LONG WHITE FRENCH.	Delicious when cooked; roots of medium size05	.15	.40	1.25

SEA KALE. (*Meerkohl.*)

Sow one inch deep in drills; thin to six inches; transplant the following spring three feet apart.

✓ SEA KALE. The blanched shoots are used like Asparagus; very tender . . Pkt., .05; oz., .30; ¼ lb., .85; lb., \$3.00

SWEET, POT, AND MEDICINAL HERBS.

	Pkt.	Oz.		Pkt.	Oz.		Pkt.	Oz.		Pkt.	Oz.
ANISE05	.15	CARAWAY05	.10	LAVENDER10	.39	SAGE05	.15
ARNICA15	1.00	CATNIP10	.50	LOVAGE25	1.00	SORREL05	.20
BALM05	.30	CORIANDER05	.10	MARJORAM05	.20	SUMMER		
BASIL05	.20	DILL05	.20	PENNYROYAL25	1.00	SAVORY05	.15
BORAGE05	.20	FENNEL05	.10	ROSEMARY10	.40	THYME10	.30
BURNETT05	.15	HOREHOUND05	.25	RUE05	.15	WORMWOOD05	.25
CAMOMILLA10	.75	HYSSOP05	.25	SAFFRON05	.10			

BIRD SEEDS, MOCKING BIRD AND PARROT FOOD.

	Per lb.	100 lbs.		Per lb.	100 lbs.
CANARY, best Sicily10	\$5.00	RAPE, GERMAN10	\$5.00
HEMP10	5.00	UNHULLED RICE10	7.00
LETTUCE SEED25		VETCHES FOR PIGEONS10	6.00
MAW, BLUE POPPY15		PEAS FOR PIGEONS10	3.50
MILLET10	4.50	PREPARED FOOD FOR MOCKING BIRDS25	
MILLET, WHITE FRENCH PEARL15	8.00	SUNFLOWER FOR PARROTS10	5.00
RAPE, ENGLISH10	6.00			

HIGH GRADE GRASS SEEDS ARE A LEADING FEATURE WITH US.

(See pages 28-32.)

EVIDENCE OF QUALITY.

R. & J. Farquhar & Co.:

Dear Sirs: Visitors here this season have been very much interested in the turf on my Gold Course and Bowling Green. Many of them have informed me that it is the best they have seen anywhere. I can highly recommend your Grass Seeds for golf courses and other special purposes. The clean quality of the turf on our courses here is the best evidence of the high-grade quality of Seeds you have heretofore supplied. I trust you will continue to send me and my friends the same article.

Yours truly,

Bretton Woods, N.H., Nov. 3, 1903.

GEO. S. MERRITT.

Messrs. R. & J. Farquhar & Co.:

Gentlemen: I cheerfully give my opinion of the quality of your Grass Seed. I have used it very largely especially for lawns and permanent pasture. I sowed sixty acres with your Grass last spring, and the success was remarkable. The take was close and even, and the fields now look very fine and indicate large crops of hay for next year. I shall need a further supply next spring, and, as my experience with your seed has proved invariably good, will send you my order accordingly.

Yours very truly,

GEO. T. PHILCOX, Mgr.,
Elm Court Farm.

Lenox, Mass., Oct. 11, 1903.

R. & J. Farquhar & Co.:

Dear Sirs: All the lawns sown with your Grass Seeds have done remarkably well. They are the admiration of all who have seen them, and surprise has been expressed that so good a lawn could be made in such a short time. The lawn made and sown last spring looks quite as good as old turf.

Yours truly,

WILLIAM ANDERSON, Gardener to Bayard Thayer, Esq.

South Lancaster, Mass., Nov. 16, 1903.

R. & J. Farquhar & Co.:

Dear Sirs: I take much pleasure in recommending your Lawn Grass Seed, which I have used here for the last fifteen years. Grown on lawn by the cliffs and under trees, and especially on tennis court, which have been admired by all.

Yours very truly,

R. HUNNICK,
Gardener for F. W. Vanderbilt, Esq.

Rough Point, Newport, R.I., Oct. 14, 1903.

FARQUHAR'S EVERGREEN LAWN GRASS.

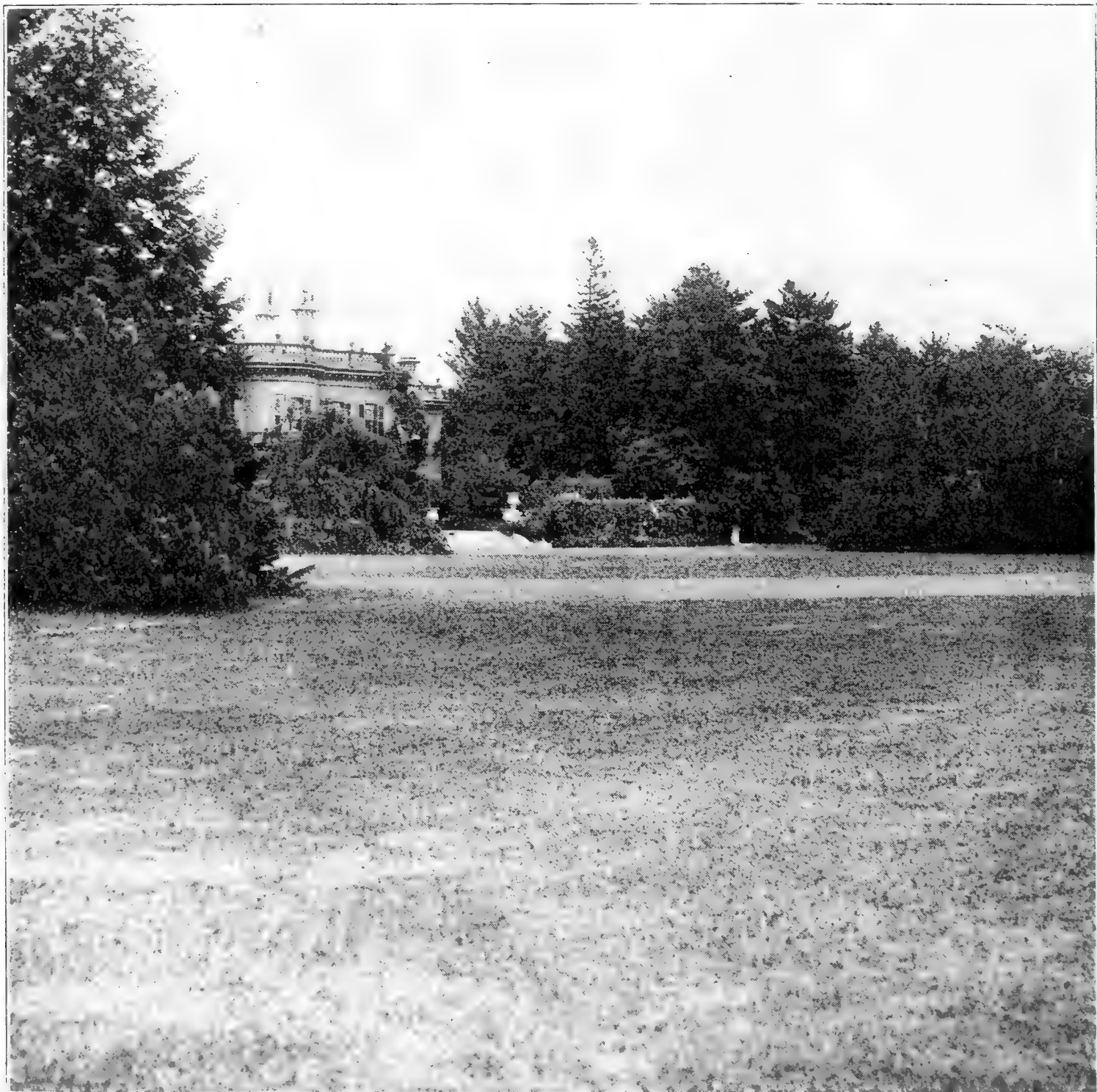

A Partial View of the Celebrated Lawn on the Estate of Mr. Walter Hunnewell, Wellesley, Mass., the Product of Farquhar's Evergreen Lawn Grass Seed.

OUR GRASSES FOR LAWNS are celebrated for producing a perfect, rich, deep-green sward from early spring till late in fall. The varieties are specially selected, tested, and blended, and the lawns made from our formulas are unsurpassed anywhere for beauty and color. As a result of our care in invariably furnishing clean, pure, fresh Lawn Seed, our trade in this specialty is enormous. We annually furnish seed for the parks and gardens of Boston, and ship large quantities to Newport, Lenox, Bar Harbor, and other leading summer resorts.

FARQUHAR'S EVERGREEN LAWN GRASS.

Specially reliable mixture of dwarf, hardy, fine-leaved grasses, the growth of which has been *thoroughly tested*.

One quart will sow 300 square feet. Price per quart, 20 cents; by mail, 25 cents.

Four quarts will sow 1,200 square feet. Price, 60 cents; by express only.

One peck will sow 2,400 square feet. Price, \$1.00; by express only.

One bushel (20 lbs.) will sow 10,000 square feet. Price, \$4.00; by express or freight.

Four bushels (80 lbs.) is sufficient for one acre.

NEW BOSTON PARKS LAWN-SEED.

We have received from Messrs. Olmsted, Olmsted & Eliot their formula used in seeding the beautiful lawns and terraces of Boston's new parks. Franklin Park and the Metropolitan parks have been planned by this firm of eminent landscape architects, and their formula may be accepted as the best which experience can suggest.

62 lbs., sufficient for *one acre* (43,560 square ft.), \$15.00 | 16 lbs., sufficient for *one-quarter acre* (10,890 sq. ft.), \$4.00
 31 lbs., sufficient for *one-half acre* (21,780 sq. ft.), 7.50 | 1 lb., sufficient for 700 sq. ft., \$.30; by mail40

FARQUHAR'S SPECIAL GRASS SEED MIXTURES FOR TENNIS COURTS, GOLF LINKS, PUTTING GREENS, SHADY PLACES AND TERRACES, ARE FAVORABLY KNOWN EVERYWHERE FOR PRODUCING A FINE, CLOSE, ENDURING SWARD OF VELVETY GREEN



SPECIAL GRASS SEED MIXTURES.

Quart., .35; by mail, .45; peck, \$1.50; per bushel of 20 lbs., \$5 00.

FARQUHAR'S MIXTURE FOR SHADY PLACES.

This is a mixture of extra fine grasses adapted for growing in the shade and under trees. We recommend the use of this mixture wherever other grasses have failed to make a close sward.

FARQUHAR'S "GOLF LINKS" MIXTURE.

We have supplied several Clubs with this Mixture, which is the result of a careful study of the requirements for making beautiful Golf Links, and we do not hesitate to say that it has given entire satisfaction.

FARQUHAR'S "PUTTING GREEN" MIXTURE.

The very finest low growing Grasses are contained in this Mixture, and very hardy. This Mixture will produce a beautiful and lasting green turf wherever used, calculated to withstand hard tear and wear.

FARQUHAR'S "TERRACE MIXTURE."

A mixture of strong, deep-rooted Grasses for "banks" or "terraces." Although the Grasses are strong and deep rooted, they will produce a fine green velvety appearance, and also prevent washing away during heavy rains.

FARM AND FIELD SEEDS.

Prices Subject to Market Fluctuation.

We sell the finest quality of new crop Grass and Clover seeds; selected, re-cleaned, tested. Customers in comparing prices should bear in mind that there are several grades in the trade, according to weight, purity, and germination.

GRASSES.



Timothy.

KENTUCKY BLUE. *Poa Pratensis.* Known as *June Grass.*

A perennial, especially adapted to dry limestone soils, but will thrive on any good ground which is not too wet. Very nutritious, hardy, and early. Sow three bushels per acre if alone. (14 lbs. per bushel.) Lb., 20 cents; 100 lbs., \$15.00.

RHODE ISLAND BENT. *Agrostis canina.* A bottom Grass, suitable for using with tufted varieties. Hardy and early and a grass that will withstand heat and dry weather. Sweet and nutritious and relished by all kinds of stock. Sow 4 bushels per acre if alone. (10 lbs. per bushel.) Per lb., 30 cents; per bushel, \$2.50; 100 lbs., \$22.50.

ORCHARD. *Dactylis glomerata.* A deep rooted perennial, growing in tufts. A strong, vigorous grower, which succeeds best on rich lands or clayey soils. Should be cut for hay at the time of first flowering. Sow three bushels per acre if alone. (14 lbs. per bushel.) Per lb., 25 cents; per bushel, \$3.00; 100 lbs., \$18.00.

TALL OAT GRASS. *Avena elatior.* A perennial which grows in loose tufts and throws up an abundance of leaves and tall stalks. Succeeds best on rich upland soils, and when once established is a great drought resister. Early. Makes its heaviest growth the second year. Per lb., 30 cents; per 100 lbs., \$22.00.

TIMOTHY OR HERDS GRASS. *Phleum Pratense.* This Grass is usually considered and treated as a short-lived perennial, and hence is the best grass to grow in a short rotation. It succeeds best on moist loams and clays naturally rich in humus or on those which have been heavily manured. It grows in loose tufts, with few short leaves, so that Red Top or Red Clover should be sown with it to furnish heavy bottom growth of leaves. Sow one-half bushel per acre if alone. (45 lbs. per bushel.) Per bushel, \$2.50.

RED TOP. *Agrostes vulgaris.* A good permanent Grass, which grows naturally in cold wet soils. It should be grown in cultivation in similar situations. A perennial with long creeping stems and underground runners; one of the best bottom grasses bearing large numbers of fine root leaves, making it invaluable for sowing with erect tufted Grasses, such as Orchard and Timothy, filling in between the clumps and producing a continuous turf. Sow four bushels per acre if alone. (10 lbs. per bushel.) Per lb., 15 cents; per bushel, \$1.00; 100 lbs., \$8.50.

RED TOP. CLEAN SEED. Chaff and weeds sifted out; pure fancy seed. We recommend this to all who desire the best results, as its absolute purity and excellence insure satisfaction for farm, park, or lawn. Excellent for restoring worn-out swards. Per lb., 20 cents; 100 lbs., \$14.00.



Orchard Grass.

GRASSES — *Continued.*

ITALIAN RYE GRASS. *Lolium Italicum.* A biennial which grows in broad, compact tufts, producing a large number of stalks from a single root. Succeeds best in warm, rich, moist soils. A rapid grower and a good crop to rid land of weeds, as it quickly overtops them, preventing them from ripening seeds. Sow three bushels per acre. (18 lbs. per bushel.) Lb., 15 cents; 100 lbs., \$10.00.

PERENNIAL RYE GRASS. *Lolium perenne.* A perennial forming large and broad tufts. Grows best on stiff, wet soils, and on heavy clays or marshy lands where the soil is good it is one of the best pasture Grasses. (22 lbs. per bushel.) Lb., 15 cents; 100 lbs., \$12.00.

MEADOW FESCUE. *Festuca pratensis.* A perennial which succeeds best on rich, moist loams. A heavy yielder and also an excellent pasture Grass. (15 lbs. per bushel.) Per lb., 20 cents; per 100 lbs., \$16.00.

VARIOUS LEAVED FESCUE. *Festuca Heterophylla.* Early, hardy perennial two or three feet high. Valuable for permanent pasture. Thriving in high altitudes and in shady locations. Per lb., 30 cents; 100 lbs., \$25.00.

HARD FESCUE. *Festuca duriuscula.* This splendid Grass is found in all the best lawns and permanent pastures; invaluable for dry soils; of low, dense-growing habit. (14 lbs. per bushel.) Per lb., 20 cents; per 100 lbs., \$15.00.

RED OR CREEPING FESCUE. *Festuca Rubra.* A splendid Grass for light sandy soils. Extreme drought resister. Valuable in seeding banks and exposed locations, binding drifting sands, and as lawn grass for shady spots. Forms a very close, durable turf, suitable for putting greens. Per lb., 25 cents; per 100 lbs., \$18.00.

SHEEP'S FESCUE. *Festuca ovina.* Of dense growth; excellent for dry situations and sheep pastures. Sow two and a half bushels per acre. (12 lbs. per bushel.) Per lb., 20 cents; per 100 lbs., \$14.00.

FINE LEAVED SHEEP'S FESCUE. *Festuca ovina tenuifolia.* A very fine-leaved Grass, dwarf in habit. Will succeed in dry, high locations and inferior soils. Hardy and durable. Per lb., 40 cents; 100 lbs., \$30.00.



Tall Fescue.



Red Fescue.

TALL FESCUE. *Festuca elatior.* Excellent for permanent pastures on moist soils on which it yields immensely. Cattle and stock eat it greedily. (15 lbs. per bushel.) Per lb., 40 cents; per 100 lbs., \$36.00.

CRESTED DOG'S TAIL. *Cynosurus cristatus.* A perennial valued for its dwarf habit and its hardiness. (28 lbs. per bushel.) Per lb., 40 cents; per 100 lbs., \$30.00.

SWEET VERNAL, TRUE PERENNIAL. Invaluable in lawns on account of its very early growth and fragrant odor which it imparts to the other grasses in drying. Remains green very late. Hardy and permanent. Per lb., 85 cents.

REED CANARY GRASS. *Phalaris Arundinacea.* A creeping rooted perennial. Grows in alluvial marshy lands, sides of rivers, lakes, ditches, and rivulets. Its seed affords food for trout and wild fowl. A strong growing grass, but eaten with apparent relish by cattle and horses when cut prior to flowering. Per lb., 85 cents; per 100 lbs., \$60.00.

MEADOW FOX TAIL. *Alopecurus pratensis.* Very valuable in mixtures for permanent pastures exposed to heat and drought; early and rapid in growth. (8 lbs. per bushel.) Per lb., 35 cents; per 100 lbs., \$28.00.

ROUGH-STALKED MEADOW. *Poa trivialis.* An excellent permanent Grass to mix with other varieties for moist pastures. Produces a constant supply of nutritious herbage. Suitable for growing in shade. (14 lbs. per bushel.) Per lb., 50 cents; per 100 lbs., \$36.00.

WOOD MEADOW. *Poa nemoralis.* Well adapted for growing under trees and in shaded situations. Dwarf and fine growing. Sow two and a half bushels an acre. (14 lbs. a bushel.) Per lb., 50 cents; per 100 lbs., \$40.00.

GRASSES — *Continued.*

AWNLESS BROME GRASS. *Bromus Inermis.* A hardy perennial, standing extremes of heat, cold, and drought better than any other of our cultivated Grasses. It grows with wonderful rapidity, and produces heavy hay crops and luxuriant pasture. The seed should be sown as early in the spring as the ground can be worked. Sow 35 to 40 lbs. to the acre. Per lb., .20; per 100 lbs., \$16.00.

WATER MEADOW GRASS. *Poa aquatica.* A creeping rooted perennial, grows in alluvial marshy soils, slow running streams, margins of fresh water, lakes, etc. An excellent pasture Grass, for wet situations. Trout and wild ducks relish the seeds and young shoots as food. Per lb., .60.

GRASSES SUITABLE FOR BEACH USE AND FOR MAKING EMBANKMENTS.

ELYMUS ARENARIUS. SEA LAND LYME GRASS. A creeping rooted perennial; grows among shifting or blowing sea sands, for binding which, along with *Ammophila Arundinacea*, thereby preventing the encroachments of the sea, its numerous strong spreading roots render it most suitable. Per lb., .75; 100 lbs., \$55.00.

AMMOPHILA ARUNDINACEA. SAND OR MAT GRASS. A creeping rooted perennial which grows naturally among shifting sea sands. Adapted for consolidating Sand, Embankments, or Terraces. Per lb., .40; 100 lbs., \$35.00.

CLOVERS.

RED MEDIUM. *Trifolium pratense.* The best Clover for all practical purposes. Succeeds best on rich, warm loams, containing humus. Lime and potash are essential for its best development. A biennial, but by close pasturage may be made to last several years. Per lb., .20; per 100 lbs., \$15.00.

MAMMOTH OR LARGE RED NORTHERN. *Trifolium pratense.* On rich loamy soils this variety grows nearly twice as large as the Medium Red Clover, and earlier to start a spring growth. Per lb., .25; 100 lbs., \$18.00.

ALSIKE OR SWEDISH. *Trifolium Hybridum.* This Clover will thrive where the soil is quite wet, and will even stand flooding without being killed. Productive and sweet and extremely valuable for both pasturage or soiling. Per lb., .20; per 100 lbs., \$15.00.

WHITE CLOVER. *Trifolium repens.* This Clover should always be sown on permanent or temporary pastures. Will grow on any soil, but especially adapted to low meadows, where the surface soil is mellow and rich.

Sweet and nutritious. Per lb., .30; 100 lbs., \$25.00.

ALFALFA OR LUCERNE. *Medicago sativa.* The chief merit of Alfalfa is the fact that it can be cut three or four times in a season. The soil should be deep, rich, and well prepared. It does not succeed on compact clay, nor on land with impervious subsoil. The roots shoot downwards till they are ten to fifteen feet below the surface, and will therefore resist the driest weather. Per lb., .20; per 100 lbs., \$15.00.

SCARLET OR CRIMSON CLOVER. *Trifolium incarnatum.* This annual Clover thrives best on warm, loose, sandy soil. Its chief value is as a winter or early spring pasture crop and as a green manure. A rapid growing, nitrogen-storing plant, and as such is invaluable for growth in orchards and wherever it can occupy the land from July to December. Sow fifteen to twenty pounds per acre. May be sown at any time from May to October. Per lb., .10; per 100 lbs., \$8.00.

YELLOW TREFOIL. *Medicago Lupulina.* On very light, dry, or poor ground this variety is valuable for a sheep pasture. Per lb., .15; per 100 lbs., \$12.00.

MILLETS.

Nothing on the market is as well adapted to cover up shortages in hay crops as "Millets." They can be sown up to the end of July, and will make a valuable catch crop.

Millets will yield quick pasturage on almost any soil. They are rank feeders, however, and do best on a fertile, mellow soil, which has had a liberal application of barnyard manure. Sow in June or July, broadcast, one to one and one-half bushels of seed per acre, or drill one-half bushel. Cut (if for hay) as soon as the heads are formed.

MILLET, HUNGARIAN. *Panicum Hungariensis.* An annual forage plant, which germinates readily and withstands drought. If cut early, makes an excellent hay, often yielding two or three tons per acre. Sow from June to August, using about one and one-half bushels to the acre. (48 lbs. per bushel.) Per bushel, \$2.00.

MILLET, COMMON. *Panicum Miliaceum.* Excellent for forage. Requires a dry, light, rich soil. Height, 2½ to 4 ft. (50 lbs. per bushel.) Per bushel, \$1.50.

MILLET, GERMAN OR GOLDEN. *Panicum Germanicum.* An improved variety, growing from three to five feet high. Under some circumstances it will yield more per acre than the above. (50 lbs. per bushel.) Per bushel, \$1.75.

MILLET, JAPANESE. *Panicum Crus Gali.* Imported from Japan by Professor Brooks, of the Massachusetts Agricultural College. Has yielded in America about 7 tons dry straw and 90 bushels of seed per acre. Height, 6 ft. Has numerous side leaves and heads a foot in length. The fodder is relished by cattle and horses, and the ground seed makes an excellent feed for poultry and cattle. Sow one peck per acre. Pound, 10 cents; per 100 lbs., \$6.00.



Hungarian Millet.

OUR SPECIAL GRASS MIXTURE

FOR HAY AND PERMANENT PASTURES.



GRASSES FOR PERMANENT PASTURES AND MEADOWS.

Containing only the most suitable Grasses, the proportionate quantity of each being regulated by soil, situation, and purpose for which desired. The object to be attained is a constant, successive growth of rich pasturage from spring till fall. It is a well-established fact that soils sown with a variety of different grasses which are adapted to the soil, and which attain perfection at alternate months from April to September, *produce very much larger and more satisfactory crops, both for hay and pasturage*, than when only one or two kinds of grasses or clovers are sown. The results given by our mixtures have been most satisfactory, and have resulted in a very large increase in our trade for same. We unhesitatingly recommend them for use on the largest scale. Fall seeding is preferable, but spring sowing will be successful if done early, when the land is cool and moist. In addition to the Grasses, we advise sowing 10 lbs. of Mixed Clover Seed per acre. Clovers in their young state are tender in our climate, and should therefore be sown in spring, separately, being heavier in weight.

10 lbs. Mixed Clover Seed sufficient for one acre, \$2.00.

MIXTURES FOR PERMANENT PASTURES FOR ONE ACRE.

FOR GOOD SOILS, COOL AND MOIST.	FOR DRY SOILS.	FOR WET SOILS.
8 lbs. Timothy.	10 lbs. Timothy.	10 lbs. Timothy.
5 " Fancy Red Top.	5 " Creeping Bent.	4 " Fancy Red Top.
4 " Orchard Grass.	5 " Orchard.	10 " Kentucky Blue Grass.
5 " Perennial Rye Grass.	3½ " Tall Oat Grass.	4 " Orchard Grass.
3 " Sheep's Fescue.	2 " Hard Fescue.	7 " Perennial Rye Grass.
1½ " Hard Fescue.	4 " Sheep's Fescue.	1 " Meadow Fescue.
2 " Meadow Fescue.	1 " Sheep's Fescue, fine leaved.	1 " Tall Fescue.
2 " Tall Oat Grass.	1 " Meadow Foxtail.	1 " Meadow Foxtail.
2 " Meadow Foxtail.	½ " Perennial Sweet Vernal.	1 " Rough Stalked Meadow Grass.
7 " Kentucky Blue Grass.	8 " Perennial Rye Grass.	1 " Various Leaved Fescue.
½ " Perennial Sweet Vernal.		
40 lbs. per acre, \$5.50.	40 lbs. per acre, \$5.75.	40 lbs. per acre, \$5.50.

MIXTURES FOR PERMANENT MEADOWS FOR ONE ACRE.

FOR GOOD SOILS, COOL AND MOIST.	FOR HIGH, DRY SOILS.	FOR WET SOILS.
17 lbs. Timothy.	15 lbs. Timothy.	12 lbs. Timothy.
5 " Fancy Red Top.	5 " Fancy Red Top.	5 " Rhode Island Bent.
3 " Orchard Grass.	7 " Orchard Grass.	5 " Fancy Red Top.
5 " Perennial Rye Grass.	4 " Tall Oat Grass.	5 " Orchard Grass.
1 " Meadow Foxtail.	3 " Hard Fescue.	5 " Perennial Rye Grass.
2 " Tall Oat Grass.	3 " Sheep's Fescue.	2 " Italian Rye Grass.
2 " Hard Fescue.	1 " Sheep's Fescue, fine leaved.	2 " Tall Oat Grass.
2 " Sheep's Fescue.	1 " Rough Stalked Meadow Grass.	1 " Various Leaved Fescue.
1½ " Italian Rye Grass.	1 " Crested Dogtail.	2 " Meadow Fescue.
1 " Various Leaved Fescue.		1 " Tall Fescue.
½ " Perennial Sweet Vernal.		
40 lbs. per acre, \$4.75.	40 lbs. per acre, \$5.25.	40 lbs. per acre, \$5.25.

FARM AND FIELD SEEDS.

Prices Subject to Market Fluctuation.

MISCELLANEOUS.



BARLEY, TWO ROWED. Per bushel, \$1.50. BARLEY, SIX ROWED. Per bushel, \$1.50.

BUCKWHEAT. Should be sown about the middle of June, broadcast, using from one to three pecks of seed to the acre.

—COMMON. Per bushel, \$1.25.

—JAPANESE. Excels all other varieties in yield and earliness. On account of its earliness it can be grown farther north than any other. The grains are nearly double the size of those of any other variety. Enormously productive. Per bushel, \$1.50.

—SILVER HULL. About one week later in maturing than the Japanese. Grain is of a light gray color, thin husk; good yielder. Bushel, \$1.50.

COW PEAS. *For fodder or soiling.* A valuable and nutritious green forage or hay crop. Enriches poor land. Improves good land. One of the best and cheapest ways of improving soil is the plowing under of leguminous crops. Cow Peas have been found superior for this purpose, especially on medium or light soils. Like Clover they absorb nitrogen from the atmosphere, the roots reach deep into the soil and bring up the necessary potash, thus making a complete and natural fertilizer. For fertilizing purposes, Cow Peas are superior to Clover from the fact that the foliage is greater, besides making full growth in from three to four months. Sow as early as May 10 or as late as July, one (1) bushel to the acre in drills, two and one-half bushels to the acre broadcast. \$3.50 per bushel.

OATS, WELCOME. This is now a well-known and extensively grown variety, and is one of the heaviest, handsomest, and most productive white varieties grown. They stool heavily with extra

strong, straight straw, standing well. Succeeds well in a wide range of climate, and under a great variety of soils and methods of culture. Per bushel, \$1.00.

OATS, CLYDESDALE. *Imported.* A handsome English white Oat. Very early and an enormous cropper. Per bushel, \$2.00.

PEAS FOR FIELD CULTURE, ONLY. WHITE CANADA AND GREEN FIELD. These two varieties are the best for general cultivation. One of the most profitable crops for fattening stock. They have been grown by dairymen with very satisfactory results, following winter Rye, which was cut green in June for dairy cows, then stubble turned under and sown to mixed Peas and Oats, furnishing a large amount of forage in August, when Grass pastures usually short, and producing a supply of milk as abundant as in early summer months. Sow two bushels to the acre; if with Oats, one bushel of each. White, per peck, .60; per bushel \$2.00; Green, per peck, .75; per bushel, \$2.50.

RAPE, DWARF ESSEX. A forage plant of great merit, easily grown in any part of the United States. Is of great value for sheep and lambs. One acre of Rape is sufficient to pasture ten to fifteen lambs on for two to two and one-half months. It is often sown broadcast, about five lbs. to the acre, but will yield much better if drilled about two lbs. to the acre, in rows twenty-two inches apart, and cultivated until plants are too large. Seed may be sown in May, but we do not advise sowing until June or July. Per lb., .10; 100 lbs., \$8.00.

RYE, SPRING. Sow as a "catch" crop, where winter grain has failed. The straw is shorter and stiffer than the winter variety, and is always easily secured, while the grain is of equal value. Per bushel, \$1.50.

RYE, FALL OR WINTER. Sow in August and September. Prepare the ground as for Wheat and sow at the rate of one and one-half bushels per acre. This has no equal as a crop to be used for late fall and early spring pasture, and is one of the best to turn under for green manure. Per bushel, \$1.25.

SAND VETCH, OR HAIRY VETCH. *Vicia villosa.* An annual, a native of western Asia, has been cultivated in this country and Europe for about fifty years. Its desirability as a forage crop has become established and it is being cultivated each year on a more and more extensive scale. It should be sown at the rate of from four to six pecks per acre, broadcast or in drills, from August 15 to October 1, and with it as a supporting crop to raise the vines up off the ground there should be planted from two to four pecks of winter Wheat, Oats, or Rye. It should be cut while the Vetch is in full bloom. It may be planted in spring in order to supply an early green crop for soiling purposes, or in midsummer for late autumn forage. Per lb., .15; 100 lbs., \$12.00.

SPRING VETCHES OR TARES. *Vicia sativa.* A valuable plant grown extensively for stock and sometimes mixed with Oats for soiling. Culture the same as field Peas. Per bushel, \$3.50.

SUNFLOWER, MAMMOTH RUSSIAN. This is highly prized by poultry raisers and farmers as a cheap food for fowls, stock, and also for fuel. It is immensely productive, and can be raised cheaper than corn, as any waste piece of ground will suffice. It is the best egg-producing food known. Per lb., .10; per 100 lbs., \$6.00.

WILD RICE. *Zizania aquatica.* The only one of our native plants furnishing food for wild fowl, ducks, geese, etc., which has been made an article of commerce. This seed can be sown on the borders of lakes, ponds, and along small streams to great advantage, attracting all of these wild birds from September on. It purifies the water and affords refuge to the small fry from the large fish. It makes a good hay, and in the South two crops can be cut, and all cattle are fond of it. Sow in water having a mud bottom. Per lb., .30.

WHEAT. SPRING SASKATCHEWAN. Per bushel, \$2.00. WHEAT. WINTER, WHITE CLAWSON. Per bushel, \$2.00.

CHOICE SEED CORN.

FOR FODDER AND ENSILAGE. CAREFULLY SELECTED AND TESTED.

Plant in hills, 8 to 12 qts. per acre, and for soiling 3 to 4 bushels per acre.

Good Seed Corn will be very scarce this spring in many localities, owing to the past unfavorable season. All our stocks have been carefully tested and can be relied upon.

Quart, of any variety, .15; by mail, .30. When ordering to go by express or freight please add for 2 bus. cotton bags, .20 each; no charge for smaller bags.

EARLY YELLOW DENT, OR PRIDE OF THE NORTH.

Remarkably early, maturing in 90 to 100 days, ripening where nearly every other variety failed on account of bad season. Can be successfully grown farther north than any other dent sort. Ears are of good size, with 12 to 16 rows of long kernels of a deep yellow color. Peck, .50; bushel, \$1.25.

IMPROVED LEAMING.

An early, very heavy, long-eared corn, maturing in 100 to 120 days. Stalk grows medium tall, with large amount of foliage. A good ensilage corn, very much relished by stock. Cob small and red, with a deep, large grain of bright yellow. Peck, .50; bushel, \$1.25.

EARLY SANFORD.

A well established variety, and uniformly adapted to New England. Medium size ear, averaging about 10 inches long; 8-rowed; kernels large and broad, and of a silvery white flint color. An excellent fodder and ensilage sort. Peck, .50; bushel, \$1.75.

LONGFELLOW.

An 8-rowed yellow flint sort; ears average 10 to 15 inches long; cob small, kernels large and broad. Heavy yielder, and particularly adapted to New England. An extraordinary heavy yielder in Massachusetts. Peck, .50; bushel, \$1.75.

IMPROVED EARLY YELLOW CANADA.

An early, 8-rowed, flint variety, with a deep grain and very small cob. Where a flint corn is desirable for earliness or other reasons, this is one of the best sorts to plant, seldom failing to produce a crop. Peck, .50; bushel, \$1.75.

ANGEL OF MIDNIGHT.

An early, 8-rowed, flint corn of the Canada type. Ears long, kernels long and deep, color a rich, glossy yellow. Peck, .50; bushel, \$1.75.

BLOUNT'S WHITE PROLIFIC OR MAMMOTH ENSILAGE.

A well-known popular variety of half dent ensilage corn, producing a very large amount of foliage and a good yield of grain. One of the best ensilage varieties for our cold northeast climate. Peck, .50; bushel, \$1.50.

RED COB ENSILAGE.

A red-cobbed white-dent corn, large growing, very popular in northern dairy districts. Fodder sweet, tender, and juicy. Heavy yielder. Peck, .50; bushel, \$1.25.

STOWELL'S EVERGREEN SWEET.

The standard main crop variety, excelling all other late sorts in sweetness and productiveness. Our seed is of strictly first quality. Peck, \$1.75; bushel, \$6.00.

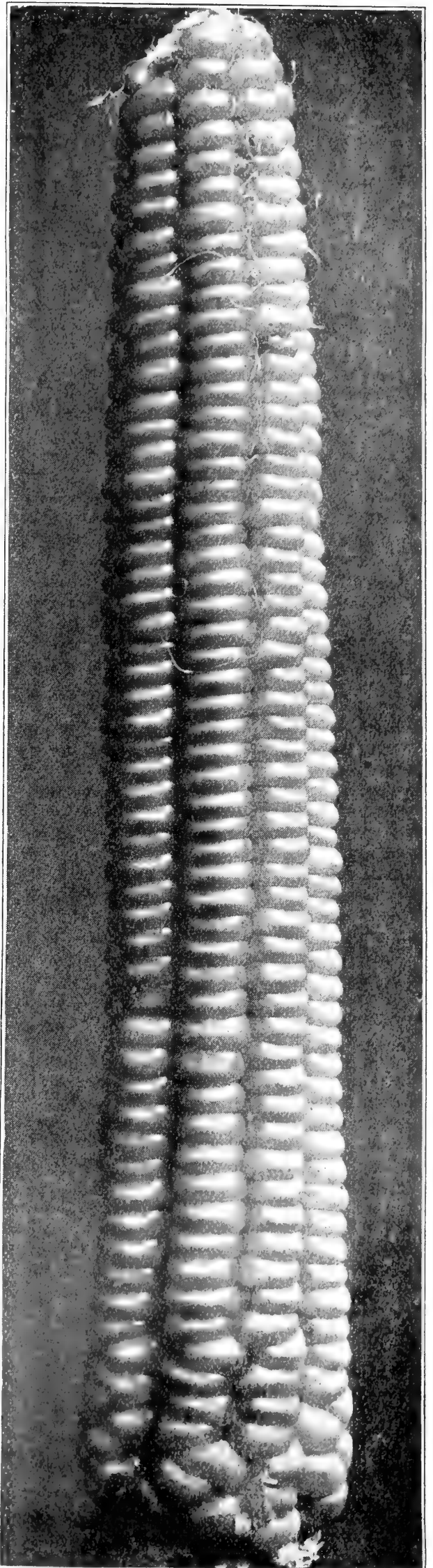

Early Sanford.

Farquhar's Novelties and Specialties in Flower Seeds.



A GROUP OF GIANT COMET ASTERS IN A NATURAL GARDEN. For varieties, see page 47.

FARQUHAR'S SHORE AND MOUNTAIN COLLECTION OF FLOWER SEEDS.

A FINE ASSORTMENT AND QUANTITIES SUFFICIENT FOR A LARGE GARDEN FREE BY MAIL FOR \$1.00.

Among the thousands of visitors to the seashore and mountain resorts of New England, many come to us inquiring what flower seeds are most suitable for producing a satisfactory and continuous display of flowers in their summer gardens. Our purpose in offering this collection is to save such purchasers the disappointment of selecting and cultivating varieties quite unsuited to their purpose. It has been our aim to make the assortment large and varied, with ample quantity of the more important flowers. We have also borne in mind the fact that flowers suitable for cutting are preferred, and nearly all are available for bouquets or vase decoration.

The collection includes $\frac{1}{4}$ lb. FARQUHAR'S COLUMBIAN PRIZE SWEET PEAS, 1 oz. FARQUHAR'S KENT STRAIN TALL NASTURTIUMS, $\frac{1}{2}$ oz. LARGE FRAGRANT MIGNONETTE, and a liberal packet of each of the following, namely: SWEET ALYSSUM, EARLY-FLOWERING ASTERS, CLARKIA, DWARF MORNING GLORY, CORNFLOWER, CHINESE PINKS, ESCHSCHOLTZIA, GODETIA, SINGLE MINIATURE SUNFLOWER, ANNUAL LUPINS, MALLOWS, MARIGOLDS, NEMOPHILA, DRUMMOND'S ANNUAL PHLOX, ISLES OF SHOALS POPPIES, SCABIOUS, *Mourning Bride*, ZINNIA. Also ONE SPECIAL PACKET FARQUHAR'S BOUQUET MIXTURE OF FLOWER SEEDS MIXED FROM OVER A HUNDRED VARIETIES OF THE BEST CUTTING FLOWERS. ONE SPECIAL PACKET FLOWER SEEDS FOR WILD GARDENS, MIXED FROM OVER TWO HUNDRED SPLENDID ANNUALS.

Full Cultural Directions on each Packet.

FARQUHAR'S MIXED FLOWER SEEDS FOR BOUQUETS.

This mixture produces a most charming variety of flowers for cutting purposes. We have had grown in large quantities seeds of many of the choicest Hardy Annuals for this mixture specially in order to give customers a variety of flowers of unapproachable excellence and beauty.

Every desirable color and tint is included, and the variety is endless. Most of the sorts begin to bloom early and continue until the end of the season. These seeds can be grown by any one and in any common garden soil.

Full cultural directions are printed on each package.

LARGE PACKET, post-paid	\$0.15
ONE-OUNCE PACKET, post-paid40
QUARTER-POUND, post-paid	1.25
POUND, post-paid	4.50

FLOWER SEEDS FOR WILD GARDENS

SPLENDID MIXTURES OF MORE THAN ONE HUNDRED BEAUTIFUL VARIETIES.

These mixtures contain many beautiful and interesting Annuals, furnishing a profusion of bloom from early summer until frost. They are intended to produce a display without the care necessary to regularly-kept flower beds. We sell annually large quantities of these seeds for beautifying the surroundings of seashore and country hotels and residences. They not only beautify the grounds, but afford many varieties of flowers useful to cut for house decoration; and owing to the large number of varieties comprising the Mixtures, one finds some new sort of bloom almost every day, and it is most interesting to watch for them.

DWARF WILD GARDEN FLOWER SEEDS. Half-ounce packet with full directions, .15; ounce, .25; quarter pound, .75; pound \$2.50, post-paid.

TALL WILD GARDEN FLOWER SEEDS. Half-ounce packet with full directions, .15; ounce, .25; quarter pound, .75; pound, \$2.50, post-paid.

NOVELTIES IN FLOWER SEEDS — *Continued.*

FARQUHAR'S NEW GIANT FRINGED CYCLAMEN.

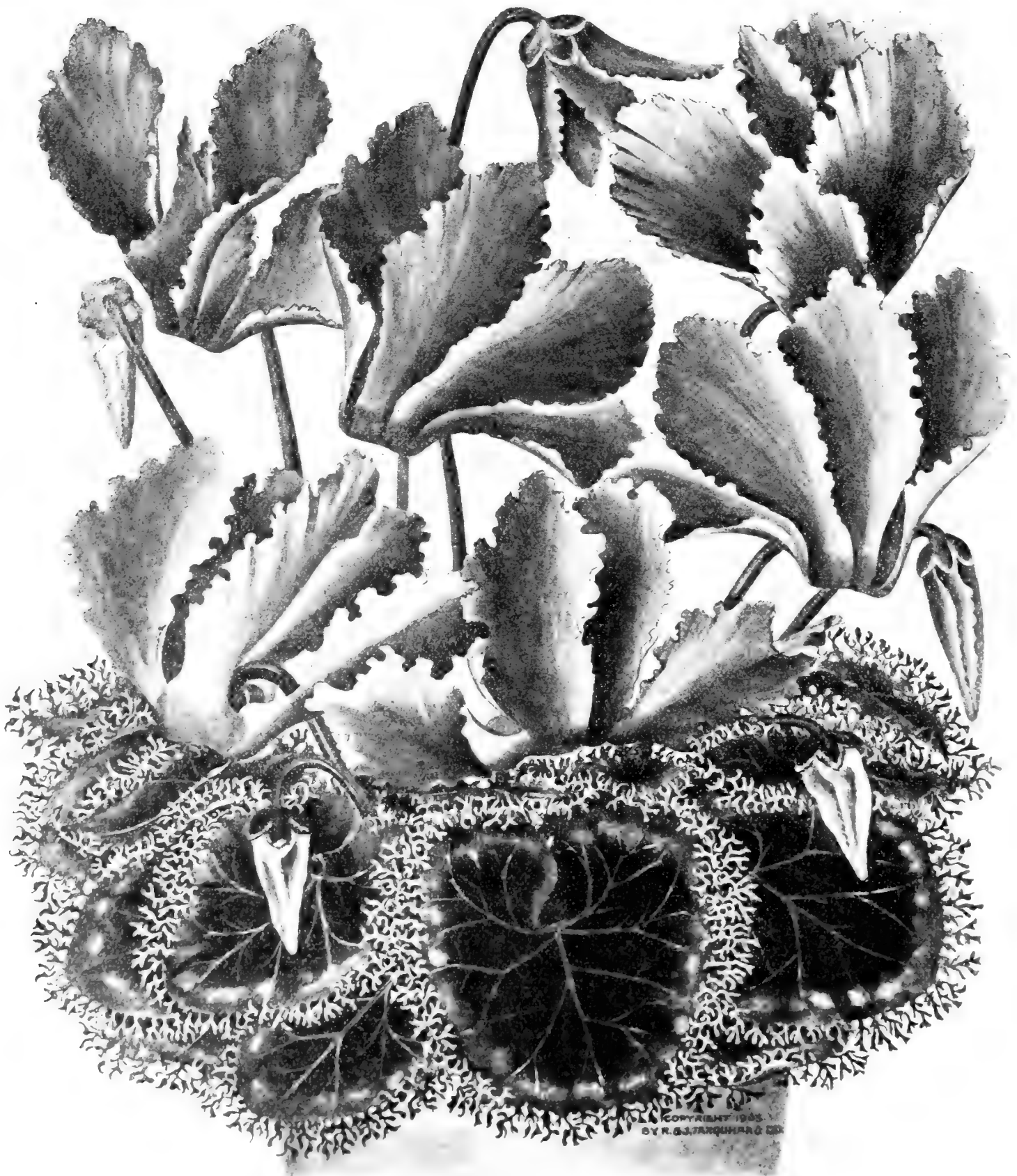

No. 3145. This new strain of Cyclamen, which we offer for the first time, is unquestionably the most important floral introduction of the season. It differs from our giant type of Cyclamen in the foliage having a broad, lace-like fringe around the edge. The flowers are of the giant form, embracing the leading colors, and are frequently fimbriated. The delicate lace-edged leaves, however, form the great charm of this fascinating new variety. Per packet of 30 seeds, \$1.00; 100 seeds, \$3.00.

NOVELTIES IN FLOWER SEEDS— *Continued.*

No. 292. ALYSSUM WHITE FLEECE. A dwarf, fragrant Sweet Alyssum of great beauty. Begins to bloom early and continues throughout the season a fleece-like mass of white. Particularly desirable for dwarf beds and edgings. Oz., \$1.00; pkt., .10.



General Jacqueminot Aster.

No. 882. ASTER, GENERAL JACQUEMINOT. One of the most beautiful Asters grown. The flowers are large, full, double, and finely imbricated. The color is rich crimson, almost identical with that of the lovely General Jacqueminot Rose. Height, 2 ft. Oz., \$5.00; ¼ oz., \$1.50; pkt., .25.

No. 982. ASTER, LADY WASHINGTON. No Aster offered is more beautiful than this superb tall sort. The very large, perfectly double flowers are white, charmingly shaded with pale rose, and are produced in such numbers that each individual plant is in itself an object of rare elegance and attractiveness. Oz., \$5.00; ¼ oz., \$1.50; pkt., .25.

No. 1162. ASTER, BLUE PRINCE. A grand and stately Aster growing to a height of about 2 ft., with flowers about 4 inches across, of a lovely shade of dark blue. Oz., \$4.50; ¼ oz., \$1.25; pkt., .15.

No. 4335. HOLLYHOCK, FIG-LEAVED. A new type of Hollyhock growing 4 to 6 feet in height, and producing numerous branches in bush form. The flowers are single or semi-double, and show many pleasing colors. Oz., \$1.00; pkt., .15.

No. 4442. INULA ROYLEANA. A magnificent species from Himalaya with large yellow flowers 3 inches or over in diameter. They are larger and deeper than those of *Inula glandulosa grandiflora*; hardy perennial, 3 ft.; pkt., .25.

LARKSPUR INVINCIBLE. This splendid strain of Larkspur is most valuable for cut-flower use. The plants are of tall, branching habit, bearing a profusion of large sprays of flowers which are mostly double. It is advisable to make two or three sowings at intervals of six weeks for succession of bloom.

No. 4610. Collection of 6 colors. (Dark Blue, Light Blue, Flesh Color, Lilac, Pink, White.) .40.

No. 4612. LARKSPUR INVINCIBLE PINK. A superb and popular color, esteemed for floral decorations. Oz., .50; pkt., .10.

No. 4614. LARKSPUR INVINCIBLE DARK BLUE. Large sprays of rich blue flowers. Oz., .50; pkt., .10.

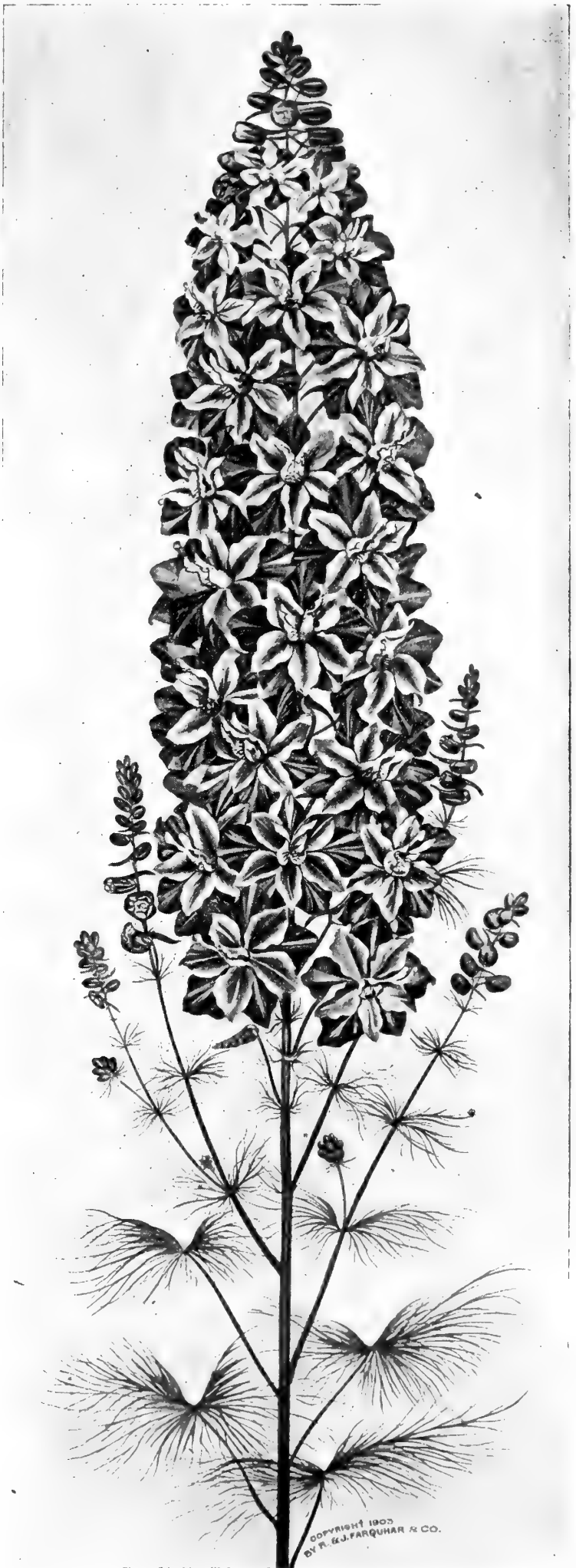

Larkspur invincible, No. 4610.

WALLFLOWER, ANNUAL BLOOD RED. An annual variety of blood-red color has long been desired. It will prove invaluable for summer and autumn cutting. Per pkt., .20.

NOVELTIES IN FLOWER SEEDS — *Continued.*



Farquhar's Pink Annual Lupin.

No. 4842. FARQUHAR'S PINK ANNUAL LUPIN. Of old-fashioned flowers none is more worthy of attention than the Lupin. This variety is one of the prettiest annual sorts, growing about two feet in height, and producing handsome spikes of salmon-pink flowers. The flowers are particularly useful for cutting, lasting a week or longer in water. Sowings should be made in April or May, and again in July for succession. Oz., .50; pkt., .10.

No. 5106. MIGNONETTE IMPROVED MACHET. Machet has been acknowledged to be one of the most valuable varieties of large flowering, sweet-scented Mignonette, for florists' and amateurs' use, ever introduced. The strain now offered has been obtained through careful selection for a number of years by a specialist in Northern Europe. It is of robust growth and very hardy, producing large, broad flower spikes of a reddish-green color and agreeable fragrance. Oz., \$1.00; large pkt., .15.

No. 5085. EVANS' BOSTON GIANT MIGNONETTE. Pronounced by our leading florists the "finest Mignonette grown," and extensively used throughout the country for forcing. When sown out of doors for summer flowering, it produces spikes of the largest size, and is now the favorite summer Mignonette in Newport and other summer resorts. Oz., \$1.50; ¼ oz., .50; pkt., .25.

Boston, Mass.

I have used from fifteen to twenty dozen of "Evans' Boston Giant Mignonette" daily, and can say truthfully it is the finest and most fragrant Mignonette grown.

THOMAS F. GALVIN.



Evans' Boston Giant Mignonette.

NOVELTIES IN FLOWER SEEDS — *Continued.*



No. 5457. FARQUHAR'S RAINBOW MIXTURE; TALL NASTURTIUM. The most showy and varied in color of all Running Nasturtiums; the mixture includes thirty of the choicest named varieties of tall Nasturtiums and Tropæolums. In common with our Kent-grown strain, this Rainbow Mixture is distinguished by the richness of color and size of the flowers, which exhibit every shade of rose, salmon, bright red, bronze, maroon, pale yellow, etc., self-colored, spotted, and striped; exceedingly fragrant, and flower freely until severe frost; cannot be surpassed for covering trellises, fences, railings, balconies, etc. Lb., \$1.50; ¼ lb., .50; oz., .20; liberal pkt., .10.

No. 6236. PAPAVER NUDICAULE HYBRIDUM. A new race of Iceland Poppies of German origin, producing flowers of large size and embracing many new shades of yellow, salmon, and rose. Pkt., .20.



Silene Asterias grandiflora.

No. 7240. SILENE ASTERIAS GRANDIFLORA. A beautiful and hardy perennial from the Balkans, throwing up flower-stalks, about 2 feet in height, each carrying a large globular head, about 2 inches across, of crimson scarlet flowers. On account of its early bloom in spring it is of great value for cut flowers. Pkt., .20.



New Giant Primula Obconica, Mixed.

No. 6810. NEW GIANT PRIMULA OBCONICA, MIXED. The flowers of this strain are a half larger than those grown heretofore; they also show great improvement in their colors, which embrace pure white, lavender, pink, and rosy-red. Pkt., .50.

No. 6812. — — — white. .50.

No. 6814. — — — rosy-red. .50.



Scarlet Gem, Double Zinnia.

No. 8367. ZINNIA, DWARF, SCARLET GEM. One of the most charming introductions, the plants fairly bristling with double blooms of intense, dazzling scarlet. Oz., \$1.25; pkt., .10.

No.		Pkt.
AGERATUM — <i>Continued.</i>		
160	MEXICANUM. Blue; flowers large and numerous, 1½ ft. Oz., .40	.05
165	— ALBUM. White; 1½ ft. " .50	.05

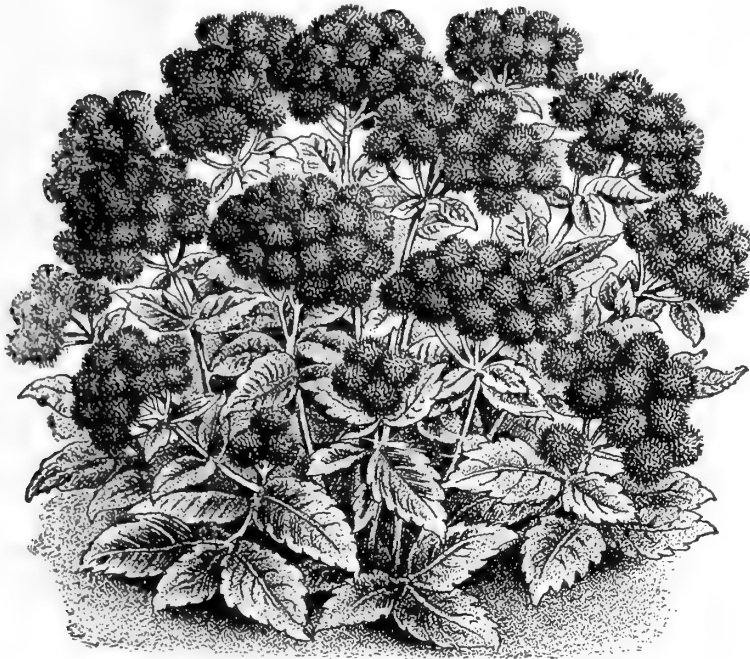

Ageratum Blue Perfection. No. 166.

166	— BLUE PERFECTION. Dark blue; large and free-blooming; one of the best; 1½ ft. Oz., 1.00	.10
170	— DWARF BLUE, LITTLE DORRIT. Lovely azure blue shade, free-flowering; superb for edgings; 6 inches . . . Oz., .75	.10
172	— DWARF SWANLEY BLUE. Deep blue, large flowers, excellent bedding sort; 9 inches Oz., .75	.10
175	— DWARF WHITE. Pretty for edgings; 9 inches Oz., .60	.05
180	— DWARF YELLOW. 9 in. " .60	.05
200	AGROSTEMMA. CÆLI-ROSA. <i>Rose of Heaven.</i> Beautiful, free-blooming hardy annual; flowers bright rose-color, excellent for cutting; 1½ ft., July to Sept. Oz., .25	.05
205	— ALBA. White " .25	.05
210	CORONARIA ATROSANGUINEA. <i>Mullein Pink or Rose Champion.</i> Showy hardy perennial, dark blood-red; 2 ft., June to Sept. Oz., .25	.05
215	— ALBA. White " .25	.05
225	HYBRIDA WALKERI. Hardy perennial; large bright pink flowers; 1 ft., June to Sept. ½ oz., 1.25	.25
	ALONSOA. <i>Mask Flower.</i> Showy half-hardy annual, suitable for small beds and borders; 1 ft., July to Oct. Sow in hot-bed and plant out in May.	
235	FINEST MIXED. Scarlet, rose, and white. Oz., .30	.05
270	ALOYSIA CITRIODORA. <i>Lemon-Scented Verbena.</i> Greenhouse evergreen with fragrant foliage10
275	ALSTRÆMERIA. HYBRID SORTS MIXED. Handsome, lily-like hardy perennials with elegant clusters of flowers borne on erect, slender stems, ranging from pale yellow to orange-red, valuable for cutting; 3 ft., June to Aug. Protect with leaves or straw during winter. ¼ oz., .75	.25

No.		Pkt.
280	ALYSSUM BENTHAMI. <i>Sweet Alyssum.</i> This well-known hardy annual is much esteemed for edgings as well as for bouquets. Its fragrant white blossoms are borne in profusion from June until November; 6 inches ¼ lb., \$1.00; Oz., .35	.05
285	— COMPACTUM. Profusely covered with small white flowers; very compact; 4 inches Oz., .50	.05
295	— PROCUMBENS. <i>Little Gem.</i> Very dwarf, dense and spreading; the best sort for design bedding; 4 inches . . . Oz., .60	.05
300	ARGENTEUM. Hardy perennial; foliage silvery, flowers yellow; 6 inches, April to June Oz., .60	.10
305	SAXATILE COMPACTUM. <i>Gold Dust.</i> Hardy perennial, of spreading habit and producing masses of golden yellow flowers; 9 inches, April to June Oz., .60	.10
	AMARANTHIUS. Stately and highly decorative annuals with long racemes of interesting flowers, and brilliantly colored coleus-like leaves. July to Oct.	
320	CAUDATUS. <i>Love-Lies-Bleeding.</i> Erect plant with long drooping crimson racemes; 2 ft. Oz., .25	.05
325	CRUENTUS. <i>Prince's Feather.</i> Dark-red feathery flowers; 3 ft. Oz., .25	.05
350	SALICIFOLIUS. <i>Fountain Plant.</i> Long slender leaves, edged and tipped with orange, carmine, and bronze, graceful and beautiful; 3 ft. Oz., .75	.05
355	TRICOLOR SPLENDENS. <i>Joseph's Coat.</i> Foliage green, beautifully variegated with scarlet and yellow; 2 ft. Oz., .40	.05
367	AMARYLLIS HIPPEASTRUM, NEW HYBRIDS. The largest and finest race of Amaryllis. The flower spikes usually carry three or four splendid trumpet-shaped blossoms varying in color from salmon to deep crimson, generally striped and feathered with white; 3 ft.50
370	AMBROSIA MEXICANA. Yellow, sweet-scented hardy annual, much esteemed for bouquets; 1 ft., July to Sept. . . Oz., .60	.05
375	AMMOBIUM ALATUM GRANDIFLORUM. <i>Winged Everlasting.</i> Splendid annual, with white everlasting flowers; useful for bouquets and as dried flowers; 2½ ft., July to Oct. Oz., .25	.05
380	AMPELOPSIS VEITCHII. <i>Japanese Woodbine, or Boston Ivy.</i> This is the best hardy vine for covering brick or stone buildings, to which it clings firmly. It now covers many of our finest buildings, completely hiding their masonry by its dense, green foliage, which in autumn turns to rich scarlet; hardy perennial. . . . Oz., .25	.05
395	ANCHUSA BARRELIERI. Attractive hardy perennial, with leep blue flowers resembling large Forget-Me-Nots; useful for bouquets; 2 ft., June to Sept. . . . ¼ oz., .30	.10
400	CAPENSIS. Hardy annual; azure blue; 1½ ft. Oz., .30	.05
405	ITALICA. Hardy perennial; deep blue; 2 ft. Oz., .50	.05
410	SEMPERVIRENS. Hardy perennial; rich blue; 1½ ft., May Oz., .50	.05
	ANEMONE CORONARIA. <i>Wind Flower.</i> Half-hardy spring-flowering perennials; shades of blue, red, and white; 9 inches.	
415	SINGLE CAEN VARIETIES. Many colors05

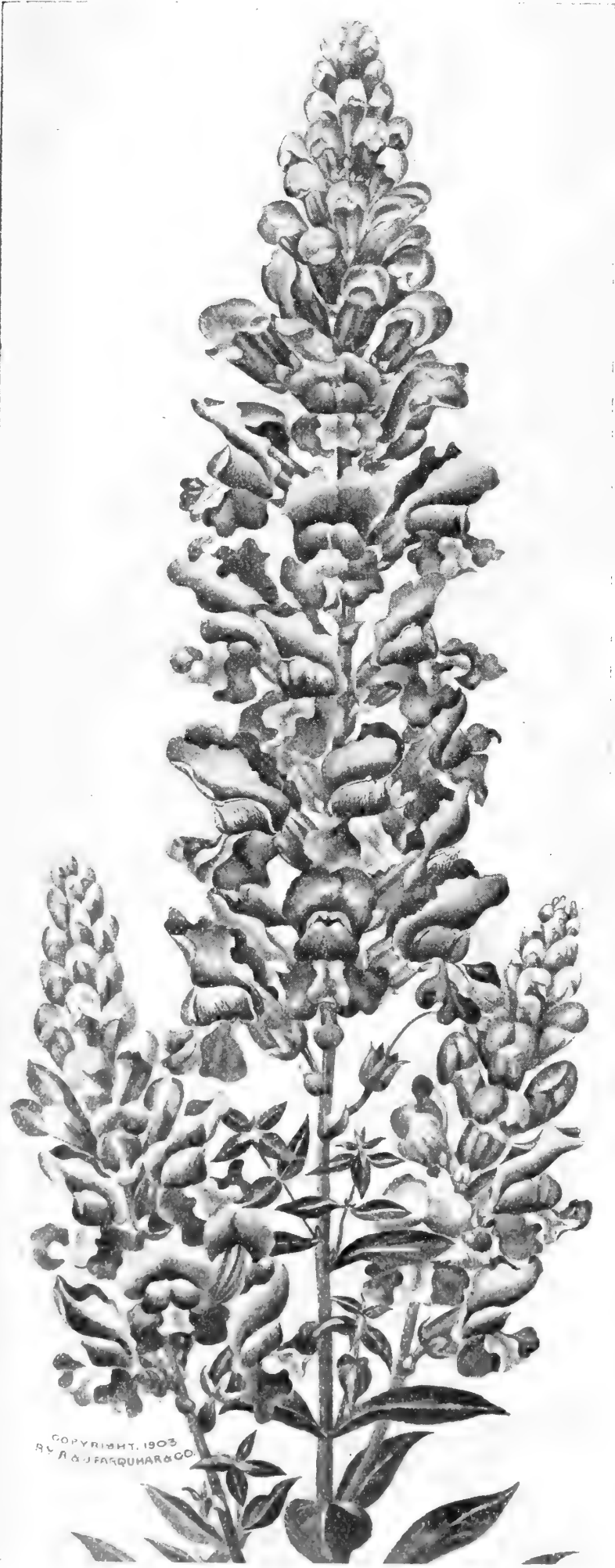

Tall Antirrhinum, No. 462.

NOVA SCOTIA NURSERY, Halifax, N.S., Feb. 6, 1903 writes:

"The Sweet Pea Seed had from you last year was very satisfactory; in truth, we never had finer."

No.		Pkt.
ANEMONE — <i>Continued.</i>		
420	ST. BRIGID. <i>Irish Poppy Anemone.</i> Mixed colors15
450	ANTHEMIS TINCTORIA. Hardy perennial, with bright yellow daisy-like flowers; 1½ ft., June to August Oz., .30	.05
452	— KELWAYI. An improved form of A. tinctoria, with larger flowers . Oz., .60	.10
455	ANTHERICUM LILIAGO. <i>St. Bernard's Lily.</i> Splendid hardy perennial with elegant spikes of pure white, lily-like flowers, which are fragrant and excellent for cutting; 1½ ft., May to August Oz., .60	.10
460	LILIASTRUM. Larger than the preceding, with a green spot on each segment of the flower; very fine border plant. Oz., 1.00	.10
ANTIRRHINUM. MAJUS. <i>Snapdragon.</i>		
If sown under glass in February or March Antirrhinums commence to bloom in July and continue until late in the autumn. The tall sorts are extremely useful for massed beds and border groups; they are also extensively grown under glass for cutting during winter, for which purpose pure white and yellow varieties are most esteemed. The dwarf sorts are admirably adapted for ribbon borders and edgings.		
462	COLLECTION OF 12 TALL VARIETIES; 2 ft.	.50
465	COLLECTION OF 6 TALL VARIETIES30
470	TALL VARIETIES, FINEST MIXED, Oz., .50	.05
471	— CORAL RED " .60	.05
472	— ROSE " .60	.05
473	— SCARLET " .60	.05
475	— WHITE " .60	.05
480	— YELLOW " .60	.05
485	DWARF FINEST MIXED, 8 inches, " .60	.05
486	— SCARLET. " FIREBRAND " " .75	.10
487	— PURE WHITE. " QUEEN OF THE NORTH " " .75	.10
488	— YELLOW, " GOLDEN QUEEN " " .75	.10
AQUILEGIA COLUMBINE. Elegant hardy perennials of easiest cultivation, blooming profusely from May to August. They are suitable for herbaceous borders and groups among shrubs, preferring rather moist soil. Seeds may be sown in the open ground in spring. They may also be sown in July, shaded from the sun, and the plants will bloom next season; 1½ to 3 ft.		
490	FARQUHAR'S CHOICE HYBRIDS. Our Hybrids comprise the best and brightest colors as well as many new and beautiful combinations of colors of charming and striking contrast in the same flower. The strain includes shades of blue, mauve, lavender, rose, scarlet, orange, yellow, and white, of the large-flowered and long-spurred forms Oz., 3.00; ¼ oz., 1.00	.25
495	COLLECTION OF 12 VARIETIES50
500	SINGLE VARIETIES, FINEST MIXED, Oz., .75	.10
505	DOUBLE VARIETIES, FINEST MIXED. " .75	.10
510	ALBA FLORE PLENO. Double white, " .50	.05
515	CALIFORNICA HYBRIDA. Petals golden yellow, sepals and spurs crimson, magnificent; 2 ft. ¼ oz., 1.25	.25
520	CANADENSIS. Scarlet mixed with yellow; 1½ ft. Oz., .80	.05
525	CHRYSANTHA. Beautiful bright yellow; 2 ft., Oz., 2.00	.10
530	— GRANDIFLORA ALBA. White, long spurs. ¼ oz., 1.25	.25



Farquhar's Choice Hybrid Aquilegias. No. 490.

- No. AQUILEGIA — *Continued.*
- 535 CÆRULEA. *Rocky Mountain Blue Columbine.* Violet-blue and white flowers, 2½ to 3 inches across; one of the best; 3 ft., ¼ oz., 1.25 .25
- 537 — FLORE ALBO. *Rocky Mountain White Columbine.* Similar to the last but with pure white flowers; the best white sort ¼ oz., 1.25 .25
- 540 GLANDULOSA. Dark blue with white corolla, flowers 3 inches across; ft. A superb sort. 50
- 542 HAYLODGENSIS. *Cærulea hybrida.* Large-flowered hybrids with long spurs; blue, white, and yellow; 3 ft. . ¼ oz., 1.25 .25
- 545 JAETSCHAUI. Large yellow blossoms with red spurs; 2 ft. ¼ oz., 1.00 .10
- 547 NIVEA GRANDIFLORA. Pure white; 2½ ft. Oz., .40 .05
- 550 OLYMPICA. Delicate mauve-blue flowers, with white corolla; large and charming; 1½ ft. Oz., 1.00 .10
- 560 SKINNERI. *Mexican Columbine.* Flowers large, with long spurs, scarlet and greenish yellow; 2 ft. ¼ oz., 2.00 .25
- 565 STUARTI. Enormous dark blue flowers with white corolla; 2 ft. 50
- 572 TRUNCATA. Orange-scarlet with yellow; splendid; 1½ ft. ¼ oz., .75 .25
- 575 VERVÆNEANA ATROVIOLOACEA. Double flowers; dark violet; 3 ft. . Oz., 1.00 .10

- | No. | | Pkt. |
|-----|--|------|
| 590 | ARABIS ALPINA (ALBIDA). <i>Rock Cress.</i> Very early flowering hardy perennial, with erect spikes of pure white flowers; April-May, 6 to 9 inches Oz., 1.25 | .10 |
| 595 | ARALIA SIEBOLDII. <i>Fatsia Japonica.</i> Elegant greenhouse shrub, with large glossy leaves 1,000 seeds, 1.00 | .10 |
| 598 | ARCTOTIS GRANDIS. Splendid annual from South Africa, with large lilac Daisy-like flowers, 2½ to 3 inches across; July to Oct., 2½ ft. | .15 |
| 605 | ARGEMONE GRANDIFLORA. <i>Prickly Poppy.</i> Hardy annual with white Poppy-like flowers and glaucous leaves; very showy; 2 ft. Oz., .30 | .05 |
| 620 | ARISTOLOCHIA SIPHO. A well-known hardy climber of luxuriant and rapid growth with large heart-shaped leaves and curious pipe-shaped yellowish-brown flowers; 30 ft. ¼ oz., 1.50 | .25 |
| 622 | ARMERIA CEPHALOTES (FORMOSA). <i>Thrift or Sea Pink.</i> This is the finest species of Thrift and is easily raised from seeds; hardy perennial with showy deep pink flowers; 1 ft. Oz., .50 | .05 |
| 623 | — ALBA. White " .50 | .05 |
| 650 | ASCLEPIAS TUBEROSA. <i>Milkweed or Swallow-Wort.</i> Hardy perennial with umbels of very showy orange-red flowers; excellent for border and shrubbery groups; 2 ft. ¼ oz., .75 | .15 |
| 652 | ASPARAGUS PLUMOSUS NANUS. An excellent pot-plant for conservatory decoration or cutting on account of its very graceful, finely cut foliage. It will remain fresh in water for three or four weeks after being cut. 100 seeds, 1.25 | .25 |
| 653 | SPRENGERI. Drooping feathery foliage; invaluable for hanging baskets and bouquets. 1,000 seeds, 4.00 | .25 |
| 655 | ASPERULA AZUREA SETOSA. A charming little hardy annual with clusters of fragrant blue flowers, useful for bouquets; July-Sept., 1 ft. Oz., .30 | .05 |
| 665 | ODORATA. <i>Sweet Woodruff.</i> Pretty hardy perennial, thriving in partial shade; flowers white; May-June; 9 inches. The leaves and flowers when dried have an odor like new hay, and when laid among clothes perfume them and keep away insects Oz., .80 | .10 |
| 670 | ASPHODELUS ALBUS. <i>Asphodel.</i> Hardy perennial with stately spikes of beautiful white flowers suitable for borders and shrubberies; May-June; 2 ft. . . ¼ oz., 1.50 | .25 |
| 671 | LUTEUS. Yellow, sweet-scented; June-July, 4 ft. Oz., 1.50 | .10 |

THE FARQUHAR ROSE.

The finest hardy climbing Rose and one of the best vines for covering pergolas, arbors, and lattice-work, because of its rapid growth and shining deep green ivy-like foliage. It bears clusters of beautiful double pink flowers, and, when better known, will be the favorite climbing Rose.

Large two-year plants, \$1.00 each; \$10.00 per doz.



ASTERS.

Our Asters are grown for us by specialists, from the finest strains in the world, and are unrivalled.

The Queen of the Market varieties are valuable for early cut flowers, coming in July; the Comet and Ostrich Feather sorts are charming for their delicately curled petals; American Branching kinds have shaggy flowers on long stems resembling Japanese Chrysanthemums; while Truffaut's Pæony-Flowered and Improved Victoria are undoubtedly the best types of old-fashioned French and German Asters.

AMERICAN BRANCHING. *Simple's, or Vick's Branching.* A free-growing Aster of robust, erect habit; producing large, feathery blossoms, resembling Japanese Chrysanthemums; one of the finest for cutting; 3 ft.

No.		Pkt.
672	COLLECTION OF 5 VARIETIES40
673	FINEST MIXED . Oz., \$1.75; ¼ oz., .50	.10
675	CRIMSON " 2.00 " .60	.10
676	DARK BLUE " 2.00 " .60	.10
677	LIGHT BLUE " 2.00 " .60	.10
678	ROSE-PINK " 2.00 " .60	.10
679	WHITE " 2.00 " .60	.10
680	SCARLET " 2.00 " .60	.10

Farquhar's American Branching Aster, No. 672.

No.		Pkt.
ASTERS — <i>Continued.</i>		
BETTERIDGE'S IMPROVED QUILLED. The finest form of Aster having quilled or tube-shaped petals; flowers large and quite double; 2 ft.		
690	COLLECTION OF 10 VARIETIES50
695	FINEST MIXED ¼ oz., .30	.05
BOSTON FLORISTS'. A fine variety with large, full flowers, the outer petals of which are gracefully recurved. The plants branch freely from near the ground, so that the flowers have long stems; 2 ft.		
710	FINEST MIXED . Oz., \$2.50; ¼ oz., .75	.10
712	BRILLIANT ROSE . " 3.00 " 1.00	.10
715	DARK BLUE . . . " 3.00 " 1.00	.10
720	LIGHT BLUE . . . " 3.00 " 1.00	.10
730	PEACH BLOSSOM . " 3.00 " 1.00	.10
735	SCARLET " 3.00 " 1.00	.10
740	WHITE " 3.00 " 1.00	.10
CHRYSANTHEMUM-FLOWERED DWARF. A useful sort for bordering beds and for pot culture, each plant bearing from 15 to 20 large, broad-petalled blossoms; 10 inches.		
770	COLLECTION OF 6 VARIETIES50
775	FINEST MIXED . . Oz., \$3.00; ¼ oz., 1.00	.10
GIANT COMET. Elegant flowers, with long, wavy, twisted petals, like Japanese Chrysanthemums. They are admirable for vases and table decorations, producing a striking yet exceedingly graceful effect; 2 ft.		
780	COLLECTION OF 12 VARIETIES90
785	COLLECTION OF 6 VARIETIES50
790	FINEST MIXED . . Oz., \$3.00; ¼ oz., 1.00	.10
795	CRIMSON " 3.00 " 1.00	.10
797	DARK BLUE " 3.00 " 1.00	.10
800	LIGHT BLUE " 3.00 " 1.00	.10
810	LILAC " 3.00 " 1.00	.10
815	PEACH BLOSSOM " 3.00 " 1.00	.10
820	ROSE " 3.00 " 1.00	.10
825	SCARLET " 3.00 " 1.00	.10
830	SNOW-WHITE " 3.00 " 1.00	.10
834	YELLOW, PALE PRIMROSE. Oz., 3.00 " 1.00	.10
CROWN, OR COCARDEAU. The flowers are large and flat-petalled, each having a white centre with a wide margin of some brilliant color; 1½ ft.		
845	COLLECTION OF 6 VARIETIES50
850	FINEST MIXED Oz., \$3.00	.10
900	DAYBREAK. The flowers are large, very double, and of a beautiful shell-pink color; 2 ft. This is one of the best sorts for cutting Oz., \$4.00; ¼ oz., \$1.25	.10
JEWEL, OR BALL. A valuable sort for cutting and florists' use, bearing many ball-shaped flowers about 3 inches in diameter, with the petals beautifully incurved; 2 ft.		
945	COLLECTION OF 6 VARIETIES50
950	FINEST MIXED . . Oz., \$3.00; ¼ oz., 1.00	.10
960	CRIMSON " 3.50 " 1.00	.10
962	DARK BLUE " 3.50 " 1.00	.10
963	LIGHT BLUE " 3.50 " 1.00	.10
965	ROSE " 3.50 " 1.00	.10
970	SCARLET " 3.50 " 1.00	.10
980	WHITE " 3.50 " 1.00	.10
MIGNON. A fine variety of upright branching habit and with 40 to 50 well-formed flowers of medium size on each plant. One of the best Asters for cut-flower use; 1½ ft.		
990	COLLECTION OF 6 VARIETIES50
1000	FINEST MIXED . . Oz., \$3.00; ¼ oz., 1.00	.10
1010	ROSE " 3.00 " 1.00	.10
1015	WHITE " 3.00 " 1.00	.10

No.		Pkt.
OSTRICH FEATHER. A new class of Aster, of still more feathery appearance than the Comet and resembling some of the large Japanese Chrysanthemums, with long, curved, fringe-like petals; 2 ft.		
1025	COLLECTION OF 6 VARIETIES50
1030	FINEST MIXED . Oz., \$3.00; ¼ oz., 1.00	.10
1035	CRIMSON " 3.00 " 1.00	.10
1040	DARK BLUE " 3.00 " 1.00	.10
1045	LIGHT BLUE " 3.00 " 1.00	.10
1050	LILAC " 3.00 " 1.00	.10
1055	SALMON ROSE " 3.00 " 1.00	.10
1060	WHITE " 3.00 " 1.00	.10
PÆONY-FLOWERED PERFECTION, IMPROVED. <i>Truffaut.</i> The finest form of incurved Aster; splendid for exhibition and popular for both florists' and private use. The flowers are usually 4 inches across, very double, and of fine globular form; 2 ft.		
1070	COLLECTION OF 18 VARIETIES	1.00
1075	COLLECTION OF 12 VARIETIES75
1080	COLLECTION OF 6 VARIETIES40
1085	FINEST MIXED. The softer and more delicate shades as well as the brilliant colors are included in this mixture.	
	Oz., \$3.00; ¼ oz., 1.00	.10
1087	APPLE BLOSSOM " 3.00 " 1.00	.10
1090	BLOOD RED " 3.00 " 1.00	.10
1095	BRILLIANT ROSE " 3.00 " 1.00	.10
1100	BRILLIANT SCARLET " 3.00 " 1.00	.10
1105	DARK BLUE " 3.00 " 1.00	.10
1110	DELICATE ROSE " 3.00 " 1.00	.10
1115	GLOWING CRIMSON " 3.00 " 1.00	.10
1120	LIGHT BLUE " 3.00 " 1.00	.10
1130	SNOW WHITE " 3.00 " 1.00	.10
CHINESE SINGLE. The plants produce a profusion of large, brilliant, daisy-like flowers with yellow centres. They are exceedingly showy, and are exquisite when cut for vase decorations; 1½ ft.		
1425	COLLECTION OF 6 VARIETIES50
1421	FINEST MIXED. All the flowers have yellow centres Oz., \$1.00	.10
1422	DARK BLUE " 1.00	.10
1423	LIGHT BLUE " 1.00	.10
1424	ROSE " 1.00	.10



Chinese Single Aster. No. 1425.

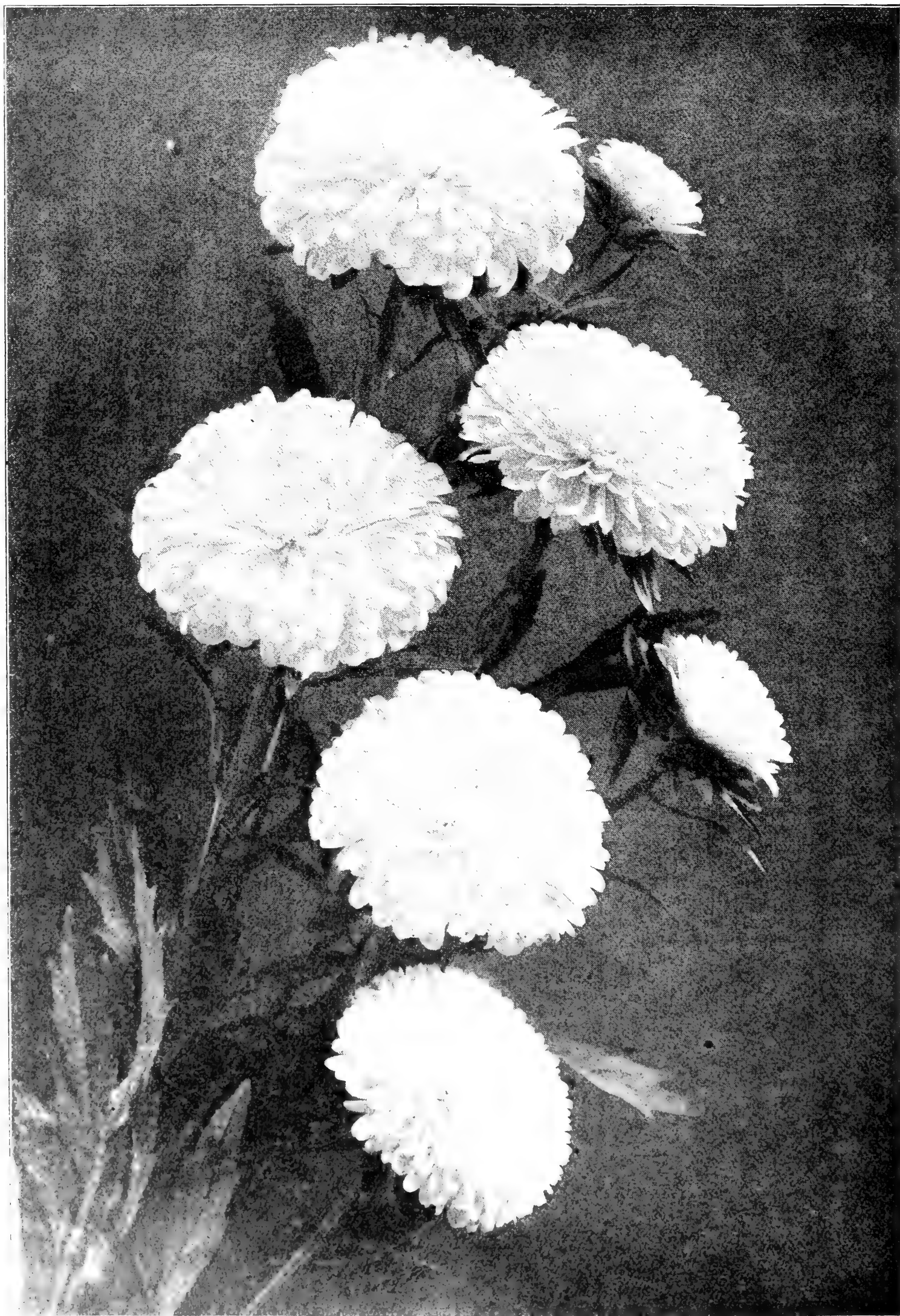

FARQUHAR'S QUEEN OF THE MARKET ASTER, No. 1200.

This Aster blooms three to four weeks earlier than other large-flowered sorts.

No.		Pkt.
ASTERS — <i>Continued.</i>		
QUEEN OF THE MARKET. <i>Queen of the</i> <i>Earlies.</i> This class is remarkable for its size and earliness. The plants branch freely and produce many large, well- formed flowers nearly a month earlier than other large-flowered kinds. It is of great value for early cutting; 1 ft.		
1200	COLLECTION OF 5 VARIETIES40
1205	FINEST MIXED . . Oz., \$1.00; ¼ oz., .35	.10
1207	CRIMSON " 1.00 " .35	.10
1208	DARK BLUE " 1.00 " .35	.10
1210	LIGHT BLUE " 1.00 " .35	.10
1220	ROSE " 1.00 " .35	.10
1225	WHITE " 1.00 " .35	.10
1270	SNOWBALL, OR PRINCESS. A free bloom- ing, pure white variety of medium size and exquisite form, the petals being finely imbricated; 2 ft. Oz., \$3.00; ¼ oz., 1.00	.10
VICTORIA, IMPROVED. The flowers are of enormous size, very double, showy, and massive, with the petals beautifully recurved. For decorative effect and exhibition the Vic- toria is unrivalled. The plants bear 20 to 25 blooms each; 2 ft.		
1285	COLLECTION OF 20 VARIETIES	1.25
1290	COLLECTION OF 12 VARIETIES90
1295	COLLECTION OF 6 VARIETIES50
1296	FINEST MIXED. A splendid combination of bright colors and delicate shades.	
	Oz., \$3.50; ⅛ oz., .50	.20
1297	APPLE BLOSSOM " 4.00 " .60	.10
1300	AZURE BLUE " 4.00 " .60	.10
1310	CRIMSON " 4.00 " .60	.10
1315	DARK BLUE " 4.00 " .60	.10
1320	LIGHT BLUE " 4.00 " .60	.10
1325	DELICATE ROSE " 4.00 " .60	.10
1340	PEACH BLOSSOM " 4.00 " .60	.10
1345	SCARLET " 4.00 " .60	.10
1350	DEEP VIOLET " 4.00 " .60	.10
1355	WHITE " 4.00 " .60	.10
DWARF VICTORIA. Similar to Victoria, but growing only 9 inches high.		
1370	FINEST MIXED . . Oz., \$3.50; ⅛ oz., .50	.10
1375	LIGHT BLUE " 4.00 " .60	.10
1380	ROSE " 4.00 " .60	.10
1385	WHITE " 4.00 " .60	.10

No.		Pkt.
ASTERS — <i>Continued.</i>		
WASHINGTON. A stately Aster growing about 2½ ft. high, and producing on its erect, stout branches 10 to 15 enormous flowers.		
1405	COLLECTION OF 6 VARIETIES50
1410	FINEST MIXED . . Oz., \$3.50; ⅛ oz., .50	.10
1420	FARQUHAR'S IMPERIAL PRIZE. MIXED. The mixture comprises the finest varieties of large-flowered Asters, includ- ing Victoria, Giant Comet, American Branching, Pæony-flowered, Jewel, Os- trich Feather, Washington, and others, and the best colors of these. This com- bination enables the purchaser to get in a single packet a choice and varied selec- tion of the most splendid Asters in cul- tivation Oz., \$5.00; ⅛ oz., .75	.15
ASTERS, PERENNIAL VARIETIES. <i>Michael- mas Daisy.</i> These hardy perennials are easily raised from seeds, and if sown early in spring are likely to bloom the following autumn. They may be sown also in July.		
1428	ALPINUS SPECIOSUS. Large purple flowers; 2 ft.25
1430	BESSARABICUS. Rich purple; very large; 2 ft.	.10
1437	NOVÆ ANGLIÆ. Rosy purple; 3 ft.25
1440	NEW HYBRIDS, FINEST MIXED; 3 ft.25
AUBRIETIA. Hardy perennials of dwarf, compact growth, suitable for rockwork and herbaceous borders; April, 4 inches.		
1450	BOUGAINVILLEI. Light violet10
1455	LEICHTLINII. Deep rose; very beautiful25
AURICULA. See Primula Auricula, No. 6790.		
BACHELOR'S BUTTON. See Centaurea, No. 2585.		

MR. JAMES BRAIK, Assistant Superintendent, Depart-
ment of Parks, Buffalo, N.Y., in writing, July 27, 1903,
says:

"I may also add that with thirty-five years' practical
experience in America I have yet to see a better class of
Flower Seeds than we are in the habit of receiving from
your house."



Farquhar's Ostrich Feather Aster, No. 1025.



- | No. | | Pkt. |
|------|--|------|
| 1460 | BALLOON VINE. <i>Cardiospermum Halicacabum</i> . Rapid-growing annual climber, with white blossoms and seed vessels like miniature balloons; succeeds best in light, warm soil; 8 ft. Oz., .25 | .05 |
| | BALSAM. Showy and easily grown tender annuals, succeeding best in sunny situations where there is rich loam and moisture; July to Sept., 1 to 1½ ft. | |
| 1465 | FARQUHAR'S PRIZE MIXED. Flowers large, very double and perfect in form; superb colors Oz., 2.00 | .25 |
| 1470 | IMPROVED CAMELLIA-FLOWERED, COLLECTION OF 6 VARIETIES | .60 |
| 1475 | — — FINEST MIXED Oz., 1.00 | .10 |
| 1490 | FARQUHAR'S PERFECTION WHITE. Large flowers, very double, resembling small Camellias Oz., 2.00 | .25 |
| 1495 | FARQUHAR'S PERFECTION PINK " 2.00 | .25 |
| 1500 | ROSE-FLOWERED, FINEST MIXED. Flowers mostly self-colored, very full and double. Oz., .80 | .10 |
| 1505 | — COLLECTION OF 12 VARIETIES | .65 |
| 1510 | — COLLECTION OF 6 VARIETIES | .35 |
| 1515 | — BLOOD RED Oz., 1.00 | .10 |
| 1517 | — ROSE " 1.00 | .10 |
| 1520 | — WHITE. "Snowball" " 1.00 | .10 |
| 1530 | BAPTISIA AUSTRALIS. A fine hardy perennial, producing spikes of pea-shaped blue flowers 6 inches in length; June-July, 2½ ft. Oz., .30 | .05 |

- | No. | | Pkt. |
|------|--|------|
| 1535 | BARTONIA AUREA. One of the brightest hardy annuals, flowers golden yellow; thrives in partial shade; June to Oct., 1½ ft. Oz., .25 | .05 |
| 1540 | BEAN, SCARLET RUNNER. Hardy annual climber, scarlet flowers; July-Sept., 6 ft. Qt., .40 | .05 |
| 1545 | — WHITE RUNNER " .40 | .05 |
| 1550 | — PAINTED LADY. Pink and white "60 | .05 |
| | BEGONIA, TUBEROUS. The value of the single-flowered Tuberous Begonias for bedding purposes has been fully established, and the gorgeous effects they have produced have readily given them precedence over the more ordinary bedding plants. Seeds sown in February or March will produce nice plants for planting out in June. The double varieties succeed best when grown as pot plants, and are adapted to conservatory and piazza decoration; 1 ft. | |
| 1600 | FARQUHAR'S GIANT-FLOWERED SINGLE, COLLECTION OF 8 COLORS. A new strain with erect flowers of large size and circular form, the broad petals overlapping and often beautifully fringed. We put up this collection from seeds grown for us by special agreement with the foremost grower in Europe, and we believe that nothing finer exists | 2.00 |
| 1605 | FARQUHAR'S GIANT-FLOWERED SINGLE MIXED. The same strain as the foregoing, in mixture | .50 |

- No. Pkt.
- BEGONIA — *Continued.*
- 1610 FARQUHAR'S SUPERB DOUBLE. The flowers are of superb rosette form, of large size, and of great variety of colors 1.00
- BEGONIA SEMPERFLORENS. The dwarf varieties of Begonia semperflorens are now extensively used for carpet bedding. Seeds sown in February or March give fine plants for bedding out in June. The plants continue in bloom until frost.
- 1657 — DWARF VERNON. A fine bedding sort, with rich red flowers and glossy bronze-red foliage; 4 inches25
- 1658 — CORAL GEM. Habit dwarf; flowers pale rose; fine bedding sort; 4 inches25
- 1659 — WHITE GEM. Satiny white flowers; 4 inches25
- 1660 ERFORDIA. A dwarf hybrid variety with small, glossy, dark green leaves and delicate rosy-carmine flowers; one of the best bedding sorts; 6 inches50
- Begonia Erfordia, being a hybrid, has a tendency to revert and cannot be depended upon to come always true from seed.*
- BEGONIA, ORNAMENTAL-LEAVED.
- 1665 REX VARIETIES. Large, handsome leaves, dark green, variegated with red-bronze, red, and silver-white; green-house perennial; 1 ft.25

- No. Pkt.
- BELLIS — *Continued.*
- 1680 WHITE Oz., 5.00 .25
- 1690 MAXIMA, OR GIANT, FINEST MIXED. 1/8 oz., 1.00 .25
- 1695 SNOWBALL. Large; white; very beautiful, 1/8 oz., 1.00 .25
- 1700 BELVIDERE, SUMMER CYPRESS. *Kochia Scoparia*. Hardy annual with graceful foliage; useful in making bouquets05
- 1720 BOCCONIA JAPONICA. Hardy perennial with large, glaucous, decorative leaves; 4 ft. Oz., 40 .10
- 1725 BOLTONIA LATISQUAMA. A beautiful autumn-flowering hardy perennial, closely resembling and allied to the perennial Asters; flowers violet-blue; 4 ft.25
- 1730 BRACHYCOME IBERIDIFOLIA. *Swan River Daisy*. Elegant, profuse-flowering half-hardy annual with handsome blue flowers, resembling those of the Cineraria; 9 inches Oz., 1.00 .10
- BROWALLIA. Elegant, free-flowering, half-hardy annuals for house or garden; growing about 18 inches in height, with Verbena-like flowers; excellent for cutting. Seeds started in July will give fine plants for winter blooming in the greenhouse, for which they are valuable. For summer blooming they may be sown under glass in March, or in the open ground in May.
- 1740 FINEST MIXED. Shades of blue, purple, and white Oz., 1.00 .10
- 1755 ELATA CÆRULEA GRANDIFLORA. Bright blue; fine for cutting Oz., 1.00 .10
- 1767 SPECIOSA MAJOR. A new variety with clear blue flowers, much larger than other sorts. .25
- 1775 BUPHTHALMUM SALICIFOLIUM. *Ox-Eye*. Showy hardy perennial; flowers yellow, with long stems; 2 ft. Oz., .50 .05
- 1780 CACALIA COCCINEA. *Tassel Flower*. Showy, hardy annual, with trusses of tassel-like scarlet flowers; 1 1/2 ft., July to Oct. Oz., .40 .05
- 1805 CALANDRINIA UMBELLATA. Half-hardy perennial; flowering the first season if sown early, with crimson flowers and of trailing habit; excellent for rockwork and sunny slopes; 6 inches05
- CALENDULA. *Pot Marigold*. Splendid hardy annuals, with large disc-like double flowers, borne in profusion from June to November. They are valuable for cut flowers, for which purpose they are largely grown under glass. Their vigorous growth enables them to withstand light soils and dry situations; 1 ft.
- 1855 DOUBLE MIXED Oz., .25 .05
- 1860 ORANGE KING. Deep orange, double flowers Oz., .25 .05
- 1870 METEOR. Orange striped with primrose. Oz., .25 .05
- 1885 LEMON QUEEN. Clear lemon-yellow. " .25 .05
- 1895 PLUVIALIS. *Cape Marigold*. White. " .25 .05
- 1897 PONGEL. Large, double white flowers. " .30 .05

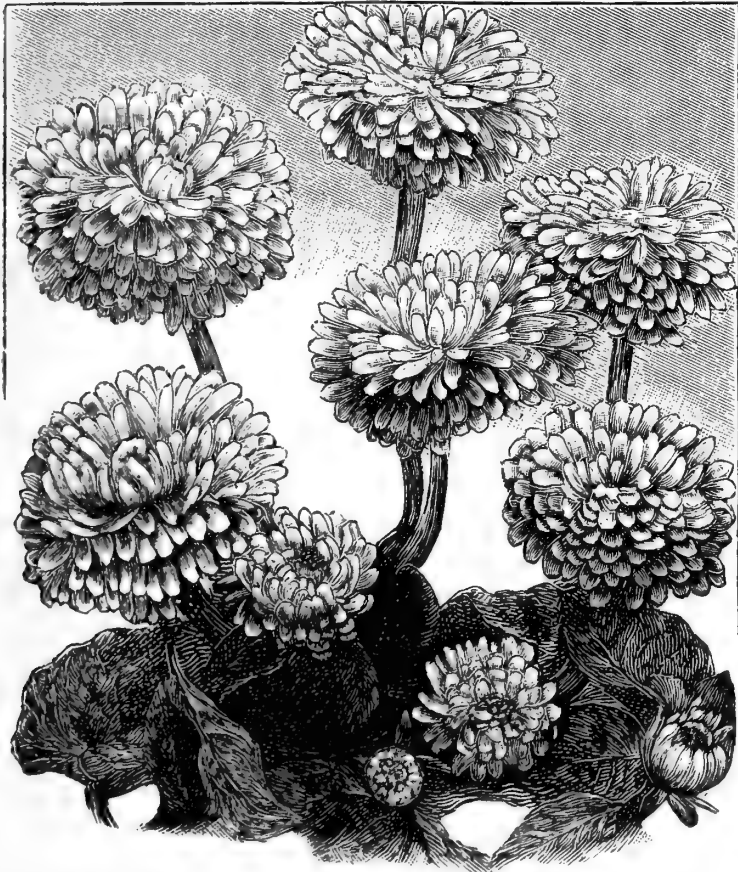

Bellis Perennis. No. 1670.

- BELLIS PERENNIS FLORE PLENO. *Double Daisy*. Favorite spring-flowering perennials, producing charming effects when planted with Pansies, Forget-Me-Nots, or Silene. They are easily raised from seed, flowering in autumn if sown in spring, although it is better to sow in July or August in cold frames and plant them out the following April; 4 inches.
- 1670 FINEST MIXED. Saved from the finest double flowers Oz. \$5.00 .15
- 1675 ROSE, Longfellow " 6.00 .25

Guy's Cliff, Bar Harbor, Me., Jan. 13, 1903.

Messrs. R. & J. Farquhar & Co.:

Gentlemen: Your seeds in general were quite a success with us here last summer. Sweet Peas, Tuberous Begonias, Gladiolus, African Marigolds, Salvia, and Shirley Poppies were specially fine. I had quite a few Begonia Blooms, measuring 6 1/2 to 7 inches in diameter. You might please send Catalogues to following address.

Yours truly,
JOHN RENWICK, Gardener to E. C. Cushman, Esq.

No.		Pkt.
	CAMPANULA — <i>Continued.</i>	
1990	— ALBA. <i>White Carpathian Bell.</i> Pure white Oz., .60	.05
2005	FRAGILIS. Fine trailing plant for hanging-baskets and vases, flowers light blue; half-hardy perennial; July to September . 1/8 oz., \$1.00	.25
2020	MACRANTHA. Large purplish-blue flowers; hardy perennial; 3 ft., July to September . . . Oz., .40	.05
2030	MARIESI. <i>Japanese Balloon Flower.</i> Hardy perennial; flowers the first year from seed; rich violet; 1 1/2 ft., July to October . . . Oz., \$1.00	.10
2032	MIRABILIS. Very ornamental hardy perennial of upright branching habit; 2 ft. in height; each branch tipped with numerous large, light blue flowers; July to September .	.25
2035	PERSICIFOLIA GRANDIFLORA COE- RULEA. One of the best hardy per- ennial plants, bearing erect spikes of large blue, cup-shaped flowers; 2 ft., July and August25
2040	— — ALBA. Pure white; splen- did25
2045	— — COERULEA PLENA. Double blue, rosette-like flowers25
2050	— — ALBA PLENA. Pure white flowers, like Camellias25
2065	PYRAMIDALIS. <i>The Chimney Cam- panula.</i> Stately hardy perennial; very handsome as border plants or grown in pots for conservatory decoration; 4 ft., June to August. Oz., .60	.10
2070	— ALBA. White; magnificent, Oz., .80	.10
2075	ROTUNDIFOLIA. <i>Scotch Blue-bell.</i> Deep blue; perennial; 1 ft., June to Sept. Oz., 1.00	.10



Calliopsis, No. 1905.
Page 52.



Farquhar's Prize Canterbury Bells. No. 2079.

No.		Pkt.
	CANTERBURY BELLS. <i>Campanula medium.</i>	
	Showy, hardy biennials, growing in pyramidal form and bearing many large, bell-shaped flow- ers; very showy in mixed borders and in shrub- beries; 2 1/2 ft., July to September. Seedlings raised in July or August bloom the following sum- mer.	
2079	FARQUHAR'S PRIZE MIXED. An improved strain containing the finest colors of both single and double forms Oz., 1.75	.10
2080	SINGLE BLUE40 .05
2085	— ROSE40 .05
2090	— STRIPED40 .05
2095	— WHITE40 .05
2100	— MIXED. All colors40 .05
2105	DOUBLE BLUE	1.00 .10
2110	— ROSE	2.00 .25
2120	— WHITE	2.00 .25
2125	— MIXED. All colors	1.25 .10
2130	CALYCANTHEMA. <i>Cup and Saucer.</i> Blue,	1.50 .10
2135	— ROSE	2.00 .25
2145	— WHITE	2.00 .25
2150	— MIXED. All colors	1.25 .10
	CANARY-BIRD FLOWER. See <i>Tropæolum</i> <i>Canariense</i> , No. 8005.	



Marguerite Carnation, Farquhar's Giant Mixed. No. 2350.

- | No. | | Pkt. |
|------|---|------|
| | CARNATION AND PICOTEE PINKS. Many of the best market varieties have originated from our seeds, which are grown for us by specialists in Europe. The green-house varieties, if sown in February or March, should flower in autumn and throughout the winter. | |
| 2285 | COLLECTION OF 12 VARIETIES. Carnations and Picotees | 1.00 |
| 2300 | FARQUHAR'S FRENCH PERPETUAL. The finest strain of florists' Carnations, producing a large percentage of full, double, perfectly-formed flowers, most of them strongly clove-scented, and embracing the choicest colors. | .50 |
| 2340 | PICOTEE, DOUBLE SHOW VARIETIES. The petals of the large double flowers beautifully spotted or laced with some distinct color. Finest mixed | .50 |

- | No. | | Pkt. |
|------|--|------|
| | MARGUERITE CARNATIONS. The earliest of all Carnations, blooming in July or August if sown in spring, and continuing until frost. Being half-hardy perennials, a slight protection of coarse straw or pine boughs will preserve them during winter and they will flower profusely the next summer, or they may be potted to bloom during winter in the house. The flowers are large, about 80 per cent. usually coming double. | |
| 2350 | FARQUHAR'S NEW GIANT MIXED. An improved strain, producing a high percentage of double flowers, usually about 3 inches in diameter, including white, pink, scarlet, crimson, and yellow | .25 |
| | <i>"The Margaret Carnations and Sweet Peas were the best I have ever seen; in fact, everything sent by your house was highly satisfactory.</i> | |
| | <i>"J. Mahan, Newport, R.I."</i> | |
| 2360 | CHOICE MIXED. A fine selection; seed saved from large double flowers and including all colors Oz., 1.50 | .10 |
| 2365 | RED " 2.00 | .10 |
| 2370 | ROSE " 2.00 | .10 |
| 2380 | WHITE " 2.50 | .10 |
| 2381 | YELLOW 1/8 " 1.50 | .25 |
| 2383 | GIANTS OF NICE. The florists of the Riviera have long had the reputation of producing the finest Carnations in Europe. This strain originated with M. Chabaud, who is foremost among them, and our seed is raised by him. The plants come in bloom in six months after sowing; the flowers are long-stemmed, of large size and thick of petal. For cutting this strain is most valuable, particularly for summer use. Mixed colors | .50 |
| | HARDY CARNATIONS. FOR THE OPEN GARDEN. It is advisable to protect these with a light covering of pine boughs or coarse straw during winter. | |
| 2385 | GRENADIN SCARLET. Double flowers, early; 2 ft. 1/4 oz., 1.00 | .25 |
| 2390 | — WHITE | .25 |

- | No. | | Pkt. |
|-------------------------------------|---|------|
| HARDY CARNATIONS— <i>Continued.</i> | | |
| 2400 | DOUBLE PRIZE STRAIN, FINEST MIXED. The best type of Hardy Border Carnation, fine for cutting Oz., 4.00 | .25 |
| 2402 | — FINE MIXED " 2.00 | .10 |
| 2405 | — EARLY WHITE VIENNA. Ornamental and useful for cutting Oz., 3.00 | .25 |
| 2410 | PLUMARIUS CYCLOPE, DOUBLE MIXED. A splendid race of double "Pheasant-Eye" pinks. Very fragrant and hardy | .50 |
| 2430 | SCOTICUS FLORE PLENO. <i>Paisley Pink.</i> This race of Scotch pinks is quite as much in favor for winter forcing as for border cultivation. The flowers resemble the true Carnation and have the strongest spice fragrance | .50 |
| 2445 | CASTILLEJA INDIVISA. Half-hardy annual with brilliant scarlet flower bracts; 1½ ft., July to Oct. | .25 |
| | CASTOR OIL BEAN. <i>See Ricinus, No. 6925.</i> | |
| | CATCHFLY. <i>See Silene, No. 7220.</i> | |
| 2235 | CANNA, CROZY'S LARGE-FLOWERING SORTS. This race of Cannas is remarkable for the size and lasting quality of the flowers, and being of compact habit they are invaluable for sub-tropical bedding Oz., .50 | .10 |
| 2245 | DARK-LEAVED VARIETIES " .25 | .05 |

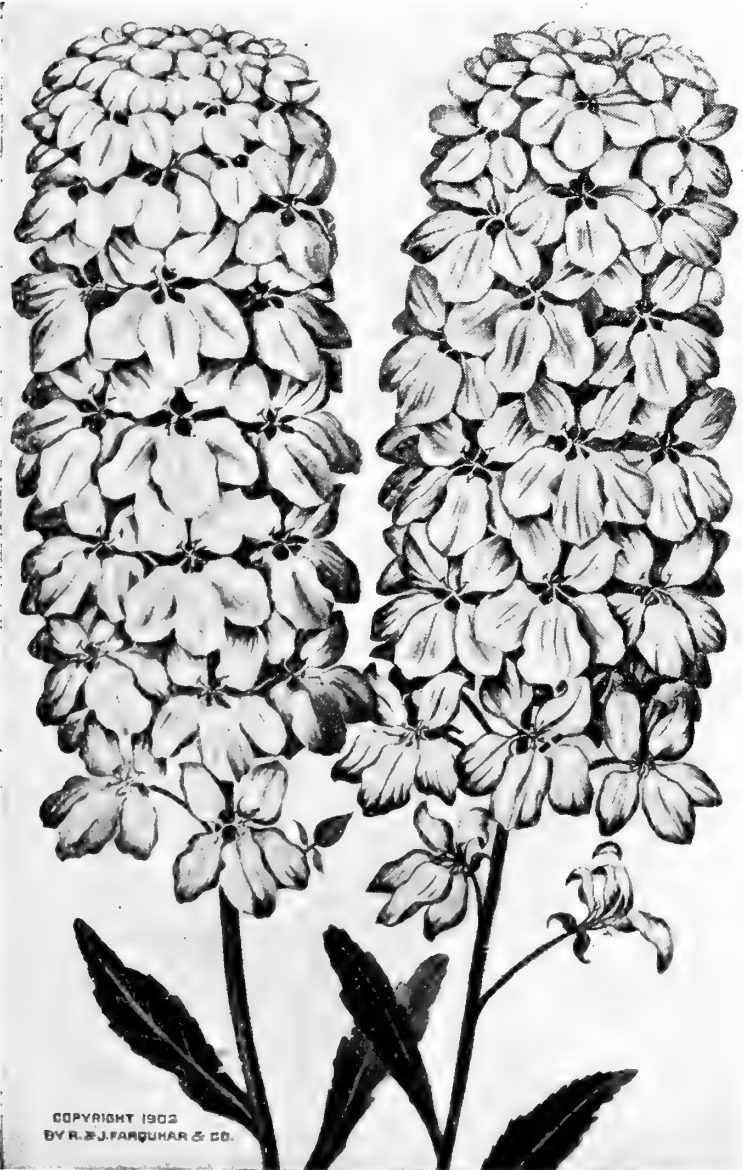

Giant White Candytuft. No. 2190.

- | No. | | Pkt. |
|------|--|------|
| | CANDYTUFT. <i>Iberis.</i> Showy hardy annuals, useful for edgings and masses, and most serviceable for cutting. If sown in April they bloom from July to October. They are frequently sown in autumn and kept over winter in cold frames to bloom in spring; 1 ft. | |
| 2165 | FINEST MIXED. All colors Oz., .25 | .05 |
| 2170 | CARMINE " .40 | .05 |
| 2175 | DARK CRIMSON. Dunnett's Improved " .25 | .05 |
| 2185 | EMPRESS. A large-flowered white sort, with broad, conical heads; extensively used for forcing Oz., .50 | .05 |
| 2190 | GIANT WHITE. Grand variety; producing immense spikes of large, pure white flowers; excellent for cutting Oz., .50 | .05 |
| 2195 | ODORATA. White; fragrant " .25 | .05 |
| 2200 | PURPLE. Rich shade " .25 | .05 |
| 2210 | DWARF, FINEST MIXED. Useful for edgings Oz., .75 | .05 |
| 2225 | — ROSE " .75 | .05 |
| 2230 | — WHITE " .50 | .05 |
| | IBERIS. <i>Candytuft.</i> PERENNIAL VARIETIES. Free-flowering dwarf perennials, suitable for rockwork and the edges of herbaceous borders. Height, 6 inches. | |
| 2231 | GIBALTARICA. White, shaded with pink. ¼ oz., 1.00 | .25 |
| 2232 | PRUITI. White; very early " 1.00 | .25 |
| 2233 | SEMPERVIRENS. White, glossy green foliage, Oz., .75 | .05 |
| | CELOSIA, OR COCKSCOMB. Showy annuals of easy cultivation; producing large, brilliant, comb-like flower heads. They prefer a light soil, and should not be allowed to become crowded if a dwarf habit is desired. | |
| 2465 | DWARF, FINEST MIXED ¼ oz., .50 | .05 |
| 2480 | — DARK CRIMSON. (<i>Glasgow Prize</i>) " .75 | .10 |
| 2500 | — GOLDEN YELLOW " .75 | .10 |
| 2505 | — LIGHT YELLOW " .75 | .10 |
| 2510 | — ROSE " .75 | .10 |
| 2515 | — SCARLET " .75 | .10 |
| 2524 | — VESUVIUS. Flame color and crimson: splendid ¼ oz., 1.25 | .25 |
| 2525 | — COLLECTION OF 10 VARIETIES | .75 |
| 2530 | — COLLECTION OF 6 VARIETIES | .50 |
| 2535 | TALL. FINEST MIXED; 1½ ft. . Oz., 1.00 | .05 |
| 2540 | PLUMOSA, FINEST MIXED. Showy annuals, with brilliant, plume-like flowers; 1½ ft. Oz., .50 | .05 |
| 2545 | — CRIMSON " .60 | .05 |
| 2550 | — GOLDEN YELLOW " .60 | .05 |
| 2555 | — SCARLET " .60 | .05 |
| 2565 | THOMPSON'S SUPERB. Splendid strain, with bright red and dark foliage; flowers crimson Oz., 1.00 | .10 |
| | CENTAUREA, WHITE-LEAVED VARIETIES. <i>Dusty Miller.</i> Half-hardy perennials of dwarf growth, with silvery leaves; splendid for ribbon-bedding. | |
| 2570 | CANDIDISSIMA. Thick, white leaves; 1 ft. 1,000 seeds, .75 | .10 |
| 2573 | GYMNOCARPA. White, fern-like leaves; very graceful. Splendid bedding plant; 1½ ft. Oz., .80 | .10 |

MR. SYDNEY MITCHELL, Park Avenue, Montreal, Can., writes:
 "Gentlemen: *Cosmos*, usually considered too late a plant to flower in our northern climate, bloomed beautifully in September and October from June-sown seed of Farquhar's Early Flowering Hybrids."

COPYRIGHT 1902 BY R. & J. FARQUHAR & CO.



Centaurea Imperialis. No. 2575.

No.	CENTAUREA. FLOWERING ANNUAL SORTS.	Pkt.
	These are among the most serviceable annuals for cutting, and they may be sown from April to July for succession.	
2574	COLLECTION OF 8 LARGE-FLOWERING VARIETIES40
	IMPERIALIS. <i>New Giant Corn-Flower</i> . The flowers are of enormous size, fragrant, and of most charming colors. They are superb for cutting; 2 ft.	
2575	— FINEST MIXED. All colors	1.25 .10
2576	— LILAC	1.50 .10
2577	— PINK, WITH WHITE CENTRE	1.50 .10
2578	— ROSE	1.50 .10
2579	— PURPLE	1.50 .10
2581	— WHITE	1.50 .10
2582	MARGARITAE. <i>Giant White Corn-Flower</i> . Blossoms 3 to 4 inches across, pure white, fragrant	Oz., 1.50 .10
2583	ODORATA. Fragrant; purplish crimson; very large blossoms	Oz., 1.50 .10
2584	— CHAMÆLEON. Large flowers, pale sulphur-yellow, changing to rosy-lilac	Oz., 2.00 .10
	CYANUS. <i>Bachelor's Button, or Corn Flower</i> . Fine, free-flowering hardy annuals; easily grown, and excellent for cutting; 2 ft.	
2585	— FINEST MIXED	¼ lb., .60 Oz., .25 .05
2590	— EMPEROR WILLIAM. Deep blue.	¼ lb., .75 " .30 .05
2610	— ROSE	" .30 .05
2615	— WHITE	" .30 .05
	MOSCHATUS. <i>Sweet Sultan</i> . Fragrant and showy hardy annuals. Splendid for cut flowers; 1½ ft., June to Sept.	

No.	CENTAUREA — Continued.	Pkt.
2625	— FINEST MIXED. All colors	Oz., .30 .05
2627	— BLUE	" .30 .05
2628	— WHITE	" .30 .05
2630	SUAVEOLENS. <i>Yellow Sweet Sultan</i> . "	" .60 .05
2635	AMERICANA. Lilac-purple flowers, often 4 inches in diameter; 2½ ft.	Oz., .75 .10
2636	— ALBA. White; lovely flower; ¼ oz., .60 .25	
	CENTAUREA, HARDY PERENNIAL VARIETIES.	
2638	BABYLONICA. Yellow; very showy; 3 ft.	¼ oz., .30 .10
2640	MACROCEPHALA. Large, deep yellow flowers; 3 ft.	¼ oz., .30 .10
2642	MONTANA. Very showy; deep purple; 2 ft.	¼ oz., .50 .10
2647	CEPHALARIA ALPINA. Hardy perennial, with showy light blue flowers; 2½ ft., July to Sept.10
2655	CERASTIUM TOMENTOSUM. <i>Snow-in-Summer</i> . The foliage of this hardy perennial is perfectly white and its dense matted growth makes it desirable for edgings and rockeries; 4 inches25
2670	CHELONE BARBATA TORREYI. Fine perennial, with scarlet flowers like the Pentstemon; fine for summer display and cutting; 2 ft., July to Oct.	¼ oz., .50 .10
2675	HYBRIDA. The colors vary from flesh-pink to deep red and violet; beautiful as cut flowers for vases	¼ oz., .50 .10
	CHRYSANTHEMUM. ANNUAL VARIETIES. Showy hardy annuals of easiest cultivation and blooming from July until frost. They are especially desirable for seashore and mountain gardens; 2 ft.	
2680	SINGLE VARIETIES MIXED	Oz., .30 .05
2685	DOUBLE VARIETIES MIXED	" .40 .05
2700	TRICOLOR BURRIDGEANUM. <i>Lord Beaconsfield</i> . Single daisy-like flowers, white, crimson, and yellow	Oz., .40 .05
2702	— ECLIPSE. Single, golden yellow, with scarlet ring and brown disc	Oz., .50 .05
2703	— DUNNETT'S DOUBLE CRIMSON. "	1.25 .10
2705	— — — WHITE	" 1.00 .10
2707	— — — YELLOW	" 1.00 .10
2750	— DOUBLE FRINGED MIXED	" 1.25 .10
2765	INODORUM PLENISSIMUM. Free-flowering variety of spreading habit, with pure white flowers, resembling Asters; 1 ft., ¼ oz., .30 .10	
2770	MULTICAULE. Pretty, single yellow flowers; fine bedder; 4 inches	Oz., .30 .05
2775	SEGETUM GRANDIFLORUM. Bright golden yellow; 2 ft.	Oz., .30 .05
	CHRYSANTHEMUM, PERENNIAL VARIETIES.	
2780	CHINESE FINEST MIXED. The large autumn-flowering Chrysanthemum25
2790	JAPANESE DOUBLE EARLY FLOWERING, DELAUX STRAIN. These bloom in the open ground from Aug. to Nov. Splendid hardy perennials; 2 ft.25
2805	FRUTESCENS. <i>The White Paris Daisy</i> . Charming plant for greenhouse or summer bedding out doors; tender perennial, 1½ ft.10
2810	— COMTESSE DE CHAMBORD. <i>Golden Paris Daisy</i> . The true Golden Marguerite, a favorite flower, both for cutting and bedding, worthy of more extensive use, tender perennial; 3 ft.15
2815	MAXIMUM. <i>Ox-Eye Daisy</i> . The largest-flowered hardy perennial Daisy; white; 3 ft., July to Oct.10



COPYRIGHT 1903
BY R. & J. FARQUHAR & CO.

Farquhar's Columbian Prize Cineraria. No. 2820.

Pkt.

CINERARIA HYBRIDA. The large-flowered varieties are among the most ornamental and useful plants that can be grown for conservatory and house decoration, and they are of easiest culture. Seed may be sown

No. from May to September for succession, but the principal sowing should be made in July.

FARQUHAR'S COLUMBIAN PRIZE. The plants are of compact growth, carrying large flower-heads of finest form and substance. The strain includes the richest and brightest self colors as well as perfectly marked ringed and margined forms of all colors.

2820	First size packet	\$1.00
2825	Second size packet50

MR. JAMES BRAIK, Asst. Supt., Dept. of Parks, Buffalo, N.Y., Jan. 30, 1903, writes:

"Our Cinerarias are just coming in bloom, and promise equally as good as last year, which is saying it all."



Cineraria Stellata. No. 2845.

- | No. | | Pkt. |
|---|---|------|
| <i>CINERARIA — Continued.</i> | | |
| 2830 | GRANDIFLORA NANA. FINEST MIXED. Plants of dwarf habit with large flowers of fine substance. Valuable for window decoration | .50 |
| 2840 | DOUBLE-FLOWERING, FINEST MIXED. The flowers are in the form of small rosettes, and are useful for cutting | .75 |
| 2845 | STELLATA. <i>Star-Flowered Cineraria.</i> A charming new race with large corymbs of delicate little flowers, in appearance somewhat like our native American asters. For vases and bouquets they are most fascinating, and they keep fresh a week or longer. Mixed colors | 1.00 |
| <i>CINERARIA. WHITE-LEAVED VARIETIES.</i> | | |
| <i>Dusty Miller.</i> Silvery-leaved perennials, much used for bedding; 1 to 1½ ft. | | |
| 2850 | MARITIMA. Dwarf habit; silvery leaves. Oz., 30 | .05 |
| 2855 | ACANTHIFOLIA. White, finely-cut leaves. Oz., 1.50 | .10 |
| 2860 | CANDIDISSIMA. White; fine for edging, " .50 | .05 |
| <i>CLARKIA.</i> Showy, hardy annuals of easy cultivation, slender and branching in growth, with handsome flowers; desirable for beds and cutting; July to Oct., 1 ft. | | |

- | No. | | Pkt. |
|--|--|------|
| <i>CLARKIA — Continued.</i> | | |
| 2865 | ELEGANS, DOUBLE MIXED. Shades of rose, crimson, violet, and white . . . Oz., .25 | .05 |
| 2880 | PULCHELLA, SINGLE MIXED. Many colors. Oz., .25 | .05 |
| 2883 | — INTEGRIPETALA MIXED. Large, showy flowers Oz., .25 | .05 |
| 2890 | CLERODENDRON FALLAX. Splendid greenhouse perennial with scarlet flower-heads resembling the Hydrangea. Seeds sown in March give flowering plants by Sept.; 2 ft., | .75 |
| 2900 | CLEMATIS PANICULATA. The beautiful hardy Japanese autumn-flowering variety so extensively used about Boston, and admired for its masses of fragrant white star-shaped flowers; 25 ft. Oz., .60 | .10 |
| FOR PLANTS OF CLEMATIS PANICULATA, which bloom the first season, see <i>Hardy Climbing Plants.</i> | | |
| 2908 | CLEOME PUNGENS. <i>Spider Plant.</i> Tender biennial, with beautiful rose-colored flowers; blooms the first season if started early; 2 ft. Oz., 1.75 | .10 |
| 2910 | CLIANTHUS DAMPIERI. <i>Glory Pea.</i> Gorgeous, summer-flowering plants; flowers scarlet with large, glossy black blotch; pea-shaped; greenhouse shrub; July to Oct., 4 ft. | .25 |
| 2925 | CLITORIA COELESTIS. <i>Blue Pea.</i> Greenhouse climber; lovely blue flowers; 4 ft. . | .10 |
| 2930 | COBEA SCANDENS. Well-known climbing perennial of rapid growth and flowering the first season; producing large purple, bell-shaped blossoms; July to Oct., 20 ft. Oz., .75 | .10 |



Clarkia Elegans, Double. No. 2865.

No. COBEA — *Continued.*

2935 — FLORE ALBO. White.
Oz., 2.00; pkt., .25

2937 MACROSTEMMA. Purple
flowers with corolla
divided and curious
long-stalked anthers.
Pkt., 25

2940 COCCINEA INDICA.
Annual climber, with
white flowers and
scarlet fruit; 8 ft.
Pkt., .10

COCKSCOMB. *See Ce-*
losia, No. 2465.

COLEUS. Splendid
bedding plants, with
beautifully colored and
handsomely marked
foliage. They are
easily raised from seed
if kept in a warm
temperature. Tender
perennials; 1½ to 2 ft.

2955 NEW LARGE-LEAVED
VARIETIES. Superb
colors and markings.
Pkt., .50

2957 FINEST MIXED HY-
BRIDS . Pkt., .25

2960 COLLINSIA, FINEST
MIXED. Charming
hardy annuals adapted
to dry situations;
flowers white, lilac,
and purple; June to
Sept.; 1 ft.

Oz., .30; pkt., .05
2965 COLLOMIA COCCINEA.
Fine hardy annual;
scarlet and yellow;
fine plant for bees;
June to Oct.; 1½ ft.

Oz., .30; pkt., .05
COLUMBINE. *See*
Aquilegia, No. 490.

2982 COMMELINA SEL-
LOWIANA. Half-hardy
perennial with beauti-
ful cobalt-blue flowers
and having tuberous
roots which may be
kept over winter like
dahlias. July to Oct.; 1½ ft., ¼ oz., .1.00

CONVOLVULUS MAJOR. *See Ipomœa Pur-*
purea, No. 4445.

CONVOLVULUS MINOR. *Dwarf Morning*
Glory. Early-blooming hardy annuals, with
very brilliant flowers; splendid for seashore
and mountain gardens; 1½ ft., June to Sept.

2985 — FINEST MIXED. Shades of rose, crimson,
violet, and white Oz., .25 .05

2990 — BLUE. Rich indigo " .25 .05

3015 MAURITANICUS. Charming half-hardy peren-
nial of trailing habit, with light blue flowers
suitable for hanging-baskets . . Oz., .80 .10

3025 COSMIDIUM BURRIDGIANUM. Showy an-
nual, with large, orange-brown flowers, re-
sembling Calliopsis; 2 ft., July to Oct. Oz., .25 .05

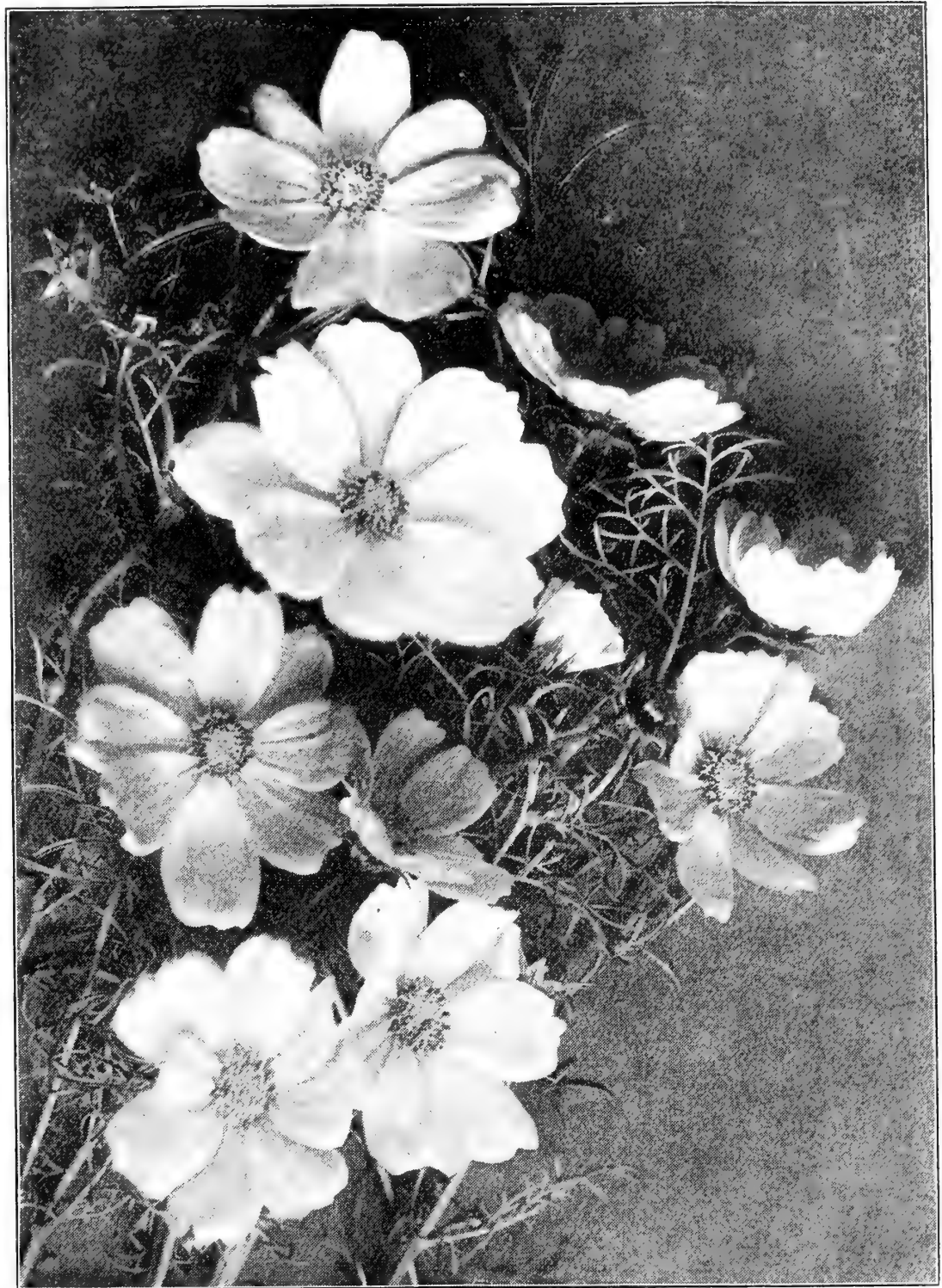

Farquhar's Early Flowering Cosmos, No. 3032.

Messrs. R. & J. Farquhar & Co.:
Dear Sirs: I am very much pleased with your new Early
Flowering Cosmos. It commenced to bloom about the first of
July and continued until frost. The flowers are of large size
and fine colors. It is decidedly the most useful Cosmos I have
met with. Yours very truly, P. VOLQUARSEN.

Fairlawn, Newport, R.I.

	Pkt.	No.	Pkt.
COSMOS. This is one of our most useful and beautiful autumn flowers. To get it in bloom early, the seed should be sown in May in the open ground where the plants are desired to bloom, and the seedlings allowed to grow and flower without being transplanted.			
3032 FARQUHAR'S EARLY MIXED HYBRIDS. The earliest strain of Cosmos in existence. If sown in May in the open ground, it usu- ally blooms by the first or second week in July. The colors include pure white, shades of lilac, rose, and crimson. Our seed is grown in Massachusetts and has frequently ripened and been gathered before ordinary Cosmos had begun to bloom; 4 ft. Oz., 1.25	.10		.10
3033 FARQUHAR'S EARLY PINK	1.50		.10
3034 FARQUHAR'S EARLY WHITE	1.50		.10
3036 MAMMOTH, FINEST MIXED. Flowers usu- ally 4 in. across Oz., .50	.10		.10
3037 — PINK75		.10
3038 — RED75		.10
3039 — WHITE75		.10

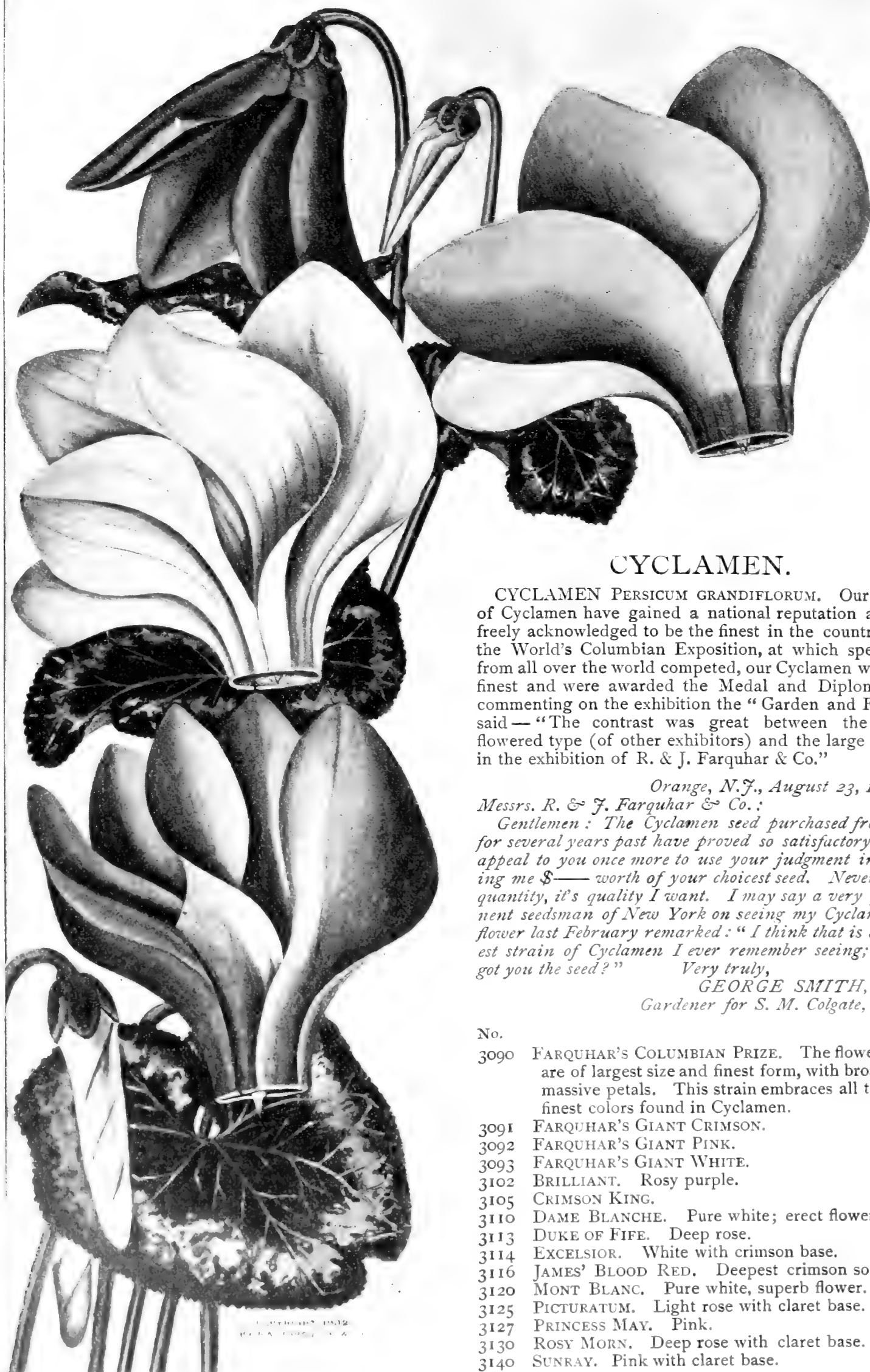

CYCLAMEN.

CYCLAMEN PERSICUM GRANDIFLORUM. Our strains of Cyclamen have gained a national reputation and are freely acknowledged to be the finest in the country. At the World's Columbian Exposition, at which specialists from all over the world competed, our Cyclamen were the finest and were awarded the Medal and Diploma. In commenting on the exhibition the "Garden and Forest" said—"The contrast was great between the small flowered type (of other exhibitors) and the large flowers in the exhibition of R. & J. Farquhar & Co."

Orange, N.J., August 23, 1902.

Messrs. R. & J. Farquhar & Co.:

Gentlemen: The Cyclamen seed purchased from you for several years past have proved so satisfactory that I appeal to you once more to use your judgment in sending me \$— worth of your choicest seed. Never mind quantity, it's quality I want. I may say a very prominent seedsman of New York on seeing my Cyclamen in flower last February remarked: "I think that is the finest strain of Cyclamen I ever remember seeing; where got you the seed?"

Very truly,

GEORGE SMITH,

Gardener for S. M. Colgate, Esq.

No.

- 3090 FARQUHAR'S COLUMBIAN PRIZE. The flowers are of largest size and finest form, with broad massive petals. This strain embraces all the finest colors found in Cyclamen.
- 3091 FARQUHAR'S GIANT CRIMSON.
- 3092 FARQUHAR'S GIANT PINK.
- 3093 FARQUHAR'S GIANT WHITE.
- 3102 BRILLIANT. Rosy purple.
- 3105 CRIMSON KING.
- 3110 DAME BLANCHE. Pure white; erect flowers.
- 3113 DUKE OF FIFE. Deep rose.
- 3114 EXCELSIOR. White with crimson base.
- 3116 JAMES' BLOOD RED. Deepest crimson sort.
- 3120 MONT BLANC. Pure white, superb flower.
- 3125 PICTURATUM. Light rose with claret base.
- 3127 PRINCESS MAY. Pink.
- 3130 ROSY MORN. Deep rose with claret base.
- 3140 SUNRAY. Pink with claret base.

Prices of the above named Cyclamen: Per 1,000 seeds, \$12.00; per 100 seeds, 1.50; per packet, .75.

- | No. | Pkt. |
|---|------|
| COWSLIP. <i>See Primula acaulis</i> , No. 6785. | |
| CUCUMBER ORNAMENTAL. <i>See Echinocystis</i> , No. 3500. | |
| 3075 CUPHEA, PLATYCENTRA. <i>Cigar Plant</i> . Half-hardy perennial, valuable as a bedding and border plant. The flowers are bright scarlet with a black and white lip; 1 ft., July to Oct. It flowers the first year from seed | .25 |
| 3160 CYCLANTHERA EXPLODENS. A free-growing annual climber, with handsome foliage, yellow flowers, and pretty oval fruit, which explodes when ripe; 8 ft. | .10 |
| 3175 CYPERUS ALTERNIFOLIUS. <i>Umbrella Plant</i> . Handsome, half-hardy perennial easily raised from seed; useful for table decorations and combining with palms; semi-aquatic; 2 ft. | .25 |
| 3177 PAPYRUS. <i>Egyptian Paper Plant</i> . Half-hardy perennial; semi-aquatic, with large spreading flower-heads. Splendid for subtropical beds and aquatic gardens; will survive the winter if well mulched. Height, 6 ft. | .25 |
| CYPRESS VINE. <i>Ipomœa Quamoclit</i> . Very graceful and beautiful twining annuals with feathery dark green foliage and star-like flowers; 20 ft., July to October. | |
| 3180 FINEST MIXED Oz., .30 | .05 |
| 3185 BRIGHT SCARLET " .30 | .05 |
| 3195 WHITE " .30 | .05 |
| 3196 CYTISUS RACEMOSUS. Beautiful winter-blooming greenhouse shrub, with clusters of bright yellow pea-shaped blossoms; 3 ft. | .50 |
| DAHLIA. This popular flower can easily be raised from seed and flowered the same season. The roots should be placed in dry sand and kept in a cellar where there is no frost during winter; 3 ft. | |
| 3200 CACTUS-FLOWERED. The petals are fluted and twisted loosely, producing a very graceful and free effect. Finest mixed. Oz., 2.00 | .10 |
| 3205 DOUBLE LARGE-FLOWERED, FINEST MIXED. Saved from the finest sorts . . Oz., 2.00 | .10 |
| 3210 — POMPON, FINEST MIXED | .10 |
| 3212 GLORIA. A new strain with very large reflexed petals and with a bold yellow centre, | .25 |
| 3215 SINGLE, FINEST MIXED. Saved from the best European collections . . Oz., 1.25 | .10 |
| 3220 — STRIPED MIXED " 1.50 | .10 |
| 3225 — WHITE SHADES " 1.50 | .10 |
| DAISY. <i>See Bellis perennis</i> , No. 1670. | |
| DATURA, OR TRUMPET FLOWER. Half-hardy annuals of rapid growth with large trumpet-shaped fragrant flowers; very showy; 3 ft. | |
| 3235 FINEST MIXED. Shades of lilac, purple, yellow, and white Oz., .40 | .05 |
| 3236 ARBorea. <i>Brugmansia</i> . Flowers trumpet-shaped; usually about 12 inches long; fragrant and pure white . . . 1/8 oz., .75 | .25 |
| 3240 CORNUCOPIA. White, marbled with purple, Oz., 1.00 | .10 |
| DELPHINIUM. <i>Larkspur</i> . The perennial Larkspurs are perfectly hardy and can be grown with ease in any garden. They are handsome plants for the herbaceous border and shrubbery and are splendid for cut flower use. When sown in April or May, Delphiniums will usually bloom in September; they may also be sown in July to bloom the following June; 1 1/2 to 4 ft. | |

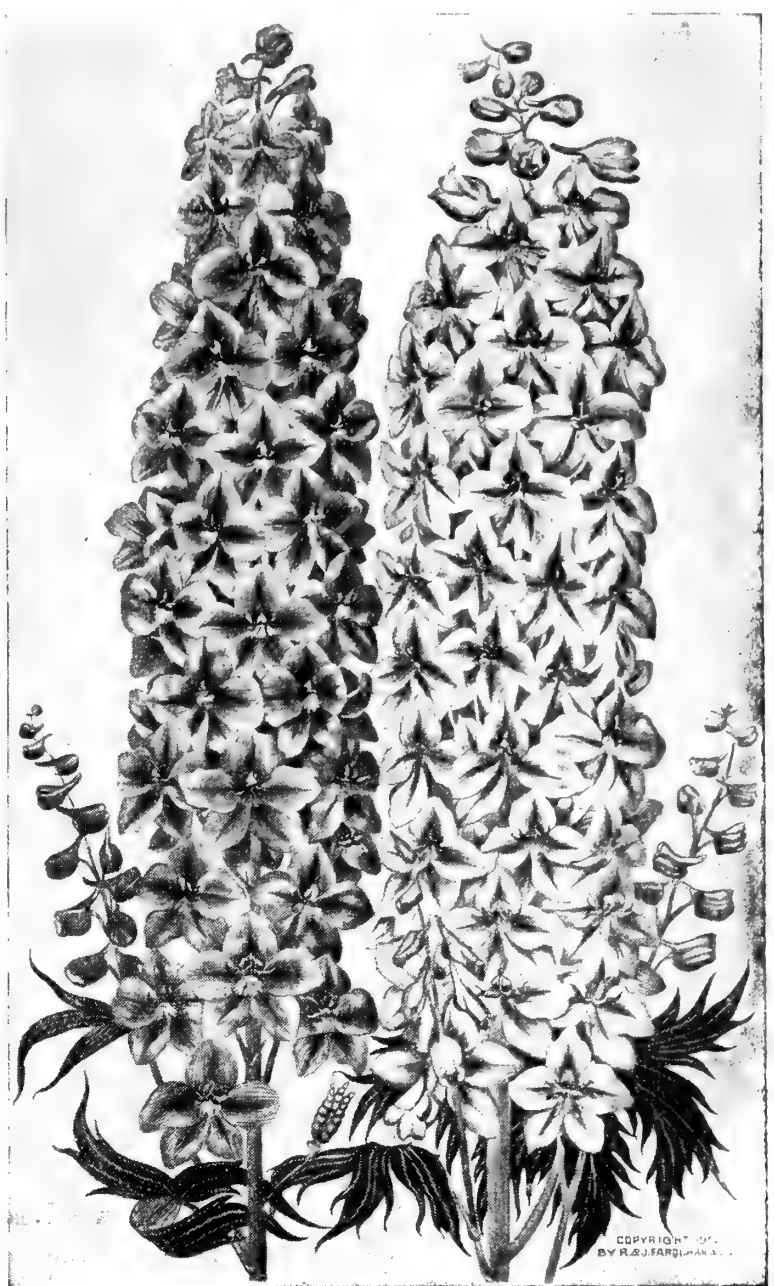

Delphinium, Farquhar's Selected Hybrids. No. 3255

- | No. | Pkt. |
|---|------|
| DELPHINIUM — <i>Continued</i> . | |
| 3255 FARQUHAR'S SELECTED HYBRIDS. This strain includes the best of the new single and double varieties; the flower-spikes being large, varying in color from pearly white to lavender and from soft azure blue to rich indigo. Finest mixed Oz., 2.50 | .25 |
| 3257 LEMOINE'S HYBRIDS, FINEST MIXED. A splendid race, including all colors, Oz., 1.50 | .10 |
| 3270 CARDINALE. Scarlet; 3 ft. . . 1/8 oz., 1.50 | .25 |
| 3275 CASHMIRIANUM. Large flowers, dark blue; 1 1/2 ft. 1/4 oz., 1.25 | .25 |
| 3277 CAUCASICUM. Violet, magnificent; 1 1/2 ft., Oz., 1.25 | .10 |
| 3280 CHINENSIS MIXED. <i>Grandiflorum</i> . Shades of blue and pure white; 1 1/2 ft. . Oz., .50 | .05 |
| 3282 — AZUREUM. Azure blue " .60 | .05 |
| 3283 — ALBUM. Pure white " .60 | .05 |
| 3285 ELATUM. <i>Bee Larkspur</i> . Blue; 4 ft., " .50 | .05 |
| 3290 FORMOSUM. Splendid dark blue with white eye; 3 ft. Oz., .75 | .10 |
| 3295 — CÆLESTINUM. Light blue . 1/4 oz., 1.00 | .25 |
| 3320 NUDICAULE. Scarlet; 1 to 1 1/2 ft., 1/4 oz., 1.00 | .25 |
| 3321 — AURANTIACUM. Orange-scarlet | .25 |
| 3322 PARRYI. Indigo blue; 3 ft. | .25 |
| 3323 SIBIRICUM HYBRIDUM. Shades of blue; blooms in August if sown in spring; 1 1/2 ft. | .25 |
| 3325 SPECIOSUM. Magnificent bright blue; 3 ft., | .25 |
| 3330 SULPHUREUM. <i>Zalil</i> . Tall spikes of sulphur yellow flowers; very beautiful; 4 ft. | .25 |



Double Japanese Pinks. No. 3345.

- | No. | | Pkt. |
|------|--|---------------|
| | DIANTHUS CHINENSIS. <i>Chinese or Indian Pinks.</i> These, although biennials, bloom the first season and should be treated as hardy annuals. They flower early in summer and continue until frost. They are excellent for small beds or edgings, flowering profusely and in great variety of colors. The <i>Heddewigii</i> varieties are a week or ten days later than the others and are remarkable for their size and the brilliancy of their colors; 1 ft. | |
| 3335 | COLLECTION OF 12 VARIETIES. <i>Chinensis</i> and <i>Heddewigii</i> | .50 |
| 3340 | CHINENSIS FLORE PLENO. <i>Double Chinese Pink.</i> Saved from the finest double flowers; mixed colors | Oz., .40 .05 |
| 3345 | HEDDEWIGII FLORE PLENO. <i>Double Japanese Pink.</i> Large flowers of many beautiful and brilliant colors. Finest mixed, | Oz., .80 .10 |
| 3350 | — DOUBLE WHITE. Large, fringed flowers, | Oz., 1.00 .10 |
| 3355 | — — CRIMSON. Brilliant shade | " 1.00 .10 |
| 3360 | — — DARK CRIMSON WITH WHITE EDGE. <i>Mourning Cloak.</i> Dark velvety crimson, with distinct white frill | Oz., 1.00 .10 |
| 3385 | — SINGLE, FINEST MIXED. Large, attractive flowers of most brilliant colors | Oz., .75 .05 |
| 3387 | — BRILLIANT. <i>Crimson Belle.</i> Brilliant velvety crimson, large single flower, | Oz., 1.00 .10 |
| 3390 | — LACINIATUS, SINGLE MIXED. Flowers deeply fringed, varying in color from blush-white to deep rose, with a circle of rich crimson surrounding the eye | Oz., .75 .05 |
| 3392 | — LACINIATUS FLORE PLENO. Double fringed flowers, beautifully striped; many colors, | Oz., 1.25 .10 |
| 3402 | — DIADEMATUS FLORE PLENO. <i>Double Diadem Pink.</i> Large, double flowers, varying in color from lilac to crimson and maroon, with the edges fringed and almost white. Finest mixed | Oz., 1.00 .10 |
| 3403 | IMPERIALIS FLORE PLENO. <i>Double Imperial Pink.</i> Variegated flowers of many colors | Oz., .50 .05 |

- | No. | | Pkt. |
|------|---|--------------|
| | DIANTHUS — <i>Continued.</i> | |
| 3404 | LATIFOLIUS, DOUBLE HYBRIDS MIXED. Beautiful pinks blooming the first season with double flowers varying from rose to crimson and maroon | Oz., .75 .05 |
| 3405 | DICTAMNUS FRAXINELLA. <i>Dittany.</i> Fine, hardy perennials, with handsome spikes of purplish crimson or white flowers. The leaves are fragrant, giving off an odor of balsam when rubbed. Mixed colors, | Oz., .40 .05 |



Dianthus Heddewigii, Single Mixed. No. 3385.



Digitalis Purpurea. No. 3435.

- | No. | | Pkt. |
|------|---|------|
| | DIGITALIS. <i>Foxglove</i> . This favorite hardy plant is of easy cultivation and most decorative either in garden borders or in groups among shrubs. It thrives in sun or partial shade, and is excellent for semi-wild effects. Seeds may be sown from April to July for plants to bloom the next summer; June to Sept.; 3 ft. | |
| 3415 | GLOXINÆFLORA, MIXED. Flowers spotted in the throat Oz., .40 | .05 |
| 3416 | — ALBA. White, delicately spotted " .40 | .05 |
| 3417 | — ROSEA. Pink " .40 | .05 |
| 3420 | GRANDIFLORA. Yellow " .30 | .05 |
| 3425 | IVERY'S SPOTTED. <i>Maculata superba</i> . Beautiful spotted flowers of various colors, .50 | .05 |
| 3430 | MONSTROSA. The tall spikes have a monstrous saucer-shaped terminal flower, Oz., 1.25 | .10 |
| 3435 | PURPUREA. Common red Foxglove " .30 | .05 |
| 3436 | — ALBA. White " .30 | .05 |
| 3437 | MIXED. All colors " .30 | .05 |
| 3445 | DODECATHEON MEDIA. <i>American Cowslip</i> . Pretty, hardy perennial, with rosy-purple flowers in shape resembling the Cyclamen; succeeds best in partial shade; 1 ft., April and May | .25 |
| 3450 | DOLICHOS LABLAB. <i>Hyacinth Bean</i> . Rapid-growing annual climber with clusters of white or purple flowers. Mixed colors; 10 ft., July to Sept. Oz., .25 | .05 |
| | DRACÆNA. Highly decorative greenhouse plants with elegant leaves; valuable for vases and conservatory decoration. | |
| 3455 | ORNAMENTAL-LEAVED VARIETIES, FINEST MIXED. Including the variegated and brilliant-colored sorts | .25 |
| 3460 | AUSTRALIS. An excellent vase plant. ¼ oz., 1.00 | .25 |
| 3465 | INDIVISA. Long, slender leaves; valuable for hanging baskets Oz., 1.00 | .10 |
| 3470 | — VEITCHII. Like the preceding, but having the back of the mid-rib deep red | .25 |
| 3472 | DRACOCEPHALUM ARGUNENSE. Showy, hardy perennial, producing spikes of bright blue Salvia-shaped flowers. It blooms the first season if sown early; 1½ ft., July to Aug. | .10 |

- | No. | | Pkt. |
|------|---|------|
| 3485 | ECHEVERIA METALLICA. Handsome succulent plant with purplish glaucous leaves | .50 |
| 3490 | SECUNDA. The best sort for mosaic beds, the rosette-like plants having glaucous foliage | .25 |
| 3500 | ECHINOCYSTIS LOBATA. <i>California Cucumber</i> . One of the quickest growing annual vines. The seeds should be sown in autumn, or if sown in spring, first soaked in warm water 24 hours; 20 ft. Oz., .60 | .10 |
| 3502 | ECHINOPS RITRO. <i>Globe Thistle</i> . Splendid, hardy perennial with white foliage and bright blue thistle-like flowers; 3 ft. Oz., .60 | .10 |
| 3505 | EDELWEISS. <i>Leontopodium Alpinum</i> . The interesting white-leaved plant, so eagerly sought by tourists in the Swiss Alps, easily grown in gardens; hardy perennial; 6 inches | .25 |
| 3525 | EREMURUS ROBUSTUS. Tall-growing perennial resembling the Asphodel, rose-color spikes; 8 ft., June | .25 |
| 3530 | TURKESTANICUS. Reddish-brown; 5 ft. | .25 |
| 3565 | ERYNGIUM AMETHYSTINUM. Handsome thistle-like hardy perennial, with bright blue flowers and bracts; 3 ft., July to Aug. ¼ oz., .75 | .10 |
| | ESCHSCHOLTZIA. <i>California Poppy</i> . One of the best hardy annuals, having delicate silvery foliage and large poppy-like flowers, running chiefly in shades of yellow. It blooms profusely from June until frost, and is extremely beautiful for border edgings and for large beds; 1 ft. | |
| 3595 | FINEST MIXED. Shades of yellow, rose, and white ¼ lb., .75; oz., .30 | .05 |



Eschscholtzia Californica. No. 3600.

No.		Pkt.
ESCHSCHOLTZIA — <i>Continued.</i>		
3600	CALIFORNICA. Bright yellow, large. 1/4 lb., 1.00; oz., .40	.05
3605	— ALBA. Pure white40 .05
3608	— FLORE PLENO. Double white, "60 .05
3610	— CARMINEA. Rose-color60 .05
3612	— GOLDEN WEST. Bright yellow; very large. Oz., 1.00	.10
3615	— MANDARIN. Orange-scarlet60 .05
3625	— ROSE CARDINAL. Deep rose75 .05
3630	CROCEA. Deep rich orange40 .05
3635	— FLORE PLENO. Double deep orange. Oz., .60	.05
3650	MARITIMA. Bright yellow with orange centre. Oz., .60	.05
3655	EUCALYPTUS GLOBULUS. <i>Australian Blue Gum Tree.</i> This half-hardy tree is used with us as a pot plant, its bluish foliage contrasting beautifully with palms and other foliage plants	Oz., .75 .05
3675	EUPATORIUM FRASERI. Fine, hardy perennial, blooming the first season from seed and producing clusters of white flowers; fine for cutting; 2 ft., August to October05
3680	PURPUREUM. Deep pink10



Gaillardia picta. No. 3755.

3685	EUPHORBIA HETEROPHYLLA. <i>Mexican Fire Plant.</i> Showy annual with large glossy leaves, which in midsummer become tipped with orange-scarlet; 4 ft. Oz., 1.25	.10
3690	VARIEGATA. White and green bracts; useful for bouquets; 1 1/2 ft.	Oz., .40 .05
3695	EUTOCA VISCIDA. Extremely showy, hardy annual, with pretty deep blue flowers; 1 ft., July to Sept.	Oz., .40 .05
FEVERFEW. <i>See Matricaria</i> , No. 5015; also <i>Pyrethrum</i> , No. 6860.		
3713	FERNS. HARDY VARIETIES, FINEST MIXED. Useful plants for decorating shady nooks, rockworks, or borders on the northerly sides of buildings25
3715	GREENHOUSE VARIETIES, FINEST MIXED. Fine sorts25
3717	MAIDEN-HAIR VARIETIES. FINEST MIXED25
3718	— ADIANTUM CUNEATUM25
3719	— GRACILLIMUM25
3720	SWORD VARIETIES. Finest mixed25
FORGET-ME-NOT. <i>See Myosotis</i> , No. 5235.		
FOUR-O'CLOCK. <i>See Mirabilis</i> , No. 5195.		
FOXGLOVE. <i>See Digitalis</i> , No. 3415.		
FUCHSIA. These are not difficult to raise from seed if given a warm temperature. The plants bloom the first season if started early. They are admirably suited to partially shaded situations.		
3730	DOUBLE AND SINGLE VARIETIES, MIXED50
GAILLARDIA. <i>Blanket Flower.</i> Very showy, hardy plants; useful for beds, borders, and cut flowers, commencing to bloom in June and continuing until severe frost. They are of large size and great durability, and embrace many beautiful shades of yellow, orange, and crimson; 2 to 4 ft.		

ANNUAL VARIETIES.

3755	PICTA. Single, mixed colors; 2 ft. Oz., .40	.05
3758	— AMBLYODON. Single, deep red; 2 ft. "40 .05
3760	— LORENZIANA. Double, mixed colors; 2 ft. Oz., .50	.05
3765	— — GOLDEN GEM. Double, pure yellow. Oz., .60	.05

GAILLARDIA PERENNIAL VARIETIES.

No.		Pkt.
These are handsome summer and autumn flowering plants, quite hardy and easily grown. It is advisable to mulch them with straw during winter; 3 ft.		
3770	GRANDIFLORA, NEW HYBRIDS MIXED. Shades of yellow and red	Oz., .80 .10
3775	— MAXIMA. Yellow, very large75 .10
3780	— SUPERBA. Crimson and yellow75 .10
3785	GALEGA OFFICINALIS ALBA. Hardy perennial, with white pea-shaped flowers; very ornamental and useful for cutting; 3 ft., June to September05
3790	— PURPUREA. Blue05
3795	GAURA LINDHEIMERI. Half-hardy perennial; flowering the first season from seed and producing long sprays of white, red-tinted flowers. It is most useful for vases; the slender-stemmed blossoms fluttering like butterflies; 2 ft.	Oz., .40 .05
3802	GENISTA ANDREANA. A handsome variety of Broom; flowers crimson and yellow; half-hardy perennial; a showy pot plant; 2 ft.25
3805	CANARIENSIS. Yellow; greenhouse perennial; 2 ft.10



Gloxinia, Farquhar's Erect Giant. No. 3925.

No.		Pkt.	No.		Pkt.
3810	GENTIANA ACAULIS. <i>Blue Gentian</i> . Dwarf, hardy herbaceous perennial, with large, deep blue flowers; suited to moist and shady situations; 4 in., April-May. ¼ oz., .30	.10	3875	GILIA FINEST MIXED. These are among the earliest annuals to bloom. They are extremely pretty and keep long in water when cut; 1 ft., June to August . . . Oz., 25	.05
3815	LUTEA. Yellow flowers in whorls; hardy perennial; 4 ft., June to August10		GLOBE AMARANTH. <i>Gomphrena</i> . Showy annuals with brilliant globe-shaped <i>everlasting</i> flowers; useful plants for bedding and for cut-flower work; 1½ ft., July to October.	
3820	GERANIUM APPLE-SCENTED. <i>Pelargonium odoratissimum</i> . This sort is highly esteemed for bouquets on account of its ferny, fragrant foliage; 1 ft.25	3905	FINEST MIXED Oz., .25	.05
3835	SHOW PELARGONIUM. Seed saved from the best sorts50	3910	REDDISH PURPLE " .25	.05
3840	ZONALE, SINGLE MIXED. Splendid bedding and pot plants10	3915	ORANGE " .30	.05
3845	— DOUBLE MIXED. In great variety50	3920	WHITE " .25	.05
3852	GERARDIA HYBRIDA MIXED. The seeds of this half-hardy perennial should be sown early in heat and the plants treated as annuals. They will bloom freely the first season, growing two feet in height, and producing handsome spikes of flowers varying from light pink to dark purple; splendid for cutting; July to September10	3925	GLOXINIA, FARQUHAR'S ERECT GIANT MIXED. This is the finest type of Gloxinia. The flowers are of enormous size, massive and upright in growth, with the throat wide open. The strain includes self-colors, spotted and marked sorts, embracing pure white, pink, scarlet, crimson, lilac, violet-purple, and deep purple. This strain received highest honors at the World's Fair, since which time it has been much improved. First size packet, No. 3925, \$1.00. Second size packet, No. 392650
3855	GESNERIA, FINEST MIXED. Beautiful tuberous-rooted greenhouse plants, with richly marked velvety leaves and handsome spikes of brilliant flowers, mostly shades of yellow and scarlet; 1 ft.50	3930	FARQUHAR'S AVALANCHE. Pure white, very large50
3860	GEUM ATROSANGUINEUM, FLORE PLENO. Beautiful hardy perennial, with large, showy, double, scarlet flowers05	3935	FARQUHAR'S SKY-BLUE. Sky-blue, throat white50
3865	COCCINEUM. Bright scarlet05	3945	FARQUHAR'S FIRE KING. The most brilliant scarlet sort, very large erect flowers50
			3950	FARQUHAR'S SUPERB SPOTTED. The flowers are so delicately spotted that the effect is soft and most pleasing50

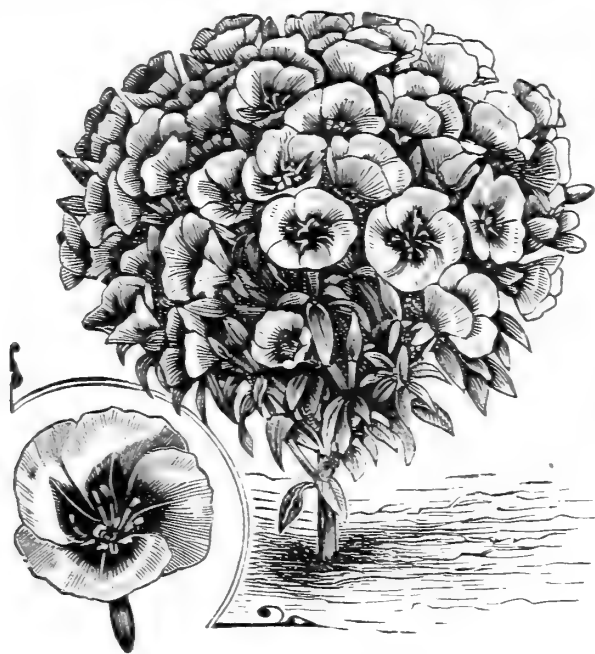

Godetia. No. 3965.



Pear-Shaped Gourd. No. 4070.

No.		Pkt.
	GODETIA. Splendid hardy annuals with large mallow-like flowers, varying from pure white to all shades of pink and crimson. They grow rapidly, flower abundantly, and are exceedingly showy. For summer displays at the seashore or in the mountain they are unsurpassed; they are also desirable to cut for vase decorations; 1 to 1½ ft., July to Oct.	
3965	FINEST MIXED Oz., .25	.05
3975	DUCHESS OF ALBANY. Satiny pure white, Oz., .30	.05
3980	GLORIOSA. Deep crimson; splendid new sort Oz., .50	.05
3985	LADY ALBEMARLE. Flowers crimson, edged with lilac Oz., 30	.05
	GOURDS, ORNAMENTAL. Luxuriant climbing annuals, useful in covering arbors, fences, or slopes, and bearing gourds which are of interesting forms and colors; 10 to 15 ft.	
4000	FINEST MIXED. In great variety, Lb., 2.00; oz., .25	.05
4010	COLLECTION OF 12 VARIETIES50
4015	ANGORA. Fruit large; spotted white. Oz., .30	.05
4020	APPLE-SHAPED. Small fruit, striped yellow and dark green Oz., .30	.05
4025	BOTTLE-SHAPED. Fruit yellowish white, with circles of dark green Oz., .25	.05
4035	DIPPER-SHAPED. The fruit is of slender, neck-like form for two-thirds of its length, widening at the apex in the form of a bowl. In tropical countries, the pulp being removed, the shells are dried and used by the natives as dippers Oz., .25	.05
4040	DISH-CLOTH. <i>Chinese Loofa, or Sponge Gourd.</i> A very ornamental climber, with large, deep, golden-yellow flowers, extensively grown in China and Japan. Fruit large and elongated, with a spongy network of tough fibre inside, which when dried is used by the Japanese to form the soles of sandals. It is also used like a sponge for bathing Oz., .25	.05
4045	EGG-SHAPED. A Japanese gourd with small, white fruit resembling an egg Oz., .25	.05
4050	GOOSEBERRY. Small, dark green fruit, resembling gooseberries; fine climber, Oz., .50	.05
4055	HERCULES' CLUB. Fruit 4 ft. long, white. Oz., .25	.05
4060	LEMON-SHAPED. Fruit small " .25	.05
4065	ORANGE-SHAPED. Small " .25	.05

No.		Pkt.
	GOURDS — Continued.	
4070	PEAR-SHAPED. Striped; very pretty. Oz., .25	.05
4075	SERPENT-SHAPED. Fruit striped like a serpent; 3 to 5 ft. in length and very slender; changing to carmine when ripe Oz., .25	.05
4080	SUGAR-TROUGH. Large, pumpkin-shaped fruit; shells used as water calabashes, Oz., .25	.05
4086	TURK'S TURBAN. Turban-shaped fruit, beautifully striped with red Oz., .25	.05
	GRASSES, ORNAMENTAL. See No. 8440.	
4090	GREVILLEA ROBUSTA. <i>Silk Oak.</i> This is one of our most useful decorative plants, easily raised from seed, and of remarkably rapid growth. Its graceful evergreen, fern-like foliage combines admirably with palms and other massive-leaved plants. It is a charming table plant, and can be employed in many ways, either in the conservatory or summer garden Oz., 1.00	.10
	GYPSOPHILA. <i>Baby's Breath.</i> Free-flowering, hardy plants; extremely light and graceful, easy of cultivation, and most useful for bouquet and cut-flower work; 1½ ft., June to Sept.	
4105	ELEGANS. Hardy annual; small white flowers in light, airy sprays Oz., .25	.05
4107	— ROSEA. Delicate pink " .25	.05
4110	MURALIS. Hardy annual; bright rose, " .50	.05
4115	PANICULATA. Tiny white flowers in light panicles; hardy perennial; 2 ft. Oz., .40	.05
4130	HEDYSARUM CORONARIUM. <i>French Honeysuckle.</i> Showy perennials; flowers red or white; 2 ft., July to Sept. Mixed colors. Oz., .25	.05
	HELENIUM. <i>Sneezeweed.</i> Hardy perennials with yellow composite flowers; named after the beautiful Helen of Troy; 3 to 4 ft., Sept. to Oct.	
4132	AUTUMNALE. Yellow; large heads, ¼ oz., .50	.10
4133	HOOPESII. Yellow10
4135	HELIANTHEMUM ALPESTRE. <i>Sun Rose.</i> Hardy trailing perennial with bright yellow flowers, suitable for rockwork or edgings; 6 inches, June to July Oz., .50	.05
	HELIANTHUS. <i>Sunflower.</i> The larger varieties are useful in forming backgrounds of large beds or borders and for distant effects, while the smaller sorts may be planted with scarlet Salvia, Cannas and other tall bedding plants, besides being excellent for cutting. Hardy annuals.	
4140	ARGYROPHYLLUS. <i>Texas Silver Queen.</i> Silvery, woolly leaves; small, single yellow flowers; 5 ft. Oz., .20	.05



Helianthus Cucumerifolius. No. 4150.

No.		Pkt.
	HELICHRYSUM. <i>Everlasting Flower.</i> Showy annuals for beds or borders; useful as dried flowers for winter bouquets, for which use the blooms should be cut before they are fully open, and hung up to dry with the flowers downward, which stiffens the stems; 2 ft., July to October.	
4195	COLLECTION OF 12 VARIETIES50
4200	DOUBLE, FINEST MIXED. The colors include pure white, shades of yellow, pink, scarlet, crimson, and purple Oz.,	.50 .05
4205	ANGUSTIFOLIUM. White foliage, fine plant for edgings; 1 ft.10
4210	HELIOPSIS LÆVIS. <i>Orange Sunflower.</i> Handsome autumn-flowering hardy perennial, producing masses of deep orange-yellow flowers, invaluable for cutting; suitable for the back of flower-beds, or border planting among shrubs; 5 ft.10
	HELIOTROPE. Delightfully fragrant greenhouse perennial; excellent for bedding or indoor cultivation and particularly useful for cutting; 1½ ft.	
4215	FINEST MIXED10
4220	DARK SORTS, FINEST MIXED10
4230	LEMOINE'S GIANT HYBRIDS. Mixed colors .	.25
4240	SNOWBALL. Large, pure white, fragrant flowers10
4245	HELIPTERUM, MIXED COLORS. Pretty everlasting annuals with dense masses of white or yellow flowers; adapted to light soils; 1 ft.	.10
	HELLEBORUS. <i>Christmas and Lenten Roses.</i> Remarkably hardy plants, blooming from December to April. In our climate they should be protected with a frame to prevent the flower buds being injured by frost or ice, and to promote full development of the flowers; perennials; 1 ft.	
4250	NEW HYBRIDS MIXED. Pure white to crimson-purple25
4257	HESPERIS MATRONALIS MIXED. <i>Rocket.</i> Hardy perennials with lilac-purple or white flowers; 3 ft., June to July Oz.,	.30 .05

No.		Pkt.
4145	CALIFORNICUS FLORE PLENO. <i>Double Californian Sunflower.</i> Large, deep yellow flowers of perfect form; 5 ft. Oz.,	.20 .05
4150	CUCUMERIFOLIUS. <i>Miniature Sunflower.</i> One of the finest Sunflowers, producing a profusion of small, elegant, bright yellow, single flowers with a black centre. It comes into bloom in July and continues till frost; splendid for cutting; 4 ft. Oz.,	.40 .05
4152	— STELLA. Similar to the foregoing, but having flowers nearly twice as large, Oz.,	.40 .05
4165	GIANT RUSSIAN. Large, single flowers; 6 ft. lb., .75; oz.,	.10 .05
4167	GLOBOSUS FISTULOSUS FLORE PLENO. Large, double, globe-shaped flowers of rich yellow color; 7 ft. Oz.,	.25 .05
4170	NANUS FLORE PLENO. Plant of compact growth with large, double, deep yellow flowers; 3 ft. Oz.,	.30 .05
4185	HENRY WILDE. Flowers of medium size, yellow with black disc; 9 ft. Oz.,	.20 .05
4187	PRIMROSE QUEEN. Large, single flowers of delicate primrose yellow; one of the most beautiful sorts; 5 ft. Oz.,	.30 .05
4190	UNIFLORUS GIGANTEUS. Each plant bears one enormous single flower, yellow with a dark centre, measuring usually a foot or more in diameter; 10 ft. Oz.,	.25 .05
	HELIANTHUS, PERENNIAL VARIETIES.	
4192	DECAPETALUS. Elegant sulphur yellow, single flowers; 6 ft.10
4193	MAXIMILIANI. Flowers clear yellow, with several rows of large ray petals and full centre; continues in bloom late in the autumn; 6 ft.10
4194	RIGIDUS. Golden yellow; very showy and valuable for cutting; 6 ft.25



Double Helichrysum. No. 4195.



Chater's Double Hollyhock. No. 4285.

No.		Pkt.
HIBISCUS — <i>Continued.</i>		
4270	MILITARIS. Hardy perennial, attaining a height of 6 feet and producing large, pink flowers shaded with carmine towards the eye; July to Sept. Oz., \$1.00	.10
4272	MOSCHEUTOS ALBUS. <i>White Swamp Mallow.</i> None of the hardy Hibiscus are more useful and beautiful than our native Swamp Mallows. They begin to bloom in July and continue to September, producing flowers like single Hollyhocks but much larger. They are excellent for moist places, but succeed in any good soil. Flowers pure white; 4 ft. Oz., .75	.10
4273	— ROSEUS. <i>Pink Swamp Mallow.</i> Large pink flowers Oz., .75	.10
4275	PALUSTRIS ROSEUS. Hardy perennial with large pink flowers; 3 ft. Oz., .50	.05
4277	ROSA SINENSIS. <i>Chinese Hibiscus.</i> Magnificent greenhouse plants with gorgeous flowers 4 to 6 inches in diameter, of brilliant shades of crimson, scarlet, pink, and yellow. For several years they have been a feature in the Boston Public Garden; 4 to 8 ft.50
HOLLYHOCK. Hollyhocks succeed best in rich, well-drained soil. They should be lightly protected during winter with pine boughs, coarse straw, or other mulch not liable to rot. Seeds sown in July produce fine plants for blooming the following summer. Hardy biennials; 6 to 8 ft.		
4280	CHATER'S DOUBLE FINEST MIXED. The best strain Oz., 1.50	.15
4285	— — COLLECTION OF 12 VARIETIES	1.00
4290	— — COLLECTION OF 6 VARIETIES60
4295	— — CRIMSON Oz., 2.00	.10
4300	— — PINK " 2.00	.10
4302	— — SALMON " 2.00	.10
4305	— — PURPLE " 2.00	.10
4310	— — WHITE " 1.50	.10
4315	— — YELLOW " 1.50	.10
4320	— ENGLISH DOUBLE FINEST MIXED " 1.00	.10
4325	— — COLLECTION OF 12 VARIETIES80
4330	— — COLLECTION OF 6 VARIETIES50
4331	— SINGLE COLLECTION OF 8 VARIETIES75
4340	— — FINEST MIXED. All colors. Oz., 1.00	.10
4342	— ALLEGHENY. Single and semi-double fringed flowers. Mixed colors . Oz., 1.25	.10
4345	HONESTY OR SATIN FLOWER. <i>Lunaria Biennis.</i> An early-flowering hardy biennial, with purple or white flowers and flat round seed vessels, of silvery appearance; 2 ft. Mixed colors Oz., .30	.05
4355	HUMEA ELEGANS. Decorative half-hardy biennials with fragrant foliage and drooping racemes of rose-colored flowers. Splendid for sub-tropical beds; 6 ft., Aug. to Oct.25
4360	HUMULUS LUPULUS. <i>Hop.</i> The Hop with its luxuriant foliage and rapid growth makes an ornamental and useful hardy climber; 15 ft.10
4365	JAPONICUS. <i>Japanese Hop.</i> Splendid annual climber of fast growth and very ornamental; 12 ft. Oz., .75	.10
4370	— FOLIIS VARIEGATIS. A variegated form of the preceding; leaves rich green blotched and marbled with creamy white10
4375	HUNNEMANNIA FUMARIÆFOLIA. <i>Giant Yellow Tulip Poppy.</i> A splendid perennial plant from Mexico, which blossoms the first season from seed. It grows to a height of two feet, bearing large flowers resembling those of the <i>Eschscholtzia</i> ; July to Oct. Oz., 1.00	.10

No.		Pkt.
4260	HEUCHERA SANGUINEA. Splendid dwarf hardy perennial, producing erect spikes of vivid crimson flowers; 1 ft., July to Sept.25
4261	ALBA. Flowers white; bell shaped25
HIBISCUS. <i>Marsh-Mallow.</i> Showy plants of vigorous growth, producing large, handsome flowers. They are especially suitable for mixed beds or borders where massive effects are desired; 2 to 5 ft.		
4265	AFRICANUS. Free-growing, hardy annual; flowers yellow with maroon centre; 2 ft., July to Oct. Oz., .25	.05
4266	CRIMSON EYE. Splendid, hardy perennial, blooming the first season from seed in the open ground; flowers 5 to 6 inches across, pure white with rich crimson centre. An excellent plant for lawn groups and borders; 4 ft., July to Sept. Oz., .75	.10

No.		Pkt.
4385	HYPERICUM ELEGANS. <i>St. John's Wort</i> . Fine hardy perennial, useful for planting under trees; flowers yellow, very showy; 1 ft.	.05
	ICE PLANT. <i>See Mesembryanthemum</i> , No. 5050.	
4420	IMPATIENS SULTANI. <i>Perennial Balsam</i> . A charming plant for house and conservatory decoration, of easy cultivation and blooming continuously. The flowers are of bright rosy-carmine color, and are very freely produced; 1 to 1½ ft.	.25
4425	— HYBRIDA FINEST MIXED. Colors varying from pale pink to dark crimson	.15
4430	— ROSEA. Bright rose pink	.15
4432	INCARVILLEA DELAVAYI. A new plant from Northern China and one of the finest hardy perennials. It produces divided pale green leaves about 2 feet in length, resembling those of the Acanthus. The flowers are produced in long spikes, cup-shaped, 2 inches across and of a bright rose color; in fact they look like Gloxinias; 2½ ft., June to Aug.	.50
4435	INULA ENSIFOLIA. Compact growing hardy perennial with bright yellow flowers one-and-a-half inches across, blooming in July and August; 9 inches	.10
4440	GRANDIFLORA. Flowers golden yellow, 4 inches across, borne on stout, erect stems; 2 ft.	.25



Ipomoea Imperialis. No. 4452.

IPOMCEA. Rapid growing twining plants useful for covering arbors and trellises, remarkable for their showy flowers of white, pink, blue, and purple; 5 to 30 ft., June to Oct.

4445	PURPUREA. <i>Convolvulus Major</i> . <i>Morning Glory</i> . Useful and showy annual climbers of easy culture; popular for their rapid growth and brilliant colors. Finest mixed, Lb., .60; oz., .10	.05
------	---	-----

No.		Pkt.
	IPOMCEA — <i>Continued</i> .	
4450	— COLLECTION OF 12 VARIETIES	.50
4452	IMPERIALIS. <i>Japanese Morning Glory</i> . The flowers are of enormous size and of great variety of colors, many of them being beautifully striped, spotted, or edged with distinct colors. Some of the plants have leaves of curious shapes, others having them marbled with white; 10 ft.	.30 .10
4453	— FRINGED. Very large, many colors.	.60 .15
4455	BONA NOX. <i>Evening Glory</i> . Large fragrant violet flowers, opening in the evening; 15 ft.	.30 .05
4460	COCCINEA. <i>Star Ipomoea</i> . Bright scarlet flowers; 10 ft.	.25 .05
4465	GRANDIFLORA ALBA. <i>Moon Flower</i> . Rapid-growing climber with large heart-shaped leaves and fragrant white flowers 5 to 6 inches across, expanding in the evening or during dull days; 30 ft.	.75 .10
4475	RUBRO CÆRULEA. <i>Heavenly Blue</i> . Large sky-blue flowers; very beautiful; 15 ft.	1.00 .10
4505	SETOSA. <i>Brazilian Morning Glory</i> . Splendid rapid-growing variety with large leaves and bright rose-colored flowers 3 to 4 inches in diameter; 15 ft.	.75 .10
4520	IRIS KÆMPFERI, FINEST MIXED. <i>Japanese Iris</i> . Seed saved from a magnificent collection	.10
	JAPANESE IVY. <i>See Ampelopsis</i> , No. 380.	
4525	KALANCHOE FLAMMEA. Splendid greenhouse plant with large heads of orange-scarlet flowers; 1½ ft.	.50
4545	KENILWORTH IVY. <i>Kentucky Ivy</i> , <i>Linaria Cymbalaria</i> . Trailing perennial with neat foliage and small violet flowers; 3 in.	.10
4550	KENNEDYA, FINEST MIXED. Greenhouse twining evergreen with showy flowers of various shades of rose scarlet, purple, and white; 4 ft.	.10
4555	KUDZU VINE. <i>Pueria Thunbergiana</i> . Tender perennial climber from Japan, growing 30 to 50 feet in a season	.75 .10
4560	LANTANA HYBRIDA, FINEST MIXED. Ornamental and free-blooming greenhouse perennials of shrubby growth; splendid for bedding and pot culture; 2 to 3 ft.	.40 .05
4565	LAPAGERIA ROSEA. Magnificent greenhouse climber with thick, dark green leaves and long, tube-shaped flowers of brilliant rosy-red color; 15 ft.	.50
	LARKSPUR, ANNUAL VARIETIES. These fine hardy annuals are splendid sown in clumps along the edges of shrubbery; and the tall flower spikes are elegant when cut for vases and bouquets. The colors are various shades of blue, lilac, and white; July to Oct.	
	<i>For Perennial Larkspurs, see Delphinium.</i>	
4575	DOUBLE DWARF BRANCHING, FINEST MIXED. <i>Candelabra-Flowered</i> ; 1 ft.	1.00 .10
4580	— — ROCKET, FINEST MIXED. Large and full rocket-shaped spikes; 1 ft.	.30 .10
4585	— — COLLECTION OF 12 VARIETIES	.50
4590	— TALL EMPEROR, DARK BLUE. Excellent for cutting; 2 ft.	.50 .05
4592	— — — PINK	.50 .05
4593	— — — WHITE	.50 .05
4595	— GIANT HYACINTH-FLOWERED, FINEST MIXED; 1½ ft.	.30 .05
4600	— TALL ROCKET, FINEST MIXED; 3 ft.	.30 .05
4605	— — — COLLECTION OF 8 VARIETIES	.40

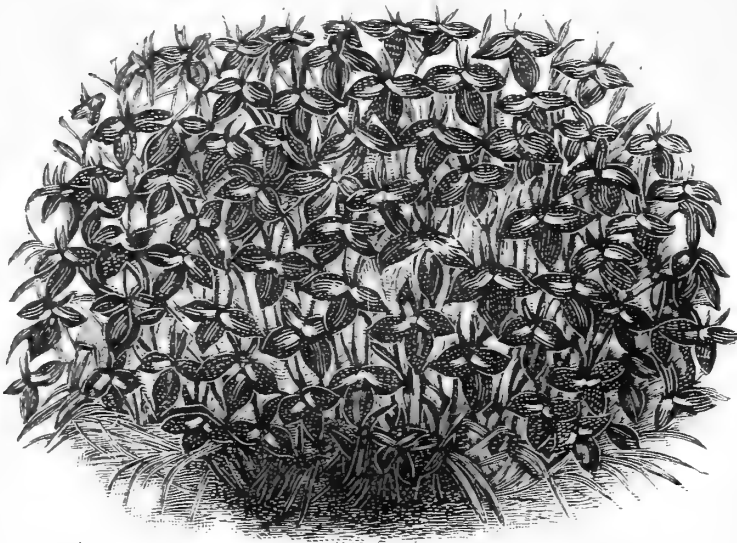

Lobelia, Farquhar's Dwarf Blue. No. 4730.

- | No. | | Pkt. |
|------|---|------|
| 4620 | LATHYRUS LATIFOLIUS, FINEST MIXED. <i>Perennial Pea</i> . Magnificent hardy perennial climbers with white, pink, and crimson pea-shaped flowers in clusters. They are excellent vines for covering piazza railings or fences and the blossoms are most useful for bouquets; 6 ft., July to Sept. Oz., .40 | .05 |
| 4625 | — ALBUS. White; charming flowers " .60 | .10 |
| 4630 | — SPLENDENS. Crimson " .50 | .10 |
| 4635 | LAVATERA ARBOREA VARIEGATA. <i>Tree Mallow</i> . An excellent plant for sub-tropical beds or groups, with large ornamental leaves profusely mottled with pale yellow and white; half-hardy perennial; 4 ft. Oz., .75 | .10 |
| 4640 | TRIMESTRIS ALBA. <i>White Mallow</i> . Tall growing, bushy, hardy annual, producing large, pure white single flowers in profusion; 3 ft. Oz., .30 | .05 |
| 4642 | — ROSEA. <i>Pink Mallow</i> . Bright rose pink; a very handsome annual . . . Oz., .30 | .05 |
| 4645 | LAVENDER. Ornamental, hardy perennial bearing long spikes of very fragrant blue flowers; 1½ ft., July to Sept. . . . Oz., .30 | .05 |
| 4660 | LEPTOSYNE MARITIMA. Showy half-hardy annual with large, yellow, sweet-scented flowers on long stems; useful for cutting; 2 ft., Aug. to Oct. | .10 |
| 4665 | LIATRIS GRAMINIFOLIA VAR. DUBIA. <i>Blazing Star</i> . Extremely showy border plant, thriving in any ordinary soil; flowers purple. Hardy perennial. Aug. to Oct.; 2 ft. . . . | .25 |
| 4670 | SPICATA. Large flower-spikes; violet-purple | .10 |
| 4675 | LIBONIA FLORIBUNDA. Splendid plant for house or conservatory decoration during winter; flowers scarlet and yellow; tube-shaped; 1½ ft. | .25 |
| 4705 | LINUM FLAVUM. <i>Golden Flax</i> . Hardy perennial with golden-yellow flowers, blooming freely from June to September; 1 ft. . . . | .10 |
| 4710 | GRANDIFLORUM RUBRUM. <i>Scarlet Flax</i> . Brilliant scarlet, profuse-flowering hardy annual; splendid for gardens in the mountains; 1 ft., July to Sept. . . . Oz., .30 | .05 |
| 4715 | LUTEUM. Yellow; perennial | .10 |
| 4720 | PERENNE, MIXED. Hardy perennials; colors blue, rose, and white; 1½ ft. . . . Oz., .75 | .10 |
| | LOBELIA, DWARF BEDDING SORTS. These are of compact growth, four to six inches high, and dense flowered. They are reproduced remarkably true from seed. | |

- | No. | | Pkt. |
|------|--|------|
| | LOBELIA — <i>Continued</i> . | |
| 4730 | FARQUHAR'S DARK BLUE. The most dwarf and compact sort; the best for carpet bedding; 4 inches . . . Oz., 2.50; ¼ oz., .75 | .25 |
| 4735 | EMPEROR WILLIAM. Sky blue; 4 inches, Oz., 2.00 | .10 |
| 4740 | ERECTA, CRYSTAL PALACE UPRIGHT. Dark blue; 6 inches Oz., 2.00 | .10 |
| 4755 | GRACILIS. Deep blue, of trailing habit; the best for vases and hanging baskets; 6 in. Oz., .60 | .05 |
| 4765 | PUMILA MAGNIFICA. Dark blue, ball-shaped plants Oz., 1.50 | .10 |
| 4770 | — WHITE GEM. Pure white . . . " 2.00 | .10 |
| 4780 | SPECIOSA. <i>Crystal Palace Variety</i> . Dark blue, of spreading growth; 6 inches; excellent for wide edgings . . . Oz., 1.00 | .10 |
| | LOBELIA. HARDY PERENNIAL SORTS. Splendid border plants blooming from July to October; 2 ft. | |
| 4800 | CARDINALIS. <i>Cardinal Flower</i> . Intense scarlet, succeeds best in rather moist situations, ⅛ oz., 1.00 | .10 |
| 4805 | — NANSENIANA. Deep crimson, foliage dark red | .25 |
| 4812 | SYPHILITICA. Light blue | .25 |
| 4815 | LOPHOSPERMUM COCCINEA. A beautiful climber with rosy-red flowers like large Foxglove blooms. Half-hardy annual; 10 ft., July to Oct. | .25 |
| 4820 | SCANDENS. Large pink flowers; ¼ oz., 1.00 | .10 |
| 4825 | LOTUS JACOBÆUS. Free-flowering hardy annual with dark-brown pea-shaped flowers; 1 ft. Oz., .75 | .10 |
| 4830 | LUTEUS. Yellow " 1.00 | .10 |
| | LOVE-LIES-BLEEDING. <i>See Amaranthus</i> , No. 320. | |
| | LUNARIA BIENNIS. <i>See Honesty</i> , No. 4345. | |
| | LUPINUS. <i>Lupin</i> . Showy plants of very easy cultivation and succeeding in any ordinary soil. | |
| 4835 | ANNUAL VARIETIES MIXED. Including blue, white, pink, and yellow; July to Oct., 2 ft. Oz., .20 | .05 |
| 4836 | CRUICKSHANKI. Blue and yellow; 3 ft., annual Oz., .30 | .05 |



Perennial Lupin, Snow Queen. No. 4845.

No.		Pkt.
LUPINUS — <i>Continued.</i>		
4837	HYBRIDUS ROSEUS. The finest of all, large spikes of pink flowers; 2½ ft., ann'l. Oz., .50	.10
4838	SUBCARNOSUS. Deep blue, fine for cutting; 2 ft., annual Oz., .40	.05
4840	ARBOREUS. Bright yellow, fragrant flowers, half-hardy perennial; June to July, 3 ft. Oz., 1.50	.10
4845	— SNOW QUEEN. Pure white, magnificent spikes25
4850	PERENNIAL VARIETIES MIXED. These bloom in May and June, and frequently again in autumn; flowers mostly blue and white; 2 to 3 ft. Oz., .30	.05
LYCHNIS. Profuse-blooming hardy perennials, remarkable for the brilliancy of their flowers; excellent for mixed borders and for cutting; June to Sept.		
4855	CHALCEDONICA. <i>Jerusalem Cross</i> . Large scarlet flower-heads; 2 ft. . . . Oz., .30	.05
4860	— ALBA. White " .50	.05
4862	FLOS CUCULI. <i>Cuckoo Flower</i> . Deep red; 2 ft. Oz., 1.00	.10
4865	FULGENS. Scarlet; 1½ ft. " 1.00	.10
4870	HAAGEANA HYBRIDA. Various colors; 1½ ft. Oz., 1.25	.10



Malope Grandiflora. No. 4890.

No.		Pkt.
MALVA — <i>Continued.</i>		
4905	MOSCHATA. <i>Musk Mallow</i> . Flowers rose-colored; hardy perennial, blooming the first season if sown early; 2 ft. . . . Oz., 1.00	.10
4910	— ALBA. Pure white flowers " 1.00	.10
4918	MATHIOLA BICORNIS. <i>Fragrant Evening Stock</i> . This hardy annual is desirable for the delightful fragrance its gives off towards evening; flowers crimson; 1 ft., Aug. to Oct. Oz., .30	.05



Lychnis Haageana hybrida. No. 4870.

4875	SIEBOLDI. Pure white; beautiful; 1 ft. Oz., 1.50	.10
4880	VISCARIA SPLENDENS. Scarlet; large flowers; 1½ ft. Oz., .50	.05
4885	LYTHRUM ROSEUM SUPERBUM. Very showy hardy perennial, with numerous spikes of deep rose flowers; 3 ft. . . . Oz., .30	.05
MALOPE. Splendid hardy annuals, with showy Mallow-like flowers, suitable for beds and borders; 3 ft., July to Oct.		
4887	GRANDIFLORA ALBA. White . . . Oz., .30	.05
4890	— ROSEA. Pink " .30	.05
4893	MALVA ALCEA. <i>Hollyhock Mallow</i> . Handsome hardy perennial, blooming continuously from June to October; flowers pink; splendid for cutting; 3 ft. . Oz., .50	.05
4895	CRISPA. <i>Curled Mallow</i> . Hardy annual with leaves beautifully crisped; flowers white; 3 ft. Oz., .25	.05
4900	MINIATA. <i>Sunset Plant</i> . Large scarlet flowers; hardy annual; 3 ft. . . Oz., .50	.05

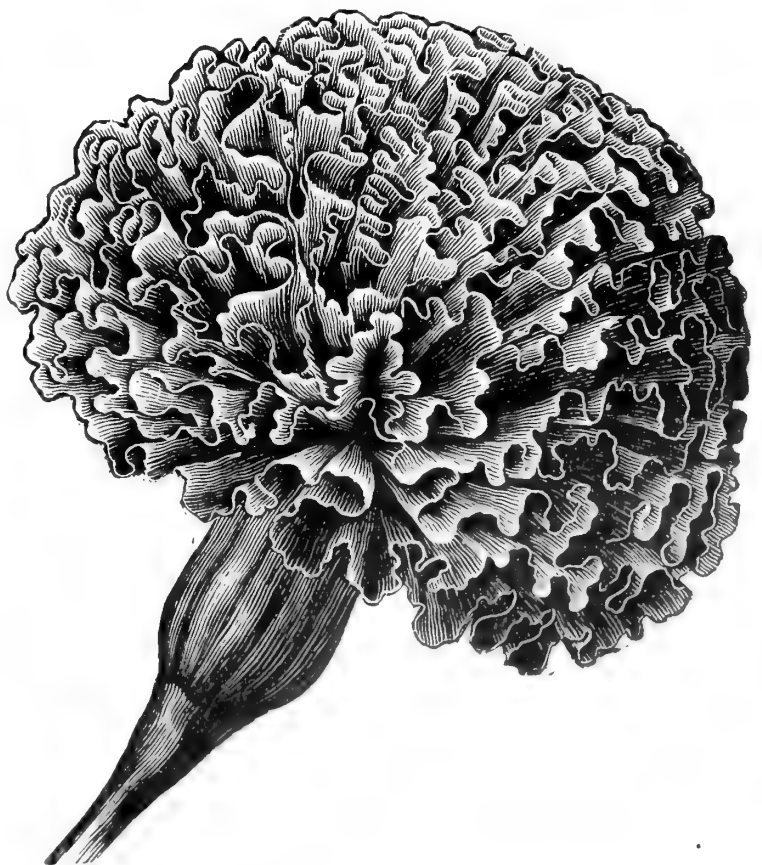

African Marigold. No. 4920.

MARIGOLD. <i>Tagetes</i> . Well-known hardy annuals of easiest cultivation, producing a gorgeous display from July until frost.		
4920	AFRICAN, DOUBLE, COLLECTION OF 6 VARIETIES; 3 ft.25

No.		Pkt.
MARIGOLD — <i>Continued.</i>		
4925	— DOUBLE, TALL, FINEST MIXED. Oz., .40	.05
4930	— — DWARF, FINEST MIXED; 2 ft. " .50	.05
4935	— — EL DORADO. Splendid, large flowers; mixed colors Oz., .60	.05
4940	— — DOUBLE, LEMON " .40	.05
4950	— — ORANGE " .40	.05
4955	FRENCH, DOUBLE, COLLECTION OF 12 VARIETIES50
4960	— — COLLECTION OF 6 VARIETIES30
4961	— TALL, DOUBLE, FINEST MIXED . Oz., .40	.05

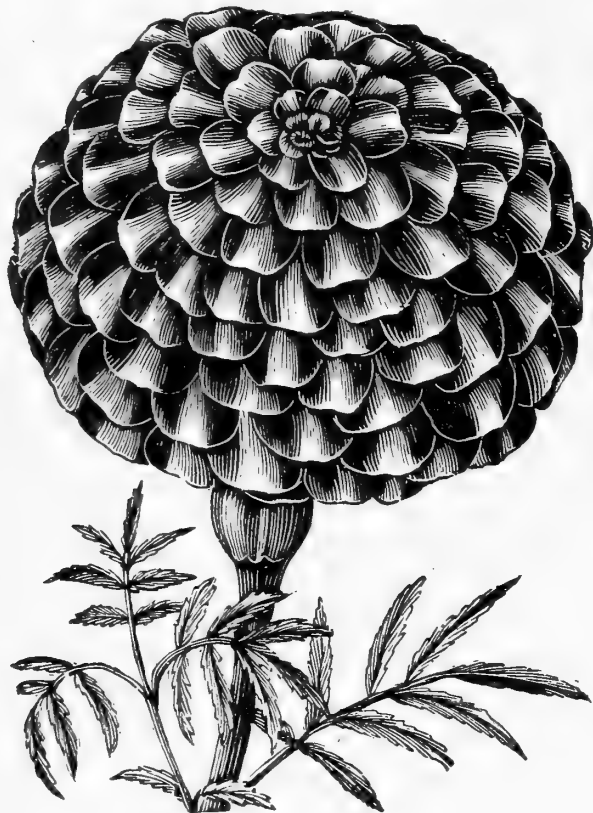

Marigold, Scotch Prize. No. 4962.

4962	— — SCOTCH PRIZE, STRIPED. Fine double flowers beautifully striped, golden yellow and dark crimson ¼ oz., 1.25	.25
4963	— TALL, SINGLE STRIPED. Yellow and crimson; excellent for cutting . . . Oz., .50	.05
4965	— DWARF, DOUBLE, FINEST MIXED, " .40	.05
4990	— — — STRIPED " .40	.05
4992	— — SINGLE, LEGION OF HONOR. Flowers dark crimson edged with yellow . Oz., .40	.05
4993	— VERY DWARF, DOUBLE, STRIPED. <i>Nana Pulchra</i> . Of dense dwarf growth; suitable for edgings Oz., .40	.05
4995	— VERY DWARF, SINGLE, GOLDEN YELLOW. <i>Signata Pumila</i> . Excellent for edgings; constantly in bloom; 1 ft. . . . Oz., .60	.05
4997	— VERY DWARF, SINGLE GOLDEN RING. Flowers pure yellow; splendid for edgings. Oz., .50	.05

MARIGOLD GARDEN. *See Calendula.*

MARVEL-OF-PERU. *See Mirabilis*, No. 5195.

MATRICARIA. *Feverfew*. Half-hardy perennials blooming the first year from seed, with large showy flowers; splendid for cutting.

5015	GRANDIFLORA FLORE PLENO. Large, double, pure white flowers, 15 inches . . Oz., .75	.10
5020	EXIMIA, GOLDEN BALL. Compact-growing variety with broad corymbs of golden yellow flowers. A charming plant for beds and borders; 1 ft.25
MAURANDYA. Elegant greenhouse perennial climbers producing the first season innumerable tube-shaped flowers. Unexcelled as vines for hanging-baskets, vases, and trellises; July to Oct.		
5025	FINEST MIXED ¼ oz., .75	.10
5030	ALBIFLORA. White 1/8 oz., 1.00	.25
5035	BARCLAYANA. Purplish blue . . ¼ oz., 1.00	.10

No.		Pkt.
MESEMBRYANTHEMUM. Beautiful trailing annuals, useful for rockeries, edgings, and vases, particularly adapted to dry or sunny situations; July to Oct., 4 inches.		
5050	CRYSTALLINUM. <i>Ice Plant</i> . Hardy annual with thick succulent leaves which are covered with sparkling ice-like globules, as are also the stems; flowers white05
5055	TRICOLOR. Flowers bright rose05
5060	CORDIFOLIUM VARIEGATUM. Green and white variegated foliage; flowers rose-colored; a fine plant for edgings25



Mignonette Machet. No. 5105.

MIGNONETTE. *Reseda Odorata*. The most popular fragrant annual, prized as much for forcing in winter as for the summer garden. The seed should be sown early and the plants as they grow thinned sufficiently to allow them to branch. The beds should be liberally watered during dry weather.

5065	GRANDIFLORA, OR LARGE-FLOWERING. The best form of the old-fashioned sweet Mignonette . . Lb., 1.25; ¼ lb., .40; oz., .15	.05
5067	ALLEN'S DEFIANCE. The spikes of this variety, when well-grown, are from 12 to 15 inches in length and they are very fragrant Oz., .50	.10

- | No. | | Pkt. |
|------|--|------|
| | MIGNONETTE — <i>Continued.</i> | |
| 5075 | CRIMSON GIANT, OR PYRAMIDAL. Large spikes of handsome reddish-tinted flowers; very fragrant; one of the best for out-door cultivation Oz., .30 | .05 |
| 5080 | COVENT GARDEN VARIETY. A compact growing sort with large spikes; excellent for pot cultivation; perhaps the sweetest Mignonette Oz., .75 | .10 |
| 5100 | GOLDEN QUEEN. The strongest and most beautiful yellow sort; flowers tinted golden yellow; fragrant Oz., .50 | .05 |
| 5105 | MACHET. The most popular sort for winter culture under glass. It produces large dense spikes of reddish-tinted flowers which are exceedingly fragrant. It is equally valuable for out-door use. Our seed is from a European strain of highest excellence, Oz., .60 | .10 |
| 5110 | MILES' HYBRID SPIRAL. The flowers are whitish; the spikes usually from 8 to 12 inches in length; very beautiful, Oz., .30 | .05 |
| 5115 | PARSONS' WHITE. Splendid spikes of whitish flowers; very sweet-scented; excellent for forcing Oz., .30 | .05 |
| 5140 | MIMOSA PUDICA. <i>Sensitive Plant.</i> A tender annual of graceful light growth with rosy-lilac flowers at the axils of the leaves. The leaflets fold up when touched Oz., .60 | .10 |
| | MIMULUS. <i>Monkey Flower.</i> Very handsome half-hardy perennials, blooming the first year from seed. They thrive best in rather moist ground; July to Oct. | |
| 5155 | CARDINALIS GRANDIFLORUS. Large scarlet flowers; 2 ft. | .10 |
| 5165 | MOSCHATUS. <i>Musk Plant.</i> Splendid trailing plant for hanging pots, emitting a delicious fragrance; flowers yellow; 6 inches | .10 |
| 5175 | TIGRINUS GRANDIFLORUS. Flowers large; shades of yellow, elegantly spotted and marked with crimson and maroon; 1 ft. | .10 |
| 5190 | MINA LOBATA. Handsome, half-hardy climbing annual of rapid growth; bearing twin-like racemes of flowers which in the bud are orange-red, but open orange-yellow and soon turn to creamy-white; 20 ft., July to Oct. | .10 |
| | MIRABILIS. <i>Marvel-of-Peru, or Four O'Clock.</i> Splendid half-hardy perennials blooming the first year from seed, with most brilliant flowers; 2 ft., July to Oct. | |
| 5195 | FINEST MIXED. Shades of red, white, and yellow Lb., .75; oz., .10 | .05 |
| 5205 | TOM THUMB, FINEST MIXED. Flowers striped. Height, 1 ft. Oz., .30 | .05 |
| 5215 | MOLUCELLA LÆVIS. <i>Shell Flower.</i> Interesting hardy annual; its erect branches terminating in tufts of bright leaves, with pale green and white bell-shaped calyces or cups; flowers white and purple; Aug. to Sept., 1½ ft. | .10 |
| 5220 | MOMORDICA BALSAMINA. <i>Balsam Apple.</i> Remarkably handsome climbing annual with rich green foliage and golden-yellow warted fruit shaped like an apple, which when ripe opens, displaying its brilliant crimson interior. This charming vine is worthy of more general cultivation; 10 ft. Oz., .50 | .05 |
| 5225 | CHARANTIA. <i>Balsam Pear.</i> The fruit of this variety is pear-shaped; otherwise it resembles the preceding Oz., .50 | .05 |
| 5230 | MONARDA DIDYMA. <i>Bee Balm.</i> Showy hardy perennial with bright red Salvia-like flowers; July to Sept., 2 ft. | .25 |

- | No. | | Pkt. |
|------|---|------|
| 5232 | MORINA ELEGANS. Hardy perennial resembling the Acanthus in growth; the flowers are crimson, in form like those of the Verbena but larger, and produced in whorls around the stem; June to July, 3 ft. | .10 |
| | MOONFLOWER. <i>See Ipomœa, No. 4465.</i> | |
| | MORNING GLORY. <i>See Ipomœa, No. 4445.</i> | |
| | MOURNING BRIDE. <i>See Scabiosa, No. 7105.</i> | |



Musa Ensete. No. 5233.

- | | | |
|------|--|-----|
| 5233 | MUSA ENSETE. <i>Abyssinian Banana.</i> Of all plants available to us for sub-tropical effects, this is the most luxuriant. It is frequently grown here to a height of twelve or fifteen feet and with leaves eight or nine feet in length. Seeds sown in January or February in heat produce good plants for planting out of doors in June 100 seeds, 2.00 | .25 |
| | MUSK. <i>See Mimulus, No. 5165.</i> | |
| | MYOSOTIS. <i>Forget-Me-Not.</i> Dwarf, half-hardy perennials, bearing a profusion of little star-shaped flowers. They thrive best in rather moist shady situations. Most of them will bloom the first year from seed if sown early. If sown in July or August in shaded frames fine plants will be obtained for spring blooming. They are very beautiful when planted in combination with late spring bulbs, Daisies, Arabis, or Golden Alyssum. | |
| 5235 | FINEST MIXED VARIETIES. Various shades of blue, rose, and white Oz., .75 | .05 |
| 5240 | ALPESTRIS. Bright blue; 6 inches Oz., 1.00 | .10 |
| 5285 | — GRANDIFLORA. <i>Eliza Fonrobert.</i> Large bright blue flowers; 1 ft. Oz., 1.00 | .10 |
| 5290 | — — ALBA. Large white flowers, " 1.00 | .10 |
| 5295 | — — ROSEA. Large pink flowers, " 1.00 | .10 |
| 5305 | — VICTORIA. The plants are of dwarf compact growth with multitudes of bright blue flowers in dense umbels Oz., 2.00 | .10 |
| 5310 | DISSITIFLORA. Rich blue; flowers very early; one of the finest; 6 inches, ¼ oz., 1.25 | .25 |
| 5311 | PALUSTRIS. True <i>Forget-Me-Not</i> ; bright blue; 9 inches Oz., 3.00 | .10 |
| 5313 | — SEMPERFLORENS. Splendid bright blue variety; blooms from early spring until autumn Oz., 2.50 | .10 |
| 5314 | SYLVATICA. A splendid sort for spring bedding, with large bright blue flowers; 9 inches Oz., 2.00 | .10 |



NASTURTIUMS.

Our Nasturtiums are famous throughout the country for their size, variety of colors, and their brilliancy. Our mixtures of the Tall and Dwarf forms are carefully proportioned in their colors from stock specially grown for us in Kent, England, together with some of the more recent and improved productions of France and Germany.

No.	Pkt.	No.	Pkt.
TOM THUMB OR DWARF. These hardy annuals are of easiest cultivation, succeeding best in rather light soil, withstanding heat and drought and flowering profusely from June or July until cut down by severe frost usually well into November. The dark-leaved varieties are particularly adapted for ribbon beds and borders; 1 ft.		TOM THUMB OR DWARF — <i>Continued.</i>	
5315	FINEST MIXED. Our special mixture of the finest sorts in great variety of colors. Lb., 1.00, ¼ lb., .30; oz., .10 .05	5395	LILLI SCHMIDT. Intense scarlet, flowers small Oz., .15 .05
5320	COLLECTION OF 12 VARIETIES50	5400	OCHRE YELLOW " .30 .05
5325	COLLECTION OF 6 VARIETIES30	5405	PEACH BLOSSOM. Fine shade of pink " .15 .05
5330	AURORA. Chrome yellow, lower petals veined with dark carmine; very fine . . Oz., .15 .05	5410	PEARL. White " .15 .05
5335	BEAUTY. Golden yellow, spotted scarlet, Oz., .15 .05	5420	ROSE " .15 .05
5337	BRILLIANT. Dark scarlet " .20 .05	5425	RUBY KING. Rosy scarlet, dark foliage " .20 .05
5340	BRONZE. Distinct dark shade " .15 .05	5430	SCARLET " .15 .05
5347	CHAMELEON. Pale yellow, blotched and flaked with red Oz., .25 .05	5435	SPOTTED. Yellow, spotted with crimson, Oz., .15 .05
5355	CRYSTAL PALACE GEM. Sulphur yellow, blotched with maroon Oz., .15 .05	5440	SPOTTED KING. Yellow, spotted maroon; dark foliage Oz., .20 .05
5360	DARK CRIMSON. Rich dark shade " .15 .05	5445	STRIPED. Shades of yellow, striped crimson, Oz., .15 .05
5375	EMPRESS OF INDIA. Deep crimson; dark foliage Oz., .25 .05	5450	YELLOW. Canary-yellow " .20 .05
5375	GOLDEN KING. Fine deep yellow " .15 .05	TALL OR RUNNING. The most useful of decorative climbing annuals and serviceable for covering unsightly fences or trailing over rocks. If vigorous growth is desired the soil should be rich and of good depth; 8 to 10 ft.	
5380	KING OF TOM THUMBS. Brilliant scarlet with dark foliage Oz., .20 .05	5455	FINEST MIXED. A superb mixture embracing our Kent Grown as well as choicest new sorts from French and German hybridizers . . Lb., 1.00; ¼ lb., .30; oz., .10 .05
5385	KING THEODORE. Maroon, dark foliage, Oz., .20 .05	5460	COLLECTION OF 12 VARIETIES50
		5470	BROWNISH LILAC. <i>Edward Otto</i> . . Oz., .15 .05
		5475	CHOCOLATE COLOR. <i>Hienemanni</i> . . " .15 .05
		5480	DARK CRIMSON " .15 .05
		5485	KING THEODORE. Deep maroon " .20 .05
		5487	NANKEEN YELLOW " .20 .05

No.		Pkt.
TALL OR RUNNING NASTURTIUMS —		
<i>Continued.</i>		
5490	ORANGE Oz., .15	.05
5495	PEARL. White " .15	.05
5500	PINK AND YELLOW. <i>Hemisphericum</i> " .15	.05
5502	PRINCE HENRY. Yellow and scarlet " .15	.05
5505	PURPLE VIOLET. <i>Regelianum</i> " .15	.05
5510	SCARLET " .15	.05
5515	SCARLET STRIPED. Straw-color, striped scarlet Oz., .15	.05
5520	STRAW-COLOR SPOTTED. Spotted crimson. Oz., .15	.05
5525	VESUVIUS. Dazzling crimson " .20	.05
5527	VON MOLTKE. Bluish pink " .15	.05
5530	YELLOW. Light yellow " .15	.05
LOBB'S NASTURTIUM. <i>Tropæolum Lobbianum</i>. These are exceedingly free-bloom- ing and of the most brilliant colors with neat dark green or purplish foliage, climbing about eight feet. They are excellent for window boxes, vases, hanging-baskets, and rockeries; they are also the most satisfactory class for conservatory or house cultivation during winter.		
5535	FINEST MIXED. All colors. Lb., 2.00; ¼ lb., .60; oz., .20	.05
5540	COLLECTION OF 12 VARIETIES50
5545	COLLECTION OF 6 VARIETIES30
5550	ASA GRAY. Yellowish white; very fine. Oz., .25	.10
5552	ATROPURPUREUM. Deep crimson " .25	.10
5553	AUREUM. Pure golden yellow. New, " .30	.10
5560	CARDINAL. Cardinal red " .30	.10
5572	DUC DE VICENCE. Pale lemon-color, " .25	.10
5575	FLAMMULUM GRANDIFLORUM. Scarlet and yellow Oz., .25	.10
5580	GEANT DES BATAILLES. Sulphur yellow with carmine Oz., .25	.10
5585	LILLI SCHMIDT. Scarlet " .25	.10
5590	LUCIFER. Rich dark scarlet " .30	.10
5605	NAPOLEON III. Yellow spotted brown, " .25	.10
5615	ROI DES NOIRS. Almost black " .30	.10
5620	SPITFIRE. Dazzling scarlet " .25	.10
NELUMBIUM. <i>Lotus</i>. The beautiful Lotus is quite hardy in our climate. It is easily raised from seeds which should be sown early in the spring in sandy loam, covered half an inch, and the pots submerged in water at a temperature of seventy degrees which should be maintained.		
5635	KERMESINUM. Crimson, very fine25
5636	LUTEUM. <i>American Lotus</i> . Large yellow fragrant flowers25
5639	SPECIOSUM. <i>Egyptian Lotus</i> . Large pink flowers25
5640	NEMESIA STRUMOSA SUTTONI. FINEST MIXED. A splendid annual for small beds with very attractive flowers. The colors in- clude white, yellow, orange, pink, and crim- son; July to Sept., 1½ ft.25
NEMOPHILA. Splendid free flowering, dwarf hardy annuals, with cup-shaped flowers of many bright colors, the blue shades being particularly fascinating. They should be planted in moist soil, partial shade being favorable; June to Oct., 1 ft.		
5645	FINEST MIXED. Including white, lilac, brown, and many shades of blue Oz., .25	.05
5648	INSIGNIS. Beautiful light blue " .25	.05
5652	NERTERA DEPRESSA. <i>Coral Berry</i> . A charming dwarf plant for the conservatory. The tiny leaves form a dense close green mat about two inches above the ground which becomes covered with small orange-red ber- ries; tender perennial25

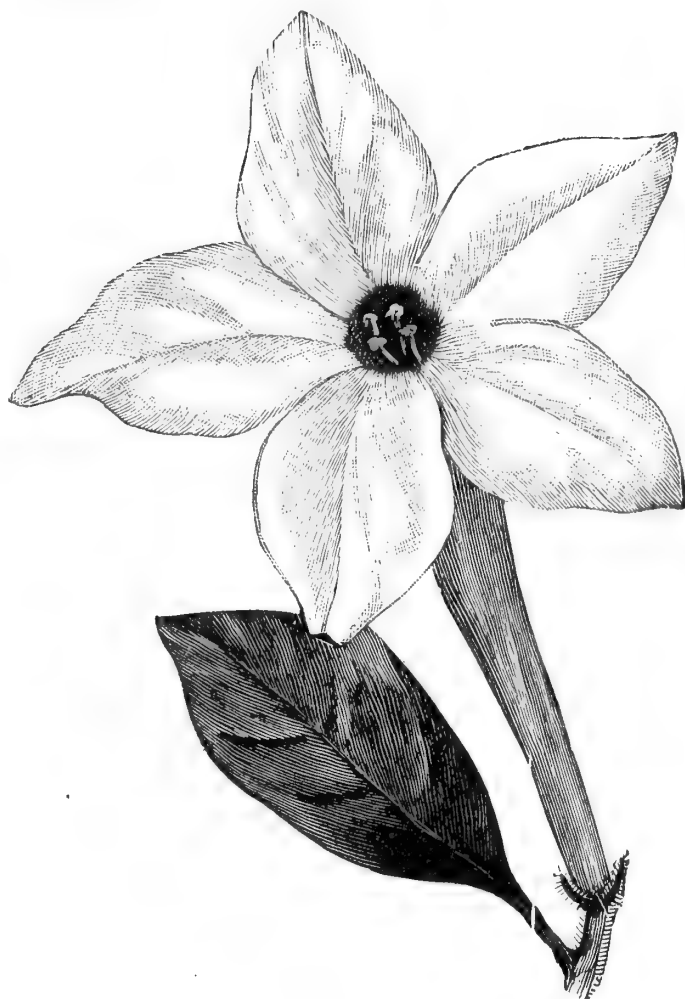

Nicotiana Affinis. No. 5655.

No.		Pkt.
5655	NICOTIANA AFFINIS. Splendid annual, pro- ducing clusters of long white tube-shaped flowers, fragrant towards evening; July to Oct., 3 ft. Oz., .50	.05
5670	COLOSSEA. Magnificent foliage plant, the young leaves at first tinted with red. It soon attains a height of five or six feet with leaves two feet in length and a foot in width. Excellent for foliage beds25
5675	SYLVESTRIS. A splendid new variety with glaucous leaves and large pendent, pure white, tube-shaped flowers; a very stately plant; Aug. to Oct. Oz., .50	.05
5685	NIEREMBERGIA FRUTESCENS. Half hardy perennials of light and elegant growth with large cup-shaped lilac flowers; July to Oct., 1 ft. Oz., .60	.05
5690	GRACILIS. Flowers purple and white, " .75	.10
5695	NIGELLA DAMASCENA. <i>Love-in-a-Mist</i> . Showy half-hardy annual, with finely cut foliage and interesting blue flowers; 1½ ft., July to Sept. Oz., .25	.05
5715	NYCTERINIA CAPENSIS. Half-hardy annual of dwarf growth with white sweet-scented flowers; 6 inches, July to Sept.05
NYMPHÆA. <i>Water Lily</i>. These are easily raised from seeds. The tender varieties, the roots of which are often troublesome to keep alive through the winter, flower freely the first season if sown early. Start the seeds in the same manner as suggested for Nelumbium.		
5725	HYBRIDA. HARDY VARIETIES. FINEST MIXED25
5730	TENDER VARIETIES. FINEST MIXED25
5735	ALBA. <i>White Pond Lily</i> . Hardy10
5740	CÆRULEA OR STELLATA. Light blue; ten- der25



Farquhar's Finest Show Pansies. No. 5855.

PANSY.

(*Viola Tricolor.*)

For many years choice Pansy Seeds have been a specialty with us. By repeated personal visits we have made ourselves familiar with the strains of the leading specialists in the several countries of Europe, with whom we contract yearly for seeds. We are thus enabled to offer the finest in existence.

Pansies thrive best in a cool, moist, but well-drained soil, enriched with well-rotted barnyard manure or fine ground bone. Seeds sown in spring in a partially shaded situation will produce fine plants for autumn flowering. The finest blooms are to be obtained, however, by sowing in July or August, giving the plants protection during winter, when they will bloom profusely in the spring and summer.

Hingham, Mass., May 23, 1902.

Messrs. R. & J. Farquhar & Co., Boston:

Gentlemen: My Pansies are now in full bloom, and I write to express my satisfaction with the seeds you sent me.

They are Farquhar's Finest Show Strain, and for size, substance, and fine colors they are the finest I have ever grown or seen.

My people are delighted with them. I shall send you an order in a few weeks for a larger lot of seed for next year.

Yours very truly,

JOHN L. CHAPMAN.

No.

5855 FARQUHAR'S FINEST SHOW STRAIN, MIXED. Large round flowers of perfect form and massive texture, embracing the finest colors and markings in great variety. Oz., \$12.00; ¼ oz., \$3.50; ⅛ oz., \$2.00; pkt. of about 250 seeds, .50; No. 5860. Pkt. of about 100 seeds, .25.

Page 77.

No.		Pkt.
	NYMPHÆA — <i>Continued.</i>	
5745	DENTATA. White, very large; tender25
5750	ODORATA ROSEA. <i>Pink Pond Lily.</i> Beautiful rose pink; hardy25
5755	ZANZIBARIENSIS AZUREA. <i>Royal Water Lily.</i> Large azure blue flowers, very fragrant; one of the most beautiful and free-blooming water lilies25
5760	— ROSEA. Similar to the preceding, but having deep pink flowers and reddish leaves25
	CENOTHERA. <i>Evening Primrose.</i> Beautiful hardy plants of easy cultivation, succeeding best in light soil; July to October.	
5770	ACAULIS. Large silvery white flowers; hardy annual; 6 inches . . .	Oz., 1.00 .10
5772	FRASERI. Beautiful large yellow flowers; hardy perennial; 1½ ft. . .	Oz., 1.50 .10
5775	FRUTICOSA MAJOR. Large golden-yellow flowers; hardy perennial; 2 ft. . .	Oz., .75 .05
5776	LAMARCKIANA. Enormous yellow flowers three to four inches in diameter; very free-flowering, hardy perennial; 3 ft. . .	Oz., .25 .05
5780	YOUNGII. Yellow, very large; 3 ft. . .	.25
5810	OXALIS ROSEA. Dwarf half-hardy perennial of rapid growth, with beautiful rose-colored flowers; excellent for hanging pots; 6 inches,10
5815	TROPÆOLOIDES. Splendid dwarf bedding plant with dark-brown foliage forming a dense mat, the tiny yellow flowers being inconspicuous; excellent for mosaic bedding; 4 inches . . .	Oz., 1.25 .10
5835	PÆONY. CHINESE DOUBLE AND SINGLE SORTS MIXED. These popular plants are easily raised from seed . . .	Oz., 1.25 .25
5840	JAPANESE TREE VARIETIES. <i>Mutans.</i> Flowers often 10 to 12 inches in diameter. . .	.25

PANSIES.

5855	FARQUHAR'S FINEST SHOW STRAIN, MIXED. Large round flowers of perfect form and massive texture, embracing the finest colors and markings in great variety. Oz., \$12.00; ¼ oz., \$3.50; ⅛ oz., \$2.00; pkt. of about 250 seeds, .50; No. 5860. Pkt. of about 100 seeds, .25.	
5865	BUGNOT'S PRIVATE STRAIN. This is the finest strain known; the flowers being of perfect form and richest colors. It should be grown under glass to bring its fine qualities to perfection. Our seed is saved for us each year by M. Bugnot in France. Finest mixed. 1,000 seeds, 5.00	1.00
5870	BUGNOT'S LARGE BLOTCHED. Finely formed flowers of rich and varied colors; mixed . . .	Oz., 8.00 .25
5880	CASSIER'S GIANT, FINEST MIXED. An excellent strain for out-door or greenhouse cultivation. The plants are of sturdy growth, producing large round flowers, the petals overlapping and often frilled. The colors are rich and varied . . .	Oz., 6.00 .25
5885	ENGLISH AND SCOTCH PRIZE VARIETIES. The characteristics of this strain are the fine velvety texture and bold face-like markings of the flowers. . .	Oz., 5.00 .25
5915	SPECIAL MIXTURE. Embracing the leading strains, all grown by specialists in Europe and including the finest colors and markings in endless variety. This mixture is extensively used by florists . . .	Oz., 5.00 .25
5920	EXTRA FINE MIXTURE. Large-flowering varieties in fine assortment of colors; excellent for bedding . . .	Oz., 2.50 .10
5925	FINE MIXTURE. Many colors. Oz., 1.00	.05

No.		Pkt.
	PANSIES — <i>Continued.</i>	
	TRIMARDEAU, OR GIANT PANSIES. A vigorous race, producing very large flowers of rich colors, unexcelled for bedding.	
5930	PARISIAN STRAIN. FINEST MIXED. Great variety of colors . . .	Oz., 2.50 .10
5942	EMPEROR WILLIAM. Ultramarine blue; the finest blue variety . . .	Oz., 3.00 .15
5945	GOLDEN QUEEN. Pure yellow. " . . .	3.00 .15
5950	GOLDEN YELLOW WITH DARK EYE " . . .	3.00 .15
5955	KING OF THE BLACKS . . .	" 3.00 .15
5970	LORD BEACONSFIELD. Violet; upper petals shading to white . . .	Oz., 3.00 .15
5972	RUBY RED. New . . .	" 8.00 .25
5973	SNOW QUEEN . . .	" 3.00 .15
5974	STRIPED. Great variety of colors " . . .	3.00 .15
5975	WHITE WITH VIOLET EYE . . .	" 3.00 .15
	LARGE-FLOWERED BEDDING PANSIES.	
5985	COLLECTION OF 12 VARIETIES75
5990	COLLECTION OF 6 VARIETIES40
5995	AZURE BLUE . . .	Oz., 1.25 .10
6000	BLACK . . .	" 1.25 .10
6010	BRONZE . . .	" 1.25 .10
6025	CARDINAL. Brightest red . . .	" 4.00 .25
6030	EMPEROR FREDERICK. Deep purple edged with scarlet and yellow; centre golden bronze . . .	Oz., 1.25 .10
6035	EMPEROR WILLIAM. Deep blue. " . . .	1.25 .10
6045	GOLD MARGINED. Purple, golden edge, . . .	Oz., 1.25 .10
6050	GOLDEN YELLOW . . .	" 1.50 .10
6060	LORD BEACONSFIELD. Violet, upper petals shading to white . . .	Oz., 1.25 .10
6062	MASTERPIECE. Petals ruffled; mixed colors, . . .	Oz., 8.00 .25
6063	MADAME PERRET. Wine-colors " . . .	3.00 .15
6065	PRESIDENT CARNOT. Petals violet, broadly bordered with white; extra fine, Oz., 3.00	.15
6080	STRIPED. Many colors; showy . . .	" 1.25 .10
6085	VICTORIA. Fine deep red . . .	" 2.00 .10
6088	WHITE . . .	" 1.25 .10



Tufted Pansies. No. 6090.

No.		Pkt.
	TUFTED PANSIES. <i>Viola Cornuta</i> . Elegant free-blooming plants for partially-shaded beds and borders. They are more hardy than the regular Pansies and may be kept growing for years with slight protection during winter. The flowers are not large, but very numerous, of brilliant colors and produced throughout the season.	
6090	FINEST MIXED. Shades of blue, yellow, and white Oz., 1.50	.10
6091	ADMIRATION. Dark blue; beautiful, " 2.00	.10
6092	BLUE PERFECTION. Mauve " 2.50	.10
6093	GRANDIFLORA LUTEA. Splendid yellow. Oz., 1.25	.10
6094	WHITE PERFECTION. Very fine; free blooming Oz., 2.00	.10

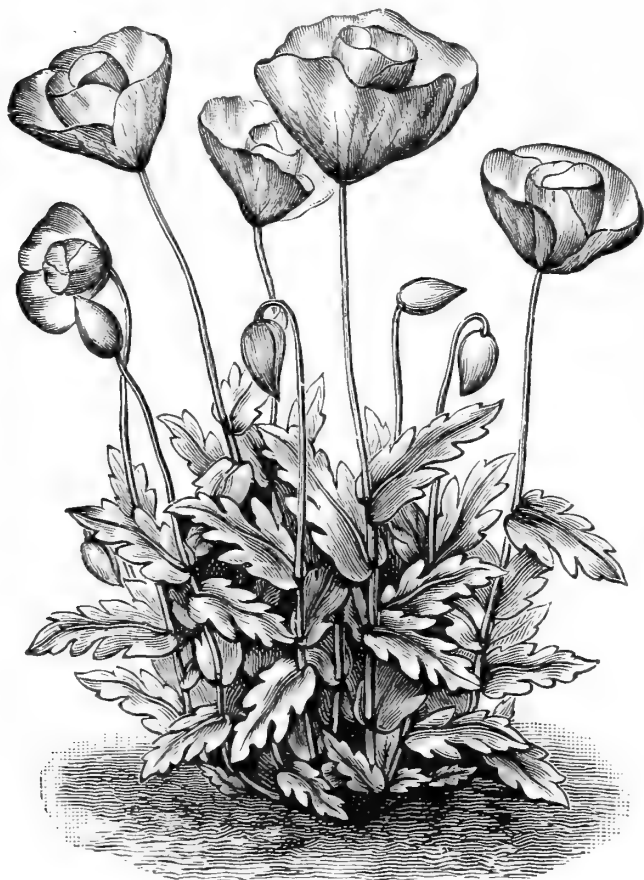

Tulip Poppy. No. 6135.

POPPY, ANNUAL VARIETIES. *Papaver*. The Poppy is justly a favorite flower. It comes so early in the summer, with its buds drooping as gracefully as a swan's neck, then the delicate tissue-like flowers rise erect and boldly display their brilliant colors. Poppies should be sown early in the spring where they are intended to bloom, as it is difficult to transplant them.

New Brunswick, N.J., March 3, 1902.

Messrs. R. & J. Farquhar & Co.:

Gentlemen: I should like to say in sending my small order to you this year, that I have never found such satisfaction in my seeds as I did last season in yours. I planted them with other seed from various houses, and none proved so reliable as yours. My Asters were the pride of the neighborhood, the Poppies were a glory, the Dahlias a revelation of new varieties, and the Marigolds were superb. I have a large collection of Gladioli, but should like to try some you advertise this year.

Yours truly,

MRS. K. C. LATHAM.

No.		Pkt.
	POPPY — Continued.	
6095	ANNUAL VARIETIES, FINEST MIXED. A combination of the finest double and single-flowered sorts, giving an endless variety of colors and producing charming effects, Lb., 3.00; ¼ lb., 1.00; oz., .30	.05
6100	AMERICAN FLAG. Large double flowers, white striped with scarlet; 2 ft., Oz., .30	.05
6110	CARNATION-FLOWERED, DOUBLE. COLLECTION OF 12 VARIETIES. Large fringed flowers; 2 ft.50
6115	— DOUBLE, FINEST MIXED. 2 ft., Oz., .25	.05
6116	— BRIGHT ROSE " .30	.05
6117	— CARDINAL " .30	.05
6118	— SCARLET " .30	.05
6119	— WHITE SWAN " .30	.05
6120	CHINESE, FINEST MIXED. Very double, globe-shaped flowers with slender, wavy petals, varying from pure white to dark scarlet; 15 inches Oz., .30	.05
6125	DANE BROG. Danish Flag. Single scarlet flowers with a large white blotch on each petal; 2 ft. Oz., .25	.05
6135	GLAUCUM. Tulip Poppy. Dazzling scarlet, single flower; 1 ft. Oz., 1.00	.10
6140	HOOKE'S SINGLE MIXED. A superb strain producing the brightest and largest flowers; 2 ft. Oz., .40	.05
6145	JAPANESE POMPON, FINEST MIXED. Double fringed flowers varying in color from white to crimson; extremely beautiful; 15 inches, ¼ oz., 1.00	.15
6150	LEVIGATUM. Large, showy, single flowers, brilliant scarlet with black spots margined with white; 18 inches Oz., 1.50	.10
6152	MAID OF THE MIST. Large single white, beautifully fringed Oz., .60	.10
6155	MEPHISTO. Single, deep scarlet with blackish violet spots; 18 inches Oz., .25	.05
6160	MIKADO. Double fringed flowers, white striped with crimson; 1 ft. Oz., .25	.05
6165	PÆONY-FLOWERED, DOUBLE. COLLECTION OF 12 VARIETIES. Immense double flowers; 2 ft.50
6170	— DOUBLE, FINEST MIXED, Lb., 1.50; oz., .20	.05
6175	— NANKEEN YELLOW Oz., .25	.05
6180	PAVONINUM. Peacock Poppy. Scarlet with black ring; 18 inches Oz., .50	.05
6185	RANUNCULUS-FLOWERED. African Rose. Showy double flowers having thin crinkled petals. Many beautiful colors; 2 ft. Oz., .25	.05



Hooker's Single Mixed Poppy. No. 6140



Delavan, Wis., Jan. 27, 1902.

R. & J. Farquhar & Co.:

Gentlemen: The Flower Seeds that I got from you last year were excellent. I send you a money order for \$—; please send me the following seeds as soon as possible. . . .

Yours respectfully.

CHARLES GAY,

Gardener for G. E. Rickcords, Esq.

- | No. | | Pkt. |
|--------------------|---|------|
| POPPY — Continued. | | |
| 6195 | SHIRLEY, FINEST MIXED. A most charming race of single Poppies with shining flowers of silky texture, varying in color from pure white and delicate pink to rosy carmine and deep crimson, many of them being beautifully striped and edged with white. The blooms if cut while young will keep in water for two or three days; 2 ft. | |
| | Lb., 4.00; ¼ lb., 1.25; oz., .40 | .05 |
| 6190 | RHÆUS. <i>Scarlet Field Poppy</i> . The single Poppy so much admired by tourists in Europe, where it abounds on the railroad banks and in the fields; 18 inches . . . | |
| | Lb., 2.50; oz., .25 | .05 |
| 6200 | THE BRIDE. Large, single, white flowers, which if cut while young will keep in water for several days; 2 ft. | |
| | Oz., .30 | .05 |
| 6205 | UMBROSUM. <i>Caucasian Poppy</i> . Enormous single flowers, crimson with a black spot on each petal; 2 ft. | |
| | Oz., .30 | .05 |
| 6142 | POPPIES, ISLE OF SHOALS. This strain of Poppies was furnished by us to the order of the late Mrs. Celia Thaxter, poetess, and is among the most attractive of the flowers she loved and cultivated at the Isles of Shoals. They can be grown by any one, and make a grand display. Their beauty is indescribable and the variety endless. All are hardy annuals . . . | |
| | Oz., .50 | .10 |

MR. SAMUEL T. WRIGHT, 17 Stephen Street, Lynn, Mass., Sept. 17, 1903, writes:

"The seeds purchased from your firm have given the very best results. I have beds of them arranged for effect, and they have got great praise from the neighbors in this vicinity."

COPYRIGHT 1902
BY R. & J. FARQUHAR & CO.

Shirley Poppy. No. 6195.

No.		Pkt.
	POPPY. HARDY PERENNIAL VARIETIES. <i>Papaver.</i> Showy plants for mixed borders and clumps among shrubs. The Iceland Poppy will bloom the first season if sown early in spring. All perennial Poppies may be sown from June to August, to bloom the following summer.	
6215	COLLECTION OF 6 PERENNIAL SORTS. All hardy40
6220	ALPINE POPPY, FINEST MIXED. <i>P. Alpinum.</i> Charming dwarf Poppies, with delicate flowers, including yellow, pink, scarlet, and white. May to August; 1 ft.10
6225	— — WHITE15
6230	— — PINK15
6232	BRACTEATUM. Very early, free-blooming; large crimson flowers; May to July, 3 ft.	Oz., .50 .10



Farquhar's Superb Iceland Poppies. No. 6235.

	ICELAND POPPY. <i>P. Nudicaule.</i> This beautiful species will bloom the first season if sown early in spring. Its delicate form and bright colors render it desirable as a border plant, and exquisite for cutting. April to Oct.; 1 ft.	
6235	— FARQUHAR'S SUPERB MIXED. Shades of yellow, scarlet, and white	Oz., 1.25 .10
6240	— BRIGHT YELLOW, SINGLE	1/4 oz., .50 .10
6245	— — — DOUBLE	1/8 oz., .50 .10
6250	— PURE WHITE, SINGLE	1/4 oz., .50 .10
6255	— — — DOUBLE	1/8 oz., .75 .25
6260	— BRIGHT ORANGE-SCARLET, SINGLE,	1/4 oz., .50 .10
6265	— — — DOUBLE25
6267	— PRIMROSE YELLOW	1/4 oz., .75 .10
6270	ORIENTAL POPPY. <i>P. Orientale.</i> Very early; flowers orange-scarlet, with black spots; May to July, 3 ft.	Oz., 2.00 .10
6272	— NEW HYBRIDS. Pink, scarlet, and crimson	Oz., 2.00 .10
6273	— BLUSH QUEEN. Pale pink	1/8 oz., .50 .15
6275	— PARKMANII. Deep scarlet	1/8 oz., .50 .15
6280	PILOSUM. Salmon-red; branching; June to Aug., 2 ft.	1/8 oz., 1.00 .25
	PASSIFLORA. <i>Passion Flower.</i> Ornamental climbing plants with numerous large showy flowers useful in the conservatory and garden in summer; greenhouse perennials; 10 to 30 ft.	
6290	CERULEA. Blue; half-hardy perennials10
6305	INCARNATA. White, lilac rays10
6315	VAN VOLXEMI. <i>Tacsonia.</i> Scarlet; magnificent25

No.		Pkt.
	PELARGONIUM. See <i>Geranium</i>, No. 3835.	
	PENTSTEMON. Although these are perennials, they can easily be grown as annuals. If sown in heat in February or March they will flower freely the first year producing large spikes of handsome flowers, very ornamental in the garden and admirable for cutting. Hardy or half-hardy perennial; 3 ft.; June to Oct.	
6320	HYBRIDUS GRANDIFLORUS, FINEST MIXED. Saved from large-flowered varieties of rich and varied colors	1/4 oz., 1.00 .25
6325	ATROPURPUREUS. Dark red with white throat10
6327	DIGITALIS. Large spikes of pure white flowers, the throat spotted with violet10
6330	GLOXINIOIDES. <i>Annual Pentstemon.</i> A new variety producing large spikes of Gloxinia-like flowers often two inches across and of most brilliant and varied colors. If started early in heat they flower in July continuing until frost, 1/8 oz., 1.0025
6331	MURRAYANUS. Bright scarlet; splendid25
6332	PULCHELLUS HYBRIDUS, MIXED. Shades of red and lilac25
6333	SPECTABILIS. Blue and red; very beautiful,10
6335	WRIGHTII. Bright scarlet; very fine25
6340	PERILLA ATROPURPUREIS LACINIATIS. Half-hardy annual with dark purple foliage resembling Coleus; 2 ft.	Oz., .25 .05
	PETUNIA. The Petunia is popular because it is of easiest cultivation, blooms from early summer continuously until frost, and is one of the most showy and free-growing annuals; 1 to 1 1/2 ft.	
	Great care is exercised in the saving of our Petunia seeds. The seed stocks are of the finest strain in existence, and only such plants as produce high grade flowers are allowed to seed, those inferior being discarded.	
	SINGLE BEDDING PETUNIAS.	
6350	FINEST MIXED. A splendid strain producing flowers of medium size in great variety of colors. Very free-blooming and excellent for beds and masses	Oz., 1.50 .10
6355	FINE MIXED. Choice colors75 .05
6360	STRIPED AND BLOTCHED. Very effective strain for beds and borders; flowers beautifully striped and mottled	Oz., 2.00 .10
6370	CRIMSON75 .05
6375	WHITE	1.00 .05
6385	NANA COMPACTA MULTIFLORA. <i>Inimitable Dwarf.</i> The flowers are beautifully striped and they completely cover the compact little plants. This variety is most useful for edgings and for early blooming in pots; 6 inches	1/4 oz., 1.00 .25
6390	GIANT OR GRANDIFLORA. COLLECTION OF 12 VARIETIES	1.00
6395	COLLECTION OF 6 VARIETIES60
6400	FINEST MIXED. <i>Giants of California.</i> Flowers of enormous size and superb colors	1/8 oz., 4.00; 1/16 oz., 2.25 .25
6405	CRIMSON25
6410	STRIPED AND BLOTCHED. Very large beautifully striped flowers25
6412	WHITE. <i>Snow Storm</i>25
6415	YELLOW THROATED. <i>Intus Aurea.</i> The flowers are very large, of richest colors with yellow throats50



Petunia Ruffled Giants. No. 6443.

- | | | |
|------|------|---|
| No. | Pkt. | |
| | | PETUNIAS — Continued. |
| 6443 | | RUFFLED GIANTS. A Californian strain producing large flowers having the edges deeply ruffled or fluted. They are of fine substance with deep wide throats and vary in their colors from pure white to dark purple-violet; many of them being beautifully striped or veined . . . $\frac{1}{8}$ oz., 3.00 .50 |
| 6444 | | GIANT FRINGED SORTS, MIXED25 |
| | | DOUBLE FLOWERING PETUNIAS. |
| | | Seeds of the double varieties being obtained by hybridization, produce only a small percentage of double-flowering plants, the remainder being single of fine quality. The weaker seedlings should receive particular care, they usually produce the finest double flowers. |
| 6445 | | GIANT OR GRANDIFLORA. DOUBLE FINEST MIXED. Fine hybridized seed producing a large percentage of double-flowering plants of finest colors. 1,000 seeds, 1.00 .50 |
| 6450 | | — DOUBLE FRINGED FINEST MIXED. Flowers of large size, beautifully fringed and of superb colors. . . . 1,000 seeds, 1.50 .50 |
| 6460 | | — — LADY OF THE LAKE. Pure white, double fringed flowers75 |
| 6462 | | CHOICE MIXED25 |
| 6465 | | PHACELIA CAMPANULARIA. A charming hardy annual of dwarf spreading habit with deep blue flowers, produced from July until frost; 9 inches Oz., .50 .05 |
| | | PHLOX DRUMMONDI. This is one of the finest annuals, being hardy, easy of cultivation, and making as a summer bedding plant an effective and brilliant display. The flowers are of long duration and of most gorgeous and varied colors; June to Oct., 1 ft. |
| 6475 | | FINEST MIXED. Splendid colors. Oz., .60 .05 |
| 6480 | | GRANDIFLORA, FINEST MIXED. The flowers are of large size, finely rounded form, and with well defined eyes. The colors are superb Oz., 1.00 .10 |

- | | |
|------|---|
| No. | |
| | PHLOX — Continued. |
| 6485 | — COLLECTION OF 12 VARIETIES. Pkt., .70 |
| 6490 | — COLLECTION OF 6 VARIETIES. Pkt., .40 |
| 6495 | — BLOOD-RED. Black Warrior . Oz., 1.50; pkt., .10 |
| 6500 | — BRILLIANT SCARLET,
Oz., 1.50; pkt., .10 |
| 6505 | — CRIMSON WITH WHITE STAR,
Oz., 1.50; pkt., .10 |
| 6510 | — PINK . " 1.50; " .10 |
| 6515 | — SCARLET WITH WHITE EYE.
Oz., 1.50; pkt., .10 |
| 6517 | — VIOLET, " 1.50; " .10 |
| 6520 | — WHITE, " 1.50; " .10 |
| 6525 | DOUBLE FINEST MIXED.
Oz., 2.50; pkt., .15 |
| 6535 | — WHITE. Useful for cutting,
$\frac{1}{4}$ oz., .75; pkt., .15 |
| 6545 | DWARF FINEST MIXED. These come in bloom very early; they are of dwarf habit; excellent for pot culture and edgings. Oz., 2.00; pkt., .10 |
| 6550 | — WHITE. $\frac{1}{4}$ oz., 1.00; pkt., .15 |
| 6555 | — SCARLET. " 1.00; " .15 |
| 6560 | CUSPIDATA. The petals have long points, giving the flowers a star-like form, novel and distinct. Mixed colors,
Oz., 1.00; pkt., .10 |

- | | | |
|------|------|---|
| No. | Pkt. | |
| | | PERENNIAL PHLOX. Phlox Decussata. |
| | | Splendid hardy herbaceous plants producing large trusses of showy flowers on tall stems; which bloom from July until frost. They are equally effective for beds, perennial borders, or groups among shrubs. The colors range from pure white to deep crimson and purple; 3 ft. |
| 6570 | | NEWEST HYBRIDS, MIXED . . . $\frac{1}{4}$ oz., .75 .25 |
| 6572 | | — COLLECTION OF 12 VARIETIES75 |
| 6573 | | — COLLECTION OF 6 VARIETIES50 |
| | | <i>Plants of Perennial Phloxes are offered in the Plant Section of this Catalogue.</i> |
| 6577 | | PHORMIUM TENAX FOLIIS VARIEGATIS.
<i>New Zealand Flax.</i> A handsome plant for lawn or conservatory decoration, with long sword-shaped leaves, which are beautifully variegated. The flowers are orange-color, borne on spikes 12 to 15 feet in height. Half-hardy perennial25 |

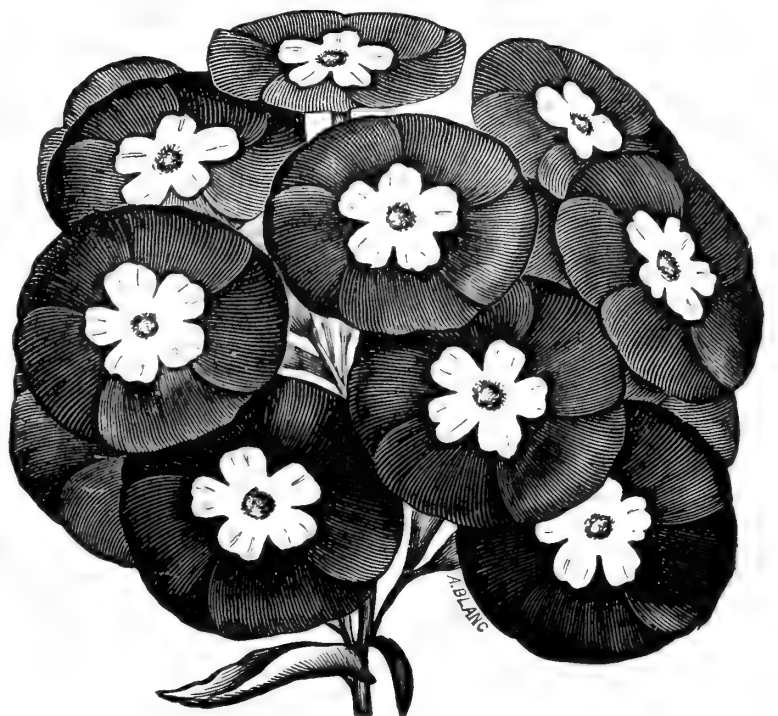

Phlox Drummondii Grandiflora. No. 6480.

No.		Pkt.
6578	PHYSALIS FRANCHETI. <i>Japanese Winter Cherry</i> . A large and ornamental variety of the Ground Cherry or Strawberry Tomato. The fruit is large, deep red in color, edible, and enclosed in enormous balloon-shaped husks of brilliant orange-red. A very showy hardy annual; 2 ft.10
6580	PHYSOSTEGIA SPECIOSA. Beautiful hardy perennial growing 18 inches in height and bearing in July spikes of charming pink flowers10
	PLATYCODON. <i>See Wahlenbergia</i> , No. 8195.	
6590	POINSETTIA PULCHERRIMA. A very ornamental greenhouse shrub, producing large heads of brilliant scarlet bracts most valuable for house and conservatory decoration during winter. If sown in February or March the seedlings produce splendid scarlet tops by December . . . 100 seeds, 2.00	.50
	POLEMONIUM. <i>Jacob's Ladder, or Greek Valerian</i> . Hardy perennials with deeply-cut foliage and clusters of handsome flowers; thriving in any good soil; 2 ft., May to August.	
6595	CÆRULEUM GRANDIFLORUM. Beautiful spikes of deep blue flowers Oz., .50	.10
6600	— — ALBUM. Pure white " .75	.10
6605	RICHARDSONII. Large deep blue flowers, Oz., 1.00	.10
	PORTULACA. Charming dwarf annuals for sunny situations or light soils, producing flowers of most brilliant colors in great profusion; July to October, 6 inches.	
6610	DOUBLE, FINEST MIXED, Oz., 5.00; ¼ oz., 1.50	.10
6615	— COLLECTION OF 8 VARIETIES50
6620	SINGLE, FINEST MIXED, ¼ lb., 1.50; oz., .50	.05
6625	— COLLECTION OF 8 VARIETIES40
6627	— ROSE Oz., .60	.05
6630	— SCARLET " .60	.05
6635	— WHITE " .60	.05
6640	— YELLOW " .60	.05
6645	POTENTILLA, DOUBLE HYBRIDS, FINEST MIXED. Splendid hardy perennials with ornamental foliage and brilliant flowers, chiefly shades of yellow and red, borne in great profusion from July until frost. They prefer a sandy loam. 2 ft.25
6650	SINGLE, FINEST MIXED10
	PRIMULA, OR PRIMROSE. HARDY AND HALF-HARDY VARIETIES.	
6785	ACAULIS GRANDIFLORA, FINEST MIXED. <i>Large-Flowering Garden Primrose</i> . A splendid strain; flowers of large size and containing many bright and beautiful colors25
6787	— YELLOW. <i>Yellow English Primrose</i> . The best sort for forcing and bunching for corsage bouquets25
6788	— CÆRULEA. <i>Blue Primrose</i> . A new color in Primroses obtained by the famous English hybridizer, Mr. G. F. Wilson. The flowers vary from pale lavender to deep blue25
6790	AURICULA. A lovely race of Primula with large umbels of velvety flowers of many beautiful colors, chiefly yellow, crimson, maroon, and purple, frequently edged with gray or green. Seed saved from show flowers. Finest mixed25
6800	FORBESI. <i>Baby Primrose</i> . A much advertised variety producing delicate sprays of small lavender-colored flowers. Although pretty for bouquets, the flowers are too small for general usefulness25

No.		Pkt.
	PRIMULA — <i>Continued</i> .	
6805	JAPONICA, FINEST MIXED. Showy perennial producing several whorls of large flowers on their erect stems, the flowers varying from white to crimson; 15 inches, .10	.10
6815	OBCONICA GRANDIFLORA. Splendid for winter and spring blooming in cool greenhouse; flowers varying from white to lilac and growing in large clusters on erect slender stems. Handsome as a pot plant and exquisite for cutting; 1 ft.25
6817	— — FIMBRIATA. Flowers finely fringed, .25	.25
6818	— — — CARMINEA. Bright carmine50
6825	SIEBOLDII, NEW LARGE FLOWERING VARIETIES, FINEST MIXED. Free blooming variety, excellent for pots, with large and beautiful clusters of flowers, colors white to rosy crimson; 1 ft.50
	PRIMULA POLYANTHUS VARIETIES.	
	<i>Elatior</i> . Charming spring-flowering perennials with most fascinating and richly colored velvety flowers. They are of easiest cultivation succeeding best in partial shade; 9 inches; April to May.	
6830	FARQUHAR'S GIANT FANCY, FINEST MIXED. The flowers are of large size supported on stout stems well above the leaves in splendid clusters. The colors are brilliant, ranging from white to deep maroon; the yellow, rose, and crimson shades being particularly fine. These larger forms are most desirable for winter flowering in the conservatory ¼ oz., 2.00	.25
6837	FARQUHAR'S GIANT WHITE25
6840	FARQUHAR'S GIANT YELLOW25
6842	FARQUHAR'S BLUE. New50
6845	GOLD LACED. Flowers of brilliant colors with distinct yellow edges Oz., 3.00	.10
6847	CHOICE MIXED Oz., 1.50	.10



Primula Obconica Grandiflorum, No. 6815.

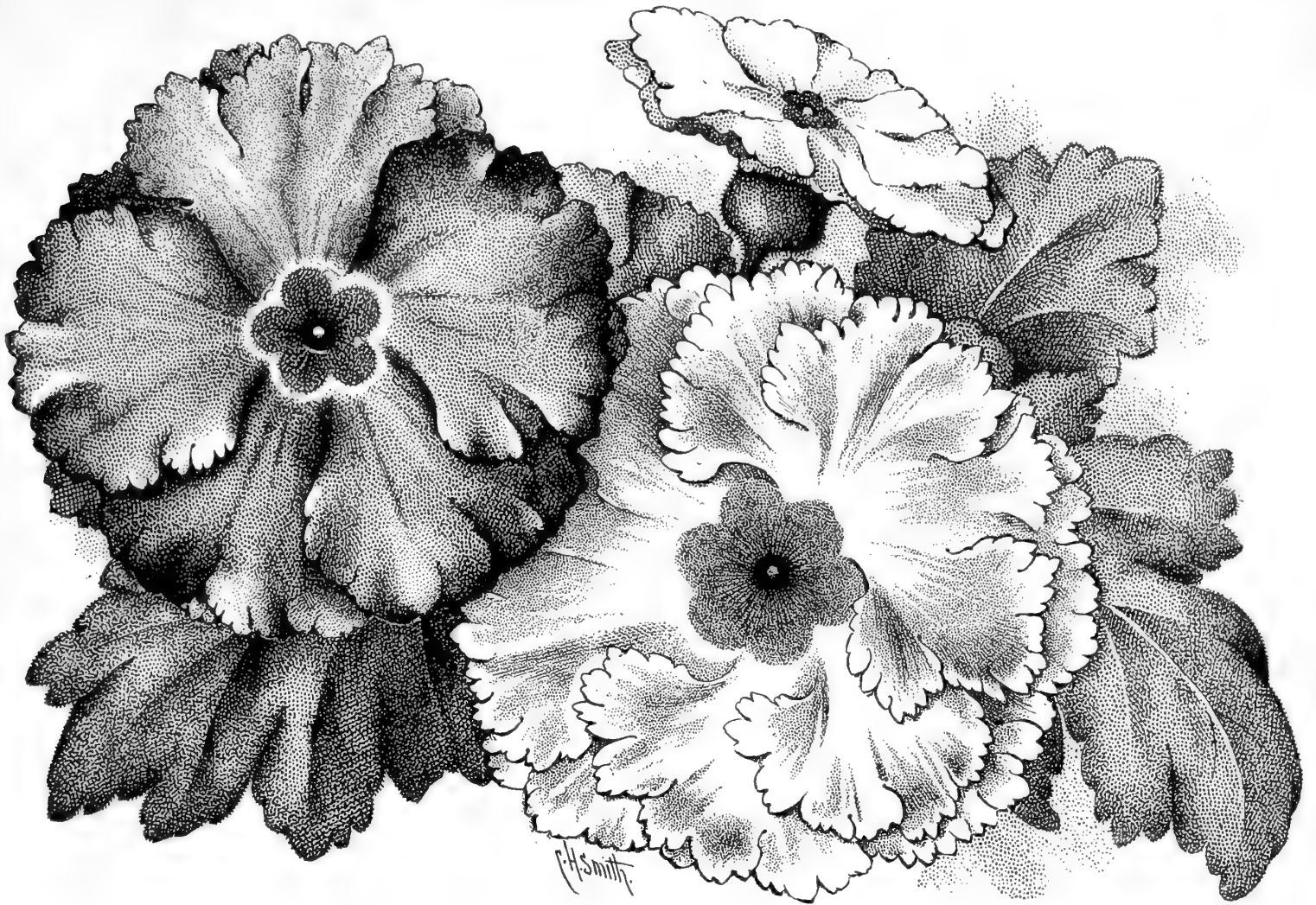

Primula Chinensis. Farquhar's Columbian Prize. No. 6665.

PRIMULA CHINENSIS. CHINESE PRIMROSE. Our Primulas received the Medal and Diploma at the World's Columbian Exposition. Since that time our strains have been steadily improved and are acknowledged to be the finest sold in the United States.

Harvard University Botanic Garden, Cambridge, Mass., Nov. 14, 1902.

Messrs. R. & J. Farquhar & Co.:

Gentlemen: For the last ten years I have grown Chinese Primroses from your seed. The seeds always germinate quickly and produce strong, vigorous, compact plants. The flowers are produced abundantly, and a splendid feature about them is that they stand well above the foliage. Your Chiswick Red and Farquhar's Giant White are especially good. Farquhar's Improved Blue is the best blue Primrose in cultivation. Your Primula Stellata is very fine, especially the white variety, for which I received last year a First Class Certificate of Merit from the Massachusetts Horticultural Society.

Yours respectfully,

ROBERT CAMERON, Superintendent.

No.	Pkt.	No.	Pkt.
6665	FARQUHAR'S COLUMBIAN PRIZE MIXED. The plants are of sturdy growth, producing large, thick flowers, which are beautifully fringed, and carried on erect stems well above the foliage. For size, substance, and beautiful colors this strain is unexcelled. The smallest seedlings should be carefully grown, they often give the best flowers. 500 seeds, 3.00	6690	FARQUHAR'S GIANT SALMON. Very large flowers; colors soft and pleasing75
6667	COLLECTION OF 6 SPLENDID VARIETIES2.50	6695	FARQUHAR'S GIANT WHITE. Large flowers of great substance and perfect form . . .75
6670	FARQUHAR'S SPECIAL MIXTURE. Large fringed flowers, including nearly all the best named sorts50	6705	FARQUHAR'S COMET. Flowers lustrous crimson, of large size and finely fringed, one of the best sorts75
6675	FARQUHAR'S GIANT PINK. This is perhaps the most beautiful Primula in cultivation. The flowers are fringed, very large and of most fascinating bright pink color. New, 1.00	6710	ALBA MAGNIFICA. Pure white fringed flowers, with well-defined yellow eye . . .50
6680	FARQUHAR'S IMPROVED BLUE. Flowers of large size and deep blue color; the finest blue sort75	6715	FARQUHAR'S IMPROVED CHISWICK RED. Crimson-scarlet, beautifully fringed flowers of massive appearance50
6685	FARQUHAR'S GIANT RED. The most intense red variety; flowers very large1.00	6720	FARQUHAR'S DOUBLE MIXED. The double varieties are very useful for cutting; they are also adapted to window decoration because of their long lasting quality. The flowers are large and of charming colors . .75
		6725	FARQUHAR'S DOUBLE BLUSH75
		6730	FARQUHAR'S DOUBLE CRIMSON75
		6735	FARQUHAR'S DOUBLE CARNATION-STRIPED .75
		6740	FARQUHAR'S DOUBLE PINK75
		6745	FARQUHAR'S DOUBLE WHITE75



Primula Stellata. No. 6783.

- 6782 PRIMULA STELLATA. This is unquestionably one of the most graceful and beautiful of winter-blooming plants. Although quite new, it is in great demand, and the numerous colors now obtained will increase its usefulness. It is equally valuable as a pot plant and for cutting. For the latter purpose it is the best of all Primulas, and will keep fresh in water for many days. Finest mixed . . . Pkt. 1.00
- 6783 COLLECTION OF 6 VARIETIES . . . " 2.50



Pyrethrum Roseum, Single Hybrids. No. 6890.

- | No. | Pkt. |
|---|------|
| PYRETHRUM. GOLDEN FOLIAGED. Dwarf bedding plants with yellow Fern-like leaves useful for edging beds and borders. Half-hardy perennials; 6 to 9 inches. | |
| 6860 AUREUM. <i>Golden Feather</i> . Golden yellow foliage, excellent bedding sort . . . Oz., .60 | .10 |
| 6875 — SELAGINOIDES. Foliage golden yellow, finely serrated; compact . . . Oz., .80 | .10 |
| PYRETHRUM. FLOWERING VARIETIES. Hardy perennials, very beautiful for borders and most desirable for cutting. The flowers are of brilliant colors and very lasting. | |
| 6880 ATROSANGUINEUM. Crimson with yellow centre; 2 ft. | .10 |
| 6885 ROSEUM, DOUBLE HYBRIDS, FINEST MIXED. Beautiful Aster-like flowers ranging in color from white to brilliant rose and crimson; 18 inches; June to Sept. 1/8 oz., 2.50 | .25 |
| 6890 — SINGLE HYBRIDS, FINEST MIXED. Daisy-like flowers of brilliant colors with yellow centres Oz., 1.50 | .10 |
| 6895 — ULIGINOSUM. Large, single, white flowers; hardy perennial; 2 ft. | .10 |
| RESEDA. See <i>Mignonette</i> , Nos. 5065—5130. | |



Rhodanthe Manglesi. No. 6910.

- RHODANTHE. Half-hardy annuals with *Everlasting* flowers. They are beautiful for the open garden, or grown in pots for the conservatory. If required for winter use as dried flowers, they should be cut before they are fully expanded; 1 ft., July—Oct.
- | | |
|--|---------|
| 6900 MACULATA. Bright pink with crimson circle, Oz., .75 | .05 |
| 6905 — ALBA. Pure white, very beautiful, " | .75 .05 |
| 6910 MANGLESI. Brilliant rose | .75 .05 |
| 6915 — FLORE PLENO. Beautiful rose-colored flowers, a large percentage of them double, 1/4 oz., 1.25 | .10 |

Mr. Foster says the Cyclamen I got from you are the best he ever saw.
DONALD SIM,
East Islip, L.I., N.Y.

No.		Pkt.
	RICINUS. CASTOR OIL PLANT. Tender annuals of rapid and gigantic growth producing enormous dark green or bronze-colored palmate leaves; excellent for sub-tropical beds or for massive foliage effects on lawns or backgrounds.	
6925	FINEST MIXED Lb., .75; oz., .10	.05
6930	BORBONIENSIS ARBOREUS. Large purplish leaves; 15 ft. Oz., .15	.05
6935	CAMBODGENSIS. The plant is of compact growth with stems and leaf stalks like shining ebony, foliage varying according to age from bronze green to black-purple; 6 ft. Oz., .40	.05
6950	GIBSONI MIRABILIS. Dark red stems and foliage; 5 ft. Oz., .20	.05
6955	MACROCARPUS. White stems and light green leaves Oz., .20	.05
6960	SANGUINEUS. Fine tall variety, reddish purple leaves; 10 ft., Lb., .60; oz., .10	.05
6965	ZANZIBARIENSIS, MIXED. A distinct race from East Africa, producing leaves of enormous size varying in color from light green to purplish red; 15 ft. Oz., .30	.05
6970	— NIGER. Dark purple " .30	.05
	ROCKET. See <i>Hesperis</i> , No. 4257.	
6985	ROMNEYA COULTERI. <i>California Tree Poppy</i> . Half-hardy perennial with large single white flowers, centres yellow; 3 ft.10
6990	ROSA MULTIFLORA NANA. <i>Dwarf Polyanthus Rose</i> . A dwarf variety of bushy growth, flowering the first year from seed. The first blossoms are single, but these are followed by clusters of double and semi-double flowers. Hardy shrub; 1 ft.25
	RUDBECKIA. <i>Cone Flower</i> . Showy, hardy annual and perennial plants of easiest cultivation, suitable for borders or clumps among shrubs. July to Oct.	
6995	AMPLEXICAULIS. Golden yellow; hardy annual; 3 ft. Oz., .30	.05
7000	BICOLOR. Yellow, with purple centre; hardy annual; 2 ft. Oz., .30	.05
7002	— SUPERBA. Large flowers, golden yellow, with large dark spots; 2½ ft. Oz., .60	.05
7003	— — SEMI-PLENA. Splendid new hardy annual, shades of yellow and crimson; excellent for cutting10
7004	PURPUREA. Reddish-purple; hardy perennial; 3 ft.25
7005	NEWMANI. Magnificent golden-yellow flowers with maroon centre; perennial; 2 ft.25
7010	SABBATIA CAMPESTRIS. Hardy annual, with charming rose-colored flowers; 1 ft., July to Sept.25
7022	SAINTPAULIA IONANTHA. <i>African Violet</i> . A very beautiful dwarf greenhouse perennial, with many flowers which are violet like in form and color, borne on stems 3 inches long over the dark green, downy foliage which forms a flat rosette below25
	SALPIGLOSSIS. Exceedingly beautiful half-hardy annuals, with large, funnel-shaped flowers, beautifully pencilled and veined in rich shades of yellow, crimson, and purple. They flower freely from July until frost, and are invaluable for cutting; 2 ft.	
7025	GRANDIFLORA. FINEST MIXED. Large flowering and of many beautiful colors, Oz., 1.00	.05
7030	— COLLECTION OF 6 VARIETIES40
7031	— MAROON, GOLDEN VEINED Oz., 1.50	.10
7032	— ROSE. GOLDEN VEINED " 1.50	.10
7034	— SULPHUR YELLOW " 1.50	.10

No.		Pkt.
	SALVIA. <i>Flowering Sage</i> . Splendid hardy or greenhouse perennials, with spikes of showy flowers freely produced from July until frost.	
7035	ARGENTEA. White silvery foliage, lying flat on the ground; flowers yellow; hardy perennial; 2 ft. Oz., .25	.05
7040	HORMINUM VIOLACEA. <i>Clary</i> . Flowers beautiful violet blue; 18 inches, Oz., .25	.05
7050	PATENS. Flowers intense bright blue, of large size and velvety texture; 2 ft., ¼ oz., 1.25	.25
7065	SPLENDENS. One of our most useful and gorgeous bedding plants, with long spikes of brilliant scarlet flowers, blooming uninterruptedly from July until frost; 3 ft., Oz., 2.00	.10
7070	— COMPACTA. Forms a compact dense bush covered with large brilliant scarlet flowers; blooms very early; 2 ft., Oz., 2.50	.15
7075	— BONFIRE. A splendid dwarf variety with large erect spikes of rich scarlet flowers; height 2 ft. Oz., 3.00	.25



Salpiglossis Grandiflora. No. 7025.

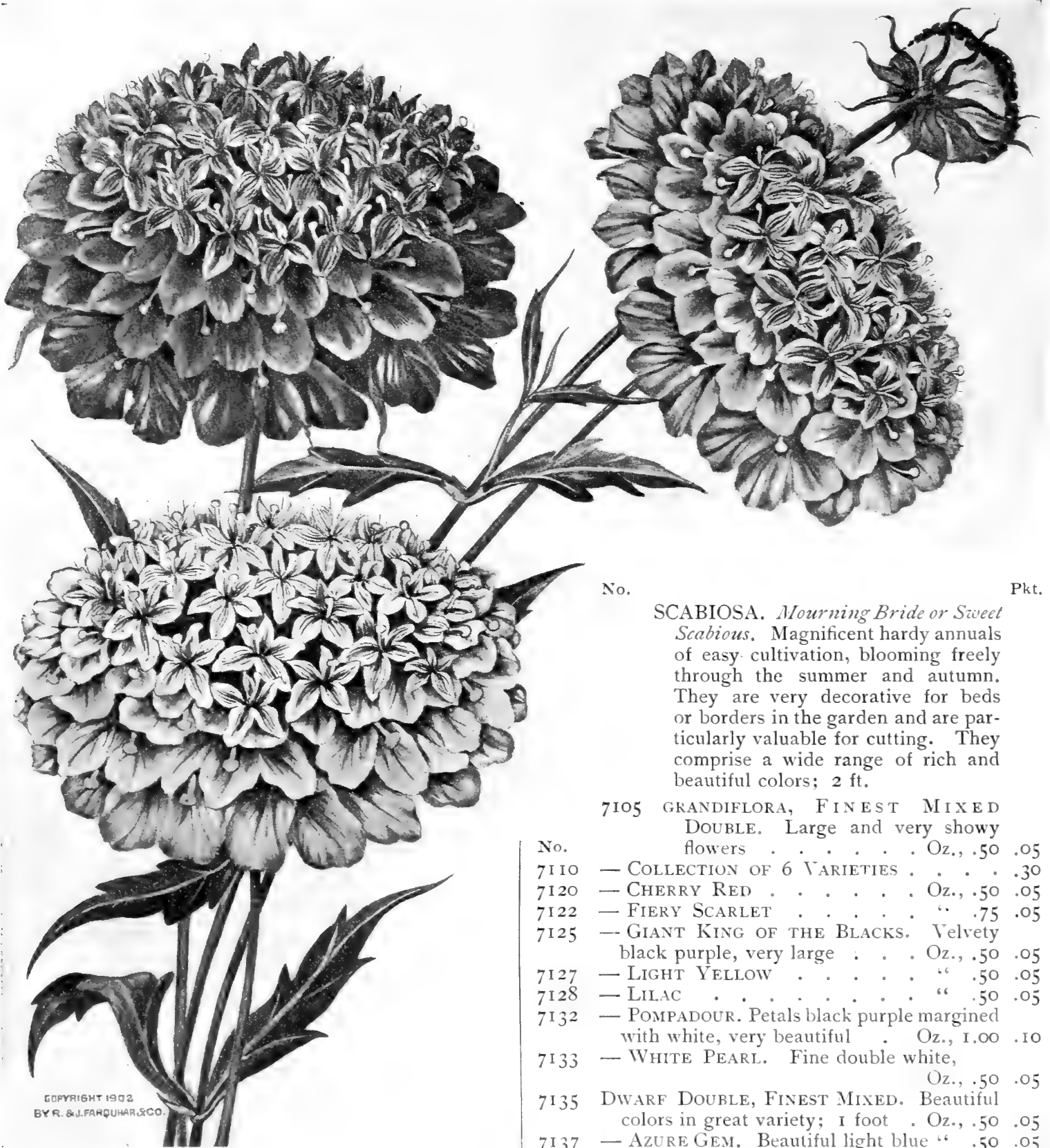

COPYRIGHT 1902
BY R. & J. FARQUHAR & CO.

Scabiosa Grandiflora. No. 7110.

- | No. | | Pkt. |
|------|---|------|
| 7080 | SANTOLINA MARITIMA. A useful bedding plant with fine silvery white foliage, suitable for edgings; flowers yellow; half-hardy perennial; 1 ft. | .05 |
| 7085 | SANVITALIA PROCUMBENS FLORE PLENO. Pretty dwarf annual with bright yellow double flowers. It blooms from July until frost and succeeds best in rich light soil; 6 inches | .05 |
| 7095 | SAPONARIA CALABRICA. A charming hardy annual of dwarf growth thickly covered with bright pink star-shaped flowers; excellent for edgings and small beds. It flowers early and is one of the best annuals for gardens in the mountains; July to Sept. 1 ft. Oz., .30 | .05 |
| 7100 | OCYMOIDES SPLENDENS. Trailing hardy perennial with small deep red flowers; May to Aug. Oz., .30 | .05 |

No. Pkt.

SCABIOSA. *Mourning Bride or Sweet Scabious*. Magnificent hardy annuals of easy cultivation, blooming freely through the summer and autumn. They are very decorative for beds or borders in the garden and are particularly valuable for cutting. They comprise a wide range of rich and beautiful colors; 2 ft.

7105 GRANDIFLORA, FINEST MIXED DOUBLE. Large and very showy flowers Oz., .50 .05

- | | | |
|------|--|-----|
| 7110 | — COLLECTION OF 6 VARIETIES | .30 |
| 7120 | — CHERRY RED Oz., .50 .05 | |
| 7122 | — FIERY SCARLET " .75 .05 | |
| 7125 | — GIANT KING OF THE BLACKS. Velvety black purple, very large . . . Oz., .50 .05 | |
| 7127 | — LIGHT YELLOW " .50 .05 | |
| 7128 | — LILAC " .50 .05 | |
| 7132 | — POMPADOUR. Petals black purple margined with white, very beautiful . . . Oz., 1.00 .10 | |
| 7133 | — WHITE PEARL. Fine double white, Oz., .50 .05 | |
| 7135 | DWARF DOUBLE, FINEST MIXED. Beautiful colors in great variety; 1 foot . . . Oz., .50 .05 | |
| 7137 | — AZURE GEM. Beautiful light blue "50 .05 | |
| 7138 | — CRIMSON. Rich shade " .50 .05 | |
| 7140 | — GOLDEN YELLOW " .50 .05 | |
| 7145 | — SNOWBALL. Pure white " .50 .05 | |

SCABIOSA OR SCABIOUS PERENNIAL VARIETIES.

- | | | |
|------|--|--|
| 7150 | CAUCASICA. Magnificent hardy perennial with beautiful, large, light blue flowers; 2 ft. ¼ oz., 1.00 .15 | |
| 7155 | — ALBA. White ¼ oz., 1.50 .25 | |
| 7170 | SCHIZOPETALON WALKERI. Elegant hardy annual with numerous white almond-scented fringed flowers. It should be sown where intended to bloom; 9 inches, June to Sept.10 | |

- | | | |
|------|--|--|
| 7180 | SEDUM CERULEUM. <i>Blue Annual Stonecrop</i> . A useful plant for rockwork, edgings, stone walls or dry situations; 3 inches. ⅛ oz., .75 .10 | |
|------|--|--|

SENSITIVE PLANT. See *Mimosa*, No. 5140.



Schizanthus. No. 7160.

- | No. | | Pkt. |
|------|--|------|
| | SCHIZANTHUS. <i>Butterfly Flower.</i> Elegant free-flowering hardy annuals for the garden in summer or for the greenhouse during winter; 1½ ft., July to Oct. | |
| 7160 | FINEST MIXED. Shades of rose, scarlet, purple, and white Oz., .25 | .05 |
| 7165 | GRANDIFLORUS OCULATUS. Lilac with large violet blotch on each petal . . Oz., .30 | .05 |
| 7167 | RETUSUS ALBUS. White with yellow spots; beautiful for winter forcing . . Oz., .50 | .05 |
| 7168 | WISETONENSIS. Colors ranging from white with yellow centre to pink with brown centre, useful for winter cultivation | .25 |
| | SILENE. <i>Catchfly.</i> Free-blooming hardy plants of easiest cultivation, useful for beds and borders. | |
| 7220 | ARMERIA MIXED. Hardy annual, colors white, pink, and red; 1 ft., July to Sept. . . | .05 |
| 7230 | PENDULA DWARF ROSE. Very bright, excellent for spring bedding; 6 in., May to Aug. Oz., .30 | .05 |
| 7235 | — DWARF WHITE " .25 | .05 |
| 7260 | VIRGINICA. Free-flowering hardy perennial, intense crimson; 1 ft., June to Aug. | .10 |
| 7262 | SILPHIUM PERFOLIATUM. <i>Compass Plant.</i> Stately, hardy perennial with handsome yellow flowers in corymbose heads; useful for backgrounds of herbaceous borders or planting among shrubs; 6 ft. | .15 |
| 7265 | SMILAX. <i>Myrsiphyllum asparagoides.</i> A popular greenhouse climber with small dark-green foliage of great value for floral decorations. Flowers white, fragrant; tender perennial; 10 ft. Oz., .75 | .10 |
| | SNAPDRAGON. <i>See Antirrhinum, No. 462.</i> | |
| 7275 | SOLANUM. CAPSICASTRUM NANUM. <i>Jerusalem Cherry.</i> A very ornamental plant for winter decoration in the greenhouse or window. It is of compact branching habit with small dark green leaves and numerous bright scarlet berries. Seeds sown in February or March produce fine plants for autumn fruiting; tender perennial; 1 ft. | .10 |
| 7276 | ROBUSTUM. A noble plant for sub-tropical beds, with massive spiny bronze-colored leaves; tender perennial; 6 ft. | .10 |

- | No. | | Pkt. |
|------|--|------|
| 7285 | SOLIDAGO LATIFOLIA. <i>Golden Rod.</i> Hardy perennial with dense heads of deep golden yellow flowers; 2 ft., Aug. to Oct. | .10 |
| 7300 | STATICE. PERENNIAL SORTS MIXED. <i>Sea Lavender.</i> Handsome plants with large flower heads, which are everlasting and useful when dried for winter bouquets; 1 to 2 ft., July to Oct. | .10 |
| 7315 | STELLARIA GRAMINEA AUREA. Dwarf, hardy perennial with fine golden yellow foliage; very useful for edgings and carpet bedding; 3 inches | .10 |
| | STEVIA. Elegant greenhouse perennials producing very graceful sprays of tiny flowers exceedingly valuable for cutting. They bloom the first year from seeds and are valuable for summer and winter cultivation; 2 ft. | |
| 7325 | EUPATORIA. White ¼ oz., .30 | .10 |
| 7330 | LINDLEYANA. Blush white; fragrant, ¼ oz., .30 | .10 |
| 7335 | PURPUREA. Purple " .30 | .10 |
| 7340 | SERRATA. Pure white; fragrant " .40 | .10 |
| | STOCK. <i>Gilliflower.</i> The charming colors, delightful fragrance, and free-blooming character of the stocks have made them favorite plants for both summer and winter cultivation. They are very effective for beds and borders, and their handsome flower spikes are invaluable for bouquets and floral decorations. | |

Our Seeds are grown and saved in the most careful and skilful manner by celebrated European growers from the finest strains in existence.

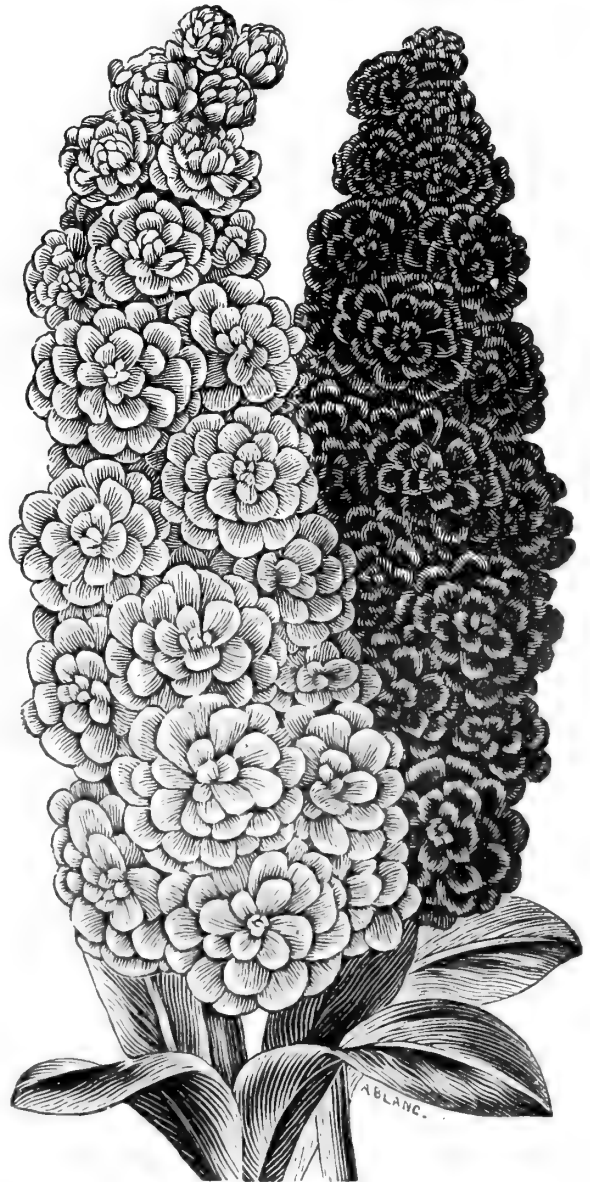

Large Flowering Ten-Week Stock. No. 7345.

No.	Pkt.	
STOCK — <i>Continued.</i>		
LARGE-FLOWERING DOUBLE TEN-WEEK VARIETIES. HIGHEST GRADE POT-GROWN SEED. The best variety for early summer blooming, producing massive pyramidal flower-spikes of brilliant colors and delightful fragrance; 1 ft.		
7345		COLLECTION OF 12 VARIETIES75
7350		COLLECTION OF 6 VARIETIES40
7355		FINEST MIXED Oz., 4.00 .10



Farquhar's White Column Stock. No. 7430.

No.	Pkt.	
STOCK — <i>Continued.</i>		
7365		BRILLIANT ROSE Oz., 4.00 .10
7370		CANARY YELLOW " 4.00 .10
7375		CARMINE " 4.00 .10
7380		CRIMSON " 4.00 .10
7385		DARK BLOOD RED " 4.00 .10
7390		DARK VIOLET-BLUE " 4.00 .10
7395		DARK PURPLE " 4.00 .10
7400		LIGHT BLUE " 4.00 .10
7402		PINK " 4.00 .10
7403		SCARLET " 4.00 .10
7404		SNOW WHITE " 4.00 .10
7406		FINE MIXED " 2.50 .05

FARQUHAR'S COLOSSAL TEN-WEEK.

This variety is especially valuable for bedding on account of its branching habit and continuance of bloom throughout the season. The enormous flower spikes, with numerous Carnation-like flowers, are not surpassed by any stock for cutting purposes; 1 1/2 to 2 ft.

7407		COLLECTION OF 12 VARIETIES1.50
7408		COLLECTION OF 6 VARIETIES90
7409		FINEST MIXED . . . Oz., 6.00; 1/8 oz., 1.00 .15
7410		WHITE " 6.00; " 1.00 .15
7411		PINK " 6.00; " 1.00 .15
7412		LIGHT BLUE " 6.00; " 1.00 .15
7415		BOSTON FLORISTS' DOUBLE WHITE. A favorite variety, producing a high percentage of large double white flowers, excellent for summer and winter cultivation . Oz., 5.00 .15
7425		FARQUHAR'S IMPROVED CUT-AND-COME-AGAIN. DOUBLE WHITE. A splendid early-flowering perpetual Stock. It is of tall branching habit, and when the first blooms have been cut, side branches start out bearing large flower trusses. The flowers are of large size, snowy whiteness, and thick massive form, with a high percentage double . Oz., 6.00; 1/8 oz., 1.00 .25
7430		FARQUHAR'S WHITE COLUMN. This is an early flowering sort, bearing one enormous spike of large double white flowers; 2 ft. 1/8 oz., 2.00 .25
7435		FARQUHAR'S CRIMSON COLUMN, 1/8 oz., 2.00 .25
7455		VICTORIA, FINEST MIXED. An early branching variety, producing large fragrant flowers, very useful for cutting; 15 inches. Oz., 4.00 .10
7460		DARK BLOOD RED. Rich shade . . " 4.00 .10
7480		BROMPTON. FINEST DOUBLE MIXED. Half-hardy perennial variety of pyramidal branching habit and producing handsome spikes of showy fragrant flowers25
7485		EAST LOTHIAN. FINEST DOUBLE MIXED. If sown in March these bloom in autumn, or if sown in June or July will make handsome pot plants for conservatory decoration in winter. The plants are of dwarf, compact habit, producing large, erect, Hyacinth-like flower trusses25
7490		— — CRIMSON25
7495		— — WHITE25
7497		STREPTOCARPUS HYBRIDUS. FINEST MIXED. <i>New Hybrid Cape Primroses.</i> Charming greenhouse perennials, of dwarf, neat habit, with clusters of Achimenes-like flowers borne on erect, slender stems. The colors embrace white, rose, red, purple, and violet, many of the flowers being beautifully blotched and striped; 9 inches50

SUNFLOWER. See *Helianthus*, No. 4140.

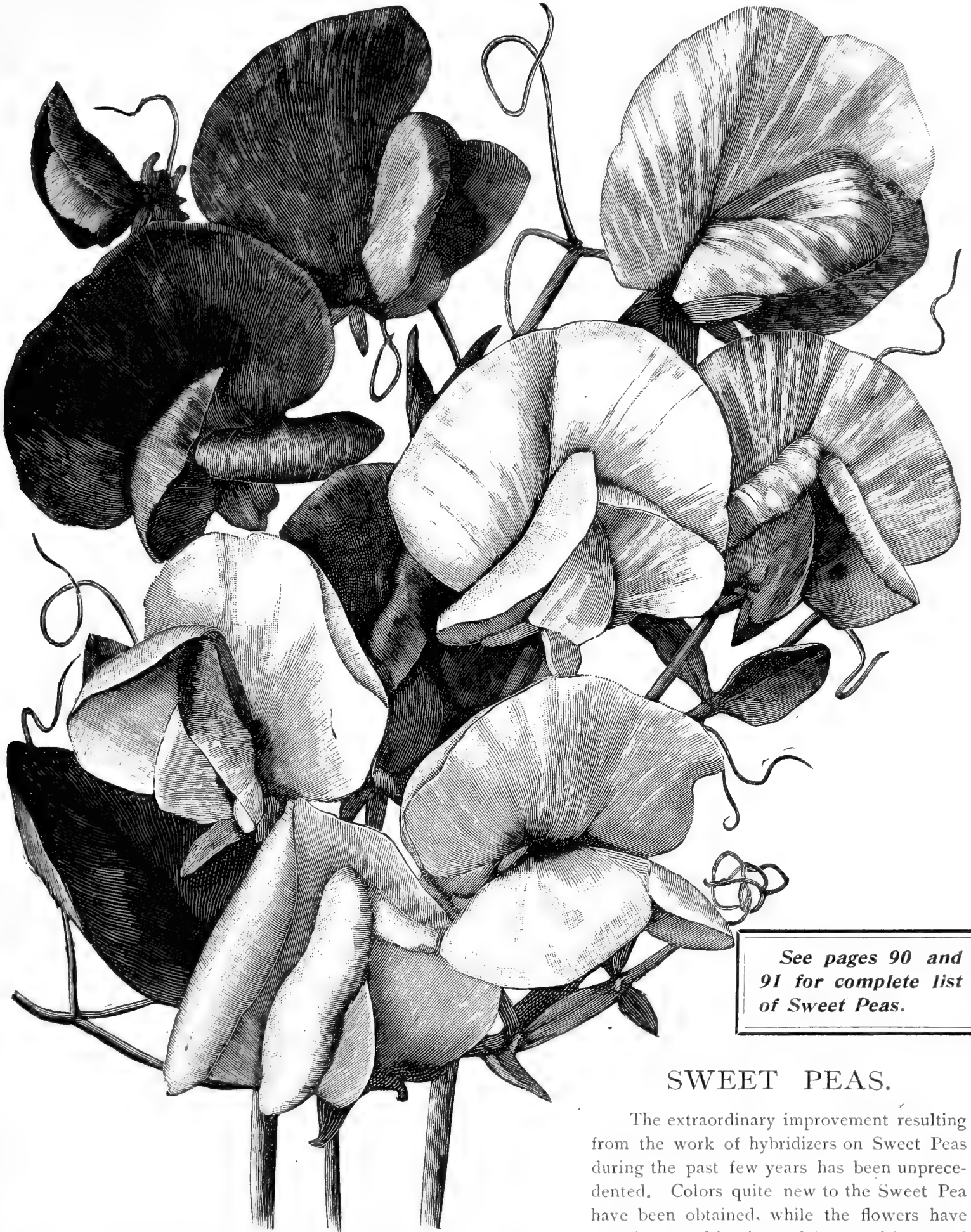

See pages 90 and 91 for complete list of Sweet Peas.

SWEET PEAS.

The extraordinary improvement resulting from the work of hybridizers on Sweet Peas during the past few years has been unprecedented. Colors quite new to the Sweet Pea have been obtained, while the flowers have been improved in size and form and increased in number.

Farquhar's Columbian Hybrid Sweet Peas. No. 7500.

7500 FAROUHAR'S COLUMBIAN HYBRIDS. FINEST MIXED. This mixture contains over fifty of the newest and best large-flowering varieties and none of the inferior sorts. The balance of color is carefully studied and the proportion of each variety weighed out before being mixed. Most of them have long stems each carrying three or four flowers of the finest substance. The more they are picked the more the flowers come, and the better for the vines. Pound, post-paid, \$1.00; $\frac{1}{4}$ lb., .30; oz., .15; large pkt., .10.

SWEET PEAS — *Continued.*

No.	Pkt.
7502 FARQUHAR'S "BOUQUET GEMS." Col- lection of 10 splendid colors. We have selected the finest sorts in existence for this collection; all large flowered, fragrant, and with long sten.s. The packets are of good size Per collection	.40
7505 FARQUHAR'S INTERNATIONAL PRIZE MIXTURE. This mixture includes all the leading colors as well as new sorts of estab- lished merit. It is mixed from named sorts and contains most beautiful and diversified colors . . . Lb., .75; ¼ lb., .25; oz., .10	.05
7510 CHOICE MIXED. All colors in great vari- ety . . . Lb., .50; ¼ lb., .20; oz. .10	.05

*Landscape Hill, New York Mills, N.Y.,
Feb. 10, 1902.*

Messrs. R. & J. Farquhar & Co.:

*Gentlemen: Allow me to state that the flower seeds we
had from you last year gave great results and great sat-
isfaction too.*

*The family never saw such Sweet Peas, seven feet high,
four and five blooms to a stem, and stems over 12 inches.
I had over 50 varieties.*

*Petunias, Zinnias, Antirrhinum, Primroses, and now
the Cinerarias, all superb. Please send the above order
at your earliest convenience, and oblige,*

Yours respectfully,

*JAMES HEPBURN,
Gardener, Mrs. Samuel Campbell.*

The rapid increase in the number of closely allied or
assumed varieties of Sweet Peas during the past few
years has caused much confusion and annoyance. We
have consequently discarded the inferior sorts and syn-
onyms, retaining the finest in each class. These we have
classified as nearly as possible, according to their colors,
to facilitate and simplify selection.

THE FOLLOWING SWEET PEAS, *except where
otherwise priced, PER LB., .75; ¼ LB., .25; OZ.,
.10; PKT., .05.*

No.	Pkt.
WHITE VARIETIES.	
7520 BLANCHE BURPEE. <i>Eckford's Large White.</i>	
7522 EMILY HENDERSON. Pure white, bold flower.	
7525 MRS. SANKEY. Opens pale blush turning to pure white, strong growing sort.	
7530 MONT BLANC. The earliest white sort; large, pure white flower. Lb., 1.25; oz., .15	.10
7535 SADIE BURPEE. Very large, pure white.	
PRIMROSE SHADES.	
7540 MRS. ECKFORD. The best shade of prim- rose.	
7545 PRIMROSE. Pale primrose.	
BLUSH VARIETIES.	
7550 BLUSHING BEAUTY. Light-delicate pink.	
7555 COUNTESS OF ABERDEEN. Light blush pink.	
7560 DUCHESS OF SUTHERLAND. Very light blush, nearly white.	
7565 HON. F. BOUVERIE. Beautiful self coral pink.	
7570 MODESTY. Soft blush. The lightest pink sort.	
PINK AND ROSE SHADES.	
7575 APPLE-BLOSSOM. Standards bright rose, wings rosy pink.	
7580 KATHERINE TRACY. Most beautiful shade of soft but brilliant pink; large flowers.	
7585 LOVELY. Large deep rose flowers shading to pink at the edges.	

No.	Pkt.
PINK AND ROSE SHADES — <i>Continued.</i>	
7595 PRIMA DONNA. A most beautiful shade of soft bright pink; frequently four flowers on a stem. One of the best Sweet Peas.	
7597 ROYAL ROBE. Beautiful deep pink.	
7600 ROYAL ROSE. Brilliant rosy pink; very large blossoms.	
7605 VENUS. Wings salmon-buff, standards rosy pink.	
ORANGE AND PINK SHADES.	
7610 GORGEOUS. Orange-pink, free blooming.	
7620 LADY MARY CURRY. Brilliant orange pink, large and beautiful flower.	
7625 ORIENTAL. Bright pink suffused with orange and primrose.	
DEEP ROSE AND ROSY CARMINE SHADES.	
7635 HER MAJESTY. Bright rose, large and brilliant.	
7637 MRS. DUGDALE. Crimson rose.	
7640 PRINCE OF WALES. Bright rose, very large and beautiful.	
SCARLET AND CRIMSON SHADES.	
7655 MARS. Brilliant crimson-scarlet, large flower.	
7660 PRINCE EDWARD OF YORK. Large open flowers of brilliant cherry-red color.	
7665 SALOPIAN. Pure cardinal; flowers large and of fine form.	
CLARET AND MAGENTA SHADES.	
7675 CAPTIVATION. Purplish magenta; distinct shade.	
7680 DUKE OF CLARENCE. Rich rosy claret.	
MAROON VARIETIES.	
7685 BLACK KNIGHT. Very deep maroon; lus- trous and handsome; large flower.	
7690 OTHELLO. Dark chocolate.	
7695 STANLEY. <i>Boreatton Improved.</i> Beautiful deep maroon.	
BLUE AND PURPLE SHADES.	
7700 CAPTAIN OF THE BLUES. Purplish-blue standard and blue wings; splendid.	
7705 COUNTESS OF CADOGAN. Sky blue.	
7710 DUKE OF SUTHERLAND. Purple-maroon standard; wings indigo blue; fine dark sort.	
7715 DUKE OF WESTMINSTER. Violet-crimson.	
7730 NAVY BLUE. Bluish-purple standard; wings navy blue; the best dark blue variety.	
7735 SHAHZADA. Dark maroon and violet.	
MAUVE AND LAVENDER SHADES.	
7740 COUNTESS OF RADNOR, IMPROVED. <i>New Countess.</i> Pure light lavender, self-color. The best lavender sort.	
7742 DOROTHY TENNANT. Deep rosy mauve.	
7745 EMILY ECKFORD. Heliotrope.	
7750 LADY GRISEL HAMILTON. Clear lavender.	
7755 LADY NINA BALFOUR. Delicate mauve.	
7760 LADY SKELMERSDALE. Rosy lilac.	
PINK OR RED VARIETIES WITH WHITE OR BLUSH WINGS.	
7765 EARLIEST OF ALL. Standard pink, wings white.	
7770 EXTRA EARLY BLANCHE FERRY. Pink and white.	
7775 COQUETTE. Deep primrose suffused with purplish rose; very fascinating flower.	
7790 QUEEN VICTORIA. Standard pale pink; wings light primrose yellow.	
7800 STELLA MORSE. Standards pale pink; wings primrose-yellow. One of the finest varieties.	

- | No. | | Pkt. |
|------|---|------|
| | SWEET PEAS — <i>Continued.</i> | |
| | WHITE WITH BLUE EDGE. | |
| 7805 | BUTTERFLY, IMPROVED. <i>Maid of Honor.</i>
White with light blue edge. | |
| | STRIPED RED AND WHITE. | |
| 7810 | AMERICA. Bright cardinal and white striped. | |
| | STRIPED SALMON OR PINK AND WHITE. | |
| 7820 | AURORA. Salmon and white striped; large flower; one of the best striped sorts. | |
| 7835 | RAMONA. White striped with soft pink; large, well-formed blossoms. | |
| | STRIPED LAVENDER AND WHITE. | |
| 7842 | WAWONA. Heliotrope and white striped. | |
| | STRIPED PURPLE AND WHITE. | |
| 7845 | GREY FRIAR. White marble with light purple. | |
| | DWARF OR CUPID SWEET PEAS. | |
| | These grow only about six inches in height, producing numerous flowers on rather short stems. They are interesting for pot culture or borders, but may be regarded as curiosities rather than acquisitions. | |
| 7860 | BLUSH. | |
| 7865 | ROSY PINK. | |
| 7870 | PURE WHITE. | |

SWEET CLOVER. In colonial times the Sweet Clovers were cultivated for their fragrant flowers, which, when dried, were used to perfume clothes.

- | | |
|------|---|
| 7880 | WHITE. <i>Melilotis gracilis.</i> Hardy biennial, blooming the first season with white, sweet-scented flowers; 3 ft. . . . Oz., .30 .05 |
| 7885 | BLUE. <i>Melilotis cœrulea.</i> Hardy annual; very fragrant; 2 ft. . . . Oz., .30 .05 |
| 7890 | YELLOW. <i>Trifolium suaveolens.</i> " .30 .05 |
| | SWEET SULTAN. <i>See Centaurea, Nos. 2625, 2630.</i> |



Single Sweet William. No. 7905.

SWEET WILLIAM. *Dianthus Barbatus.* Showy hardy biennials of easiest culture; admirable for clumps among shrubs or borders; June to Sept., 1½ ft.

- | No. | | Pkt. |
|------|---|------|
| | SWEET WILLIAM — <i>Continued.</i> | |
| 7905 | SINGLE, FINEST MIXED. Splendid colors. . . . Oz., .30 .05 | |
| 7915 | AURICULA-EYED, MIXED COLORS, " .75 .10 | |
| 7920 | DARK CRIMSON. Rich dark shade " .50 .05 | |
| 7925 | PURE WHITE. Excellent for cut flowers. . . . Oz., .50 .05 | |
| 7926 | DOUBLE FINEST MIXED. . . . " .75 .10 | |
| | TAGETES. <i>See Marigold, Nos. 4920-4987.</i> | |
| 7930 | THERMOPSIS CAROLINIANA. A tall growing hardy perennial with Clover-like leaves and magnificent spikes of golden yellow pea-shaped flowers; 5 ft., July to Sept.25 | |
| | THUNBERGIA. Charming climbing annuals of rapid growth, excellent for window boxes, hanging baskets and vases; 5 ft., July to Oct. | |
| 7945 | FINEST MIXED. Flowers white, yellow, and orange with black eyes . . . Oz., .75 .10 | |
| 7950 | ALATA. Yellow with black eye " 1.25 .10 | |
| 7955 | — ALBA. White with black eye " 1.25 .10 | |
| 7960 | AURANTIACA. Orange with black eye, " 1.25 .10 | |
| | TORENIA. A most beautiful genus of free-flowering tender annuals. If started in heat in February or March they commence to bloom in June and continue until frost. They are now extensively used for summer bedding as well as for conservatory decoration in pots; height 10 inches. | |
| 7970 | BAILLONI. Flowers golden yellow with purple throat25 | |
| 7975 | FOURNIERI. Flowers sky blue, with three large dark blue spots and a bright yellow throat 1/8 oz., .60 .10 | |
| 7980 | — GRANDIFLORA. A very large flowering form of the preceding . . . 1/8 oz., 1.00 .25 | |
| 7985 | — — COMPACTA. A dwarf form of <i>T. Fournieri</i> with large flowers; excellent for bedding 1/8 oz., 1.25 .25 | |
| 7990 | — WHITE WINGS. Blush white with yellow throats, very beautiful25 | |
| | TRITOMA OR KNIPHOFIA. <i>Flame or Fire Lily.</i> Magnificent hardy perennial bearing large spikes of brilliant flowers three to four feet in height. Unsurpassed for lawn or shrubbery groups. They should be mulched during winter; July to Nov. | |
| 7997 | UVARIA GRANDIFLORA. Scarlet and orange yellow; 4 ft. Oz., 1.25 .15 | |
| 8002 | TROLLIUS. JAPONICUS FLORE PLENO. <i>Giant Double Buttercup or Globe Flower.</i> One of our most handsome hardy perennials flowering in the early summer, with delicate foliage and handsome globular, golden yellow flowers; 18 inches . . . 1/8 oz., 1.25 .25 | |
| 8005 | TROPÆOLUM CANARIENSE. <i>Canary Creeper.</i> Elegant half-hardy annual climber with delicately cut leaves and lovely bright yellow fringed flowers; 10 ft., July to Sept. Oz., .50 .05 | |
| 8015 | TUNICA. SAXIFRAGA. Hardy perennial of dwarf spreading growth, studded with light pink flowers from July to October; 6 inches, .10 | |
| 8025 | VALERIANA. FINEST MIXED. Showy hardy perennials with flowers having the fragrance of Mignonette; June to Sept., 3 ft.05 | |
| | VERONICA. <i>Speedwell.</i> Showy, hardy perennials of easy culture and thriving in any good soil. | |
| 8100 | GENTIANOIDES. Violet; very beautiful; June to Aug., 2 ft.10 | |
| 8102 | LONGIFOLIA. Showy spikes of rich blue, lasting from July to September; 3 ft.10 | |

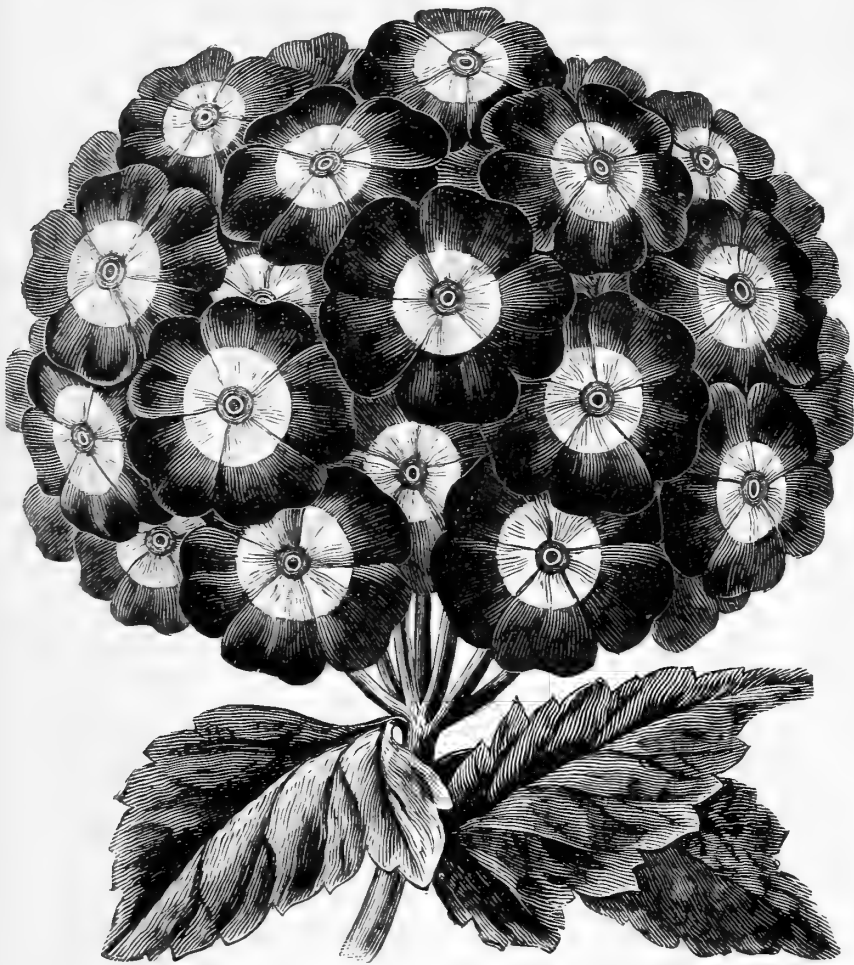

Verbena. Farquhar's Mammoth Hybrids. No. 8045.

- | No. | | Pkt. |
|------|--|------|
| | VERBENA. The Verbena is one of the most decorative and easily grown bedding plants. If started in heat in March the seedlings begin to bloom in June and continue until frost. Plants raised from seeds are stronger and flower more freely than those grown from cuttings. Half-hardy perennial; 1 ft. | |
| 8045 | FARQUHAR'S MAMMOTH HYBRIDS. A strain of very vigorous growth producing trusses of large flowers of brilliant and varied colors Oz., 2.50 | .10 |
| 8050 | AURICULA-FLOWERED, FINEST MIXED. Large flowers with distinct white eye in the centre of each floret Oz., 2.00 | .10 |
| 8055 | FINE MIXED. Choice colors in great variety, Oz., 1.00 | .05 |
| 8070 | LARGE-FLOWERED BLUE " 2.00 | .10 |
| 8075 | — PINK " 2.00 | .10 |
| 8080 | — SCARLET DEFIANCE. The finest scarlet sort, intense color Oz., 2.00 | .10 |
| 8082 | — WHITE. <i>Candidissima</i> . Pure white, splendid variety Oz., 2.00 | .10 |
| 8085 | — STRIPED. Many colors " 2.00 | .10 |
| 8095 | VERBENA MONTANA. <i>Drummondii</i> . Dwarf hardy perennial with lovely rose colored flowers, blooms the first season if sown early; July to Sept., 1 ft. | .10 |
| | VINCA. <i>Madagascar Periwinkle</i> . Beautiful perennial bedding plants, flowering freely the first season from seed if sown in February or March in heat. They have dark green Laurel-like foliage and handsome pink and white single flowers. They are most effective for beds and borders, and bloom from early summer until frost. The seed is of slow germination. Height, 1 ft. | |
| 8110 | FINEST MIXED Oz., 1.00 | .10 |
| 8115 | BRIGHT ROSE " 1.00 | .10 |
| 8120 | PURE WHITE " 1.00 | .10 |
| 8125 | WHITE WITH ROSE EYE " 1.00 | .10 |

- | No. | | Pkt. |
|------|--|------|
| | VIOLA CORNUTA. <i>See Pansies, Tufted</i> , No. 6090. | |
| | VIOLET. VIOLA ODORATA. The single-flowered varieties only can be raised from seeds; these, however, are very fragrant and quite hardy; April to June. | |
| 8150 | FINEST MIXED ¼ oz., .75 | .15 |
| 8160 | SEMPERFLORENS. Deep blue Oz., .75 | .10 |
| 8165 | THE CZAR. Very large; dark blue, ¼ oz., .75 | .10 |
| 8170 | WHITE CZAR. White; large flower, ¼ oz., .50 | .10 |
| 8175 | VIRGINIAN STOCK. Early, free-flowering hardy annual; May to June; 6 in.; mixed red and white Oz., .25 | .05 |
| 8180 | VISCARIA, FINEST MIXED. <i>Rock Lychnis</i> . Showy and free-blooming hardy annuals, allied to the Lychnis, suitable for small beds and borders; July to Sept., 1 ft., Oz., .25 | .05 |
| | WALLFLOWER. Half-hardy perennials of delicious fragrance. If sown in heat in March or April good plants will be obtained for flowering during the following winter in a cool greenhouse, or they may be kept in cold frames and bloomed in the spring and early summer. The early Parisian variety may be treated as an annual; if sown in heat in February or March, the plants will bloom freely during the summer and autumn. | |
| 8215 | EARLY PARISIAN, OR ANNUAL. Light brown. Oz., .60 | .10 |
| 8217 | SINGLE, FINEST MIXED. Colors yellow to maroon Oz., .40 | .05 |
| 8220 | — BLOOD-RED. Very rich color " .50 | .10 |
| 8221 | — PRIMROSE-YELLOW. A lovely shade, Oz., .50 | .10 |
| 8222 | DOUBLE, COLLECTION OF 8 VARIETIES | .80 |
| 8223 | DOUBLE BRANCHING, FINEST MIXED, ¼ oz., 1.00 | .25 |



Annual Wallflower. No. 8215.

No.		Pkt.
	WAHLENBERGIA, OR PLATYCODON, <i>Japanese Balloon Flower</i> . Magnificent hardy perennials of erect bushy growth and bearing a profusion of large, bell-shaped flowers, varying in color from pure white to deep violet; June to Oct., 3 ft.	
8195	GRANDIFLORA. Deep blue, balloon-like flowers Oz., .75	.10
8200	— ALBA. White " .75	.10
8210	— CÆRULA PLENA. Double blue, ¼ oz., .75	.25
8212	— ALBA PLENA. Double white " .50	.25
8225	WHITLAVIA GRANDIFLORA. Showy hardy annual with dark blue bell-shaped flowers; very floriferous and excellent for small beds or ribbon borders; June to Oct., 1 ft., Oz., .30	.05
8230	— ALBA. White; very beautiful in combination with the preceding . . . Oz., .30	.05
	WIGANDIA. Stately and decorative half-hardy perennials with large, beautifully-veined leaves frequently three feet long by one and a half in width; excellent for subtropical beds and lawn groups. Seeds sown in heat in February or March produce fine plants for planting out in May or June, 6 ft.	
8235	CARACASANA. Lilac10
8240	IMPERIALIS. Very ornamental10
8245	XERANTHEMUM, FINEST DOUBLE MIXED. Profuse blooming hardy annuals with Everlasting flowers; useful for winter bouquets; colors pure white and deep purple; July to Sept., 1½ ft. Oz., .75	.05
8250	YUCCA FILAMENTOSA. <i>Adam's Needle</i> . Splendid, hardy plants for shrubbery or lawn groups; thriving in any soil; with magnificent spikes of creamy white flowers; leaves with thread-like filaments on their edges; hardy perennial; 4 ft., July to Aug.	.10

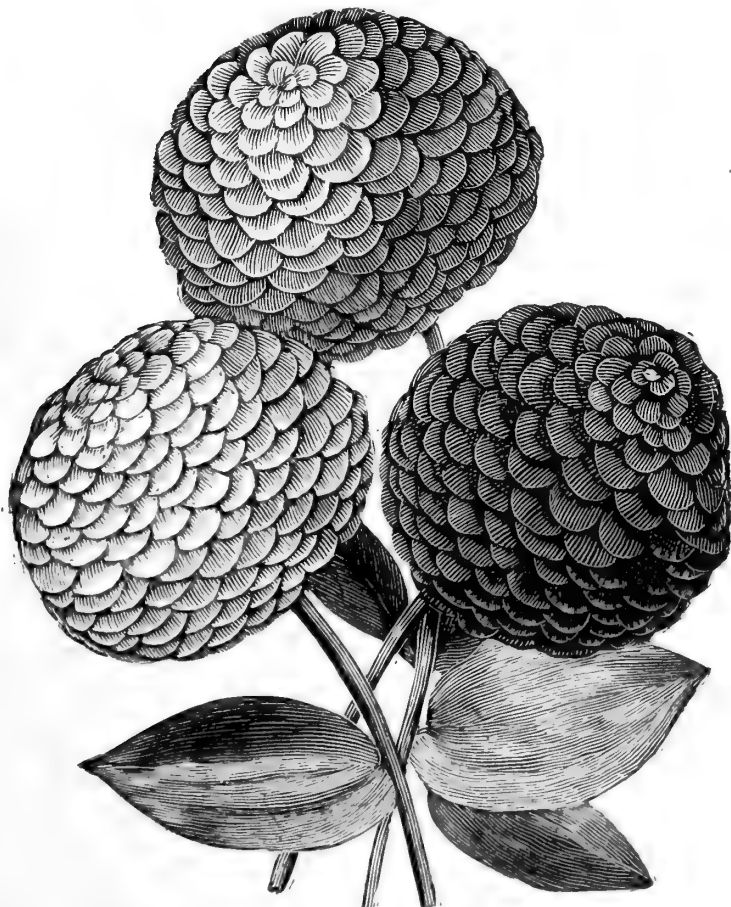

Zinnia, Farquhar's Exhibition Prize. No 8275.

No.		Pkt.
8260	ZAUSCHNERIA CALIFORNICA. <i>Humming Bird Trumpet</i> . A very attractive hardy perennial with bright vermilion, Fuchsia-like drooping flowers; 1½ ft.25
8265	ZEA JAPONICA VARIEGATA. <i>Striped Japanese Maize</i> . Beautifully striped green and white foliage; annual; 5 ft. Oz., .10	.05
8270	GRACILLIMA VARIEGATA. <i>Miniature Maize</i> . Long slender foliage beautifully striped; 4 ft. Oz., .10	.05
8272	QUADRICOLOR. Leaves bright green, white, sulphur-yellow, and rose striped, Oz., .20	.10
	ZINNIA. Most desirable and decorative annuals for beds and mixed borders. The dwarf varieties from their compact and dense growth are particularly useful for beds, while the tall sorts are well adapted for inside rows in ribbon borders. Hardy annuals of easy culture, blooming from July until frost.	
8275	FARQUHAR'S EXHIBITION PRIZE, MIXED. Saved from the finest double flowers and comprising the most brilliant and beautiful colors. Height, 2 ft. Oz., .50	.05
8280	LARGE DOUBLE, COLLECTION OF 10 COLORS	.50
8285	— COLLECTION OF 6 COLORS30
8290	— BRIGHT ROSE. Beautiful soft shade, Oz., .60	.05
8295	— CARMINE. Brilliant color . . . " .60	.05
8300	— DARK CRIMSON " .60	.05
8305	— DARK PURPLE " .60	.05
8315	— FLESH PINK " .60	.05
8320	— GOLDEN-YELLOW. Rich and beautiful, Oz., .60	.05
8325	— LEMON-YELLOW " .60	.05
8330	— LILAC " .60	.05
8335	— SCARLET. Intense shade . . . " .60	.05
8340	— STRIPED OR ZEBRA. Many colors, Oz., .75	.05
8345	— WHITE " .60	.05
8350	DWARF, FARQUHAR'S PRIZE DOUBLE, FINEST MIXED. Flowers of large size and splendid colors; very numerous. Height, 15 inches Oz., .75	.05
8351	— LARGE-FLOWERED, DOUBLE COLLECTION OF 6 COLORS30
8355	— BRIGHT ROSE Oz., .75	.05
8360	— CRIMSON " .75	.05
8365	— DAZZLING SCARLET. Very brilliant, Oz., .75	.05
8370	— FLESH PINK " .75	.05
8380	— ORANGE. Rich golden yellow . . . " .75	.05
8385	— PURPLE " .75	.05
8390	— VIOLET " .75	.05
8395	— WHITE " .75	.05
8400	— YELLOW " .75	.05
8405	GIANT OR ROBUSTA, FINEST MIXED. The largest of all Zinnias; flowers double; many brilliant colors; 3 ft. Oz., 1.25	.10
8415	CURLED AND CRESTED. A strain, having large double flowers, the petals of which are curiously twisted and curled; many colors mixed Oz., .75	.10
8420	HAAGEANA FLORE PLENO. <i>Mexican Zinnia</i> . A dwarf variety with small, double, orange-colored flowers Oz., 1.50	.10
8425	LILIPUT, DOUBLE MIXED. Interesting little plants with small globular flowers; 9 in., Oz., 1.25	.10
8430	TOM THUMB, FINEST MIXED. A charming variety with small, well-formed, double flowers of brilliant colors; 9 inches, Oz., 1.25	.10

ORNAMENTAL GRASSES.

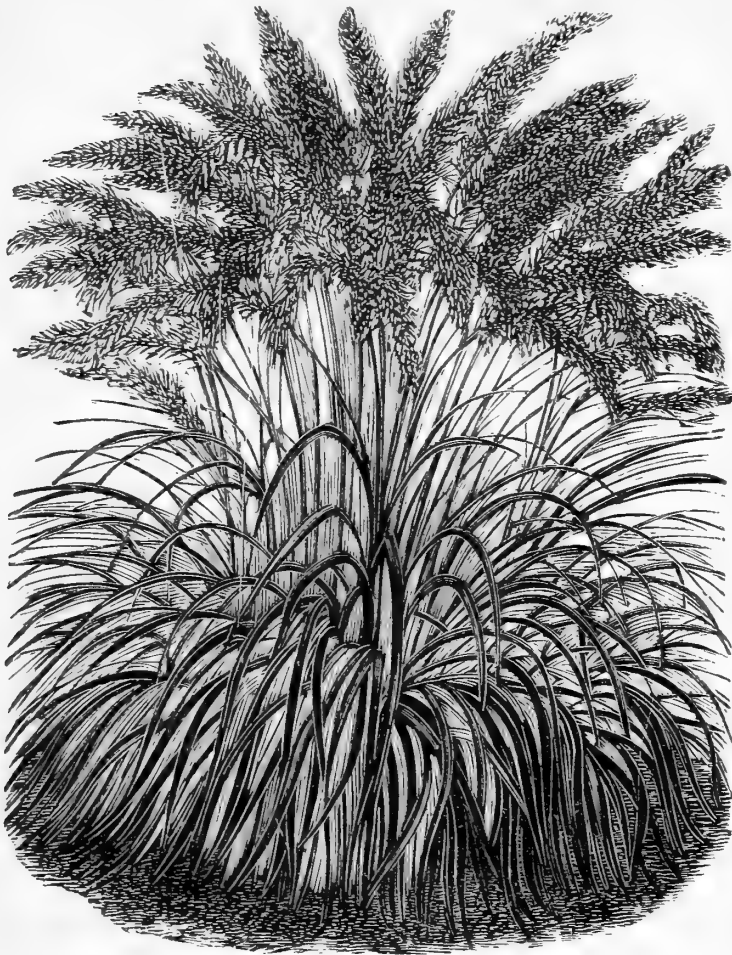

Pennisetum Ruppelianum. No. 8533.

The perennial varieties, many of which have beautifully variegated foliage, are valuable for borders and clumps on lawns or among shrubs. The annual sorts are chiefly grown for their elegant flower panicles which are useful in bouquet work and for dried flowers. They should be cut before being fully expanded.

No.		Pkt.
8440	COLLECTION OF 25 VARIETIES75
8445	COLLECTION OF 12 VARIETIES50
8450	FINEST MIXED. Many sorts05
8455	AGROSTIS NEBULOSA. One of the most elegant annual sorts; 1 ft.05
8460	ANDROPOGON ARGENTUS. Hardy perennial with silvery plumes, very ornamental in groups; 3 ft.05
8465	ANIMATED OATS. <i>Avena sterilis</i> . The long sensitive awns readily expand and contract, causing the seed to move about; annual, 18 inches05
8470	ANTHOXANTHUM GRACILE. For edgings; annual05

No.		Pkt.
8475	ARUNDO DONAX VARIEGATA. Stately perennial with drooping green and white striped leaves; excellent for lawn clumps; 9 ft.10
8480	BRIZA GRACILIS. <i>Small Quaking Grass</i> . Beautiful for bouquets; ann'l, 1 ft. Oz., .4005
8485	— MAXIMA. <i>Large Quaking Grass</i> . Elegant panicles, excellent for bouquets and dried flowers; annual, 1 ft.40 .05
8490	BROMUS BRIZÆFORMIS. Large drooping panicles, useful for bouquets; annual, 2 ft.05
8500	COIX LACHRYMA. <i>Job's Tears</i> . A strong broad leaved grass with large shining pearly seeds; annual, 3 ft.25 .05
8505	ERIANTHUS RAVENNÆ. A hardy perennial Grass resembling the Pampas, with beautiful foliage and fine silvery plumes; excellent for lawn specimens. Blooms the first year from seed if sown early; 8 ft.10
8510	ERAGROSTIS ELEGANS. <i>Love Grass</i> . Elegant for bouquets and for use with Everlasting flowers; annual, 1 ft.05
8515	EULALIA JAPONICA FOLIIS VITTATIS. This is one of our finest hardy perennial Grasses, with long graceful leaves, dark green and white striped. It is one of the most beautiful for forming clumps; 4 ft.10
8517	— ZEBRINA. <i>Zebra Grass</i> . The dark green leaves are barred or crossed at intervals with broad markings of yellowish white. Few variegated plants equal this in beauty,10
8520	GYNERIUM ARGENTUM. <i>Pampas Grass</i> . Half-hardy perennial with magnificent silvery plumes; 10 ft.10
8525	HORDEUM JUBATUM. <i>Squirrel-Tail Grass</i> . Bushy panicles, excellent for bouquets, annual; 3 ft.05
8530	LAGURUS OVATUS. <i>Hare's Tail Grass</i> . Hardy annual with silvery-gray tufts; useful for dried flower work; 1 ft.30 .05
8532	PENNISETUM LONGISTYLUM. An annual grass with gracefully drooping heads; 2 ft.05
8533	— RUPPELLIANUM. The foliage is long and slender, gracefully recurved and glossy deep green in color. If sown in March in heat, the plants should bloom by the middle of July, and the silvery plumes tinted with violet-purple waving in the sunlight are exquisitely beautiful; hardy perennial; 3 ft.10
8535	STIPA PENNATA. <i>Feather Grass</i> . Hardy perennial with silvery white, feathery plumes; 2 ft.05
	ZEA JAPONICA. See No. 8265.	

REPAIRING LAWN MOWERS.

Parties sending mowers to us for repairs will please PUT THEIR NAME ON THE TAG, and when shipping same NOTIFY US OF THE SHIPPING, giving full shipping directions.

Please give us full particulars as to repairing and sharpening same, as all mowers that we repair are taken apart and cleaned, each part separately. Price for sharpening is \$1.50 each for hand mowers, and if repairs are needed they will be charged extra.

In all cases the FREIGHT OR EXPRESS MUST BE PREPAID or it will be charged up against the goods repaired.

GUIDE TO SELECTION OF SEEDS AND PLANTS.

PLANTS SUITABLE FOR CUTTING, FLOWERING THE FIRST YEAR FROM SEED.

Ageratum, Agrostemma, Alyssum, Ambrosia, Antirrhinum, Arctotis, Asperula, Aster, Belvidere, Cacalia, Calendula, Calliopsis,	Candytuft, Carnation Marguerite, Celosia plumosa, Centaurea, Chrysanthemum, Clarkia, Cleome, Collinsia, Collomia, Cosmidium, Cosmos,	Dahlia, Diarrhus, Gaillardia, Gaura, Gerardia, Godetia, Gypsophila, Helianthus, Larkspur, Lavatera, Leptosyne, Lupinus,	Malope, Mathiola, Marigold, Matricaria, Mignonette, Nasturtium, Nicotiana, Nigella, Pansy, Poppy, Pentstemon, Phlox Drummondii,	Salpiglossis, Salvia, Scabious, Schizanthus, Stevia, Stock, Sweet Pea, Sweet Clover, Verbena, Wallflower, Zinnia, Ornamen'l Grasses.
--	--	--	--	---

PLANTS FOR BEDDING, FLOWERING THE FIRST YEAR FROM SEED.

Adonis, Ageratum, Alonsoa, Amaranthus, Antirrhinum, Argemone Aster, Balsam, Bartonia, Begonia, Brachycome, Browallia, Calendula, Calliopsis, Callirhoe, Candytuft, Carnations,	Celosia, Centaurea, Chrysanthemum, Cineraria, Clarkia, Coleus. <i>For foliage.</i> Convolvulus, Cuphea, Datura, Dianthus, Eschscholtzia, Eutoca, Gaillardia, Gerardia, Gilia, Godetia, Grasses, Ornamen'l	Helianthus, Helichrysum, Hibiscus, Larkspur, Lavatera, Linum, Lobelia, Lotus, Lupinus, Malope, Marigold, Mignonette, Mirabilis, Molucella, Nasturtium, Nemesia, Nemophila,	Nicotiana, Nigella, Nycterinia, Pansy, Poppy, Perilla. <i>For foliage.</i> Petunia, Phlox Drummondii, Physalis, Pyrethrum. <i>For foliage.</i> Ricinus, Sabbatia, Salpiglossis, Salvia, Santolina, Sanvitalia,	Saponaria, Scabious, Schizanthus, Schizapetalon, Sedum, Silene, Solanum, Stevia, Stock, Torenia, Verbena, Vinca, Virginian Stock, Viscaria, Whitlavia, Zea or Maize, Zinnia.
--	---	--	---	--

PLANTS WITH ORNAMENTAL FOLIAGE.

Acanthus, Agrostemma, Amaranthus, Canna,	Centaurea, Cerastium, Cineraria, Coleus,	Echeveria, Edelweiss, Euphorbia, Grevillea, Wigandia, Zea.	Lavatera, Musa, Nicotiana, Perilla,	Phormium, Pyrethrum, Ricinus, Salvia,
---	---	--	--	--

FRAGRANT FLOWERS.

Sweet Alyssum, Asperula, Carnation,	Heliotrope, Lavender, Mathiola,	Mignonette, Nicotiana affinis, Nycterinia, Wallflower.	Rocket, Scabious, Stock,	Sweet Pea, Sweet Sultan, Violet,
---	---------------------------------------	---	--------------------------------	--

EVERLASTINGS FOR WINTER DECORATION.

Acroclinium, Ammobium,	Globe Amaranth, Helichrysum,	Helipterum, Honesty,	Rhodanthe, Xeranthemum,	Ornamen'l Grasses.
---------------------------	---------------------------------	-------------------------	----------------------------	--------------------

PLANTS FOR SHADY PLACES.

Alyssum, Amaranthus, Aquilegias, Bartonia, Begonia,	Browallia, Calendula, Candytuft, Centaurea, Chrysanthemum,	Convolvulus minor, Foxglove, Fuchsia, Godetia, Larkspur,	Linum, Lobelia cardinalis, Malope, Marigold, Mirabilis,	Myosotis, Memophila, Nicotiana, Pansy.
---	--	--	---	---

PLANTS FOR DRY, SUNNY SITUATIONS.

Alyssum, Balsams, Calendula,	Chrysant'm tricolor, Dianthus, Eschscholtzia,	Helichrysum, Marigold, Mesembryanth'm,	Petunia, Portulaca, Rhodanthe,	Salvia, Verbena, Vinca.
------------------------------------	---	--	--------------------------------------	-------------------------------

CLIMBING PLANTS, FLOWERING THE FIRST YEAR FROM SEED.

Abobra, Adlumia, Bean, Scarlet Runner,	Cobea, Coccinea, Cyclanthera, Cypress Vine,	Dolichos, Echinocystis, Gourds, Humulus, Thunbergia, Tropæolum Canariense.	Ipomoea, Lophospermum, Maurandya, Moonflower,	Mina, Momordica, Nasturtium, Sweet Pea,
--	--	--	--	--

BIENNIAL AND PERENNIAL PLANTS FOR OLD-FASHIONED GARDENS AND HERBACEOUS BORDERS.

Acanthus, Achillea, Aconitum, Adenophora, Adonis, Agrostemma, Alstroemeria, Alyssum, Anchusa, Anemone, Anthemis, Anthericum, Aquilegia, Arabis, Armeria, Asclepias, Asperula, Asphodelus, Aster, Aubretia, Baptisia, Bellis perennis, Bocconia,	Boltonia, Borago, Bupthalmum, Calimeris, Calliopsis, Campanula, Candytuft, Carnations, Centaurea, Cephalaria, Cerastium, Chelone, Chrysanthemum, Commelina, Dahlia, Delphinium, Dictamnus, Digitalis, Dodecatheon, Dracocephalum, Echinops, Edelweiss, Eremurus,	Eryngium, Eupatorium, Gaillardia, Galega, Gentiana, Geum, Gypsophila, Hedysarum, Helenium, Helianthemum, Helianthus, Heliopsis, Helleborus, Hesperis, Heuchera, Hibiscus, Hollyhock, Hunnemannia, Hypericum, Incarvillea, Inula, Liatris, Linum,	Lobelia, Lupinus, Lychnis, Lythrum, Malva, Monarda, Morina, Myosotis, Cenothera, Oxalis, Pæony, Tufted Pansies, Poppy, Pentstemon, Phlox, Physostegia, Polemonium, Polyanthus, Primrose, Primula, Pyrethrum, Romneya, Rosa polyantha,	Rudbeckia, Saponaria, Scabious, Silene, Silphium, Solidago, Statice, Stellaria, Stevia, Sweet William, Thermopsis, Tritoma, Trollius, Tunica, Valeriana, Verbena, Veronica, Violet, Wahlenbergia, Wallflower, Yucca, Zauschneria, Ornamen'l Grasses.
---	--	--	---	--

BULBS, ROOTS, AND TUBERS.

FOR SUMMER AND AUTUMN FLOWERING.



Achimenes.

ACHIMENES.

Profuse blooming tender perennials for greenhouse or conservatory decoration during summer. The scaly tubers should be potted in the early spring in a compost of turfy loam, leaf mould, and sand. They should be grown in a moist, warm temperature, shaded from the sun until they begin to bloom, when they should be kept cooler to prolong the duration of the flowers. The colors comprise white, shades of lilac, mauve, and crimson.

		Doz.	Per 100.
NAMED VARIETIES.	The finest sorts	\$1.00	\$6.00
MIXED VARIETIES.	All colors75	4.50

ADONIS VERNALIS.

Hardy perennial plant with beautiful cup-shaped yellow flowers and delicately divided leaves; height, 6 inches. Each, 15 cents; per doz., \$1.50; per 100, \$10.00.



ACIDANTHERA BICOLOR.

ACIDANTHERA BICOLOR.

A valuable new bulbous plant for greenhouse or open ground. Each flower stalk produces from four to eight widely expanded fragrant flowers, of creamy white color with broad violet-maroon blotches. The flowers are very lasting, and being borne on long stems are excellent for bouquets and table decorations. The bulbs should be treated like Gladioli. Each, .15; doz., \$1.50.

AGAPANTHUS.

(*African Lily.*)

Handsome summer and autumn flowering plants, throwing up large umbels of twenty to thirty blossoms. They should be grown in pots or tubs. They are particularly suitable for piazza or terrace decoration, and may also be forced in the greenhouse.

UMBELLATUS. Fine blue. Each, .25; \$2.00 per doz.; by mail, .35 each.

UMBELLATUS ALBUS. White. Each, .20; \$1.50 per doz.; by mail, .30 each.



Alstroemeria Aurantiaca.

ALSTRÆMERIA AURANTIACA.

A beautiful summer-flowering tuberous plant, growing about three feet high, and bearing large clusters of handsome, lily-like flowers, deep orange, spotted with crimson, very beautiful and excellent for cutting. Set the roots six inches deep and protect during winter with a heavy covering of leaves or litter. Per doz., \$1.50; per 100, \$10.00.

AMARYLLIS.



Amaryllis Hippeastrum.

	Each.	Per Doz.	Per 100.
BELLADONNA MAJOR. (<i>Belladonna Lily</i> .) Flowers white, flushed and tipped with deep rose; extra large bulbs25	\$2.00	\$12.00
DEFIANCE. Rich carmine, striped and suffused with white75	7.50	
EQUESTRIS. Scarlet, with broad white stripes, extending from the throat to half way up the segments,50	4.00	25.00
FORMOSISSIMA. (<i>Jacobean Lily</i> .) Dark crimson20	1.50	8.00
HIPPEASTRUM, NEW HYBRIDS. (<i>Vittata</i> .) The finest race of Amaryllis in cultivation; exceeding in the size and fine form of their flowers, as well as in the diversity of colors and markings, all former hybrids. The segments are of nearly uniform size, giving the flowers a regular trumpet form	1.00	9.00	60.00
JOHNSONI. (<i>Barbadoes Spice Lily</i> .) Enormous bright crimson flowers with a white stripe through each segment; magnificent75	7.50	50.00
LUTEA. (<i>Mount Etna Lily</i> .) Bright golden yellow; hardy if well covered during the winter10	.75	3.50

	Each.	Per Doz.	Per 100.
PRINCE OF ORANGE. Orange scarlet	\$2.00	\$20.00	
RETICULATUM STRATEFOLIUM. Lilac, striped white	2.50	25.00	
VALLOTA PURPUREA. (<i>Scarborough Lily</i> .) Vivid scarlet; most effective for piazza pots and vases in summer and autumn,50	4.50	\$30.00
ZEPHYRANTHES ROSEA. Beautiful rose-pink flowers, three to four inches across05	.40	2.00
ZEPHYRANTHES CANDIDA. (<i>Fairy Lily</i> .) Pure white, delicately scented05	.40	2.00

ANEMONES. (*French Type*.)

SINGLE DE CAEN. (*Giant French Poppy-flowered*.) If planted in April or May, these produce an abundance of large Poppy-like flowers early in summer of very brilliant colors.

Per doz., .15; per 100, .85.

ST. BRIGID. (*Irish Anemone*.) Semi-double flowers, in shades of scarlet, blue, and purple. Per doz., .60; per 100, \$3.50.

For Japanese Anemones, see *Herbaceous Perennial Plants*.

BESSERA ELEGANS. (*Coral Drops*.) An elegant bulbous plant with thin rush-like foliage and slender flower stems 18 inches in height, each bearing several scarlet flowers suspended by thread-like flower stalks.

Each, .05; per doz, .50; per 100, \$2.50.

CYCLOBOTHTRA FLAVA. In habit of growth this plant resembles *Bessera Elegans*, the flowers, however, being cup-shaped, golden yellow with black spots, and of nodding habit.

Each, .05; per doz., .40; per 100, \$2.00



Single French Anemone.

FARQUHAR'S SUPERB LARGE-FLOWERING TUBEROUS-ROOTED BEGONIAS.

The Finest Produced in Europe at Minimum Prices.

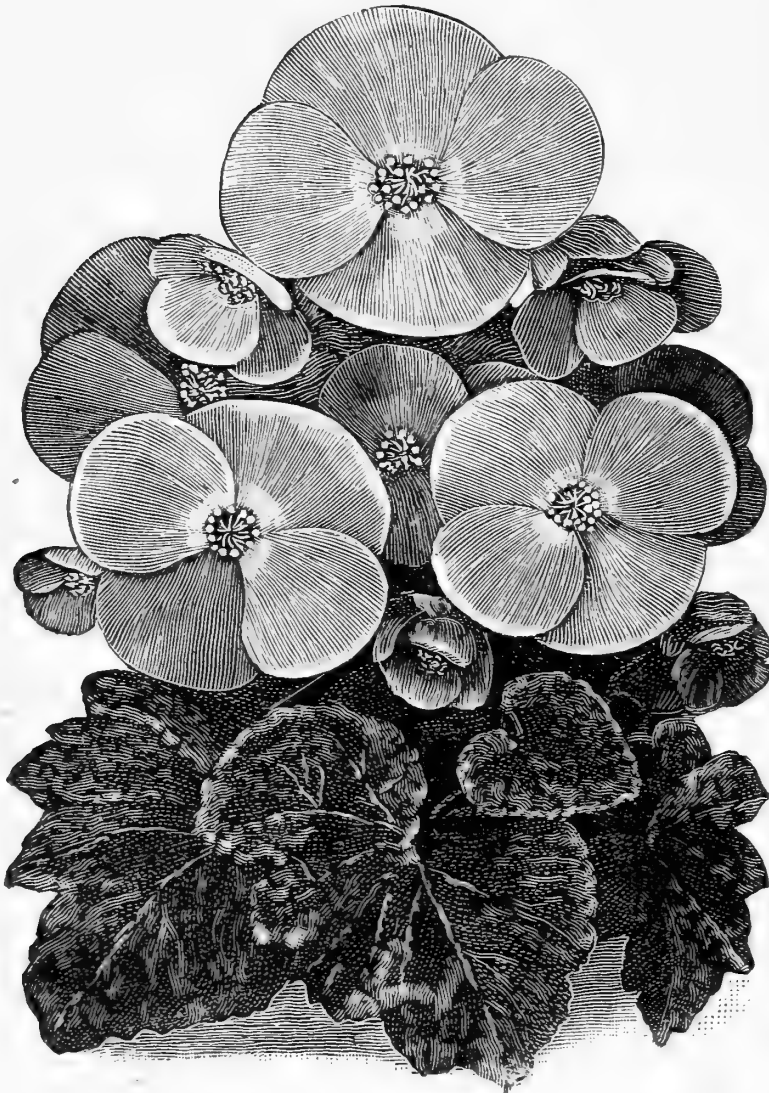

Tuberous-Rooted Begonia.

The great value of Tuberous-Rooted Begonias for *Lawn Beds and Borders* is now being appreciated. They bloom continuously from early summer until frost, producing a profusion of large and gorgeous flowers. Throughout Europe they are used very extensively, particularly in the beautiful parks of Paris.

They are of easiest cultivation, rarely attacked by insects or blight, and succeed in any good soil which is kept moderately moist.

The tubers we offer have been specially grown for us by celebrated European cultivators, and we feel assured that they are not surpassed by any strain in commerce. *Mailed free at dozen rates.*

SINGLE-FLOWERING VARIETIES.

These are best adapted to outdoor planting.

	Per Doz.	Per 100.	Per 1,000.
MIXED, all colors50	\$3.50	\$30.00
SEPARATE COLORS. White, yellow, orange, rose, scarlet, crimson60	4.00	35.00

DOUBLE-FLOWERING VARIETIES.

These should be grown in pots under glass.

	Per Doz.	Per 100.	Per 1,000.
MIXED, all colors	\$1.00	\$7.00	\$60.00
SEPARATE COLORS. White, yellow, orange, rose, scarlet, crimson, each	1.25	9.00	80.00

Six of a kind at dozen rate, 50 at hundred rate, 250 at 1,000 rate.

CULTURAL DIRECTIONS.—The tubers may be started in February or March, either singly in small pots or set two inches apart in flat boxes. The soil should be light, containing plenty of leaf mould and sand. In planting, care should be taken to set the crown of the tuber, which is usually somewhat depressed, upwards. The tubers should be covered half an inch with light soil and watered sparingly until they start, after which more water may be given. The temperature should be 60 to 70 degrees. The started plants, when intended for bedding purposes, may be transferred to the beds in the open ground early in June, by which time they should be in bloom. The plants should be set ten or twelve inches apart.

Although there is much to be gained by starting the tubers as early as just described, they may be planted unstarted in the open ground beds in the last week of May or later, with excellent results.

They will thrive either in full sunshine or partial shade, but when fully exposed to the sun the beds must be kept moist. A wind-swept situation should be avoided.

Allen Winden Farm, Lenox, Mass., Dec. 21, 1903.

Dear Sirs: It gives me pleasure to tell you that the Tuberous Begonia Bulbs we bought of you have given us every satisfaction. I can particularly recommend your strain for fine bold flowers of good form and color, while the vigor of the bulbs cannot be surpassed.

Very truly yours,

A. H. WINGETT, Supt.

"The Begonias you sent me last spring are the finest I have ever grown, remarkable for their free flowering and for the size of their blooms. Many of the Flowers have measured six and a quarter inches in diameter."

CHARLES SIMPKINS, Oak Hill, Peabody, Mass.

CALLA LILIES. (*Richardia*.)

GOLDEN YELLOW CALLA. *Elliottiana*. This is a true golden yellow Calla, having the same habit of growth, form, and size of flower as the common white Calla, and is vastly superior to previous yellow varieties. The flowers are exquisitely beautiful and rich in effect, their color pure golden yellow; foliage dark green, lightly spotted with white; a handsome and charming plant. Large bulbs, each, \$1.00; per doz., \$10.00.

WHITE CALLA. *Æthiopica*. Will bloom continually summer and winter, if kept in growing condition. Each, .20; per doz., \$2.00.

LITTLE GEM. Miniature White Calla; grows only about a foot high, and bears many white flowers half the size of those of the common White Calla. Each, .15; per doz., \$1.50.

HARDY SPOTTED-LEAF CALLA. *Alba maculata*. Flowers white; leaves rich green, spotted with white; hardy with slight mulching during winter. Each, .10; per doz., .75.

FANCY-LEAVED CALADIUMS.

Wherever high-class decorations are required during summer, these plants are indispensable. When grown in pots they may be used in the conservatory or the house with equal satisfaction. For table decoration, for jardinières, and for enlivening groups of palms or ferns, they are most serviceable. They are quite as desirable for bedding purposes, and may be planted out after the middle of June in the sunniest situations, if well watered, or in partial shade, but they should be sheltered from strong wind. The tubers should be started in the greenhouse in February or March, and if intended for out-door beds gradually hardened off before being transferred to the open ground.

ANNIBAL. Stems ebony; leaves light green; ground shaded dark green; brilliant crimson ribs and nerves.

BEETHOVEN. Uniform green ground thickly speckled and spotted with white; midrib white, or with faint pink line.

CHRISTIANI OTTONII. Leaves white, suffused with green and splashed crimson; lovely.

DUC DE RATIVOR. Dark green ground, mottled and suffused with white; ribs and veins dull crimson.

DUCHARIRII. Body of leaf rose-pink, profusely veined and traced with sea-green veinings and splashed with crimson; very effective; ribs lustrous green, and leaf margined with a narrow band of green.

ED. MOREAU. Ribs rich glossy crimson; centre of leaf darker crimson; body of leaf rich deep green, profusely spotted with irregular white blotches changing to pink.

EMILE VERDIER. Gray-green ground; ribs pale green; centre dull red, changing to a beautiful creamy white bordered gray; deep crimson spots.

MRS. J. LINDEN. Deep green ground, mottled and splashed white, suffused pink, ribs dull crimson.

ROSSINII. Ribs and centre of leaf rich crimson; body of leaf rich deep green, with a few large, irregular, bright blood-red blotches which look as though varnished.

WIGHTII. Entire leaf uniform green, with silvery white blotches and a lesser number of larger crimson blotches.

CHANTINII. Green ground, ribs light maroon, bordered white; centre of leaf green. Numerous large and small spots and irregular blotches of a rich, deep scarlet. Striking and handsome.

RICHENBACHIAN. Medium green ground, ribs pale pink, centre rich rose-pink bordered gray, the whole marked with a few small scarlet spots.

RIO CLARA. Light green ground thickly spotted white; centre of leaf light violet, ribs and nerves deep pink.

RONCADOR. Pink and white ground, green ribs and veins.

WILMA. Lustrous green ribs and veins, body of leaf elegantly marked in shades varying from white to rose-pink.

HAROLD. Medium green ground, spotted and splashed white; centre of leaf gray, ribs deep crimson; magnificent.

CANDIDA. Centre of leaf a big blotch of purple madder, cut and divided by white or cream ribs and bordered with gray, shading off into a green ground.

PILOTA. Deep maroon ribs bordered deep crimson. Green ground thickly spotted and splashed with irregular pink spots, which change to light pink and white; rich and striking.

SPLENDIDUM. Ribs scarlet, bordered with crimson maroon. Deep green ground nerved and veined crimson.

DORMANT TUBERS. Each .20; doz., \$2.00; free by mail at single price.

GROWING PLANTS. Ready in May. Each .30; doz., \$3.00. Not sent by mail.

CALADIUM ESCULENTUM. (*Elephant's Ear.*)

A magnificent plant for sub-tropical groups or single specimen on the lawn, producing enormous smooth green leaves, often three to four feet in length and two to three feet in width. It thrives best in a warm, light soil which can be liberally watered.

	Each.	Doz.	Per 100.
DRY TUBERS, 2 to 3 inches diameter	\$0.10	\$1.00	\$5.00
“ “ 3 to 4 “ “20	2.00	10.00
“ “ Mammoth35	3 50	
GROWING PLANTS in pots; ready in May. <i>By express only.</i>20	2.00	10.00

CINNAMON VINE. (*Chinese Yam.*)

Splendid hardy climber of rapid growth, with bright glossy-green heart-shaped leaves and white cinnamon-scented flowers. In China it is cultivated for its edible tubers. 8 ft. Roots by mail, postage paid, each, .05; doz., .50.

CRINUM KIRKII.

A magnificent bulbous plant, producing usually two purplish flower spikes two feet in height, surmounted by large clusters of Amaryllis-like flowers, which are pure white striped with purple. Each, .30; doz., \$3.00. By mail, add 10 cents each for postage.



Fancy-Leaved Caladium.

FARQUHAR'S SUPERB DAHLIAS.



QUILLED SHOW DAHLIA, GRAND DUC ALEXIS.

White, tinged with lilac. Each, .25; per doz., \$2.50; per 100, \$18.00. By mail, each, .30; per half dozen, \$1.50.

NEW AND SELECT CACTUS DAHLIAS.



We are indebted chiefly to English and French specialists for the exquisitely beautiful forms of Cactus Dahlia which have recently been obtained. They are most desirable for house and table decorations.

COLLECTION OF 12 SORTS	\$2.00
COLLECTION OF 6 SORTS	1.00
EACH20
COLLECTION OF 6 SORTS, free by mail	1.25

- ALFRED VASEY. Salmon.
- ARACHNE. White, striped red.
- BEATRICE. Pure pink.
- BRIDESMAID. Primrose shading to pink.

- BRITANNIA. Buff salmon and pink.
- EARL OF PEMBROKE. Purple.
- KEYNES WHITE. White.
- MATCHLESS. Deep maroon.
- MRS. BENNETT. Crimson.
- PRIMROSE DAME. Sulphur yellow.
- ROBERT CANNELL. Cerise pink.
- STANDARD BEARER. Vivid scarlet.

NEW DECORATIVE DAHLIAS.

This splendid new class has become known in France as *Rustique* and in England as *Decorative* Dahlias.

The flowers are of large size, usually quite double, but of less dense and much freer form than those of the *Large Show* Class, the long, usually fluted petals giving the flowers an artistic, loose, and graceful form hitherto unattained in Dahlias.

COLLECTION OF 12 SORTS	\$2.00
COLLECTION OF 6 SORTS	1.00
EACH20
COLLECTION OF 6 SORTS, free by mail	1.25

- AMPHION. Yellow, tipped with cerise.
- C. W. BRUTON. Yellow.
- CLARIBEL. Brilliant purple.
- COUNTESS OF PEMBROKE. Lavender-pink.

- DOLLY. (*Improved Nymphaea*.) Pink and white.
- HENRY PATRICK. White.
- KING. Brilliant scarlet.
- MAID OF KENT. Red tipped with white.
- MRS. GEO. REED. White and lavender.
- OBAN. Silvery fawn and mauve.
- WM. AGNEW. Red; very large.
- ZULU. Black.

MRS. CHARLES TURNER, *Decorative*. Rich canary yellow; very large flower; considered the finest yellow sort. Each, .25; per doz., \$2.50; per 100, \$18.00. By mail, each, .30; per half-dozen, \$1.50.

LARGE DOUBLE SHOW DAHLIAS.



COLLECTION OF 12 SORTS	\$2.00
COLLECTION OF 6 SORTS	1.00
EACH20
COLLECTION, 12 standard sorts, our selection	1.50
COLLECTION OF 6 SORTS, free by mail	1.25

- A. D. LIVONI. Pink.
- ARABELLA. Sulphur and pink.
- CAMELLIAFLORA. White.
- DR. KIRTLAND. Large crimson.
- ELEGANS. Deep pink, tipped with white.

- FRANK SMITH. Deep maroon, tipped with white.
- GOLDEN AGE. Deep yellow.
- M. E. HALLOCK. Canary yellow; quilled.
- MADAME ZALER. Yellow, tipped with pink.
- METEOR. Brilliant scarlet.
- MRS. DEXTER. Salmon pink.
- MRS. LANGTRY. Cream, peach, and purple.
- PERII. White, suffused with pink.
- PURITY. White.
- WILLIAM RAWLINS. Maroon.

SINGLE-FLOWERING DAHLIAS.

COLLECTION OF 12 SORTS	\$2.00
COLLECTION OF 6 SORTS	1.00
EACH20
COLLECTION, 12 standard sorts, our selection	1.50
COLLECTION OF 6 SORTS, free by mail	1.25

- FASHION. Maroon, base of petals yellow.
- GUY MANNERING. Creamy white, shading to yellow.
- G. E. VARNUM. Crimson.
- ISAAC PITMAN. Purple; very large.

- JOHN COWEN. Rich scarlet.
- JUNO. White, tipped with lavender.
- LEHER CARKE SACHE. Rosy lavender, base of petals yellow.
- MAN FRIDAY. Black, edged with maroon.
- MISS ROBERTS. Large yellow.
- PHOEBE GILBERT. Pink.
- SNOW QUEEN. Pure white.
- THOMAS BECKET. Crimson-lake, with disc of yellow.

GLADIOLI.

These may be planted in the open garden from April until June. They succeed in ordinary garden soil, and well repay any care in cultivation bestowed upon them. The ground should be liberally enriched and dug over to a depth of fifteen to eighteen inches. The bulbs should be set four inches deep and six inches apart. Clumps of Gladioli planted through shrubby borders are most effective, also among beds of roses, where they will bloom when the roses have passed.

FARQUHAR'S PRIZE SEEDLINGS MIXED. A magnificent strain, producing flower spikes of fine form and substance and of most charming colors. Many of the flowers are self-colored or delicately marked, while others have white or light grounds, beautifully blotched or striped with bright colors. Doz., .40; 100, \$2.50; 1,000, \$20.00.

EXTRA FINE MIXED. All colors in great variety. Doz., .25; 100, \$1.50; 1,000, \$12.00.

SCARLET AND CRIMSON SHADES MIXED. Doz., .25; 100, \$1.50; 1,000, \$12.00.

WHITE AND LIGHT SHADES MIXED. Doz., .35; 100, \$2.50; 1,000, \$20.00.

PINK AND ROSE SHADES MIXED. Doz., .30; 100, \$2.00; 1,000, \$16.00.

YELLOW SHADES MIXED. Doz., .60; 100, \$4.00; 1,000, \$35.00.

STRIPED AND VARIEGATED SORTS MIXED. Doz., .50; 100, \$3.00; 1,000, \$26.00.

BRENCHLEYENSIS. Vermilion-scarlet, the best sort for planting in clumps among shrubs. Doz., .25; 100, \$1.50; 1,000, \$12.00.

SNOW WHITE. Pure white with a faint line of rose on the lower petal; spike and flowers large and handsome. Each, .25; doz., \$2.50; 100, \$15.00.

LEMOINE'S SPOTTED HYBRIDS MIXED. A free-flowering race remarkable for the richness and variety of their colors and for their odd orchid-like markings. Doz., .45; 100, \$3.00; 1,000, \$25.00.

GROFF'S NEW HYBRIDS MIXED. A new race of Canadian origin, resembling the Lemoine Hybrids, but showing greater diversity of colors. Awarded a Silver Medal by the Massachusetts Horticultural Society. Doz., .50; 100, \$3.00; 1,000, \$25.00.

GROFF'S GOLD MEDAL AND SILVER TROPHY. These comprise the later and finer varieties raised by Mr. Groff. Red shades, doz., \$1.00; 100, \$6.00. Light shades, doz., \$1.25; 100, \$8.00.

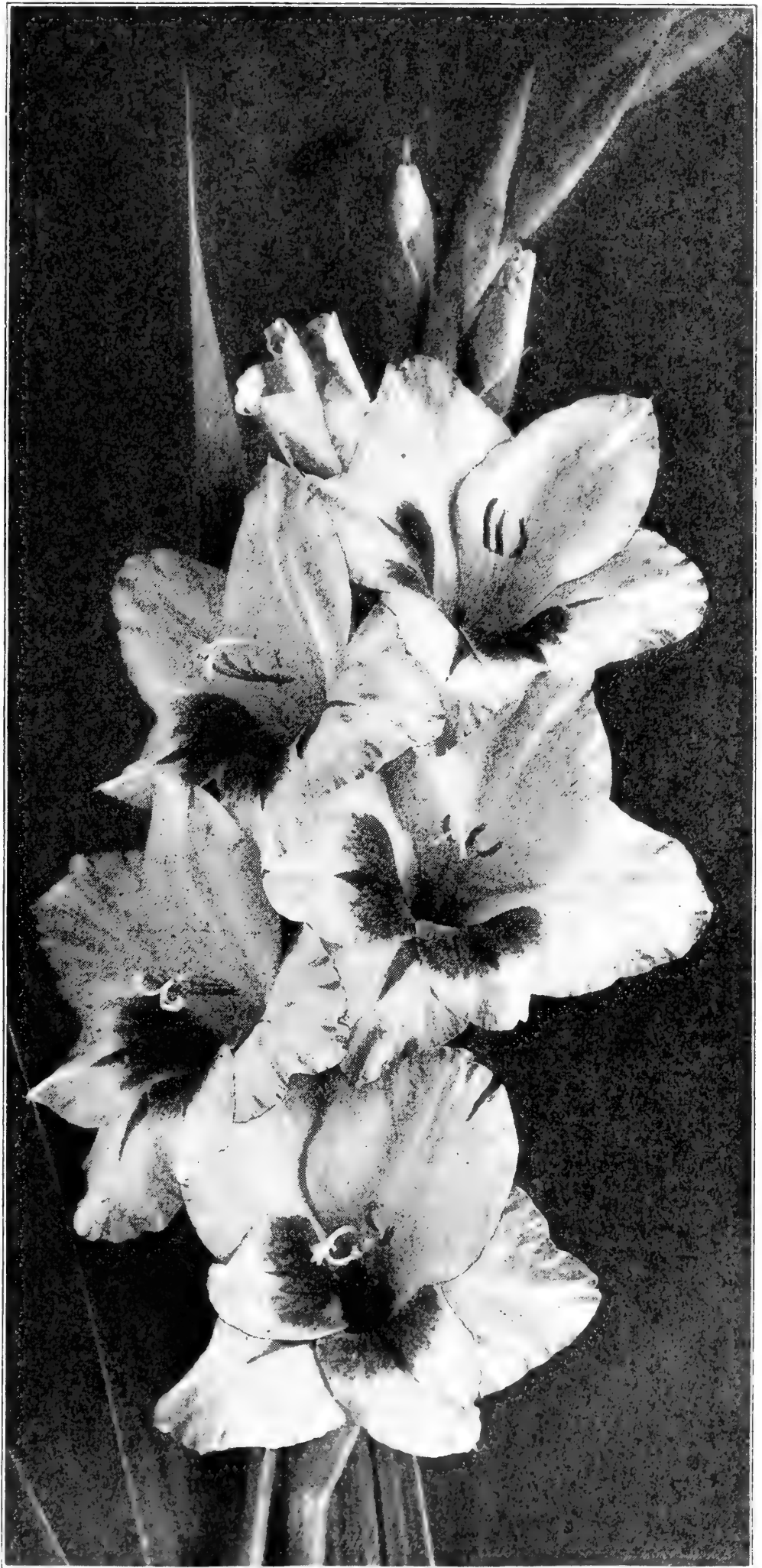

GLADIOLI FOR FORCING.

White and light shades mixed. Doz., .35; 100, \$2.50; 1,000, \$20.00.



Gloxinia Large Flowering. Bulbs.

GLOXINIAS

These are desirable summer-flowering plants for both greenhouse and window. For cutting purposes they may be very successfully grown during summer in cold frames, with the glass shaded with whitewash or slats to moderate the heat of the sun.

	Each.	Per Doz.	Per 100.
LARGE-FLOWERING VARIETIES, MIXED	.10	\$1.00	\$7.00
LARGE-FLOWERING SPOTTED VARIETIES	.15	1.25	9.00
LARGE FLOWERING WHITE VARIETIES	.15	1.25	9.00
LARGE-FLOWERING PINK AND RED VARIETIES	.15	1.25	9.00
LARGE-FLOWERING VIOLET AND PURPLE VARIETIES	.15	1.25	9.00

HYACINTHUS CANDICANS.

A hardy summer-flowering Hyacinth producing erect spikes of pure white, bell-shaped flowers 3 ft. in height. It is very effective when planted in clumps among shrubs.

Per doz., .30; 100, \$2.00. By mail, add 5 cents per doz. for postage.

LILY OF THE VALLEY.

SELECTED DRESDEN PIPS. We can furnish retarded pips during spring or summer. They should be started immediately after shipment. They are sold only in whole cases of 2,500 pips. Per case, \$45.00.

LARGE DUTCH CLUMPS. Each contains many flowering pips; best for planting in the open ground. Each, .40; per doz., \$4.00; per 100, \$25.00. By express only.

MADEIRA VINE.

A favorite tuberous-rooted climbing plant with dense and beautiful shining foliage and of very rapid growth, twining on strings to a great height or forming garlands in many fanciful forms. It will grow anywhere, but does best in a warm, sheltered, sunny location. It is also a very pretty plant for training around the windows in the house. Per doz., .40; per 100, \$2.50.

MILLA BIFLORA.

One of the loveliest bulbous plants; most desirable on account of its immense pure waxy-white flowers, which are borne in clusters of two to three, on a flower-stalk twelve to eighteen inches high. The petals are very thick and firm, and the flowers will keep in water for a week after cutting. A single bulb will produce as many as six flower-stalks. Per doz., .50; per 100, \$3.00.

MONTBRETIA.

Hardy border plants with elegant and gracefully branched Gladiolus-like flowers which are now much prized for cutting during summer. The colors vary from clear yellow to rich scarlet, and the plants grow about 2 feet in height. Plant the bulbs five inches deep and protect them during winter with liberal mulching.

	Per Doz.	Per 100.	Per 1,000.
CROCOSMIÆFLORA. Orange-scarlet	.20	\$1.00	\$6.50
ETOILE DE FEU. Rich scarlet, yellow centre	.50	3.00	23.00
GOLDEN SHEAF. Clear yellow, beautiful	.20	1.25	8.50
RAYON D'OR. Deep yellow, very large	.20	1.25	8.50
ROSEA. Bright salmon-rose	.60	3.75	25.00
TRANSCENDENT. Large golden-yellow flowers, outside bright red	.25	1.25	10.00
POTTSH. Bright yellow, flushed with red	.15	.75	5.00
NEW SEEDLINGS. Choice sorts	.30	1.75	12.00

ORNITHOGALUM.

ARABICUM. (*Arabian Star of Bethlehem*.) An effective variety, with large heads of fragrant star-shaped flowers, white with black eye, borne on erect stems 18 inches high; excellent for forcing and winter cultivation. Per doz., .50; per 100, \$2.75. By mail, add 15 cents per dozen for postage.



Montbretia, New Seedlings.

COPYRIGHT DOZ BY R & J FARQUHAR & CO

GERMAN IRISES. (*Iris Germanica. The True Fleur-de-Lis.*)

Japanese Iris.

JAPANESE IRISES. (*Iris Kämpferi.*)

In these we find combinations of form and beauty far excelling any other type. The stately flowers are often 8 or 10 inches in diameter, and of wonderfully varied and beautiful colors. They require rich, moist soil.

- No.
1. GEKKA-NO-NAMI. Double white.
 2. SHISHI-ODORI. Light purple.
 3. KUMOMA-NO-SORA. White, shaded light blue.
 4. KUMO-NO-OBI. Purple, shaded blue, centre white.
 5. HO-O-JO. Velvety crimson, centre white.
 6. GEISHO-UI. Double crimson.
 7. SOFU-NO-KOI. White, shaded and blotched lavender, double.
 8. MANA-DSURU. White, veined with blue, centre violet.
 9. HANA-NO-NISHIKI. Cerise, centre white.
 10. YOMO-NO-UMI. Lilac, centre violet.
 11. MEI-RAN. White, shaded and blotched pink.
 12. KUMA-FUNJIN. Rich deep purple, double.
 13. TAIHEI-RAKU. Light magenta.
 14. HANA-AOI. White, veined and shaded light violet, centre dark violet.
 15. ULCHIU. Sky blue, centre white, double.
 16. OSHOKUN. Dark purple, centre white.
 17. SHIPPO. Light blue, shaded dark blue, centre reddish purple.
 18. KUMO-NO-ISHO. Velvety dark red, centre purple.
 19. KIMI-NO-MEGUMI. Porcelain blue, veins violet, violet and red centre.
 20. KUMO-NO-UYE. Deep purple, double.
 21. YEZO-NISHIKI. Light heliotrope, shaded and blotched dark heliotrope.
 22. SHISHI-IKARI. Light crimson, maroon centre.
 23. ONIGA-SHIMA. Deep purple, centre blue.

Each, 25 cents; per dozen, \$2.50; per 100, \$15.00.

These flourish either in ordinary soil or in moist situations. They are perfectly hardy and as handsome as Orchids. Their colors are of the widest range, as will be seen in the descriptions following:

	Each.	Per Doz.	Per 100.
AUREA. Golden yellow25	\$2.00	\$12.00
DARIUS. Falls lilac, white striped, standards orange35	2.75	16.00
DUBOIS DE MILAN. Dark purple, veined white, standards lavender40	3.00	20.00
DUC DE NEMOURS. Purple, edged white50	4.00	22.00
INNOCENZA. Ivory white35	2.50	16.00
KOCHI or ATROPURPUREA. Reddish purple25	2.00	12.00
MACRANTHA. Standards blue, falls violet30	2.25	14.00
MADAME CHEREAU. White, elegantly frilled with azure blue, .15	1.20	7.50	
MRS. H. DARWIN. White, reticulated with violet at base35	2.75	16.00
MAORI KING. Rich golden yellow standards, falls velvety crimson, margined with gold25	2.00	12.00
QUEEN OF MAY. Rosy lilac25	2.00	12.00
SPECTABILIS. Deep velvety blue, .25	2.00	12.00	

COLLECTION OF 12 VARIETIES, OUR SELECTION.
From the foregoing or other fine sorts, \$2.00.

PER 100 PLANTS IN VARIETY, OUR SELECTION,
\$12.00.

By mail, add 5 cents each for postage.

- No.
24. SANO-WATASHI. Pure white.
 25. YEDO-JIMAN. Dark purple, shaded light purple.
 26. SENJO-NO-HORA. Pink, shaded and blotched with light red, bluish centre.
 27. O-TORIGE. Violet, maroon centre.
 28. SHIVA-TAKI. Pure white.
 29. SHIGA-NO-URA-NAMI. Light purple.
 30. KAGARIBI. Vermilion.
 31. KOSUI-NO-IRO. White, shaded lilac.
 32. KOMOCHI-GUMA. Rich purple.
 33. KAKU-JAKU-RO. Light violet, centre light blue.
 34. MOMIJI-NO-TAKI. Pink, centre purple and maroon.
 35. SUCHIU-KWA. White, edged with bright red.
 36. YEDO-KAGAMI. Red, shaded light purple.
 37. UJI-NO-HOTARU. Light and dark blue, centre purple.
 38. SHIMO-YONO-TSUKI. Double white, shaded yellow.
 39. TSURUGI-NO-MAI. Purple red, centre dark maroon.
 40. ISO-NO-NAMI. Light blue, blotched dark blue.
 41. OYODO. Rich deep purple.
 42. BANDAI-NO-NAMI. White, centre yellow.
 43. WAKA-MURASAKI. Bright magenta, blotched white.
 44. KYODAI-SAN. Navy blue, shaded bronze.
 45. KIGAN-NO-MISAO. White, tinged lilac, centre yellow.
 46. KOKI-NO-IRO. Bright purple.
 47. SAMIDARE. White, centre yellow.
 48. TORA-ODORI. White, blotched and shaded blue and lavender.
 49. TSURU-NO-KEGOROMO. White, yellow centre.
 50. DATE-DOGU. Magenta red.

By mail, add 5 cents each for postage.

HARDY LILIES.



Lilium Auratum.

The increased production of many varieties of these in Japan has greatly reduced their cost, and in consequence their use has now become very general.

It is our opinion that we should plant the bulbs much deeper than we have done heretofore. While travelling in Japan, we found that the bulbs of the wild Lilies were usually twelve to eighteen inches below the surface, and we gathered the finest flowers from specimens growing on mountains of decaying lava where they had abundant rainfall and ample drainage. We believe that varieties like *Auratum* and *Speciosum* would be favored by being set ten or twelve inches deep and would be less affected by frost and drought. The beds should be thoroughly covered with leaves or litter during winter.

Langwater Gardens,
North Easton, Mass., May 26, 1902.
Messrs. R. & J. Farquhar & Co.:

Dear Sirs: The *Lilium Candidum* we had from you last August have been superb. On our forced plants many of the spikes carry from 12 to 15 flowers and buds each, and numerous bulbs produced two flower stalks. Not one of the 500 bulbs supplied has a trace of disease which for years has been so rife, and which has discouraged so many from continuing the culture of this superb lily.

Yours very truly,
WILLIAM N. CRAIG,
Head Gardener to Mrs. F. L. Ames.

The following Lilies sent by mail at the price of single bulbs.

	Each.	Per. Doz.	Per 100.
AURATUM. (<i>Golden-rayed Japanese Lily</i> .) Flowers 6 to 8 inches in width, pure white, with a wide band of gold running through the centre of each petal and numerous crimson spots	\$0.30	\$3.00	\$20.00
AURATUM PICTUM. A broad yellow or red band extends from the base to the tip of each petal	.30	3.00	20.00
AURATUM VITTATUM RUBRUM. Flowers pure white, with broad crimson band in the centre of each petal; numerous crimson spots	1.25	12.00	80.00
BATEMANNI. A most beautiful Japanese variety, growing 3 feet high, with six to eight apricot-colored flowers on a stem; blooms in July and August	.15	1.50	10.00
BROWNI. Large trumpet-shaped flowers, interior pure white, exterior purplish brown; very beautiful	.75	7.50	55.00
CANADENSE. (<i>Canadian Bell-Flower Lily</i> .) One of our most beautiful native lilies, flowers bright yellow, with black spots	.15	1.25	9.00
CANADENSE RUBRUM. Crimson, spotted with black; 2 to 3 feet; flowers June and July	.15	1.50	9.00
CANDIDUM. The earliest and one of the most beautiful sorts, large trusses of pure white, fragrant flowers; 3 ft.	.15	2.00	8.00
CHALCEDONICUM. (<i>Scarlet Turk's Cap</i> .) Brilliant scarlet recurved flowers; height, 3 feet; blooms in June	.50	5.00	36.00
COLCHICUM. (<i>Monodelphum or Scovitzianum</i> .) Beautiful golden yellow, spotted with black; height, 2 feet; superb sort	.60	5.50	35.00
CONCOLOR. Brilliant scarlet with black spots; 2 feet	.10	1.00	5.00
ELEGANS, THUNBERGIANUM, OR UMBELLATUM. These vary in color from yellow to orange-crimson, usually with black spots. From eight to twelve flowers are produced on each stem; height, about 2 feet. They bloom in June and July, are exceedingly hardy, and are most effective for grouping among shrubs.			
ELEGANS ATROANGUINEUM. Rich deep crimson, with dark spots	.25	2.50	15.00
ELEGANS AURANTIACUM. Deep yellow, spotted with black	.10	.85	5.00
ELEGANS ERECTUM. Orange, spotted with scarlet; erect flowers	.15	1.25	7.50

SIX OF A KIND SOLD AT DOZEN RATES; 25 AT 100 RATES; 250 AT 1,000 RATES.

HARDY LILIES — *continued.*



COPYRIGHT 1902 BY R. & J. FARQUHAR & CO.

Lilium Batemanni.

	Each.	Per Doz.	Per 100.
ELEGANS VENUSTRUM. Buff, with dark spots	\$0.60	\$6.00	\$42.00
ELEGANS VARIETIES MIXED. Ranging from yellow to deep red15	1.25	7.50
EXCELSUM. Deep buff, reflexed flower, fragrant, 3 to 4 feet; very beautiful; blooms in June and July75	7.50	55.00
GRAYI. Dark reddish-orange flowers, 2 feet, July and August30	3.00	20.00
HANSONI. Deep golden yellow, lightly spotted crimson, 3 feet; blooms in June. The finest yellow hardy lily	1.25	12.00	90.00
HUMBOLDTII. Reddish orange, with purple spots, 4 to 5 feet, July; very handsome. The bulbs should be planted 10 inches deep in well-drained soil. It should be mulched during winter50	5.00	35.00
KRAMERI. Pure blush pink, fragrant and beautiful trumpet-shaped flowers, 3 feet; blooms in August25	2.50	18.00
LEICHTLINI. Flowers deep golden yellow, with purple spots, 3 to 4 feet, August50	5.00	38.00
LONGIFLORUM. Large trumpet-shaped pure white flowers, 2 feet, strong bulbs20	1.75	12.00
MARTAGON. Purplish crimson, with dark spots, 3 feet, July and August20	2.00	12.00

PHILADELPHICUM. Bright orange-red, with purple spots, 2 feet, July \$0.15 \$1.50 \$10.00

SPECIOSUM OR LANCIFOLIUM. The most popular class of Japanese Lilies, their hardiness, free growth, and branching habit rendering them most valuable for permanent beds and borders. They grow from 3 to 4 feet in height and continue in bloom from August until frost.

SPECIOSUM ALBUM. Pure white, fragrant20 2.00 14.00

SPECIOSUM MELPOMENE. White, suffused with darkest crimson20 2.00 12.00

SPECIOSUM RUBRUM. White, shaded and spotted with rosy crimson25 2.50 16.00

SUPERBUM. (*Turk's Cap Lily.*) Rich orange, petals tipped red and dark spotted, 3 to 4 feet; blooms in July and August15 1.25 7.50

TENUIFOLIUM. (*Coral Lily.*) A very graceful miniature Lily with fiery scarlet flowers, 1 1/2 feet, July30 3.00 20.00

TIGRINUM. (*Tiger Lily.*) Orange, spotted black, 3 to 4 feet, August, very hardy10 .75 5.00

TIGRINUM FLORE PLENO. (*Double flowering Tiger Lily.*) 3 to 4 feet, August10 .75 5.00

WALLACEI. Orange-scarlet, spotted with maroon, 3 feet, September15 1.50 8.50

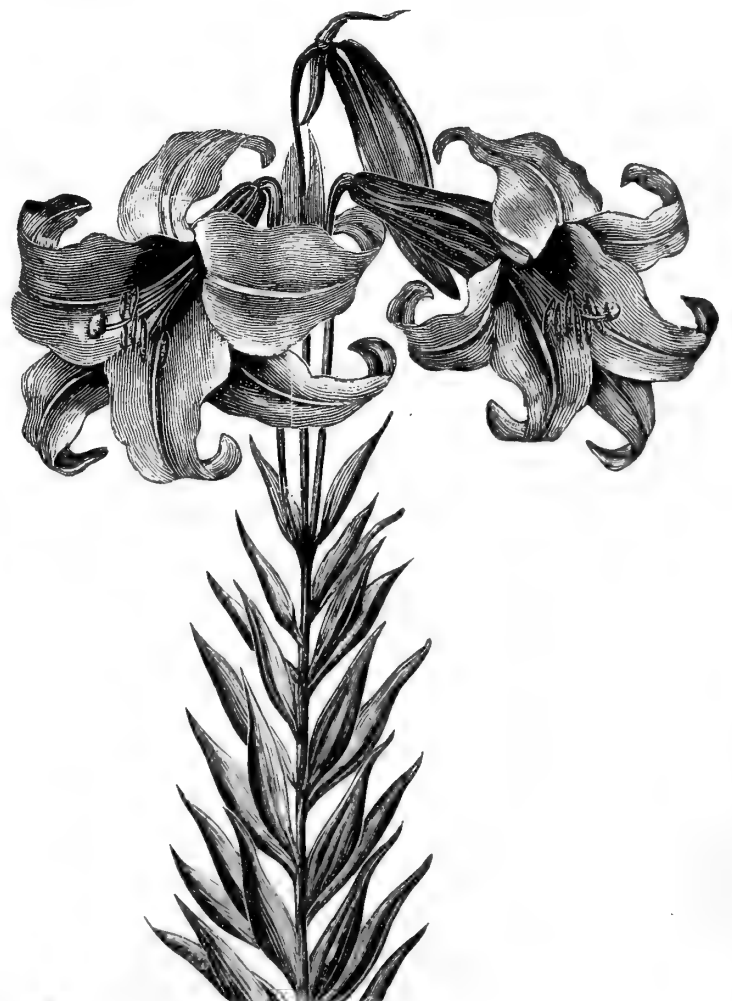

COPYRIGHT 1902 BY R. & J. FARQUHAR & CO.

Lilium Kramerii.

DOUBLE CHINESE PÆONIES. (*Pæonia Sinensis.*)

Pæonies succeed best on rich, well-drained, sunny land, where they can be liberally supplied with water during the early summer. The best months in which to transplant them are April, August, and September.

THE FOLLOWING PÆONIES, EACH, 25 CENTS; PER DOZ., \$2.50; PER 100, \$18.00; unless otherwise priced.

- AMABILIS GRANDIFLORA. White, very large, double, fringed petals; very sweet.
- BARON ROTHSCHILD. Outside petals rose, centre salmon; sweet.
- CAROLINE MATHER. Purple-crimson, very dark, large, and double.
- ELEGANS. Outside petals dark pink, large salmon centre, loose form, elegant, sweet.
- FRANCIS ORTEGAL. Deep purple-crimson, very large, double, and sweet.
- HUMEL. Rose, large and full; one of the best.
- LA MARTINE. Bright red, fine full flower.
- OFFICINALIS RUBRA. Dark red, very early.
- PERFECTION. Outside petals rose lilac, inside salmon; sweet.
- PIUS IX. Dark red-purple; semi-double.
- TRIUMPH DU NORD. Violet-rose, lilac shade.
- VARIENCE. Outside petals rose-lilac, inside salmon.

UNNAMED CHINESE PÆONIES.

	Each.	Per doz.	100.
PINK SHADES	\$0.20	\$2.00	\$12.00
RED SHADES20	2.00	12.00
WHITE AND BLUSH SHADES20	2.00	12.00

JAPANESE TREE PÆONIES.

(*Pæony Mutans.*)

There are several classes of Japanese Pæonies. The "Botan," a shrubby variety bearing single, semi-double, or full-double flowers, frequently 10 or 12 inches in diameter, is the most prized. We have visited Japan and we have personal knowledge as to where the best sorts are grown. Our importations include the finest forms, ranging in color from white to deep crimson. Each .75; per dozen, \$7.50; per 100, \$60.00.

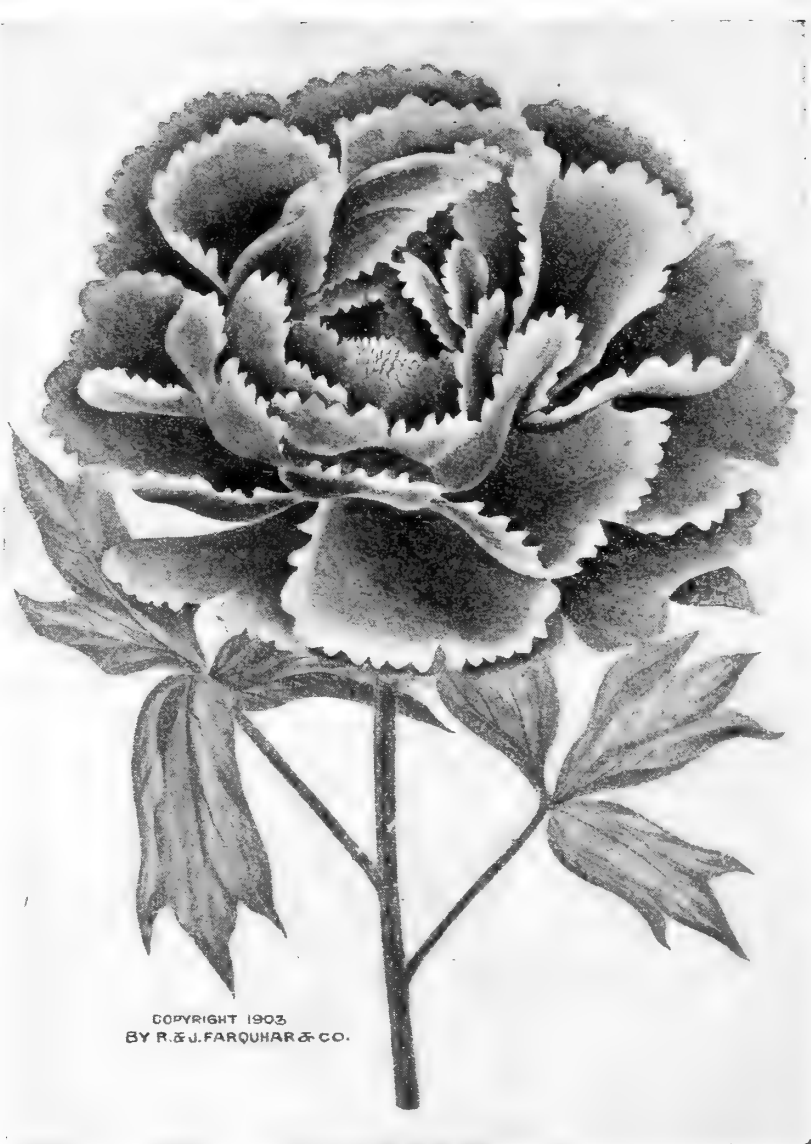

Japanese Tree Pæony.

PÆONIA TENUIFOLIA.

(*Fern-Leaved Pæony.*)

- SINGLE. Shining crimson. Each, .25; per doz., \$2.50; per 100, \$15.00.
- DOUBLE. Shining crimson. Each, .50; per doz., \$5.00; per 100, \$30.00. *By mail, add 5 cents each for postage on all Pæonies.*

TIGRIDIA. (*Shell Flower.*)

Curious and beautiful shell-like flowers about four inches in diameter, flowering from July to October. The bulbs can be planted about the middle of May, and taken up in October and kept over winter in dry sand.

	Per doz.	Per 100.
CONCHIFLORA. Orange, with crimson spots50	\$3.50
GRANDIFLORA. Very large; deep crimson50	3.50
GRANDIFLORA ALBA. Large ivory-white flowers, spotted with maroon and rosy lake in centre50	4.00
PAVONIA. Red, with crimson spots50	3.50

TUBEROSES.

Before potting the bulbs, remove the small offsets. Use good, rich loam, and start in a hot-bed or forcing-pit. They should not be set in the garden till June. Our Tuberoses are grown with great care and invariably give excellent satisfaction in New England, being specially grown with the view of flowering early.

EXCELSIOR DOUBLE PEARL. Large flowering bulbs; spike 2½ to 3 ft. high, with large and very double flowers, favorite sort. Dozen, .40; 100, \$2.00. *By mail, add 10 cents per dozen.*



Tigridia.

AQUATIC PLANTS.

NELUMBIUM. (*Lotus*.) HARDY.

- ALBUM STRIATUM. Flowers pure white, edges of petals striped and tipped with rosy-carmine. Each, \$1.50.
 LUTEUM. (*American Lotus*.) Superb yellow flowers and massive foliage. Height, six to eight feet. Each, .75; *extra large roots*, each, \$1.50.
 KERMESINUM. A distinct and beautiful variety with large crimson flowers. Each, \$1.00.
 SPECIOSUM. (*Egyptian Lotus*.) Flowers often a foot in diameter and standing well above the surface of the water, of a beautiful deep rose color and very fragrant. *Flowering roots*, each, .75; *extra large roots*, each, \$1.50.

NYMPHÆA. — HARDY VARIETIES.

- ALBA. (*White English Water Lily*.) Large; continuous bloomer. Each, .50.
 CANDIDISSIMA. Flowers pure white; very numerous. Each, .50.
 GLADSTONIANA. Improved variety of *N. Alba* with glistening white flowers. Each, .50.
 LAYDEKERI LILACEA. French hybrid; flowers lilac-rose, shaded bright carmine, tea-rose fragrance. Each, \$1.00.
 LAYDEKERI PURPURATA. Flowers large, wine-red color, shaded crimson, stamens bright red. Each, \$1.00.
 MARLIACEA CHROMATELLA. Hardy; flowers clear yellow. Each, .50.
 MARLIACEA ALBIDA. Best white. Each, .75.
 MARLIACEA ROSEA. Rose; a gem. Each, \$1.00.
 MARLIACEA CARNEA. Flesh tint. Each, .75.
 ODORATA. The fragrant pond lily. Each, .20.
 ODORATA GIGANTEA. Large, white, free-flowering, fragrant. Each, .20.
 ODORATA MAXIMA. Large, massive, cup-shaped flowers; the petals are broad and of the purest white, being so numerous as to make the flowers appear double. The sepals are bright green. Each, .25.
 ODORATA ROSEA. (*The Hardy Cape Cod Pink Water Lily*.) One of the most beautiful flowers; deep pink; highly fragrant; shell-like. It is absolutely hardy and worthy of very wide cultivation. Each, .50.
 ODORATA SULPHUREA. Large yellow fragrant flowers, leaves mottled reddish purple. Each, .50.
 O. LUCIANA. This variety is identical with *N. O. Caroliniana*, save in color, which is rosy carmine. Each, \$1.25.
 PYGMÆA (*syn. tetragona*). A gem. The smallest species in cultivation; leaves dark green above, with occasional brown blotching, reddish beneath; flowers white with yellow stamens, 1½ to 2½ inches across. Each, .30.
 HELVOLA (*syn. N. pygmaea Helvola*). Sulphur-yellow flowers; leaves green, early stage reddish, blotched with brown; adapted for growing in aquariums or tubs. Each, .30.
 RICHARDSONII. Immense white flowers eight inches in diameter and quite double, standing well above the water. The sepals and outer petals droop, giving the flowers a globular form. Each, .50.
 ROBINSONI. The large, floating flowers of this distinct and striking variety are difficult to describe, but may be said to have a ground color of yellow overlaid with purplish red, the general effect being dark orange red. The foliage is dark green, spotted with chestnut above, dark red on the under side. Each, \$1.00.
 WM. DOOGUE. Flowers cup-shaped, shell-pink color, sepals royal pink. Each, \$3.00.

**The "Water Garden," a book
 about Aquatics. Price, \$2.00
 per copy, postpaid.**

NYMPHÆA. — TENDER VARIETIES.

- CAPENSIS — THUNB. Flowers rich sky blue; sepals green outside, whitish within, flushed blue. Each, .75.
 CÆRULEA, or STELLATA. Clear, light blue; delicately scented; blooms constantly till frost. Each, .50.
 DEVONIENSIS. Brilliant rosy red; very large; often ten to twelve inches across; magnificent. Each, .50.
 DENTATA. The largest white, with long, pointed buds. Each, .50.
 GRACILIS. Large white flowers, golden-yellow stamens, and a fragrance resembling Lily of the Valley. Each, \$1.00.
 KEWENSIS. Leaves dark green, slightly bronzy with a few brown blotches; young leaves more spotted on surface and purplish on underside. Flowers six to eight inches across; light pink; petals broadly ovate; sepals light brownish green outside, rosy red inside. Each, \$1.50.
 MEXICANA. A valuable addition to this class of Nymphæas, closely resembling *N. Flava*. The flowers are rich golden yellow, five inches in diameter; produced freely through the season until frost. New Mexico. Each, .30.
 MRS. C. W. WARD. Flowers from eight to ten inches in diameter, and borne on stout stems fifteen inches above the water. Color deep rosy-pink with golden-yellow stamens, a most desirable variety for cutting. Certificated at New York by the Society of American Florists, also by the Massachusetts Horticultural Society. Each, \$2.50.
 O'MARANA. Leaves bronzy-green; flowers large rosy red; stamens orange-red. Each, \$2.50.
 PULCHERRIMA. Flowers ten to twelve inches in diameter, bright violet hue, resembling in color those in *N. Gigantea*, excepting the bases of the petals and the stamens, which are deep yellow. The buds are long, pointed, and irregularly striped with chocolate-red. Leaves bronzy-green, slightly blotched red. Each, \$2.00.
 RUBRA. Brilliant crimson, large cup-shaped flowers; very free bloomer. Each, \$1.00.
 RUBRA-ROSEA. Splendid deep rosy-carmine flowers, ten to twelve inches in diameter. Each, \$1.50.
 ZANZIBARENSIS. Flowers deep purple, sepals green outside, purple within, margined with red. Each, \$2.00.
 ZANZIBARENSIS AZUREA. Deep, rich, azure blue; one of the largest and best. Each, .50.
 ZANZIBARENSIS-ROSEA. Beautiful deep rose; very choice. Each, .50.
 WM. STONE. No color in Water Lilies is more attractive than blue, and in this variety we have one of the most distinct and pleasing of this shade, the color being a rich violet-blue shaded amaranth; stamens purple with deep yellow centre. The flowers open early in the day and remain open until late evening. Each, \$2.00.

If ordered by mail, add ten cents each to above prices for postage.

VARIOUS AQUATICS.

- LIMNANTHEMUM INDICUM. (*Water Snowflake*.) A pretty floating species with roundish light green leaves and pure white beautifully fringed flowers. By mail, .30. Each, .20.
 WATER HYACINTH, or WATER ORCHID. (*Pontederia*.) Very interesting and beautiful; floats on the surface of the water and produces fine spikes of light rosy lilac, orchid-like flowers. By mail, .25. Each, .15.
 WATER POPPY. (*Limncharis Humboldtii*.) Flowers beautiful, clear yellow with black stamens; must be grown in shallow water; does splendidly in a tub; very attractive. By mail, .30. Each, .15.
 CYPERUS PAPYRUS. (*Egyptian Paper Plant*.) Produces a number of slender stems, surmounted by dark-green, shining plumes. By mail, .30. Each, .25.

CANNAS.

The Cannas we offer are plants in growth, not dormant roots. They will be ready for delivery in April.

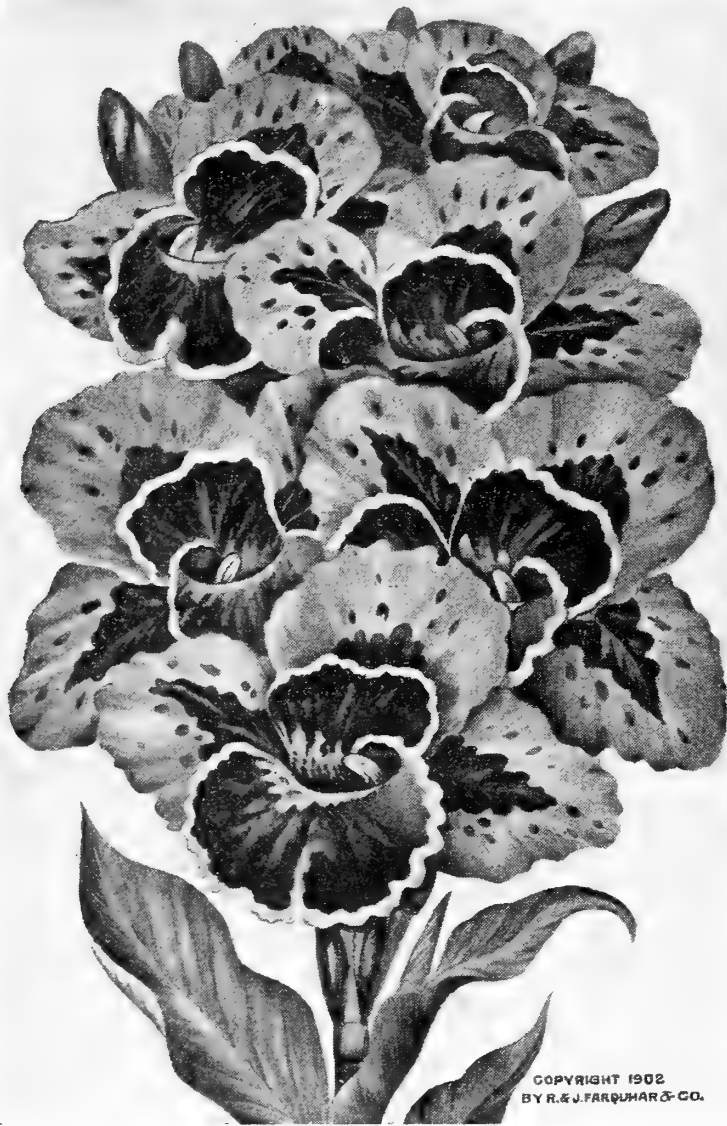

COPYRIGHT 1902
BY R. & J. FARQUHAR & CO.

GIANT ITALIAN CANNAS.

EACH, 20 CENTS; PER DOZEN, \$2.00; BY MAIL, 25 CENTS EACH.

- ALEMANNIA.** Flowers very large; scarlet, edged with yellow; wide Musa-like leaves.
- AMERICA.** Large, glowing red flowers; foliage dark red.
- APHRODITE.** Golden yellow flowers, blotched with salmon; foliage green.
- EDOUARD ANDRE.** Trusses of 9 to 12 large flowers, fiery red with orange-yellow spots.
- GOLDEN SCEPTRE.** Deep golden yellow.
- H. WENDLAND.** Enormous flowers in large trusses; outer petals scarlet with golden border, inside fiery red with yellow centre; broad, green leaves.
- LA FRANCE.** Brilliant orange-scarlet; lustrous dark foliage.
- OCEANUS.** Outer petals flame-color with border of golden-yellow; inner petals scarlet; leaves green.
- PANDORA.** Rich red flowers, margined and mottled with golden yellow.
- PLUTO.** Large and beautiful dark scarlet flowers.

DARK-LEAVED AND MIXED CANNAS.

- NIGRICANS.** Very dark foliage, one of the best of the tall varieties. Doz., \$1.50; each, .15.
- MIXED.** Many sorts. Splendid for tropical beds and borders. Per 100, \$10.00; doz., \$1.50; each, .15.

CHOICEST FRENCH CANNAS.

CROZY'S LARGE-FLOWERING TYPE.

These French Cannas are of dwarf compact growth, bearing large trusses of brilliant flowers which are of long duration. The varieties in the following list are the cream of the Crozy type; Each.

- ADMIRAL DEWEY OR TARRYTOWN.** A superb bedding sort; large trusses of deep red flowers; leaves green. Doz., 2.0020
- ALEX MCLELLAN.** An improved form of Madame Crozy; popular in Newport. Doz., 2.0020
- AMI PICHON.** Large scarlet. Doz., 2.0020
- ANTOINE CROZY.** Flowers rich dark carmine; foliage green; very attractive. Doz., 2.0020
- CHARLES HENDERSON.** Crimson with gold. Doz., 1.5015
- COMTE DE BOUCHARD.** Yellow, blotched with carmine; large, broad petals. Doz., 2.0020
- COMTE DE SACH.** The finest self-colored crimson sort; flowers of enormous size, with broad, massive petals. Doz., 4.0050
- E. G. HILL.** Scarlet, marbled carmine. Doz., 2.00, .20
- FLORENCE VAUGHAN.** One of the best; flowers yellow, handsomely spotted. Doz., 1.5015
- G. O. QUINTUS.** Bright orange red, edged with crimson. Doz., 2.0020
- HYDE PARK.** Large, golden-yellow flowers spotted with crimson. The trusses are of enormous size and of long duration. Doz., 2.00 /20
- JOHN LAING.** Red, edge canary yellow. Doz., 2.00 .20
- J. D. CABOS.** Rich apricot with deeper shadings; very fine. Doz., 1.5015
- L. PATRY.** Large flowers, vermilion with dark spots and yellow edge. Doz., 2.0020
- MADAME CROZY.** Dazzling crimson-scarlet, bordered with golden yellow. Doz., 1.5015
- MADAME MESMER.** Deep orange, edged with yellow. Doz., 2.0020
- MERRIAM LOMBARD.** Nearly white. Doz., 2.00 . .20
- MRS. WILLIAM STONE.** *The darkest of all Cannas.* The plant grows to a height of about four feet, bearing light green leaves and large trusses of rich dark crimson flowers. Doz., 2.5025
- PAOLA RADAELLI.** Garnet, yellow edge. Doz., 2.00 .20
- P. J. BERKMANS.** Large, lustrous rosy carmine. Doz., 2.0020
- PRESIDENT MCKINLEY.** Fiery crimson scarlet, large trusses. Doz., 2.0015
- PRESIDENT CLEVELAND.** Fine crimson. Doz., 1.50, .15
- QUEEN CHARLOTTE.** Scarlet with yellow edge. Doz., 1.5015
- ROSLINDALE.** Large trusses of golden-yellow flowers, spotted and blotched with carmine. One of the best. Doz., 2.0020
- ROSE OF MAY.** Rose carmine. Doz., 2.00 . . .20
- SIR THOMAS LIPTON.** *New.* Gigantic flower trusses of richest crimson; one of the finest. Doz., 2.50, .25
- SOUVENIR ANTOINE CROZY.** Petals large and broad, edged with deep golden-yellow, centre vermilion. One of the best. Doz., 2.0020
- SOUVENIR DE MADAME HARDY.** Chrome yellow, spotted carmine; large, handsome flowers of fine substance; grows tall. Doz., 2.0020
- SOUVENIR DE CHARGUERAUD.** Soft red striped with deep red; fine flower. Doz., 2.0025
- VAN DEN BERG, JR.** Buff red, spotted. Doz., 2.00 .20
- YELLOW BIRD.** Fine deep yellow with slight mottling on the lower petal; large and free-flowering. Doz., 2.0020

By mail, add 5 cents each for postage.

BEDDING PLANTS.

We grow our Bedding Plants in greenhouses especially constructed to produce compact, stocky plants. They are not forced, but grown at low temperature and are of the hardiest possible character.

	Per doz.	Per 100.
ABUTILON. Sorts	\$1.25	\$8.00
ACHYRANTHES, DARK BLOOD-RED90	6.00
— BRIGHT CRIMSON90	6.00
— GREEN, VEINED WHITE90	6.00
AGERATUM, BLUE75	5.00
ALTERNANTHERA, DWARF SCARLET75	5.00
— DWARF YELLOW75	5.00
ALYSSUM, WHITE. Sweet scented60	4.00
ANTIRRHINUM, MIXED. <i>Snapdragon</i>90	6.00
ASTERS, ASSORTED COLORS40	3.00
— WHITE40	3.00
BEGONIA, VERNON. Flowers red, bronze foliage	1.25	8.00
— VESUVIUS. Bright crimson, blooms all summer, one of the best bedding sorts	1.50	10.00
— TUBEROUS-ROOTED. Strong plants	1.25	8.00
— REX. For shady situations	2.00	15.00
CALADIUM ESCULENTUM. Strong plants,	1.50	10.00
CARNATIONS, SUMMER-FLOWERING.		
— CAMP FIRE. Deep scarlet Each, .25	2.50	16.00
— EL Dorado. Canary yellow, pencilled with red Each, .25	2.50	16.00
— FRANCIS JOOST. Deep salmon pink. Each, .25	2.50	16.00
— MRS. FISHER. Pure white25	2.50
— SEBEIC. Dark crimson25	2.50
— WILLIAM SCOTT. Bright pink, profuse blossomer Each, .25	2.50	16.00
— MARGUERITE, MIXED COLORS	1.50	10.00
CENTAUREA GYMNOCARPA. <i>Dusty Miller</i> ,90	6.00
COCKSCOMB DWARF. Various colors75	5.00
COLEUS, VERSCHAFFELTI. Red foliage90	6.00
— GOLDEN BEDDER. Yellow foliage90	6.00
— PRINCESS ROYAL. Bright red with golden edge90	6.00
— FASCINATION. Mottled, yellow, red and green90	6.00
DAISY, ENGLISH. Assorted50	3.50
— PARIS GOLDEN. An admirable plant both for bedding and cut flowers	1.50	10.00
— PARIS WHITE	1.50	10.00
DIANTHUS HEDDEWIGI. Japan Pink60	4.00
FEVERFEW, GOLDEN. Dwarf golden-leaved50	3.50
— DOUBLE WHITE. Valuable for cutting,90	6.00
FUCHSIA. In variety	1.25	10.00
GERANIUM, ALPHONSE RICARD. Deep scarlet, semi-double	1.25	10.00
— BEAUTE POITEVINE. Salmon pink, double	1.25	10.00
— DRYDEN. Salmon red	1.25	10.00
— LA FAVORITE. Double white, very fine	1.25	10.00
— IVY-LEAVED. Elegant for edges and hanging baskets. Assorted varieties	1.25	10.00
— ROSE-SCENTED. Fragrant foliage	1.25	10.00
HELIOTROPE. Sorts	1.00	7.00
HOLLYHOCK, DOUBLE. Mixed colors	2.00	12.00
— SINGLE. Mixed colors	2.00	12.00
LANTANA DELICATA. Rosy purple; trailing	1.25	8.00
LOBELIA, DWARF BLUE. For edgings60	4.00
LEMON VERBENA. Very fragrant foliage,	1.50	10.00
MARGUERITE. See Daisy. Paris Golden.		
MARIGOLD, DWARF FRENCH. Yellow and maroon60	4.00
— TALL AFRICAN. Lemon and orange60	4.00
MUSA ENSETE. <i>Abyssinian Banana</i>50	5.00
— — LARGER PLANTS. Stock limited	1.00	10.00



Paris Golden Daisy. True Marguerite.

	Per doz.	Per 100.
NASTURTIUM, DWARF. Assorted colors60	\$4.00
PANSY, LARGE-FLOWERED MIXED50	3.00
— GIANT FANCY. Finest strains75	5.00
PETUNIA, SINGLE. Assorted colors90	6.00
— DOUBLE. Choicest sorts	1.25	10.00
RICINUS. <i>Castor Oil Bean</i> . Sorts	1.25	8.00
SALVIA SPLENDENS. Brilliant scarlet	1.25	8.00
STOCK. DOUBLE GERMAN. Assorted75	5.00
— PERPETUAL DOUBLE WHITE. Excellent for cutting75	5.00
SWAINSONIA GALEGIFOLIA ALBA. Elegant white pea-shaped flowers	1.50	12.00
— — ROSEA. Rosy pink	1.50	12.00
VERBENA. Assorted colors60	4.00
ZINNIA, EXHIBITION PRIZE. Mixed60	4.00

CLIMBING PLANTS.

	Each.	Doz.	100.
COBEA SCANDENS15	\$1.25	\$9.00
MOONFLOWER15	1.50	10.00
NASTURTIUM, TALL10	.60	4.00
SENECIO SCANDENS. German Ivy15	1.25	8.00
VINCA. Trailing sorts25	2.50	18.00

PLANTS FOR VASES.

DRACÆNA INDIVISA. Graceful centre plant for vases, bears the sun. Doz., \$5.00	Each.	.50
FICUS ELASTICUS. <i>Rubber Plant</i> . Makes a good vase centre		1.00
HYDRANGÆA OTAKSA. The variety usually seen in tubs, flowers, pink or bluish: LARGE PLANTS IN POTS for display this season. Each \$1.25 to		2.00
— — PLANTS IN LARGE TUBS. Per tub, \$5.00		

HARDY PERENNIAL PLANTS.

OLD-FASHIONED HARDY GARDEN FLOWERS.

The favorites of the old-time gardens are coming to the front, and deservedly so. No feature of the garden can be more satisfactory than a well-arranged Hardy Plant border, producing from April to November a continuous succession of charming flowers, much more interesting than the usual greenhouse assortment, and equally valuable for garden embellishment and cutting purposes. The Hardy Plants have the advantage of greater permanency, requiring only cultivation enriching, a slight mulch during winter, and occasional checking of the more robust growers to keep the plantation in good condition for years.

Where early flowers are desired we advocate the introduction of groups of Narcissi, Scillas, which bloom in April and May and should be planted in October, as well as Montbretias, the hardier species of Gladioli and Lilies for summer blooming, and which may be planted in spring.

We limit our list to varieties which have been found generally hardy and most desirable for the severe climate of New England.

FARQUHAR'S COLLECTION OF HARDY FLOWERS.

For purchasers who may not be familiar with the different sorts we offer the following collection for succession of bloom from early spring until November:

12 distinct species or varieties, our selection	. .	\$1.50
25 " " " " " " " "	. .	2.75
50 " " " " " " " "	. .	5.00
100 " " " " " " " "	. .	9.00



Delphinium Chinensis.

This charming hardy Larkspur should be better known. The flowers run in shades of blue, many of remarkable brilliance, also pure white, and they are not excelled in beauty by any hardy flower. Those who like the blue Bachelor's Button for cutting will prize still more this very graceful and beautiful larkspur. A bed of tall larkspur (see *Delphinium*, Farquhar's Hybrids, page 114), with *D. Chinensis* interspersed or used for a border, is most effective. Per doz., \$1.50; per 100, \$10.00.



Achillea Ptarmica Fl. Pl. "The Pearl."

HARDY PERENNIAL PLANTS — *Continued.*

NAME.	Ht. in Feet.	Mo. of Flowering.	Color of Flower.	Use, Soil, Position, Treatment, etc.	PRICE.	
					Each.	Doz.
ACANTHUS MOLLIS. <i>Bear's Breech</i>	3	7-8	White . . .	Ornamental; deep soil; sun; bold decorative leaves	\$0.25	\$2.50
ACHILLEA MILLEFOLIUM ROSEUM. <i>Pink Milfoil</i>	1½	5-10	Rose	Useful for cutting; sun15	1.50
— PTARMICA FL. PL. "THE PEARL"	1½	6-10	Pure white . . .	One of the best plants for garden effects and cutting15	1.50
— TOMENTOSA. <i>Yellow Yarrow</i>	1	6-8	Deep yellow . . .	Effective border plant; sun15	1.50
ACONITUM AUTUMNALE. <i>Monk's Hood</i>	4	7-9	Dark blue . . .	Handsome plants for border and shrubbery; sun or shade15	1.50
— NAEPELLUS		7-8	Dark blue . . .			
ADONIS VERNALIS	1	4-5	Golden yellow . . .	Desirable spring flower15	1.50
AGROSTEMMA CORONARIA. <i>Mullein Pink</i>	2	6-9	Bright crimson. . .	Sun or shade15	1.50
AJUGA REPTANS RUBRA	½	5-6	Blue	Dark purple foliage in masses15	1.50
ALSTREMERIA AURANTIACA	3	7-9	Orange spotted crimson . . .	Excellent for cutting; deep soil15	1.50
ALYSSUM ROSTRATUM	1½	6-7	Golden yellow . . .	Useful for massing; sun15	1.50
— SAXATILE COMPACTUM. <i>Gold Dust</i>	1	4-6	Golden yellow . . .	Showy rock and border plant15	1.50
ANCHUSA ITALICA	3	6-10	Deep blue	Broad foliage, large flower heads.15	1.50
ANEMONE JAPONICA	2-3	8-10	Deep rose	Invaluable plants for garden display and cut flowers in autumn	Per 100 { \$10.00 10.00 10.00	.15 .15 .15 .15
— — ALBA	2-3	8-10	White			
— — RUBRA	2-3	8-10	Carminc			
— — WHIRLWIND	2-3	8-10	White; double			
ANTHEMIS TINCTORIA. <i>Hardy Marguerite</i>	1½	6-9	Yellow	Useful for massing and cutting15	1.50
ANTHERICUM LILIAGO. <i>St. Bernard's Lily</i>	1½	5-6	Pure white10	1.00
— LILIASTRUM MAJOR. <i>St. Bruno's Lily</i>	1½	5-6	White, fragrant.10	1.00
AQUILEGIA CHRYSANTHA. <i>Golden Columbine</i>	2	5-7	Yellow	Very free grower15	1.50
— — ALBA	2	5-7	White	Of very graceful habit15	1.50
— CERULEA. <i>Rocky Mountain Blue Columbine</i>	2	5-7	Blue	Large handsome flowers15	1.50
— — ALBA	2	5-7	White	The largest white sort15	1.50
— HAYLOGDGENSIS	2	5-7	Shades of blue	Hybrids of the Rocky Mountain Columbine15	1.50
— MIXED SORTS	2	5-7	Many colors	Per 100, \$9.0015	1.50
ARABIS ALPINA. <i>Rock Cress</i>	½	4-6	White	Borders and rockeries15	1.50
ARMERIA MARITIMA LAUCHEANA. <i>Sea Pink or Thrift</i>	1½	5-9	Pink	Borders and rockeries; sun15	1.50
ASCLEPIAS TUBEROSA. <i>Butterfly Weed</i>	2	7-9	Deep orange	Showy plant for borders and wild gardens; sun15	1.50
ASPHODELUS LUTEUS. <i>Asphodel</i>	3	6-7	Yellow	Fragrant, lily-like flowers20	2.00
ASTER ALPINUS SPECIOSUS	1	5-6	Deep blue	Rockery or border plant; of great value for cutting20	2.00
— AMETHYSTINUS	3	9-10	Amethyst blue	Lovely border plant15	1.50
— NOVÆ ANGLIÆ	4	9-10	Bluish purple15	1.50
— — — ALBA. <i>New</i>	4	9-10	White15	1.50
— — — ROSEA	4	9-10	Pink15	1.50
— UMBELLATUM	4	9-10	White	Flowers in panicles15	1.50
BAPTISIA AUSTRALIS. <i>False Indigo</i>	2	6-7	Dark blue	Border or wild garden15	1.50
— EXALTATA	3	6-7	White15	1.50
BELLIS PERENNIS FL. PL. <i>English Daisy</i>	4	4-6	White or pink	Per 100, \$3.5010	.50
BOCCONIA CORDATA. <i>Plume Poppy</i>	4-8	6-8	Creamy white	Lawn groups and shrubbery15	1.50
BOLTONIA ASTEROIDES	5-6	8-10	White	Aster-like flowers; borders and shrubberies. Per 100, \$10.0015	1.50
— LATUSQUAMA	3-4	8-10	Pink			
CALLA ALBA MACULATA. <i>Spotted Calla</i>	2	6-7	White	Beautiful leaves, spotted white10	1.00
CALLIRHOE INVOLUCRATA. <i>Poppy Mal-low</i>	1	6-10	Crimson	Rockeries and wild gardens15	1.50
CAMPANULA ALLIARIÆFOLIA	2	6-7	White	Nodding flowers15	1.50
— CARPATICA. <i>Carpathian Bells</i>	3	6-9	Blue	Borders and rockeries15	1.50
— GLOMERATA. <i>Clustered Bell-flower</i>	1½	6-9	Violet Blue.	Borders and wild gardens15	1.50
— MEDIA. <i>Canterbury Bells</i>	2	6-7	Blue, pink or white	Biennials. Per 100, \$6.0010	1.00
— — CALYCANTHEMA. <i>Cup-and-Saucer Bell-flower</i>	2	6-7	Blue, pink or white	Biennials. " " \$8.0015	1.25
— PERSICIFOLIA GRANDIFLORA ALBA	2	6-8	White15	1.50
— — — MOERHEIMI. <i>New</i>	1-2	6-8	White, double	Splendid for cutting25	2.50
— — — CERULEA	2	6-8	Blue	Large salver-shaped flowers15	1.50

HARDY PERENNIAL PLANTS — *Continued.*

NAME.	Ht. in Feet.	Mo. of Flowering.	Color of Flower.	Use, Soil, Position, Treatment, etc.	PRICE.	
					Each.	Doz.
CARNATION HER MAJESTY. <i>Hardy Pink.</i>	1½	5-7	Pure white . . .	Clove scented; borders and cutting. Per 100, \$12.00	\$.20	\$2.00
— HARDY GERMAN	1½	6-9	Various	Single and double. " " \$8.00	.15	1.50
— PLUMARIUS CYCLOPE	1½	5-7	Pink, dark centre	Useful for edgings and cutting15	1.50
CEDRONELLA CANA	2	6-7	Crimson	Strong cedar fragrance15	1.50
CENTAUREA MACROCEPHALA	3	6-8	Golden yellow	Esteemed for cutting15	1.50
— MONTANA	2	6-8	Violet15	1.50
— ROSEA	2	6-8	Rosy red15	1.50
CHRYSANTHEMUM HARDY, POMPON						
GLOBE D'OR	2	9-10	Golden yellow	Most useful for autumn display and cutting. The flowers continue beautiful, and may be cut in abundance, long after other out-door flowers are destroyed by frost which does not readily harm these15	1.50
— — MARIE ANTOINETTE	2	9-10	Pink15	1.50
— — PRESIDENT	2	9-10	Crimson15	1.50
— — ROSINANTE	2	9-10	Blush-rose15	1.50
— — SŒUR MELAINE	2	9-10	Pure white15	1.50
— — STRATHMEATH	2	9-10	Rosy pink15	1.50
— — TIBER	2	9-10	Bronze15	1.50
— — TROJAN	2	9-10	Maroon, yellow centre		.15	1.50
CLEMATIS DAVIDIANA	3	6-8	Pale blue	Adapted to partial shade; fragrant25	2.50
— RECTA	4	6-7	Pure white	Sun; handsome as a bush25	2.50
CONVALLARIA MAJALIS. <i>Lily of the Valley.</i> Large Dutch Clumps	¾	5-6	White	Moist, shady ground. Per 100, \$25.00	.40	4.00
COREOPSIS GRANDIFLORA	2	6-10	Golden yellow	Showy, graceful and invaluable for cutting. Per 100, \$10.00	.15	1.50
— LANCEOLATA	2	6-10	Golden yellow		.15	1.50
CRINUM POWELLII	2-3	7-8	Deep rose	Elegant bulbous plants, with large, trumpet-shaped flowers50	5.00
— — ALBA	2-3	7-8	Pure white50	5.00
— — LIGHT ROSE. <i>New</i>	2-3	7-8	Beautiful pink		1.25	5.00
DAPHNE CNEORUM	1	5-10	Deep pink	Edgings, constant bloomer50	5.00
DELPHINIUM. <i>Larkspur</i> FARQUHAR'S HYBRIDS	3-5	6-10	Light azure to dark blue, and from delicate lavender to purple.	Stately decorative plants for masses, beds and clumps; the tall flower spikes are superb for decorations. Per 100, \$12.00	.20	2.00
— CHINENSIS	1½	6-10	Light and bright shades of blue. Per 100, \$10.00	.15	1.50
— — ALBA	1½	6-10	Pure white Per 100, \$10.00	.15	1.50
— FORMOSUM	3-4	7-10	Deep blue15	1.50
— — CŒLESTINUM	3-4	7-10	Sky blue Per 100, \$10.00	.15	1.50
— — SIBIRICUM	1½	6-10	Intense blue Per 100, \$10.00	.15	1.50
DIANTHUS BARBATUS. <i>See SWEET WILLIAM.</i>						
— DIADEMATIC. <i>Diadem Pink</i>	1	6-10	White, pink, and crimson.	Useful for edgings. Per 100, \$6.00	.10	1.00
— PLUMARIUS. <i>See CARNATION.</i>						
DICTAMNUS FRAXINELLA. <i>Gas Plant</i>	2½	6-7	Rosy Crimson15	1.50
DIELYTRA SPECTABILIS. <i>Bleeding Heart</i>	2	5-6	Pink15	1.50
DIGITALIS PURPUREA. <i>Foxglove</i>	2	6-7	White spotted and crimson.	Partial shade, and naturalizing in woodlands. Per 100, \$10.00	.15	1.50
— — ALBA	2	6-7	White15	1.50
— — IVERY'S SPOTTED	2	6-7	White and rose spotted15	1.50
DODECATHEON MEADIA. <i>American Cowslip</i>	1	4-5	Rosy purple	Partial shade15	1.50
DORONICUM CAUCASICUM	1	4-8	Bright yellow	Sun; borders or rockeries25	2.50
ECHINACEA PURPUREA. <i>Rudbeckia purpurea.</i> Giant Purple Cone-flower	2½	7-9	Rosy purple15	1.50
ECHINOPS EXALTATA. <i>Globe Thistle</i>	3	7-9	Pale blue	Stately plants for clumps20	2.00
— RITRO	3	7-8	Deep steel blue	Strikingly beautiful20	2.00
ERIGERON SPECIOSUS	2½	6-10	Purplish lilac	One of the prettiest and freest blooming perennials.		
ERYNGIUM ALPINUS AMETHYSTINUM. <i>Sea Holly</i>	2-3	7-8	Amethyst blue	Shrubbery and wild gardens25	2.50
EUPATORIUM FRASERI	2-3	8-10	White	Useful for cut flowers15	1.50
EUPHORBIA COROLLATA	1½	7-8	White	Valuable for cutting10	1.00
FUNKIA SUBCORDATA GRANDIFLORA. <i>Giant Day Lily</i>	1½	6-8	Pure white	Shrubbery borders, and shade15	1.50

HARDY PERENNIAL PLANTS — *Continued.*

NAME.	Ht. in Feet.	Mo. of Flowering.	Color of Flower.	Use, Soil, Position, Treatment, etc.	PRICE.	
					Each.	Doz.
FUNKIA TENUIFOLIA	1	6-8	Light purple		\$0.15	\$1.50
— UNDULATA MEDIA VARIEGATED	1	7-8	Lilac	Leaves variegated green and white, desirable for edgings15	1.50
GAILLARDIA GRANDIFLORA	3	6-10	Red and yellow.	Desirable for cutting15	1.50
GALIAM BOREALE. <i>Bed Straw</i>	1½	7-9	White	Delicate flower sprays prized for cutting15	1.50
GENTIANA ACAULIS. <i>Blue Gentian</i>	¼	4-5	Intense blue	Moist, shady ground20	2.00
— ANDREWSII	2	8-10	Deep blue20	2.00
GYPSOPHILA ACUTIFOLIA. <i>Baby's Breath</i>	3	7	White15	1.50
— PANICULATA	2	7-9	White	Exquisite for cut flowers15	1.50
HELENIUM AUTUMNALE. <i>Helen Flower.</i>	4	8-10	Pure yellow	Beds and shrubbery clumps15	1.50
— BOLANDERI	2	8-9	Yellow, brown centre	Splendid for cutting15	1.50
— GRANDICEPHALUM STRIATUM	3	7-10	Yellow, striped crimson	Rich and striking flower, very decorative15	1.50
HELIANTHUS LAEVIS. <i>Sunflower</i>	3	7-10	Yellow15	1.50
— RIGIDUS MISS MELLISH	4	8-10	Orange yellow15	1.50
— MULTIFLORUS. <i>Double Hardy Sunflower</i>	4	7-9	Golden yellow	Double dahlia-like flowers15	1.50
HELLEBORUS NIGER. <i>Christmas Rose</i>	1	3-4	White50	5.00
HEMEROCALLIS AURANTIACA MAJOR	2-3	6-8	Deep orange	Very large flowers50	5.00
— DISTICHA FLORE PLENO	2-3	6-8	Rich orange	Double flowers25	2.50
— FLAVA. <i>Yellow Day Lily</i>	2-3	6-8	Yellow	Fragrant10	1.00
— MIDDENDORFII	1½-2	6-7	Bright yellow20	2.00
HEUCHERA SANGUINEA	2	6-8	Coral-red15	1.50
HIBISCUS CRIMSON EYE	4	7-8	White, crimson centre15	1.50
— MOSCHEUTOS. <i>Swamp Mallow</i>	4	7-8	Pink	Thrive best in moist soil15	1.50
— — ALBUS	4	7-8	White15	1.50
HOLLYHOCK, SINGLE MIXED. <i>Althæa Rosea</i>	5	7-9	Various		Per 100, \$12.00	.20
— DOUBLE MIXED COLORS	5	7-9		“ “ 12.00	.20	2.00
— — SEPARATE COLORS				“ “ 15.00	.25	2.50
HYPERICUM MOSERIANUM. <i>St. John's Wort</i>	1	6-10	Golden yellow	One of the finest plants20	2.00
IBERIS SEMPERVIRENS. <i>Evergreen Candytuft</i>	½	4-5	Pure white	Rockeries and edgings15	1.50
INCARVILLEA DELAVAYI	1½	6-9	Rose pink	Beautiful gloxinia-like flowers in erect clusters25	2.50
IRIS CRISTATA. <i>Crested Iris</i>	½	5	Pale blue	Desirable for edgings15	1.50
— GERMANICA. <i>German.</i> See p. 105.						
— KÆMPFERI. <i>Japanese.</i> See p. 105.						
— ORIENTALIS	2	6-7	Violet blue	Rich, moist soil15	1.50
— PANCHREA	2		Yellow15	1.50
— SIBERICA	2½	5-6	Light Blue15	1.50
LATHYRUS LATIFOLIUS. <i>Everlasting Pea.</i>	8	7-8	Rose	Beautiful climbers for trellises or fences25	2.50
— — ALBUS	8	7-8	White25	2.50
LAVENDULA VERA. <i>Lavender</i>	1½	7-8	Blue	Very fragrant15	1.50
LIATRIS PYCNOSTACHIA. <i>Kansas Gay Feather</i>	4	7-9	Rosy purple	Very attractive flower spikes15	1.50
— SPICATA	2½	7-9	Deep purple15	1.50
LILIUM. See special list pages 106-7.						
LINUM PERENNE. <i>Flax</i>	1½	6-9	Blue	Border or rockery15	1.50
LOBELIA CARDINALIS. <i>Cardinal Flower.</i>	3	8-10	Cardinal red	Moist soil15	1.50
— SYPHILITICA	2½	8-10	Clear blue15	1.50
LUPINUS POLYPHYLLUS <i>Lupin</i>	3	6-10	Dark blue	Fine for naturalizing. Per 100, \$8.00	.15	1.50
— — ALBUS	3	6-10	White15	1.50
— — LILACINA	3	6-10	Lilac15	1.50
LYCHNIS CHALCEDONICA	2	6-9	Intense scarlet	Rich sandy loam15	1.50
— — ALBA	2	6-9	White15	1.50
— HAAGEANA	1½	5-6	Orange scarlet	Per 100, \$6.00	.10	1.00
— VISCARIA FL. PL.	1½	6-7	Deep red	Flowers double15	1.50
LYTHRUM ROSEUM SUPERBUM. <i>Rose Loose Strife</i>	3	7-9	Deep rose	Naturalizes well15	1.50
MERTENSIA VIRGINICA. <i>Blue Bell</i>	1½	5-6	Light blue	Extremely beautiful native plant15	1.50
MONARDA DIDYMA. <i>Bergamot</i>	2½	7-8	Bright scarlet	Desirable for wild gardens15	1.50
MYOSOTIS ALPESTRIS VICTORIA. <i>Forget-Me-Not</i>	½	5-7	Bright blue	Compact habit. Per 100, \$6.00	.10	1.00
— PALUSTRIS GRANDIFLORA	½	4-10	Bright blue	Shady border or rockery. Per 100, \$6.00	.10	1.00

HARDY PERENNIAL PLANTS — *Continued.*

NAME.	Ht. in Feet.	Mo. of Flowering.	Color of Flower.	Use, Soil, Position, Treatment, etc.	PRICE.	
					Each.	Doz.
CENOTHERA FRUTICOSA MAJOR. <i>Evening Primrose</i>	2	6-8	Golden yellow .	Adapted to naturalizing. Per 100, \$6.00	\$.10	\$1.00
— LAMARCKIANA	3	7-9	Yellow	Flowers three to four inches across. Per 100, \$6.00	.10	1.00
— YOUNGI	1½	6-9	Bright yellow .	Per 100, \$6.00	.10	1.00
PÆONIA. <i>Pæony</i> . See page 108.						
PAPAVER NUDICAULE. <i>Iceland Poppy</i>	1	4-10	White and yellow to deep orange-scarlet .	Rockeries and borders; their graceful, bright colored flowers are invaluable for table decorations. Per 100, \$10.00	.15	1.50
— ORIENTALE. ORIENTAL POPPY	3	5-7	Orange-scarlet .	Shrubby and wild gardens. Per 100, \$10.00	.15	1.50
— — ROYAL SCARLET	3	5-7	Deep scarlet .	The strongest growing sort20	2.00
PENTSTEMON ATROPURPUREUS	3	6-9	Dark red, white throat	Graceful flower spikes15	1.50
— BARBATUS COCCINEUS. <i>Chelone barbata</i>	3	6-9	Scarlet	Rockery and border plants. } Elegant for cutting. } Per 100, \$10.00 {	.15	1.50
— — TORREYII	3	6-9			
— PUBESCENS	1½	6-7	Rosy Purple15	1.50

PHLOX, HYBRID GARDEN SORTS. SEE ILLUSTRATION ON FIRST COVER PAGE.

Among hardy herbaceous plants none are more gorgeous and more easily grown than these. They are perfectly hardy, succeeding in any garden soil, and producing magnificent spikes of showy and lasting flowers, year after year, with comparatively little care. The varieties we offer are among the finest in cultivation and comprise the best and most distinct colors. 2½ to 3 ft. EACH, .20; PER DOZ., \$2.00; PER 100, \$12.00.

- | | |
|--|--|
| AMPHITRYON. Lilac, centre white. | EUGENE SCOTT. Porcelain blue and white. |
| ASTIER REHU. Violet purple; centre white. | HENRY MURGER. Pure white, rose eye. |
| AZUREA. Violet. | JEAN BART. Crimson, white eye. |
| BOULE DE FEU. Brilliant cherry red. | JEANE D'ARC. Pure white, very free flowering. |
| CANDEUR. Pure white, dwarf. | LA CYGNE. Pure white. |
| COCUELICOT. Orange scarlet, centre carmine; brilliant, large flower. | LEONARDO DA VINCI. White, carmine eye. |
| DIADEME. White, large truss. | LORD RALEIGH. Dark violet. |
| ECLAIREUR. Glowing crimson; extra. | PANTHEON. Brilliant rose. |
| ESPERANCE. Mauve. | RODIN. Lilac with rosy white edge. |
| ETNA. Bright orange-red. | SNOWDIN. Pure white; dwarf; very early. |
| | THEBAIDE. Beautiful rose, large and bold flower. |

PHLOX DIVARICATA	1	5-6	Lavender blue .	Borders; fragrant15	1.50
— SUBULATA ALBA. <i>Moss Pink</i>	½	4-5	Pure white	Rockeries and borders10	1.00
— — ROSEA	½	4-5	Pink10	1.00
PHYSOSTEGIA VIRGINIANA	4	7-9	Rosy lilac	Very ornamental15	1.50
PLUMBAGO LARPENTÆ	½	7-10	Deep blue	Beautiful for edgings and rockeries20	2.00
PLATYCODON GRANDIFLORA. <i>Chinese Bell Flower</i>	3	5-10	Violet blue	} Borders; elegant spikes of } } cupped flowers }	.15	1.50
— — ALBA	3	5-10	White			
— — MARIESI	1½	5-10	Rich violet	} Borders; cup-shaped flowers } } 3 inches across }	.15	1.50
— — ALBA	1½	5-10	White			
POLEMONIUM COERULEUM. <i>Jacob's Ladder</i>	1	6-7	Deep blue	Borders and shrubberies15	1.50
— — ALBUM	1	6-7	White15	1.50
— RICHARDSONI	1	6-7	Sky blue15	1.50
POLYGONATUM MULTIFLORUM. <i>Solomon's Seal</i>	2	6-7	White	Wild gardens15	1.50
PYRETHRUM ATROSANGUINEUM	2	6-9	Crimson, yellow centre	Valuable for cutting15	1.50
— ROSEUM. SINGLE HYBRIDS	1½	6-9	Shades of pink, crimson and white	Beautiful for borders and among the best flowers for cutting. Per 100, \$10.00	.15	1.50
— ULIGINOSUM. <i>Giant Daisy</i>	4	7-9	White, yellow centre	Useful for cutting15	1.50
RANUNCULUS ACRIS FL. PL. <i>Double Buttercup</i>	2	4-6	Golden yellow	Desirable for wild gardens10	1.00
RUDBECKIA FULGIDA. <i>Brilliant Cone Flower</i>	2½	8-9	Brilliant orange	Wild gardens. Per 100, \$8.00	.15	1.25

HARDY PERENNIAL PLANTS — *Continued.*

NAME.	Ht. in Feet.	Mo. of Flowering.	Color of Flower.	Use, Soil, Position, Treatment, etc.	PRICE.	
					Each.	Doz.
RUDBECKIA LANCEOLATA GOLDEN GLOW.	5-6	7-9	Deep yellow.	Shrubby clumps; flowers like double Cactus Dahlias, valuable for cutting. Per 100, \$8.00	\$1.25	\$0.15
— NEWMANII	2	7-10	Golden yellow, cone maroon.	Fine for cutting	1.25	.15
— SUPERBA SUBTOMENTOSA	2	7-9	Lemon yellow, cone purple.	Pyramidal form, branching	1.25	.15
SALVIA AZUREA GRANDIFLORA	2½	8-9	Sky-blue.	Free blooming	1.50	.15
— PRATENSIS. <i>Meadow Sage</i>	1½	6-8	Rich blue	Flowers in long spikes25
SANTOLINA CHAMÆCYPARISSUS. <i>Lavender Cotton</i>	½		Foliage silvery white	A dwarf spreading plant, useful for carpet beds and borders	1.00	.10
SAPONARIA OCYMOIDES SPLENDENS	½	5-6	Rosy crimson		1.50	.15
SAXIFRAGA CRASSIFOLIA	1	4-6	Pale rose	Grows in any position; handsome broad leaves	2.50	.25
SCABIOSA CAUCASICA	2	6-8	Pale blue	Borders and cutting. Per 100, \$12.00	2.00	.20
SEDUM SPECTABILE VAR. BRAUNI	1½	8-10	Bright rose	Clumps and borders	1.50	.15
SILENE VIRGINICA. <i>Fire Pink</i>	1	6-8	Crimson	Borders and wild gardens	1.50	.15
SPIRÆA ARUNCUS	3	6-7	White	Long, feathery panicles	1.50	.15
— ASTILBOIDES	3	6-7	White		1.50	.15
— AUREA RETICULATA	1½	6-7	White	Foliage dark green veined golden yellow. Per 100, \$12.00	2.00	.20
— JAPONICA	2	6-7	White		1.50	.15
— — COMPACTA MULTIFLORA	1½	6-7	White	Large, feathery flowers	1.50	.15
— PALMATA	3	6-7	Rosy crimson	Very brilliant. Per 100, \$8.00	1.50	.15
STATICE GMELINI. <i>Sea Lavender.</i>	1½	6-8	Violet blue	Rockwork or border	2.50	.25
— LATIFOLIA	1½	6-8	Blue		1.50	.15
STELLARIA HOLOSTEA. <i>Stitchwort</i>	½	5-7	White	Border or rockery	1.50	.15
STOKESIA CYANEA	1	7-10	Sky blue	One of the best native plants; exquisite for cutting	1.50	.15
SWEET WILLIAM MIXED. <i>Dianthus barbatus</i>	1½	6-9	White, pink, crimson	Borders. Per 100, \$6.00	1.00	.10
— WHITE				" " \$6.00	1.00	.10
— CRIMSON				" " \$6.00	1.00	.10
THALICTRUM ADIANTIFOLIUM. <i>Meadow Rue.</i>	1½	5-6	Creamy white	Foliage like maiden-hair fern	1.50	.15
THERMOPSIS CAROLINIANA	5	6-7	Yellow	Wild gardens and shrubberies	1.50	.15
TRILLIUM GRANDIFLORUM. <i>Wood lily</i>	2	4-5	White	Shade	1.00	.10
TRITOMA PFITZERI. <i>Red-hot Poker</i> or <i>Flame Flower</i>	3-4	7-10	Orange scarlet.	The earliest to bloom	2.50	.25
— UVARIA GRANDIFLORA	4	8-10	Crimson, shaded yellow	Lawn and shrubby clumps. Per 100, \$15.00	2.50	.25
— — NOBILIS	4	8-10	Bright scarlet		2.50	.25
TROLLIUS EUROPÆUS. <i>Globe Flower</i>	1½	5-8	Bright yellow	Borders and cutting. Per 100, \$12.00	2.00	.20
— CAUCASICUS, "ORANGE GLOBE"	1½	5-8	Rich orange			.35
VALERIANA OFFICINALIS	2	6-7	Purplish white.	Fragrant	1.50	.15
VERNONIA NOVE BORACENSIS	3-6	9-10	Dark purple	Clumps among shrubs	2.00	.20
VERONICA AMETHYSTINA	1	5-7	Amethyst blue		1.50	.15
— INCANA	2	7-9	Violet	Silvery leaves	1.50	.15
— LONGIFOLIA SUBSESSILIS	2	6-10	Rich blue	One of the best hardy plants, with showy flower spikes a foot long; blooms from June until frost. Per 100, \$12.00	2.00	.20
VINCA MINOR. <i>Periwinkle</i> or <i>Trailing Myrtle</i>	½	5-7	Blue	Dwarf evergreen used to cover shady ground. Per 100, \$8.00	1.50	.15
VIOLA CORNUTA. BLUE PERFECTION. <i>Tufted Pansy</i>	½	4-10	Mauve	Partial shade	1.50	.15
— — SILVER QUEEN	½	4-10	White		1.50	.15
YUCCA FILAMENTOSA. <i>Adam's Needle</i>	4	6-7	Creamy white	Effective and striking in any position; one of the most decorative hardy plants. Per 100, \$15.00	2.50	.25

HARDY ORNAMENTAL GRASSES.

	Each.	Doz.
ARUNDO DONAX. Grows in dense clumps, 9 feet in height	\$0.25	\$2.50
— — VARIEGATA. Foliage striped white	.25	2.50
EULALIA JAPONICA FOL. VITTATIS. Long, graceful striped foliage; 4 ft.	.25	2.50
— — ZEBRINA. Long leaves, elegantly barred with yellow	.25	2.50
GYNERIUM ARGENTEUM. <i>Pampas Grass.</i> Elegant silvery plumes; 10 ft.	.50	5.00
UNIOLA LATIFOLIA. Graceful panicles of large, flat flower heads; 3 ft.	.25	2.50

ROSES.

HARDY HYBRID
PERPETUAL
ROSES.

STRONG PLANTS, each, .35;
doz., \$3.50; per 100,
\$25.00.

ALFRED COLOMB. Brilliant
carmine-crimson; large.

ANNA DE DIESBACH. Clear,
bright rose.

BARON DE BONSTETTIN
Velvety blackish crimson.

BARONESS ROTHSCHILD.
Pale flesh pink; very fine.

BEAUTY OF WALTHAM.
Bright light red.

BOULE DE NEIGE. Pure white.

CAPT. HAYWARD. Bright crim-
son.

CHARLES LEFEBVRE. Bright velvety
scarlet.

DUKE OF EDINBURGH. Vermilion.

DUPUY JAMAIN. Very bright cerise.

EARL DUFFERIN. Velvety crimson, shaded ma-
roon.

FISHER HOLMES. Rich velvety crimson.

FRANCOIS MICHELON. Deep rose.

GENERAL JACQUEMINOT. Brilliant scarlet-crimson.

GLOIRE LYONNAISE. Fine chrome yellow.

JEANNIE DICKSON. Rosy pink.

JOHN HOPPER. Brilliant rosy-crimson.

JULES MARGOTTIN. Bright cherry.

LA FRANCE. Bright lilac-rose; centre silvery white.

LOUIS VAN HOUTTE. Deep red, shaded with ma-
roon

MABEL MORRISON. White, faintly flushed with pink.

MADAME GABRIEL LUIZET. Fine satiny rose.

MAGNA CHARTA. Bright pink suffused with carmine.

MARCHIONESS OF LONDONDERRY. Ivory white.

MARGARET DICKSON. White, pale flesh centre.

MARIE BAUMANN. Rich carmine-crimson.

MERVEILLE DE LYON. White, centre blush.

MRS. JOHN LAING. Soft pink; superb flower.

MRS. R. G. S. CRAWFORD. Rich, clear rose pink.

MONSIEUR BONCEME. Velvety dark crimson.

PAUL NEYRON. Deep rose; very large.

PRIDE OF WALTHAM. Delicate flesh color.

PRINCE CAMILLE DE ROHAN. Velvety crimson.

SENATEUR VAISSE. Dazzling red.

SIR ROWLAND HILL. Port-wine color.

ULRICH BRUNNER. Cherry-crimson.

VICTOR VERDIER. Deep rose; centre bright rose.

XAVIER OLIBO. Velvety black, shaded with amaranth.

HARDY MOSS ROSES.

Each, .50; doz., \$4.00.

BARONNE DE WASSENAIR. Fine deep rose.

BLANCH MOREAU. Large white.

CRESTED. Deep rose-pink.

MR. W. R. SMITH, Curator United States Botanic Garden, Wash-
ington, D.C., writes:

"I saw your new Rose, 'The Farquhar,' when it first bloomed,
with its raiser, Mr. Jackson Dawson, of the Arnold Arboretum,
and was so pleased with it that I at once pronounced it a rose for the
people."



COPYRIGHT
1903
BY R. & J. FARQUHAR & CO.

The Farquhar Climbing Rose.

HARDY CLIMBING ROSES.

THE FARQUHAR. (New.) The finest hardy climbing Rose. Bright pink double flowers in clusters; shining, rich green foliage which remains until November; plants have grown over 20 feet high in one season.

	Each.	Doz.	100.
Plants, 2 to 3 ft.75	\$7.50	\$50.00
" 4 to 5 ft. . . .	1.00	10.00	75.00
" 5 to 7 ft. . . .	1.50	15.00	

DEBUTANTE. A beautiful new Rambler, bearing clusters of soft pink double flowers having a sweet briar fragrance, and especially suited for climbing or trailing. Each, \$1.00; doz., \$9.00.

SWEET-HEART. It is a strong grower with glossy, dark green foliage. The flower buds are bright pink; the blossoms, however, open white, very double, 2¼ in. in diameter; fragrant. Each, \$1.00; doz., \$9.00.

CRIMSON RAMBLER. Blossoms in immense clusters, of a brilliant crimson color.

Flowering plants. Each, .25; per doz., \$2.00.
Larger size, 5 to 6 ft. Each, .50; per doz., \$5.00.
Largest size, 6 to 8 ft. Each, \$1.00; doz., \$9.00.

YELLOW RAMBLER; AGLAIA. Double flowers, yellow in the bud, but almost white when open. Each, .50.

BALTIMORE BELLE. White; large; double. Each, .50.

CARMINE PILLAR. Rosy carmine; very early. .50.

GEM OF THE PRAIRIES. Crimson; fragrant. Each, .50.

GLOIRE DE DIJON. Buff, centre orange. Requires protection in winter. Each, .50.

MADAME PLANTIER. White. Each, .50.

MULTIFLORA, OR SEVEN SISTERS. White. Each, .50.

QUEEN OF THE PRAIRIES. Bright red. Each, .50.

VARIOUS ROSES.

DAWSON. This splendid new Rose forms a bush about four feet in height, having long arching branches covered with double deep pink flowers. It is highly esteemed for landscape planting. Each, .30; doz., \$3.00; 100, \$20.00.

MULTIFLORA. Elegant rose for landscape work, growing five to six feet in height; small single white flowers in clusters, followed by orange colored berries. Each, .30; doz., \$3.00.

RUGOSA VARIETIES. These Japanese Roses grow in compact bushes, having glossy foliage and large, fragrant flowers. The large red seed pods are attractive in autumn. Each, .50; doz., \$4.00.

RUGOSA ALBA. Large, single, pure white flowers.

RUGOSA RUBRA. Single, beautiful rosy-crimson.

RUGOSA RUBRA FL. PLENA. Double, rosy-crimson.

SETIGERA. Valuable for natural effects and wild gardens, bearing large brilliant pink flowers in July. Each, .50; doz., \$5.00.

SWEET BRIARS. Foliage deliciously scented. Each, .50.

AMY ROBSART. Lovely deep rose.

ANNE OF GEIERSTEIN. Dark crimson.

FLORA McIVER. White, shaded pink.

LORD PENZANCE. Soft fawn, passing to yellow.

AUSTRIAN YELLOW VARIETIES. Each, .50; doz., \$4.00. The showiest Yellow Roses in cultivation.

AUSTRIAN COPPER. Rich coppery yellow.

PERSIAN YELLOW. Very deep and full.

WICHURIANA. Trailing species from Japan, valuable for covering banks and rocks, thrives near the sea; single; flowers white. Each, .25; doz., \$2.50.

HARDY CLIMBING PLANTS.

AKEBIA QUINATA. Dense clover-like foliage, purple flowers in clusters. Each, .35; doz., \$3.50.

AMPELOPSIS VEITCHII. *Japanese Woodbine*. Known as *Boston Ivy*; the beautiful hardy climber, conspicuously attractive on our finest streets and buildings.

One Year Plants. Each, .20; doz., \$2.00; 100, \$12.00

Two Year Plants. " .30; " 3.00; " 20.00

— QUINQUÆFOLIA. *Virginia Creeper*. Each, .25.

ARISTOLOCHIA SIPHO. *Dutchman's Pipe*. Very large foliage; flowers pipe shaped. Two sizes. Each, .50 and \$1.00.

BIGNONIA, OR TRUMPET FLOWER. Handsome, large scarlet flowers. Each, .50; doz., \$5.00.

CELASTRUS SCANDENS. *Roxbury Wax-Work*. A bold, vigorous vine; orange-scarlet. Each, .35; doz., \$3.50.

HONEYSUCKLE. BELGIAN. Very sweet; red and buff flowers. Each, .30; doz., \$3.00.

— HALL'S JAPAN. White, fragrant. Each, .25; doz., \$2.50.

— JAPAN VARIEGATED. Leaves yellow and green. Each, .35; doz., \$3.00.

— RED TRUMPET. Monthly blooming. Ea., .35; doz., \$3.50.

— VARIEGATED MONTHLY. Fragrant, yellowish-white flowers. Each, .25; doz., \$2.50.

HOP VINE. Suitable for covering walls, arbors, etc. Each, .25; doz., \$2.50.

MATRIMONY VINE. *Lycium Chinense*. Purple flowers followed by bright scarlet berries. Each, .25; doz., \$2.50.

PERIPLOCA GRÆCA. Handsome and vigorous. Ea., .35; doz., \$3.50.

WISTARIA, CHINESE PURPLE. The finest of climbing plants; purple flowers. Each, .50 to \$1.00.

— — WHITE. Each, .50 to \$1.



CLEMATIS.

Clematis paniculata.

PANICULATA. This lovely white variety, with its thousands of fleecy, small, star-like flowers, is one of the finest climbing plants. It is deliciously fragrant; a very rapid climber; flowers freely the first year, and is perfectly hardy. Flowering plants, each, .25; doz., \$2.50; 100 \$20.00. Extra large plants, each, .50; doz., \$5.00.

JACKMANNI. One of the best; fine, rich purple. Each, .75.

JACKMANNI ALBA. One of the finest whites. Each, .75.

MISS BATEMAN. Pure white; creamy band down each petal, .75.

HARDY ORNAMENTAL SHRUBS.



New Large-flowered Lilac.

	Each.
ALMOND. DOUBLE PINK-FLOWERING. May50
— — WHITE-FLOWERING. May50
ALTHEA. PURPLE, RED, OR WHITE. September.35
— VARIEGATED FOLIAGED. Beautiful50
AZALEA, GHENT. Magnificent large-flowering hybrids, in various fine colors. June	1.25
— MOLLIS. Large, showy, and fragrant	1.00
BACCHARIS HALMIFOLIA. Feathery white flowers. September50
BERBERIS PURPUREA. Dark purple foliage25
— THUNBERGII. <i>Japan Barberry</i> . Dwarf; handsome, shining foliage. June. Doz., 2.5025
— VULGARIS. <i>Common Barberry</i> . June25
CALYCANTHUS FLORIDUS. <i>Spice Bush</i> . Brown flowers; very fragrant. June to September50
CHIONANTHUS VIRGINICUS. <i>Fringe Tree</i> . White. June50
CLETHRA ALNIFOLIA. <i>Sweet Pepper Bush</i> . White; intensely fragrant; very fine. Doz., 3.0035
CORCHORUS JAPONICUS FLORE PLENO. <i>Kerria</i> . Double orange-yellow. June-July. Doz., 3.0035
— — VARIEGATA. Green and white foliage. Doz., 3.0035
CORNUS FLORIDA. <i>Dogwood</i> . Large, open, white flowers. May50
— ALBA. <i>Red Osier</i> . Bark deep red35
— SIBERICA. <i>Scarlet Dogwood</i> . Bark scarlet35
— STOLONIFERA. <i>Red-twigged Dogwood</i>50

	Each.
DESMODIUM PENDULIFLORUM. <i>Sweet Pea Shrub</i> . Red and violet pea-shaped flowers. Autumn35
DEUTZIA CRENATA FL. PL. PRIDE OF ROCHESTER. Double white; very beautiful. June35
DEUTZIA CRENATA ROSEA PLENA. Double pink. June35
— GRACILIS. White; very free; dwarf. June35
EUONYMUS ATROPURPUREUS. <i>Burning Bush</i> . Purple; in clusters. June50
EXOCHORDA GRANDIFLORA. <i>Pearl Bush</i> . One of the finest shrubs, with numerous loose clusters of pure white, starry flowers. Highly recommended. May50
FORSYTHIA FORTUNEI. Upright growing; golden yellow; free. May35
— SUSPENSА. <i>Weeping Golden Bell</i> . Pendulous habit, covered with yellow, drooping flowers. April35
HYDRANGEA PANICULATA. The original form of hardy Hydrangea brought from Japan. The flowers are less dense, more erect, and more graceful than the paniculate form usually seen. Doz., 3.0035
— PANICULATA GRANDIFLORA. The showiest of autumn shrubs, bearing immense heads of creamy-white flowers, turning to pleasing shades of red, Flowering plants, 2 years old. Doz., 2.5025
Extra large plants, 3 years old. " 5.0050
ILEX VERTICILLATA. <i>Winterberry</i> . Beautiful orange red berries which remain during winter. Doz., 5.0050
KALMIA LATIFOLIA. <i>Mountain Laurel</i> . Doz., 5.0050
LILAC, COMMON PURPLE. <i>Syringa</i> . Very fragrant. May. Doz., 2.5025
— COMMON WHITE. Fragrant; May. Doz., 3.0035
— CHARLES X. Reddish purple; trusses large; vigorous	1.00
— MADAME LEMOINE. Double white	1.00
— MARIE LEGRAYE. The finest white sort	1.00
— PERSIAN PINK. Large and fine. Doz., 5.0050
— — WHITE. Doz., 5.0050
— ROTHMAGENSIS. <i>Rouen Lilac</i> . Reddish-lilac, immense flower trusses50
— SOUVENIR DE LOUIS SPAETH. Dark purplish red	1.00
LONICERA TARTARICA. <i>Bush Honeysuckle</i> . Pink; sweet-scented. May35
— MORROWII. White flowers in May, followed by bright red fruit during summer and autumn. Doz., 3.0035
— RUPRECHTA. Large deep pink flowers in May; large red fruit. Doz., 3.0035
PRIVET CALIFORNIA. Glossy foliage, almost evergreen. Doz., 2.5025
PRUNUS PISSARDI. <i>Purple-Leaved Plum</i>50
— TRILOBA. Double pink flowers. May50
PYRUS MALUS BACCATA. Flesh-colored, double50
— — PARKMANNI. Dark rose; drooping	1.00
RIBES AUREUM. <i>Flowering Currant</i> . Yellow35
— SANGUINEUM. Red35
SAMBUCUS AUREA. <i>Golden Elder</i> . Broad, golden-yellow leaves50

HARDY ORNAMENTAL SHRUBS — *Continued.*



Rhododendron.

RHODODENDRONS, HARDEST HYBRIDS. We import annually a large assortment of the best English-grown, large-flowering, hardy sorts. These plants, being grown on English heathland, are of hard, stocky growth with abundance of fibrous roots and well set with flower buds. They are better suited to our variable climate than the soft wooded and scantily-rooted plants grown at half the cost on the lowlands of Holland and usually sold here for no less prices.

FINE PLANTS. Each, \$1.50; doz., 18.00; 100, 125.00.
LARGER PLANTS. Each, \$2.00; doz., 24.00; 100, 175.00. SPECIMEN PLANTS. Each, \$2.50 and 3.00; doz., 30.00 and 36.00, according to size.

RHODODENDRON MAXIMUM. *Native Rhododendron.* Each, \$1.50 to 5.00; doz., 15.00 to 50.00, according to size. Carload price on application.

	Each.
SPIRÆA CALLOSA ALBA. White flowers; May35
— ANTHONY WATERER. Brilliant rosy carmine flowers in dense clusters. Doz., 3.5035
— OPULIFOLIA AUREA. White flowers in clusters; golden foliage. May. Doz., 3.5035
— PRUNIFOLIA FLORE PLENO. <i>Bridal Veil.</i> Double white; very free; May. Doz., 3.5035
— THUNBERGII. Very ornamental, narrow, willow-like foliage; flowers white. Doz., 3.5035
— VAN HOUTTEI. One of the finest shrubs; pendulous; pure white flowers in clusters. Doz., 3.5035

	Each.
SPIRÆA REEVESII FLORE PLENO. Double flowered; very choice. Doz., 3.5035
STEPHANANDRA FLEXUOSA. Erect growing shrub with elegant fern-like foliage35
SYRINGA, GOLDEN. <i>Philadelphus aurea.</i> Foliage golden yellow; fine; June50
— LEMOINEI. Small, white, fragrant flowers; June. . .	.35
— SWEET-SCENTED. <i>Philadelphus Coronarius.</i> White, fragrant, orange-like flowers; June. Doz., 3.0030
— — LARGE FLOWERED. Doz., 3.5035
SYMPHORICARPUS RACEMOSUS. <i>Snowberry.</i> Flowers pink with pure white berries in the fall; July25
— VULGARIS. <i>Coral Berry.</i> Dark red berries25
VIBURNUM CASSINOIDES. Rich foliage, flowers white. May-June. Doz., 3.5035
— DENTATUM. Clusters of deep blue berries. Doz., 3.0035
— OPULUS. <i>Snowball, or Guelder Rose,</i> handsome in flower and in fruit. Doz., 2.5025
— TOMENTOSUM. <i>Japanese Snowball.</i> Pure white flowers in large round trusses50



Weigelia Rosea.

WEIGELIA EVA RATHKE. Fine deep crimson flowers; June to October50
— ROSEA. Large rose flowers; June35
— — VARIEGATA. Pink, foliage variegated; June35
ZANTHORIZA APIIFOLIA. Splendid dwarf spreading shrub with green feathery foliage. Doz., 3.0030

ORNAMENTAL AND SHADE TREES.

	Each.
ASH, MOUNTAIN	\$.075
BEECH, PURPLE. 3 to 4 ft.	1.00
BIRCH, PURPLE LEAVED	1.00
— WHITE CUT-LEAF WEEPING. 6 to 7 ft.	1.50
CATALPA KÆMPFERI75
CERCIS CANADENSIS. <i>Red Bud.</i> 4 to 5 ft.75
ELM, AMERICAN. 6 to 7 ft. Each, .75; 8 to 9 ft.	1.25
— ENGLISH. 6 to 7 ft.	1.00
GINGKO. <i>Salisburia adiantifolia.</i> 6 to 8 ft.	1.00
HAWTHORN, PAUL'S DOUBLE SCARLET	1.50
— DOUBLE WHITE	1.50
HORSE CHESTNUT. 6 ft.	1.00
— — RED FLOWERING. 5 to 6 ft.	1.00
— — DOUBLE FLOWERING. 5 to 6 ft.	1.00
SWEET CHESTNUT. American. 4 to 5 ft.75
LABURNUM, GOLDEN. 4 to 5 ft.75
LARCH, EUROPEAN. 3 to 4 ft.50
LINDEN, AMERICAN. 6 to 8 ft.	1.00
— EUROPEAN. 6 to 7 ft.	1.50

	Each.
MAGNOLIA ATROPURPUREA. Chinese purple . . .	\$1.50
— CONSPICUA. Chinese white	1.50
— LENNEI. Dark purple, very fine	2.00
— SOULANGEANA. Large white and purple flowers	1.50
MAPLE, NORWAY. 10 to 12 ft.	1.50
— SILVER. 10 to 12 ft.	1.50
— SUGAR. 10 to 12 ft.	1.50
— JAPAN. <i>Acer polymorphium atropurpureum.</i> A most beautiful dwarf hardy tree; foliage coppery-red. 1½ ft. Each, \$1.00; 2 ft.	2.00
— WIER'S CUT-LEAF. 8 to 10 ft	1.00
OAK, RED <i>Quercus rubra.</i> 6 to 8 ft.	1.50
POPLAR BOLLEANA. 8 to 9 ft.	1.00
— BALSAM. <i>Balm of Gilead.</i> 7 to 9 ft.	1.00
— GOLDEN. 5 to 6 ft.75
— LOMBARDY. 8 to 10 ft.75
SYRINGA JAPONICA. <i>Tree Lilac.</i> 4 to 6 ft.	1.25
WILLOW, KILMARNOCK. Weeping	1.00

HARDY CONIFERS.



Abies pungens Kosteriana. Colorado Blue Spruce.

- ABIES ALBA. *White Spruce*. Valuable for planting near the sea. 3 ft. 75
- BALSAMEA. *Balm of Gilead Fir*. Rich, dark green foliage, silvery underneath. 2 to 2½ ft. 75
- CANADENSIS. *Hemlock Spruce*. Dark green foliage, valuable for partial shade. 3 to 4 ft. 1.50
- CONCOLOR. *Colorado Silver Fir*. One of the most beautiful and graceful evergreen trees, growing in symmetrical pyramid form, with long feathery foliage of silvery green color which curves upward. As a lawn specimen it is one of the most decorative trees and it is perfectly hardy. 2 ft. 3.00
- VIOLACEA. Foliage silvery blue. 2 ft. 3.00
- EXCELSA. *Norway Spruce*. Serviceable for screens, shelter and clumps. 2 to 2½ ft. Per doz., \$3.00 30
- AUREA. *Golden Crested Spruce*. The leaves on the upper sides of the shoots become golden yellow. 2 to 3 ft. Per doz., \$15.00 1.50
- NORDMANNIANA. *Nordmann's Silver Fir*. A symmetrical and massive tree with horizontal branches and rich dark green foliage, silvery underneath. 2½ to 3 ft., bushy. Doz., \$30.00 3.00

Each.

- PLUMOSA. Forms a handsome pyramid of dense, feathery branches, fine, light green foliage. 2 ft. Doz., \$5.00, each, .60; 3 ft. Doz., \$12.00, each, \$1.25; 4 ft. Doz., \$20.00 2.00
- AUREA. One of the best Evergreens, forming a pyramid of rich golden foliage which holds its color the year round. It is one of the most brilliant and hardy conifers. 1½ to 2 ft., each, \$1.00; 2½ to 3 ft., each \$2.00. Larger specimens, \$3.00 to \$20.00.
- SQUARROSA GLAUCA. Beautiful, hardy sort, is of a glaucous steel blue color. 2 ft. Doz., \$8.00 75
- 3 ft., each, \$2.00; 4 to 5 ft., each, \$4.00; 6 to 7 ft. 7.50
- THUJA OCCIDENTALIS. *American Arborvitæ*. Extremely useful for screens, clumps or lawn specimens. 3 to 4 ft. Doz., \$5.00 50
- 5 to 6 ft. Doz., \$10.00 1.00
- LUTEA. *Nootka Sound Cypress*. Yellow foliage. 2 to 2½ ft. Doz., \$20.00 2.00
- 2½ to 3 ft. 3.00
- GLOBOSA. *Globe Arborvitæ*. 1½ to 2 ft. 75
- GEORGE PEABODY. Golden yellow, very hardy. 2 ft. 1.50
- SIBERICA. *Siberian Arborvitæ*. 2 ft. 50

Each.

ABIES PUNGENS KOSTERIANA. The finest form of Colorado Blue Spruce. One of the hardiest and choicest Evergreens; foliage steel blue. 1½ ft., each \$2.50; 2½ ft., \$5.00. Larger specimens, each \$7.50 to \$25.00.

JUNIPERIS CHINENSIS. *Chinese Juniper*. A handsome, compact bush, branches slightly drooping; foliage dark green. 1½ to 2 ft. 1.50

— AUREA. *Golden Chinese Juniper*. Foliage of the twigs golden yellow; very beautiful. 1½ ft. Doz., \$15.00 1.50

— VAR. SUECICA. *Swedish Juniper*. Grows in the form of a neat, compact column; foliage golden green. 3½ ft. Doz., \$7.50 75

— JAPONICA AUREA. Of erect conical habit; golden foliage. 2 to 2½ ft. 2.00

— VIRGINICA. *Red Cedar*. Well-formed, cultivated specimens of this native evergreen are highly ornamental. 2 ft. Doz., \$5.00 50

PINUS AUSTRIACA. *Austrian Pine*. A noble tree of rapid growth with massive horizontal branches covered with long, thick, dark green foliage; very hardy. 3 to 4 ft., bushy. Doz., \$10.00 1.00

— STROBUS. *White or Weymouth Pine*. Useful for screens, wind-breaks, and backgrounds. 3 to 3½ ft. Doz., \$10.00 1.00

— SYLVESTRIS. *Scotch Pine*. One of the best trees for exposed situations. 3 to 4 ft. Doz., \$10.00 1.00

RETINOSPORA ERICOIDES. Foliage coppery violet, turns green in winter. 1½ ft. Doz., \$8.00 75

— FILIFERA. Thread-like, drooping, light green branches; pyramidal form; graceful and beautiful. 2½ to 3 ft. Doz., \$16.00 1.50

— AUREA. New. A golden leaved form of the preceding. 2½ ft. 2.00

— OBTUSA. A compact, pyramidal tree, dark green foliage, tinted bronze. 3 to 3½ ft. Doz., \$15.00 1.50

BOXWOOD TREES.

PYRAMIDAL. 3 to 3½ ft. Each, \$2.00; doz., \$20.00. 3½ to 4 ft. Each, \$2.50; doz., \$25.00. 4 to 5 ft. Each, \$5.00 to \$6.00. STANDARDS 15-inch diam. Each, \$2.00; doz., \$20.00. 18-inch diam. Each, \$3.00; doz., \$30.00. BUSHES, 2½ to 3 ft. Each, \$1.50; doz., \$15.00.

GRAPE VINES AND SMALL FRUITS.

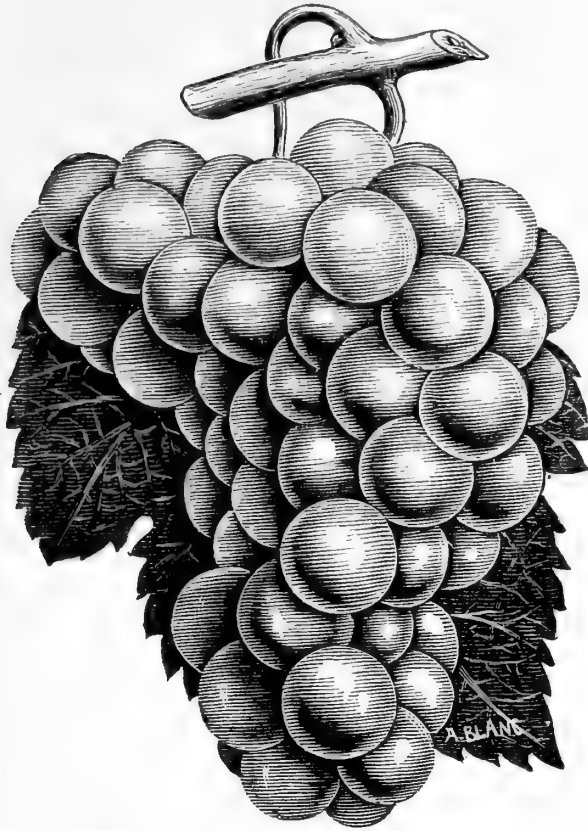

HARDY GRAPES.

Good plants, each, 35 cents.

- CAMPBELL'S EARLY, BLACK. Rich and sweet.
- MOORE'S EARLY, BLACK. Excellent early sort; large.
- CONCORD, BLACK. Vigorous grower; excellent flavor.
- BRIGHTON, RED. Early; fine flavor; strong grower.
- GREEN MOUNTAIN, WHITE. Sweet early white sort.
- NIAGARA, WHITE. Hardy sort, of fine flavor.

HOT-HOUSE GRAPES.

Strong Planting Canes, each, \$3.50.

- ALICANTE. Black, large, fine; late-keeping.
- BLACK HAMBURG. Delicious; best for general use.
- LADY DOWNE'S SEEDLING. Black; large sweet berries.
- MADRASFIELD COURT. Black; large fruit.
- MUSCAT, BOWOOD. White, oval, very fine.
- MUSCAT OF ALEXANDRIA. Best white grape, delicious.

BLACKBERRIES.

Per Doz.

- DORCHESTER. Large, black, oblong fruit; sweet, \$1.00
- SNYDER. Very sweet, large, and free . . . 1.00

CURRANTS.

- FAY'S PROLIFIC RED. Largest and finest . . . 1.75
- WHITE GRAPE. Early; very fine . . . 1.00

GOOSEBERRIES.

- SMITH'S IMPERIAL. The best green variety . . . 1.50
- WINDHAM'S INDUSTRY. Large red berries; sweet, 2.50

STRAWBERRIES.

Bi-sexual or staminate varieties marked S. are self-fertilizing. Pistillate or imperfect varieties marked P. require a staminate sort planted near them for fertilization.

- Layer plants, ready in May. Per 100, \$1.00; 1,000, \$7.00.
- Pot-grown Plants, ready about July 25; bear freely the following summer. Per 100, \$3.00; 250, \$7.00; 500, \$12.50; 1,000, \$25.00.

- BELMONT, S. Heavy cropper; unsurpassed quality; late.
- BISMARCK, S. Early, medium, very sweet.
- BRANDYWINE, S. Excellent large fruit; late.
- CLYDE, S. Favorite market sort, second early.
- EXCELSIOR, S. The largest early sort; dark red.
- GLEN MARY, S. Large, conical, bright red berries; firm and of fine flavor.
- HAVERLAND, P. Vigorous; productive; fine quality.
- MARSHALL, S. One of the best; remarkable for its enormous size and delicious flavor; very vigorous.
- MINUTE MAN, P. Bears longer than others, excellent quality.
- NEW YORK, S. A delicious and productive early sort.
- NICK OHMER, S. Fine; second early; glossy red.
- SAMPLE, P. Excellent for either market or home use; prolific, large, firm, and delicious.
- SENATOR DUNLOP. Large, dark red; early.

RASPBERRIES.

Per dozen, \$1.00.

- CUTHBERT. Red, large, dark crimson; one of the best.
- GOLDEN QUEEN. Yellow, large, of highest quality.
- LOUDON. Best and hardiest; large and sweet.
- MARLBORO. Red, very large berries.

HEDGE PLANTS.

	Per Doz.	Per 100.
ARBOR VITÆ. Transplanted, 1½ to 2 feet, \$2.00	\$2.00	\$10.00
BARBERRY, COMMON. 1½ to 2 feet . . .	1.50	10.00
— THUNBERG'S. 18 inches . . .	2.25	15.00
HEMLOCK SPRUCE. 2 to 3 feet . . .	7.50	55.00
LILAC, COMMON . . .	1.50	10.00

	Per Doz.	Per 100.
NORWAY SPRUCE. 1 to 1½ feet . . .	\$1.50	\$10.00
— — 1½ to 2 feet . . .	2.00	15.00
PRIVET, CALIFORNIA. 1 to 1½ feet . . .	1.00	6.00
— — 2 to 2½ feet . . .	1.50	10.00

COMMONWEALTH OF MASSACHUSETTS.

STATE BOARD OF AGRICULTURE.

OFFICIAL CERTIFICATE No. 87.

BOSTON, SEPT. 21, 1903.

To whom it may concern.

This is to certify that I have this twenty-first day of September, 1903, completed the inspection of the nursery stock of R. & J. FARQUHAR & Co., grown at Roslindale and Sharon, State of Massachusetts, and find it to be apparently free from the San Jose Scale, Phylloxera, and other injurious insects and diseases which might be transferred on nursery stock from the nursery to the orchard or garden.

This certificate is good until July 1, 1904.

(Signed)

H. T. FERNALD,
Inspector.

Inspected by Deputy H. E. HODGKISS.

STANDARD WORKS ON AGRICULTURE, HORTICULTURE, LANDSCAPE GARDENING, AND FORESTRY.

All books sent post or express paid at prices quoted.

FARM AND GARDEN.

Amateur's Practical Garden Book, The. C. E. Hunn and L. H. Bailey	\$1.00
American Farm Book. Allen	2.00
Flower Garden, English. W. Robinson	6.00
Flower Garden, The Amateur's. Shirley Hibberd,	2.50
Forage Crops Other Than Grasses. Thomas Shaw,	1.00
Gardener's Dictionary, Johnson's	4.00
Gardening, Encyclopedia of. J. C. Loudon, F. L.S. 1,000 woodcuts, 8vo. \$7.50. The theory and practice of horticulture, floriculture, arboriculture, and landscape gardening	7.50
Gardening, The Dictionary of. Geo. Nicholson, A.L.S. 6 vols. Per vol.	5.00
Garden, The Wild. William Robinson	4.80
Garden Making. L. H. Bailey	1.00
Gardening for Pleasure. Peter Henderson	1.50
Grasses and Forage Plants. Charles L. Flint	2.00
Grasses of North America. W. J. Beal. Vol. I., \$2.50. Vol. II.	5.00
Handbook of Plants and General Horticulture. Peter Henderson	3.00
Horticulturist's Rule Book. L. H. Bailey75
How to Make a Flower Garden	1.60
How to Make a School Garden. Hemenway	1.00
Nursery Book, The. L. H. Bailey	1.00
Pastures, Permanent and Temporary. Sutton	2.00
Play and Profit in My Garden. E. P. Roe	1.00
Principles of Agriculture, The. L. H. Bailey	1.25
Propagation of Plants. A. S. Fuller	1.50
Pruning Book, The. L. H. Bailey	1.50
Silos, Ensilage and Silage. M. Miles50
Soil, The; Its Nature, Relations, and Fundamental Principles of Management. King75
Weeds, How to Eradicate Them. Thomas Shaw,75

FIELD AND GARDEN VEGETABLES.

Asparagus. G. M. Hexamer50
Cabbage, Cauliflower, and Allied Vegetables. C. L. Allen50
Cabbage, Gregory on. J. J. H. Gregory30
Celery for Profit. T. Greiner20
Forcing Book, The. L. H. Bailey	1.00
Gardening for Profit. Peter Henderson	1.50
Market Gardening, Success in. W. W. Rawson,	1.00
Mushrooms, How to Grow Them. Falconer	1.00
Mushroom Culture. Robinson50
Onion Culture, The. New. T. Greiner50
Principles of Vegetable Gardening. L. H. Bailey,	1.25
Rhubarb Culture, The. New. J. E. Morse50
Vegetable Gardening. S. B. Green	1.00

FRUITS AND FRUIT CULTURE.

American Fruit Culturist. J. J. Thomas	2.50
Barry's Fruit Garden. P. Barry	1.50
Fruits and Fruit Trees of America; or, The Culture, Propagation, and Management in the Garden and Orchard of Fruit Trees Generally. A. J. Downing	5.00
Fruit Harvesting, Storing, Marketing. Waugh	1.00
Grape Culturist, The. A. S. Fuller	1.50
Principles of Fruit Growing. L. H. Bailey	1.25
Propagation of Plants, The. A. S. Fuller	1.50
Small Fruit Culturist, The. A. S. Fuller	1.00
Strawberry Culturist, The. A. S. Fuller25
Systematic Pomology. F. A. Waugh	1.00
Vines and Vine Culture. Considered the best Book on Grapes. Archibald F. Barron	1.50

INSECTS AND FUNGI.

Injurious Insects and the Use of Insecticides. Frank W. Sempers	\$0.40
Insects and Insecticides. C. M. Weed	1.50
Spraying of Plants. E. J. Lodeman	1.00

FLOWERS AND ORNAMENTAL PLANTS.

American Carnation, How to Grow It. Ward	3.50
Bulbs and Tuberous Rooted Plants. C. L. Allen.	1.50
Carnation Culture, American. By L. L. Lamborn,	1.50
Cyclopedia of American Horticulture. Bailey and Miller. (4 volumes)	20.00
Dahlia, The. By Lawrence K. Peacock30
Dahlia; Its History and Cultivation. R. Dean75
Ferns and Evergreens of New England. Edward Knobel. Net, 50c. Cloth75
Field, Forest, and Wayside Flowers. Going	1.50
Greenhouse Construction. L. R. Taft	1.50
Greenhouse Management. L. R. Taft	1.50
Herbaceous Plants Cultivated in Royal Gardens, Kew, Eng.	1.00
Greenhouse and Window Plants. C. Collins40
Home Floriculture. E. E. Rexford	1.00
House Plants and How to Succeed With Them	1.00
Nature's Garden. An aid to the knowledge of our Wild Flowers and their insect visitors	3.00
Pansies, Violas, and Violets. Cuthbertson75
Plant Culture. George W. Oliver	1.00
Plea for Hardy Plants. A. J. Wilkinson Elliot. Paper, 80c. Cloth	1.60
Practical Floriculture. Peter Henderson	1.50
Propagation of Plants. A. S. Fuller	1.50
Rhododendrons. E. S. Rand, Jr.	1.50
Rose, Parsons on the. S. B. Parsons	1.00
Rose, The. H. B. Ellwanger	1.25
Shrubs of N.E. America, The. Newhall	1.75
Shrubs, Ornamental. Lucius D. Davis	3.50
Sweet Peas, All About. W. T. Hutchins20
Violet Culture, Commercial. B. T. Galloway	1.50
Water Garden, The. William Tricker	2.00
Water Lilies and Aquatics, The Culture of25
Window Flower Garden, The. Julius Heinrich,50
Wild Flowers, Field Book of American. F. Schuyler Mathews	1.75

LANDSCAPE GARDENING AND FORESTRY.

American Gardens. Guy Lowell	7.50
Gardens, Italian. Charles A. Platt	5.00
Handbook of Practical Landscape Gardening. F. R. Elliot	1.50
How to Plan the Home Grounds. S. Parsons	1.00
Landscape Gardening. F. A. Waugh50
Landscape Gardening. Samuel Parsons	3.50
Landscape Gardening. Edward Kemp	2.50
Picturesque Gardens and Ornamental Gardening. Charles Henderson	2.50
Residential Sites and Environments. Johnson	2.50
Shrubs of N.E. America, The. Newhall	1.75
Shrubs, Ornamental. Lucius D. Davis	3.50
Tree Planting, Handbook of; or, Why to Plant, Where to Plant, What to Plant, How to Plant. Nathaniel H. Egleston75
Trees and Shrubs of New England A Guide to Find the Names of all Wild-Growing by their Leaves. Edward Knobel75
Trees and Their Leaves, Familiar. F. Schuyler Mathews	1.75
Trees of Northeastern America, The. Chas. S. Newhall	1.75

INSECTICIDES AND FUNGICIDES.

ANT DESTROYER. A specially prepared powder which will destroy or drive away Black Ants from lawns, trees, plants, houses, or other infested localities. Price, $\frac{3}{4}$ -lb. can, .50; by mail, .60.

ARSENATE OF LEAD. For spraying trees. A remedy for Elm Leaf Beetle, Gipsy Moth, Brown Tail Moth, etc. Price, 1-lb. tin can, .20; 5-lb. pail, .90; 10-lb. pail, \$1.70; 20-lb. pail, \$3.40; 50-lb. pail, \$8.00; 100-lb. keg, \$15.00.

APHIS PUNK. NIKOTEEN. It kills bugs under glass. .60 per box 1 doz. rolls, \$6.50 per case 1 dozen boxes. 3 rolls will fumigate 100-foot house.

BORDEAUX MIXTURE, LION BRAND. A valuable and indispensable fungicide for grape growers, ensuring larger crops and finer grades and preventing failure. Successful against black rot, mildew, and rust. Being in liquid form, it is very convenient to handle. One gallon will make 50 gallons of spraying liquid by the addition of 49 gallons of water. Price, 1-gal. patent cans, \$1.00; 1-qt. cans, .40.

DRY BORDEAUX MIXTURE, POWELL'S IMPROVED. Ready for use by simply adding water. Lb. box makes 5 gallons spray, .20; 5-lb. box makes 25 gallons spray, .75; 10-lb. box makes 50 gallons spray, \$1.25; 25-lb. box makes 125 gallons spray, \$3.00; 300-lb. barrel makes 1,500 gallons spray, \$27.00.

BOWKER'S PYROX. A combined insecticide and fungicide for fruit trees, vegetables, and flowers. Kills canker worms, rose worms, caterpillars, etc., and prevents blights, mildews, and rots. 10 lbs. makes 60 gal. of spray. 5-lb. can, .75; 10-can, \$1.25; 100-lb. keg, \$9.00.

BOWKER'S DISPARENE. A remedy for elm beetle, potato-beetle, caterpillars, and all leaf-eating insects. Used and endorsed by leading Experiment Stations and park superintendents. 2-lb. can, .50; 5-lb. can, \$1.00; 10-lb. can, \$1.80; 100-lb. keg, \$15.00.

BOWKER'S INSECT EMULSION. An effective emulsion of insecticide oils scientifically combined. Kills plant lice, aphids, thrips, green fly, scale insects, etc., in greenhouses and out of doors. 1 gal. makes 20 gal. of spray. 1 qt., .50; 2 qts., .75; 1 gal., \$1.00.

BOWKER'S BODLIME. Prevents canker worm damage. A viscid, sticky material which, when applied in a narrow band around tree trunks, intercepts and kills canker worm moths and other crawling insects. Cheaper and more effective than metallic protectors. One application sufficient for the season. 5-lb. can, .75; 10-lb. can, \$1.25; 100-lb. keg, \$7.50.

BUG DEATH. We give this insecticide our fullest endorsement. It has now been on the market seven years, and the sale is rapidly increasing. It is a non-poisonous powder, and can be applied dry just as it came from the package, or it can be mixed with water and sprayed on vines with any of the sprayers on the market, 12½ lbs. to 80 gallons water mixed thoroughly. It is death to the potato, squash, and cucumber bugs, currant and tomato worms, and many other plant-eating pests. As Bug Death contains no arsenic it will not burn or blight the vine, thus giving the potato a better chance to mature, which means a more starchy potato, and one less liable to rot, and the extra yield of marketable potatoes will more than pay the entire expense. Use freely on all house plats. Price, 1-lb. package, .15; 3-lb. package, .35; 5-lb.

package, .50; 12½-lb. package, \$1.00; 100-lb. package, \$7.00. Perfection Shaker, .65.

CATTLE COMFORT. A practical remedy against insects pestering cows, oxen, horses, mules, or dogs. It can be diluted half and half with kerosene oil, *thus insuring economy of cost.* Its use on milch cows protects the cow from shrinkage of summer milk, and when a cow has shrunk in her milk flow no subsequent feeding will restore it. Cattle comfort is applied to best advantage by spraying. Qt., .50; ½ gallon, .75; 1 gallon, \$1.25.

COPPER SOLUTION AMMONIATED. A concentrated liquid fungicide, prepared ready for immediate use on trees, vines, or vegetables affected with rot, blight, or scab, and with safety to the foliage. The various plant diseases to which it is applicable are: Rot of the grape, mildew of the grape, anthracnose of the grape, pear scab and leaf blight, apple scab, gooseberry mildew, cranberry scald, potato blight, tomato blight, melon blight, quince blight, black spot on the rose, mignonette disease, carnation rust. Directions: 1 quart of solution to 25 gallons of water. Per quart, \$1.00.

DALMATIAN OR PERSIAN INSECT POWDER. One of the best insecticides for all insects. Lb., .50.

FIR TREE OIL. SOLUBLE. For destroying all insects that infest plants and animals, such as mealy bug, scale, red spider, green fly, thrip, lice, fleas, etc. Harmless to the hands of the user. Directions with each package. Price, ½ pint, .40; pint, .75; quart \$1.25; half gallon, \$2.25; gallon, \$4.00. Not available.

FIR TREE OIL SOAP, STOTT'S. A non-poisonous insecticide for destroying scale, mealy bug, aphis, red spider, currant and grape worm, etc. Price, ½-lb. tin, .25; 2-lb. tin, .75.

FLOWERS OF SULPHUR. Prevents and cures mildew on roses, grape-vines, etc. Apply with gun or bellows. Price, lb., .08; 100-lbs., \$6.00.

FOSTITE. An excellent remedy for blackrot, mildew, and Carnation rust. Price, 5-lb. box, .60; 25-lb. box, \$2.50.

GISHURST'S COMPOUND. For destroying red spider, mealy mug, scale, thrip, etc. Boxes, .60; by mail, .80.

GRAPE DUST, HAMMOND'S. A preparation for destroying mildew on grape vines. Can also be used on plants or trees affected with mold, mildew, or rust mites, either in greenhouses or the open air. Its diffusibility is great. One part of Grape Dust will spread itself over a greater surface than sulphur. To be thoroughly effectual, it must be applied frequently by dusting, as atoms of fungi are always spreading or floating. Apply at the first appearance of trouble. Dust on a warm, dry day. Use Grape Dust for Violets, Roses, etc., in the greenhouse. Fill the house with dust and let it settle over the plants, or put one pound to a pail of water and spray it finely over everything, plants, ground, benches, etc. Spores are likely to settle anywhere about, and prevention is the best remedy. Price, 5-lb. package, .35.

HELLEBORE POWDER, WHITE. We furnish a pure, fresh, very effective powder. One of the best insecticides for rose slugs, currant worms, green fly, and other insects. Price, lb. package, .30; ½-lb. package, .15.

KEROSENE EMULSION CONCENTRATED. Kills the pea louse, San José scale, and all sucking insects. Ready for use by adding water, 25 to 50 parts water to 1 of Emulsion. Quart, .40; gal., \$1.00; 5 gals., \$4.50.

LEMON OIL INSECTICIDE. Destroys scale, thrip, mealy bug, red spider, black and green fly. Dilute with 30 to 50 times the bulk of water before using. Price, ½ pint, .25; pint, .40; quart, .75; ½ gallon, \$1.25; gallon, \$2.00; 5-gallon keg, \$9.00.

Practical Sprayers of every description.

See page 127.

INSECTICIDES AND FUNGICIDES.

- LONDON PURPLE.** One of the best destroyers of insects. It is cheaper and less dangerous than Paris Green. The proportions for using are at the rate of one pound to 150 gallons of water. Price, pound, .25.
- NICOTICIDE FUMIGATING COMPOUND.** For killing all kinds of insects on plants in greenhouses and frames. This compound is used for destroying green and black fly, thrip, mealy bug, red spider, etc. The compound for vaporizing is sold in cans as follows: No. 1, containing 1 pint, sufficient for 32,000 cubic feet of space, \$2.50 each; No. 2, containing $\frac{1}{2}$ pint, sufficient for 16,000 cubic feet of space, \$1.25 each; No. 3, containing 4 ounces, sufficient for 8,000 cubic feet of space, .70 each. *How to Measure the House.*—To ascertain how many cubic feet there are within any greenhouse, etc., multiply the length in feet by the breadth in feet, and then by the average height; the result being the number of cubic feet. **FUMIGATORS.** Price, .50. Each fumigator consists of three parts—the pan, the wire frame, and the lamp.
- NIKOTEEN.** All private gardeners recommend this Liquid for spraying or vaporizing. Will destroy all insects which infest plants or flowers. Price, \$1.50 per pint package; \$13.00 per case, 10 packages.
- NEW X. L. ALL LIQUID INSECTICIDE.** The famous English patented preparation; purely nicotine; harmless to very delicate plants; kills mealy bug, red spider, and all insect pests. The perfect insecticide for spraying; goes farther than any. Price, pint, .65; quart, \$1.00; half gallon, \$1.75.
- NEW X. L. ALL VAPORIZING COMPOUND.** An English patent claimed to be the most easy, safe, effectual, and cheapest method of fumigating greenhouses and frames ever invented. The cost of fumigating is only .25 per 1,000 cubic feet of space. Sufficient for 10,000 cubic feet, \$2.25 per bottle; 20,000 cubic feet, \$4.50 per bottle. Vaporizing lamp, for above, complete, \$1.00.
- NEW X. L. ALL VAPORIZING COMPOUND.** In solid dry cake form. Each cake contains sufficient compound for 1,000 cubic feet of space. Price, .25 per cake (about one ounce).
- PARIS GREEN.** Best grade. For all insects that eat foliage, this insecticide is a very effective antidote. $\frac{1}{2}$ lb., .15; lb., .30; 5 lbs., \$1.25.
- SEAL OIL SOAP.** One of the best insecticides for general use on plants. It is especially effective on green and black flies, red spider, scale, rose thrip, and currant worms. Directions for use are printed on each package. Price, 1-lb. box, .25; 5-lb. box, \$1.00; in tubs, 25 lbs. and upwards, .15 per lb.
- SLUG SHOT, HAMMOND'S.** Is a light, composite, impalpably fine powder, easily distributed either by Duster, Bellows, or in water by Spraying. It is thoroughly reliable in killing Currant Worms, Potato Bugs, Cabbage Worms, Lice, Slugs, Sow Bugs, etc., and is also strongly impregnated with fungicides. Price, 5 lbs., .25; 10 lbs., .50. In kegs, 125 lbs. net, or barrels, 235 to 250 lbs. each, at $4\frac{1}{2}$ cents per lb.
- SULPHO-TOBACCO SOAP.** Quickly exterminates all insect life on plants and flowers in and out of doors. Unsurpassed for rose hushes. For a cheap, effective, clean, insecticide for amateur and professional growers this is unexcelled. It also acts as a valuable fertilizer, reviving plant life. For domestic purposes it rids the house of cockroaches, and is a superior wash for dogs and all animals. Prevents poultry lice. You cannot afford to be without this popular and well-known insecticide if you desire to be successful in plant culture. A trial will give highly gratifying results. 3-oz. cake sufficient for $1\frac{1}{2}$ gallons prepared solution, .10; mailed, post-paid, .13. 8-oz. cake, sufficient for 4 gallons prepared solution, .20, mailed, post-paid, .28.
- TOBACCO DUST.** A remedy for green fly. Price, 5-lb. package, .25; 10-lb. package, .40; 100-lb., \$3.00.
- TOBACCO DUST AND SULPHUR.** Very finely pulverized and mixed. Prevents mildew on plants; destroys the green and black flies, and other insects which attack plants. Should be dusted on with a powder bellows, or by hand. Price, per lb., .10; 10 lbs., .75; 100 lbs., \$6.00.
- TOBACCO EXTRACT.** A powerful extract of tobacco combined with sulphur. Remarkably effective against plant lice, red spider, and insects of all kinds. Dilute one part to ten or more of water and apply with syringe or vaporizer. For insects at the root, prepare as above and apply with watering pot sufficient to reach the roots. Price, half pint, .30; pint, .50; quart, .75; gallon, \$1.50; 5 gallons, \$4.25.
- TOBACCO STEMS.** For fumigating. Invaluable as a mulch for rose beds, lettuce beds, etc., where insects frequently do much injury to roots or foliage. Price, barrels, \$1.00; bale or case, \$3.00.
- WHALE OIL SOAP.** An excellent wash for trees and plants; kills insects and their eggs. Price, in boxes, with full directions for use, 1 lb., .15; 2 lbs., .25; 5 lbs., .50; 10 lbs., .90; 50 lbs., \$4.50.
- NYE'S CAUSTIC POTASH WHALE OIL SOAP.** For washing and spraying trees, shrubbery, and flowering plants, preventing insectile destruction, and aiding growth by its fertilizing properties. Dissolve one pound to each gallon of warm water. 2 lbs., .25; 5 lbs., .50; 25 lbs., \$2.25.
- MORRILL'S TREE INK.** A sure protection to trees from the ravages of grub and canker worm. Directions with each can. 2-lb. cans, .30; 3-lb., .45; 5-lb., .60; 10-lb., \$1.10; 20-lb., \$2.00; 28-lb., \$2.80; 50 and 100-lb. kegs, per lb., .09. **TARRED PAPER** for using with the ink, in rolls about 50 lbs. each, per lb., .04.
- "HERBICIDE," OR WEED EXTERMINATOR.** Perfectly odorless. One single dressing done according to directions will keep gutters, paths, and roadways clear of weeds, poison ivy, grasses, mosses, dandelions, burdocks, etc., for two full years or more. It is the most effectual weed killer known, does the work at one-twentieth the cost of any other method, and is also far more convenient to use. It completely destroys all weeds wherever applied, and by its effect on the ground prevents the growth of fresh ones for two years afterwards, thus saving an immense amount of hoeing, rolling, and re-rolling. In 2-gallon kegs, sufficient to make 40 gallons of liquid, \$2.75; in 5-gallon kegs, sufficient to make 100 gallons of liquid, \$5.50; in 10-gallon kegs, sufficient to make 200 gallons of liquid, \$10.00. *Net, f. o. b. Boston.*
- "ELECTRIC WORM ERADICATOR."** Perfectly odorless. For the instantaneous extermination of worms of every sort. The worms will immediately rise to the surface of the ground or flower-bed; or will fall off the trees, fruits, or flowers, and in a few minutes will die. It will be found exceedingly effective. It is highly concentrated, one gallon being sufficient to make 120 gallons of fluid for use, by the addition of water. Full directions for use with each package. Shipped in kegs, \$4.50 each, to make 120 gallons. Also, .50 and \$1.00 bottles. *Net, f. o. b. Boston.*

SPRAYING CALENDAR

Mailed upon application.

SPRAYERS.



THE EMPIRE QUEEN SPRAYING PUMP. With automatic mechanical agitator. This pump has a seamless brass cylinder two inches inside diameter and eight inches long, brass plunger, with leather bucket, brass lower valves, and brass rod, also a brass screw spout to which hose is attached by a screw coupling. It has a large air chamber, by means of which the spray is strong and continuous.

The Agitator works in connection with cog's from the lever, connecting with a companion gear at the upper end of a steel shaft; at the lower end of the shaft is a horizontal wooden bar, to which are attached two upright paddles.

This pump has a fine brass strainer at bottom of suction pipe which prevents leaves or dirt from getting into pump or nozzle, and it also has a brush on the agitator arm which swings under the strainer, keeps the dirt brushed off, and prevents clogging the pump. **PUMP AND OUTFIT "B."** Empire Queen Pump, with brass screw spout, and agitator complete, also 10 feet of best 3-ply hose, Niagara spray nozzle and couplings, nicely mounted on 50-gallon barrel, the agitator carefully adjusted, the whole apparatus ready for use, price, \$15.00; additional hose, .16 per foot; 5-foot extension pipe, bamboo, brass lined, \$1.00.

THE TRUCK AND BARREL SPRAYER. This machine consists of our Empire Queen pump mounted on a barrel having a capacity of 32 gallons, together with the cart. The cart has strong iron



wheels, 34 inches in diameter, and 37 inches from outside to outside of hubs with tires 3 inches wide; it has strong hardwood handles, and is a very convenient machine for use in small orchards or gardens, where it is impractical to drive a horse. Price, \$23.50.

WOODASON VAPORIZING BELLOWS. (Fig. 16B.) This Bellows throws a spray as fine as mist, rendering the use of insecticides perfectly safe on tender plants. Price, No. 1, \$1.50; No. 2, \$2.00.

THE AQUAPULT HAND FORCE PUMP. (Fig. 81.) Strong and durable; not liable to get out of order. \$4.00.

ADJUSTABLE WATER BARREL TRUCK.

(Figs. 13, 14, 15, and 16.) By a simple arrangement of the axle, the barrel can be detached at pleasure, whether full or empty. Very useful for carrying water to the garden or lawn during dry weather, for emptying cess-pools, and for innumerable other purposes. Price, truck and barrel, complete: wheel, 2½-inch tire, \$10.00, without barrel, \$7.75; wheel, 3½-inch tire, \$10.75; without barrel, \$8.50. The following extra attachments can be supplied for use on the same truck when the barrel is detached, viz.: Hand-cart box, \$3.00; leat rack, \$5.00; extra barrels with trunions, \$2.75; sprinkler attachment, for barrel, \$3.50.

SPRAYERS.

JOHNSON'S CHAMPION FORCE PUMP. (Fig. 96.) The pump has a sprinkler, straight-stream nozzle, and rubber hose attached. Throws six gallons of water per minute, with ease. Price, \$4.25.

THE FAULTLESS SPRAYER. (Fig. 91.) Throws a spray as fine as mist. No. 2, all brass, each, .75.

SCOLLY'S RUBBER PLANT SPRINKLER. (Fig. 90.) Made of rubber with flat bottom and a finely perforated, detachable brass top. Very useful for sprinkling, and all purposes where a fine spray is required. Four sizes. .50, .60, .75, and \$1.00; by mail, .10 each extra.

SCOLLY'S ANGLE RUBBER SPRINKLER. (Fig. 90.) By means of this new device, liquids can be applied to the *under* side of the leaves. Price, each, \$1.00.

GALVANIZED IRON WATERING POTS.

Made from best quality iron and heavily galvanized after being made. Two copper-faced roses go with each pot for fine and coarse watering. 4 quarts, \$1.50; 6 quarts, spout 21 inches long, \$1.75; 8 quarts, spout 23 inches long, \$2.00; 10 quarts, spout 25 inches long, \$2.25; 12 quarts, spout 25 inches long, \$2.75.

HEAVY TIN WATERING POTS. Nicely painted green. Made of extra strong, double-thick tin, braced and stayed; very substantial. 2 quarts, .60; 4 quarts, .75; 6 quarts, .85; 8 quarts, \$1.00; 10 quarts, \$1.25; 12 quarts, \$1.50; 16 quarts, \$1.75.

GALVANIZED IRON WATERING POTS, FRENCH PATTERN; with brass bale handle. 8 qts., \$2.25; 10 qts., \$2.50.

SYRINGES.

FARQUHAR'S NEW CYCLONE ROSE SYRINGE, with improved self-oiling piston, barrel 16 inches long. Specially designed by us for the application of insecticides *directly upon* insects infesting roses and other plants. As the rose is interchangeable with cap, the spray can be thrown straightaway or at a right angle at pleasure. Price, strong brass, with cap and spray rose, \$3.00; with cap and two spray roses (fine and coarse), \$3.50.

NO. G. GARDEN AND GREENHOUSE SYRINGE. With elbow joint, stream and spray; excellent for applying liquid insecticides; \$4.25.

AA. PARLOR SYRINGE. Fine spray rose. \$1.25.

NO. 5. GARDEN AND GREENHOUSE SYRINGE. Stream and two spray roses; \$7.00.

NO. 7. GREENHOUSE SYRINGE. Stream and two spray roses, and knuckle joint turning in all directions; for applying water or other liquids to the under-surface of the leaves to destroy insects, etc.; \$8.00.

NO. O. GARDEN SYRINGE. For applying liquids, solution, etc.; \$2.25.

NO. C. GARDEN SYRINGE. One stream and one spray rose; \$3.25.

POWDER DISTRIBUTORS.

FRENCH SULPHUR AND POWDER BELLOWS. (Fig. 89.) The best of all powder distributors; excellent for effectually and economically applying Sulphur, Hellebore, etc., to plants. No. 1, \$2.00; No. 2, \$1.60; No. 3, with powder receiver in shank, \$1.50.

POWDER BELLOWS. For applying Hellebore, Sulphur Slug Shot, etc. Small, .75; medium, \$1.00; large, \$1.25.

SCOLLY INSECT POWDER-PUFF. A new device for applying insect powder of any kind to plants, etc. Very useful for house-plants and to housekeepers generally. Price, each, \$1.00; by mail, \$1.10.

STAR POWDER GUN. For applying insect powders. Each, .10; by mail, .12.

JUMBO POWDER GUN. (Fig. 92.) Each, .25.

TIN DUSTER FOR PARIS GREEN. For applying Paris Green Mixture, Slug Shot, etc., on potato vines and other plants; bottoms finely perforated. Each, .15.

NORTON PLANT DUSTER. For dusting potatoes, vines, etc. A slight jolting movement distributes the dust. It is made with a cylinder air-chamber projecting above the powder, so that it never clogs. Each, \$1.00.

HIGH GRADE FERTILIZERS.

Prices subject to change. Net, except where noted, f. o. b. cars Boston.

FARQUHAR'S LAWN AND GARDEN DRESSING.

The best fertilizer in the market for all garden and farm crops. It is as dry and fine as meal; made of dried, finely pulverized blood, bone, potash, and refuse meat. The mixture is in such good mechanical condition that it can be applied conveniently by any one. For gardens and lawns it is most excellent, being not a stimulant merely, but a plant food of lasting, enriching properties. Price, per ton, \$50.00.

10 lbs.,	for about 1,000 square feet,	50 cents.
25 " " "	2,500 " "	\$1.00.
50 " " "	5,000 " "	1.75.
100 " " "	one-fourth acre,	3.00.

FARQUHAR'S VEGETABLE AND POTATO FERTILIZER.

A new brand of extraordinary strength, being a complete fertilizer for vegetables and potatoes. It is very rich in phosphoric acid, potash, and nitrogen. Can be safely used alone. Apply 400 to 600 lbs. per acre, depending upon the previous manuring, cropping, etc., and present condition of the land. Price, per ton, \$40.00; 100 lbs., \$2.50; 50 lbs., \$1.50; 25 lbs., \$1.00; 10 lbs., .50.

PULVERIZED SHEEP MANURE.

PURITY BRAND.

A soluble plant food highly recommended for all purposes where a first-class fertilizer is required. It is a pure natural manure, and has long been recognized as one of the most beneficial. As a top-dressing for lawns it is unequalled, being free from weed-seeds, and extremely stimulating. For lawns, it should be used at the rate of 500 pounds per acre. As a fertilizing agent for plants, indoors and in the open garden, it is one of the very best. Price, ton, \$35.00; half ton, \$17.50; 500 lbs., \$8.75; 100 lbs., \$2.00; 50 lbs., \$1.25; 25 lbs., .75; 10 lbs., .40; 5 lbs., .25; 1 lb., .10.

PURE CANADA UNLEACHED HARDWOOD ASHES.

Ashes lack ammonia and phosphoric acid, but contain potash and lime, which are essential, not only as plant food, but also as sweeteners of the soil and solvents of other plant food ingredients. So far as they supply potash and lime, they are "nature's plant food." These things have been extracted from the soil by the trees, and now we return them in the shape of ashes. Pure wood ashes is one of the best fertilizers for top-dressing lawns, grass lands, and seeding down; also for fruit of all kinds, especially strawberries, peaches, and apples. They are exceedingly valuable for lawns, imparting a rich dark shade of green, destroying insects and bad weeds, particularly moss, which is so common on lawns. 100-lb. bag, \$1.25; 200 lbs., \$2.00; ton, \$16.00. *In car load lots of from 15 to 25 tons, at \$11.00 per ton in bulk or \$12.50 per ton in 100-lb. bags delivered at any freight station in Massachusetts, Vermont, New Hampshire, Rhode Island, Connecticut, and to any station in Maine except points on the Maine Central R.R.*

PURE GROUND BONE

Is made from the best quality of bone, finely pulverized by improved machinery. It is far superior to some ground bone in the market, which is often composed of refuse bones from which the plant-food has been largely removed in manufacturing glue and other products. Analysis: Nitrogen, equal to Ammonia, 3 to 4 per cent.; Phosphoric Acid, 22.80 to 25.23 per cent.; equal to Bone Phosphate, 50 to 55 per cent. Price, 10 lbs., .50; 25 lbs., \$1.00; 50 lbs., \$1.50; 100 lbs., \$2.50; 500 lbs., \$8.00; ton, \$30.00.

INCH BONE FOR GRAPES, ETC.

The very best fertilizer for grape vines, fruit trees, shrubs, and trees of all kinds. The pieces of bone vary from one-fourth inch to one inch in size. Should be used at setting out, mixed with the soil to the depth of a foot or more. Price, in bags or barrels, 2¼ cents per lb.; ton, \$34.00.

SCOTCH SOOT.

A fertilizer and fungicide. One of the best remedies and preventatives for mildew, when mixed with sulphur, at the rate of two-thirds soot, one-third sulphur. As a fertilizer it promotes growth, and heightens color of foliage and flower. Price, 100-lb. bag, \$2.50.

SALT.

Valuable as a top-dressing for asparagus, etc. Apply early in spring. Bag, 140 lbs., \$1.25.

CLAY'S FERTILIZER.

Imported. A safe, lasting, productive, economical fertilizer for all horticultural purposes. A reliable vitalizing medium for conservatory, greenhouse, and garden. Can also be used to prepare and preserve the lawn in splendid condition. Highly recommended by leading horticulturists in the cultivation of flowers, fruit, and vegetables for exhibition, pleasure, and profit in the highest perfection. Original bags, 112 lbs., \$7.00; 56 lbs., \$4.00; 28 lbs., \$2.25; 14 lbs., \$1.25; 7 lbs., .75.

BRADLEY'S XL PHOSPHATE

has been more extensively used than any other brand of fertilizer in the world, and has given universal satisfaction on all crops and under all conditions.

BRADLEY'S POTATO MANURE

For Growing Smooth, Sound Potatoes of the Best Quality without Barnyard Manure.

It is admitted by successful potato growers that a good commercial fertilizer is indispensable in raising potatoes of the best quality and free from rot or scab.

Bradley's Potato Manure is in no sense a theoretical or experimental mixture. It is prepared from formulas which repeated *field-tests* have proven to produce the largest crops of smooth, sound, and handsome potatoes.

It is finely ground and very dry; it will, therefore, work perfectly in any planter.

BRADLEY'S COMPLETE MANURES FOR ALL CROPS.

Specially Adapted to Intensive Farming and Market Gardening.

These manures are the richest and most effective fertilizers sold, as has been abundantly proved by results in the field. They are manufactured from the very best plant-food materials obtainable. In mechanical condition they are unequalled. They drill perfectly in any machine. They are divided into classes, based upon exhaustive field tests, and not upon theoretical experiments of the laboratory, the fault of "special crop fertilizers," in which common sense and practical experience are sacrificed for the sake of theoretical hobbies.

Bradley's Complete Manures are, in the fullest sense, "complete" fertilizers, and the several grades furnish complete plant-food in the best forms for all crops grown.

HIGH GRADE FERTILIZERS — *Continued.*

PRICES FOR BRADLEY'S STANDARD FERTILIZERS.

	50-lb. bag.	100-lb. bag.	Ton.
Bradley's Superphosphate	\$1.00	\$1.80	\$34.00
Bradley's Potato Manure	1.00	1.80	34.00
Bradley's Complete Manure for Potatoes and Vegetables		2.00	38.00
Bradley's Complete Manure for Corn and Grain		2.00	38.00
Bradley's Complete Manure for Top Dressing Grass and Grain		2.00	38.00
Bradley's Complete Manure with 10 per cent. Potash		2.00	38.00
Bradley's High Grade Tobacco Manure		2.45	48.00
Bradley's Seeding-Down Manure		1.80	34.00
Bradley's Eclipse Phosphate		1.50	28.00

A discount of 5 per cent. on Bradley's Standard Fertilizers when cash accompanies order.

AGRICULTURAL CHEMICALS, FERTILIZER MATERIALS, AND PLASTER.

HIGH GRADE SULPHATE OF POTASH. 90 to 95 per cent. Sulphate of Potash, 48 to 50 per cent. actual Potash. 10 lbs., .50; 100 lbs., \$3.50; in original bags, 224 lbs. each, \$6.25; per ton, \$50.00.

DOUBLE SULPHATE OF POTASH AND MAGNESIA. 40 to 50 per cent. Sulphate of Potash, 25 to 28 per cent. actual Potash. 10 lbs., .30; 100 lbs., \$2.00; in original bags, 224 lbs. each, \$3.75; per ton, \$30.00.

MURIATE OF POTASH. 80 to 85 per cent. Muriate of Potash, 50 to 55 per cent. actual Potash. 10 lbs., .50; 100 lbs., \$3.00; in original bags, 224 lbs. each, \$5.75; per ton, \$45.00.

KAINIT. 23 to 25 per cent. Sulphate and Muriate of Potash, 12 to 13 per cent. actual Potash. 100 lbs., \$1.25; 200-lb. bag, \$2.00; per ton, \$15.00.

NITRATE OF SODA. 96 per cent. purity, 19 per cent. Ammonia. 10 lbs., .50; 25 lbs., \$1.00; 100-lbs., \$3.50; in original bags, about 275 lbs. each, \$7.50; per ton, \$50.00.

SULPHATE OF AMMONIA. 24.75 per cent. Ammonia. 10 lbs., .75; 100 lbs., \$5.00; 200-lb. bag, \$8.00; per ton, \$70.00.

DISSOLVED BONE BLACK. 15 to 18 per cent. Soluble and Available Phosphoric Acid. 200-lb. bag, \$2.50; per ton, \$22.00.

PLAIN SUPERPHOSPHATE. 14 to 17 per cent. Soluble and Available Phosphoric Acid. 200-lb. bag, \$2.00; per ton, \$17.00.

DRIED BLOOD. 12 per cent. Ammonia. 200-lb. bag, \$5.00; per ton, \$43.00.

DRIED BLOOD. 15 per cent. Ammonia. 200-lb. bag, \$5.50; per ton, \$50.00.

FINE GROUND TANKAGE. 9 per cent. Ammonia, 20 per cent. Bone Phosphate. 200-lb. bag, \$4.00; per ton, \$37.00.

FINE GROUND TANKAGE. 6 per cent. Ammonia, 30 per cent. Bone Phosphate. 200-lb. bag, \$3.50; per ton, \$30.00.

FINE GROUND NOVA SCOTIA PLASTER. White and fine. 100-lb. bag, .75; 200-lb. bag, \$1.25; per ton, \$9.00.

BOWKER'S AMMONIATED FOOD FOR FLOWERS. Made expressly for flowers grown in the house or garden; clean, odorless, and produces early abundant blossoms, greatly adding to the richness and brilliancy of color, health, and luxuriance of the foliage. It is clean and absolutely odorless, thus supplying a long-felt want by ladies and florists. *Price*, put up in neat packages with directions for use, No. 1, .15; No. 2, .25. If ordered by mail, add 6 cents for No. 1, and 12 cents for No. 2, to prepay postage.

CANARY GUANO. The best in the world for greenhouse and garden. Perfectly clean, may be used by a lady, unsurpassed for liquid application. Provides all the nutriment required by Bulbous Plants, Chrysanthemums, Ferns, Palms, etc. Sold in large tins as imported; full directions on each. Per original tin, .50.

"CHEMICALS" FOR IMP. LIQUID PLANT FOOD.

For high-grade growing under glass and out-of-doors.

A clean, dry powder which entirely dissolves in cold water. It is the highest grade fertilizer known, or possible to make, and contains 63% actual plant foods.

Guaranteed analysis Nitrogen, 15.1% = Ammonia 18.3%; Phosphoric Acid, 21.5%; Potash, 26.1%. Is used dry, mixed with earth or sand, or is first dissolved in water.

11 oz. when dissolved makes 50 gals. fertilizer,	\$.25
55 oz. " " " 250 " "	1.00
7 lbs. " " " 500 " "	1.60
20 lbs. " " " 1,500 " "	4.00
50 lbs. " " " 3,600 " "	8.00
100 lbs. " " " 7,200 " "	14.00

It does not change on keeping either dry or in solution.

IMPERIAL GRASS FERTILIZER, a similar mixture for lawns and Golf Greens, very largely used, same prices as above.

These fertilizers have been in constant use for six years.

The Imp. Nozzle and Sprayer, for automatically applying the solutions of above fertilizers, all brass, \$2.00.

PEAT, MOSS, POTTING SOILS.

CHARCOAL. Price, per lb., .10; 100 lbs., \$5.00.

SILVER SAND. For propagating, mixing with plant soils, etc. Price, per barrel, \$2.50; bush., \$1.50; peck, .50.

ROTTED FIBROUS PEAT. An excellent material for mixing with potting soils for many plants. This peat has been dug from an old bog and exposed for a number of years until it has become thoroughly decayed, and is very fine and light. Price, per barrel, \$2.00; bush., \$1.00.

ORCHID PEAT OR FERN ROOT. Price, per barrel, \$2.75; bush., \$1.50.

PREPARED POTTING SOIL. A carefully prepared soil for pot plants; composed of Leaf Mould, Peat, Loam, Sand, and a sufficient quantity of fertilizer. Price, per barrel, \$2.00; bush., \$1.00.

SPHAGNUM MOSS. We furnish a Moss of excellent quality for the gardener's use. We can supply it at most seasons freshly gathered or dried. Price, per bag, \$1.50; bush., \$1.00; bale, \$6.50.

COCOANUT FIBRE. Price, 125-lb. bag, \$1.25; per ton \$15.00.

LAWN MOWERS.

THE VICTORY BALL-BEARING LAWN MOWER.

10-inch wheel, four-bladed reel, construction light; easily run and almost silent. One of the best Mowers ever built.

14 in.	16 in.	18 in.	20 in.	22 in.
\$8.50.	\$9.50.	\$10.50.	\$11.50.	\$12.50.

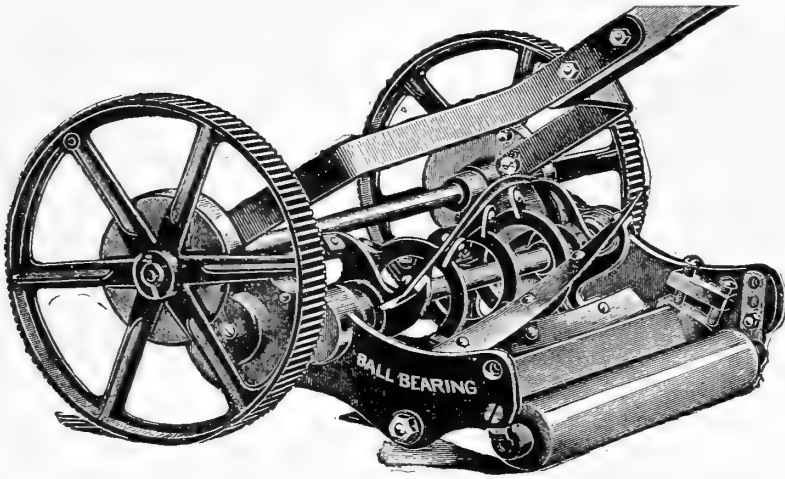

Victory Ball Bearing.

BOSTON, MASS., Dec. 9, 1899.

MESSRS. R. & J. FARQUHAR & Co.,
6 South Market St., Boston:

GENTLEMEN: Last June you furnished me with a 20-inch Ball Bearing Lawn Mower. I was so well pleased with it that I ordered another one in July. My gardener, with the help of a boy, found that he could cut the grass in about half the time he required to do it with the old machines and with more comfort to himself, owing to its being so light to handle and run. It does excellent work, and is easier to run than the old-fashioned 15-inch, and I take pleasure in recommending it in the highest terms. Very truly yours,

(Signed) HOWARD MARSTON.

GENUINE PHILADELPHIA LAWN MOWERS.

E HIGH WHEEL.

Four blades, 10-inch wheel, 6½-inch cylinder, train of 3 gears double wheel. One of the lightest draft mowers manufactured; made of iron and steel.

It has one special point of excellence over other mowers of this style, which consists in removing the box caps to the cylinder cutter, and removing the cutter without disturbing the frame of the mower; it therefore has a solid frame, with little trouble in case of repairing same.

15 in.	17 in.	19 in.	21 in.
\$8.25	\$9.25	\$10.25	\$11.25

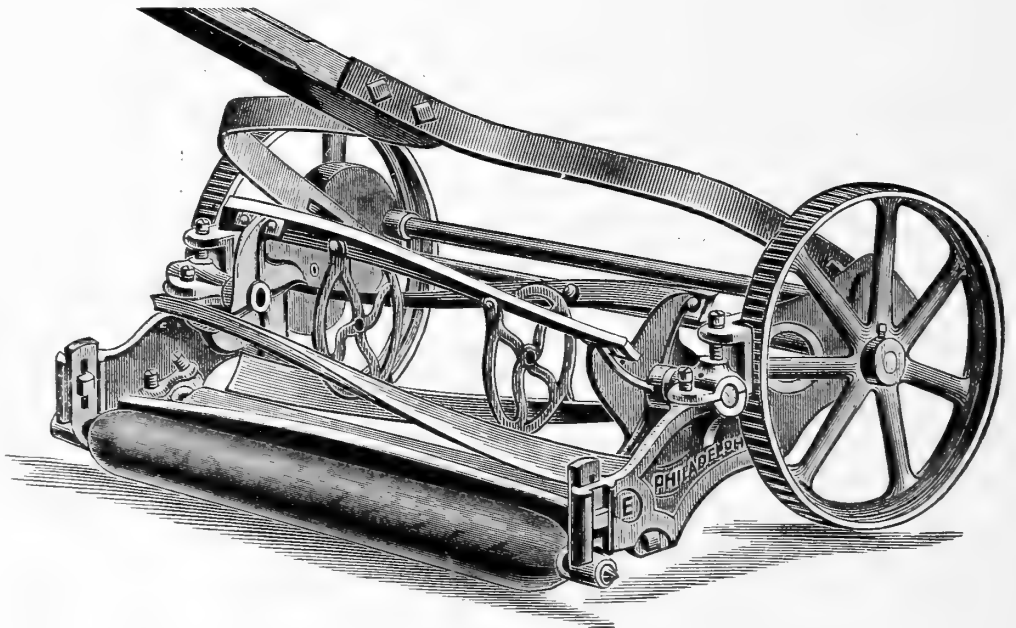

E High Wheel.

STYLE C.

4 Blades, 8½-inch Wheel, 5¼-inch Cylinder, Single Pinion, Geared on both sides.

This is a medium High Wheel Mower which is very popular, for the reason that it has 8½-inch driving wheels and is so geared that with the additional height in wheels it does good work and runs some lighter. It is the same style as some makers put on the market for a high wheel mower.

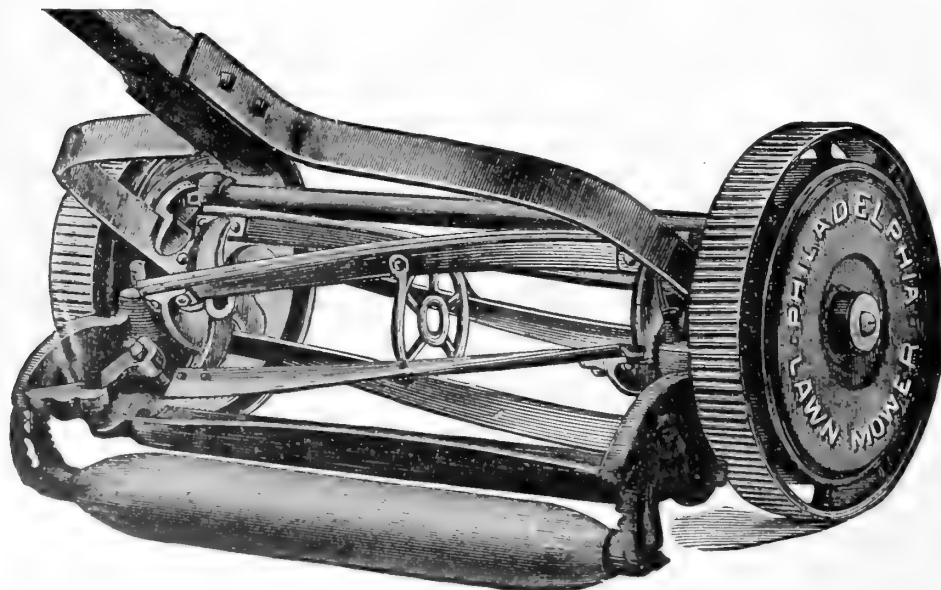

Style C.

14 in.	16 in.	18 in.	20 in.
\$6.25.	\$7.00.	\$7.75.	\$8.50.

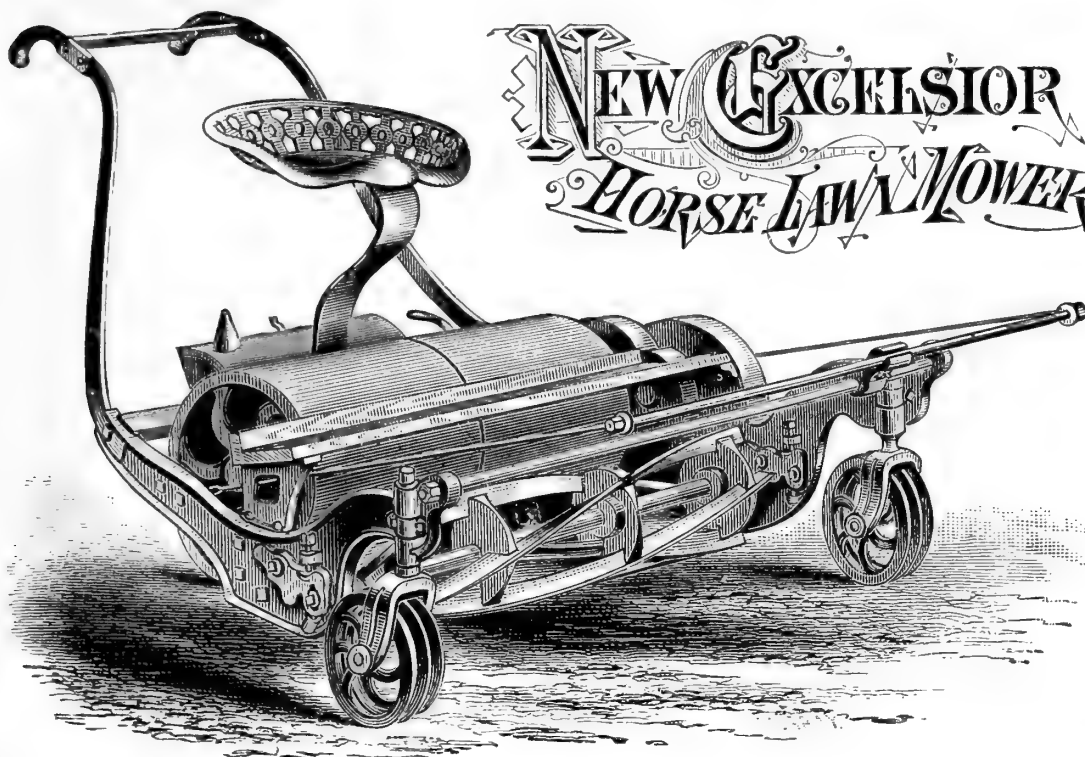

NEW EXCELSIOR HORSE LAWN MOWER

SHARPENING AND REPAIRING OF LAWN MOWERS.

We employ a practical machinist and attend to all orders promptly. The correct adjustment and replacement of worn-out parts requires skilful hands, and as we give first-class work and make low charges, customers are invited to send their Lawn Mowers for repairs to us. Please send **EARLY IN THE SEASON** so as to be ready to use as soon as wanted. New parts furnished at manufacturers' list price

NEW EXCELSIOR HORSE LAWN MOWER. Unquestionably the Best Horse Lawn Mower manufactured.

Net Cash Prices.	25-inch cut, without seat or shafts	\$35.00
	25-inch cut, with shafts and side-draught attachment	40.00
	30-inch cut, with seat, shafts, and side-draught attachment	60.00
	35-inch cut, with seat, shafts, and side-draught attachment	72.50
	40-inch cut, with seat, shafts, and side-draught attachment	92.50

No risk. Every Mower fully warranted to give satisfaction. These Mowers are used exclusively by the government and on the largest public parks and lawns in the country.

CHAIN ROLLER MOWER.

BALL-BEARINGS, CHAIN DRIVE, 5 BLADES.

Specially designed for Borders and Golf Greens.

This Mower will cut close enough and clean enough to satisfy the most fastidious golfer.

It will run easier than any other ever built.

It will stay in perfect order longer than any other.

SIZES.	12-in.	14-in.	16-in.	18-in.
PRICES.	\$11.00	\$12.00	\$13.00	\$14.00

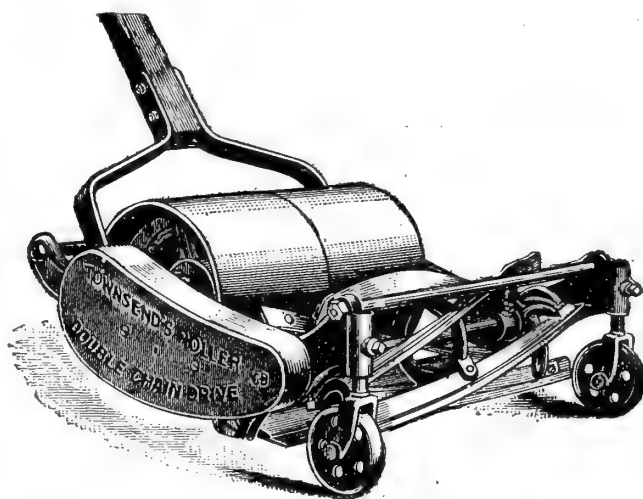

PHILADELPHIA GRASS COLLECTOR.

A Galvanized Iron Bottom Collector. Never-rip Cloth Connections. It will fit Philadelphia Mowers only.

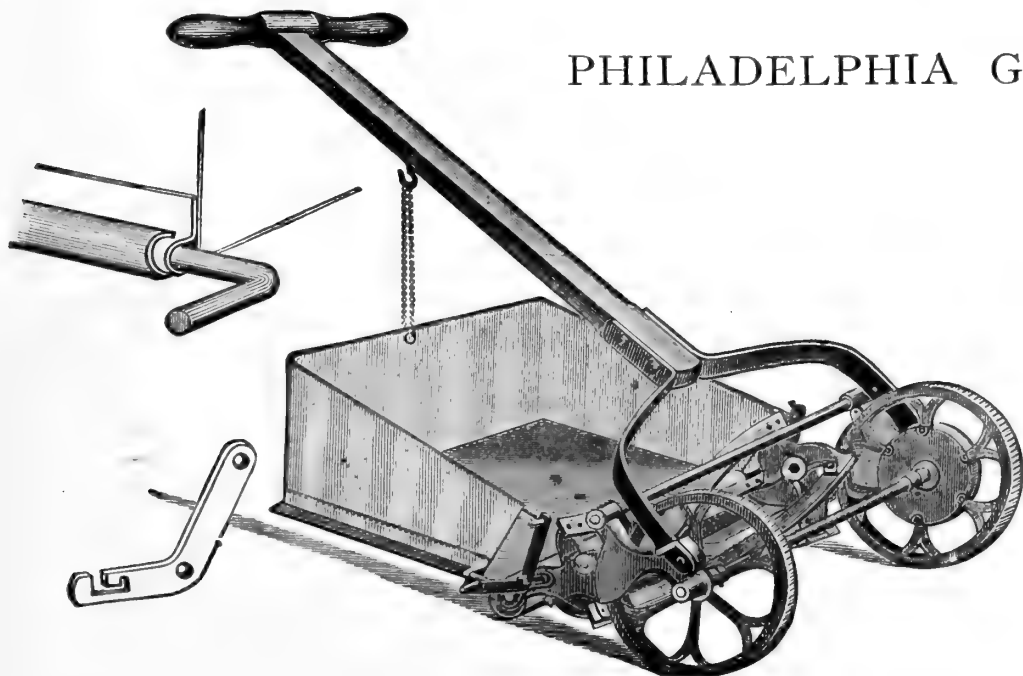

LOW WHEEL MOWERS.

14-inch	\$1.60
16 "	1.70
18 "	1.80
20 "	1.90

HIGH WHEEL MOWERS.

15-inch	\$1.70
17 "	1.80
19 "	1.90
21 "	2.00

The
"BOSS"
Roller

HEART DESIGN
Outer edges beveled.
Face silver finished.



ABOUT ROLLING LAWNS.

The benefit derived from the use of a roller on the lawn, especially in the spring, is not fully understood. The action of freezing and thawing causes the ground to heave, and if the sod is not firmly pressed back with a roller before the hot weather begins, the grass is apt to be killed or injured, leaving the lawn full of bare spots.

THE "BOSS" HEART DESIGN HAND LAWN ROLLER.

									List Price.	Net Price.
No. 2.	15 inch diameter,	22 inches long,	in 3 sections;	7½ inch. face;	200 lbs.	. . .	\$12.50		\$11.25	
No. 4.	20 " " "	20 " " "	in 2 " "	10 " " "	250 lbs.	. . .	15.50		14.00	
No. 6.	20 " " "	24 " " "	in 3 " "	8 " " "	300 lbs.	. . .	18.50		16.65	
No. 11.	24 " " "	24 " " "	in 3 " "	8 " " "	450 lbs.	. . .	27.50		24.75	
No. 15.	28 " " "	30 " " "	in 3 " "	10 " " "	600 lbs.	. . .	36.50		32.85	

THE BEST LAWN SPRINKLER YET.

Made of Heavy Brass.

Easily moved over the lawn without turning off the water.

No
Rust.
No
Mech-
anism.



No
Fancy
Price.

"Fountain."

The mist-like spray is a veritable "thing of beauty." Different and better than any other. That's why you should have it. Price, \$1.25 each; by mail, 15c. each extra.

ENTERPRISE LAWN SPRINKLER.

The advantages of our No. 1 Sprinkler are as follows:

Each machine is furnished with a cord or rope, so that the Sprink-

ler may be easily moved, when running, without going near it. The water passes through a Strainer before it enters the small perforations, which are thereby prevented from filling up. The weight of the revolving parts is supported by the water. This reduces wear to a minimum. All parts of the machine are made sufficiently strong for ordinary rough usage, and are interchangeable. The machine is TINNED and NICKEL-PLATED, and is of very handsome appearance. No. 1, \$3.50.



No. 1.

RUBBER HOSE.



We warrant our "Reliable" and "Extra" Brands, which are sure to give satisfaction. Prices on "Reliable" and "Extra" include couplings.

R. & J. FARQUHAR & CO.'S "RELIABLE."

3/4-inch, 3-ply, at .15 per foot; 1/2-inch, 3-ply, at .14 per foot.

R. & J. FARQUHAR & CO.'S "EXTRA."

3/4-inch, 3-ply, at .13 per foot; 1/2-inch, 3-ply, at .11 per foot.

CHICAGO ELECTRIC HOSE. Strong and durable. Manufactured in continuous lengths of 500 feet. Jointless and seamless. 3/4-inch, .16 per foot; 25 and 50 ft. lengths, .18 per foot; couplings, .25 per pair.

COTTON HOSE. Rubber lined, best quality. 3/4-inch, foot, .12; 1/2-inch, foot, .11.

HOSE COUPLINGS. Common set, .25.

LAWN SPRINKLERS.

TWIN COMET LAWN SPRINKLER. (Fig. 95.) The three upper arms revolve rapidly, sprinkling meanwhile, and carrying around a slowly revolving nozzle, which sprinkles the ground for a great distance. Very substantial and durable. Height, 17 inches. Price, \$5.00.

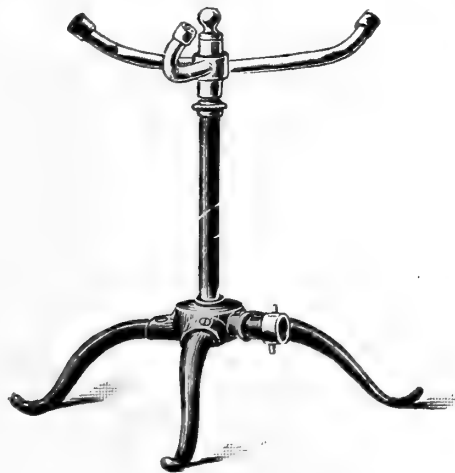

Columbian Lawn Sprinkler.

COLUMBIAN LAWN SPRINKLER. Three-arm; \$1.00 each.

THE STEARNS REVERSIBLE LAWN SPRINKLER. (Fig. 21A.) This Sprinkler is suitable for use with either high or low water pressure; the cap is reversible, and a high or low spray covering a wide area of ground may be secured by simply reversing the cap. .75 each; by mail, \$1.05.

CACTUS LAWN SPRINKLER. (Fig. 87.) With centre spray; indestructible, beautiful, cheap; no revolving parts; can be moved about the lawn without turning off the water. Recommended on account of its simplicity, durability, and beauty. No. 5, for 3/4-inch hose, .85 each; by mail, \$1.15.

JAPANESE LAWN SPRINKLER. (Fig. 84.) Indestructible, beautiful, cheap; adjustable to suit any pressure. This Sprinkler has no revolving parts to leak or wear out. The only Sprinkler that will give satisfaction with a low pressure. No. 12, for 3/4-inch hose, .85 each; by mail, \$1.10.

HOSE MENDERS.

ELECTRIC TAPE FOR MENDING HOSE. If wound around a leaking or weak part it will adhere closely and make the hose as effective as before. It requires no heat, and can be applied in a minute. Comes in the form of a ribbon. Coil, .25; large coil, .50.

HOSE MENDERS, METAL. For 1/2 and 3/4 inch hose; .50 per dozen.

HOSE MENDERS, WOOD. Very useful and durable; .20 per dozen.

THE "COOPER" HOSE MENDER. (Fig. 32.) Hose mended with the Cooper Mender is good as new at the point mended. Menders are made in 1/2 and 3/4 inch in diameter and are three inches long. There are no wires or plyers required, just your two hands are all the tools necessary to make hose perfect. .75 per dozen; by mail, \$1.00.

HOSE MENDERS, HUDSON'S. (Fig. 33.) Whoever uses a hose will require Hudson's Mender, as, with the plyers and bands, it is the cheapest, simplest, and best. It is a metallic tube, made to fit snugly into the end of the hose, where it is held firmly by the soft brass bands, which fit closely around the hose and grooved tube. It is equally valuable for fastening on loose couplings. 1/2-inch hose, .35 doz.; by mail, .10 extra; 3/4-inch hose, .45 doz.; by mail, .10 extra; plyers, .25 each; by mail, .35; bands, .18 per doz. We put the 3/4 and 1/2-inch size in boxes containing 1 plyer, 6 menders, and 12 wires at .75 per box; by mail, .90. In ordering, please state size desired.

HOSE REELS.

THE "AUBURN" HOSE REEL, SIX-ARM. (Fig. 5.) This Reel has six arms with ratchet drum and will carry one hundred feet of 3/4-inch hose. It is made of white ash. Sides are bent. Wheels 9 inches in diameter. Nicely painted vermilion red, striped, ornamented, and varnished. Very strong and durable. Price, \$2.50.

HOSE REEL, NEW, ALL IRON. (Fig. 4.) A substantial hose reel for garden and lawn use at a low price has long been wanted. The reels are light in weight with high wheels, are constructed entirely of wrought iron pipe and malleable iron, and are almost indestructible. They are entirely frictionless, and have none of the objectionable features so numerous in the ordinary wood reels.

No.	Height of Wheel.	Weight.	Capacity.	Price.
10	21 in.	18 lbs.	100 ft.	\$2.75
20	24 "	22 "	150 "	3.25
30	30 "	32 "	500 "	5.00

HOSE NOZZLES.

THE STOTT NOZZLE. (Fig. 82.) Patented. Each, \$1.25; by mail, \$1.35.

GRADUATING SPRAY HOSE NOZZLE. (Fig. 83.) For rose-bed, hot-bed, lawn, or garden, this sprinkler is superior to any. The water falls in a gentle, rain-like spray without drowning or uprooting the young plants or washing out the earth. One or more should be in the possession of every one who uses a hose. We have them specially made of heavy brass to order. Each, .50; by mail, .60.

FARQUHAR'S SPRAYING NOZZLE. (Fig. 93.) The most substantial and durable nozzle; made of very heavy brass. 3-inch, .50; 4-inch, .75. Shut-off connection for same, .75.

IMPROVED VERMOREL NOZZLE. (Fig. 88.) Arranged with stuffing box to prevent wetting the operator. Fitted for 1/2-inch male end pipe, each, \$1.00; fitted for 3/4-inch hose connection, each, \$1.25.

PUMP, KINNEY'S ATOMIZER. Used to distribute liquid fertilizer or to mix or temper hot and cold water under water pressure. Connect between sections of hose and lower it into the barrel. Each, \$2.00.

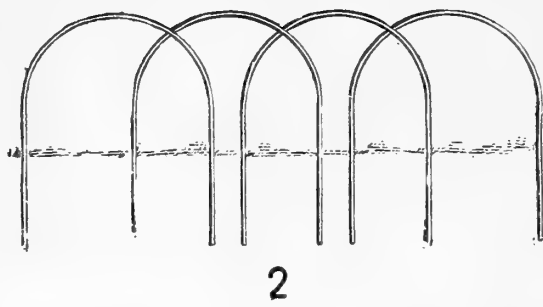
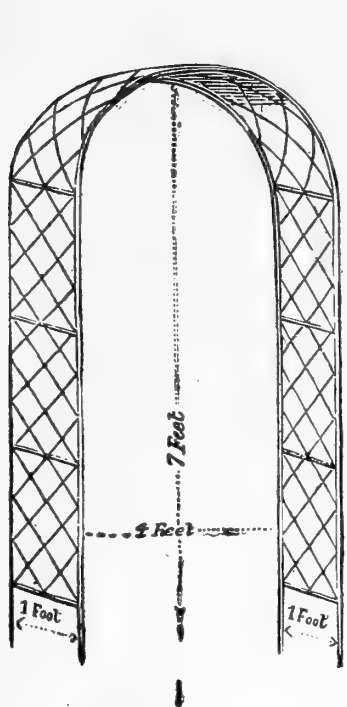

2

3

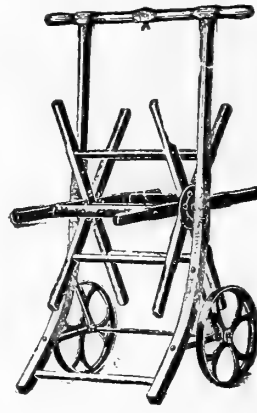
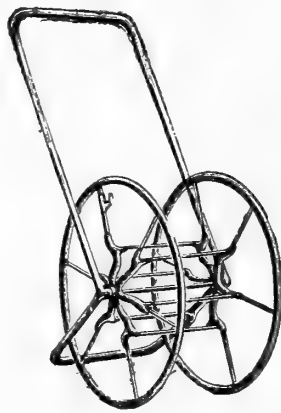

4

5

6



7

8

9

10

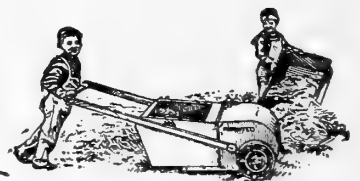

11

12

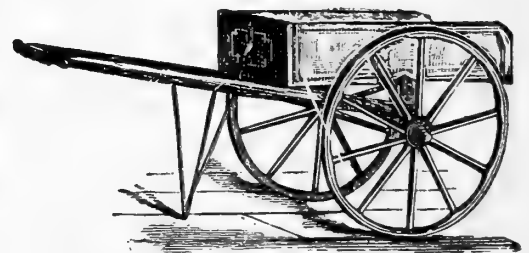

13

14

15

16

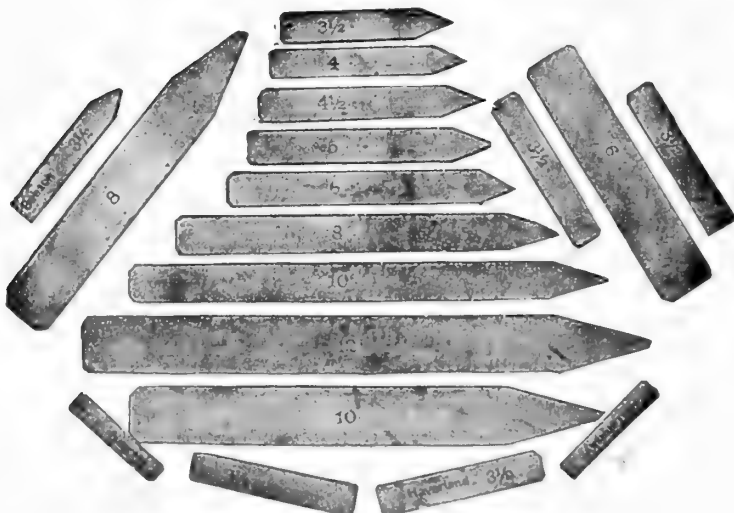

16A



16B

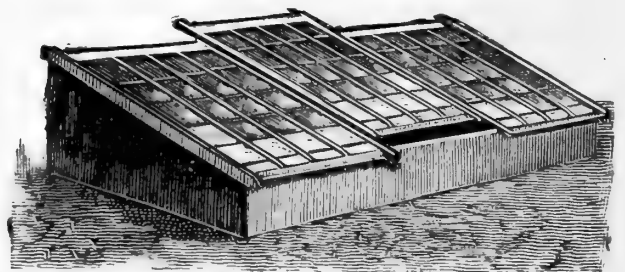

16C

PLANT AND TREE LABELS.

(Fig. 16 A.)

	Plain. 100.	Plain. 1,000	Painted. 1,000
4-in. Wood Pot Label	\$0.15	\$0.50	\$0.70
4½-in. " "15	.60	.80
5-in. " "15	.70	.95
6-in. " "15	.90	1.20
8-in. " Garden Label40	3.00	3.70
10-in. " " "50	3.90	4.80
12-in. " " "60	5.00	6.00
3½-in. Wood Tree Label15	.50	.55
3½-in. " Iron wired15	.80	1.00
3½-in. " Copper "20	1.00	1.20

LARGE BORDER LABEL, WOOD. Length, 16 inches; width, 1¾ inches; from 3/8-inch clear stock. If given a light application of white lead, before writing with a hard lead-pencil, the name will be almost imperishable. Per 100, \$2.50; per 1,000, \$20.00.

ZINC GARDEN LABELS.

(Figs. 36 and 37.)

These are unsurpassed, being neat, durable, and indelible. The ink marks a jet black, which remains distinct indefinitely. Use a clean quill pen or pointed stick. Price per 100:

No.	1	2	3	4	5	6	7	13	14	15	20	21
	\$1.25	1.00	1.00	.90	1.15	.75	.65	.60	.50	.60	.75	1.25

FARQUHAR'S IMPROVED INDESTRUCTIBLE LABEL WITH ROD.

We recommend this label as by far the best for permanency. On a strong, neat rod of galvanized iron, eighteen inches long, is attached a label by copper wire passed through a drilled eye at the top of the rod. For trees, shrubs, herbaceous plants, and in fact all purposes for which a lasting label is wanted, it is indispensable. Price, Rods, 100, \$3.50; Labels (Fig. 30), 100, No. 1, 3¾ in. x ¾ in., .75; No. 2, 5 in. x 1½ in., \$1.25.

INDELIBLE INK. For writing on zinc labels; makes a permanently black writing; use a quill or clean steel pen. Small bottle, .20; large bottle, .35.

GARDEN STAKES.

SQUARE, GREEN PAINTED, TAPERING STAKES.

1½ ft. long,	Each,	Doz.,	100,
1½ ft. long,	.02	.15	\$1.00
2 " "	.03	.25	1.50
2½ " "	.04	.30	2.00
3 " "	.05	.60	4.00
3½ " "	.06	.70	4.50
4 " "	.07	.80	5.50
5 " "	.10	1.10	7.50
6 " "	.15	1.35	9.00

SQUARE GREEN PAINTED, TAPERING STAKES, EXTRA HEAVY BLACK POINTS.

4 ft. long,	Each,	Doz.,	100,
4 ft. long,	.10	1.00	\$6.50
5 " "	.15	1.75	12.00
6 " "	.20	2.00	14.00

ROUND, GREEN PAINTED, TAPERING STAKES, LIGHT.

1½ ft. long,	Each,	Doz.,	100,
1½ ft. long,	.02	.20	\$1.20
2 " "	.04	.35	2.30
2½ " "	.05	.50	3.50
3 " "	.06	.65	4.70
3½ " "	.08	.80	5.90
4 " "	.10	1.00	7.20
5 " "	.12	1.20	8.50

MATCH STICKS. Plain Pine, 5/32 in. thick, .15 per 100. \$1.00 per 1,000.

ROUND, GREEN PAINTED STAKES, HEAVY.

Ft.	Each.	Doz.	100.	Ft.	Each.	Doz.	100.
3	.10	\$1.00	\$7.00	5	.15	\$1.75	\$12.20
3½	.10	1.10	8.30	6	.20	2.00	14.80
4	.12	1.35	9.70				

UNPAINTED SQUARE HARDWOOD STAKES.

Ft.	100.	1,000.	Ft.	100.	1,000.
2	\$0.30	\$2.50	4	\$0.60	\$5.00
3	.40	3.50	5	1.00	8.00

GARDEN STAKES — Continued.

GALVANIZED WIRE ROSE STAKES. No. 8 Wire.

Ft.	100.	1,000.	Ft.	100.	1,000.
3	\$1.50	\$12.00	4½	\$2.25	\$17.00
3½	1.75	13.00	5	2.50	19.00
4	2.00	15.00	6	3.00	23.00

CANE STAKES.

These resemble the bamboo, and are strong and durable. Vary in length from six to ten feet. Bundle of about 250, \$2.50; 100, \$1.25.

VERANDA TRELLIS FOR VINES.

(Fig. 9.)

This is by far the most ornamental and substantial Trellis made, and is especially adapted to outdoor use. Made of Wood and Rattan, and painted green.

2 ft. high	Doz.,	Each,
2 ft. high	\$4.00	\$0.40
3 " "	5.00	0.45
4 " "	6.00	0.55
5 " 18 in. wide	9.00	0.75
6 " 18 " "	11.00	1.00
6 " 28 " "	15.00	1.25
7 " 18 " "	13.00	1.15
8 " 18 " "	15.00	1.25
8 " 28 " "	24.00	2.00
9 " 20 " "	18.00	1.50
10 " 20 " "	21.00	1.85
10 " 31 " "	32.00	2.75
11 " 24 " "	25.00	2.25
12 " 24 " "	28.00	2.35
12 " 36 " "	42.00	3.50

FAN TRELLIS FOR VINES.

(Fig. 10.)

1½ ft. high, 7 in. wide at top,	Doz.,	Each,
1½ ft. high, 7 in. wide at top,	\$1.00	\$0.10
2 " 10 " "	1.50	.15
2½ " 13 " "	2.00	.20
3 " 16 " "	4.50	.40
3½ " 21 " "	5.50	.50
4 " 27 " "	6.50	.60
5 " 32 " "	9.00	.80
6 " 38 " "	10.00	.85
7 " 42 " "	12.00	1.00
8 " 46 " "	13.00	1.10

WOOD TOMATO TRELLIS.

(Fig. 11.)

These are made of neatly finished hard wood. Height, two and one-half feet. One and one-half feet square at top, one foot at bottom. Dozen, \$1.85.

THE "HANDY" VINE TRELLIS.

(Fig. 3.) Price, \$2.00 per dozen.

"TWO BARREL HOOP" TOMATO TRELLIS.

Price, \$1.00 per dozen.

THE MODEL EXTENSION CAR-NATION SUPPORT.

(Fig. 7.) \$3.00 per 100; \$27.50 per 1,000.

EXCELSIOR FLOWER SUPPORTS.

(Fig. 8.)

Length.	13 in.	15 in.	16 in.	18 in.	20 in.
Price, per 100	\$1.25	\$1.25	\$1.35	\$1.35	\$1.40

Two lengths form a complete Excelsior Flower Support. When ordering state the two required sizes. The prices quoted are for the single length only.

KRICK'S "PERFECT" FLOWER POT HANDLE AND HANGER. (Fig. 35.)

No. 0.	Will fit from 2 to 3½ to 5 inch pots,	per doz.,	.20
No. 1.	Will fit from 3½ to 5 inch pots,	"	.30
No. 2.	Will fit from 5 to 8 inch pots,	"	.40
No. 3.	Will fit from 8 to 12 inch pots,	"	.50

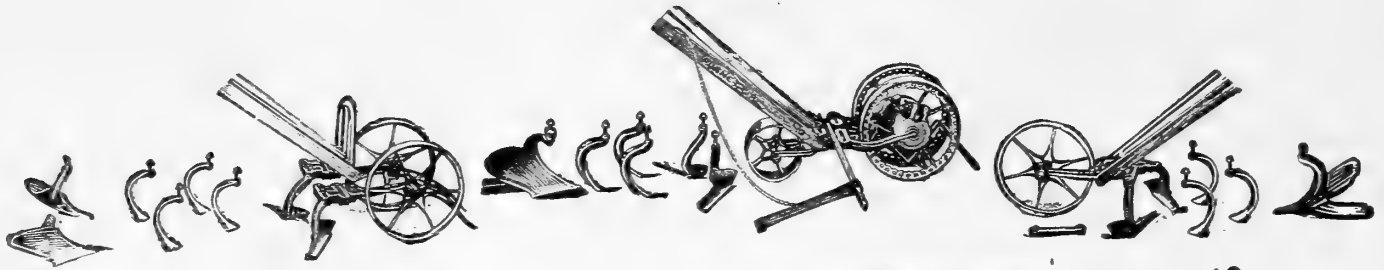

17

18

19

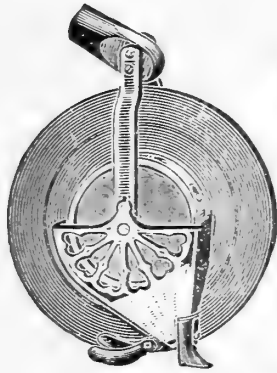

21

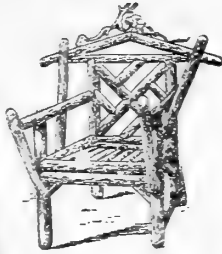

20

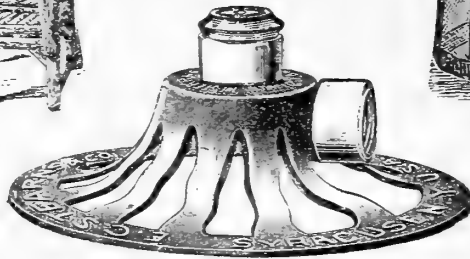

21A

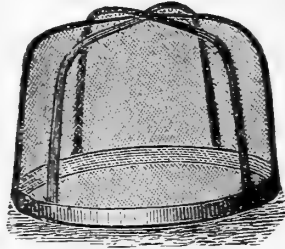

22



23



24

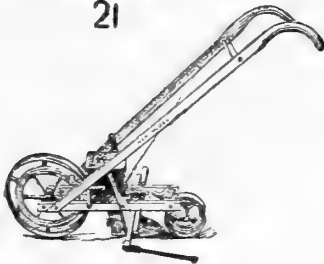

25

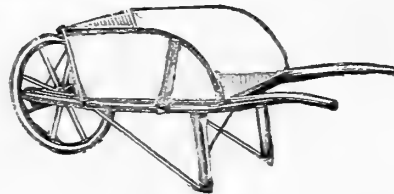

26



27



28



29



30

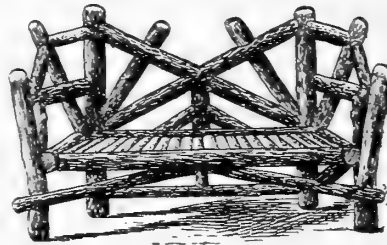

31



32



30 A

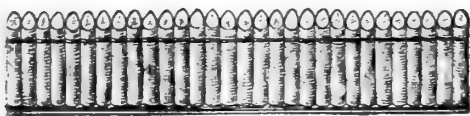

34



35

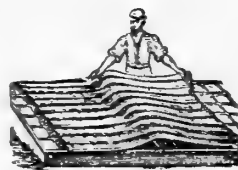

35 A



37

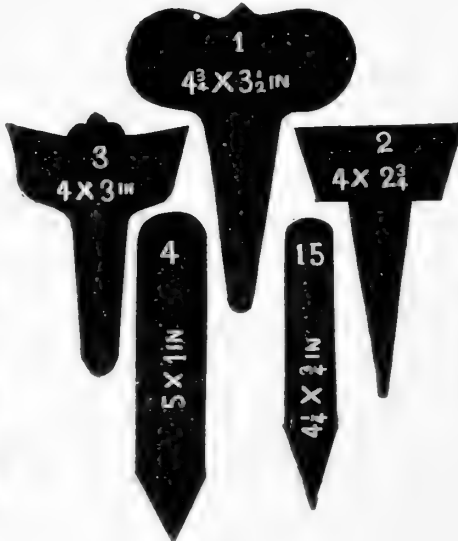

36

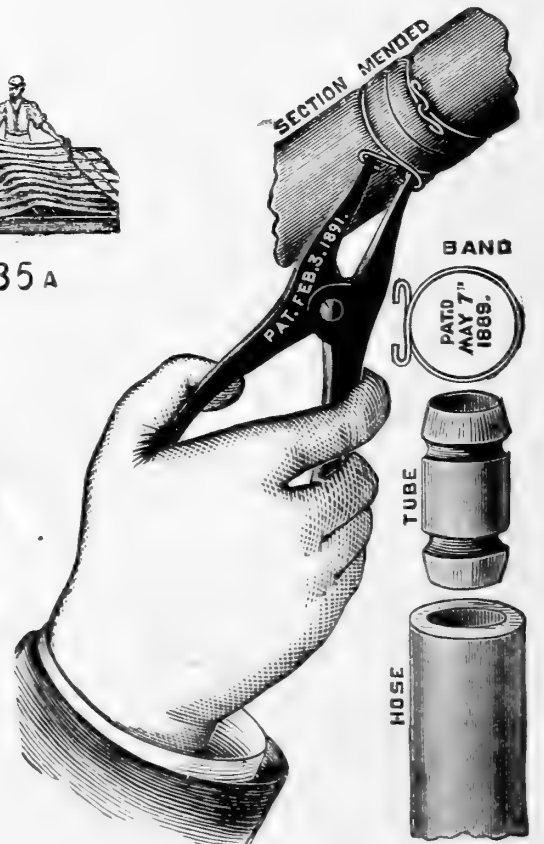

33

GARDEN IMPLEMENTS AND RUSTIC WORK.

THE NEW MODEL SEED DRILL.

THE MOST SATISFACTORY SEED DRILL MADE.

(Fig. 25.)

The diamond shaped adjustable hole regulates the discharge, and can be made larger or smaller, as occasion requires. No other drill has this advantage. The seed cut-off claps up underneath the hole; it does not slide under the same as in other similar drills; on this account it does not clog nor cut the seed. It has a broad wheel and a covering roller. The opening plow is adjustable in depth. The whole make-up of the drill is simple. It can be worked by any one. Price, \$7.50.

WAYLAND, MASS., May 11.

Mr. L. S. Hannas writes: "The 'New Model' Seed Drill that I bought of you has proved to be one of the best machines that I have ever used. If I could not get one like it I would not take \$20 for it, and any one in need of a Seed Drill will never make any mistake when they order one of the 'New Models.'"

"PLANET, JR.," No. 1.

COMBINED DRILL SEEDER AND WHEEL HOE, CULTIVATOR AND PLOW.

(Fig. 18.) PRICE, \$9.50.

This has long been the most popular combined tool made. From a drill it is changed to its other uses by removing two bolts, when hoes, etc., can be quickly attached. It is an excellent seed sower, a first class double or single wheel hoe, an excellent furrower, an admirable wheel cultivator, and a rapid and efficient garden plow. It is a practical, every-day time and labor saver, and a grand remedy for backache.

A pair of 6 tooth rakes supplied when specially ordered. Price, 50c.

No. 12 DOUBLE WHEEL HOE, CULTIVATOR AND PLOW.

(Fig. 17.) PRICE, \$7.00.

This perfected wheel hoe is invaluable for use in all small crops. Its variety of work is almost incredible. Changes and adjustments of the tools are made with the greatest quickness. It has 11-inch wheels, which can be set at four different distances apart; the frame is malleable, with ample room for tool adjustment and can be set three different heights. The handles are adjustable at any height, and, being attached to the arch, are undisturbed in making changes of adjustment in frame, wheels, or tools. The arch is of stiff steel, unusually high; the quick change frame permits the tools to be changed without removing the nuts. All the blades are of tempered and polished steel.

No. 17 SINGLE WHEEL HOE, CULTIVATOR AND PLOW.

(Fig. 19.) PRICE, \$5.00.

This single wheel hoe has a pair of 6-inch hoes, a plow, and a set of cultivator teeth, — an outfit sufficient for most garden work. It has 11-inch wheel, with broad face; is very light, strong, and easy running. It has adjustable handles and quick-change frame. The frame changes in height, and the wheel may be attached to the other side of the frame, when both sides of the row may be hoed at one passage.

CAHOON'S SEED SOWER.

For sowing grass seed, wheat, oats, barley, rye, etc. Sows at a common walking gait four to eight acres per hour; a saving of labor and one-third of the seed is effected by this machine. Price, \$3.00.

EUREKA KITCHEN GARDEN AND HOT-BED SEED DRILL. (Fig. 21.)

It will sow and cover Beets, Cabbage, Carrots, Celery, Lettuce, Onions, Radishes, Spinach, Turnips, and all such seeds with the greatest regularity.

The quality of work equals that done with the costly machines, and infinitely better and faster than hand work.

It's the only machine suited to sow in a hot-bed. Sows up close to the sides in straight rows. Sows the smallest packet of seeds as well as a large bulk. Each, .75.

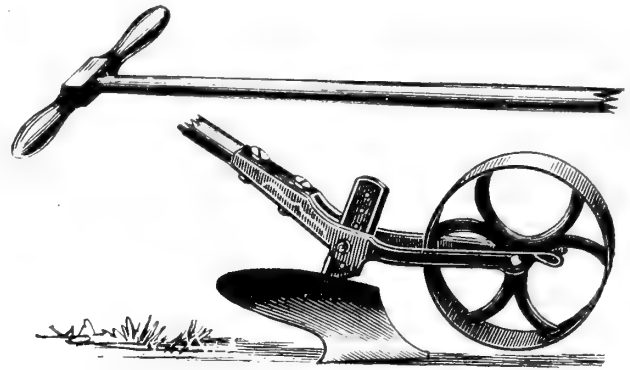

NEW UNIVERSAL HAND WHEEL PLOW.

Price, boxed, \$2.00.

This little labor-saving implement is one that commends itself to all gardeners. It can be used to prepare the ground, to furrow out, to cover, and to cultivate. The mould-board is of steel, polished and tempered. The Hand Plow is also a very useful implement for the poultry raiser for loosening up the runs or yards.

AMES GARDEN WHEELBARROWS.

(Fig. 26.)

No. 3, \$3.80; No. 4, \$4.00; No. 5, \$4.70.

GARDEN BORDERING.

(Fig. 2.)

WROUGHT IRON BORDERS. Painted green.

No. 1 D, size, 16 x 25 inches. Takes 100 Borders for 100 feet. Price, \$1.25 per dozen; each, .12.

No. 1 C, size 13 x 20 inches. Takes 130 Borders for 100 feet. Price, .65 per dozen; each, .06.

No. 1 B, size, 10 x 15 inches. Takes 180 Borders for 100 feet. Price, .40 per dozen; each, .04.

No. 1 A, size, 8 x 12 inches. Takes 220 Borders for 100 feet. Price, .25 per dozen; each, .03.

RUSTIC WORK.

NEWPORT CEDAR SETTEE (Fig. 31). — With the bark on, artistic and very handsome. Built to last a lifetime. Prices, 4 feet, \$15.00; 5 feet, \$20.00; 6 feet, \$22.50.

CEDAR CHAIR (Fig. 20), \$12.00.

WINDOW BOX (Fig. 34). — Very handsome for parlor use. We make this style to suit any size window, large or small. Three sizes on hand, 18, 24, and 30 in. in length, 7 in. wide, and 7 inches deep. Prices, \$3.50, \$4.50, and \$6.00.

RUSTIC STUMP BOX. — Hexagon, diameter 14 and 16 inches. Prices, \$3.50 and \$4.50 each.

ROUND HANGING RUSTIC BASKETS (Fig. 27). — These baskets, filled with flowers hung in windows, verandas, etc., look very pretty.

Diameter.	Prices each.	Diameter.	Prices each.
8 inches . . .	\$0.75	12 inches . . .	\$1.50
9 " . . .	1.00	15 " . . .	2.25
10 " . . .	1.25		



323 3NB 204 207 195 188 196 189

GARDEN TOOLS.

- ASPARAGUS KNIFE. (Fig 53.) For cutting Asparagus under the surface of the soil. Each, .40.
- BILL HOOKS. (Fig. 50.) A pruning-hook and hatchet combined. Price, No. 2, \$1.50; No. 3, \$1.75.
- CROW BARS. Best steel, various sizes. Lb., .06.
- DIBBERS. (Fig. 64.) Used for transplanting Cabbage and Cauliflower plants, etc. Metal, .35 each. Saynor's spade-handled Dibber, each, \$1.20.
- FORKS, MANURE.
- 4 tine, wood, D handle, strap ferrule75 each.
 - 4 tine, long handle, strap ferrule60 "
 - 5 tine, wood, D handle, strap ferrule95 "
- FORKS, SPADING.
- 4 tine, wood, D handle, plain ferrule, flat tine . . .85
 - 4 tine, long handle, strap ferrule, flat tine . . .75
- FORKS, HAY.
- No. 1, 2 tine, 5 ft. handle35
 - No. 2, 2 tine, 5 ft. handle40
 - No. 2, 3 tine, 5 ft. handle45
- FORKS, SAYNOR'S HAND. (Fig. 59.) Suitable for ladies' use. Small size, each, .75; large, each, \$1.00.
- FRUIT PICKER. Made of heavy galvanized wire, easily adjusted to a pole. For picking Apples, Peaches, Pears, etc. Does not bruise the fruit. Price, .35 each.
- HOES, FIELD SOCKET, 6-inch, each, .40; 8-inch, each, .45.
- HOES, STREET, 5-inch, each, .50; 9-inch, each, .60.
- HOES, AMES SCUFFLE, handled, each, 6-inch, .40; 7-inch, .45; 8-inch, .50; 9-inch, .55; 10-inch, .60.
- HOES, ENGLISH SCUFFLE. (Fig. 55.) Imported. Each, 4-inch, .40; 5-inch, .40; 6-inch, .45; 7-inch, .50; 8-inch, .55; 9-inch, .65; 10-inch, .75; 12-inch, .85.
- KNIVES, SAYNOR'S PRUNING AND BUDDING. Illustrated on page 122. Saynor's garden cutlery is the finest manufactured.
- | | | | | | | | | |
|--------|--------|------|------|------|------|------|--------|------|
| No. | 189 | 196 | 188 | 195 | 207 | 204 | 3 N.B. | 323 |
| Price, | \$1.75 | 2.00 | 1.50 | 1.50 | 1.50 | 1.50 | 1.50 | 1.50 |
- KNIVES, GRASS EDGING. Handled; American, .70; English, \$1.50.
- LADIES' OR BOYS' GARDEN TOOLS.
- Shovels . . .85 each. Spading Forks . .55 each.
 - Spades . . .85 " Shank Hoes . .35 "
- PICKS AND MATTOCKS, AMES R.R., with 36-inch walnut pick handle, 5½ to 6½ lbs.; each, \$1.00; 6½ to 7 lbs., each, \$1.10.
- PRUNER, WATER'S IMPROVED TREE. (Fig. 46.) The Water's Pruner never fails to cut the slightest twig. The thin blade of the Pruner passes through the limb so easily that the grain is uninjured, and the bark left smooth. Length, 4 ft., each, .75; 6 ft., .85; 8 ft., \$1.00; 10 ft., \$1.15; 12 ft., 1.25. Extra blades, .20 each; \$2.00 per dozen.
- PRUNER, TELEGRAPH TREE. (Fig. 47.) The blade can be taken out to be sharpened; there is a steel coiled spring for throwing out the blade; the socket has a thread on the inside, and can thus be easily screwed on to a pole of any length. Sold without handles. To be operated with a cord. Price, \$1.50 each. Extra blades, .30 each; extra springs, .25 each.
- PRUNER, THE ROCKDALE. (Fig. 41.) Blades made from the best tool steel. Will cut 1¼-inch stick with ease. Length, 26 inches, .75; 41 inches, \$1.00.
- RAKES, STEEL GARDEN AND LAWN. SHORT AND LONG TEETH. 10 tooth, each, .40; 12 tooth, .45; 14 tooth, .50; 16 tooth, .55; 18 tooth, .60.
- RAKES, HAY. (Fig. 63.) Wooden, 3 bow, bent handle, varnished, best quality, 14 teeth. Each, .45.
- RAKES, LAWN. (Fig. 63.) Wooden, 3 bow, bent handle, varnished, 24 teeth, best quality. Each, .50.
- RAKES, STEEL WIRE. For lawns. Each, .50.
- RAKES, ENGLISH DAISY. (Fig. 68.) For lawns. \$3.50.
- RAKE, GIBBS' LAWN. The best rake for cleaning lawns. Light, durable, and easily operated. Each, .50.
- SHEARS, HEDGE NOTCHED. Blade, 7½-inch, \$1.60; 8-inch, \$1.75; 9-inch, \$2.00; 10-inch, \$2.50.
- SHEARS, BRANCH OR LOPPING. (Fig. 40.) For cutting large branches; long, stout handles. Saynor's, three sizes, \$2.75, \$3.00, 3.50 each.
- SCYTHE SNATHS. No. 45. Pat. ash grass. Each, .75
- SCYTHE STONES. Silver grit. Each, .10; doz., .75.
- SCYTHE STONES. Genuine Welsh. .25.
- SCYTHE RIFLES. Farmer's friend. Each, .10; doz., .75.
- SCYTHES, SIBLEY'S SOLID STEEL, 32 to 34 inches; 34 to 36 inches; 34 to 38 inches; 36 to 40 inches, at .85 each.
- SCYTHES, BROAD ENGLISH OR LAWN. Each, \$1.40.
- SAW, FARQUHAR'S POLE PRUNING. (Fig. 43.) For cutting strong, high limbs of trees. Each, handled, \$1.85; without handle, \$1.50.
- SAWS, PRUNING. (Figs. 44 and 45.) Long, narrow blades for pruning. Single edge, 18-in., .75; 20-in., .85; 22-in., \$1.00. Double edge, 18-in., \$1.00; 20-in., \$1.25; 22-in., \$1.50.
- SHEARS, NEW FRENCH PRUNING. (Fig. 48.) This is the best pruner ever offered; quality unequalled. Price, 6¼-inch, \$1.35; 7-inch, \$1.50; 8½-inch, \$1.75; 9½-inch, \$2.00; 10¼-inch, \$2.25. By mail, .10 each extra. Extra springs, .30 each.
- SHEARS, TAYLOR'S PRUNING. (Fig. 49.) The best low-priced pruner. Each, .50. By mail, .10 extra.
- SCISSORS, GRAPE THINNING. (Fig. 72.) For thinning the bunch. Saynor's 6-inch, \$1.00; 7-inch, \$1.20; 8-inch, \$1.50. By mail, .05 each extra.
- SCISSORS, FLOWER. (Fig. 70.) For cutting and holding flowers. Saynor's 6-inch, \$1.00; 7 inch, \$1.50; 8-inch, \$1.85. By mail, .05 extra.
- SCISSORS, FRENCH FLOWER GATHERERS'. (Fig. 71.) Superior to all; made on a new principle; of best material and workmanship. Price, each, \$2.00.
- SCISSORS, BOW PRUNING. (Fig. 73.) Bright; sizes, 4 inches, .75; 6 inches, \$1.25.
- SHEARS, GRASS, WITH LONG HANDLES. (Fig. 39.) Saynor's best, for cutting the edges of grass borders. Blade, 8½-inch, \$2.50; 9-inch, \$2.75; 9½-inch, \$3.00; 10-inch, \$3.25.
- SHEARS, GRASS. (Fig. 42.) Best steel from Sheffield. Blade, 5½-inch, \$1.25; 7½-inch, \$1.40; 8-inch, \$1.50; 9-inch, \$1.80; 10-inch, \$2.25.
- SHEARS, GRASS OR SHEEP. (Fig. 51.) Best steel, English, No. 120, 7-inch, \$1.00; True Vermonter, No. 055, .75.
- SHOVELS, MERCHANTS'.
- No. 2, D handle, square or round point . .80 each.
 - No. 2, long handle, square or round point . .80 "
- SPADES, MERCHANTS'.
- No. 2, D Handle, .80. No. 2, long handle . .80
- SPADES, AMES BEST, No. 2, D Handle. Each, \$1.30.
- SICKLES OR GRASS HOOKS. English, .60, .75, and \$1.00; American, .50.
- SOD CUTTER. For lifting sods. Each, \$2.25.
- TREE SCRAPERS. (Fig. 58.) Best steel, .55.
- TROWELS, GARDEN. (Fig. 65.) Curved steel blade, 5-inch, .15; 6-inch, .15; 7-inch, .20; 8-inch, .20.
- TROWELS, GARDEN, EXTRA, FORGED STEEL. Solid steel blade and shank. 6-inch, .30; 7-inch, .40.
- TROWELS, FLAT STEEL. Best quality steel. Riveted shank and tempered blade. 6-inch, .75; 7-inch, .85.
- TROWELS, CLEVE'S ANGLE. (Fig. 66.) It is admirably adapted for digging weeds from lawns, transplanting flowers, cultivating and other purposes. No. 1, 8-inch tempered and polished, each, .25; No. 2, 8-inch, Bright Steel, .20; No. 3, 5-inch Bright Steel, .15 each. By mail, 5 cents each extra.
- WEEDER, HAZELTINE. (Fig. 60.) Very useful for weeding and thinning. Each, .30. By mail, .40.
- WEEDER, LANG'S. (Fig. 54.) A most useful and practical little tool, with leather band holder, so that the fingers may be free to pull weeds or thin plants. Price, .25. By mail, .30.
- WEEDER, EXCELSIOR HAND. (Fig. 61.) For weeding, or loosening the soil. Each, .15. By mail, .20.
- WEEDER, NOYES' HAND. (Fig. 69.) Steel. Cutter, diamond shape. Price, .25. By mail, .30.
- WEEDER, FORGED STEEL, THREE PRONG. (Fig. 62.) Each, .35. By mail, .50.
- WEED GRUBBERS. (Fig. 52.) For removing weeds. Price \$1.50.

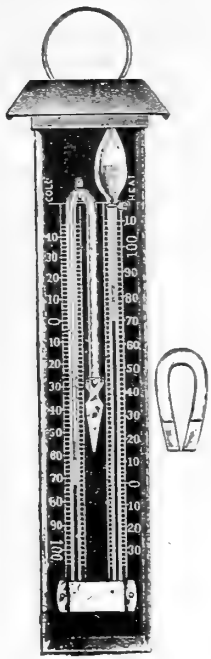

77

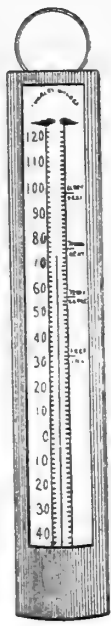

78



79



80

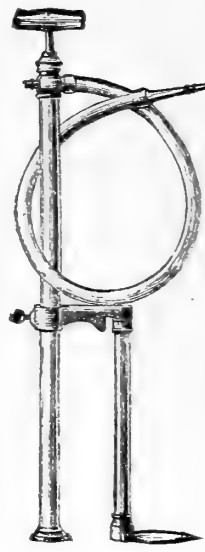

81



82

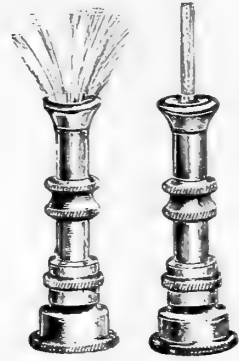

83

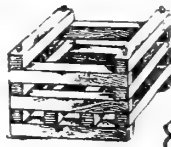

85



86



87



88

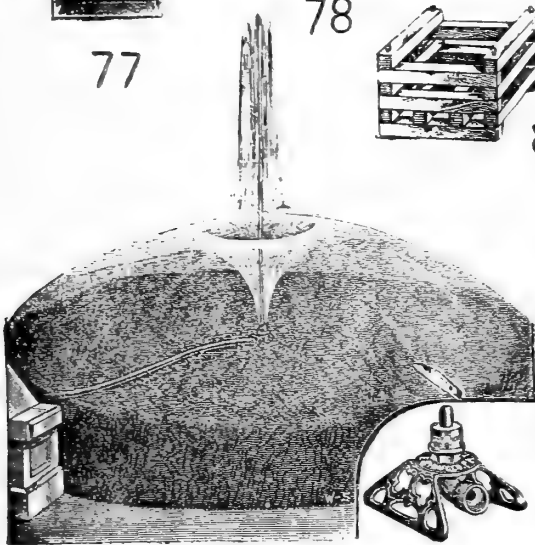

84

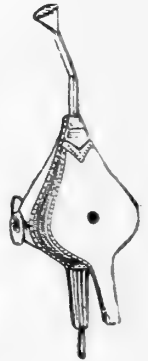
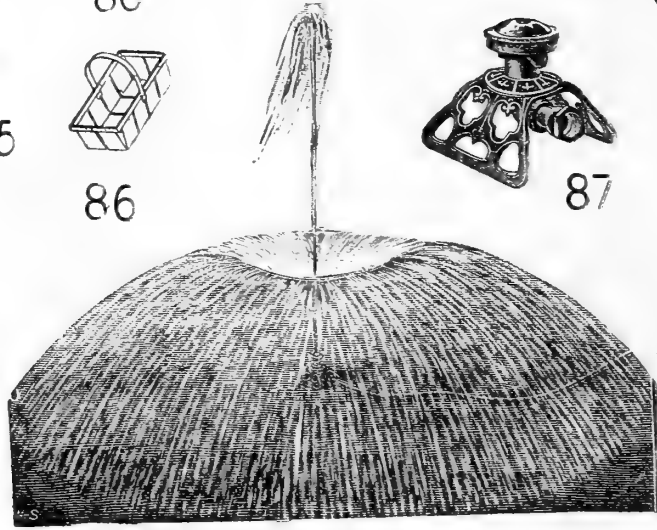

89

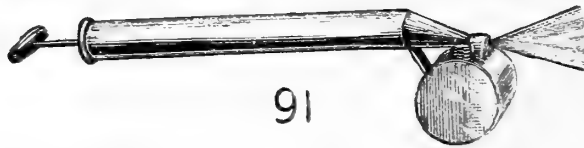

91



90



92

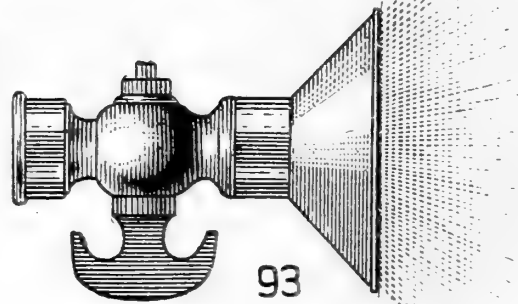

93

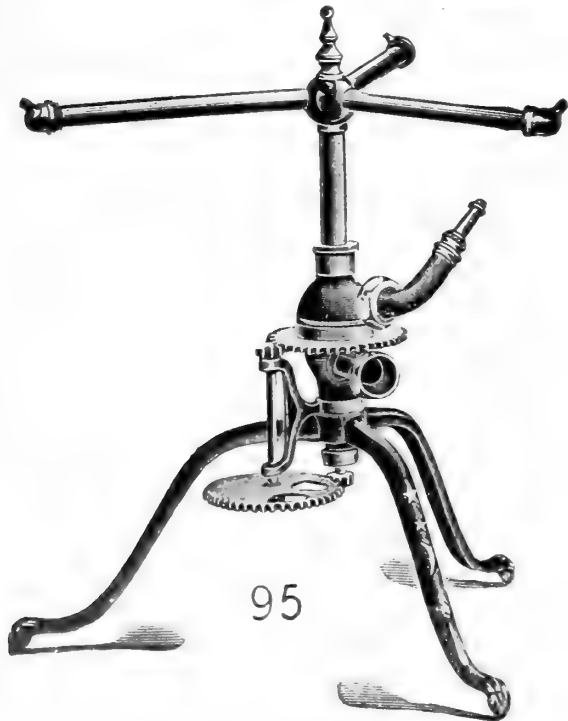

95

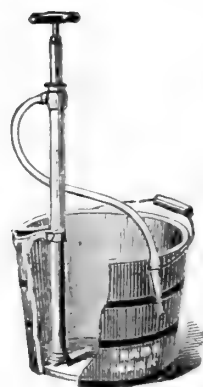

96

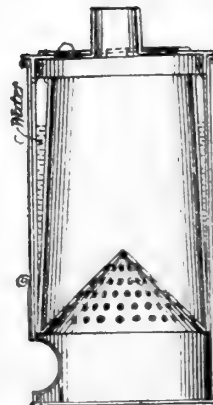

97



98

HOT-BED REQUIREMENTS.

FARQUHAR'S NEW SINGAPORE FIBRE HOT-BED MAT. Mouse proof, rot proof, almost indestructible. Price, 6 feet 2 inches long by 6 feet wide, each, \$2.00; 6 feet 2 inches long by 3 feet wide, each, \$1.20.

STRAW MATS FOR HOT-BEDS. Made by hand from fresh rye straw; thick and well put together. Excellent protection from frost. All our mats are carefully and firmly made, being tied with the finest quality of twisted, tarred marline. Odd sizes made to order at very reasonable prices. Regular size, 6 x 6 feet, each, \$1.50; extra heavy, to order, \$2.00. 3 x 6 feet, \$1.00; extra heavy, \$1.25.

ARCHANGEL MATS. Used for protecting from frost in spring. Size, 5 x 8 feet, each, .75.

PALMER'S HOT-BED MATS. (Fig. 35A.) Wool filled. Frost-proof. Made expressly for winter covering of hot-beds, cold frames, plants, and seeds of all kinds. No. 1, made of jute, stitched through, hemmed with canvas, and thickly padded; size, 76 x 76 inches; one mat covers two sashes. \$1.25 each. No. 2, Duck cloth outside, filled and quilted same as No. 1, size, 76 x 76 inches, \$1.75 each.

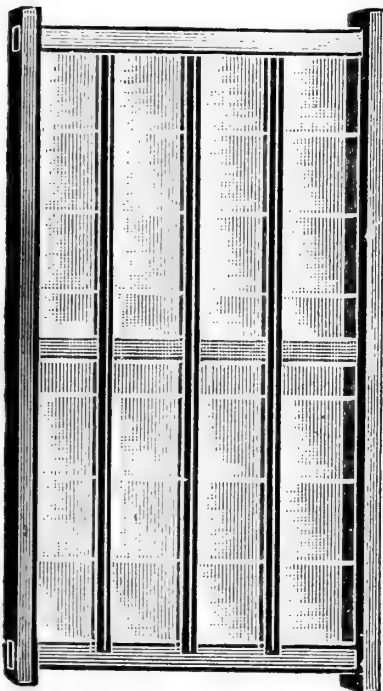

HOT-BED SASHES. These are well made, of the very best quality, thoroughly seasoned lumber, and free from sap or knots and other imperfections. Painted and glazed with double thick glass, 8 x 10 inches, in four rows. Frame, 1 3/4 inches, 3 x 6 feet, \$3.25 each; frame, 1 1/2 inches, 3 x 6 feet, \$3.00 each.

PATENT PROTECTING CLOTH FOR HOT-BEDS. Largely used in place of glass for protecting plants in early spring. The material used in its preparation renders it very tough and durable,

prevents it from shrinking, and makes it also partially water-proof. Pieces containing fifty to sixty yards, one yard wide. Prices, medium grade, yard, .10; by the piece, yard, .07 1/2. Heavy grade, yard, .12; by the piece, yard, .10.

ARLINGTON PLANT PROTECTOR. (Fig. 22.) The great value of this simple and cheap article for the protection of young plants from frost and the ravages of all kinds of insects has been proved by years of use. They promote the growth of the plants, admitting light and air freely. Two sizes. Width at bottom, 18 inches; height, 9 inches and 12 inches. Price, doz., \$1.50.

THERMOMETERS.

HEAVY JAPANNED TIN CASE. (Fig. 78.) Wilder's 8-inch, .50; 10-inch, .65; 12-inch, .75.

HOT-BED THERMOMETERS. (Fig. 80.) 16-inch Box-wood Scale, Brass Points. Each, \$1.75.

SELF REGISTERING THERMOMETERS, RUTHERFORD MINIMUM. (Fig. 79.) 10-inch. Each, \$1.50.

TAYLOR'S NO. 55 B, 8-INCH COMBINED MAXIMUM AND MINIMUM. (Fig. 77.) Each, \$2.50.

"PEERLESS" GLAZING POINT. (Improved Van Reyper.)

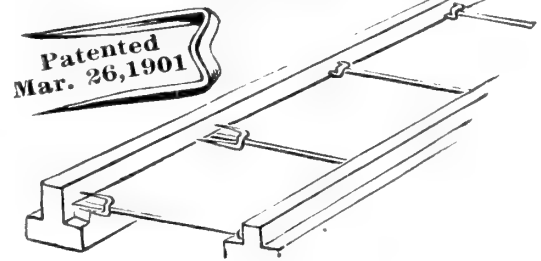

These points are made of steel and galvanized. They are used on either side of the bar. A perfect preventative of glass from sliding. Price, box of 1,000, .60; by mail, .75; .55 per 1,000 in lots of 5,000 and over. Pincers for driving points, .40; by mail, .50. **PEERLESS GLAZING POINT.** Brass. No. 2 1/2, \$1.00 per box of 1,000; by mail, \$1.15.

MASTICA.

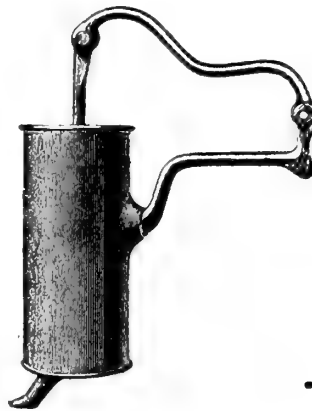

MASTICA. An elastic, adhesive substance for glazing greenhouses, new or old. Being elastic, it is not affected by expansion and contraction. One gallon will cover about 300 running feet (one side). Prices, 1/4 gallon, .35; 1/2 gallon, .65; 1 gallon, \$1.25.

MASTICA GLAZING MACHINES. Each, \$1.25.

SCOLLAY'S PUTTY-ING BULB. A simple and useful device for applying putty to sashes. The

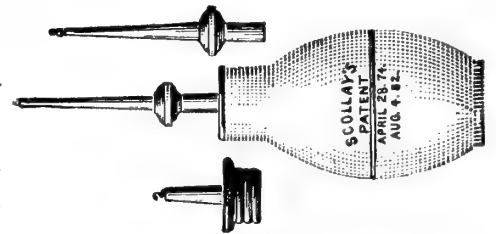

putty in a semi-liquid state is ejected by pressing the bulb, enabling one to do the work very rapidly. Price, \$1.00; by mail, \$1.10.

FUMIGATORS.

FARQUHAR'S STANDARD FUMIGATORS. (Fig. 98.) For burning tobacco stems, etc., in greenhouses, are made of heavy galvanized iron.

Price, 16 inches high, with cover \$2.25
24 " " " " " 3.75
28 " " " " " 4.50

PERFECTION FUMIGATOR. (Fig. 97.) The tank should be filled with tobacco water. When in operation a vapor arises from this and mixes with the dry smoke from the stems, producing a dampened smoke more dense and less injurious than from any other fumigator made.

No. 1, holds one peck of Stems \$3.00
No. 2, holds half bushel of Stems 3.50
No. 3, holds three-quarters bushel Stems 4.00

ASBESTOS CATERPILLAR BURNER.

An excellent device for burning insects' nests. Saturate with kerosene oil, light and hold under the caterpillars' nests, and pass quickly along the branches and around the trunk of the tree where the insects lodge. The great heat instantly destroys the insects. Each, .30.

VERBENA AND PANSY BASKETS.

(Fig. 86.)

MARSTON'S PATTERN. Adjustable wooden handles with tin fastenings on the ends. 10 inches long; 5 inches wide; 3 inches deep. 100, \$2.00; 1,000, \$18.00.

MARSTON'S PATTERN. Large size. 12 inches long; 7 inches wide; 4 inches deep. 100, \$3.00; 1,000, \$25.00.

FLOWER POTS, SAUCERS, SEED AND BULB PANS.

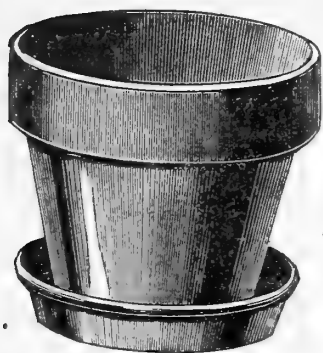

Sizes and shapes as adopted and recommended by the Society of American Florists. They are of perfect shape, with a convex bottom; and drainage is perfect. Breakage is not one-half as great as in other pots, the deep rim protecting them from any ordinary hard usage.

STANDARD FLOWER POTS. Measurement from inside to inside. Width and depth equal.

Inches.	Doz.	100.	Inches.	Doz.	100.
2	\$0.10	\$0.55	7	\$1.20	\$6.65
2½	.15	.75	8	1.70	9.35
3	.20	.95	9	2.40	13.35
3½	.25	1.15	10	3.25	20.00
4	.30	1.50	11	4.35	24.00
4½	.35	2.00	12	6.00	33.35
5	.50	2.65	14	each	1.00
5½	.60	3.35	16	"	1.25
6	.75	4.00	18	"	2.00
6½	.95	5.35			

FLOWER POT SAUCERS.

3½	\$0.15	\$0.95	7	\$0.50	\$2.65
4	.20	1.20	8	.75	4.00
4½	.25	1.35	9	.95	5.35
5	.30	1.50	10	1.20	6.65
5½	.30	1.65	11	1.45	8.00
6	.35	2.00	12	1.80	10.00
6½	.45	2.35			

ROUND SEED PANS.

Inch.	Each.	Doz.	100.
6	\$0.07	\$0.75	\$4.00
8	.10	1.20	6.65
10	.20	2.25	12.00
12	.35	4.20	23.50
14	.75	9.00	50.00

SQUARE SEED PANS.

Inch.	Each.	Doz.	100.
6x6	\$0.25	\$3.00	\$16.65
8x8	.30	3.60	20.00
10x10	.35	4.20	23.35
12x12	.40	4.80	26.65
x2¼			
12x12x4	.50	6.00	33.35

FERN PANS.

Something new in Fern Pans and Saucers. These pans are made thin and strong, and the saucers very shallow. They are very popular, and are made in eight sizes, to be sold with or without saucers.

These pans are especially adapted for linings to porcelain and Silver Fern Pans.

Dimensions given are outside measurements.

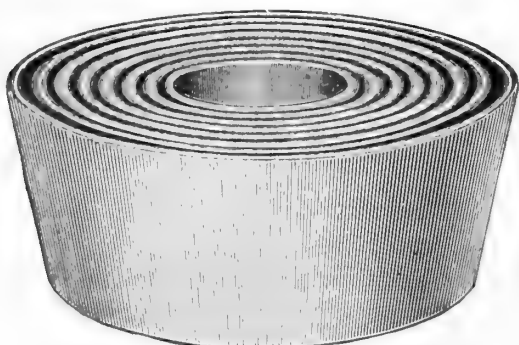

Size.	POTS.		SAUCERS.	
	Doz.	100.	Doz.	100.
4 x 1⅞ in.,	.35	\$2.00	.20	\$1.20
4¾ x 2⅞ in.,	.45	2.65	.30	1.55
5½ x 2¼ in.,	.60	3.35	.35	2.00
6¼ x 2½ in.,	.70	4.00	.45	2.35
7 x 2⅝ in.,	.85	4.65	.50	2.65
8 x 3⅞ in.,	1.20	6.65	.75	4.00
9 x 3¼ in.,	1.45	8.00	.95	5.35
10 x 4 in.,	1.70	9.35	1.20	6.65

NEPONSET PAPER FLOWER POT.

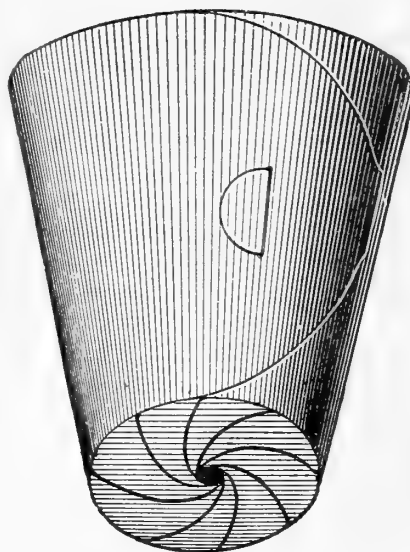

UNBREAKABLE, HANDSOME, CHEAP.

Size.	Per 100.	Per 1,000.
2¼	\$0.25	\$2.20
2½	.30	2.40
3	.45	3.90
3½	.60	5.15
4	.80	6.90
5	1.20	10.35
6	1.65	14.55

Not less than original crates at 1,000 rate.

INDURATED FIBRE WARE.

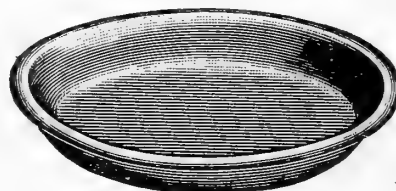

INDURATED FIBRE FLOWER POT SAUCERS. Not easily broken and very light.

Far cheaper in the end and better in every way than the earthenware

article. Are not porous, and will protect woodwork, tables, etc., on which plants are to stand.

Size.	Each.	Doz.	100.	Size.	Each.	Doz.	100.
4 in.	\$0.08	\$0.95	\$7.50	12 in.	\$0.20	\$1.65	\$13.00
6 "	.10	1.00	8.00	14 "	.25	2.25	17.00
8 "	.12	1.20	9.40	16 "	.40	4.00	30.00
10 "	.15	1.40	11.00	18 "	.50	5.00	35.00

ROLLING STANDS.

FOR HEAVY PLANTS AND PALMS.

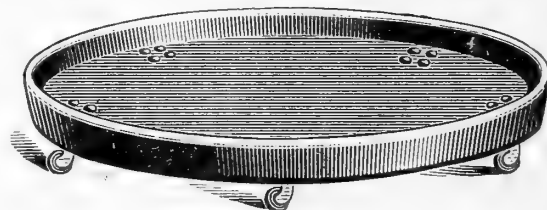

Platforms are Indurated Fibre Ware. Will not soak or rust.

Outside Diam. about	Will Take Pot.		Each.	Per Doz.
12 inches	10 inches	3 casters.	\$0.60	\$6.00
14 "	12 "	3 "	.70	7.20
16 "	14 "	4 "	.85	9.00
18 "	16 "	4 "	1.00	10.00
20 "	18 "	4 "	1.25	12.00
22 "	20 "	5 "	1.50	15.00

FLORISTS' VASES.

FOR DISPLAYING CUT FLOWERS.

No.	Diam.	Depth.	Each.	Doz.
0	8 in.	13 in.	\$0.45	\$4.80
1	5½ "	10 "	.40	4.20
2	4½ "	9 "	.35	3.60
3	4 "	6 "	.30	3.00
4	3 "	4½ "	.25	2.40
00	9 "	22 "	.80	9.00
11	5½ "	18 "	.45	4.80
22	4½ "	15 "	.45	4.80
33	4 "	12 "	.40	4.20
44	3 "	9 "	.35	3.60
000	9 "	29 "	1.60	18.00

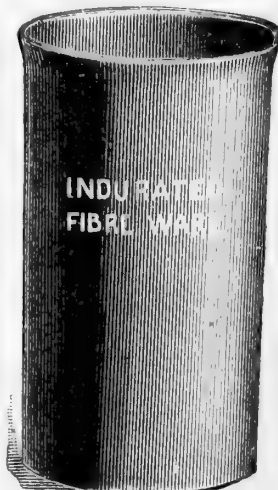

CEDAR PLANT TUBS.

(Fig. 30A.)

For Ferns, Palms, and other large plants. Made of thick cedar, nicely painted green. Drop handles on sides. The best made. Outside measurements:

No.	Diameter across Top.	Height Outside.	Price.
1	28 in.	22 in.	\$5.00
2	26 "	20 "	4.25
3	24 "	18 1/2 "	3.50
4	22 "	17 "	3.00
5	20 "	16 "	2.50
5	18 1/2 "	15 "	2.00
7	16 1/2 "	14 "	1.75
8	15 1/2 "	13 "	1.50
9	14 "	12 "	1.30

OAK PLANT TUBS.

Natural wood finish. These are neatly made with galvanized iron handles. They are admirably adapted for use on lawns, in halls, etc. The bottom is composed of pine, rendering the tub lighter and much more durable. Outside measurements:

12 inches in diameter.	11 inches high	Price
12	11	\$1.15
14	12	1.25
16	13	1.75
18	15	2.00
20	17	2.25
24	20	2.50
26	22	3.00

CUT-FLOWER BOXES.

"C. L.," OR CORNER LOCK STYLE.

Size	Per 100	Price
C 3 x 12 x 5 inches	Per 100	\$1.60
E 3 x 18 x 5 "	"	2.10
L 4 x 18 x 8 "	"	3.30
N 4 x 24 x 8 "	"	3.90

EXTRA HEAVY BOXES FOR SHIPPING.

Size	Price
Q 5 x 24 x 8 inches	\$4.25
U 6 x 30 x 12 "	8.30
Y 6 x 36 x 14 "	10.00

ENAMELLED LITHOGRAPHED VIOLET BOXES.

Size.	Depth.	Length.	Width.	Price per 100.
E	5 in.	9 in.	7 in.	\$5.00
F	4 1/2 in.	8 in.	5 in.	4.00
G	3 1/2 in.	7 in.	4 in.	3.50

ORCHID BASKETS.

(Fig. 85.) Made of finest Cherry Wood.

Size.	Doz.	100.	Size.	Doz.	100.
4-in.	\$2.75	\$18.00	8-in.	\$4.75	\$30.00
5 "	3.25	21.00	9 "	5.50	35.00
6 "	3.75	24.00	10 "	6.00	37.50
7 "	4.00	27.00	12 "	6.50	42.50

JONES' FOLDING PLANT STANDS.

(Fig. 6.) 3 Wire Trays, 7 1/2 x 30 inches, Each, \$3.00

HANGING BASKETS. (Fig. 23.)

Size	Per Doz.	Each	Price
5-inch bottom	Per Doz., \$2.00	Each,	.20
7 "	"	"	.25
9 "	"	"	.30

MOSS BASKETS. (Fig. 24.)

Size	Per Doz.	Each	Price
6 inches across top	Per Doz., \$2.00	Each,	.20
8 "	"	"	.25

ARCH WIRE GARDEN. (Fig. 1.)

Green painted 3/8-inch rods, 7 feet high, 4 feet wide. Each, \$6.00.

EXTENSION LADDER (CAMBRIDGE).

When ordering add 4 ft. for splice at regular price per foot. Per foot, .30.

SIEVES, WIRE.

For sifting loam, gravel, etc. Strong and well made. Any size mesh. 18 inches diameter; each, \$1.00.

SUNDRIES.

BROOMS. For greenhouse and garden use, three sizes. .40, .50, .60.

COTTON BATTING. For packing; large sheets. Each, .05; per doz., .50; per bale, 480 sheets, \$15.00.

GARDEN LINES. Extra quality best Russian hemp, Single, .75; double, \$1.25.

GARDEN REELS. (Fig. 67.) Small, .50; large, .75.

GARDEN AND PRUNING GLOVES. Ladies' Tanned Gauntlets, per pair, \$1.00; ladies' gardening with gusset, per pair, \$1.00; men's pruning gauntlets, per pair, \$1.50; men's button drummonds, per pair, \$1.25; men's tanned Oxford outseam, per pair, \$1.25.

GRAFTING CHISELS. Fine quality steel, .50 and .75.

GRAFTING WAX. The finest quality made, as used by fruit growers. 1/4 lb., .10; 1/2 lb., .15; 1 lb., .30.

HORSE LAWN BOOTS. (Figs. 28 and 29.) Made of heavy leather, very substantial. Indispensable on fine lawns, preventing injury to the sward by the horse's feet. Price, set of four, small, medium, large, \$10.00.

MOLE TRAPS. (Fig. 56.) Iron. Each, .35.

MOLE TRAP, THE REDDICK. (Fig. 57.) A first-class trap. No mole can pass under this trap and live. Each, .75.

OIL, LUBRICATING, FOR LAWN MOWERS, ETC. We supply a very superior article for lubricating axles, etc. Price, quart, .25; gallon, .75. Steel Oilers for applying lubricating oil, .30 each; Copper Oilers, .75 each.

OIL, LAWN MOWER, IN OILERS. Ready for use. No. 1, each, .20; No. 2, .30.

PAPER, WHITE. For cut flowers. Sheets, 24 x 36 inches, per lb., .10; per ream, 47 lbs., \$3.25.

PAPER, WHITE TISSUE. Sheets 24 x 36 inches; per lb., .20; per ream, 10 lbs., \$1.75.

PAPER, BROWN MANILA TISSUE. For cut flowers. Sheets 24 x 36 inches. Per ream, \$1.25; per lb., .15.

PAPER, PARCELLING. Sheets 20 x 30 inches, 24 x 36 inches, 30 x 40 inches; per lb., .08; per ream, 50, 60, and 100 lbs., respectively, .06 per lb.

PAPER, WAXED. Thin, white; aids in preventing the escape of moisture. Sheets 18 x 14 inches; per lb., .30; per ream, 5 lbs., \$1.25.

PENCILS, WOLF'S INDELIBLE GARDEN. For writing on wood labels, in red, black, or blue colors. Each, .15; doz., \$1.50.

TAPE LINES. 100 feet, \$1.50.

TINFOIL. For bouquets. Price variable. Lb., .15.

TINFOIL. Violet, lb., .60.

TYING MATERIAL.

ROFFEA. The best material for tying plants; exceedingly strong, soft, and pliable. Lb., .25.

SILKALINE, OR SMILAX GREEN THREAD. Largely used for tying in bouquet work. Spools, each, .25, box of 8 spools, \$1.25.

TWINE. Heavy and light parcelling. Ball, .25.

TWINE, GREEN. For stringing Smilax. Ball, .25.

TWINE, SOFT. For tying vines, etc.; very strong. 3 and 5 ply. Large balls, .15.

TARRED YARN. Excellent; low priced material for raspberries, shrubs, etc. Lb., .15.

TARRED MARLINE. Of better quality than the above; twisted in strands. In 5 and 10 lb. balls. Lb., .18.

YACHT MARLINE. In 1-lb. balls, .50 per ball.

WIRE, BOUQUET.

Prices Variable.

FLORESTA'S ANNEALED. Nos. 22, 23, and 24, in coils of 12 lbs. .85 per coil.

FLORESTA'S BRIGHT, CUT IN LENGTHS. In boxes of 12 lbs. (one stone).

9 inches long, per 12 lbs., No. 22 Wire, \$1.00; No. 24 Wire, \$1.15.

12 inches long, per 12 lbs., No. 22 Wire, \$1.00; No. 24 Wire, \$1.15.

Single pounds at 15 cents per pound.

INDEX.

GUIDE TO SELECTION OF SEEDS AND PLANTS

Page 95

PAGE.		PAGE.		PAGE.		PAGE.	
VEGETABLE SEEDS.							
Artichoke	1	Aquilegia	44, 45	Solanum	87	Hydrangea	111, 120
Asparagus	1	Asters	36, 39, 46-49	Stocks	87, 88	Iris	115
Beans, Bush Lima	2	Auricula	82	Streptocarpus	88	Kalmia	120
" Bush	2	Balsam	50	Sweet Peas	89, 90, 91	Lantana	111
" English Broad	1	Balloon Vine	50	Sweet Sultan	91	Lemon Verbena	111
" Pole	4	Begonia	50	Sweet William	91	Lilac	120
" Pole Lima	4	Browallia	51	Tagetes	71, 72	Lotus	109
Beets	4, 5	Calceolaria	52	Thunbergia	91	Lychnis	115
Broccoli	6	Calendula	51	Torenia	91	Magnolia	120
Brussels Sprouts	6	Calliopsis	52	Tropaeolum	91	Monarda	115
Cabbage	7	Campanula	52, 53	Verbena	92	Mock Orange	121
Cardoon	6	Canary Bird Flower	91	Violet	92	Moon Flower	111
Carrot	6	Canterbury Bell	53	Wallflower	39	Pæonies	108
Cauliflower	8	Candytuft	55	Water Lily	75, 77	Pansies	111
Celery	9	Carnation	54, 55	Zinnia	41, 93	Petunias	111
Celeriac	6	Celosia	55	SUMMER FLOWERING			
Chervil	6	Centaurea	55, 56	BULBS AND ROOTS.			
Chicory	6	Chrysanthemum	56	Achimenes	96	Pinks	114
Chives	6	Cineraria	57, 58	Acidantha	96	Poppies	116
Corn Salad	6	Clarkia	58, 59	Agapanthus	96	Privet	120, 123
Corn, Sweet or Sugar	10, 11	Coleus	59	Amarylhis	97	Pyrethrum	116
" Fodder and Field,	35	Commelina	59	Anemones	97	Retinospora	122
Cress	6	Convolvulus	59	Begonias	98	Rhododendron	121
Cucumber	12	Coreopsis	52	Cinnamon Vine	99	Roses	118, 119
Dandelion	13	Cosmos	59	Crinum	114	Rudbeckia	116, 117
Egg Plant	13	Cyclamen	38, 60	Dahlias	100, 101, 102	Salvia	117
Endive	13	Cypress Vine	61	Gladioli	103	Snowball	121
Garlic	18	Dahlia	61	Gloxinias	104	Snowberry	121
Herbs: Sweet, Pot, and		Daisy	51	Hyacinthus	104	Spiræa	117
Medicinal	27	Datura	61	Iris	105	Tarragon	26
Horse Radish	13	Delphinium	61	Liliums	106, 107	Taxus	122
Kale	13	Dianthus	62	Madeira Vine	104	Tritoma	117
Kohl-Rabi	13	Digitalis	63	Milla	104	Trollius	117
Leek	13	Dracæna	63	Montbretia	104	Verbena	117
Lettuce	14	Echinocystis	63	Pæonies	108	Vinca	111
Mangel-Wurzel	5	Eschscholtzia	63, 64	Tigridias	108	Weigelia	121
Martynia	16	Ferns	64	Tuberoses	108	Wistaria	119
Melons, Musk	15	Gaillardia	64	Zephyranthes	97	Yucca	117
Melons, Water	15	Gentiana	65	AQUATIC'S			
Mushroom Spawn	16	Gloxinia	65	PLANTS.			
Mustard	16	Globe Amaranth	65	Abies	122	BEDDING PLANTS	
Okra	18	Godetia	66	Abutilon	111	CLIMBING PLANTS	
Onion Seed	18	Gourds, Ornamental	66	Achyranthus	111	HARDY BIENNIAL	
" Sets	18	Grasses, Ornamental	94	Ageratum	111	PLANTS	
Parsley	19	Grevillea	66	Akebia	119	HARDY SHRUBS	
Parsnip	19	Gypsophila	66	Alternanthera	111	AND TREES	
Peas	20, 21	Helianthus	66, 67	Ampelopsis	119	HEDGE PLANTS	
Pepper	19	Helichrysum	67	Anemone	113	CONIFERS	
Potatoes	22	Heliotrope	67	Anthericum	113	HARDY PERENNI-	
Pumpkin	19	Hibiscus	68	Aquilegia	113	ALS	
Radish	23	Hollyhock	39, 68	Aristolochia	119	Hardy Roses 118, 119	
Rhubarb	27	Ice Plant	72	Aster	113	Plants for Vases 111	
Ruta-Baga	26	Impatiens	69	Azalea	120	Hardy Ornamental	
Salsify	27	Ipomœa	69	Barberry	120	Grasses 117	
Sea Kale	27	Kenilworth Ivy	69	Begonia	98, 111	SMALL FRUITS	
Sorrel	27	Lantana	69	Caladium	99	GRAPE VINES	
Spinach	23	Larkspur	39, 69	Calycanthus	120	MISCELLANEOUS.	
Squash	24	Lavender	70	Campanula	113	Books on Gardening 124	
Tarragon	26	Lobelia	70	Cannas	110	Cultivators, Hand 137	
Tomato	25	Lophospermum	70	Canterbury Bells	102	Earthenware 142	
Turnips	26	Lupinus	40, 70, 71	Carnations	114	Fertilizers 128, 129	
FARM AND FIELD							
SEEDS							
30-34							
GRASS SEEDS, Lawn,							
Golf Links, Terrace,							
Shady Places							
27, 28, 29							
BIRD SEEDS							
27							
FLOWER SEEDS.							
Novelties and Special-							
ties in Flower Seeds							
36-40							
Flower Seeds for Wild							
Gardens							
37							
Farquhar's Mixed							
Flower Seeds for Bou-							
quets, Vases, etc.							
37							
Abutilon							
42							
Achillea							
42							
Aconitum							
42							
Acroclinium							
42							
Adonis							
42							
Ageratum							
42							
Agrostemma							
43							
Alyssum							
39, 42, 43							
Amaranthus							
43							
Antirrhinum							
44							

R. & J. FARQUHAR & CO.,

Seed Growers, Importers and Dealers,

6 & 7 South Market St.,

BOSTON, Mass.



**GREENHOUSES
ROSE HOUSES
CONSERVATORIES, Etc.**

**Durably & Economically
Erected and Heated**



Iron and Air-Dried Cypress Structural Material Furnished Ready for Erection

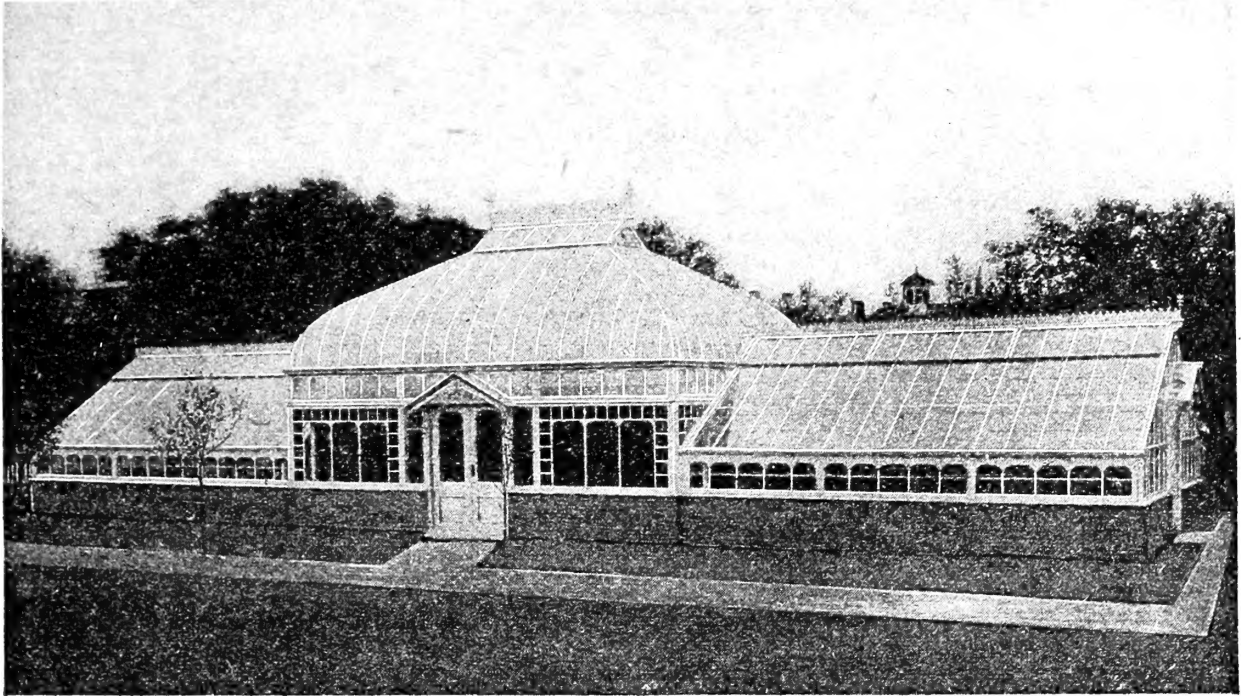

Designed and erected by us for Mr. J. M. Smith, Springfield, Mass.

“HITCHINGS” HOTWATER BOILERS

Round and Sectional The Standard for Greenhouse Heating Six Styles Twenty-six Sizes

**PERFECT SASH OPERATING APPARATUS
“EVERYTHING FOR THE GREENHOUSE”**

PLANS and ESTIMATES cheerfully submitted. Send four cents postage for our illustrated catalogue on GREENHOUSE CONSTRUCTION and HEATING

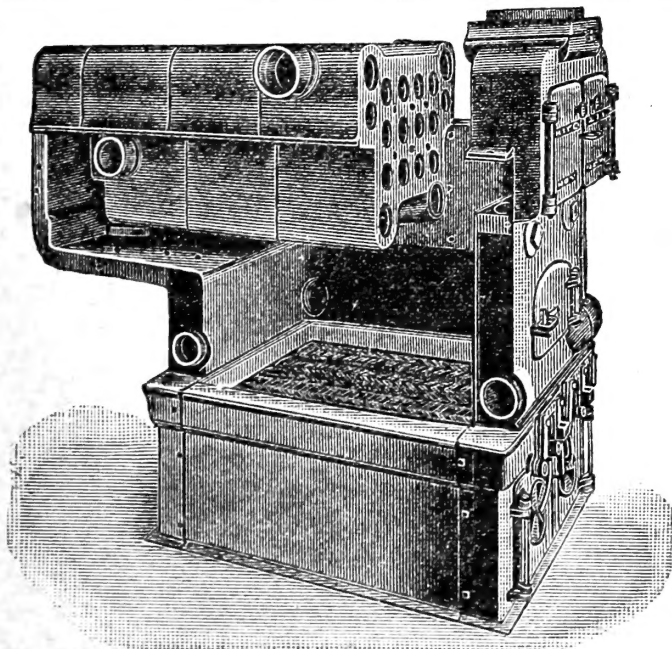

Our New Sectional Tubular Boiler.

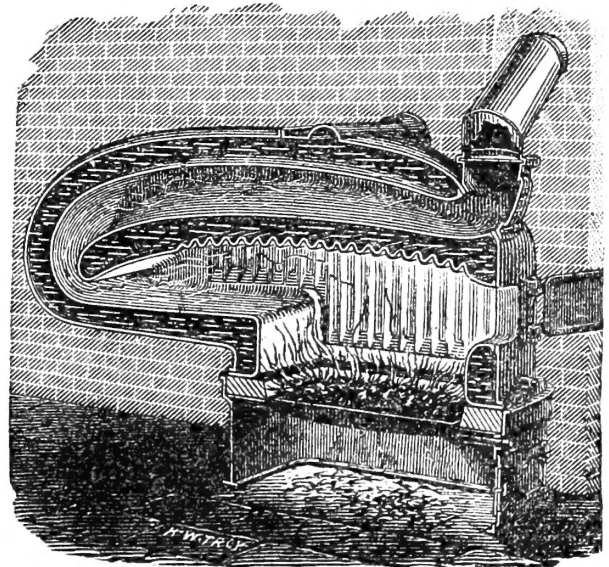

Our Well-known Corrugated Fire-Box Boiler.

Hitchings & Co.

Horticultural Designers & Builders

ESTABLISHED 1844

233 Mercer Street

NEW YORK



FARQUHAR'S
JAPANESE IRISES
IN 12 SPLENDID VARIETIES, OUR SELECTION,
PER DOZ. \$250. PER 100 \$15.00