

FERTILISERS  
AND  
MANURES

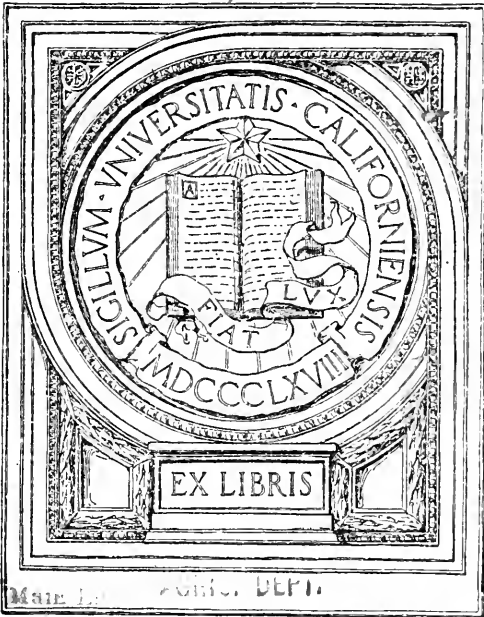

EX LIBRIS

Main Lib AGRIC. DEPT.

AGRIC.  
LIBRARY

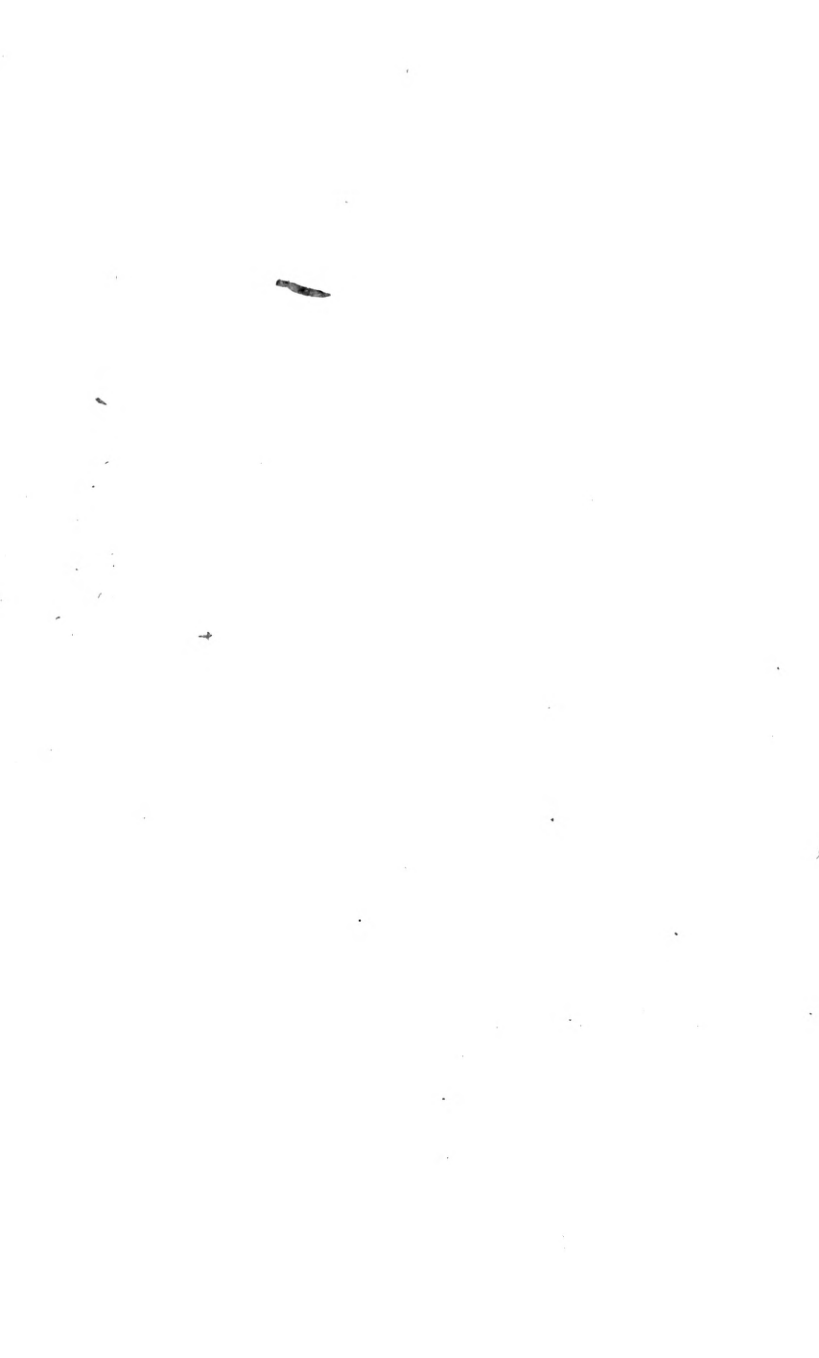









# FERTILISERS AND MANURES



# FERTILISERS AND MANURES

BY A. D. HALL, M.A., F.R.S.

DIRECTOR OF THE ROTHAMSTED EXPERIMENTAL STATION; FOREIGN MEMBER  
OF THE ROYAL ACADEMY OF AGRICULTURE IN SWEDEN

THE  
ROTHAMSTED EXPERIMENTAL STATION  
ROTHAMSTED, SUSSEX

NEW YORK

E. P. DUTTON AND COMPANY

1912

AGRIC.  
LIBRARY

DEDICATED TO  
SIR CHARLES LAWES-WITTEWRONGE, BARONET  
OF ROTHANSTED

WHO HAS SHOWN IN OTHER FIELDS  
THE DISTINCTION AND IMAGINATION  
WHICH MARKED HIS FATHER'S WORK  
FOR AGRICULTURE

FIRST EDITION . . . . . June 1909  
*Reprinted* . . . . . June 1910  
*Reprinted* . . . . . May 1912

## PREFACE

THE use of some form of fertiliser is becoming more and more a mark of modern agriculture. Though many farmers, and among them some of our best, still profess to scorn all artificial manures and pin their faith on the dung made by their stock, they none the less are buying the elements of fertility—nitrogen, phosphoric acid, and potash—in the cakes and other feeding stuffs which they bring from some outside source and consume on their farms. It is the continual introduction of plant food from outside which distinguishes modern intensive methods of cultivation from the old farming. Prior to a period which roughly coincides with the foundation of the Royal Agricultural Society of England in 1838, the farmer, living on the inherent capital of the soil, was forced into a conservative system of cultivation, which by restoring in the dung the greater part of what had been taken from the soil by the crops, would reduce the losses from his land to a point where they would be more or less balanced by the natural recuperative processes at work in the soil. In consequence the level of production was low, and it was the discovery and introduction of artificial fertilisers and feeding stuffs—nitrate of soda, guano, the phosphates, cotton cake, maize, etc.,—which enabled the British farmer to raise his output per acre by at least 50 per cent. during the reign of the late Queen. It is true that all

intensive farming in the United Kingdom received a great set-back in the 'eighties and 'nineties, when the continued opening up of new areas of virgin soil and the fall in freights filled the country with corn and meat at prices below our cost of production under the conditions then prevailing, because declining prices cannot be met by more intensive methods, but only by a reduction in the expenditure. However, we are steadily recovering from that position: the supply of rich virgin soil is not without a limit nor are its riches inexhaustible; the cost of production has begun to rise in the new countries, already we see the American farmer is in his turn being compelled to resort to fertilisers; and with each rise in prices the intensive farmer can recoup himself for an increased outlay. The future, too, lies with intensive farming; every year the ratio of the cultivable land to the population of the world shrinks; every year science puts fresh resources in the hands of the farmer. In the United Kingdom for some time the stream may still run backwards and the more expensive forms of arable cultivation continue to be replaced by grass which demands no outlay, because as long as ours is the one market open to the competition of all other countries selling agricultural produce, prices are still liable to such wreckage as frightens the home grower out of the business; still, in the end, whatever agriculture survives in this country will be forced into more and more intensive methods by the increasing scarcity of the land. As it is, the specialist farmers in Great Britain—the potato growers, the market gardeners, the hop growers—have reached a pitch of cultivation which is hardly to be paralleled elsewhere.

Intensive farming implies the use of fertilisers; still



more it implies, or should imply, skill and knowledge in using them.

If this book is to have any justification for its existence, it will be by helping men to a greater skill and knowledge in the use of their fertilisers and manure. There is no lack of books which give an account of the origin and composition of fertilisers: my object is rather to make the reader understand their mode of action and their relation to particular crops and soils. For it is only by understanding the why and the how that a farmer can properly adjust his manures to his soil and his style of farming; he must to some extent reason the scheme out for himself, he cannot simply be told.

The scientific man is always being asked to arrange his experiments to demonstrate the *best* way of growing this or that crop, by the best being implied the cheapest: farming visitors to Rothamsted are often inclined to suggest that the plots, if interesting, are not "practical." After sixty years of work they rather expect to see the absolutely cheapest form of manuring each crop set out once and for all. But in practical farming there is no "best" way of doing things; the mere fact that the weather of the coming season is unknown makes it impossible to specify the absolutely right course either in cultivation or in manuring. The question even of the best manure for a given crop is complicated by the manner in which every farm differs somewhat from every other, not merely in its soil and climate, for these matter less than is commonly supposed, but in its object and management. One man aims at crops, another man gets his money back by his stock; one man has only to pay 15s.

an acre rent, another has to get twice as much out of his land before he touches a profit; one man's markets are such that he can repay himself for an outlay of £3 an acre for fertilisers on his root area, whereas another man could not afford 20s.; no one recipe can be handed out to suit all these different men.

The object, then, of the scientific man should be to lay down principles which the practical man in his turn must learn to apply to his own conditions; success is only possible when he too does some thinking. Furthermore, the object of experiments should be to provide knowledge that can be thus applied to other conditions, and an experiment is practical just in so far as it carries out its avowed object, which is to lead men into a sound and fruitful way of thinking on the question at issue.

It is in this respect—the elucidation of general principles—that the Rothamsted experiments have proved so exceedingly valuable; though initially laid out to test certain definite questions about the nutrition of crops, the answers to which have long since been absorbed into farming practice, the design was so sound and the continuity of the record has been so rigorously maintained that the results now afford an instructive commentary on the whole range of the science of crop production. We have by no means come to the end of the lessons the Rothamsted experiments can teach: every new theory, each extension of our knowledge, finds an unsuspected criticism or an illustration in the records that are still accumulating.

I have in consequence throughout this book used very freely the results of the Rothamsted experi-

ments; and if the conclusions I have drawn do not always square with popular opinion, I have none the less set them out in the hope that other experimenters would thereby be led to check or revise them. Agricultural chemistry is still cumbered with a good many *a priori* deductions resting upon a very slender foundation—first approximations to the truth which fail because they do not take all the factors into account; it is about many of these opinions that the Rothamsted results suggest scepticism.

The book is intended for farmers and for the senior students and teachers in our agricultural schools. I have therefore kept the language as non-technical as possible, though some elementary knowledge of chemistry has to be assumed. If sometimes, as in Chapter X., I may seem to have gone rather far in the discussion of theoretical questions, it is in pursuance of my main idea that it is only by thinking about the rationale of manuring we can arrive at right practice. And as the book is intended for those who are using or going to *use* fertilisers, I have not troubled to say much about their manufacture, nor have I dealt at all with their analysis: these are both technical matters outside the business of the farmer.

I have meant this to be a companion to my book, *The Soil*; they are both written for the same audience, and on similar lines. I hope later to complete the series by a third book, dealing with the chemistry of the growing plant.

A good deal of the material in the book has already been utilised and in part published in a course of Cantor Lectures delivered before the Society of Arts in 1906, and again in a course of lectures delivered

at Cornell University to the Graduate School of Agriculture of the United States Department of Agriculture in July 1908. In this way, much of the substance of Chapters II., III., IV., V., and VI. has already been printed in the *Journal of the Society of Arts*, the greater part of Chapter VII. has appeared in the *Journal of the Board of Agriculture*, and Chapter X., the last of my American lectures, was printed in *Science*.

I have drawn so freely upon my friends for information, that it seems invidious to single out for thanks some more than others: but I owe much to Dr E. J. Russell of this Laboratory, who has read and criticised parts of the text; to Dr J. A. Voelcker, who has so often placed the results of his wide experience at my disposal; to Mr H. Voss of the Anglo-Continental Guano Co., and to Mr T. Elborough of the Lawes Chemical Manure Co., who have furnished me with many facts and figures respecting the trade in fertilisers; and once again, to Mr G. T. Dunkley of the Rothamsted Laboratory, who has been indefatigable in verifying references and in securing the accuracy of the many figures and tables the book contains.

A. D. HALL.

THE ROTHAMSTED EXPERIMENTAL STATION,  
HARPENDEN, *December 1908.*





	PAGE
Superphosphate—Fate of Superphosphate applied to the Soil—Soils appropriate to Basic Slag—Neutral Phosphatic Manures for Light Soils—Comparison of Bone Meal with other Phosphatic Fertilisers . . . . .	136

## CHAPTER VI

## THE POTASSIC FERTILISERS

Early Use of Wood Ashes—The Stassfurt Deposits—Manufacture and Composition of Commercial Potash Fertilisers—The Retention of Potash by the Soil—The Function of Potash in the Nutrition of the Plant—Dependence of Carbohydrate Formation upon Potash, as illustrated in the Barley and Mangold Crops—The Action of Nitrate of Soda upon Insoluble Potash Compounds in the Soil—Potash Fertilisers as promoting the Growth of Leguminous Plants—Effects of Potash Starvation upon Vegetation—Potash as a Preventive of Fungoid Disease—Potash as prolonging the Growth of the Plant—Destruction of the Tilth of Clay Soils by Potash Salts—Soils deficient in Potash . . . . .	158
--	-----

## CHAPTER VII

## FARMYARD MANURE

Variable Composition of Farmyard Manure—The Fate of the Constituents of Food during Digestion and Excretion—Composition of Urine and Fæces of Farm Animals—Fermentation Changes taking place during the Making of Dung—The Breakdown of the Nitrogenous Bodies and of the Carbohydrates—Gases found in the Dunghill—Losses of Nitrogen during the making of Farmyard Manure—Preservatives used to minimise the Losses during Dung-making—Composition of Farmyard Manure—Cake-fed <i>v.</i> Ordinary Manure—Long and Short Manure—London Dung—The Value of Fresh Manure—The Fertilising Value of Farmyard Manure—Recovery of its Nitrogen in the Crop—Long Duration of the Action of Farmyard Manure—Farmyard Manure as a Carrier of Weeds or Disease—The Physical Effects of Farmyard Manure upon the Soil—The Improvement in Texture and Water-retaining Power—Value of Farmyard Manure as a Mulch on Grass Land—Farmyard Manure best utilised for the Root Crop or Grass Land—Value of Farmyard Manure: Cost of making One Ton . . . . .	178
--	-----

## CHAPTER VIII

PERUVIAN GUANO AND OTHER MIXED  
FERTILISERS

Origin of the Deposits of Guano—Variation in Composition with Age—Compounds of Nitrogen present in Peruvian Guano—Ichaboe and Damaraland Guanos—Fish Guano—Meat Guano—Dried Blood—Greaves—Rape Dust and other Cake Residues—Manures derived from Fæcal Matter—Sewage Sludges . . . . .	PAGE 229
--	-------------

## CHAPTER IX

## MATERIALS OF INDIRECT FERTILISING VALUE

Lime—Early Use of Lime—White and Grey Limes—Lime Ashes—Marl—Chalk—Ground Limestone—Indications of the Lack of Lime in the Soil—Action of Lime upon the Soil—Improvement of Texture—Promotion of the Oxidation of nitrogenous Residues in the Soil—Increase in the Availability of Phosphoric Acid and Potash—General Action of Soluble Salts on the Soil—Gas Lime—Gypsum—Salt—Sulphate and Carbonate of Magnesia—Sulphate of Iron; Supposed Connection of Iron in the Soil with the Colour of Fruit and Flowers—Manganese Salts—Silicates—Green Manuring—Folding Catch Crops on the Land . . . . .	249
--	-----

## CHAPTER X

## THEORIES OF FERTILISER ACTION

Liebig's Ash Theory—Part played by the Soil in the Nutrition of the Crop—Ville's Theory of Dominants—Liebig's Law of the Minimum—Law of diminishing Returns—Limiting Factors in Plant Growth—Is the Composition of the Soil Water unaffected by Fertilisers?—Attack of the Plant's Roots upon Insoluble Fertilisers—The Part played by Carbon Dioxide in the Soil—Excretion of Toxic Substances from Plant Roots—Rotations as a Substitute for Fertilisers—Unexplained Factors in the Nutrition Problem . . . . .	276
---	-----





## LIST OF ILLUSTRATIONS

FIG.	PAGE PAGE
1. Water Cultures of Barley . . . . .	17
2. Deflocculating Action of Nitrate of Soda on Clay Soils . . . . .	55
3. Curves showing the effect of Phosphoric Acid in hastening the formation of Grain of Barley, and the Migration of Nitrogen to the Grain . . . . .	137
4. Effect of Excess of Nitrogen, with and without Potash, on the Leaves of Mangolds . . . . .	174
5. Relation between Cost of Production and Returns with varying quantities of Manure . . . . .	284
6. Diagrammatic Section of Manure Distributor—Seed Drill Type . . . . .	373
7. Diagrammatic Section of Manure Distributor, with Revolving Drum Feed . . . . .	373
8. Diagrammatic Section of Manure Distributor—Endless Chain Feed Type . . . . .	374
9. Broadcast Manure Sower with Revolving Discs for Distribution . . . . .	374

# FERTILISERS AND MANURES

## CHAPTER I

### INTRODUCTORY

Early Notices of Manures and Manuring—History of the Theory of Nutrition of Plants—Priestley, de Saussure, Boussingault, Liebig, Lawes and Gilbert, Hellriegel and Wilfarth—The Introduction of Commercial Fertilisers—General Outline of the Process of Nutrition of Plants—The Constituents of the Soil—Mode of Entry of Food into the Plant—Nature and Function of a Fertiliser.

THE word “manure,” when first met with in English, possessed a much wider significance than it does to-day. Of the same origin as manœuvre, it meant, primarily, to work by hand, and it is used in that sense by Defoe in *Robinson Crusoe*—“The land which I had manured or dug”; but it also took on the extended meaning of any process or material by which the land could be ameliorated. In the seventeenth and early eighteenth centuries this latter sense alone began to prevail; agricultural writers enumerated chalk, lime, marl, burnt clay, etc., as manures, and began to speak of the operations of cultivation as tillages or husbandry; and more recently the tendency has been to restrict the employment of the term even further, confining it to the natural substances possessing a direct fertilising

value. Farmyard manure is the typical "manure"; marl or chalk would no longer be regarded as manure, because they do not feed the plant directly; while substances like basic slag or nitrate of soda, which simply supply one or other element in the nutrition of a plant, should be termed "fertilisers" rather than artificial manures. The distinction is not, however, very clearly drawn, and manure and fertiliser are generally and unconsciously used as interchangeable terms, as indeed they will be in this book.

It is impossible to assign a period to the discovery of the fertilising properties of the excrement of animals: agriculture must be almost coeval with the human race; and that tissue of experience and observation which reaches us as the tradition of farming—the stock-in-trade of the practical man—began to form long before letters existed by which it could be recorded. At any rate, when in Roman times we began to get some record of agricultural practices, we find that not only was the value of dung recognised, but that the virtues of certain other manures, such as marl, had been established. Even the fertilising effect of a crop of vetches or lupins upon the succeeding wheat crop was sufficiently well known to be related, not only by professed agricultural writers like Varro and Columella, but also by a poet like Virgil. But to whatever point the knowledge of manures had reached in the time of the Romans, for a long time it made no further advances and bade fair to be utterly lost with the irruption of the barbarians. When the new peoples emerge again in Europe, after the great movements of the races, we mostly find them practising the Germanic common field system of agriculture, with its rotation of wheat, beans or barley, and fallow, followed up by general grazing over the whole area—a system which lends no

encouragement to the use of substances like manures for the improvement of the land.

Doubtless the old traditions did not perish in the Romance countries, but as before were handed down from one generation to another; as long as corn and wine continued to be cultivated the immemorial precepts concerning their management would linger about the country side and be treasured in the memories of the workers in the fields. But during the Dark Ages this kind of knowledge sank below the level of whatever literature was being written; it had to diffuse slowly from the remains of Roman civilisation among the invading peoples, and it is only by chance that we get any record of what the countryman did or thought. In many English tenures we find that the flocks of the tenants had to be folded on the lord's land at night, the manure thus brought being one of his most valued privileges; while in Walter de Henley's *Husbandrie*, the great mediæval treatise on the duties of a land agent, we find instructions for the preservation of dung by the use of litter and marl. The manure thus obtained was to be stored in a heap and preferably applied to sandy land. From mediæval times also we derive such maxims as the Flemish proverb,

Point de fourrage, point des betail,  
Point des betail, point de fumier,  
Point de fumier, point de fourrage.

When, with the general resurrection of learning at the Renaissance, we once more get books on agriculture, we find that either old tradition or the experience of men of an enquiring turn of mind, who had been trying all sorts of things on their land, had already built up a certain knowledge of manures and manuring. The value of marl and chalk, of woollen rags and ashes, was certainly known in the sixteenth century; men

had even begun to reason a little on the mode of action of manures. For example, Bernard Palissy the potter, in his *Recepte Véritable*, published in 1563, not only recommends the use of marl and lime, but can assign a reason for the value of ashes, and shows that the richness of farmyard manure resides in the portion soluble in water:—"Et ainsi la paille estant bruslee dedans le champ, elle servira d'autant de fumier, parce que elle laissera la mesme substance qu'ell auoit attirée de la terre . . . ;" and again, "au lieu où ledit pilot de fumier aura reposé quelque temps, ils n'y laisseront rien dudit fumier, avis le jetteront deçà et delà, mais au lieu ou il aura reposé quelque temps, tu verras qu'après que la blé qui aura esté semé sera grand, il sera in cest endroit plus espes, plus haut, plus verd et plus droit. Par là tu peux aisement cognoistre que ce n'est pas le fumier qui a causé cela, car le labourer le jette autre part ; mais c'est que quand ledit fumier estoit au champ par pilots, les pluyes qui sont suruenues, ont passé à travers des dits pilots, et sont descendu à travers du fumier jusqu'à la terre, et en passant, ont dissout et emporté certains parties du sol qui estoit audit fumier."

If, then, by the sixteenth century we find written evidence of the knowledge of the fertilising properties not only of dung but of other waste substances, we may safely push back the original discovery of the properties of these bodies to a much more remote epoch, if such a term as discovery can properly be applied. Just as happens to-day, this or that man tried an experiment or noticed the result of an accident which caused him to report well of the action of some substance on his crops ; his opinion would often be mistaken and often, again, it would be forgotten ; but occasionally it would be repeated and find confirmation, until it acquired the wide circulation and staying power

of a farming tradition and passed more or less into the common routine. Even at the present time there are many beliefs and practices more or less current among farmers, which science has neither verified nor disproved, and which may either be examples of sound observation or only imperfect generalisations. Such opinions require to be examined with the utmost care and open-mindedness, for even when correct they are of no final use to agriculture until they have been explained and absorbed into the general stream of scientific knowledge. The value of many fertilisers must have been observed and lost sight of over and over again, because of the lack of any general theory to serve as a touchstone and discriminate between the true and the false reports. So, despite the experience that was accumulating respecting the fertilising value of this or that substance, no real progress towards a theory of manuring was made until the close of the eighteenth and the beginning of the nineteenth century.

Before the development of a science of chemistry it was naturally impossible to form any idea of how a plant came to grow; while the nature of the plant itself, of the air, water, and earth were equally unknown, no correct opinion could be reached as to how the latter gave rise to the former. In spite of Palissy's very sound conclusions as to the salts plants draw from the ground, Van Helmont described an experiment to show that a tree is made out of water alone. Jethro Tull, arguing from his hoeing experiments, concluded that manures were unnecessary: for the soil, if only stirred up enough and exposed to the air, will provide all that the plant requires. Even so late as 1810 we find Thaer writing that there is no doubt that the fallow absorbs or attracts the fertilising properties of the atmosphere.

The true theory of the nutrition of the plant begins very soon after the discovery of the composition of the air. "Thus, Priestley observed that plants possessed the faculty of purifying air vitiated by combustion or by the respiration of animals; and he having discovered oxygen, it was found that the bubbles which Bonnet had shown to be emitted from the surface of leaves immersed in water consisted chiefly of that gas. Ingenhousz demonstrated that the action of light was essential to the development of these phenomena, and Sennebier proved that the oxygen evolved resulted from the decomposition of the carbonic acid taken up."

Following up these results, de Saussure demonstrated with as much quantitative accuracy as was then possible that the oxygen which was split off by the leaf was contained in the carbonic acid, and that the gain in weight of the plant was practically represented by its carbon; combined with the elements of water to make up such carbo-hydrates as sugar and starch. De Saussure further arrived at very clear ideas as to the source and value of the ash constituents of plants: the nitrogen, which he also pointed out as an invariable constituent of plants, he considered to be either derived from the ammonia in the atmosphere or the organic matters in the soil. Sir Humphrey Davy, in his lectures before the Board of Agriculture from 1802 to 1813, practically adopted de Saussure's views, and emphasised the importance of the ash constituents, which could come neither from the air nor water, as he yet thought it necessary to demonstrate.

Though Davy made no advances towards ascertaining the relative importance of these substances, and was by no means certain that the plant derived all its carbon from the atmosphere, his lectures did



much to pave the way for the adoption of a sound theory.

Thaer, about the same period, was still attributing the chief share in the nutrition of the plant to the organic juices, or, as we should say, to the humus in the soil, which substance he showed to contain hydrogen, nitrogen, sulphur, and phosphorus. Though knowledge of the composition of plants, soils, and manures continued to accumulate, as seen in the work of Sprengel and Schubler, the next step forward was due to Boussingault, who was the first man to undertake field experiments on a practical scale. Farming his own land at Bechelbronne, Alsace, from 1834 onwards, he systematically weighed crops and manure and analysed both so as to obtain a balance-sheet showing the quantities of carbon and nitrogen added in manure and removed in the crops. He thus in 1838 demonstrated on a working scale the enormous amounts of carbon which are assimilated by the plant from the atmosphere—far greater quantities than the humus in the soil could continue to supply. Boussingault's experiments led him to conclude that the plant derives its nitrogen from the soil, though he also showed that in certain rotations more nitrogen is removed in the crop than is supplied in the manure.

But it is to the great Liebig that we must attribute the chief impulse which agricultural chemistry has received; though he made little original contribution himself to the theory, adopting in the main the conclusions that arose from the work of Priestley, Ingenhousz, Senneber, and de Saussure, he was the man who drove home to the minds, both of scientific men and of farmers, the true theory of plant nutrition.

In his report to the British Association, published in 1840, and his *Chemical Letters*, he laid down the general principle that the carbon compounds, which

constitute more than 95 per cent. of the dry matter of the plant, are derived by the plant from the atmosphere, and that if the plant be supplied with the 2 per cent. or so of mineral constituents which are found in its ash, it will then draw upon the atmosphere for all the other materials the crop ultimately contains.

Coming at a time when much intellectual interest was directed towards agriculture, and backed by his great scientific reputation and his commanding personality, Liebig's views aroused instant and general attention; they became the foundation both of practical experiment and scientific research, and were the starting-point of a controversy the echoes of which are but now dying down. In several respects Liebig's views required modification; he seemed to consider all the ash constituents were of equal importance, and even that one base like soda could replace any similar one like potash; he regarded the composition of the plant's ash as determining its proper fertiliser—a point which will be considered later; and he misapprehended the part played by nitrogen compounds in manuring. At that time, owing to imperfections in the methods of analysis, very exaggerated ideas were current as to the amount of ammonia naturally present in the atmosphere: the rain was believed to bring down 30 or 40 lb. per acre per annum of combined nitrogen instead of the 3 or 4 lb., which we now know to be contributed to the soil, and to this source Liebig was disposed to look for the nitrogen in the plant. He stated that manures containing nitrogen certainly stimulated growth, because they fermented and increased the proportion of ammonia in the air round the plant; but in the main nitrogenous manures were unnecessary, for full crops could be grown if only the constituents removed in the ash were annually returned to the soil.

In particular, these views on the nutrition of plants and the part played by the nitrogenous manures, did not commend themselves to John Bennet Lawes, a young Hertfordshire landlord who had recently come into possession of the family estate of Rothamsted, near St Albans, and had already begun to try manurial experiments on a small scale. In 1843 the experiments took more systematic form and Lawes obtained the services of Joseph Henry Gilbert, a chemist who had worked under Liebig at Giessen, to conduct them, thus inaugurating the field trials which have continued without a break to the present day. The immediate result of the Rothamsted experiments was to demonstrate the necessity of a supply of combined nitrogen, the yield being in fact roughly proportional to the amount of combined nitrogen added as manure. If only the mineral constituents of the ash were supplied, the crop fell away rapidly as soon as the reserves of active nitrogen in the soil had become exhausted. Lawes, Gilbert, and Pugh further repeated, with great exactitude, a series of laboratory experiments initiated by Boussingault, and demonstrated that the ordinary plants of the farm were incapable of utilising the free nitrogen of the atmosphere, but only took up nitrogen in a combined form from the soil or the manure. Lawes and Gilbert were fiercely attacked by Liebig; but as far as his views can be extracted from his writings, there was no very great difference between the opinions held by the rival parties. Liebig laid the chief stress on the need for the mineral manures, whereas the latter investigators were more concerned to demonstrate the importance of nitrogen. Liebig also seems to have thought that the leafy crops, like clover or roots—the so-called restorative crops—could gather nitrogen from the atmosphere and dispense with any supply in

manure. But in addition to establishing the value of nitrogenous manures, the Rothamsted experiments also settled in a practical fashion the question of which of the ash constituents were indispensable to the plant and were necessary constituents of a complete manure. The fundamental necessity of phosphoric acid and potash, and the non-essential nature of soda, magnesia, and silica as manure constituents were soon established, and the experiments began at once to bear fruit in the way the various artificial manures, then being discovered and put on the market, were utilised by farmers. Contemporaneously the methods of pot cultures in weak solutions of known salts were evolved, and in the hands of Boussingault, Knop, Stohmann, and others, demonstrated with all the precision of a laboratory process that of the elements found in the plant, only compounds of nitrogen, phosphoric and sulphuric acids among acids, and potash and lime with a trace of iron among bases, are absolutely essential to the nutrition of the plant.

There was, however, still one point which remained somewhat unintelligible—the gain in combined nitrogen which seemed to take place when certain crops of the leguminous order were grown. Cases were recorded where more nitrogen was found in the crop than was supplied in the manure, and yet the soil on which the crop had been grown itself showed an increase of nitrogen.

Boussingault, in his earliest investigations, had shown that in certain rotations which included clover or lucerne more nitrogen was removed in the crop than had been supplied in the manure, and many of the Rothamsted results could only be explained on the assumption that the roots of such crops ranged exceptionally deep and drew upon stores of subsoil nitrogen unavailable for other

plants, thus leaving the upper soil the richer for their growth, since the roots and stubble, in which this subsoil nitrogen has been accumulated, decay near the surface. It was not until 1886 that these difficulties were cleared up by the discovery of Hellriegel and Wilfarth that leguminous plants do fix the atmospheric nitrogen by the help of certain bacteria living in symbiosis upon the root of the leguminous plant. The leguminous plant, however, will also feed upon combined nitrogen in the soil like any other plant, and the failure of Lawes and Gilbert to detect any nitrogen fixation in their laboratory experiments with beans and clover, was due to the great care to shut out any intrusion of foreign matter during the experiments, thus preventing the leguminous plants from becoming inoculated with the bacteria causing fixation. In a measure, the discovery of Hellriegel and Wilfarth, which has formed the starting-point of much further research, may be taken to have justified some of Liebig's arguments, although the mechanism by which the nitrogen fixation is brought about—by bacteria living in concert with the higher plant—would have been entirely foreign to his way of looking at things, just as it was to Lawes and Gilbert, who thus unhappily missed the clue which would have rendered intelligible many of their results.

It has been already indicated how impossible it is to recover the date of the original discovery of the fertilising value of the substances we now call artificial manures; only by an occasional allusion in the older books can we find that particular materials were in common use at the period of the writer. Blithe's *English Improver*, published in 1653, mentions the value of rags, wool, marrow bones or fish bones, horn shavings, soot, and wood ashes; and Evelyn, writing a few years later, adds also blood, hair, feathers, hoofs,

skin, fish, malt dust, and meal of decayed corn, so that a knowledge of the value of these materials must have been widespread.

William Ellis, a Hertfordshire farmer who wrote in 1732, enumerates a long list of "hand manures," the use of which he regarded as characteristic of Hertfordshire farming in his day. These include soot, wood ashes, woollen rags, horn shavings, hoofs, hair, coney clippings, oil cake, and malt dust; and the regular part they evidently played in the farming of that district show that they must have been known and used for a long time previous to Ellis's writings. Throughout the eighteenth century we hear of the same materials, and also of bones, which Ellis does not mention, though their value is stated by several of the seventeenth century writers. Early in the nineteenth century we begin to hear of guano from Peru, though the first importation did not take place until 1840.

The importation of nitrate of soda from Chile had begun a year or two before; its value as manure was for a time in doubt, though as early as 1669 Sir Kenelm Digby had recounted an experiment to show how much barley plants were benefited by watering with a weak solution of nitre, and Evelyn in 1675 had written: "I firmly believe that were saltpetre to be obtained in plenty, we should need but few other composts to meliorate our ground."

The employment of ammoniacal salts seems to have begun entirely upon theoretical grounds; de Saussure had attributed the nitrogen of vegetation to the ammonia in the atmosphere, and in this he was followed by Liebig; fortunately, about the same time, the manufacture of coal-gas gave to the world a cheap source of ammonium salts. Lawes had already been trying them before Liebig's paper of 1840, and when

the Rothamsted experiments were definitely started in 1843, a mixture of muriate and sulphate of ammonia became their standard nitrogenous manure.

The use of mineral phosphates as manure begins with Lawes' superphosphate patents in 1842, although no mineral phosphates were available on a large scale until Henslow's discovery of the coprolite beds of Cambridgeshire in 1845, soon after which time Lawes and others took them up as material for the manufacture of superphosphates. Putting aside the various methods adopted for the utilisation of slaughter-house refuse, etc., no further novel manurial substances can be said to have been introduced until the development of the Stassfurt potash deposits, which began about 1860, and the discovery of basic slag in 1879, which has been followed in the last few years by various processes for bringing atmospheric nitrogen into a combined form.

Since the nutrition of the plant is the object with which all manures are employed, it will be necessary at the outset to obtain some knowledge of how a plant feeds under the simplest possible conditions without any of the disturbing effects introduced by the many complex processes going on in the soil.

If we take any living plant and reduce it to its elements, we find but a small range of substances; water forms the greatest portion of the plant, the rest is almost wholly composed of compounds of carbon with hydrogen and oxygen, approximately in the proportions which make up water. Of the dry matter of the plant at least half is carbon; oxygen and hydrogen constitute most of the remainder; then a certain restricted number of other elements are present in much smaller quantities. Nitrogen constitutes about 2 per cent. of the dry matter; the other substances, which are found in the ash when the plant is burnt, make up a

further 2 per cent. or so. These ash constituents comprise sulphur, phosphorus, silicon, and chlorine, among the non-metals; potassium, sodium, calcium, magnesium, and a little iron and manganese, among the metals. Traces of other metals occur from time to time in the ashes of plants growing on soils which happen to contain them, but they are unessential and may in this connection be neglected.

Carbon, then, is the main element in the plant's economy, and we know that it is obtained by the plant from the carbonic acid in the atmosphere through the agency of the living cells in the leaf, which contain green chlorophyll. The carbonic acid is taken in through the small openings in the skin of the leaf, the stomata; it is decomposed by the chlorophyll-containing cells, and the carbon is retained in combination with the elements of water, so that it is first identifiable as sugar and then as starch; at the same time oxygen is returned to the atmosphere. This decomposition is one that necessitates an external supply of energy, which is found to be derived from the light incident upon the leaf, the process stopping in darkness, and for low illuminations becoming proportional to the amount of light falling upon the leaf.

The conditions affecting this process of photosynthesis—the fundamental reaction of the whole plant-world—have been subjected to considerable examination of late. In the method adopted by H. T. Brown, the leaf, which may still be attached to the plant, is enclosed in a flat air-tight box with glass sides, through which sweeps a rapid but measured current of air. The issuing air which has passed over the leaf is led into an apparatus for the determination of the carbonic acid (and, if need be, of the water) it contains; at the same time a parallel experiment without the leaf



measures the proportion of carbonic acid and water in the incoming air. Thus the amount of carbonic acid absorbed, and therefore decomposed, in a given time by a leaf, whose area can be afterwards measured, is directly determined, and such factors as illumination and temperature can be varied at will. The energetics of the process have been worked out by Brown and Escombe, from whose paper the following examples have been selected:—

TABLE I.—UTILISATION OF THE ENERGY INCIDENT ON A GREEN LEAF. (BROWN AND ESCOMBE.)

Plant.	CO <sub>2</sub> absorbed per sq. dm. of Leaf, per hour.	Water transpired per sq. dm. of Leaf, per hour.	Energy in Calories per sq. cm. of Leaf, per minute.				
			Solar radiation falling on Leaf.	Solar radiation absorbed by Leaf.	Energy required for assimilation.	Energy required for transpiration.	Energy lost by radiation and convection.
Polygonum (June 19)	c.c. 3·758	grms. 1·054	0·1942	0·1256	0·0031	0·1041	0·0184
Tropæolum (September 4)	1·498	0·141	0·0889	0·0622	0·0012	0·0139	0·0471
Helianthus (August 7)	2·134	1·259	0·2569	0·1762	0·0017	0·1243	0·0502

These experiments show that the leaf of a plant is not to be regarded as a very efficient machine for the decomposition of carbonic acid, since in no case was more than 1·66 per cent. of the total energy incident on the leaf used for photo-synthesis, so that even dull, diffuse daylight can amply provide a growing plant with the energy it wants for assimilation. The process, however, is limited by many factors, any one of which may fix a minimum rate at which assimilation will take

place, however favourable the other conditions are. Temperature, the supply of water, the proportion of carbonic acid in the air, the number and area of the stomatic openings, are all limiting factors of this kind, as also is the supply of other nutriment to the plant.

Though the compounds of carbon with hydrogen and oxygen make up so much of the solid matter of the plant, the remaining substances, comparatively small in amount as they are, are still all-important to the process of growth. The part they respectively play and their mode of entry can best be illustrated by the method of water cultures, of which Fig. 1 shows an example. By this method the roots of young seedling plants are just allowed to dip into a large jar of water in which salts of the elements found in the plant are dissolved. A complete solution might be made up as follows:—

	Grammes per litre.
Calcium Nitrate . . . . .	0·7
Potassium Phosphate. . . . .	0·6
Potassium Chloride . . . . .	0·8
Magnesium Sulphate . . . . .	0·3

with a trace of ferric chloride.

This will contain all the elements, except silicon, normally found in plant ashes, and under such conditions the plant will grow and go through its whole cycle of life, assimilating freely, producing large quantities of dry matter, setting flowers, and ripening healthy seed. Certain precautions have to be taken, but if the right conditions are assured, the growth of a plant in a water culture is perfectly normal, and may be taken, as far as the plant is concerned, as representing the course of its nutrition in the field. The advantage of the method lies in the fact that it is possible to vary the composition of the nutrient solution by omitting in turn from successive jars each of the salts used in



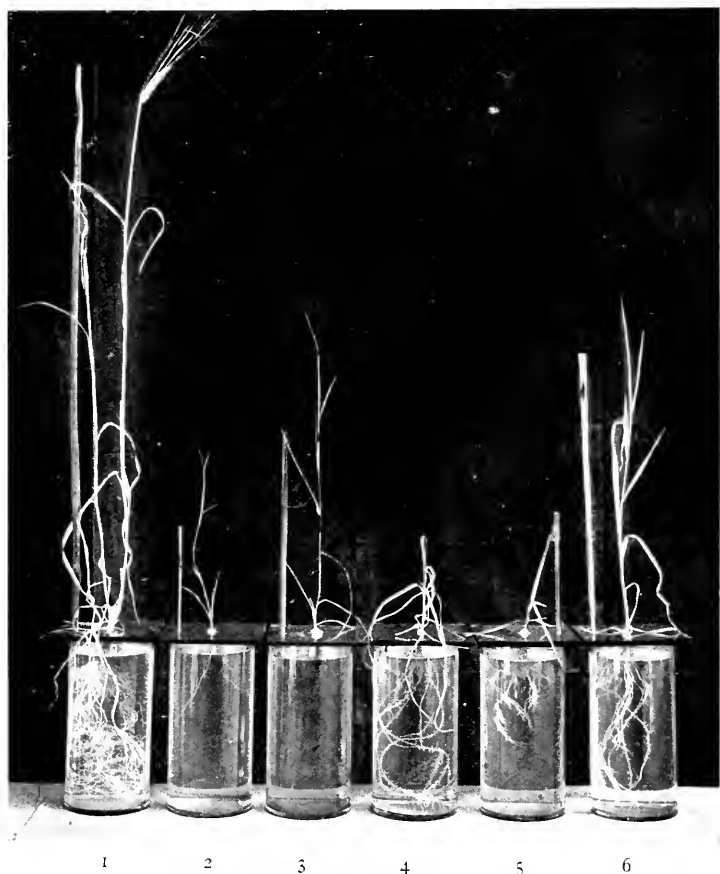

FIG. 1.—WATER CULTURES OF BARLEY.

- |                        |                 |
|------------------------|-----------------|
| 1. Complete Manure.    | 4. No Potash.   |
| 2. No Nitrogen.        | 5. No Lime.     |
| 3. No Phosphoric Acid. | 6. No Magnesia. |

making up the complete solution, thus obtaining media for the plant containing no nitrogen, no phosphorus, no potassium, etc., the other constituents found in the plant being present in each case. The result of one such series of experiments is shown in Fig. 1, which illustrates that when, *e.g.*, nitrates are omitted from the culture solution, the plant is quite unable to grow after it has used up the material in the seed, however freely it may have been provided with potassium, magnesium, etc. The net result of such experiments, in agreement with the one shown in the photograph, is that a plant must obtain by means of its root nitrogen in combination, phosphorus, sulphur, potassium, magnesium, calcium, and a little iron—all of which constituents are indispensable to the growth of the plant and cannot be omitted from the culture solutions. Sodium, silicon, and probably chlorine, though invariable constituents of the ash, are not necessary and can be dispensed with. From these water culture experiments we arrive, then, at the conclusion that the plant must draw certain elements, in quantities which are small compared with the weight of the crop but are nevertheless indispensable, out of the soil by means of its roots, the rest of the plant being built up from air and water. These water culture experiments may also be made to lead to another conclusion, which we first of all owe to de Saussure—that the nutrient substances must first of all be dissolved or capable of going into solution before they can feed the plant. The growing plant contains 80 per cent. or more of water, but this amount bears but a small proportion to the total quantity of water which passes through the plant during the whole period of growth. There exists, in fact, a continual “transpiration current” through

the plant, of water which enters by the root hairs and is eventually evaporated from the leaves and other growing surfaces of the plant. It has been shown that under the normal conditions the plant transpires from 200 to 500 pounds of water for every pound of dry matter that is simultaneously produced; the lower number being nearer the factor prevailing in our humid atmosphere, and the higher one holding for drier countries. With this water enter the nutrient constituents of the soil and of fertilisers applied to it; but the process by which they enter is rather more complex than one of the simple intake of a solution.

The passage of the dissolved substances into the plant takes place by the purely physical process of osmosis, the walls of the root hairs (which consist of single elongated cells) acting as membranes through which water or salts will pass independently, according to the relative concentration of the solutions inside or outside the cell. Should the cell sap be more concentrated than the soil water outside, pure water will pass through the wall until a certain osmotic pressure (causing turgor in the plant) is reached, which varies with the concentration. If, on the contrary, the soil water became more concentrated than the cell sap, water will leave the cell, the plant will become flaccid, and even die if the withdrawal of water be too great. It is in this way that plants become "scorched" or "burnt" by too concentrated solutions of any kind of soluble salts, such as are formed when a little soluble manure, salt, etc., falls upon the surface of a leaf.

Not only will water pass in or out of the cell, but an equilibrium will be attained between the cell sap and the external soil water for each constituent present in the latter. If, for example, sodium or potassium chlorides

be present in solution in the external soil water, both will continue to diffuse through the cell wall until their respective concentrations are the same within and without the cell. If now the potassium compounds be withdrawn from the solution within the cell by the living protoplasm in order to take part in the various vital processes requiring potassium, there will be a fresh influx of potassium until the old equilibrium within and without is restored. It is in this way that the apparent selective action of a plant takes place; as a rule, sodium compounds are more abundant in soil water than salts of potassium, yet the ash of the plant will be found much richer in potassium than in sodium. Similarly, again, the ash of any particular plant will maintain a fairly constant composition although grown on soils of widely differing character. The selective power resides in the living cells themselves; all substances dissolved in the soil water diffuse through the walls of the root hairs into the plant, but will not continue to accumulate therein unless they are utilised and withdrawn from solution by the protoplasm.

Further, it is not necessary to consider that the plant takes up the various salts presented to it as wholes; the process of diffusion until equilibrium is attained, of withdrawal by the protoplasm and consequent renewal of the process of diffusion, takes place for each acid or base independently of the others. As a rule, a plant growing in a nutrient medium containing nitrates as sources of nitrogen, will withdraw an excess of acid and render the solution alkaline, but cases also occur when the medium becomes acid during growth because the plant takes more base than acid. According to modern views of solution, we must regard the soil water as a highly

ionised solution, and each particular kind of ion establishes its own conditions of equilibrium within and without the cell.

The soil, however, is not to be regarded merely as an inert medium to anchor the plant and convey the manure to it when convenient, but is itself an enormous potential reserve of plant food.

We may take, by way of an example, the Rothamsted soil. On the one hand, it is neither richer nor poorer than the majority of British soils and has no abnormal characteristics, so that it represents a very fair average type; on the other hand, there is no other soil about which so much knowledge has been accumulated.

TABLE II.—ANALYSIS OF THE SOIL OF BROADBALK FIELD,  
ROTHAMSTED, UNMANURED FOR 50 YEARS.

	Per cent.		Lb. per Acre.
Loss on ignition . . . . .	4.20	...	...
Containing Carbon . . . . .	...	0.89	22,250
"  Nitrogen . . . . .	...	0.10	2,500
Matter soluble in Hydrochloric Acid . . . . .	12.53	...	...
Containing Soda . . . . .	...	0.06	1,500
"  Potash . . . . .	...	0.27	6,750
"  Magnesia . . . . .	...	0.36	9,000
"  Lime . . . . .	...	2.49	62,250
"  Alumina . . . . .	...	4.49	112,250
"  Oxide of Iron . . . . .	...	3.40	85,000
"  Phosphoric Acid . . . . .	...	0.11	2,750
"  Sulphuric Acid . . . . .	...	0.05	1,250
"  Carbonic Acid . . . . .	...	1.30	32,500
Undissolved Siliceous Matter . . . . .	83.27	...	...

The accompanying analysis shows, as usual, that the greater part of the soil consists of insoluble siliceous matter, of which no account need be taken; there is, further, a certain amount of organic material, important as containing a store of nitrogen which may



eventually reach the plant. In addition, we have various salts going into solution in the acids used for the analytical process, and these include precisely the substances that have already been indicated as constituents of the ash of plants—amongst metals, calcium, magnesium, potassium, sodium, with iron and aluminium in quite disproportionate amounts; sulphuric and phosphoric acids, chlorine and silica supply the non-metals. Read as percentages some of these amounts seem small enough, but they represent enormous quantities of material in the soil, as will be realised when they are correlated with the fact that the layer of soil at Rothamsted, nine inches deep, which is taken for analysis, weighs, over the area of one acre, rather more than two and a half million pounds. Translating, then, the percentages into pounds per acre, 0.1 per cent. of nitrogen becomes 2500 lb., 0.11 of phosphoric acid becomes 2750 lb., and the potash rises to 6750 lb.; also, these quantities are in the surface soil only, without considering the lower layers into which the plant roots penetrate freely. A comparison of the materials in the soil with those taken away by ordinary crops at once leads to results which seem paradoxical; the stock of plant food in the soil is so much greater than any requirements of the crop that further additions of the same stuff in the shape of fertilisers would seem to be needless. The accompanying table (III.) shows the amounts of various materials per acre which are on the average drawn from the soil by various crops at Rothamsted.

Roughly speaking, an average soil contains enough plant food for a hundred full crops, yet without fresh additions of plant food as manures the production will shrink in a very few years to one-third or one-fourth of the average full crop. Once, however, the yield has

reached this lower level, it will remain for an indefinite period comparatively stationary, affected only by the fluctuations due to season. At Rothamsted, for example, wheat has now been grown year after year on the same land for sixty-five seasons, and one plot has received no manure throughout the whole period. In the first

TABLE III.—SOIL CONSTITUENTS CONTAINED IN AVERAGE CROPS.

	Wheat.	Barley.	Swedes.	Mangolds.	Hay.
Crop . . .	Tons. 2·2	Tons. 2·0	Tons. 16·1	Tons. 30·1	Tons. 1·5
	Lb.	Lb.	Lb.	Lb.	Lb.
Nitrogen . . .	50	49	98	149	49
Soda . . .	2·6	5·0	32·0	118·7	9·2
Potash . . .	28·8	35·7	79·7	300·7	50·9
Magnesia . . .	7·1	6·9	9·2	42·5	14·4
Lime . . .	9·2	9·2	42·4	42·9	32·1
Phosphoric Acid	21·1	20·7	21·7	52·9	12·3
Sulphur . . .	7·8	6·1	17·8	14·0	5·7
Chlorine . . .	2·5	4·1	15·1	83·1	14·6
Silica . . .	96·9	68·6	6·7	17·9	56·9

few years the crop declined steadily, but since then little or no further drop has been seen. The yield remains at about  $12\frac{1}{2}$  bushels per acre for each successive ten years' average, and has considerably overtopped that amount during recent favourable seasons. This yield, however, of  $12\frac{1}{2}$  bushels of corn per acre, is only about a third of that obtained on the adjacent plots receiving manure every year during the same period.

These facts lead to a new point of view: it is not merely the amount of this or that plant food present in the soil which must be taken into account but also their mode of combination. The material may be present in the soil and soluble in the acid used for analysis, but yet may be beyond the reach of the plant

in a locked-up or dormant condition. The plant can only obtain substances which have been previously dissolved in the water contained by soils in the field, hence plant food in the soil is only available for the plant in so far as it can pass into solution.

Accepting, then, the fact that the soil contains a vast store of all the elements necessary to its nutrition but in forms of low availability, it remains to ascertain which of the substances are normally likely to fall below the current requirements of the crop. This is a question that can only be solved by field experiments, and though the answer will vary with each crop and each soil yet certain general principles at once become evident and upon them the whole idea of a fertiliser is based. For example, field experiments at once show that certain elements indispensable to the plant, as seen from water culture experiments, need not be supplied to the crop in the field, since the soil is practically always able to provide a sufficiency. Calcium, magnesium, iron, sulphur, chlorine, and silicon fall into this class; to judge by field experiments alone there are only three elements required for the nutrition of the crop—nitrogen, phosphorus, and potassium—and this means that soils can usually supply the elements necessary to the plant in sufficient quantities, except in these three cases. Fertilisers, then, are designed to supply deficiencies in the soil, and for all practical purposes are to be regarded as consisting of compounds of nitrogen, phosphoric acid, and potash, either singly or together. They may also contain magnesia, lime, or sulphuric acid, but these, though equally necessary to the plant, are not counted, since the unaided soil may be trusted to furnish the crop with them.

To summarise the position we have reached: a fertiliser must contain one or more of the three sub-

stances, nitrogen, phosphoric acid, and potash, which alone among the various elements necessary to the nutrition of the plant cannot be supplied by cultivated soils in amounts sufficient for profitable crop production. The soils do contain these substances in comparatively enormous quantities, but the distinguishing feature of a fertiliser which makes it effective when supplied in quantities comparable with those removed by the crop, is its "availability."

A distinction is often drawn between natural and artificial manures; properly speaking, the latter should include only such materials as are the results of some manufacturing process, *e.g.*, sulphate of ammonia, superphosphate and basic slag. But practically speaking, any concentrated fertiliser that is brought on to the farm in bags, though its origin be as natural as the sea birds' excrement constituting "guano," or the ground seeds known as "rape dust," gets called an artificial manure, in contradistinction to the farmyard manure which is the normal product of the farm. In all the published reports dealing with the Rothamsted experiments it has been customary to distinguish such substances as are found in the ash of a plant—the phosphates, the sulphates, and chlorides of the alkalis or alkaline earths—as "mineral manures"; the compounds containing nitrogen are regarded as distinct, since they are ultimately of organic origin, even when they consist of such obviously mineral substances as nitrate of soda or chloride of ammonia. The term "cinereals" has also been proposed in place of mineral manures or ash constituents; none of the terms are satisfactory, but since attempts at corrected terminology only result in increased confusion, the term "mineral manures," however imperfect, will continue to be used throughout this book for fertilising substances containing no nitrogen.

## CHAPTER II

### FERTILISERS CONTAINING NITROGEN

The Importance of Nitrogen—Evidence that Plants cannot utilise the Free Nitrogen of the Atmosphere—Ammonia and Nitric Acid in the Atmosphere—Origin of the World's Stock of Combined Nitrogen—Nitrogen-fixing Bacteria—Fixation of Atmospheric Nitrogen to form Calcium Cyanamide—Fixation of Atmospheric Nitrogen in the Electric Arc ; Manufacture of Nitrate of Lime—Nitrate of Soda : Nature and Origin—Properties of Nitrate of Soda : Use as a Fertiliser—Value of the Soda Base—Injurious Effects of Nitrate of Soda upon the Texture of the Soil—Sulphate of Ammonia : Sources and Production—Changes undergone by Sulphate of Ammonia in the Soil—Acidity of Soil induced by Sulphate of Ammonia—Relative Value of Nitrate of Soda and Sulphate of Ammonia—Other Nitrogenous Fertilisers : Soot, Shoddy, Fur and Feather Waste, Hoofs and Horns—Slow Action of such Manures—Seaweed.

AMONGST the elements of the nutrition of the plant the first place must be given to nitrogen ; not only does it cost more per pound to the farmer than do the other necessary elements, but as a fertiliser applied to ordinary soils it seems to have a more direct and immediate effect upon the plant ; furthermore, it differs from the others in that plants live habitually in contact with a vast unusable store of it. Since plants live in an atmosphere four-fifths of which consists of elementary nitrogen, it is perhaps necessary to justify a little the

statement made in the previous chapter, that they only obtain the nitrogen they require in a combined form by means of their roots. The form that the demonstration has taken may be seen in the water culture experiment which has already been illustrated; in the absence of combined nitrogen, the development of the plant is very small. The same is true for cultures in sand, which reproduce more closely the natural conditions, and many experiments have been performed with the greatest care with plants thus growing in artificial soils supplied with a known amount of nitrogen. When the plants have come to the full term of their growth, the nitrogen they contain is found to be exactly balanced by the amount of the same element which has been removed from the soil. Among these experiments, a most elaborate series were carried out at Rothamsted in 1857-58, and were generally regarded as definitely settling the question against the fixation of nitrogen by the plant itself.

The experiments were made with wheat, barley, oats, clover, beans, peas, and buckwheat, and the trials were repeated, in the one case with no manure in the pots, and in the other with the supply of a small quantity of sulphate of ammonia. The soils employed were made up from either ignited pumice or ignited soil, and the glass shades under which the plants were grown rested in the groove of a stoneware vessel, mercury being used as a lute. The air, previously passed through sulphuric acid and sodium carbonate solution and washed, was forced into the apparatus, so as to always maintain a greater pressure inside than out, thus minimising all danger of unwashed air leaking in; carbonic acid was also introduced as required. Under these rigorous conditions the following results were obtained:—

TABLE IV. — SUMMARY OF THE RESULTS OF EXPERIMENTS MADE AT ROTHAMSTED TO DETERMINE WHETHER PLANTS ASSIMILATE FREE NITROGEN.

			Nitrogen.—Gram.			Ratio of Nitrogen recovered to Nitrogen supplied.
			In Seed and Manure if any.	In Plants, Pot, and Soil.	Gain or Loss.	
WITH NO COMBINED NITROGEN SUPPLIED BEYOND THAT IN THE SEED SOWN.						
Gramineæ .	1857 {	Wheat .	0.0080	0.0072	- 0.0008	0.90
		Barley .	0.0056	0.0072	+ 0.0016	1.29
		Barley .	0.0056	0.0082	+ 0.0026	1.46
	1858 {	Wheat .	0.0078	0.0081	+ 0.0003	1.04
		Barley .	0.0057	0.0058	+ 0.0001	1.02
		Oats .	0.0063	0.0056	- 0.0007	0.89
	1858 {	Wheat .	0.0078	0.0078	...	1.00
		Oats .	0.0064	0.0063	- 0.0001	0.98
	Leguminosæ {	1857 {	Beans .	0.0796	0.0791	- 0.0005
1858 {		Beans .	0.0750	0.0757	+ 0.0007	1.01
		Peas .	0.0188	0.0167	- 0.0021	0.89
Other Plants .	1858	Buckwheat	0.0200	0.0182	- 0.0018	0.91
WITH COMBINED NITROGEN SUPPLIED.						
Gramineæ .	1857 {	Wheat .	0.0329	0.0383	+ 0.0054	1.16
		Wheat .	0.0329	0.0331	+ 0.0002	1.01
		Barley .	0.0326	0.0328	+ 0.0002	1.01
		Barley .	0.0268	0.0337	+ 0.0069	1.25
	1858 {	Wheat .	0.0548	0.0536	- 0.0012	0.98
		Barley .	0.0496	0.0404	- 0.0092	0.81
		Oats .	0.0312	0.0216	- 0.0096	0.69
	1858 {	Wheat .	0.0268	0.0274	+ 0.0006	1.02
		Barley .	0.0257	0.0242	- 0.0015	0.94
Oats .		0.0260	0.0198	- 0.0062	0.76	
Leguminosæ {	1858 {	Peas .	0.0227	0.0211	- 0.0016	0.93
		Clover .	0.0712	0.0665	- 0.0047	0.93
	1858	Beans .	0.0711	0.0655	- 0.0056	0.92
Other Plants .	1858	Buckwheat	0.0308	0.0292	- 0.0016	0.95

And if objection be made that such plants were enfeebled by the unnatural conditions, so that they had lost their power to bring nitrogen into combination—to “fix” it, in current language—there are many other types of experiment which render such criticism invalid. For example, Hellriegel performed a long series of experiments with different plants, which

TABLE V.—BARLEY (HELLRIEGEL AND WILFARTH).

Nitrogen Supplied.	Dry Matter Produced.
0	0.51
0.028	3.0
0.056	5.6
0.112	10.8
0.336	29.3

showed, up to a point, that the amount of growth was very closely proportional to the amount of nitrogen supplied in a combined form, when there was a sufficiency of the other elements of plant food present. This would not be the case were the plant able to get any nitrogen for itself from the atmosphere. Again, to meet an early objection of Liebig and his followers that the Rothamsted crops, which seemed unable to draw upon the nitrogen of the air though freely supplied with phosphoric acid and potash, failed to do so because they had not got the necessary initial development of leaf, to one plot there was supplied a very small amount of active nitrogenous manure, just to give the young plant a good start, whereupon it might be able to continue to feed upon the atmospheric nitrogen. But, as Table VI. shows, the small addition of nitrogen only produced a small increase of crop, very fairly proportional to the much larger increase produced by a normal application of the same fertiliser. If, then, the yield of



most of our field crops is, until some other limiting factor comes into play, proportional to the amount of combined nitrogen they receive, it is necessary to conclude that they have drawn none from the atmosphere. It is indeed true that the atmosphere does contribute a small amount of nitrogen for the use of the plant under ordinary conditions, because traces of both ammonia

TABLE VI.—ROTHAMSTED MANGOLDS (1876-1902).

	Roots per Acre.	Increase per lb. of N.
	Tons.	Tons.
Superphosphate and Sulphate of Potash . . . . .	4.55	...
Do. do. + 7.8 lb. N. . . . .	5.93	0.17
Do. do. + 86 " . . . . .	14.03	0.11
Do. do. + 93.8 " . . . . .	14.60	0.107

and nitric acid are found in the air and are washed out by the falling rain. Table VII. shows the average amount of nitrogen as nitric acid and ammonia brought down in the rain falling at Rothamsted for the thirteen years between 1st September 1888 and 30th August 1901, together with the corresponding results obtained at a few other places where observations have been made for any long period. It will be seen that the Rothamsted results are considerably lower than those obtained at the Paris, Copenhagen, or Florence stations, though they do not notably differ, as regards the total amount of nitrogen falling per acre, from those obtained at the two tropical stations in the West Indies. The high results are probably due to the proximity of towns, because the majority of other determinations, not quoted here because they have only been continued for one or two years, agree more nearly with the Rothamsted figures. It may thus be assumed that ordinary

land receives about 4 to 5 lb. per acre per annum of combined nitrogen from the atmosphere, an amount which only forms a small fraction of the requirements of the crop:—

TABLE VII.—NITROGEN AS AMMONIA AND NITRIC ACID IN RAIN.

Locality.	Date.	Rain-fall.	NITROGEN.				
			Per Million.		Per Acre per annum.		
			As Ammonia.	As Nitric Acid.	As Ammonia.	As Nitric Acid.	Total.
Rothamsted .	1888-1901	27.25	0.440	0.183	2.71	1.13	3.84
Copenhagen .	1880-1885	21.95	1.97	0.473	9.27	2.21	11.48
Montsouris .	1876-1900	21.52	2.13	0.66	10.37	3.22	13.59
Florence .	1869-1875	38.31	1.004	0.57	8.70	3.09	11.79
Barbados .	1885-1897	63.95	0.084	0.268	1.22	3.88	5.10
British Guiana	1890-1900	102.41	0.055	0.078	1.17	1.82	2.99

The tenacity with which in the face of such evidence the opinion has been held that the leaf of the plant can obtain nitrogen as well as carbon from the atmosphere, is due to the difficulty of explaining how the world's original stock of combined nitrogen can have arisen. Assuming the world to have cooled down from the state of incandescent gas, it must have started with all its nitrogen in the free gaseous state; yet as we see it to-day, the whole stock of combined nitrogen is of organic origin.

The circulatory process through which combined nitrogen passes is very plain. Animals only use the highly organised compounds like the proteins; these they break down during their vital processes to simpler compounds like urea and the amides, which in turn are

taken by plants and built up once more into the protein complexes. The nitrogen, however, only circulates from one form of combination to another, with occasional losses when a compound is broken down as far as elementary nitrogen; there is never any bringing of fresh elementary nitrogen into the account. The stocks of combined nitrogen that have been handed down from past ages all speak of the same organic circulation, never of fixation. Coal is but the *débris* of an extinct vegetation; nitrate of soda represents the glorified result of the same decay processes which give rise to nitrate of potash in India and nitrate of lime in the old nitre beds. Virgin soils with their vast stores of nitrogenous humus are often looked upon as having gained nitrogen by the accumulation of long epochs of vegetable growth; but if plants cannot fix nitrogen there can have been no gain, however long the growth, but only a circulation of the pre-existing combined stock. At first sight there seem to exist no processes which can either bring about the original combination or renew the stock from time to time. Inorganic agencies are certainly trifling, because nitrogen is a difficult element to bring into combination, so great an initial expenditure of energy is required to separate the atoms in the gaseous molecule. Electric sparks will effect a combination of nitrogen and oxygen, and lightning flashes through the air have been invoked to account for the trace of nitric acid to be found in the atmosphere and in rain water. Again, it has been supposed that during the evaporation of water there is always a slight combination of nitrogen with the elements of water to form ammonium nitrite, but more recent and refined experiments are against the existence of any such reaction.

There has, however, of late years been discovered one vital process capable of fixing nitrogen, which has

probably been operative since the beginning of life on the earth, and this power is the property of certain groups of bacteria only. The history of nitrogen-fixing bacteria began some thirty years ago with the resolution by Hellriegel and Wilfarth of the great outstanding difficulty in the theory that plants only make use of combined nitrogen. Though the demonstration in the laboratory of this opinion seemed perfect, and though in the main it was corroborated by field experiments, there was one group of plants—peas, beans, clover, and their allies—which seemed to derive little or no benefit from nitrogenous fertilisers, and yet actually left the land richer in nitrogen after their growth, although in the crop removed there was an exceptional amount of nitrogen. That beans or vetches or lupins were the best preparation for a wheat crop was a commonplace of Roman agriculture, and the same observation became afterwards enshrined in that most fundamental of rotations, the Norfolk four-course system, in which wheat follows clover or beans. Hellriegel and Wilfarth found that leguminous plants did gather nitrogen from the atmosphere, and could, therefore, become wholly independent of nitrogenous manures; but this only took place when, by infection from the soil, certain characteristic nodules were formed upon the roots. These nodules were found to be colonies of a particular bacterium which seems to live symbiotically on the host plant, furnishing it with nitrogenous matter and deriving from it the carbohydrate required for the fixation of nitrogen. As the fixation of nitrogen is a chemical process analogous to going uphill, it requires a supply of energy from outside, which external source of energy the bacteria obtain by the oxidation of carbohydrate in some form or other. The particular bacterium living in symbiosis with the leguminous plants is highly

specialised and has not been transferred to other non-leguminous plants; only with some difficulty has it also been made to grow and to fix nitrogen when living alone and no longer in association with its host. But with increasing knowledge of the methods of handling this organism, it seems probable that by cultivation we shall be able to obtain races showing variations in their power of fixing nitrogen, though how long they will retain this greater or lesser virulence after inoculation back to the leguminous plant is still uncertain.

The leguminous plants form, then, by their association with nitrogen-fixing bacteria, one considerable natural source of combined nitrogen, and how effective they can be in accumulating fertilising matter in the soil may be judged from the accompanying table (VIII.) showing the results of one of the Rothamsted experiments upon crops grown in rotation.

TABLE VIII.—EFFECT OF CLOVER ON SUCCEEDING CROPS.

Manuring for Swede Crop only.	Clover, 1894.	Wheat, 1895.			Roots, 1896.			Barley, 1897.		
		After Fallow.	After Clover.	Increase due to Clover.	After Fallow.	After Clover.	Increase due to Clover.	After Fallow.	After Clover.	Increase due to Clover.
	Cwts.	Lb.	Lb.	Per cent.	Cwts.	Cwts.	Per cent.	Lb.	Lb.	Per cent.
Mineral manure	59.7	4,220	5,180	+22.7	179.1	244.5	+36.5	2,103	3,991	+89.8
Complete manure	76.7	4,547	5,209	+14.6	379.8	388.8	+2.4	3,595	4,913	+36.7

On this field (Agdell) the rotation begins with a crop of Swede turnips, which is manured, in one case with mineral manures, in the other with a complete fertiliser. Following the Swedes comes barley without manure, then the field is divided, and on one portion clover is grown, while the other is bare fallowed and carries no

crop throughout the year. A crop of wheat, still unmanured, completes the rotation. In the table the yield on the portions which have grown clover is compared with that on the portions without crop; it will be seen that although a crop of nearly three tons of clover hay has been taken away from the one portion, the wheat which follows it is 23 per cent. better than on the portion where no clover had been grown in the previous year. Nor is the benefit due to the clover exhausted by the wheat crop, for it is seen to persist in the root crop following the wheat and in the barley which comes a year later still.

The only practical limitation to the gathering of nitrogen by this method lies in the difficulty that is found in growing leguminous crops frequently on the same land. Although the Rothamsted experiments have demonstrated that it is possible to grow wheat year after year for more than half a century and maintain the yield if the appropriate manures are employed, on few soils can clover be grown with success more frequently than once in four and even once in seven years. As the farmer says, the land becomes "clover sick," and though the clover seed germinates and grows for a time, the constitution of the plant is so weak that it almost inevitably succumbs during the winter to an attack of fungoid or other disease. The determining cause of this weakness of constitution which lies at the back of "clover sickness" is still unknown, but preventing as it does the more extended use of these nitrogen-collecting crops it would be of real economic importance to find the cause and a remedy.

More recently, however, other bacteria have been discovered in the soil which are capable of fixing free atmospheric nitrogen without association with any

host plant, provided they are supplied with some carbohydrate, by the oxidation of which they derive the energy necessary to bring the nitrogen into combination. Of these bacteria the best known and probably the most effective is a large organism, discovered by Beijerinck in Holland, and called by him *Azotobacter chroococcum*. It is widely distributed in cultivated soils both in Europe and America, and although the author failed to detect it in the arid soils from the high veldt or the Karoo in South Africa similar though perhaps slightly varying bacteria were obtained from cultivated soils from tropical East Africa, Egypt, India, Russia, Western America and Canada, Sarawak, and Monte Video. It appears to be only active when there is some calcium carbonate in the soil, possibly because in its oxidising reaction certain acids are produced which must be neutralised before its activity will continue. Roughly speaking, its action is to oxidise carbohydrates to carbon dioxide and water, forming as bye-products certain organic acids, and some dark brown humus (whence the name "chroococcum"), and incidentally bringing a certain amount of nitrogen into combination, not more, however, under the most favourable laboratory conditions than 1 to 2 per cent. of the carbohydrate consumed. It is, however, extremely probable that we may look to this organism and its allies as the origin of the continued accumulation of nitrogen in such rich virgin soils as the black soils of the Russian Steppes or of Manitoba. As long as these lands were uncultivated, the annual fall of the leaf and dying down of the summer vegetation furnished the conditions necessary for the activity of the *Azotobacter*. The carbohydrate-containing material thus returned to the soil provided the organism with its necessary food supply, by the oxidation of which it gained energy to fix the atmospheric nitrogen. In

cultivated soils where the crop is removed the action is almost brought to a standstill, as may be seen in the steady loss of nitrogen from the arable soils at Rothamsted during the fifty years they have been cropped without any extraneous nitrogen supply. Only when land is laid down to grass is there a sufficient amount of carbohydrate *débris* returned to the soil to enable the *Azotobacter* to fix a measurable quantity of nitrogen. A good example of the natural accumulation of combined nitrogen may be seen in two pieces of land at Rothamsted, which for the last twenty-five years have been allowed to run wild and assume a natural prairie condition of self-sown weeds and grasses, that are never taken away but left to rot where they die down. Samples of the soil had been taken at the beginning of the period, and by comparing them with more recently taken samples it has been possible to detect a very considerable fixation of nitrogen, amounting in the most favourable case to nearly fifty pounds of nitrogen per acre per annum. The second similar piece of land shows a much lower result, and this is correlated with the lack of carbonate of lime in the soil of this plot and a corresponding absence of the *Azotobacter* organism.

It is too early yet to speculate freely on the work of the various nitrogen-fixing bacteria; we may, however, confidently attribute to their action both the current stock of combined nitrogen in the world and the main source of its renewal in the future.

Attempts have already been made to raise the nitrogen-fixing bacteria artificially, particularly those associated with leguminous plants, and by introducing them into soil that is lacking or poorly supplied with them, to render it capable of self-enrichment in this most natural manner. Such cultures are, in fact, sold



commercially at the present time and have in some cases been somewhat unscrupulously boomed as dispensing with the need for nitrogenous fertilisers. Undoubtedly cases may be quoted where the use of these pure cultures of nodule-forming bacteria has been of great service, generally on newly-reclaimed soils, which have thus become for the first time capable of carrying a leguminous crop. But in old cultivated soils the organism is already present, and sufficient evidence is not yet forthcoming to show that the new introductions have had any effect; certainly the results obtained in the British Isles are almost wholly negative. Doubtless the useful soil bacteria will be domesticated, improved, and made more effective, just as our flocks and herds have been tamed and developed, while the useless ones will be stamped out as vermin; but at the present time we cannot be satisfied that any improved race of bacteria introduced artificially into the soil has managed to persist and get a real footing in face of the competition of the enormous natural bacterial flora already existing there. So the picture of the farmer carrying the manure for a field in his waistcoat pocket and applying it with a hypodermic syringe, is still a vision of the future.

These natural processes for the recuperation of our stock of combined nitrogen have, during the last year or two, been supplemented by one or two manufacturing processes of great interest in themselves, which are on the point of becoming factors of importance in the fertiliser market.

Speaking broadly, there are two ways of bringing free nitrogen gas into combination: first, at extremely high temperatures, such as are attained in the electric arc or sparks, nitrogen will combine with oxygen to form various oxides from which nitric acid will eventually

result by solution in water; secondly, nitrogen will combine with a few metals and allied bodies, again at high temperatures, to yield substances which under the action of water give rise to ammonia. It is this latter method which was first developed on a commercial scale by Frank and Caro in Berlin. They did not exactly start with a metal, but with calcium carbide, the substance now so well known as the source of acetylene for illumination. This body, Frank and Caro found, would combine readily with nitrogen gas at quite moderate temperatures, and the resulting substance, calcium cyanamide, nitrolim, or *kalk-stickstoff*, as it is called, will decompose under the action of water, yielding its nitrogen as ammonia and the calcium and carbon as calcium carbonate. An Italian company, which was the first to take up the patents for the manufacture of calcium cyanamide, has established its factory alongside one of the great producers of calcium carbide at Piano d'Orte in the hills above Rome, where water-power can be obtained for the cheap generation of electricity, and other works are being erected in Norway, in Savoy, and in America, where suitable water-power can be obtained. On theoretical grounds, one electrical horse-power per annum should bring about the fixation of 772 kilogrammes of nitrogen; in practice 300 to 330 have been attained. In the manufacturing process the calcium carbide is first roughly ground and then heated in iron tubes through which a current of nitrogen gas is passed. The calcium carbide, which itself results from the reaction of a mixture of chalk and coke in the electric furnace, must either be purchased or manufactured by a preliminary process. The two reactions of forming the carbide and uniting it with nitrogen can indeed be carried out simultaneously, but this method has been abandoned in practice. The

nitrogen gas is obtained by passing a current of air over red-hot copper, the copper oxide formed being afterwards reduced to the metallic state again by sending over it a current of coal-gas while it is still hot. More recently a process of obtaining nitrogen by fractional distillation from liquefied air has been employed. The resulting calcium cyanamide is a very fine dark grey powder, light and rather difficult to sow alone because it floats so readily in the air.

Since the product also contains about 20 per cent. of free lime, it readily absorbs water from the atmosphere, the first change that takes place being the slaking of the quicklime. At the same time the cyanamide begins to decompose slowly into ammonia and calcium carbonate in eventual accordance with the equation

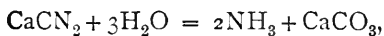

so that some loss of ammonia may take place if the manure is left lying about exposed in a loose condition to the atmosphere. In bags, however, it may be stored without any sensible loss.

With superheated steam the reaction takes place more rapidly, and with acids or acid manures salts of calcium and ammonium are formed, preceded of course by an active interaction between the free lime and the acid. The same reaction may be expected to take place when calcium cyanamide is applied to the soil: it should change slowly into ammonia, which will be arrested by the soil, and calcium carbonate. It has been shown, however, by Löhnis, that the reaction with water alone is slow and not particularly effective, but that in practice certain soil bacteria bring about the change.

Commercial cyanamide contains as much as 20

per cent. of nitrogen, the theoretical substance being  $\text{CaCN}_2$  with 35 per cent. of nitrogen. As a fertiliser, calcium cyanamide has been subjected to a series of sufficiently conclusive trials which show that on most soils it is almost but not quite as effective as sulphate of ammonia supplying an equal amount of nitrogen. For example, Table IX. shows the results of four trials at Rothamsted in 1905, mangolds and barley being the crops under experiment. On soils poor in lime, doubtless the cyanamide would give

TABLE IX.—ROTHAMSTED EXPERIMENTS WITH CALCIUM CYANAMIDE, 1905.

	Barley.		Mangolds. Roots.		
	Grain.	Straw.			
	Bushels.	Cwts.	Tons.	Tons.	Tons.
Calcium Cyanamide .	34.3	19	22.0	11.1	28.9
Sulphate of Ammonia .	37.5	24	23.5	10.0	27.9

comparatively better results, because then the carbonate of lime, which is the bye-product of the decomposition taking place in the soil, would itself be of considerable value. The Rothamsted soil, however, contains sufficient carbonate of lime to minimise the effect of this factor. The chief drawback to the practical employment of calcium cyanamide as a manure is its light, blow-away character, and the injurious effect upon germinating seeds of the ammonia and other gases given off when it is first applied to the soil. It has, therefore, to be sown on the land alone, and it should be incorporated with the soil a week or so before any seed is sown. For similar reasons it should not be used as a top dressing unless mixed with earth beforehand, though recent experiments suggest that this objection has been

exaggerated. It is best to mix the cyanamide with superphosphate before application to the land; in most cases when cyanamide is used phosphates will also be required, and a mixture of cyanamide with from five to ten times its weight of superphosphate can be conveniently made and forms a good fertiliser for barley or turnips. The mixture should be made on the floor of the manure shed at least a day before the manure has to be sown; if the cyanamide is carefully handled and covered with superphosphate, it can be mixed without creating an unbearable dust. With the slaking of the lime a good deal of heat is developed and the manure begins to steam, but a sprinkling from a watering pot will help to keep the heat down without rendering the mixture in any way difficult to handle. The heap should be turned over two or three times to secure a good mixture, and left until the next day to cool off. It remains in a nice friable condition and undergoes practically no further change if it cannot be sown at once. No unpleasant gases are given off during the mixing; the samples of cyanamide first made contained some unchanged calcium carbide which gave off acetylene on wetting, but this is now avoided in the manufacturing process.

Two methods have been adopted to obviate the dustiness; in one the product is treated with a small proportion of heavy shale or coal oil, in the other just sufficient treatment with steam is applied to convert the quicklime into slaked lime, and give the material a more granular form. This latter process has the further advantage of decomposing any traces of calcium carbide and phosphide that may be present in the original material. A slightly different product containing calcium cyanamide is manufactured by a firm in Westeregeln, under the patents of F. Polzenius, by

heating a mixture of calcium carbide and chloride in a stream of pure nitrogen at about  $750^{\circ}$  C. The product, known as *stickstoff-kalk*, is a black powder containing over 20 per cent. of nitrogen and about 10 per cent. of calcium chloride, together with a considerable amount of free lime. As a manure *stickstoff-kalk* behaves in all essential respects like the *kalk-stickstoff* of which a more detailed description has been given.

The other method of bringing nitrogen into combination—that of effecting its union with oxygen at the temperature of the electric arc—has received considerable attention, and forms the base of at least two working processes. It will be remembered that when Sir William Crookes in 1898, in his British Association address, warned the world of the rapidly progressive exhaustion of its supplies of combined nitrogen, it was to the union of nitrogen with oxygen that he looked for the future supply of combined nitrogen for the wheat crop, and he showed experimentally how the two gases would burn together at a very high temperature. Not enough heat, however, is given out by the flame to bring more gas up to the ignition point, hence the flame is only continuous as long as external energy is poured in.

Calculating from the best results Lord Rayleigh had obtained in bringing nitrogen and oxygen into combination by the electric spark, Crookes decided that if electricity could be generated at one-seventeenth of a penny per Board of Trade unit, as it was expected would be the case at Niagara, then nitrate of soda could be made artificially at about £5 per ton.

Such an electrical process was installed at Niagara by Bradley and Lovejoy, who produced a number of arcs between platinum poles with a continuous current at a potential of 10,000 volts. The oxides of nitrogen

generated were converted into nitric and nitrous acids by steam and more oxygen, and a mixture of sodium nitrite and nitrate was prepared for agricultural purposes. The installation, however, only ran for fifteen months, for though considerable amounts of nitric acid were produced, technical difficulties in maintaining the apparatus in working order proved insuperable. More recently a working process has been devised by Berkeland and is running on a commercial scale at Notodden in Norway. In the Berkeland-Eyde process an alternating current at about 5000 volts is set to form an arc between U-shaped copper electrodes, which are hollow and kept cool by a current of water within. The electrodes are placed equatorially between the poles of a powerful electro-magnet, which has the effect of causing the arc to spread out into a broad flat flame. Though the temperature of the arc-flame is calculated to be  $2600^{\circ}$  C., it is not particularly luminous; it may be looked at directly from a yard's distance.

Through the furnace in which this special arc is generated about 15,000 litres of air are blown per minute at gentle pressure and the issuing air contains about 1 per cent. of nitric oxide and is at a temperature of  $600^{\circ}$  to  $700^{\circ}$  C. It is cooled and then passes into two oxidising chambers, where the combination of the nitric oxide with the oxygen of the uncombined air takes place, after which it passes into a series of five condensing towers. Down the fourth tower, which is filled with broken quartz, water trickles and picks up enough of the nitrous gases to become 5 per cent. nitric acid at the bottom; this is pumped up and trickles down the third tower, the process being repeated until the liquid leaving the bottom of the first tower contains 50 per cent. of nitric acid. In the

fifth and last tower the absorbing liquid is milk of lime, and the resulting mixture of solution of calcium nitrite and nitrate is treated with enough of the previously-formed nitric acid to convert it wholly into nitrate, the nitrous fumes evolved being led back into the oxidising chambers. The product is then concentrated until it solidifies as a material containing about 13 per cent. of nitrogen, or 75 per cent. of pure calcium nitrate.

The present factory has three electric furnaces installed, each employing 500 kilowatts, and the production amounts to about 150 kilogrammes of nitrogen fixed per kilowatt year.

Berkeland calculates that the cost of manufacturing calcium nitrate containing 13 per cent. of nitrogen is about £4 per ton, and that it can be sold at a profit at £8 a ton, which would be equivalent to nitrate of soda at about £10 a ton. The present large factory at Notodden has been putting calcium nitrate on the market for two years or more, the rate of production now being about 20,000 tons per annum. When the extensions to the factory are completed it is expected the output will amount to nearly 3000 tons per month. As a fertiliser there cannot be the least doubt that nitrate of lime will be just as valuable, nitrogen for nitrogen, as nitrate of soda. At Rothamsted a chemically prepared nitrate of lime has been used for two or three years for a special purpose on one of the mangold plots, and it has given exactly equal results to the nitrate of soda plot alongside. Many field experiments have also been carried out with the electrical product in Norway during the last year or two, and have shown that the new material can be strictly valued against nitrate of soda on the basis of the nitrogen it contains. Indeed, on some soils it



is likely to be more valuable, because, as will be shown later, part at least of the lime base will be left behind in the soil as calcium carbonate. This will be an advantage in peaty soils, and will also save clay soils from the peculiar wetness and stickiness which results from the employment of much nitrate of soda. The present price is about £8, 8s. per ton at the British ports.

Turning now from the atmospheric nitrogen and the various possibilities of utilising it to the purely nitrogenous fertilisers that are available, we can begin by dividing them into two classes, the quick and the slow acting, in the first of which we have practically only nitrate of soda, sulphate of ammonia, cyanamide, and nitrate of lime. Our acquaintance however with the two latter is too limited as yet to enable us to do more than predict that they will fall into line with sulphate of ammonia and nitrate of soda respectively. Nitrate of soda has now been in use in this country for something like seventy years, the Chilian deposits having been first discovered about the time of Darwin's voyage round the world in the *Beagle*. As nitre had long been known to possess great manurial value, the exportation of nitrate of soda to Europe was at once suggested, and in 1830 it appears that a trial shipment was made of 18,700 quintals of about 100 lb. each. By 1838, the date of the first volume of the *Journal of the Royal Agricultural Society*, it was being tried experimentally by a good many landlords and farmers in this country. The production grew rapidly, and reached its maximum in 1899, when 1,344,550 tons were consumed; since then the output has declined a little, owing to combination between the producers. At the present time the United Kingdom takes about one-twelfth of the total production, Belgium an equal

share, France and the United States about one-sixth each, and Germany rather more than one-third of the whole. Opinions differ greatly as to the approaching exhaustion of the Chilian deposits; various estimates set their probable life at from twenty to forty years, but doubtless long before exhaustion sets in the poorer grounds, now being neglected as containing less than the paying amount of nitrate, will be exploited, provided always that the artificial nitrate of lime does not render the whole industry unprofitable.

As to the origin of the nitrate of soda deposits there are two theories, to understand which some description of the mode of occurrence is necessary. The chief deposit lies in the province of Tarapaca, in Chile, on an elevated plain, about 3000 feet above sea level, known as the Pampa of Tamarugal, which stretches for a breadth of some thirty or forty miles from the Corderillas on the eastward to a low range of foothills separating it from the sea. The climate is intensely dry, rain falling only every two or three years, and then in quantities so small as to evaporate rapidly. The special nitrate-bearing deposit or *caliche* occurs a few feet below the surface, and in it the nitrate is associated with earthy matters, gypsum, common salt, and sulphates of sodium and potassium. The generally accepted theory regards the plain as an ancient sea-bed elevated by one of the volcanic movements common on that coast, and then desiccated. The nitrate of soda is set down to the oxidation of immense masses of seaweed present in the original sea, the salt of which has provided the necessary sodium base. The chief argument in support of this supposition is the presence of a small amount of sodium iodate in the crude caliche, seaweed being known to contain iodine. But such a theory is as impossible on chemical grounds as it is untenable geologically. It

involves, in the first place, an extravagant amount of seaweed, and our knowledge of the nitrification process is quite opposed to the idea that it would take place in a rapidly concentrating medium containing common salt. Nor have we any reason to suppose that salt would supply a base for nitrification; even if its hydrochloric acid could be turned out the liberated acid would at once suspend the process. And again, if the iodates are to be taken as indicating seaweed, why are not bromates also present in the caliche, since both bromine and iodine are associated in seaweed.

A much more probable theory is that the deposit represents the saline residues of fresh-water streams flowing off the Corderillas, containing nitrates and other salts derived from old rich soils or rocks on the heights. The evaporation of such waters for a long period of progressive desiccation would result in the accumulation of the dissolved salts in the dry region over which the waters formerly spread when the rainfall was greater. The occurrence of iodine cannot be explained until more is known as to the amount of this element present in the waters and soils of the Corderillas.

The only other deposits of nitrate of soda which assume any economic importance are those which occur in Upper Egypt, where certain shale beds of Eocene age, out-cropping on both sides of the Nile between Qena and Assouan, contain enough sodium nitrate to make the clay worth carriage as a manure known locally as "tafla." Analyses of a series of these shales by F. Hughes show an average of 6.7 per cent. of nitrate of soda associated with 10.1 per cent. of sodium chloride, and 5.4 per cent. of sodium sulphate. The material is disseminated throughout the whole bulk of the clay; and as this is not permeable to any

extent by water, the nitrate can hardly be due to infiltration, but must have been formed *in situ*—a conclusion which is much strengthened by the fact brought out by Hughes' analysis that small quantities of nitrogenous organic matter, ammonia and nitrites are also present in the extract from the clay.

In all probability the nitrates in these shales represent the results of nitrification of a mass of organic matter originally contained in the deposit, but until further data have been accumulated as to the depth to which the nitrates extend, and their replacement or not by unoxidised organic nitrogen compounds at depths beyond the access of atmospheric oxygen, it is impossible to say whether we are dealing with recent or with what might be termed fossil nitrification, or again whether there has been any concentration of the salts in the surface layer analysed.

In any case, these Egyptian deposits give a clue to the possible origin of the Chile beds by washing from similar strata (and the Corderillas consist of rocks of recent age) into a rainless area, where the salts are accumulated by evaporation. The two deposits present this common difficulty: that the deposit is nitrate of soda instead of nitrate of lime—the usual product of nitrification in soil; again, both are associated with a preponderance of sulphates over chlorides, a fact which seems to put any marine origin out of the question. We are, however, dealing with typically arid conditions, and in all parts of the world sodium salts are characteristically abundant in the soils and rocks of areas of small rainfall; indeed, sodium carbonate is always found in such cases, and this would form the base for nitrification. At the same time, similar oxidising processes to those which give rise to nitrates would convert the sulphur of the organic matter to sulphates. But to settle the problem

of the origin of the Chile deposits of nitrate of soda, an examination is required of the salts in the rocks of the Corderillas, the drainage from which would find its way into the plain of Tamarugal.

The nitrate of soda is found in a deposit named *caliche*, of which it constitutes from 60 per cent. down to 17 per cent., lower grades not being at present worked. In the caliche it is associated with sodium chloride, sulphates of calcium, sodium, and potassium, and a varying proportion of insoluble earthy matter. The caliche is not found on the surface, but is covered by various earthy and gypseous deposits to the depth of 2 to 10 feet. After the deposit has been broken up by blasting, the caliche is removed to the works, broken up and lixiviated in large vats heated by steam. The saturated solution is led into tanks in which the nitrate of soda deposits on cooling, further crops being obtained from the mother liquors by continuing the treatment. After draining and drying the nitrate is made up into 2-cwt. bags for export. A further product of the nitrate process is iodine, because the caliche always contains a small quantity of sodium iodate. The nitrate of soda thus obtained is a coarsely crystalline powder, varying in colour from a slight brown or pink shade to a grey-white, containing 95 to 96 per cent. of pure sodium nitrate, the remainder being made up of moisture, sodium chloride, and traces of sulphates of sodium, magnesium, and calcium.

A sample of the crystals after drying in the sun had the following composition:—

Sodium Nitrate . . .	94·164	Magnesium Chloride	0·289
Potassium Nitrate . . .	1·763	Calcium Sulphate . . .	0·102
Sodium Chloride . . .	0·933	Insoluble matter . . .	0·138
Sodium Iodate . . .	0·010	Water . . . . .	2·100
Potassium Perchlorate . . .	0·282		
Magnesium Sulphate . . .	0·219		
			100·00

The salt is very soluble in water and is deliquescent, so that it will gradually absorb enough water to liquefy when exposed to the damp air of an English winter in a manure shed. The salt is poisonous in quantity, and both horses and stock have not infrequently been killed by licking nitrate of soda or the bags in which it has been stored. Nitrate of soda contains as much as 56 per cent. of oxygen and accelerates the combustion of such bodies as wood or coal with almost explosive violence, one accident at least has been recorded from this source of danger. Nitrate of soda is not only soluble in water, but it is not in any way retained by the soil, so that it must wash through into the drains or subsoil when percolation is going on. For this reason it should only be applied as a top dressing when the crop is growing. Like all other saline bodies which form a strong solution with water, nitrate of soda will scorch and destroy any green tissue with which it is left in contact; it withdraws water from the cells and kills them by plasmolysis (see p. 18). Hence in sowing nitrate of soda on a crop like cabbage, a certain amount of care should be taken not to let the salt lodge in the crown of the plant.

Nitrate of soda may be mixed with other manures except superphosphates and dissolved bones, the acid of which gradually liberates nitric acid, so that such a mixture should be sown immediately after it has been made.

Nitrate of soda is always sold by the producers with a guarantee of 95 per cent. pure, which guarantee should also be obtained by the farmer, for the material should be sold exactly as it is imported. It usually contains about 96 per cent. of pure sodium nitrate, which is equivalent to 15.7 per cent. of nitrogen or 19.1 per cent. of ammonia.

Sodium perchlorate is sometimes present in small quantities as an impurity; this has a very injurious effect upon vegetation, but the instances of damage due to this cause are uncommon. Adulteration of nitrate of soda has become rare nowadays; in the past (and to a certain extent still) it was mixed with common salt, a substance which it resembles in colour and crystalline appearance. In the manufacture of gunpowder it is customary to make potassium nitrate by mixing sodium nitrate with potassium chloride and crystallising out the less soluble nitre. The mother liquors contain sodium chloride (common salt) with small quantities of the more valuable potassium nitrate, and when evaporated down yield what is sometimes known as "gunpowder salt." On occasion this material has been sold at a fraudulent price as "nitrate of salt," and credited with being a combination of nitrate of soda and salt, more valuable than either for such crops as mangolds.

As there is no occasion for any admixture with nitrate of soda, the farmer should always insist on buying the unmixed substance of standard purity.

As a manure, nitrate of soda is of course treated as a source of nitrogen. It is not sufficiently realised how valuable the soda base may be. This is not because soda is in any way necessary to the nutrition of the plant, but because of the action of any soluble salt upon the insoluble potash compounds in the soil. The potash of the soil is due to the partial weathering of double silicates like felspar into clay, which is not to be regarded as pure kaolinite,  $\text{Al}_2\text{O}_3 \cdot 2\text{SiO}_2 \cdot 2\text{H}_2\text{O}$ , but as containing a certain proportion of zeolitic bodies intermediate between felspar and kaolinite—hydrated double silicates containing potash, soda, magnesia, and lime combined with alumina and silica. Any soluble salt, and particularly a soluble soda salt, will react with

these zeolites and exchange bases to an extent depending upon the relative masses of the two bodies; hence nitrate of soda acts on the clay in the soil and brings a little potash into solution. To such an extent does this action take place that in practice a dressing of nitrate of soda on any but the lightest soils will dispense with the necessity of a specific potash manuring, even for potash-loving crops.

This is well illustrated in the Rothamsted experiments (see Table X.) upon mangolds, if we compare the yields on the plots receiving equivalent amounts of nitrogen as nitrate of soda, sulphate of ammonia, and rape cake, both with and without potash. The table refers to the season of 1900, the twenty-fifth year of that series of experiments, when it might be supposed the potash in the soils of the plots receiving no potash in the manure must have become thoroughly exhausted:—

TABLE X.—EFFECT OF SODA IN NITRATE OF SODA, MANGOLDS, ROTHAMSTED, 1900.

Plot.		With Nitrate of Soda.	With Sulphate of Ammonia.	With Rape Cake.
		Tons.	Tons.	Tons.
6	Superphosphate and Potash .	29·6	28·2	29·4
5	Superphosphate only . . .	28·3	12·0	14·9

The plots receiving potash all give about the same yield, whatever the source of nitrogen; but on plots 5, without potash, the yield is only maintained on the nitrate of soda plot; on the other two the plant is neither supplied with potash by the manure, nor is the soil forced to yield some of its stored-up potash as it is by the nitrate of soda, whereupon the yield declines by



one-half or more. For twenty-five years, then, the use of nitrate of soda alone has enabled the soil to supply a mangold crop with the large amount of potash it wants, though the store of potash in the soil apparently soon becomes exhausted when a manure is used which cannot bring it into solution. With other crops the same results are obtained, though the lack of potash does not become manifest so quickly as in the case of mangolds. For example, we may compare the yield of barley (Table XI.) for successive ten-year periods, the yield of each plot being calculated as a percentage of that on the completely manured plot receiving nitrate of soda, to eliminate seasonal influences.

TABLE XI.—BARLEY GRAIN, HOOSFIELD, ROTHAMSTED.

Plot.		10 years (1862-1861).	10 years (1862-1871).	10 years (1872-1881).	10 years (1882-1891).	10 years (1892-1901).
4N	Nitrate, Superphosphate, and Potash . . . . .	100.0	100.0	100.0	100.0	100.0
2N	Nitrate and Superphos- phate . . . . .	98.0	100.2	99.5	105.7	101.4
4A	Ammonia, Superphosphate, and Potash . . . . .	92.4	93.7	97.2	100.7	100.8
2A	Ammonia and Superphos- phate . . . . .	91.4	97.8	96.0	90.8	77.8

It will be seen that when the manure contains potash the ammonium salts yield practically the same crops as nitrate of soda. When the nitrogenous manure is nitrate of soda, the omission of potash causes no diminution in the yield; but with ammonium salts and no potash the crop after the third decade becomes unable to satisfy its potash requirements from the soil alone, and the yield declines. In other words, nitrate of soda has dispensed with the necessity

of a potash dressing, which after a time becomes necessary when sulphate of ammonia is the nitrogenous manure.

One of the most characteristic effects of the use of nitrate of soda as a manure, either repeatedly or in any quantity, is its deleterious action upon the texture of a heavy soil; farmers have repeatedly observed that where nitrate of soda has been applied the land remains very wet and poaches badly if it is at all disturbed before it has dried. Market gardeners in particular, who manure heavily with nitrate of soda, have found this destruction of the tilth a serious drawback to its use. The cause has usually been put down to the hygroscopic character of nitrate of soda; since the salt itself readily attracts moisture from the air and will even liquefy spontaneously, it is considered that it keeps the land moist for the same reason. But the extra amount of moisture that could be held in the soil by a few hundredweights of nitrate of soda would be wholly imperceptible when distributed through the hundred tons or more which the top inch of soil weighs per acre, even if the application of nitrate of soda persisted near the surface and were not quickly washed down in the soil. Some of the Rothamsted plots in the mangold field, where very large amounts of nitrate of soda have been applied year after year for the last fifty years, show this deterioration of tilth in very marked fashion, the land being intolerably sticky after rain and drying into hard intractable clods, so much so that it is very difficult to secure a plant of roots unless the season is favourable. Determinations, however, of moisture in the surface soil do not show any sensible difference between these plots of bad texture and those working more kindly, so that we must put aside the



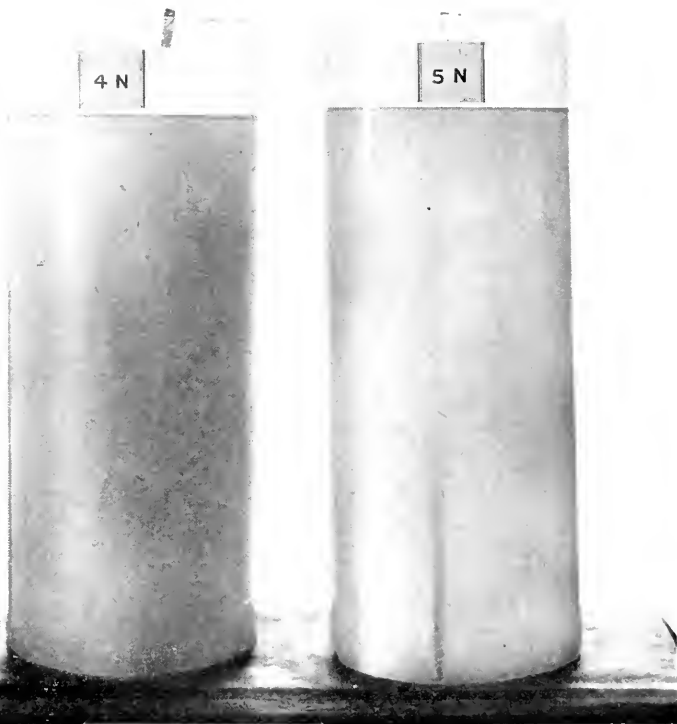

FIG. 2.—DEFLOCCULATING ACTION OF NITRATE OF SODA ON CLAY SOILS.

The jars contain water in which equal amounts of clay soil had been suspended and allowed to settle for forty-eight hours. The soil in the left-hand jar had been taken from a plot regularly receiving nitrate of soda.

idea that there is any direct attraction of water by nitrate of soda remaining in the soil. The explanation appears to be more complex. When a plant is feeding upon a neutral salt like nitrate of soda, it takes up rather more of the nitric acid than of the soda, leaving behind in the soil some of the soda combined with carbonic acid excreted from the root. Water cultures in which plants are grown with nitrate of soda will actually become alkaline to test-paper from this cause. Now, a very small quantity of a free alkali, like carbonate of soda, has an altogether disproportionate effect upon clay; the clay is deflocculated—*i.e.*, the little aggregates of very fine particles which cause the clay to crumble down when dry and to allow water to drain through it, are immediately resolved into their finest state of division, and all the characteristic properties of clay are accentuated. Deflocculation is effected mechanically whenever clay is puddled or worked in a wet condition, and all the features of puddled clay, which is both retentive of water and impermeable by it, which shrinks greatly in drying and then holds together with extreme tenacity, are found in these soils when the deflocculation has been brought about by a little dissolved alkali. The fact that such deflocculation has taken place may be illustrated by a very simple experiment. Fig. 2 shows two large jars, each containing 3 litres of distilled water, in which has been shaken up 1 gramme of the Rothamsted clay loam, in the one case from a plot manured with nitrate of soda, in the other, from the adjoining plot receiving ammonium salts. It is obvious how much greater is the amount of material remaining suspended in the jar containing soil manured with nitrate of soda, which means that this latter soil had been previously brought into a more fine-grained and less flocculated

condition. Collateral evidence is furnished by some of the other Rothamsted plots; for example, when the tile drains beneath the wheat plots run, the water percolating from below the nitrate of soda plot is always slightly turbid with fine suspended clay material, while the water from the other plots is clear. This removal of the finest material from the nitrated plot has been so persistent during the fifty years or so of experiment on this field, that the mechanical analysis of the soil now shows a smaller proportion of clay, which removal has only been possible because of the deflocculation brought about by the nitrate of soda manuring.

Again, the soil of the plots receiving nitrate of soda is found to be losing carbonate of lime to the water percolating through it at a lower rate than the soil of the unmanured plot; this is because the production of a free base by the plant's own growth has, to a certain extent, saved the carbonate of lime in the soil from attack. The following table (XII.) shows the

TABLE XII.—CALCIUM CARBONATE IN BROADBALK WHEAT SOILS.  
FIRST DEPTH (1 TO 9 INCHES).

Plot.		Per cent. in Fine Dry Soil.		Loss per Acre per annum. Lb.
		1865.	1904.	
3	Unmanured . . . . .	4.54	3.29	800
9	Complete Minerals and 275 lb. Nitrate of Soda . . . . .	4.24	3.36	564
7	Complete Minerals, and 400 lb. Ammonium Salts . . . . .	3.82	2.25	1010
2	Dung . . . . .	4.20	3.28	590

annual average rate of loss of carbonate of lime for the last forty years from some of the chief plots of the Broadbalk field; it will be seen that the nitrate of soda has reduced the loss of carbonate of lime from the

soil by between 200 and 300 lb. per acre per annum, this quantity representing the base it has itself supplied. The bad texture of the land induced by the use of nitrate of soda is not easily removed; lime is of no service in this case, because it only adds another alkali; a better remedy is to be found in the simultaneous application of an acid manure like superphosphate. Better still, when an active nitrogenous manure is needed, instead of nitrate of soda alone a mixture of sulphate of ammonia with nitrate of soda might be employed; for, as will be seen later, sulphate of ammonia acts on soil like an acid, hence a mixture of the two manures ought to make a better source of nitrogen than either alone.

Amongst farmers a certain amount of prejudice against nitrate of soda still lingers; it is described as a "stimulant," even as a "scourge," and is regarded as producing a crop to the detriment of the fertility of the land. To a certain extent it is true of nitrate of soda, as of any other fertiliser containing only a single constituent of a plant food, that its continued use alone must increase the draft upon the other nutritive elements in the soil, in this case phosphoric acid and potash. Nitrate of soda, also, is such an active source of nitrogen and nitrogen is so dominant a factor in producing growth that large crops can often be grown for a time by the help of nitrate of soda alone. But so far from nitrate of soda being specially harmful in this way, the Rothamsted experiments show that the yield of any crop is maintained with nitrate of soda alone better than with any other single manure. For example, the produce of mangolds with nitrate of soda alone averages  $10\frac{1}{4}$  tons for twenty-seven years, as against 10 tons with rape cake alone, and under 6 tons with ammonium salts alone. But, of course, the true answer to such criticism

is that nitrate of soda requires to be used with phosphates and potash in order to make up a complete fertiliser, and that only in this way can the fertility of the soil be maintained. As has already been seen, potash can generally be omitted in practice, but phosphates must be added except in the special cases when only a nitrogenous manure is needed, as in top dressings for wheat. The prejudice against nitrate of soda is probably really due to its injurious effect upon the tilth; if it is used in large quantities or repeatedly, not only does the humus content run down but the land begins to work badly, so that poor crops result, although the land has not been particularly exhausted of plant food.

As a fertiliser the special value of nitrate of soda lies in its immediate availability; no change has to take place before it passes into the plant; in consequence, it has a very immediate effect in early spring, when the land is still so cold that the production of nitrates by bacterial processes is almost suspended however rich the soil. As an aid to the rapid production of spring vegetables, or to give a start to a field of spring corn dwindling in the cold east winds, or to push a crop through an insect attack, nitrate of soda is without a rival.

The great rival of nitrate of soda is at present sulphate of ammonia, of which over 200,000 tons are annually produced in this country. The source of origin is coal, which contains about 1.5 to 2 per cent. of nitrogen derived from the original vegetable matter giving rise to the coal. When coal is subjected to any destructive distillation by heat, as in the process of gas-making or even when it is burnt, about 15 per cent. of its nitrogen is given off as ammonia, which may be recovered from the gases by simply washing them with water. The ammoniacal gas liquor thus produced



is redistilled into sulphuric acid and sulphate of ammonia is crystallised out; the resulting commercial salt contains about 20.5 per cent. of nitrogen. Not only gas works, but blast furnaces, coke ovens, shale oil works, etc., are now arranged to recover this valuable product of the coal, and the accompanying table shows the current output from each of these sources:—

TABLE XIII.—PRODUCTION OF SULPHATE OF AMMONIA IN THE UNITED KINGDOM.

Source.	1901.	1900.	1899.
	Tons.	Tons.	Tons.
Gas works . . . .	148,500	142,000	134,000
Iron works . . . .	16,000	17,000	18,000
Shale works . . . .	36,500	37,000	38,500
Coke, etc., works . . . .	19,000	17,000	15,000
Total production . . . .	220,000	213,000	205,500
Exports . . . . .	150,203	145,285	140,371
Home consumption . . . .	69,797	67,715	65,129
Average price . . . .	£10, 11s. 4d.	£11, 2s. od.	£11, 5s. 10d.

In the early days of the industry hydrochloric acid was sometimes employed, in which case ammonium chloride (muriate of ammonia) was obtained, but the only salt now prepared as a manure is the sulphate.

Sulphate of ammonia, when pure, is a white crystalline salt freely soluble in water; the commercial article varies somewhat in colour, being generally grey or yellow from a trace of tarry matter; in some cases it is distinctly blue, owing to the presence of a little ferrocyanide, derived from the cyanides always present in coal-gas. The pure salt contains 21.2 per cent. of nitrogen, and as the commercial article is generally of

about 95 per cent. purity, it is usually guaranteed to contain 20.2 per cent. of nitrogen, or 24.5 per cent. of ammonia. Adulterations are infrequent and can readily be detected, because sulphate of ammonia is the cheapest substance which is wholly volatile. A handful of sulphate of ammonia placed on a fire shovel and heated to redness over a fire should leave no appreciable residue. Samples of the salt are occasionally found containing ammonium sulphocyanide (thiocyanate), a substance actively injurious to vegetation. Its presence can be readily detected by adding to a solution of the salt a little ferric chloride, with which a sulphocyanide produces an intense red coloration. Like all salts of ammonia, the sulphate reacts with lime and even with carbonate of lime, giving off free ammonia as a gas. For this reason sulphate of ammonia should never be mixed with lime or with basic slag, which contains a certain amount of free lime, lest a loss of nitrogen should ensue. A lightly calcareous soil in dry weather may induce a similar loss of free ammonia.

As a nitrogenous manure sulphate of ammonia is practically as effective, nitrogen for nitrogen, as nitrate of soda; it is also to all intents and purposes as rapid in its action, because the process of nitrification, which generally precedes the utilisation of the ammonia by the plant, takes place very rapidly in suitable soils. The fact is well illustrated in the following table (XIV.), showing the composition of the water draining from one of the Rothamsted wheat plots to which a mixture of sulphate and chloride of ammonia had been supplied on 25th October, followed the next day by heavy rain, so that on the 27th the drains began to run. It will be seen that at this early date the ammonia had not been wholly caught up by the soil, so that a little found its way into the drains; at the same time, however, the

proportion of nitrate has been enormously increased, due to immediate nitrification, and the later runnings of the drains in November and December show that the ammonium salts were being rapidly oxidised and removed from the soil as nitrates.

TABLE XIV.—BROADBALK WHEAT FIELD, ROTHAMSTED. NITROGEN AND CHLORINE IN DRAINAGE WATER FROM PLOT 15. PARTS PER MILLION.

Year.	Month.	Nitrogen as Ammonia.	Nitrogen as Nitrates.	Chlorine.	Nitrogen as Nitrates to 100 Chlorine.
1880	October 10 . . . .	None	8.2	22.7	37.0
1880	October 27, 6.30 A.M. . .	9.0	13.5	146.4	9.2
1880	October 27, 1 P.M. . . .	6.5	12.9	116.6	11.1
1880	October 28 . . . .	2.5	16.7	95.3	17.5
1880	October 29 . . . .	1.5	16.9	80.8	20.9
1880	November 15, 16 . . . .	None	50.8	54.2	93.7
1880	November 19, 26 . . . .	None	34.6	47.6	72.7
1880	December 22, 29, 30 . . .	None	21.7	23.2	93.5
1881	February 2, 8, 10 . . . .	None	22.9	19.4	118.0

When applied to the soil sulphate of ammonia is very rapidly and completely absorbed; the instance quoted above (Table XIV.) being one of the very few cases when ammonium salts have been found in the waters draining from the Rothamsted wheat field, however recent the application of ammonium salts had been. The sulphuric acid or chlorine is found at once in the drainage water, but combined with calcium and magnesium derived from the soil. It is commonly supposed that the reaction taking place is one of double decomposition with the calcium carbonate in the soil—



the ammonium carbonate being held without further

change by the humus in the soil. But experiments with pure kaolin and samples of natural humus—peats of various age and origin—show that the reaction which takes place is one of double decomposition whereby ammonium displaces calcium and magnesium in clay and humus. With kaolin and clays the reaction takes place with the double hydrated silicates or zeolites, with humus with certain natural calcium compounds of the insoluble complex organic humic acids produced during decay. A certain amount of the ammonia is also taken up at once by soil bacteria and converted into more organised and insoluble forms like proteins.

It is the calcium carbonate in the soil that finally suffers loss, because before nitrification takes place the ammonium compounds just described have to be decomposed by calcium carbonate with the production of ammonium carbonate, which alone can be attacked by the nitrification organisms.

Referring again to the analyses of the Rothamsted wheat soils, p. 56, it will be seen that the long continued use of ammonium salts has reduced the proportion of calcium carbonate below that of the unmanured plots by amounts which are approximately those to be expected if interaction between the salts and the calcium carbonate had taken place according to the equation set out above.

The Rothamsted wheat soils started with sufficient calcium carbonate to withstand this loss, but on soils initially poor in calcium carbonate its removal by sulphate of ammonia soon induces a condition approaching actual sterility. The best example is afforded by the experimental plots on the farm of the Royal Agricultural Society at Woburn, where through the continued use of ammonium salts as manure, the soil

refuses to grow barley any longer, though the former fertility is at once restored by the application of a dressing of lime. The soil of the plots receiving ammonium salts is actually acid to litmus paper, and a similar condition prevails on some of the grass plots at Rothamsted, where the soil, unlike that of the wheat field, is deficient in calcium carbonate. At Woburn the soil is a light sandy loam which contained in 1876, when the experiments began, only 0.074 per cent. of calcium carbonate. For many years the wheat and barley plots manured with ammonium salts gave as good returns as those receiving an equal amount of nitrogen as nitrate of soda. Towards 1895 it became every year more difficult to obtain a plant of barley on the plots receiving ammonium salts, the soil was noticed to be acid to litmus paper, and certain special weeds, spurry in particular, invaded the plots. The plots were then divided, and on one portion 2 tons per acre of lime were applied, whereupon the soil recovered its healthy condition and the crop was restored.

Table XV. shows the result on the crop of 1904 of the dressing of lime applied in December 1897, and also the destruction of the crop where the soil had remained acid through the use of ammonium salts.

The effect of sulphate of ammonia upon wheat at Woburn is not so marked as upon barley, probably because of the deeper rooting habit and more robust constitution of the wheat plant.

The acidity of the soil where the ammonium salts have been used is due to the attack of various moulds and other micro-fungi upon the ammonium salts; they seize upon the nitrogen for their own nutrition, and set free the acids with which the ammonia was combined. If

there is no calcium carbonate present to neutralise the acids, they combine with the calcium of the humus and set free humic acid, which accumulates from year to year, until, with the small amount of mineral acid from the salts that is also left free, the acidity becomes considerable enough to be detected. But the injury to the crop seems to be less due to the direct effect of the

TABLE XV.—WOBURN. YIELD OF BARLEY, 1904.

	Bushels per Acre.	
	No Lime.	After Liming.
Ammonium Salts alone (41 lb. N. per acre) . . .	0·7	14·3
Nitrate of Soda alone (41 lb. N. per acre) . . .	11·5	...
Minerals + Ammonium Salts (41 lb. N. per acre) .	1·8	23·9
Minerals + Nitrate of Soda (41 lb. N. per acre) .	24·7	...

acids upon the plant than to the way the acidity tends to suspend the normal bacterial activities of the soil, as, for example, the process of nitrification, and to replace them by the growth of moulds and fungi. In the acid grass soils at Rothamsted, for example, nitrification is almost at a standstill, the organisms are very few in number, and the plant is chiefly feeding on the unchanged ammonia of the manure.

Although under ordinary farming conditions an actually acid reaction is not likely to arise through the use of sulphate of ammonia, the experiments at Woburn and Rothamsted clearly indicate that it is not a desirable source of nitrogen for soils which are deficient in calcium carbonate. The reaction of ammonium salts with the soil, resulting in the withdrawing of the ammonia from solution, gives a clue to the difference in both the yield and the character of the crop when

grown with sulphate of ammonia and nitrate of soda respectively. On the grass plots at Rothamsted, for example, where the manuring has now been repeated year after year for fifty years, very distinct types of herbage have associated themselves with the two manures. Putting aside the prevalence of sorrel as due to the acid conditions, the characteristic grasses on the plots receiving ammonium salts possess a shallow-rooted habit, *e.g.*, sheep's fescue and sweet vernal grass, while the nitrate of soda has favoured deeply rooting

TABLE XVI.—AMMONIUM SALTS *v.* NITRATE OF SODA, ROTHAMSTED.

	Average Yield.		
	Wheat (22 years).	Barley (51 years).	Mangolds (27 years).
	Bushels.	Bushels.	Tons.
COMPLETE MANURE :—			
Nitrogen as Nitrate .	28.7	43.5	18.01
„ „ Ammonia .	23.4	42.1	14.86

grasses like the soft brome. Actual examination of the subsoil shows that the roots have penetrated much deeper on the nitrate of soda than on the ammonia plots, the roots having followed the soluble nitrate down into the soil in the one case, whereas in the other they remain near the surface where the nitrogenous material has been accumulated. We may apply the clue thus obtained to interpret the comparative results given by the two manures on other crops; wheat, for example, a deep-rooted crop, may be contrasted with barley, which feeds near the surface, but agrees again with mangolds, another deep-rooted crop.

It will be seen that with the deep-rooting crops, wheat and mangolds, nitrogen in nitrate of soda gives

a better return than an equivalent amount of nitrogen in ammonium salts, although no other disturbing factors, such as lack of potash or lime, intervene in the cases quoted ; with barley, however, the yield is sensibly equal from the two manures. At the time of harvest, the crop grown with ammonium salts is always a little the riper ; in the case of barley, this is of distinct value, for it results in a more uniform product of higher quality. Taking an average of fourteen years' valuations of the barleys grown on the Rothamsted plots, the corn grown with minerals and ammonium salts was valued at 104.3, while the produce from minerals and nitrate of soda was set at 100.3, and that from the plot receiving farmyard manure at 96.4 only, 100 being the average price of barley for the year. These figures are calculated from the cash valuations put on the various barleys every year. With the mangolds again, it is seen that the plants manured with nitrate continue to grow long after those manured with ammonium salts have so completed their season's growth that the leaves are beginning to turn yellow and flaccid. All these differences are explained by the deeper rooting habit induced by the nitrate ; the plant is less affected by the drought and the changes of temperature incident to autumn, growth is more prolonged, with the corollary of a larger yield but a later and less uniform maturity.

One other factor may also contribute to the general superiority of nitrate of soda. It must not be forgotten that when a nitrogenous manure reaches the soil there will be competition for it between the plant's roots and the mass of living organisms present in the soil, nearly all of which required combined nitrogen for their own development. Some of these organisms, like the nitrification bacteria, are wholly useful. Others cause



permanent loss by liberating some of the nitrogen in the form of gas, but the majority simply withdraw the soluble nitrogen for a time from circulation, building it up in their own tissues. The immediate result is, however, a lessened availability of the manure, and this loss will fall far more upon ammonium compounds than upon nitrates, which are not so generally utilisable by the organisms found in the soil.

It is generally assumed that since nitrate of soda is not retained by the soil, while ammonium salts are, the former is a manure better suited to dry seasons and climates, whereas under wetter conditions there is less danger of the latter washing out of the soil. This view, however, forgets that if the ammonium salts are to feed the plant they must be nitrified, and that the calcium nitrate produced is just as likely to be washed down in a wet season. Indeed, the Rothamsted results do not bear out the popular idea. In exceptionally dry seasons there may be some advantage from the use of nitrate of soda because of the deep-rooted habit it induces, but the advantage is still more pronounced in seasons of excessive wet. Taking an average of the wet seasons against the dry, the ammonium salts do better in the latter. Probably the nitrification of the ammonium salts is checked in wet seasons when the temperature is low, when also aëration is deficient through the repeated saturation of the soil.

In addition to the definite compounds which have just been described, a very large number of waste products from some industrial or manufacturing process dealing with material containing nitrogen are employed as nitrogenous manures. For example, almost all animal products contain nitrogen, hence the residues from slaughter-houses, fish-curing sheds, and other processes concerned in the preparation of food,

which are not utilisable in other ways, are available for manure. Again, all industries dealing with wool, silk, hair, feathers, skins, give rise to highly nitrogenous waste material, and other residues of vegetable origin occur from time to time.

From their origin and mode of preparation it follows that these substances must be of very variable composition: again, the supply is apt to be irregular and limited, so that their use is somewhat local and confined to particular classes of farmers.

Most of the manures of organic origin will contain phosphoric acid as well as nitrogen, but as a matter of convenience some of them may be treated as purely nitrogenous fertilisers, leaving others to be dealt with among the compound substances.

Of these waste materials the most generally used is soot; its value, which is due as much to its physical effects upon the soil as to its fertilising constituents, has been known for the last three centuries at least. It has already been pointed out that coal contains one per cent. or more of nitrogen; in a fire some of this is evolved as ammonia when the coal is heated, and if it escapes combustion in the higher levels of the fire it is afterwards partially arrested by the particles of carbon constituting soot, which possess an exceptional power of condensing gases upon their surface. In the main soot is only an impure form of carbon; its fertilising value is due to the small and variable proportion of ammonia it has thus absorbed from the gases in the chimney. The percentage of nitrogen present may be as low as 0.5, in exceptional cases it may rise to 6, 3.2 being the mean of a large number of analyses.

Since the nitrogen is present in the form of ammonia, soot as a fertiliser may be regarded as one of the ammonium salts; its action, however, is pro-

foundly modified by its physical condition. In the first place, the dark colour of soot makes it a very effective absorbant of the sun's rays, so that in sunlight the temperature of land which has been darkened by a sprinkling of soot will rise two or three degrees above that of the same land uncoloured. And as the radiation from such darkened soil at low temperatures is not increased in the same proportion, there is no corresponding loss of heat at night from the sooted land to discount its higher temperature by day. Soot is most commonly used by farmers as a top dressing for wheat and other spring corn; these crops are particularly responsive to a small application of active nitrogenous manure in the early months of the year when the soil is cold and the oxidation of its nitrogenous residues is slow, hence part of the value of the soot. At the same time, the increased temperature of the soil induced by the black colour of the soot is particularly valuable in forwarding the growth both of the plant itself and of the bacteria which are rendering available the reserves of plant food in soil.

Soot also helps materially to lighten the texture of heavy soils, and on that account is much valued by market gardeners in districts like Evesham, where the land is somewhat clayey and retentive.

Soot is also very distasteful to the slugs and small snails which often do great damage to cereal and other crops in their earlier stages.

Soot is usually sold by the bushel, which weighs about 28 lbs., and the lighter the soot is per bushel the more it is valued, because this indicates its purity and freedom from ashes or other admixture. This is probably the best test the farmer can apply, for soot being bought locally no guarantee can be obtained as to its composition, nor could one very well be given,

so small and irregular are the parcels from which any bulk of soot is made up.

Another group of substances which practically are purely nitrogenous manures are the shoddies and kindred products derived from textile industries and other trades dealing with silk, wool, hair, fur, or skin. Properly speaking, shoddy should consist of the short, broken fragments of wool which are rejected in the various processes for preparing woollen fabrics because they are not long enough to make up into yarn, but now the term is applied more generally to any form of waste from silk or wool manufacturing which is no longer profitable to work up for cloth. The material is thus extremely valuable in composition; pure wool contains over 17 per cent. of nitrogen, pure silk about as much, and at one end of the scale of shoddies come materials like carpet waste, cloth clippings, and gun wad waste, which are nearly pure and may contain as much as 14 per cent. of nitrogen. Less valuable, because of the greater admixture of dirt, are wool combings, flock dust, and other cloth wastes where cotton is also used, these may have 5 to 10 per cent. of nitrogen; while lower still come the manufacturing dust from textile factories, the sweepings of workshops, etc., in which the nitrogen may fall as low as 3 per cent.

Closely allied to such shoddies are hair and fur waste, skin waste, rabbit flick (ears, tail, feet, etc., and other fragments of rabbit skins), feathers, ground hoofs, horn shavings, and leather dust.

In all these materials the nitrogen exists in very complex compounds of carbon, insoluble in water, and requiring to pass through several stages of bacterial decomposition before they reach the plant. In consequence of their very variable composition and character it is impossible to make any general statements about

their action as manures, though certain principles may be laid down. In the main they are slow and lasting manures, akin in this respect to the more resistant constituents of farmyard manure, but the rapidity of their action will depend to a very large extent upon the fineness of their division and to the warmth and the amount of cultivation the soil receives. Fine woollen material like flock dust, rabbit hair, and small feathers decays with some rapidity in the soil, and give a very considerable return in the season of their application, as may be seen from the following table of results obtained at Rothamsted with a fine flock dust shoddy containing 12.6 per cent. of nitrogen. In the table (XVII.) the results of four years' experiments with different crops are reduced to a common standard, the unmanured plot each year being reckoned as 100, and the effect of the manure is shown for the four successive crops following the application:—

TABLE XVII.—VALUE OF RESIDUES FROM PREVIOUS APPLICATIONS OF SHODDY. ROTHAMSTED.

	Un-manured.	Shoddy, same year.	Shoddy, previous year.	Shoddy, 2 years before.	Shoddy, 3 years before.
Swedes . .	100	143.1	...	...	...
Barley . .	100	166.9	139.9	...	...
Mangolds .	100	140.8	136.9	121.9	...
Wheat . .	100	177.2	147.3	107.5	110.4
Swedes . .	100	130.7	146.9	126.6	108.1
Mean . .	100	152	142	119	109

Many of the coarser materials, rags, hair, skin, may be found in the soil apparently but little changed for a year or two after their application; while such coarse and tough material as crushed hoofs and leather waste must change with extreme slowness, and can be

of little service except in such cases as vine borders, where the prime cost is not of very great moment but the land has to remain without further manuring for many years. The presence of oil in a sample of shoddy is generally regarded as detrimental, since it hinders the access of water and so delays the decomposition of the nitrogenous material. But considering how rapidly all oils and fats are attacked by bacteria, it is doubtful if this objection is valid, and actual experiments are lacking.

The value of woollen rags as manure has long been known. Blithe wrote in 1653: "Coarse wool, nippings, and tarry pitch marks, a little whereof will do an acre of land, there is great virtue in them. I believe one load hereof will exceedingly well manure half an acre," and at the beginning of the nineteenth century Arthur Young recommended them for dry, gravelly, and chalky soils. At the present day, though shoddy is used to some extent in general farming in the neighbourhood of cloth-manufacturing districts, and though a certain amount is worked up into compound manures, it is mainly consumed by the hop and fruit growers. Such farmers are dealing with a perennial crop, the quality of which is important; in consequence they prefer a nitrogenous manure which will come into action steadily and continuously throughout the season, rather than an active one which will at any time induce a sudden rush of growth. As the plant continues on the same ground year after year, the residues of slow-acting manures which are not recovered in the first crop accumulate in the soil. Eventually the land becomes stored with manurial residues, which come into action—*i.e.*, decay and nitrify—*pari passu* with the growth of the plant, because both the plant and the soil bacteria are similarly affected by the variations in such factors as warmth and

moisture. The result of the continuous and steady feeding of the plant in this fashion is an equable development, which is found to give rise to high quality in the product.

Hop and fruit growers, in fact, regard shoddy as the best substitute for farmyard manure, of which they are rarely able to make, or even to buy, as much as they require; for fruit, indeed, shoddy is often regarded as preferable to farmyard manure, because it results in healthier growth. The organic matter present in shoddy is of value in improving the texture and water-retaining power of the soil, and 1 to 2 tons, according to the nitrogen it contains, are regarded as a fair equivalent for 20 tons of farmyard manure, though the latter will supply considerably more non-nitrogenous organic matter. Shoddy is only suitable for arable land, and should preferably be applied in the early winter and ploughed or dug in as soon after it has been spread as possible, in order to start the decay processes.

The inevitable irregularity in the composition of shoddy, even in the output from week to week from a single factory, renders its sale on any exact basis a matter of some difficulty. It is, indeed, a very unsatisfactory task to obtain a sample of a few pounds which will properly represent the bulk of a consignment, and the difficulties are renewed in the laboratory when the large sample has to be reduced to a few grammes for analysis. When, therefore, shoddy is bought and sold on a guarantee, a somewhat wide margin of variation must be allowed; a large bulk is, perhaps, best purchased on the basis of a given price per unit of nitrogen, samples being drawn from each consignment on arrival and a mean taken of their analyses in order to fix the price. While nothing but an analysis will

afford a definite idea of the quality of a shoddy, some opinion can be formed by tearing a small sample to pieces and trying each portion in a gas or candle flame. Wool, silk, hair, and all nitrogenous materials, frizzle up and burn slowly with an unpleasant smell; cotton, linen, and similar substances of no fertilising value, burn quickly with a clear flame, since they consist when pure of cellulose. Or the mass may be digested by gentle heating with a strong solution of caustic soda or potash, in which the wool and kindred substances will dissolve, leaving untouched the cellulose and dirt. But analysis forms the only real basis for determining the richness of the material, added to which the farmer must exercise his own judgment about its fineness and the possibility of getting it properly distributed throughout the soil.

Woollen shoddies are sometimes treated with sulphuric acid, with a view of starting the decomposition of the nitrogen compounds and so rendering them more quickly available. Shoddy thus treated is also used as a source of nitrogen in making various compound and mixed manures. Evidence is, however, lacking that the sulphuric acid does quicken the decay of the shoddy, and on any soils but those rich in calcium carbonate the introduction of so much free sulphuric acid is not advisable.

It would be difficult to enumerate all the bodies which from time to time get applied to the land as nitrogenous manures: tallow chandlers' waste or "greaves" is a residue containing from 3 to 9 per cent. of nitrogen, according to its origin, and a little phosphoric acid; it is often, however, comparatively high in price, because the better qualities are saleable as poultry food.

Spent hops, and kiln or malt dust (the rootlets of the germinated barley which are broken off when the



malt is dried) are sometimes available, and the latter is a valuable and active manure if it can be obtained cheaply.

In the neighbourhood of the sea other materials can sometimes be obtained; sprats or herrings, when a glut renders such fish unsaleable, mussels, and starfish or "five fingers" collected from the oyster beds, are all used in the Kentish hop gardens, and the two latter supply carbonate of lime as well as nitrogen. Off the south and west coasts, and in the Channel Islands, seaweed forms the staple manure, being collected after heavy weather and laid up in heaps to dry and rot. On the heaviest soils it is sometimes ploughed in immediately after gathering, just as "long" dung is used on clays to open up the soil. The following analyses (Table XVIII.) show the composition of three different kinds of seaweed used for manure in Jersey:—

TABLE XVIII.—ANALYSES OF SEAWEED. RUSSELL.

	Fucus.	Laminaria.	Sea Grass.
Water . . . . .	30.5	52.8	22.6
Organic matter . . . . .	51.3	30.0	59.1
Containing Nitrogen . . . . .	1.56	0.7	0.52
Ash . . . . .	18.2	17.2	18.3
Containing Phosphoric Acid . . . . .	0.50	0.43	0.62
" Potash . . . . .	4.5	3.7	0.56
" Sand . . . . .	0.86	0.54	2.8

Thus, even the poorest of these samples is in its wet condition about as rich as the ordinary farmyard manure, while the fucus would be valued as highly as £2 a ton.

These results are probably above the average; a number of samples of Fucus from the North Sea gave only 0.3 to 0.4 per cent. of nitrogen, and 0.1 to 0.2 per

cent. of phosphoric acid, while species of *Laminaria* from the same locality contained from 0.15 to 0.5 of nitrogen, and 0.2 to 0.3 of phosphoric acid.

It is needless to continue the enumeration of the substances which from time to time are employed as manures: leather in the form of dust, turnings and shavings of horn, meat and cheese that have been condemned for food, all find their way from time to time either to the manure manufacturer or to the land.

The only general rule one can apply to such residues is to buy them on their approximate nitrogen content, paying a low unit price because of their slowness of action, and also to take into account the comparative fineness of division and ease of spreading. Even the most resistant material, such as leather or horn, will decay if it is only freely enough divided and disseminated through the soil.

## CHAPTER III

### THE FUNCTION AND COMPARATIVE VALUE OF NITROGENOUS MANURES

Nitrogen promotes the Vegetative Activity of the Plant—Growth proportional to Nitrogen Supply—With Excess of Nitrogen Maturity is deferred and the Proportion of Straw to Grain is increased—Variation of Composition of Crop with Nitrogen Supply—Susceptibility of Plants to Disease when supplied with Excess of Nitrogen—Crops requiring Large Quantities of Nitrogen—Relative Availability of Nitrogenous Manures—Nitrate of Soda *v.* Sulphate of Ammonia—Question to be decided by the Nature of the Soil—Residues left by the Different Nitrogenous Manures—Greater Value attached by Farmers to Manures containing Nitrogen in Organic Combination.

BEFORE passing on to a comparison of the values of the different nitrogenous manures, it is necessary to consider how far nitrogen exerts on the plant a specific effect that shows itself whenever there is either an excess or defect of the constituent in the soil. To answer this question properly, we should require to know what is the physiological function of nitrogen in the nutrition of the plant, and though we are still far from any fullness of knowledge, certain general conclusions may be drawn both from field experiments and from the experience of the farm. In the first place, nitrogen is mainly concerned with the vegetative growth of the plant, with the formation of leaf and stem that are the necessary

preliminaries to complete development. A deficiency of nitrogen results in a stunted general growth, in which the grain or seed bears a high proportion to the whole weight of the crop; the plant on analysis, however, shows no marked lack of nitrogen as compared with the other constituents. These other bodies, phosphoric acid, potash, etc., in whatever excess they may be present in the soil, are only taken up by the plant as it can use them—*i.e.*, in quantities proportionate to the growth, which in its turn is proportionate to the nitrogen supply. As the amount of available nitrogen is increased, the development of leaf and shoot increases, their green colour deepens, and maturity becomes more and more deferred, so that a crop grown on land over-rich in nitrogen always tends to be late and badly ripened, and to show a profusion of leaf—characters which, in the case of a grain crop, often result in lodging before harvest.

But the fact that the primary growth of the plant is up to certain limits almost proportional to the supply of nitrogen, so that an application of nitrogenous manure has a quickly visible effect, not only makes it the leading constituent of a fertiliser, but is apt to give it a fictitious importance in the farmer's eyes.

On most of our cultivated soils, when the cropping is continued and manure withheld to a point when there begins to be a serious falling off in the yield through lack of plant food, it is the want of available nitrogen rather than of phosphoric acid and potash which determines the yield; in other words, the soil is much more rapidly exhausted of its available nitrogen than of its available phosphoric acid and especially of its available potash. Thus, while each of these three constituents of plant food is equally indispensable to the plant, good crops can often be grown by the aid of a

nitrogenous manure alone, and in nearly all cases by a mixture of nitrogenous and phosphatic manures. The special value of nitrogen in this connection is well seen in the Rothamsted experiments; on the wheat field, for example, we may compare the yield of the unmanured plot with that receiving nitrogen alone and minerals alone, and again that which receives nitrogen and phosphoric acid against that which receives nitrogen, phosphoric acid, and potash.

From Table XIX. it will be seen that plot 5, which is nitrogen starved but which receives an excess of all the other elements of nutrition, only yields 1.9 bushels

TABLE XIX.—AVERAGE YIELD OF WHEAT. BROADBALK, ROTHAMSTED. 56 YEARS (1852-1907).

Plot.		Grain.	Straw.
		Bushels.	Cwts.
3	Unmanured . . . . .	12.9	10.5
5	Mineral Manures only, no Nitrogen . . . . .	14.8	12.3
10	Nitrogen only, no Minerals . . . . .	20.5	18.7
11	„ and Phosphates . . . . .	23.7	22.8
13	„ Phosphates, and Potash . . . . .	31.6	31.9

more grain than the unmanured plot; whereas plot 10, which receives an excess of nitrogen but has had to rely solely upon the original reserves of minerals in the soil, has produced on the average 7.6 bushels of corn more than the unmanured plot. The minerals only increased the yield by 14.7 per cent., but nitrogen by 59 per cent., and these differences would have been much more pronounced had they been calculated on the results of the first year or two of the experiments only, instead of over a period so long that the mineral reserves of the soil are also highly exhausted. It is this greater relative deficiency of available nitrogen than of available

potash or phosphoric acid in the soil which makes the nitrogenous compounds the most important manures in practice, though in the formation of this opinion something also must be set down to the fact that an application of nitrogenous manure always shows itself in the richer green colour and increased vigour of the plant, whereas the effect of phosphatic manures is generally only to be ascertained from the weight of the ripe product like the grain.

Another result of the amount of mineral reserves in the soil is that crops such as wheat or mangolds, which are chiefly dependent upon an external supply of nitrogen, give yields that are roughly proportional to the amount of nitrogen supplied as long as it is not large; there, however, soon comes a point when the law of diminishing returns comes into play and the return for each further addition of nitrogen falls off rapidly. The following table (XX.) taken from the Rothamsted

TABLE XX.—WHEAT WITH INCREASING AMOUNTS OF NITROGEN.  
BROADBALK, ROTHAMSTED. (Average, 1852-1864.)

Plot.	Manures.	Total Produce.	Increase per 43 lb. N.	Grain.		Straw, cwts.	Grain to 100 Straw.
				Bushels.	Wt. per Bushel.		
5	Minerals only	Lb. 3009	...	18.3	58.2	16.6	62.0
6	+ 43 lb. N. .	4829	1820	28.6	58.9	27.1	58.9
7	+ 86 " .	6601	1772	37.1	58.7	38.1	54.6
8	+ 129 " .	7234	633	39.0	58.2	42.7	51.3
16	+ 172 " .	7713	479	39.5	58.0	46.6	47.9

experiments, illustrates this in regard to wheat; there are five plots each receiving the same phosphoric acid and potash, in excess of the crops' requirements, but the supply of nitrogen increases by regular steps from none to 172 lb. per acre.

Considering the total produce as a measure of the growth, it will be seen that the increase produced by the second 43 lb. of nitrogen is almost as great as that due to the first, but that the third application gives a smaller, and the fourth a still smaller increase.

As the nitrogen increases the character of the development changes, the extra growth is seen more in the straw—*i.e.*, in the vegetative parts of the plant—than in the grain; the fourth addition of 43 lb. nitrogen only increases the yield of grain by half a bushel, but the straw is greater by 3.9 cwts. The proportion which the grain bears to the straw—62 per cent. when no nitrogen is used—drops with each increment of nitrogen, and falls to 48 per cent. when 172 lb. of nitrogen per acre are applied. An excess of nitrogen also tells upon the quality of the grain, as judged by the size of the berry and the weight per bushel. The weight per bushel increases for the first application of nitrogen, but after that it becomes less and less with each increment; other results from the same field show a parallel variation for the weight of a hundred grains and for the average market value of the corn from the different plots.

When dealing with barley, an exactly similar state of things prevails: the proportion the grain bears to the straw decreases with each addition of nitrogen; while as regards the quality of the grain, the weight per bushel falls, the percentage of nitrogen increases, and the barley takes on all the appearances that are summed up as "coarse." This is due to the fact that the glume and pale, vegetative parts, are pushed on out of proportion to the endosperm, so that the berry is light and appears thick-skinned; at the same time the colouring matter is increased, though this is more apparent in the ear than in the grain.

These differences may be illustrated by one of the Rothamsted experiments in 1905, where barley was grown on one plot with 283 lb. of nitrogen in the form of wool dust, on the neighbouring plot with the residue of the same amount of shoddy that had been applied the year before to a Swede crop, and on a third plot with no nitrogen. The results are shown in Table XXI.

TABLE XXI.—EFFECT OF EXCESSIVE NITROGEN ON BARLEY.  
ROTHAMSTED, 1905.

	Weight per Bushel.	Grain to 100 Straw.	Offal Corn to 100 Dressed Grain.	Nitrogen.
	Lb.			Per cent.
No nitrogen . . . . .	58.0	110.4	5.9	1.61
Shoddy, previous year .	57.3	96.6	12.5	1.79
Shoddy, same year . .	55.1	72.8	34.9	2.42

This is an extreme case, but it illustrates the effect of an excess of nitrogen in producing a disproportionate amount of straw and a thin, light, nitrogenous barley. Of course some nitrogen is necessary in order to obtain a good-sized berry; the long series of Rothamsted experiments all show that high quality cannot be secured by merely growing barley on land exhausted of nitrogen: it is the excess, especially the relative excess when the mineral constituents are deficient, that leads to inferior grain.

Although these results show that the quality, and therefore the composition, of the grain is affected by the amount of nitrogen supplied to the crop, it is really astonishing to find how small are the changes brought about by extreme differences in the manuring.

To begin with, the plant reacts against variations in the composition of the soil and tends to keep its own composition constant; when also the time comes for the





with good quality in wheat; yet the flour made from the grain of the plots on the Broadbalk field, which received the highest amount of nitrogen, gives rise to such a loose, unstable dough that it can hardly be formed into anything resembling a loaf.

Table XXIII. shows the percentages of nitrogen in the grain and in the flour made from the grain grown in 1903 on certain of the Rothamsted plots, which vary greatly as regards their nitrogen supply.

TABLE XXIII.—NITROGEN IN WHEAT GRAIN AND FLOUR.  
BROADBALK, ROTHAMSTED, 1903.

Plot.	Manuring.	Nitrogen applied per Acre.	Nitrogen in Grain.	Nitrogen in Flour.
		Lb.	Per cent.	Per cent.
3	Unmanured . . .	0	1·844	1·462
6	Complete Manure . . .	43	1·923	1·575
7	" " . . .	86	2·195	1·738
8	" " . . .	129	2·332	1·785
10	Nitrogen only . . .	86	2·113	1·736
2	Farmyard Manure . . .	200 (?)	2·462	2·014

The variations in the nitrogen content of the flour are extreme, ranging from 1·462 for the unmanured plot to 2·014 for the dunged plot. The increased nitrogen thus obtained did not, however, result in the stronger flour which is associated with a higher nitrogen content when wheat is grown under more normal conditions, the loaves made from the grain of Plots 2 to 10 being very greatly inferior to that made from the grain of the unmanured plot. This only shows that such a characteristic as the strength of wheat—the quality, as the practical man would term it—is as a rule due to some more subtle combinations than are measured in ordinary analysis. In this case strength is not to be measured by the nitrogen content, though the two often vary together.

When dealing with root crops like Swedes and mangolds, the effect of large quantities of nitrogen may be seen to some extent in an increased production of leaf in relation to the root, especially in the case of Swedes, but the variation thus induced is not great. The root or bulb is to be regarded as a vegetative part of the plant just as much as the leaf; the true physiological maturity does not set in until the second season, when the production of the seed takes place. The Rothamsted mangold plots afford a good illustration, and Table XXIV. shows the production of root and leaf and the relation between them for several plots which vary in the amount of nitrogen supplied, in 1900, a year when a very uniform plant was obtained.

TABLE XXIV.—EFFECT OF INCREASING NITROGEN SUPPLY ON RATIO OF ROOT TO LEAF. ROTHAMSTED.

Plot.	Nitrogen supplied, lb. per acre.	Mangolds, 1900.			Swedes, 1908.		
		Root. Tons.	Leaf. Tons.	Root Leaf	Root. Tons.	Leaf. Tons.	Root Leaf
4O	0	8.75	1.10	8.0	4.07	1.51	2.7
4A	86	28.95	3.25	8.9	11.48	5.63	2.0
4AC	184	43.20	6.30	6.9	11.65	10.94	1.1

The proportion of leaf is a little greater with the excessive dressings of nitrogen applied to the last two plots, but the variations are not great nor closely parallel to the supply of nitrogen. When Swede turnips were sown on the same plots in 1908 the increase of leaf with the greater nitrogen supply was much more manifest, as is shown in the last three columns of the table.

The effect of the large amounts of nitrogen upon the vegetative development of the plant is more dis-

tinctly seen in a prolongation of growth far into the autumn; on the plots receiving little or no nitrogen the leaves turn yellow and begin to fall in early October, when the mangolds on the high nitrogen plots are still putting out fresh growths of green leaves and showing no signs of entering into a resting period. It is hardly possible to illustrate this effect by figures, but analysis of the mangolds from these plots demonstrate the preponderance in the roots grown with excess of nitrogen of such unelaborated materials as the nitrates, amides, and reducing sugars, associated also with a higher proportion of water.

TABLE XXV.—COMPOSITION OF BARN FIELD MANGOLDS, 1902.

Plot.	Nitrogen per acre in Manure.	Dry Matter.	Cane Sugar.	Reducing Sugar.	Glucose × 100. + Cane Sugar.	Nitrogen.		
						Total.	As Amide.	As Nitrate.
	Lb.							
4O	0	15.62	10.80	0.20	1.85	0.1192	0.0263	0.0020
4A	86	12.98	8.49	0.32	3.77	0.1336	0.0320	0.0023
2O	200	13.73	8.86	0.30	3.39	0.1388	0.0427	0.0158
2A	286	12.47	7.78	0.19	2.44	0.1902	0.0651	0.0148
4AC	184	12.78	8.11	0.19	2.34	0.1615	0.0514	0.0153
4C, Aug. 28/03	98	11.74	7.11	0.16	2.25	0.1507	0.0331	0.0155

In November the roots grown with excess of nitrogen approximate in composition to normally manured roots taken in August, when still growing vigorously.

One of the most important effects upon plants of an excess of nitrogen is their increased susceptibility to fungoid attacks of all kinds; for example, rust is always much more abundant upon wheat which has been heavily manured with nitrogen, just as it appears

on normally manured wheat whenever the character of the season has been such as to induce a specially rapid production of nitrates while the plant was making its growth, as when great heat and moisture come together in May. In seasons when rust is prevalent the high nitrogen plots at Rothamsted are always markedly the more rusty, and can easily be picked out by their colour; the grass plots are also marked by their special rusts; and, again, such a characteristic grass fungus as *Epichiloe typhina* is generally common enough on the high nitrogen plots but absent from the others. But susceptibility to disease brought about by an excess of nitrogen is perhaps most strikingly seen at Rothamsted on the mangold plots, though the mangold is a plant which, as a rule, suffers but little from fungoid attacks. In September, however, the leaves of the mangolds at Rothamsted that receive an excess of nitrogen begin to be attacked by a leaf spot fungus, *Uromyces betae*, which develops rapidly until on the worst plots all the larger leaves turn brown and present a burnt-up appearance, because the spots of destroyed leaf tissue have become so numerous as to run together. Where the application of nitrogen has been less heavy but is still high, the severity of the attack is diminished, while the fungus is entirely absent from the leaves of the normally manured plots, although they are in close proximity and equally exposed to infection. The association of high nitrogenous manuring with susceptibility to disease may be seen in all plants; it is often very manifest in greenhouses where crops are grown in specially rich soil, nitrifying very rapidly owing to the high temperature prevailing. The dark green aspect of the leaves of such plants is generally evidence of the excessive amounts of nitrogen they are receiving, and it is well known that if any fungoid disease makes

its appearance it is very difficult to keep in check and often destroys the whole crop with great rapidity; as, for example, has been the case with the leaf spot fungus *Cercosporium melonis*, which has of late years proved so destructive to cucumbers grown under glass.

Various attempts have been made to get a little nearer to the cause of this association of high nitrogenous manuring with susceptibility to disease. In the first place, certain physical differences can be traced in the tissues of the plants; just as high nitrogen results in a weakness of straw in cereals, due to a long-jointed soft stem, so the cuticle of the leaf and the cell walls of the leaf tissue are measurably thinner when the plant has been grown with an excess of nitrogen. The cause is, however, more probably to be found in some alteration in the composition of the cell sap, which renders it a better medium for the growth of the fungus in question. It has been found, for example, that spores of the *Uromyces betae* will grow freely upon a bruised surface of the mangold leaves grown with excess of nitrogen, but make no headway when sown upon a similarly bruised surface of the leaf of a normally manured plant.

The softness of tissue that is induced by large applications of nitrogenous manure—most markedly by nitrate of soda, because of its immediate availability—is recognised in other ways; for example, cabbages and similar vegetables grown rapidly with nitrate of soda are preferable for immediate consumption because of their tenderness, but in the market they bear a bad reputation, because the same softness of tissue leads to rapid wilting and a faded appearance when the vegetables have been cut for some time and have experienced the usual amount of rough handling in transit.

When various crops are considered in relation to manures, they are found to show considerable differences in their response to the individual elements of nutrition, differences which are only to be ascertained by trial, but which are not determined by the greater or less amount of the fertilising ingredient in question taken up from the soil. For example, Ville introduced the idea that for each plant there is a "dominant" element of fertility, and if the requirements of the plant in this respect are satisfied it is generally capable of obtaining the other necessary constituents from the soil. For wheat, grass, and mangolds, nitrogen is the dominant; under ordinary conditions of farming if the wheat crop is well supplied with nitrogen it is waste of money to give it any phosphatic manure or potash salts, because neither will result in any adequate increase of crop, supposing the soil to show no abnormal deficiencies. Without pushing the idea too far, it may generally be recognised that when the land is in good condition most of our crops require a special, rather than a general manuring; the plant, owing to some peculiarity in its habit of growth, finds a particular difficulty to obtain one of the constituents of its nutriment from the soil; if that weak spot is repaired by the manure employed, the soil will furnish the other essentials for growth. For example, wheat and barley, cereals that are so similar in their general character, demand entirely distinct treatment; under ordinary farming conditions, wheat, as we have stated above, requires an active nitrogenous manure and little else; barley requires comparatively little nitrogen, but is very responsive to a supply of phosphates.

This contrast between wheat and barley is due to the differences in the time and growth of the two plants: wheat is generally grown in the autumn after

a single ploughing, and this light preliminary preparation of the soil is not followed up by any further cultivation except rolling, and possibly a single hoeing. The winter rainfall not only washes away much of the nitrate that may have been present in the soil at the end of the summer, but it also tends to set the soil down into a close mass, in which aëration may become defective. The main growth of the crop takes place also during the early spring months when low temperatures prevail; and all these causes work together to reduce the rate of decay and nitrification, and so keep the soil poorly supplied with nitrates. In consequence, wheat is specially responsive to an early supply of some active compound of nitrogen, such as nitrate of soda or sulphate of ammonia. But apart from this difficulty in obtaining nitrogen, wheat possesses a very extensive root system and also has a comparatively prolonged period of growth, by which means it is able to satisfy its requirements for potash and phosphoric acid, even on comparatively poor land.

Barley, on the other hand, is a comparatively shallow-rooted crop, occupying therefore a much more restricted layer of soil, and possessing but a short period of growth; it has not the same opportunity as wheat to search for phosphates, and thus becomes specially dependent upon an artificial supply. Barley, further, makes its chief growth at rather a later date in the spring than wheat does; the land receives a spring cultivation before the barley is sown and the tilth is not destroyed by the winter rains. Thus the nitrification of the natural reserves of the soil can count for much more in the nutrition of barley, and in consequence external supplies of nitrogen are rarely required.

Swede turnips afford another example of a crop comparatively indifferent to nitrogenous manuring,



although large amounts of nitrogen, 100 to 150 lb. per acre, are taken up from the soil. The turnip is a shallow-rooted crop possessing a considerable development of small fibrous roots, but which are confined to a surface layer of restricted depth; as a rule, the crop is grown with a moderate dressing of farmyard manure and 4 to 5 cwts. per acre of phosphates. When farmyard manure is not used,  $\frac{1}{2}$  cwt. per acre of sulphate of ammonia or its equivalent is found to be enough nitrogenous manure; and in the south and east of England even that is sometimes omitted when the land is in good heart. But the land receives a very thorough preparation during the spring months before the seed is sown, so that the fine seed-bed has already been enriched by an accumulation of nitrates, the production of which has been greatly stimulated by the working and aëration of the soil. The seed is not sown until the end of May or early June, by which time temperatures are high and nitrification very active, and the growth of the crop is accompanied by continual hoeing and working of the land between the rows. There thus continues to be produced in a rich soil sufficient nitrates for the requirements of the crop, and large external supplies in the manure are unnecessary. Mangolds, on the contrary, are a much deeper rooted plant, are sown earlier and generally on stronger soils less adapted to rapid nitrification, and are found by experience to require a far greater supply of nitrogenous manure.

One of the most important questions to be settled in connection with nitrogenous manures is their relative availability and rapidity of action. It has already been stated that the nitrates are both soluble and can be taken up without further change by the plant; the ammonium salts as a rule require to be nitrified, but

this action is speedy in normal soils, whereas the organic compounds of nitrogen have to undergo several successive processes of bacterial breaking down before they reach the plant, so that some of them, like straw and the residues of protein digestion, may remain for a very long period in the soil before their nitrogen becomes converted into nitrate.

It is important for the farmer to know what return he may expect from a given nitrogenous manure in the year of its application, and whether the nitrogen which is not recovered by the first crop may be expected to become available in the next or following seasons. It is necessary even to put a money value upon the residues left behind in the soil after the first crop has been grown with the manure, because a tenant leaving his farm is entitled to compensation for the unexhausted fertility he has thus added to the soil but has had no opportunity of cropping out.

A large number of investigations have been made as to the relative value of nitrogen combined as nitrate of soda and sulphate of ammonia; but it has already been explained in the preceding chapter that the comparative effect of nitrogen from these two sources will be determined by a variety of external conditions, such as the crop under consideration, the amount of calcium carbonate in the soil, the supply of potash, dormant or available, and the effect of the manures upon the tilth of the soil; in consequence, no general answer is possible that will apply to all cases. From the Rothamsted experiments it is found that nitrate of soda affords the better source of nitrogen for wheat, grass, and mangolds, the superiority amounting on the average to about ten per cent.; but that, for barley, potatoes, and turnips, the two manures are of equal value, nitrogen for nitrogen.

While these results might not be exactly borne out on other soils, it will be within the limits of ordinary error to conclude that, for equal amounts of nitrogen, nitrate of soda possesses a slightly greater value than sulphate of ammonia, but that the choice between the two should be dictated by the relative price of the nitrogen per unit, the nature of the crop, and the amount of carbonate of lime in the soil. Since sulphate of ammonia contains approximately 20 per cent. of nitrogen against 15 per cent. in nitrate of soda, the relative prices of the two manures ought to be in the ratio of 3 to 4; if sulphate of ammonia is £12 per ton, nitrate of soda, to yield an equivalent value of nitrogen, ought not to cost more than £9 per ton; if nitrate of soda is £10 per ton, the equivalent value of sulphate of ammonia would be £13, 6s. 8d. per ton. For mangolds, nitrate of soda should certainly be chosen, unless the advantage in price is largely on the side of the sulphate of ammonia, because of the great value of the soda base in rendering available the dormant potash so much required by the mangold. On soils short of lime, and especially if they have any tendency to become acid, nitrate of soda will always be preferable; and again, when extra large quantities of nitrogenous fertilisers are to be used, as is sometimes the case in market-garden work. For barley, sulphate of ammonia is preferable, because of the better quality it produces; on the light soils also it should have the preference, provided they are properly supplied with carbonate of lime.

But undoubtedly the best plan is to use a mixture of the two fertilisers; there is then nitrate for the immediate use of the crop, and yet no great excess of salt remains, with the risk of its being washed down below the range of the plant's roots in the soil water;

the nitrification of the ammonia continues the supply of nitrate at a later stage, and the injurious effects upon the soil of the two manures, nitrate of soda as a producer of alkali, and sulphate of ammonia as causing acidity, neutralise one another.

Several of the organic compounds of nitrogen, such as those contained in Peruvian guano, rape cake, and dried blood, are almost as active sources of nitrogen as the salts of ammonia, especially when used continuously, so that the residues left in any one year are available for succeeding crops. For example, the Rothamsted barley plots receive equal weights of nitrogen as nitrate of soda, sulphate of ammonia, and rape cake; and as the following table shows, the returns from the rape cake are but little below those from the other two manures.

TABLE XXVI.—NITROGENOUS MANURES WITH MINERALS.  
AVERAGE YIELD OF BARLEY (1852-1901). ROTHAMSTED.

Plot.	Manuring.	Grain.	Straw.
		Bushels.	Cwts.
4A	Ammonium Salts = 43 lb. N. . . . .	42·1	25·0
4N	Nitrate of Soda = 43 lb. N. . . . .	43·6	27·4
4C	Rape Cake = 49 lb. N. . . . .	41·0	24·5

These results do not, however, show how much return from the given manure is obtained in the year of application, but from other of the Rothamsted plots we learn that on such a soil neither nitrate of soda nor ammonium salts leave any appreciable residue behind. On the wheat field, two of the plots receive in alternate years either 400 lb. of ammonium salts or a mixture of complete mineral manures; so that in any year there is one plot with the ammonium salts and the residue of the previous year's minerals, and another with mineral

manures and a residue of ammonium salts. The results are set out in Table XXVII., the basis of comparison being a third plot, which receives both the ammonium salts and the mineral salts in the same year, and a fourth plot, which never receives any ammonium salts, but the minerals every year.

TABLE XXVII.—RESIDUAL EFFECT OF MANURES,  
ROTHAMSTED. WHEAT (1852-1902).

Plot.	Manuring.	Grain.	Straw.
		Bushels.	Cwts.
7	400 lb. Ammonium Salts and Minerals . . . . .	32.9	33.0
17	400 lb. Ammonium Salts and Mineral Residues . . . . .	30.4	29.5
18		Minerals + Residues of 400 lb. Ammonium Salts . . . . .	15.3
5	Minerals only . . . . .	14.9	12.2

Thus the residue from the ammonium salts applied in the previous year only raises the yield by 0.4 bushel of grain and 0.9 cwt. of straw above the yield of the plot which never receives any nitrogen, whereas the application of fresh ammonium salts on Plot 7 causes an increase of 18 bushels of grain and 20.8 cwt. of straw. On the other hand Plot 17, with the residues of mineral manures applied in the previous year, only falls behind Plot 7 to which they had been applied in the same year, by 2.5 bushels of grain, and 3.5 cwt. of straw.

A very similar experiment is included among the Woburn plots, the only difference being that there the minerals are put on every year, and that the trials are also repeated with nitrate of soda.

Table XXVIII. shows the average results for the five years, 1882-86, from which it will be seen that the ammonium salts left behind considerable residues which

were of service to the succeeding crop, while little benefit was derived from the preceding year's application of nitrate of soda. With barley the residues from both manures were more pronounced.

TABLE XXVIII.—EFFECT OF NITRATE OF SODA AND AMMONIUM SALTS APPLIED IN THE PREVIOUS YEAR. WOBURN (1882-1886).

Plot.	Manuring.	Wheat.	Barley.
		Bushels.	Bushels.
4	Minerals only . . . . .	18·3	24·6
8a	Minerals + Residue of Ammonium Salts . . . . .	20·4	37·0
8b	Minerals + Ammonium Salts . . . . .	42·8	55·5
9a	Minerals + Residue of Nitrate of Soda . . . . .	17·1	34·5
9b	Minerals + Nitrate of Soda . . . . .	40·9	59·9

This essential difference in the results at Rothamsted and Woburn arises from two causes; in the first place, the soil at Woburn is very deficient in carbonate of lime, indeed at a later date than the period from which the figures in the table are quoted the soil of the barley plots had become so acid that the crop would no longer grow. Under these conditions nitrification will be very slow and some of the ammonium salts will be retained unchanged in the soil until the following season, instead of nitrifying and so getting into a form that will wash through the soil. Thus the ammonium salts will leave a much greater residue than the nitrate; that the latter has any effect in the following season must be set down to the texture of the fine sandy loam at Woburn, which admits of a much greater capillary rise of the soil water than is possible in the close Rothamsted soil, with the result that some of the nitrates which have been washed down during the winter are brought back to the surface.

In the main, however, it will be safer to regard the fertilising effect of both sulphate of ammonia and nitrate of soda as confined to the season of their application; the only residues they leave behind being due to the increased root and stubble left in the land and the extra nitrogen in the crop, some of which, *e.g.*, the nitrogen in the straw or the roots grown, does remain on the farm as a permanent addition to the stock of fertility.

Wagner of Darmstadt has made a very extensive series of comparisons of various nitrogenous manures based upon experiments in pots, and from them has compiled the following table, showing the comparative recovery in the crop of 100 of nitrogen supplied in each fertiliser.

TABLE XXIX.—RETURN IN CROP FOR 100 NITROGEN APPLIED AND RELATIVE VALUE WHEN NITRATE OF SODA = 100. WAGNER.

Nitrate of Soda . . . .	82	100
Ammonium Salts . . . .	77	94
Peruvian Guano . . . .	71	87
Green Plants . . . .	63	77
Horn Meal . . . .	61	74
Dried Blood . . . .	60	73
Castor Cake . . . .	60	73
Wool Dust . . . .	21	26
Cow Dung . . . .	18	22
Leather Meal . . . .	13	16

These results are, however, based upon the results of pot experiments, which, because of the rapid variations of temperature and the comparative concentration of manures employed, are always somewhat unfair to organic manures, especially to the bulky ones coming at the lower end of the scale.

Experiments have been carried out of late years at Rothamsted to examine the question from a slightly different point of view by means of field plots. The

scheme of experiment is to take four plots for each manure ; one receives the manure in any particular year, while the others remain unmanured except for the residues that may remain from a similar application that had been made one, two, and three years previously, a fifth plot continuously unmanured being employed as a check.

The experiments have not been in progress long enough to enable exact results to be obtained, especially as regards the residues remaining in the second or third year after the application, but the following figures show the kind of return which may be anticipated. In order to eliminate the effect of season and crop, the increase given by a residue is always compared with the increase brought about by a fresh application of the same manure, which increase is reckoned as 100.

TABLE XXX.—INCREASED YIELD DUE TO RESIDUES OF NITROGENOUS MANURES COMPARED WITH INCREASE PRODUCED IN FIRST YEAR. ROTHAMSTED.

	Year of Application.	Second Year.	Third Year.
Dung . . . .	100	46	37
Wool Waste . . . .	100	79	38
Peruvian Guano . . . .	100	12	12
Rape Cake . . . .	100	9	2

Thus rape cake, a manure which we have seen to be comparatively active, leaves behind for the following year a very small residue, having only 9 per cent. of the effect of a fresh application of manure ; whereas a wool shoddy increases the crop in the second year by as much as 79 per cent. of the increase produced by a fresh application of the same manure, and even after two crops have been removed the residue is still one-third as effective as a fresh application.



From many of the Rothamsted experiments it is possible to calculate how much of the manure applied year after year has been eventually recovered in the crop; with the mangold crop it will be shown later that (Table LXIII.) 78 per cent. of the nitrogen applied as nitrate of soda was recovered in the crop, the percentage falling to 71 for rape cake, 57 for ammonium salts, and only 31 per cent. for dung. When manures were applied to plots which were also enriched with dung the recovery was less in all cases, the usual law of diminishing returns coming into play.

It cannot be said that the conclusions which may be drawn from these results as to the relative availability of different compounds of nitrogen are in any way endorsed by their price in the market, or by the general opinions of farmers. From the experimental point of view the value of the different compounds of nitrogen, unit for unit, ought to be proportional to their availability; a slow-acting manure not only involves a delay in realising the capital that has been put into the land, but much of the residue is never recovered at all. Notwithstanding this the farmer has a strong preference, to which credit must be given as founded upon experience, for the organic sources of nitrogen; furthermore, prices fluctuate in accordance with accidents of supply that are quite independent of agriculture. For example, the relative value of nitrogen in nitrate of soda and sulphate of ammonia, which may be regarded as equally valuable in farming opinion, has fluctuated widely of late years; on occasion the nitrogen in sulphate of ammonia has been the dearer of the two, while at other times it has been so much the cheaper that the price per ton of sulphate of ammonia, with 20-21 per cent. of nitrogen, has fallen below that of nitrate of soda with 15-16 per cent. of nitrogen. The

unit of nitrogen in dried blood is always expensive, because of the limited supply of this material and the special value to manure manufacturers it possesses for compounding purposes; in rape cake, nitrogen is also greatly above the average price, because of the comparatively short supply of this manure. Again, in Peruvian guano the unit of nitrogen always costs more than in the average run of manures, whereas in fish and meat guanos it ranges at almost the same price as in sulphate of ammonia. Finally, in all the shoddies and waste materials of that nature the price of the unit of nitrogen is extremely variable, a large proportion being made up by the cost of carriage of so bulky a material, but, as a rule, it will not be more than one-half of the price asked for nitrogen in its more available forms. At the time of writing, the unit of nitrogen in Peruvian guanos costs about 18s. and rather more in dried blood and rape dust, in fish guano about 17s., in nitrate of soda about 16s., in meat guano about 14s., and in sulphate of ammonia about 13s., while shoddies can be obtained in which it costs as little as 6s.

Putting aside shoddy, it is thus seen that the farmer is prepared to pay more for nitrogen in any form of organic combination than in its inorganic salts, though all the experimental evidence goes to show that the latter give the larger and speedier returns in the crop.

What, then, is the origin of this strong prejudice of the farmer in favour of an organic source of nitrogen, the prejudice which is further seen in the common description of nitrate of soda and sulphate of ammonia as stimulants or even "scourges" of the soil, rather than plant foods? Of course, no purely nitrogenous substance is a complete manure; cropping with one alone must eventually exhaust the land of phosphoric acid or

potash ; but, as has already been shown, the reserves of such materials in the soil are so large that long-continued cropping would be needed to deplete them seriously.

Some other source must be found for the farmer's prejudice, and its true cause is probably the manner in which organic manures improve the tilth of the soil by maintaining the stock of humus, whereas sulphate of ammonia, and particularly nitrate of soda, injure it. The importance of this factor of tilth will be more realised when we remember that nearly the whole of the farmer's labour in spring is directed towards obtaining a fine seed-bed for such crops as barley and roots. Furthermore, if the weather conditions are adverse to the start of the crop, the eventual yield will depend more upon the condition of the seed-bed than upon any other factor.

The potent effect of organic manures in promoting a good tilth is very clearly shown by the Rothamsted experiments upon mangolds, where the nitrogenous manures are nitrate of soda, sulphate of ammonia, and rape cake respectively. In a good season the nitrate of soda is the most effective manure ; but taking an average over the whole period, rape cake shows a great superiority, simply because of the difficulty of getting a full plant upon the other plots. Though all the plots are cultivated in the same way and at the same time, the condition of the soil has become so bad where purely inorganic manures have been used, that only in favourable seasons is what a farmer would call a good plant obtained on the nitrate and the ammonia plots, whereas the rape cake plot starts regularly enough. On three occasions the plant has completely failed on the ammonia and nitrate plots. Even in the other years there are great deficiencies, as shown by the average

number of plants counted on each plot, which is set out in Table XXXI.

TABLE XXXI.—EFFECT OF MANURES UPON THE NUMBER OF ROOTS.  
ROTHAMSTED MANGOLDS, 1876-1902.

Plot.	Manures	Average Crop per acre.	Average Number of Roots per acre.
		Tons.	Number.
4C	Complete Minerals with Rape Cake . . . . .	21.3	17,474
4A	Complete Minerals with Ammonium Salts . . . . .	14.9	14,802
4N	Complete Minerals with Nitrate of Soda . . . . .	18.0	14,130

In ordinary farming the effect upon the soil is never likely to become so pronounced as in these experiments at Rothamsted, but without a doubt a considerable element in the extra value which the farmer sets on organic nitrogen must be put down to its improvement of the texture of the soil, a factor the farmer rightly regards as of the first importance.

## CHAPTER IV

### PHOSPHATIC MANURES

The Phosphates of Calcium—The Early Use of Bones as Manure—Preparation of Bone Meal and Steamed Bone Flour—Dissolved Bones and Bone Compounds—The Discovery of Mineral Phosphates, Coprolites, Phosphorite, Phosphatic Guanos, Rock Phosphates—The Invention of Superphosphate, Lawes and Liebig—The Manufacture of Superphosphate—The Manufacture of Basic Slag—Nature of the Phosphoric Acid Compounds in Basic Slag: their Solubility in Dilute Acid Solutions—Basic Superphosphate—Wiborg Phosphate—Wolter Phosphate.

ALTHOUGH the fertilising effect of bones, in common with most other substances of animal origin, had been known in an empirical way for a very long time, the efficacy was generally put down to the oil they contained, and it was only at the close of the eighteenth century that attention became fixed on the phosphoric acid.

Lord Dundonald, in his *Treatise on the Connection of Agriculture with Chemistry*, published in 1795, had arrived at a very sound perception of the case. When treating of phosphate of lime, he writes that it "is contained in animal matters, such as bone, urine, shells, etc., in some sorts of limestone, and in vegetable substances, particularly in the gluten, or the vegeto-animal part of wheat and other grain. It is a saline compound, very insoluble. There is reason to believe a very

considerable proportion of this nearly insoluble salt is contained in most fertile soils. . . . These alkaline phosphates (potash and soda) will be found to promote vegetation in a very great degree, the substance of which they are composed, viz., alkaline salts and phosphoric acid, are found in the ashes of most vegetables." Again, Kirwan writes in 1796 about the constituents of plants: "Phosphorated calx is found in greatest quantity in wheat, where it contributes to the formation of animal gluten. . . . Hence the excellence of bone ashes as a manure for wheat. . . ." Finally, de Saussure, in his *Recherches Chimiques sur la Végétation*, published in 1804, writes: "Le phosphate de chaux contenu dans un animal, ne fait peut-être pas la cinquième partie de son poids: personne ne doute cependant qu ce sel ne soit essentiel à la constitution de ses os. J'ai trouvé ce même sel dans les cendres de tous les végétaux où je l'ai recherché, et nous n'avons aucune raison pour affirmer qu'ils puissent exister sans lui." This opinion was repeated by Davy, and adopted and disseminated by Liebig, by which time various other experimenters had reached the conclusion that the mineral and not the organic matter contained in bones was their chief fertilising constituent.

Since all the phosphatic manures which possess any practical importance are phosphates of calcium, it is necessary to discuss these compounds a little before proceeding further. The phosphatic material which is most widely disseminated, occurring in all the primitive crystalline rocks and occasionally found massive, is the true crystalline mineral apatite,  $\text{Ca}_5(\text{PO}_4)_3\text{F}$ , in which the fluorine atom may be wholly or partially replaced by chlorine. This is a definite crystalline compound, the undoubted source of all the other compounds of phosphoric acid, but being very hard and difficult of

solution in acids it is little used in manure-making. The typical phosphate of lime, which is regarded as the starting-point for the manures, is the tricalcium phosphate  $\text{Ca}_3\text{P}_2\text{O}_8$ , which is supposed to exist in bone ash and in the natural uncrystalline phosphate rock, such as is mined in Algeria or Florida. It is, however, doubtful if such a phosphate really exists in any stable condition; it has been shown that bone ash and such phosphates, when treated with water, continue to yield a little phosphoric acid to solution and become more and more basic; crystals of the composition  $\text{Ca}_3\text{P}_2\text{O}_8$  do not exist, nor can a substance corresponding to this formula be precipitated. This, however, is an academic question; in all dealings with manures tri-calcium phosphate is supposed to exist, and whatever the actual compound in the manure may be, the quantity of phosphoric acid is always expressed as if it were combined as tri-calcium phosphate. Thus 310 parts of calcium phosphate are equivalent to 142 parts of phosphoric acid, hence whatever the percentage of phosphoric acid found by analysis it is multiplied by 2.18  $\left( = \frac{310}{142} \right)$  and expressed as percentage of tri-calcium phosphate. This puts all phosphatic manures on an equal basis and enables a comparison to be made of one against the other, just as would the percentages of phosphoric acid which are really obtained by analysis, but which are not in favour with manufacturers because, being so much smaller numbers, they seem to give the manure too poor a showing.

When a solution of phosphoric acid, such as is obtained by treating any of the natural phosphates with sulphuric or hydrochloric acid, is precipitated with lime water, a salt of the composition  $\text{CaHPO}_4$ , di-calcium hydrogen phosphate, is obtained, and this is a perfectly stable and definite compound. It sometimes comes on

the market as precipitated phosphate; it is also known as retrograde or reverted phosphate, because it arises when the soluble compound next to be described, "superphosphate," passes into the insoluble condition. When tri-calcium phosphate is treated with such an amount of sulphuric acid as is required to combine with two out of the three lime radicles in the molecule, a mixture is obtained of gypsum and of soluble mono-calcium phosphate,  $\text{CaH}_4\text{P}_2\text{O}_8$ , which is known as superphosphate. Some uncertainty may still be supposed to exist as to the exact identity of this compound, but in practice a readily soluble mixture of phosphoric acid and lime in something like these proportions does get formed, and the reactions of this solution are explained accurately enough by the formula  $\text{CaH}_4\text{P}_2\text{O}_8$ . Soluble phosphoric acid itself,  $\text{H}_3\text{PO}_4$ , also exists, and some is always supposed to be present in a free state in superphosphate.

It has already been mentioned that by the continued treatment of ordinary insoluble phosphates with water a more and more basic phosphate is formed, to which Warington gave the formula  $(\text{Ca}_3\text{P}_2\text{O}_8)_2\text{Ca}(\text{OH})_2$ ; and a definite phosphate of this type,  $\text{Ca}_4\text{P}_2\text{O}_9$  or  $4\text{CaO}, \text{P}_2\text{O}_5$ , has been isolated in crystals from basic slag and may be supposed to mark the compound of lime and phosphoric acid which is stable at high temperatures. It is this tetra-calcium phosphate which is supposed to constitute the greater part of the phosphoric acid compounds of basic slag, but little is really known of its existence.

Of the phosphatic manures, the earliest and for a long time the only ones to be employed on a large scale were those derived from bones. It would be impossible to attribute the discovery of the fertilising value of bones to any individual; in common with all other waste materials of animal origin, they were prob-



ably tried and appreciated by numbers of people in all ages and countries; they are mentioned by Blithe in 1653, Evelyn in 1674, and Worlidge in 1668, and by the close of the eighteenth century their use was becoming common in the neighbourhood of all the great towns. Arthur Young mentions the use of the waste from the making of knife-handles near Sheffield, and again enumerates bones as one of the substances the Hertfordshire farmers were in the habit of bringing back from London when their carts had been delivering hay or grain. A Mr St Leger writes to Dr Hunter of York (edition of Evelyn's *Terra* published in 1778): "I also dressed an acre of grass ground with bones in October 1774, and rolled them in. The succeeding crop of hay was an exceeding good one. However, I have found from repeated experience that upon grass ground this kind of manure exerts itself more powerfully the second year than the first. It must be obvious to every person, that the bones should be well broken before they can be equally spread upon the land. No pieces should exceed the size of marbles . . . At Sheffield it has now become a trade to grind bones for the use of the farmer."

It was in the early years of the nineteenth century, however, that the demand began to grow; and it received a considerable impetus from the introduction, probably first of all in Yorkshire, of machines for reducing the bone into half- or quarter-inch fragments, or even into powder. By 1815 the home supply was proving insufficient, and bones began to be imported from the Continent in rapidly increasing quantities until nearly 30,000 tons per annum were brought in, chiefly from Europe—a demand which is said to have resulted in the ransacking of many of the battlefields. In this connection a characteristic outburst of Liebig's has often been

quoted: "England is robbing all other countries of their fertility. Already in her eagerness for bones, she has turned up the battlefields of Leipsic, and Waterloo, and of the Crimea: already from the catacombs of Sicily she has carried away the skeletons of many successive generations. Annually she removes from the shores of other countries to her own the manurial equivalent of three million and a half of men, whom she takes from us the means of supporting, and squanders down her sewers to the sea. Like a vampire she hangs upon the neck of Europe, nay, of the whole world, and sucks the heart blood from nations without a thought of justice towards them, without a shadow of lasting advantage to herself!"

For a time the importations fell off, but with the growth of the artificial manure trade and the opening up of India and South America as sources, the amounts introduced increased enormously, though since the discovery of basic slag and the cheapening of mineral phosphates, they have been falling greatly again for the last fifteen or twenty years. In 1906 the imports amounted to 42,600 tons, the home production being estimated at about 60,000 tons, so that they still form a very important part of the fertiliser trade, even if they no longer retain their old pre-eminence.

Bones are but rarely used for manure in their raw condition as they are received from the collectors; in nearly all cases they are put through one or more steaming processes. The raw bone consists of a mineral framework, amounting to 70 per cent. or so of the dry bone and consisting in the main of phosphate of lime, which, together with a little carbonate of lime, is left behind when the bone is burnt, as in bone ash. The whole of the mineral framework is permeated by cartilage consisting of nitrogenous compounds—

collagen, chondro-mucoid, etc.—which are insoluble in acids and are left behind in a soft tough condition if the bone be put to soak for some time in weak acid. Mixed with the cartilage is a certain amount of fat, and the first treatment the bones receive is to steam them under a pressure of 15 to 20 lb. in order to melt and remove the fat, which is sold as tallow or used for soap-making forthwith. In some cases the fat is extracted even more thoroughly by the action of benzene. The boiled or steamed bones thus obtained contain 4 to 5 per cent. of nitrogen and 43 to 50 per cent. of calcium phosphate, and are ready for conversion into manure. They are sometimes merely crushed into  $\frac{1}{2}$ -inch or  $\frac{1}{4}$ -inch bones, though there is no longer much demand for material so coarse; more generally they are ground down into “bone meal.” A really fine powder is, however, rarely obtained, because the cartilage interferes materially with the disintegration unless special methods are employed. It is this crushed material which is also treated with sulphuric acid for the manufacture of “dissolved” or “vitriolised” bones. In factories making glue the cleaner bones are picked out, and, after the fat extraction, they are broken up and steamed afresh at a much higher pressure and temperature, 50 to 60 lb. to the square inch, by which process the collagen takes up water and becomes converted into gelatine, which dissolves. The solution is concentrated and allowed to set, when it becomes glue: the bone residue, which now contains only 1 to 1.5 per cent. of nitrogen but 55 to 60 per cent. of calcium phosphate, is ground and sold as “steamed bone flour.” Owing to the removal of the cartilage, this material can be ground finely, and forms a dry friable powder very convenient for use as a manure.

The coarser kinds of bone meal are converted into

dissolved bones by being mixed with enough sulphuric acid (see p. 124) to convert about half the phosphates into a soluble condition; steamed bone meal is also often treated with acid, but the product is not regarded by the trade as dissolved bones, but should be called soluble bone compound or some other name not implying that it has been made from unchanged bones and acid only.

There are thus four classes of bone fertilisers—(1) the bone itself deprived of fat and crushed into the state of  $\frac{1}{2}$ -inch or  $\frac{1}{4}$ -inch bones or bone meal; (2) steamed bone flour, from which most of the nitrogenous material has been removed; (3) dissolved bone consisting of No. 1 treated with acid; (4) bone compound, generally consisting of No. 2 treated with acid and perhaps fortified with nitrogen from some extraneous source. Table XXXII. shows a number of typical analyses of these substances.

Bone meal, by far the most abundant of these products, is a somewhat gritty powder with a strong and distinctive smell, which should not contain less than 45 per cent. of calcium phosphate. The percentage of nitrogen is more variable: good fresh English samples sometimes show 5, but 4 per cent. is good, and Indian samples which have been much weathered and are a little decayed fall to 3 or even lower; this nitrogen is not present in a very active form, the cartilage being slow to decompose in the soil. Of the phosphates in bones about one-half can be dissolved on shaking up 1 gramme of the bone meal with 1 litre of 1 per cent. citric acid solution, which would show that the phosphoric acid is easily available. However, there is plenty of experimental evidence that bone meal is rather slow acting as a source of phosphoric acid, probably because of its comparative coarseness and the consequent small surface of the manure

particles offered to the solvent action of the soil water ; and it is the appreciation of this fact, and the rise of other phosphatic manures like basic slag, which have caused the decline in recent years of the popularity of

TABLE XXXII.—COMPOSITION OF BONES AND BONE MANURES.

	Nitrogen.	Phosphoric Acid.	Equivalent to Tri-calcium Phosphate.	Phosphoric Acid.	Equivalent to Tri-calcium Phosphate.
<b>RAW BONES:—</b>					
Not degreased . . .	4.45	20.14	43.98	...	...
" " " " . . .	5.01	22.00	48.03	...	...
" " " " . . .	4.06	23.36	51.01	...	...
<b>BONE MEAL:—</b>					
Fat extracted . . .	4.94	22.81	49.80	...	...
" " " " . . .	5.17	22.46	49.03	...	...
Steamed . . . . .	4.59	22.09	48.23	...	...
" " " " . . .	4.50	21.48	46.92	...	...
Indian . . . . .	3.35	23.19	50.62	...	...
" " " " . . .	3.6	22.6	49.35	...	...
<b>STEAMED BONE:—</b>					
Meal . . . . .	0.93	29.02	63.36	...	...
Flour . . . . .	1.34	28.27	61.72	...	...
" " " " . . .	1.04	31.5	68.76	...	...
<b>DISSOLVED BONES:—</b>					
From raw bone . . .	2.92	Soluble.		Insoluble.	
" " " " . . .	3.21	5.59	12.2	11.57	25.25
" " " " . . .	3.44	5.10	11.64	12.23	26.69
" " " " . . .	2.96	4.84	10.54	11.06	24.12
" " " " . . .	2.96	6.91	15.08	10.40	21.93
" " " " . . .	3.47	7.84	17.13	9.44	20.62
" boiled bone . . .	1.33	4.58	9.99	8.28	17.90
" " " " . . .	1.42	8.96	19.55	3.83	8.38
<b>BONE COMPOUND . .</b>	<b>0.82</b>	<b>8.5</b>	<b>18.55</b>	<b>5.2</b>	<b>11.35</b>

bone meal. It was, however, bones in their even coarser form—merely roughly broken, sometimes by hand on the farm—which built up the fertility of much English land, as, for instance, the famous dairy pastures of Cheshire, which were made during the early years

of the nineteenth century. Large dressings of bones were employed—a ton or more per acre—and the application was expected to last for twenty years, little return being obtained during the first year or two; for this reason the landlord contributed freely to the cost of boning, even if he did not pay for it entirely. The pastures improved steadily after the dressing of bones; in particular, such a growth of white clover was encouraged that farmers began to suspect the manure contained clover seed, a supposition which was repeated fifty years or more later when basic slag first began to be used on clay pastures. At one time bones and bone meal were subject to a good deal of adulteration, often of the most flagrant description; nowadays, however, there is very little admixture of foreign substances with bone meal. Occasionally mineral phosphates may be used to raise the percentage of phosphoric acid, or the bone meal may be represented as richer than it is, but these frauds are at once detected on analysis, which indeed should never be omitted because of the natural variations in the material.

If bone meal is still somewhat overvalued on account of the long experience farmers have had of its value, on the other hand, steamed bone flour hardly gets justice done to it. Its deficiency in nitrogen is regarded as a defect, but when steamed bone flour is considered merely as a phosphatic manure, its finer grinding and freedom from cartilage render it more available than bone meal ever can be. The experiments of the Highland and Agricultural Society during 1890-1 have shown it to be about the most suitable of all the phosphatic manures for the turnip crop on light soils which are too poor in lime for superphosphate and too short of water for basic slag. For the sands and gravels, a neutral easily soluble manure like steamed bone flour is the best

form of applying phosphates; a mixture of steamed bone flour and superphosphate left for a few days in the mixing shed and then broken down again is also very useful on such land.

Dissolved bones also represents a manure which at one time had a much greater vogue than it possesses at the present day, when it is no longer admitted that superphosphate made from bone possesses any superiority over the same compound made from mineral phosphates, except in so far as the bone manure also contains nitrogen. Dissolved bones or bone superphosphate generally contains from 35 to 40 per cent. of phosphate, of which from 12 to 18 will usually be in a soluble condition; while the nitrogen amounts to about 3 per cent.

Dissolved bones forms a brown mass generally somewhat damp and sticky, and not rubbing down into a convenient powder for sowing; it is, in fact, impossible to get it into a dry friable condition without some admixture of "dryers" like gypsum, which are not considered as admissible. The trade in dissolved bones usually proceeds on a guarantee that it contains pure bones and sulphuric acid only, though it is difficult to demonstrate that such a product possesses any intrinsic superiority over any other manure mixture compounded so as to show the same composition. Such mixtures are furnished by the bone compounds and bone manures, which are often mineral superphosphates mixed with more or less superphosphate made from steamed bone flour, with a little extra nitrogen derived from dried blood, fine shoddy, or even sulphate of ammonia. Such compounds are useful enough if they are cheap; before purchase they should be valued on the basis of their analysis and judged accordingly.

*Mineral Phosphates.*

With the recognition that the fertilising value of bones lay in the phosphate of lime they contained, which we may conclude had become the accepted opinion about 1840, attention began to be directed to mineral sources of phosphate of lime,—apatite and phosphorite, the existence of which had long been known to mineralogists. Acting on an analysis of Proust's, Professor Daubeny and Captain Widdrington made an expedition in 1843 to Estremadura to find a bed of phosphatic rock there reported. They discovered the deposit and secured enough of it for a few field experiments in England in the following year, but difficulties of transport prevented anything more than small quantities being exported until a much later period. The immediate demand for such material was satisfied by the discovery in 1845 by Professor Henslow of the bed of coprolites lying at the base of the Greensand near Cambridge.

These coprolites—small rounded nodules of impure phosphate of lime, mixed with fragments of bone and shell, shark's teeth, etc.—were at one time regarded as fossilised dung, but are now considered to be pebbles of carbonate of lime in which the carbonic acid has been replaced by phosphoric acid by long contact with material containing organic matter. They occur at various horizons in the newer secondary and tertiary rocks, *e.g.*, at the base of the Upper Greensand and at the base of the Gault, and in the Crag, where it rests upon the London Clay. Shortly after their discovery these deposits began to be worked for coprolites at various places in Suffolk, near Cambridge, and at Potton in Bedfordshire. The output reached 50,000 tons or so in the early eighties of the last century, but then rapidly



declined owing to the opening up of so many cheaper foreign deposits, and has of late years entirely ceased. The coprolites formed hard dark-coloured nodules, which were ground down to a grey powder containing from 50 to 60 per cent. of calcium phosphate, about 10 per cent. of calcium carbonate, and 3 per cent. of calcium fluoride. Though occasionally applied directly to the land in a ground form, they were almost wholly used in the manufacture of superphosphate.

Another phosphatic material which is practically mineral and at one time entered into competition with coprolites and bone phosphates as material for the manufacture of superphosphate, consists of these guano deposits in which the nitrogen has been wholly removed or nearly so by the action of rain. Such deposits are found in the West Indies (Aruba, Navassa, Sombrero, Curaçao), the Pacific (Baker, Abrolhos, Christmas, and Ocean Islands), Bolivia (Mejillones), and one or two other places of less importance. The action of the weather, particularly where the climate is not absolutely rainless, is always removing the nitrogenous compounds from guano, so that the proportion of phosphoric acid tends to increase, until even among the Peruvian deposits a guano is found on Lobos Island containing little more than 2 per cent. of nitrogen and 60 per cent. of phosphate of lime. In some of the other deposits that have been enumerated, Christmas Island for example, the nitrogen has entirely disappeared and a phosphate rock is left behind which can only be termed a guano in virtue of its origin. These purely phosphatic deposits, many of which are now exhausted or no longer pay to work, have been so much mineralised that they are not sold as guanos but are employed for the manufacture of superphosphate. However, the Lobos phosphatic guano is still exten-

sively imported, and being naturally soft and in a fine state of division, it can be applied without treatment to the land, and forms one of the most valuable of the neutral phosphates that are so well adapted to light soils. With the exception of the Peruvian deposits and those from the Pacific—Christmas and Ocean Islands, practically none of the other deposits are now worked.

While some of these "crust guanos," as they were termed, contained high percentages of phosphoric acid, the presence of oxides of iron and aluminium in quantity seriously interfered with the use of the Aruba and Navassa rock as material for superphosphate making.

More akin to the English coprolites were the phosphates obtained from France, Germany, and Belgium, where they occur in the secondary and tertiary formations on a more important scale than do the similar deposits in England. Of these materials the most important were the Lahn phosphates, extensively worked for some time after their discovery in 1864, the Belgian phosphates worked near Mons, with 45 to 60 per cent. of phosphate of lime, and the Somme phosphates, of which extensive deposits were found in the north of France, and formed an important source of supply to the manure market about 1890.

The Lahn phosphates fell out of favour because of the large amount of iron and alumina they contained, the Belgian phosphates became of too low grade, but the Somme phosphates remained valuable because they contained in the better grades 70 per cent. or so of phosphate of lime, and only 1 to 2 per cent. of oxides of iron and alumina. They also yielded a very dry and friable superphosphate, and were useful for mixing with the Florida phosphates before treatment with acid. These coprolitic phosphates, however, attain their greatest development in Florida, Tennessee, and South

Carolina. There in many places the subsoil is a sandy deposit full of coprolitic pebbles, which can readily be separated by screens or washing; the beds of the rivers and creeks, again, are wholly composed of the same pebbles, which are recovered by dredging. The land phosphate contains some oxide of iron and alumina, and is chiefly sold in the United States, but the river deposits have been particularly valued in Great Britain for superphosphate making, because though they only contained about 60 per cent. of phosphate of lime they were specially free from iron and alumina. About 150,000 tons per annum used to be imported, but of late years the supply has been falling off. The various phosphate deposits in North America yielded in 1901 nearly 1,600,000 tons, of which more than half was exported to Europe.

Just as it is impossible to draw a line between the recently formed true guanos and the weathered deposits which have practically become phosphate rock, so again no real distinction can be made between the guanos and coprolites of known origin and the phosphate-bearing strata which are to be found in many countries and at all geological horizons. Many of these may have originated in guano beds, others are coprolitic, others again are due to solution of phosphate of lime, originally diffused through a great mass of rock, and its concentration in a single layer. In all cases, however, the material has been of animal origin, whatever processes of solution and redeposition it may have suffered since. In the older rocks the phosphate has often become crystalline, forming the hard mineral known as apatite, which is mined on a small scale in Canada and Norway. The Estremadura deposits were perhaps the first of the rock phosphates to be described, though they were not much worked until the seventies of the last century.

All these phosphate deposits are now yielding to the competition of the great deposits of phosphate rock which have been discovered in Northern Africa and are now being exported in immense quantities from Algeria and Tunis. The phosphate bed appears to stretch right across the continent, but Morocco has, naturally, not been explored, while the Egyptian rocks as yet examined are hardly rich enough in phosphoric acid for export, though immense beds exist containing 40 to 50 per cent. of tricalcium phosphate. The most important of the phosphate mines in North Africa occur in the province of Constantine in the district of Tebessa, from whence they extend into Tunis, near Gafsa. The rock is generally at the base of the Eocene system, and occurs in strata that may be  $2\frac{1}{2}$  or 3 metres thick and contain as much as 60 per cent. of calcium phosphate, which may be raised to 70 per cent. by picking over. These African phosphates contain but little iron and alumina, and are rapidly becoming the chief material for the manufacture of superphosphate in this country.

The mineral phosphates have been but little employed directly as manures, though there is plenty of evidence that when they are really finely ground they are effective enough on soils retaining plenty of water, and particularly on those of a peaty nature. Recent experiments also indicate that such ground mineral phosphates are most available when used with ammonium sulphate, which, as already explained, acts as a physiologically acid manure and helps to bring the phosphoric acid into solution. In the main, however, the mineral phosphates are used for the manufacture of superphosphate, practically the only manure which contains phosphoric acid at all readily soluble in water.

*Superphosphate.*

In the early years of the nineteenth century, long prior to the introduction of superphosphate as a manure, the existence of a soluble phosphate of lime produced by the action of sulphuric acid upon bone ash was a matter of common chemical knowledge, and the composition of this and the other phosphates had been studied accurately by Berzelius. The application of this knowledge to agriculture and the introduction of superphosphate as an artificial manure began about 1840. The first published suggestion of the kind is due to Liebig, in 1840, in his Report to the British Association, which was published in the September of that year as *The Chemistry of Agriculture and Physiology*. Writing of bones as a manure and the necessity of their being finely divided, he goes on:—“The most easy and practical mode of effecting their division is to pour over the bones, in a state of fine powder, half of their weight of sulphuric acid, diluted with three or four parts of water; and after they have been digested for some time to add 100 parts of water, and sprinkle this mixture over the field before the plough. In a few seconds the free acids unite with the bases contained in the earth, and a neutral salt is formed in a very fine state of division. Experiments instituted on a soil formed from a Grauwacke, for the purpose of ascertaining the action of manures thus prepared, have distinctly shown that neither corn nor kitchen garden plants suffer injurious effects in consequence, but that, on the contrary, they thrive with much more vigour.” Liebig then adds:—“In the manufactories of glue, many hundred tons of a solution of phosphates in muriatic acid are yearly thrown away as being useless. . . . It would be important to examine

whether this solution might not be substituted for the bones."

In 1841, a Mr Fleming of Barrochan had made an experiment with about three-quarters of a pound of dissolved bones, and in 1842 the Highland and Agricultural Society offered a prize for an experiment with bones dissolved in sulphuric acid. In January 1842, Professor Johnston, in his published lectures, suggested the use for purposes of manure of acid or soluble phosphate of lime, made by adding sulphuric acid to burnt bones or bone ash:—"Acid or biphosphate of lime.—When burned bones are reduced to powder, and digested in sulphuric acid (oil of vitriol) diluted with once or twice its weight of water, the acid combines with a portion of the lime, and forms sulphate of lime (gypsum), while the remainder of the lime and the whole of the phosphoric acid are dissolved. The solution, therefore, contains an *acid* phosphate of lime, or one in which the phosphoric acid exists in much larger quantity than in the earth of bones. "If the mixture of gypsum and acid phosphate above described be largely diluted with water, it will form a most valuable liquid manure, especially for grass land and for crops of rising corn. In this liquid state, the phosphoric acid will diffuse itself easily and perfectly throughout the soil, and there will speedily lose its acid character by combining with one or other of the *basic* substances, almost always present in every variety of land." Mr Hannam in Yorkshire, in 1843, claimed to have been the first to carry out this experiment with burnt bones and acid.

All these experiments, however, had in reality been anticipated by Mr J. B. Lawes, to whom, in May 1842, was granted a patent for making superphosphate, from the specification of which the following extract has

been made:—"Whereas bones, bone ash, and bone dust and other phosphoric substances have been heretofore employed as manures, but always, to the best of my knowledge, in a chemically undecomposed state, whereby their action on the soils to which they have been applied has been tardy and imperfect. And whereas it is in particular well known that in the case of a large proportion of the soils of this country, the application of bone dust is of no utility in producing crops of turnips on account of the slow decomposition of the bone dust in the soil, and the consequent exposure of the young plant for a long period to the ravages of the turnip fly. Now, the first of my said improvements consists in decomposing, in manner following, the said bones, bone ash, bone dust, and other phosphoric substances. Previous to using them for the purposes of manure, I mix with the bones, bone ash, or bone dust, or with apatite or phosphorite, or any other substance containing phosphoric acid, a quantity of sulphuric acid just sufficient to set free as much phosphoric acid as will hold in solution the undecomposed phosphate of lime."

Subsequently, on becoming acquainted with Liebig's published suggestion, Lawes amended his patent by disclaiming all references to bone and bone products, and confining it to "apatite and phosphorite, and other substances containing phosphoric acid." Following on his patent, Lawes began the manufacture of superphosphate on a commercial scale, establishing a factory at Deptford and using for the purpose at first bone ash and later the crag coprolites from Suffolk, to which Henslow's paper in 1845 had attracted attention. The first advertisement appears in the *Gardener's Chronicle and Agricultural Gazette* in 1843, the price being 4s. 6d. per bushel. From the dates of Liebig's

book and Lawes' patent, Liebig has generally been regarded as the inventor of superphosphate, and even though Lawes was able to take out a patent for making it from mineral phosphates instead of from bones, the idea is generally set down to Liebig. Owing, however, to actions for infringement of his patent brought by Lawes in 1853, the steps leading up to Lawes' patent are on record, and it is seen that he arrived at the idea of making superphosphate and had tried it experimentally on a considerable scale, prior to Liebig's publication.

In his proof of evidence, Lawes, after describing his fitting up of a laboratory and taking over the Rothamsted estate in 1834, stated that during 1836, 1837, and 1838, he used considerable quantities of bone dust on his farm for the purpose of manuring his turnip crops, and finding that it produced no good effects, and knowing that upon other soils its properties as a manure were very great, he commenced a series of experiments with bones and mineral phosphate of lime decomposed by sulphuric and other acids, applied to the most important agricultural plants of the farm. These experiments were in 1839 conducted on a small scale by plants in pots and by manuring a certain number of plants in a field. The result of these small experiments was most remarkable with turnips, and he in 1840 used the superphosphate on half an acre or more of that crop. In 1841 the results were so far advanced that he used about 20 tons of superphosphate. He was prepared to have taken out a patent in 1841, but was persuaded by his friends not to do so, as they objected to his embarking in any mercantile or business occupation (Lawes was then only twenty-six years of age). Lawes further stated that he had not noticed Liebig's recommendation until after the date of his



patent, whereupon he disclaimed the use of bone substances included therein. He also declared that he began his manufacture with bone ash, apatite and phosphorite being unobtainable commercially, though in 1843 he imported several tons of the Spanish phosphorite from Estremadura, and early in 1845 began his enquiries if coprolites could be obtained cheaply from the Eastern counties. Gilbert also gave evidence that the manufacture and use of superphosphate on a large scale prior to the date of the patent were matters of common knowledge at Rothamsted when he came there in 1843. Putting aside the fact that Lawes was the first man to make superphosphate a practical possibility, there is thus no doubt that he arrived at the idea of the importance of a soluble phosphatic manure quite independently of Liebig, and had tested the idea on a working scale before taking out his patent. The only other point of interest in this early history of superphosphates is that Sir James Murray of Dublin took out a patent a few weeks before Lawes, in which he suggested as manure phosphoric acid prepared by treating phosphorite with sulphuric acid. Murray's object, however, was to generate carbonic acid in the ground, and his patent is for a means of "mechanically fixing and solidifying mineral acids"—sulphuric, muriatic, nitric, and phosphoric—by mixing them with absorbent matter like bran, sawdust, peat, etc., the phosphoric acid thus coming in incidentally only, and not for its own nutritive value to plants. A few years later, to avoid any question of priority that might arise, Lawes purchased Murray's patent, and amended it by disclaiming everything but the manufacture of a manure by the treatment of phosphorite with acid.

The early superphosphate thus manufactured by

Lawes and sold at about £7 a ton, was a mixture of soluble and insoluble phosphate derived from coprolites or from guanos, mixed with animal substances and ammoniacal salts, resembling, in fact, dissolved bones and very much the kind of thing nowadays sold as soluble bone compound. Way in 1851 gives analyses ranging from 3.24 to 0.12 per cent. of nitrogen, soluble phosphate of lime from 18.5 down to 1.6 per cent., insoluble from 28.3 down to 0.06 per cent. By 1862 the manufacture had risen to 150,000 to 200,000 tons per annum; in 1907 about 700,000 to 800,000 tons were made in the United Kingdom, of which about 120,000 tons were exported.

In the manufacture of superphosphate, the finely-ground materials, graded and mixed after analysis so as to produce superphosphate of the desired quality, are mixed with sufficient dilute oil of vitriol, containing about 60 per cent of pure acid, to bring about the following reaction:--

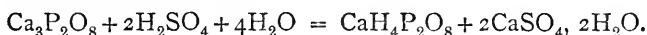

At the same time, an excess of acid must also be employed to convert into sulphates the carbonate, fluoride, and chloride of calcium present. The mixing is performed mechanically, a considerable rise of temperature ensues, and there is an evolution of water vapour, carbonic, hydrochloric, and hydrofluoric acids; the two latter, besides causing a waste of sulphuric acid, are troublesome to the manufacturer, because they must be condensed, and not allowed to escape into the atmosphere. After mixing, the hot damp mass is dropped into a lower chamber where the reaction completes itself, and the whole solidifies as the gypsum combines with the remaining water. The mass is easily friable, and is dug out, crushed, and put into store. At one time artificial drying had to be employed, in order to obtain

a really dry product that would run easily through a drill, but all necessity for that process has passed away since high grade phosphates containing but little iron or alumina have been available. The more gypsum the finished "super" contains, the drier and more friable the powder, hence the former value of Somme phosphate for mixing purposes, because its impurity was almost wholly calcium carbonate. The objection of the superphosphate maker to oxides of iron and aluminium in the raw material arises from two sources—the bad mechanical condition of the resulting compound and its tendency to revert. In calculating the amount of sulphuric acid to use, a little calcium phosphate is always left undecomposed, because free phosphoric and sulphuric acids would injure the mechanical condition of the fertiliser. This phosphate of lime left unattacked will always slowly combine with some of the acid phosphate to form two molecules of the intermediate di-calcium phosphate, which is thus known as reverted or retrograde phosphate—

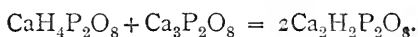

Since this last compound is insoluble in water, freshly made superphosphate always contains a little more phosphoric acid soluble in water than it does after it has been stored for some time, and as in England this fertiliser is valued only on the basis of its water soluble phosphoric acid, to this extent it deteriorates on storage.

The deterioration is more pronounced when the raw material contains oxides of iron and aluminium, because both of these substances will slowly react with acid phosphate to form insoluble phosphates of iron or aluminium. Even if these oxides have been attacked by the sulphuric acid to form ferric or aluminium sulphates, or if the iron and aluminium were originally

present as phosphates, which by treatment with the acid give rise to sulphates of these metals and free phosphoric acid, reversion will still take place at the lower temperatures. A mixture of ferric sulphate and phosphoric acid is not stable, but will always partly go back to ferric phosphate and sulphuric acid, the final state of equilibrium which is attained being one with a large proportion of insoluble ferric phosphate. It is for this reason that so much stress is laid in the United Kingdom on raw phosphates being free from iron and aluminium; on the Continent, where reverted phosphate (estimated by solubility in ammonium citrate or 2 per cent. solution of citric acid) is ranked as almost the equal of water soluble phosphate, there is not the same objection to the use of such materials.

Superphosphate as manufactured nowadays is a grey friable powder, which is made in various grades containing 26, 30, 35 and 40 per cent. of phosphate made soluble or 12, 14, 16, and 18 respectively of phosphoric acid, together with about 2 per cent. of insoluble phosphate. The 26 per cent. super has for long been the standard article and is still the most generally manufactured, because a good dry product can be made from the raw phosphates most readily available, whereas the higher grades require selected materials if the result is to be dry. They were, in fact, chiefly made for export, but since they are now, owing to the better quality of the raw phosphates available, just as cheap per unit of phosphoric acid as the lower grades, there is every reason for saving carriage by their purchase.

The chief phosphates at present employed for superphosphate-making are those from North Africa—Tocqueville, Gafsa, Tebessa, and Algerian—Florida hard rock and pebble, Christmas Island phosphate, and the Aruba and Carolina deposits. The material is ground

until 80 per cent. passes through a sieve with 100 meshes to the inch, the African phosphates being much easier to grind than those from Florida, and then it is mixed with about 70 per cent. of chamber acid of a specific gravity 1.52, according to the composition of the rock. The mass takes a day or two to cool, is disintegrated and thrown into heaps, after which it must be crushed again before it is bagged. About half a ton of acid is used in making a ton of super.

The next great development in regard to phosphatic manures came from a very unexpected source—the introduction of basic slag as a waste product in steel-making. A great many ores of iron, notably those found in the Cleveland district of North Yorkshire, contain considerable quantities of phosphates, and in the process of smelting in the ordinary blast furnace much of the phosphorus passes into the iron. As far as the product of the blast furnace goes—the cast iron—the presence of phosphorus does no particular harm, but as soon as the cast iron has to be converted into steel it becomes highly objectionable. With the general introduction of mild steel, obtained cheaply by the Bessemer process of blowing air through the molten cast iron until all the carbon and silicon are burnt out of it, and then adding just enough of an iron rich in carbon to get back to the proportion of carbon and iron which forms steel, the Middlesborough iron made from the Cleveland ores was at a serious disadvantage, since it contained a considerable amount of phosphorus which could not be removed in the Bessemer process. After much research two chemists, Thomas and Gilchrist, invented a process for removing the phosphorus in the Bessemer process, and so obtained a phosphorus free steel from the impure Middlesborough iron. Their plan was to line the “converter,” the great vessel con-

taining the molten iron through which the blast of air was forced, with a "basic" lining composed of lime and magnesia, instead of the previous acid lining of bricks composed mainly of silica. Lime was also added to the converter, and when the oxidation due to the blast of air takes place in the molten metal, in presence of the lime the phosphorus oxidises as well as the carbon and silicon, because the resulting phosphoric acid is at once taken up by the bases present and so removed from the action, instead of being immediately reduced again by the molten iron. Under these conditions the resulting slag, or molten impurities derived from the iron, which is "basic" from the excess of lime instead of "acid" as usual from excess of silica, contains considerable quantities of phosphoric acid, ranging from 12 up to as much as 23 per cent. At the present time the Bessemer has largely been replaced by the "open hearth" process of making steel, but as the principle is the same—the oxidation of the impurities in the iron by a current of air—it can similarly be carried out in the presence of lime with the production of a "basic slag" containing phosphoric acid.

For some time after Thomas and Gilchrist had introduced their process in 1879, no use was made of the basic slag, though it was known to contain so much phosphoric acid, and it accumulated in the usual mounds near the steel furnaces. Various methods were tried for extracting the phosphoric acid or bringing it into a soluble form, though without any success; but early in the 'eighties it began to be found that the only thing necessary to make the basic slag available as a manure was to grind it to an extremely fine powder. In this country the value of fine ground basic slag was first brought to light by Wrightson and Munro in 1885, who carried out a series of experiments, on a chalk

soil in Wiltshire and a heavy clay in Durham with basic slag finely ground on the one hand and on the other dissolved by treatment with sulphuric acid, compared with superphosphate and other forms of undissolved phosphate. The results were highly favourable and showed that the slag was comparable with superphosphate as a source of phosphoric acid to the crop, being much superior to the other insoluble phosphates tried. About the same time as Wrightson and Munro's experiments, basic slag, which was known in Germany as Thomas slag or Thomas phosphate, after one of the inventors, attracted considerable attention there; many experiments were made with it and turned out so successful that it rapidly grew into considerable demand for agricultural purposes. Indeed, so much more quickly was basic slag taken up in Germany, that a considerable export trade from Great Britain at once grew up, and even at the present day of the 300,000 tons annually made in Great Britain, about 150,000 tons are exported to Germany.

Basic slag, basic cinder, or Thomas phosphate powder (the two latter names are little used in the United Kingdom nowadays) comes into the market as a dense black powder, so finely ground that four-fifths of it will pass through a fine brass wire sieve carrying 100 meshes to the inch, which is found to pass only particles having a smaller diameter than 0.2 mm. A small but varying amount of free quicklime is present; from 2 to 10 per cent. may be obtained from fresh samples by careful extraction with pure carbon dioxide free water. Both free iron and magnetic oxide of iron are present, and can be separated from the bulk by means of a magnet; this test, together with the presence of free lime, the density of the material, and the evolution of a little sulphuretted hydrogen on treatment with

an acid, make it easy to distinguish between basic slag and made-up imitations in which the phosphates are derived from ground phosphate rock.

Table XXXIII. shows an analysis of the material, in which the most striking feature will be seen to be the large amount of lime and magnesia present—more than would normally combine with the phosphoric acid, even when allowance has been made for any lime that is free or that may be supposed to be

TABLE XXXIII.—ANALYSIS OF BASIC SLAG  
(Stead and Ribsdale).

Lime . . . . .	41.58
Magnesia . . . . .	6.14
Alumina . . . . .	2.57
Peroxide of Iron . . . . .	8.54
Protoxide of Iron . . . . .	13.62
"    Manganese . . . . .	3.79
"    Vanadium . . . . .	1.29
Silica . . . . .	7.38
Sulphur } . . . . .	0.23
Calcium } . . . . .	0.31
Sulphuric Anhydride . . . . .	0.12
Phosphoric Acid . . . . .	14.36
	99.93

combined with the silica. The analysis alone suggests that basic slag does not contain the usual tri-calcium phosphate, and its behaviour in the soil and the ready availability of the phosphoric acid strengthen the view that it contains some other compound of phosphoric acid. For example, basic slag is found to be readily attacked by a solution of carbon dioxide or other very weak acid; a much larger proportion of phosphoric acid goes into solution than would be the case with an equally fine ground sample of tri-calcium phosphate containing the same amount of phosphoric acid. Nearly



the whole of the phosphoric acid in basic slag also goes into solution when it is shaken with an alkaline solution of ammonium citrate, in which tri-calcium phosphate is not very soluble. The analysis of certain flat square plate crystals, occasionally found in cavities in the balls of slag, proved them to consist of a tetra-basic phosphate of calcium of the formula  $(\text{CaO})_4\text{P}_2\text{O}_5$ , the molecule of phosphorus pentoxide being combined with four molecules of lime instead of with three as in ordinary calcium phosphate. To this tetra-basic phosphate of lime the properties of basic slag have usually been ascribed, it is supposed to be readily acted upon by carbon dioxide with the formation of calcium carbonate and di-calcium phosphate, and as this latter phosphate is readily soluble in water containing carbonic acid, the availability of the basic slag is accounted for.

But it is by no means certain that this association of tetra-calcium phosphate with basic slag is correct. In the first place, the detailed analysis of the basic slag hardly bears out this view; there is more lime than is necessary to make up tetra-calcium phosphate even when every allowance is made for silica and sulphur, and the amount of free lime that can be determined is not sufficient to make up the balance. Moreover, the crystals of tetra-calcic phosphate are only to be found in basic slags made from irons poor in silicon; the usual crystals found in the basic slag cavities are long hexagonal needles, pale green or blue in colour, of which considerable quantities can be picked out from the cindery portions of the slag. The appearance also of a fractured surface of the ordinary molten parts of the slag would agree much better with a structure built up of such prismatic crystals than of the flat crystals of tetra-calcium phosphate. The prismatic crystals, according to Stead, consist of a double silicate and phosphate of lime

of the composition  $(\text{CaO})_5\text{P}_2\text{O}_5\text{SiO}_2$ , and contain about 29 per cent. of phosphoric acid, 11 per cent. of silica, and 56 per cent. of lime. Moreover, when separated from the mass of the cinder, finely ground, and attacked with water charged with carbon dioxide or with very dilute citric acid, the phosphoric acid they contain shows approximately the same solubility as that of the phosphoric acid in an ordinary sample of basic slag, whereas the crystals of tetra-basic phosphate of lime are markedly less soluble. On the whole, it seems more probable that the typical phosphoric acid compound of basic slag is this  $(\text{CaO})_5\text{P}_2\text{O}_5\text{SiO}_2$ —and not the tetra-calcium phosphate,  $(\text{CaO})_4\text{P}_2\text{O}_5$ , especially as there is plenty of other evidence to show how large a part silica will play in bringing phosphoric acid into a soluble state.

Whatever may be the form of combination of the phosphoric acid in basic slag, it is undoubtedly easily attackable by the soil water, so that it is more available to the plant than any of the forms of tri-calcium phosphate, though as a rule it falls below superphosphate. In this availability the fineness of grinding is a very important factor, and all samples should be carefully tested; at least 90 per cent. of the material should pass through the standard wire sieve of 100 meshes to the inch. The content in phosphoric acid varies with the amount of phosphorus present in the iron employed in the steel-making process; of late years basic slags have been on the whole richer than they were in the earlier years of its manufacture, and it is possible to obtain material containing 23 per cent. of phosphoric acid (equivalent to 50 per cent. of tri-calcium phosphate). Lower grade material is more common, but has been shown to be equally valuable when quantities containing equal amounts of phosphoric acid are compared; consequently basic slag should always

be bought on the basis of an analysis. For a long time it was customary in Germany to estimate only the phosphoric acid in the slag which could be dissolved by shaking the material for a specified time with an alkaline solution of ammonium citrate, and to value the slag on such a basis, the idea being that the solvent differentiated between the available tetra-calcium phosphate which dissolved, and other compounds of phosphorus and phosphoric acid with iron, which possessed no fertilising value and did not dissolve in the reagent. Ammonium citrate as a solvent has, however, been replaced by a 2 per cent. solution of citric acid, and in the United Kingdom the vendor of basic slag is now compelled to give a guarantee of the percentage of phosphoric acid that is dissolved when 5 grms. of the slag are shaken in a litre bottle for half an hour with 500 c.c. of a solution containing 10 grms. of citric acid. Though this method gives no absolute separation between the different phosphates in the slag, it affords a sufficiently good practical means of estimating what are easily soluble and therefore of fertilising value.

A few other manufactured phosphates find their way into commerce, though none of them have much agricultural importance as compared with superphosphate and basic slag. Basic superphosphate is a form of precipitated calcium phosphate introduced in 1901 by John Hughes and made by mixing ordinary superphosphates with sufficient lime to neutralise all the free acid and convert the superphosphate into di-calcium phosphate, leaving in addition a small proportion of free lime. The material is very finely ground and forms a light white very bulky powder, which remains dry and works readily through any manure-sowing machine. On analysis it shows a little over 12 per cent. of phosphoric acid and about 4 per cent. of free lime, and as the phos-

phoric acid is almost wholly combined as di-calcium phosphate, it is to that extent soluble in the dilute citric acid solution above described. The fine state of division of this manure and the form of combination in which the phosphoric acid exists render it very available to the plant, so that it is a good phosphatic manure for use on light soils deficient in lime, though it may be doubted whether a mode of manufacture which first involves solution of the phosphoric acid by means of sulphuric acid and then neutralisation and precipitation by lime is not essentially uneconomical.

Small quantities of various forms of precipitated phosphate come on the market from time to time: these are bye-products in the manufacture of gelatine, when the bones are treated with hydrochloric or sulphuric acid to dissolve out all the earthy matter, and the resulting solution of phosphoric acid is neutralised with milk of lime. When the initial solution has been effected by sulphuric acid the product is sometimes sold as "phosphatic gypsum," since it consists largely of gypsum formed by the reaction of the sulphuric acid and the lime. These fertilisers are very good sources of phosphoric acid, which is combined in them in the form of di-calcium phosphate; they form excellent phosphatic fertilisers for light soils, being easily available and neutral.

*Wiborg Phosphate* is the product of the heating of apatite, occurring as a waste material mixed with felspar in the preparation of certain Swedish iron ores, with sodium carbonate in the proportions of 30 soda to 100 apatite containing 17 per cent. of felspar. The result is a phosphate to which Nilson ascribes the formula  $2\text{Na}_2\text{O} \cdot 10\text{CaO} \cdot 3\text{P}_2\text{O}_5$ , which is completely soluble in ammonium citrate solution and has proved to be particularly valuable on the peaty soils poor in phos-

phoric acid of the island of Gothland, though it is not so effective as basic slag containing an equivalent amount of phosphoric acid. While extensively used in Sweden, it does not find its way into this country.

*Wolter Phosphate* is made by melting together in a regenerative furnace 100 parts of powdered phosphorite, 70 parts of acid sodium sulphate, 20 parts of carbonate of lime, 22 parts of sand and 6 or 7 parts of coke, the molten material being run into water and then finely powdered. The resulting phosphate is almost wholly soluble in dilute citric acid and has proved in experiments to be more assimilable by the plant than phosphoric acid in basic slag, and almost equivalent to phosphoric acid in superphosphate. At present the cheapness of basic slag and superphosphate prevent any wide distribution of fertilisers of the type of Wiborg and Wolter phosphates, though they may be remunerative in a locality where some waste phosphatic material is available.

## CHAPTER V

### THE FUNCTION AND USE OF PHOSPHATIC FERTILISERS

Ripening Effect of Phosphoric Acid—Most manifest in wet Seasons—Effect of Phosphoric Acid in stimulating the Formation of Roots and adventitious Shoots—Association of Phosphoric Acid with the Intake of Nitrogen by the Plant—Solvents to determine the relative Availability of Phosphatic Fertilisers—Relative Value of Phosphatic Fertilisers determined by the Soil—Soils appropriate to Superphosphate—Fate of Superphosphate applied to the Soil—Soils appropriate to Basic Slag—Neutral Phosphatic Manures for light Soils—Comparison of Bone Meal with other Phosphatic Fertilisers.

BEFORE considering the question of the relative fertilising value of the different phosphatic manures and their application in practice, it will be necessary to get some idea of the function of phosphoric acid in the nutrition of the plant.

Just as nitrogen delays maturity by promoting growth, phosphoric acid has an opposite effect; it is in some way closely bound up with grain formation, being always found in greater proportions in the reproductive parts of the plant than elsewhere. This ripening action is very clearly seen in the Rothamsted experiments on barley; the plots without phosphoric acid being as a rule about a week behind those which receive this fertiliser.

This effect is brought out in the diagrams, Fig. 3,



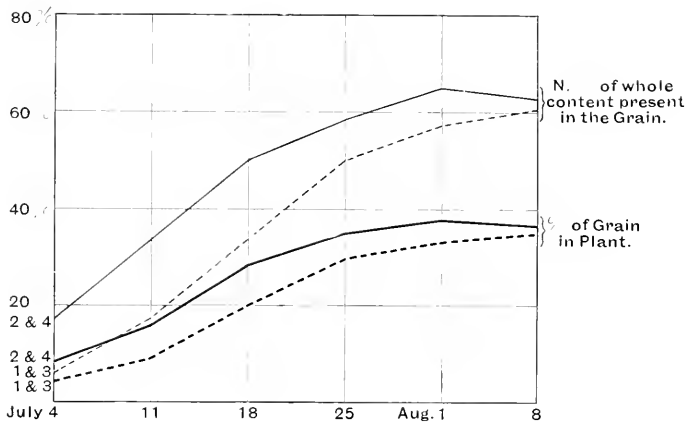

FIG. 3.

Curves showing the effect of Phosphoric Acid in hastening the formation of Grain of Barley, and the Migration of Nitrogen to the Grain. 2 and 4 with Phosphoric Acid. 1 and 3 without Phosphoric Acid.



which show the results of certain determinations made upon barley cut at regular intervals during the development of the grain from some of the Rothamsted barley plots in 1904.

The two lower curves show the rate of the formation of the grain week by week, calculated as percentages of the weight of the whole plant, for the two plots which receive phosphoric acid and for the corresponding plots without, both series being similarly treated as regards nitrogen and potash. It will be seen that the formation of grain begins earlier where phosphatic fertilisers have been used, and even at the end is more complete. Similarly, the two upper curves show the migration of the nitrogen to the grain, again calculated as percentages of the nitrogen of the whole plant, and, as before, the movement of nitrogen begins at an earlier date, and is more completely carried out when there is plenty of phosphoric acid.

TABLE XXXIV.—EFFECT OF PHOSPHORIC ACID AND POTASH UPON BARLEY AT ROTHAMSTED. WET AND DRY YEAR COMPARED.

	Grain, Bushels.		Grain to 100 Straw.		Nitrogen per cent. in Grain.	
	1893.	1894.	1893.	1894.	1893.	1894.
Ammonium Salts alone . . .	11.6	10.4	85.3	67.5	2.19	1.65
Ammonium Salts and Superphosphate . . .	18.1	34.9	101.0	77.0	2.13	1.60
Ammonium Salts and Potash . . . . .	16.8	17.8	85.9	73.8	2.17	1.61
Ammonium Salts, Super- phosphate, and Potash .	30.8	41.4	102.2	77.7	2.08	1.44

As might be expected, this ripening effect of phosphoric acid will be particularly seen in a wet year when the crop is late to harvest. Table XXXIV. will illustrate the point: it gives the yield and other particulars

of one series of the Rothamsted barley plots in 1893, a specially dry season, and in 1894, which was almost equally wet.

The phosphoric acid increases the proportion of grain to straw, and decreases the nitrogen content of the grain, and it will be noticed that this latter effect is more marked in the wet season of 1894. Even on the yield itself the phosphoric acid had the greater effect in the wet season.

Exactly the same result can be observed in the wheat crop, as may be seen in Table XXXV., which gives the yield of grain and straw in 1879, the wettest year in the Rothamsted records, and in 1893, which was characterised by an extremely dry hot spring and summer.

TABLE XXXV.—EFFECT OF PHOSPHORIC ACID AND POTASH ON THE DEVELOPMENT OF WHEAT. BROADBALK FIELD, ROTHAMSTED.

	Grain, Bushels.	Straw, Cwts.	Weight per Bushel, lb.	Grain to 100 Straw.
WET SEASON, 1879.				
Unmanured . . . . .	4.5	6.7	51.8	42.8
Nitrogen only . . . . .	4.3	8.5	50.8	33.6
Nitrogen and P <sub>2</sub> O <sub>5</sub> . . . . .	11.1	18.0	54.6	36.2
Nitrogen, P <sub>2</sub> O <sub>5</sub> , and K <sub>2</sub> O . . . . .	16.0	27.2	57.8	35.2
DRY SEASON, 1893.				
Unmanured . . . . .	10.7	5.6	62.5	110.3
Nitrogen only . . . . .	8.4	5.6	59.1	84.4
Nitrogen and P <sub>2</sub> O <sub>5</sub> . . . . .	7.7	6.2	56.4	67.3
Nitrogen, P <sub>2</sub> O <sub>5</sub> , and K <sub>2</sub> O . . . . .	16.4	9.7	62.6	98.0

In the wet year the use of phosphoric acid increases the yield from 4.3 bushels with nitrogen only to 11.1 bushels with nitrogen and phosphoric acid, the

proportion of grain to straw being raised from 33.6 to 36.2. In the dry year the phosphoric acid so hurried on the premature ripening of the grain that the yield declined from 8.4 to 7.7 bushels, and the proportion the grain bore to the straw similarly fell from 84.4 to 67.3 per 100 of straw.

The action of phosphoric acid on the plant is not confined to its ripening effect; it stimulates the early development of the young seedling to a remarkable extent. Farmers are well acquainted with the good start that any crop gets when manured with superphosphate; indeed, it is often used merely to secure a better plant, though with little expectation of otherwise increasing the yield. More than sixty years ago this had been noticed by the late Sir John Lawes; and in one of his earliest papers on "Turnip Culture" in 1847, he writes: "Whether or not superphosphate of lime owes much of its effect to its chemical actions in the soil, it is certainly true that it causes a much enhanced development of the underground collective apparatus of the plant, especially of lateral and fibrous root." For this statement he was vigorously attacked by Liebig, but some experiments, which are still in progress, show that it was the result of sound observation and that in some way or other phosphoric acid does stimulate the root development of the young plant. Barley seedlings, for example, grown in water cultures without, or with a minimal amount of, phosphoric acid develop practically no root, whereas when they are nitrogen or potash starved the root growth will be proportional to that of the rest of the plant. Both in the field and in pot experiments the phosphoric acid has a great effect in promoting the formation of adventitious buds, so leading to the tillering of the plant. To what extent this stimulus to root growth is brought about

by other sources of phosphoric acid and under diverse conditions of soil, has not yet been worked out, but there can be little doubt but that it explains why a phosphatic manuring has such a valuable effect in establishing the plant, even if the gross yield is not ultimately much enhanced.

It may also go to explain the extraordinary results of quite small dressings of phosphoric acid upon soils in Southern Australia, where a manuring with half a cwt. per acre or even less of superphosphate has been found sometimes to double the yield of cereals. On analysis the soils are not rich, but they show no such signal deficiency in phosphoric acid as would account for the action of the manure; it seems much more likely that in a semi-arid country where the whole success of the crop depends on the roots getting quickly down to the cooler and moister subsoil, the stimulating action of the phosphoric acid upon the young roots becomes of the greatest value. In this connection it may be noted that the two crops which most respond to phosphatic manuring, turnips and barley, are both possessed of shallow roots, confined to a comparatively limited layer of soil; whereas, under ordinary farming conditions, wheat responds very little to phosphoric acid and mangolds hardly at all, both being deep-rooted plants. But even for mangolds farmers are accustomed to use superphosphate, because they have found by experience it is of great assistance in securing a plant.

It has sometimes been stated that phosphoric acid is associated with the assimilation of nitrogen by the plant, and particularly with its migration from the stem or roots into the seed, the opinion being probably founded on the fact that the nucleo-proteins, so characteristic of the reproductive parts of plants, contain phosphorus. This opinion is not, however, borne out

by the examination of a large number of analyses of barley grain from the Rothamsted plots; when phosphoric acid is deficient the intake of nitrogen is not proportionally reduced; in fact, the grain grown on the plots receiving no phosphoric acid is the richest in nitrogen.

This point may be further elucidated from some experiments upon wheat made at Rothamsted in 1907; a large number of ears of wheat were marked just as they came into flower, in order to secure that all should be as nearly as possible the same age at starting. A number of these heads were gathered every third day, and the grain was extracted and analysed, so as to trace any progressive changes in composition as the grain formed and ripened. Table XXXVI. shows the ratio of nitrogen to phosphoric acid in such grain from three of the Rothamsted plots—from the unmanured Plot 3, where all the elements of nutrition and particularly nitrogen are lacking; from Plot 10, where there is an excess of nitrogen and a great deficiency of phosphoric acid; and from an adjoining plot under ordinary farming conditions, where phosphoric acid will be relatively abundant. It will be seen that on any plot the ratio of nitrogen to phosphoric acid remains pretty constant throughout the whole development of the grain, but that a different ratio exists for each plot. From this we may conclude that the material which the plant on any particular plot moves from its straw and root to form into grain is the same throughout the development of the grain, but that each plant, according to the soil and manure conditions under which it is growing, builds up a type of grain of a composition special to itself. It is true that the nitrogen and phosphoric acid move into the grain *pari passu*, and in that sense the phosphoric acid might be regarded as a carrier of the

nitrogen, but then the starch also migrates in an equally constant ratio to the nitrogen compounds, though no such association is claimed between nitrogen and starch. Both actually and relatively the nitrogen is highest in the grain from Plot 10, where the plant is phosphoric acid starved.

TABLE XXXVI.—DEVELOPMENT OF WHEAT GRAIN, 1907.

Date.	Plot 3. Unmanured.		Plot 10. Nitrogen only.		Normal Manuring.	
	Nitrogen per cent. in Dry Grain.	Ratio of Nitrogen to P <sub>2</sub> O <sub>5</sub> .	Nitrogen per cent. in Dry Grain.	Ratio of Nitrogen to P <sub>2</sub> O <sub>5</sub> .	Nitrogen per cent. in Dry Grain.	Ratio of Nitrogen to P <sub>2</sub> O <sub>5</sub> .
July 16 .	2.68	2.15	...	...	...	...
" 19 .	2.41	2.15	2.61	2.35	...	...
" 22 .	2.46	2.12	2.45	2.32	...	...
" 25 .	2.17	2.00	2.13	2.25	...	...
" 28 .	2.12	2.05	2.10	2.53	...	...
" 31 .	2.06	2.22	2.11	2.32	2.27	1.91
Aug. 3 .	1.86	1.87	1.92	2.27	2.20	1.88
" 6 .	1.83	2.04	1.85	2.50	2.05	1.91
" 9 .	1.80	1.89	1.88	2.45	1.97	1.85
" 12 .	1.72	1.86	1.83	2.41	1.84	1.82
" 15 .	1.86	2.28	1.83	2.17	1.85	2.00
" 18 .	1.79	1.96	1.88	2.29	1.89	1.81
" 21 .	1.85	2.06	1.90	2.38	1.88	1.82
" 24 .	1.78	1.99	...	...	2.03	1.91
" 27 .	...	...	...	...	1.98	1.85
" 30 .	...	...	...	...	2.05	1.98

The phosphatic manures are practically all compounds of phosphoric acid with lime, and, as is well known, four distinct combinations exist and are found in commerce. Only one, the dihydrogen calcium phosphate, the characteristic constituent of superphosphate, is to any degree soluble in water; the others give rise to extremely dilute solutions of phosphoric acid, too dilute, as has been shown by experiment to nourish a plant properly, with however large a volume

of the solution it may be in contact. Yet insoluble as di-, tri-, and tetra-basic phosphate of lime are, when they are sufficiently finely divided and well incorporated with the soil so as to be in contact with the roots, they are all effective in supplying the plant with phosphoric acid. It will be shown later (p. 290) that the carbonic acid excreted by the roots of the plants is the chief agent in producing a solution in the soil water capable of attacking these insoluble phosphates; acid humus and ammonium sulphate, which gives rise to free acid in soils, also assist in rendering them available to the plant.

Since only one of the commercial phosphates is freely soluble in water, yet all of them have to enter into solution before they can be utilised by the plant, the question of their relative availability is not easy to settle, and a variety of solvents have been proposed for its determination in the laboratory. In Germany, for example, basic slag was formerly valued, not on the total amount of phosphoric acid it contains, but on the amount that is soluble in a strong ammoniacal solution of ammonium citrate, the idea being that this reagent discriminates between the tri-calcium phosphate, which is insoluble, and the di- and tetra-calcium phosphates, which will dissolve in the medium. Instead of the ammonium citrate, a 2 per cent. solution of citric acid is now employed, and 1 per cent. and 0.1 per cent. solutions have also been proposed by various chemists for the valuation of phosphatic fertilisers. None of these solvents, however, really draws a sharp distinction between the different phosphates, which are all soluble up to a certain point, when an equilibrium is established between the phosphoric acid in solution and that remaining undissolved. If the first solution formed is replaced by a fresh portion of the solvent, more

phosphoric acid will come into solution ; in fact, all the phosphates can be eventually completely dissolved away by the solvents in question. The following table (XXXVII.) shows the amount of phosphoric acid extracted by a 1 per cent. solution of citric acid from one of the Broadbalk soils manured for fifty years with superphosphate, the extraction being repeated with fresh solvent as soon as one portion had been saturated and then removed :—

TABLE XXXVII.—100 GRMS. BROADBALK SOIL (PLOT 7), WITH 1 LITRE 1 PER CENT. SOLUTION OF CITRIC ACID.

First Extraction	. .	56.1 mg. P <sub>2</sub> O <sub>5</sub> dissolved
Second	" . .	22.8 " "
Third	" . .	8.9 " "
Fourth	" . .	6.5 " "
Fifth	" . .	4.4 " "
Sixth	" . .	4.4 " "

Very similar results have been obtained when manures are treated in the same manner, and they may be taken to show that a single extraction of any solvent of the kind proposed does not dissolve the whole of a particular compound of phosphoric acid, which may be thereupon reckoned as distinct in kind from the rest of the phosphates left unattacked. This mode of attack with weak solvents should be regarded as affording only empirical figures to assist the analyst in forming a judgment of the manure ; and the conditions of making the solution, such as time, shaking, relative amounts of solvent and substance, must be strictly defined. Furthermore, the only solvent which has any *a priori* justification is a solution of carbon dioxide, such as does the work in the soil ; the acids of the cell sap, to resemble which citric acid was taken, have been shown to experience no direct contact with the soil particles.



The kind of information which is yielded by the attack of dilute solvents may be seen in Table XXXVIII., which shows some of the results obtained by J. K. S. Dixon when certain phosphates of similar character were shaken with a 2 per cent. solution of citric acid. The results agree in the main with practical experience and with the field trials which have been made upon

TABLE XXXVIII.—RELATIVE SOLUBILITY OF VARIOUS PHOSPHATIC MANURES (Dixon).

Manure.	Nitrogen.	Total P <sub>2</sub> O <sub>5</sub> .	P <sub>2</sub> O <sub>5</sub> dissolved by 2 per cent. Citric Acid Solution as per cent. of total P <sub>2</sub> O <sub>5</sub> .
	Per cent.	Per cent.	
Steamed Bone Meal . . .	1.86	29.07	64.29
Steamed Bone Flour . . .	1.07	29.14	70.55
English Bone Meal . . .	5.17	22.46	56.67
Indian " " . . . . .	3.35	23.19	52.29
Peruvian Guano . . . . .	1.40	27.28	66.05
" " . . . . .	3.26	21.36	85.95
" " . . . . .	8.11	13.13	95.73

these materials; the phosphoric acid of bone meal is less soluble than that of steamed bone flour, and the Indian bones which have long been dried and exposed show a lower solubility than do the fresh English bones. The phosphatic guano and the steamed bone flour show much the same solubility of their phosphoric acid, but the younger the guano is, as indicated by the increased percentage of nitrogen, the greater is the solubility of the contained phosphoric acid. It will be explained later that as the guano ages and loses its nitrogen the phosphates pass more and more into tri-calcium phosphate, and eventually by solution and redeposition become much the same material as a rock phosphate. But while it would thus be possible by the use of one

of these weak acid solvents to arrange the various phosphates in a scale of decreasing solubility, and argue from that as to their availability to the plant, the order of the table would not represent their relative value in practice.

In considering the action of the various phosphatic manures in the field, the most important factor to be taken into account is the soil, for the relative value of the fertilisers will change entirely with different types of soil. For example, the choice between superphosphate and basic slag or bone meal, as a phosphatic manure, must be determined, not by their comparative solubility, but by the amount of calcium carbonate and the wetness or dryness of the soil to which the fertiliser is to be applied. A very large number of experiments have been made to institute a comparison between these fertilisers, but without resulting in any very general information, just because the question is really settled by those external soil factors which are generally unrecorded. On certain soils one or other of these manures will always give the best results, on other soils their effects may be so much alike that the choice between them can be settled by price alone or by any consideration of convenience that may enter. For example, in one of the Rothamsted experiments one series of plots receive superphosphate, another series basic slag, and a third bone meal, in quantities supplying the same phosphoric acid to each, the plots being otherwise treated alike as regards nitrogen and potash. If we abstract the results which refer to the yields in the year of the application of each manure and reduce them to a common standard each year by taking the yields of the unmanured plot as 100, we obtain the relative figures in Table XXXIX.

It will be seen that the phosphates have produced a greater effect upon Swedes and barley than upon the deeper rooting and more slowly growing mangolds and wheat, but that on the whole the three fertilisers are equally valuable as sources of phosphoric acid on the Rothamsted soil. The soil of the Little Hoos field, in which the experiment is being conducted, contains a

TABLE XXXIX.—RELATIVE YIELD FROM VARIOUS PHOSPHATES  
(Rothamsted). UNMANURED = 100.

Crop.	Superphosphate.	Basic Slag.	Bone Meal.
Swedes . .	120	116	126
Barley . .	119	121	110
Mangolds . .	114	105	111
Wheat . .	106	108	117
Swedes . .	132	109	131
Means . .	118	112	119

reasonable working quantity of carbonate of lime; it is also fairly heavy and cool, so that it retains sufficient moisture to give the phosphates of basic slag and bone meal an opportunity of coming into solution.

Without attempting any detailed review of the numerous experiments upon phosphatic fertilisers, we may yet draw certain general conclusions from them.

On nearly all normal soils superphosphate is the most effective phosphatic fertiliser when equal amounts of phosphoric acid are compared. The exceptions are the light sands and gravels very deficient in carbonate of lime, peaty soils where the humus is of the sour acid type and all other soils that have developed an acid reaction. On the peaty soils of the fen country superphosphate is the fertiliser most valued, but there the humus is of the "mild" type, consisting

of calcium humate, with which the superphosphate reacts.

When superphosphate is applied to the soil, the soluble phosphoric acid it contains is rapidly reprecipitated; to some extent the clay provides the necessary base, but on most soils the calcium carbonate takes the chief part in the reaction, with the production of di-calcium phosphate. As this precipitation takes place all throughout the soil, the phosphate is very finely divided and thoroughly disseminated, hence the great effectiveness of superphosphate. Though di-calcium phosphate, like tri-calcium phosphate itself, is probably eventually converted in the soil into a compound approaching the composition of tetracalcium phosphate, it remains effective as a fertiliser because of the fine state of division in which it continues to exist.

How thorough is the precipitation of the phosphoric acid within the soil may be seen from Dyer's examination of the soils from the Broadbalk wheat field, which had been receiving  $3\frac{1}{2}$  cwts. per acre of high grade super for fifty years previously. He found that though the surface soil to the depth of 9 inches had been enormously enriched in phosphoric acid soluble in 1 per cent. solution of citric acid, the subsoil below had practically gained none, so complete had been the precipitation in the layer stirred by the plough. Again, the drainage waters from these plots show a most trifling amount of phosphoric acid, so that losses by washing out must be negligible. Still more cogent evidence of the retention of phosphoric acid by the soil has been obtained more recently by applying the method of successive extractions with a 1 per cent. solution of citric acid, until the phosphoric acid going into solution has fallen to the low constant figure indicating the

solubility, not of the recently added, but of the original soil phosphates. About five extractions remove the phosphoric acid down to this point, further extractions remove very little more, and the sum of the phosphoric acid dissolved in these five extractions approximates very closely to the surplus of phosphoric acid supplied as superphosphate over that removed in the crop.

TABLE XL.—PHOSPHORIC ACID SOLUBLE IN FIVE EXTRACTIONS WITH 1 PER CENT. CITRIC ACID, COMPARED WITH THAT IN MANURE AND CROP (Rothamsted).

	Phosphoric Acid, lb. per acre.			
	Supplied in Manure.	Removed in Crop.	Surplus in Soil.	Dissolved by 1 per cent. Citric Acid.
Broadbalk, Plot 3 .	...	550	- 550	565
"    "    5 .	3960	790	3170	3000
"    "    7 .	3810	1370	2440	2470
"    "    8 .	3810	1520	2290	2055
Hoos, Plot 1 .	...	555	- 555	400
"    "    2 .	3390	1200	2190	2315
"    "    4 .	3390	1240	2150	2000

This shows that phosphoric acid supplied as superphosphate remains in the surface soil, and in a form that is readily soluble in such weak acids as a dilute solution of citric acid or the natural solution of carbon dioxide occurring in the soil. Doubtless the result would be modified if the soil were not well provided with calcium carbonate, in which case more insoluble phosphates of iron and alumina would be formed. It is a fair conclusion to draw from these results that superphosphate and indeed all phosphatic manures, may be applied to the land much earlier than is usually the case; because there is not the least fear of their washing out, and it is all-important to get them well

disseminated through the soil. For the turnip crop there may perhaps be some advantage in drilling the manure with the seed, so important is it to have the young roots stimulated by an abundance of phosphoric acid close at hand, but with other crops much of the benefit of phosphatic manures is often lost because they are applied when the land has already begun to run short of water. Fine grinding and early application are the two great factors in making phosphatic manures available.

The essential condition that should dictate the choice of superphosphate as a fertiliser, is the presence of sufficient carbonate of lime in the soil to ensure the precipitation of the soluble phosphoric acid as a calcium compound. On acid soils, on some clays, and on many sands and gravels, there is such a deficiency of carbonate of lime that the phosphoric acid becomes precipitated as iron or aluminium phosphate, which possess a much lower solubility in the soil water and are therefore less available to the plant. But on the great majority of our British soils experience has shown that the extra price of the unit of phosphoric acid in its soluble form in superphosphate is more than justified by its superior effectiveness, which is due to the rapidity with which it becomes disseminated in a finely divided condition in the soil immediately near the roots of the crop.

On many of the heavier clays, which are in general deficient in phosphates, though superphosphate is a valuable fertiliser, especially if lime has been applied to the soil previously, basic slag is really the more effective manure when quantities costing the same money are compared. In the first place, basic slag is so much cheaper that nearly twice as much phosphoric acid can be bought at the same cost, and on heavy soils well provided with moisture or on peaty soils its effectiveness,

unit for unit, is not much less than that of the phosphoric acid in superphosphate, especially when it has been put on early and has had plenty of time to saturate the soil water and to be disseminated within the soil by solution and reprecipitation.

Moreover, the lime contained in the basic slag is itself of considerable value; it supplies what is often a much-needed base, and on old grass land in particular its effect in bringing the soil potash into solution and in promoting the oxidation of the nitrogenous reserves in the soil is very marked; on tillage land also the lime is of assistance in improving the texture of the soil. When such soils are poor in carbonate of lime there is always some danger of "finger-and-toe" in the turnips, and if once this disease has appeared superphosphate should no longer be used, but basic slag should take its place. The spread of the disease is promoted by any acid manure like superphosphate; the free lime of basic slag, on the contrary, tends to render the soil unfit for the survival of the spores. Thus the choice between superphosphate and basic slag should in the main be determined by the soil; the more calcareous and loamy the soil, the more effective is superphosphate, but heavy soils and land poor in carbonate of lime respond better to basic slag, and on wet sour soils no other phosphatic manure should be used.

In this country there is rather a prejudice against the use of basic slag on the lighter soils—the sands, and gravels, which are yet too poor in carbonate of lime to be fitted for superphosphate. They are generally regarded as too dry to allow the basic slag to be effective, but in view of the value that basic slag has been found to possess on the light sandy soils of Eastern Germany, where, too, the rainfall is less than that of

England, the popular opinion seems to be founded on a misapprehension. It has probably arisen from the fact that on the poor sandy grass pastures basic slag never shows the extraordinary effect it does on the poor clay pastures. This is due, not to the ineffectiveness of the phosphoric acid in the basic slag, but to the lack in the sandy soil of both potash and of humus to be set in action by the lime contributed by the basic slag. The great outburst of white clover which often follows the application of basic slag to a clay pasture is mainly promoted by the potash liberated from the soil. As a source of phosphoric acid for tillage land basic slag is probably little less effective on a light than a heavy soil, but it should be applied early and well worked in.

On such light land, however, there is a very general preference for some of the forms of insoluble phosphate that are found by experience to be readily attacked by the soil water and available to the plant; phosphatic guano, steamed bone flour, basic superphosphate, and precipitated phosphate are all of the type that is valuable on such soils. Very effective phosphatic fertilisers for light soils deficient in carbonate of lime, and therefore requiring a neutral manure, may be made by mixing about two parts of superphosphate with one of steamed bone flour, phosphatic guano, bone meal, or basic slag itself. If the mixture be left in a heap for a time in the manure shed the superphosphate will react with the tri-calcium phosphate of the bone or guano to produce a di-calcium or precipitated phosphate; and though the mass cakes a little when the reaction is complete, it can easily be broken down into the original fine powder. This is probably the cheapest way of obtaining an easily available neutral phosphate for use on light arable land where superphosphate is unsuitable



because of the lack of carbonate of lime. Otherwise the choice between these different phosphates is very much one of price, since, phosphoric acid for phosphoric acid, they have proved to be about equally effective.

Raw bones or bone meal, though the price has been at a low level for some years, still seems to be rated too highly, the nitrogen of the phosphoric acid it contains being over-valued if we take into account the low availability which field experiments indicate it possesses. Most of the experiments go to show bone meal to be so slow in its action that excessive amounts have to be applied and locked up in the soil if any immediately appreciable result is to be obtained.

For example, Table XLI. shows the results of one series of experiments carried out by the Highland and

TABLE XLI.—RETURNS FROM BONE MEAL AND OTHER PHOSPHATIC MANURES.

	1878.	1879.	1880.	1881.
	Swedes.	Barley, Unmanured. Total Produce.	Seeds Hay, Unmanured.	Oats, Manured. Total Produce.
	Tons.	Lb.	Cwts.	Lb.
Ground Coprolites .	15·0	5844	38·5	5911
Bone Meal . . .	13·4	6052	41·5	6686
Phosphatic Guano .	15·4	6016	33·8	6726
Ground Coprolites, dissolved . . .	15·8	5964	41·3	7696
Bone Meal, dissolved	15·1	6364	44·3	7460
No Phosphate .	13·1	5955	33·5	7132

Agricultural Society, wherein bone meal was less effective than fertilisers of the superphosphate class, not only in the year of its application but afterwards also, when further crops were grown without the application of fresh manure. It is probably on grass

land that bone meal answers best, for there the fine roots of the grasses can come into very intimate contact with the fragments of the fertiliser.

The reason of the comparative ineffectiveness of bone meal is not far to seek: owing to the toughness of the cartilage structure of the bone, it is a matter of difficulty to reduce it to a really fine state of division—at any rate the bone meal of commerce is a comparatively coarse powder. Now, it has already been pointed out that a tri-calcic phosphate, such as exists in bones, is very far from insoluble in water charged with carbon dioxide, but, as with all sparingly soluble salts, the rate of solution will be proportional, other things being equal, to the amount of surface the substance exposes to attack, and for a given weight of material this increases in the same proportion as the average diameter of the particle decreases. In consequence, fineness of grinding is perhaps the most important factor in determining the value of the insoluble phosphatic manures, upon it more than even upon the chemical composition depends the availability of the fertiliser to the plant. Bone meal is slow-acting and ineffective, because it is coarse; nor is the phosphoric acid brought into solution more readily in the second year than in the first, because the coarse condition still persists. The availability of a phosphatic fertiliser might even be reckoned as the product of two factors: a solubility factor depending upon its chemical composition, and a second factor—the area of surface of unit weight of the material.

If bone meal has been overrated, on the other hand steamed bone flour has not received the credit it deserves. In the first place, analysts have rather warned the farmer against steamed bone flour, as representing in some way a spurious bone meal from which the nitrogen had been illicitly extracted. The warning would

be needful enough if the steamed bone flour were in any way being passed off as bone meal, but provided it is sold on its own basis as a material containing nearly sixty per cent. of tri-calcic phosphate and one per cent. or so of nitrogen, it is a better manure than bone meal. The fine grinding of the steamed bone flour allows the phosphates to pass into solution, while the extra nitrogen of the raw bone is so slow in its action, that as a rule it would pay the farmer to buy steamed bone flour instead of bone meal and to make up this deficiency by the addition of a more active nitrogenous material.

Just as the long-standing knowledge of the effect of bones has given rise to a certain prejudice in their favour, which is reflected in the fact that they realise a rather higher price than their content in nitrogen and phosphoric acid would justify, something of the same tradition exists on the side of dissolved bones and bone superphosphate. There is no experimental evidence to lead one to expect that a mixture of superphosphate and sulphate of ammonia will not give as good results as dissolved bones containing the same amount of nitrogen and phosphoric acid; indeed, the former mixture will probably be more effective, because it is finer and in better mechanical condition. And yet dissolved bones is generally much the dearer fertiliser: for example, at the time of writing, the price of dissolved bones in London is £5, 5s. per ton, and it contains 2.75 per cent. of nitrogen and 15 per cent. of phosphoric acid. To supply 2.75 units of nitrogen,  $2\frac{3}{4}$  cwts. of sulphate of ammonia containing 20 per cent. of nitrogen will be required, and this costs 32s.; to supply 15 units of phosphoric acid  $1\frac{1}{4}$  tons of superphosphate with 12 per cent. of phosphoric acid would be wanted, and this would cost £3, 2s. 6d. For  $32 + 62.6 = 94$ s. 6d., therefore, the same amount of nitrogen and phosphoric acid could be

purchased as are contained in the ton of dissolved bones, and the phosphoric acid would be wholly soluble instead of partially, as in the bone manure; there is a saving of 10s. 6d. a ton, against which would only have to be offset the greater carriage on the extra 8 cwts. the mixture weighs.

This, of course, is only an example of the general fact that the longer a fertiliser has been known, and the greater the number of people who have had experience of its value and learnt how it can be profitably employed, the better will be its standing in the market, and the higher its price per unit of nitrogen, phosphoric acid, etc.

It has already been stated that finely-ground rock phosphates are occasionally employed as fertilisers without any treatment with acid. In America they are often obtainable very cheaply in comparison with superphosphate and are ground to an extremely fine powder, so that on the basis of equal money value they give more favourable results on many soils than the acid phosphates. In Britain they have proved most effective on wet and peaty soils; they require a soil containing plenty of organic matter to generate a comparatively strong solution of carbon dioxide in the soil water, in which they must become dissolved. For the same reason their action is forwarded by the ploughing in of green crops or by the use of sulphate of ammonia as a source of nitrogen, but on the generality of soils they form but an ineffective source of phosphoric acid.

It will thus be seen that it is impossible to arrange the phosphatic fertilisers in a scale of value depending upon the relative availability of the phosphoric acid they contain, for this availability is mainly determined by the soil, and will vary for the same manure from

soil to soil. In order to make a proper choice, the farmer ought, first of all, to know how much carbonate of lime his soil contains, and in the light of his knowledge of that factor and of the general character and climate of the soil, he will decide first whether he requires a basic, acid, or a neutral phosphate, and then which is the cheapest inside the selected class.

## CHAPTER VI

### THE POTASSIC FERTILISERS

Early Use of Wood Ashes—The Stassfurt Deposits—Manufacture and Composition of commercial Potash Fertilisers — The Retention of Potash by the Soil—The Function of Potash in the Nutrition of the Plant—Dependence of Carbohydrate Formation upon Potash, as illustrated in the Barley and Mangold Crops—The Action of Nitrate of Soda upon insoluble Potash Compounds in the Soil—Potash Fertilisers as promoting the Growth of Leguminous Plants—Effects of Potash Starvation upon Vegetation—Potash as a Preventive of Fungoid Disease—Potash as prolonging the Growth of the Plant—Destruction of the Tilth of Clay Soils by Potash Salts—Soils deficient in Potash.

ALTHOUGH the water cultures already described, coupled with the results of the Rothamsted experiments even in their early years, showed that of the alkali metals found in the plant's ash only potassium was indispensable, for a long time the salts of potash could not be obtained in quantities or at a price appropriate to agricultural requirements. Almost the only source of potash was the crude carbonate or "potashes," which was obtained by dissolving the soluble salts found in wood ashes; and though this was to a small extent supplemented by the nitrate of potash or saltpetre obtained from India, and by a certain amount of sulphate of potash obtained from "kelp"—the ashes of seaweed—no widespread use could be made of potash

salts in farming until the opening up of the great Stassfurt deposits in Germany. The fertilising value of wood ashes had long been known, and in the south-east of England it had been customary for the hop-growers to organise a regular system of collection of the ashes of their cottagers, who burned little besides wood, but such a supply was only local and early exhausted.

William Ellis, again, writing in 1750, states that "at Long Marston, in Bucks, is a potash kiln, where they make ashes from bean straw for the most part, and sell a vat of them, which contains 32 five-bushel sacks, which dresses one acre for fourteen shillings, to be shovelled out of a cart or waggon, and throwed over grass land in this month (July) or at any time till Candlemass."

In 1861, the output of potash salts began from Stassfurt and rapidly grew, until in 1900 no less than 1,158,000 tons were being used for agricultural purposes alone.

The German potash deposits are situated near the Harz mountains, and centre round the old town of Stassfurt, where for a very long time common salt had been manufactured from natural brine springs. A boring made in 1858 proved the presence of rock-salt at a little more than 1000 feet below the surface, but found above the rock-salt a layer of minerals containing potash and magnesia salts, which were at first regarded as worthless but have since become the most valuable substances in the mine, because they constitute the only known source of potash on a large scale. The deposits occur between the Dyas and Trias formations, and are, therefore, of much the same age as the salt-beds of Cheshire and Worcestershire, and like them they represent the result of the drying up in a hot climate of a great lake or sea, which retained some con-

nection with the ocean so as to admit of the constant inflow of fresh sea water. It has been shown that all the various minerals—salts of sodium, potassium, magnesium, and calcium—which occur in these deposits, are formed at different stages in the concentration and drying up of a solution originally of the composition of sea water, and the sequence of their deposition has led to the estimation that a period of about 13,000 years was necessary for the formation of the bed. The sequence of deposits varies somewhat from shaft to shaft, especially where the influx of water in the past has effected some rearrangement in the salts; but in the main, after passing through 600 to 800 feet of red sandstone, limestone, etc., a bed of gypsum is first reached, underneath which is a bed of very pure, “younger” rock-salt, which in its turn gives place to a bed of anhydrite (anhydrous sulphate of lime) with some gypsum. Below the anhydrite comes a bed of tough impervious salt clay, which has acted as a water-proof layer and prevented the solution of the highly soluble potash and magnesium salts immediately below; at the top is a layer 50 to 130 feet thick of carnallite, a crude double chloride of potassium and magnesium which is the main source of the manufactured salts. Below the carnallite comes the “kieserite” region, where this mineral, a crude sulphate of magnesia, predominates, and below it again comes a “polyhalite” region, characterised by the prevalence of this complex sulphate of potash, lime, and magnesia. The polyhalite overlies the “older” rock salt, 2000 feet or more in thickness, interspersed with and underlaid by layers of anhydrite, before the limiting bituminous sandstones are reached. It will be noticed that the bottom layer of anhydrite represents the least soluble salt in sea water; above it comes the sodium chloride in bulk; while at the top are



gathered together the magnesium and potassium salts, which would be the last to remain in solution. The manufacturing is extremely simple in principle; the salts of the potash region, chiefly carnallite, are mixed and brought into solution, from which products of various grades of purity can be obtained by evaporation. In this way are obtained the sulphates and muriates of potash of commerce, but the substances chiefly used in agriculture are certain crude salts contained by grinding suitable mixtures of the original material as mined. Of these the best known in this country is kainit, a mineral which, properly speaking, only occurs in some of the mines where water had formerly access, but which commercially represents a mixture of sulphates and chlorides—chiefly sulphates, of sodium, potassium, and magnesium, containing a little over 12 per cent. of potash.

A crude "hard salt" or "sylvinit," consisting chiefly of chlorides, but equally containing 12 per cent. of potash, is put upon the market rather more cheaply than the kainit, and for most purposes will serve equally well. Owing to the rapid exhaustion of the true kainit deposits, this material is now taking the place of kainit in the manure market. In Germany a crude "carnallite" of still lower grade, containing only about 9 per cent. of potash, is used, but its hygroscopic nature and low concentration prevent its export to any distance. Table XLII. shows the analyses of the chief Stassfurt products, of which only 1, 3, 4, and 6 come to this country in any quantity.

The Stassfurt salts are white or grey or pink (owing to the presence of a little iron as impurity) gritty powders, which dissolve readily and almost entirely, and are, as a rule, more or less deliquescent. Potassium chloride, and particularly magnesium chloride, are very

TABLE XLII.—AVERAGE ANALYSES OF THE PRINCIPAL STASSFURT POTASH SALTS. (PERCENTAGES.)

NAME OF SALTS.	Sulphate of Potash, $K_2SO_4$ .	Muriate of Potash, KCl.	Sulphate of Magnesia, $MgSO_4$ .	Chloride of Magnesia, $MgCl_2$ .	Chloride of Sodium, NaCl.	Sulphate of Lime, $CaSO_4$ .	Substances Insoluble in Water.	Water.	Pure Potash, $K_2O$ .	
									Average.	Guarantee Minimum.
A. Crude Salts (Natural Products).										
1. Kainit (Old Product) . . . . .	21.3	2.0	14.5	12.4	34.6	1.7	0.8	12.7	12.8	12.4
2. Kainit (as now sold) . . . . .	...	20.5	15.9	1.1	46.8	1.8	1.1	12.8	12.8	12.4
3. Sylvinit . . . . .	...	26.3	1.4	2.6	59.2	2.8	3.2	4.5	17.4	12.4
B. Concentrated Salts (Manufactured Products).										
a. Sulphates nearly free from Chloride:—										
1. Sulphate of Potash { 96% . . . . .	97.2	0.3	0.7	0.4	0.2	0.3	0.2	0.7	52.7	51.8
{ 90% . . . . .	90.6	1.6	2.7	1.0	1.2	0.4	0.3	2.2	49.9	48.6
b. Salts containing Chloride:—										
2. Muriate of Potash { 90/95% . . . . .	..	91.7	0.2	0.2	7.1	...	0.2	0.6	57.9	56.8
{ 80/85% . . . . .	...	83.5	0.4	0.3	14.5	...	0.2	1.1	53.7	50.5
{ 70/75% . . . . .	..	73.2	1.8	0.6	21.2	0.2	0.5	2.5	46.7	44.1
3. Potash Manure Salts, minimum 20% Potash . . . . .	...	33.6	10.6	5.3	40.2	2.1	4.0	4.2	21.0	20.0
4. Potash Manure Salts, minimum 30% Potash . . . . .	..	48.8	9.4	4.8	26.2	2.2	3.5	5.1	30.6	30.0

soluble and greedy of moisture ; and as both chlorides and magnesium are present in all but the purest grades of sulphate of potash, the salts used for manurial purposes are always somewhat deliquescent.

These salts constitute practically the only sources of potash for manurial purposes ; wood ashes are a little used occasionally, a small amount of sulphate of potash is derived from kelp, and the ashes which form the final waste product in beet sugar refining are used for the carbonate of potash they contain ; but the whole amount is trifling compared with the increasing output of the Stassfurt mines.

Attempts have been made from time to time to utilise as fertilisers various minerals which occur in large quantities and contain considerable amounts of potash ; for example, orthoclase felspar,  $K_2Al_2O_4, 6SiO_2$ , with 17 per cent. of potash, and leucite,  $K_2Al_2O_4, 2SiO_2$ , with 22 per cent. of potash. In some cases these minerals have been simply reduced to a very fine powder, in others they have been heated with lime or soda salts in order to bring the potash into a more soluble form. Though the results show that the potash can thus be rendered comparatively available for the plant, the great cheapness of the completely soluble Stassfurt salts has prevented any general adoption of the processes.

The question of which of these salts it is advisable to apply as a manure has excited a good deal of attention, but cannot be said to have reached any very definite settlement, probably because the problem is complicated by a secondary action of the salts on the texture of the soil, which will be discussed later. But, speaking generally, it may be said that for grass and mangolds, and wherever the salts can be put on in the winter months so as to allow the magnesium chloride

to be washed away, kainit and the crude salts are as effective, potash for potash, as the concentrated salts in which the unit of potash is more expensive. But for potatoes, malting barley, and similar crops where quality is of moment, especially when the manure is put on near the time of seeding, sulphate of potash is advisable, especially upon heavy soils.

Muriate of potash has often been shown to yield a greater weight of potatoes than sulphate, though the tubers are more watery, and this result has been associated with the chlorine, which is supposed to assist in the migration of starch about the plant, but the facts are by no means certain as yet.

All the compounds of potash found in these fertilisers are freely soluble in water, so that some danger of loss by washing out might be apprehended when the manures are applied in the winter. As early, however, as 1850, Way found that ordinary soils possessed considerable powers of reacting with potash salts to produce insoluble potassium compounds, the chlorine or sulphuric acid of the salt remaining in solution combined with calcium and other bases derived from the soil. The absorptive power was found to be greatest with soils rich in clay and humus, and the retention of the potash is chiefly effected by interaction with the zeolitic double silicates of the clay, potassium being exchanged for calcium, magnesium, or sodium in the zeolite. To a certain extent a similar exchange of calcium for potassium takes place in the humus, a comparatively insoluble potassium humate being precipitated and calcium sulphate or chloride going into solution.

When experiments are made in the laboratory, by treating a soil with a weak solution of potassium sulphate or chloride, the removal of the potassium from solution is never complete; the extent of the

removal will in any case depend upon the relative masses of the potassium salt and the zeolite, so that it is practically complete when a few hundred pounds of fertiliser are applied to the great weight of soil which represents an acre. Voelcker's analyses of the drainage waters collected below the various plots at Rothamsted showed that the amount of potash in the water flowing from the drain below the unmanured plot was 1.7 parts per million, and was only increased to 2.9, 3.3, 4.4, and 5.4 parts respectively on other plots which are annually manured with 300 lb. per acre of potassium sulphate. Dyer's examination, also, of the soils from the same Broadbalk wheat field show that, of the potash applied as manure during fifty years and not removed in the crops grown during the same period, about one-half was still to be found in the top 9 inches of soil, much of it in such a combination as to be soluble in 1 per cent. solution of citric acid, while further quantities of the applied potash, also soluble in the weak citric acid, were to be found in the second and third 9-inch layers of soil. Thus, from the point of view of practice, no loss of potash need be apprehended through its application in the winter before the crop is occupying the land, except on the lightest sands where clay and humus are lacking.

To understand the use of potassic fertilisers in the ordinary routine of farming, it is necessary to enquire into the function of potassium in the nutrition of the plant, for the water culture experiments hitherto quoted only demonstrate that it is one of the indispensable elements.

Further enquiry goes to show that in some way potash is an essential part of the mechanism of the process of assimilation; when it is deficient the manu-

facture of carbohydrates, like starch, sugar, and cellulose, is greatly reduced, and in practice it is the crops rich in carbohydrate which are most dependent upon a full supply of potash. Reed observed that starch grains were not formed in the cells of a green alga immersed in a culture fluid containing no potash, and that those originally present in the chlorophyll gradually disintegrated and disappeared. Some earlier experiments of Hellriegel and Wilfarth illustrate the dependence of starch formation on potash even more clearly. They started a series of water cultures, in one of which the supply of nitrogen increased in successive jars from nothing to the full amount required for the plant; the other constituents were fully supplied in every jar. In a second series, the phosphoric acid supply was similarly varied, and in a third series the potash. As would be expected, in each series the amount of dry matter grown was roughly proportional to the supply of the constituent which was in defect. Further, when nitrogen or phosphoric acid was lacking the formation of grain was small, but, as far as might be, the grains produced were perfect; a larger number of grains, but not bigger ones, being found as the supply of nitrogen or phosphoric acid increased. Hence the weight of a single grain was fairly constant whether there was much or little nitrogen and phosphoric acid. But when potash was lacking the individual grains were small and undeveloped, and the average weight of each grain increased with each addition of potash. In the absence of potash the assimilation process was at a standstill, hence the grains could not be filled with the starch which is their main constituent. The following table (XLIII.) shows the total dry matter, the percentage of grain, and the weight of a single grain in each experiment of the three series:—

TABLE XLIII.—GROWTH OF BARLEY WITH INCREASING AMOUNTS OF NITROGEN, PHOSPHORIC ACID, AND POTASH (Hellriegel and Wilfarth).

NITROGEN SERIES—OTHER CONSTITUENTS IN EXCESS.			
Nitrogen supplied.	Dry Weight of Produce.	Corn.	Weight of One Grain.
Mg.	Grms.	Per cent.	Mg.
0	0.7	11.9	19.5
56	4.9	37.9	27.0
112	10.8	38.0	33.0
168	17.5	42.6	32.0
280	21.2	38.7	31.5
PHOSPHORIC ACID SERIES—OTHER CONSTITUENTS IN EXCESS.			
Phosphoric Acid supplied.	Dry Weight of Produce.	Corn.	Weight of One Grain.
Mg.	Grms.	Per cent.	Mg.
0	1.9	...	...
14.2	8.3	22.4	27
28.4	12.6	31.8	29
56.8	19.5	38.4	38
85.2	19.5	41.6	34
113.6	20.2	43.8	41
142	18.7	41.3	38
213	17.8	40.1	30
284	31.3	43.4	34
POTASH SERIES—OTHER CONSTITUENTS IN EXCESS.			
Potash supplied.	Dry Weight of Produce.	Corn.	Weight of One Grain.
Mg.	Grms.	Per cent.	Mg.
0	2.3	...	...
23.5	5.4	4.8	5.0
47.0	9.0	21.5	9.5
70.5	11.6	27.2	13.0
94.0	15.3	30.1	17.0
188.0	21.2	38.5	26.0
282.0	29.8	42.8	34.0

The Rothamsted results with barley are less striking, because of the large amount of potash originally in the soil; it is only during the later years, as has already been explained, that any deficiency of potash has been manifest on the plots that do not receive this fertiliser. Still, as shown in the following table (XLIV.), which gives average results for the fourteen years 1889-1902, the use of potash has increased both the weight per bushel and the weight of the individual grains:—

TABLE XLIV.—ROTHAMSTED BARLEY (14 YEARS, 1889-1902).

Plot.	Manuring.	Weight (per Bushel.	Weight of 100 Grains.
		Lb.	Grms.
1A	Nitrogen only . . . .	52.3	4.03
2A	Nitrogen and Phosphoric Acid	52.2	3.86
3A	Nitrogen and Potash . . . .	53.3	4.14
4A	Nitrogen, Phosphoric Acid, and Potash . . . .	53.8	4.21

The effect of potash manuring on the production of a carbohydrate, in this case sugar, is most manifest on the mangold crop. If Nos. 4 and 5 of the Rothamsted mangold plots which receive the same supply of nitrogen and phosphoric acid are compared, it will be found that in a good year they produce approximately the same weight of leaf; indeed, the similarity would be still closer if the comparison were made when the leaves were in full activity, and not at the end of the growing season. One plot (4), however, receives a dressing of potash salts, but not the other (5), and the plot with potash produces nearly two and a half times the weight of roots grown upon the other plot without potash. Now the difference in dry weight is almost wholly due to sugar and other carbohydrates, which were manufactured in the leaf and then passed on to the root for storage; yet



the two plots possessed practically the same leaf development, working under identical conditions of illumination, carbon dioxide, and water supply. But in one case the photo-synthetical process had been limited by the want of potash; all the machinery was there and the power was in excess, but the machinery was running idle for the lack of one necessary link—in this case the potash:—

TABLE XLV.—EFFECT OF POTASH ON THE PRODUCE OF MANGOLDS AT ROTHAMSTED, 1900.

Plot.	Manure.	Leaf per acre.	Roots per acre.	Sugar per acre.
5A	Ammonium Salts and Superphosphate	Tons.	Tons.	Tons.
4A	Ammonium Salts, Superphosphate, and Potash	2.95	12.00	0.797
		3.25	28.95	2.223

The effect of potash upon the mangold crop is also to be seen upon the plots where dung is also supplied, as shown in Table XLVI. :—

TABLE XLVI.—ROTHAMSTED MANGOLDS (12 YEARS, 1895-1906).

Manuring.	No Potash.	+Phosphates and Potash.
	Tons.	Tons.
Dung only . . . . .	18.6	19.5
„ and Nitrate of Soda . . . . .	27.7	26.8
„ and Ammonium Salts . . . . .	21.8	25.9
„ and Rape Cake . . . . .	24.9	23.6
Dung, Rape Cake, and Ammonium Salts	24.2	29.9

Here it will be seen that potash increased the crop in every case, except where nitrate of soda had been used as the nitrogenous cross dressing, in which case the soda liberates so much potash from the soil that

specific application of potassic manures is unnecessary. In the earlier years of this experiment only phosphates had been added to the dung and nitrogenous manures, but had produced no increase; we may conclude, therefore, that in the series quoted it was the potash alone that had been active. This result is the more striking, in that dung itself contains a large proportion of potash, yet the use of 14 tons of dung per acre year after year, beginning in 1856, has still been unable to supply the mangold crop with all the potash it needed.

Both in this series of plots and that in which the mangolds receive no dung, the value of potassic manurings is small where nitrate of soda is the source of nitrogen. This is not only because the sodium can be made to do some of the work usually done by potassium in the plant, but also because it is able to attack the compounds of potash in the soil (the Rothamsted soil contains an enormous reserve of insoluble potash), and bring it into solution so that it becomes available for the plant.

This can be illustrated by the results obtained on the Rothamsted mangold field in 1900 (a good year); Table XLVII. shows the yield of roots and leaves, and the potash and soda removed from the soil by the crop, both with and without potash, when the nitrogenous manures were ammonium salts and nitrate of soda respectively.

It will be seen that on Plot 5N, without any potash but where nitrate of soda is used, the yield of roots and leaves is almost as great as that obtained on 6N where potash salts are also added, and is more than double that given by the corresponding plot without potash, 5A, but which receives its nitrogen as ammonium salts. The amount of potash taken from the soil by the crop on Plot 5N is 92.7 lb. against 59.6 lb. on 5A, the increase repre-

senting the attack of the soda salt upon the insoluble potash in the soil, but it will be seen that the potash thus present in the crop by no means came up to the quantity removed by the crops on 6A and 6N, where an excess of potash had been applied in the manure. Since, also, the sum of the two alkalis, potash and soda together, in

TABLE XLVII.—POTASH AND SODA CONTAINED IN MANGOLDS. ROTHAMSTED, 1900.

Plot.		Roots.	Leaves.	Potash.	Soda.
		Tons.	Tons.	Lb.	Lb.
5A	Ammonium Salts and Superphosphate . . .	12.00	2.95	59.6	56.9
6A	Ammonium Salts, Superphosphate, and Potash .	28.20	3.60	306.6	67.0
5N	Nitrate of Soda and Superphosphate . . .	28.35	3.85	92.7	251.6
6N	Nitrate of Soda, Superphosphate, and Potash .	29.65	3.60	220.9	160.6

the crops on 5N, 6A, and 6N is nearly the same, it may be concluded that on 6A and 6N the plant was taking up a much greater amount of potash than it needed, due to the excess of this constituent in the soil and manure.

Next to their effect upon carbohydrate-making crops, the most striking action of potassic manures is their value in promoting the growth of clover and all leguminous crops. The function of potash here may be still that of promoting assimilation, because the bacteria which fix nitrogen in the nodules on the roots of the leguminous plants must be supplied with carbohydrate by the plant in order to obtain, by its oxidation, the energy requisite for the fixation of nitrogen. There is evidence to show that the fixation of nitrogen by these organisms is promoted by a supply of carbohydrate; but

whatever may be the explanation it is found in practice that the growth of clover, etc., is very much promoted by a free supply of potash, and this is very manifest upon sands and gravelly soils usually poor in potash.

This effect may be very strikingly seen when the fertiliser is applied to grass land carrying a mixed herbage, for the potash encourages the leguminous plants until the aspect of the vegetation may be entirely changed. On the Rothamsted grass land, which is mown for hay every year, one plot gets a complete mineral manure—phosphates and sulphates of potash, soda, and magnesia; the adjoining plot receives the same phosphoric acid, magnesia, and soda, but no potash, while a third plot gets the phosphates alone. The Table XLVIII. shows the comparative yield and the composition of the herbage by weight:—

TABLE XLVIII.—ROTHAMSTED HAY CROP, WITHOUT AND WITH POTASH.

Plot.	Manuring.	Dry Hay.		Composition of Herbage in 1902.		
		1856 to 1902.	1893 to 1902.	Grasses.	Leguminous Plants.	Weeds.
		Cwts.	Cwts.	Per cent.	Per cent.	Per cent.
7	Complete Mineral Manure . . .	38.8	36.5	20.3	55.3	24.4
8	Do. without Potash . . .	28.1	21.6	28.8	22.1	49.1
4	Superphosphate only . . .	23.3	17.8	54.4	15.4	30.2
3	Unmanured . .	21.9	15.9	34.3	7.5	58.2

On the plots receiving a mineral manure including potash half the vegetation now consists of leguminous plants, but in the absence of potash the proportion is

only 22 per cent. and 15 per cent., the higher proportion being where magnesia and soda, which attack the potash reserves in the soil, are applied. It should be noticed that the large amount of phosphoric acid received by these two latter plots does not result in any great stimulus to the leguminous plants, which constitute 7.5 per cent. of the herbage of the unmanured plot. Where nitrogen is applied and potash omitted, no leguminous plants are to be found.

On these grass plots another very striking effect of potash manuring is also very manifest, which confirms, on a large scale, the experiment of Hellriegel and Wilfarth's already quoted. On the potash-starved plots the grasses fail to a large extent to develop any seed, and the heads are soft and barren, presumably because of the deficiency in carbohydrate formation. For the same cause the straw, not only of the grasses, but also on the similarly manured wheat and barley plots, is always weak and brittle when potash is wanting. The plants of the potash-starved plots at Rothamsted are also characterised by certain other appearances, which to a less degree are to be observed in nature where the soil is naturally poor in potash, as on many peaty and sandy lands. The grass has a dull colour, partly due to a deficiency of chlorophyll and its substitution by a certain amount of a red colouring matter along the stems, and partly because the tops of the grass blades show a great tendency to die off for an inch or two and leave a brown withered end. When in 1908 the man-golds on the Barn field were replaced by Swede turnips, they grew with considerable vigour and remained perfectly healthy on the potash-starved plots, except that the leaves in the autumn showed a flecked appearance, especially towards the margins, where a good deal of the leaf tissue had a yellow brown papery look which

marked off the whole plot very distinctly, especially after the first frosts had taken place.

There is abundant experimental evidence to show that potash makes the plant more resistant to the attacks of fungoid diseases. It has already been explained how susceptible the use of nitrogenous manures renders the mangolds on certain of the Rothamsted plots to the attack of a leaf spot fungus—*Uromyces betae*. The attack is, however, much less severe on the plots receiving an abundant supply of potash; there the plant remains healthy even though the nitrogen is in excess. The photograph, Fig. 4, shows two typical roots taken in 1902 from plots with and without potash, both receiving the same large dressing of nitrogenous manures.

Just in the same way, the wheat on the potash-starved plots is always subject to rust, even in a good season when very little is to be seen on the other plots normally manured. The grass also on potash-starved plots is attacked by various fungi; hence it may be taken as a general rule, that crops which do not receive their full supply of potash will be correspondingly susceptible to disease.

It is not possible to say whether this is due to any specific alteration in the composition of the cell contents or to a general lack of vigour, but the latter is probable, because an excess of potash tends to prolong the vegetative growth of the plant and to delay maturity. Plants receiving potash are always a little the greener, especially late in the season, and this is not always an advantage, as may be seen from the fact that the barleys grown on the plots receiving potash at Rothamsted, show a somewhat darker and less attractive colour than those grown without potash. That potash tends to prolong growth may also be

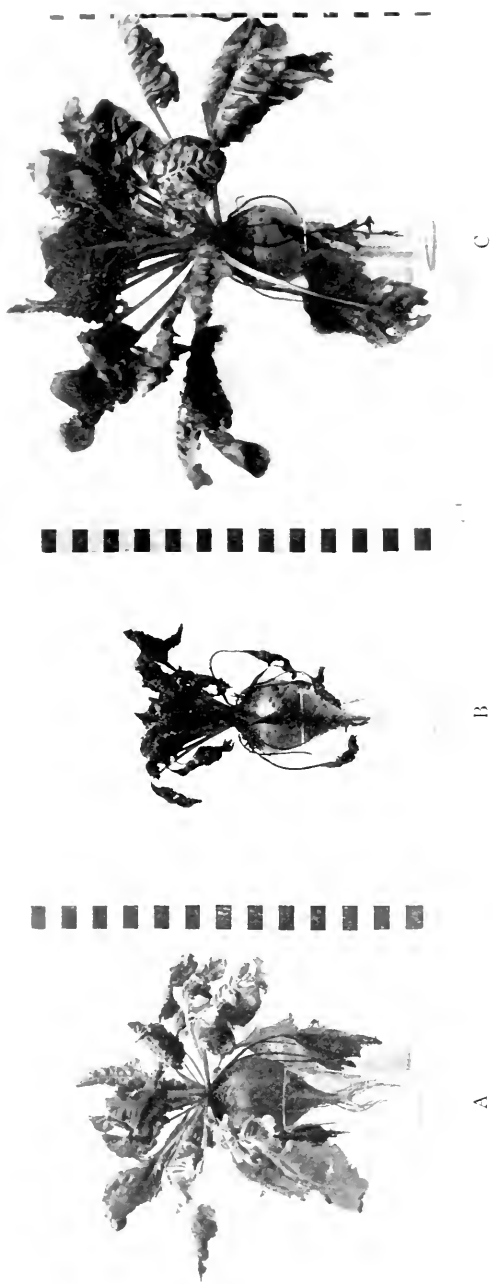

FIG. 4.—EFFECT OF EXCESS OF NITROGEN, WITH AND WITHOUT POTASH, ON THE LEAVES OF MANGOLDS.

- A. Normal Manuring.
- B. Excess of Nitrogen.
- C. Excess of Nitrogen, but Potash also given.





inferred from the fact that its effect upon the yield is always most pronounced in dry seasons.

Referring again to Table XXXIV., it will be seen that in the dry season of 1893, the yield of barley (grown also with ammonium salts and superphosphate) was increased by a dressing of potash from 18.1 to 30.8 bushels per acre, whereas in the wet season of 1894 the increase was only from 34.9 to 41.4 bushels per acre.

Similarly with the wheat (Table XXXV., p. 139), in the wet season the application of potash only increased the yield of grain from 11.1 to 16.0 bushels, and the weight from 54.6 to 57.8 lb. per bushel; whereas in the dry season the yield was increased from 7.7 to 16.4 bushels (more than double), while the weight was raised from 56.4 to 62.6 lb. per bushel. That the bad results in the dry year were due to a premature ripening of the plant, which was deferred by the potash, is seen from the fact that with potash the ratio of grain to straw was 98, whereas without potash it only reached 67.3, in which case the migration of materials from the straw to the grain is clearly incomplete. But though in such cases of grain crops the use of potash prolongs the development of the plant and defers maturity, apparently an opposite effect is produced upon root crops. On the Rothamsted field, for example, where potash is used, the mangold leaves will begin to turn yellow and fall, indicating that the plant has finished its season's growth, long before any such appearance is seen on the potash-starved plots alongside, where a tuft of dark green and apparently growing leaves persists until the plant is cut off by the frosts. Similar appearances, though in a less pronounced degree, can be seen on ordinary crops in light soils, whenever a strip has been left to show the action of potash in the manure.

The apparent contradiction may be explained on physiological grounds; with the root crops ripeness does not represent the completion of a migration process of material previously stored up, such as takes place from straw to grain, but marks the completion of the work of the leaves in manufacturing carbohydrate and passing it on to the root for storage. It has already been shown (Table XLV.) that in the absence of potash the leaves cannot carry on the assimilation process properly, and probably they continue green instead of ripening off because their function of storing up material in the root has not been completed.

From time to time field experiments have been reported which show a reduced yield for the use of potassic salts, and while in many cases the results might be put down to experimental error, the cases are too numerous to be entirely covered by such an explanation.

A clue to this apparent depressing effect of potash is provided by the appearance of the soil on certain of the experimental plots at Rothamsted, as on the Barn field, where considerable amounts of potash salts are applied every year. The behaviour of the soil, which lies extremely wet and sticky after rain, and dries with a hard glazed surface, shows that the clay particles must have become thoroughly deflocculated, just as they are on the plots receiving nitrate of soda (p. 55).

This deflocculating effect of the potash salts, which in themselves would flocculate clay particles, is due to a prior interaction between the potassium salt and the calcium carbonate in the soil, resulting in the formation of a certain amount of potassium carbonate, the deflocculating powers of which have already been recognised.

The destruction of tilth of the soil brought about in this way may easily give rise to an irregular stand and so

account for an inferior plant and a reduced yield on the plots receiving potash salts; the author has observed a case on heavy land where the application of a rather excessive amount of kainit so altered the texture of the soil, that the draught of ploughs upon it was perceptibly increased, and the crop suffered to a marked degree.

The examples that have been given to illustrate the specific action of potash must, however, be used with some caution as a guide to the manuring of crops under ordinary conditions of farming. They are extreme cases, drawn mostly from the later years of the Rothamsted experiments, when the exhaustion of the available potash in the soil had become very pronounced through the continuous cropping with the help of a manure containing all the other elements of fertility except potash. Except on special soils and with the specially potash-loving crops, it is not usual to find in this country that the use of a dressing of potash salts has any visible effect on the yield, so large is the stock of potash in the soil, and so well is it conserved by the ordinary systems of cropping.

On the lighter soils, the sands and the gravels, potash is most likely to be deficient, and the ill-effects arising from its absence are intensified by the dryness of these soils. Even on such soils, potash manures will rarely be found remunerative for cereal crops; for mangolds and potatoes, and to a less extent for turnips, they are necessary; while grass land can hardly be maintained in a satisfactory character without potash at regular intervals. On the stronger soils, potash is a remunerative manure for mangolds, and occasionally for land laid up for hay; but in general, the use of nitrate of soda as a source of nitrogen will liberate enough of the locked-up potash in the soil for the needs of the crop.

## CHAPTER VII

### FARMYARD MANURE

Variable Composition of Farmyard Manure—The Fate of the Constituents of Food during Digestion and Excretion—Composition of Urine and Fæces of Farm Animals—Fermentation Changes taking place during the Making of Dung—The Breakdown of the Nitrogenous Bodies and of the Carbohydrates—Gases found in the Dunghill—Losses of Nitrogen during the making of Farmyard Manure—Preservatives used to minimise the Losses during Dung-making—Composition of Farmyard Manure—Cake-fed *v.* Ordinary Manure—Long and Short Manure—London Dung—The Value of Fresh Manure—The Fertilising Value of Farmyard Manure—Recovery of its Nitrogen in the Crop—Long Duration of the Action of Farmyard Manure—Farmyard Manure as a Carrier of Weeds or Disease—The Physical Effects of Farmyard Manure upon the Soil—The Improvement in Texture and Water-retaining Power—Value of Farmyard Manure as a Mulch on Grass Land—Farmyard Manure best utilised for the Root Crop or Grass Land—Value of Farmyard Manure : Cost of making One Ton.

FARMYARD manure, foldyard manure, yard manure, and dung are all terms employed in various parts of the country for the same more or less decomposed mixture of the excreta of domestic animals with the straw or other litter that is used in the yards or stalls to absorb the liquid portions and keep the animal clean. Probably it would be more correct to retain dung as a name for the excreta alone, and farmyard manure for the product that leaves the yards, but it is impossible in practice to observe any such distinction. It follows, from its origin,

that the composition of farmyard manure must be far from constant, varying with the nature of the animal making the dung, the kind and amount of food it receives, the proportion between excreta and litter, the nature of the litter, and the extent and character of the decomposition which has taken place in the manure itself. The composition of the excreta being the largest of these factors, it will be necessary first of all to trace the effect of the process of digestion on the various manurial substances in the food—compounds of nitrogen, phosphoric acid, and potash. Animals that are not increasing in weight, such as working horses or full-grown cattle simply being maintained in store condition, excrete the whole of the nitrogen, phosphoric acid, and potash they receive in a liquid or solid form, the carbohydrates and fat of the food being mostly got rid of as gases. But the fate of the manurial constituents varies according as they are present in the food as digestible or indigestible compounds; for example, part of the proteins of the food withstand the action of the digestive ferments, and are excreted unchanged in the *fæces*, but to a much greater extent they are broken down into soluble compounds which pass into the blood and eventually are excreted as urea, uric acid, etc., in the *urine*. Similarly, for the phosphoric acid and the potash in the food, whatever is digestible is excreted in the urine in some simpler combination, whatever resists digestion passes out unchanged in the solid excreta. Hence a great difference in the manurial value of the two portions of the excreta; the compounds in the urine—urea, uric acid, soluble phosphates, and potash salts—are either ready for the nutrition of plants or require but slight further changes to become so; whereas in the solid dung the materials have several stages of decomposition

to go through before they can reach the plant, and having already shown themselves able to resist the attack of the animal's digestive ferments they are correspondingly unaffected by the ordinary decay processes in the soil. The proportion the digestible bear to the indigestible constituents of a food varies with the nature and even with the mechanical condition of the material, also with the kind and age of the animal; roughly speaking, the richer the food the greater the proportion that is digestible—*e.g.*, decorticated cotton cake contains 7 per cent. of nitrogen, of which 87 per cent. is digestible and finds its way into the urine, while hay contains about 1.5 per cent. of nitrogen, of which only 50 to 60 per cent. is digestible.

When the animal consuming the food is growing or fattening or yielding milk, a certain proportion of the manurial constituents in the food is retained, the proportion varying with the nature both of the food and the animal. Cows in milk and young growing animals take the greatest toll from their foods, animals in the later stages of fattening the least. If, for example, 100 lb. of linseed cake be fed to milch cows and oxen nearly fat respectively, the manurial constituents contained in the cake will be distributed in each case as shown in Table XLIX.

TABLE XLIX.—NITROGEN RETAINED AND DIGESTED.

	In 100 lb. Cake.	Fattening Oxen.			Milch Cows.		
		In Meat.	In Urine.	In Fæces.	In Milk.	In Urine.	In Fæces.
Nitrogen . . .	4.75	0.21	3.88	0.66	1.32	2.75	0.66
Phosphoric Acid .	2.0	0.14	0.09	1.77	0.5	0.07	1.43
Potash . . .	1.4	0.02	1.10	0.28	0.14	1.05	0.21

It is thus impossible to state the composition of the excreta of the various farm animals except within certain wide limits, owing to the variations induced by the food and the age of the animal. Table L. shows certain average results which will serve to characterise the different animals.

TABLE L.—COMPOSITION OF URINE AND EXCRETA.

Animal.	Excreta.	Water.	Nitrogen.	Phosphoric Acid.	Potash.
Horse . . .	solid	75.0	0.56	0.35	0.1
	liquid	90.0	1.52	trace	0.92
Cow . . .	solid	86.0	0.44	0.12	0.04
	liquid	91.5	1.05	trace	1.36
Sheep . . .	solid	57.6	0.72	0.44	...
	liquid	86.5	1.31	0.01	...
Pigs . . .	solid	76.0	0.48	0.58	0.36
	liquid	97.6	0.50	0.14	0.70

It will be seen that the urine of sheep and horses is much more concentrated than that of cattle and pigs; similarly, the solid excreta of the two former are also the drier. It is this greater dryness and richness which causes the gardener to describe horse manure as "hotter" than that produced by either cows or pigs; bacterial changes take place in it much more rapidly, a greater amount of ammonia is produced, and the rise of temperature is more pronounced.

The next factor which enters into the composition of the dung is the nature of the litter on which the animals are placed; from time to time, especially among small holders, various materials, such as bracken fern, hop bine, leaves, even manufacturing refuse like spent tan and sawdust, are used; but on a large scale only two—straw and to a less extent peat moss litter, get employed.

The litter has a twofold function: it absorbs the urine and other liquid portions, and it provides both organic matter and nitrogen for the resulting manure. The cereal straws contain about 0.5 per cent. of nitrogen, 0.2 per cent. of phosphoric acid, and 1.0 per cent. of potash, the variations in composition between individual samples of any one kind of straw being as great as the variation between average samples of wheat, oat, and barley straw. Speaking generally, straw grown in

TABLE LI.—COMPOSITION OF LITTER.

	Water.	Organic Matter.	Ash.	Nitrogen.	P <sub>2</sub> O <sub>5</sub> .	K <sub>2</sub> O.
1. Wheat Straw (Wet Season) . . .	17.8	76.2	6.0	0.38	0.19	0.77
2. Wheat Straw (Dry Season) . . .	15.6	78.9	5.5	0.21	0.17	1.00
3. Oat Straw . . .	16.5	77.9	5.6	0.4	0.28	0.97
4. Barley Straw . . .	20.0	74.6	5.4	0.27	0.18	0.45
5. Bracken . . .	13.6	81.7	4.7	1.44	0.20	0.11
6. Hop Bine . . .	18.7	77.3	3.95	0.28	0.07	0.10
7. Peat Moss . . .	31.8	47.6	20.6	0.83	0.10	0.17

the north of England and Scotland is richer than straw grown in the south and east of England, because the vegetative growth has been more prolonged and the migration of food materials from the straw into the corn has not been quite so thorough. Straw will absorb from two to three times its weight of water, and again the variation in absorbing power between different samples of the same kind of straw is greater than that between different kinds of straw. In practice wheat straw is the most highly esteemed, as cleaner and wearing better under the feet of the animals than any other kind of straw. Oat straw comes next, and is often almost as good as wheat straw; barley straw is least liked, as it is often brittle and dusty.



Peat moss litter consists of humified vegetable matter, being derived from the upper layers of a peat bog, where the material still retains a good deal of its original structure; it forms a brown, spongy, fibrous mass consisting almost wholly of organic matter. It will absorb a greater amount of water than will an equal amount of straw, up to about ten times its own weight of water. Peat moss is also remarkable for its power of absorbing ammonia even from the atmosphere, so that a stable littered with peat moss will remain sweet for a comparatively long time. Table LII. shows the result of an experiment in which two similar stables carrying the same stock were littered—the one

TABLE LII.—AMMONIA IN STABLE PER MILLION OF AIR.

Litter.	1st day.	2nd day.	3rd day.	4th day.	5th day.	6th day.	17th day.
Straw . .	·0012	·0028	·0045	·0081	·0153	·0168	...
Peat Moss	0	0	0	0	trace	·001	·017

with straw, the other with peat moss, and the amount of ammonia in the air was determined every day. As will be seen, the peat moss proved a much more efficient absorber of the ammonia produced than the straw. The peat moss itself usually contains a higher proportion of nitrogen than straw does, hence the manure it makes appears to be correspondingly richer, and this difference is often increased by its longer retention in the stalls. But the peat moss itself is very slow to decay, especially in dry soils, so that it is doubtful whether its extra content in nitrogen is of much value; direct experiments, however, are lacking to compare the relative value of manure made from the same amount of feeding stuffs with peat moss and straw respectively. Peat moss manure is

always short, and is less easy to handle in consequence, but it requires no making and can be applied straight from the yards even to the lightest of soils.

However the farmyard manure has been made, it thus starts with a mixture of excrement, urine, and litter, which become more or less consolidated and mixed together by the trampling of the animals. Other changes, however, intervene very rapidly, and these in the main are brought about by bacteria, which for convenience may be divided into two groups, one acting on the cellulose and other carbon compounds of the straw that make up the bulk of the manure, and the other acting on the nitrogenous compounds that do not weigh so much but supply the main fertilising properties of the dung.

Among the more important of the organisms dealing with nitrogenous material are those which attack the urea in the urine and by adding to it the elements of water give rise to a carbonate of ammonia, which very readily dissociates into free ammonia and carbonic acid—both gases, and therefore capable of escaping into the atmosphere.

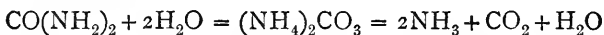

There exists more than one organism bringing about this change, but the best known is a small coccus known as *Micrococcus ureæ*, which is widely disseminated in the air and dust, and is naturally extremely abundant in such places as stables and cattle stalls, where it is always giving rise to ammonia. This change into ammonium carbonate is an extremely rapid one; in the liquid draining from a yard or a manure heap, or even in the liquid manure tank, little or no urea can be detected, so complete has been the change to ammonia. As long as the liquid containing the ammonium car-

bonate is protected from evaporation, no loss of nitrogen will result, but the more surface it exposes to the air and the higher the temperature, the greater will be the amount of ammonia passing off in a gaseous condition. Thus thin films of urine on the floors, walls, or even on the surface of loose straw, easily lose nitrogen by the fermentation of the urea and subsequent volatilisation of the ammonia; the smell of a stable arises in this way and is clear evidence of the escape of ammonia. As will be brought out more clearly later, this volatilisation of ammonia causes most of the loss of nitrogen that takes place in making dung.

The ammonium carbonate is itself subject to change and even to loss by other actions than evaporation: there are always present in the manure heap various bacteria which can oxidise ammonia into free nitrogen gas and water; in consequence dung which is allowed to lie about loosely grows poorer in nitrogen from this cause as well as through volatilisation of ammonia. Though the action has been recognised as taking place in practice, little is known of the specific bacteria which set free gaseous nitrogen in this way, a process which is often called "denitrification," though the term is better restricted to the change whereby nitrates are reduced to nitrogen gas. Nor have the conditions favourable to this change been closely investigated; it is, however, certain that rapid oxidation such as is brought about by a loose condition of the manure or by turning it, will be accompanied by some destruction of ammonia. It is also favoured by the presence of soluble carbohydrates—*i.e.*, easily oxidisable material—and it is materially reduced, if not suspended, as soon as these substances have been used up.

Another group of bacteria which are extremely abundant in fresh fæces are the so-called putrefactive

bacteria which break down the proteins into simpler compounds such as amino-acids, amides, and finally ammonia. Some of these bacteria, like *B. coli communis*, are abundant in the large intestine of herbivorous animals, and of course continue their work in the excreta after ejection. Without discussing them individually, their function is to convert the insoluble nitrogenous bodies of the straw (those of the fæces are more difficult of attack because they have already resisted the actions of digestion) into soluble bodies akin to ammonia and therefore more nearly utilisable by the plant. Thus, with a certain amount of loss as free nitrogen, the trend of the bacterial actions taking place in the fresh farmyard manure is to break down the complex insoluble compounds of nitrogen to more and more simple ones, ammonia being the final term. At the same time, there is always a reverse change going on; as the bacteria themselves multiply, they seize upon the active soluble forms of nitrogen and convert them into insoluble proteins in their body tissues. Which action is predominant will depend on the stage that has been reached in the dung-making process—*i.e.*, on the supply of carbohydrate, air, water, and other variable factors—but after the first rapid production of ammonium compounds, the longer the dung is stored the more the ammonia returns to a protein form.

So far we have been considering only changes in the nitrogenous material of the excreta and the litter, since nitrogen is the chief fertilising constituent of the manure, but the most characteristic change in dung-making is the destruction of the straw and its conversion into dark brown "humus," which in the end retains none of the structure of the original straw. There are a number of organisms to be found commonly in the air and dust which readily attack such carbo-

hydrate material as straw affords, and in the presence of oxygen burn it up completely into carbon dioxide, water, and inorganic ash. Such organisms, however, do not play a very large part in manure-making, because oxygen soon gets excluded from the mass; the work is taken up instead by other bacteria capable of working in the absence of oxygen. Two of these only have been as yet studied in any detail; they both rapidly attack carbohydrates like cellulose, and give rise to carbon dioxide, marsh gas or hydrogen respectively, certain fatty acids, of which butyric is the chief, and the indefinite brown acid substance known as "humus," which is richer in carbon than the original carbohydrate. The evolution of such gases can easily be demonstrated during the making of dung, either by laboratory experiments or by an analysis of the gases extracted from a dunghill.

Table LIII. shows the gases extracted from a fresh dunghill by Dehérain during one of his experiments at Grignon.

When the first sample was taken, the dungheap was still in process of formation, and was in too dry a condition. The hydrogen fermentation was most prominent at this stage, and hydrogen and carbon dioxide were the most prominent gases. On that day the liquid manure was pumped up over the whole mass, and fermentation became more active, as seen by the very high temperatures reached on the 24th, when the formation of hydrogen had diminished, while that of marsh gas had increased greatly. The analyses on 30th August show the result of having again let the heap get dry; the top and middle were full of air, as may be seen from the large proportions of nitrogen and the presence of some oxygen; the percentage of carbon dioxide had also become so

low that losses of ammonia would take place by volatilisation, especially as the temperature was high. The later analyses, taken when the heap was well consolidated and kept moist, show that a steady

TABLE LIII.—COMPOSITION OF GASES IN DUNGHILL (Dehérain).

Date, 1899.	Height of Dunghill.	Point at which Samples were taken.	Temperature.	Carbon Dioxide.	Oxygen.	Marsh Gas.	Hydrogen.	Nitrogen.
	Metres.		°C.					
Aug. 22 .	2.00	middle	52	54.3	0.0	7.8	23.5	14.4
„ 23 .	2.00	middle	52	58.0	...	14.2	11.8	16.0
„ 24 .	2.30	{ top middle bottom	71 67 63	50.0 68.0 49.0	... ... ...	17.4 23.9 40.8	3.1 7.4 3.9	29.5 0.7 6.0
„ 26 .	2.30	bottom	60	51.0	...	46.6	2.4	0.0
„ 30 .	2.50	{ top middle bottom	60 65 60	7.2 14.5 50.8	7.0 4.7 0.0	0.0 1.3 49.2	... ... ...	85.8 79.5 0.0
Sept. 20 .	2.50	{ top middle bottom	66 65 52	42.7 49.5 47.8	1.1 ... ...	52.4 48.3 51.2	... ... ...	9.8 2.2 1.0
Oct. 4 .	2.50	{ top middle bottom	55 65 40	54.0 42.7 48.3	0.5 ... ...	43.0 56.1 51.7	... ... ...	2.0 0.0 0.0

anaërobic fermentation of carbohydrates into equal volumes of carbon dioxide and marsh gas was then going on, while the evolution of hydrogen had stopped.

From these and the other analyses executed by Dehérain, it may be learnt that the main anaërobic fermentation which takes place when the straw and other materials are fresh, is that which gives rise to hydrogen and carbon dioxide; if the heap gets too dry and air penetrates, an aërobic fermentation begins, which gives rise to carbon dioxide only; but at the

same time the proportion of this gas falls to such an extent because of its dilution with the air, that ammonia can be lost by volatilisation. By consolidating the heap and pumping the liquid over it afresh, the anaërobic fermentation rapidly sets in again and the proportion of carbon dioxide is restored, thus checking the dissociation and volatilisation of the ammonium carbonate. After the first outburst of fermentation, the evolution of hydrogen ceases and the marsh-gas fermentation takes its place.

A considerable proportion, amounting to one-quarter or more, of the dry matter of the original dung is lost during this process of humification, by the conversion of carbohydrates into carbon dioxide, marsh gas or hydrogen, and water. The various acids which are also produced are neutralised by the liquid part of the manure, which is alkaline from the presence of ammonium and potassium carbonates resulting from the fermentation of the nitrogenous constituents and salts of the urine; the dark brown liquid to be seen draining from a dunghill is a solution of the humus formed in this alkaline liquid.

The changes going on during the making and storage of farmyard manure are thus exceedingly complex; it is in the early stages that the bacterial actions are most rapid, and they fall chiefly upon the soluble nitrogenous compounds like urea. At this time the greatest losses of nitrogen take place both by volatilisation of ammonia and by evolution of nitrogen gas, and so active is the oxidation that the temperature of the mass rises continually. If the rate of oxidation be promoted by occasionally turning over the mass, as in preparing a hot bed or a mushroom heap, the rise in temperature is much increased; at the same time the losses of nitrogen rise rapidly, and the amides and

ammonium carbonate disappear more quickly. What the gardener calls "taking the fire" out of the manure, means so reducing the free ammonia that the material is no longer injurious to a plant's roots, though it still remains rich in nitrogen and organic matter capable of further decay. As soon as the first violent reactions are over, especially after the mass has become consolidated by trampling and the oxygen in the entangled air has been used up, the rate of change slows down considerably; it now consists mainly in the attack of the anaërobic organisms upon the carbohydrate material. The long strawy dung begins to change to "short" or rotten manure, and this change may continue slowly for years, until all trace of structure is entirely gone and only a brown pulp is left. During this second change but little loss is experienced by the nitrogenous compounds; if the mass is kept tightly pressed and moist enough to exclude air, there will be no loss of fertilising constituents, only a gradual decline of weight as some of the carbon compounds are converted into gases. Of course, as the manure gets older and shorter it becomes richer in nitrogen; this apparent increase is, however, simply due to the loss of non-nitrogenous carbon compounds, whence it follows that the nitrogen, which does not waste, always bulks larger and larger in the residue. But though there is no loss in nitrogen in these later stages, the more active compounds, such as ammonia and the easily decomposable amides, become converted by bacterial action into carbon compounds which take longer to reach the plant when the manure finally gets in the soil.

Thus, during the making and storage of farmyard manure there are a large variety of bacterial actions at work, some running in an opposite sense to others, and it will depend on such external conditions as the



supply of air and water which class of action predominates at any given time. Putrefactive bacteria are resolving proteins into simpler compounds of nitrogen and ultimately into ammonia; oxidising bacteria (sometimes called denitrifying bacteria) set free nitrogen gas; meantime the bacteria engaged in the destruction of cellulose and the formation of humus are always building proteins or bodies akin to them out of the previously produced amides and ammonia.

One other change sometimes takes place when the manure is allowed to get too loose and dry—instead of bacteria, fungi begin to develop very rapidly until the whole mass becomes permeated with the mycelium. The masses of manure begin to look white and dusty, a condition which the practical man describes as “fire fanged.” It is generally agreed that such manure is seriously deteriorated, but no analyses are available.

With these general facts in mind it will be possible to interpret the experiments which have been made to ascertain what part of the fertilising materials contained in foods consumed by animals is recovered in the dung and what losses occur during the making and storage of farmyard manure. In the first place, it can be shown that there is no loss of nitrogen in the gaseous form due to the animal; the nitrogen contained in the urine and fæces is equal to the nitrogen in the food, less whatever may have been retained by the animal in its bodily increase. Numerous feeding experiments demonstrate this point; the following example from Kellner's researches may be taken as an illustration.

An ox was fed on a daily ration of 2 kg. of gluten meal, 2 kg. of starch meal, 4 kg. of dried sugar-beet slices, 5 kg. of hay, and 1 kg. of chaff, containing in all 388.8 grms. of nitrogen. About 18.5 kg. of dung was excreted containing 15.36 per cent. of dry matter and

100.9 grms. of nitrogen, and about 13 kg. of urine containing 2.03 per cent. of nitrogen, equal to 265.5 grms. of nitrogen. The ox was putting on weight, and retained from the food 714.5 grms. of carbon and 22.5 grms. of nitrogen. Thus of the nitrogen supplied 68.2 per cent. was excreted in the urine, 25.4 per cent. in the fæces, and about 6 per cent. was retained by the animal. To attain such a result, however, it is necessary to collect the urine and fæces as they are voided, and to preserve them or analyse them before any fermentation and evaporation of ammonia can take place.

Assuming the animal itself to cause no loss of nitrogen other than that retained in the increased live weight, a number of experiments have been made to ascertain the losses in making farmyard manure under ordinary working conditions.

For example, Maercker and Schneidewind, at Leuchstadt, in 1896-7 tied up twenty-four three-year-old steers from 16th June to 29th October 1896—136 days—during which their average increase of live weight was 306 lb. The food consisted of lucerne hay, chaff, barley straw, dried sugar beet pulp, decorticated cotton cake, and bran, and they were littered on wheat straw.

Twelve of the beasts were tied up in a deep, carefully cemented box or pit, from which no losses by drainage could take place, and the dung was not disturbed but kept trampled down until the end of the trial. The second twelve were fed in an ordinary stall, and the dung and litter were removed every other day to one or other of two heaps in the yard alternately, one of these being covered by a roof, and the other open to the weather. At the end of the feeding experiment the three lots of dung were carefully sampled and analysed, with the results set out in Table LIV. below.

In a second experiment, fourteen steers were fed in

TABLE LIV.—LOSS OF NITROGEN IN MAKING AND STORING DUNG (Maercker and Schneidewind).

No.	Conditions under which Manure was made.	Nitrogen supplied.		Nitrogen recovered.		Nitrogen of Food.			Active Nitrogen recovered.		
		In Food.	In Litter.	In Meat.	In Dung.	Recovered.	Lost.	Per cent.	Per cent.	Calculated.	Found.
FIRST EXPERIMENT.											
1	Deep box . . . . .	Lb. 1033	Lb. 68.0	Lb. 64.3	Lb. 900	Per cent. 6.2	Per cent. 80.6	Per cent. 13.2	Per cent. 70	28.5	
2	Covered heap . . . . .	Lb. 1033	Lb. 68.0	Lb. 68.0	Lb. 652	Per cent. 6.6	Per cent. 56.5	Per cent. 36.9	Per cent. 70	18.0	
3	Open heap . . . . .	Lb. 1033	Lb. 68.0	Lb. 68.0	Lb. 646	Per cent. 6.6	Per cent. 56.0	Per cent. 37.4	Per cent. 70	13.0	
SECOND EXPERIMENT.											
4	Deep box . . . . .	922	52.1	54.6	797	6.0	80.8	13.2	...	...	...
5	Deep box, dung lying one month untrampled . . . . .	953	65.4	45.9	634	4.8	59.7	35.5	...	...	...

the deep pit from 6th November 1896 to 21st February 1897, when the dung made was cleared out, sampled, and analysed. The experiment was then resumed until 21st May, after which the dung was left in the box for another month, until 17th to 18th June, without any beasts to keep it trodden down, the weather being meantime very hot. The results appear under items 4 and 5 in Table LIV. It will be seen from this that the loss of nitrogen was much greater during the second series, which only differed from the first in the fact that the dung lay without trampling for a month during the summer.

Taking these results as a whole, it is seen that, even with the most careful management, the loss in making the dung amounts to 13 per cent. of the total nitrogen supplied in the food, in addition to 6 per cent. or so which the animals retain. This loss increases with great rapidity if the conditions are less favourable; the minimum is only attained if the dung be kept trampled beneath the animals in a deep box, for if it be left to itself for a time, or if it be made in a shallow stall and thrown out daily into a heap, as is often the practice, the loss rises to between 30 and 40 per cent.

In connection with the first-mentioned experiment, Maercker and Schneidewind made determinations of the state in which the nitrogen exists in the dung, whether it was soluble and therefore active, or insoluble and comparatively inactive. From the known digestibility of the foods consumed, it was possible to calculate what proportion of the nitrogen in each food left the body in a digested condition as urea and kindred bodies dissolved in the urine, and what proportion consisted of undigested and insoluble compounds in the fæces. Maercker and Schneidewind found not only that the loss had fallen upon the active nitrogen—*i.e.*,

that urea had been transformed into ammonium carbonate and volatilised, or broken up with loss of free nitrogen—but also that some of the active nitrogen had been converted into an insoluble form, as though the bacteria swarming in the dung had seized upon the active nitrogen and converted it into the insoluble material of their own substance. Of course, this withdrawal of nitrogen from the active into the insoluble form still further reduces the value of the dung as a whole.

In France, experiments were carried out on the same question by MM. Müntz and Girard, with omnibus horses, cows, and sheep. They showed that with horses and milking cows, where the manure was removed every day, the loss of nitrogen amounted to from 30 to 35 per cent. of the total nitrogen contained in the food. With sheep the losses were still higher. Liberal littering and immediate treading of the excreta into it by the animal greatly reduced this loss. The results are given in Table LV. It is apparent that, on the whole, the proportion of the nitrogen recovered in the manure is about one-half of that supplied in the food.

Further experiments with sheep show that the loss was greatest with no litter, and could be reduced by using an excess, or particularly by using peat moss or earth.

		Loss per cent.			Loss per cent.	
Cows.	{	No Litter . . .	59.0	Horses	{ On Straw . . .	58.0
		Litter . . .	50.2		{ „ Peat Moss . . .	44.1
		Litter . . .	44.2	Sheep.	{ On Straw . . .	50.2
		Abundant Litter	40.8		{ „ Earth . . .	25.7

Experiments of the same kind have also been carried out on the farm of the Royal Agricultural Society at Woburn for some years, and the results obtained in 1899, 1900, and 1901, are given in Table LVI.



TABLE LVI.—LOSS OF NITROGEN IN MAKING AND STORING FARMYARD MANURE PRODUCED BY CONSUMPTION OF FOODS BY FATTENING BULLOCKS, 1899, 1900, AND 1901 (Woburn).

	For Continuous Wheat Experiments.				For Continuous Barley Experiments.			
	Manure as removed from Boxes.		Manure as applied (after storing) to Land.		Manure as removed from Boxes.		Manure as applied (after storing) to Land.	
	1899.	1900.	1899.	1901.	1899.	1900.	1899.	1901.
Total Nitrogen estimated to be in Manure, as calculated from Foods consumed after deducting live-weight increase (Lawes and Gilbert) . . . .	34.23	32.39	29.87	29.87	34.23	32.39	29.87	29.87
Total Nitrogen actually found in Manure . . . .	29.81	26.47	24.96	19.84	32.07	26.66	24.67	20.39
Loss of Nitrogen . . . .	4.42	5.92	4.91	10.03	2.16	5.73	5.20	9.48
Percentage loss of Total Nitrogen . . . .	12.90	18.28	16.44	33.60	6.30	17.69	17.41	31.80

The animals were fed in deep boxes with cemented bottoms and sides, and the dung was not removed until the feeding experiment had concluded; it was then weighed and samples taken for analysis. The manure was then, in the early winter, made up in a heap in the open on ground beaten down hard and covered thoroughly with earth. No liquid appeared to drain away, and in the spring the heap was again weighed and sampled before application to the land for the root crop. Here, again, the loss of nitrogen in making the dung under the best conditions varied from 13 to 18 per cent., while the making into a heap and storage brought up the loss to 33-37 per cent.

Wood, at Cambridge, has also estimated the losses involved during the making and storage of farmyard

TABLE LVII.—LOSS OF NITROGEN IN MAKING MANURE (Wood).

	Retained by Animal.	Lost.		Recovered in Dung.	
		During Making.	During Storage.	When Made.	After Storage.
DRY MATTER.					
Roots and Hay only .	2.6	38.8	16.2	58.6	42.4
Roots and Hay with Cake	5.0	35.0	18.6	60.0	41.4
NITROGEN.					
Roots and Hay only .	8.0	16.8	10.6	75.2	64.6
Roots and Hay with Cake	9.0	12.5	26.9	78.5	51.6

manure. In his experiments four heifers were tied up and fed, one pair on mangolds, hay, and straw alone, the other pair on the same foods with the addition of decorticated cotton cake. The feeding went on for



84 days in boxes with well-rammed clay floors, the dung was not disturbed but was kept trampled down by the animals; this is taken as the period of "making" the dung, and at the end samples were drawn by cutting out sections. The dung was now left without moving for six months, May to November, and again sampled as it was taken out—this constitutes the storage period. Table LVII. shows the fate of 100 lb. of dry matter and nitrogen respectively fed to the animals.

In an experiment made by Russell and Goodwin at the Wye Agricultural College, the beasts were fed upon roots, hay, and linseed cake, a comparison being made between linseed cake poor and rich in oil respectively. The feeding lasted for twelve weeks and the litter was composed of a bottom layer of peat moss, to which straw was added at the rate of 28 lb. per week. Table LVIII. shows the results obtained.

TABLE LVIII.—LOSS OF NITROGEN IN MAKING MANURE (Russell).

	Nitrogen supplied.			Nitrogen recovered.			Nitrogen lost.	
	Digestible.	In-digestible.	In Litter.	In Meat.	Ammonia, etc.	Slowly available.	Actual.	Per cent.
1. Cake poor in Oil .	Lb. 43.83	Lb. 11.77	Lb. 4.35	Lb. 3.07	Lb. 28.6	Lb. 20.9	Lb. 7.38	14.9
2. Cake rich in Oil .	Lb. 33.29	Lb. 10.19	Lb. 4.35	Lb. 2.04	Lb. 22.1	Lb. 16.9	Lb. 6.69	14.4

The dung was sampled immediately the experiment was over, while the manure was still tight under the feet of the animals; the experiment also took place during the winter months, yet the loss still amounted to nearly 15 per cent. of the total nitrogen. It is noteworthy that all the experiments quoted show practically this same loss of 15 per cent. for the first stage of

the dung-making process under the best conditions. Not only does the loss fall upon the active compounds of nitrogen, but a still further amount is converted into more slowly acting bodies. For example, in experiment 1 there were 43.83 lb. of digestible nitrogen fed, of which the animal only retained 3.07; the remainder, 40.76 lb., was excreted as urea, but only 28.6 lb. of ammoniacal and amide nitrogen were found in the dung, so that besides the loss of 7.38 lb. another 4.78 lb. had been transformed into proteins and other insoluble compounds.

It will be seen that in all cases the losses fall most heavily on the rich dung made by animals receiving concentrated foods; they also fall almost entirely on the most valuable part of the manure—the urea and ammonia compounds arising from the digestible portions of the food. It is also clear that these losses are avoided when the food is consumed upon the land, as by sheep folded on the arable, milch cows grazing or beasts fattened with cake upon the summer grass.

Of course, in all these considerations no account has been taken of such preventable losses as those which too often occur through the escape of the liquid portions of the manure in a leaky yard or into the drains, or by the washing of rain through the dung heap. Such losses are very great and fall on the most valuable substances in the manure—the soluble ammonia and potash compounds which occur in the liquid portion.

In order to minimise these losses of nitrogen, a number of substances have been suggested, which, when strewn about the cattle stalls and mixed with the fresh dung, would either combine with the ammonia and prevent its volatilisation, or by reducing the bacterial actions would hinder its formation. These preservatives fall into two classes: those designed merely to

fix the ammonia, and the true antiseptics which will check the production of either ammonia or free nitrogen gas. Of the first class of substances, the oldest proposal was to use gypsum, which would react with the ammonium carbonate and form the non-volatile ammonium sulphate.

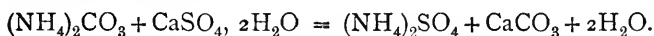

The drawback to the use of gypsum lies in the large quantities that are required; the reaction represented by the above equation is really a reversible one, so that only part of the ammonium carbonate is transformed into sulphate, the amount being proportional to the excess of gypsum present. As also the gypsum is an insoluble salt, far more than the calculated quantity will be required for an efficient fixation of the ammonia. Again, the urine contains nearly all its potash in the form of potassium carbonate, and this also will react with gypsum, increasing the quantity that must be used before the ammonia is fixed.

From the above equation, about 11 lb. of gypsum would be required for each ton of dung, but at least ten times as much as this would be necessary in practice, or a hundredweight of gypsum, costing 2s. for each ton of farmyard manure made. Besides the question of cost, another great drawback to the use of gypsum lies in the fact that the calcium sulphate is itself liable to bacterial change; during the storage of the dung it is reduced by anaërobic bacteria to the state of calcium sulphide, which afterwards acts injuriously on plant life when the farmyard manure is applied to the soil.

Another suggestion has been to use kainit, because it is composed of salts of magnesium and potassium which will to a certain extent be transformed into

carbonates and fix the ammonia as chloride or sulphate. Here, again, the quantity required is very large, though the soluble nature of the kainit enables it to be utilised more thoroughly. But of this class of substances the most effective is superphosphate; the acid calcium phosphate it contains reacts with the ammonium carbonate to form a double ammonium calcium salt, insoluble indeed, but readily becoming available for the plant. The same objections, however, apply to superphosphate as to gypsum; uneconomical quantities are required if the fixation of the ammonia is to be complete, the superphosphate itself contains gypsum which becomes reduced to the injurious calcium sulphide, and again the acid superphosphate is found to be harmful to the feet of the animals treading down the litter among which it is strewn.

Sulphuric acid itself has been tried, as also peat moss impregnated with small quantities of the same acid, but neither have proved successful for the reasons indicated above.

As to antiseptics proper, soluble fluorides and even carbon bi-sulphide have been tried, but the saving effected in the nitrogen is never sufficient to pay for the cost of the material and the trouble of applying it. Schneidewind, in the course of his experiments at Leuchstadt, found that the only practical means of reducing the losses of nitrogen, was to place a layer of old well-rotted farmyard manure as a basis for the new manure heap; this had a distinctly beneficial effect and always resulted in smaller losses of nitrogen, probably because of the constant evolution of carbonic acid from the layer of old manure.

Turning now to the composition of farmyard manure, the average of a large number of analyses at Rothamsted shows that it contains about three-quarters of its

weight of water, about two-thirds of 1 per cent. of nitrogen, one-quarter of 1 per cent. of phosphoric acid, and one-third of 1 per cent. of potash, or per ton about 15 lb. of nitrogen, 5 lb. of phosphoric acid, and 7 lb. of potash. The composition, however, will vary very greatly, both with the nature and feeding of the animals, and the treatment and storage the manure receives.

The influence of the feeding is well illustrated in a series of analyses of two lots of dung, made in

TABLE LIX.—PERCENTAGE COMPOSITION OF FARMYARD MANURE MADE AT ROTHAMSTED FROM ROOTS AND HAY ONLY, OR FROM ROOTS AND HAY WITH CAKE.

	Year.	Dry Matter.	Total Nitrogen.	Nitrogen as Ammonia.	Nitrogen as Amides.	Insoluble Nitrogen.	
Roots and Hay only . . .	1904	23.6	0.577	0.046	0.067	0.464	} Made into Mixen and stored.
Cake-fed . . .	1904	24.03	0.716	0.079	0.096	0.541	
Roots and Hay only . . .	1905	29.5	0.462	0.040	0.047	0.375	} Do.
Cake-fed . . .	1905	31.3	0.698	0.182	0.055	0.461	
Roots and Hay only . . .	1906	22.0	0.466	0.022	0.033	0.411	} Do.
Cake-fed . . .	1906	24.3	0.690	0.097	0.049	0.544	
Roots and Hay only . . .	1907	25.3	0.589	0.125	0.053	0.411	} Not stored.
Cake-fed . . .	1907	25.5	0.815	0.377	0.033	0.405	

adjoining boxes by bullocks receiving in the one case roots and hay only, and in the other a fattening ration of cake in addition to the roots and hay. The two lots of dung were generally made up into separate mixens out of doors, and sampled a month or two later, when they were carted out to the land; in one case they were sampled as they left the boxes. Table LIX. shows the analytical results, not only as regards the

total nitrogen, but also that present as salts of ammonia, and as amido-compounds easily changing into ammonia.

It will be seen that the cake-fed dung is always considerably richer in nitrogen, the average percentage being 0.73 as against 0.523, a superiority of nearly 40 per cent. Moreover, the extra nitrogen in the cake-fed dung is mostly in the highly available forms, the ammonia, urea, and amido-compounds which represent the digestible nitrogen of the cake; the insoluble nitro-

TABLE LX.—CROP RETURNS FROM THE ABOVE MANURES.

	Year of Application.	Second Year.	Third Year.
	Mean of 4.	Mean of 4.	Mean of 3.
Unmanured Plot . . . . .	100	100	100
16 tons per acre Root and Hay Dung	132	131	112
16 tons per acre Cake-fed Dung .	183	137	118

gen in the cake-fed dung is only 0.488, as against 0.415 in the dung made from roots and hay, a superiority of less than 18 per cent. That the superiority of the cake-fed dung as regards the soluble nitrogen compounds is not even more pronounced, is due to the change back from ammonia into proteins effected by bacteria during storage; in 1907, when the dung was sampled as it left the yard, both lots contained practically the same proportion of insoluble nitrogen, and both possessed an exceptional amount of ammonia, which, however, was three times as much in the cake-fed as in the other manure. These differences in composition are clearly reflected in the crops grown with equal quantities of the two manures, the weights of which are summarised and reduced to a common standard (the yield of the unmanured plots being taken as 100) in Table LX. The crops grown in these trials were

Swedes, barley, mangolds, and wheat in rotation, and after the two kinds of dung had been applied in a given year, no other manure was used on those plots for the next three years. In the first year the increase in yield produced by the cake-fed dung was 83 per cent., as compared with an increase of 32 per cent. produced by the root and hay dung; in the following year the residue left by the cake-fed dung produced an increase of 37 per cent., as against 31 per cent. from the residue of the other manure; in the third year the increases produced by the residues still remaining were 18 and 12 per cent. respectively. The great difference in the value of the two manures comes in the first year, for though the superiority of the cake-fed dung may still be seen in the second and third year, it is almost covered by the experimental error.

The analyses in Table LXI. show the change in composition which results from the storage of farmyard

TABLE LXI.—COMPOSITION OF FARMYARD MANURE FROM VARIOUS SOURCES.

	Water.	Nitrogen.	Phosphoric Acid.	Potash.
1. Fresh long Straw . .	66.17	0.544	0.318	0.673
2. No. 1 after rotting . .	75.4	0.597	0.454	0.491
3. Very old and short from a mushroom bed . . . .	53.14	0.80	0.63	0.67
4. Fresh } French data {	75.0	0.39	0.18	0.45
5. Rotten } {	75.0	0.50	0.26	0.53
6. Very old } {	79.0	0.58	0.30	0.50
7. Rothamsted average . .	76.0	0.64	0.23	0.32
8. Fresh Liquid Manure . .	98.02	0.044	0.051	0.355
9. Old " . . . .	99.13	0.026	0.014	0.22

manure; it will be seen that old short dung contains a higher proportion of fertilising constituents (*i.e.*, when reckoned in the dry matter, because the amount of water present at any time is a matter of accident)

than fresh dung, if it has been at all properly managed. We have already seen that though considerable losses of nitrogen take place during the rotting down of the manure, the losses of non-nitrogenous organic matter are greater still, so that the manure becomes concentrated in nitrogen and still more so in phosphoric acid and potash. The active compounds of nitrogen, however, like ammonium carbonate, grow less as the manure ages, since they are constantly being converted into insoluble protein-like bodies making up the bacteria themselves. These of course, die and decay, giving rise again to soluble nitrogenous compounds, but the tendency is on the whole in the other direction, so that the older the manure the poorer it becomes in ammonia and kindred bodies. Hence old short dung is both slower in its action and less caustic to germinating seedlings or the fresh delicate rootlets of tender plants; it can in consequence be used with more safety in the spring in potato drills or immediately beneath the seeds of Swedes and mangolds, particularly on a light soil. A few analyses of liquid manure are also given, though it is subject to such variations in the amount of rain-water that gets mixed with it and the degree to which its constituents are held back by the litter, that little can be deduced from these results as to the composition of any other sample. It will be seen, however, that the fertilising constituents are chiefly nitrogen and potash, both in an active form; hence it forms a very valuable manure for grass land.

Table LXII. shows a series of analyses made by B. Dyer of stable manure from London, such as is used in very large quantities by farmers and market gardeners, whose distance from London does not render the freight too great. The most noticeable thing in the five last analyses is the very low proportion of nitrogen that



remains soluble; the frequency with which the stables are cleaned out in London, the open nature of the heaps, and the many turnings to which the manure is subjected in collection and transit, all result in extreme aëration and a rapid fermentation with a corresponding loss of ammonia. The last three samples had been stored for eight or nine months on the farm; usually no great care is taken to consolidate such heaps, so that the

TABLE LXII.—COMPOSITION OF LONDON STABLE MANURE  
(B. Dyer).

	Peat Moss.	Straw.	Mixed Peat Moss and Straw.				
			Fresh.		After Storage.		
			1	2	1	2	3
Water . . . . .	77.8	70.0	76.1	62.0	53.8	61.9	52.9
Organic Matter . . .	18.0	24.3	19.3	26.4	17.5	22.0	23.0
Nitrogen, soluble . .	0.51	0.10	0.08	0.08	0.06	0.08	0.10
Nitrogen, insoluble .	0.37	0.52	0.46	0.62	0.58	0.68	0.79
Phosphoric Acid . .	0.37	0.48	0.33	0.45	0.49	0.56	0.66
Potash . . . . .	1.02	0.59	0.45	0.58	0.58	0.65	0.80

rotting down process goes on rapidly. In the above cases Dr Dyer calculates that the loss in organic matter had been about 40 per cent., and in nitrogen from 15 to 20 per cent., during the storage.

From a consideration of the origin of the losses of nitrogen which take place during the making of dung, and of the above analyses, a good deal of guidance can be obtained as to the practical management of farmyard manure, which remains the fundamental fertiliser in the ordinary course of farming in this country. In the first place, since it is clear that the most valuable part of the manure resides in the liquid, far more care should be taken to preserve this than is usually the case. Whether the dung is made in boxes or in yards, there should be

sufficient depth to allow the manure to accumulate under the animal for the whole winter if need be, and the floors should be rammed with clay to render them water-tight. Yards, in particular, should be constructed so that the accumulated manure is not above the general ground line outside, in which case there will always be a gradual soaking away of the liquid. On the other hand, yards made thus below the general ground level are apt to flood in heavy rain, so that the excess of liquid containing the soluble part of the manure has to be run off to waste by means of a drain; this can, however, be avoided by cutting drains outside to keep land water from running into the yard, and by seeing that all the surrounding sheds are properly provided with guttering. For real economy of litter, part at least of the yard should be covered; if the whole yard is covered a certain amount of care is necessary to prevent the dung from getting at times too dry. Only just enough litter should be used to soak up the urine, and in order to prevent the liquid working up to the surface with the trampling, the floor of the yard should run down to a slight hollow, filled at first with something stiff like bean haulm or coarse peat moss, in which the excess of liquid may collect. Above all, the manure should be kept tightly trampled; the greatest amount of loss takes place when the urine falls on a thin layer of loose strawy litter. The yards and boxes should be deep enough to carry the animals through the whole winter, so that they need not be cleaned out except when dung is wanted to go straight on the land. A box, for example, 8 ft. by 10 ft. in area, with an available depth of 3 ft. would hold about 9 cubic yards, or 8 tons of dung when well trodden down. This would accommodate two beasts, each receiving 10 lb. of straw in food and 12 lb. in litter per diem, for four months.

As far as possible manure made in the spring should be left undisturbed until the autumn, it may then be carted out on to the stubbles and ploughed in where potatoes or roots are to be taken in the following spring. Even on the lightest soils the land will be more benefited thus than if the manure is made up into a mixen and only put on immediately before the roots are grown. Sometimes, of course, a potato grower must have a supply of well-rotted manure to put in the drills immediately before planting; this can often be got from the lower layers of the earliest used boxes or yards, since a mixen should be avoided as much as possible. The principle to keep in mind is that every disturbance of farmyard manure results in loss, and that the shorter the time which elapses between the dropping of the dung and its application to the land, the less this loss of fertilising material will become.

In considering the value of farmyard manure as a fertiliser one has to keep in mind that it is an essential product of the farm, and that it must constitute the main source of manure for the land under the conditions of ordinary mixed farming, where artificial manures will only be used as supplements and not as rivals. It is only in certain special cases, such as potato or hop growing, where the ordinary course of farming does not supply as much farmyard manure as is wanted, that the question has to be decided whether artificial manures or dung from the towns shall be purchased, or again whether stock shall be fattened solely with the view of making manure.

As a fertiliser, the chief value of farmyard manure lies in the fact that it contains all the elements of a plant's nutrition—nitrogen, phosphoric acid, and potash—though for a well-balanced manure the phosphoric acid is comparatively deficient. Moreover, the nitrogen

is present in various forms of combination, varying from the rapidly acting ammonia compounds down to some of the undigested residues which will remain for a very long period in the soil before becoming available for the plant. In consequence dung is a lasting manure, which accumulates in the soil to build up what a farmer calls "high condition"—the state of affairs which prevails when the reserves of manure in the soil are steadily and continuously passing into the available condition in sufficient amount for the needs of the crop, so that there is no necessity for freshly applied active manure—a state of affairs which results in healthy growth and good quality. But however marked the farmer's preference is for such lasting manures, the delay in realising the capital they represent means a certain amount of loss; besides which, some of the constituents of farmyard manure are so slowly acting as to be hardly recoverable during the lifetime of the tenant. The imperfect recovery of the nitrogen from large dressings of farmyard manure is illustrated in Table LXIII.,

TABLE LXIII.—MANGOLDS. RELATION BETWEEN THE NITROGEN RECOVERED IN CROP AND THAT SUPPLIED IN MANURE (Rothamsted.)

Plots.	Manure.	Average Produce per acre of Roots.	Nitrogen.			
			Per cent. in Fresh Roots.	Per acre per annum in Roots.	Supplied in Manure per acre per annum.	Recovered in Roots for 100 lb. Manure.
		Tons.	Per cent.	Lb.	Lb.	Per cent.
4N	Nitrate of Soda, 550 lb.	17.95	0.164	67.2	86	78.1
4A	Ammonium Salts, 400 lb.	15.12	0.145	49.3	86	57.3
4C	Rape Cake, 2000 lb.	20.95	0.148	69.4	98	70.9
10	Farmyard Manure, 14 tons	17.44	0.162	63.3	200	31.6

which shows the nitrogen removed in the mangold crops at Rothamsted when grown with farmyard manure and other sources of nitrogen.

In this case 78 per cent. of the nitrogen applied as nitrate of soda is recovered in the crop, and 71 per cent. of that applied as rape cake, while only 32 per cent. of that which was estimated to be included in the dung has come back in the crop. This low figure is partly due to the fact that the dung was put on year after year in considerable quantities (14 tons per acre); hence all

TABLE LXIV.—FATE OF NITROGEN IN FARMYARD MANURE, APPLIED TO WHEAT (Rothamsted).

Plot.	Manuring.	Nitrogen in Soil 9 inches deep, 1893.		Approximate supply of Nitrogen in Manure in 50 years.	Approximate re- moval of Nitrogen in Crops, 50 Years (1844-1893).	Surplus of Nitrogen over Plot 3, unaccounted for in Crop or Soil.
		Per cent.	Pounds per acre.			
3	Unmanured . . .	0.0992	2570	Lb. ...	Lb. 850	Lb. ...
2	Farmyard Manure	0.2207	5150	10,000	2600	5670

the wasteful processes are increased and there is also a great accumulation of nitrogenous material in the soil. How great the waste may become is seen by comparing the nitrogen supplied to one of the permanent wheat plots at Rothamsted, which receives 14 tons of farmyard manure per acre every year, with the nitrogen stored up in the soil and that removed in the crop. Table LXIV. shows that only 26 per cent. was recovered in fifty years, and that nearly 57 per cent. has been lost, since it is accounted for neither in the crop nor in the soil at the end of the period.

These, however, are extreme cases; on referring to the crops grown with the rich and poor dung on p. 204,

where four crops in rotation are grown after each application of farmyard manure, out of 207 lb. of nitrogen supplied as dung made from roots and hay alone 144 lb. were recovered in the three following years, and of 257 lb. supplied as cake-fed dung 158 lb. were similarly recovered.

The extremely lasting character of those nitrogenous compounds in farmyard manure which are not recovered in the first year is illustrated in an exceptional manner in the Rothamsted experiments. On the grass land, for example, one plot received 14 tons of dung per acre per annum for eight years (1856-63) and then was left unmanured. Table LXV. shows that it has continued to give a larger crop than the unmanured plot alongside for more than forty years. The table shows that in the first year after the application of farmyard manure had been stopped the plot with the residues of the previous eight years' manuring gave double the yield of the unmanured plot; in the following year the yield was still double; but from that time its superiority has slowly declined, though for the last ten years it has still amounted to 15 per cent.

A similar experiment was made on the barley plots, one of which received 14 tons per acre of farmyard manure for twenty years from 1852 to 1871, and has since been left unmanured. Table LXVI. shows the yield from this plot, from the unmanured plot, and from the plot which has continued to receive 14 tons of farmyard manure every year, for the years immediately following the discontinuance of the dung and for successive five-year periods since. It will be seen that though the yield has fallen continuously to about 40 per cent. of that of the continuously dunged plot, it still remains more than double that of the wholly unmanured plot.



In considering the results of these last two experiments, it must be remembered that such a long duration of the residues of farmyard manure would not be perceptible in practice: they only become apparent when the soils are cropped to a state of exhaustion that would never be met with in ordinary farming experience.

TABLE LXVI.—TOTAL PRODUCE PER ACRE OF BARLEY PLOTS, SHOWING RESIDUAL EFFECTS OF DUNG.

	Dung every year, 1852, and since.	Dung for 20 years, 1852-1871. Unmanured since.	Unmanured continuously.	Relation to Produce of Plot 7-2, reckoned as 100.		
	Plot 7-2.	Plot 7-1.		Plot 7-2.	Plot 7-1.	Plot 1-0.
Mean. 1852-1871	Lb.	Lb.	Lb.	Lb.	Lb.	Lb.
	5933		2454	100		41
1872	5202	4870	1282	100	94	25
1873	6561	5165	1570	100	79	24
1874	7943	5675	1922	100	71	24
1875	5825	3955	1448	100	68	25
1876	6166	4010	1561	100	65	25
Mean.						
1877-1881	6167	3305	1528	100	54	25
1882-1886	6546	3494	1529	100	53	23
1887-1891	5334	2664	1379	100	50	26
1892-1896	6477	3101	1508	100	48	23
1897-1901	5349	2251	1141	100	42	21
1902-1906	6223	2485	1301	100	40	21

Since only a portion—and that not the largest—of the nitrogen of farmyard manure is readily available, if it is the only manure supplied the crop in a good season is often unable to obtain nitrogen rapidly enough, even though very large quantities are lying dormant in the soil. As an example, we may take the Rothamsted



mangold crops for the years 1900 and 1907, when crops considerably above the average were grown, and compare the yields obtained when farmyard manure was used alone, with that given by a purely artificial dressing containing nitrate of soda and by farmyard manure supplemented by nitrate of soda :—

TABLE LXVII.—YIELD OF MANGOLDS AT ROTHAMSTED, 1900 AND 1907.  
ROOTS ONLY.

Year.	Farmyard Manure +Phosphoric Acid and Potash =200 lb. N.	Nitrate of Soda +Phosphoric Acid and Potash =86 lb. N.	Farmyard Manure =200 lb. N. +Nitrate of Soda =86 lb. N.	Farmyard Manure =200 lb. N. +Nitrate of Soda +Phosphoric Acid and Potash =86 lb. N.
	Tons.	Tons.	Tons.	Tons.
1900	28·0	33·1	41·3	41·8
1907	26·5	32·8	41·4	42·1

The farmyard manure, though it contains about 200 lb. of nitrogen, cannot provide the rapidly growing mangolds with as much nitrogen as does the nitrate of soda containing 86 lb. of nitrogen, since it only grew 27·2 tons of mangolds against 33 tons with nitrate of soda, and this notwithstanding the great accumulation in the soil of the residues of thirty years' previous manuring with dung. That only the nitrogen was concerned in these differences is seen from the fact that both the plots received the same phosphoric acid and potash. The crop had by no means reached its limit, for an addition of nitrate of soda to the dung increased the crop to 41·4 tons; and here, again, only the nitrogen is concerned, because, on a further plot where phosphoric acid and potash were added to the combination of dung and nitrate of soda, there was but a very slight additional increase of crop.

From other experiments it has been repeatedly

demonstrated that where the grower is aiming at a very large crop it is more economical to attain this by using dung and a mixture of active artificial fertilisers than by increasing the amount of dung; 20 loads of dung, with 1 to 2 cwt. of nitrate of soda and 3 cwt. of superphosphate costing about 30s., will generally be more effective than 40 loads of dung, of which the second 20 loads cannot be charged at less than £4 or £5.

Farmyard manure has frequently been blamed for carrying the seeds of disease and of weeds which have passed through the animals making the dung in an unchanged condition and thus contaminate the land for other crops. When bullocks have been fed with Swedes affected with "finger-and-toe" and the uneaten fragments of the roots have been thrown among the litter, the spores of the disease have been found to live unharmed through the making and rotting of the manure, so that fresh land may thus become infected when the dung is carried on to it. Similarly, when hop vines are used as litter, the spores of the hop mildew are not destroyed; but no other cases of transmission of disease have been investigated. As regards weeds, farmyard manure is very commonly employed for root crops, in which case the usual cultivations will keep down any weeds whose seeds are in the dung, and when the dung is put on grass land the weed seeds stand little chance of establishing themselves.

The value of farmyard manure to the land is by no means confined to its fertilising action; its physical effects upon the texture and water-holding powers of the soil are equally important; indeed, for some crops, and particularly in drougthy seasons, these factors count for more than fertilisers towards ensuring a good yield. The farmyard manure, as it rots down in the soil, goes to restore the stock of humus, which otherwise

is always tending to oxidise and diminish, and the humus, considered merely from the physical side, contributes largely to the fertility of the soil. In the first place, it improves the texture of all soils; to sands it gives cohesion and water-retaining power, while by loosely binding together the finest particles of clay soils it renders them more porous and friable. When a piece of old grass land, even on the stiffest of soils, has been ploughed up it is easy to see the beneficial effect of the humus that has been accumulated; after the winter the plough slice will crumble naturally so as to harrow down at once to a mellow seed-bed, whereas a neighbouring piece of the same soil that has long been under arable cultivation will only show a number of harsh intractable clods. The importance of a good seed-bed to the future well-being and ultimate yield of the crop can hardly be exaggerated; it is the basis of all good farming; so that even when the fertilising properties of farmyard manure have been replaced by artificial manures, some other means, such as the ploughing-in of green crops, must be resorted to in order to maintain the stock of humus. Of course, the value of humus—and in this respect of farmyard manure—will vary on different soils and with different crops; cereals, for example, are comparatively unaffected by its absence, as may be seen by the manner in which Mr Prout grows cereals almost continuously on his strong soil with artificial fertilisers only, but root crops are very dependent on a mellow seed-bed. This may be seen on the Rothamsted plots; the wheat which has now been grown on the same land for sixty-five years, comes as well and yields as big crops on the plots receiving only artificial manures as it does on the plot receiving dung, but on the mangold field the result is different. Where artificial manures containing no organic matter have

been supplied, the tilth is bad, and in trying seasons, when drought succeeds heavy rain soon after sowing, the plant obtained is so imperfect as to reduce the yield considerably. If the conditions are favourable to germination and the plant once becomes established, then, as we have previously seen in Table LXVII., the plot manured with minerals and nitrate of soda will grow a bigger crop than that receiving dung; but this superiority is masked in many seasons by the defective plant resulting from the bad texture of the soil. Table LXVIII. shows the proportion the number of roots on each plot bears to the possible number, as calculated

TABLE LXVIII.—NUMBER OF MANGOLD PLANTS AS PERCENTAGES OF THE POSSIBLE. AVERAGE OF 7 YEARS, 1901-1907.

Farmyard Manure, etc.	Minerals and Nitrate of Soda.	Minerals and Rape Cake.
69	62	83

from the width of the rows and the distance apart at which they are singled, for three plots, one of which receives farmyard manure, minerals and nitrate of soda, another only the minerals and nitrate of soda, and the third, minerals and rape cake, as an organic source of nitrogen.

These are average figures for a period which includes several years when a very good plant was obtained all over the field, and only one of the occasional years when the plant failed entirely on the plots receiving no organic manure. It is noticeable that the plot receiving rape cake (2000 lb. every year) is actually better as regards the number of plants it carries than the dunged plot, because the repeated dressings of an organic manure like rape cake supply enough humus to maintain

the texture without getting the soil too open—a defect which is now beginning to overtake the plot that has been so continuously treated with large amounts of farmyard manure.

A soil which has been enriched in humus by repeated applications of farmyard manure will resist drought better than one in which the humus is low; the difference is seen, not so much in the greater amount of moisture present in the soil containing humus, as in the way it will absorb a large amount of water

TABLE LXIX.—PERCENTAGES OF WATER IN ROTHAMSTED SOILS.

Depth.	Broadbalk Wheat.		Hoos Barley.	
	Unmanured.	Dunged.	Unmanured.	Dunged.
Inches.				
0 to 9	16.0	19.3	17.0	20.7
9 „ 18	19.8	17.0	22.5	17.7
18 „ 27	23.3	18.4	22.1	18.3

temporarily during heavy rainfall and then let it work more slowly down into the soil, thus keeping it longer within reach of the crop. Good examples are afforded by the Rothamsted plots; samples of soil were taken from the wheat land on 13th September 1904; on the previous day 0.262 inch of rain had fallen, but for nine days before there had been little or no rain. The portions of the plots from which the samples were drawn had been fallowed through the summer, so that the drying effect of the crop is eliminated. Samples were also taken from the barley plots on 3rd October of the same year; 0.456 inch of rain had fallen on the 30th September, before which there had been fifteen days of fine weather. Table LXIX. shows the water in the soil of the unmanured and the continuously

dunged plots respectively, calculated as percentages of the fine earth from which the stones had been sifted.

It is thus seen that in both cases the dunged soil, rich in humus, had retained more of the comparatively recent rainfall near the surface, so that the top soil was moister, while the subsoil was drier. The difference in favour of the surface soil is about 3·5 per cent., which on that soil would amount to about 30 tons per acre, or approximately 0·3 inch of rain. It is thus seen that the surface soil of the dunged plot had retained practically the whole of the preceding rainfall: and the greater dryness of the subsoil is due to the way the soil has kept back the small rainfalls, which have evaporated instead of being passed on to the subsoil, as happens on the unmanured plots. The same fact is illustrated by the behaviour of the drains, which lie below the centre of each of the wheat plots at a depth of 30 inches; below the dunged plot the drain very rarely runs—only after an exceptionally heavy and long-continued fall; whereas the drain below the unmanured plot runs two or three times every winter. Putting aside the greater drying effect of the much larger crop on the dunged plot, the difference is mainly due to the way the surface soil rich in humus absorbs more of the water at first, and then lets the excess percolate so much more slowly that the descending layer of over-saturation, which causes the drain to run, rarely or never forms.

The water-retaining power of the dung may also be seen in the superior yield of the dunged plots in markedly dry seasons. Table LXX. shows a comparison of the yield on Plot 2, receiving 14 tons of dung, and Plot 7, receiving a complete artificial manure, for the years 1879, which was exceptionally wet and cold, and for 1893, which was hot and dry throughout

the growing period of the plant. The rainfall for this period, *i.e.*, for the four months March to June, was 13 inches in 1879 and only 2.9 inches in 1893. The average yield on the dunged plot is about 3 bushels more than on Plot 7, but in the dry year its superiority amounted to 14 bushels, whereas in the very

TABLE LXX.—EFFECT OF FARMYARD MANURE IN DRY AND WET SEASONS. WHEAT. (Rothamsted.)

Plot.	1879 (Wet).	1893 (Dry).	Average, 51 years.
	Bushels.	Bushels.	Bushels.
2	16.0	34.25	35.7
7	16.25	20.25	32.9

wet year the two plots sank to the same low level. In a bad season the bacterial changes, which render the plant food in dung available for the crop, go on very slowly.

It has been suggested that farmyard manure may have an effect upon the water-content of the soil by reducing the surface tension of water with which it comes in contact. If the surface tension of the soil water were thus reduced, it would be less readily lifted to the surface and therefore less available to shallow-rooted plants, but more conserved in the lower layers of the soil. Although an extract of dung possesses a lower surface tension than pure water, the facts concerning its behaviour in the soil are very obscure as yet, and the figures just quoted as to the relative distribution of moisture under dunged and unmanured plots lend no support to the theory.

The application of farmyard manure to grass land, not only has a fertilising and water-retaining effect, but is also valuable from the way it acts as a mulch and affords the springing grass in the early months of the

year some protection from cold and drying winds. At Rothamsted on the permanent grass plots it is often noticed that the plots which receive applications of farmyard manure once in every four years start a little earlier and make a quicker growth than the others. This mulching effect partly accounts for the great value attached to dung as a dressing for permanent grass land on open chalky soils, as in Wiltshire, where it is customary to reserve all the farmyard manure for the grass and farm the arable land entirely with artificial manures, aided by the folding off of catch crops. Such a practice is wasteful of the farmyard manure as a fertiliser, for the loss of nitrogen from a layer spread loosely over the ground until it decays is considerable, but the waste is tolerated in view of the gain to the physical or mechanical condition of the land.

In ordinary mixed farming undoubtedly the best way of utilising farmyard manure is to apply it to the root crops, and especially to mangolds and potatoes. Swedes require much less nitrogen than do the other root crops. They also require a firm but fine tilth; in consequence, not more than 10 to 12 tons of dung per acre should be given for Swedes and it should be applied in the autumn, in order that it may become well rotted down before the spring cultivation begins. But up to 20 tons of dung per acre can be profitably employed for mangolds and potatoes, and it can if necessary be applied immediately before sowing. Any surplus dung, after the requirements of the root crops have been satisfied, is probably best given to the young seeds in the early winter, to act both as a fertiliser and as a mulch. The seeds benefit greatly, and at the same time much of the added fertility is retained for the corn crop that follows; manuring the young seeds



is certainly preferable to the very general custom of manuring the old ley before it is ploughed up for wheat or oats. A certain amount of the farmyard manure made on the farm should, however, always be reserved for the meadow land, especially on light soils and on land comparatively newly laid down to grass. Of course dung would be wasted on rich grazing land; it is the thin light soils that are cut for hay, or grass land that has only been laid down for a few years and has had no time to accumulate a stock of humus, which are most benefited by an occasional dressing of farmyard manure—once in every four or five years.

What price should be set upon a ton of farmyard manure is a question often asked, but no general answer is possible, so much depends upon the other conditions prevailing upon the farm. As a rule, farmyard manure is part of the normal output of the farm; the farmer has only to make it and use it to the best advantage, he is not concerned with the question of whether it would be cheaper to replace it with an equivalent amount of some other fertiliser. There are, however, occasions when the problem does arise of whether it is cheaper to make farmyard manure, to buy it, or to attempt to replace it by artificials; for example, the men who are farming specially for potatoes or hops often fatten bullocks or pigs solely for the sake of the manure thus made, and are content to lose money on the live stock because of the value of the dung. Since farmyard manure made in this way is often a very expensive article, it is important to try and put some monetary value on it, so that the farmer may attain a clearer idea of the profit or loss attached to the keeping of live stock as manure makers. It is, of course, possible to treat farmyard manure like any other fertiliser and

value it on the unit system (see p. 348), the result of which would be somewhat as follows:—

Farmyard manure contains—

0.6 per cent. Nitrogen at 12s. . . . .	=	£0 7 2
0.3 per cent. Phosphoric Acid at 3s. . . . .	=	0 0 11
0.5 per cent. Potash at 4s. . . . .	=	0 2 0
		-----
Value per ton . . . . .	=	£0 10 1

Much weight cannot, however, be attached to such a valuation, because the unit values are taken from concentrated manures and do not apply to dung; for example, nitrogen in waste materials like shoddy can often be obtained at half the price paid for it in sulphate of ammonia or nitrate of soda, and considering the slow availability of much of the nitrogen in dung its unit value should be much below 12s. On the other hand, the organic matter supplied in the farmyard manure is not valued; yet it is for the effect of this organic matter on the texture of the soil that farmyard manure is most generally required. The cost of handling farmyard manure, which is so much greater than it is for an equivalent amount of artificial fertiliser, should also be taken into comparison but cannot well be estimated, because it will vary on each farm.

While it is thus practically impossible to value farmyard manure on its composition, a proper system of book-keeping will show what it costs to make, in a manner that is independent of the profit and loss upon the live stock. In this way a farmer can form for himself a clear idea of the economics of dung-making as compared with the purchase of either town manure or artificial fertilisers. The most valid principle on which a cost can be worked out, and one which does justice equally to the live stock and to the manure, is to

charge the dung with the cost of the litter and with the manure value of all the foods consumed in the yards or boxes. These manure values are what the valuer would allow to an outgoing tenant for the fertilising material which he brought on to the farm during the last year of his tenancy and which he leaves behind in the form of dung. Of course the valuer does not allow compensation for the roots, hay, and straw grown on the farm; these, however, must be reckoned in making up the cost of the dung.

The manure value of any food (see p. 356) is based upon its composition and represents the value at current market rates of whatever part of the food has a fertilising value and may be supposed to find its way into the manure; the values employed below are those recommended by the Central Chamber of Agriculture for adoption in farm valuations and have been obtained by the method to be shortly described. To arrive at the cost of the dung the manure values of all the food consumed must be taken and added to the whole cost of the litter, whether straw or peat moss; the sum is then divided by the amount of manure ascertained to have been made. In Table LXXI. this principle is applied to the data obtained from some of the feeding experiments already quoted (pp. 196-9), and also to two cases extracted from the accounts of an ordinary farm. The first column gives the nature of the food and the second its manure value per ton; the remaining double columns give for each food the amount consumed in the experiment and its manure value. The cost of the litter is set out below, and, added to the manure values, gives the total cost of the manure made in each case, the amount of which is also shown. Working on these lines we learn that farmyard manure costs from 5s. to 12s. a ton to make on the farm, without taking into

TABLE LXXI.—COST OF MAKING ONE TON OF FARMYARD MANURE.

Foods.	Manure Value per ton.		Royal Agricultural Society's Farm, Woburn.						Cambridge University.				Wyo.		Ordinary Farm.			
	s.	Cwts.	1899.		1900.		1901.		1		2		Quantity.	Manure Value.	Quantity.	Manure Value.	Quantity.	Manure Value.
			Quantity.	Manure Value.	Quantity.	Manure Value.	Quantity.	Manure Value.	Quantity.	Manure Value.								
Peas	30.0	..	..	..	..	..	..	..	..	..	..	..	..	..	..	..	..	..
Mangolds	2.5	..	..	..	..	..	..	..	..	..	..	..	..	..	..	..	..	..
Swedes	2.5	22.0	2.8	22.5	2.8	21.5	2.7	..	..	..	..	..	..	..	..	..	..	..
Decorticated cotton cake	56.0	2.5	7.0	2.5	7.0	1.5	4.2	..	..	..	..	..	..	..	..	..	..	..
Undecorticated cotton cake	34.0	..	..	..	..	..	..	..	..	..	..	..	..	..	..	..	..	..
Linseed cake	38.0	..	..	..	..	..	..	..	..	..	..	..	..	..	..	..	..	..
Oats	14.0	..	..	..	..	..	..	..	..	..	..	..	..	..	..	..	..	..
Barley	14.0	2.0	1.4	..	..	..	..	..	..	..	..	..	..	..	..	..	..	..
Maize meal	14.0	..	..	2.1	1.5	1.5	1.0	..	..	..	..	..	..	..	..	..	..	..
Bran	30.0	..	..	..	..	..	..	..	..	..	..	..	..	..	..	..	..	..
Straw	7.0	6.0	2.1	8.5	3.0	4.8	1.7	..	..	..	..	..	..	..	..	..	..	..
Hay	15.0	..	..	..	..	2.7	2.0	..	..	..	..	..	..	..	..	..	..	..
LITTER:—																		
Wheat Straw	30.0	10.0	15.0	10.0	15.0	9.5	14.2	..	..	..	..	..	..	..	..	..	..	..
Peat Moss	37.3	..	..	..	..	..	..	..	..	..	..	..	..	..	..	..	..	..
Total cost		28.3s.	29.3s.	29.3s.	25.8s.	48.8s.	64.1s.	23.3s.	35.68s.	46.58s.	46.58s.	23.3s.	35.68s.	46.58s.	46.58s.	46.58s.	46.58s.	46.58s.
Quantity dung made		46.7 cwts.	49.5 cwts.	43.3 cwts.	100 cwts.	110 cwts.	90 cwts.	9200 cwts.	9200 cwts.	14,320 cwts.	14,320 cwts.	90 cwts.	9200 cwts.	14,320 cwts.	14,320 cwts.	14,320 cwts.	14,320 cwts.	14,320 cwts.
Cost per ton		12.1s.	11.8s.	11.9s.	9.8s.	11.7s.	5.2s.	7.8s.	7.8s.	6.5s.	6.5s.	5.2s.	7.8s.	6.5s.	6.5s.	6.5s.	6.5s.	6.5s.

account any profit or loss on the live stock, because this latter question is so much dependent upon the turn of the market and the skill of the dealer. It is necessary to discriminate and to keep distinct the two operations—the making of dung and the fattening of the cattle—so that a conclusion can be reached as to the profitableness of each separately. Of course in making out the charges against the cattle, the whole cost of the cake, etc., which they consume must not be put down, but only that part of it which is not debited to the dung as manure value; *e.g.*, if a ton of linseed cake cost £8, only £6, 2s. should be charged against the stock for food, because £1, 18s., its manure value, would be charged to the manure.

To make this clearer, we can draw up a balance-sheet for the feeding of two of the heifers already mentioned:—

TABLE LXXII.—CAMBRIDGE, No. 2.

<i>Dr.</i>	£ s. d.	<i>Cr.</i>	£ s. d.
Purchase price of 2 Heifers	30 0 0	Manure value of Mangolds	0 15 0
6 tons of Mangolds at 5s.	1 10 0	"    Hay	0 7 6
½ ton of Hay at 45s.	1 2 6	"    Cake	0 16 10
6 cwts. of Decorticated Cotton Cake at £8	2 8 0	(Charged to Dung)	
Attendance, 12 weeks at 6d.	0 6 0	Sale price of Heifers	34 0 0
Balance, being profit	0 12 10		
Total	35 19 4	Total	35 19 4

Thus the feeding has resulted in a small profit of 12s. 10d., and at the same time, as was shown in Table LXXI., 5½ tons of farmyard manure were made at a cost of 11s. 8d. per ton, or if the heifers are considered to have been fattened solely for the purposes of making dung and the two accounts are combined by crediting the 12s. 10d. profit to the dung, the latter has cost about 9s. 4d. per ton.

This figure, about 10s. per ton for farmyard manure, is considerably higher than the usual estimate attached to dung for purposes of valuation or of drawing up the the balance-sheet of a manurial experiment; it does, however, represent what it will cost the potato or hop grower who sets out to keep cattle solely for the purpose of making dung. It is for him to decide whether he can secure sufficient profit from the cattle themselves to make it worth while to buy farmyard manure at such a price. A big cake bill is indeed a great source of loss on many farms; unless the cattle themselves pay for their food, the increased richness of the dung due to the purchased food will not produce a very remunerative increase in the crops.

## CHAPTER VIII

### PERUVIAN GUANO AND OTHER MIXED FERTILISERS

Origin of the Deposits of Guano—Variation in Composition with Age—Compounds of Nitrogen present in Peruvian Guano—Ichaboe and Damaraland Guanoses—Fish Guano—Meat Guano—Dried Blood—Greaves—Rape Dust and other Cake Residues—Manures derived from Fæcal Matter—Sewage Sludges.

THE term “guano” (Spanish *huano* = dung) is properly restricted to a fertilising material consisting almost wholly of the excreta of sea birds, which has accumulated upon certain oceanic islands where rain rarely falls. The original guano came from islands off the coast of Peru between the 7th and 20th degrees of south latitude, and this “Peruvian Guano” still forms the bulk of our importations, although since the time of the first introduction of guano, other deposits, formed under similar conditions of climate and situation, have been opened up. All these deposits, being of similar origin, possess many features in common. The islands, small and uninhabited, are the resort for breeding purposes of enormous flocks of pelicans, albatrosses, and other oceanic birds, which resort to land only in their breeding season. On the favoured spots they nest very closely, and the young birds after they are hatched are fed for a month or more with great quantities of fish

brought by the parent birds. In addition to the excreta the deposit will thus also contain many carcasses of young birds dying from some cause or other, fragments of fish, feathers, seaweed, and even sand and stones originally swallowed by the parent birds. When the birds leave the island the tropical sun and the intense dryness of the atmosphere rapidly desiccate the accumulated materials and prevent any change or loss by fermentation.

The excreta of the birds, which is the starting-point, is highly nitrogenous, consisting very largely of uric acid, together with a fair amount of phosphoric acid derived from the fish, which is the exclusive diet of the birds. An old analysis of a white Peruvian deposit, consisting mainly of recently deposited excreta, showed as much as 18.3 per cent. of nitrogen and only 9.2 per cent. of phosphoric acid.

TABLE LXXIII.—ANALYSIS OF FRESHLY-DEPOSITED GUANO.

Water . . . . .	10.9
Organic Matter and Ammonium Salts . . . . .	65.63
Containing Nitrogen . . . . .	(18.32)
Phosphoric Acid . . . . .	9.20
Lime . . . . .	6.08
Alkaline Salts . . . . .	6.43
Sand . . . . .	1.76

Dry as is the climate a certain amount of change still goes on; the uric acid is fermented to urea and to ammonium salts, some of which are volatilised, while the occasional rains dissolve out both the ammonium compounds and soluble phosphates and the alkalis. As a result, the composition of guano deposits is extremely variable, both in the different strata of one deposit and still more in passing from island to island. The older a deposit is, and the greater the washing it has



received, the more will it have lost nitrogen and the richer will it have grown in phosphoric acid, until from the material described above deposits are formed containing little or nothing beyond phosphate of lime.

The analyses (Table LXXVII.) will show how great is the range in quality that thus results.

*Peruvian Guano.*—Peruvian guano is derived from three groups of islands off the coast of Peru, of which the most important, Chinchas, is a little south of Callao. The fertilising value of the deposit was known long prior to the Spanish occupation of the country, in many parts of which crops could only be obtained by the aid of guano.

A. von Humboldt was the first European to call attention to the use of guano; he brought samples home with him about 1804, at which time he found some fifty vessels annually employed in carrying guano from the Chinchas Islands for use in Peru.

The exportation to Europe, however, did not begin until nearly forty years later, the first crops being landed in Liverpool early in 1840. The success of the manure was rapid and the exportation soon assumed considerable dimensions, as much as 283,300 tons reaching the United Kingdom in 1845. For some time the annual consumption remained at a very high figure, but financial troubles, the war between Peru and Chili, the exhaustion of the richest deposits, and difficulties induced by adulteration and the natural variation in the composition of the cargoes, led to a slackening in the demand. During the last few years the exportation has been at the rate of about 60,000 to 70,000 tons per annum, of which the United Kingdom consumed about one-half.

During the earlier years Peruvian guano was derived from the Chinchas Islands only, and was an exceedingly

rich deposit, containing 11 to 15 per cent. of nitrogen; but as that deposit became exhausted, the other islands producing a poorer material were in turn drawn upon. Of recent years it has been found that new deposits have accumulated on the Chinchas Islands to such an extent as to justify fresh workings, and accordingly a guano with a very high percentage of nitrogen is again obtainable. Another of the islands, Ballestas, has latterly been yielding a very rich guano with more than 12 per cent. of nitrogen and about an equal amount of phosphoric acid, and now it is expected that material of this class will always be available.

It is difficult to form an adequate idea of the enormous bird population of these islands and the amount of food consumed during the breeding season, but a recent commission which visited the islands estimated the current production of fresh guano as 10,000 tons per annum. Thus, freshly deposited guano is light grey in colour and contains about 16 per cent. of nitrogen, with 9 of phosphoric acid, the usual brown colour coming as the material ages and undergoes some decomposition. A law has been recently passed ensuring a four-months close season during the breeding of the birds, and the Peruvian Government have recently forbidden the working of the deposits during this close season in order to ensure as little disturbance as possible. The guano islands are now, in fact, being regularly "farmed," and the exportations will consist of the previous years' rich deposit, together with a certain amount of the older accumulated stock.

The bulk of the imports, however, consists of material containing from 5 to 8 per cent. of nitrogen, and each consignment is sold on the basis of an analysis of a sample drawn by the officials of the Dock Company as the vessel unloads. Another class of material has

latterly been exported in large quantities; it consists of the phosphatic guanos derived from the Lobos Islands, containing as much as 60 per cent. of calcium phosphate and only from 2 to 3 per cent. of nitrogen. In addition to these cargoes of varying composition which are sold in the condition in which they arrive, the importers make up a mixture to a standard composition with about 7 per cent. of nitrogen, which is sold as equalised Peruvian guano.

Peruvian guano, as imported, is a loose dry powder, grey in the richer samples and becoming browner as it grows more phosphatic. As a rule, it is friable and may be sown by any manure distributor, but there are found in it occasional fragments of slaty rock, with a number of half-decayed feathers in the richer specimens. It possesses a strong and characteristically ammoniacal smell and an alkaline reaction due to the presence of ammonium carbonate.

The following detailed analysis, Table LXXIV.,

TABLE LXXIV.—ANALYSIS OF CHINCHAS GUANO, 1897.

Nitrogen as Nitrate . . . . .	0.32	
"  as Ammonium Salts . . . . .	3.94	
"  as Uric Acid . . . . .	8.85	
"  in other Organic Forms . . . . .	2.98	
Total Nitrogen . . . . .		16.09
Phosphoric Acid soluble in Water . . . . .	2.63	
"  soluble in Ammonium Citrate . . . . .	6.29	
"  insoluble . . . . .	.37	
Total Phosphoric Acid, all soluble in 1 per cent. Citric Acid solution . . . . .		9.29
equivalent to Tri-calcium Phosphate . . . . .		20.28

shows the composition of a sample of the Chinchas deposit; it will be seen that the nitrogen is mainly present in compounds soluble in water—uric acid, a little urea, guanine, and ammonium salts, with a trace of nitric acid. The phosphoric acid is also largely

soluble in water, being combined with the ammonia and the potash and soda also present in small quantities.

Similar detailed analyses are not available for poorer grades, but it may be taken as a general rule that the lower the percentage of nitrogen, the less of it will be found in a soluble form, and the more insoluble will the phosphoric acid compounds have become, so that the richest guanos are also the most readily available for the plant. It is also characteristic of a good guano, and to this much of its value as a choice fertiliser is due, that the compounds of nitrogen present are very varied and require different series of bacterial changes in the soil before they become available, so that the crop is fed steadily and continuously.

It is this property and the fact that guano is naturally a well-balanced manure, rich in phosphates as well as nitrogen, and containing also a small proportion of potash, which makes guano so popular. It is essentially a safe manure, applicable to all crops, and not requiring the skill in its adjustment to the land or the crop which is necessary with the more active single manures like nitrate of soda, etc. Again, coming into action continuously and equably, it is more calculated to yield produce of high quality than more concentrated manures; it is therefore specially suited for fruit and similar valuable crops. As a natural consequence of these advantages the good Peruvian guanos are always somewhat dearer than other manures when valued on a unit basis, the extra price representing partly the value of this natural blending and partly the long farming tradition of the excellence of guano, which was the earliest of the concentrated manures to find a large sale in this country.

Few fertilisers have been subjected to a greater amount of sophistication and adulteration than has Peruvian guano, but since the passing of the Fertilisers and Feeding Stuffs Act, and the better organisation of its sale from a single distributing centre, there has been but little fraud. It should always be found on receipt to be in the sealed bags of  $1\frac{1}{2}$  cwt. in which it is distributed, and, as with all manures of variable composition, the guarantee should be checked by analysis, so as to ensure the delivery has been made from the specified cargo. Deliberate adulterations with sand or dirt can generally be detected by the incineration of a sample, the incombustible residue should be white, and show but few signs of red oxide of iron.

A certain amount of Peruvian guano is treated with sulphuric acid, so as to convert the ammonium carbonate into non-volatile ammonium sulphate, and also to render a larger proportion of the phosphoric acid soluble. In this way is obtained "dissolved Peruvian guano," which is made to contain about 6 per cent. of nitrogen and 10 per cent. of phosphoric acid, of which 9 per cent. is soluble in water. The use of acid adds to the value of the guano, and not only will it store and travel with less risk of deterioration through volatilisation of ammonium carbonate, but the increased solubility of the phosphates present, and their consequent activity, makes the whole a better balanced manure.

Compared with the Peruvian, the other deposits of guano which can be classed as nitrogenous are comparatively unimportant, and only those from Ichaboe Island and Damaraland on the south-west coast of Africa have of late been articles of commerce in this country.

The Damaraland deposits are apparently exhausted, while shipments of Ichaboe guano only come inter-

mittently, when the requirements of Cape Colony have been satisfied.

Ichaboe guano only represents the deposit of a single year, it is thus very fresh and distinguished by the undecomposed feathers it contains. With about 8 per cent. of nitrogen, it is usually proportionally less rich in phosphoric acid than a similar grade of Peruvian guano would be. It usually also contains more sand.

On the many other oceanic islands where guano has been deposited, the occasional rains or heavy dews have been sufficient to remove the soluble nitrogen compounds and even in time the organic nitrogen bodies, which in the presence of moisture have been able to decay and break down into soluble material, leaving behind a residue consisting mainly of phosphate of lime. In other cases chemical reactions have taken place with the calcium carbonate of the coral rock on which the deposit happened to be formed, resulting in the production of a calcium phosphate, containing sometimes rather a large proportion of iron and alumina. These phosphates, at one time of importance in the manufacture of superphosphates, will be dealt with under phosphatic manures.

Besides the true guanos derived from bird droppings and the closely allied bat guanos, small deposits of which are found in caves in America and South Africa but which possess no commercial importance, a good many other substances containing nitrogen and phosphoric acid are called guano, though they have no proper claim to the title. For example, the residues from various processes dealing with fish (*e.g.*, in the preparation of cod liver oil, the curing of herrings, the tinning of sardines, etc.), are dried and reduced to a powder, which is sold as "fish guano"; and again, meat residues, such as accumulate in the manufacture of meat

extracts, are similarly dried and disintegrated for sale as "meat guano"; even some forms of dried sewage sludge masquerade under the name of guano.

*Fish guano* is manufactured in many places where any considerable fish waste is available. The oil is extracted by heat and pressure, and the remaining material is dried and disintegrated as finely as possible. Considering the very varied origin of fish guano, its composition is remarkably constant: the nitrogen varies between 6 and 9 per cent., the phosphoric acid represents from 13 to 20 per cent. of tri-calcic phosphate. The fineness of grinding is less uniform; two classes of fish guano are found: in one of them the material is reduced to a light fluffy powder, the other is denser and contains pieces of hard bone up to a quarter of an inch in diameter. This coarsely ground material must be less available, at any rate as regards the phosphates. Fish guanos generally contain a distinct amount of oil which has not been removed in the manufacture; it has been suggested that more than 3 per cent. should be regarded as detrimental to the value, but this opinion—that the presence of oil delays the decomposition of such manures—has really never been demonstrated.

Fish guano is a comparatively active nitrogenous manure, since some of the compounds it contains are soluble in water and are rapidly decomposed by bacteria; the main constituents are, however, proteins and gelatinoids which resist attack to a greater or less degree. In consequence fish guano shares with the true guanos the property of continuing to yield nitrogen available to the plant throughout the whole growing season, though the range of compounds in fish guano must be regarded as a little less active than those in Peruvian guano. Fish guano has for many

years been a favourite manure among hop growers; it is also occasionally used for root crops when farm-yard manure is not available. It should be applied early in the year, when the land is first worked, and it should be dug or ploughed into the land as soon as sown, otherwise rooks and other birds will eat it as long as they are allowed to do so. Like all manures of this class, it is injurious to germinating seeds or the tender rootlets of growing plants, until it has been in the soil for a short time and the first active fermentation is over.

*Meat guano* is prepared from all kinds of slaughter-house refuse in much the same way as fish guano—the waste of carcasses, condemned imported meat, tallow boilers refuse, the residues obtained in making meat extracts, and so forth, are heated and pressed to remove fat, and the residue is then finely ground. Material of this class, though more often after treatment with acid or other admixture, is known in America as “tankage.” In some cases a good deal of bone is mixed with the material before grinding, and the resulting “guano” approximates to bone meal; in other cases the nitrogenous material predominates. Thus the nitrogen may be as high as 12-13 per cent., in which case there is little or no phosphate of lime present; whereas at the other end of the scale come mixtures with 4 to 5 per cent. of nitrogen and 35 to 40 per cent. of phosphate of lime. A good representative example, manufactured by the Liebeg Company under the name of Fray Bentos Guano, contained 7 per cent. of nitrogen and 30 per cent. of phosphate of lime, all in a fine friable condition, dry, and suitable for sowing.

In its action and uses meat is very similar to fish guano, and all that has been said about the time and manner of application of the one, equally applies to



the other. On the whole, the hop growers appear to prefer fish to meat guano, but this is probably only due to the greater regularity of the supply of fish guano and its more uniform composition. There is no evidence of the relative superiority of one over the other which should deter anyone from buying whichever of the two shows the lower price per unit of nitrogen and phosphoric acid. The price of the better grades of meat guano is raised to a certain extent by the fact that it can also be used as a cattle, and especially as a poultry food, in which case the nitrogen compounds always command a higher price than when they can only be employed as manure.

As with fish guano, meat guano should be ploughed in pretty quickly after it is sown; birds find both manures very palatable, and the rooks in particular will carry off large amounts if left on the surface.

*Dried blood* is a product of the slaughter-houses, which in its origin is closely allied to the meat guanos, differing from them in the absence of bone and in the nature of the proteins supplying the nitrogen. As will be seen from its analysis, it is a rich fertiliser and a very active one, because of the readiness with which its nitrogen compounds are broken down into ammonia.

Dried blood, however, comes but little on the market and is rarely purchased by the farmer. The total production is small and it is practically all taken up by the manure manufacturers, who, because of its richness in organic nitrogen and its good mechanical texture, find it valuable for mixing with other manures, when it is desired to raise the percentage of nitrogen in a compound manure.

*Greaves* may be regarded as a low grade of meat guano; properly speaking it is the waste from tallow-making, and consists of the scraps of cartilage and bone

which remain after the fat has been melted down and expressed as far as possible. The resulting waste material is still very fatty, and contains anything from 1.5 up to 6 per cent. or even more of nitrogen, with phosphates varying from 5 to 12 per cent. of phosphate of lime. As a rule, the mechanical condition of greaves is bad and much against its proper distribution in the soil; the price is also often higher than its nitrogen content would warrant, because reasonably clean samples can be used as poultry food. The amount of fat present is again possibly detrimental to its availability. Since greaves is extremely variable in its composition, according to the kind of material which happens to be treated at the factory from day to day, it is difficult to buy any large bulk on a guarantee, just as is the case with shoddy. It is difficult also to judge a consignment from a small sample, so that, as with shoddy, it is best to fix the price on the agreed unit value for nitrogen, taking the mean of several analyses from the bulk.

*Rape dust and other cake residues.*—In the manufacture of oil cake the oil-bearing seeds are subjected to great hydraulic pressure, either in bags or in metallic moulds which permit of the escape of the oil. The pressure is increased, aided sometimes by a little heat, until as much oil as possible has been obtained, there being left behind a cake consisting of the other parts of the seed, the proteins, carbohydrates, fibre, etc., together with a certain amount of oil which cannot be expressed. The remaining cake is usually a valuable cattle food and is sold as such. In crushing rape seed, however, the resulting cake is apt to be very impure; rape seed not only contains a large proportion of impurities, but often also a good deal of wild mustard seed, from which, when the cake is

used as food, mustard oil is generated in the stomach to a dangerous extent. It thus becomes the custom only to use the purer grades of rape cake for cattle feeding; in the other cases the cake is ground to powder and sold for manure. More recently a method of extracting the ground rape seed with carbon bisulphide, in which the oil is soluble and can be recovered by distilling off the solvent, has been generally adopted, because the whole of the oil in the seed is obtained in this way. The residue, which is really improved by the complete removal of the oil, is only used for manure.

Rape dust, as the ground rape cake is termed, has long been valued as a manure; William Ellis in 1735 speaks of oil cake with approval as one of the Hertfordshire "hand dressings" for corn, and at the time of the beginning of scientific agriculture in the second quarter of the last century we find that the use of rape dust had become pretty general throughout the eastern counties.

Rape dust contains about 5 per cent. of nitrogen, with such small quantities of phosphoric acid and potash that it must in the main be treated as a nitrogenous manure. In its action it may be classed with the fish and meat guanoses previously described, in that decomposition and nitrification is set up pretty rapidly and continues throughout the whole season. It has been largely used in the Rothamsted experiments, and the results with barley and mangolds (Tables XXVI., XXX., and LXIII.) show that, nitrogen for nitrogen, it is almost as effective as nitrate of soda or sulphate of ammonia. In these cases, however, the manure is applied year after year to the same land, so that the residues unused in the year of application accumulate for the benefit of the crop in future years, other

experiments, however, show that it is active enough to produce nearly its full effect in the first season. The organic matter rape dust supplies has a beneficial effect upon the tilth of the soil; on the Rothamsted mangold field, as has been pointed out earlier (p. 218), the best results as regards the proportion of a full plant obtained are yielded by the plot manured with rape cake. In general farming rape cake has been found a very suitable source of nitrogen for the barley crop; it is highly esteemed by hop growers, though of late years its comparatively high price per unit of nitrogen has much diminished its consumption in Kent and Sussex. It is also valued by fruit growers, but it is supposed to make a bad top dressing for grass, and, like all manures of its class, it should not in its fresh condition be put in contact with germinating seeds or young plants, probably because of the fungi and moulds with which it becomes permeated in the soil.

Other cake residues of a similar character come on the market from time to time in the shape of damaged cargoes of cotton, linseed, or other cakes, that have been spoiled for food by getting damp and heating or by the access of sea water. They may be judged on the same basis as rape cake and their value estimated from their analysis.

Castor cake or pomace, the residue left after castor oil has been expressed from the seeds, has no value for food, but makes a good fertiliser of the same class as rape cake. It is not often available in this country, as the castor oil is generally expressed before exportation; in India and other tropical countries, however, it forms a very valuable source of manurial nitrogen, because organic compounds of nitrogen are particularly desirable in tropical soils, which so rapidly lose their humus under cultivation.

*Manures derived from Human Excreta.*

Since the process of digestion in man does not essentially differ from that of animals, the greater part, and in the case of adults the whole, of the nitrogen, phosphoric acid, and potash, contained in human food is excreted in the urine and fæces. We have already seen that when plants are grown to feed animals, the nutrient constituents drawn from the soil are for the most part returned to the land; the only fertilising

TABLE LXXV.—COMPOSITION OF HUMAN EXCRETA.

	Fæces.		Urine.	
	Per cent.	Lb. per annum.	Per cent.	Lb. Per annum.
Water . . . .	77.2	...	96.3	...
Organic matter .	19.8	...	2.4	...
Ash . . . .	3.0	...	1.3	...
Nitrogen . . .	1.0	1.04	0.6	6.9
Phosphoric Acid .	1.1	1.3	0.17	3.2
Potash . . . .	0.25	0.3	0.2	3.4

constituents which leave the farm permanently are the corn, the wool, and the fat stock for the use of man. Even of these the husk of the grain, the wool, the bones and hair find their way back to the land eventually, but under modern conditions the permanently valuable constituents of human food which pass into the excreta are then wasted agriculturally by being washed away into the rivers and sea. In the gross the waste is enormous; the only difficulty of preventing the loss lies in the fact that most of the methods for rendering serviceable the wasted material cost more than an equal amount of fertiliser from some other extraneous source.

Wolff and Lehmann have estimated (Table LXXV.)

the average composition of human excreta, and for the average yearly output of each individual, from which it will be seen that neither urine nor fæces are particularly rich fertilisers.

These are mean figures for all ages, and the weights of nitrogen and phosphoric acid excreted per annum are calculated upon a somewhat different basis; for adults the quantities should be at least half as large again. But taking high average figures, an adult only excretes during a year about 12 lb. of nitrogen, 7 of phosphoric acid, and 5 of potash, worth respectively about 7s. 6d., 2s., and 1s., or 10s. 6d. a year in all when converted into a marketable fertiliser. Though for a large population the total waste may thus seem to be enormous, 10s. 6d. per head is yet but a small amount to be set against the expense of dealing with such a quantity of low grade material so difficult to handle.

Many attempts have naturally been made to utilise the fertilising material contained in human excreta; on the crowded lands of China it is applied fresh to the soil and is daily fetched by hand from the cities for that purpose, but such a mode of dealing with night soil is only possible with an excessively low standard of living. In the towns of Flanders and the north of France it was the custom to collect the excreta in large tanks, and after fermentation, to cart them out in a liquid form to the fields, though modern views on public health are rapidly getting rid of such practices. Almost the only method of getting human excreta back to the land cheaply and inoffensively is in houses or small communities where the "earth closet" system prevails. There the excreta are mixed with dry sifted earth, which deodorises them quickly and completely, the mixture is removed daily to a heap under cover, and

in a very short time, the fæcal solids, paper, etc., are so completely broken down by bacterial decay that the soil can be spread upon the land and used for growing crops.

In some towns attempts have been made to manufacture a concentrated fertiliser by collecting human excreta without any admixture and evaporating off the water, sometimes with the addition of a little acid to fix the ammonia arising from the urea, sometimes with powdered turf, etc., to give the finished material a better mechanical texture. In Rochdale, one of the towns where such a system prevails, the houses are provided with external pan closets and the fæces are collected at short intervals for conveyance to the manure works. The following analysis shows the composition of the resulting manure—

Water . . . . .	13.9
Organic matter . . . . .	63.7
Containing Nitrogen . . . . .	6.74
Phosphoric Acid . . . . .	3.12
Potash . . . . .	2.16
Insoluble Ash . . . . .	3.45

The almost universal prevalence of a water-borne system of dealing with excreta puts an end to all such systems and intensifies the difficulty of saving the fertilising constituents of human food for the land again, because of the enormously increased dilution they have experienced; the sewage from towns with water-closets only contains on the average about 2.2 parts of nitrogen per 100,000. Where the conditions are favourable and the community has at hand a sufficient area of light, permeable land which can be cheaply graded and adapted to irrigation, then the sewage waters, either with or without a preliminary

treatment to get rid of suspended matter, can be profitably utilised in raising crops. But light land, permitting of free percolation, is necessary, and it must not be overloaded with sewage but allowed intervals for aëration and oxidation, or else the surface becomes sealed with a layer of organic matter difficult to break down and both percolation and purification cease. An acre of land is not capable of dealing with the sewage of many more than one hundred people. This is hardly the occasion to discuss the various processes now in vogue for the purification of sewage by bacterial action or by land filtration, but at one point they do touch the manure question by turning out "sewage sludges" which possess a certain fertilising value. In many of the processes the raw sewage is first submitted to some process of chemical precipitation to effect the removal of the suspended matter and obtain a clear effluent, which can be purified by bacterial filter beds or by application to the land. As precipitating agents, lime, alum, and sulphate of iron are commonly employed, alone or together, the object being to produce a bulky colloidal precipitate which will entangle and drag down the flocculent organic matter of the sewage. After mixing with the precipitant, the sewage is left in tanks to settle, the clear liquid is passed on for further treatment, and the remaining sludge is freed from excess of water by passing through some form of pressure filter. The resulting press cakes are either disposed of locally in the wet state or, in one case at least, dried and sold as a manure under the name of "native guano." It is obvious that any such precipitating process with either lime or the sulphates of alumina and iron, can only take out of the sewage such nitrogenous bodies as proteins, leaving the greater part—the amides and ammonium salts, still in solution. Thus the sludge will only con-



tain the smaller and least valuable portion of the nitrogenous material, also the phosphates but not the potash of the sewage. Table LXXVI. gives a series of analyses of such sludges, made for the Royal Commission on Sewage Disposal in 1906, which may be taken as typical of this class of material:—

TABLE LXXVI.—COMPOSITION OF SEWAGE SLUDGES.

	1	2	3	4
Water . . . . .	10·1	31·2	40·6	3·55
Organic matter, etc. . . . .	49·8	24·9	16·8	38·23
Nitrogen . . . . .	2·32	0·94	0·55	1·65
Phosphoric Acid . . . . .	2·27	0·80	1·42	1·25
Lime . . . . .	2·34	24·6	24·45	8·40
Potash . . . . .	traces	traces	traces	traces
Insoluble matter . . . . .	23·27	7·06	5·57	28·28

Of these sewage sludges No. 1 represents the material sold as "native guano," 2 and 3 are lime sludges, while for 4 the precipitant had chiefly been sulphates of iron and alumina. It will be seen that in no case is the material possessed of much fertilising value, for not only are the percentages of nitrogen and phosphoric acid low, but they must be combined in extremely inactive forms. Field trials show that the action of these sludges as manures is very small, below that of equivalent amounts of nitrogen and phosphoric acid in commercial fertilisers, so small in fact to be negligible unless the material is applied in very large quantity. Indeed, we can only conclude that these sludges possess little or no value as fertilisers, though they may be valuable for the lime they contain, especially on light sandy land where they will also add some water-retaining humus and improve the texture of the soil.

TABLE LXXVII.—COMPOSITION OF GUANOS AND KINDRED FERTILISERS.

	Nitrogen.	Phosphoric Acid.	Equivalent to Tri-calcium Phosphate.	Potash.	Oil.
Peruvian Guano, Ballestas, 1902 .	12.24	11.36	24.76	...	...
"    Macabi, 1902 .	10.57	13.90	30.30	...	...
"    Guanape, 1902 .	7.75	18.59	34.00	...	...
"    Lobos, 1902 .	2.86	29.52	64.35	...	...
"    "    1902 .	1.50	31.63	68.95	...	...
"    "    1906 .	8.4	13.17	28.70	2.85	...
"    "    1906 .	4.9	21.22	46.25	3.51	...
"    "    1906 .	2.37	21.61	47.12	2.90	...
"    Equalised .	7—8	11—14	25—30	2—3	...
Ichaboe . . . . .	8.64	12.14	28.09	2.47	...
"    . . . . .	8.22	14.3	31.3	2.0	...
Damaraland . . . . .	6.83	14.63	31.89	...	...
Fish Meals . . . . .	8.97	8.87	19.34	...	4.96
"    . . . . .	8.68	10.14	22.11	...	8.48
"    (from herring refuse) .	8.78	6.59	14.37	...	16.46
"    . . . . .	9.29	7.70	16.79	...	...
"    . . . . .	6.26	5.96	12.99	...	...
"    . . . . .	6.15	5.26	11.47	...	...
Meat Meals . . . . .	12.3	0.92	2.0	...	...
"    . . . . .	6.51	13.22	28.82	...	...
"    . . . . .	6.36	14.32	31.27	...	...
"    . . . . .	5.82	12.80	27.94	...	...
"    . . . . .	5.61	11.35	24.77	...	...
Greaves . . . . .	6.22	5.48	11.96	...	...
"    . . . . .	4.19	2.18	4.75	...	...
"    . . . . .	2.61	2.56	5.50	...	...
Dried Blood . . . . .	9.65	0.83	1.82	...	...
Rape Dust (Homco) . . . . .	4.84	1.7	3.8	...	...
"    . . . . .	5.08	1.58	3.44	...	...
Damaged Cotton Cake . . . . .	4.78	1.73	3.77	2.77	...
Castor Cake . . . . .	5.77	1.83	3.99	1.04	...

## CHAPTER IX

### MATERIALS OF INDIRECT FERTILISING VALUE

Lime—Early Use of Lime—White and Grey Limes—Lime Ashes—Marl—Chalk—Ground Limestone—Indications of the Lack of Lime in the Soil—Action of Lime upon the Soil—Improvement of Texture—Promotion of the Oxidation of Nitrogenous Residues in the Soil—Increase in the Availability of Phosphoric Acid and Potash—General Action of Soluble Salts on the Soil—Gas Lime—Gypsum—Salt—Sulphate and Carbonate of Magnesia—Sulphate of Iron ; Supposed Connection of Iron in the Soil with the Colour of Fruit and Flowers—Manganese Salts—Silicates—Green Manuring—Folding Catch Crops on the Land.

THERE are several substances commonly used by farmers as manures, which produce desirable effects upon the crops, although they are not themselves plant foods and only act indirectly on the soil, either by making it more amenable to cultivation or by bringing into action the stored-up reserves in the soil.

Such substances are lime, gypsum, salt, all of which contain elements present in the plant, though they also exist in the soil in quantities sufficient for the nutrition of the crop ; they are valuable as soluble salts for their indirect effect in making soluble other more important plant foods in the soil.

*Lime.*—When the value of lime became known it is impossible to ascertain, but we find that the use of both lime and marl was recognised among the Romans.

For example, Pliny writes:—"There is another way of nourishing earth by earth, which has been found out in Britain and Gaul. It is thought that there is a greater degree of fruitfulness in this kind than in any other. It is a certain richness of earth, like the kernels in animal bodies, that are increased by fatness. "The principal of those, reckoned the fat kinds, is the white; of this there are many. One very acrid, that has already been mentioned. Another kind of the white is like a soft clay. It is found at a great depth; the pits very frequently dug an hundred feet down, narrow at the mouth; but the vein, as in metals, widening within. This is chiefly used in Britain. It remains eighty years; nor is there an instance of any man laying it twice on the same field. "The Hedui and Pictones manure their fields with lime, which is likewise found very good for olives and vines. All marl ought to be laid upon ploughed land, that its virtue may be the easier sucked in by the soil. A little dung should be laid on with it, particularly with that kind that at first is too hard, and does not dissolve well enough to nourish plants. Besides, of whatever kind it is, it hurts the soil, by its being new, and does not render it fertile till after the first year."

The regular use of some form of lime or chalk was part of the accepted routine of farming as early as we possess any records of British agriculture, and among the manures it figures in all books of the sixteenth and seventeenth centuries. In fact "the black and the white," dung and lime, were the only manures employed by the great mass of farmers until well into the nineteenth century.

Lime itself, or quicklime, is obtained by the "burning" of any form of calcium carbonate, which occurs as limestone [either pure in the Mountain Limestone of

Derbyshire and North Yorkshire, or argillaceous in the Lias] as chalk, and even as shell sand, on the Cornish and other coasts. The so-called "burning" consists in driving off by heat the carbonic acid contained in the calcium carbonate. The resulting lime, known sometimes as quicklime, stone lime, cob lime, lime shells, etc., combines with great readiness with water, developing much heat and falling down into a fine powder termed "slaked lime," and this slaked lime will then combine with the carbonic acid present in the atmosphere to reconstruct the original carbonate of lime. Thus when lime is applied to the soil it very rapidly becomes carbonate and the effects of "liming" are really due to carbonate of lime.

The quality of lime varies considerably, according as it has been made from a pure limestone or from the impure forms containing some admixture of clay and sand. In the former case the result is a white, "fat," lime which swells considerably on slaking and falls into a very fine powder; the other grey or thin limes do not slake so readily nor swell much, they also contain a smaller proportion of free lime and are less valuable for agricultural purposes. In some parts of the country the limestone is dolomitic and contains considerable proportions of magnesium carbonate, but the limes arising from it are not regarded with so much favour by farmers.

Lime ashes, which are to be had cheaply in the neighbourhood of the kilns, consist of the waste accumulating in burning the lime and are therefore mixtures of lime in a powder with the ashes of the coal employed. The percentage of lime may vary from 20 to 60 according to circumstances, so that the value of each lot must be judged by its apparent cleanliness and freedom from clinker.

Since lime becomes calcium carbonate in the soil, obviously the same results would be obtained by applying the latter material, the main advantage in the use of lime lies in the very fine state of division into which it falls on slaking and the consequent good admixture with the soil that is effected.

Such a finely divided calcium carbonate is provided in many parts of the country by the calcareous marls which occur in beds sufficiently near the surface to admit of working, as in the New Red Sandstone formations in Cheshire, Worcester, etc., or the shell marls which occur in Norfolk. A true marl is a clay containing a variable percentage of calcium carbonate, it is specially valuable on sandy or peaty soils, not only for its calcareous matter but also for the clay, which improves the texture of the soil.

In many parts of the country, where the superficial formations resting upon the Chalk are devoid of carbonate of lime, it was formerly the custom to sink bell pits into the chalk rock, haul it up in baskets and spread it upon the surface. In Hertfordshire, for example, this chalking was part of the regular routine of farming from the earliest times of which we have records, and from the analyses of the Rothamsted soils it has been ascertained that by the repetition of the process a hundred tons per acre or more must have been applied before the beginning of the nineteenth century, there being now present in the soil from 2 to 5 per cent. of carbonate of lime, all of artificial origin. Chalk was also formerly carried for considerable distances on to the clay formations—the London Clay, the Gault Clay, and the Weald Clay—that are contiguous, but the increased cost of labour has put an end to this practice.

None of the other British limestones are sufficiently

soft to allow of their direct application to the land with any prospect of their reduction to a fine state by the action of the weather, but of late years, since many of the lime works have established grinding plants, it has been possible to obtain both limestone and chalk in a finely ground condition. In certain parts of the country precipitated carbonate of lime in a very fine state of division is to be obtained from water works which soften their hard calcareous water by the use of lime, and this forms valuable material for all land in need of lime. Ground quicklime is also manufactured and forms a very convenient means of applying small quantities of lime to the soil; unfortunately the ground lime available is generally grey or cement lime, so that at its higher price and with its lower proportion of pure lime it is often more profitable to buy a larger quantity of ordinary lime. When the practice of liming was more general it was customary to apply very large amounts, 4 to 6 or 8 tons per acre (100 to 200 bushels) at long intervals, but this is likely to act injuriously by causing too rapid oxidation in the soil at first, and a better plan is to put on 1 ton or so of ordinary lime every time the turnip crop comes round in rotation, or 5 to 10 cwt. of ground lime to each crop for which artificial manures are applied. A heavy dressing of lime is also supposed to affect the processes of nitrification detrimentally for some time after its application.

Lime, chalk, or ground limestone, in whatever form it is used, should always be applied to the land as early in the winter as may be convenient, on arable land before ploughing.

The question of whether lime is required as a regular part of the routine of farming on a given soil can only be decided by an analysis of the soil; any soil containing less than 1 per cent. of calcium carbonate will be

benefited by liming, and when the percentage falls to  $\frac{1}{8}$  per cent. lime becomes a necessity to enable the manures to exert their proper action.

Many clays and sands are in this latter condition; and although the absence of lime may often be concluded from the appearance of the vegetation, every farmer ought to get a determination made of the amount of carbonate of lime in his soil, because the whole scheme of manuring should depend on whether the soil is properly supplied with a base.

In arable land the presence of the small sorrel (*Rumex acetosella*), corn marigold (*Chrysanthemum segetum*), Spurrey (*Spergula arvensis*), and the growth of foxglove (*Digitalis purpurea*) and bracken (*Pteris aquilina*) on the waste places are pretty sure signs of the absence of lime, while the pastures on such soils are generally very deficient in leguminous herbage. If a little soil when covered with dilute hydrochloric acid shows no visible effervescence, the proportion of carbonate of lime must be below what is desirable for the healthy growth of vegetation. Nor must it be supposed that the use of artificial manures, such as superphosphate of lime, or bones which are phosphate of lime, or gypsum which is sulphate of lime, will obviate the necessity of liming. Lime or its carbonate are needed in the soil to supply a free base, and in the compounds mentioned it is already saturated with a fixed acid; in fact, in superphosphate of lime there is an excess of acid, so that this fertiliser reduces the amount of carbonate of lime in the soil. Gas lime is again of very little service in this connection, since the base has already been largely combined with various compounds of sulphur, and still remains so after these sulphur compounds have been oxidised by exposure of the gas lime for some time. The following table (LXXVIII.)



shows analyses of "grey" and "white" limes made from chalk :—

TABLE LXXVIII.—ANALYSIS OF LIME.

	White Lime.	Grey Lime.
Caustic Lime . . . .	90.20	74.00
Carbonate of Lime . . . .	2.40	2.66
Magnesia . . . .	0.35	0.38
Oxide of Iron . . . .	0.52	1.00
Alumina . . . .	1.70	7.60
Silica as Soluble Silicates . . . .	2.60	8.60
Insoluble residue . . . .	0.25	0.94
Water, Alkalis, etc. . . .	1.98	4.82
Total . . . .	100.00	100.00

Lime is best applied to the stubbles in the autumn before ploughing in preparation for a root crop; if ground lime is used it may be sown broadcast with any form of manure distributor, choosing a quiet morning while the dew is still on the surface.

Stone lime should be distributed in small heaps, covered with a little earth and left for a week or two to slake, under which conditions it will fall into a fine powder. The heaps are then broken down and thrown abroad before ploughing.

The action of lime is partly physical, affecting the texture of the soil, and partly chemical, setting free the dormant reserves of plant food.

On the strong soils the physical action of lime is most manifest; it acts by flocculating the finest clay particles, causing them to aggregate into temporarily larger units, and so making the soil effectively of coarser texture. The soil thus becomes less retentive of moisture; percolation is increased, making the limed land dryer and warmer, so that it admits of cultivation earlier in the spring and is far more friable when dry.

In dry seasons the clay will crack less and the crop will keep on growing longer, because the improved texture of the soil admits of a better supply of subsoil water to the plant by surface tension.

It is difficult to exaggerate the improvement that lime effects in the dryness and workability of strong soils, which in many cases would not be fit for arable cultivation had they not been so treated. It has already been mentioned that on the Rothamsted estate the custom of chalking has added from 2 to 5 per cent. of carbonate of lime to the surface soil, which is otherwise non-calcareous; but on one of the fields, formerly under experiment, the treatment had never been carried out. This field, Geescroft, formerly carried experimental crops of oats and beans, but during the rainy seasons about 1879 the land lay so persistently wet in the spring that on several occasions a tilth could not be obtained in time for sowing, and the land had to lie fallow, until at last cultivation was abandoned and the field was allowed to fall down into grass. Even now the herbage is very inferior and shows the wet character of the soil by the prevalence of *Aira cæspitosa*; yet in situation, drainage, and mechanical composition this soil is in no respects different from that of the other Rothamsted fields. The essential factor which has caused all the difference in the character of the two soils is the absence of calcium carbonate from the Geescroft field, which for some reason had escaped the chalking given to the other fields. The physical improvement of a clay soil by lime is not apparent at once but grows from year to year after the application of the lime; the flocculating action is really not due to the lime itself but to the soluble calcium bicarbonate which arises from the action of water and carbonic acid upon the calcium carbonate formed from the lime.

On the lighter soils—the sands and gravels—lime exerts a good effect by forming a weak cementing agent and increasing the cohesion of the particles. As a rule, however, it is not wise to apply quicklime in any quantities to very light open soils, because oxidation of the organic matter is pushed on too rapidly. Either chalk or marl, or some form of calcium carbonate should be used, or the quicklime should only be applied in small quantities.

From the chemical side the great value of carbonate of lime in the soil lies in its power of maintaining the neutral reaction necessary to the development of those bacteria which oxidise the organic compounds in the soil to the state of plant food. In the absence of lime, organic matter by its decay gives rise to various acid bodies which may be grouped as humic acid, and the acidity thus produced inhibits the action of many of the valuable groups of bacteria, such as the *Azotobacter* which fix nitrogen, and the nitrifying bacteria which convert ammonia into nitrates. It has been shown that in soils that are acid through the accumulation of humic acid, nitrification is at a standstill and bacterial life generally is repressed in favour of the growth of moulds and micro-fungi, which compete actively with the crop for the plant food in the soil.

On all land which has been enriched by the residues of past manuring or by the débris of previous vegetation, lime is very necessary to promote the oxidation of the nitrogen compounds and the formation of nitrates for the crop; consequently it is on bog or peaty land, on old turf or reclaimed forest land, or on old gardens, that liming exercises its maximum effect. The following figures (Table LXXIX.) show the comparative crops on limed and unlimed plots, otherwise manured alike, in an old hop garden at Farnham,

Surrey, which had been heavily dressed with organic manures for many years previously :—

TABLE LXXIX.—EFFECT OF LIME UPON HOP SOILS.

Year.	Artificial Manures.	
	With 1 ton Lime per acre.	With no Lime.
1895	100	70
1896	100	84
1897	100	80
1900	100	81
1901	100	90

Because of the wide fluctuations due to season the yield each year has been calculated on a basis of the limed plot = 100, showing that, on the average, liming has increased the return by 19 per cent.

It is on soils with a tendency to sourness that liming is of the greatest value, for in such cases dung or any other organic manure only tends to aggravate the evil. This is very well illustrated by the action of lime upon the grass plots at Rothamsted, where 2000 lb. per acre of ground lime was applied to half of the plots in January 1903, with the results shown in Table LXXX. ; the yield of the limed half of the plot in each year has been compared with the yield of the unlimed portion taken as 100.

It will be seen that the increased yield due to liming is most manifest on plots 4/2, 9, and 11/1, where the soil had become acid through the long-continued use of ammonium salts. It should also be noticed that the action of lime is slow, and is more manifest in the third and fourth year after its application than in the first and second.

It has already been stated that moulds and other

micro-fungi are favoured by an acid reaction in the soil, consequently we find that various fungoid diseases of plants are specially prevalent on soils devoid of calcium carbonate, a notable example being the slime fungus, *Plasmodiophora brassicæ*, which causes "finger-and-toe," "club root," or "anbury" in turnips, cabbages,

TABLE LXXX.—EFFECT OF LIME UPON ROTHAMSTED GRASS PLOTS  
(UNLIMED=100).

Plot.		1903.	1904.	1905.	1906.	1907.
3	Unmanured . . . .	154	134	119	98	119
4/2	Super. and Am.-salts .	124	111	134	118	113
7	Complete Minerals .	105	100	106	120	110
8	Minerals ; no Potash .	93	90	103	93	110
9	As 7, + Am.-salts . .	121	110	142	128	106
11/1	As 7, + extra Am.-salts .	115	103	206	120	167
10	As 8, + Am.-salts . .	120	111	128	112	104

and similar plants. This disease does not occur on calcareous soils and can be obviated on soils where it does prevail by a thorough liming, best applied both after the removal of one turnip crop and again immediately before another is sown. As long an interval as possible should elapse between the two cruciferous crops to enable the spores of the disease to die off in the soil, now rendered faintly alkaline. The finger-and-toe fungus is not the only one thus affected by lime, but it is the one known on the widest scale; speaking generally, calcareous soils are always the healthiest for crops.

But the nitrogenous compounds in the soil are not the only ones rendered more available by the presence of carbonate of lime; both phosphoric acid and potash are thereby kept or brought into a more soluble form. When soluble phosphates are applied to the land they are precipitated either as di-calcium phosphate, ferric

phosphate, or aluminium phosphate; and on soils containing any reasonable amount of calcium carbonate the former will predominate, the two latter on the sands and clays where calcium carbonate is lacking. Now the effective solubility of the two latter phosphates in the soil water is very much below that of the precipitated calcium phosphate, consequently their phosphoric acid is much slower in reaching the plant, which may remain short of this necessary constituent even though large amounts have been applied to the soil. Similarly a soil may contain considerable amounts of phosphoric acid, which in the absence of lime is combined with ferric oxide or alumina so as to be in a highly insoluble condition; for example, a soil derived from the marlstone has been known to contain 0.84 per cent. of phosphoric acid but yet show great response to phosphatic manures, because at the same time it contained 28.16 per cent. of ferric oxide and no calcium carbonate. Applications of lime or calcium carbonate are of great value on these soils because they form a certain amount of calcium phosphate by interaction with the iron or aluminium phosphates, and so increase the proportion of phosphoric acid in the soil water.

The action of lime upon the potash compounds in the soil is equally marked; as the soil water carries down the dissolved calcium bi-carbonate it attacks the zeolitic double silicates in the clay and some of their soluble bases, potash among them, change place with the lime and come into solution. Thus lime is precipitated and potash is found in the soil water. The action is the converse of that which takes place when potash salts are applied as manures; whatever base is in excess in the water reaching the soil will turn the others out and be precipitated in the solid zeolite. When potash salts are applied to the land the strong solution thus

formed attacks the zeolites and replaces calcium by potassium, thus the potash is precipitated and lime salts go into the drainage water; when lime is applied to the land the process is reversed and potash goes into solution as bicarbonate.

This may again be seen in the results quoted in Table LXXX. of the application of lime to the Rothamsted grass plots: on Plot 8, where potash had not been used previous to the application of the lime there is little or no increase of yield, because there were no reserves of potash to be set free. That lime acts in this fashion may also be inferred from its beneficial effect upon clovers and other leguminous plants in a mixed herbage, or by the remarkable power of basic slag to promote the growth of white clover in a pasture where it was formerly dormant. Other phosphatic manures have often little effect in such cases, so that free lime in the basic slag, by liberating potash, is evidently as important a factor in the growth of the clover as the phosphoric acid. If the basic slag is applied to a soil poor in potash it has little effect, and again after two or three applications to grass land it ceases to show its previous beneficial action upon the clover, because the readily attackable potash in the soil has all been brought into solution and a direct application of potash salts becomes necessary.

The fact that a solution of calcium bicarbonate will react with the potash-containing double silicates in the soil, so as to bring some of the potash into solution, is only a particular case of a more general proposition, which is applicable to any soluble salt brought into contact with the zeolites. Whatever the salt may be, if its base be one normally found in the zeolite, *e.g.*, either sodium, potassium, calcium, or magnesium, it will

effect an exchange with the bases in the zeolite, to a greater or less degree according to the relative mass of salt and zeolite, becoming itself insoluble and bringing the other bases into solution. Thus in practice the application of any soluble salts of calcium, magnesium, and sodium to the soil results in potash going into solution and thus becoming available for the crop, always supposing that the soil is provided with a normal amount of clay containing zeolites derived from potash felspar. This principle serves to explain the fertilising value of all such bodies as gas lime, gypsum, salt, and sulphate of magnesia, and also the irregularity of their action, because they are only effective when the soil contains potash and yet the crop requires more than the soil can normally furnish.

This general action of soluble salts in increasing the supply of available potash for the plant may be well illustrated from the Rothamsted experiments. Taking the wheat crop, there are five plots treated alike as regards their supply of nitrogen and phosphoric acid, but whereas one receives nothing further, one each of the others also receives sulphate of sodium, potassium, or magnesium respectively, and the fifth plot all three of these salts, with the results set out in Table LXXXI. for five successive ten-year periods.

It will be seen that in the first decade the lack of any alkaline salt on Plot 11 caused a serious reduction of crop, but on the other plots there was much the same yield, the mixed sulphates giving somewhat the highest and the sulphate of potash itself the lowest yield. From this alone it might be concluded that it is a matter of indifference to the plant which of the alkaline salts it receives, but as time goes on it will be seen that Plot 13, receiving potash, remains but little behind Plot 7 receiving all the salts, but that Plots 12 and 14, receiving



soda and magnesia without potash, fall further and further behind, though they never reach the low level of Plot II, with no alkaline salts at all. At first the soda and magnesia can do the work of the potash because they can render soluble enough potash in the soil to satisfy the needs of the crop; but as the treat-

TABLE LXXXI.—EFFECT OF ALKALINE SALTS UPON THE WHEAT CROP (Rothamsted).

Plot.	Alkaline Salt added to Ammonium Salts and Superphosphate in Manure:—	1852-1861.	1862-1871.	1872-1881.	1882-1891.	1892-1901.
GRAIN, BUSHELS.						
II	None . . . . .	28.4	27.9	21.7	22.7	19.5
12	Sulphate of Soda . . .	33.4	34.3	25.1	30.1	26.7
13	Sulphate of Potash . . .	32.9	34.8	26.8	32.5	29.6
14	Sulphate of Magnesia . .	33.5	34.4	26.4	31.1	25.0
7	Sulphates of Soda, Potash, and Magnesia . . .	34.7	35.9	26.9	35.0	31.8
STRAW, CWTS.						
II	None . . . . .	28.2	24.5	21.3	20.8	18.8
12	Sulphate of Soda . . .	34.2	30.5	25.0	27.3	24.0
13	Sulphate of Potash . . .	34.4	33.4	27.6	31.9	28.6
14	Sulphate of Magnesia . .	35.0	30.7	26.3	28.6	23.4
7	Sulphates of Soda, Potash, and Magnesia . . .	36.4	34.3	28.7	34.1	31.1

ment is continued the readily attackable potash in the soil becomes depleted and the yield falls off despite the great initial store of potash in the Rothamsted soil. That the potash in the soil had been rendered soluble by the soda and magnesia, is made still more clear by a consideration of the composition of the ash of the plants from these plots: and Table LXXXII. shows the average composition of the straw ash for the 10 years

1882-91, the straw ash alone being given because there is practically no variation in the composition of the ash of the grain.

TABLE LXXXII.—PERCENTAGE COMPOSITION OF THE ASH OF WHEAT STRAW. MIXED SAMPLES REPRESENTING 10 YEARS, 1882-1891 (Rothamsted).

	Ammonium Salts and Superphosphate with—				
	0.	Sulphate Soda.	Sulphate Potash.	Sulphate Magnesia.	Sulphate Soda, Potash, and Magnesia.
Plot . . . . .	11	12	13	14	7
Ash (crude) in Dry Matter, per cent. . . . .	5.84	5.69	5.93	5.52	5.89
Iron Peroxide, etc. . . . .	0.43	0.33	0.34	0.41	0.50
Lime . . . . .	9.14	7.73	5.39	7.70	5.69
Magnesia . . . . .	2.25	1.92	1.53	2.46	1.76
Potash . . . . .	9.91	14.68	23.28	14.87	25.89
Soda . . . . .	0.58	0.57	0.03	0.33	0.21
Phosphoric Acid . . . . .	4.26	3.65	3.39	3.87	3.82
Sulphuric Acid . . . . .	5.44	5.33	5.07	5.31	5.41
Chlorine . . . . .	1.66	2.89	5.61	2.81	6.60
Carbonic Acid . . . . .	trace	none	none	trace	...
Silica . . . . .	65.19	61.93	54.26	61.06	49.68
Sand . . . . .	1.46	1.43	1.76	1.39	1.32
Charcoal . . . . .	0.06	0.19	0.60	0.42	0.61
Total . . . . .	100.38	100.65	101.26	100.63	101.49
Deduct O = Cl. . . . .	0.38	0.65	1.26	0.63	1.49
Total . . . . .	100.00	100.00	100.00	100.00	100.00

There is no great variation in the percentage of ash in the dry matter, but while the percentage of potash in the ash of the straw from Plot 13, receiving only potash, is 23.28, it is raised to 25.89 when soda and magnesia

are also added to the potash in the manure, but sinks to 9.91 when all the alkaline salts are lacking. From this low figure of 9.91 the addition of soda causes a rise to 14.68, of magnesia to 14.87; the differences in the yield of the plots are in fact reflected in the proportions of potash in the ash, though the variations are not so great. But though the addition of soda or magnesia on Plots 12 and 14 causes an increase in the proportion of potash in the ash, neither the magnesia nor the soda in the ash are perceptibly raised. Hence, we may conclude that the whole effect of either sulphate of soda or sulphate of magnesia upon the crop is indirect and due to their attack upon the potash reserves in the soil.

These results with wheat at Rothamsted are confirmed by the parallel experiments upon mangolds and grass; in each case sodium and magnesium salts add to the effect of a potash dressing, and in the absence of potash partially do its work, more in the earlier than in later years of the experiment when the easily attacked soil potash is becoming exhausted.

*Gas lime* is a greenish yellow, evil smelling substance obtained during the purification of coal-gas by its passage over trays of freshly slaked lime, which absorbs sulphuretted hydrogen and other sulphur compounds from the crude gas. Various sulphides and partially oxidised sulphur compounds of calcium are formed, as may be seen from the analyses set out below, and these are to some extent attacked by the carbon dioxide of the air with the liberation of the original gaseous sulphur compounds. The main action, however, on exposure to the air is one of oxidation, so that eventually the material becomes little more than a mixture of gypsum and calcium carbonate from the uncombined lime. It is in this oxidised form only

that gas lime should be applied to the land unless the ground is badly infested with some insect pest which the raw sulphur compounds may check or destroy, and even then on light soils the fertility of the land may be impaired for some time. It is on heavy land that gas lime is of most value; the flocculating effect of the calcium salts improves the texture, and the soil also contains a great reserve of dormant potash compounds to be rendered soluble. The crude material from the gas works should be laid up in heaps, mixed with a little earth for a year or more, spread on the stubbles in the early autumn, and then ploughed in.

TABLE LXXXIII.—ANALYSES OF GAS LIME.

	London, fresh.	London, a little Oxidised.	Oxidised.
Water . . . . .	19.2	32.3	30.1
Calcium Hydrate (Slaked Lime) . . . . .	15.1	17.7	32.6
„ Carbonate . . . . .	24.2	44.5	17.5
„ Sulphide . . . . .	6.9	...	trace
„ Thio-sulphate . . . . .	11.8	12.3	...
„ Oxy-sulphide . . . . .	3.2	...	...
„ Sulphite . . . . .	1.5	14.57	} 20.2
„ Sulphate . . . . .	0.25	2.80	
Sulphur . . . . .	4.3	5.14	...
Silica, etc. . . . .	3.55	0.71	...

*Gypsum*.—That gypsum, crystallised sulphate of lime, or land plaster,  $\text{CaSO}_4, 2\text{H}_2\text{O}$ , had a beneficial effect upon certain crops and soils has been known for a very long time; it was probably familiar to the Romans, and the knowledge survived to a certain degree among the southern nations, especially in connection with vines. In Britain it appears to have been less commonly used and no very general agreement as to its value had become traditional; in fact it was only among the hop growers of Kent and especially of Sussex,

that any regular use was made of gypsum. In this latter case it is not easy to make out to what extent its employment was the result of experience, or of a quasi-scientific opinion which traced a connection between the action of sulphur upon the mildew of the hop, a supposed lack of sulphates in a mildewed leaf, and the sulphates in the gypsum. In the latter part of the eighteenth century the value of gypsum for leguminous crops like clover and lucerne became widely recognised; Benjamin Franklin, in America, is said to have sown gypsum so as to form the word "plaster" on clover crops by the wayside, in order that passers by should learn by the eye what had so stimulated the growth. It is, in fact, on leguminous and such other crops as are specially dependent upon potash, that gypsum has an effect. This is intelligible on the principle set out above, that the solution of calcium sulphate which arises from the gypsum will attack the zeolites containing potash and will so bring some potassium sulphate into solution in the soil water. In confirmation of this view, Boussingault has shown that when clover is manured with gypsum and improved thereby, the ash of the crop contains a greater proportion of potash but shows no increase in either the lime or the sulphuric acid.

The figures obtained by Boussingault are set out in Table LXXXIV.

Thus, while the variations in lime and sulphuric acid—the constituents of the gypsum, are small, the proportion of potash has been greatly increased by the use of gypsum.

Similarly, it has been found, in testing the action of gypsum upon hops, that it has a beneficial effect only upon the soils where hops also respond to dressings of potash salts, and that the result of applications of

gypsum is similar to that of potash salts, though to a less degree. Some crops, like Swede turnips and cabbage, may take up more sulphur compounds than the soil can normally supply and so be benefited by the sulphur in the gypsum, but in the main its value is as a liberator of potash in the soil.

TABLE LXXXIV.—COMPOSITION OF CLOVER ASH.

	Without Gypsum.	With Gypsum.
Potash . . . . .	23·6	35·4
Soda . . . . .	1·2	0·9
Magnesia . . . . .	7·6	6·7
Lime . . . . .	28·5	29·4
Oxides of Iron and Manganese .	1·2	1·0
Chlorine . . . . .	4·1	3·8
Phosphoric Acid . . . . .	9·7	9·0
Sulphuric Acid . . . . .	3·9	3·4
Silica . . . . .	20·0	10·4

*Salt.*—The use of salt, alone or as an adjunct to other fertilisers, is a common farming practice; for example, in growing mangolds it is customary to give them 2 or 3 cwt. per acre of salt as a top dressing with or without nitrate of soda. On the fen land of Lincolnshire potatoes are generally grown with farmyard manure, superphosphate, and a liberal dressing of salt, and in barley growing, salt alone is sometimes used where roots have been folded off, with an idea of stiffening the straw. Though, in the first case, the value of salt is often ascribed to the fact that the mangold has been derived from a maritime plant, it is really due to the dependence of mangolds upon an abundant supply of potash (see p. 168), because the soluble sodium chloride will bring into solution the reserves of insoluble potash in the soil and the manure. Potatoes again are much in need of potash, and the straw

stiffening effect is similarly explicable by the extra potash made available for the barley plant. Even the ill effects of salt upon the malting quality of the barley that are sometimes experienced, can be paralleled by the observed effects of potash in prolonging the growth of barley and deepening the colour of the grain. Salt is also credited at times with injuring the tilth of heavy soils and rendering them sticky and wet; this effect again is paralleled by the action of potash salts (p. 176); an interaction takes place between the salt and the carbonate of lime in the soil, and a little free alkaline carbonate is formed, which deflocculates the clay.

We may therefore conclude that the action of salt is entirely indirect, rendering available the potash in the soil instead of itself feeding the crop. None the less it forms a valuable adjunct to other manures for all crops requiring large supplies of potash, such as mangolds and other root crops, and may greatly economise if not entirely replace the use of potash salts themselves. In some districts a waste product termed "gunpowder salt" is obtainable; this is the bye-product in the manufacture of saltpetre by the interaction of nitrate of soda and potassium chloride, and is identical with common salt except that it also contains a little nitrate and some potash. These technical impurities render it more valuable for agricultural purposes, so that it forms a very excellent top dressing for mangolds.

*Sulphate of Magnesia.*—The action of this salt has already been explained (p. 262); it is never required to supply the plant with magnesia, sufficient quantities of which are to be found in all ordinary soils for the needs of the crop, and while it would render available some potash in the soil, common salt will do the same thing more cheaply. Carbonate of magnesia has from time to time been suggested, and even put upon the market,

as a manure, but there is no evidence to show that its action is in any way different from that of calcium carbonate, *i.e.*, it behaves as a base but is not of any further value as supplying magnesia to the plant.

*Sulphate of Iron.*—It is well known that iron is one of the essential constituents of all green plants; for example, in water cultures it is easy to show that seedling plants become blanched, chlorophyll does not form in the leaf, and the plants soon die, unless a small quantity of some soluble iron compound is added to the culture liquid. Such an addition is followed by a rapid return of the green colour to the leaf and by the renewed growth of the plant. A very widespread opinion has been based upon such experiments and is specially current in horticultural literature, that high colour in fruit and flowers is to be associated with an abundance of iron compounds in the soil, and that in consequence sulphate of iron is valuable as an adjunct to manures. One argument advanced in favour of this opinion is the bright colouring of apples, roses, etc., grown on the red sandstones and loams of Herefordshire and Worcestershire, the red hue of which is admittedly due to oxides of iron. When the facts are more closely examined, they afford, however, little support to such a theory. In the first place, the plant requires very little iron indeed: as a rule, not more than 1 per cent. of the ash of a plant consists of oxide of iron, 2 per cent. might be taken as an outside limit, so that the amount of oxide of iron taken from the soil by a heavy crop of mangolds (the leaf of which is specially rich in iron) only amounts to about 10 lbs. per acre. Now it is very rare to meet with a soil that does not contain 2 per cent. (or 20 tons per acre in the top 9 inches) of oxide of iron soluble in hydrochloric acid, and of this a considerable proportion



is soluble in the weakest acids and must be regarded as available for the plant. Moreover, the red sands and loams mentioned above show rather less than the normal amount of iron on analysis; the bright red colour is due to some variation in the mode of deposition of the oxides of iron and not to any excess in their amount. These facts alone render the theory improbable, but the chief point is that no direct evidence has been adduced for the beneficial effect of an application of iron salts, either on colour or yield. From time to time experiments with iron sulphate have been quoted, but they have never been conducted in a manner to raise the supposed increase due to the iron beyond the range of experimental error. Even had the results been positive they would have required further examination, because the application of sulphate of iron to the soil would result in a variety of secondary effects, due to the precipitation of the iron and the solution of a corresponding amount of other bases present. As far as colour goes, no evidence has ever been adduced to show that iron plays a part; experiments made by the author upon apples gave purely negative results; and though some effects upon the colour of carnations were seen, no positive conclusions could be drawn. In practice the employment of sulphate of iron for either farm or garden crops may be dismissed.

Manganese appears also to be a constituent of all plants, and recently experiments have been put forward to show that small quantities of manganese salts have a stimulating effect upon the growth of crops. The experiments are, however, by no means conclusive, and pending further investigations, the use of manganese salts cannot be recommended in practice.

*Silicates.*—Silica is so large a constituent of the ash of many plants, particularly of the straw of cereals, that

it was inevitably regarded as a necessary constituent of the food of such plants, and was naturally enough supposed to contribute to the stiffness of the straw. In his manures Liebig supplied the alkalies combined with silica, and when Way discovered that certain strata of the Upper Greensand, near Farnham, contained considerable quantities of silicates readily dissolved by acids, the rock was for a time extracted and ground up as a manure for cereals. But Sachs showed that these plants, however rich in silica their ash was when they had grown on ordinary soil, could yet be grown with complete success in a water culture devoid of any silica, and Jodin succeeded even in raising four generations of maize in water cultures with no more silica than was contained in the original seed. It was also shown that the stiffness of the straw depended upon such physiological factors as light and exposure, rapidity of growth, etc., and was independent of the amount of silica present, so that the use of silicates for manurial purposes ceased, except at the instance of one or two unscrupulous firms puffing worthless materials. However, it must not be supposed that so large a constituent of a plant's ash is entirely without physiological function, and from the Rothamsted barley experiments (which include plots receiving sodium silicate) it may be seen that soluble silica does play some part, at present not properly understood, which enables the plant to make better use of the dormant phosphoric acid in the soil. The silicates, however, possess no practical use as fertilisers, the increase thus produced would not repay the expense of applying the silicate of soda.

*Green manuring.*—Green manuring consists in the ploughing under of some rapidly growing crop—mustard or tares in this country, lupins on sandy soils on the

Continent, and cowpeas in America being among the plants most commonly employed. The practice has three objects :—

(1) The improvement of the texture of the land by increasing the store of humus; this is particularly valuable on heavy clays and on the light sandy soils at the other end of the scale.

(2) The saving of the store of nitrates, which on light warm soils form with great rapidity after harvest, and which may then easily be washed away. If some catch crop like mustard is sown immediately the stubbles are clear, it will grow with great rapidity after the first rain and will gather up these nitrates, converting them into proteins, which become more slowly available on the decay of the plant material.

(3) For cleaning purposes; when the land is in very foul condition a good many weeds can be got rid of by growing a smothering crop.

On many soils green manuring may be extremely valuable, especially where there is any shortage of farmyard manure; a green crop of mustard turned in, especially if it had been previously manured with some mixture of artificials, will have all the lasting beneficial effects of a coat of dung. Of course the "seeds" crop in the rotation has much the same effect, because of the roots and stubble left behind, but it does not always come round often enough in the rotation to keep the land in condition.

When vetches, lupins, or other leguminous crops are grown, the land is also enriched by the nitrogen gathered from the atmosphere by the bacteria living in the root nodules, and large areas of land in Pomerania and East Prussia have been brought under cultivation from the state of barren sandy heath, by ploughing in lupins

manured with basic slag and potash salts, until a soil had been built up.

Curiously enough, on the sandy soil at Woburn, Voelcker has always obtained better crops after mustard than after vetches, despite the fact that the vetches had contributed a greater weight both of dry matter and nitrogen to the land. The vetch compounds may decay the more slowly, but Voelcker further showed that the land was left drier by the vetch crop; that this was the cause of the superiority of the mustard as a green manure is rendered more probable by the fact that the result was reversed on the strong Rothamsted soil, where the vetches are the better preparation for a succeeding wheat crop. The real difficulty experienced in utilising green manuring and catch crops generally on many soils in this country, to which they are otherwise most admirably suited, is the way they deplete the water-supply for the succeeding crop. For example, a crop of vetches or crimson clover may be sown on the stubble in August or September and harvested in May, in plenty of time to prepare the land for turnips, but in many cases the soil and subsoil will be left so dry that the turnip crop will fail or be greatly reduced, unless the incidence of rain be unusually favourable. The difficulty of starting the catch crop after the drying effect of the harvested corn, and the dryness of the land which again ensues after the catch crop in spring, form the great objection to catch-cropping, which indeed only flourishes where the annual rainfall is well over 30 inches. In this respect mustard is the least objectionable crop, since it will grow in six or eight weeks under good conditions in autumn, and can then be turned in, leaving the ground broken to catch the late winter rainfall. On the light soils it is more general to fold sheep on the catch crops

than to plough them in, and though the greater part of the humus is thus lost to the land, there is still a considerable gain, while the essential manurial substances—nitrogen, phosphoric acid, and potash—are almost wholly returned to the soil. Where the land is light enough to be improved by the treading of sheep and the rainfall admits of catch-cropping, there is no better way of building up a fertile soil than by folding; the actual enrichment of the soil can be effected either by manuring for the catch crops with inorganic fertilisers like superphosphate and nitrate of soda or by consuming cake and corn with them. The losses inherent in making dung are thus obviated, for when the urine falls directly on the land, no evaporation of ammonia is allowed to take place; no labour is required; the tilth of the land is improved by the humus and the trampling of the sheep; no more effective nor cheaper system of growing corn can be devised than to alternate it with green crops consumed on the land, as is practised with so much success on the brick earths of West Sussex and the chalky loams of Wiltshire.

## CHAPTER X

### THEORIES OF FERTILISER ACTION

Liebig's Ash Theory—Part played by the Soil in the Nutrition of the Crop—Ville's Theory of Dominants—Liebig's Law of the Minimum—Law of diminishing Returns—Limiting Factors in Plant Growth—Is the Composition of the Soil Water unaffected by Fertilisers?—Attack of the Plant's Roots upon Insoluble Fertilisers—The Part played by Carbon Dioxide in the Soil—Excretion of Toxic Substances from Plant Roots—Rotations as a Substitute for Fertilisers—Unexplained Factors in the Nutrition Problem.

IT is to Liebig that we owe the first general theory of the nutrition of the plant and the function of fertilisers: although Liebig himself did not add anything to the knowledge of the process of carbon assimilation which had been acquired by Priestley, Senebier, and others, nor to the study of the nitrogen and ash constituents which had been begun by de Saussure, he yet drew up from these facts a coherent theory of the course of nutrition, and put it before the world with such vividness that it forthwith took its place in the general body of accepted scientific opinion. Liebig argued that since the ash constituents alone are drawn from the soil, it is only necessary that there shall be no deficiency in such inorganic materials as are left behind when the plant is burnt, in order to ensure the complete nutrition of the plant. According to Liebig, the function of the

fertiliser is to supply to the soil the materials removed therefrom by the crop, and the fertiliser required can be ascertained beforehand by the analysis of a similar crop, so that the soil can be supplied with the exact amounts of potash, soda, magnesia, lime, phosphoric acid, etc., which would be removed by a normal yield of that particular crop. Neglecting Liebig's misconception of the source of the plant's nitrogen and the long controversy which arose as to the necessity of its artificial supply, we can restate the theory as assuming that the proper fertiliser for any particular crop must contain the amounts of nitrogen, phosphoric acid, potash, and other constituents which are withdrawn from the soil by a typical good yield of the plant in question.

In this form the opinion that the composition of the crop affords the necessary guide to its manuring prevailed for some time and still survives in horticultural publications, but the course of field experiments, particularly those at Rothamsted, and the accumulation of farming experience soon demonstrated that it was a very imperfect approximation to the truth. Liebig's theory fails because it takes no account of the soil and of the enormous accumulation of plant food therein contained. Water culture experiments demonstrated that certain elements, *e.g.*, sodium and silica, though universally present in the plant's ash, are unessential to its nutrition. Field experiments also showed that other elements—magnesium, calcium, chlorine, sulphur, iron—though essential, are always supplied in sufficient quantities by all normal soils. Thus the elements to be supplied by the fertiliser became reduced to three—nitrogen, phosphorus, and potassium—and even the amounts required of each of these are not indicated by the composition of the crop. To take an example—normal crops of barley and wheat

would withdraw from the soil approximately the following fertilising materials.

TABLE LXXXV.—FERTILISING CONSTITUENTS CONTAINED IN WHEAT AND BARLEY CROPS.

	Yield of Grain, Bushels.	Lb. per acre Removed.		
		Nitrogen.	Phosphoric Acid.	Potash.
Wheat .	36	50	21	29
Barley .	48	49	21	36

Now the results of field-experiments, which are abundantly confirmed by ordinary farming experience, go to show that the yield of wheat is chiefly determined by the supply of nitrogen; phosphoric acid is of secondary importance, and only on exceptional soils will there be any return for the application of potash. With barley, though its composition is very similar to that of wheat, the results are very different: nitrogen is still the most important element in nutrition, but phosphoric acid has equally marked effects, whilst in ordinary soils potash counts for little or nothing.

This may be illustrated from the Rothamsted experiments, and the part played by the reserves in the soil will be made evident by comparing the results obtained in the first and the fifth series of ten years.

The analysis of the barley plant would indicate that it requires nitrogen in the largest amounts, then potash, and, least of all, phosphoric acid; but if the results for the first ten years of the experiment are considered, it will be seen that the omission of either nitrogen or phosphoric acid from the fertiliser causes a big decline in yield in comparison with that of the completely fertilised plot. The omission of potash, however, is of little or no moment, since it only causes the yield to fall



from 46.1 to 45.6 bushels per acre. Evidently the soil was able to supply all the requirements of the plant for potash, despite the large amounts which the crop removes. In the latter years of the experiment this stock of available potash in the soil had become somewhat depleted, so that the omission of potash from the fertiliser reduced the yield from 36.3 to 28.0 bushels per acre. The exhausted soil in these latter years causes the

TABLE LXXXVI.—AVERAGE YIELD OF BARLEY GRAIN (Hoos Field, Rothamsted).

Plot.	Manuring.	Average Yield of Grain, Bushels.	
		First 10 years (1852-1861).	Fifth 10 years (1892-1901).
4A	Complete Fertiliser—Nitrogen, Phosphoric Acid, Potash . . . . .	46.1	36.3
3A	Phosphoric Acid omitted—Nitrogen and Potash . . . . .	35.0	22.1
2A	Potash omitted—Nitrogen and Phosphoric Acid . . . . .	45.6	28.0
1A	Nitrogen only . . . . .	33.6	16.6
4O	Nitrogen omitted—Phosphoric Acid and Potash . . . . .	30.5	12.8
1O	Unmanured . . . . .	22.4	10.0

crop to respond to the constituents of the fertiliser only when they are all present together; taken singly, they increase the yield but little, and the omission of any one of them reduces the crop almost to the minimum produced on the unmanured plot. The soil has thus become but a small factor in the nutrition of the crop, whereas, as regards potash, it was a very large one at the beginning of the experiment, and the defect of Liebig's theory was to neglect it entirely.

These differences in the manurial requirements of wheat and barley, differences which would not be

apprehended from their respective compositions, may be correlated with the habits of growth of the two plants: wheat is sown in the autumn after but a slight preparation of the ground, nitrification is thus restricted, especially as the chief development of the plant takes place in the winter and early spring before the soil has warmed up; as a consequence, the crop is particularly responsive to an external supply of some active form of nitrogen. On the other hand, the wheat plant possesses a very extensive root system and a long period of growth, hence it is specially well fitted to obtain whatever mineral constituents may be available in the soil. In ordinary farming the only fertiliser used for the wheat crop will be a spring top-dressing of 1 cwt. per acre or so of nitrate of soda, or an equivalent amount of sulphate of ammonia or soot.

Barley is a spring-sown crop, for which the soil generally receives a more thorough cultivation; in consequence the nitrates produced with the rising temperature will be sufficient for the needs of the crop; often more than enough when the barley follows a root crop that has been liberally manured and perhaps consumed on the ground by sheep. But being shallow-rooted, and having only a short growing season, the barley plant experiences a difficulty in satisfying its requirements for phosphoric acid, hence the necessary fertiliser consists, in the main, of this constituent. Only on sandy and gravelly soils, exceptionally deficient in potash and subject to drought, is any benefit derived from a supply of potash to the barley crop.

A still more noteworthy example is provided by the Swede turnip crop; an analysis of a representative yield would show it to withdraw from the soil about 150 lb. per acre of nitrogen, 30 lb. of phosphoric acid, and 120 lb. of potash. Yet the ordinary fertiliser for

the Swede crop will consist in the main of phosphatic material, with but a small quantity of nitrogen and rarely or never any potash. For example, 4 cwts. of superphosphate or 5 cwts. of basic slag, according to the soil (*i.e.*, 50 to 100 lb. of phosphoric acid), together with 12 to 15 lb. of nitrogen as contained in half a hundredweight of sulphate of ammonia, will form a very satisfactory mixture. Swedes are sown late in the season after a very thorough preparation of the soil, so that the nitrification alone of the nitrogenous residues in the soil is capable of furnishing almost all the large amount of nitrogen they require; they are very shallow-rooted, and must be supplied with an abundance of phosphoric acid. It was considerations of this kind which led Ville to suggest that for each crop there is a "dominant" fertilising constituent, *e.g.*, nitrogen for wheat, phosphoric acid for Swedes, and that the particular dominant is the constituent which the plant finds the most difficulty in appropriating from the soil, and which is, therefore, more often indicated by a comparative deficiency than by an abundance in the ash of the plant. Such a theory is, however, not borne out by more general experiments; many plants do not exhibit such idiosyncrasies as are shown by wheat and Swedes, but require a general fertiliser, the composition of which is determined more by the soil than the plant. Indeed, no theory of manuring can be based upon the plant alone but must also take the soil into account, so that a fertiliser may be regarded as rectifying the deficiencies of the soil as far as regards the requirements of the crop in question. What those special requirements are can only be decided by experiment, just as the soil conditions are ascertainable by trial rather than from *a priori* considerations of analysis. If an analysis be made of any soil in cultivation it will be found to

contain sufficient plant food for the nutriment of a hundred or more full crops: the soil of the unmanured plot on the Rothamsted wheatfield contained in 1893, after fifty-four years' cropping without fertiliser, 2570 lb. per acre of nitrogen, 2950 lb. of phosphoric acid, and 5700 lb. of potash. Of course much of this material is in a highly insoluble condition, but though attempts have been made by the use of weak acid solvents to discriminate between the total plant food in the soil and that portion of it which may be regarded as available for the plant, no proper dividing line can be thus drawn. The availability of a given constituent, say of phosphoric acid, will depend upon the nature of the crop. A given soil may contain sufficient easily soluble phosphoric acid for the needs of the wheat plant and yet fail to supply Swede turnips with what they require. Again, the mechanical texture of the soil may be such as to limit the root range of the plant, so that a richer soil is necessary to produce as good results as are obtained in a poorer soil of more open structure; the state of the micro-flora of the soil may also have much to do with the amount of a given nutrient that can reach the plant.

Perhaps the best general point of view of the action of fertilisers is obtained by extending the "law of the minimum" originally enunciated by Liebig, according to which the yield of a given crop will be limited by the amount of the one particular constituent which may happen to be deficient; if the soil, for example, is lacking in nitrogen, the yield will be proportional to the supply of nitrogen in the fertiliser, and no excess of other constituents will make up for the shortage of nitrogen. To take an example from the Rothamsted experiments, Table LXXXVII. shows the yield of wheat grain and straw from the unmanured plot,

and from a series of plots, all of which receive an excess of phosphoric acid, potash, etc., but varying amounts of nitrogen, ranging from 43 lb. to 172 lb. per acre. That the nitrogen was deficient is shown by the almost negligible increase produced by the mineral constituents without nitrogen; from this point the increase of yield is roughly proportional to the supply

TABLE LXXXVII.—EXPERIMENTS ON WHEAT (Broadbalk Field, Rothamsted). AVERAGES OVER 13 YEARS (1852-1864).

Plot.	Manures per acre.	Dressed Grain.		Straw.	
		Produce per acre.	Increase for each additional 43 lb. N. in Manure.	Produce per acre.	Increase for each additional 43 lb. N. in Manure.
		Bushels.	Bushels.	Cwts.	Cwts.
3	Unmanured . . .	15·6	...	14·6	...
5	Minerals alone . . .	18·3	...	16·6	...
6	Minerals and 43 lb. N. as Ammonium Salts.	28·6	10·3	27·1	10·5
7	Minerals and 86 lb. N. as Ammonium Salts.	37·1	8·5	38·1	11·0
8	Minerals and 129 lb. N. as Ammonium Salts.	39·0	1·9	42·7	4·6
16	Minerals and 172 lb. N. as Ammonium Salts.	39·5	0·5	46·6	3·9

of nitrogen, until it reaches an excessive amount. The table also illustrates the generalisation which is familiar to economists under the name of the "law of diminishing returns"—that the first expenditure of fertiliser or other factor of improvement is the most effective, each succeeding application producing smaller and smaller returns, until a further addition causes no increase in the yield. If the cost of the fertiliser, added to a prime outlay of 80s. per acre for the cultivation, and the value of the returns in cash, are expressed in the form of a diagram, the law is clearly expressed

by the series of curves in Fig. 5; where the cost of production forms a straight line that is always intersected by the curves expressing the value of the returns, which begin by rising more rapidly than the cost of production, but tend to become horizontal. The point of intersection, when profit ceases, is nearer the origin the lower the range of prices obtainable for the crop, as shown by the two curves representing the returns at low and high prices respectively; this demonstrates that the expenditure on fertilisers or anything else required by the crop must be reduced when prices of produce are low, or, as expressed by Lawes, high farming is no remedy for low prices.

Liebig's law of the minimum must, however, be extended to all the factors affecting the yield as well as to the supply of plant food, *e.g.*, to such matters as the supply of water, the temperature, the texture of the soil. Any one of these may be the determining factor which limits the yield, or two or more of them may act successively at different periods of the plant's growth. On poor soils the water-supply is very often the limiting factor—on very open soils because the water actually drains away, on extra close soils because the root range is so restricted that the plant has but little water at hand and the movements of soil water to renew the supply are very slow; in either case for comparatively long periods the plant will be sure to have as much nutriment as is required for the small growth permitted by the water present. It is only when the water-supply is sufficient that the resources of the soil, as regards all or any of the constituents of a fertiliser, are tested and may become in their turn the limiting factors in the growth of the crop. Hence it follows that fertilisers may often be wasted on poor land, where growth is limited by the texture of the soil, by the water-supply, or

Yield.  
bushels or Cwt.

Returns & Cost  
Shillings.

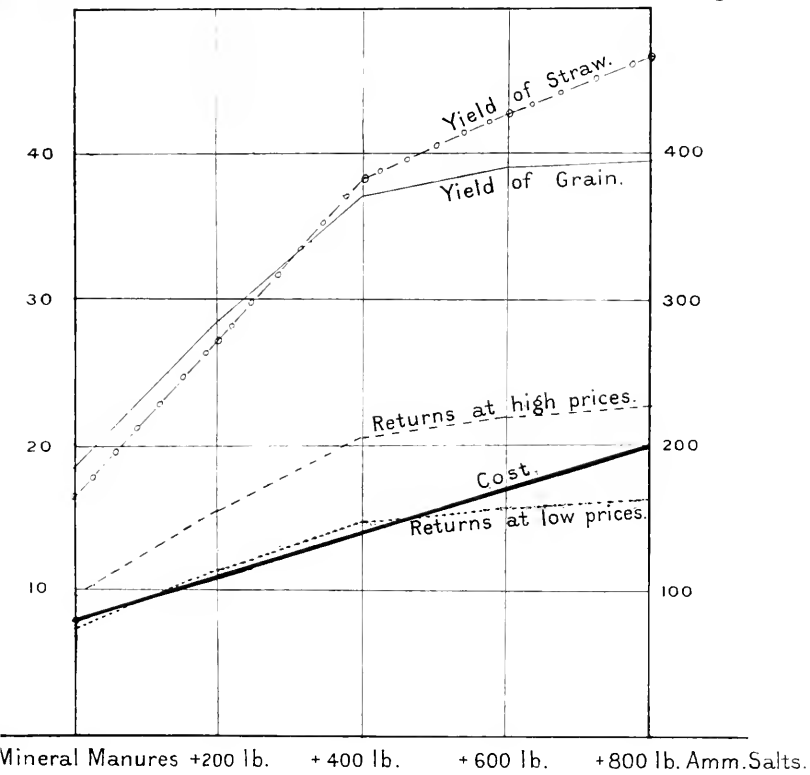

FIG. 5.—RELATION BETWEEN COST OF PRODUCTION AND RETURNS WITH VARYING QUANTITIES OF MANURE.





by some other factor hardly controllable by the farmer : it is a truism that poor land cannot be converted into good by manuring and that fertilisers give the best returns when applied to a good soil.

One fundamental difficulty still remains in considering the action of fertilisers ; it has already been pointed out that a soil by no means notably fertile may contain enormous quantities of plant food, which is however combined in so insoluble a form as to reach the plant in quantities insufficient for the requirements of the crop. For example, a soil may contain 0.1 per cent., or 2500 lb. per acre, of phosphoric acid, and yet yield a very indifferent Swede crop unless it be supplied with an additional dressing of 50 lb. per acre of soluble phosphoric acid. It is usually assumed that the effect of this phosphoric acid manuring is due to the soluble nature of the fertiliser, because of which the additional plant food is directly available for the crop. But a little consideration of the reactions set up in the soil will show how insufficient such a theory must be ; the phosphoric acid is very rapidly precipitated within the soil, as is shown by the fact that on many soils it remains close to the surface for many years, and is never washed out into the drains. Bearing in mind this precipitation of the phosphoric acid in an insoluble condition, Whitney and Cameron argue that previous to the addition of the fertiliser a certain amount of phosphoric acid exists in solution in the soil water, this amount being in equilibrium with the various phosphates of calcium, iron, aluminium, etc., making up the great store of phosphates in the soil. This particular state of equilibrium would be but little disturbed by the addition of the soluble fertiliser in quantities which are small compared with the great mass of undissolved phosphates in contact with the soil water ; the added

phosphoric acid would only displace an almost equivalent amount of the phosphoric acid already in solution, and the concentration of the new solution would only differ from the old in the same degree as the ratio of the phosphoric acid in the soil plus fertiliser (2500 + 50 lb. of phosphoric acid), bears to the phosphoric acid originally in the soil (*i.e.*, 2500 lb. phosphoric acid). In other words, before the fertiliser was added, the soil water was as fully saturated with phosphoric acid as the amount of calcium, iron, aluminium, and other bases would permit, and as these bases are present in enormous excess, the soil water must remain at the same saturation point after the fertiliser has been added, just as water will only hold 35 per cent. of common salt in solution with however large a quantity of salt it may be in contact. In the same way the soil contains certain double silicates of which potassium is a constituent, and these hydrolyse to a slight extent in contact with the soil water to yield a solution containing potassium ions. The addition of a soluble potassium salt, as in a fertiliser, will diminish the dissociation and therefore the solubility of the double silicate, the potassium of which is thrown out of solution; until, as Whitney and Cameron argue, no more potassium ions remain in solution than were present before the addition of the fertiliser. According to this point of view, the concentration of the soil water for a given plant food, such as phosphoric acid, must be approximately constant for all soils of the same type, however much or little phosphatic fertiliser may have been applied, and since water culture experiments show that this low limit of concentration attained by the soil water is more than sufficient for the needs of the plant, no soil can be regarded as deficient in this or any other element of plant food. It therefore follows that the action, if any,

of a fertiliser must be due to some other cause than the direct supply of plant food, with which the soil water must always be saturated to a degree which is quite unaffected by the supply of fertiliser.

This view of the interactions between the sparingly soluble phosphates of the soil, the soil water, and the added soluble fertiliser can hardly be regarded as valid in theory, even if the conditions under which the reagents exist in the soil were the same as those which prevail in the laboratory when such states of equilibrium between sparingly soluble solids and water are worked out. It has no bearing whatever on the amount of nitrates in the soil water, since they come into a dissolved state as fast as the nitrifying bacteria produce them and are not in equilibrium with any store of undissolved nitrates in the background. As regards phosphoric acid, the theory assumes such an excess of bases that all soils behave alike in immediately precipitating the phosphoric acid in the same form; while as regards potash, the argument seems to forget that though the addition of a soluble potassium salt may throw some of the other sparingly soluble potassium compounds out of solution, the total amount of potassium remaining in solution will still be greatly increased. The function of the carbonic acid in the soil water is ignored, as also is the fact that the processes of solution in the soil must be in a constant state of change, so that it is the rate at which the constituents go into solution rather than the actual amount dissolved at any given moment which is of importance. The soil is too complex a mixture to permit as yet of attaching great weight to theoretical deductions as to the actions taking place in it, and that the state of affairs postulated by Whitney and Cameron does hold in the soil, has not however been verified by experiment; the analyses,

given by the authors of the theory, of the cold water extracts from a number of soils show great variations in their concentration in nitrates, phosphoric acid, and potash; nor is any evidence forthcoming that such concentrations are not immediately raised by the addition of fertilisers. Indeed, when the Rothamsted soils, with their long-continued differences in fertiliser treatment, are extracted with water charged with carbon dioxide—the nearest laboratory equivalent to the actual soil water—the amount of phosphoric acid going into solution is closely proportional to the previous fertiliser supply, and this proportionality is maintained if the extraction is repeated with fresh solvent, as must be the case in the soil. In the field it is not merely the initial concentration of the soil water in plant food which determines the supply of nutriment to the crop; it is also the capacity of the soil to keep renewing the solution as the plant withdraws from it the essential elements.

In one essential respect again the conditions prevailing in the soil are very different from those of the laboratory. In the soil all reactions are extremely localised, since they take place in the thin film of water normally surrounding the soil particles, in which movement of the dissolved matter takes place very slowly, mainly by diffusion. Of the extreme slowness of the diffusion of soluble salts in the soil the Rothamsted experiments afford some good examples. For instance, on the grass plots only an imaginary line divides the plots receiving different fertilisers; the manure is sown right up to the edge of the plot, a screen being placed along the edge to prevent any being thrown across the boundary, then immediately on the other side of the boundary the different treatment begins. In two cases plots receiving very large

amounts of soluble fertiliser, *e.g.*, 550 lb. per acre of nitrate of soda, or 600 lb. per acre of ammonium salts, march with plots receiving either no fertiliser or a characteristically different one, yet in neither case is there any sign in the herbage that the soluble fertiliser has diffused over the boundary. Although the treatment has been repeated now for fifty-two years, the dividing line between the two plots remains perfectly sharp, and the rank herbage produced by the excess of nitrogenous fertiliser on one side does not stray 6 inches over the boundary. Again, on the Rothamsted wheatfield the plots were 24·7 feet in breadth, and were separated by unfertilised strips only about a foot in breadth; in 1893, each plot was sampled down to a depth of 7·5 feet, and the amount of nitrates was determined in each successive sample of 9 inches in depth. The amount of nitrates found was in each case characteristic of the supply of nitrogen to the surface of the plot, and right down to the lowest depth there were no signs of the proportions approximating to a common level, as they would have done had any considerable amount of lateral diffusion been taking place. Considering that the plots are only separated by a foot or so of soil, and each had been receiving its particular amount of nitrogen for forty and in some cases for fifty years, the sharp differentiation of plot from plot in the amount of nitrates at a depth of 7 feet is sufficiently remarkable, and is evidence that the movements of the soluble salts in the soil are almost wholly confined to up and down motions due to percolation and capillary uplift, lateral diffusion taking place only to an insignificant extent.

From these considerations we may conclude that when a fertiliser is mixed with the soil, each particle will establish round itself a zone of a comparatively

concentrated solution, to which the plant's roots will be drawn by the ordinary chemiotactic actions, and that these zones will extend but a little way into the generally much less dilute mass of the soil water, because of the slowness of the diffusion process.

That some such state of things prevails in the soil may be surmised from the common farming experience of the benefits derived from sowing the fertiliser close to the seed, as when superphosphate is sown with turnip seed, because in that case the fertiliser is not injurious to germination and the young plant is specially dependent on being rapidly pushed into growth in the early stages. Again, the intimate way in which the feeding fibrous roots of a plant will surround and cling to a fragment of fertiliser in the soil, such as a bone or a piece of shoddy, shows that some other actions are at work in the soil than the feeding of the plant upon the nutrients contained in the general soil solution.

Whitney and Cameron's theory also supposes that the plant itself exerts no solvent action, whereas it has often been supposed that the roots excrete substances of an acid nature which exert a solvent action upon the soil particles. In this direction an experiment of Sachs' has become classical. He took a slab of polished marble and set it vertically in a pot of soil in which beans or some kindred plant were grown. After the plants had been growing for some time the contents of the pot were turned out and the slab of marble washed, whereupon the polished surface was found to be etched wherever the roots had been growing in contact with it. A polished slab of gypsum similarly treated shows a raised pattern wherever the roots have protected the surface from the solvent action of the general mass of water in the soil. Although Sachs himself attributed the etching to the action of the carbon dioxide which is

always being given off by the roots, it has also been set down to fixed acids excreted by the root hairs, and determinations have been made of the acidity of the sap of the roots with the idea of differentiating between the solvent power of various plants. The roots of germinating seedlings are also found on occasion to redden blue litmus paper, and undoubtedly may excrete substances of an acid character, but the behaviour of seedlings, which are building up their fresh tissue out of the broken-down reserve materials contained in the seed, is essentially different from that of plants leading an independent existence, so that nothing is thereby proved as to the source of the etching in Sachs' experiments.

Czapek instituted a fresh series of experiments with smooth slabs prepared by floating on to glass plates mixtures of plaster of Paris and various phosphates of calcium, iron, and aluminium; since the iron and aluminium phosphates were attacked, most of the possible acids were excluded, and the etching action of the plant's roots could only be due to carbon dioxide or acetic acid. The latter was again excluded by a further experiment in which the slab was coloured with Congo red, and as this was not affected the sole remaining solvent body the plant could have excreted was carbon dioxide. Again, it has already been shown that water cultures containing nitrates, where the plant is growing in such solutions as exist under normal soil conditions, tend to become alkaline instead of acid, so that the balance of evidence is against the idea that plant roots excrete any fixed acids exerting a solvent action upon the soil particles. The carbon dioxide, however, probably exerts a considerable action, especially in the immediate vicinity of the root from which it is given off, for as it passes through the cell wall it must momentarily form a

solution of considerable concentration' possessing a proportionally increased solvent power, and it is to this supersaturated solution that may be attributed the highly localised attack of the roots upon the soil particles. An experiment by Kossowitsch illustrates the part played by the roots in attacking the insoluble materials in the soil: two pots of sand were prepared, each mixed with the same quantity of calcium phosphate in the form of ground rock phosphate, a third pot contained sand only. In this latter and in one of the pots containing the calcium phosphate, seeds of mustard, peas, and flax were sown. The growing plants were then furnished with a slow continuous supply of water containing appropriate amounts of nitrates, potash, and other nutrient salts except phosphates. Before, however, this nutrient solution reached the pot containing the sand only, it was made to percolate through the second pot containing sand and calcium phosphate, but it was applied directly to the pot containing calcium phosphate. In the pot containing calcium phosphate, the growth was much greater than in the other pot, where the nutrient solution only contained what phosphoric acid it could dissolve in its passage over the calcium phosphate in the pot in which nothing was growing, although this solution was continually renewed. The only factor determining the supply of phosphoric acid and the consequent difference in growth was the solvent action of the roots when they were actually in contact with the calcium phosphate, and this solvent action, as has already been shown, may most probably be attributed to the carbon dioxide they excreted.

Following up their conclusions that the soil water possesses an approximately constant composition under all circumstances and always contains more of the



constituents of plant food than would be required for the nutrition of the plant, Whitney and his colleagues have suggested another theory of fertiliser action. According to this point of view, a soil falls off in fertility and ceases to yield normal crops, not because of any lack of plant food brought about by the continuous withdrawal of the original stock in the soil, but because of the accumulation of injurious substances excreted from the plant itself. These toxins are specific to each plant but are gradually removed from the soil by processes of decay, so that if a proper rotation of crops be practised, to ensure that the same plant only recurs after an interval long enough to permit of the destruction of its particular self-formed toxin, its yield will be maintained without the intervention of fertilisers. The function of fertilisers is to precipitate or to put out of action these toxins, and various bodies such as lime, green manure, and ferric hydrate are also effective in this direction; the same result of destruction of the toxins excreted by the plant may even be brought about by minute quantities of certain bodies like pyrogallol. According to this theory the function of fertilisers is to remove toxins rather than to feed the plant: they are only required when the same crop is grown continuously, and the need for them may be obviated by a judicious rotation which permits of the destruction of the toxins by natural causes. Careful consideration will show that this theory can be made to fit a good many of the phenomena of plant nutrition, it would also explain the difficulties experienced in growing certain crops continuously on the same ground; it is in fact an elaborated revival of one of the earliest explanations of the value of rotations, originally suggested by de Candolle. Furthermore, Whitney's colleagues have succeeded in extracting certain substances from the soil—di-hydroxy-

stearic acid, picoline-carboxylic acid, etc., which when introduced into water cultures are toxic to seedling plants. The compounds isolated are, however, all of them products of the oxidation and decay of proteins, fats, and other compounds contained in plant residues; there is no evidence to show that they are specific excretions from particular plants or that they are more abundant in soil impoverished by the continuous growth of a crop than in soil which would be usually termed rich. Again, it has not been demonstrated that such substances, although harmful to young plants in water culture, are toxic under soil conditions; it is well known how exceedingly sensitive are plants in water culture, where growth, for example, is inhibited by traces of copper not to be detected by ordinary methods of analysis. A body like ammonia, itself a product of protein decay and present in the soil, is exceedingly toxic to water cultures, yet when applied to the soil it increases the growth of the plant. Turning to the fertiliser side of the theory, evidence is yet lacking to show that fertilisers in such dilute solutions as they form in the soil water can exert any precipitating or destructive action on such toxic substances as have been extracted from the soil; particularly the specific action of fertilisers is difficult to explain. Why should substances so dissimilar as nitrate of soda and sulphate of ammonia exert the same sort of action on the same toxin? Why should phosphates cause all classes of plants to develop in one direction, or why should they be appropriate to the toxins of all plants on one particular type of soil, whereas potash answers on another soil type?

Lastly, there is a lack of evidence for the fundamental thesis that the rotation will take the place of fertilisers and that the yield only falls off when a

particular crop is grown continuously on the same land. On the rotation field at Rothamsted the yield of wheat on the unfertilised plot has been remarkably maintained; for the last five courses (10th to 14th of the whole series) it has averaged 26.2 bushels per acre, but it is below the yield of the fertilised plots on the Broadbalk field, which averaged 35.7, 32, and 39.7 bushels for the same years, and also below the fertilised plot on the same rotation field, which averaged for the same period 37.1 bushels per acre, although the fertiliser is only applied once in four years to the Swedes, which are followed by barley and either clover or a bare fallow before the turn of the wheat comes round. But with other crops than wheat no such maintenance of yield is to be seen on the unfertilised plot of the rotation field—the barley yield has been reduced to 15.8 bushels against 27.7 on the fertilised plot, the clover yield to 9.4 cwts. against 37.8 on the fertilised plot, and the turnips to as little as 16 cwts. against 400 on the fertilised plot. Here we see that with the barley, clover, and particularly with the turnip crop, a rotation is quite unable to do the work of the fertiliser; the yield of turnips is reduced to a minimum on the impoverished soil, even though the crop only comes round once in four years and then grows so poorly that it can do little specific excretion to harm the succeeding crop. Many instances could be given of the incapacity of certain plants to grow in soil the fertility of which had been exhausted by other crops; for example, at Rothamsted in 1903, Swede turnips were sown on Little Hoos field, which was known not to have been cropped with Swedes or any kindred crop for more than forty years, and the average yield from thirty-two unmanured plots was only 9.3 tons per acre, although an exceptionally good start was made by the plant. In the following season barley

was grown and the unmanured plots averaged 24·2 bushels per acre, a relatively much higher yield than the Swedes had shown—yet barley had been repeatedly grown on the field in the years immediately before it was brought under experiment.

As it stands at present Whitney's theory must be regarded as lacking the necessary experimental foundation; no convincing evidence has been produced of the fundamental fact of the excretion of toxic substances from plants past the autotrophic seedling stage, nor is there direct proof of the initial supposition that all soils give rise to soil solutions sufficiently rich in the elements of plant food to nourish a full crop, did not some other factor come into play. If, however, we give the theory a wider form, and instead of excretions from the plant understand débris of any kind left behind by the plant and the results of bacterial action upon it, we may thereby obtain a clue to certain phenomena at present imperfectly understood. The value of a rotation of crops is undoubted and in the main is explicable by the opportunity it affords of cleaning the ground, the freedom from any accumulation of weeds, insect, or fungoid pests associated with a particular crop, and to the successive tillage of different layers of the soil, but for many crops there remains a certain beneficial effect from a rotation beyond the factors enumerated.

The Rothamsted experiments have shown that wheat can be grown continuously upon the same land for more than fifty years, and that the yield when proper fertilisers are applied remains as large in the later as in the earlier years of the series; any decline that is taking place is hardly outside the limits of seasonal variation and can easily be accounted for by the difficulties of tillage and the increase of one or two troublesome weeds. Mangolds, again, in the Rothamsted

experiments show no falling off in yield, though they have now been grown upon the same land for thirty-two years; but with the barley crop, despite the application of fertilisers, there is a distinct secular decline in the yield. Again, it was found impossible to obtain satisfactory crops of Swede turnips upon the same land for more than ten or twelve years in succession, and clover is well known to render the land "sick" for its own renewed growth for a period of from four to eight years on British soil. In this last case the persistence of the resting stages of the *sclerotinia* disease in the land may be the determining factor, but there are other crops, *e.g.*, flax, hemp, and strawberries, which are considered by the practical cultivator to render the land more or less "sick," so that their growth cannot profitably be renewed until an interval of some years has elapsed.

Again, it is well known that when a plant is sown upon land which has not carried that particular crop for many years beforehand, it starts into growth with a vigour it rarely displays upon land where it forms an item in the regular rotation, even though the new land is so impoverished that the final yield is indifferent. In the instance quoted above, where Swedes were sown on the Little Hoos field after a very long interval, although the yield was poor on the unmanured plots yet the seeds germinated and made their early growth in a very remarkable fashion, incomparably better than did the same seed sown upon adjoining land in a high state of fertility, but which had been cropped with Swedes from time to time previously. There is thus some positive evidence that most plants—some to a very slight degree, like wheat and mangolds, others markedly, like clover, turnips, and flax—effect some change in the soil which unfits it for the renewed

growth of the crop. The injurious action may even arise from the growth of a different crop, as in the well-known experiments at the Woburn Fruit Farm, where Pickering has shown that the roots of grasses exert a positively injurious effect, distinct from competition for food, water, or air, upon fruit trees growing in the same soil.

Assuming that the persistence in the soil of obscure diseases appropriate to the particular plant can be neglected as the cause of these phenomena, there still remains some unexplained factor arising from a plant's growth which is injurious to a succeeding crop, and this may either be the excreted toxins of Whitney's theory or may be some secondary effects due to the competition or injurious products of the bacteria and other micro-flora accumulated in the particular soil layer in which the roots of the crop chiefly reside. Experimental evidence is as yet wanting as to these highly complex interactions between the higher plants and the micro-flora of the soil, but Russell and other observers have shown how greatly a disturbance of the normal equilibrium of the flora of the soil may affect its fertility, as measured by the yield of a higher plant. Partial sterilisation, such as is brought about by heating the soil to  $98^{\circ}$  for ten hours, will double the yield of the succeeding crop and will show a perceptible beneficial effect up to the fourth crop after the heating; and exposure to the vapours of volatile antiseptics like toluene or carbon bisulphide, which are afterwards entirely removed by exposure, will increase the yield in a similar but smaller degree; even drying the soil appears to have an influence upon its fertility.

It is in this direction perhaps that the clue may be found to the unexplained benefits of the rotation of crops, and to some of the other facts difficult of ex-

planation upon the ordinary theories of plant nutrition which have been advanced by Whitney and his co-workers. The soil however is such a complex medium—the seat of so many and diverse interactions, chemical, physical, and biological—and is so unsusceptible of synthetic reproduction from known materials, that experimental work of a crucial character becomes extremely difficult and above all requires to be interpreted with extreme caution and conservatism

## CHAPTER XI

### SYSTEMS OF MANURING CROPS

High and Low Farming—Fertilising Constituents removed in Meal and Corn—Losses of Nitrogen increased when Land is in High Condition—Manures for Wheat—Barley : Importance of Quality—Oats—Root Crops : Swedes, Mangolds, Potatoes—Importance of Farmyard Manure for Root Crops—Leguminous Crops : Beans, Clover, Lucerne, Sainfoin—Value of Potassic Fertilisers—Grass Land—Effect of Manures in changing the Botanical Character of the Herbage—Land laid up for Hay—Manures for Poor Pastures—Hops—Fruit—Garden Manures—Manures for Tropical and Semi-Tropical Crops : Sugar Cane, Tobacco, Cotton, Tea.

IN dealing with the specific properties of the various fertilisers, a number of illustrations have been given from the results of field experiments on particular crops from which conclusions might be drawn as to the fertilisers most appropriate to those crops, but in the main these experiments have been selected to illustrate the action of the fertiliser rather than the requirements of the plant. It remains to reconsider the information derived from experiments under its practical aspect, so as to obtain a guide to the methods of manuring which the farmer should adopt for the crops he is setting out to grow. It is never possible to do this absolutely ; the proper manure for any particular crop must always be conditioned by a number of local circumstances special to the farm in question ; from which it follows that the



mixtures sold as "Turnip Manures," "Potato Manures," and so forth, must be in the majority of cases more or less wasteful if they are to be effective everywhere. Instead of applying a kind of average manure, the farmer ought to have such an appreciation of manurial principles that he can adapt his fertilisers as economically as possible to his own soil and conditions of farming.

In discussing the application of fertilisers to crops, even when the special features presented by the soil are neglected, we can draw no conclusions as to the proper methods of manuring unless we take into account the place the crop occupies in the rotation adopted by the farmer, and also the character of his land and style of farming. For example, we have not to consider the wheat crop as standing by itself in the manner we see it in the Rothamsted experiments, but as it is generally grown in practice—after a clover crop, or perhaps after mangolds which have been manured with dung. Furthermore, one man may be in possession of good land in high condition, and may be farming "high" for big crops; he will be justified in a greater outlay upon fertilisers than would be advisable for an equally good farmer on poorer land, where it may be more economical to be content with smaller crops and to keep down the expenditure. The manuring to be adopted on a given farm must be looked at as a whole, as a system to be shaped as much by various wider considerations of farming policy as by the particular crops that are being grown. It is easy, for example, to indicate the composition a manure for Swedes should possess, but whether a farmer should spend 15s. or 40s. an acre on fertilisers for his Swede land depends entirely upon the general character and style of his farm. It is for this reason that many field experiments, however ostensibly designed on a cash basis to show the returns

for a given outlay in manure, are really unpractical; so variable is the basis—the condition of the land—upon which the return depends, and so much does the power of realising products like roots change from farm to farm. The style of farming, and with it the amount of fertilisers that can be profitably employed, will always be dictated by such local conditions as the markets available, the supply of labour, and the rent of the land. On the one hand we have the systems prevailing in the middle west of America and other more newly settled countries where the farmer is living upon the capital originally stored up in the virgin soil. He grows, for example, maize and wheat alternately, using no fertiliser and restoring nothing to the soil, often burning the straw and not even taking the trouble to cart out the manure accumulated beneath any cattle he may feed. Year after year 50 to 100 lb. of nitrogen per acre are being removed and the soil is getting steadily poorer, yet it has proved to be more profitable to move to fresh land than to spend money in restoring the lost fertility. On the other hand, in many parts of Great Britain we may see a strictly conservative system at work. The land possesses a certain condition and will yield fair average crops, only part of which are sold—the wheat and barley—the rest are converted into meat and dung, by which means the greater part of the plant food drawn from the soil is returned. There is, however, a certain removal in the corn and meat and a certain amount of waste in dung-making, but this is repaired by the growth of clover, etc., and by the purchase of a comparatively limited amount of fertilisers or feeding stuffs, so that the condition of the land is maintained but not at a very high level. Again, at the other end of the scale we have the intensive farmer who uses his land as a sort of manufacturing medium to convert

fertilisers into crops, and steadily increases the fertility of his soil by putting on more plant food every year than he removes in his crops.

We can begin by considering what is necessary to maintain the condition of the land under a conservative system of farming, and we may take the case of a farm under a four-course rotation, where nothing but corn and meat are sold and all the dung goes back to the land. Under such conditions, as we have already learnt, the feeding animals only retain about 10 per cent. of the fertilising constituents of the food they consume; the other 90 per cent. comes back in the manure and wholly or in part reaches the land again.

TABLE LXXXVIII.—FERTILISING CONSTITUENTS REMOVED FROM FARM IN CORN AND MEAT SOLD.

	Nitrogen.	P <sub>2</sub> O <sub>5</sub> .	K <sub>2</sub> O.
	Lb.	Lb.	Lb.
Swede Turnips, 20 tons fed . . . . .	10.0	5.8	0.7
Barley, 6 quarters sold . . . . .	40.0	18.0	12.0
$\frac{1}{2}$ ton Straw fed, the rest made into Dung . . . . .	1.2	0.7	0.1
Clover, 2 tons Hay fed . . . . .	4.1	2.8	0.4
Wheat, 4 quarters sold . . . . .	35.2	15.3	10.3
Straw made into Dung.			
Total for 4 acres . . . . .	90.5	42.6	23.5
Per acre per annum . . . . .	22.6	10.6	5.9

In this way the land loses 22.6 lb. of nitrogen per acre per annum; but this estimate fails to take into account the very considerable losses that occur during the making of the farmyard manure, which may be estimated at 50 lb. in the four years, and those due to drainage and bacterial action. On the other hand, the nitrogen contained in the clover crop has been obtained

from the atmosphere; indeed, the Rothamsted experiments would show that the land is left richer in nitrogen after a big clover crop has been grown and taken away.

A further consideration of the rotation field at Rothamsted shows that the clover crop alone would be able to maintain the fertility of the land at about the condition which would produce such yields as are shown in the table. For instance, the Agdell field in the 47th to the 50th years gave the following crops on the portion which had received no nitrogen throughout the whole period, though phosphates and potash are supplied to the Swede crop.

TABLE LXXXIX.—PRODUCE OF AGDELL FIELD UNDER ROTATION.  
NO NITROGEN SUPPLIED IN MANURE. (Rothamsted.)

1894	Clover Hay	Carted away . . .	64.7 cwts.
1895	Wheat .	Carted away . . .	} 39.6 bushels, and 25.3 cwts. Straw.
1896	Swedes .	Consumed on the land	
1897	Barley .	Carted away . . .	} 37.7 bushels, and 24.9 cwts. Straw.

If, then, in this case the Swede turnips had also received whatever manure would have been made from the clover hay and the wheat and barley straw, it is evident that the production would have been little short of the average indicated in Table LXXXVIII., and that the nitrogen necessary to maintain the fertility of the land at such a level would be supplied indefinitely by the recurring clover crop. In the Agdell example phosphatic and potassic fertilisers were however freely employed, and it is obvious that the soil possesses no power of increasing its stock of these constituents in the same way as it can obtain nitrogen from the atmosphere. Three hundred and fifty pounds of superphosphate per acre during the four-year period of rotation would,

however, repair the losses, and as regards potash the losses are so small that on a loamy or clay soil they would be made up by the continual slow weathering into an available form of the insoluble potash compounds in the soil.

It is, however, a low level of production that is attained in this example of an almost self-supporting piece of land, and if the average yield is to be raised, say to 5 qrs. of wheat and 6 qrs. of barley per acre, an external supply of nitrogen must be obtained, either in the form of fertilisers or feeding stuffs. Moreover, this additional nitrogen must be considerably more than would be contained in the extra quarter of wheat and other larger crops that are grown; there must be enough to compensate for the greatly increased waste by drainage, denitrification, etc., which will accompany the higher fertility of the soil. Several examples have already been given to show that the greater the amount of fertiliser added to the soil the smaller is the proportion returned in the crop; these are only particular cases of the general rule that the wastage of nitrogen is greater the higher the fertility of the soil. Fertilisers go less to feed the crop directly than to maintain the level of fertility of the land, and as this rises all the actions which result in loss of nitrogen are increased at a rapid rate. Thus the intensive farmer often becomes wasteful because, after his land is in good heart, he continues to add fertilisers at the same rate as he did when he was building up its condition.

It therefore follows that an account of what is removed from the soil year by year by the crops or animals raised upon the farm provides very little guidance towards determining the amount of fertiliser which must be brought in; at a low level of production, good land will practically recuperate itself without any

extraneous manure, while really high farming for big crops involves a considerable wastage of nitrogen applied to the land and never recovered in the crop. It is only by experience, by the knowledge of his own land and the market conditions which prevail, that the individual farmer can tell how high it is profitable for him to farm, and therefore to what degree he can utilise the information as to feeding his crops which is provided by field experiments.

The discussion that follows of the manures appropriate to each of the staple crops is therefore intended to supply the farmer, not with a series of recipes or patent mixtures that are universally applicable, but with principles out of which he can construct a rational system appropriate to his own farm. In the practice of farming many things may at once be set down as "wrong," but there can be nothing absolutely "right"; the proper course of action is never anything more than a judicious compromise adapted to all the various conditions of climate, soil, and markets. We can now consider the ordinary farm crops separately.

*Wheat* in the typical four-course rotation follows the ploughed-up clover ley, and generally derives all the nitrogen it requires from the residues left by the clover in the soil. In many cases, however, oats are now substituted for wheat after the ley, because more time is thus obtained to graze the aftermath and break up the land before seeding; oats also after the ploughed land has been exposed for the winter suffer less than wheat from the wireworm which is apt to be prevalent in the old clover land. Should wheat follow a good crop of clover further manuring is not required; though if the second growth of the clover has been allowed to ripen seed, which removes a large proportion of the stored up nitrogen, or if much rye grass has been

present in the seeds mixture and the clover has failed somewhat, it may be desirable to enrich the ground still further. This may be done either by spreading a coating of dung (10 tons per acre) on the clover before ploughing, or by a spring top-dressing of 1 to  $1\frac{1}{2}$  cwts. per acre of nitrate of soda or sulphate of ammonia, preferably the former for wheat. When wheat follows mangolds, as is not unfrequently the case, no manure is likely to be required, because the mangolds will have received dung and will have been frequently cultivated. Speaking generally on soils in good heart wheat will rarely require manuring; at any rate, it will be wise to wait until the early spring, if the plant then appears to be growing badly or losing ground a top dressing of nitrate of soda (1 to  $1\frac{1}{2}$  cwts. per acre), sulphate of ammonia (1 cwt. per acre), or soot (20 bushels per acre) will do all that is needful. Soot has for some centuries been employed as a spring top-dressing for wheat; besides the nitrogen it supplies, it also tends to preserve the plant from the attacks of the small slugs and snails which are so active at that time of year.

Of course, when wheat and other cereals are grown continuously on the same land, as on Mr Prout's farm at Sawbridgeworth, it is necessary to employ a more complete fertiliser—2 cwts. per acre of nitrate of soda or sulphate of ammonia will be required as a spring top-dressing, and 3 cwts. of superphosphate or 2 cwts. of basic slag, according to the amount of calcium carbonate in the soil, should be sown before the seed. Potash would only be necessary on the lighter soils, on which wheat is not likely to be grown continuously, but in such a case 3 cwts. or so per acre of kainit would be desirable. Fertilisers for wheat may be crude salts, like nitrate of soda or superphosphate; the establishment of a plant is little affected by the amount of humus in the soil and

the extra price of organic manures like the guanos will rarely be repaid by any increased yield.

*Barley* is grown under two very different conditions of tilth. In the first place, it may follow wheat and form the second or even the third white straw crop after roots or a clover ley; in the Isle of Thanet three, four, or even five barley crops may be taken in succession after an old lucerne or sainfoin ley has been broken up. In such cases the high condition will have been taken out of the soil by the first crop of wheat, there will no longer be any excess of readily available nitrogen, and as there is a good opportunity of getting the soil early into tilth, barley of high quality may be expected. Good malting barley contains a low percentage of nitrogen, hence the soil on which it grows must not be too rich, nor must any large quantity of nitrogenous manure be employed. On the other hand, however, it is a mistake to suppose that impoverished soil alone will yield good barley; unless a reasonable amount of nitrogen be available not only will the yield be small but the size of the berry will fall away. This may be illustrated from the Rothamsted experiments on the Agedell field, where the barley follows Swede turnips in the rotation. On this field the plots are manured for the root crop but not for the barley which follows, and on three of the plots the following average results were obtained (Table XC.).

The soil of the first plot was in a very impoverished condition because a crop of roots had been grown without nitrogenous manure and had been wholly removed from the soil; the grain in consequence was poorly developed for want of nitrogen, as is shown by its low weight per bushel and per 1000 grains; its value was, in consequence, low in spite of the small percentage of nitrogen it contained. The second plot, on which a



small crop of roots had been fed, gave the best results; the third plot, on which a large crop of roots had been fed, evidently received too much nitrogen, as shown by the high percentage in the grain; as a result the value fell off. The figures are the means of several years' valuations.

TABLE XC.—RELATION OF QUALITY OF BARLEY TO THE NITROGEN SUPPLIED IN MANURE (Rothamsted).

Manuring for Roots.	Treatment of Roots.	Yield of Barley, per acre.		Weight per bushel.	Weight of 1000 Grains in grams.	N. per cent. in Dry Grain.	Value per quarter.
		Grain.	Straw.				
Minerals, no Nitrogen .	Carted off .	Bush. 13·6	Cwts. 9·2	54·0	39·7	1·484	28/7
Minerals, no Nitrogen .	Fed on Land	28·9	17·5	55·3	44·3	1·576	29/11
Minerals and Nitrogen .	Fed on Land	34·1	23·4	55·3	46·2	1·693	29/6

In preparing for a crop of barley of high quality it is therefore necessary not to allow the land to become really poor, but it is desirable that the nitrogen should come more from condition in the land than from very active manures. If the land is in really high condition before the first straw crop of wheat or oats is taken, barley may follow without any fertiliser, especially if the ground can be got into good tilth and the barley sown really early. But for a second barley crop or for the first on land in poorer heart some nitrogenous manure must be used, and sulphate of ammonia and rape cake are found to give better quality than nitrate of soda, though in neither case must a large quantity be used. Furthermore, it has been shown earlier (p. 140) that phosphoric acid is a very essential constituent of any fertiliser for barley, and

whatever the tilth it seems desirable to give this crop about 3 cwts. per acre of superphosphate, or its equivalent in steamed bone flour or phosphatic guano on light soils poor in carbonate of lime. The question of potash is more doubtful; while potash manures have been found to stiffen the straw and increase the size of the berry by promoting starch-formation, they also prolong the maturity of the barley and darken its colour slightly. Hence, potash manures must be used carefully and are only likely to be valuable on light sandy or gravelly soils. We thus arrive at the following mixture for a barley manure, when barley follows one or more white straw crops and the land is no longer in high condition:—

Sulphate of ammonia  $\frac{1}{2}$  to  $1\frac{1}{2}$  cwts., or rape dust 4 to 6 cwts. per acre.

Superphosphate 3 cwts. per acre, or steamed bone flour 2 cwts.

Sulphate of potash  $\frac{1}{2}$  cwt. per acre, on light soils only.

The superphosphate and sulphate of ammonia or rape dust should be mixed and sown broadcast before the seed is drilled; it is impossible to distribute small quantities like a  $\frac{1}{2}$  to 1 cwt. as a top dressing evenly unless they are mixed with a much larger bulk of ashes.

A mixture of this kind would also serve for the rare case of barley following roots which have been grown without farmyard manure and then carted off the land.

When barley follows roots which have been highly manured with farmyard manure, still more so when the roots have been folded off by sheep, the land is already too rich in readily available nitrogen to grow barley of the highest quality, the more so as the roots are often left so late on the ground that a good seed-bed cannot

be obtained early in the year. Early sowing is essential for barley of high quality, and except on the very lightest soils if the root land cannot be broken up before the New Year, so that the frosts may have time to break down the clods which have been formed by the sheep treading the wet land, it is better to sow either oats or a barley like Archer's, which will yield well for feeding purposes though the quality may not reach a malting standard. When the roots have been fed on the land 3 cwts. per acre of superphosphate sown with the seed is found to improve the quality of the grain and help to correct the excess of nitrogen; but neither potash fertilisers nor salt, which is sometimes recommended and which acts as a liberator of potash in the soil, are of value except on the very lightest of soils. When the roots have been grown with farmyard manure and then carted off the land will be in about the right condition for barley, and will want no help except a little superphosphate, should none have been used for the root crop.

*Oats.*—The general principles of manuring for barley hold also for oats, except that, being grown for feeding purposes only, they can be given much larger quantities of nitrogen without any fear of injuring their quality. When grown on a ploughed-up ley, which in many cases is also lightly dunged before ploughing, oats are not likely to require any fertiliser; at the most a little nitrate of soda if they are found to be starting away too slowly. As an all-round fertiliser for oats when the land is in poor condition 1 to 2 cwts. of nitrate of soda or sulphate of ammonia, and 2 cwts. of superphosphate or basic slag, according to the class of soil, will answer all the requirements of the oat crop; potash fertilisers would be wasted, as also would the more expensive organic forms of nitrogen with a crop which occupies the land for so short a period. Of course, in a wet

season as much as 2 cwts. per acre of nitrogenous manure might easily result in the crop going down.

*Rye*, which is grown in the south of England for early spring keep is rarely manured; but *maize*, which is also grown to some extent as fodder, requires the land to be brought into fairly high condition. A preliminary dressing of 12 to 15 loads of dung per acre should be given, with 2 to 3 cwts. per acre of superphosphate at the time of sowing, then 1 cwt. per acre of nitrate of soda may be used as a top dressing round the plants when they are set out and side hoed.

*Root-crops*.—In British farming the bulk of the manure that is made upon the farm or purchased is applied to the root-crops—Swedes or mangolds; though in the east and south-east of England it is more general to apply the farmyard manure to the seeds before ploughing up for wheat. In these warm soils much nitrogenous manure is apt to cause Swedes to run to top and to be more susceptible to mildew. Big crops of roots mean more food for the stock, and so in turn more farmyard manure. Moreover, the roots are grateful, and continue to respond to liberal treatment without lodging or growing an excess of straw, as cereal crops will do. It is questionable, however, whether the very common practice in the north of putting on all the available manure, farmyard and artificial, for the root-crop and making that serve for the whole of the rotation, is wise; better results will be obtained by a careful adaptation of the fertiliser to the particular crops forming the rotation. As regards *Swedes*, the earliest work that was done at Rothamsted consisted in showing the dependence of this crop upon an ample supply of phosphatic manure of an available character, and it was the response of this crop to soluble phosphates which built up the superphosphate and other artificial fertiliser

industries. The point may be illustrated from the Rothamsted experiments on the Agdell field, where crops are grown in rotation with the following average results:—

Unmanured . . . . .	16 cwts.
Mineral only — Superphosphate and Sulphate of Potash . . . . .	208 „
Complete Manure — Nitrogen, Superphosphate, and Sulphate of Potash . . . . .	400 „

Without manure the yield is trifling, but with the mineral manures (and the phosphoric acid is the effective factor) the yield rises to 208 cwts. per acre, although the land had been continually cropped without any nitrogen supply; lastly, when nitrogen also is added, the yield becomes that of a high average crop for the south of England. In practice, however, it is found that where the land has been kept in good condition and there has been adequate preparation of the seed-bed, little or no manurial nitrogen will be required to supplement the nitrates produced from the soil reserves, and that consequently the great increase due to the nitrogen in the experiments quoted will not be reproduced under ordinary conditions of farming.

In a large co-operative series of trials undertaken by the Highland and Agricultural Society over the whole of Scotland it was found that 84 lb. per acre of sulphate of ammonia, or its equivalent in 1 cwt. of nitrate of soda, was as much nitrogenous manure as could be profitably employed. About 5 cwts. per acre of superphosphate, or 4 cwts. of basic slag, or 2 cwts. of steamed bone flour, according to the soil, were indispensable; the superphosphate being best on loams and calcareous soils, the basic slag on clays and peaty land, and the steamed bone flour on sands and gravels.

An abstract from these experiments shows the following average results obtained from 108 plots during the years 1892-94:—

TABLE XCI.—YIELD OF TURNIPS WITH DIFFERENT FERTILISERS.

	Roots per acre.
	Tons.
Unmanured . . . . .	11·3
Superphosphate and Basic Slag (7½ cwt. only) . . . . .	17·9
Superphosphate (6 cwt.), Sulphate of Ammonia ( $\frac{1}{5}$ ) . . . . .	18·9
Superphosphate (6 cwt.), Nitrate of Soda (1 cwt.) . . . . .	19·1
Basic Slag (9 cwt.), Nitrate of Soda (1 cwt.) . . . . .	18·4
Bone Meal (4 cwt.), Nitrate of Soda ( $\frac{1}{2}$ cwt.) . . . . .	17·0
Superphosphate, Basic Slag, Nitrate of Soda (1 cwt.) . . . . .	19·2
Superphosphate, Basic Slag, Nitrate of Soda (2 cwt.) . . . . .	19·4

It will be seen that in these experiments the phosphatic manures are the most effective in producing an increased yield; phosphate alone put up the crop from 11·3 to 17·9 tons per acre: 1 cwt. of nitrate of soda or sulphate of ammonia only add about another ton to the crop, while a second hundredweight produced no perceptible increase at all.

The question of the most appropriate manurial treatment for Swedes depends upon how much farmyard manure is available; while the ordinary four-course rotation is being practised, most of the dung made will come back to the land for the Swede crop, about 10 tons to the acre being available. Of course, with such quantities of farmyard manure the Swedes will require no further nitrogenous dressing; phosphates are, however, still indispensable. In such cases it is generally the custom to finish off the seed-bed preparation with a ridging plough, and to apply the dung to the furrows just before sowing. The ridges are then split back over the dung, the new ridges thus formed are rolled, and

the seed and superphosphate are sown from the same drill on the top of the ridge. This plan answers excellently in the cooler and moister parts of the country, where the Swede flourishes and grows big crops, but in the south and east of England such a method exposes the crop too much to risk of damage from drought, both through evaporation from the sides of the ridge and because the fresh manure as it rots leaves the land too open. On warm dry soils it is better to plough in the farmyard manure in the autumn, and to sow the Swedes on the flat with their appropriate artificial manure. It is in the south again that farmyard manure is often lacking for the Swede crop, because it has been wanted for wheat or hops or potatoes, or sometimes for the grass land; many sheep farmers, again, who fold on the Swede land have a strong objection to Swedes grown with farmyard manure. A suitable mixture in this case, when no farmyard manure is available, will consist of 4 cwts. of superphosphate (or its equivalent in basic slag or steamed bone flour as before), 2 cwts. of fish or meat guano, and  $\frac{1}{2}$  cwt. of a mixture of nitrate of soda and sulphate of ammonia as a top dressing when the plants are singled. If the land is in really good heart, the fish guano can be omitted or reduced. It will be seen that various compounds of nitrogen are used in order to ensure a steady and continuous supply of nitrates as long as the plant is growing; the mixture of sulphate of ammonia and nitrate of soda ensures a neutral reaction in the soil. Though superphosphate and sulphate of ammonia are, on the whole, the best fertilisers in their respective classes for Swedes, they must be employed with care where there is little lime in the soil, and not at all if the land is known to be subject to "finger-and-toe." Both are acid manures, and the organism causing finger-and-toe

only flourishes in an acid medium. Potash salts are rarely used for the Swede crop, though, like other root-crops storing up a good deal of carbohydrate, the Swede will respond to liberal allowances of potash. On the lighter soils, when farmyard manure is only scantily used, it is undoubtedly wise to apply about 3 cwts. of kainit while the land is being prepared for the seed-bed.

Of the other crops allied to Swedes, white turnips require much the same treatment, except that the fish guano may be omitted because they possess a shorter period of growth, while the potash is more necessary. Kohl rabi may have just the same treatment as Swedes, as may thousand-headed kale and cabbage, with the addition of more nitrogen. Cabbages in particular will respond to enormous quantities of nitrogen; in addition to the farmyard manure or fish guano recommended for the Swedes, up to 3 cwts. per acre of the mixture of nitrate of soda and sulphate of ammonia may be used in two or three top dressings. In market garden work such active nitrogenous manure brings the cabbages earlier to cutting and renders them tenderer, though they are reputed in consequence not to travel so well to distant markets. Stock feeders do not like cabbages or any other root crop grown with an excessive amount of nitrogen, especially of nitrate of soda; the plant material that has been forced in this fashion becomes a poor or even a harmful food, but whether this is due to the increased amount of nitrates in the plant or to other compounds of nitrogen is as yet uncertain.

*Mangolds* are often described as heavy feeders, by which we may understand that the yield will go on responding to very large additions of manure rather than that the crop removes a specially large amount of manurial constituents from the soil; a fact which would



not be apparent in the succeeding crops but could only be ascertained by analysis. The mangold differs entirely from the Swede in its requirements. In the first place, it will give returns for very large quantities of nitrogen; secondly, it needs much potash and but little phosphoric acid in the fertiliser. The Rothamsted experiments show that mangolds can be grown successfully for very many years in succession upon the same land if suitable fertilisers are provided. The only difficulty experienced lies in the getting of a plant on the plots where the tilth of the soil has been injured by long-continued treatment in one particular direction.

The results given by some of the Rothamsted plots are set out in Table XCII.

TABLE XCII.—AVERAGE YIELD OF MANGOLDS (Rothamsted).  
32 YEARS, 1876-1907.

	Superphosphate.		Dung.	
	No Potash.	Potash, etc.	Alone.	With Phosphate and Potash.
Rape Cake=98 lb. N.	11.1	22.0	24.5	25.7
Nitrate of Soda=86 lb. N.	15.3	18.0	25.9	26.4
Ammonium Salts=86 lb. N.	7.5	15.2	22.5	24.0

These results illustrate the following points in the manuring of mangolds:—

(1) The value of dung and of organic manures like rape cake, which, by maintaining a good texture in the soil, ensure a plant and a vigorous start.

(2) The value of an addition of active nitrogenous manures, particularly nitrate of soda, even when dung is also used.

(3) The importance of potash salts even when

farmyard manure rich in potash is also used. The beneficial effect of potash salts is, however, less apparent when nitrate of soda is employed as a source of nitrogen, because the soda attacks and renders soluble some of the reserves of potash in the soil. Potash thus becomes more necessary when ammonium salts or rape cake form the source of nitrogen; but in any case it is desirable to use some sodium salt, such as common salt itself, as an economiser of the more valuable potash.

(4) That with proper manuring mangolds can be grown year after year on the same land without any falling-off in yield or any accumulation of disease. It is sometimes convenient to keep a little piece of land near the homestead always in mangolds, this can be done for a long time in perfect safety if organic manures are employed to maintain the texture of the soil.

Coming now to the requirements of the crop in practice, not much variation will be required because of its position in the rotation, since mangolds are practically always grown on a stubble with the land in comparatively poor condition. The basis of a manure for mangolds should be dung; probably there is no crop in the rotation to which farmyard manure can be better applied than to mangolds. When, therefore, the mangolds are grown on a portion of the root breadth, the dung should be concentrated on this part of the field. On light soils and in dry climates it is better to plough in the dung in the autumn and grow the mangolds on the flat, lest the fresh manure should leave the soil too open and let in the drought, but on heavier land and where the rainfall is greater the land will generally be laid up in ridges. The dung should be spread in the furrows; the artificial manure, other than nitrate of soda or other active nitrogenous manure, should be sown on the dung and the ridges then split back on to the dung.

Supposing 20 loads of dung per acre to be available for the crop, the supplementary manure should consist of 3 to 5 cwts. per acre of kainit (the larger quantity on light soils), and 2 cwts. of fish guano or kindred fertiliser if the land is in poor heart and a large yield wanted. Phosphates in many cases, as at Rothamsted, are not required when dung is used, but on soils where phosphates are specially necessary, as on many of the clay soils so suited to the mangold crop, it will be well to add 2 cwts. of superphosphate to the mixture whenever the fish guano is omitted. The after-treatment will consist in giving top dressings of a mixture of equal weights of nitrate of soda and salt; about 3 cwts. of the mixture at singling time, and perhaps an equal amount a few weeks later, should a specially heavy yield be aimed at.

*Potatoes.*—It is more than usually difficult to lay down general rules for the manuring of the potato crop, so varied are the tilths upon which it is grown and so different are the yields that are aimed at. Potato growing is largely carried out in the neighbourhood of great cities where dung can be cheaply obtained; in such cases the farmer will often crop suitable land every other year with potatoes, taking a cereal or a green crop in the intervening years. On the other hand the farmer who does not make a speciality of potatoes will simply plant them on a portion of his mangold or Swede land, while in good potato-growing districts they will form one item in a five- or six-year rotation. In the Lothians, for example, a common rotation is:—

Turnips	}	or	{	Turnips.
Barley				Barley.
Clover				Potatoes.
Oats				Oats.
Potatoes				Clover.
Wheat				Potatoes.

In both these cases about 30 loads of farmyard manure are put on the stubble and ploughed in the autumn before the potatoes are grown, artificial fertilisers to the value of 20s. or 30s. are also added in the spring.

Another rotation in the Dunbar country, so famous for the high quality of its potatoes, avoids the use of any farmyard manure :—

Swedes, in part fed on the land.  
Barley.  
Clover, cut for hay.  
Clover, grazed with cake and corn.  
Potatoes, no farmyard manure.  
Oats.

On the Lincolnshire fen soils a common rotation is as follows :—

Swedes  $\frac{1}{2}$ , Potatoes  $\frac{1}{2}$ , with farmyard manure.  
Wheat.  
Seeds.  
Wheat.  
Oats.

On the black soils of Lancashire a common rotation is :—

Oats.  
Potatoes.  
Oats.  
Seeds, farmyard manure being used in large quantities.

In view of all these variations in practice it will be best to discuss a few general principles :—

(1) Potatoes do not want an excess of nitrogenous manure, because it renders them waxy and gives them a tendency to boil a bad colour; it also makes them susceptible to disease. As quality is so important, the

nitrogen they require should be derived more from mellow soil in high condition than from recent manure.

(2) A good supply of phosphatic manure has been shown to be important.

(3) Potash is essential, since the potato is a starch-making plant.

(4) Manures setting up an alkaline reaction should be avoided, since they facilitate the attack of *Oospora scabies*, the fungus causing potato scab. Hence sulphate of ammonia should be preferred to nitrate of soda for a top dressing and superphosphate to basic slag; lime also should not be used.

As regards the use of dung it has been repeatedly shown that a better return is obtained by using farmyard manure in moderate quantities of 20 loads per acre or so and supplemented with artificial manures, than by spending all the money available for manuring upon dung alone. On any but the heaviest soils it is better to plough in the farmyard manure in the autumn and so get the land into good heart, but on the close badly working soils it is an advantage to the potato plant to have the ground left a little hollow by the decay of the farmyard manure; on such soils, therefore, the dung should be applied in the drills just before planting. The mixture of artificials should either be sown broadcast before the land is ridged up or sown upon the farmyard manure in the drills before the ridges are split. For ordinary cropping a mixture of 4 cwts. per acre of superphosphate, 1 cwt. of sulphate of potash and 1 cwt. of sulphate of ammonia will be ample; when extra heavy crops are aimed at, 2 cwts. or so of a good guano may be added to the mixture already specified, and a further hundredweight of sulphate of ammonia may be applied as a top dressing when the haulm is beginning to appear.

*The Leguminous Crops.*—It has already been explained that the leguminous plants are able to obtain nitrogen from the atmosphere by the agency of the bacteria in their nodules and can in this way satisfy their requirements for nitrogen: it should, however, not be forgotten that they also feed upon combined nitrogen like all other plants, and as a rule derive their nitrogen both from the air and from the soil. To obtain the biggest crops rich soil and certain nitrogenous manures are necessary, but to secure the greatest profit out of a leguminous crop, it should be left as far as possible to derive its nitrogen from the atmosphere. All leguminous plants are particularly sensitive to any trace of acidity in the soil, so alkaline fertilisers like basic slag or nitrate of soda should be selected. Lime is also desirable, both for its basic properties and as a liberator of insoluble potash in the soil, because all leguminous crops are specially dependent upon an abundant supply of potash.

*Beans.*—Beans no longer play the important part in British agriculture that they once possessed; essentially a heavy land crop, the cultivation has declined since so much of the strong clay land has been laid down to grass. In the rotation beans generally come between two white straw crops. They will follow oats or barley, for example, and precede wheat, and as a rule they do not receive any manure. A little farmyard manure may be spread on the stubble before it is ploughed, but other nitrogenous manures have little beneficial effect upon the crop. The Rothamsted experiments show that beans, like other leguminous plants, respond chiefly to phosphates and potash, to the latter especially, and are able to derive most of the nitrogen they require from the atmosphere. For example, the average results for eight years at Rothamsted were—

TABLE XCIII.—YIELD OF BEANS AT ROTHAMSTED,  
1847-1854.

	Unmanured.	Minerals only.	Minerals and Nitrogen.
Corn . . .	1205 lb.	1676 lb.	1763 lb.

More recent experiments made by the Highland and Agricultural Society, and others in Essex, upon beans under ordinary farming conditions confirm these results, showing that nitrogenous manures are non-effective but that the crop responds to phosphates and potash. Thus in practice, when beans are being grown on strong land, we may reduce the manuring to 3 or 4 cwts. per acre of basic slag, any other expenditure on fertiliser is not likely to be repaid by the increase in the crop.

*Clover.*—Red Clover forms perhaps the most important crop cultivated by the farmer; not only does the hay furnish a particularly valuable fodder, the nitrogen in which is largely derived from the atmosphere and is therefore clear gain to the farm, but the nitrogen left behind in the roots and stubble also enriches the land for future crops.

Since the time of the Romans it has been known that the wheat is most luxuriant where the clover had grown best in the preceding year; the Rothamsted experiments afford some interesting examples from which the gain of nitrogen can be estimated. One example of the great benefit which the succeeding crops in a rotation derive from a good crop of clover, although it is removed from the land as hay, has already been quoted (Table VIII., p. 33).

Again, in 1873 a piece of land in Little Hoos field was cropped, part with barley and part with clover, in 1874 barley was taken over the whole, and the amount

of nitrogen removed in the crop from each piece of land was estimated as follows:—

TABLE XCIV.—GAIN OF NITROGEN BY CLOVER CROP,  
ROTHAMSTED.

	Lb. of Nitrogen removed per acre in the Crop.	
	1873 . . . . .	Barley, 37·3
1874 . . . . .	Barley, 39·1	Barley, 69·4
Nitrogen per cent. in Soil, end of 1873.	0·1416	0·1566

Thus, although 151 lb. per acre of nitrogen was removed in 1873 from the clover portion of the field, as compared with 37 lb. from the barley portion, the former in the following year yielded an extra 20 bushels of barley.

As to the manurial treatment of clover, it is difficult to quote very extensive experiments, because of the failure of the plant which takes place through clover "sickness." On the best clover soils in this country it cannot be grown more frequently than once in four years, and more often once in seven or eight years only is safe. The Rothamsted experiments all go to show that manuring alone will not keep off clover sickness, though it was found possible to maintain a long succession of clover crops on a small patch of rich garden soil. Lime and potash salts are helpful but cannot be trusted to maintain the plant in health. The Rothamsted experiments, however, served to show that nitrogenous manures have little effect (indeed, sulphate of ammonia may be harmful), but that mineral manures, and potash in particular, are of great value. Nitrate of soda has sometimes been found beneficial to stimulate a weakly



plant in the spring, and doubtless the soda had a share in this result, but clover so forced has a bad effect upon stock. In practice clover is rarely manured; it is nearly always sown in the barley crop, and is then left to the mineral residues from the preceding root crop and the nitrogen it can gain from the atmosphere; at the most, a little farmyard manure may be spread during the winter and is valuable as affording shelter to the young plants. If plenty of phosphates have been used for the Swede and barley crops, nothing more in this direction is likely to be required, but on many soils, especially of the lighter kind, an application of potash during the late autumn or winter after the clover has been sown will have a marked effect upon the yield of clover, and the cost of about 4 cwts. of kainit per acre will be amply repaid.

It is rarely wise to attempt to manure standing clover for a second year's crop; nitrogenous fertilisers are not required, and the potash and phosphates hardly have time to get well down to the plants' roots in the time the crop still occupies the ground. A thin coating of dung in the winter is valuable for its shelter, and if the crop must be forced along, then in the winter 3 cwts. of basic slag and 3 cwts. of kainit may be sown broadcast; even if they do not produce much immediate return they will not be washed away.

*Lucerne and Sainfoin.*—The principles which have been laid down for the treatment of clover apply equally to lucerne and sainfoin (*i.e.*, that mineral manures should be used, and that only the young plant will respond to fertilisers), but since these crops are generally sown to stand five years or more, it is wise to make a good preparation of the soil before sowing. As a rule, they are sown in barley or oats and about 5 cwts. per acre of basic slag should be worked into the soil before sowing

the corn crop. The potash salts (4 cwts. per acre of kainit), being soluble, can be kept until the autumn or winter. Beyond this it is not wise to use fertilisers on these crops; a little nitrate of soda may serve to give the young plant a start in its first spring, and a coat of dung is often valuable, but the proper way to regard lucerne or sainfoin is as a cheap means of enriching the land with a minimum of expenditure.

*Vetches, Trefoil, Crimson Clover*, and similar rapidly growing leguminous crops are usually grown as catch crops on land that is already in good heart and do not require any fertiliser. Lupins are sometimes grown on poor sandy land in order to be ploughed in as green manure; in such a case the preparation of the land (supposing it to be poor heathy land undergoing reclamation) should include the application of 4 to 5 cwts. per acre of basic slag and 3 to 4 cwts. of kainit to supply the lupins with the necessary mineral food, for without it they could neither gather nitrogen nor accumulate humus for the amelioration of the soil.

*Grass Land.*—In considering the effect of manures upon the grass crop, we have to take into account not only the weight of the produce but the character and botanical composition of the herbage that ensues. Every meadow possesses a characteristic vegetation made up of various species of grasses, a few leguminous plants like white and red clover, bird's foot trefoil, the yellow vetchling, etc., and sundry miscellaneous species which are, in the main, of little value to stock and may be classed as weeds. The proportion which each of these species contributes to the herbage represents the degree to which it is suited by the various conditions of food, water, soil, texture, etc., which prevail in that field. A strenuous competition is going on between the different species, each of which is endeavouring to

crowd out its neighbours, so that the characteristic vegetation of the field represents the state of equilibrium which has been attained by the various plants under the prevailing conditions of soil and climate. The physical texture of the soil has much to do with the nature of the grasses which will establish themselves under the stress of competition: on the deep, kindly alluvial pastures rye grass becomes prominent; on the thin chalky soils of the Downs sheep's fescue thrives best; on heavy clays where aëration is deficient the creeping rooted bent grass will cover the surface, while sandy droughty soils often become covered with tufts of cock's foot or brome grass. Just in the same way manuring, by altering the food conditions in the soil, can effect a great change in the character of the herbage of a given field, and the direction which these changes will take must be kept in mind in any discussion of the application of fertilisers to grass land, since in Great Britain we are never dealing with a crop of a pure unmixed grass, like the crops of timothy or blue-grass in America. The best example of the effect of long-continued manuring on the composition of the herbage is afforded by the Rothamsted experiments, where certain plots of old grass land receive the same treatment every year and are mown for hay.

Table XCV. shows the average yield for fifty-three years, and also the character of the resulting herbage, as shown by its separation into grasses, clovers, and weeds in 1902, the forty-seventh year of the experiment.

From this table certain facts become apparent. If grass is constantly mown without any return in manure, the resulting impoverishment is shown not only in the small yield but in the preponderance of weeds in the herbage. One-sided manures, which contain only

nitrogen or only phosphoric acid, however successful at first, eventually result in increased impoverishment of the land. Nitrogenous fertilisers promote the growth of the grasses at the expense of the clovers. Mineral manures, and particularly potash, promote the growth of leguminous plants and enable them to make headway against the grasses.

TABLE XCV.—YIELD AND COMPOSITION OF HAY AT ROTHAMSTED.

Plot.	Manure.	Yield of Hay.	Botanical Composition, per cent.		
			Gramineæ.	Leguminosæ.	Other Orders.
		Cwts.			
3	Unmanured . . . . .	21.5	34.3	7.5	58.2
1	Nitrogen only as Ammonium Salts . . . . .	34.7	77.6	1.4	21.0
17	Nitrogen only as Nitrate of Soda . . . . .	35.5	43.8	3.4	52.9
7	Mineral Manures, no Nitrogen . . . . .	40.9	20.3	55.3	24.4
4-2	Phosphoric Acid and Nitrogen, no Potash . . . . .	35.8	91.5	...	8.5
9	Complete Manure, Nitrogen as Ammonium Salts . . . . .	54.8	91.2	1.3	7.5
14	Complete Manure, Nitrogen as Nitrate of Soda . . . . .	60.8	88.8	3.7	7.5
11-1	Complete Manure, excess of Nitrogen . . . . .	66.8	99.2	...	0.8

Another consequence follows from these experiments; since any special combination of fertilisers or any method of treatment encourages particular species, the best results in any given field will always be attained by persisting in the treatment selected. For instance, when a field is laid up for hay certain strong-growing grasses get an advantage; when the field is grazed other grasses of a dwarfer-spreading habit are more suited by the conditions. It is therefore desirable to keep one field for hay every year and another for

grazing, rather than alternately to graze and hay the same field, in which case particular grasses are first of all encouraged and then repressed.

Again, we may conclude that manure will be wasted upon a field unless there is a proper herbage to take advantage of it; in dealing with poor grass land it is uneconomical to spend much on manure until by degrees the character of the vegetation has been reformed. With these general principles in mind, we may proceed to the consideration of a few typical cases, which, however, cannot be made to cover all the variations of soil and management to be met with in practice.

*Land laid up for hay* every year must receive a regular manuring, unless it happens to be rich river meadow or alluvial flat which derives its fertility from the percolating water or the mud deposited during flood time. But if it is ordinary medium grass land, about 3 cwts. per acre of kainit and 2 cwts. of superphosphate should be applied in the early spring, in January or February, followed by 1 to  $1\frac{1}{2}$  cwts. of nitrate of soda as soon as the grass begins to move. On heavy soils, especially on old grass land, basic slag may be advantageously substituted for the superphosphate. At intervals of five years or so the mixture of artificial manures should be replaced by a winter dressing of 15 tons or so of farmyard manure. Occasionally, once in five or six years, a light dressing of lime should be given, a ton to the acre put on in the form of ground quicklime is best. Land that has been but recently laid down to grass should be dunged more frequently. If much cake and corn is fed on the aftermath the nitrate of soda can be reduced or even omitted.

*Pasture* that is of any value to begin with will rarely require any general manuring, so much cake and corn

will usually be fed to the stock fattening upon it in the summer that as regards nitrogen the soil is likely to become richer every year. Lime and phosphates may, however, often be deficient on these rich old pastures, and for lack of these constituents the great residues of manure left on the land every year are not adequately realised. For this reason occasional dressings of ground lime (1 ton per acre) and of basic slag (5 cwts. per acre) are of great value on these rich lands where cake and corn are fed. The result of the application may not be visible in an increased growth of grass, but the cattle will be found to prefer the manured portions of the field and to thrive there better. The prevalence of weeds, especially buttercups and to a less degree daisies, is an indication of this over-richness produced by heavy cake feeding, unconnected by an adequate supply of minerals.

*Poor pasture* cannot repay any large expenditure; indeed, any liberal application of manures at first will only encourage the strongly growing weeds. The poor grass land in Great Britain may be divided into three classes: (1) poor clay land covered with creeping-rooted bent grass; (2) thin sandy soils covered with sheep's fescue, florin, sweet vernal, and soft brome grasses; (3) thin soils near the chalk with an extremely variegated herbage.

As regards the first class of land, the experiments initiated by Somerville at Cockle Park, and extended later to many other clay soils all over the country, show that dung and other nitrogenous manures are worse than useless on such soils. The sound way of improvement is to give them a dressing of 10 cwts. or so per acre of basic slag, whereupon the white clover, which before existed as tiny plants under the bents, is favoured and becomes prominent in the herbage. The

grazing is at once improved, and as the nitrogen consumed mostly comes back to the grass, a permanent improvement sets in. Should white clover not appear the season after the basic slag has been sown, it is possible that the land was without the small plants mentioned above, and a few pounds of white clover seed should be sown and harrowed in. After this first dressing of basic slag, the land will steadily improve for five or six years, after which time a fresh application of fertiliser is called for. By this time the soil will have gained nitrogen through the growth of the white clover, but it will not be wise to trust to basic slag alone for the second dressing, since the land will have lost some of the potash liberated by the original treatment with basic slag. The second and later dressings should therefore be accompanied by about 3 cwts. per acre of kainit to keep the clover vigorous; and if the land is ever laid up for hay, it will be necessary to use nitrogenous fertilisers pretty freely. As long as a pasture containing a good proportion of white clover is only grazed, it is probable that the nitrogen content of the land does not fall off, but we cannot trust to white clover to make good the large removal of nitrogen in a hay crop.

The thin sandy soils are more difficult to improve than the clays; basic slag exerts but little effect, partly because the soil is too dry to allow it to act very freely, but more because there is but little potash in the soil to be liberated by the action of the lime in the basic slag. Bone meal has often been recommended for these soils, remembering the improvement which bones have effected upon the Cheshire pastures. Bone meal is, however, too slow in its action to be profitable, and a phosphate like steamed bone flour or phosphatic guano will be better. About 2 to 3 cwts. of such a phosphate

and an equal amount of kainit forms the only mixture which will improve the herbage on these very light soils, but even then the change will be slow and never so pronounced as on clay land, because the tufted deep-rooting grasses which prevail are better able to resist the competition of the leguminous plants. Nitrogenous manures, and particularly dung, are harmful and only encourage the coarse herbage.

On the thin chalky soils nitrogenous manures are valuable, and a pasture may be permanently improved as well as enabled to carry more stock in the current season by the application of 3 or 4 cwts. per acre of a mixed fertiliser, containing 3 of superphosphate, 3 of kainit, and 1 of sulphate of ammonia. But for the creation of a good pasture on the thin chalk soils, dung is the most essential manure; as much farmyard manure as possible should be spared for the grass land and a hay crop taken the season after the application; then it should be grazed and, if necessary, helped during the grazing by the artificial mixture specified above.

But it must always be remembered that on the thin dry soils, whether chalk or sand, only a very limited expenditure on fertilisers is likely to be repaid; large applications of manure will be certainly wasted, but it is possible gradually to build up better pastures by repeated small applications of the nature described.

*Seeds hay* should not require any manuring; if the land has been properly treated before the seeds were sown there should be enough residue from previous manuring to grow a good crop of mixed seeds. Any active nitrogenous manure will stimulate the rye grass, etc., at the expense of the more valuable clovers. A fertiliser is sometimes used in the spring when the land has lost plant severely through the winter, but this is generally a wasteful proceeding, because fertilisers



should only be used when there is a crop or the prospect of a crop to utilise them.

When land has been newly laid down to grass, there often comes a very critical period from its fourth to its seventh year, especially on stiff soils and when the first two or three crops of grass have been fed off by store stock only. At that period the leguminous plants have begun to die away, and the grasses have lost vigour because the plant food that had been rendered available by the tillage has become exhausted. The mechanical condition of the soil has also deteriorated because as yet little humus has been accumulated. Applications of basic slag have less effect than usual on such young grass land, there are no residues of past growth to be set in action by the lime of the basic slag. What is wanted is either farmyard manure or applications of a complete fertiliser such as has been described above. Better still, the land should be carefully pastured, the sheep should not be allowed to eat too closely, and should be fed with cake or corn to enrich the land.

*Hops.*—No other crop is so liberally manured as hops; potato land may perhaps receive as much in any one year, but on hops the expenditure for fertilisers will average £8 or £10 per acre year after year. The hop plant shows no special requirements, so that it is the needs of the soil rather than the crop which should determine variations in the character of the manure. The manurial treatment of hops should begin with a liberal use of dung, and most hop growers either buy it in quantities from London or other large towns, or fatten cattle or pigs in order to make enough for their requirements. As much as 40 tons per acre are sometimes employed and that year after year, but one such application every third year will be sufficient to maintain the requisite soil texture, and in the intervening years

the necessary plant food can be more cheaply obtained in other forms. The subsidiary manures for hops are of the most varied nature, but shoddy in some form or other is a highly favoured substance, and should be applied at the rate of from 1 to 2 tons per acre, according to its richness in nitrogen, in the autumns when dung is not being used. When the ground is first worked in the spring the more active fertilisers should be applied, 6 cwts. per acre of fish or meat guano or of rape dust, with about 4 cwts. per acre of superphosphate, or 3 cwts. of steamed bone flour or phosphatic guano, will then carry the crop through. Many growers are in the habit of using a further dressing of rich guano or active nitrogenous manure when the hops are coming into burr, but this is probably unwise, as it induces late sappy growth, very susceptible to attacks of blight. A good coat of dung at this time is, however, of great value, especially on young hops, but its immediate action is more as a mulch than a fertiliser. Potash manures are only required on the light sandy or chalky lands; in such cases they should be applied in the winter or early spring. Phosphates are, however, most essential; on the strong soils as much as 10 cwts. per acre of basic slag may be applied in the winter in place of the superphosphate specified above.

*Fruit plantations* under tillage should receive much the same kind of manuring as hops do, though in smaller quantities. Dung is not so desirable, and the necessary nitrogen can be well supplied by digging in 1 ton per acre of shoddy in the winter, or a spring manuring of meat or fish guano or rape dust may take its place. Phosphates are very important, and potash is also indispensable, especially on the lighter soils and for all stone fruit. Four cwts. of kainit per acre may be given in the winter. Fruit trees in grass land should not

receive any fertiliser, but should be manured by keeping the land closely grazed with sheep receiving hay, roots, cake, and corn, etc.

*Tropical and sub-tropical crops.*—It is very difficult to lay down any general rules for the manuring of tropical and sub-tropical crops, because the conditions of soil and climate are subject to such extreme variations that entirely different methods of treatment have to be pursued in different countries. Certain general principles may, however, be indicated, to be taken into account whenever any scheme of manuring has to be tentatively adopted in practice. All the processes by which the insoluble constituents of plant food in the soil are rendered available for the plant are greatly accelerated in tropical soils, always provided they contain a sufficiency of water. The decay of organic matter takes place with extreme rapidity, so that the humus content of cultivated soils will be quickly reduced unless means are found of repairing the losses; for the same reason all organic manures containing nitrogen are both more quickly and more completely utilised by the plant than they are in temperate soils. The higher temperature of the soil water, the greater production of carbon dioxide in the soil, also result in a more rapid weathering of the mineral constituents of the soil, so that the reserves of phosphoric acid and nitrogen present in the soil are more available in tropical countries.

It also follows that smaller amounts of manure in proportion to the plant food withdrawn by the crop are effective under tropical conditions; whereas, in England, one cannot hope to recover more than one-half of the nitrogen applied as farmyard manure, in a hot soil with an abundant rainfall nearly the whole will be available, and a correspondingly smaller application will be required. It is always the crops of short duration on

the land—tobacco, cotton, and to a less extent sugar cane—which most require manuring; really perennial crops like tea and coffee require much less manure and that of a more slowly acting kind. It is only the short-period crops which will respond properly to active sources of nitrogen like nitrate of soda or sulphate of ammonia.

The incidence of rainfall must be closely studied. No manure can be effective when the soil is either dry or waterlogged; and as the nitrogenous manures cannot be expected to persist very long in the soil, their application should be timed so as to be followed by a period of growth with neither excessive rain nor a dry soil.

*Sugar cane.*—A large number of experiments have been conducted with sugar cane, and, though the results naturally vary in the different countries, certain general conclusions can be drawn. Before planting, a comparatively slow acting nitrogenous fertiliser should be used, either the equivalent of farmyard manure or some seed residue like castor pomace, to supply about 100 lb. of nitrogen per acre. For the ratoon growths more active forms of nitrogen are desirable—either sulphate of ammonia or nitrate of soda supplying 50 lb. of nitrogen per acre; which of the two will prove the more suitable depends upon the soil. Excess of nitrogen must be avoided, as it induces late cane and an impure juice. On many soils applications of potash salts (sulphate of potash is generally the most economical form) are very effective. Phosphates are less needed, though superphosphate is often valuable on black alluvial soils.

*Cotton.*—Cotton responds freely to fertilisers, and there is evidence that the fertiliser should be a mixed one but mainly phosphatic. About 4 cwts. per acre of superphosphate and 2 cwts. per acre of cotton seed meal or some equivalent organic source of

nitrogen, should be ploughed in before sowing, and this may be followed up by a  $\frac{1}{2}$  cwt. per acre of a more active nitrogenous fertiliser like sulphate of ammonia or nitrate of soda when the crop has begun to grow. Potash manures are only required on certain soils of a light type.

*Tobacco.*—Tobacco is a crop requiring comparatively rich land, and the fertilisers should chiefly supply nitrogen and potash, phosphates being less required. Too great an amount of nitrogenous fertiliser should not be used, or the quality of the leaf falls off, up to 50 lb. per acre is safe; and ammoniacal manures should be avoided, as they result in a leaf burning badly. Before planting out the tobacco 200 to 300 lb. of an organic nitrogen compound—cotton seed meal or castor pomace—200 lb. of superphosphate and 100 lb. of sulphate of potash should be applied, followed by 100 lb. of nitrate of soda when the plant is growing. Potash appears to be very essential, and may be given as nitrate, carbonate, or sulphate.

*Tea.*—Being perennial the tea plant requires neither heavy nor active manuring; it is also very important to maintain both the proper habit of growth of the plant and the quality of the leaf. If any large amount of nitrogen is employed an excessive development of weak vegetative shoots takes place on the bush, and the plant suffers in ensuing seasons. The fertility of a tea garden as regards nitrogen can be maintained by carefully burying the lighter prunings and weeds, and by digging in from time to time leguminous plants which have been grown between the rows, cut down, and allowed to wither and rot somewhat. By also supplying basic slag at the rate of about 2 cwts. per acre the residues thus utilised are balanced by the phosphates, and the lime of the basic slag is beneficial in keeping the soil healthy

and in assisting the decay of the organic matter. When manures are necessary it is best to employ slow acting substances like bone meal and castor pomace.

*Garden manures.*—In an ordinary way gardens require little artificial fertiliser, since they receive a superabundance of stable manure until the soil often becomes over-rich in nitrogenous residues. Under such conditions the only fertiliser wanted will be some form of phosphatic manure, and this is very desirable to induce a properly balanced growth in the crops. Superphosphate may be used on the loams, basic slag on the strong soils, steamed bone flour or phosphatic guano when the soil is sand or gravel, and about  $\frac{1}{4}$  lb. per square yard of one of these fertilisers should be dug in with the farmyard manure on those portions of the ground which come to be dunged in the usual rotation. Nitrate of soda is often valuable to push on early lettuce, cabbage, peas, etc., in a backward spring; it may also be applied with advantage to asparagus and celery. The compound garden manures sold under fancy prices should be avoided: though good fertilisers enough, their cost is excessive, even considering the small parcels in which they are sold. Where stable manure is not available and a mixed fertiliser is required, nothing is better than a good Peruvian guano with 6 or 7 per cent. of nitrogen. In such circumstances the humus of the soil should be maintained by digging in as much organic matter—weeds, grass clippings, vegetable refuse, etc.—as possible, and by growing mustard on any land that is not wanted for a short time, and digging the green crop in. It should not be forgotten that lawns which are constantly cut must become greatly impoverished if they are not manured, for which purpose Peruvian guano at the rate of 2 oz. per square yard every other year forms

a suitable dressing. When Peruvian guano or any similar concentrated fertiliser is used to enrich potting soil, the mixture should be allowed to stand a week before potting, because guano and all kindred manures, when in a raw condition, are very destructive of young plant roots.

## CHAPTER XII

### THE VALUATION AND PURCHASE OF FERTILISERS

Valuation on the Unit System—The current Market Price of the Unit of Nitrogen, Phosphate of Lime and Potash—Variations in Unit Values due to Market Fluctuations—Valuation of Fertilisers before Purchase—The Fertilisers and Feeding Stuffs Act; Obligations of the Vendor—Sampling Consignments of Fertilisers—Mixed *v.* Unmixed Fertilisers—Incompatibles—Residues of Fertilisers after the Growth of one or more Crops—Valuation of unexhausted Residues derived from the Consumption of purchased Feeding Stuffs.

IN buying fertilisers the farmer will generally have a considerable choice between materials of different origin and composition, but which will so far serve the same purpose that their relative price becomes the most important factor in determining the purchase of one or the other. For example, should an active nitrogenous manure be needed, for many soils and crops it is a matter of indifference whether nitrate of soda or sulphate of ammonia is used; among phosphatic manures the choice may be between superphosphate, basic slag, and a neutral manure like steamed bone flour; or, to take a case where even fewer secondary considerations enter, practically nothing but relative cheapness need determine a decision between such materials as fish and meat guanoses or rape cake. But



since all these materials possess different compositions, a method of valuation must be found which will reduce them to a common basis of the cost of the actual fertilising ingredients alone—*i.e.*, of the nitrogen, the phosphoric acid, and the potash respectively. It is possible, for example, to calculate the price per pound of each of these fundamental substances, but the more convenient method is to ascertain the cost of a unit consisting of one-hundredth of a ton; such unit cost being obtained by dividing the price per ton of the fertiliser by the percentage of the constituent in question.

It is the custom of merchants to set out the analysis of the various fertilisers in terms of both nitrogen and ammonia, and to express the phosphatic constituents sometimes as phosphoric acid but more commonly as tri-calcium phosphate, and again to give the potassium in terms of potash, whatever may happen to be the form in which the element is actually combined. For example, nitrate of soda contains no ammonia, and the statement that a given sample of nitrate of soda contains 19 per cent. of ammonia is only meant to signify that the 15.5 per cent. of nitrogen present is equivalent to 19 per cent. of ammonia. In superphosphate the phosphoric acid is chiefly combined as di-hydrogen calcium phosphate,  $\text{CaH}_4\text{P}_2\text{O}_8$ , hence an analysis setting out the presence of 26 per cent. of soluble phosphate or of tri-calcium phosphate rendered soluble, must be read as meaning that it contains 11.9 per cent. of phosphoric acid soluble in water, which amount of phosphoric acid would be also contained in 26 per cent. of tri-calcium phosphate. Similarly, muriate of potash, which is potassium chloride— $\text{KCl}$ —might be described as containing 50 per cent. of potash— $\text{K}_2\text{O}$ —though no true potash or potassium oxide is present;

the statement merely signifies that the essential element, potassium, is present in such a quantity that if it were combined with oxygen as potash the latter would amount to 50 per cent. of the fertiliser. It is therefore necessary to remember that 14 of nitrogen are equivalent to 17 of ammonia, and that 142 of phosphoric acid are contained in 310 of tri-calcium phosphate (see p. 377), but that necessity of making such calculations is obviated by the fact that in the United Kingdom dealers in fertilisers are now obliged to give the analysis of their wares in terms of nitrogen, tri-calcium phosphate, and potash, on which basis the calculations which follow will be made.

The prices given are the wholesale prices ruling in London in October 1908; naturally they do not hold for other times and places, and they do not include carriage, but they are comparable among themselves and with due additions for the locality show the range of prices which may be expected at the present time.

In order to find the price of nitrogen, we can take nitrate of soda and sulphate of ammonia, which contain nitrogen only, and calculate the unit value as follows:—

TABLE XCVI.—PRICE OF UNIT OF NITROGEN.

	Price per ton.	Nitrogen, per cent.	Unit-value of Nitrogen.
Sulphate of Ammonia . . .	£11, 15s.	19.75 to 20.0	12s.
Nitrate of Soda . . .	£10	15.0 ,, 15.5	13s.

In making this calculation the farmer must be careful to base it upon the price per ton delivered at his local station, since freight charges fall more heavily on the less concentrated manures, to such an extent indeed that at distant points the relative cost

of different fertilisers may be entirely altered by the carriage charges. In the instances quoted above the two fertilisers contain nitrogen only and the calculation is consequently of the simplest; as a rule, however, more than one constituent is present. The unit values of the two have to be obtained by a little adjustment and do not possess quite the arithmetical certainty which characterises the single constituent fertilisers. Among phosphatic fertilisers there are practically only three which contain no other constituent, and in these the unit value of tri-calcium phosphate may be calculated as follows:—

TABLE XCVII.—PRICE OF UNIT OF PHOSPHATE OF LIME.

	Tri-calcium Phosphate, per cent.	Price per ton.	Unit-value of Tri-calcium Phosphate.
Superphosphate, high grade	35	66s.	1s. 11d.
Superphosphate, low grade	26	50s.	1s. 11d.
Basic Slag (1) . . .	38	48s.	1s. 3d.
Basic Slag (2) . . .	35	45s.	1s. 3d.
Basic Superphosphate .	25	52s.	2s. 1d.

The unit is dearer in the superphosphates because acid has been employed to render them soluble in water.

Supposing it is now desired to find the value of the phosphate unit in certain other fertilisers which also contain a little nitrogen, it is necessary to make a deduction from the price of the fertiliser for the nitrogen present, assuming this latter to have approximately the value calculated from such purely nitrogenous fertilisers as the nitrate of soda already quoted. For example, steamed bone flour containing 1.25 per cent. nitrogen and 59 per cent. tri-calcium phosphate is quoted at £4, 7s. 6d. per ton; taking nitrogen at 13s. per unit the 1.25 per cent. would be worth 16s. 3d., which

deducted from £4, 7s. 6d. leaves £3, 11s. 3d. for the phosphate. Dividing this figure by 59 (the percentage of phosphate), we get 1s. 2½d. as the price of the unit of phosphate of lime.

Calculating in this way, the following figures are obtained for phosphatic manures containing some nitrogen:—

TABLE XCVIII.—PRICE OF UNIT OF PHOSPHATE OF LIME.

	Price.	Nitrogen, per cent.	Value at 13s. per unit.	Phosphate, per cent.	Valuation per unit.
Steamed Bone Flour.	87s. 6d.	1.25	16s. 3d.	59	1s. 2½d.
Bone Meal . . .	105s.	4.0	52s.	44	1s. 2½d.
Phosphatic Guano .	110s.	2.5	32s. 6d.	58	1s. 4d.

We have thus obtained a valuation for tri-calcium phosphate ranging from 2s. per unit for its water soluble form in superphosphate, down to 1s. 3d. or less per unit in bones or phosphatic guanos.

Potassic fertilisers do not show a large variation, the more concentrated and purified forms being naturally somewhat the more costly, as follows:—

TABLE XCIX.—PRICE OF UNIT OF POTASH.

	Potash, per cent.	Price.	Unit Value.
Sulphate of Potash . . .	48 to 50	200s.	4s. 1d.
Muriate of Potash . . .	50 ,, 52	180s.	3s. 7d.
Kainit . . . . .	12 ,, 13	47s.	3s. 9d.

In dealing with mixed fertilisers the nitrogen is generally the more important element to consider, as being the most valuable and the most subject to

variations in price; its unit value is, therefore, the one to be determined after deductions have been made for the phosphates and potash at the rates quoted above. For example, in the fish, meat, and oil cake residues the phosphates are all of much the same order of solubility and may be valued at the same rates, the small amount of potash present also may be neglected, so that the following range of values is obtained for the nitrogen:—

TABLE C.—UNIT VALUES IN MIXED FERTILISERS.

	Price.	Phosphates.		Nitrogen.	
		Per cent.	Value at 1s. 3d. per unit.	Per cent.	Cost per unit.
Fish Guano, 1 . . .	140s.	15.0	18s. 9d.	8.0	15s. 2d.
Fish Guano, 2 . . .	120s.	11.5	14s. 4d.	6.0	17s. 7d.
Meat Guano, 1 . . .	130s.	9.0	11s. 3d.	8.5	14s. 0d.
Meat Guano, 2 . . .	110s.	27.0	33s. 9d.	6.0	12s. 8d.
Dried Blood . . .	190s.	5.0	6s. 3d.	12.5	14s. 8d.
Bone Meal . . .	105s.	44.0	55s. 0d.	4.0	12s. 6d.
Rape Meal . . .	110s.	5.0	6s. 3d.	4.5	23s. 1d.

The variation in the price of nitrogen in these very closely related manures is therefore enormous, and the important thing to realise is that these variations do not represent intrinsic differences in value—*i.e.*, greater or less effectiveness in producing crops—but are market variations due to temporary or local fluctuations of supply and demand. As far as anyone knows the nitrogen and phosphoric acid in fish guano are exactly of the same value to the crop as in meat guano, and only a few years ago they were to be obtained much more cheaply in fish guano, the present high price of which is due to a recent falling off in the supply, coupled with a large new demand from Japan. Just in the same

way, rape dust was formerly almost as cheap a source of nitrogen as nitrate of soda and established itself in the favour of hop growers and other farmers, who have continued to demand it in the face of a falling supply until the price per unit of nitrogen has been forced up to nearly double its former level.

In Peruvian guano the potash must also be taken into account, and some of the phosphoric acid is water soluble, so that a higher allowance must be made on that account.

When all these allowances have been made, it will be found that the unit value of either nitrogen or phosphoric acid shows considerable variation in passing from one fertiliser to another, and that the relative position fluctuates from time to time. Even in fertilisers so similar in their use as nitrate of soda and sulphate of ammonia the unit of nitrogen rarely possesses the same price; sometimes one and sometimes the other is the cheaper, the changes being determined by factors of supply and demand outside the fertiliser market, or by the operations of the combinations controlling the production and sale of each commodity. Furthermore, in comparing the price of the unit of nitrogen generally, it is not as might be expected at its highest in the most active fertilisers such as nitrate of soda, in which form experiments have shown it to be most available to the crop. On the contrary the experience of the market shows that farmers are willing to pay more per unit for nitrogen in organic than in inorganic combinations, thus indirectly bringing into the account the value of the organic matter in maintaining the texture of the soil. The prepossession arising from an old experience of the well-balanced nature of the manure and its safety under almost any conditions also counts in the farmer's

estimation of a fertiliser; for example, the Peruvian guanos have been favourably known for so long that they always command the highest unit value. Unmixed fertilisers, which require combining by the farmer and so demand more knowledge in their use, are generally the cheaper; and as a rule, little attention is paid to the imperfect availability of the slow-acting forms of nitrogen, only the shoddies show any such lowering of the unit value as would compensate for their low availability.

It is impossible, in fact, to reduce all fertilisers to a common basis and choose among them simply according to the unit value; the wheat grower who wants a nitrogenous top dressing must choose between nitrate of soda, sulphate of ammonia, and soot, to which nitrate of lime and cyanamide may nowadays be added; the hop grower requiring an all-round spring fertiliser would not get the quality of growth from a mixture of superphosphate and sulphate of ammonia that is equivalent in nitrogen and phosphoric acid to the guano he usually employs, though a fertiliser made up from the former substances might be perfectly satisfactory to the grower of barley or Swede turnips. The advantages of the unit system of valuation really come in the means of comparison it affords between fertilisers of closely related origin but different composition, as, for example, between the fish and meat guanos in Table C.; it rarely happens but that a careful enquiry will not reveal on the market some one fertiliser of the desired kind which is considerably cheaper than the rest.

To this end it is generally more convenient to make a slight change in the form of valuation just described; instead of calculating out for each manure the unit value of the constituents, we may take a standard series of

such values and compare the actual price with the estimates formed on that basis. In such comparisons it is not necessary to know the exact current unit value of each constituent, as long as a due proportion between them is preserved, and it will be sufficiently accurate to use what are approximately the rates prevailing in 1908, viz. :—14s. per unit for nitrogen, 1s. 3d. per unit of insoluble and 2s. per unit of soluble phosphate, and 4s. per unit of potash.

For example, fish and meat guanos were offered as follows :—

TABLE CI.—ESTIMATED VALUE OF FERTILISERS.

	Fish Guano, 1.		Fish Guano, 2.		Meat Meal, 3.		Meat Meal, 4.	
	Per cent.	Value.	Per cent.	Value.	Per cent.	Value.	Per cent.	Value.
Nitrogen, at 14s. . .	7½	= 105s. od.	10½	= 147s. od.	7	= 98s. od.	6	= 84s. od.
Phosphates, at 1s. 3d. . .	13	= 16s. 3d.	15	= 18s. 9d.	30	= 37s. 6d.	20	= 25s. od.
Estimated value per ton		121s. 3d.		165s. 9d.		135s. 6d.		109s. od.
Sale price .		146s. 3d.		190s. od.		127s. 6d.		115s. od.

Clearly, among these manures No. 3 is much the cheapest fertiliser, while No. 1 is exceptionally dear; unless there was something wrong with the mechanical condition of No. 3 there is nothing in the relative nature of the fertilisers to prevent the farmer taking advantage of its lower cost.

The example just quoted, which was derived from actual experience, shows the importance to the farmer of a careful consideration of the analysis of fertilisers on sale; too much stress cannot be laid on the necessity of conducting all transactions regarding fertilisers on such



a basis of exact knowledge, especially as the farmer has no difficulty in obtaining the analyses beforehand or in checking the results on delivery. The trade in fertilisers is regulated by the Fertilisers and Feeding Stuffs Act of 1906, according to which "Every person who sells for use as a fertiliser of the soil any article which has been subjected to any artificial process in the United Kingdom, or which has been imported from abroad, is required to give to the purchaser an invoice stating the name of the article and what are the respective percentages (if any) of nitrogen, soluble phosphates, and potash contained in the article, and the invoice is to have effect as a warranty by the seller that the actual percentages do not differ from those stated in the invoice beyond the prescribed limits of error."

Certain limits of error are laid down for each fertiliser in the regulations accompanying the Act; for instance, one grade of superphosphate is guaranteed to contain 26 per cent. of phosphates made soluble; the warranty implied is that the fertiliser contains 27 to 25 per cent., and that the purchaser can sustain a claim against a vendor if the percentage has fallen below 25 per cent. Vendors of manures are no longer allowed to give nominal guarantees such as 1 per cent. of nitrogen; any statements of composition, made either verbally or in a circular about the fertiliser, have all the effect of a warranty.

Every county council and county borough is bound by the Act to appoint an agricultural analyst, who for a fee (generally small) must analyse and report on samples sent to him, provided these samples have been taken within ten days of the receipt of the fertiliser or of the invoice. The purchaser must supply a copy of the invoice to the analyst, but may omit therefrom the name of the vendor. The samples for analysis must, of

course, be taken with great care; an official sampler can be called in, and this will be the wisest course to follow when the purchaser has any reason to suspect fraud. When the farmer samples himself he must select a certain number of bags, two for the first ton in the consignment and one more for each other ton up to ten bags, empty the contents of each on to a clean dry floor, work it up and set aside a spadeful from each, either separately or one after the other. These spadefuls must then be thoroughly mixed, all lumps broken down, and 4 to 6 lb. taken out for the sample for analysis. It is never right merely to open the bags and take out a spadeful from the mouth of each; most fertilisers, especially heavy powders like basic slag, will show considerable differences between top and bottom of a bag which has been in transit for some time. The sample as soon as taken should be put in a clean dry bottle or jar, and either corked or fastened up with a bladder or other waterproof packing; it must never be allowed to lie about in a package or tin to gain or lose moisture.

Now that every farmer in the country can so readily and cheaply obtain an analysis of any fertiliser he purchases, for besides the county agricultural analyst most of the large agricultural societies have retained an analyst for the assistance of their members and the agricultural colleges also undertake analyses for the farmers resident within the area they serve, he ought to get analyses made of every purchase of certain classes of fertiliser, if he has any regard to the economical conduct of his business. While it is true that with very few exceptions the manufacturers and vendors of fertilisers are strictly honest and only wish to supply the farmer with the material they have undertaken to sell, still a great number of fertilisers

are, from their mode of origin, subject to variations of composition which may escape the notice of the vendor himself. As regards the pure unmixed fertilisers, standard articles made on an enormous scale, such as nitrate of soda, sulphate of ammonia, superphosphate, kainit, and sulphate of potash, any farmer dealing with a reputable firm may count on getting what he pays for, because these materials do not vary in composition except they have been deliberately falsified after they have left the wholesale hands. But with basic slag, guanos, fish, meat, and bone compounds, so many different samples exist of varying composition, and so easily may even a single cargo show differences in passing from one part to another, that the farmer will be always wise to check his purchases by an analysis, not of course of the sample that may be submitted to him before purchase, but of the consignment on arrival.

The farmer should buy his fertiliser on the strength of the analysis or guarantee which he must get from the vendor before he gives his order, and on which he should work out a valuation by the method described earlier in the chapter; he must then be careful to see that the invoice agrees with the guarantee on which he bought, and check the invoice by getting an analysis made of a sample drawn from the bulk delivered. But in both his own interests and those of the vendor the farmer must take some trouble over the sampling; a good many of the disputes that arise between the two parties are due to careless sampling or to the storage of the sample afterwards where it can lose or gain moisture.

In order to exercise to the full his power of buying in the cheapest market prevailing, it is clearly necessary for the farmer to know with some exactitude the kind

of fertiliser he wants for the crop in question, so that he can compound the available materials in the right proportions and not be dependent upon the much more limited range of fertilisers already mixed by the manufacturer. For example, every merchant's catalogue will show examples of turnip manures, barley manures, mangold or grass manures, containing such mixtures of nitrogen, phosphoric acid, and potash as experience has shown to be generally suitable to the crops in question. In such cases the farmer gets the advantage of the knowledge of the merchant and also obtains a carefully mixed fertiliser of even composition throughout, which can be distributed without further trouble. Such mixtures, however, can only represent a certain average adaptability to the crop and cannot take into account either the particular kind of land or the condition it has been left in by previous cropping. The farmer who has really made himself acquainted with the theory of manuring and with the special conditions of his own land can always manure both more cheaply and more effectively by purchasing unmixed fertilisers. These he must either sow separately, or by paying a little extra to the merchant he may get made up whatever mixture he desires before delivery. It should not, indeed, be a matter of any difficulty to make up a sufficiently accurate mixture on the farm itself, all that is necessary being a suitable weighing machine and a floor with a space cemented or paved, on which lumps can be crushed. The heaps of separate manures should be weighed out and thrown into a common heap by alternate shovelfuls; the mixture should be then passed through a half-inch screen and the lumps broken down with a wooden rammer or the back of a shovel, the resulting heap being cast down and remade two or three times until it is uniform in appearance.

It must be remembered that certain fertilisers cannot be mixed together without setting up reactions which are either wasteful or render the mixture difficult to work. Basic slag and basic superphosphate cannot be mixed with sulphate of ammonia or guano or any other fertiliser containing ammonium salts, because the caustic lime reacts with the ammonium salts and sets free ammonia, which escapes as a gas. Superphosphates cannot long remain mixed with nitrate of soda without setting free a certain amount of nitric acid, which is both wasteful and injurious to anyone handling the mixture. It is, however, safe enough to make up the mixture and sow it straight away; the nitric acid only begins to be in evidence when the mixture is left in a heap or in bags overnight, or when it is sown from a machine which has some moving part working in the manure. Most mixtures containing superphosphate will turn into a paste round machine parts working in the material. Kainit and superphosphate will also begin to set free hydrochloric acid if they are left long together.

Superphosphate, either mineral or bone, can be safely mixed with sulphate of ammonia or guano or any of the fish or meat compounds, but the only nitrogenous fertiliser that can properly go with basic slag is nitrate of soda. In any case, however, these latter are better sown separately because they differ so much in density and fineness that the mixture would separate very much in sowing; very rarely, indeed, would anyone want to sow them at the same time. Of course lime, like basic slag, should never be mixed with sulphate of ammonia or any of the guanos or organic nitrogen fertilisers.

Under ordinary conditions of farming, however, very little mixing will be required, partly because the

manures are adjusted to the various crops in the rotation, and partly because it is generally advisable to apply the nitrogenous fertilisers as top dressings at a later period than the phosphatic or potassic manures.

One other question of valuation and price comes into play in connection with fertilisers, and that is the value of the residues left behind in the soil after one or more crops have been grown. The provisions of the Agricultural Holdings Act of 1900 award the tenant compensation for any unexhausted fertility he has brought to and leaves behind on the holding. A tenant, for example, who has given his grass land a dressing of 10 cwts. per acre of basic slag and then leaves his farm within the following two years will by no means have reaped the full benefit the land has derived from its treatment. On the other hand, a tenant who has used nitrate of soda to grow his last crop of oats or wheat, and then sells the grain produced, will have obtained all that the manure can return; no nitrogen will be left behind in the soil for the benefit of the succeeding tenant.

It is thus necessary to consider each fertiliser separately and attach some value to the residue left behind after one or two crops have been grown since its application. It cannot, however, be said that proper data exist for the compilation of such a scale of compensation; it is not sufficient to estimate what proportion of the fertilising materials that have been applied the crop may be expected to remove, and then assume that the remainder is available for future crops. Experiments already quoted will have served to show that residues of slow-acting fertilisers, such as farmyard manures and shoddy, are very far from being wholly recovered even after such long intervals of time as would render any compensation quite out of the

question. To a certain extent, again, the value of the residue left by a particular fertiliser will be determined by the nature of the land and the crop to which it has been applied; kainit applied to heavy clay land would not add to the value of the land, but on the other hand the benefit derived from the application of fertilisers to grazing land is largely cumulative, depending upon the change it effects in the botanical composition and quality of the herbage, so that the benefit may be greater at the end of the third or fourth year after application than earlier. Certainly no *a priori* rules for compensation based upon purely theoretical considerations can be laid down; any scale of compensation must be based upon experiments only and must always be considered as approximate and subject to revision according to the particular conditions of soil and cropping.

Experiments instituted at Rothamsted to provide data for drawing up such a scale have not progressed far enough to eliminate the experimental error that occurs in dealing with such small quantities as are involved in the residual effects of most fertilisers after one or two crops have been grown. The crude practice adopted by many valuers of allowing to the outgoing tenant half the cost of the purchased fertilisers he has applied during the last year of his tenancy, can find little or no justification, and in the case of such substances as nitrate of soda and sulphate of ammonia is obviously unjust to the incoming tenant, unless the manure has been applied to root crops which have been consumed on the farm. The whole subject is very complex, and data do not as yet exist for constructing any table that would serve as a basis for valuation, for the compensation to be awarded will always have to be decided on the merits of each case after due consideration of the soil and other local circumstances.

In the somewhat analogous case of the compensation to be paid to the outgoing tenant for the fertility he leaves on the farm from foodstuffs purchased and consumed during the last years of his tenancy, it is possible to draw up a fairly satisfactory scale. The custom in many parts of the country was, and still is, to allow the outgoing tenant one-half of the cost of the foodstuffs he had brought on to the farm during the last year of his tenancy, but such a system has obviously no scientific basis. The price of a given feeding stuff is determined by its value as food, not as manure; oil or fat, for example, is one of the most costly constituents of a feeding stuff and yet leaves no fertilising residue behind. Many foods, *e.g.* maize and rice, consist mainly of carbohydrates and contain an unusually small proportion of nitrogen and ash which would wholly or in part add to the fertility of the farm. The proper basis is to begin by ascertaining the nitrogen, phosphoric acid, and potash contained in each class of feeding stuff; an estimate can then be formed of how much of each of these is likely to reach the manure, and a valuation made of these latter quantities at the current rates. The difficulty lies in estimating the proportion in which the fertilising constituents will reach the manure; for example, it has already been shown (p. 199) that of the nitrogen fed to an animal anything up to 15 per cent. will be retained by the animal, and of the rest that is excreted as much as one-half may be lost in making the dung. Taking a general average from the experiments quoted, it will be seen that about one-half of the nitrogen in the food is likely to find its way to the land in the dung produced under ordinary conditions of farming. If the manure is carelessly managed the losses will be greater; on the other hand, if the food is consumed directly on the land



TABLE CII.—MANURE VALUE OF FOOD RESIDUES PER TON.

	Nitrogen.			Phosphoric Acid.			Potash.		Compensation Value per Ton for	
	Per cent. in Food.	Value at 12s. per unit.	Half value to Manure.	Per cent. in Food.	Value at 3s. per unit.	Three-quarters Value to Manure.	Per cent. in Food.	Value at 4s. all to Manure.	Last year of Tenancy.	Last year but one of Tenancy.
Decorticated Cotton Cake	6.90	83.0	41.5	3.1	9.5	7.0	2.0	8.0	56	28
Linseed Cake . . .	4.75	57.0	28.5	2.0	6.0	4.5	1.4	5.5	38	19
Beans . . . . .	4.0	48.0	24.0	1.1	3.5	2.5	1.3	5.0	32	16
Maize . . . . .	1.7	20.5	10.0	0.6	2.0	1.5	0.37	1.5	14	7

the only loss will be the amount retained by the animal. Similarly, milch cows will retain more than fattening bullocks, young growing stock than work horses; and again, these variations will be set off by the fact that both milch cows and young stock are largely fed on the land.

Taking these and other considerations into account J. A. Voelcker and the author have constructed a scale of compensation for purchased foods, which has been largely adopted by valuers in practice, on the following basis—one-half the nitrogen, three-quarters of the phosphoric acid, and the whole of the potash in the food consumed during the last year of the tenancy will be found in the dung, while of the food consumed in the previous year only one-half of these latter values will remain on the farm. Thus the figures given in Table CII. are obtained for 1 ton of purchased foods.

A more complete set of figures for the foods in general use may be found in *J. Roy. Ag. Soc.*, 1902, p. III, or in a report published by the Central Chamber of Agriculture.

Of course, no such table can hope to be more than an approximation to the truth; as has been indicated above, the style of farming must introduce variations special to each case, nor can the table take into account any bad management of land or manure on the part of the farmer. The table assumes ordinary mixed farming and reasonably good management of the dung heap.

## CHAPTER XIII

### THE CONDUCT OF EXPERIMENTS WITH FERTILISERS

Magnitude of Experimental Error involved in Field Experiments  
—Choice of Land for Field Experiments—Size and Shape of  
Plots—Machines for sowing Fertilisers—Should Farmers con-  
duct Experiments upon their own Land?

THE value of any fertiliser, new or old, on any particular soil can only be settled by experiment; for though it is now possible to a large extent to recognise types of soil by their analysis and predict their behaviour, because the main outlines of the principles of the manuring are understood, yet unknown factors will often intervene and upset expectations. The proper conduct of field experiments is therefore a matter of considerable moment, and it is of particular importance that the degree of accuracy which may be expected from a series of such trials should be realised before any scheme of experimentation is embarked upon. One often sees experiments so designed that the differences between the plots are likely to be less than the experimental error; still more often one sees conclusions drawn from differences between the yields of the plots that are smaller than the experimental error. Nor must it be supposed that by any amount of care the experimental error can be got rid of; there are various ways by which it may be diminished, but in some form

or other it must exist in all work involving measurements, and the only scientific method of dealing with it is to estimate its magnitude and to draw no conclusions from results which are not well outside that magnitude. For example, the experimental error of a field plot on average soil and under ordinary farming conditions in this country may be taken as about 10 per cent.; this means that if the yield of the standard Plot A be taken as 100, and another Plot B yields 109, while a third C yields 91, the conclusion cannot be drawn that B is better than A, and A better than C, because the same variations in the results might have been seen had the three plots been treated exactly alike. Furthermore, unless the real difference brought about by two different methods of treatment is greater than 10 per cent., it is hopeless to expect to reveal the difference at all by a single pair of experimental plots.

These points may be illustrated by actual examples drawn from the Rothamsted experiments, where the soil conditions are fairly uniform, though by no means exceptionally so, and the control and management is about as good as they can be under ordinary farming conditions.

On the grass fields are two unmanured plots almost at the two extremities of the field, and taking a fifty years' average, one of these plots (No. 12) is 10 per cent. better than the other (No. 3), owing to some fundamental superiority of soil or situation. Table CIII. (pp. 361-2) shows the actual results given by these plots year by year, reduced to a common standard by taking the yield of Plot 3 in each year as 100.

It will be seen that though on the average of the whole period Plot 12 is represented by 110 when Plot 3 is 100, yet there are twelve occasions when Plot 12

TABLE CIII.—ACTUAL AND RELATIVE YIELD ON TWO UNMANURED GRASS PLOTS. ROTHAMSTED.

	Yield of Hay.		Relative Yield of Plot 12. Plot 3=100.	Mean of Plot 12. 5-year periods.
	Plot 3.	Plot 12.		
	Lb.	Lb.		
1856	2515	2351	93	} 105
1857	2856	2592	91	
1858	2472	3360	136	
1859	2540	2576	101	
1860	2760	2884	104	
1861	2844	3304	116	} 121
1862	3052	3424	112	
1863	2284	2844	125	
1864	2688	2808	104	
1865	1296	1932	149	
1866	2660	3012	113	} 128
1867	3332	3048	91	
1868	1960	2676	137	
1869	4256	4352	102	
1870	644	1260	196	
1871	2844	2960	104	} 121
1872	1644	2252	137	
1873	1372	1804	131	
1874	1412	1642	116	
1875	3620	4232	117	
1876	1384	1599	116	} 108
1877	2364	2165	92	
1878	1848	1832	99	
1879	3028	3157	104	
1880	848	1081	127	
1881	1480	1393	94	} 102
1882	2524	2340	93	
1883	2266	2322	102	
1884	1804	1996	111	
1885	2101	2339	111	
1886	2547	2672	105	} 96
1887	1471	1330	90	
1888	2296	2298	100	
1889	2638	2383	90	
1890	1648	1565	95	

TABLE CIII.—Continued.

	Yield of Hay.		Relative Yield of Plot 12. Plot 3=100.	Mean of Plot 12. 5-year periods.
	Plot 3.	Plot 12.		
	Lb.	Lb.		
1891	2060	2422	118	} 114
1892	1627	2130	131	
1893	391	487	125	
1894	2685	2538	95	
1895	1402	1399	100	
1896	1144	1272	111	} 123
1897	1742	2048	118	
1898	1922	2256	117	
1899	1342	1788	133	
1900	1379	1859	135	
1901	455	765	168	} 121
1902	1004	1200	119	
1903	1509	1571	104	
1904	2949	2872	97	
1905	1936	2297	119	
Average	2057	2254	110	...

yielded less than Plot 3, while in a single year Plot 12 has risen as high as 196 per cent. or fallen as low as 90 per cent. of Plot 3.

Applying what is known as the method of least squares to the results, we can calculate that the mean error of a single result is  $\pm 10$  per cent., and that the probable error of the fifty years' mean is  $\pm 1.9$  per cent. In other words, Plot 12 is probably better than Plot 3 by more than 8.1, and less than 11.9 per cent.; but this superiority could never be assured from a single year's experiment, because it is smaller than the mean error, which is equal to a 10 per cent. difference between the two plots. The probable error is always reduced by the number of trials; if the fifty years are

collected into ten groups of five years each, we should get the following figures for Plot 12—105, 121, 128, 121, 108, 102, 96, 114, 123, 121. In all cases except one the five years' average of Plot 12 is higher than that of Plot 3, and as we can calculate as before that the mean error attached to each figure is  $\pm 10.5$ , we could hardly have concluded with confidence from any five years' series that Plot 12 was superior to Plot 3, and the extent of the superiority would have remained unknown.

To take another example, Table CIV. represents the results of five years' experiments with different crops on five similarly treated plots in Little Hoos field, reduced each year to a common standard by taking the mean of the five as 100.

TABLE CIV.

Plot.	1904.	1905.	1906.	1907.	1908.	Mean of 5 years.
A	98.1	88.8	95.8	86.3	92.8	92.3 $\pm$ 1.4
B	95.8	92.4	90.6	95.1	94.9	93.7 $\pm$ 0.7
C	101.0	98.9	99.2	102.4	100.2	100.3 $\pm$ 0.6
D	101.7	114.1	105.0	109.1	114.9	109.0 $\pm$ 1.7
E	103.4	105.8	109.2	107.0	97.3	104.5 $\pm$ 1.4

Again, it will be seen that the variations from the mean of the single plots in any given year are considerable, the mean error being  $\pm 7.5$ , on the assumption that all the plots should be exactly alike. But from the five-year means there would seem to be some constant difference in the plots, which improve from A to D, though the superiority indicated is still of much the same magnitude as the experimental error, and that can only be reduced by continuing the trials over a longer series of years.

It will not be necessary to go into further detail, but the above numbers illustrate the general principle that

as an error of 10 per cent. or so must be expected in the returns from a single plot, this error must be taken into account in the design of any scheme of field experiments.

For example, if trial plots are being laid out and are only expected to continue a single year, it would be useless to include among them a comparison of sulphate of ammonia and nitrate of soda containing equal amounts of nitrogen. There is abundant evidence that the superiority of the nitrate of soda is somewhere about 10 per cent.; but as this is no more than the expected experimental error a single experiment must be inconclusive. If it is important to settle for the particular soil the relative value of nitrate of soda and sulphate of ammonia more plots must be given up to this one question; at least five would be needed, and even then there would remain a possibly considerable error due to the season.

This suggests that the prime consideration in designing a set of field experiments should be to limit the scheme strictly to certain definite questions which can be answered in the time and space available. There should be no haphazard laying-out of plots with all sorts of variations of manuring; the problems to be solved should be clearly thought out beforehand; it will generally be found that only a very small number of problems can be attacked at one time and every plot should be arranged to contribute to the result without the introduction of any secondary or disturbing factors.

As to the choice of land for experimental plots little can be done beyond exercising ordinary discretion in selecting a field which promises to be uniform. The geological drift map should be consulted, and places marked by thin patches of drift or on the boundaries of



one or more outcrops should be avoided; trial holes should be sunk to see that the depths of soil and subsoil are fairly uniform; thin soils on the chalk or limestone should be avoided, because of the very irregular surface of the underlying rock. Naturally, sharp slopes should be avoided; if there is any gradient, the plots should be laid out to run parallel to one another up and down the slope, so that each plot shares both the higher and the lower levels. Other points will suggest themselves; speaking generally, the opinion of an intelligent farmer well acquainted with the land is the most valuable guide. It has been suggested to weigh up a number of areas when the field is in ordinary crop, but, as indicated above, the normal variations are so great that several years of such trials would be required to arrive at any exact conclusion. The condition of the land is equally important, land in high condition should be avoided, since for some years at least the effect of the manures would be swamped and all the plots would give very similar results. On the other hand, bad land is not desirable, if the object is to illustrate the action of fertilisers and not to work out a method of dealing with that particular class of land; good land in poor condition after two or more white straw crops is the best. Care should also be taken to ascertain that the field has not been cropped or manured irregularly for the five or six years previous to the trials; it is astonishing how long the disturbing effect of farmyard manure or a leguminous crop, or folding sheep on a portion only of a field, will persist and become manifest under experimental conditions.

The size of experimental plots is a matter on which there are considerable differences of opinion; on the one hand, large plots smooth out the small irregularities due to minor differences of soil and drainage, insect

attacks, and preparation of the land ; errors of weighing and measuring are also proportionally reduced by being spread over the larger quantities involved. On the other hand, the larger plots mean greater risks of meeting with irregular patches of soil, and much greater difficulty is experienced in getting the cultivation of all the plots carried out under uniform conditions. It is of the first importance that the whole of the experimental land should be worked on the same day ; autumn ploughings perhaps matter least, but spring ploughings and cultivations, and above all seeding, should be carried through in a single day. Otherwise, if part of the land is worked and left and then the weather changes, a considerable interval may elapse before the operation can be completed, and a new factor, often of considerable magnitude, is thus introduced into the results. Sometimes large plots are necessary to obtain sufficient material for further investigation ; account, too, should be taken of the facilities for weighing up the crop ; if no weighbridge large enough to take a cart is available on the farm it is difficult to deal with large areas. Speaking generally, it may be said that with due care a plot one-twentieth of an acre can be made to answer all ordinary purposes. But whether large or small the most important point is to repeat the plots on some regular system about the ground, and to have four or five similar plots of one-twentieth of an acre for each treatment rather than one of a fifth or a quarter of an acre. In the Danish experiments conducted by Dr Sonne upon the relative value of different varieties and management of barley, which may be taken as the most carefully elaborated series of field trials for practical purposes which have ever been carried out, the plots are about  $\frac{1}{25}$  acre each, and at any one station there are always four plots

receiving the same treatment, arranged about the field as follows :—

A	F	E	G
B	G	D	F
C	A	C	E
D	B	B	D
E	C	A	C
F	D	G	B
G	E	F	A

In this way the experimental errors due to inequalities of soil and other accidentals are greatly reduced. With several stations repeating the same experiment in different districts the effects of soil may also be largely eliminated, and in the course of a single season a result can be obtained which is only subject to the error due to variations of season. The shape of the plots should be long and narrow rather than square, as this tends to equalise the soil conditions, and their breadth should be chosen to give each exactly the same number of rows of roots or corn, as the case may be, a point which must be closely watched in seeding. When the plots are continued for more than one season, some method must be adopted to mark their position permanently, but posts at the corners interfere with cultivation and are often in consequence taken up by the labourers. At Rothamsted the method adopted is to set out the plots initially in the field, keeping the boundaries well away from the hedges and trees (the soil on the headlands of a field is generally irregular, and trees have a very wide-reaching effect), and then mark the outside lines of the experimental area by means of stout posts painted white and set in the hedges round the field. These being out of the way

are subject to no disturbance until they need renewing through decay, and they afford sighting lines along which lie the corners of the actual plots. Each of these corners is marked by a stake or post of creosoted oak, 1 foot long  $\times$   $2\frac{1}{2}$  inches square, sunk a foot below the surface, so as to be out of the way of the plough or any other cultivating tools. When the time comes for setting out the plots before sowing the manures, the operator measures off along the sighting line the known distance to the corner of the first plot and then probes the ground with a pointed steel rod until he finds the buried post, above which he sets up a temporary but sufficiently conspicuous stake. Proceeding in the same way he marks the corners of all the plots, after which the manures can be sown and the temporary stakes removed before the manures are ploughed or harrowed in. As a rule it is desirable to set out the plots with paths or dividing strips between; division strips are particularly necessary on arable land to prevent the plough carrying manured soil from one plot across on to the next. Paths result in a stimulus, "the fallow effect," to the outside row whether of corn or of roots; consequently each plot must be bordered by the same extent of path; in some respects it would be better to dispense with them, but the necessity of studying the plots during growth, and often of showing them to large numbers of people, renders them indispensable. Whatever divisions are adopted, it is better to sow the whole field and strike out the paths afterwards by a hoe, care, of course, being taken to start the drills each time at the same distance from the edge of each plot.

If the plots are continued year after year, it is necessary to watch the method of ploughing; if a turnwrest plough be used, the mould-board should be set to throw the furrows opposite ways in alternate

ploughings, otherwise the manured soil will gradually be displaced sideways; if the plots are ploughed in lands the furrows should be alternately gathered to and cast away from the middle of the plot, or the manured soil will be accumulated towards the middle.

It is best to sow the manures (except the nitrates and ammonium salts) a week or so before the seed and plough them in. For sowing the manures, one of the machines to be described later is best; hand-sowing produces considerable irregularities which can only be obviated by mixing the manure with sufficient ashes or burnt earth to make up a bulk of 10 or 12 cwts. per acre and sowing the mixture in three successive operations. Calm weather must be chosen for sowing the manures; many fertilisers blow considerably if there is the least wind stirring; generally a few still hours may be secured in the early morning.

It will often be necessary, indeed always when the manures are sown broadcast by hand, to have a screen on the edge of the plot when sowing the strip which comes up to this edge. At Rothamsted a canvas-covered screen 16 feet long  $\times$  4 feet 3 inches high is carried along the edge parallel with the machine or man sowing. After sowing, the usual operations of cultivation are carried out, but rather more care than usual should be given to the singling of root crops, so as to obtain a uniformly set out plant. Gaps and misses can, on some soils, be repaired by transplanting at this stage, but it is not always desirable to do so, because one of the properties of the manure under examination may be to increase or diminish the tendency to lose plant. In all experiments with root crops the actual number of plants on the plot should be counted before harvest and recorded, as the figures often afford a means of criticising the weight results, and of estimating the effect

of the manures upon the constitution of the plant. At harvest-time cereal plots can either be cut by scythe or a small reaping-machine ; if the plots are large and the paths wide, an ordinary binder can be employed, as is done on the Broadbalk wheatfield at Rothamsted. As the sheaves are tied they must all be gathered on to the plot from which they were cut, and a distinguishing label may also be tied to each, especially if the plots are small. In some cases threshing is done in the field, but generally in the United Kingdom it will be necessary to carry the unthreshed sheaves to a rick or preferably a barn. To keep the produce of each plot separate until threshing time, a number of squares of thin canvas should be prepared, of a fabric sufficiently open to allow of the freest ventilation but not the passage of any shed corn. The bottom of the stack should begin with some non-experimental corn over which one of the canvas squares is thrown, followed by the produce of one plot together with two wooden tallies by which it can be identified. Another cloth is then spread before the produce of the next plot is stacked, and so on with the other plots. Threshing may be done with a special machine, but the ordinary travelling steam-thresher, if of modern construction, will do all that is required ; at the end of each run the screens must be removed and a little of the straw again put through the machine, so as to work out all the grain, the last pint or so of which must be extracted by hand from the hopper. The grain should be measured out bushel by bushel, and every bushel weighed and recorded ; the tail corn should be weighed as a whole ; the straw and cavings should also be weighed. Hay is best weighed as it leaves the field on the way to the stack, and as different manures are liable to lead to different rates of drying, it is well to take a weighed sample from each plot of



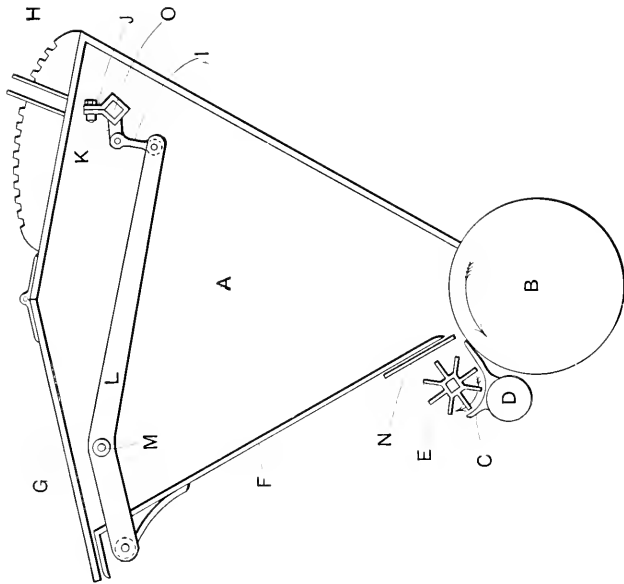

FIG. 7.

Diagrammatic Section of Manure Distributor, with Revolving Drum Feed.

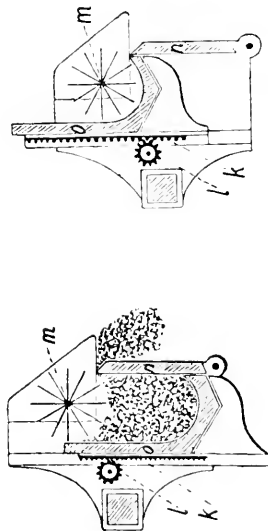

FIG. 6.—DIAGRAMMATIC SECTION OF MANURE DISTRIBUTOR—SEED DRILL TYPE.



the hay as carted, and preserve it for a dry-matter determination in the laboratory.

In dealing with root crops it is found convenient to cut the tops off and weigh them in large baskets in the field; the roots themselves are carted off to the weigh-bridge. Whatever the crop, the whole produce of the plot should be weighed; to cut out and weigh a small area introduces a fatal source of error—the selection of the area. There are a number of other precautions to take which cannot be here enumerated, but speaking generally, the original records should be as full of detail as possible; forms for the entries should be drawn up beforehand in such a fashion that there is a place for every figure obtained in the work without any additions or subtractions, and all this original material should be preserved untouched.

In the use of fertilisers, whether for experimental purposes or in practical farming, it is very important to get them distributed evenly on the land; nothing is more common in a hay or cereal crop where nitrate of soda has been used as a top dressing than to see regular waves of a darker green and stronger growth than the bulk of the crop, representing the places where the fertiliser fell from the sweep of the sower's arm. With other manures the irregularity is not so evident, partly because they are often sown before the final working of the ground, and partly because they have not the striking effect upon the colour and vegetative development of the crop that nitrate of soda has. But if artificial manures are to be sown evenly by hand, it is necessary to mix them with a much greater bulk of burnt earth or ashes and to go over the land more than once; better and quicker work will always be done by a machine if there is enough work of the kind on the farm to justify its purchase. Some fertilisers, basic slag

and ground lime in particular, are unpleasant and even dangerous to sow by hand. There are a number of different types of machine on the market, and all will do good work with unmixed dry fertilisers, though some fail to do so with mixed manures. With a mixture containing superphosphate, or still more so dissolved bones, any machine which possesses moving parts working in the manure will be sure to cause the formation of a paste which eventually clogs up the machine and puts it out of action. Whenever a farmer expects to sow mixtures, he must be careful to get a machine of which no part in contact with the manure is actively moving.

At the Rothamsted experiment station a machine made by Coultas, of Grantham, has been in regular use for some time, and answers admirably. The principle upon which the machine works will be gathered from the diagrams, Fig. 6, which show a section through the box *o n*, 8 ft. or 10 ft. 6 ins. long, which contains the manure. The manure is thrown over the lip of *n* by the revolving spindle *m*, running the whole length of the box, and furnished with a series of radial arms which dip in the manure and toss it over the lip. As the machine travels the bottom and side *o* of the manure box lift, being driven by the rack and pinion *k* and *l*, which are geared to the wheels of the machine; the side *n* of the box, however, remains stationary. The spindle is also geared to the wheels of the machine, and the rate at which it revolves, and therefore the rate at which manure is delivered, can be varied by changing the gear wheels. After it is tipped over the lip of *n*, the manure falls through a closed channel and can be delivered only a few inches from the ground, so as to avoid blowing. It will thus be seen that this machine fulfils the great desideratum of having no parts working

in the manure, its delivery can be stopped and started sharply, the rate of sowing can be accurately gauged, and by filling part of the manure box with ashes only it can be made to sow a narrow strip at the edge, should the width of the plot not form a round number of widths of the machine; thus it forms a very suitable tool for experimental work. On a very similar principle is a machine made by Messrs J. Wallace & Sons, of Glasgow, shown in diagrammatic section in Fig. 7. Here the bottom of the hopper box A, containing the manure, is formed by a revolving drum B, which carries out the manure through the aperture regulated by the adjustable slide-plate N on to the tray C, from which it is thrown so as to fall on the ground by the revolving spindle with radial arms, as in the previous machine. The rate of sowing is regulated by the size of the aperture controlled by N.

Several other makers construct machines akin in principle to the two described, in that a revolving spindle with arms corresponding to the cups of a seed drill takes up the manure and delivers it; they only differ in the way in which the manure is presented to delivery arms.

Entirely different are the machines constructed by several makers on the principle illustrated in the section Fig. 8, derived from a tool manufactured by B. Reid & Co., of Aberdeen. Here the manure is again contained in a long hopper, across the bottom of which a number of endless chains move, actuated by a series of pitch chain wheels geared to the wheels of the machine. The chains come out of the box through a narrow slit and drag with them some of the manure, which then falls to the ground; the rate of sowing being regulated by the gear wheels which actuate the spindle carrying all the pitch chain wheels. A more slowly moving

stirrer within the hopper box keeps the manure moving down to the delivery chains.

Again, on a different principle are the well-known broadcast distributors, of which an example made by Messrs J. & R. Wallace, of Castle-Douglas, is shown in Fig. 9. Here the manure is carried in a circular hopper from which it simply falls through two apertures the size of which can be regulated, the manure being kept in motion by stirrers within the hopper. The manure is, however, not allowed to fall direct to the ground, but is intercepted by two horizontal discs with radial ribs, which are kept in rapid revolution by gearing connected with the wheels of the machine. As it reaches these discs the manure is flung rapidly in all directions, and so falls on the ground over a much wider strip than the track of the machine. Machines of this type are cheap, light to drive, and handy, and are very convenient for sowing large acreages of grass land with lime or basic slag. The distribution is, however, not very uniform; if the manure is a mixture, the heavy particles are thrown further than the light, while the very lightest powders are so beaten up into a dust that they float for a considerable distance, especially in a wind; they are thus unsuited for experimental purposes or any very exact work.

The question is often raised of how far very small plots, a few yards square, cultivated with all the care and attention given by a good gardener to his plants, or even pots, can be made to serve for experimental work on fertilisers, in place of the ordinary field plots of  $\frac{1}{2}$  acre or more. For demonstration purposes they do well enough, but for investigation and local enquiry the very care with which the cultivation is carried out prevent the variations induced by the manures in the constitution

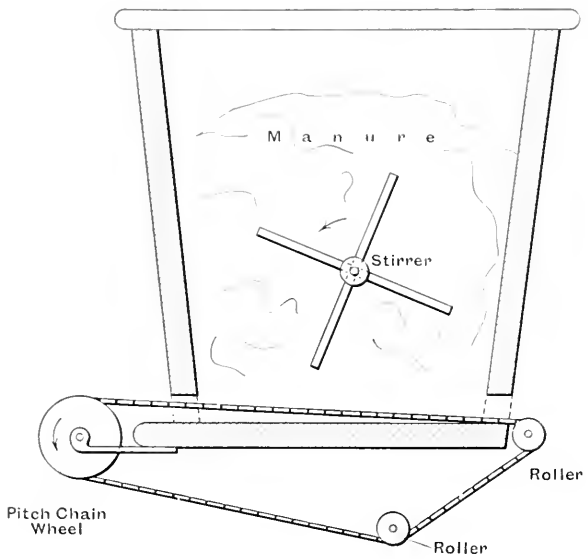

FIG. 8.

Diagrammatic Section of Manure Distributor—Endless Chain Feed Type.

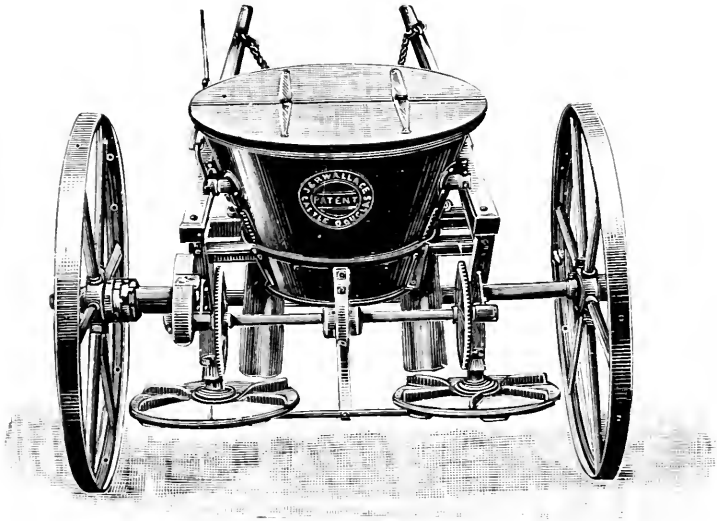

FIG. 9.—BROADCAST MANURE SOWER WITH REVOLVING DISCS FOR DISTRIBUTION.



of the plants as regards disease, insect attacks, etc., and in the texture of the soil, from having due weight. In pot work the artificiality of the conditions is increased; pot experiments are only of value to the investigator in clearing up the earlier stages of an enquiry before the applications to practice begin to be considered. Deductions from pot experiments with regard to field work must be drawn with great caution and always regarded with suspicion.

It will follow from what has been said about the care with which field experiments are to be conducted and the large margin of error inherent in their results even under favourable conditions, that they are hardly to be lightly entered upon by the ordinary busy farmer, and that the advice so often given to him to work out by experiment the manures best suited to his own farm would really involve a disproportionate amount of work. Single-handed it will take too long and cost too much to arrive at accurate results; the farmer's experimenting should be done as part of a large co-operative local trial designed to establish the characteristics of the soil on which he is working, in regard to its customary cropping. Even the usual habit of testing a fertiliser by leaving one breadth of the field unmanured may often deceive; concentrated nitrogenous manures easily show up under such conditions, because they affect the colour and vegetative appearances of the crop so markedly; basic slag, again, effects an extraordinary change in the appearance of some pastures; but, speaking generally, the effects of the mineral and some mixed manures are only to be seen in the yield. Experience shows that it is difficult to detect by eye the difference between two adjoining plots when the yield of one is 20 per cent. above the other; differences like 10 per cent. will always go unperceived. In estimating the yield of root crops the

difficulty is increased by the way the leaf takes the eye, so that a lighter but more leafy crop, due to a comparative excess of nitrogen, will generally be set down as the heavier.

In field experiments, as in all other applications of science to agriculture, the problems involved are so complex, the factors which intervene are so various and unexpected, that the greatest rigour and technical skill are called for in the conduct of the investigation, to be followed by an even greater measure of scientific caution in interpreting the results.



TABLES FOR THE CONVERSION OF NITROGEN INTO AMMONIA AND PHOSPHORIC ACID INTO TRI-CALCIUM PHOSPHATE.

Ammonia.		Nitrogen.		Nitrogen.		Ammonia.
1	=	.8235		1	=	1.214
2	=	1.647		2	=	2.429
3	=	2.471		3	=	3.643
4	=	3.294		4	=	4.857
5	=	4.118		5	=	6.071
6	=	4.941		6	=	7.286
7	=	5.765		7	=	8.500
8	=	6.588		8	=	9.714
9	=	7.412		9	=	10.93

Tri-calcium Phosphate.		Phosphoric Acid.		Phosphoric Acid.		Tri-calcium Phosphate.
1	=	.4576		1	=	2.185
2	=	.9152		2	=	4.370
3	=	1.373		3	=	6.556
4	=	1.831		4	=	8.741
5	=	2.288		5	=	10.926
6	=	2.746		6	=	13.111
7	=	3.203		7	=	15.297
8	=	3.661		8	=	17.482
9	=	4.119		9	=	19.667

*Example.*—Reduce 6.43 per cent. Ammonia and 35.21 per cent. Tri-calcium Phosphate to Nitrogen and Phosphoric Acid :—

6	Ammonia	=	4.941	Nitrogen		Tri-calcium Phosphate.		Phosphoric Acid.
.4	"	=	.329			30	=	13.73
.03	"	=	.025			5	=	2.288
						.2	=	.091
						.01	=	.005
			<u>5.295</u>					<u>16.114</u>

# INDEX

- ABSORPTIVE** power of litter, 182  
 Acetylene evolved from cyanamide, 41  
 Acidity of soil, 62, 258, 315  
 Adulteration of manures, 235  
 Agricultural Holdings Act, 354  
*Aira cæspitosa*, 256  
 Algerian phosphates, 118  
 Alkaline, reaction in soil, 55, 321; salts required by plant, 170, 262  
 Ammonia, absorbed by peat-moss litter, 183; conversion into nitrogen, tables for, 377; fixers of, 200; lost in dung-making, 189  
 Ammonium carbonate from urea, 184  
 Ammonium citrate as a solvent, 126, 132, 143  
 Ammonium salts, 12; action on soil, 62; duration of, in soil, 96; in rain, 29; nitrification of, 60; versus nitrate of soda, 94  
 Ammonium sulphate, composition of, 58; in drainage water, 60; production of, 58; retention of, by soil, 61  
 Analysis of fertilisers, 349  
 Anhydrite, 160  
 Antiseptics in dung-making, 202  
 Apatite, 104, 117, 121  
 Artificial manures, 24  
 Australia, value of superphosphate in, 140  
 Assimilation, 6, 14, 165  
 Availability, of manures, 91, 97, 145, 156, 215; of plant food, 23, 282  
*Azotobacter chroococcum*, 35, 257  
**BACTERIA**, competing for nitrogenous manures, 66; denitrifying, 185; humus-forming, 186; in soil, 257; nitrogen-fixing, 11, 32, 34, 273; putrefactive, 185  
 Bacterial changes in dung-making, 190  
 Barley, Danish experiments on, 366; effect of phosphatic manures, 137; effect of potassic manures, 168; quality, effect of salt on, 269; quality with nitrogenous manures, 66, 81, 308  
 Basic slag, 13, 106, 127, 143, 150; composition of, 129; effect on poor pastures, 329  
 Basic superphosphate, 133, 152  
 Bat guano, 236  
 Beans, manures for, 322  
 Beijerinck, 35  
 Berkeland - Eyde, process for nitrogen fixation, 43  
 Bessemer process, 127  
 Blithe, W., on manures, 11, 72, 107  
 Blood, dried, 11, 239, 248  
 Bone flour, 145  
 Bone meal, 109, 145, 153; effect on pastures, 331  
 Bones, 11, 103, 106, 145; dissolved, 113, 155  
 Bonnet, oxygen evolved by leaves, 6  
 Boussingault, action of gypsum, 267; theory of plant nutrition, 7  
 Bracken fern, as indicator of lack of lime, 254; as litter, 182  
 Bradley and Lovejoy, electrical fixation of nitrogen, 42  
 Brown on assimilation, 14  
**CABBAGES**, manures for, 316  
 Cake-fed dung, 203; cost of, 227  
 Calcium carbide, 38  
 Calcium carbonate, 250; removed from soil, 56, 62  
 Calcium cyanamide, 38  
 Calcium phosphates, 104, 142  
*Caliche*, 46  
 Candolle, 293  
 Carbide, combination of nitrogen with calcium, 38

- Carbohydrates, denitrification favoured by, 185; potash required for production of, 166; required by nitrogen-fixing organisms, 35, 171
- Carbon bisulphide, 202, 241
- Carbonic acid, assimilation of, 6, 14; excretion of, by roots, 290; in soil water, 143, 149, 156, 287
- Carnallite, 160
- Cartilage, 108, 154
- Castor cake, 242, 248
- Catch crops, 274
- Chalk, 252
- Cellulose, fermentation of, 187
- Cercosporium melonis*, 88
- Cheshire, use of bones in, 111
- Chinchas guano, 231
- Chlorophyll, 14, 173
- Christmas Island, 116
- Cinereals, 24
- Citric acid solution as solvent, 126, 132, 143, 149, 165
- Cleveland iron ore, 127
- Clover, effect of potash on, 171; manures for, 325; value of lime to, 261; value of, in rotation, 33, 295, 323
- Clover sickness, 34, 297, 324
- Club root, 259
- Coal, nitrogen in, 58
- Colour, relation to iron salts, 270
- Compensation for unexhausted fertilisers, 354
- Composition affected by manuring and season, 83, 86
- Composition of, ash of wheat, 264; average crops, 22; basic slag, 129; bone manures, 111; clover ash, 268; excreta, 181; farmyard manure, 202; gas lime, 266; gases in dunghill, 188; guanos, 248; lime, 255; litter, 182; London dung, 207; Peruvian guano, 230, 233; plant, 13; sewage sludges, 247; Stassfurt salts, 161
- Condition in soil, 101, 210
- Continuous growth of crops on same land, 296
- Conservative systems of farming, 302
- Coprolites, discovery of, 13, 114, 121, 153
- Corn marigold, 254
- Cotton, manures for, 336
- Cotton cake, damaged, composition of, 248
- Cow, composition of excreta of, 181
- Crookes, Sir W., on fixation of nitrogen, 42
- Crust guanos, 116
- Cyanamide, 38
- Czapek, 291
- DAMARALAND guano, 235, 248
- Danish barley experiments, 366
- Daubeny, 114
- Davy, nutrition of plants, 6, 104
- Deflocculation due to, nitrate of soda, 54; potash salts, 176; salt, 269
- Defoe, use of the word manure, 1
- Dehérain, 187
- Denitrification, 185, 305
- Diffusion of soluble salts in soil, 288
- Digby, Sir Kenelm, on nitre, 12
- Digestion, process of, 179, 191
- Diminishing returns, law of, 283
- Diseases, fungoid, 86, 174, 216
- Dissolved bones, 109, 113, 155
- Dissolved Peruvian guano, 235
- Dominant fertilisers, 89, 280
- Dormant plant food, 23, 282
- Drainage, affected by farmyard manure, 220; water, composition of, 61, 165
- Dried blood, 239
- Dry and wet seasons, effect of farmyard manure in, 220; value of potash salts in, 175; with nitrogenous manures, 67; with phosphatic manures, 137
- Dundonald, 103
- Dung, cake-fed, 203; definition of, 178; value for mangolds, 316
- Dyer, 148, 165, 206
- EARTH closet system, 244
- Egypt, nitrate of soda deposits in, 47
- Ellis, W., on manures, 12, 159, 241
- Epichloe typhina*, 87
- Error of experiment, 359
- Estremadura, phosphates in, 114, 117, 123
- Evelyn, J., on bones, 107; on manures, 11; on nitre, 12
- Excreta, composition of, 181, 243

- Experiments, with fertilisers, 359;  
pot, 375
- FÆCES, nature of, 179, 243
- Farmyard manure, changes during making, 189; composition of, 202, 205; cost of making, 224; definition, 178; fire-fanged, 191; lasting action of, 212; loss of nitrogen in making, 192; management of, 207; physical effects of, 216; slow availability of, 215; utilisation of, 222, 315, 318, 321; value of, 209, 216
- Feathers, 11, 71
- Felspar, 163
- Fermentation, of cellulose, 187; of urea, 184
- Fertilisers, compensation for residues of, 354; experiments with, 359; machines for sowing, 372; mixed, 352; required in ordinary farming, 305; sampling of, 350; significance of term, 2, 23; valuation of, 340
- Fertilisers and Feeding Stuffs Act, 235, 349
- Fertility, of soil, 305; unexhausted, 354
- Finger-and-toe, 151, 216, 259, 315
- Fire-fanged manure, 191
- Fish guano, 236, 248, 345
- Fish waste, 12, 75, 236
- Five fingers, 75
- Fixation of nitrogen, by bacteria, 32; by calcium carbide, 38; by electricity, 42
- Flocculation of soils by lime, 255
- Flock dust, 71
- Florida phosphates, 116
- Folding of sheep, 274
- Foods, fate of nitrogen in, 180; manure value of, 225, 356
- Foxglove, 254
- Frank and Caro, cyanamide, 38
- Franklin, Benjamin, 267
- Fray Bentos guano, 238
- Fruit, manures for, 334
- Function of, iron salts, 270; nitrogenous manures, 77; phosphatic manures, 136; potassic manures, 165; silica in plant nutrition, 271
- Fungi in dung, 191
- Fungoid diseases, and lime, 259; and nitrogenous manures, 86; and potash manures, 174; carried by farmyard manure, 216
- GARDEN manures, 338
- Gases contained in dunghill, 187
- Gas lime, 254, 262, 265
- Gilbert, Rothamsted experiments, 9
- Grasses, appearance of potash-starved, 173; developed by nitrogenous manures, 65
- Grass land, effect of lime on, 259; effect of potash on, 173; manures for, 326; value of dung on, 221
- Greaves, 74, 239, 248
- Green manuring, 272
- Grinding of bones, 107; of fertilisers, value of fine, 150, 154
- Ground lime, 253
- Guano, 12, 145, 346; bat, 236; Damaraland, 235; fish, 236; Ichaboe, 235; meat, 236, 238; native, 246; phosphatic, 115, 145, 152, 229
- Gunpowder salt, 269
- Gypsum, 106, 113, 124, 160, 262, 266; as an ammonia fixer, 201; phosphatic, 134
- HAIR, 11, 71
- Hay, manures for, 329
- Hellriegel, experiments upon barley, 166; growth and nitrogen supply, 28; nitrogen-fixing bacteria, 11
- Henslow, discovery of coprolites, 13, 121
- High farming, 301
- Highland and Agricultural Society's experiments, 153, 313
- History of manuring, 2, 11, 103, 158, 249
- Holdings Act, Agricultural, 354
- Hoofs, 11, 71
- Hop bine, composition of, 181
- Hops, manures for, 333; spent, 74
- Horn, 11
- Horse, composition of excreta of, 181
- Hughes, F., analysis of Egyptian nitrate of soda, 47
- Hughes, J., basic superphosphate, 133
- Humboldt, A. von, 231

- Humus, formation in dunghill, 186 ;  
in soil, value of, 216, 273
- Hydrogen evolved from dunghill,  
187
- ICHABOE guano, 235, 248
- Incompatibles, 353
- Ingenhousz, light essential to  
assimilation, 6
- Inoculation of soil, 36
- Iron in soil, function of, 270 ; sul-  
phate of, 270
- JODIN, 272
- KAINIT, 160, 164, 201
- Kalk-stickstoff, 38
- Kellner, 191
- Kelp, 158, 163
- Kiln dust, 74
- Kirwan, 104
- Knop, water cultures, 10
- Kohl rabi, manures for, 316
- Kossowitsch, 292
- LAHN phosphates, 116
- Law of, diminishing returns, 283 ;  
the minimum, 282
- Lawas, manufacture of superphos-  
phate, 13, 120 ; on turnip culture,  
138 ; origin of Rothamsted ex-  
periments, 9 ; use of ammonium  
salts, 12
- Lawns, manures for, 338
- Leather, 71
- Leaves, assimilation by, 6, 14, 168 ;  
stimulated by nitrogen, 85
- Leguminous crops, manures for,  
322 ; plants and nitrogen, 10, 32 ;  
effect of potash on, 171
- Leuchstadt, experiments at, 192, 202
- Leucite, 163
- Liebig, on bones, 104, 107 ; on  
superphosphate, 119 ; silicate  
manures, 272 ; source of plants'  
nitrogen, 9, 11 ; theory of plant  
nutrition, 7, 276 ; use of am-  
monium salts, 12
- Lime, action of, on soil, 63, 249,  
257 ; ashes, 251 ; ground, 253 ;  
in basic slag, 128, 151
- Limestone, 250
- Limiting factors for growth, 284
- Liquid manure, 205
- Litter, composition of, 181 ; effect  
of, on losses of nitrogen, 195
- Lobos phosphatic guano, 115
- Lodging, due to excessive nitrogen,  
78
- Löhnis, decomposition of cyanamide,  
39
- London dung, 206
- Lucerne, manures for, 325
- Lupins as green manure, 272
- MACHINES for sowing fertilisers, 372
- Maercker and Schneidewind, 192
- Magnesium salts in manures, 163,  
262, 269
- Magnesian limestone, 251
- Maize, manures for, 312
- Malt dust, 12, 74
- Manganese salts, action of, 271
- Mangolds, with increasing nitrogen,  
29 ; effect of sodium salts on, 52 ;  
late growth with nitrate of soda,  
66 ; effect of manuring on com-  
position, 86 ; effect of manuring  
upon number, 102 ; effect of  
potassic manures, 168 ; value of  
salt for, 268 ; manures for, 316
- Manure, significance of term, 1, 24
- Manure value of foods, 225, 356
- Manures, compounded, 301
- Manures for barley, 308 ; beans,  
322 ; cabbages, 316 ; clover, 324 ;  
cotton, 336 ; fruit, 334 ; garden,  
338 ; grass land, 326 ; hops, 333 ;  
lucerne, 325 ; maize, 312 ; man-  
golds, 316 ; oats, 311 ; pasture,  
329 ; potatoes, 319 ; rye, 312 ;  
sainfoin, 325 ; sugar, 336 ;  
Swedes, 312 ; tea, 337 ; tobacco,  
337 ; tropical crops, 335 ; vetches,  
326 ; wheat, 306
- Marl, 249
- Marsh gas evolved from dunghill,  
187
- Maturity, accelerated by phosphoric  
acid, 136 ; deferred by excess of  
nitrogen, 78 ; effect of potash on,  
174
- Meat guano, 236, 238, 248, 345
- Micrococcus ureæ*, 184
- Mineral manures, 24 ; duration of,  
in soil, 96

- Minimum, law of, 282  
 Mixed fertilisers, 352  
 Müntz and Girard, 195  
 Murray, Sir James, 123  
 Mussels, 75  
 Mustard, as green manure, 272  
 Mustard seed in rape cake, 240  
 Mulch, farmyard manure as a, 221
- NATIVE** guano, 246  
 Night soil, 244  
 Nilson, 134  
 Nitrate of lime, 44  
 Nitrate of soda, 12, 307; action on soil, 51, 54; compared with ammonium sulphate, 64, 94; composition, 49; for cabbages, 316; in Egypt, 47; source of, 45; value of soda, 53, 170  
 Nitrates, saving of soil, 273; soil, 289  
 Nitric acid in rain, 29  
 Nitrification, in spring, 90; in wet seasons, 67  
 Nitrogen, and fungoid diseases, 86; compounds of, in dung, 206; contained in rain, 29; conversion into ammonia, tables for, 377; electrical fixation of, 42; fixation by calcium carbide, 38; fixed by Leguminosæ, 11; growth proportional to supply of, 28; in food, fate of, 180; in wheat grain and flour, 84; losses by denitrification, 185, 305; lost in dung-making, 192; origin of combined, 30; recovered in crop, 99, 210; removed in four-course rotation, 303; source of plants', 9, 26; value of unit, 342; vegetative growth promoted by, 77  
 Nitrolim, 38  
 Nodule organisms, 273  
 Nucleo-proteins, 140  
 Nutrition, theories of, 5-6, 13
- OATS**, manures for, 311  
 Oilcake, 12, 240, 242, 345  
 Oil in manures, 72, 237  
*Oospora scabies*, 321  
 Organic manures, value of, 94, 100  
 Organic matter, value of, in soils, 73
- PALISSY, B.**, observations on manures, 4  
 Pasture, manures for, 329  
 Peat moss, as litter, 181, 195; manure, 183  
 Peruvian guano, 12, 115, 229, 248, 338, 346; dissolved, 235  
 Phosphate rock, 115, 156  
 Phosphatic guano, 115, 152  
 Phosphate, conversion into phosphoric acid, tables for, 377; of iron, 125; of lime, 104, 142; value of unit, 343  
 Phosphates, action of lime on soil, 260; required by barley, 309; required by turnips, 313  
 Phosphatic gypsum, 134  
 Phosphoric acid, 103, 136; and nitrogen in plant, 140; conversion into phosphate of lime, tables for, 377; value of unit, 343  
 Phosphorus in iron, 127  
 Photo-synthesis, 15, 169  
 Pickering, 298  
 Pigs, composition of excreta of, 181  
 Plant food, dormant and available, 23; in soil and crop, 21  
 Plasmolysis, 18, 50  
*Plasmodiophora brassicæ*, 259  
 Pliny, 250  
 Plots for field experiments, size of, 365  
 Polyhalite, 160  
 Polzenius, stickstoff-kalk, 41  
 Pot experiments, 375  
 Potash salts, 13  
 Potash, 158; value of unit, 344  
 Potassium carbonate, 163; function of, in nutrition of plant, 166; salts, retention by soil, 164  
 Potatoes, manures for, 319  
 Precipitated phosphate, 134, 152  
 Preservatives in dung-making, 200  
 Priestley, discovery of assimilation, 6, 276  
 Pugh, source of plant nitrogen, 9
- QUALITY** in produce, 66, 72, 81, 269, 270, 308, 320  
 Quicklime, 250
- RABBIT** hair, 71  
 Rags, 11, 72

- Rain, nitrogen contained in, 29  
 Rape dust, 94, 240, 248, 345  
 Recovery of nitrogen in crop, 99, 210  
 Residues from manufactories, 67 ; compensation for manurial, 354 ; duration of manurial, 71, 96, 98, 212  
 Retention of fertilisers by soil, 148, 164  
 Reverted phosphate, 106, 126  
 Ripening caused by phosphatic manures, 136  
 Rochdale manure, 245  
 Rock salt, 159  
 Roman agriculture, 2, 250  
 Roots, development of, with nitrogenous manures, 65 ; effect of phosphatic manures on, 139 ; ratio of, to leaf, 85 ; solvent action of, 290  
 Root system, importance of, 280  
 Rotations, 32, 293, 301, 319  
 Rothamsted, analysis of soil, 20 ; experiments, 9, 13, 26, 277, 360 ; grass plots at, 65  
 Russell, dung-making experiments, 199 ; on heated soil, 298 ; composition of seaweed, 75  
 Rye, manures for, 312
- SACHS, 272, 290  
 Sainfoin, manures for, 325  
 Sale of fertilisers, 349  
 Salt, 262, 268, 319 ; gunpowder, 269 ; nitrate of, 51  
 Sampling of fertilisers, 349  
 Saussure, nutrition of the plant, 6, 17, 276 ; on ammonia, 12 ; on phosphate of lime, 104  
 Scabby potatoes, 321  
 Schubler, theory of manures, 7  
 Schneidewind, 192, 202  
 Sclerotinia disease, 34, 297  
 Season, effect of, on yield and quality, 67, 83  
 Seaweed, 75  
 Secular decline in yield of crops grown continuously, 296  
 Selective action of plant, 19  
 Senebier, assimilation, 6, 276  
 Sewage, 245 ; sludge, 246  
 Sheep, composition of excreta of, 181  
 Shoddy, 71, 334  
 Short manure, 190, 205  
 Sickness of land, 297  
 Silica, action of, on plants, 271  
 Skin, 12, 71  
 Slaked lime, 251  
 Slaughter-house refuse, 13, 70  
 Sodium perchlorate, 51 ; salts, action of, 53, 170  
 Solubility of phosphatic manures, 143 ; soil phosphates, 285  
 Soil, acidity, 62 ; analysis of Rothamsted, 20 ; condition in, 210 ; inoculation of, 36 ; phosphates in, 144 ; temperature, 69 ; texture affected by manures, 101, 163, 176, 216, 269, 273 ; requiring potash manures, 177  
 Somme phosphates, 116  
 Sonne, Danish barley experiments, 366  
 Sorrel, 254  
 Soot, 11, 68, 307  
 Sprengel, theory of manures, 7  
 Spurrey, 254  
 Stassfurt deposits, 13, 159  
 Steamed bone flour, 109, 145, 152  
 Stickstoff-kalk, 42  
 Stohmann, water cultures, 10  
 Straw, composition of, 182  
 Stimulus due to manganese salts, 271  
 Sugar cane, manures for, 336  
 Sulphuric acid, as an ammonia-fixer, 202 ; in manures, 74  
 Superphosphate, 106, 119 ; as an ammonia-fixer, 202 ; retention by soil, 148 ; use of, 150 ; value in Australia, 140  
 Swede turnips and nitrogenous manures, 90, 280, 312  
 Surface tension of dung solutions, 221  
 Sylvinit, 161  
 Systems of manuring, 300
- TAFLA, 47  
 Tankage, 238  
 Tares as green manure, 272  
 Tea, manures for, 337  
 Temperature of soil raised by soot, 69  
 Tetra-basic phosphate of lime, 106, 131, 143

- Texture of soil affected by manures, 101, 163, 176, 216, 269, 273
- Thaer, theory of plant nutrition, 5, 7
- Theories of, plant nutrition, 5-6, 13; fertiliser action, 276
- Thomas and Gilchrist, 127
- Thomas phosphate, 129
- Tillering promoted by phosphoric acid, 139
- Tobacco, manures for, 337
- Top-dressings, 58, 307
- Toxic substances excreted by plants, 293
- Transpiration, 18
- Trefoil, manures for, 326
- Tropical crops, manures for, 335
- Tull, theory of plant nutrition, 5
- Tunis phosphates, 118
- Turnips, manures for, 313
- UNEXHAUSTED residues, compensation for, 354
- Unit system of valuing manures, 341, 348
- Urea, decomposition of, 184; in guano, 230, 233
- Urine, nature of, 179
- Uromyces betæ*, 87, 174
- VALUATION, of farmyard manure, 223; of manures, 73, 100, 155, 340
- Van Helmont, theory of plant nutrition, 5
- Vetches, as green manure, 272; manures for, 326
- Ville, 89, 281
- Virgin soils, 31, 35, 302
- Vitriolised bones, 109
- Voelcker, 195, 274, 358
- WAGNER, comparison of nitrogenous manures, 97
- Walter de Henley's *Husbandrie*, 3
- Warrantry of fertilisers, 349
- Waste products as manures, 67
- Water, effect of dung on surface tension of, 221; retained by humus in soil, 219
- Water cultures, 10, 16, 55, 277
- Way, analysis of superphosphate, 124; retention of manures by soil, 164; soluble silicates as manures, 272
- Wet seasons, effect of farmyard manure in, 220; with nitrogenous manures, 67; with phosphatic manures, 137; with potash manures, 175
- Wheat, development of grain, 142; effect of phosphatic manures on, 139; habit of growth, 89; manures for, 306; nitrogen in grain and flour, 84; yield with increasing nitrogen, 80
- Whitney and Cameron, 285
- Wiborg phosphate, 134
- Wilfarth, nitrogen-fixing bacteria, 11
- Woburn, acidity of soil at, 62; experiments at, 95, 274; experiments on dung-making, 195; fruit farm, 298
- Wolff and Lehmann, 243
- Wolter phosphate, 135
- Wood, dung-making experiments, 198
- Wood ashes, 11, 159, 163
- Wool, 11, 72
- Worldidge, 107
- Wrightson and Munro, 128
- YOUNG, A., on woollen rags, 72; on bones, 107
- ZEOLITES in soil, 51, 260, 267







U.C. BERKELEY LIBRARIES



C027320842

14 DAY USE  
RETURN TO DESK FROM WHICH BORROWED  
AGRICULTURE LIBRARY  
40 GIANNINI HALL

EXT. 4493

This book is due on the last date stamped below, or  
on the date to which renewed.

Renewed books are subject to immediate recall.

~~MAY 25 '65~~

~~MAR 20 1972~~

~~JUN 10 1978~~

REC'D BY AGRIC LIB JAN 7 1981

LD 21-5021-2,132  
(D4471s10)475

General Library  
University of California  
Berkeley



