

RURAL TEXT-BOOK
SERIES



FIELD CROPS
FOR THE
COTTON-BELT



MORGAN

L. H. BAILEY
EDITOR



Class S.B.185

Book M 68

Copyright N^o _____

COPYRIGHT DEPOSIT.

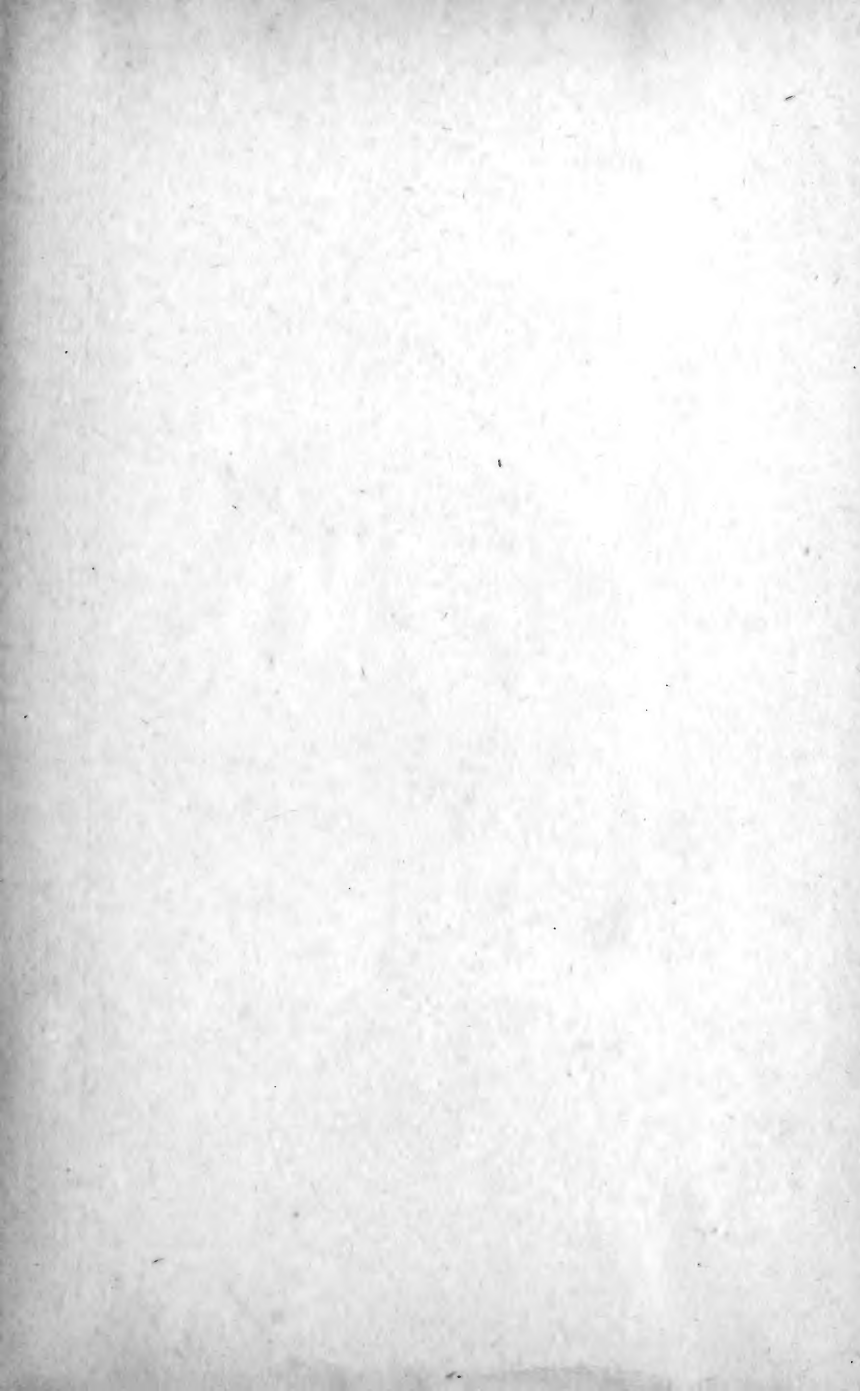

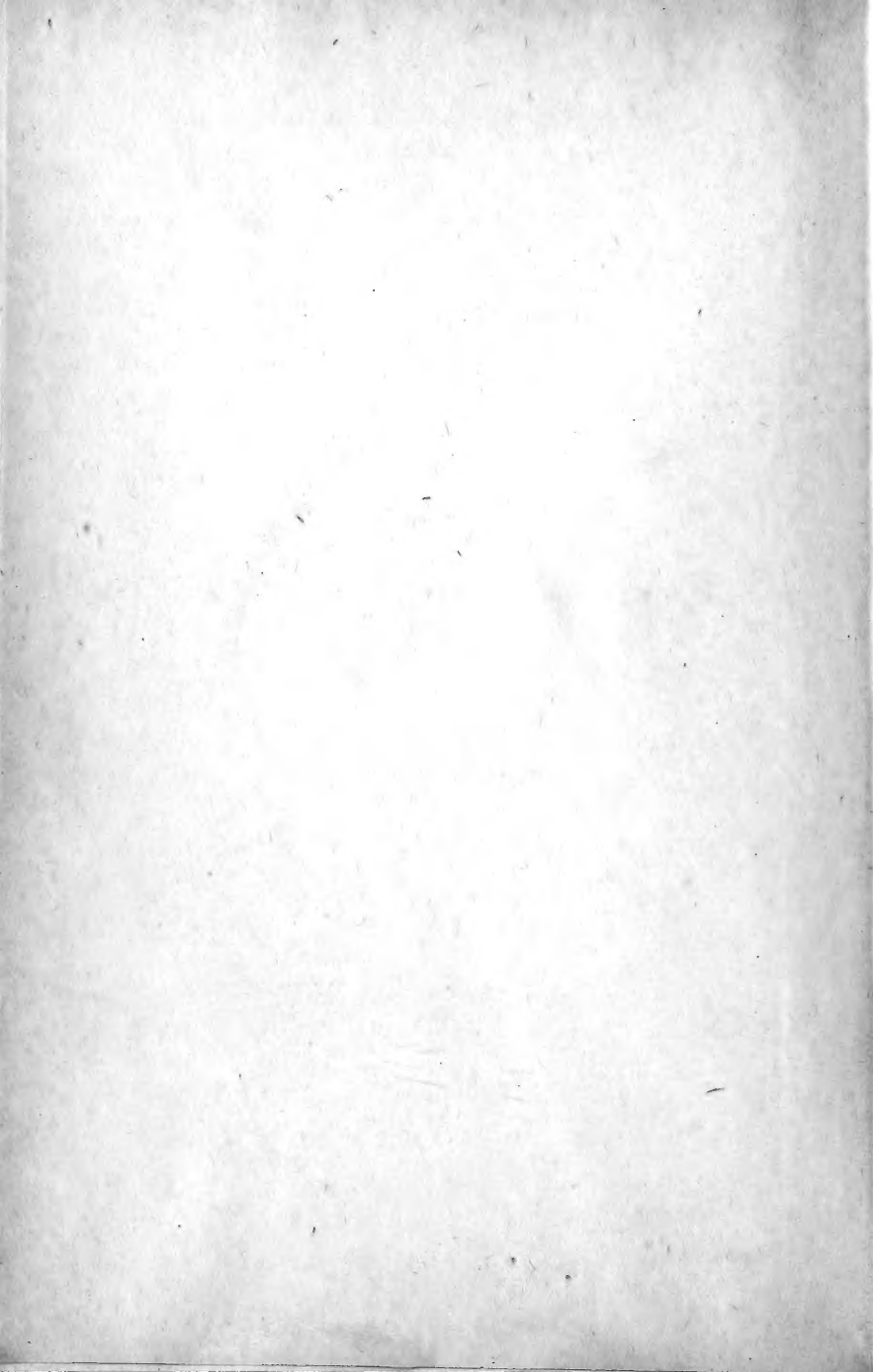

The Rural Text-Book Series

EDITED BY L. H. BAILEY

FIELD CROPS FOR THE COTTON-BELT

The Rural Text-Book Series

EDITED BY L. H. BAILEY

- Carleton*, THE SMALL GRAINS.
B. M. Duggar, PLANT PHYSIOLOGY, with special reference to Plant Production.
J. F. Duggar, SOUTHERN FIELD CROPS.
Gay, THE BREEDS OF LIVE-STOCK.
Gay, THE PRINCIPLES AND PRACTICE OF JUDGING LIVE-STOCK.
Goff, THE PRINCIPLES OF PLANT CULTURE, Revised.
Harper, ANIMAL HUSBANDRY FOR SCHOOLS.
Harris and Stewart, THE PRINCIPLES OF AGRONOMY.
Hitchcock, A TEXT-BOOK OF GRASSES.
Jeffery, TEXT-BOOK OF LAND DRAINAGE.
Livingston, FIELD CROP PRODUCTION.
Lyon, Fippin and Buckman, SOILS — THEIR PROPERTIES AND MANAGEMENT.
Mann, BEGINNINGS IN AGRICULTURE.
Montgomery, THE CORN CROPS.
Piper, FORAGE PLANTS AND THEIR CULTURE.
Warren, ELEMENTS OF AGRICULTURE.
Warren, FARM MANAGEMENT.
Wheeler, MANURES AND FERTILIZERS.
White, PRINCIPLES OF FLORICULTURE.
Widtsøe, PRINCIPLES OF IRRIGATION PRACTICE.

FIELD CROPS FOR THE COTTON-BELT

BY

JAMES OSCAR MORGAN, M. S. A., PH. D.

PROFESSOR OF AGRONOMY IN THE
AGRICULTURAL AND MECHANICAL COLLEGE OF TEXAS

New York

THE MACMILLAN COMPANY

1917

All rights reserved

SB185
.M68

COPYRIGHT, 1917
By THE MACMILLAN COMPANY
Set up and electrotyped. Published January, 1917.

185

JAN 11 1917

©CLA453602

175

in 11

To

MY PARENTS

JAMES WILSON MORGAN

AND

ORRIE OSGOOD MORGAN

THIS BOOK

IS AFFECTIONATELY DEDICATED IN APPRECIATION

OF THEIR HIGH CHRISTIAN IDEALS

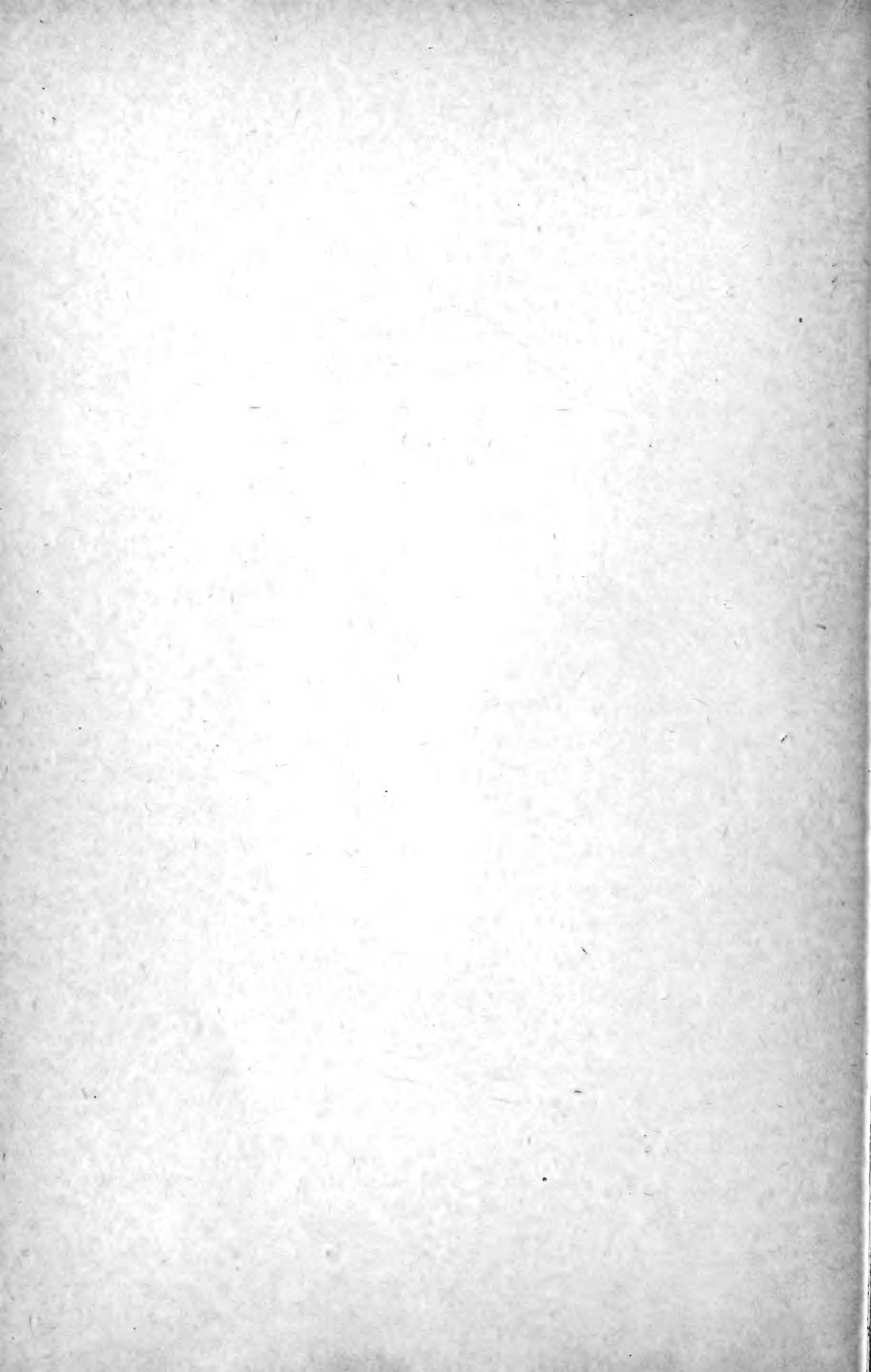

PREFACE

CLIMATIC conditions in the cotton-belt states are markedly different, in many respects, from those in any other large area of the United States. For this reason the practices involved in the production of field crops in the cotton-belt present many modifications of those of other regions. In the preparation of this volume the author has endeavored to present clearly and accurately the science and art of field-crop production in the south. As the art of crop production is based primarily on the sciences of botany (physiological and ecological) and chemistry, the aim has been to give to these subjects their proper application.

Although this book will be of much service to farmers and general readers, it has been written primarily with the needs of the college student in view. Considerable attention has been given to the principles of plant structure and nutrition, particularly with reference to cotton and corn, the two leading crops in the cotton-belt. The student who is unfamiliar with the crop and its life-processes is ill-prepared for a proper study of the tillage practices involved in the production of the crop.

The author wishes to acknowledge here his indebtedness to S. A. McMillan for many helpful suggestions in preparing this volume, and to A. B. Conner, F. H. Blodgett,

F. B. Paddock, J. B. Bagley, and W. H. Thomas for reading the manuscript for certain chapters. Drawings for several of the illustrations have been made by G. A. Geist and W. J. Skeeler. Credit is given for each illustration, not original, in the list of illustrations.

J. O. MORGAN.

COLLEGE STATION, TEXAS,
Nov. 1, 1916.

CONTENTS

CHAPTER I

	PAGE
CLASSIFICATION AND VALUE OF FIELD CROPS	1-6
Classification by use, 1; Classification for the study of cropping systems, 2; Important botanical groups, 3. <i>Value of Field Crops</i> : Rank of the cotton-belt states, 4; Importance of field crops in the cotton-belt, 5.	

CHAPTER II

DESCRIPTION OF THE COTTON PLANT	8-20
The root-system, 6; Types of roots, 7; Functions of the root-system, 8; The stem, 9; The branches, 10; The leaves, 11; The vascular system, 12; Air cavities, 13; The peduncles, 14; The flowers, 15; The bolls, 16; Number of bolls to the plant, 17; The seed, 18; The lint, 19; Length and strength of fiber, 20.	

CHAPTER III

PHYSIOLOGY OF THE COTTON PLANT	21-29
The plant structure, 21; The living substance in the plant, 22. <i>The Composition of the Cotton Plant</i> : Composition, 23; The essential constituents, 24. <i>Nutrition</i> : The absorption of food, 25; The taking up of carbon, 26; The necessary energy, 27. <i>The Giving off of Water</i> : 28. <i>Reproduction</i> : The reproductive organs, 29; The pollen-grains and egg-cells, 30; Fertilization, 31; The embryo, 32.	

CHAPTER IV

THE PRINCIPAL SPECIES OF COTTON	30-37
Malvaceæ or mallow family, 33; The genus <i>Gossypium</i> , 34; Number of species, 35; Classification of	

	PAGE
species, 36; The extensively cultivated species, 37; American upland cotton, 38; Sea Island cotton, 39; Peruvian cotton, 40; Indian cotton, 41; Bengal cotton, 42.	
CHAPTER V	
COTTON VARIETIES	38-52
What is a variety, 43; Origin of varieties, 44; Stability of varieties, 45; Influence of soil and climate, 46; Classification of varieties, 47; Cluster type, 48; Semi-cluster type, 49; Rio Grande type, 50; Early varieties of the King type, 51; The Big-boll type, 52; The long-limbed type, 53; Intermediate varieties, 54; Long-staple upland varieties, 55; High ranking varieties, 56.	
CHAPTER VI	
COTTON BREEDING	53-66
Reasons for breeding cotton, 57; Need of improvement in cotton, 58; Start with the best variety, 59; Qualities sought for in breeding cotton, 60; Qualities associated with high yield, 61; Characters that determine quality, 62; Well defined ideal necessary, 63; Methods of improving cotton, 64. <i>The Improvement of Cotton by Selection</i> : Selection of foundation stock, 65; Ginning cotton from select plants, 66; Testing transmitting power of plants, 67; Selecting the best progenies, 68; Making the second generation selections, 69; The multiplication plot, 70; Influence of environment, 71. <i>The Use of Hybridization in Cotton Breeding</i> : Reasons for hybridizing cotton, 72; The nature of hybrids, 73; Fixation of cotton-hybrids, 74; Methods of crossing cotton, 75; Hybridization versus selection, 76; Acclimatization, 77.	
CHAPTER VII	
COTTON SOILS AND CLIMATIC ADAPTATIONS	67-80
<i>Cotton Soils</i> : Soil types, 78; Cotton soils of the Coastal Plain Province, 79; Cotton soils of the	

Piedmont Plateau, 80; Cotton soils of the Appalachian Province, 81; Cotton soils of the limestone valleys and uplands, 82; Cotton soils of the Loessial region, 83; Cotton soils of the River Flood Plains Province, 84; Cotton soils of the Great Plains Region, 85. *Climatic Adaptations*: Length of growing season, 86; Amount and distribution of the rainfall, 87; Temperature and sunshine, 88.

PAGE

CHAPTER VIII

FERTILIZERS, MANURES AND ROTATIONS FOR COTTON 81-100

Fertility removed by cotton, 89; Maintenance of fertility, 90. *Commercial Fertilizers for Cotton*: Nitrogen-supplying fertilizers, 91; Sodium nitrate *versus* cotton-seed meal, 92; Cotton-seed *versus* cotton-seed meal, 93; Need of cotton soils for nitrogen, 94; Phosphatic fertilizers, 95; Need of cotton soils for phosphoric acid, 96; Potassic fertilizers, 97; Need of cotton soils for potash, 98; Potash fertilizers check rust, 99; A fertilizer test for cotton, 100; Judging fertilizer needs by appearance of plants, 101; Home-mixing fertilizers, 102; Time of applying fertilizers, 103; Methods of applying fertilizers, 104; Fertilizer formulas for cotton, 105. *Farm Manures for Cotton*: Stable manure for cotton, 106; Composts for cotton, 107. *Green-Manures and Rotations for Cotton*: Need of organic matter, 108; Suitable crops for green-manure, 109; Green-manures and the supply of organic matter, 110; Green-manure crops and the nitrogen supply, 111; Will crop rotation maintain fertility, 112; Rotations for cotton, 113.

CHAPTER IX

TILLAGE FOR COTTON 101-116

Preparation of the Seed-bed: Drainage the first essential, 114; Disposal of stalks and litter, 115; Fall plowing for cotton, 116; Spring plowing for cotton,

117; Depth of plowing, 118; Subsoiling, 119; Subsequent tillage, 120; Ridging *versus* level preparation, 121; Forming the ridges, 122. *Planting*: Time of planting, 123; Advantage of planting heavy seed, 124; Quantity of seed, 125; Methods of planting, 126; *Cultivation*: Objects of interculture, 127; Broadcast tillage for cotton, 128; Tillage by separate rows, 129; The first cultivation, 130; Chopping, 131; The second cultivation, 132; Subsequent culture, 133; Frequency of tillage, 134; The value of late tillage, 135; Distance between rows, 136; Distance between plants in the row, 137.

CHAPTER X

HARVESTING AND MARKETING COTTON 117-126

Picking, 138; Cotton-picking machines, 139; Ginning, 140; Types of cotton gins, 141; Baling, 142; Care of baled cotton, 143; Compressing, 144. *Selection and Classification of Commercial Grades of Cotton*: Important points in cotton valuing, 145; Grade, 146; Relative values of different grades, 147; Staple, 148.

CHAPTER XI

SOME IMPORTANT INSECT ENEMIES OF COTTON 127-140

The Mexican Cotton Boll-weevil: Life history and habits, 149; Food of the weevil, 150; Rate of increase, 151; Dissemination, 152; Hibernation, 153; Drainage, 154; Means of control, 155; Destroy cotton stalks early in fall, 156; Destroy weevils in hibernating places, 157; Make provision for an early crop, 158; Proper spacing of plants, 159. *The Cotton Boll-worm*: Description, 160; Life history, 161; Food plants, 162; Damage, 163; Means of control, 164. *The Cotton Leaf-worm*: Life history and habits, 165; Damage, 166; Means of control, 167. *Insects of Secondary Importance*: The cotton leaf-louse, 168; The cotton red-spider, 169; The cowpea pod-weevil, 170.

CONTENTS

xiii

CHAPTER XII

	PAGE
DISEASES OF COTTON	141-149
<i>Cotton Wilt</i> : Occurrence, 171; Cause, 172; Symptoms, 173; Remedies, 174. <i>Cotton Root-rot</i> : Occurrence, 175; Cause, 176; Symptoms, 177; Remedies, 178. <i>Root-knot</i> : Occurrence, 179; Cause, 180; Symptoms, 181; Remedy, 182. <i>Cotton Anthracnose</i> : Occurrence, 183; Cause, 184; Symptoms, 185; Remedies, 186. <i>Mosaic Disease</i> : Occurrence, 187; Cause, 188; Symptoms, 189; Remedies, 190.	

CHAPTER XIII

MAIZE OR INDIAN CORN	150-160
<i>Description of the Corn Plant</i> : The root-system, 191; Structure of roots, 192; Adventitious roots, 193; Stems, 194; Structure of the stem, 195; Tillers, 196; Leaves, 197; The flower, 198; The pistillate flowers, 199; The ear, 200; The kernels, 201.	

CHAPTER XIV

PHYSIOLOGY OF THE CORN PLANT	161-172
<i>Composition of the Corn Plant</i> : Composition, 202. <i>Water Requirements</i> : Leaf surface, 203; Figuring the leaf surface of a corn plant, 204; Conditions affecting water requirements, 205; Amount of water required, 206. <i>Growth</i> : Growth, 207; The factors of growth, 208; The growth of roots, 209; Growth of stems, 210; Growth of leaves, 211. <i>Reproduction</i> : Fertilization, 212; Double fertilization, 213; Development of the ear, 214.	

CHAPTER XV

ORIGIN, CLASSIFICATION AND VARIETIES OF CORN	173-186
Nativity, 215; Biological origin, 216. <i>Classification of Maize</i> : <i>Zea Mays canina</i> , 217; <i>Zea Mays tunicata</i> or pod corn, 218; <i>Zea Mays everata</i> , the pop-corns, 219; <i>Zea Mays indurata</i> , the flint corns,	

220; *Zea Mays indentata*, the dent corns, 221; *Zea Mays amylacea*, the soft corns, 222; *Zea Mays saccharata*, the sweet corns, 223; *Zea Mays amylea-saccharata*, 224; *Zea Mays japonica*, 225; *Zea Mays hirta*, 226; Varieties, 227; Discussion of varieties, 228.

CHAPTER XVI

THE BREEDING OF CORN 187-210

The significance of type in corn breeding, 229; Defects in southern varieties, 230; Barren plants, 231; Tendency to sucker, 232; Methods of improving corn, 233. *Selection*: Start with the best variety, 234; Mass selection, 235; Value of mass selection, 236; Pedigree selection, 237; The initial choice of ears in the field, 238; Selecting the breeding plot, 239; Second year, 240; Cultivation, 241; Detasseling, 242; Harvesting, 243; Third year, 244; Breeding for high and low ears, 245; Breeding for composition, 246; Other effects of breeding for composition, 247; Objects of breeding for composition, 248. *Hybridization*: Objects of hybridization, 249; Degrees of relationship among corn plants, 250; The transmission of characters—Mendel's law, 251; Dominant qualities in corn-hybrids, 252; Effects of inbreeding, 253; Value of crossing varieties, 254; Method of producing cross-bred seed, 255.

CHAPTER XVII

SOIL AND CLIMATIC ADAPTATIONS OF CORN 211-216

Soil Adaptations: Soils adapted to corn, 256; Soils not adapted to corn, 257; Modification of soils for corn, 258; Soil type and crop variety, 259. *Climatic Adaptations*: Factors of climate, 260; Influence of rainfall, 261; Influence of sunshine, 262; Influence of temperature, 263; Length of growing season, 264; Influence of climate upon habit of growth, 265.

CONTENTS

XV

CHAPTER XVIII

	PAGE
CROPPING SYSTEMS, MANURES AND FERTILIZERS FOR CORN	217-229
<i>Cropping Systems for Corn:</i> Continuous corn culture impoverishes soil, 266; The place of corn in a rotation, 267; Suggested rotations for the cotton-belt, 268. <i>Manures and Fertilizers for Corn:</i> Manures, 269; Lime for corn, 270; Fertilizers for corn, 271; Plant-food removed by corn, 272; Soils and fertilizers, 273; Relative importance of fertilizing constituents, 274; When to apply fertilizers, 275; Method of applying fertilizers, 276; Fertilizer formulas for corn, 277; Some general principles, 278.	

CHAPTER XIX

PREPARING THE SEED-BED FOR CORN	230-237
<i>Plowing the Land:</i> Destroying the stalks, 279; Time of plowing, 280; Depth of plowing, 281; Covering rubbish, 282; Subsoiling, 283. <i>Preparation of Plowed Land:</i> Treatment of plowed land, 284; The disk-harrow, 285; The smoothing harrow, 286; Special harrows, 287; Sub-surface packers, 288; Ridging corn land, 289; Wide beds for corn, 290.	

CHAPTER XX

PLANTING AND CULTIVATING THE CORN CROP	238-250
<i>Planting the Seed:</i> Testing the seed, 291; Methods of planting corn, 292; Time of planting, 293; Depth of planting, 294; Importance of getting a stand, 295; Distance between rows and hills, 296. <i>Cultivating the Crop:</i> The objects of interculture, 297; Importance of thorough early cultivation, 298; Cultivation by separate rows, 299; Depth and frequency of cultivation, 300; Value of late cultivation, 301; Kinds of cultivators, 302; The McIver Williamson method of corn production, 303.	

CHAPTER XXI

	PAGE
HARVESTING AND STORING THE CORN CROP	251-263
<i>Harvesting Corn:</i> Time of harvesting, 304; Methods of harvesting, 305; Effect of method of harvesting on yield of grain, 306; Yields of forage by different methods of harvesting corn, 307; Cutting and shocking the entire plant, 308; Harvesting the ears only, 309; Hand methods of cutting corn, 310; Comparative cost of harvesting by different methods, 311; Corn harvesting machinery, 312; Shocking corn, 313; Husking corn, 314; Shredding corn, 315. <i>Storing Corn:</i> Crib, 316; Shrinkage of stored corn, 317; Measuring corn in the crib, 318.	

CHAPTER XXII

ANIMAL AND INSECT ENEMIES AND FUNGOUS DISEASES OF CORN	264-271
<i>Animal Enemies:</i> Treatment, 319. <i>Insect Enemies:</i> Causes, 320; Corn bud-worms, 321; Cut-worms, 322; Wire-worms, 323; The corn ear-worm, 324; Chinch bugs, 325; Grain moths and weevils, 326. <i>Fungous Diseases:</i> Corn-smut, 327.	

CHAPTER XXIII

OATS	272-284
Origin and botanical classification, 328. <i>Structure and Composition of the Oats:</i> The plant, 329; The panicle, 330; The spikelets, 331; Pollination, 332; The grain, 333; Composition, 334. <i>Varieties of Oats:</i> Classification, 335; Varieties grown in the cotton-belt, 336; Red Rust-proof oats, 337; Burt oats, 338; Turf oats, 339; Beardless red oats, 340. <i>Improvement of Varieties:</i> Need of improvement, 341; Introduction of new seed, 342; Mechanical selection, 343; The seed-plot, 344; The isolation of elementary species, 345; Improvement by hybridization, 346.	

CHAPTER XXIV

	PAGE
OATS—CLIMATE, SOILS, TILLAGE PRACTICES AND USES	285-295
Climate, 347; Soils, 348; Fertilizers and manures, 349; Place in the rotation, 350; Preparation of the seed-bed, 351; Time of seeding, 352; Methods of seeding, 353; The open-furrow method of seeding, 354; Rate of seeding, 355; Subsequent care, 356. <i>Uses of oats</i> : Grain as food, 357; Oat straw, 358; Oat hay, 359; Oats for pasture and soiling, 360.	

CHAPTER XXV

OATS—HARVESTING, MARKETING, INSECT ENEMIES AND DISEASES	296-304
Time of cutting, 361; Shocking, 362; Stacking, 363; Thrashing and storing, 364. <i>Marketing</i> : Bleached oats, 365; Market grades of oats, 366. <i>Insect enemies</i> : 367. <i>Fungous diseases</i> : Oat rust, 368; Oat smut, 369; The hot-water treatment, 370.	

CHAPTER XXVI

WHEAT	305-322
Antiquity of wheat, 371; Nativity, 372; Biological origin, 373; Botanical classification, 374. <i>Structure and Composition of Wheat</i> : Roots, 375; Culms, 376; Tillering, 377; Leaves, 378; The spike, 379; The spikelets, 380; Fertilization, 381; The grain, 382; Composition, 383. <i>Types and Varieties of Wheat</i> : Botanical classification of wheat types, 384; Einkorn, 385; Spelt, 386; Emmer, 387; Common wheat, 388; Club wheat, 389; Poulard wheat, 390; Durum wheat, 391; Polish wheat, 392; Wheat varieties, 393; Varieties for the cotton-belt, 394; Wheat-growing areas of the cotton-belt, 395; Improvement of varieties, 396.	

CHAPTER XXVII

WHEAT—CLIMATE, SOILS, ROTATIONS, CULTURAL METHODS AND HARVESTING	323-333
--	---------

Climate, 397; Soils, 398; Rotations, 399; Fertilizers, 400. *Cultural Methods*: Preparing the seed-bed, 401; Date of seeding, 402; Rate of seeding, 403; Methods of seeding, 404; Wheat seeding machinery, 405; Cultivating wheat, 406; Pasturing wheat, 407. *Harvesting Wheat*: Methods, 408; When to harvest, 409; Methods of handling as related to quality of grain, 410.

CHAPTER XXVIII

WHEAT—WEEDS, INSECT ENEMIES AND FUNGOUS DISEASES	334-340
Weeds, 411; Insect enemies, 412; Hessian fly, 413; Chinch-bugs, 414; Fungous diseases, 415; Loose smut, 416; Covered smut, stinking smut or bunt, 417.	

CHAPTER XXIX

RYE	341-346
Origin and nativity, 418; Description, 419; Composition, 420; Varieties, 421; Climate, 422; Soils and fertilizers, 423; Rotations, 424; Seed, 425; Culture, 426; Harvesting and handling, 427; Enemies, 428.	

CHAPTER XXX

BARLEY	347-353
Nativity, 429; Description, 430; Composition, 431; Types of barley, 432; Climate, 433; Soils, fertilizers and rotations, 434; Sowing, 435; Harvesting, 436; Enemies, 437.	

CHAPTER XXXI

RICE	354-371
Structure, 438; Composition, 439; Varieties, 440; Upland rice, 441; Climatic adaptations, 442; Irrigation, 443; Rice-growing sections, 444; Drainage, 445; Soils, rotations and fertilizers, 446; Preparation of	

the seed-bed, 447; Planting, 448; Irrigation practices, 449; Harvesting, 450; Thrashing, 451; Yield, 452. *Preparation and Uses of Rice*; Cleaned rice, 453; Classification of rice products, 454; Uses, 455. *Enemies of Rice*: Weeds, 456; Insects, 457; Fungous diseases, 458.

CHAPTER XXXII

THE SORGHUMS	372-380
Biological origin, 459; Geographical origin, 460;	
Botanical classification, 461; Root-system, 462;	
Tillers and branches, 463; Drought resistance, 464;	
Effects on the soil, 465; Fertilization and crossing,	
466; Breeding, 467; Sorghum poisoning, 468.	

CHAPTER XXXIII

THE SACCHARINE SORGHUMS	381-388
Classification of saccharine sorghums, 469; Sumac	
sorghum, 470; Orange sorghum, 471; Amber sorghum,	
472; Gooseneck sorghum, 473; Honey sorghum, 474;	
Climatic adaptations, 475; Soils and fertilizers, 476;	
Preparation of the land, 477; Time, rate, and method	
of planting, 478; Cultivation, 479; Harvesting, 480;	
Manufacturing the sirup, 481; Yield, 482; Enemies,	
483.	

CHAPTER XXXIV

THE NON-SACCHARINE SORGHUMS	389-400
The grain-sorghum belt, 484; Groups of non-sac-	
charine sorghums, 485; Kafir, 486; Durra, 487; Shallu,	
488; Kowliang, 489; Broom-corn, 490; Culture of the	
grain sorghums, 491; Time, rate and method of seed-	
ing, 492; Cultivation, 493; Harvesting the grain-	

sorghums, 494; Culture of broom-corn, 495; Harvesting broom-corn, 496.

CHAPTER XXXV

SUGAR-CANE 401-411

Nativity, 497. *Description*: The plant, 498; Roots, 499; The leaves, 500; Inflorescence, 501; The stem, 502; Structure of the stem, 503; Amount and distribution of juice, 504; Composition of the juice, 505; Conditions affecting the composition of the juice, 506; Relative composition of cane in the Louisiana sugar-belt and in the coastal pine-belt, 507. *Varieties and Improvement of Sugar-cane*: Varieties, 508; Japanese sugar-cane, 509; Improvement, 510.

CHAPTER XXXVI

SUGAR-CANE—CLIMATE, SOILS, ROTATIONS, FERTILIZERS AND TILLAGE PRACTICES 412-422

Climate, 511; Soils, 512; Rotations, 513; Fertilizers, 514; Fertilizers for cane in the pine-belt, 516. *Tillage Practices*: Preparation of the land, 517; Time of planting, 518; Method of planting, 519; Keeping seed-cane over winter, 520; Cultivation, 521.

CHAPTER XXXVII

SUGAR-CANE—HARVESTING, USES, INSECT PESTS AND DISEASES 423-429

Harvesting: Time of harvesting, 522; Stripping, topping, and cutting, 523; Handling the harvested cane, 524; Yields, 525; Uses, 526. *Insect Pests*: The sugar-cane borer, 527; The southern grass worm, 528. *Fungous Diseases*: Origin, 529; Red-rot of sugar-cane, 530; The rind disease, 531; The pineapple disease, 532; The root-rot disease, 533.

CONTENTS

xxi

CHAPTER XXXVIII

PAGE

PEANUT 430-442

Nativity, 534; Distribution, 535; Description, 536; Composition, 537; Varieties, 538; Improvement of varieties, 539. *Culture of Peanuts*: Soil, 540; Rotations, 541; Lime for peanuts, 542; Fertilizers, 543; The use of stable manure, 544; Preparing the seed-bed, 545; Planting, 546; Cultivation, 547; Harvesting, 548; Stacking, 549; Picking, 550.

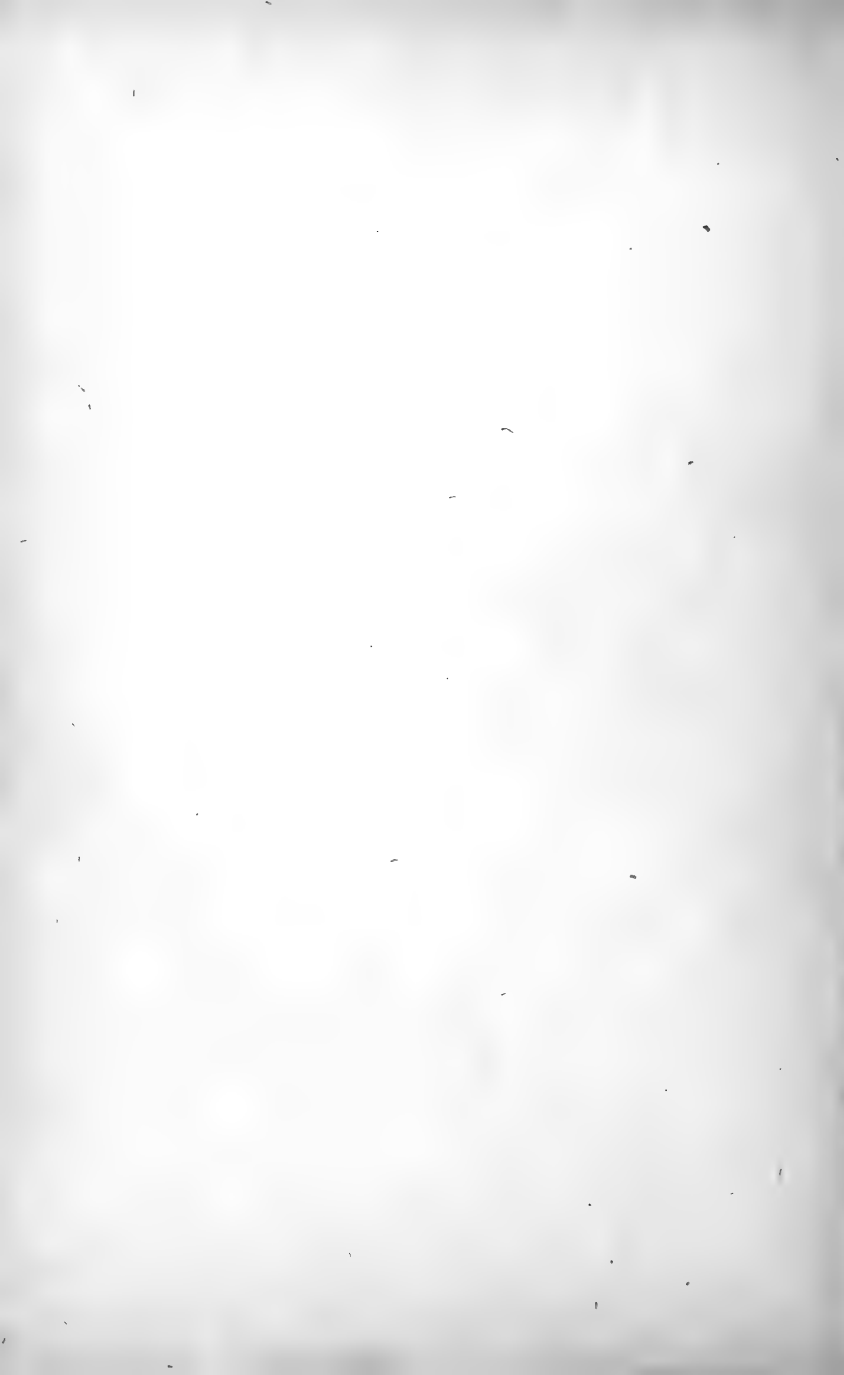

LIST OF ILLUSTRATIONS

FIG.	PAGE
1. Diagram showing relative value of field crops in United States and in cotton-belt	5
2. Diagram showing the total value of all crops and the relative value of the leading crops for each state in the cotton-belt	7
3. Stalk of Lone Star upland cotton, with (a) vegetative and (b) fruiting branches from the same node. (U. S. Dept. Agr.)	13
4. Flower of upland cotton, from the side, showing the position of the small calyx-lobe opposite the smallest bract (U. S. Dept. Agr.)	15
5. Bracts of upland cotton inclosing bud, showing twisted teeth (U. S. Dept. Agr.)	15
6. Stamens and stigmas of Egyptian cotton. (U. S. Dept. Agr.)	16
7. Cotton-producing areas of the world. (After Todd.)	34
8. Plant of the Jackson Limbless variety of cotton, representing the Cluster group (U. S. Dept. Agr.)	41
9. Plant of the Hawkins variety of cotton, representing the Semicluster group (U. S. Dept. Agr.)	42
10. Plant of the Peterkin variety of cotton, representing the Peterkin group (U. S. Dept. Agr.)	43
11. Plant of the Shine variety of cotton, representing the Early group (U. S. Dept. Agr.)	44
12. Plant of the Truitt variety of cotton, representing the Big-boll group (U. S. Dept. Agr.)	45
13. Plant of the Allen variety of cotton, representing the upland long-staple group (U. S. Dept. Agr.)	47
14. Cotton seeds with fibers attached. (U. S. Dept. Agr.)	57
15. Outfit used in crossing cotton; also buds showing the steps in emasculation and a boll three days after pollination (Ga. Station)	65

FIG.	PAGE
16. Average length of the crop-growing season in days (U. S. Weather Bureau)	78
17. Interior view of a one-seed drop cotton planter (B. F. Avery & Sons Plow Co.)	111
18. Adult boll-weevil showing characteristic teeth on front legs which serve to distinguish this insect from other weevils (Paddock)	127
19. Showing variation in size of boll-weevils (Paddock).	128
20. Root distribution of corn at silking time (U. S. Dept. Agr.)	152
21. Structure of corn plant at different stages of growth (after Bull)	155
22. Ear of corn showing tendency to laminate (after Harshberger)	158
23. Botanical parts of the corn kernel and its integuments (after Harshberger)	159
24. Cross section of the outer portion of a grain of corn (after Webber)	160
25. Illustrating development of corn stem (after Montgomery).	167
26. Illustrating the process of fertilization of the corn flower (after Montgomery)	169
27. Illustrating structure of corn kernel at pollination (after Crosthwait)	170
28. Cross-section of corn ear looking toward the base (after Winton)	171
29. Illustrating the relationship between gama grass, teosinte, and corn (after Montgomery)	175
30. A small ear of the pod-corn group	178
31. An ear of white rice pop corn (U. S. Dept. Agr.)	178
32. An ear of White Pearl pop corn (U. S. Dept. Agr.)	179
33. A good ear of the flint-corn group (U. S. Dept. Agr.)	180
34. A good ear of dent corn (U. S. Dept. Agr.)	181
35. An ear of the sweet-corn group	182
36. Showing the average angle of declination of corn ears after five generations of breeding for erect ears (Ill. Station)	188
37. Showing the average angle of declination of corn ears after five generations of breeding for declining ears (Ill. Station)	189

LIST OF ILLUSTRATIONS

XXV

FIG.	PAGE
38. Showing effect of five generations of breeding for high ears and low ears (Ill. Station)	199
39. Diagram showing method of producing cross-bred seed of corn	209
40. Corn harvesting tools	256
41. A corn-shocking horse (U. S. Dept. Agr.)	259
42. Illustrating a method of cutting and shocking checked corn to economize steps (Farmers' Bulletin, 313)	260
43. Husking peg and husking hook (after Montgomery)	261
44. Ear of corn showing characteristic injury by the corn-weevil (Paddock)	269
45. Corn smut (U. S. Dept. Agr.)	271
46. Plats of winter oats in November at the Maryland Agricultural Experiment Station, College Park, Md. (U. S. Dept. Agr.)	280
47. Smut of oats, showing a smutted head and for comparison a sound oat head (U. S. Dept. Agr.)	303
48. Diagrammatic section through the stem of wheat about 25 days after planting, (enlarged) (after Hayes and Boss)	307
49. A wheat leaf (after Hunt)	308
50. Front and side view of spikelet of wheat (after Hunt)	309
51. Illustrating the opening and closing of the wheat flower (after Hayes and Boss)	310
52. The reproductive organs of wheat (after Hayes and Boss)	311
53. Cross-section and transverse section of a grain of wheat (Hunt's Cereals in America, p. 36)	312
54. Representative heads of five varieties of hard winter and hard spring wheat (U. S. Dept. Agr.)	316
55. Heads of some beardless winter varieties of wheat (U. S. Dept. Agr.)	317
56. Heads of some bearded winter wheat varieties (U. S. Dept. Agr.)	318
57. Heads of Tennessee Winter barley, side and front views; also detached kernels with the awns removed (U. S. Dept. Agr.)	348
58. A grain of 2-rowed barley (U. S. Dept. Agr.)	349
59. High grade barley grains with the glumes removed to show the embryo with its collar-like scutellum (U. S. Dept. Agr.)	349

FIG.	PAGE
60. Loose smut of barley, showing five smutted heads at various stages of development and for comparison a sound barley head (U. S. Dept. Agr.)	352
61. Typical heads of five varieties of rice together with the unhulled and hulled grains (Texas Station)	357
62. Blue Rose rice (La. Station)	358
63. Two heads of Milo showing desirable form (on left) and undesirable form (on right) U. S. Dept. Agr.)	378
64. Three plants of Blackhull Kafir, 5.5 feet high, selected for low stature and high yielding power (U. S. Dept. Agr.)	379
65. A head of Orange sorghum (U. S. Dept. Agr.)	383
66. Heads of four varieties of Kafir (U. S. Dept. Agr.)	391
67. Milo heads; one pendent, one erect (U. S. Dept. Agr.)	392
68. Milo seeds, hulled and unhulled (U. S. Dept. Agr.)	393
69. Two heads of shallu (U. S. Dept. Agr.)	394
70. Broom-corn fruit with chaff (after Winton)	396
71. A field of sugar-cane (La. Station)	402
72. Spanish type of peanut (U. S. Dept. Agr.)	434
73. Commercial types of peanuts (U. S. Dept. Agr.)	435
74. Machine potato digger adapted for harvesting peanuts (U. S. Dept. Agr.)	441
75. Laborer building a stack of peanut vines, showing method used. Completed stacks in background (U. S. Dept. Agr.)	442

FIELD CROPS FOR THE COTTON-BELT



FIELD CROPS FOR THE COTTON-BELT

CHAPTER I

CLASSIFICATION AND VALUE OF FIELD CROPS

THE term "field crops," in its broadest sense, includes all crops grown in cultivated fields under an extensive system of culture. Horticultural crops may be defined as those crops which are grown in relatively small areas under systems of intensive culture. They are the fruits and vegetables. There are some exceptions to this rule. For example, sugar-beets and tobacco are field crops that require intensive culture. On the other hand, fruits and vegetables are frequently grown in large areas.

No satisfactory classification of field crops has, as yet, been made, on account of the new uses to which plants are constantly being put and also because one crop may be used for a variety of purposes. For convenience in study and in describing methods of culture, field crops have been grouped into several classes.

1. Classification by use. — According to use, crops are commonly grouped as follows:

Cereal or grain crops, as corn, wheat, oats, rye, barley, and rice.

Forage crops, including the grasses and legumes cut for hay, fodder, silage, or for feeding green.

Legumes for seed, as beans, lentils, and peas.

Fiber crops, as cotton, flax, and hemp.

Root crops, as beets, turnips, and carrots.

Tubers, as Irish potatoes.

Sugar plants, as sugar-beets and sugar-cane.

Stimulants, as tobacco, tea, and coffee.

2. Classification for the study of cropping systems. —

For the purpose of studying crop rotation, field crops are divided into six general groups. These are grain crops, grass crops, cultivated crops, catch-crops, green-manure crops, and cover-crops.

In this classification the grain crops include all crops that are grown primarily for grain and receive no cultivation from seed time until harvest. The grass crops include those crops most commonly grown for hay, or pasture, such as Bermuda-grass, timothy, Kentucky blue-grass, alfalfa, red clover, crimson clover, and the like. The cultivated crops, as the name signifies, include all crops so planted as to permit or require intertillage. The term "catch-crop" is used to designate those crops that are used as substitutes for staple crops which, on account of unfavorable conditions, have failed after being planted. They are quick-growing crops such as millet, buckwheat, rye. Green-manure crops are crops that have been planted for the purpose of producing organic matter to be plowed into the soil. Cover-crops are used to prevent erosion or leaching. In some cases one crop may be used for two or more of the above purposes.

3. Important botanical groups. — The classifications given above are not based on any botanical relationships whatever. With few exceptions the important field crops belong to two families, namely, the Gramineæ or grass family and the Leguminosæ or legume family. The former includes all of the cereals, except buckwheat, and

CLASSIFICATION AND VALUE OF FIELD CROPS 3

perhaps three-fourths of the cultivated forage crops. The latter family, so called because the seeds, in most cases, are borne in a pod or "legume," includes the true clovers, alfalfa, the vetches, peas, beans, and the like. The Irish potato and tobacco belong to the nightshade family, Solanaceæ, while cotton belongs to the mallow family, Malvaceæ.

VALUE OF FIELD CROPS

According to the 1910 Census, the leading farm crops in the United States possessed for the year 1909 the following values:

CROP	MILLIONS OF DOLLARS	CROP	MILLIONS OF DOLLARS	CROP	MILLIONS OF DOLLARS
1. Corn.....	1,438	8. Barley.....	92	15. Peanuts.....	18
2. Hay and forage	824	9. Sweet potatoes	35	16. Rice.....	16
3. Cotton.....	704	10. Flax seed.....	28	17. Dry peas.....	11
4. Wheat.....	658	11. Sugar-cane...	26	18. Kafir & milo..	11
5. Oats.....	415	12. Dry beans....	22	19. Sorghum.....	10
6. Potatoes.....	166	13. Rye.....	20	20. Buckwheat...	9
7. Tobacco.....	104	14. Sugar-beets...	19		

Below is given the 1909 value of the eleven field crops treated in this text for the cotton-belt states only:

CROP	MILLIONS OF DOLLARS	CROP	MILLIONS OF DOLLARS	CROP	MILLIONS OF DOLLARS
1. Cotton.....	699	5. Sugar-cane....	26	9. Sweet sor-	
2. Corn.....	335	6. Rice.....	16	ghum.....	5
3. Wheat.....	30	7. Peanuts.....	14	10. Rye.....	0.6
4. Oats.....	28	8. Kafir & milo...	6	11. Barley.....	0.2

The states comprising the cotton-belt are North Carolina, South Carolina, Georgia, Florida, Alabama, Mississippi, Louisiana, Texas, Oklahoma, Arkansas and Tennessee.

In 1909, all farm crops in the United States occupied 311,293,382 acres and had a total value of \$5,073,997,594, which was 92.5 per cent of the value of all crops, since these totals did not include orchard fruits, nuts, flowers, nursery and forest products on farms, amounting to a total of \$413,163,629, for which no acreage was reported.

The cotton-belt, with 25.6 per cent of the land area of the continental United States, 33.7 per cent of the farm area, and 24.4 per cent of the improved land in farms, had 25.8 per cent of the crop acreage and produced 29.3 per cent of the value of all crops in the United States with acreage reported.

4. Rank of the cotton-belt states. — The total value of all crops for each state in the cotton-belt for 1909, together with the percentage value of the United States' crop produced in each state, is shown below:

TABLE 1, SHOWING TOTAL VALUE OF ALL CROPS WITH ACREAGE REPORTS

CROP OF 1909. MILLIONS OF DOLLARS

U. S.	TEX.	GA.	MISS.	S. C.	ALA.	OKLA.	N. C.	ARK.	TENN.	LA.	FLA.
5,074	287	214	139	136	136	130	128	109	108	73	26

PER CENT OF VALUE OF U. S. CROPS PRODUCED IN EACH STATE

100	5.7	4.2	2.8	2.7	2.7	2.6	2.5	2.2	2.1	1.5	0.5
-----	-----	-----	-----	-----	-----	-----	-----	-----	-----	-----	-----

Texas ranks first, having produced two-thirty-fifths of the value of the entire United States' crop. Florida ranks last, having produced one-two-hundredths of the value of the country's crop.

5. Importance of field crops in the cotton-belt. — Below is shown the relative importance of the eleven field crops treated in this text to the agriculture of both the United States and the cotton-belt:

TABLE 2, SHOWING PERCENTAGE OF ENTIRE ACREAGE OCCUPIED BY EACH CROP

	Cotton	Corn	Wheat	Oats	S. Cane	Rice	Peanuts	Kafir & milo	Sweet sorghum	Rye	Barley
U. S.....	10.3	31.7	14.2	11.2	0.2	0.2	0.3	0.5	0.1	0.7	2.5
Cotton-belt.....	39.5	38.2	3.5	3.7	0.6	0.8	0.9	1.4	0.3	0.1	0.02

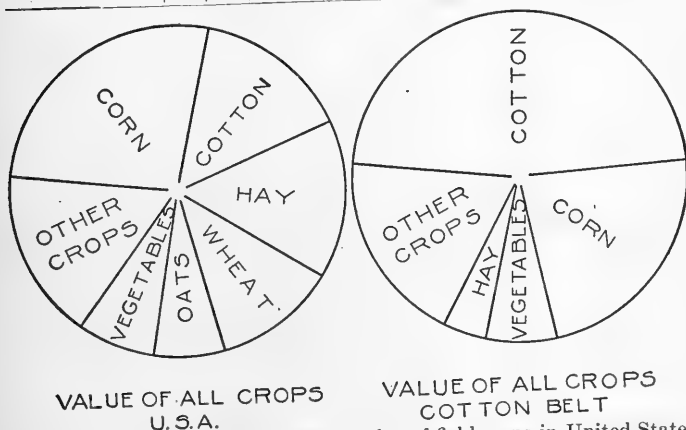

FIG. 1. — Diagram showing relative value of field crops in United States and in cotton-belt.

PERCENTAGE OF VALUE OF ALL CROPS REPRESENTED IN EACH CROP

U. S.....	13.9	28.4	13.0	8.4	0.5	0.3	0.4	0.2	0.2	0.4	1.8
Cotton-belt.....	47.0	22.5	2.0	1.9	0.2	1.1	0.9	0.4	0.4	0.04	0.01

In 1909, practically all of the cotton, sugar-cane, rice, and peanuts grown in the United States was produced in the cotton-belt. On the other hand, a relatively small percentage of the small-grain crop was produced in the

cotton-belt. Barley, for example, occupies 1 acre in 40 of all United States' crops and 1 acre in 5,000 in the cotton-belt. Corn occupies a greater relative area and returns a smaller relative value in the cotton-belt than in the entire United States.

The total value of all field crops and the relative value of the leading crops for each state in the cotton-belt are graphically shown in Fig. 2.

In the cotton-belt cotton occupies two-fifths of the land in crops and produces one-half the value of all crops. Texas, Georgia, Mississippi and South Carolina are the four leading cotton states in order of rank. The 1910 Census shows that the acreage of corn and cotton is almost equal in the cotton-belt. The value of the cotton crop is 2.1 times the value of the corn crop.

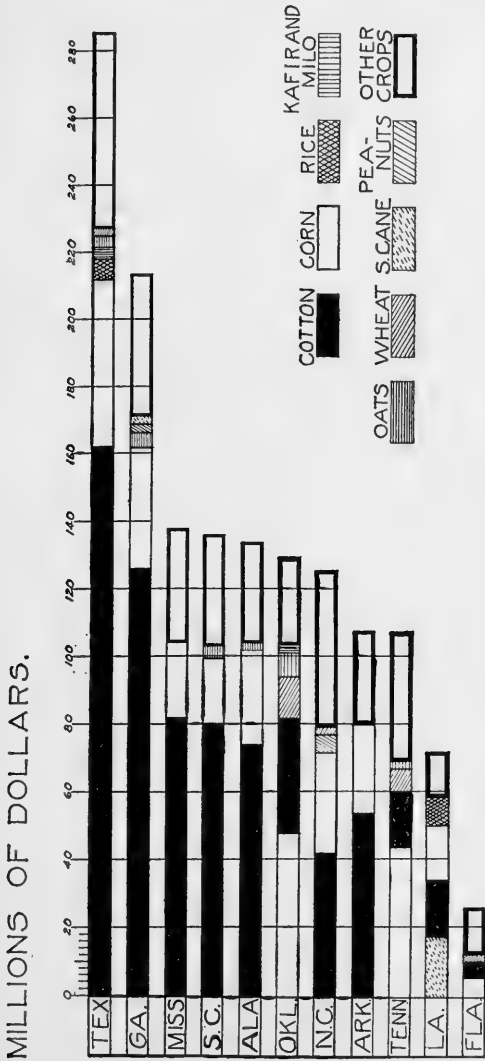

Fig. 2. — Diagram showing the total value of all crops and the relative value of the leading crops for each state in the cotton-belt.

CHAPTER II

DESCRIPTION OF THE COTTON PLANT

THE cotton plant is indigenous to the tropical regions of both hemispheres. In its native home it is a perennial. The cotton of the southern United States, and of all important cotton-producing countries, is an annual, being killed by the low temperatures of winter. Under cultivation it is a much branched herbaceous shrub ranging in height from two to six feet. Cotton is grown primarily as a source of fiber. From the seed various by-products of considerable value are obtained.

6. The root-system. — When a cotton seed is placed in a warm, moist soil, it absorbs water and swells. Subsequently the seed coverings burst and the radicle, and the plumule, a short time later, grow out and elongate in opposite directions. The radicle grows to form the root-system while the plumule develops into the aerial portion. The cotton plant, while possessing a strong tap-root, produces the greater portion of its feeding roots in the upper two to six inches of soil. The copious branching which the root system exhibits enables the cotton plant to draw its food supplies from a large area of soil.

7. Types of roots. — Cotton roots may be classed as primary roots, and secondary roots. The primary root is commonly termed the tap-root. It is a continuation of the above-ground stem and from it the secondary roots branch. The depth to which the primary root grows is determined largely by the drainage conditions and the

character of the soil. After reaching the upper surface of the water-table in the soil, the primary root either ceases to grow or is diverted horizontally. Balls,¹ working with Egyptian cotton, traced a tap-root to a depth of more than seven feet. In a sandy soil and subsoil the South Carolina Station traced well-developed tap-roots to a depth of nearly three feet without coming to their end.² Conversely, it was found that cotton plants growing on heavy clay loam soil very rarely produced well-developed tap-roots more than nine inches in length. Under very unfavorable conditions the tap-roots may be absent.

The secondary roots branch off laterally from the primary root. They again produce other laterals and this branching process continues until the soil is completely filled with a net-work of copiously branched roots to a depth that varies from two to eight inches. The lateral roots begin to grow below the surface of the soil at a depth varying from one-half inch to three inches. If the soil is moist they may come almost to the surface a short distance from the plant. In almost any soil the secondary roots develop sufficiently near the surface to be injured by deep cultivation. After growing in a lateral direction for a distance varying from two to three feet, some of the secondary roots grow abruptly downward to a depth of three or more feet, presumably for the purpose of aiding the plant in securing moisture.

The absorptive power of the secondary roots is due largely to the root-hairs. These root-hairs are microscopic in size and never develop into true roots. They comprise an infinite number of delicate out-growths of the surface cells of the root, forming thin-walled hairs. They are

¹ Balls, W. L., "The Cotton Plant in Egypt," p. 33.

² South Carolina Station Bulletin No. 7, 1892.

limited to a zone not far behind the growing point, or the apex, of the young roots. Root-hairs are very short-lived. As the young root grows in length, the root-hairs farthest from the growing tip perish, more being formed continually at about the same distance from the apex.

8. Functions of the root-system. — In the main, the functions of the root-system are: (a) to obtain food and water for the plant, (b) to excrete carbon dioxide and possibly organic acids that render plant-food available, and (c) to anchor the plant to the soil, and thus afford a firm support for the aerial portion.

The primary function of the tap-root is probably that of aiding the plant to secure moisture. During periods of drouth it is very helpful in this respect. This is evidenced by the fact that it grows faster and deeper in a relatively dry soil than in a wet soil. The lateral roots, by their extensive growth and copious branching, are the means of producing the infinite number of root-hairs. The interspaces of the soil are penetrated by the young growing portions of the roots in such a way as to bring them into close contact with the soil particles. The delicate root-hairs stand out at right angles to the surface of the true root. Consequently they are brought into very intimate relations with the surface of the particles. A film of capillary water surrounds each soil particle and contains, in solution, mineral plant-food which has been dissolved from the soil. Thus the acid juices in the root-hair and the solution of minerals surrounding the soil particle are separated only by the thin porous wall of the root-hair. This relationship makes it easy for the root-hairs to perform their functions, namely, to absorb the water and soluble food in the soil, and also to excrete into the soil-

water acids which aid in dissolving fresh supplies of plant-food. While the root-hairs constitute the absorbing organs of the plant, a small quantity of food in solution is absorbed directly by the epidermal tissues of the true roots. The process of absorption by both the root-hairs and the true roots is that of osmosis.¹

9. The stem. — The cotton plant possesses a cylindrical, erect, gradually tapering central stem ranging in length from two to six feet. From the nodes of this stem the branches arise. The stem and branches are covered with a tough greenish or reddish bark. Because of its strength, due to the relatively large percentage of bast fibers contained, cotton bark has been used to a limited extent as a coarse fiber. Inside the bark the stem is composed of brittle, white wood, which decays readily when plowed into the soil.

10. The branches. — Like all true branches, the cotton branches arise in the axils of the leaves. As they are borne at the nodes on the stem their number is determined by the length of the stems and the distance between nodes. The Texas Station has found that late planting

¹“*Osmosis.* — When two solutions of different density are separated by a porous membrane, there will be first a movement of the weaker solution through the membrane into the stronger, and later a return movement, the process continuing until the two solutions have the same density. The contents of a root-hair being denser than the soil solution surrounding it, there is a constant movement of the soil solution into the root-hair. By some means the exosmosis, which would take place in the case of an ordinary membrane (movement of the cell solution outward), seems to be restrained in the root-hair, probably by some functional activity of the cell. The result is a much greater movement into the root-hair than exudation out of it. The soil solution passes from the root-hair into the root and is finally transmitted to the stem and leaves.” — E. G. Montgomery.

has a tendency to produce tall plants with long joints.¹ Fertile soils containing an abundance of moisture produce longer jointed plants than do poor soils of a thirsty character. It has also been found that the structure of the cotton plant with reference to the number and arrangement of the branches is, to some extent, a hereditary character and can be modified by careful selection.

The length of the branches varies with the variety, the position on the main-stem, and the character of the soil. The largest branches are borne at the base of the plant, the length decreasing toward the top of the plant. This gives most cotton plants a cone-shaped appearance. A different shape, however, is presented by the "cluster varieties," there being only a few long basal branches; above these only very short branches are produced.

Cotton branches may be classified into (1) "vegetative branches" and (2) "fruiting branches." Vegetative branches are of two kinds: (a) long branches springing from the main-stem and having no boll-stems directly attached, but possessing sub-branches which bear bolls; (b) sterile branches whose only function is to increase the leaf area of the plant. The cotton plant often bears both a vegetative and a fruiting branch from the axil of the same leaf (Fig. 3). In fact, this seems to represent the normal branching habit. In most cases, however, one or the other of these branches fails to develop, only the rudiment of a branch being produced. The very frequent occurrence of the sterile branches produces leafy, unproductive plants. This defect can be remedied by carefully selecting seed from plants that produce a large proportion of fruiting limbs.

11. The leaves. — Cotton leaves are borne alternately

¹ Texas' Station Bulletin, No. 77, p. 20.

on the stem or branch. They are petioled, somewhat heart-shaped, three to seven-lobed and three to seven-veined. The petioles and veins are often hairy. The midveins, and sometimes the adjacent ones, bear a gland one-third the distance from their base. In some cases these glands are absent. Cotton leaves are very variable in size, even on the same plant. They range from three to six inches in length and from two to five inches in width. The leaves of the American upland cotton (both short and long staple) are most commonly three-lobed, sometimes five-lobed. The lobes are rather blunt, the spaces between lobes being shallow. This is especially true as regards the big-boll kinds. Certain of the small-boll kinds, of which King and Peterkin are representatives, produce leaves having narrow sharp-pointed lobes. The leaves

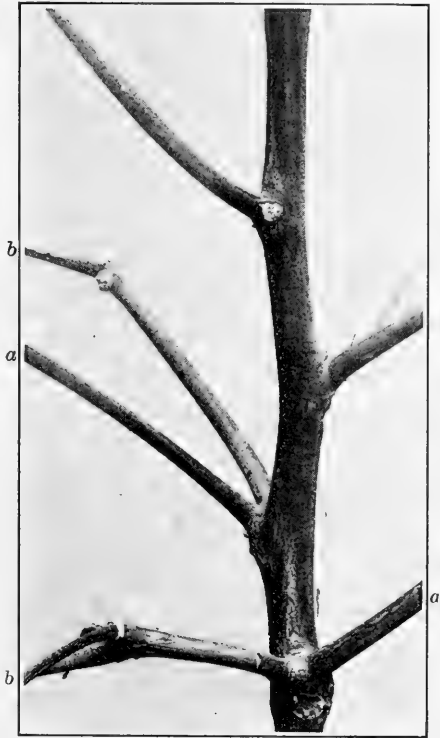

FIG. 3. — Stalk of Lone Star upland cotton, with (a) vegetative and (b) fruiting branches from the same node.

of Sea Island cotton are three-lobed also, but the lobes are much longer and slenderer and the indentations much deeper than in the upland cottons.

The principal functions of the leaves are: (1) to make possible the free circulation of solutions of food and air throughout the plant; (2) to give off the excess of water taken up by the roots; (3) to take up from the air the carbon dioxide needed to build plant-tissue; (4) to elaborate plant-food from the minerals and water taken from the soil, and the carbon and oxygen taken from the air; (5) to absorb from the sun the energy necessary for the activities enumerated above.

12. The vascular system. — In the description of the cotton leaf attention was called to the system of leaf-veins, ranging in number from three to seven. A careful examination will reveal a much-branched net-work of minor veins springing from the larger veins. If a cross-section of a leaf is examined under the microscope, it will be seen that these veins are composed of specialized tissue of vessels and fibers. This fibrous tissue of the leaves extends throughout the petioles, the branches, the main-stem, and into the root-system, and is known as the vascular system. It is by means of this vascular system that solutions are carried from the roots to the stems and leaves.

13. Air cavities. — Besides being supplied with food and water, each leaf cell must have air, or rather carbon dioxide from the air. To supply this there is provided throughout the entire leaf tissue a system of continuous openings, or air spaces, between the cells. These air cavities communicate with the exterior in all the green parts of the leaf. The openings through which the air enters are known as stomata and are most numerous on the under side of the leaves. By means of this delicate

system of air-passages, each leaf cell is, in a somewhat intricate manner, brought into contact with the external air.

14. The peduncles. — The peduncles are small stems connecting the flowers and later the bolls with the branch. Their length varies with the variety of cotton, and also in different parts of the



FIG. 4. — Flower of upland cotton, from the side, showing the position of the small calyx-lobe opposite the smallest bract.

same plant. In American upland cotton the length ranges from one-half inch to two inches.

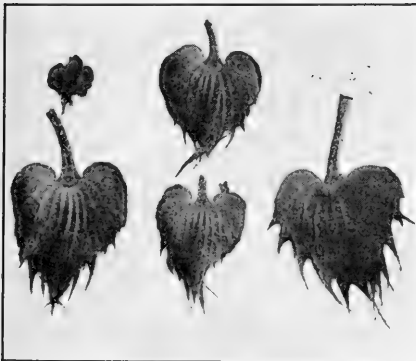

FIG. 5. — Bracts of upland cotton inclosing bud, showing twisted teeth.

There seems to be a relation between the length of the peduncle and "storm resistance" in cotton. The length should be such as will permit the boll to hang with its tip downward, so that the leafy bracts, or involucre,

will protect the lint from rain. The peduncle should not be so long as to cause it to bend

abruptly, as this retards the development of the boll.

15. The flowers (Figs. 4-6). — Cotton flowers are large and rather conspicuous. At the juncture of the peduncle and the flower is borne a three- (sometimes four-) leaved involucre. The calyx is short and composed of five united sepals, presenting a cup-shaped appearance. The corolla



FIG. 6. — Stamens and stigmas of Egyptian cotton.

is free from, but inserted beneath, the pistil. There are five petals, which are often grown together at their base and attached to the lower part of the stamen-tube. The stamens are numerous; the anthers one-celled and kidney-shaped; the pollen-grains spheroid in shape, heavy and waxy. The ovary is sessile and three- to five-celled. The pistil is divided into

parts or stigmas, from three to five in number. In American upland cotton the pistil is divided into four or five stigmas, while three is the prevailing number in Sea Island cotton. The number of stigmas present indicates the number of locks of seed cotton that will develop in that particular boll.

In upland cotton the flowers are a creamy-white color on the morning that they open. They change to a reddish color the second day, and later fall. The flowers of the Sea Island cotton are yellowish in color.

16. The bolls. — The ovary of the cotton flower contains from few to many ovules. After these ovules have been fertilized by the pollen-grains, the pistil develops into a more or less thickened, leathery capsule called the

boll. The length of time from the fertilization of the ovules to the production of a mature boll varies from 40 to 55 days. The bolls are oval in shape, distinctly pointed at the apex and vary in size from 1.5 to 2.5 inches in length and from 1.25 to 1.75 inches in width. From the base of the boll to the apex, divisions or valves are found, from three to five in number. The contents of each valve are called a lock. The bolls of American upland cotton (both long and short staple varieties) usually contain four or five locks. The Alabama Experiment Station, working with upland cotton, has found that bolls with five locks yield more cotton per boll than bolls having only four locks.

When the boll matures it opens, exposing the seed cotton inside. The opening is caused by the valves "separating along their central axis and at the same time splitting down the middle of the back." The valve walls after opening are spoken of collectively as the "bur."

The Texas Station ¹ has found that there is a relation between the thickness of the burs and the tendency of the seed cotton to be blown out by winds or beaten out by rains. If the burs are thin, they curl backward in opening, thus allowing the seed cotton to drop easily.

17. Number of bolls to the plant. — The factors that determine the number of bolls to the plant are fertility of soil, rain-fall, climate, variety, and the structure of the plant with reference to the arrangement and character of the vegetative and fruiting limbs. Fertile soils, well supplied with moisture, produce plants with a larger number of bolls than do poor, droughty soils. Excessively productive soils, especially as regards nitrogen, often produce a large amount of vegetative growth at the expense

¹ Texas Station Bulletin, No. 75.

of fruit. Close-jointed plants throughout, including the main-stem, the primary and fruiting limbs, bear the maximum number of bolls. While this character of the plant is influenced to some extent by environmental conditions, it is also a hereditary character and can be greatly modified by careful seed selection.

18. The seed. — Within each lock of cotton there are six to ten oblong or angular seeds. The seed tapers somewhat toward the hilum end, terminating in a sharp point. The crown or free end is enlarged and rounded. The seeds of both long-staple and short-staple upland cotton, after having the lint removed, are covered with a pronounced fuzz which may be grayish, rusty or green in color, often changing color with maturity and age. The seeds of Sea Island cotton are naked and black.

The cotton seed is composed of (1) the testa or hull, (2) the endosperm, a layer of cells composed largely of aleurone grains, and (3) the embryo or meat, which consists of the two cotyledons, the embryo sprout and the embryo root.

The seeds of upland cotton as they come from the gin have been found to have the following physical composition: linters, 10 per cent; hulls, 40 per cent; meat, 50 per cent.

The legal weight of a bushel of upland cotton seed varies from 30 to 33½ pounds; it is usually 32 pounds. A legal bushel of Sea Island cotton seed is 44 pounds.

19. The lint. — A cotton fiber may be defined as a unicellular hair which has been developed from the cuticle of the cotton seed. According to Watt¹ each fiber is composed of the following parts: (a) the cell-wall or cuticular envelope of the elongated hair; (b) the deposits

¹ Sir George Watt, "The Wild and Cultivated Cotton Plants of the World," p. 30.

of cellulose laid down within and upon the envelope; (c) the core of cell-contents filling up the central cavity.

If a cotton fiber be examined carefully under a magnifying glass it will be found that it is broadest near or a little below the middle and gradually tapers toward both the base and the apex. If the fiber is mature this examination will show the fiber-tube to be somewhat flattened and irregularly twisted. It is claimed that the number of the twists varies from 300 to 500 to an inch. The amount of twist in the cotton fiber is very important in determining its spinning qualities and, hence, its value. The degree of twisting is, to a large extent, determined by the stage of maturity of the fiber. The immature fibers, on drying, form almost flat, structureless ribbons, with very little twist. In almost any lot of cotton the following classes of fibers may be recognized: (1) ripe; (2) half ripe, and (3) unripe. In addition to these three classes, a fourth class, namely, over-ripe fibers is often noticeable. In this class the fibers are spoken of as being rod-like, devoid of elasticity and unsuitable for spinning purposes.

20. Length and strength of fiber. — The length of cotton fiber varies with different kinds of cotton, and to a slight extent with soil fertility. Duggar ¹ gives the following as the approximately average lengths of fibers of the principal kinds of cotton:

- Sea Island, 1.61 inches;
- Egyptian, 1.41 inches;
- American upland, 0.93 inches;
- American long-staple, 1.3 inches.

The fibers vary in length even on the same seed. Those at the base or pointed end of the seed are usually shorter than those borne on the apex end. This is probably due

¹ Duggar, J. F., "Southern Field Crops," p. 263.

to the slower growth and later starting of the fibers on the base of the seed. In the upland cotton there is, in addition to the fiber proper, an "under-fleece" (called fuzz or linters) which is very short, as a result of the failure of a number of "cuticular cells" to elongate.

The strength of the cotton fiber varies according to its ripeness and fineness. From 2.5 to 15 grams represents roughly its breaking strength. Williams, of North Carolina, found the average breaking strength of single fibers representing twelve different varieties, to be 6.83 grams. As a result of tests made by Hilgard the breaking strength was found to vary from 4 to 14 grams in upland cotton. The cotton fiber, in proportion to its size, is stronger than jute or flax and is three times as strong as wool. It is surpassed in strength by the fibers of hemp, manila hemp, and silk.

CHAPTER III

PHYSIOLOGY OF THE COTTON PLANT

A **PLANT**, like an animal, is dependent upon certain vital actions or functions to maintain life. Careful analysis of a living plant shows it to be made up of distinct parts, each part performing more or less definite functions. It is essential, therefore, that we become familiar with the more important of these functions and the relation of each to the well-being of the plant.

21. The plant structure.— The cotton plant is made up of innumerable cells. Each cell in the hard part of the plant has a somewhat thickened cell-wall, composed chiefly of cellulose, the substance of which paper is made. These cell-walls are united, the resulting tissue constituting the skeleton of the plant. There are two kinds of strengthening tissues composing the plant skeleton, differing mainly as regards the structure of the cell-wall. These are (1) those tissues in which the cell-walls are thickened at the corners only, (collenchyma) and (2) tissues in which the cell-walls are equally thickened throughout, (sclerenchyma). The former tissue is found only in the young growing parts of the plant, while the latter occurs in the older parts in which growth has ceased.

The function of the skeleton is to give stability to the plant. It is by means of this strengthening tissue that a cotton plant supports its own weight, and resists the force of winds.

22. The living substance in the plant.— Within the cell-walls is contained a transparent, jelly-like substance

called protoplasm. This protoplasm constitutes the life of the plant. It is the center of all the activities that the plant manifests. Quoting from Green, "The protoplasm assimilates the food which the plant requires and carries out all the chemical processes necessary for life. It constructs the framework of the plant by which it is itself supported. . . Finally it carries out the processes of reproduction."

THE COMPOSITION OF THE COTTON PLANT

23. Composition. — Approximately 90 per cent of the weight of a young, succulent cotton plant is water. The remaining 10 per cent is called dry matter. As the plant grows and becomes more woody, the percentage of water present decreases and the percentage of dry matter increases correspondingly. At maturity the plants are about 60 per cent water and 40 per cent dry matter.

TABLE 3, SHOWING APPROXIMATE COMPOSITION OF AIR-DRY COTTON PLANTS ¹

	Water	Ash	Protein	Fiber	Nitrogen free ext.	Fat
	Per ct.	Per ct.	Per ct.	Per ct.	Per ct.	Per ct.
Mature plant collected Oct. 25	7.36	5.81	9.13	30.94	42.84	3.92
Young plant collected June 3	*10.00	15.62	21.49	16.38	32.51	4.00
Young plant collected June 25	*10.00	14.59	22.09	18.79	29.98	4.55

¹ Bul. 33, Off. Exp. Sta., U. S. Dept. of Agr.

* Assumed.

The dry matter is composed largely of combustible material, nearly all of which comes from the air and water. Four elements enter into the composition of the combustible part. These are carbon, hydrogen, oxygen, and nitrogen. The ash which is left after the dry matter has been burned, is composed of mineral matter taken from the soil. Less than 2 per cent of the weight of a green cotton plant is secured from the soil.

24. The essential constituents. — There are ten elements essential to plant growth. Of these ten elements, four are metals and six are non-metals. The four metals are potassium, calcium, magnesium, and iron, all of which the plant secures directly from the soil. Of the non-metals, two, sulfur and phosphorus, are secured directly from the soil, while nitrogen is obtained indirectly from the air through the soil. The remaining three are carbon, obtained largely from the carbon dioxide of the air, and hydrogen and oxygen, obtained from water (some hydrogen is obtained from ammonia and some oxygen from the air). Those elements that are derived from the soil are absorbed in the form of salts.

NUTRITION

The growing cotton plant is dependent upon certain vital activities for its existence, such as the absorption of food and water, the assimilation of carbon dioxide, the digestion of the raw food materials, the giving off of oxygen and water, and the securing of the necessary energy for these activities. The processes which promote growth and repair the waste caused by the vital activities are called nutritive processes.

25. The absorption of food. — The essential food elements were discussed in paragraph 24. The structure

of the plant is such that all of the food materials must be taken up in solution or, in the case of carbon and some of the oxygen, as a gas. The mineral constituents obtained from the soil are taken in by the root-hairs with the stream of water. This dilute solution of food passes through the soft outer tissues (cortex) of the root to the vascular system through which it passes directly to the leaves.

In taking up food, roots exhibit a selective power in that they take up from the soil certain elements to the total or partial exclusion of others. For instance, from a solution of sodium nitrate plants take up the nitric acid and leave the sodium. The continuous absorption of food and water by the cotton plant will depend upon certain external conditions such as the moisture content of the soil, the nature and amount of plant food materials in the soil, the temperature of the soil, the activity of transpiration, and the intensity of light.

26. The taking up of carbon. — Approximately 50 per cent of the weight of a water-free cotton plant is carbon. The plant secures its carbon from the carbon dioxide of the air. It is estimated that carbon dioxide exists in the air in the ratio of about 3 parts in 10,000 or 0.03 per cent.

As shown in paragraph 11, one of the functions of the leaves is to take up from the air the carbon dioxide needed to build plant tissue. This process is greatly facilitated by the large number of stomata that are thickly scattered over the under-surface, and to a less extent, the upper-surface of the leaves. One of the primary functions of the stomata is to serve the plant as breathing pores. The air containing carbon dioxide passes through the stomata into the air-spaces of the leaf. From here the carbon

dioxide is absorbed by the leaf cells, in which it is broken down into carbon and oxygen. The carbon unites with the water which has been absorbed from the soil, the result being the formation of carbohydrates. This process is called photosynthesis. The following equation has been suggested as representing the changes that take place:

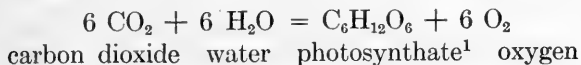

Most of the sugar thus formed is quickly converted into starch, probably in accordance with the following reaction:

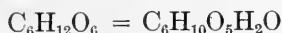

While the starch is manufactured in the leaves, it cannot be transferred in this form to other parts of the plant for building tissues as starch is not soluble. Consequently it is later changed back into sugar in which form it is carried to all parts of the plant, for the formation of carbohydrate material.

At the same time that the carbon dioxide is being taken up from the air and decomposed in the plant, an almost equal volume of oxygen is being given off from the leaves as a by-product.

27. The necessary energy. — The breaking down of the carbon dioxide and the formation of carbohydrate materials in the plant, such as sugar and starch, require the expenditure of considerable energy. The plant secures this energy from the sunlight. The leaf cells, except those in the veins, contain small green chlorophyll bodies. These chlorophyll grains absorb both the carbon dioxide and the sunlight, and with the energy thus received, the

¹ This term is being applied in the recent plant physiologies to the carbohydrate produced as the result of photosynthesis.

carbon dioxide is decomposed and various food materials are elaborated. The greater part of the energy which the plant secures from the sunlight, however, is expended in the evaporation of water from the leaves.

THE GIVING OFF OF WATER

28. We have seen that the cotton leaf is an organ for the reception of light and the absorption of gases. It is also by means of the leaves that the cotton plant rids itself of the large amount of surplus water absorbed by the roots. Not all of the leaf area, however, can be classed as transpiring surface. In fact, to prevent the too rapid loss of water, the surface of the leaf is made water-proof by waxes so that water can escape only at the stomata. Each stoma is surrounded by two guard-cells which serve as automatic devices for regulating the loss of water from the plant. The following quotation from Osterhout makes clear the function of the guard-cells.

“When the water-supply is abundant, especially in the presence of sunlight, the guard-cells absorb water and expand. The pressure causes the walls that bound the pores or stomata to open. This is due to the fact that these inner walls are thicker than the outer walls. The effect is the same as would be produced on a rubber tube by thickening one side by cementing an extra strip of rubber on it. If such a tube be closed at one end while air or water is pumped in at the other, it will bend so that the thickened side becomes concave.

“The absorption of the water by the guard-cells is aided in sunlight by the action of the chlorophyll grains which they contain; these produce sugar which aids the cells in taking up water from the other cells of the epidermis that have no chlorophyll grains.

“When, therefore, the water-supply is sufficient, and especially when sunlight, temperature and other conditions are favorable for leaf activity, the stomata open and permit the leaf to absorb carbon dioxide. On the other hand, lack of water and unfavorable conditions cause them to close.”

The evaporation of water is of great advantage to the plant, in that it regulates certain physical properties, especially the temperature of the plant. Again, it concentrates in the leaf the food materials taken up from the soil. It is in the leaf that these soluble salts meet and combine with the food taken from the air, to form elaborated food such as protein.

REPRODUCTION

The life-story of the cotton plant does not begin with the germination of the seed. The new individual begins when the generative nucleus of the pollen-grain unites with the egg-cell nucleus of the ovule. As a result of this fusion the seed containing the embryo, or miniature plant, develops.

29. The reproductive organs.—The organs of reproduction are the pistil and the stamens. The pistil is the female organ and is composed of (1) the ovary, which forms the base of the pistil and contains the ovules; (2) the style, constituting the more or less narrowed column of the pistil, and (3) the stigmas, composing that part of the pistil, which receives the pollen-grains. The stamens are the male organs of the plant. Each stamen consists of (1) a filament, or thread-like stalk, and (2) the anther—a somewhat kidney-shaped body borne on the apex of the filament and bearing the pollen-grains.

In Egyptian cotton the style is rather long, carrying

the stigmas well above the stamens, so that insects may be required for fertilization. In flowers of American upland cotton the style is usually shorter and the stigmas may remain buried among the stamens, insuring self-fertilization.¹

30. The pollen-grains and egg-cells. — The pollen-grains in cotton are almost spherical in shape. They are composed of two coats or walls which inclose a thickened, granular fluid.² According to Balls³ the pollen-grains are formed in groups of four. At first, each grain possesses only one nucleus. Later the nucleus divides, forming the two male gametes. At this stage the pollen-grain is mature.

Balls states that the spores which become the egg-cells (megaspores) are also formed in groups of four, "but the three nearest the base of the ovule abort and only the fourth member becomes a megaspore." As this megaspore develops, there are given off two polar nuclei, the function of which will be explained in the next paragraph.

31. Fertilization. — The method by which the pollen-grain reaches and fertilizes the egg-cell in cotton is outlined by Balls as follows:

"The sugar solution excreted by hairs on the style retains the pollen-grain and causes it to germinate. The single pollen-tube traverses the tissue of the style and the conducting tissues till the end enters one of the loculi, along the wall of which it passes till it finds the micropyle of an ovule. Traces of branching may be seen at this point. Passing through the micropyle channel to the

¹ Bureau of Plant Ind. U. S. Dept. Agr. Bul. 222, p. 20.

² Watts, "The Wild and Cultivated Cotton Plants of the World," p. 344.

³ Balls, W. L., "The Cotton Plant in Egypt," p. 10.

nucellus, it bores through the tissues of the latter, and after literally squeezing its way through the firmer wall of the megaspore, the end of the tube swells up and bursts. From the torn end escape the two male gametes, one of which passes to and fuses with the egg-cell, forming a zygote, and thus beginning a new life-history. The other male nucleus fuses with the two polar nuclei, and the triple nucleus thus formed serves later to provide the endosperm.

“The process is exceptionally rapid. Fertilization is normally completed within thirty hours after the first opening of the flower, i. e., by the afternoon of the following day.”

32. The embryo. — A period ranging from 40 to 60 days elapses from the time the cotton flower opens until the mature boll is formed. During this time the embryo is slowly developing inside the fertilized ovule, or seed. When the embryo is one week old it has been found to be just visible to the naked eye. It is somewhat heart-shaped in general outline. The pointed end develops into the radicle, or first root, while the two lobes go to form the first leaves of the embryo. These first leaves (cotyledons) are broader than the seed in which they are contained, and hence are much folded within the seed coat. It is in these first miniature leaves or cotyledons that the oil content of the cotton seed is contained.

CHAPTER IV

THE PRINCIPAL SPECIES OF COTTON

COTTON belongs to the natural order Malvales. This order of plants includes herbs, shrubs, and trees, nearly all of which bear showy, involucrate flowers with calyx of distinct or partially united sepals. The order Malvales comprises three families of plants, namely, Tillaceæ or linden family, Sterculiaceæ or chocolate family, and Malvaceæ or mallow family. Cotton belongs to the latter family and to the genus or subfamily, *Gossypium*.

33. Malvaceæ or mallow family. — This family includes largely tropical plants, the species diminishing rapidly in number and prevalence as we recede from the equator. According to Watt, they are also more numerous in the northern tropics of the New than of the Old World.

The mallow family includes, besides cotton, some of the silk cottons, and several well-known bast-fibers, among which is the hemp-leaved mallow of southern Europe. Okra, and a few cultivated flowers, such as hollyhocks, hibiscus, and althea or "rose of Sharon," are also members of this family. From the industrial standpoint the cotton plant is, by far, the most important member of the mallow family.

One of the chief distinguishing features of the mallow family is that the stamens unite to form a tube around the pistil. Also the anthers are one-celled.

34. The genus *Gossypium*. — This genus includes all species of both wild and cultivated cottons. The plants

in this genus are characterized by possessing erect branching stems. The leaves are petioled and palmately lobed. The flowers are showy. There are five sepals united into a cup-like calyx; also five petals, of whitish or yellowish color, often turning pink. The seeds are angular and wooly, or, more rarely, naked. In this genus the stigmas grow together and usually number from three to five, according to the number of locks that will be contained in the mature boll.

35. Number of species. — There has been much difference of opinion among botanists as to the number of species composing the genus *Gossypium*. Watt, in "The Wild and Cultivated Cotton Plants of the World" describes 29 species of cotton, many of which have never been recorded as seen under cultivation. Duggar¹ states that as many as fifty-four species of *Gossypium* have been described, most botanists, however, reducing the species to a much smaller number. It is quite possible that, as a result of modification due to hybridization and climatic factors, names of species have in many cases been needlessly multiplied.

Much confusion has also been caused as a result of misnaming species. For example, American upland cotton, (*Gossypium hirsutum*) has frequently been referred by American authors to *Gossypium herbaceum*, a species of Asiatic cotton. Recent studies have shown these two species to be quite dissimilar.

36. Classification of species. — The large number of both wild and cultivated species of cotton is classified by Watt² into five sections. This classification is based largely on the following characters: (1) the position and

¹ Duggar, J. F., "Southern Field Crops," p. 275.

² Watt, "The Wild and Cultivated Cotton Plants of the World."

condition of the bracteoles; (2) the presence or absence of nectar-yielding glands; (3) the nature of the floss and fuzz that surrounds the seed. The distinguishing features of each section are given below.

Section 1. — Species with a fuzz but no floss. This section includes a number of wild species, none of which are known ever to have been cultivated. The bracteoles are free, and the seeds are covered with a firmly adhering fuzz, but there is no trace of a true floss. These species of cotton are said to be distributed from the western coast tracts and islands of America to Australia.

Section 2. — Fuzzy-seeded cottons with united bracteoles, mostly Asiatic species, comprising both perennial and annual shrubs. In all the species of this section the bracteoles are united below and the seeds are covered with an inner coating of velvet (fuzz) and an outer of wool (floss). With one or two exceptions these species comprise cultivated types. The two most important species in this group are Indian cotton (*Gossypium obtusifolium*) and Bengal cotton (*Gossypium arboreum*).

Section 3. — Fuzzy-seeded cottons with free bracteoles. — American species with thickened leaf-stems and often bearing conspicuous external and internal glands. The seeds are large and covered with a distinct and complete fuzz and a firmly adherent floss. The leaves are generally large, broad, and hairy. Both wild and cultivated species are represented in this section. The two most important species are American upland cotton (*Gossypium hirsutum*) and Peruvian cotton (*Gossypium peruvianum*).

Section 4. — Naked-seeded cottons with the bracteoles free or nearly so and glands conspicuous. — Both Old and New World forms are included in this section. These

are mostly cultivated cottons, the most important species being Sea Island cotton (*Gossypium barbadense*).

Section 5. — Naked-seeded cotton with bracteoles quite free and floral glands absent. — So far as known, only one species belongs to this section (*Gossypium Kirkii*). This is a wild cotton found in east and central Africa. It has never been seen under cultivation.

37. The extensively cultivated species. — A relatively large number of cotton species have been described. Only a small number of these are of decided agricultural importance. The principal species are grouped into American and Asiatic cottons. The species comprising the American group are Upland cotton, Sea Island cotton, and Peruvian cotton. The important species of the Asiatic group are Indian cotton and Bengal.

38. American upland cotton (*Gossypium hirsutum*). — This species forms more than 99 per cent of the cotton crop of the United States. It embraces both the short-staple and the long-staple varieties of upland cotton. The chief difference between these two classes of cotton lies in the length of the lint, that of short-staple varying from $\frac{3}{4}$ to $1\frac{1}{8}$ inches, while the long-staple ranges from $1\frac{1}{4}$ to $1\frac{3}{4}$ inches. Between these classes is an intermediate type known as "Benders" or "Rivers" which is grown chiefly on bottom land.

The plants of American upland cotton are erect, rather coarse, much-branched, and relatively short-limbed. The shoots, leaf-stalks, and veins are clothed with an abundance of short hairs, giving the plants a dust-coated appearance. The leaves are generally 3-lobed, the lobes being rather short and blunt. The bolls are not so distinctly pointed as in Sea Island cotton and are usually 4-locked, sometimes 5-locked. The seeds are large and

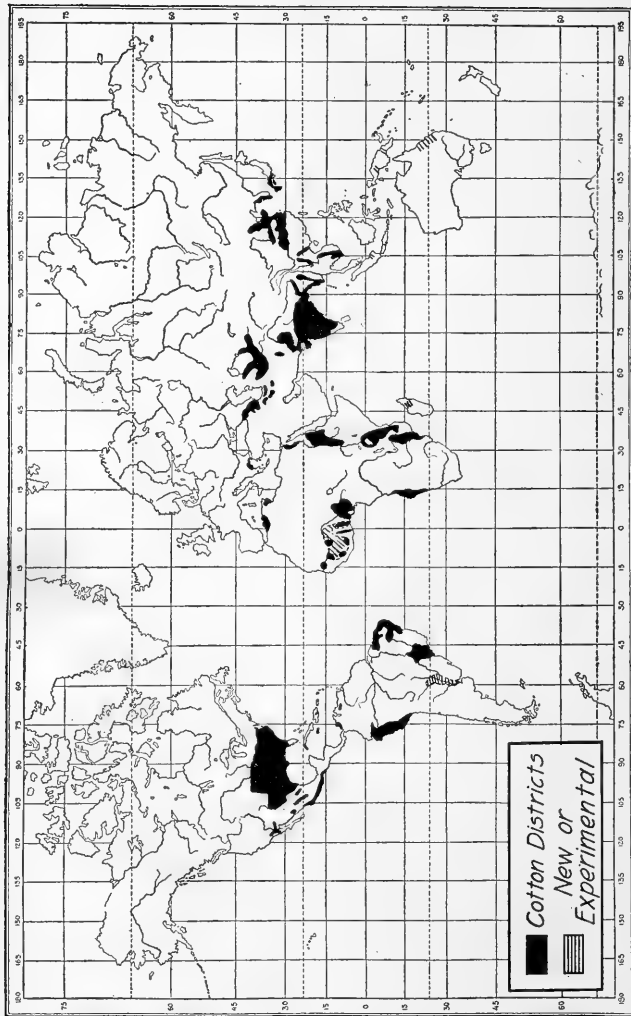

Fig. 7. — Cotton-producing areas of the world.

covered with a pronounced fuzz which gives them a greenish or grayish color. The lint adheres very firmly to the seeds, necessitating the use of the saw-gin to remove it.

It is thought that American upland cotton originated in Central America where it has been cultivated since prehistoric times. Dewey maintains that this cotton came originally from Mexico, it being the same type as that cultivated by the Moqui Indians long before the coming of white men to this continent.

39. Sea Island cotton (*Gossypium barbadense*). — The growth of this species of cotton is restricted to the James and Edisto Islands and the adjacent mainlands along the coast of South Carolina, Georgia, and Florida. The best grade of Sea Island cotton is produced on the two islands mentioned where the farmers have practiced rigid seed selecting for many years. This cotton presents a rather uniform type throughout the area to which it is adapted, not having been split up into distinct types or groups of varieties. There are two reasons for this. The first is the narrow geographical range under which it is grown, while the second is the fact that the breeders of Sea Island cotton have been selecting for one and the same purpose — to obtain staple of high quality.

In habit of growth, Sea Island cotton differs somewhat from the upland cotton. The plants are rather tall and bear long slender branches. The leaves are 3- to 5-lobed, the lobes being deep and distinctly pointed. The stems and leaves are smooth or glabrous with the exception of a very scanty coating of hairs on the leaf-stems and veins. The flowers are of a pale yellow color, each petal bearing red spots near its base. The bolls are 3- sometimes 4-locked, are much smaller and slenderer than those of upland cotton, and are more or less pointed. The seeds are

naked, black, ovate in shape and present a smooth surface. The lint is long ($1\frac{1}{2}$ to 2 inches), silky, pure white, and rather easily removed from the seed.

It has been claimed by some authors that Sea Island cotton is indigenous to the West Indies, especially Barbados. However, the recent and thorough studies made by Watt indicate that Sea Island cotton is a "modern development" and that there is no evidence to show that it is indigenous to Barbados. On the other hand, Watt makes reference to the fact that this species of cotton is so closely associated with *Gossypium vitifolium*, a vine-leaved, long-staple cotton of South America, as to suggest that the indigenous habitat is somewhere in South America.

40. Peruvian cotton (*Gossypium peruvianum*). — This is a South American cotton, but comprises most of the important varieties now grown in Egypt. It is met with in nearly all important cotton growing countries. Within recent years certain varieties of this cotton, notably Mit Afifi, Yuma, and Jannovitch, have been successfully grown in the Colorado River region in southern Arizona, and in southeastern California.

The plants of this species resemble Sea Island cotton in habit of growth. They are rather tall and produce long, flexible branches. The flowers are sulfur-yellow. The seeds are large and, unlike Sea Island cotton, are covered with a distinct gray or greenish fuzz, although in some varieties the seeds are reported to be naked. The lint is intermediate in length between American upland cotton and Sea Island cotton, and is usually of a yellowish or brownish color. A few varieties of Peruvian cotton produce white lint and are thought to have descended in part from Sea Island cotton.

41. Indian cotton (*Gossypium obtusifolium*). — This

is a distinctly Oriental species comprising the chief varieties of cotton grown throughout India. It is also met with in Ceylon and the Malay Archipelago.

The plants are rather small, shrubby, and much-branched, the branches being rather slender. The leaves are small and possess from three to five obtuse lobes. The flowers range in color from bright yellow to purple. Indian cotton is less productive than American short-staple cotton and the lint is of an inferior grade.

42. Bengal cotton (*Gossypium arboreum*). — This is another important cotton of the Orient, especially of India. Ordinarily the plants grow to be much larger than any of the other important species described. The lint is short and of a very inferior grade.

CHAPTER V

COTTON VARIETIES

PROBABLY more than 100 distinct varieties of cotton are being grown in the southern United States. The names representing different varieties will far exceed this number but many of the so-called varieties differ only in name.

43. What is a variety? — There is much difference of opinion as to what constitutes a variety. Generally speaking, a variety may be defined as a subdivision of a species, the individuals of which differ from the remainder of the species in one or more of the typical characters and which propagate true to seed except for simple individual variations.

Groups of individuals derived from a variety which differ from the original variety only in such qualities as yield or hardiness and do not differ in visible taxonomic characters, are recognized by Webber as strains rather than varieties or races.

44. Origin of varieties. — The existing varieties of cotton owe their origin mainly to the following causes:

- (1) Natural selection as affected by environment.
- (2) Artificial selection. In the making of these selections two general methods have been employed, namely, (a) the method often spoken of as "mass selection" in which the farmer merely selects seed for his general crop from the best plants in his field, no attempt being made to study separately the progeny from the individual plants;

(b) the method in which the progeny of a single ideal plant is made the basis of a new variety.

(3) Artificial crosses by which one or more of the important characters of both parents have been united in the progeny.

(4) Natural crossing resulting largely from the transference of pollen by insects from the anthers of one variety to the stigmas of another.

Cotton improvement by selection and crossing is taken up more in detail in a subsequent chapter.

45. Stability of varieties. — Cotton varieties are seldom kept pure. It is the common tendency for any improved variety to degenerate if consistent selection is not carried on every year. This degeneration is partially due to the rapid multiplication of undesirable plants.

When two different varieties of cotton are grown in close proximity, a certain amount of crossing takes place for the reason that insects carry pollen from flower to flower. This tends to break the stability of both varieties.

46. Influence of soil and climate. — It is a well-known fact that a variety of cotton when grown for a number of years under a given set of conditions, will gradually adjust itself to its surroundings. The time required for complete adjustment to take place varies with different varieties. Some varieties, of which King's Improved is an example, require only one or two years in which to become adjusted to almost any part of the cotton-belt. Others require from three to six years.

Some varieties are especially fitted to certain conditions of soil and climate and usually are not profitable when grown in new localities. There are even varieties best adapted to poor lands. It is claimed that Beat-All, a variety very popular in some parts of Georgia when grown

on poor land, is not profitable on rich land. In fact, when tested on the rich soil at the Georgia Experiment Station, it ranked 24th in 1906 and 26th in 1907.

There is experimental evidence to the effect that soil and climate regulate with considerable uniformity such characters as the number of bolls and seed per pound of lint cotton, and also the percentage of lint. Data pertaining to these characters, as exhibited by different varieties of cotton sent out by the United States Department of Agriculture in 1907 and grown at four state experiment stations, are given below:

TABLE 4. — RESULTS OF TESTS OF FIVE VARIETIES OF COTTON SHOWING THE RELATIVE NUMBER AND SIZE OF BOLLS AND SEEDS AND THE PERCENTAGE OF LINT TO SEED WHEN THE PLANTS WERE GROWN IN DIFFERENT STATES ¹

VARIETY	BOLLS PER POUND				SEEDS PER POUND				PERCENTAGE OF LINT			
	La.	Ala.	Ga.	Tex.	La.	Ala.	Ga.	Tex.	La.	Ala.	Ga.	Tex.
	No.	No.	No.	No.	No.	No.	No.	No.	P.ct.	P.ct.	P.ct.	P.ct.
Cook's Improved . . .	58	61	64	90	3650	4025	3860	4160	38.3	36.7	39.3	30.9
Corley Wonderful . . .	48	54	58	70	2670	2835	3260	3780	31.9	29.8	35.8	31.3
Gold-Standard	74	82	92	105	4050	5050	5380	5060	33.5	35.8	39.6	31.7
Pride of Georgia . . .	53	61	68	71	3540	3630	3700	3660	30.0	32.4	33.2	31.2
Sunflower	78	90	98	91	4160	4970	5260	4620	29.0	30.6	31.5	25.4
Average	62	70	76	91	3614	4102	4292	4256	32.5	33.1	35.9	30.1

Without exception, the bolls of all varieties were very small at the Texas Station, gradually increasing in size at the Georgia and Alabama Stations and were largest in every case when grown at the Louisiana Station. Also, the seed were smallest in Texas, following the same order as did the size of bolls. The percentage of lint was highest at the Georgia Station, and, in the main, lowest at the Texas Station. These results indicate quite clearly the

¹ Bureau of Plant Industry, Bul. 163, p. 13.

importance of soil and climate as factors influencing the variability of cotton.

47. Classification of varieties. — It is very difficult to classify cotton varieties owing to the readiness with which they are cross-fertilized and the great range of variation of the individual plants within a variety. The most satisfactory classification of American upland varieties known to the author is that proposed by Duggar of the Alabama Experiment Station which is given below:

Group 1. — Cluster type.

Group 2. — Semi-cluster type.

Group 3. — Rio Grande type, of which the Peterkin is an example.

Group 4. — The early varieties of the King type.

Group 5. — The Big-boll type.

Group 6. — The Long-limbed type.

Group 7. — Intermediate varieties.

Group 8. — Long-staple Upland varieties.

48. Cluster type (Fig. 8). — The plants of this type possess the characteristic property of producing one or more long basal limbs with extremely short spur-like fruiting limbs on the middle and upper parts of the main-stems. There is a tendency for the bolls and leaves to be borne in clusters as a result of the shortening of the internodes of the primary and fruit-



FIG. 8. — Plant of the Jackson Limbless variety of cotton representing the Cluster group.

ing branches. The bolls are seldom large; the leaves on the main-stem are very large while those on the fruiting limbs are much reduced in size. The seeds are small.

The varieties of the cluster type are adapted to rich bottom soils such as are found in the valleys of many



FIG. 9. — Plant of the Hawkins variety of cotton representing the Semi-cluster group.

streams in Georgia, Alabama, and Mississippi. The possibility that these varieties will make a too rank growth at the expense of the lint production is very much less than with most other types. However, the cluster cottons have decreased in popularity among farmers in recent years as a result of (a) the small size of the bolls, (b) the readiness with which

the squares and young bolls are shed during unfavorable weather and (c) the difficulty of picking the cotton without including considerable trash.

49. Semi-cluster type (Fig. 9). — It is thought by many that varieties of this type form a hybrid group. The length of the fruiting limbs is somewhat intermediate between the cluster cottons and the more commonly grown types. While the bolls and leaves are not borne in clusters, they

are much closer together as a rule than in any of the types later described in this classification. The size of bolls and seed is quite variable.

50. Rio Grande type. — The plants of this group are slender in growth. The fruiting branches are long-jointed,



FIG. 10. — Plant of the Peterkin variety of cotton, representing the Peterkin group.

slender, and rather straight. The characters that serve most to distinguish the Rio Grande from other types are (1) a high percentage of lint, usually 35 to 40 per cent; (2) small, nearly naked, dark-colored seeds; (3) bolls medium to very small in size, the locks of cotton remaining rather compact for some time after the bolls open. This group is named for an early variety which was quite

similar to the now commonly grown Peterkin cotton (Fig. 10).

51. Early varieties of the King type (Fig. 11). — The varieties of this group have been developed largely in the northern section of the cotton-belt where the growing season is relatively short. Correlated with earliness in these

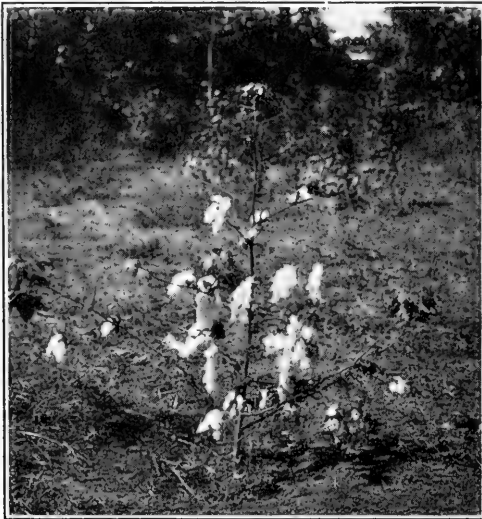

FIG. 11. — Plant of the Shine variety of cotton, representing the Early group.

varieties are (a) small plants, (b) relatively short-jointed fruiting limbs, and (c) small bolls. While the plants are small, they present a somewhat slender, rather than stocky appearance. The leaves are small to medium in size and more deeply lobed than those of big-boll cotton. The seed are small and covered with a greenish or brownish gray fuzz. The lint is usually rather short but of good strength. This group comprises the earliest of the com-

monly grown American upland cottons. While earliness is generally considered as a desirable character, the small

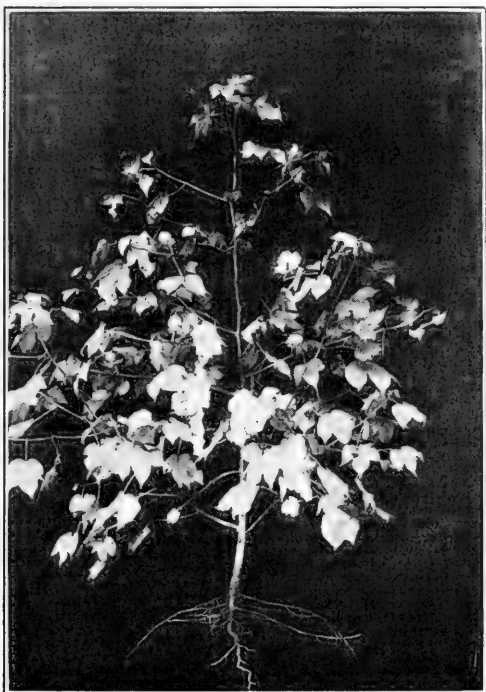

FIG. 12. — Plant of the Truitt variety of cotton, representing the Big-boll group.

size of the bolls and the short lint are undesirable characters.

52. The Big-boll type (Fig. 12). — The distinguishing character of this group is the size of the boll, often measured by the weight of dry seed cotton contained in the boll. The largest bolls contain from 10.5 to 11.5 grams of seed cotton or approximately 40 bolls to the pound. The size of

the bolls in this group varies with the variety, soil and climate. The smallest bolls produce approximately 6.5 grams of seed cotton each, requiring about 68 bolls to yield a pound of seed cotton.

The plants are rather vigorous growers. The limbs are large and short-jointed, giving the plants a stocky appearance. The leaves are large, with broad, short lobes; seeds large, fuzzy, and dark green or brownish gray.

An important subdivision of the big-boll group includes the big-boll storm-proof varieties developed west of the Mississippi, more especially in Texas. The leading varieties in this subdivision are Triumph, Rowden, and Texas Storm-proof. The development of these varieties has taken place on the western plains where cotton is more subject to severe storms than elsewhere in the cotton-belt.

53. The long-limbed type. — The varieties of this type have been more or less abandoned because they are late and not very prolific. The most important representative of this group is the Petit Gulf variety, which at one time was very popular. It often happens that the Petit Gulf cotton is so badly mixed with other cottons as to make it a poor representative of the long-limbed type.

54. Intermediate varieties. — No description can be given of the varieties in this group. Those varieties in which the characters of two or more groups are combined so as to make it impossible to place them in any of the well-defined types are classed as "intermediate varieties" for convenience.

55. Long-staple upland varieties. — The distinguishing character of this group is the length of the lint which varies from $1\frac{3}{16}$ to $1\frac{3}{4}$ inches (30 to 45 mm.). The plants

are rather tall and slender with few or no primary limbs. The bolls are small to medium in size with 3 to 5 locules, and the lint is borne in rather closely matted locks.

It is claimed that a few varieties of this group have been produced by crossing upland and Sea Island cotton. However, in most cases the varieties have been produced by straight selection. Several varieties, of which Griffin and Columbia are examples, have been developed from the big-boll group.

The upland long-staple varieties are best adapted to fertile river bottom soils. They are grown rather extensively along the Red River in Arkansas and Texas, and

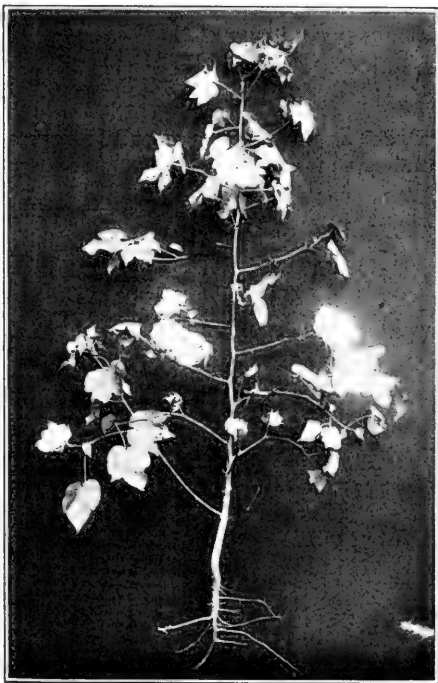

FIG. 13. — Plant of the Allen variety of cotton representing the upland long-staple group.

along the Mississippi in Mississippi and Louisiana. The yield is often lower than that obtained from the upland varieties but the greater value of the lint usually more than offsets the difference in yield. Examples of the long-staple group are Griffin,

Allen (Fig. 13), Columbia, Flemming, Moon, and Peeler.

56. High ranking varieties. — Extended variety tests conducted in all of the cotton producing states furnish conclusive evidence that there is no one best variety of cotton for all conditions. The readiness with which the cotton plant is modified by such factors as length of growing season, soil type, and moisture supply, has resulted in the development of varieties particularly adapted to more or less local conditions. On the western plains of Texas and Oklahoma the storm-proof varieties are most profitable. In North Carolina and Tennessee where the growing season is short, the early cottons are largely grown. Long-staple upland cottons are successfully grown only on rich soils such as are found in the Mississippi valley.

According to information furnished the author by the directors and agronomists of southern Experiment Stations the following are representatives of the high ranking varieties for the different states:

LIST OF HIGH RANKING COTTON VARIETIES

Alabama	Cook Cleveland Covington-Toole Poulnot Layton
Arkansas	Trice Ruble Cleveland King's Improved Simpkin's Prolific

Georgia	Triumph Cleveland Poulnot Texas Big-boll Sunbeam
Louisiana	Simpkins King Triumph Ruble Toole Cook's Improved Bank Account Money Maker
Mississippi	Cleveland Cooke Toole Russell King
North Carolina (Raleigh Sta.)	Culpepper's Improved Cooke's Improved Broadwell's Double Jointed Hawkins Extra Prolific Cleveland's Big-boll
North Carolina (Coastal Plains Region)	Russell's Big-boll Shine's Early Prolific Brown's No. 1 Cook's Improved King's Improved Sugar Loaf
Oklahoma	Mebane Cook's Improved Texas Storm-proof Rowden

South Carolina	Cook Rogers Simpkins Toole Cleveland
Tennessee	Trice Cleveland Big-boll Wilson's Improved Petway's Improved Prolific Perry
Texas	Triumph Rowden Alabama Wonder Bank Account Burnett

BRIEF DESCRIPTION OF SOME TYPICAL VARIETIES REPRESENTING DIFFERENT GROUPS

CLUSTER TYPE

Dickson Improved. — Early maturing; one to three basal limbs with fruiting limbs reduced to spurs of 2 to 6 inches in length. Leaves large; bolls small, rounded in shape and clustered; seeds small, brownish gray; lint of medium length. Rather extensively grown over the cotton-belt.

Dillon. — A wilt-resistant variety developed by selection from Jackson Limbless by W. A. Norton of the United States Department of Agriculture. Plants somewhat similar to Dickson Improved, but resistant to wilt and storms. Popular in the coastal plain belt from North Carolina to Alabama.

Jackson. — Introduced in 1894 by T. W. Jackson of Atlanta, Georgia. Plants rather tall and bolls closely clustered; leaves very large. Popular on rich soils where other types produce limbs and leaves at the expense of fruit.

SEMI-CLUSTER TYPE

Rublee. — Developed by C. A. Rublee, Seago, Texas. An early maturing variety, claimed to be well adapted to boll-weevil condi-

tions. Bolls medium to small in size; lint short; seeds of medium size and of greenish color. This variety is grown to some extent in north-east Texas.

Hawkins' Extra Prolific. — A standard semi-cluster variety developed by W. B. Hawkins, Nona, Georgia. Plants early, tall, pyramidal in shape. Bolls partially clustered, small to medium in size; lint short; seeds small and of brownish gray color.

Boyd Prolific. — Originated by a Mr. Boyd of Mississippi. This is one of the oldest of the semi-cluster varieties and now exists in a rather badly mixed state. Some strains of Boyd cotton are more similar to upland long-staple than to semi-cluster cottons. The true Boyd prolific possesses only one or two long limbs and numerous irregularly jointed fruiting branches.

RIO GRANDE TYPE

Layton. — This variety is a strain of Peterkin developed by R. D. Layton of South Carolina. The plants are rather slender with long, drooping branches. Bolls rather small and mostly 5-locked. The lint is short but the percentage is high; seeds small and of brownish gray color. A good poor land cotton.

Toole. — Also a strain of Peterkin developed by W. W. Toole of Augusta, Georgia. The plants are somewhat similar to Layton, but with a slight similarity to the semi-cluster cottons. Bolls medium in size. Lint medium in length, strong, and the percentage high. A good rich land cotton.

Money Maker. — Plants of medium height, bearing rather slender, rather long-jointed limbs. Bolls small; lint short. Distributed throughout sections of Alabama, Arkansas, Georgia, Louisiana, and Mississippi.

KING OR EARLY VARIETIES

King's Improved. — Developed from Sugar-loaf cotton by T. J. King of Louisburg, North Carolina. Plants slender with slender, short-jointed fruiting limbs. Leaves and bolls small; seeds small; lint short. This is a very early variety of cotton and is best adapted to the northern portions of the cotton-belt, especially North Carolina and Tennessee.

Simpkins. — An early variety developed from King by W. A. Simpkins of Raleigh, North Carolina. Bolls somewhat larger than King and also bearing a higher percentage of lint.

BIG-BOLL TYPE

Cook's Improved. — Originated by J. R. Cook, Ellaville, Georgia. A rather long-branched, large-bolled cotton, although the type is very variable. Often the plants are short-branched; or many of the branches are of medium length. The lint is short but the percentage is high. This variety is especially susceptible to boll-rot or to injury by storm.

Cleveland. — This variety is the result of 25 years of selection by J. R. Cleveland of Decatur, Mississippi. This variety represents a rather variable type, some of the plants resembling the semi-cluster cottons. Limbs short-jointed, bolls large; lint of medium length.

BIG-BOLL STORM-PROOF TYPE

Triumph. — This variety was developed from the Boykin Storm-proof cotton by A. D. Mebane, of Lockhart, Texas. Because of the relative earliness, the large size of the boll, and the storm-proof character of this cotton, it is the most widely grown variety west of the Mississippi River. The percentage of lint is high for cotton of this group.

Rowden. — This variety was developed from Bohemian cotton by the Rowden Brothers, Wills Point, Texas. Next to Triumph it is the most extensively grown variety in Texas. It is medium early in maturity and is well adapted to boll-weevil conditions. The plants have a stocky appearance; the joints are regular and of medium length, the branches and usually the whole plant drooping beneath the weight of mature bolls, which hang downward when ripe.

UPLAND LONG-STAPLE COTTON

Allen Long-staple. — Developed by J. B. Allen, Port Gibson, Mississippi. Plants tall and pyramidal in shape, somewhat semi-cluster in habit of growth with irregular jointed fruiting branches. Bolls medium to small; lint very long and silky; seeds medium to small in size.

Black Rattler. — This variety is grown quite extensively along the Mississippi River. It is claimed to have been developed in Bolivar County, Mississippi. The plants grow to be rather large and produce from one to three slender limbs. Bolls small, pointed, with a very sharp bur. The lint is rather short for a long-staple cotton averaging about 31 mm. or $1\frac{7}{32}$ inches.

CHAPTER VI

COTTON BREEDING

It has been only within recent years that the farmers' interest in cotton breeding has been stimulated. Even now the great mass of cotton farmers rely almost wholly upon better methods of tillage, fertilization, and drainage for increased yields. "Good seed" is the least appreciated of the important factors in cotton production.

There is probably no field crop more easily modified by breeding methods or by environment than is cotton. The first great triumph in securing a desirable modification of the cotton plant was the production of annual crops from the perennial tree-cottons. This permitted cotton cultivation to be carried beyond the natural geographical area of the genus, thus vastly increasing the possibility of its production.

57. Reasons for breeding cotton. — The object of cotton breeding is the production of strains or varieties that are better adapted to specific conditions or requirements. The ultimate benefits are increased yield and better quality. The mere production of new kinds of cotton without regard to merit is not cotton breeding in its truest sense.

58. Need of improvement in cotton. — The great number of cotton farmers use any cotton seed without regard to variety and without practicing any selection. This seed as taken from the gin is, in most cases, badly mixed and of very low quality. Much of it has been ob-

tained from the last picking and is immature, or is from late plants of inferior type. These careless practices have caused a very rapid deterioration in cotton. Even the most promising varieties soon "run out" unless some attempt is made to propagate their good qualities. It must be remembered that "on the seed depends the crop." The average cotton farmer finds the margin of profits from his crop very low. He can ill afford to neglect the proper selection of the seed which he expects to plant.

59. Start with the best variety. — The cotton farmer should make sure that he starts his breeding with the best available foundation stock. This necessitates a carefully conducted variety test in which as many of the standard varieties as possible should be included. The result of this test should indicate the variety that is best adapted to the local conditions present on his plantation. For this test, a plot of land should be selected that exhibits as little variation as possible in productiveness. Each variety should occupy a plot consisting of at least two rows of not less than 150 feet in length. In order to check the inequality in soil productiveness, seed from the same variety should be planted on every third plot. The relative yields of these check plots will show to what extent soil productiveness has influenced the yields of the different varieties. The number of plants to a plot, as well as cultural conditions, should be the same for all plots. Harvest and carefully weigh the seed cotton from each variety.

60. Qualities sought for in breeding cotton. — The qualities that determine the value of a cotton plant are of two classes: (1) those which influence yield; (2) those which determine quality. In order materially to increase the yield of a cotton variety, it is essential that special attention be given to the individual plants, particularly with

reference to their structure, vigor, and rapidity of setting and developing the squares and bolls.

61. Qualities associated with high yield. — While it is true that the plants of each distinct variety conform more or less to what is often termed “variety type,” there are a number of qualities that experience has shown to be rather closely correlated with high yield. The most important of these are outlined below:

(1) The primary branches and first fruiting limbs must be borne rather low on the main-stem. A cotton plant that bears its first limbs high up on the main-stem is usually late and unproductive.

(2) The internodes of the main-stem, the primary limbs, and the fruiting limbs must be short. They should not exceed from 2 to 3 inches, especially in the lower part of the plant. This insures the production of a large number of nodes from which either bolls or fruiting limbs are produced.

(3) The bolls must be relatively large. Aside from giving a larger yield, an increase in the size of bolls increases the ease and rapidity of picking, and less trash will be gathered with the cotton. Large bolls are also more storm-resistant than small bolls.

(4) In weevil-infested districts it is essential that after the crop has reached the fruiting stage, the squares be set and the bolls developed in a short length of time. Farmers often use the wrong standards for measuring earliness, such as dates of planting, the opening of the first bolls, or the date of securing the first bale. A cotton variety that opens its bolls first is not necessarily the most productive under weevil conditions.

(5) The plants must be resistant to such diseases as wilt, root-knot, and anthracnose. The United States

Department of Agriculture has demonstrated that disease resistant varieties of cotton can be produced by selection.

(6) The plants should yield as large a percentage of lint as possible. From 38 to 40 per cent is considered a high percentage of lint. Most varieties produce a much smaller percentage.

Plants that have a tendency to produce excessive leaf growth or to produce a large percentage of their bolls near the top of the plant or on the outer ends of the branches should be discarded. Such plants are late and unproductive.

62. Characters that determine quality. — It is not sufficient to increase the yield of seed cotton to the acre. Profits are determined by the price received as well as by the yield per acre. The quality of the fiber is an important factor in the determination of its value. The following characters are important in determining quality:

(1) *Length of fiber.* — Cotton fiber should be at least an inch in length. This length of fiber is in greatest demand as it supplies the needs of the general purpose market. For the manufacture of high grade fabrics, longer staple, such as is produced by Sea Island or upland long-staple cotton is required. However, the quantity called for is relatively small as compared with the requirement for 1-inch staple. A plant producing fiber of less than one inch in length should be discarded.

(2) *Uniformity in length of fiber.* — Uniformity has a direct commercial value in cotton. An intermixture of short and long fiber has the effect of greatly reducing the value of the entire lot. It results in an undue amount of waste in manufacturing. The length of the fiber not only varies greatly as between the individual plants of an unimproved variety, but different lengths of lint are often

produced on different parts of the same plant and even on the same seed. This objectionable character can be corrected by breeding (Fig. 14).

(3) *Strength of fiber.* — Much variation exists between cotton plants as regards the strength of the fiber produced.

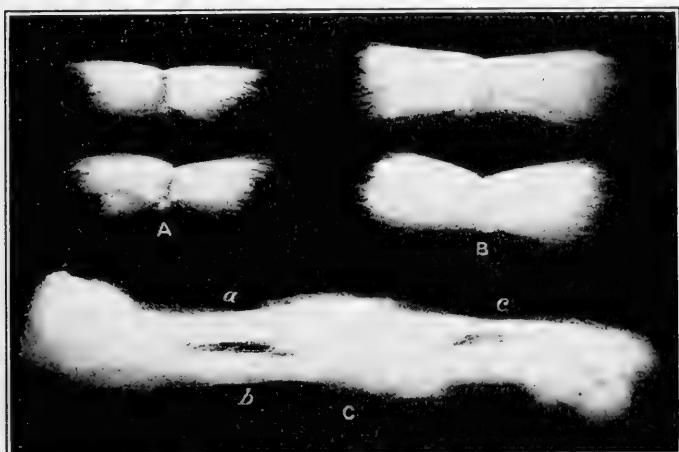

FIG. 14. — Cotton seeds with fibers attached. *A* and *B* — cotton seeds with fibers combed out to show uniformity and non-uniformity in the length of the fibers. *C* — Lock of Griffin cotton stretched so as to show joints of origin of longer fibers — *a*, *b*, *c*.

Any plant should be rejected that shows itself distinctly inferior in strength of lint.

(4) *Color and cleanliness of fiber.* — Cotton lint should have a rich, bright, creamy color and should be free from trash and dirt.

63. Well-defined ideal necessary. — Before the cotton-grower attempts the selection of his seed for breeding purposes, it is essential that he have well fixed in his mind the important qualities sought for in breeding cotton. In other words, he should keep in mind a mental picture of

his ideal plant. If this is not done, there is danger that lack of uniformity among the plants selected will exist, due to the fact that certain plants will be selected for one character and others for another. Little can be accomplished by such promiscuous selection.

64. Methods of improving cotton. — At least three methods are more or less applicable to the improvement of cotton. They are (1) the careful and systematic selection and progeny-testing of superior plants; (2) hybridizing or crossing different varieties or species with the object of securing an intermingling and fixing of points of merit; (3) acclimatization of approved stocks from one country or locality to another.

THE IMPROVEMENT OF COTTON BY SELECTION

Systematic selection is easily the most important factor in the improvement of cotton. To employ this factor successfully the breeder must be able readily to detect and choose the best plants, even when a large number of individuals are examined. This requires a thorough knowledge of the points that go to make up an ideal cotton plant.

65. Selection of foundation stock. — After having determined by variety tests the best variety for a given locality the breeder will, by careful study, satisfy himself as to what type of plant of this variety is best. He is then ready to make selections which are to furnish his foundation stock.

The selection is best made immediately before the first picking. The picking should be delayed until a rather large percentage of the bolls are open. By walking slowly through the field, examining the plants of each row, the breeder should be able readily to detect those plants which

possess exceptional excellence. These good plants should be marked by tying a white rag to one of the upper branches. The breeder's problem is to select in this manner the two or three hundred most desirable plants in his entire crop. When this has been done, the selected plants should then be given a more detailed examination.

This second examination should comprise not only a more detailed examination of the general structure of the plant but also an examination of lint with reference to its abundance and quality. Several seeds from different bolls on the same plant should be procured, the fiber being carefully parted down the middle of each seed and combed out straight by means of a small aluminum pocket comb. After this has been done, the amount of lint on the seed and the length, uniformity, and strength of the lint can be easily judged. All plants should be discarded that are found to be very inferior with regard to any of these characters. As a result of this second examination, the number of select plants will probably be reduced to 75 or 100. Before the seed cotton is picked from the select plants, they should be carefully labeled and numbered. The seed cotton from each plant should be placed in a small paper bag which is given the same number as that of the plant. These same bags can be taken to the field for the second picking, being careful that all of the seed cotton secured from each plant is kept to itself and properly numbered.

66. Ginning cotton from select plants. — Small gins, suitable for ginning very small quantities of cotton can now be secured. Often an arrangement can be made, whereby a single gin can be disconnected from the stand of gins and used for this purpose. In any event every precaution should be taken to see that the product of each plant is kept together.

67. Testing transmitting power of plants. — A good plant must possess the important property of transmitting its desirable qualities to its progeny. To determine what plants possess this property requires a field test. The seeds from each select plant should be grown in a row to themselves by the method known as the "plant-to-row" method. For this test select a uniform plot of soil that is representative of the soil upon which the general crop is to be grown.

The above plot should be isolated, if possible, 600 to 800 feet from any other cotton field. The object of this isolation is to prevent the crossing of inferior cottons with the selections. It is especially important that this test plot be a reasonable distance from cotton of a different variety. Sometimes the test plot is located in one corner of a field planted with seed of the same variety from which the selections were made. This should be done only when isolation is impossible.

The plot should be well prepared and fertilized if necessary. As each selection is planted in a row to itself, a stake bearing the same number as the plant from which the seed was taken should be driven at the end. The rows should be of equal length and should, as nearly as possible, contain the same number of plants. A method highly recommended is to plant the seed in hills about 20 inches apart, about a half dozen seeds being dropped in a hill. Later the plants are thinned to one plant in a hill. The same cultivation and care should be given this test plot as is given the general crop.

68. Selecting the best progenies. — Just before the first picking the test plot should be carefully gone over and a detailed study made of the different progenies. The most important problem now is to determine which

of the original plants have, to the greatest degree, transmitted their good qualities, such as yield, uniformity, length and strength of lint, to their progeny. The progeny row or rows that are found to be superior as regards the good points for which the plants were selected should be marked for second generation selections.

69. Making the second generation selections. — Having determined which are the best progenies in the test-plot, the breeder should immediately examine in detail each plant in the superior progenies, marking those which are nearest ideal. These good plants should be numbered as selected. The following method of numbering these second generation selections is recommended by H. J. Webber.¹ “If one of the best progenies is from the original selection No. 2, label the selection in this row 2-1, 2-2, 2-3, 2-4, 2-5, and so on, the second number after the dash being the number of the individual selected in this generation, while the first number, 2, is the number of the original selection. In the same way, if progeny 51 is one of the best, the selections made from this would be numbered 51-1, 51-2, 51-3, and so on. When the third-generation selections are made, they should be numbered in the same way, separating the generation by a dash. For example, the selections made from progeny of 51-1 would be labeled 51-1-1, 51-1-2, 51-1-3.” When the second-generation selections are made and numbered, each selection should be picked separately into a paper bag which bears the same number as the plant. These selections are to be used for planting the breeding plot the third year.

70. The multiplication plot. — Seed from the best plants left in the test-plot after the second-generation selections have been made should be used for planting

¹ Bailey's "Cyclo. of Amer. Agr., Vol. 2," page 256.

a field sufficiently large to furnish select seed for the general crop. This is known as the multiplication plot. This multiplication plot should be planted each year from the second-choice seed of the preceding test-plot, the first-choice seed being used each time, of course, to plant the test-plot of the next year.

71. Influence of environment. — It must be remembered that such environmental factors as soil and seasonal conditions will greatly modify the character of a cotton plant. For this reason it is especially important that the breeding work be conducted under as nearly as possible the same conditions of soil and climate as prevail where the general crop is to be grown. It has long been known that river bottom soils produce somewhat longer jointed plants than do upland soils of a droughty character. Also transferring cotton from the northern part of the cotton-belt where the growing season is short to more southern sections will, to an extent, produce the same effect. Cotton that has been highly improved under the conditions existing in one locality, may show very little of the improvement when grown under conditions decidedly different.

THE USE OF HYBRIDIZATION IN COTTON BREEDING

Much difference of opinion exists among experts as to the value of hybridization in the improvement of cotton. However, there is little doubt that this field offers great possibilities to the trained breeder of plants. Results of value can be obtained only when this phase of cotton improvement is made the subject of extended study and where good judgment is used in the selection of the individuals, varieties, or species that are to be crossed.

72. Reasons for hybridizing cotton. — One of the important objects in crossing different varieties or species of cotton is to increase the variation in different directions and thereby afford opportunity for greater selection than would otherwise be possible. Also it is often possible to unite in the hybrid desirable characters that are exhibited by different individuals, varieties, or species.

73. The nature of hybrids. — When plants of different varieties of cotton are crossed, the hybrid usually comes nearly intermediate between the two parents in the first generation. While it is true that these first-generation hybrids are nearly uniform in the characters presented, they are nevertheless very unstable individuals as is evidenced by the general breaking up of the characters in the second generation, with the production of a large number of variations. It is in this second generation that the desirable variations are looked for.

It has been found that the first generation of hybrids in cotton are almost always more vigorous than either parent. Especially is this true following the crossing of different species of cotton such as the upland and Sea Island. In succeeding years this increased vigor is gradually lost as the hybrid becomes fixed in type, on account of selection.

74. Fixation of cotton hybrids. — As above stated, it is in the second generation of hybrids that all manner of types are formed, the separate individuals exhibiting the characters of the two parents in very different degrees. The breeder should carefully examine the individuals of this generation and select those which show, as nearly as possible, the combination of characters which it is desired to produce. These hybrids should be self-fertilized the next year or, in other words, each plant should be pro-

tected by means of a very fine-meshed wire cage to prevent insects from bringing in foreign pollen. The succeeding year the seed from each individual should be planted in an isolated patch in order that it will be fertilized only with pollen of related progeny. In the following generations select only those plants which come the nearest to the original type and grow them in isolated patches. Usually from four to six years are required to breed the hybrids to a practical state of fixity.

75. Method of crossing cotton. — In crossing cotton it is necessary that the parent plants be selected by the afternoon preceding the day on which the transfer of pollen is to be made. Late in the afternoon several large flower-buds on each plant should be selected that would open the next morning. The anthers are at once removed from the buds on the plants that are to be used as female parents. This is best done with a small pair of scissors, pincers, or the blade of a pocket knife (Fig. 15). First carefully cut away the greater part of every petal, thus exposing the anthers which should be removed without bruising the pistil, or female organ of the flower. When the anthers have been removed, carefully pin a small paper bag over the remaining part of the bud to prevent insects from bringing in foreign pollen.

It is also necessary that the selected flower-buds on the male parent plants be covered with paper bags. This prevents the introduction by insects of pollen from other plants to the flower before the cross is made. If the buds have been properly selected with reference to stage of development, all will reach the suitable stage for crossing at about the same time on the following morning — (usually about nine o'clock). This readiness can easily be detected by means of the stickiness of the stigmas on

the one hand and by whether or not the anthers have begun to burst, setting free the pollen, on the other. When this stage is reached the pollen from the male buds should be transferred to the stigmas of the female buds. This can be done by pulling the entire flower bearing the pollen and rubbing its anthers gently over the stigmas of the emasculated flower until it is observed that some of the

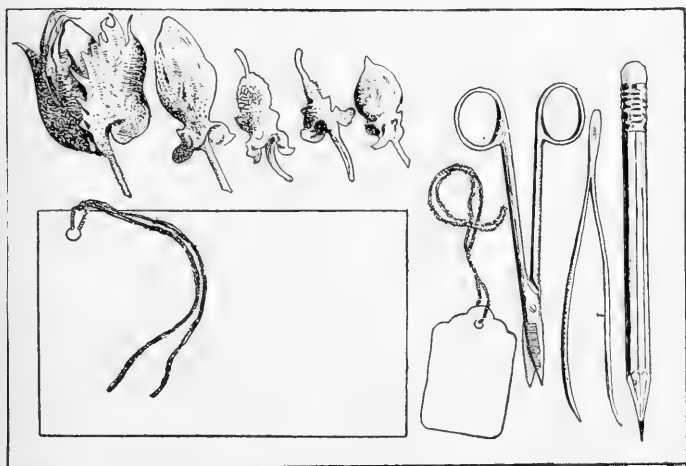

FIG. 15. — Outfit used in crossing cotton; also buds showing the steps in emasculation and a boll three days after pollination.

pollen-grains have adhered to the stigmas and sides of the pistil. The paper bags should again be placed over the emasculated flowers and allowed to remain for four or five days until the small boll is formed. With a small tag carefully label each boll so that it may be distinguished from others.

76. Hybridization versus selection. — For quick results selection offers much greater possibilities in cotton improvement than hybridization. Owing to the large

amount of training and experience necessary to produce desirable results from hybridization, the advisability of anyone except the experienced breeder attempting this method is very doubtful. The mere matter of successfully crossing two varieties means little. The progeny of this cross must be carefully studied and selected for a number of years in most cases before anything of real value is obtained.

77. Acclimatization. — The method of improving cotton by means of acclimatization is probably the least hopeful, especially when the introductions are brought direct from remote regions with widely different climatic and other conditions. For this reason this method should be employed only after a careful study of the environment of the original and the proposed new country or locality of production. However, results of considerable value have been obtained at least partially by means of this method. A noteworthy example is the successful production of several varieties of Egyptian cotton in certain sections of Arizona, New Mexico, and California.

CHAPTER VII

COTTON SOILS AND CLIMATIC ADAPTATIONS

WITH good management, nearly all types of soil within the cotton-belt can be made to produce profitable crops of cotton. However, this crop is not grown with equal success on all types of soil. The sandy uplands, as a rule, produce small yields. The heavy clays often produce a large vegetative growth accompanied by a small amount of lint. The same thing is often true of bottom-land soils. The safest cotton soils are the medium grades of loam.

The successful production of cotton in the United States is limited by climatic conditions to the region south of latitude 37 degrees. Attempts to grow cotton north of this boundary have, as a rule, failed.

COTTON SOILS

78. Soil types. — An attempt to classify the various types of soil in the cotton-belt upon which cotton is being successfully produced reveals a large number of soil types. No attempt is made to give a complete classification of these soils. The outline given on next page includes only the more important types as regards their extent and use in cotton production. This outline is based upon the work of the United States Bureau of Soils. The types are grouped in accordance with the soil provinces or regions in which they occur.

THE PRINCIPAL COTTON SOIL TYPES

<i>Provinces and Regions</i>	<i>Types</i>
Coastal Plain Province.....	{ Norfolk sand and fine sand. Norfolk sandy loam, and fine sandy loam. Tifton sandy loam. Orangeburg sand and fine sand. Orangeburg sandy loam and fine sandy loam. Greenville clay loam, sandy loam, gravelly sandy loam and loamy sand. Ruston fine sandy loam. Susquehanna fine sandy loam. Houston black clay, loam, and clay loam. Houston clay. Victoria clay, loam, and sandy loam. Durant fine sandy loam.
Piedmont Plateau.....	{ Cecil clay. Cecil clay loam. Cecil sandy loam. Louisa slate loam, fine sandy loam, and loam.
Appalachian Province.....	{ DeKalb fine sandy loam. DeKalb silt loam. Fayetteville fine sandy loam.
Limestone Valleys and Uplands..	{ Clarksville gravelly loam. Clarksville silt loam. Decatur clay loam. Hagerstown loam.
Loessial Region.....	{ Memphis silt loam.

River Flood Plains Province.	{	Miller fine sandy loam and clay loam. Trinity clay. Sharkey clay. Ocklocknee fine sandy loam and loam. Congaree loam. Kalmia fine sandy loam. Cahaba fine sandy loam.
Great Plains Region.	{	Vernon fine sandy loam, loam, and silt loam. Crawford stony clay. Amarillo loam and silty clay loam.

79. Cotton soils of the Coastal Plain Province. — In the cotton-belt the coastal plain province comprises a large area of rather flat or gently rolling soil bordering the Atlantic Ocean and the Gulf of Mexico from Virginia to the mouth of the Rio Grande. The soils of this region are predominantly sandy or loamy with limited areas of very productive clay. The more important types are briefly discussed below.

The Norfolk soils. — These soils extending from Virginia to Texas are extensively used for cotton production. They are, in the main, well-drained. In fact, the coarser textured soils of this series such as the sand and fine sand are excessively drained owing to their loose, incoherent nature, and the general lack of organic matter. The sandy loam and fine sandy loam of this series are better suited to the production of cotton than are the sands, owing to the fact that these loams are somewhat richer in plant-food. They are also underlain at a depth of 12 to 20 inches with a sandy clay subsoil, which renders them less droughty than the sands.

The yields of cotton are low on the Norfolk soils, ranging from one-fourth to one-half bale to the acre. The most urgent need of these soils is organic matter. In addition, phosphatic and potassic fertilizers are often necessary for best results.

Tifton sandy loam. — This type represents a rather important cotton soil located in southern Georgia and probably in the panhandle of Florida and in southern Alabama. It is described as a “gray or yellowish-gray medium sandy loam about 10 inches in depth.” Drainage is usually good and the yields of cotton are considerably higher than on the associated Norfolk soils.

The Orangeburg soils. — In this series the surface soils are gray or brownish in color. They are underlain by a characteristic red sandy clay or stiff clay subsoil which distinguishes them from the Norfolk soils. The Orangeburg sandy loam and fine sandy loam are extensively and successfully used for cotton, especially in central South Carolina, the upper coastal plain of Georgia and through the coastal plain of Alabama and Mississippi. They also occur in east and northeast Texas. The Orangeburg sand and fine sand are fairly important cotton soils in these sections, being more productive than the corresponding types of the Norfolk series, but not so extensive.

As a rule the surface soils in this series are not retentive of water, but the clay subsoils, in a measure, counteract this defect. The most urgent needs of these soils are: (1) organic matter, (2) deeper plowing, and (3) the prevention of erosion.

The Greenville series. — The soils of this series are generally loamy, of reddish-brown to dark-red color, and are underlain by a “red friable sandy clay subsoil.” They are admirably adapted to cotton, being more retentive of

moisture than the Orangeburg and Norfolk soils. With proper management, yields of from three-fourths to one-and-a-half bales to the acre are easily obtained, especially on the sandy loam and clay loam types.

The Greenville soils occur in southwest Georgia and in the coastal plain region of Alabama. There are also some fairly important areas in portions of Louisiana and northeastern Texas.

Ruston fine sandy loam. — This is a rather extensive cotton soil, being rather abundant in the coastal plain region of Mississippi and Alabama. It is a "light gray or yellowish-gray fine sandy loam of variable depth, but averaging about 20 inches." The subsoil is a sandy clay intermediate in color between that of the Norfolk and Orangeburg soils. This soil is inclined to be droughty and cotton yields diminish unless extreme care is exercised to prevent the waste of soil moisture.

Susquehanna fine sandy loam. — This type comprises an immense area in east Texas, Louisiana, Mississippi, and Alabama. The soil is a "gray to brown fine sand or light fine sandy loam about 12 inches deep, resting upon a red or yellowish-red clay which is usually stiff and plastic." Cotton gives only moderate yields on this type. The prevention of erosion and addition of organic matter are the most urgent needs of this soil.

The Houston soils. — This series comprises very valuable cotton soils embracing rather large areas in Texas, Alabama, and Mississippi. The Houston black clay constitutes what is known as the "black waxy belt" of north and central Texas. It is found to a limited extent in central Alabama and northeastern Mississippi. This type of soil produces more bales of cotton than any other single type in the United States. The average yield is about one-half

bale to the acre. When in a condition of moderate moisture and well tilled, the soil is friable, but it becomes exceedingly waxy and sticky when wet. This is more or less characteristic of all the Houston soils. The subsoil is a tight clay of variegated color. The most urgent need of the Houston soils is crop rotation. It is probably true that on no other group of soils in the South have cropping systems been so universally abused.

Victoria soils. — The soils of this series are closely related to the Houston soils. They “consist of brown to black soils with gray to whitish, calcareous subsoils derived from Pleistocene deposits of the Gulf Coastal Plains.” The Victoria loam and clay produce excellent yields of cotton when properly tilled. These soils are rather extensive in south Texas.

Durant fine sandy loam. — This is an important cotton soil in north central Texas and southern Oklahoma. It is 14 to 18 inches deep and of chocolate brown color. Cotton gives only fair yields as ordinarily managed, but the soil responds well to good treatment.

80. Cotton soils of the Piedmont Plateau. — That part of the Piedmont Plateau lying within the cotton-belt comprises central North Carolina, western South Carolina, northern Georgia, and a portion of east central Alabama. The topography is rolling to hilly. The soils of this region are residual, being formed in place by the decay of the underlying rocks. The more important cotton soils of this region are briefly described below:

The Cecil soils. — The most extensively used cotton soil in this series is the Cecil sandy loam. It is a rather light soil but is underlain by a red clay subsoil.

The Cecil clay and clay loam, which are closely related, are also rather extensively used for cotton. The clay is

composed of a reddish clay loam to a depth of 2 to 6 inches, underlain by a heavy red clay subsoil. The clay loam is reddish-brown to a depth of 6 to 12 inches, underlain by a red clay loam and clay subsoil.

The Cecil soils require liberal applications of vegetable matter and to a less extent lime, in order to be made productive.

The Louisa series. — The soils of this series consist of light brown or pale yellow friable loams, ranging in depth from 5 to 8 inches. The subsoils are pale yellow loams, often grading into a red clay. The yields of cotton are usually low. In dry years crops suffer from lack of moisture. It is often difficult to maintain these soils in good structural condition, owing to their inclination to run together or bake.

81. Cotton soils of the Appalachian Province. — This province is not extensive in the cotton-belt. It comprises part of Tennessee, northwest Georgia, northern Alabama, and the Ozark region of Arkansas. Soils of the DeKalb series and the Fayetteville fine sandy loam are the important cotton soils of this region.

The DeKalb soils. — The two important cotton soils of this series are the DeKalb fine sandy loam and silt loam. The former is a fine, compact sandy loam ranging in depth from 8 to 12 inches and underlain by a very loose loamy subsoil. The latter soil is not so compact and the subsoil is a friable silt-clay loam. Commercial fertilizers are necessary on both types in order to secure good yields of cotton. These soils occur in that portion of the province found in Tennessee, Georgia, and Alabama.

The Fayetteville fine sandy loam. — This is the important cotton soil of the Ozark region of Arkansas. It is 8 to 12 inches deep, of a reddish-gray color, and underlain by a

sandy clay subsoil of similar color. Drainage is generally good and fair yields of cotton are secured.

82. Cotton soils of the limestone valleys and uplands.—

In so far as the cotton-belt is concerned this region is confined to northwestern Georgia, northern Alabama, and Tennessee. The Clarksville silt loam and gravelly loam are the principal upland cotton soils, while the Decatur clay loam and Hagerstown loam are the chief valley soils for cotton. These soils have been derived very largely from the decay of underlying limestones and dolomitic limestones.

The Clarksville soils.— The only important cotton soils of this series are the Clarksville gravelly loam and silt loam. These soils give fair yields of cotton when properly managed. The gravelly loam is probably the better for this crop. The silt loam is more droughty and is looked upon as a rather weak soil. The more level areas are poorly drained.

The Decatur clay loam is a more productive soil than either of the Clarksville types described. The surface soil is 8 to 12 inches deep and ranges in color from a brown to reddish brown. The subsoil is a reddish brown to red clay. With good management, profitable crops of cotton are easily produced on this soil.

The Hagerstown loam, occurring in both Alabama and Tennessee is one of the best cotton soils of this region. "The soil is a brown yellow loam averaging about 12 inches in depth. The subsoil is a yellow or reddish clay loam to a depth of 24 inches."

83. Cotton soils of the Loessial region.— The Loessial region comprises an important area of silty deposits formed by water or wind during or following the glacial period. In the cotton-belt it occupies a rather broad belt extending

from southwestern Tennessee across the entire western border of Mississippi into Louisiana.

The Memphis silt loam is the principal cotton soil of the Loessial region. The top soil is about 8 inches deep and powdery when dry. The subsoil is a "yellowish-brown or reddish-yellow compact heavy silt loam or silty clay loam." As this soil occupies uplands, it is subject to serious erosion. It produces good yields of cotton.

84. Cotton soils of the River Flood Plains Province. — The soils of this province occupy the present flood plains or "first bottoms" and also the old flood plains or "second bottoms" of streams of that portion of the United States lying east of the Great Plains Region. These soils are composed of alluvial deposits washed from the uplands and deposited by overflow waters. In general, the soils of this province are very fertile where properly drained. The most important cotton soils of this group are briefly described below.

The Miller fine sandy loam and clay are important cotton soils found in the valleys of those rivers which rise in the Permian Red Beds such as the Brazos, Arkansas, and Red Rivers. They represent the wash from these Red Beds. The fine sandy loam is grayish brown or reddish in color and is 12 to 24 inches deep. It is well drained and is an excellent cotton soil. The miller clay to a depth of 10 inches is brownish red or chocolate colored. The subsoil is very stiff and tenacious. This soil represents the finest materials brought down from the Permian Red Beds and constitutes a strong cotton soil.

The Trinity clay is a productive cotton soil occupying rather level bottoms along the streams "in and issuing from the calcareous prairies of the Gulf Coastal Plain." This soil is easily puddled if worked while wet. Good

drainage is an essential to the profitable production of cotton on this soil.

The Sharkey clay found in certain river bottoms of Texas, Louisiana, Mississippi, and Missouri, and locally known as "buck shot land" is a valuable cotton soil when well drained. It is very stiff and waxy. Drainage and organic matter are its most urgent needs. Other important cotton soils belonging to this province are the Ocklocknee fine sandy loam, occupying level or gently sloping bottoms in Alabama and Mississippi, the Congaree loam, occupying the bottoms of streams flowing through or rising in the Piedmont Plateau, and the Kalmia and Cahaba fine sandy loams found on second bottoms along streams of the Coastal Plain.

85. Cotton soils of the Great Plains region. — In so far as the cotton-belt is concerned this region comprises western Oklahoma and western Texas. The greater portion of the soils occupying this area are residual. Climatic conditions often prohibit the successful production of cotton throughout a large part of this region.

The principal cotton soils of the Great Plains Region are the Vernon soils, comprising the fine sandy loam, loam, and silt loam, occupying the Red Beds region lying to the east of the Staked plains; also the Crawford stony clay, lying to the east and south of the Vernon soils, and the Amarillo loam and silty clay loam of the staked plains region. These soils are quite productive when the moisture supply is abundant.

CLIMATIC ADAPTATIONS

While cotton is a rather sensitive plant, it is affected less by ordinary changes in the weather than other field crops. Owing to its long growing season, it readily recovers

from minor setbacks. Nevertheless, such important climatic factors as the length of the growing season, temperature, sunshine, and the amount and distribution of the rainfall are directly related to the normal growth and fruiting of cotton.

86. Length of growing season. — The time required for the full development of cotton is 190 to 200 days from planting to harvest. In fact, the maximum yields are produced in sections where the growing season exceeds 200 days. By examining Fig. 16, it will be noticed that the length of the growing season in different portions of the cotton-belt varies from 190 to 200 days in the northernmost part to 300 days in the extreme southern limit. The present tendency is to develop early maturing cottons to avoid the injury from the boll-weevil.

87. Amount and distribution of the rainfall. — Precipitation is a very prominent factor in the development of the cotton plant. During April, at which time the greater portion of the cotton crop is planted, light but frequent showers are desired. The presence of excessive moisture in the soil at this time causes the seed to decay rather than germinate. On the other hand, an abundance of capillary water must be present or the seedlings will not secure the proper nourishment, the soil will bake, and a poor stand will result.

If the seed-bed for cotton has been properly prepared, thus insuring the presence of a rather large amount of available water in the soil at planting time, light but well distributed showers during the months of April, May, and June give best result. This permits the roots to sink deep into the soil, enabling the plants to better withstand the dry periods of late summer. A wet spring causes the rapid development of surface roots to the sacrifice of the deeper

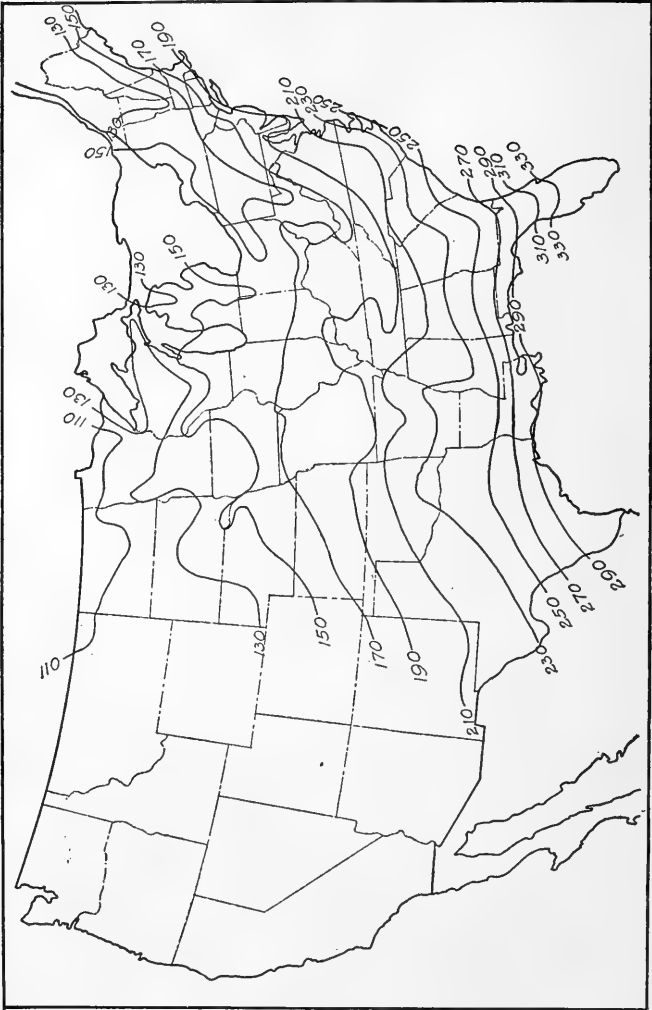

Fig. 16. — Average length of the crop-growing season in days.

roots. This abnormal development causes the plants to wilt rapidly and shed their foliage and fruit during the droughty conditions which so often prevail in late summer.

Experience has shown that if April, May, and June have been favorable, cotton can withstand considerable rain during the period from the middle of July to the middle of August. Excessive rain during the latter period of growth and maturity induces a rank growth of weed to the detriment of the fruit.

88. Temperature and sunshine. — In considering the influence of temperature and sunshine upon the development of cotton one must divide the life-history of the plant into two periods. The first is that in which the plant is in full vegetative growth, extending from planting time until about the first or middle of August. The second period is that in which the vegetative growth is checked, the plant diverting its energies to the production of fruit from the previously stored material.

During the first period the mean daily temperatures increase rapidly. Throughout the greater part of this period cotton requires a very warm or even hot atmosphere, provided there is sufficient humidity in the atmosphere to prevent excessive transpiration. It is also desirable that the daily range in temperature should be uniform during this first period; otherwise the vegetative growth is likely to be checked.

In the second period the temperature decreases rapidly and there is usually a greater range of temperature between day and night. This is very favorable to the maturing crop as it serves to check the vegetative growth and induce fruiting. It is highly important that the

plants receive an abundance of sunshine during June and a part of July. As a rule the first blooms begin to appear early in June, and the plants bloom rapidly until the middle of July. It is at this stage that very little rain and plenty of sunshine are required.

CHAPTER VIII

FERTILIZERS, MANURES AND ROTATIONS FOR COTTON

THE problem of maintaining permanently the producing power of the soils in the cotton-belt involves, (1) such a system of cropping as will provide these soils with an abundance of organic matter and nitrogen, and (2) the application of the two important plant-food materials, — phosphoric acid and potash, — to those soils in which these constituents are more or less deficient. In general, the cotton farmer has neglected the first of these practices and has greatly abused the second. In fact, he has learned to rely, almost entirely, upon commercial fertilizers to supply the nitrogen as well as the mineral foods where these constituents are deficient.

The fact that soils have rapidly decreased in productiveness following the continuous production of cotton has led most cotton farmers to believe that cotton is a very exhaustive crop. From the standpoint of the amount of plant-food materials taken out of the soil this is not true.

89. Fertility removed by cotton. — An acre of cotton yielding 500 pounds of lint, 1000 pounds of seed and 2000 pounds of stalks will remove from the soil approximately the following amounts of nitrogen, phosphoric acid, and potash:

TABLE 5. SHOWING PLANT-FOOD REMOVED BY COTTON

	NITROGEN (POUNDS)	PHOSPHORIC ACID (POUNDS)	POTASH (POUNDS)
Lint, 500 pounds	1.5	0.5	2.4
Seed, 1000 pounds	31.5	12.6	11.5
Stalks, 2000 pounds	51.0	20.0	36.2
Total Crop	84.0	33.1	50.1

The cotton plant requires much more nitrogen than either phosphoric acid or potash. Of the total nitrogen required, approximately 98 per cent is in the stalks and seed and only 2 per cent in the lint. Approximately 99 per cent of the phosphoric acid and 95 per cent of the potash is in the stalks and seed. When it is remembered that in ordinary farm practice the stalks are returned to the soil and in some cases the seed used as a fertilizer, or its equivalent in cotton-seed meal purchased and returned to the soil, the fact becomes clear that the cotton crop does not remove excessive amounts of plant-food as compared with other field crops. The gradual decline in the organic content of the soil, the leaching and erosion during the winter months, and the poor physical condition of the soil, all of which result from the continuous cultivation of cotton, are the primary reasons why cotton soils become poor.

90. Maintenance of fertility.—The ideal practice is to return to the soil, either directly or in farm manure, all plant-food not sold from the farm. However, sound fertilizer practice does not mean that the plant-food constituents must be purchased and returned to the soil in the proportions in which they are removed by crops. Many clay soils contain large quantities of potash. Here

the problem is to render this natural supply of potash available to crops by good soil management, rather than to depend upon potassic fertilizers. On the other hand, there are extensive areas of soils, especially those of an extremely sandy nature, that are very deficient in plant-food. The plant-food materials should be returned to these soils in amounts exceeding those in which they are removed by crops, as there is considerable loss of these materials as a result of leaching and erosion.

COMMERCIAL FERTILIZERS FOR COTTON

91. Nitrogen-supplying fertilizers. — The two fertilizing materials supplying the greater part of the purchased nitrogen for cotton soils are cotton-seed meal and sodium nitrate. Other materials of secondary importance are ammonium sulfate, dried blood, tankage, and cotton seed. An important factor in determining which of the above materials the cotton grower should buy is the relative cost of the element nitrogen. In fact, the farmer should secure the greater part of his nitrogen through the growth of legumes and the production and use of farm manures.

92. Sodium nitrate versus cotton-seed meal. — Experiments and farm experience have shown that on most soils, when the materials are properly applied, a pound of nitrogen will give equally good results when applied to cotton in either sodium nitrate or cotton-seed meal. As the form in which the nitrogen is contained differs in these two fertilizers, correct practices as regards their application differ somewhat. Sodium nitrate contains its nitrogen in the form of a soluble inorganic salt and for this reason it is a quick acting fertilizer. It is not absorbed by the soil in large quantities and is easily lost in the drainage water. The nitrogen in cotton-seed meal is combined with

other elements to form organic material. It does not become available to the plant until the cotton-seed meal has undergone decomposition, which results in the transformation of the organic nitrogen into nitrate nitrogen. For this reason cotton-seed meal acts less quickly than sodium nitrate. It is not so easily lost in the drainage water owing to the fact that it is readily absorbed by soils.

For the reasons just stated, sodium nitrate should not be applied in large quantities to cotton soils before or even at the time of planting. It should be applied in moderate quantity (50-100 pounds to the acre) while the crop is growing upon the soil. Cotton-seed meal is best applied a short while before or at the time of planting.

93. Cotton seed versus cotton-seed meal. — As to whether the farmer should use cotton seed or cotton-seed meal as a source of nitrogen will depend primarily upon the market prices of these products. With prices that have prevailed in past years the farmer can ill afford to use his seed for fertilizing purposes owing to the fact that the market value of the seed greatly exceeds its fertilizing value.

The following table will give at once a clear idea as to the relative value of meal and seed for fertilizer:

TABLE 6. SHOWING FERTILIZING CONSTITUENTS IN COTTON SEED AND COTTON-SEED MEAL

	COTTON SEED		COTTON-SEED MEAL	
	PER CENT	(POUNDS TO A TON)	PER CENT	(POUNDS TO A TON)
Nitrogen	3.1	62	7.0	140
Phosphoric Acid . . .	1.3	26	2.5	50
Potash	1.2	24	1.5	30

In so far as the plant-food constituents determine the fertilizing value of these two materials, cotton-seed meal is worth a little more than twice as much as cotton seed. Duggar ¹ states that "the average of a number of experiments on many soils in Alabama showed that, as a fertilizer for cotton, one pound of high-grade cotton-seed meal was equal the first year to $2\frac{1}{6}$ pounds of crushed cotton seed. Later experiments in Alabama and Georgia make a still more favorable showing for the meal." The nitrogen in cotton seed becomes available more slowly than that in cotton-seed meal, owing to the high oil content of the seed, which retards decomposition. For this reason, cotton seed usually exerts a greater influence the second year after its application than does the meal.

While the above consideration gives the preference to cotton-seed meal as a fertilizer, it must be remembered that it costs the farmer something to sell his seed and buy meal or to exchange his seed for meal. If, as we have seen, 1000 pounds of cotton-seed meal is of equal fertilizing value to 2000 pounds of seed, in order to make an even exchange of seed for meal, the farmer must get enough meal in addition to the 1000 pounds to pay the expense of making the exchange.

When cotton seed are used as a fertilizer for cotton, a common practice is to apply them in the drill in mid-winter. This prevents the seed from growing. If applied late they should first be crushed or their vitality destroyed by composting or by wetting and subsequently allowing them to heat.

94. Need of cotton soils for nitrogen. — The sandy and sandy loam soils of the Atlantic and Gulf Coastal Plain comprise a large percentage of the area devoted to

¹ Duggar, J. F., "Southern Field Crops," p. 326.

cotton in the United States. These soils are extremely deficient in both organic matter and nitrogen. There are at least three important reasons for this. (1) The cropping systems have been such as to return very little organic matter and nitrogen. (2) The open, porous character of these soils hastens the oxidation and destruction of whatever vegetable matter is applied. (3) The abundant rainfall of the region together with the porous nature of the soils causes the soluble nitrogen to leach away rapidly. The same conditions also cause much loss of nitrogen on account of erosion.

This deficiency of nitrogen is also noticeable on much of the clay soils in the cotton-belt. Most of the Houston black clay of north and central Texas, central Alabama, and northeastern Mississippi, has continuously been cropped to cotton until it is nitrogen hungry. Green-manure crops rather than commercial fertilizers should be employed to restore this nitrogen.

95. Phosphatic fertilizers. — Acid phosphate is the material most universally used by cotton growers as a source of phosphoric acid. Other materials of secondary importance are raw rock phosphate, ground bone, and slag phosphate.

Acid phosphate. — This is a manufactured product made by treating ground raw rock phosphate, $\text{Ca}_3(\text{PO}_4)_2$ with an equal weight of sulfuric acid, (H_2SO_4) . This results in the replacement of part of the phosphoric acid by sulfuric acid, thus forming monocalcium phosphate, $\text{CaH}_4(\text{PO}_4)_2$, and calcium sulfate, CaSO_4 as the chief constituents:



Phosphoric acid in the form of tricalcium phosphate is

insoluble, whereas that in monocalcium phosphate is easily soluble and therefore available to plants. The object of the sulfuric acid treatment, therefore, is to render the phosphoric acid soluble. Acid phosphate is also made by treating ground bone with sulfuric acid. Ordinarily acid phosphate contains from 12 to 16 per cent of soluble phosphoric acid. As a rule, about one-fourth of acid phosphate consists of phosphates (chiefly monocalcium phosphate) while three-fourths consists of calcium sulfate and impurities. The calcium sulfate is a soil stimulant and no doubt, in many cases, the effects produced from applying acid phosphate are partially due to the action of calcium sulfate in making soluble certain mineral elements of plant-food in the soil. The principal reason why acid phosphate is so universally used by cotton growers is that it gives quick results due to the readily soluble form in which the phosphoric acid is contained.

Raw rock phosphate. — This material is used very little by cotton growers. It consists of the finely ground phosphate rock without any acid treatment. Consequently the phosphoric acid contained is very difficultly soluble. On soils that are devoid of organic matter it produces practically no results. However, experiments that have been conducted at the Illinois, Ohio, Pennsylvania and Maryland Experiment Stations, indicate that on soils well provided with decaying organic matter, raw rock phosphate is a very profitable source of phosphoric acid. The organic acids produced as by-products in the decomposition of the organic matter act upon the raw rock phosphate changing a part of the phosphoric acid into an available form. In the event that future investigations establish the fact that raw rock phosphate may be made to materially increase the yield of cotton when applied to soils

rich in organic matter, it will furnish the cotton farmer a very much cheaper source of phosphoric acid than acid phosphate. Raw rock phosphate contains from 28 to 30 per cent of phosphoric acid.

96. Need of cotton soils for phosphoric acid. — The need of phosphatic fertilizers in the production of cotton is almost universal on the Norfolk, Orangeburg, and Susquehanna soils comprising the greater part of the Atlantic and Gulf Coastal Plain region. Analyses have shown much of these soils to contain less than 200 pounds of phosphoric acid to the acre. (For such a calculation the depth of the soil is considered to be seven inches.)

A permanently profitable system of agriculture can never be established on these soils without the more or less continued use of phosphate fertilizers. The rich alluvial soils of the Mississippi River and the Houston black clays of Texas, Alabama, and Mississippi, constitute the most important cotton soils that are not at present considered to be in need of phosphatic fertilizers.

Experience has taught that practically all of the sands and sandy loam soils and much of the upland clays in the cotton-belt, except the arid section of west Texas, are benefited by the application of phosphates.

97. Potassic fertilizers. — There are three materials that furnish the potash in cotton fertilizers. These are kainit, muriate of potash, and sulfate of potash. Of these three, kainit is most largely used. Experiments have not shown that a pound of potash in kainit, when applied to cotton, is more effective than an equal amount in muriate or sulfate of potash. The farmer should buy the material in which he can get the potash cheapest.

Kainit is a low-grade material containing approximately 12 per cent of potash, largely in the form of sulfate.

It also contains considerable quantities of magnesium sulfate and magnesium chloride. It is highly probable that part of the effect produced from adding kainit is due to the stimulating effects of these magnesium salts.

Muriate of potash and sulfate of potash are high-grade materials containing approximately 50 per cent of actual potash. For this reason it often happens that potash can be purchased cheaper in these materials than in kainit because of the decreased freight rate a unit of potash secured. All of these potash fertilizers have been secured from extensive salt deposits in the region of the Harz Mountains in northern Germany.

98. Need of cotton soils for potash. — Soils of the cotton-belt are in less need of potassic fertilizers than of phosphatic or nitrogenous materials. The principal reasons for this are: (1) these soils, in general, contain larger natural supplies of potash than of nitrogen or phosphoric acid; and (2) in ordinary farm practice the stalks of cotton, corn, and the like which contain most of the potash taken up by the crop are more often returned to the soil than the seed or seed products, which contain most of the nitrogen and phosphoric acid.

The sandy soils and often the sandy loams are usually deficient in potash and consequently respond profitably to potassic fertilizers. Clay soils, owing to the fact that they have been produced largely from the weathering of potassic feldspars are usually rich in potash.

99. Potash fertilizers check rust. — Experience has shown that potash fertilizers often greatly decrease the injury produced by cotton rust. As to whether this is due to a fungicidal action of the potash or whether it merely gives the cotton plants greater power of rust-resistance is not known. It seems to help the plants to

remain green and thrifty through periods of drouth. Duggar suggests that potash probably reduces the amount of water necessary to keep the plants in health.¹

100. A fertilizer test for cotton. — Soils differ in their requirements for fertilizers even when growing the same crop for two important reasons. (1) The natural plant-food content of soils is very variable. (2) The past treatment of a soil is important in determining its fertilizer needs. The continuous growth of one crop may exhaust one plant-food element more rapidly than others. For the above reasons the farmer should make tests of different fertilizing mixtures with the view of determining those most profitable for his particular soil. The soil on which this test is conducted should be level, of uniform productiveness, and representative of the soil type upon which the general crop of cotton is to be grown. A convenient and satisfactory size of plot for each fertilizer treatment is one-tenth of an acre. Eight rows, 136 feet long and 4 feet apart, represent an area of approximately one-tenth acre. In order that the adjacent conditions of all plots be similar, the various plots should be separated from each other by an unfertilized row of cotton, known as the "guard row." To one making this test the following treatment of the various plots is recommended, it being assumed that the plots are of the size recommended above:

Plot ² 1. No fertilizer.

Plot 2. 20 pounds of cotton-seed meal.

Plot 3. 20 pounds of 14 per cent acid phosphate.

Plot 4. 8 pounds of kainit.

¹ J. F. Duggar, "Southern Field Crops," p. 333.

² The term "plot" in this outline has reference to 8 rows, 136 feet long and 4 feet apart.

- Plot 5. No fertilizer.
- Plot 6. 20 pounds each of acid phosphate and cotton-seed meal.
- Plot 7. 20 pounds of cotton-seed meal and 8 pounds of kainit.
- Plot 8. 20 pounds of acid phosphate and 8 pounds of kainit.
- Plot 9. 20 pounds each of acid phosphate and cotton-seed meal and 8 pounds of kainit.
- Plot 10. No fertilizer.

When the cotton is well up it should be thinned, special care being exercised to see that the stand is uniform for all plots; otherwise the results will not be comparable. Likewise the cultivation and in fact all treatment except the fertilizer treatment should be the same for all plots. At harvest time the seed cotton from each plot should be carefully weighed. By comparing the yield of each fertilized plot with that from the nearest unfertilized plot one can determine the effectiveness of the various treatments. A test of this nature should be repeated for several years as it is known that seasonal conditions influence somewhat the action of fertilizers.

101. Judging fertilizer needs by appearance of plants. — In general, a rank growth of stalks and leaves associated with a rich green color indicate an abundance of nitrogen in the soil. On the other hand, small growth and pale color are not necessarily indicative of nitrogen starvation as any kind of malnutrition will produce imperfect growth. It is thought that phosphoric acid is closely associated with the fruiting process and that poorly fruited plants indicate a deficiency of phosphorus. While these indications are often correct, they do not constitute a safe criterion of fertilizer needs. It is not possible to give accurate directions whereby one can tell from the appearance of the crop what plant-food is lacking in the soil.

102. Home-mixing fertilizers. — The farmer who makes a practice of purchasing ready-mixed fertilizers usually pays more for the plant-foods secured than would have been the case had he purchased the incomplete materials and mixed them at home. The most economical use of fertilizers is possible only when a fertilizer test is made and the materials bought, mixed, and applied in accordance with the needs of the soil as indicated by this test. To assume that any particular brand of fertilizer is universally best for cotton is also an assumption that all cotton soils are alike as regards their fertilizer needs — an assumption that is grossly absurd.

103. Time of applying fertilizers. — Such fertilizing materials as acid phosphate, cotton-seed meal, dried blood, tankage, and the potash fertilizers should be applied either a short while before or at the time of planting. Phosphoric acid is readily fixed in the soil. There is little danger from leaching as it becomes well distributed in the soil and soon changes to insoluble forms. The organic nitrogenous fertilizers all have to be oxidized and converted into nitrates before they are of value to the crop. Potash is very quickly fixed in the soil by the double silicates. As a result of these properties of the above materials, experiments have shown no material gains from the practice of postponing the application of the fertilizers until the crop is up and growing. However, where very heavy applications are to be made, better results are usually secured by saving a part of the fertilizer for intercultural applications.

If nitrate of soda is to be used, it should be applied after the plants have begun growth.

104. Methods of applying fertilizers. — When fertilizers are applied to cotton in amounts less than 400

pounds to the acre, they are usually drilled in. Larger applications may be applied broadcast or partly broadcast and partly in the drill.

There are three methods of drilling fertilizers for cotton: (1) by hand distribution; (2) by the use of a fertilizer distributor; (3) by the use of a combined fertilizer distributor and planter. In drilling fertilizers by any of the above methods, one should be careful to see that such materials as cotton-seed meal and the potash fertilizers are not allowed to come in direct contact with the seed, as this is likely to interfere with germination. When fertilizers are distributed by hand, a small shovel plow or other suitable implement should be run in the drill to mix the fertilizer with the soil. In sections where the practice is to ridge the soil for cotton, the fertilizers are first distributed in the drill and the ridge subsequently formed immediately over the fertilizer. The ridge is then partially harrowed down and the seed planted, preferably by means of a planter, directly over the fertilizer. The fertilizer distributors usually cover the fertilizer sufficiently to protect the seed. When fertilizers are broadcast they should be thoroughly harrowed into the soil before the crop is planted.

In case nitrate of soda is to be applied during the growing season, it should be distributed uniformly in the middles and worked in with a cultivator.

105. Fertilizer formulas for cotton. — Owing to the varying needs of cotton soils for fertilizers one can only generalize in giving fertilizer formulas for this crop. The few formulas given below are to be used merely as guides. They are not to be adhered to strictly.

The following formula is recommended by Halligan for

“Louisiana and other parts of the South where the soil is rich in available potash:”

150-200 pounds cotton-seed meal	} to the acre.
150-200 pounds acid phosphate	

The Georgia Experiment Station recommends the following fertilizer for cotton on old, worn uplands:

Acid phosphate	1000 pounds	} 400 to 800 pounds to the acre.
Cotton-seed meal	671 pounds	
Kainit	296 pounds	

For the sandy soils of east Texas, the Texas Experiment Station recommends the following fertilizer:

100 pounds of 16 per cent acid phosphate	} to the acre.
200 pounds of cotton-seed meal	

On extremely sandy soils, from 50 to 75 pounds of muriate of potash or 200 pounds of kainit should be added to the fertilizer mixture.

FARM MANURES FOR COTTON

The cotton farmer, as a rule, uses very little farm manure. The chief reason for this is that on the average cotton farm, very little stock is kept other than the work stock necessary to produce the cotton. The limited supply of manure produced is often allowed to go to waste or is so improperly managed as to be of very inferior quality.

106. Stable manure for cotton. — Notwithstanding the limited use of stable manure by cotton-growers, farm experience and experiments have rendered unquestionable the high value of this material when used in connection with proper systems of cotton production. It lends itself most readily to those systems in which cotton is produced in rotation with other crops. In such cases the manure

usually is applied to some crop in the rotation other than cotton, preferably corn, thus allowing the cotton crop to get the residual effect of the manure. The direct application of the manure to the cotton often extends the growing season of the plants, delays maturity and hence decreases the possible yield and profit, especially in sections subject to the ravages of the boll-weevil. In case it is necessary to apply the manure directly to the cotton crop, the application should be made in the fall preceding the growth of the crop and should be immediately plowed under. This is especially important on clay soils, as decomposition takes place slowly in heavy soils and the constituents of the fresh manure become available slowly. As the clays possess very powerful absorptive properties, the value of the manure will not be lost as a result of its early application. In sandy soils, on the other hand, unless the season is dry, the conditions are such that the manure decomposes readily, and there is greater danger that some of the soluble constituents will be carried away in the drainage water.

Stable manure is usually broadcast at the rate of 6 to 12 tons to the acre. Heavy applications generally return greater profits to the acre of land while light applications give larger profits to the ton of manure applied.

107. Composts for cotton. — During the period from 1870 to 1880 composts received considerable attention as a fertilizer for cotton. Within recent years, their use for this purpose has decreased as it has been found that, in many cases, the improvement is not sufficient to compensate for the trouble and cost of making them.

The increased interest manifested in compost by cotton farmers during the period from 1870 to 1880 was due largely to the writings of Farish Furman, of Baldwin

County, Georgia. Furman recommended the composting of such nitrogenous materials as cotton seed and barnyard manure with acid phosphate and kainit for the purpose of providing a "complete fertilizer" at a lower price than that which was being paid for the ammoniated guanos so extensively used at that time. Furman's formula, as originally recommended was as follows:

Barnyard manure.....	750 pounds
Cotton seed.....	750 pounds
Acid phosphate.....	367 pounds
Kainit.....	133 pounds

In addition to the above materials, farmers often added considerable absorbent earth. The general plan followed in making the compost heap was first to put down a layer of 20 to 25 bushels of stable manure, and to cover this with an equal amount of cotton seed. Next, 200 pounds of acid phosphate was applied and occasionally kainit was added to the mixture. Absorbent earth was used at frequent intervals in sufficient amounts to cover the entire heap.

The benefits derived from adding the acid phosphate were: (1) it supplied the deficiency of phosphoric acid in composts; and (2) it added calcium sulfate (an important constituent of acid phosphate), which prevents the loss of ammonia during fermentation. The absorbent earth also prevented the loss of ammonia.

A few days before, or at the time of planting, the compost is thoroughly mixed and applied in the drill at the rate of 400 to 800 pounds to the acre.

GREEN-MANURES AND ROTATIONS FOR COTTON

108. Need of organic matter. — The most profitable use of commercial fertilizers in the production of cotton is

possible only when an adequate supply of organic matter is maintained in the soil. No greater error can be made by the cotton-grower than that of depending upon commercial fertilizers to overcome the ill effects produced by a deficiency of vegetable matter, poor tillage, and lack of drainage. In this connection it is well to remember, (1) that the primary function of commercial fertilizers is to add plant-food to the soil, and (2) that plant-food is only one of the several factors essential to the profitable production of crops.

The ability of the crop to obtain plant-food and moisture from the soil, and also profitably to utilize the nutrients supplied in fertilizers is determined largely by the physical condition of the soil, and the solvent power of the soil water. Decaying vegetable matter produces that physical condition necessary for the proper aeration of the soil and also supplies by-products which, when dissolved in the soil water, greatly increase its solvent power for plant-food. As a result of these effects, the organic matter decreases the need for fertilizers in the production of cotton on soils that are well supplied with the mineral plant-foods and renders much more effective the mineral fertilizers that are essential on soils in which the mineral plant-food naturally is somewhat deficient. The most important source of organic matter for soils in the cotton-belt is that of green-manures.

109. Suitable crops for green-manure. — Crops suitable for use as green-manures in the cotton-belt are of two classes; legumes and non-legumes. Of the first class, the cowpea, soy bean, crimson clover, bur clover, vetch, melilotus, and the velvet bean are most important. Belonging to the second class are rye, oats, wheat, barley, and millet.

110. Green-manures and the supply of organic matter. — Ordinarily, cowpeas, soy beans, and crimson clover will yield at least $1\frac{1}{2}$ tons of dry matter to the acre in tops and roots. This dry matter when plowed into the soil is equivalent to an application of six tons of average barnyard manure, containing 25 per cent dry matter and 75 per cent water. Very few farmers in the cotton-belt produce a sufficient amount of barnyard manure to enable them to apply six tons of manure to every acre of cultivated land on their farms once every four years. Practically all of them can easily add the equivalent of this much manure to their soils once every three or four years by the use of green-manures. Whether or not the entire crop should be plowed into the soil, or merely the roots and stubble, will be determined largely by the needs of the soil for organic matter and nitrogen. On soils that are quite deficient in organic matter, it will in general be a good practice to return the entire crop. Otherwise, the crop should be harvested for hay and the manure returned to the soil.

The Alabama Agricultural Experiment Station reports an increase in yield in one case of 696 pounds of seed cotton to the acre, or 83 per cent, due to plowing under a crop of cowpea vines on land which had been in cotton the previous season.

111. Green-manure crops and the nitrogen supply. — Nitrogen is the most costly constituent of commercial fertilizers, its commercial value usually being more than three times that of either phosphoric acid or potash. For this reason the farmer should attempt to secure from the air (which is $\frac{4}{5}$ nitrogen) the greatest part of the nitrogen needed in the production of his crops by the introduction of legumes into his cropping system.

A crop of cowpeas yielding $1\frac{1}{2}$ tons of hay to the acre will, if returned to the soil, increase the nitrogen supply approximately 65 pounds to the acre. This is assuming that the cowpea secures from 40 to 45 pounds of nitrogen from the air for each ton of hay it produces, the nitrogen contained in the roots and stubble being no more than that furnished by the average soil. To add this much nitrogen would require 930 pounds of cottonseed meal or 433 pounds of sodium nitrate. In addition, the organic matter supplied by the cowpeas is usually of greater value than the nitrogen. Similar yields of soy beans and crimson clover would supply to an acre, 75 and 70 pounds of nitrogen, respectively.

Non-leguminous green-manure crops, such as the small-grains, millet, and the like, while not increasing the amount of nitrogen in the soil are, nevertheless, nitrogen savers, owing to the fact that they prevent loss from leaching and erosion.

112. Will crop rotation maintain fertility? — It must not be assumed that growing cotton in a rotation which supplies the soil with an abundance of organic matter will necessarily eliminate the need of commercial fertilizers. Such a system will render the use of nitrogenous fertilizers unnecessary, and mineral fertilizers will not be needed on soils that contain an abundant natural supply of phosphoric acid and potash. However, much of the soils in the cotton-belt are quite deficient in phosphoric acid and, to a less extent, in potash. Maximum yields on these soils cannot be obtained without the application of materials containing phosphoric acid and potash.

113. Rotations for cotton. — A good rotation applicable to the greater part of the cotton-belt is: first year,

cotton; second year, corn and cowpeas; third year, winter oats or wheat followed by cowpeas as a catch crop.

If the farmer wishes to grow more cotton than is provided by the above rotation, he should grow cotton two years in succession, and thus employ a four-year rotation.

For thin land the Georgia Experiment Station recommends the following rotation: First year, corn with cowpeas; second year, oats or wheat followed by cowpeas; third year, oats or wheat followed by cowpeas; fourth year, cotton.

In the northeastern part of the cotton-belt, the following rotation is rather widely applicable: First year, corn with cowpeas; second year, peanuts; third year, cotton; fourth year, cotton.

In many sections, crimson clover is grown following cotton and preceding corn.

CHAPTER IX

TILLAGE FOR COTTON

THE tillage practices employed in the production of cotton are, as a rule, very poor. At least five reasons can be given for this. (1) A relatively large percentage of the cotton crop is produced on "one-horse" farms, where thorough plowing and the use of improved implements are impossible. (2) A scarcity of heavy draft animals is often the cause of poor tillage practices even on the large farms. (3) A large percentage of the acreage in cotton is tilled by renters rather than landowners. In most cases little or no direct supervision of farm operations is given by the landowner, and, as a result, very superficial tillage is practiced. (4) Many unprofitable practices employed in the early days of cotton production in the South have become more or less traditional, being handed down from one generation to the next. (5) Little knowledge of the fundamental principles underlying the growth and nutrition of crops.

While tillage practices vary somewhat in accordance with soil and climatic conditions, the cotton-grower must remember that all practices are based on principles and reasons, a knowledge of which is absolutely essential to maximum success.

PREPARATION OF THE SEED-BED

The most important single factor in the profitable production of cotton is the preparation of the seed-bed.

No amount of good tillage after the crop is planted can offset the ill effects of careless preparation of the soil.

114. Drainage the first essential. — Until adequate provision has been made for the rapid removal of all surplus or gravitational water from the upper portions of the soil, a suitable seed-bed for cotton cannot be prepared. The experience of many years has demonstrated beyond question the fact that such modern and essential practices as early deep plowing, the incorporation of organic matter, and thorough and frequent cultivation are of no avail on a water-logged soil. The discussion of suitable tillage practices for cotton which follows is based on the assumption that adequate drainage has in all cases been provided.

115. Disposal of stalks and litter. — If cotton is grown in a suitable rotation with other crops, there is usually little difficulty in plowing under all existing vegetation, owing to the fact that cotton commonly follows a small-grain crop or a legume crop. On most farms, however, cotton follows cotton and in such cases it becomes necessary to chop or break to pieces the stalks previous to plowing. This is most satisfactorily done by the use of a stalk cutter, the blades of which cut the stalks into short pieces. In many cases the stalks are broken to pieces after they become dry and brittle by means of a heavy stick. The rather common practice of plowing up, raking and burning the stalks should, in all cases, be avoided.

116. Fall plowing for cotton. — The primary objects sought for in the preparation of the seed-bed are an abundance of water, air, and available food. On most soils sufficient water and food during the growing season cannot be had unless early fall plowing is practiced. Late spring

plowing usually insures too much air in the seed-bed, causing it to dry out rapidly.

It must be kept in mind that the matter of making plant-food available in the soil involves important and far-reaching chemical and biological processes. An important object of tillage is to hasten these processes. It must be remembered also that under favorable conditions, considerable time is required for these processes to change the inert, insoluble soil constituents into a form suitable for nourishing the plant. Fall plowing starts these processes to work sufficiently in advance of the planting season to insure the presence of relatively large quantities of soluble food. On most soils such is not the case with spring plowing.

Another important benefit of fall plowing is that it enables the soil to absorb and hold large quantities of water during the winter months. Unplowed land retains but little water. It also gives whatever organic matter is plowed under sufficient time to be transformed into humus by the time the crop is growing. Undecomposed vegetable matter is of little value in the soil. On the other hand, it has been shown that a pound of humus will store up seven and one-half times as much water as a pound of sand and the sand will lose its water by evaporation three and one-half times more rapidly than the humus. A clay soil can store up only about one-fourth as much water as humus and will lose it by evaporation twice as rapidly.

An excellent practice which is coming into favor among cotton farmers is to plant a winter-growing cover-crop on the land following fall plowing, which prevents the leaching of plant-food during the winter months, decreases erosion, and increases the amount of vegetable matter in the soil when it is plowed under in late winter. This

practice necessitates a second plowing but the resulting benefits more than repay the cost of the extra labor.

In the semi-arid sections of the cotton-belt it is usually necessary to use some form of subsurface packer on the soil immediately following fall plowing to reestablish capillarity and to prevent the rapid drying out or blowing of the soils during the winter.

117. Spring plowing for cotton. — There are certain conditions under which deep fall plowing for cotton would be objectionable. This is especially true on deep, light sandy land subject to excessive leaching, or elevated sandy table-lands which drift in windy weather. Where the rainfall is sufficient, these soils are much benefited by disking and the planting of a cover-crop in the fall. Breaking should be deferred until late winter or spring.

There are also rich, moist river-bottom and virgin black prairie soils in the Gulf states that are best plowed in the spring for cotton, owing to the fact that they already contain a surplus of available plant-food, which condition tends to augment the growth of stalks at the expense of fruit.

118. Depth of plowing. — The proper depth of breaking cotton soils will depend upon the character of the soil, the time of plowing, and the previous treatment of the soil. In general, the soil may be plowed deeper in the fall than in the spring. In fact, deep plowing just previous to planting is very objectionable.

Clay soils should ultimately be plowed deeper than sands. The deepening of clay soils should be accomplished gradually in order that an excess of inert subsoil may not be plowed up at any one operation. The ideal practice is to plow from one to one-and-a-half inches deeper each year than the preceding year until the desired depth is

reached. An ideal plan is to use a disk plow so set that it will not bring the subsoil to the surface. With this implement the soil may be deepened more rapidly than when a mold-board plow is used.

The ultimate aim should be to plow all cotton soils, except those upon which spring plowing is advisable, to a depth of at least eight inches. The farmer must determine how soon he can secure this depth under his conditions.

119. Subsoiling. — This is a term applied to the loosening of the subsoil without bringing it to the surface. It is accomplished by first employing an ordinary turnplow, and then in its furrow running a special subsoil plow. As this latter plow has no mold-board, it merely loosens the subsoil without bringing it to the surface.

In the humid section of the cotton-belt, fine textured subsoils often become so close and compact as a result of the abundant rainfall, that air and water penetrate them with difficulty. Such soils are usually benefited by subsoiling, although the benefits may not be noticeable the first year. Soils with more or less porous subsoils are not benefited by the use of the subsoil plow at any time.

If profitable results are to be expected from subsoiling, the following facts must be kept in mind: (1) This operation should be practiced only in the fall. This gives the subsoil sufficient time to become settled before planting time. (2) It is never advisable to use the subsoil plow when the subsoil is saturated with moisture, even though the top soil is dry. This merely puddles and packs the subsoil, whereas the object is to loosen it.

120. Subsequent tillage. — After the soil has been plowed, such tillage should be given as will produce a rather firm, well-pulverized seed-bed with a loose mulch

on the surface. Where the land has been fall-plowed and no cover-crop planted, it is necessary that the soil be harrowed as soon after heavy rains during the winter months as possible in order to prevent the rapid evaporation of moisture. Such soils will usually require a thorough disking in the spring as they are likely to become compact as a result of the winter rains.

Spring-plowed soils should be immediately harrowed after plowing thoroughly to pulverize all clods and to more or less firm the soil. If harrowing is deferred until the clods become dry, the task of pulverizing then becomes very laborious.

The implements commonly used to work the plowed soil into a good seed-bed are the disk harrow, the spring-tooth harrow, and the smoothing harrow. A subsurface packer is profitably used on soils plowed in the late spring. A disk harrow can be made to serve the same purpose by weighting it and by having the disks set with only a slight angle to them.

121. Ridging versus level preparation. — The almost universal practice in the South is to plant cotton on ridges or beds. This practice is based upon the fact that when bedded the soil warms up faster and earlier in the spring, drainage is facilitated and it is easier to get a good stand. The cotton plant, being a native of the tropics, demands a high degree of temperature for the germination of its seed. It is also true that in many cases the soil will run together and get very compact unless the ridging system is practiced. Under these conditions there is great danger that the young plants will be drowned out in wet weather. The principal objection to ridging is that it causes the soil to dry out rapidly in dry weather by greatly increasing the surface area exposed. This objection is to an extent

overcome by partially harrowing or dragging down the ridges before planting.

On sandy, well-drained land farmers sometimes plant cotton without ridging the soil. In such cases very shallow planting is necessary and extreme care must be exercised to prevent covering the plants at the first cultivation.

In the western part of the cotton-belt where the rainfall is scant, ridging for cotton is not necessary and is often detrimental.

122. Forming the ridges.—As a rule the ridges should be formed at least fifteen days before planting. This allows the soil to settle and become warm. On heavy, cold soils, ridging at an even earlier date is advisable. In most cases the ridges are formed by means of an ordinary mold-board plow, four to six furrow slices being thrown together. An improvement on this practice would be the use of a double-mold-board plow, or lister, for forming the ridges, as much labor would thereby be saved.

If commercial fertilizers are to be applied, a shovel plow is first used to open a center furrow in which the fertilizer is drilled. The beds are subsequently formed immediately over the fertilizer. In many sections the fertilizers are applied and listed upon about fifteen days before planting, the ridges not being finished until some ten days later.

In sections where no fertilizer is used, the advantage of a center furrow is a disputed question. If the soil is loose at the time of forming the ridges, the use of the center furrow is usually of no advantage. However, in stiff land where the plowing has been done early, the use of a center furrow is advisable as it provides deep and thorough preparation under the center of the beds.

Just before planting, the height of the beds should be reduced by means of a harrow or drag. Drawing a smooth-

ing harrow lengthwise the beds reduces their height, drags out trash and clods, and flattens the surface preparatory to the use of the planter. This planting on relatively low beds is quite important. The cultivation can be more nearly level, thus conserving moisture in the summer when it will be needed. On well-drained, sandy soil, the beds should be dragged down almost level.

PLANTING

123. Time of planting. — It is not safe to plant cotton until at least two weeks after the average date of the last killing frost in the spring. In the extreme southern part of the cotton-belt, most of the crop is planted in April, whereas in the extreme northern part, planting does not begin until near the first of May.

Nothing is to be gained by planting cotton before the soil becomes warm in the spring. The seed will either rot rather than germinate, or the vigor of the young plants will be greatly decreased. The slow growth of the plants under such conditions, greatly increases the cost of cultivation.

In sections subject to the ravages of the boll-weevil, cotton should be planted as early as possible after the soil becomes warm.

124. Advantage of planting heavy seed. — Investigations conducted by Webber and Boykin strongly indicate the superiority of heavy cotton seed over light seed and the advisability of farmers eliminating the light seed before planting. These investigators found that when the seed are treated with a paste made from ashes, acid phosphate, or fine dry soil or flour, the "linters" or "fuzz" can be pasted down and that the seeds can thus be prevented from clinging together. The separation is accomplished by the

use of an ordinary type of air blast fanning mill in which the flue is lengthened to four and one-half feet in order that the seed may be exposed more fully to the action of the air. (For the details of this method the reader is referred to Farmers' Bulletin 285 of the United States Department of Agriculture.) It was found that the heavy seed germinated better than the light ones and also gave a higher yield of seed cotton as shown by the following data taken from a report of these investigations:

TABLE 7. SHOWING RELATIVE VALUE OF LIGHT AND HEAVY COTTON SEED

KINDS OF SEED PLANTED	FIRST PICK	SECOND PICK	THIRD PICK	TOTAL YIELD
	Pounds	Pounds	Pounds	Pounds
Test at Lamar, S. C.:				
Heavy (20 rows)	375	253 ¹ / ₄	419	1047 ¹ / ₄
Unseparated (20 rows)	335	228	381 ¹ / ₄	944 ¹ / ₄
Test at Hartsville, S. C.:				
Heavy (14 rows)	158 ³ / ₄	793	212 ⁷ / ₈	1164 ⁵ / ₈
Unseparated (14 rows)	139	715 ³ / ₄	221 ¹ / ₈	1075 ⁷ / ₈

125. Quantity of seed. — It is customary to plant 12 to 15 times the quantity of seed necessary to give the desired number of plants to the acre. A bushel of cotton seed contains between 120,000 and 150,000 seed. It is seldom that less than a bushel and often as much as a bushel and a half of seed is planted per acre. Planting in rows four feet apart and one foot in the drill requires, with a perfect stand, only 10,890 plants to the acre. A spacing of 18 inches in the drill requires 7,260, and 24-inch spacing requires 5,445 plants to the acre.

With a good quality of seed and a planter that places the seed in a narrow drill, the quantity of seed required

to the acre can be greatly reduced. However, under the best conditions it is seldom wise to plant less than one-half bushel of seed to the acre.

126. Methods of planting. — Cotton is in nearly all cases drilled and afterwards chopped to a stand. The single-row planter is most commonly used, which opens the furrow and drops and covers the seed at one trip. With the idea of decreasing the expense of chopping, planters have been put on the market which drop the seed at regular intervals rather than in a continuous drill (Fig. 17). The satisfactory use of these planters generally requires that the seed be treated before planting with a paste of some kind to cause the "fuzz" to adhere to the seed. To do this the method referred to in paragraph 124 is recommended. The use of this method reduces the amount of seed necessary to plant an acre.

Cotton seed should be covered very shallow, especially if planted early. Deeper planting may be practiced later in the season when the soil is warm and there is not so much danger of heavy rains. Best results are secured by barely covering very early-planted seed, but when planted late it is well to put the seed in moist soil, provided this does not necessitate planting more than two and one-half inches deep.

CULTIVATION

127. Objects of interculture. — Farmers often possess a confused idea as to the objects of interculture. Many have the very erroneous idea that the primary object sought is the deep stirring of the soil, and following out this idea, they attempt to accomplish, after the crop is up and growing, what should have been accomplished in the early preparation of the seed-bed.

The primary objects of interculture are (1) to conserve moisture, (2) to keep down weeds, and (3) to permit the

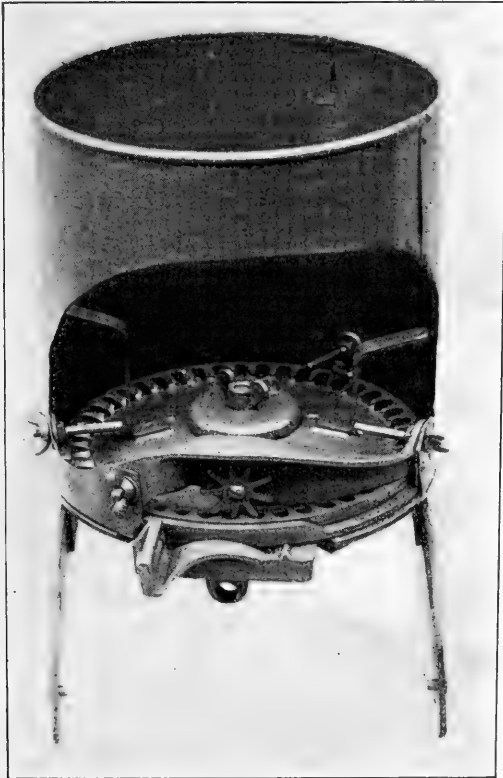

FIG. 17. — Interior view of a one-seed drop cotton planter.

air to freely enter the soil. If the seed-bed has been properly prepared, deep tillage is not necessary in order to secure these objects. On the other hand, it is usually very injurious.

128. Broadcast tillage for cotton. — Farmers are rapidly learning to appreciate the value of broadcast tillage for cotton. This operation is performed by running a weeder or light spike-tooth section-harrow across the rows, (1) after the crop is planted but before the plants are up, and (2) after the plants are up and well established but before chopping. If the section-harrow is used for this purpose, it should be adjusted so that the spikes slant slightly backward, especially for the cultivation given after the plants are up.

There are three important advantages in broadcast tillage: (1) It thoroughly breaks the crust over the entire surface of the soil, saving moisture, destroying weeds in their first stages of growth, and enabling the young cotton plants to come through the soil easily. (2) It economizes labor as by this method ten or more acres can be gone over in a day. In fact, the broadcast tillage is, by far, the most economical cultivation that the crop receives. (3) It permits the operation of chopping to be effected with less labor. Broadcast tillage is not practical if a poor stand has been secured or if the land is foul with litter.

129. Tillage by separate rows. — Before the farmer begins the cultivation of his cotton, he should be familiar with the following important facts: (1) Practically all of the food that the plant takes up from the soil is secured from that portion of the soil that is stirred in the preparation of the seed-bed. (2) The plant derives little or no food from that portion of the seed-bed that is kept stirred as a result of tilling the crop.

Knowing the above facts, the farmer can readily appreciate the injurious effects of deep cultivation, especially after the plants have become somewhat advanced in their growth. It results in limiting the feeding roots to a small

portion of soil, and renders useless a large amount of available food that with shallow cultivation would be used by the plants.

130. The first cultivation. — This must be of such a nature as to stir the soil close to the plants without covering them. Either double cultivators with fenders attached or single cultivators made similar to a side harrow may be satisfactorily used. The very crude practice of barring off the row with a turning plow should be avoided except in extreme cases. When cotton is thus barred, particularly if it is closely done, too much soil is taken away, the plants fall down after the hoes and the growth is checked. If no other damage is done, the crop is made several days late. The use of the turn-plow in barring off cotton is justified only when the grass has become so large as a result of protracted rains that its destruction by the use of more desirable types of cultivators is impossible. Many farmers, in using the two-horse or one-horse cultivators, equip them with narrow sweeps or scrapes rather than with small points. The results secured are quite satisfactory, especially if the sweeps or scrapes are equipped with a fender.

131. Chopping. — This operation follows immediately after the first cultivation by separate rows. The chopping or thinning is done with a hoe. One or two plants are left at the desired distance apart. Ultimately only one plant should be left in a hill. The ideal practice is to leave, at the time of chopping, only one plant at the desired distance apart unless chopping is done when the plants are very small, or when there is danger that disease or unfavorable weather will destroy them.

132. The second cultivation. — The first cultivation and subsequent chopping result in removing considerable

soil from the row of plants. Therefore, an important object in the second cultivation should be to return this soil to the plants. To accomplish this purpose, rather wide sweeps or scrapes are commonly used on either one-horse or two-horse cultivators. These sweeps or scrapes must be set sloping enough so that most of the soil stirred will fall back of them rather than be pushed to the sides, in which case rather hard strips are left with no mulch to prevent evaporation. Any method of cultivation that does not leave the entire middle covered with a fine mulch is not satisfactory. The use of such implements as leave a narrow, uncultivated strip or "balk" midway between the rows of cotton should be abandoned.

133. Subsequent culture. — The third and subsequent cultivations for cotton should be of such a nature as to keep the grass subdued and the soil well stirred without leaving the middles ridged or furrowed. The cultivation gets shallower as the roots get out in the row. Small buzzard wing sweeps on double cultivators are widely used for these later cultivations. After the cotton gets too large to plow with the double cultivators, single cultivators are used. On droughty soils cultivation should be continued until the cotton is locked in the rows. On very rich soils that have a tendency to produce too large a stalk, late cultivation is not advisable.

134. Frequency of tillage. — No definite rules can be adhered to as to the frequency of cultivating cotton. The aim should be to keep the soil in such a condition at all times as will provide the objects of cultivation previously stated in this chapter. To do this will necessitate stirring the soil as soon after rains as possible. For best results, at least five cultivations are usually necessary. On droughty soils six or seven cultivations are advisable.

135. The value of late tillage. — The most critical part of the cultivation of cotton is the late tillage. While there is little doubt that most farmers “lay by” cotton too early, much cotton is injured every year by late cultivation injudiciously performed. Failure to practice very shallow cultivation at this advanced stage of the crop has prejudiced many farmers against this valuable practice. After the bolls begin to form and the vegetation becomes heavy, the plants require large quantities of water. If late cultivation is not practiced, the soil bakes and the moisture evaporates. But if this late tillage is not very shallow an enormous quantity of feeding roots are destroyed. With the heavy top and the large crop of bolls to support, the reduced root system cannot supply the necessary food and moisture. To reduce proportionately its need for these materials, the plant sheds its forms and young bolls. On the other hand, much of the August shedding can be prevented by late, shallow cultivation.

136. Distance between rows. — It is impossible to say just what the distance should be between rows of cotton because of the difference in the fertility of soils. On rich soils well supplied with moisture the plants grow large, requiring more space than on poor soils, because of the outward growth of the long branches. Therefore, the richer the soil, the greater the distance between rows should be. With corn the matter of spacing is just the opposite.

On poor upland soils the usual distance between cotton rows is $3\frac{1}{2}$ feet. A less distance than this is seldom advisable under any conditions. On good upland soil capable of producing from one-half to two-thirds of a bale to the acre, the rows should be at least 4 feet apart. On rich bottom land or alluvial soils a distance

of 5 feet or in some cases 6 feet between rows is advisable. Tests conducted by the Mississippi Experiment Station on the rich delta soils averaging one bale per acre indicate that best results are obtained when the cotton is grown in four foot rows with the plants $2\frac{1}{2}$ feet apart in the row, or 10 square feet of surface for each plant.

137. Distance between plants in the row. — The general tendency of cotton-farmers is to unduly crowd the plants in the row. The same conditions govern the spacing of plants in the row as determine the distance between rows. When cotton is planted in $3\frac{1}{2}$ foot rows on poor upland soils, the distance between plants in the row should not be less than 12 inches. As the fertility of the soil increases, the distance between plants should also increase. On very productive alluvial soils a spacing of 24 or 30 inches is advisable. On soils of medium productiveness a spacing of 18 or 20 inches between plants usually gives best results. Experience and experiments have demonstrated the fact that when the plants are unduly crowded, the number of bolls to a plant is greatly decreased.

CHAPTER X

HARVESTING AND MARKETING COTTON

HARVESTING and preparing cotton for the market involve at least four important operations. These are (1) picking, (2) ginning, (3) baling, and (4) compressing into very compact bales for long distance shipping. A brief discussion of each of these operations and also a discussion of commercial grades follow.

138. Picking. — Practically all of the cotton crop is still picked by hand. This laborious operation limits the acreage that can be produced and handled by a unit of labor and adds greatly to the cost of cotton production. Picking begins in August and continues until the middle of December. The greater part of the crop is picked in September, October, and November. As a usual thing the best quality of lint is secured at the first and second pickings.

An amount varying from 175 to 225 pounds of seed cotton represents an average day's work for an experienced picker. The price paid for picking varies from 40 cents to 80 cents a 100 pounds, depending on labor conditions. In sections where labor is exceptionally scarce, even more than 80 cents a 100 pounds is paid. In picking cotton one should be careful to see that no trash is included. Diseased locks should not be picked, and stained or discolored locks should not be mixed with the general lot; otherwise the selling price will be reduced.

139. Cotton-picking machines. — Many attempts have been made to invent mechanical cotton-pickers. Pre-

liminary trials with some of these pickers have given promising results. The chief difficulty is to perfect a machine that will pick thoroughly and rapidly the seed cotton without including trash and without injuring the unopen bolls. Several machines invented within very recent years have given considerable promise of doing this. It seems certain that in time a large percentage of the cotton crop will be harvested by mechanical cotton-pickers.

"Some of these machines operate on the suction principle: the open end of a hose pipe is directed by the human hand close to each open boll, when the suction created by a revolving fan on the machine draws the seed cotton through a tube and into a hopper.

"Other mechanical pickers entangle the seed cotton by means of innumerable, sharp, tack-like points imbedded in narrow revolving belts, which are directed by human hands into contact with the open boll; the lint is instantly entangled and borne along the revolving belt to the hopper, where it is removed by brushes." ¹

140. Ginning. — After the seed cotton is harvested it is immediately hauled to the gin where the lint is removed from the seed. The ginning outfit includes an elevator for sucking the cotton through a cleaner which removes trash and dirt. Damp cotton should be allowed to dry before being ginned; otherwise the gin will break a large percentage of the fibers. Ginning usually costs the grower a dollar to a dollar and a half per bale.

141. Types of cotton gins. — There are two principal types of cotton gins, the saw gin and the roller gin. The

¹ Duggar, J. F., "Southern Field Crops," p. 365.

principles upon which these two types operate are entirely different.

The saw gin, invented in 1792 by Eli Whitney, an American, is used to gin short staple cotton and is the type commonly used in the cotton-belt, except in the districts growing Sea Island cotton. The important features of its construction may be described as a series of circular saws having fine teeth, which revolve between the interstices of an iron bed upon which the seed cotton is placed. The teeth of the saws catch the lint and pull it off the seeds. A circular brush, which makes four or five times as many revolutions per minute as the saws do, removes the detached lint from the saws. The brush creates sufficient draught to carry the lint to a condenser where it is pressed into layers. Modern gins consist of 4 to 8 gin stands. The gin stands most frequently used have 60 to 80 saws, which are either 10 or 12 inches in diameter. These saws make 300 to 400 revolutions a minute. A suitable production for a 60-saw gin stand is one bale of 500 pounds an hour, or 5 pounds to a saw. Approximately one-third of the weight of seed cotton is lint, the remaining two-thirds being seed to which the linters are attached. Varieties differ considerably as to the amount of lint they produce in proportion to the amount of seed.

The roller gin is used in ginning Sea Island cotton, the naked seeds of which are easily separated by rollers from the lint. This type is preferable for ginning all long-staple cottons, as in such cases, the saw gin breaks a large percentage of the fibers. It is also used in ginning the short staple cottons of India and is the common type used throughout Egypt where long-staple cottons are largely grown. There are at least two distinct types of con-

struction of roller gins in general use, but both of them depend upon the same principle for the removal of the fiber from the seed. In each type the seed cotton is brought in contact with a revolving roller, the surface of which is covered with leather, preferably walrus hide, which has a roughened surface. A metal plate or knife extends across the machine tangentially to the roller and very close to it. The fine fibers adhere to the leather covering of the roller and are drawn between it and the knife until the seed is pulled against the edge, and the fibers are severed. The larger types of roller gins will turn out 800 to 1000 pounds of lint to a gin stand in a day of 10 hours.

142. Baling. — The cotton lint leaves the gin in a very loose condition and has to be compressed into bales for convenience of transport. This is done by placing it in a baling press with an outside wrapper of coarse burlap, in which it is compressed into comparatively small compass and held by iron ties.

Bales from different countries vary greatly in size, weight, and appearance. The approximate weights of bales as put on the market from different countries are as follows:

United States.....	500 pounds
India.....	400 pounds
Egypt.....	700 pounds
Peru.....	200 pounds
Brazil.....	200 to 300 pounds.

American cotton bales are said to arrive at foreign markets in poorer condition than those from any other country. This is due largely to the fact that the bagging used for covering the American bale is of very poor quality and

insufficient in amount. Where the bales are not of uniform length the ends of the long bales are sometimes taken off in loading the ships. Such bales usually arrive at their destination in bad condition.

The round bale, which has been prevented from coming into general use by the opposition of owners of compresses, is usually much better protected. Its weight is approximately 250 pounds.

143. Care of baled cotton. — The fact that baled cotton does not absorb water readily has led to very careless methods of handling it. It is rather common for both farmers and warehouse men to leave large quantities of baled cotton exposed to the rain for many months at a time. There is no question but that such treatment stains and weakens the fibers, especially in the outer portions of the bale, and thereby decreases the selling price. Cotton bales should be kept at all times under shelter, and, if possible, from direct contact with moist soil.

144. Compressing. — The bales as they come from the gin are too large for economical shipment either by train or over water. For this reason, powerful steam baling compresses are to be found in practically every inland city and seaport in the cotton-belt. These compresses greatly reduce the size of the bales.

In some cases the cotton lint as it comes from the gin goes immediately into these powerful compresses where it is packed into bales of very great density.

SELECTION AND CLASSIFICATION OF COMMERCIAL GRADES OF COTTON

Cotton is bought and sold in accordance with a system of grading that has been agreed on by all of the leading cotton markets of the world. For correctly distinguishing

the qualities that add to, or detract from the market value of cotton, a long period of practice in cotton classing or judging is essential. Most cotton-growers are ignorant as to the grade of lint that they are selling and are thus more or less at the mercy of the cotton-buyer. Courses in cotton classing are now being given by the larger number of the agricultural colleges in the cotton-belt.

145. Important points in cotton valuing. — The points considered in valuing cotton are, in order of importance: (1) grade, (2) staple, (3) color, (4) amount of sand, (5) amount of dampness, (6) whether the cotton is even-running or not. Of these six points grade is, by far, the most important and will be considered more fully than the others.

146. Grade. — By this term is meant the appearance of the cotton, primarily as regards cleanliness, although color is sometimes considered under this point. Any degree of "off color" or "tinges" will tend to lower the grade.

There are seven full grades as agreed on by the leading cotton markets of the world. Classifying cotton into these seven full grades, however, does not satisfy the requirements of the cotton merchant, who demands a much finer gradation. Consequently each grade is subdivided into what are known as half grades and quarter grades, which subdivision gives a list of twenty-six different grades of cotton. The names of the grades having the word "strict" are really half grades, while those having the words "barely" and "fully" are the quarter grades. Market quotations are based upon the grade known as middling. Consequently this is considered to be the basic or middle grade. The complete list of grades follows, the full grades being printed in bold-face type:

ABOVE MIDDLING		BELOW MIDDLING	
1. Fair			Barely middling
Barely fair			Strict low middling
Strict middling fair			Fully low middling
Fully middling fair		5. Low middling	Barely low middling
2. Middling fair			Strict good ordinary
Barely middling fair			Fully good ordinary
Strict good middling	4. Middling	6. Good ordinary	Barely good ordinary
Fully good middling			Strict ordinary
3. Good middling		7. Ordinary	Low ordinary
Barely good middling			Inferior
Strict middling			
Fully middling			

The amount and size of the trash in cotton lint determine, to a great extent, its grade. Finely divided trash is much more objectionable than large leaves. In fact, very little deduction is made for a small amount of large trash.

Grades and subdivisions of grades above strict good middling are comparatively rare. The bulk of the white cotton grown in an average season in the United States is classed as either good middling, middling, or low middling. The time of picking is important in determining the grade of cotton. The high grades are composed largely of cotton from the first picking. This is usually harvested in late summer, before unfavorable weather sets in and consequently the lint is cleaner and has a brighter luster. At this time the leaves are still green and therefore trash is less abundant.

The medium grades come largely from the second picking. There is a tendency for the open cotton to be left on the plants longer and heavy dews or rains affect it adversely. The process of alternate wetting and drying injures somewhat the color of the lint. Leaves are de-

caying and more trash is included than at the first picking.

The low grades are made up largely of cotton that has been picked after killing frosts. At this time, the stalks and leaves are dead and much trash is attached to the lint. The color of the cotton is often bad owing to the prevalence of stained locks, and the repeated rains serve to remove that brightness and luster which is so desirable.

The following table shows the approximate amount of waste occurring in the various grades and half grades from strict good middling to ordinary:

Strict good middling.....	11.50 per cent
Good middling.....	12.00 per cent
Strict middling.....	12.50 per cent
Middling.....	13.00 per cent
Strict low middling.....	13.75 per cent
Low middling.....	14.75 per cent
Strict good ordinary.....	16.00 per cent
Good ordinary.....	17.50 per cent
Ordinary.....	18.75 per cent

147. Relative values of different grades. — The difference in price between the different grades of cotton will vary in accordance with (1) the quantity of dirt and trash that go to waste in the manufacturing process, and (2) the supply and demand. In an unfavorable season resulting in a scarcity of the grades above middling, the difference in favor of the upper grades will be greater than in favorable seasons when the bulk of the crop is of good quality. The quotations for Low Middling and Good Middling at various markets in the United States on February 2, 1914, based on the United States standard of classification are shown in the following table:

TABLE 8. QUOTATIONS BASED ON THE UNITED STATES STANDARD AT DIFFERENT MARKETS FOR THE SAME GRADES OF SHORT STAPLE COTTON, FEBRUARY 2, 1914 ¹

	LOW MIDDLING	MIDDLING	GOOD MIDDLING
	cents	cents	cents
New Orleans	12.06	12.81	13.69
Galveston	11.44	12.87	13.69
Memphis	12.63	13.25	13.75
Mobile	11.56	12.69	13.19
Charleston	11.75	12.75	13.25
St. Louis	12.25	13.25	13.88
Little Rock	11.50	12.50	13.00

148. Staple. — In the judging of cotton the next step after establishing the grade is to determine the staple, which comprises both the average length and strength of the fibers. The length of the fiber is considered to be a very important “spinning quality,” although it is relatively unimportant in determining the grade. It does influence the price, however. The expert cotton judge often tests both the length and strength of the fiber at the same time by simply taking a tuft and giving it one pull, judging it by the amount of “drag” or “cling” that must be overcome in pulling it apart. Sand and dirt are next determined, usually by holding a handful of lint as high as one’s head and shaking it so that the sand, if there is any, can be seen to fall from it.

A rich, bright creamy color of the lint is a property desired in cotton, especially when it is to be used in the manufacture of goods that are to be sold in an unbleached or

¹ Farmers’ Bulletin No. 591, p. 17.

undyed state. Any decided "off color" that would be recognized by the buyer as "spots," "tinges," or "stains" will greatly reduce the price of cotton. These are carefully watched for by the cotton judge.

CHAPTER XI

SOME IMPORTANT INSECT ENEMIES OF COTTON

THE three most destructive insect enemies of cotton, considering the entire cotton-belt, are the Mexican cotton boll-weevil, the cotton boll-worm, and the cotton leaf-worm. Other insect enemies of secondary importance that do considerable damage to the cotton crop, are the cotton leaf-louse, the cotton red-spider, the cowpea pod-weevil, and cutworms.

THE MEXICAN COTTON BOLL-WEEVIL (*Anthonomus grandis* (Fig. 18.)

It is thought that the cotton boll-weevil is native to Mexico or Central America, all evidence pointing to the fact that since prehistoric times it has thrived upon the perennial tree cottons of those regions. Its history in the cotton-belt of the United States begins in 1892, at which time it crossed the Rio Grande into Texas in the vicinity of Brownsville. In 1894 this pest damaged the cotton crop rather severely in half a dozen counties in south-east Texas and during the ten years following it spread over the greater portion of the state. The boll-weevil

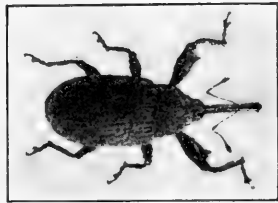

FIG. 18. — Adult boll-weevil showing characteristic teeth on front legs which serve to distinguish this insect from other weevils.

entered Louisiana in 1904, Mississippi in 1907, and Alabama in 1910. In recent years it has spread eastward much more rapidly than northward. There seems to be little doubt but that within the next ten or fifteen years it will spread over the entire cotton-belt of the United States.

149. Life history and habits. — There are four stages in the life history of the boll-weevil, — the egg, the larva or grub, the pupa, and the adult. The first three of these four stages are spent within the cotton square or young tender boll. By means of the mouth parts, which are located at the end of the snout, the adult weevil eats a



FIG. 19. — Showing variation in size of boll-weevils.

tiny hole into the square, in which an egg is deposited. Within three or four days the egg hatches into a tiny white larva or grub. This grub feeds upon the inner tissues of the square, or the young boll as the case may be, becoming full grown within six to twelve days after hatching, provided weather conditions are favorable. It is during the larva stage that the greatest damage is done. After attaining its normal size the larva passes into the pupa stage or the intermediate stage between the larva and the adult. The transformation from larva to adult usually requires from three to five days after which time the adult eats its way to the outside of the square or boll. The color of the adult weevil depends upon its age. The recently

emerged individual is light' yellowish in color, changing to a gray or nearly black shade as it becomes older. It is about one-fourth of an inch in length, including the snout which is about one-half the length of the body (Fig. 19). The breadth of the weevil is about one-third of its length.

150. Food of the weevil. — So far as is known at present, the cotton boll-weevil has no food plant other than cotton. It has been erroneously reported as feeding upon peas and various other plants. Such reports are in all probability due to the confusion of the boll-weevil with other weevils of quite similar appearance. The fact that the boll-weevil feeds on no plant other than cotton is made the basis of important measures of control.

151. Rate of increase. — The time required for a boll-weevil to develop from an egg to an adult depends upon weather conditions, especially as regards temperature. Under average conditions from two to three weeks are required. The first eggs are laid as soon as the first squares appear in the spring and their rapid multiplication continues until checked by frost. W. D. Hunter of the Bureau of Entomology, Washington, D. C., states that "a conservative estimate of the possible progeny of a single pair of weevils during a season beginning on June 20th, and extending to November 4th is 12,755,100." That this estimate is very conservative is shown by the fact that Hunter allowed for only four generations in a season, and for each female's laying only 100 eggs. Investigations seem to indicate that the average number of eggs laid by each female is approximately 140.

152. Dissemination. — The boll-weevil moves from one locality to another by making successive short flights. It is little inclined to fly, however, except during the period

from the middle of August to the end of the season. This is spoken of as the "dispersion period." At this time there is always a movement from fields in all directions probably in search of hibernating quarters. It was at first thought that this tendency of the weevils to fly at this season of the year was due to a scarcity of food. Investigations have shown, however, that this movement is due to a well-developed instinct on the part of the weevils for extending their range into new territory. It is at this season of the year that the weevils make their first appearance in uninfested territory. When aided by the wind, they have been known to travel a distance of forty miles in a very short time.

153. Hibernation. — With the advent of cool weather in the fall, the adult weevils begin to look for hibernating quarters. They fly in all directions and finally take refuge in any place that will afford some protection. They may pass the winter in woods, hedges, corn fields, farm buildings, hay stacks, Spanish moss, under grass and weeds or other trash, or in dead cotton burrs. During the hibernating period the weevils take no food, remaining practically dormant. Recent investigations have shown that in ordinary winters less than three per cent of the weevils that go into hibernating quarters in the fall live through the winter. On the appearance of warm weather in the spring, those weevils that have survived the winter emerge from their winter quarters and fly in search of the nearby cotton fields.

154. Damage. — It is in the larva stage that the boll-weevil does its greatest damage. After the egg has been deposited in the cotton square, the developing larva prevents the further development of the square. Even relatively large bolls that have been punctured either

make no further growth or open only one or two of their locks. A fair estimate of the damage inflicted upon the cotton crop by the boll-weevil is hard to make owing to the fact that it varies greatly from year to year. The injury is much greater in wet than in dry seasons. The damage is less in prairie regions where a minimum amount of protection is afforded the hibernating weevils during the winter months. Investigations by the Bureau of Entomology, Washington, D. C., and by E. D. Sanderson, formerly State Entomologist of Texas, indicate that during the period from 1902 to 1911 the farmers of Texas, without considering the value of the seed, sustained an annual loss of \$2.70 an acre, due to the ravages of the weevil. It is assumed that the average area planted in cotton in Texas during this period was 10,000,000 acres, in which case the annual loss for the state for this period was approximately \$27,000,000. Hunter states that "a conservative estimate shows that since the weevil has infested this country it has caused a loss of 2,550,000 bales of cotton at a value of about \$125,000,000." This statement embraces the period from 1892 to 1911.

155. Means of control. — No entirely successful means of fighting the cotton boll-weevil has, as yet, been devised. Years of experience, observation and study, especially as regards the life history and habits of this insect have brought to light some very effective means of reducing the injury which it inflicts. The more important of these are briefly outlined below.

156. Destroy cotton stalks early in fall. — Those who have given most study to the boll-weevil problem agree that the most important step in reducing the damage from this insect is the early destruction of the cotton stalks. There are two principal reasons why this practice

is so effective. (1) It results in the immediate destruction of many of the weevils. (2) It cuts off the food supply of the weevils which survive this operation. As a result of this scarcity of food, a large percentage of the weevils starve before the period of hibernation arrives, and those that go into winter quarters are so weakened as to greatly reduce the chances of surviving the winter. In sections where the weevils are very numerous, there is little hope of securing any cotton from the late crop of squares. Hence the crop from the relatively early maturing bolls should be picked as early as possible and the stalks destroyed, certainly not later than November 1st in most sections and earlier if possible.

There are three methods of destroying the stalks: (1) by up-rooting and burning; (2) by cutting and plowing under; (3) by pasturing.

Plowing the stalks up, raking them into windrows, and burning as soon as they are sufficiently dry is the most effective method. It has the objection, however, of impoverishing the soil of its organic matter. This objection can be overcome by a rational system of cropping, in which green-manure crops are included.

In sections where the loss of the organic matter is especially serious, the farmer is advised to cut the stalks with a stalk cutter as early as possible and follow immediately with a plow that will bury them deeply. Pasturing the stalks is not as satisfactory as either of the above methods and it is advisable only when the other methods cannot be employed.

157. Destroy weevils in hibernating places. — As many weevils live over winter in trash along turnrows, in hedges and fence corners, it is especially advisable that all rubbish and trash around or near the cotton fields

be collected and burned. It must be remembered that of the thousands of weevils that fly out of the cotton fields for hibernation, many are still within reach of the farmer.

158. Make provision for an early crop. — As comparatively few boll-weevils survive the winter, the farmer should strive in every way possible to induce his cotton to set and develop a large number of bolls early in the season, before the weevils have multiplied sufficiently to do much damage. The important means of securing an early crop are given: (1) A well-drained soil. (2) Early and thorough preparation of the seed-bed. (3) The use of such varieties as naturally set and develop a large percentage of their bolls early. (4) The liberal use of commercial fertilizers where necessary to insure a properly balanced supply of food to the plants. A deficiency of either nitrogen, phosphoric acid, or potash will delay maturity. (5) Shallow and frequent cultivation.

159. Proper spacing of plants. — The boll-weevil has natural enemies such as heat and parasites. The wide spacing of the plants augments the action of these natural enemies. The hot summer's heat not only checks the rate at which the weevils multiply, but greatly increases their mortality, especially during the larva stage. The farmer can take advantage of this by giving an abundance of space between the cotton rows and between the plants in the row. Thick spacing of the cotton plants, permitting the limbs to overlap freely, produces ideal conditions for the development of the weevil. On land of average productiveness where the weevils are abundant the rows should be five feet apart. This admits the sun readily to the infested squares.

Investigations have shown that the mortality of the larvæ is less in the infested squares that drop and remain

under the shade of the branches than in those squares that are brought to the middles between the rows. As a result of this discovery, W. E. Hinds has devised a chain cultivator which brings the infested squares out of the shade of the plants, leaving them exposed to the sun midway between the rows.

In humid regions, provided labor is cheap, it is recommended that the first-appearing weevils and first-infested squares be picked from the plants. The squares should not be destroyed but should be placed in screened cages, which will prevent the escape of the weevils but will permit the parasitic enemies of the weevils to escape and continue in the destruction of more weevils. All methods of poisoning the weevils that have been so far tried have given disappointing results.

THE COTTON BOLL-WORM (*Heliothis obsoleta*)

Next to the cotton boll-weevil, the cotton boll-worm is probably the most destructive insect enemy of the cotton plant.

160. Description. — When full grown the cotton boll-worm is from an inch to an inch and a half in length. The different individuals vary as regards their color and markings, almost every gradation occurring from a pale green through a pinkish or brown to almost black. When first hatched they are very small and often go unnoticed until their injury becomes rather severe. They are found on cotton from the time the squares are formed but their principal injury is noticeable late in the summer or fall after the bolls have grown to normal size.

161. Life history. — As in the case of the cotton boll-weevil, the life cycle of the cotton boll-worm comprises four distinct stages — the egg, the larva, pupa, and adult. ◦

The eggs are deposited on growing corn, cotton, tomatoes, and sometimes on tobacco. Fresh corn silks are preferred by the adults as a place for depositing eggs to all other objects.

The eggs hatch into small dark-colored caterpillars, or larvæ, within from three to five days after being deposited. This is the destructive stage of the insect and for this reason is the one most generally noticed. When the larvæ have completed their growth, which usually requires about 18 days, they crawl or drop to the ground, select a suitable spot and burrow from 2 to 5 inches into the soil. In their underground cell they go into the pupal or resting stage. In the summer months this stage lasts only 12 or 15 days. The larvæ that enter the soil late in the fall pass the winter in the pupal stage. At the end of this stage the adult insects emerge.

The adult is a brownish yellow moth, measuring about an inch and a half from tip to tip of the expanded wings. These moths usually fly at dusk and after dark, feeding upon the nectar of flowers.

162. Food plants. — The cotton boll-worm is known to feed upon a large number of different plants. Its principal food plants are cotton, corn, tomatoes, tobacco and many garden crops. Corn seems to be the preferred food of the boll-worm. It feeds upon the succulent corn kernels and is often called the "corn-ear-worm." When the kernels have become hardened it turns to cotton and other crops.

163. Damage. — The young caterpillars, when first hatched, feed upon the leaves and tender parts of the cotton plant close to where the eggs were laid. Later they attack the bolls or bore into the bud. Sometimes the larva will eat the entire contents of a boll before it leaves it.

In other cases it will eat its way through the boll and immediately attack another. In this way one boll-worm often destroys a number of bolls.

164. Means of control. — As previously stated, the cotton boll-worm prefers corn to cotton as a food plant. For this reason the cotton fields are invaded only after the corn has become sufficiently mature to render it an unsuitable food plant. This usually occurs about August 1st. Any cultural method, therefore, which tends to hasten the maturity of the cotton crop will serve to evade injury from the boll-worm. The most important cultural methods for accomplishing this result are: (1) Early planting in the spring; (2) The planting of early maturing varieties; (3) The proper use of fertilizers; (4) Early, frequent and thorough cultivation. As the insect passes the winter in the pupal stage in the soil, thorough fall or winter plowing will destroy a large percentage of the pupæ by exposing them to weather and birds.

Dusting the cotton plants with powered arsenate of lead in the latter part of July and the first of August, at which time many of the young larvæ are feeding upon the tender parts of the plants, has been found very effective. In applying the poison the operator rides between the rows of cotton, carrying in front of him a pole to each end of which is fastened a bag of poison. He shakes the dust out as he goes, poisoning from 15 to 20 acres in a day. The bags are made of closely woven flour-bag cloth or unbleached sheeting. This method is effective against practically all insects that devour the foliage, bolls, or squares.

Corn planted sufficiently late in the season to reach the silking stage during the latter part of July and the first of August serves as a trap crop for the boll-worms, as they prefer the corn to cotton.

THE COTTON LEAF-WORM (*Alabama argillacea*)

The cotton leaf-worm, often incorrectly called the "army worm," feeds upon nothing but cotton and has repeatedly done extensive damage to cotton throughout the south for more than a century.

165. Life history and habits. — The life cycle of the cotton leaf-worm can be more easily observed than that of the cotton boll-worm, for the reason that with the former insect all four stages are to be found on the cotton plant, and frequently at the same time. The pale, bluish green eggs are deposited on the underside of the larger leaves near the central portion of the cotton plant. Within two to five days after being deposited they hatch into small, pale, yellowish green caterpillars. Hinds states that when full grown the caterpillars are "rather slender and reach a length of one and one-half inches. The caterpillars of the earlier generations usually show much less black than do those of a later period near the end of the season. The light forms are quite bright yellowish green in body color with three narrow white stripes, and two rows of conspicuous black spots each set with a black spine, arranged along its back."

When the caterpillars are from ten to fifteen days old, or as soon as growth is complete, the worms cover their bodies by drawing together parts of leaves, spinning a silken cocoon in which they pupate and finally transform to the adult or moth stage. This process is commonly termed "webbing up." The adult moths or "candle flies" are usually of an olive brown color. They fly, feed, and lay their eggs at night. Hinds states that within a week or ten days each female moth "may deposit from 400 to 600 eggs and then dies." There are usually six

or more generations of this insect during a growing season, two or three of which are very destructive.

166. Damage. — It is the caterpillar stage which causes the damage to cotton. While very young these caterpillars feed only on the underside of the leaf on which they hatch. Later they move toward the top of the plant, eating the more tender foliage. After the caterpillars are five to seven days old the rate of destruction is very rapid, depending of course on the number present. Often an entire field of cotton is completely stripped of its leaves within two to five days. This pest is worse in unusually wet seasons.

167. Means of control. — Owing to its feeding habits, the cotton leaf-worm is easily controlled by dusting an arsenical poison lightly over the top of the cotton plants. The same method is employed as recommended for the cotton boll-worm. For average cotton, three pounds of "powdered" arsenate of lead will poison an acre. If the cotton is rank, more poison will be necessary. One good dusting should be given at the beginning of each crop of worms. No time should be lost in applying the poison after the first damage is noticed.

INSECTS OF SECONDARY IMPORTANCE

168. The cotton leaf-louse. — This is a small green louse often found in great numbers on the tender parts of young cotton plants. In cool seasons this insect does much damage to cotton by sucking the sap from the plants. It usually disappears when settled hot weather comes.

No thoroughly practical method is known for destroying the cotton leaf-louse. Any insecticide that kills by contact would destroy this pest, yet the practicability

of these methods for treating cotton is questionable. Rather late planting of cotton has been found helpful owing to the fact that the cotton leaf-louse does most of its destructive work early in the season. There are some natural enemies of the cotton leaf-louse that help to keep it in check, such as the lady-beetles and certain small black four-winged flies. These flies sting the lice and deposit their eggs in their bodies.

169. The cotton red-spider (*Tetranychus gloveri*). — This small "mite" is often found in great numbers congregated along the veins and in the depressions on the lower surface of the leaves of the cotton plant. It injures the cotton by sucking the sap from the tender part of the plants, causing, at first, the appearance of "slight yellow spots" on the surface of the leaves. As the injury increases the spots become larger and the leaves begin to curl. The cotton, when badly infested, has somewhat the appearance of "rusted cotton."

Treatment is seldom attempted, although dusting with powdered sulphur in such a way as to blow it on the under side of the leaves has been recommended. When the injury is first noticed all injured plants should be pulled and burned. Spraying these injured plants with a two per cent solution of scalecide or a two per cent lime-sulphur solution, is also recommended.

170. The cowpea pod-weevil (*Chalcodermis aeneus*). — This beetle or weevil does most damage to cotton on areas where cowpeas was the previous crop. The weevil is black with a long snout and is often mistaken for the cotton boll-weevil. It injures the growing tender parts and buds of young cotton plants.

Where the cowpea pod-weevil is very abundant it is advisable to plant no cowpeas on land that is to be planted

to cotton the next year. Other legumes, such as soy beans, velvet beans, and crimson clover may be introduced into the rotation instead of growing cowpeas.

Any treatment that will hasten the growth of young cotton will decrease the injury from this pest.

CHAPTER XII

DISEASES OF COTTON

It is estimated that the annual loss to cotton-growers in the South as a result of cotton diseases varies between twenty-five and thirty millions of dollars. The susceptibility of the cotton plant to disease is influenced by seasonal conditions, the greatest damage occurring during seasons of heavy rainfall. It is also true that the prevalence of certain cotton diseases is governed largely by soil type. Those diseases which cause the greatest injury to the cotton crop in the south are wilt, root-rot, root-knot, anthracnose, and Mosaic disease, incorrectly called "rust."

COTTON-WILT (*Neocosmospora vasinfecta*)

171. Occurrence. — Cotton-wilt occurs to a greater or less extent in every cotton producing state from North Carolina to Texas. It is most serious in the regions of sandy soils comprising southern and eastern South Carolina, southwestern Georgia and southeastern Alabama. It is pointed out by Gilbert, of the Bureau of Plant Industry, that the available records indicate an annual loss in the cotton-belt of at least \$10,000,000 from cotton-wilt alone.

172. Cause. — The cotton-wilt disease is caused by a microscopic fungus which lives as a saprophyte on the decaying organic matter in the soil. After entering the root of a cotton plant it becomes at once a true parasite. This fungus produces various types of fruiting bodies or

spores by means of which the disease is propagated. Any agency that will transfer these spores or the infected soil from one part of the field to another will serve to spread the disease. Chief among these agencies are cultivating tools, wind, drainage water, and the feet of men or of work animals.

The fungi that produce the wilts of cowpeas, tomatoes, watermelons, tobacco, and okra are thought to be closely related to the cotton-wilt fungus. There is no proof, however, that these diseases are communicable to cotton.

173. Symptoms. — The first appearance of this disease is indicated by the yellowing of the leaves at their margins and between the veins. Later the leaves wilt and fall from the plants. The characteristic tendency of cotton plants to wilt when infected with this disease is due to the growth of the fungus in the water-carrying vessels of the roots and stems, such a growth cutting off the water supply to the upper portions of the plant. Usually the badly affected plants are completely killed while others may lose only a portion of their leaves, but the plants thereafter possess a stunted appearance. An examination of the tap-root or lower part of the main-stem of a cotton plant affected with wilt will reveal a brownish color of the wood in the region of the water-ducts. This darkened color is the result of the closely woven hyphæ of the fungus growing in the water-carrying vessels.

Cotton-wilt usually makes its appearance at first in small restricted areas throughout the cotton field, which gradually become larger until the entire field is affected, provided cotton is grown on the same land year after year.

174. Remedies. — Although barnyard manure and various fertilizing materials have been suggested as a means of controlling wilt, both farm experience and ex-

periments have demonstrated that these materials are ineffective. As the fungus lives from year to year on the organic content of the soil, the use of fungicides or sterilization processes are not practical. Much can be done to decrease the prevalence of this disease by keeping cotton off the diseased soil for a number of years. It is almost impossible, however, completely to starve out cotton-wilt by crop rotation, owing to the fact that the fungus will live as a saprophyte on the organic matter of the soil for many years even though all host plants are kept off the land.

The most effective means of avoiding injury from wilt is the cultivation of wilt-resistant varieties. It has been found that the commercial varieties of cotton differ greatly as regards their susceptibility to wilt. Generally speaking, the large-bolled varieties are more susceptible than are the other groups. Beginning with some of the more or less resistant small-bolled varieties as a basis, the Bureau of Plant Industry has, as a result of 15 or 20 years' breeding, developed several strains of cotton that show marked power of wilt resistance. In fact, so resistant are these strains that there is now little doubt as to the possibility of controlling the disease in this way. The more important of these resistant varieties are Dillon, Dixie, and Modella.

In the growing of these varieties much care must be exercised to see that no crossing from other less resistant varieties is permitted and that the seed is not mixed at the gin with other varieties.

COTTON ROOT-ROT (*Ozonium omnivorum*)

175. Occurrence. — So far, this disease has caused very little damage to cotton grown east of Texas. It is

most injurious in the Houston clay or black waxy soils of the southwest. This soil is usually quite compact and often poorly aerated, a condition which seems favorable to the development of the fungus causing this disease.

Root-rot occurs on many plants other than cotton, such as alfalfa, cowpeas, sweet potatoes, and a rather large number of dicotyledonous weeds. It does not, however, seem to occur upon monocotyledonous plants, such as corn, sorghums, the small-grains, and grasses.

176. Cause. — Cotton root-rot is caused by a fungus parasite which lives and spreads in the soil. Very little seems to be known about this infection or the progressive stages of the disease. The mycelium penetrates the bark and also the wood of the roots but it does not usually extend into the wood far above the surface of the soil.

177. Symptoms. — The presence of this disease is usually first noticed by the sudden wilting and dying of the cotton plants. An examination of the root-system of the diseased plant will show that the rootlets and external surface of the roots have been destroyed. The fungus also invades the fibro-vascular system of the underground parts of the plant. The surface of the diseased roots is usually covered with dirty yellowish strands or thin wefts of the fungus filaments. While a few plants are sometimes killed by this disease during the early stages of their growth, they are far more commonly killed after some of the bolls begin to mature.

178. Remedies. — As this disease thrives best in an unaerated soil, remedial measures are based largely on the principle that air must circulate freely through the soil. Where possible, deep fall plowing is advisable. Investigations conducted near Luling, Texas, by the Bureau of Plant Industry, Washington, D. C., indicate

that the soil should be plowed not less than seven and preferably nine inches deep if favorable results are to be expected. It was also found that subsoiling was very effective in decreasing the disease.

As root-rot does not affect grasses and grains, the prevalence of the disease is greatly decreased by growing these crops on the land for two or three years preceding the growing of cotton. The results obtained from practicing such a cropping system are, however, not always uniform and satisfactory.

The application of fungicides or other chemicals or fertilizers to the soil as a means of controlling root-rot is entirely impractical.

ROOT-KNOT (*Heterodera radicum*)

179. Occurrence. — Root-knot is essentially a pest characteristic of light, sandy soils. As a rule, it is not serious on soils containing a large percentage of clay. This disease is very often associated with cotton-wilt in its occurrence. Unlike cotton-wilt, the root-knot attacks a large number of plants other than cotton. Some of the plants often affected by this disease are, — soy bean, cowpea (all varieties except Iron and Brabham and certain hybrids of these varieties), crimson clover, bur clover, cucumber, watermelon, tomato, tobacco, peach, and pecan.

180. Cause. — This trouble is caused by microscopic worms known as nematodes or eel worms which burrow into the roots, thus setting up irritations which later develop into wart-like excrescences or knots. These worms vary in length from $\frac{1}{20}$ to $\frac{1}{60}$ of an inch. The knots or galls produced by these worms vary in size from tiny enlargements on the small roots to knots an inch or more in diameter on the large ones.

181. Symptoms. — One of the first symptoms of this disease is the dwarfing of the plants. Many of the badly affected plants wilt and die. In other cases the plants may show no striking symptoms other than those exhibited by the roots. It has been noticed that when the affected roots begin to die, new roots are sent out finally resulting in a bushy and somewhat tangled root-system.

As previously mentioned, root-knot is often associated with cotton-wilt, in which case it increases the injury due to the latter disease. The wounds which the nematodes make in the roots furnish points of entrance for the wilt fungus, which then completes the destructive work.

182. Remedy. — Root-knot can be controlled by the use of proper crop rotations. In arranging this rotation one must remember that only such crops as are immune to the nematode attacks must be grown until the worms are sufficiently starved out of the soil to permit the successful growth of susceptible crops. It is also important that any weeds attacked by these worms be eradicated. In ridding the soil of the nematode disease, many farmers grow small-grains on the land during the winter months, and occupy the land during the summer with sorghum, millet, June corn, or the resistant varieties of cowpeas.

COTTON ANTHRACNOSE (*Glomerella gossypii*)

183. Occurrence. — Anthracnose, often known as pink-boll or boll-rot, occurs very generally throughout the cotton-belt. It is estimated that the annual loss from the disease amounts to several million dollars. Seasonal conditions determine, to a large extent, the prevalence of this disease. A very dry season retards the development of the spores and affords a natural means of control. Wet seasons greatly augment the injury from anthracnose.

184. Cause. — This disease is caused by a mold-like parasitic fungus which penetrates almost all portions of the cotton plant. Recent investigations have revealed the fact that in the development of anthracnose, two kinds of spores are produced, namely, the conidia and the asco spores. The former are produced by the millions and are responsible for the pink coloring so characteristic of the disease. It seems that the perfect or asco spore stage of the disease has been only rarely observed. Anthracnose is spread by insects or under certain conditions by the wind. It is also carried in or on the seed. Spores of this fungus are left in the cotton gin by badly diseased lots of cotton, the result being that seed otherwise free from the disease are infected.

185. Symptoms. — Usually the first visible indication of anthracnose is the occurrence on the bolls of minute round, dull reddish spots. As these spots increase in size, the spores develop and give the diseased portion a characteristic pinkish color. In very dry weather the spores are scarce and the diseased areas may have a grayish cast.

Badly diseased bolls produce rotten and discolored lint. Often they only partially open and the lint is hard to gather and in many cases is left in the field. Much damage is also done in cases where this disease attacks the young seedlings; it often completely kills the sprouts before they appear above ground or causes a "damping-off" near the soil of seedlings that are from 2 to 4 inches high. The pedicels of the bolls are often attacked, the result of which attack is that the bolls dry up and drop off.

186. Remedies. — Experiments have indicated that anthracnose is a disease that is largely preventable. Preventive measures involve, (1) planting only seed that is free from disease, (2) crop rotation combined with fall

plowing, and (3) the use of varieties least susceptible to the disease.

In dealing with anthracnose, one must remember that the fungus will live from one season to another in the seed; therefore it is of supreme importance that planting seed be secured from undiseased portions of the field. It has also been proved that the anthracnose fungus can survive in the field for at least a year on diseased bolls. It is therefore imperative that cotton is not grown two years in succession on land infected with this disease. If some crop other than cotton is grown on the land, the disease will largely die out within one year. It seems that rather short rotations are very effective in fighting this disease.

Fall plowing and the growth of winter cover-crops tend to reduce the prevalence of anthracnose.

MOSAIC DISEASE

187. Occurrence. — This disease is often known as black-rust and yellow leaf-blight. It is rather common throughout the cotton-belt, doing its greatest damage on light wornout sandy soils or soils deficient in humus. Under such conditions the yields of cotton are often reduced from 50 to 75 per cent as a result of mosaic disease. Any sudden check to active growth of the plants may increase the prevalence of the disease.

188. Cause. — Mosaic disease is termed a physiological disease in that the fungi causing the trouble do not usually attack thrifty and vigorous plants, but only those plants that have been weakened as a result of unfavorable conditions. Probably the three most important soil factors responsible for the prevalence of mosaic disease are (1) lack of humus, (2) lack of potash, and (3) lack of drainage.

189. Symptoms. — Usually the first indication of this disease is the yellow, mottled appearance of the leaves. It is also a characteristic of this disease that the parts of the leaves farthest from the leaf veins “yellow” first. This diseased condition of the leaves so weakens them that they are often attacked by other fungi, and, as a consequence, are totally destroyed. The premature loss of the foliage prevents the normal maturing of late bolls. The lint of diseased plants is often of inferior quality.

190. Remedies. — Prevention, rather than cure, must be employed in controlling mosaic disease. The unfavorable soil conditions must be eliminated. Good drainage, the employment of cropping systems that will maintain the organic matter in the soil, and the addition of potash fertilizers to sandy soils, are the most important preventive measures.

CHAPTER XIII

MAIZE OR INDIAN CORN (Zea Mays)

INDIAN corn is an annual grass, making its growth during the warmer part of the year. Its most important use is as a food for live-stock. The crop may be grown to maturity and the grain fed either whole or ground and the stalk and leaves utilized as a cured forage or stover. The plants may be utilized before fully mature as silage or for soiling purposes.

The grain of corn is also rather widely used as a human food. Cornbread is the most important product of corn for human consumption, while certain breakfast foods and corn starch are secondary products.

DESCRIPTION OF THE CORN PLANT

191. The root-system. — The corn plant produces three classes of roots. These are temporary roots, primary roots, and adventitious roots. The root-system is not characterized by a tap-root such as is found in cotton.

Temporary roots. — These roots serve to maintain the young plant during the first few days of its existence. When a kernel of corn is planted, the first evidence of germination is the swelling or enlargement of the kernel due to the absorption of water. Soon a small root emerges from the tip end of the seed and a little later 2 to 6 additional roots sprout from a point midway between the first root and the germ chit. At about the same time the "stem sprout" or plumule appears from the upper end of the

germ chit or near the crown of the kernel. These temporary roots die as soon as the primary roots begin to develop.

The primary roots. — The primary or permanent roots spring from the node of the underground stem, usually about one inch below the surface of the soil. The depth at which these roots originate and develop is, as a rule, independent of the depth of planting, although the Kansas Station has showed that “the roots of listed corn lie uniformly deeper in the soil than the roots of surface planted corn.” The primary roots of corn grow very rapidly and branch profusely. Growth takes place as a result of the constant addition of new cells at the growing point, which is located just back of the cap or tip. The result of this is that the tip of the root is pushed through the soil. During the early stages growth is largely in a longitudinal direction. When the root growth has extended to a distance of from 12 to 20 inches from the base of the plant, a portion of the roots turn abruptly downward, presumably to better enable the plant to secure water. In time these roots may grow to a depth of 3 or 4 feet. Lateral growth also continues until the entire upper 3 to 6 inches of the soil between the corn rows is completely filled with a mass of much branched, fibrous feeding roots. Under favorable conditions the lateral spread of corn roots is very rapid. Studies on root growth at the North Dakota Agricultural Experiment Station revealed that within thirty days after planting, corn roots from hills 3 feet apart had met midway between the hills at a depth of about 4 inches from the surface (Fig. 20).

Observations at the New York, Minnesota, Wisconsin and Colorado Stations indicate that during the first ten to twelve days corn roots will spread laterally in the soil

to a distance of 16 to 18 inches and that by the time the plants are coming into tassel the root-system may cover a radius of 4 feet.

The depths at which the greater part of the primary roots of corn develop varies somewhat in accordance with (1) the moisture content of the soil during the growing season, (2) the depth at which the seed-bed has been prepared and (3) the distance of the roots from the plant.



FIG. 20. — Root distribution of corn at silking time.

In wet seasons the tendency is for the roots to develop very near the surface of the soil. This is especially true in cases of protracted rainy weather during the first part of the growing season. On a deeply prepared seed-bed the feeding zone of the roots is much deeper than where shallow preparation has been practiced. As a rule, the upper roots 6 inches from the plant are about 3 inches below the surface and gradually increase in depth to 4 or 5 inches at a distance of 2 feet from the plant.

192. Structure of roots. — A young feeding root is made up of four different parts as follows: (1) The epidermis or "piliferous layer" composed of a single layer of cells which forms the outermost layer of the root. From these epidermal cells the root-hairs develop. This layer together with the root-hairs is really the absorbing surface for food and moisture. (2) A rather thick layer of thin-walled cells lying just inside the epidermis and known as the cortex. This layer corresponds to the bark on a stem. (3) The endodermis which is really the innermost layer of the cortex cells. This layer is differentiated by thicker walls to form a definite sheath, the probable function of which is to prevent the escape of plant-food on its upward course through the central column of the root. (4) The central cylinder which is a columnar mass of cells comprising the central portion of the root through which the plant-food is carried upward to the stem and leaves.

193. Adventitious roots. — During the latter part of the growing period, corn often puts out roots at the first two or three nodes above the surface of the soil. These roots are termed "brace roots" or "prop roots" because they serve to brace the plant against wind. In the air these roots are, as a rule, unbranched, but they branch rather profusely after entering the soil and in addition to bracing the plant, they take up moisture and food.

194. Stems. — The stem of corn is more variable in size and height than that of any other cereal. In some varieties of pop-corn the stems or culms will not average over 20 inches high. In the West Indies, corn often grows to a height of 30 feet or more. From 5 to 10 feet is the average variation in the United States. Soil, climate and variety are the important factors that determine the height of corn plants. In the northern latitudes of the United

States where the growing season is relatively short corn plants are not nearly so tall as in the southern United States. The diameter of an average corn stem between the first and second nodes in most field varieties will be from one to one and a half inches.

195. Structure of the stem. — The culm of corn is made up of a succession of nodes and internodes. It differs from that of other cereals in that it is filled with pith rather than being hollow. The internodes of the corn stem are short at the base, gradually increasing in length toward the upper end, — a modification which adds strength to the culm. That portion of the culm which extends beneath the ground surface is composed of a series of six or eight short nodes, each bearing a whorl of roots. The above-ground nodes serve as points of attachment for the leaves, the ear-branches, and the tillers. Each above-ground node bears a leaf and also a bud. With most varieties under normal conditions, only one or two of the buds develop, the others remaining dormant.

A number of the above-ground internodes of corn are alternately grooved or flattened. Each groove is covered by a leaf-sheath and accommodates the embryonic ear or the young ear-branch as the case may be.

If a cross-section of the corn stem is examined, it will be seen that the outer covering of the stem is a thin shell of hard tissue which is really a mass of closely woven fibro-vascular bundles. The chief function of this outer tissue is to give strength and rigidity to the stem. The central portion of the stem is composed of a mass of large and loosely arranged parenchyma cells known as the pith. Throughout this loose mass of tissue are the fibrous strands or fibro-vascular bundles which serve as the circulatory ducts for the water and dissolved food in their passage

from the roots to the leaves. This fibro-vascular tissue serves also as the passages for the return to the roots, ears,

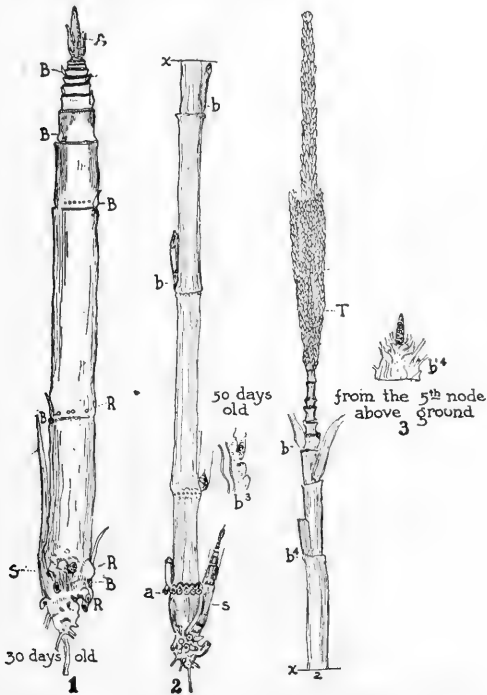

FIG. 21. — Structure of corn plant at different stages of growth: (1) Stalk one month old with leaves removed. A, tassel; B, rudimentary buds of ears and branches of which only one or two develop into ears; R, roots; R¹, root buds — often called “brace roots;” S, a branch or sucker. (2) Stalk fifty days old with the leaves removed: a, the first whorl of brace roots; b, rudimentary buds; b³, the bud at b enlarged to show the rudimentary branch of the bud; b⁴, the ear.

and stem of the food material that has been elaborated in the leaves from the materials secured from the air and soil.

These conducting tubes are large and numerous in the corn stem, a characteristic that helps to account for the very rapid growth of corn under favorable conditions.

196. Tillers. — Under certain conditions and in certain varieties there is a tendency for corn to develop branches or tillers at the base of the plant, due to the growth of the buds located in the axils of the first leaves. As a rule these latent buds remain dormant but if conditions are favorable, as is the case when corn is grown on a rich soil well supplied with moisture, or when the plants are left far apart, they may become active and produce shoots which develop their own root-systems and in a measure function as normal plants.

While it is true that soil and climatic conditions determine, in a large measure, the tendency of corn to tiller, investigations have demonstrated that tillering is, to an extent, a hereditary tendency and can be influenced by seed selection.

197. Leaves. — The leaves of the corn plant alternate on opposite sides of the stem and are therefore spoken of as being two-ranked. Each leaf is composed of three parts; the sheath, the ligule, and the blade. The sheath is that portion of the leaf that surrounds the stem. It serves to anchor the leaf and also protects the bud or embryonic ear. The ligule is a membranous outgrowth at the point where the blade joins the sheath. It is often spoken of as the rainguard from the fact that it prevents the water and dirt which run down the grooved surface of the blade, from entering between the sheath and the stem. The blade is that part of the leaf that naturally hangs free from the stem. The margins of the blade are wavy, owing to the fact that the edges grow faster than the middle. This folded or wavy condition is a natural contrivance which

gives the blade elasticity and thus enables it to withstand wind. The blade is supported by the midrib and veins which are merely branches or extensions of the fibro-vascular system previously mentioned in connection with the stem structure.

The surface of the leaf is covered with a strong epidermis, which contains many stomata. These stomata furnish the means by which air passes into and out of the leaf. They are also passage ways for the transpiration of moisture and for the intake of carbon dioxide from the air.

A microscopic examination of the internal structure of the leaf will reveal a large number of chlorophyll grains. It is to these chlorophyll bodies that the green color of the plant is due. The chief function of the chlorophyll bodies is to arrest and make use of the energy of the sun's rays in performing the various activities of the plant.

198. The flower. — The corn plant bears its stamens and pistils in separate flowers on the same specimen and is therefore monoecious. The staminate flowers are borne in clusters at the top of the plant, forming what is commonly termed the tassel. The tassel is really a panicle of spikelets, each spikelet bearing two flowers. Each flower has three stamens, which, as they mature, lengthen and thrust the pollen sacs or anthers outside of the flower where they are exposed to the wind. When the anthers are mature they open and liberate the pollen grains. It is estimated that each anther produces about 2500 pollen grains and that a single tassel produces approximately 7500 anthers, resulting in the production of approximately 18,750,000 pollen grains to a plant. Investigations as to the relative number of pollen grains to ovaries produced by a corn plant indicate that for every ovary there are

from 10,000 to 20,000 pollen grains. This excess of pollen grains is essential because of the relatively small number that really come in contact with the silks.

199. The pistillate flowers are produced on a modified branch coming from the axil of a leaf on the main stem. This branch is merely a succession of nodes and at its terminus is borne a hard spike (the cob) on which the pistillate flowers develop in even numbered rows. Each spikelet on the spike or cob produces two flowers, one of which is abortive. The other flower develops normally and is composed of (1) a flowering glume and palea, (2) an ovary, (3) a long, hairy style known as the silk, and

(4) the stigma or that part of the silk that receives the pollen. The outer end of the silk is often split and besides possessing a covering of small hairs, secretes a mucilaginous substance which aids in collecting pollen. There is but one style for each ovary.



FIG. 22. — Ear of corn showing tendency to laminate.

The spike and pistillate flowers are closely covered and protected by the modified leaves borne at the nodes on the ear-shank. These leaves are spoken of as the husk. The process

of fertilization is discussed in the chapter on the physiology of the corn plant.

200. The ear. — The ear is borne upon a branch (ear-shank) which has been shortened so as to bring the nodes

very close together. The number of nodes in the ear-shank is the same as in the main-stem above the ear.¹ At each node on the ear-shank a leaf is produced. These leaves are modified to form the husk or covering of the ear (Fig. 22). Corn ears vary in size from one inch in length in some of the varieties of pop-corn, to sixteen inches in some of the flint varieties. The number of rows of kernels on an ear may vary from 4 to 48. The most common variation is from 4 to 12 inches in length and from 8 to 24 rows of kernels. The number of ears to the plant varies with the variety and with seasonal conditions. With most varieties one or two ears to the plant are produced, although the tendency to produce several ears to the plant is quite marked in some of the varieties of pop-corn and sweet corn. The development of the ear is discussed in the next chapter.

201. The kernels. — The corn kernel is characterized by its large size as compared with the kernels of other cereals. It also possesses a very characteristic shape, being flattened, usually triangular, and having no crease or furrow on the side opposite the embryo. The most common colors exhibited by corn kernels are white and yellow, though red, blue, and mixed white and red (strawberry) colored kernels are rather common.

The corn kernel is composed of the embryo, the endosperm, the aleurone layer, and the hull (Fig. 23). The embryo contains the young plant which is made up of the rad-

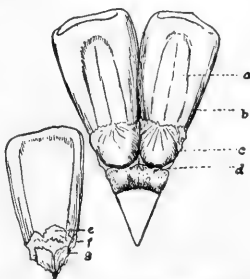

FIG. 23. — Botanical parts of the corn kernel and its integuments: *a*, embryo; *b*, mature ovary; *c*, second glume; *d*, first glume; *e*, palea; *f*, lemma; *g*, sterile palea.

¹ Montgomery, E. G., "The Corn Crops," p. 37.

icle surrounded by a root-sheath, a short hypocotyl and a simple cotyledon, that encloses the tightly rolled plumular leaves. The embryo is characterized by a high percentage of oil, protein, and ash. It is situated on the side of the kernel toward the tip of the ear.

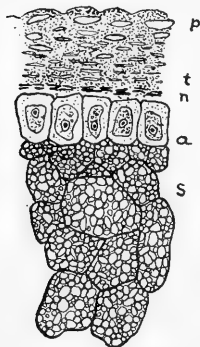

FIG. 24. — Cross section of the outer portion of a grain of corn; *p*, pericarp; *t*, testa or integuments; *n*, nucellus; *a*, aleurone layer; *s*, endosperm.

The endosperm consists of the store of reserve food surrounding the embryo. It comprises the biggest portion of the kernel (73 per cent) and is characterized by its high percentage of starch, although more than 50 per cent of the total protein in the kernel is in the endosperm. Hunt states that the endosperm of corn contains 6 to 10 per cent of protein, 89 to 93 per cent of carbohydrates (principally starch), and less than one-half per cent each of ash and fat.

The aleurone layer is composed of a layer of cells lying between the hull and the endosperm (Fig. 24). It is characterized by its rather high percentage of protein.

The hull comprises the outer coverings of the kernel and consists of (1) the pericarp which forms the greater part of the hull and (2) the testa which is a layer of much compressed cells immediately underneath the pericarp. The layers comprising the hull are composed largely of cellulose material.

CHAPTER XIV

PHYSIOLOGY OF THE CORN PLANT

THE life-processes of the corn plant are similar to those described in connection with the cotton plant. Like cotton, the corn plant is composed of a net-work of cell walls—the skeleton, which gives the plant stability. Surrounded by these cell-walls is the protoplasm which assimilates the food and carries out all of the chemical processes necessary for life and reproduction. The food elements are obtained from the soil by absorption through the root-hairs or in the case of the carbon and some of the oxygen by air currents through the breathing pores of the plant, the stomata.

COMPOSITION OF THE CORN PLANT

202. Composition.— The weight of a young rapidly growing corn plant is approximately 90 per cent water and 10 per cent dry matter. As growth advances the percentage of dry matter increases until at maturity it constitutes from 35 to 40 per cent of the total weight of the plant. The composition of this dry matter at different stages in the growth of the corn plant is shown in the table on page 162, which has been compiled from data given in Bulletin No. 175 of the Agricultural Experiment Station of Purdue University.

The dry matter of a corn plant is much richer in nitrogen during the early growth of the plant than at later stages of development. This, however, does not neces-

TABLE 9. SHOWING PERCENTAGE COMPOSITION OF CORN PLANTS AT DIFFERENT STAGES
(Calculated to dry matter)

	June 16, plant had six leaves	July 24, plant 4 ft. high	Aug. 6, tassel forming	Aug. 28, ears fully pollinized		Sept. 24, kernels glazing		Oct. 1, kernels hardening		Oct. 8, ready for harvesting and shocking		Nov. 12, plants thoroughly mature	
				Stalks and Leaves	Ear	Stalks and Leaves	Ear	Stalks and Leaves	Ear	Stalks and Leaves	Ear	Stalks and Leaves	Ear
Potash ..	5.034	5.377	3.576	1.929	1.309	1.699	0.661	1.841	0.576	1.584	0.481	1.428	0.483
Phos- phoric Acid	0.422	0.585	0.608	0.392	0.793	0.204	0.680	0.133	0.649	0.149	0.685	0.093	0.682
Nitrogen ..	4.05	3.27	2.568	1.403	2.155	0.830	1.431	0.780	1.557	0.753	1.519	0.632	1.512
Crude Protein ..	25.31	20.43	16.049	8.768	13.47	5.187	8.943	4.875	9.731	4.706	9.493	3.95	9.450
Crude fat	3.647	5.43	1.882	1.06	1.23	1.046	4.09	0.839	3.876	1.006	4.30	.825	4.326
Crude fibre.....	15.08	23.22	29.864	27.71	19.43	28.565	8.066	29.685	7.014	32.394	7.106	37.271	6.289
Ash	12.117	12.252	8.675	6.504	3.137	7.629	1.698	6.896	1.548	7.265	1.456	5.793	1.425
N. free	43.846	38.668	43.530	55.958	62.733	57.573	77.203	57.705	77.831	54.629	77.645	52.161	78.51
extract	0.00	1.93	2.33	2.58	31.89	3.35	49.58	6.55	62.77	4.13	58.65	2.98	52.74
Starch....													

sarily mean that the corn plant becomes less active in absorbing nitrogen compounds as growth advances. The explanation lies in the fact that the activity of the plant in producing nitrogen-free substances increases rapidly with growth.

It is interesting to note that the young corn plant contains no starch but a large percentage of nitrogen-free extract, probably the most of which is sugar. Until the plant reaches the stage at which the ear begins to form, only a very small percentage of the sugar is transformed into starch. During the subsequent growth of the plant the sugar is transferred in large quantities to the ear and deposited as starch. At no time do the stalks and leaves contain more than 6.55 per cent of starch, whereas, according to the above table the dry weight of the ear is made up of 62.77 per cent starch at the stage when the kernels are hardening. A large percentage of the nitrogen taken up by the corn plant during its early growth is later deposited in the developing kernels.

WATER REQUIREMENTS

203. Leaf surface. — On an acre of land producing 100 bushels of corn and three tons of stover there are approximately 11,000 pounds of dry matter. To produce this large yield of dry matter it is necessary that an enormous quantity of water pass through the plants. To accommodate this rapid transpiration of water, the corn plant is necessarily provided with a large leaf surface.

204. Figuring the leaf surface of a corn plant. — The following method of figuring the leaf surface of a corn plant is taken from "Corn" by Bowman and Crossley: "In figuring the surface area of a leaf, measure the width three inches from the ligule, also at a point six inches from

the tip of the leaf. Add these two widths, divide by two to get the average. Multiply this average width by the length of the leaf from the ligule to that point, six inches from the tip. To the area of this rectangle add the area of the isosceles triangle at the tip of the leaf, which is six inches in altitude, and as wide as the leaf is at that point. The sum of the two areas gives the leaf surface on one side of a single leaf. Multiply this sum by two and the entire surface of leaf will be ascertained. For approximate calculations, the surface of one leaf multiplied by the number of leaves on the stem will give the entire leaf surface of the stalk.”¹

205. Conditions affecting water requirements. — The term “water requirement” as here used indicates the ratio of the weight of water transpired by a plant during its growth to the dry matter produced. Studies of the water requirements of corn by King, Widtsoe, Montgomery, Briggs and Shantz of this country, Wollny of Germany and Leather of India have demonstrated quite clearly that environmental factors are important in determining the efficiency with which the corn plant uses its water. The investigations indicate that when growing in a soil containing the optimum moisture content, corn will produce more dry matter to the unit of water transpired than when growing in a very wet or a very dry soil.

There is in most cases a reduction in the water requirements of corn when fertilizers are used, especially if the soil in question is a poor one. It has been pointed out that a high water requirement is often due to a deficiency in the soil of a single plant-food element in which case growth practically ceases while transpiration goes on. It is probably true that any condition that limits the sup-

¹ Bowman and Crossley, “Corn,” p. 52.

ply of plant-food in the soil will increase the water requirements of the crop growing on that soil.

The investigations have shown the water requirements of corn to be greatly affected by atmospheric conditions. Other things being equal, the rate of transpiration is faster and the water requirements are greater in an arid than in a humid atmosphere. Shading to the extent of reducing photosynthesis, tends to increase the water requirement.

Montgomery compared narrow-leaf and broad-leaf types of corn with the result that the broad-leaf types showed the higher water requirements.

206. Amount of water required. — A summary of the water requirement measurements of corn by different investigators shows considerable variation as would be expected owing to the fact that these investigators worked under quite different conditions, and with different varieties. To produce one pound of dry matter in corn required the absorption and transpiration of the following number of pounds of water as given by the different investigators: King working in Wisconsin, 350; Widtsoe working in Utah, 386; Briggs and Shantz, working in Colorado, 369; Wollny working in Germany, 233; and Leather working in India, 337.

GROWTH

207. Growth. — Those changes involved in the growth of a corn plant may be grouped into two classes. The first group of changes have to do with the "extension" of the plant or its increase in length and size. The second group of changes result in a change of the internal structure of the plant or differentiation of the cells into special organs with more or less definite functions.

The increase in length and size of the plant results from

the formation of new cells and the enlargement or extension of old cells. The former process occurs in what is known as the formative region where the cells are constantly dividing. Adjacent to this is the elongating region where the cells expand or enlarge by absorbing large quantities of water. Both of these changes bring about a rapid increase in the length and size of the plant. During the first three weeks of growth all the organs of a corn plant are formed such as the full number of leaves and nodes, the embryonic tassel, ears and tillers, and most of the main roots. Subsequent growth involves largely the extension of these parts together with certain changes of internal structure characterized by the deposition of starch in the ear and the strengthening of the fibrous tissues. From the standpoint of the farmer the practical measure of growth is the yield of the crop.

208. The factors of growth. — Growth is conditioned upon vitality or the life of the plant, and heredity or the force which operates to reproduce specific forms. These are the internal factors of growth. The external factors are moisture, a suitable temperature, oxygen, the various nutrients and food materials, and light.

209. The growth of roots. — Under favorable conditions the roots of corn may elongate at the rate of more than an inch a day. The formation of new cells occurs in the region just behind the root-cap known as the apical meristem. Extending back from this zone of cell division for a very short space is the zone of elongation in which the newly formed cells increase rapidly in size. This rapid formation and elongation of cells tends to push forward the root-cap and the root is thus gradually extended in the soil. New lateral roots develop in the region immediately behind the growing root-tip. Under favor-

able conditions these lateral roots develop abundantly and rapidly and the root-system of corn is thus profusely branched.

210. Growth of stems (Fig. 25). — All of the nodes in the stem of a corn plant are formed while the plant is quite young.

The subsequent growth or elongation of the stem is due to the extension of the internodes. Above each node there is a layer of cells possessing a dark green color and filled with sap. These cells together with the extreme tip of the stem constitute the growing points of the corn stalk. As the average corn stem possesses from fifteen to twenty nodes and conse-

quently as many growing points, it is enabled to lengthen very rapidly during the growing season. The elongation of the corn stem has been likened to the unfolding of a telescope. The corn stem increases in diameter as a result of the internal accession of cells, rather than by adding layers on the outside. It is therefore an endogenous stem.

211. Growth of leaves. — The author has been able



FIG. 25. — Illustrating development of corn stem: 1, plant about 10 inches high; 2, section of 1, at base, showing that all nodes, leaves, and tassel are more or less developed at this stage; growth is internodal; 3, full grown stem with leaves removed; 4, cross-section of stem.

to find very little data on the growth of corn leaves. That the growing zone of a corn leaf lies at its base is shown by its continued elongation even though the tip of the leaf is cut off. There are, in all probability, two active growing zones in the corn leaf, one being at the base of the leaf-sheath and the other at the base of the blade.

REPRODUCTION

Attention has been called to the fact, page 27, that the production of a new plant does not begin with the germination of the seed. The seed itself is an embryonic plant possessed of a certain food supply and protective coverings. The new individual comes into existence with the formation of the seed as the result of a complex and peculiar physiological process known as fertilization. The organs of reproduction in corn have been discussed in a previous chapter and the process only will be considered here.

212. Fertilization. — In order that fertilization may take place it is necessary that the pollen-grains from the tassel come in contact with the exposed portion of the silk. This transfer of pollen from the tassel to the silk is a mechanical process which takes place through the agency of the wind. It is spoken of as pollination. For complete fertilization to take place, every silk must receive at least one pollen-grain (Fig. 26).

Each pollen-grain consists of merely two cells, a smaller cell within a larger. After lodging on the moist surface of the silk the larger cell germinates and sends out a vegetative tube which grows through the entire length of the silk or style, penetrates the ovule and comes in contact with the egg-cell (Fig. 27). The smaller cell of the pollen-grain, which is largely nucleus, divides and one of these

nuclei is carried to the ovule and fuses with the nucleus of the egg-cell. When this is done, fertilization is effected. The fertilized egg then develops into the new individual or embryo within the protecting coats of the seed. The protecting coverings of the young seed were, before fertilization, the coverings of the ovule. There is one silk for each ovary and for any reason, should a portion of the silks



FIG. 26. — Illustrating the process of fertilization of the corn flower.

fail to receive pollen-grains, those ovules will not develop and the result will be an ear on which some grains are lacking. It often happens in arid sections that dry hot winds kill the pollen-grains and prevent the production of grain, even though a vigorous stalk is produced.

213. Double fertilization. — The process of fertilization described above causes the development of only the

embryo.¹ The endosperm of the grain develops as the result of a fusion separate from the one already considered. Mention has been made of the fact that the nucleus of the pollen-grain divides into two nuclei, only one of which fuses with the egg-cell. The second male nucleus from the pollen-grain fuses with the nucleus of the embryo-sac, this union developing into the endosperm of the grain.

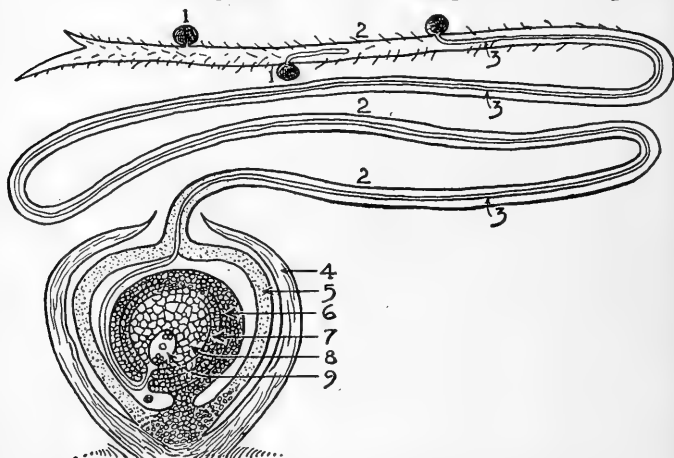

FIG. 27. — Illustrating structure of corn kernel at pollination: 1, pollen-grains; 2, silk; 3, pollen tube; 4, kernel husk; 5, ovary wall; 6, testa; 7, tegmen; 8, nucellus; 9, embryo sac; 10, micropyle.

The fertilization of both the nucleus of the egg-cell to form the embryo and the nucleus of the embryo-sac to form the endosperm is spoken of as double fertilization. As a result of this process, the endosperm may acquire, as well as the embryo, qualities of the pollen-producing plant, such as color or chemical content. Examples of this may be seen in the fact that when pollen from the

¹ "Text-book of Botany," by Coulter, Barnes & Cowles, Vol. 1, pp. 267-269.

black Mexican or Cuzco varieties of corn, in which the aleurone layer of the grain is bluish-black, is placed on the silks of white or yellow varieties, many of the kernels developing will show the bluish-black color. Also if the silks of sweet corn receive pollen from Flint and Dent varieties many of the kernels produced as a result of this immediate cross will possess the characteristic endosperms of the parent plants. Such first-generation changes in the character of the endosperm as have just been cited constitute the phenomenon known as xenia.

214. Development of the ear. — When the ear has developed to the stage at which fertilization takes place, it consists of a spike (the cob) bearing

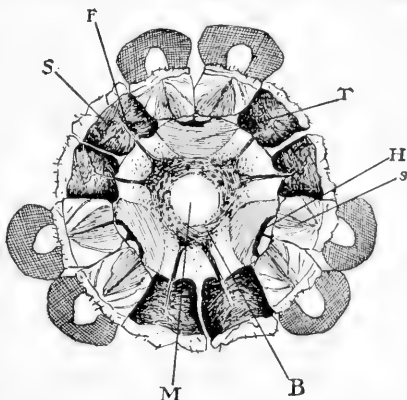

FIG. 28. — Cross-section of corn ear looking toward the base: *s*, inner surface of upper thick glume seen behind the thin glume and paleas; *S*, outer surface of lower thick glume; *F*, axes; *T*, denser portion of woody zone; *H*, depression; *B*, zone with fibro-vascular bundles; *M*, pith.

the pistillate flowers in even numbered rows, and the covering or husk. The development of the kernels after fertilization takes place completes the formation of the ear. The silks at the butt of the ear develop and are pollinated first, followed in succession by those at the middle and finally at the tip of the ear. For this reason the basal kernels develop somewhat in advance of the middle and tip kernels. Each developing kernel is fed by a single fibro-vascular bundle which extends from the stem between

the pith and the woody portion of the cob to the base of the kernel. During the early or milk-stage of development the kernel is sweet on account of the large amount of sugar which has not, as yet, been transformed into starch. During this early stage large quantities of protein, ash, and oil are deposited in the embryo. Later, large quantities of sugar, much of which has been held in readiness in the stalk, are transferred to, and deposited in the kernels in the form of starch. This deposit of starchy material constitutes the larger part of the endosperm. The bracts about the base of the ovary become the chaff of the matured cob, while the coverings of the ovule develop into the protecting coverings of the kernel (Fig. 28).

CHAPTER XV

ORIGIN, CLASSIFICATION AND VARIETIES OF CORN

IN the course of his early voyage Columbus found Indian corn growing on the island of Hayti under the name of "Mahiz," a Haytian word from which the name "maize" is derived. It is generally held that mahiz, or marisi, is an Arawak Indian word of South American origin. In England the word "corn" is used in a general sense to signify the bread grains whereas in North America it applies specifically to Indian corn or maize.

215. Nativity. — Most authorities who have given special study to the geographical origin of Indian corn have concluded that it is probably native to Mexico. Some early writers have contended that Indian corn was cultivated in Europe previously to the discovery of America, and therefore questioned its American origin. The results of careful investigation do not support this contention.

There is much evidence in support of Harshberger's conclusion that Indian corn is native, in all probability, to the high plateau region of central or southern Mexico, and that its cultivation originated there. Certain plants that are relatives botanically to maize, notably teosinte and gama grass, are native to this region. Also *Zea canina*, a type of true maize thought by some to be the progenitor of our cultivated maize has been found growing wild in this section of Mexico.

The date at which maize was first cultivated in Mexico is not clear. Harshberger, as a result of his studies of maize, concluded that it probably came into cultivation in Mexico about the beginning of the Christian era, being brought across the Rio Grande about 700 A. D. and reaching the coast of Maine some time previous to the year 1000.

In 1492, when Columbus discovered America, maize was rather extensively cultivated by the American Indians. After its discovery on the western hemisphere it was rapidly introduced into Europe, Africa, China, and Asia Minor.

216. Biological origin. — Our present conclusions regarding the biological origin of maize are based largely on a comparative study of the structure of maize and its botanically related forms together with a consideration of the embryonic development of the maize plant itself. Maize belongs to the family Gramineæ and to the tribe Maydeæ. The most important distinguishing feature of the tribe Maydeæ is the separation of the staminate flowers from the pistillate flowers. Two grasses belonging to this tribe and therefore closely related to maize are teosinte (*Euchlaena mexicana*) and gama-grass (*Tripsacum dactyloides*) (Fig. 29). Both of these grasses are of common occurrence in the high plateau region of central and southern Mexico — the region in which corn is thought to have originated.

Teosinte is a coarse annual grass growing from 8 to 12 feet high, adapted to a rich soil and a long growing season of moist hot weather. As a rule it does not mature seed north of Mexico. Teosinte is a branched plant bearing a terminal tassel on which only staminate flowers are produced, and lateral branches from the axils of the leaves, each bearing a terminal tassel on which only pistillate

flowers are produced. As the lateral branches are much shortened and are surrounded by a husk-like structure, Montgomery points out that "it is only a step in the

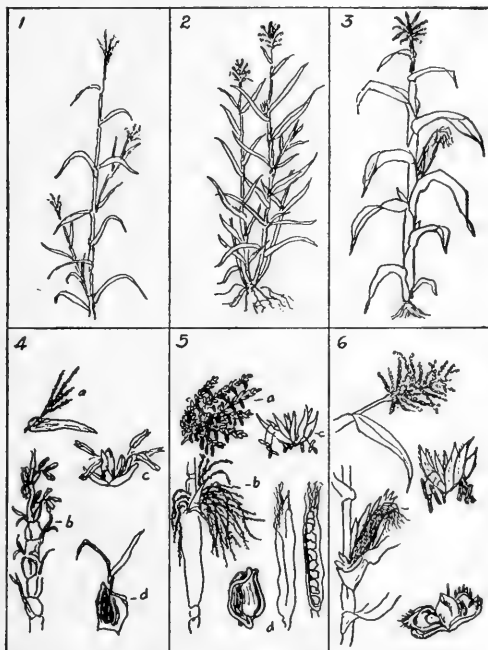

FIG. 29.— Illustrating the relationship between gama-grass, teosinte, and corn: 1, gama-grass; 2, teosinte; 3, corn; 4, floral parts of gama-grass: a, tassel; b, spike of tassel, bearing staminate flowers on upper part, c, staminate flower; d, pistillate flower; 5, floral parts of teosinte; 6, floral parts of corn.

production of an ear of maize, from teosinte by a development of the central spike of the lateral tassel into an ear."

Gama-grass at a distance bears close resemblance to maize. The average height is from 5 to 10 feet, the leaves

and stems being slenderer than those of maize. As in the case of teosinte, gama-grass branches, producing a tassel-like structure at the top and at the end of each branch. Each tassel produces both staminate and pistillate flowers, the former being borne on the lower part of the tassel and the latter on the upper part.

The general opinion is that either teosinte, gama-grass, or some rather closely related grass is the progenitor of maize.

“It is assumed that wild maize was a branched plant containing perfect flowers (both carpels and stamens) on the terminal tassel and, also, at the end of the branches. Since the plant is wind fertilized and the pollen tends to fall, the carpellate flowers in the terminal tassel would be less perfectly pollenized than those on the branches below. The pollen on the branches would tend to fall on the ground, thus being of little value. The plants which had the greatest development of carpels on the branches and of stamens in the terminal tassel would tend to survive. As the end of a branch became laden with a collection of grains (ear) the short branch would best hold the ear from drooping. Thus the culm of the branch (now called the shank) has become a succession of nodes with shorter internodes. Each node still bears the sheath of the leaf, the blade being reduced in size or aborted. This collection of leaf-sheaths is called the husk. The branch has been telescoped.”¹

There is a slight difference of opinion as to the character of the modification resulting in the formation of an ear of maize from the original tassel-like structure. The generally accepted theory is that the ear is the result of the fusing or growing together of four or more of the pistil-

¹ Hunt, “Cereals in America,” p. 145.

late spikes produced in the tassel of the lower branches. As each spike is made up of a double row of spikelets, each spikelet being two-flowered with the lower flower abortive, the result of such a fusion would be an ear having distinctly paired rows of grains. This we find to be a characteristic of an ear of maize. The cob is supposed to have been formed from the growing together of the rachis of the spikes.

Observations made by Montgomery have led him to think that "instead of the ear originating from the fusion of a number of two-rowed spikes, it developed directly from the central spike of some tassel-like structure similar to the well known corn tassel." Montgomery states further "that corn and teosinte may have had a common origin, and that in the process of evolution the cluster of pistillate spikes in teosinte were developed from the lateral branches of a tassel-like structure, while the corn ear developed from the central spike. It is probable that the progenitor of these plants was a large, much-branched grass, each branch being terminated by a tassel-like structure bearing hermaphrodite flowers."

It has been suggested by Harshberger that our cultivated maize is of hybrid origin because of the fact that fertile hybrids of teosinte and maize are known and described by Watson as *Zea canina*. As a speculative explanation of such an origin it is suggested that the starting point was a "sport of teosinte which then crossed itself with the normal ancestor, producing our cultivated corn." *Zea canina* is found growing wild in Mexico.

CLASSIFICATION OF MAIZE

According to Sturtevant, maize may be classed into the following "agricultural species":

217. *Zea Mays canina*. — A species of maize found growing wild in Mexico and thought to be a fourth or fifth generation produced by the crossing of teosinte and the black Mexican corn. The plants of this species are branched, each plant producing numerous small ears in the leaf axils of the lateral branches. The ears range from 2 to 4 inches in length and produce from 4 to 8 rows of kernels.



FIG. 30. — A small ear of the pod-corn group.

218. *Zea Mays tunicata*, or pod-corn. — An uncommon species, characterized by the fact that each kernel is inclosed in a pod or husk and the ear inclosed in husks (Fig. 30). The kernels are rather small

and occur in many colors such as red, white, yellow, and variegated as well as in different forms such as sweet, dent, and flint. Pod-corn is supposed by some to be a primitive type bred from a wild grass of Central America by a race of people called Mayas who once inhabited the regions now known as Yucatan and Guatemala. This surmise, however, seems to lack definite evidence.

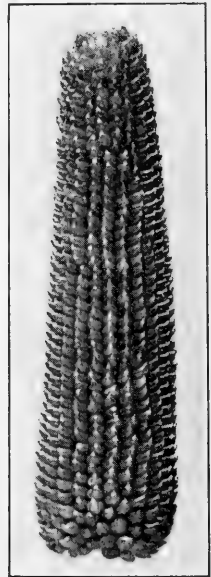

FIG. 31. — An ear of White rice pop-corn.

219. *Zea Mays everata*, the pop-corns (Figs. 31, 32). — The varieties of this species are characterized by the fact

that the kernels "turn inside out" when heated, and by the small size of the kernels and ears. There is also an excessive proportion of the corneous endosperm, which gives the property of "popping." An explanation of the property of "popping" lies in the fact that heat causes the explosion of contained moisture, and the endosperm being so dense that the expansion cannot be taken up on the inside, the endosperm is caused to evert about the embryo and hull, forming a white fluffy mass. In kernels possessing

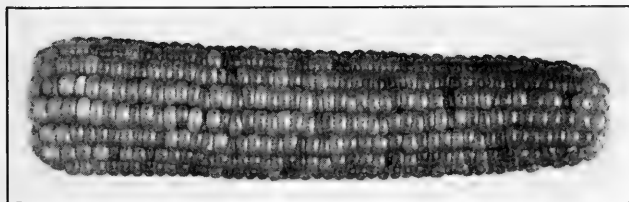

FIG. 32. — An ear of White Pearl pop-corn.

an excess of white endosperm, the moisture in the corneous portion explodes without everting the endosperm.

Although many varieties of pop-corn exist they easily fall into two groups, namely, rice pop-corn, in which the kernels are pointed at the top, and pearl pop-corn, in which the kernels are rounded at the top much as in flint corn. Ears of pop-corn vary in length from $1\frac{1}{2}$ or 2 inches in Tom Thumb to 6 or 7 inches in certain varieties of the pearl group.

220. *Zea Mays indurata*, the flint corns (Fig. 33). — Characterized by the inclosure of the starchy endosperm in a corneous endosperm. This outer arrangement of the hard part of the endosperm prevents denting, although a slight dent is sometimes visible owing to the fact that the layer of corneous endosperm is thin on the top of the

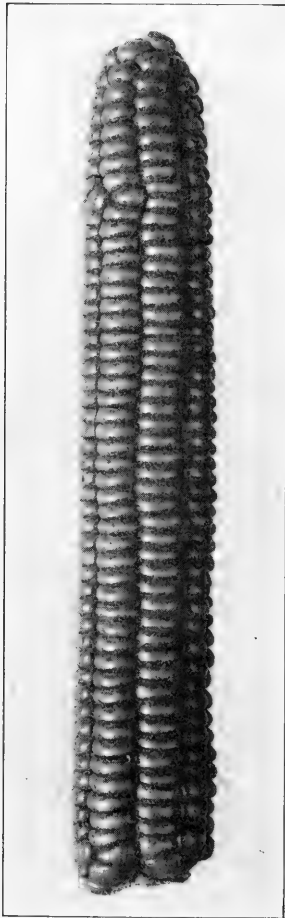

FIG. 33. — A good ear of the flint corn group; variety, Ninety Day Yellow.

kernel. Plants of flint corn vary in height from 4 to 9 feet. The ears are from 6 to 14 inches long with from 8 to 16 rows of kernels, 8 rows being the most common. The kernels of most varieties are either white or golden orange in color, hard, smooth and somewhat oval shaped. Flint varieties are adapted to regions with short growing seasons in which the dent varieties will not mature.

221. *Zea Mays indentata*, the dent corns (Fig. 34). —

In this group the corneous endosperm occurs at the sides of the kernel, the starchy reserve food extending to the summit. As the kernel matures the soft starchy part dries and shrinks, forming the characteristic indentation in the top of the kernel. In the flint corns the occurrence of the corneous endosperm over the top of the kernel, as well as at the sides, prevents the formation of an indentation. In dent corns the plant varies in height from 5 to 18 feet; the ears are from 6 to 12 inches long, having from 8 to 24 rows of kernels

to an ear, 14 to 18 being the most common. This is the type commonly cultivated throughout the cotton-belt and in fact throughout the entire United States excepting in the extreme northeastern section where the short growing season makes necessary the growth of flint corns.

222. *Zea Mays amylacea*, the soft corns. — Characterized by the absence of corneous material in the endosperm. The ear and kernels are somewhat similar in shape to the flint corns. There is no indentation. The soft corns seem to prefer the warm dry climates, being grown

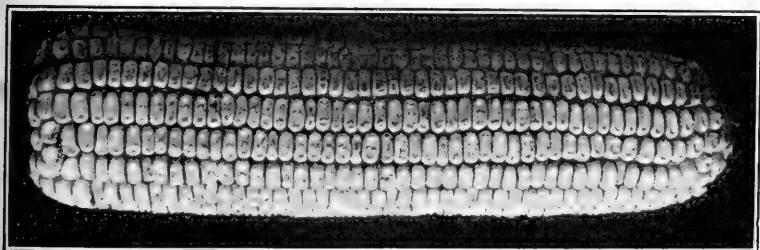

FIG. 34. — A good ear of dent corn; variety, Woodburn White dent.

largely in Mexico and adjacent regions. This type was extensively grown by the North American Indians, because it was more easily crushed between two rocks and thus made into flour.

223. *Zea Mays saccharata*, the sweet corns (Fig. 35). — Characterized by the translucent, horny appearance of the kernels and their wrinkled, shriveled condition. It is thought that the latter character is the result of the rapid conversion of the starch into sugar. In outline the grains are usually broadly wedge-shaped with rounded summit. Sweet corn is well known as a garden crop and in some sections of the United States it furnishes the basis of

large canning industries, the canned product being shipped to all parts of the world. Most varieties of this type will mature within from 70 to 100 days.

224. *Zea Mays amylea-saccharata*, a starchy sweet corn. Its chief characteristic is that the lower half of the kernel is starchy and the upper half horny and translucent. This type is not common.

225. *Zea Mays japonica*. — A corn sometimes cultivated for ornamental purposes, the leaves being striped,



FIG. 35. — An ear of the sweet corn group.

green and white. The grains are small, resembling popcorn or the small flint types.

226. *Zea Mays hirta*. — This corn is found mostly in South America and is characterized by the hairy nature of the leaves and sheaths.

227. Varieties. — Several hundred distinct varieties of corn are now in existence. So far as known to the author, no complete catalogue of corn varieties has been prepared within recent years. Sturtevant, in 1898, listed 507 named varieties and 163 synonyms. Of these 507 varieties Sturtevant classed 323 as dent corn, 69 as flint corn, 63 as sweet corn, 27 as soft corn and 25 as pop-corn. Many varieties have come into existence since the publication of Sturtevant's classification.

The nomenclature of corn varieties, especially in the

cotton-belt states, is very unsatisfactory. The indifference of farmers toward the improvement of varieties together with the natural tendency of different varieties to hybridize when grown in close proximity to each other, the mixing of names by seed dealers and the modification of varieties by environment have somewhat minimized the significance that can be attached to varietal names.

Extensive variety tests conducted by the southern experiment stations have shown conclusively that no one variety is best suited to all sections of the cotton-belt. In the following list are given the names of several leading varieties of corn for each cotton-belt state, the names of these varieties having been secured from the experiment station director or agronomist in each case:

STATE	VARIETY	COLOR OF GRAIN
Alabama.....	Mosby	W
	Marlboro	W
	Jackson Red Cob	W
	Tennessee Red Cob	W
	Hasting's Prolific	W
	Davis Poor Land	W
Arkansas.....	Johnson County White	W
	Southern Beauty	W
	Hildreth Yellow Dent	Y
	Boone County White	W
Georgia ¹	Golden Beauty	Y
	Marlboro	W
	Sanders	W
	Cocke's Prolific	W
	Boone County White	W
Louisiana.....	Mosby	W
	Yellow Creole	Y

¹ Taken from Duggar's "Southern Field Crops," p. 120.

STATE	VARIETY	COLOR OF GRAIN	
(La. Corn Growers' Assoc. 1915)	Stewart's Yel. Dent	Y	
	Calhoun Red Cob	Y and W	
	Stewart's White Shoepeg	W	
	Mosby's Prolific	W	
	Hasting's Prolific	W	
	Gandy's Prolific	W	
	Sentell's White Dent	W	
Mississippi.....	Cocke's Prolific	W	
	Mosby	W	
	North Car. Prolific	W	
	Hasting's Prolific	W	
	Davis' Poor Land	W	
	Tennessee Red Cob	W	
	Biggs Seven Ear	W	
North Carolina.....	Weekley's Improved	W	
	Goodman's Prolific	W	
	Sanders' Improved	W	
	Cocke's Prolific	W	
	South Carolina.....	Marlboro	W
		Batt's Prolific	W
		Williamson	W
Hasting's Prolific		W	
Mosby		W	
Brunson		W	
Simons 86%		W	
Tennessee.....	Pee Dee	W	
	Hickory King	W	
	Lewis Prolific	W	
	Albemarle Prolific	W	
	Neal's Paymaster	W	
	Webb's Watson	W	
	Huffman	W	
Texas.....	Reid's Yellow Dent	Y	
	Thomas ¹	W	
	Mosby ¹	W	
	Hastings ¹	W	

¹ Prolific corns for South and East Texas.

STATE	VARIETY	COLOR OF GRAIN
Texas.....	Surcropper	W
	Strawberry	R and W
	Chisolm	W
	Yellow Dent	Y
Virginia.....	Boone County White	W
	Collier's Excelsior	W
	Johnson County White	W
	Leaming	Y
	Reid's Yellow Dent	Y
	Virginia Golden Beauty	Y

228. Discussion of varieties. — Most of the leading varieties of corn grown in the cotton-belt belong to the prolific type, producing from 175 to 200, or more, ears for each hundred plants. The ears are usually small, owing to the small size of the cob, and the kernels are usually rather long and slender. Some of the important prolific varieties included in the above list are as follows:

Mosby	Sanders Improved	Albemarle Prolific
Hasting's Prolific	Batt's	Biggs' Seven Ear
Cocke's Prolific	Weekley's Improved	Davis' Poor Land
Marlboro	Lewis Prolific	Neal's Paymaster

Southern Beauty is a semi-prolific variety.

The important one-eared varieties are:

Tennessee Red Cob	Jackson Red Cob
Reid's Yellow Dent	Hildreth's Yellow Dent
Golden Beauty	Calhoun Red Cob
Boone County White	Huffman
Strawberry	

Almost all varieties are valuable for silage making. The following have been especially recommended for this purpose:

Cocke's Prolific
Weekley's Improved

Hildreth Yellow Dent
Goodman's Prolific

Of the varieties of sweet corn grown in the cotton-belt the following are most important:

Stowell's Evergreen
Adams's Extra Early

Country Gentleman
Black Mexican Sweet Corn.

CHAPTER XVI

THE BREEDING OF CORN

UNDER any given set of conditions the yield of corn is conditioned on two sets of forces. The first and most commonly recognized set of forces is external to the plant and consists of the plant's environment. The second set resides within the plant itself and is commonly expressed as heredity.

Certain factors of environment, such as temperature, light and rainfall, are beyond our control. Others, such as the ravages of insect enemies and parasitic fungi are partially controllable; whereas tillage and the supplying of food to the plant are almost wholly under control. The two last named factors have received widespread attention from corn growers. The factors of heredity have been almost wholly disregarded. The possibility of improving corn by breeding has long been recognized, and in recent years many evidences of such improvement have been furnished in this country by the agricultural experiment stations, state departments of agriculture, the national Department of Agriculture and other agencies, as well as by many growers of commercial seed.

229. The significance of type in corn breeding.— Corn breeders in the past have laid much emphasis on the value of selecting seed with a definite type of plant in view. For example, directions for selecting are often given with reference to the type of ear as regards its length and circumference as well as depth and shape of kernels. Also

the height of plant, height at which ear is borne, position of ear, and the like, are usually given careful consideration



FIG. 36. — Showing the average angle of declination of corn ears after five generations of breeding for erect ears.

in breeding corn. It nevertheless remains that yield is the primary object in corn breeding, and if each year seed is carefully selected and propagated from the highest yielding plants or progeny rows as the case may be, all other characters of the plant will naturally adjust themselves under the existing conditions in such a way that ultimately the most productive type of plant will follow. That no visible characters of the corn ear are indicative of high yielding power has been demonstrated many times by breeders and this fact is clearly summarized by Hartley as follows:

“A careful tabulation of yields as compared with other ear characters covering six years’ work with four varieties, embracing in all more than 1000 ear-to-row tests of production, indicates that no visible characters of appar-

ently good seed ears are indicative of high yielding power."

The Illinois experiments in breeding for high-ear and low-ear types demonstrate that the height at which the ear is borne on the plant bears no definite relation to yield, the same conclusion being warranted when the angle of the ear was considered.

Selection to modify certain characters of the plant, even though yield is not affected, is often justified. For example, in the South many varieties of corn have a tendency to bear the ears quite high on the stalk and in an upright position. Although neither of these characters materially affects yield, seed should be selected with the idea of correcting these defects, as

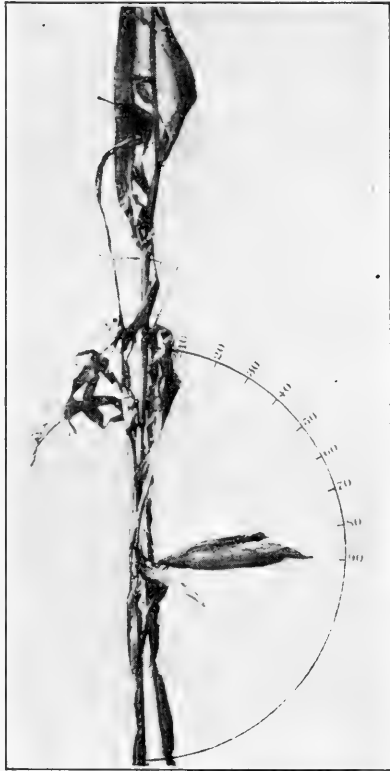

FIG. 37. — Showing the average angle of declination of corn ears after five generations of breeding for declining ears.

in the one case ease of harvesting is facilitated and in the other the quality of the grain is improved, from the fact that a drooping ear sheds water bet-

ter than one borne in an upright position (Figs. 36, 37).

The type assumed by high-yielding strains of corn varies in different regions. Therefore the ideal type for one set of conditions will vary from that growing under conditions markedly different. The acclimated high-yielding strains have adjusted themselves to their surroundings, and corn breeders should select their seed from typical plants that are in harmony with natural conditions.

230. Defects in southern varieties. — The most serious defect possessed by the bulk of the corn planted in the south is the lack of those hereditary qualities such as vigor and prolificacy that make for higher yield. In addition to these there are a number of qualities which may or may not affect yield, but which, because of their relation to the ease of harvesting, the ability of the plants to resist storm, or the quality of the grain produced, should receive careful attention by corn growers. The most important of these qualities are: (1) lower position of ear on the plant; (2) strength, or power of the plant to stand up; (3) tendency for the mature ears to turn downward; (4) more complete covering of the tip by shucks; (5) a decrease in the size of the plant in some varieties. All of the above qualities, including vigor and prolificacy, have been shown to be hereditary and are therefore under the control of the corn breeder.

231. Barren plants. — The tendency in corn to produce stalks without ears is generally held to be hereditary, although it is to a large degree dependent on climatic conditions. That this tendency in corn is to an extent hereditary is shown by the fact that seed corn that has been fertilized by the pollen from barren stalks often gives rise to an increased number of useless plants. De Vries makes reference

to the fact that in Illinois on farms where the number of barren plants has reached as high as about 60 per cent, it has been reduced by five years of selection to about ten or fifteen per cent. De Vries also finds that "some ears produce more than twelve times as many barren stalks as others." Hartley found that the destruction of barren stalks in the field from which seed was saved reduced the percentage of barren stalks in the succeeding crop from 8.11 to 3.43. While it is of the utmost importance that barren stalks be destroyed before they produce pollen, it is highly probable that this is only a partial remedy. Strains or varieties of corn that are marked in this deficiency should be discarded as a whole as in such cases the propensity to barrenness is in all probability possessed by the fertile plants as well as by the infertile. It is often difficult to detect barren stalks before pollen is produced and for this reason all poor stalks in the seed plot should be destroyed before the pollen is matured.

232. Tendency to sucker. — The removal of suckers from the corn plant is common with farmers throughout the southern states, the assumption being that they sap the energies of the main plant by robbing it of food and water without giving a compensating return in grain. The bulk of the evidence is against this practice. Williams, of the North Carolina Station, as a result of three years' work with more than fifty varieties summarizes his work as follows:

"By assigning a value of 80 cents a bushel for grain and \$8.00 a ton for stover, it has been found that, on an average of three years' results on the better grade of land, there was a diminishing by 17.7 per cent of the combined value of the grain and stover by the removal of suckers from the stalks."

The results of two years' work by the Mississippi Experiment Station on the value of suckering corn are shown below:

TABLE 10. SHOWING RESULTS OF TWO YEARS' SUCKERING CORN 1910 AND 1911

WHEN SUCKERED	1910		1911	
	Cost of labor for suckering one acre	Yield in bushels per acre	Cost of labor for suckering one acre	Yield in bushels per acre
Suckered 4 feet high	\$.96	29.5	\$1.00	38.5
Suckered 6 feet high	.96	29.4	1.00	38.0
Unsuckered	37.8	30.5

Ricks, in discussing these results, says: "Pulling the suckers from corn has never given us any increased yields. The expense in doing this work should be put into better and more frequent cultivations."

233. Methods of improving corn. — Three methods are employed in the improvement of corn. They are (1) selection, including both mass selection and pedigree selection, (2) hybridization followed by selection, and (3) acclimatization. The method of improving corn by hybridization is too technical and expensive to be of general value to the farmer. This work should be left for the skilled breeder, the farmer giving his attention to the improvement of his corn by selection.

SELECTION

Systematic selection is the most important factor in the improvement of corn. The success of this method depends upon the ability of the breeder to recognize the most

productive plants and to propagate them without the intermixture of blood from inferior sorts.

234. Start with the best variety. — The initial step in the improvement of corn is the selection of the best variety for the existing conditions. It is a waste of time and money to attempt the breeding or improvement of varieties not well adapted to the soil or climate. The value of any variety is conditioned on its yield, quality, and adaptation. The adaptation of the variety is really the deciding factor that determines whether it may be successfully grown in any locality. The work of the agricultural experiment stations has demonstrated beyond question that corn varieties differ as regards climatic adaptation and therefore differ in point of yield. Some tests reported by the Alabama Station at Auburn a few years ago showed differences in the yield of corn varieties as high as 160 per cent. The best variety can be selected only as a result of a carefully conducted variety test.

235. Mass selection. — The simplest method of improving corn is by mass selection. In following this method the grower selects from the field a large number of ears from plants that conform nearest to the ideal type. The next year all of this selected seed is mixed and planted. From the crop thus produced the best individuals are again selected, the seed mixed and planted the succeeding year. This method of selection is followed year after year. Mass selection does not recognize a difference between the individuals selected as regards their ability to produce, as by this method a performance record for single plants, such as is kept in pedigree selection, is impossible.

236. Value of mass selection. — Rapid improvement by mass selection is not possible. However, if the breeder

keeps clearly in mind a mental picture of his ideal type, and in making his selections from year to year does not deviate from this type, there is no question but that a gradual improvement can be accomplished. The fact that many of our oldest and best varieties of corn have been produced by this method is evidence of its value when properly conducted. For example, in 1825, J. L. Leaming, of Wilmington, Ohio, began selecting the best ears of his field for his seed corn. He mixed the seed and planted it with no attempt to study the progeny of individual ears. By this method he finally improved his strain to the degree that it became widely known and was imported into Illinois. There the selection was continued by the same method followed by Leaming. At present, the Leaming variety is considered one of the best yielding sorts for that state. James Riley, of Thorntown, Indiana, working with the ordinary white corn of Indiana, selected seed with the idea of diminishing the number of barren stalks and of ears of minor value in his field. The result of his work is the famous Boone County White, probably the most popular variety of corn in Indiana and Illinois. Reid's Yellow Dent, a variety widely grown in the corn belt, was produced by mass selection. The objection to this method is the slowness with which improvement is accomplished.

237. Pedigree selection. — It has been found that two ears of corn of similar appearance, and coming from plants of apparently equal value, will not necessarily produce progeny of equal value. It often happens that one ear will produce from 20 to 40 per cent more than the other when used as seed. In other words, the hereditary qualities of the two ears may differ markedly, and since the aim of corn breeding is the improvement of hereditary

qualities, the most rapid improvement can be accomplished only when the selection is based on a performance record of the different individuals. An ear of corn may be of excellent shape and size, with straight rows and perfect butt and tip, with well-shaped kernels of the most desirable structure, but such an ear is of little value as seed corn unless it possesses the power of transmitting these qualities to its progeny. Pedigree selection differs from mass selection in that after the first mother ears are selected a record is kept on the performance of each ear or its progeny. It distinguishes between those plants that were good because of favorable environment and those that were good because of inherent productiveness. The inherent productiveness of an ear can be ascertained by no other means than pedigree selection, or the separate culture and exact comparative trial of the generation grown from its kernels.

238. The initial choice of ears in the fields. — The foundation stock should be selected in the field. In the cotton-belt yield should be the primary consideration in the making of this selection. Early in the fall shortly before the time of harvesting, the breeder should go through his fields and mark the stalks of superior quality. If it is desired to correct some defect of the plant, or ear, such as the height of ear on stalk or the angle of the ear, these points should be kept in mind, and the selections made accordingly; but at no time should yield be sacrificed for other qualities. It is not necessary to adhere closely to one type of ear. In fact several types may be selected provided they are sound and well matured and come from high yielding plants. It is usually advisable to select from plants that produce more than one ear. This is especially true in the breeding of the prolific varieties.

At least 100 ears should be selected. A still greater number will be better as exceptional ears are rather scarce.

239. Selecting the breeding plot. — The comparative trial of the progeny of the ears selected in the field is made on a selected plot, usually called the breeding plot. As the value of this test depends on being able to make an accurate comparison of the yields from the different ears, it is extremely important that the plot selected be of as uniform productiveness throughout as possible. The soil need not be rich, but should be of average productiveness, and if possible should be sufficiently isolated to prevent the selected seed from becoming contaminated by pollen from unbred varieties. As pollen is often carried a quarter of a mile by the wind, the isolation of the breeding plot is often impossible, and other precautions, mentioned in the succeeding paragraph, must be resorted to. The breeding plot should be sufficiently large to admit of planting at least 100 rows of at least 100 hills in length.

240. Second year. — By means of a marker or a small plow the breeding plot should be laid off in checks $3\frac{1}{2}$ feet apart. Next, the kernels of each selected ear are planted in groups, the first row being planted from the kernels of one ear, the second row containing the progeny of a second ear and so on until the 100 ears are planted. The usual method is to carry the ear, and shell off the grains as needed. Three or four grains should be planted in each hill to insure a stand. Later the corn should be thinned to one stalk in a hill.

As it is practically impossible to secure an absolutely uniform plot of land for this work, it is well to omit every fifth row in planting the select ears, these rows to be immediately planted with a uniform lot of corn. The yield of these rows that are planted from uniform seed will

serve as a check against the inequalities in the productive-ness of the soil comprising the breeding plot.

Where isolation is impossible, the breeding plot should be surrounded by three or four rows planted with seed from the selected ears which remain after the breeding plot has been planted. Conditions will be made still more ideal if this breeding plot is situated in the midst of a large field of a selected strain of corn of the same variety. This latter precaution will be impossible during the first season of the breeding, but from the third year it will always be practicable. Such an arrangement prevents the seed plot from being contaminated by pollen from unbred sorts.

241. Cultivation. — Ordinary cultivation should be given the breeding plot, care being exercised to see that all rows are treated alike. It must be remembered that the results of pedigree selection will be meaningless unless uniform conditions are maintained throughout the entire breeding plot.

242. Detasseling. — In breeding corn by pedigree selection, the conditions are such as to favor inbreeding and close breeding, either of which is likely to decrease the vigor of the plant. To avoid this the practice of detasseling every other row or the alternate half of every row and saving seed only from the best detasseled rows is recommended. The method of detasseling consists merely in pulling the tassels out before pollen is produced, and bears no injury to the plant. The field must be gone over at least three times. In addition to pulling the tassels from the plants in the rows that are to furnish the seed, it is important that all inferior plants in the sire rows be detasseled. The methods employing the principle of detasseling to avoid inbreeding vary somewhat with

different breeders. The most important methods follow:

(1) Each year alternate rows in the breeding plot are detasseled and seed yields ascertained from these rows only. This is the method in most common use.

(2) The first year only a part of each ear is used in planting the breeding plot and no detasseling is done. By harvesting and weighing the grain from each row the breeder ascertains which were the most productive ears that were used in the planting of the breeding plot. The next season the remnants of the best ears only are planted in progeny rows, a number of which are detasseled. The advantage sought by this method is the elimination of the poor-yielding strains so that all fertilization will come from productive strains. The method is continued year after year, select ears being used from the breeding plot or the general crop for the ear-row test.

Hugo de Vries stresses the importance of the plot system in corn breeding as a means of maintaining the purity of select strains. His views are given in the following quotation: "In the system of breeding in plots, the progeny of each selected ear constitutes a square by itself, and thus at least for the central stalks a high degree of pure fertilization by the other members of the same family is insured. The observed fact of the high degree of individuality of each family, derived from one single ear, seems to point out the desirability of this plot system for the first year of trial on the breeding plot, even if the row system should be kept as the most convenient for the subsequent years of selection."¹

243. Harvesting. — Late in the fall when the corn from all of the progeny rows has become thoroughly

¹ Hugo de Vries, "Plant Breeding," p. 137.

mature the detasseled rows should be harvested separately and the corn from each row weighed. From the ten or twelve highest yielding rows, 100 of the best ears should be selected for planting the breeding plot next year. The remainder of the seed from the best yielding rows should be used for planting an increase plot or for planting the general crop.

244. Third year. — The breeding plot should be planted as before with the best selected 100 ears; the



FIG. 38. — Showing effect of five generations of breeding for high ears and low ears. The white tape marks the position of the ears on the stalks.

alternate rows should be detasseled and seed saved again from the best detasseled rows. The remainder of the selected seed should be used for planting an increase plot provided it is not sufficient for planting the general crop. The corn produced on the increase plot should be used for planting the general crop the fourth year.

One should continue this system of breeding, maintaining each year the breeding plot, the increase plot, and the general crop which is always planted from the improved seed grown on the increase plot. With this treatment the

corn should not only maintain its excellence, but should improve rapidly from year to year.

245. Breeding for high and low ears (Fig. 38). — In 1902 the Illinois Experiment Station began selecting two strains of Leaming corn, one with ears borne high on the stalk and the other with ears borne low. After six years of pedigree breeding, the basis of selection being the height of the ear, the following results were obtained:

TABLE 11. SHOWING AVERAGES OF CROPS PRODUCED IN CORN BREEDING, FOR HIGH EARS AND FOR LOW EARS ¹

YEAR	HEIGHT OF EAR		HEIGHT OF PLANT	
	High-ear Plot Inches	Low-ear Plot Inches	High-ear Plot Inches	Low-ear Plot Inches
1903	56.4	42.8	113.9	102.5
1904	50.3	38.3	106.2	97.4
1905	63.3	41.6	128.4	106.5
1906	56.6	25.5	116.3	86.0
1907	72.4	33.2	130.4	99.7
1908	57.3	23.1	114.0	79.3

246. Breeding for composition. — In 1896, Hopkins, of the University of Illinois, began the breeding of corn with the idea of changing its chemical content. Seed of White Illinois corn was selected for four different purposes: high and low protein content and high and low oil content. These different strains were selected by a mechanical examination of the ears. This method is based upon the fact that the kernel of corn consists of several distinct, easily recognized parts of quite different chemical composition. These are (1) the horny endosperm in which the protein is mainly produced, (2) the starchy endosperm

¹ Ill. Agr. Exp. Sta., Bul. 132, 1909.

which is low in protein and rich in starch, and (3) the germ which contains from 80 to 85 per cent of the total oil content of the kernel. Keeping these facts in mind one will readily see that by selecting ears whose kernels contain more than the average proportion of horny endosperm, one will secure high-protein ears. Likewise by selecting ears whose kernels contain germs larger than the average, one will secure high-oil ears. The results of ten years' pedigree breeding for high and low protein content and high and low oil content by the Illinois Experiment Station are summarized in the following table:

TABLE 12. SHOWING RESULTS OF TEN GENERATIONS OF BREEDING CORN FOR INCREASE AND DECREASE OF PROTEIN AND OIL ¹

YEAR	HIGH PRO- TEIN CROP, PER CENT	LOW PRO- TEIN CROP, PER CENT	DIFFER- ENCE	HIGH-OIL CROP, PER CENT	LOW-OIL CROP, PER CENT	DIFFER- ENCE
1896	10.92	10.92	4.70	4.70
1897	11.10	10.55	0.55	4.73	4.06	0.67
1898	11.05	10.55	0.50	5.15	3.99	1.16
1899	11.46	9.86	1.60	5.64	3.82	1.82
1900	12.32	9.34	2.98	6.12	3.57	2.55
1901	14.12	10.04	4.08	6.09	3.43	2.66
1902	12.34	8.22	4.12	6.41	3.02	3.39
1903	13.04	8.62	4.42	6.50	2.97	3.53
1904	15.03	9.27	5.76	6.97	2.89	4.08
1905	14.72	8.57	6.15	7.29	2.58	4.71
1906	14.26	8.64	5.62	7.37	2.66	4.71

247. Other effects of breeding for composition. — It was found that the continued selection of corn for high protein resulted in the production of ears averaging somewhat smaller than the low-protein ears, the number of kernels also averaging "slightly less on the typical high-

¹ Ill. Agr. Exp. Sta., Bul. 128, 1908.

protein ear." Likewise the high-oil selection resulted in a smaller type of ear than was produced in the low-oil strain.

In order to determine whether or not breeding for composition affects materially the productiveness of corn the Illinois Station has taken, every year since the sixth generation, seed from each of the four breeding plots and planted it in the station variety test plots where it is "given conditions of soil and culture as uniform as possible for securing comparable results." The results of this test are given below:

TABLE 13. SHOWING YIELDS OF "ILLINOIS" STRAINS IN VARIETY TEST PLOTS ¹

YEAR	HIGH-PRO-TEIN STRAIN BU. PER A.	LOW-PRO-TEIN STRAIN BU. PER A.	HIGH-OIL STRAIN BU. PER A.	LOW-OIL STRAIN BU. PER A.	STANDARD VARIETY USED AS CHECK
1903	27.3	37.7	32.7	41.3	40.9 Boone Co. White
1904	32.1	55.5	41.9	40.5	53.7 " " "
1905	56.6	60.7	58.4	58.1	68.4 Silver Mine
1906	65.1	73.2	66.3	83.2	{ 75.7 " " 87.9 Leaming

It will be noticed that the lowest yield has in every case been produced by the high-protein corn and Smith of the University of Illinois in discussing these results says: "It seems a high-protein content and the highest productivity do not go together."

248. Objects of breeding for composition. — The reasons for attempting to change the composition of corn by breeding are briefly summarized as follows:

(1) Protein is the most expensive animal nutrient. Corn, because of its economical production is one of the cheapest of American food stuffs. It is thought that stock

¹ Ill. Agr. Exp. Sta., Bul. 128, 1908.

feeders will profit greatly as a result of increasing the protein content of corn as it will enable them to dispense with the purchase of considerable quantities of more expensive feeding stuffs.

(2) On the other hand, the manufacturers are increasing their demands for those products derived from the starch of corn such as, alcohol, gum, glucose, dextrine and syrup. As decreasing the protein-content of corn increases the percentage of starch present, there is a demand for a low-protein corn.

(3) Corn oil has recently found a wide commercial use and there is now an actual demand for a corn of high-oil content.

(4) The object of breeding corn for a low-oil content is found in the fact that "in feeding swine, the oil in the corn tends to produce a soft, flabby quality of flesh which is very undesirable, especially for our export trade where the demand of the market is for a hard, firm product."

HYBRIDIZATION

249. Objects of hybridization. — The readiness with which corn hybridizes and the ease with which the plant is manipulated in artificial crossing have served greatly to stimulate the breeders' interest and effort in this method of corn improvement. In pursuing this method the breeder has in mind two important objects of practical value. These are (1) the recombining of the characters possessed by the parent plants so as to produce a progeny of increased value; (2) securing increased vigor and productiveness thereby augmenting the yield. In addition to these objects of immediate practical value the hybridization of corn yields interesting results of purely scientific value relating to the hereditary laws governing plant growth.

250. Degrees of relationship among corn plants. — It is possible to have several degrees of relationship among corn plants. These may be summarized as follows:

1. *Inbreeding*, occurring when the pollen from a plant fertilizes the ovules of the same plant.

2. *Close breeding*, occurring when the pollen of a plant fertilizes the ovules of a sister plant, or those of a plant that has grown from the kernels of the same ear.

3. *Narrow breeding*, occurring when pollen from a plant fertilizes the ovules of a plant not closely related but of the same variety.

4. *Broad breeding*, occurring when the pollen from a plant fertilizes the ovules of a plant of a different variety, or occurring when the pollen from a plant fertilizes the ovules of a plant of a different group, as between dent and flint corn.

251. The transmission of characters — Mendel's law. — Inheritance in plants may be studied by two methods: (1) by the statistical method of considering plants and their offspring collectively; (2) by the analytical method of studying the separate characters and their modes of transmission. The present conception of plants is that they are composed of separately heritable units known as "unit-characters." Examples of such unit-characters in corn are: the color of the grain, cob, stem or husks; the character of the endosperm; the height of the plant; susceptibility or immunity to disease, and the like. The law governing the transmission of such unit-characters from parent to offspring was first discovered by Gregor Mendel, an Austrian monk, in 1865, and rediscovered by de Vries and others in 1900, and is now known as "Mendel's law of hybrids." The manner in which the splitting up and redistribution of parental characters occurs in hybrids

according to Mendel's law, may be best understood by the following simple illustration:

If pure yellow corn be crossed with pure white corn the result will be a hybrid containing both characters, yellow and white. In this hybrid corn, however, all of the kernels will appear yellow because of the fact that in corn the character yellow is dominant over white and hence masks the white color. In this case white is said to be recessive. A plant produced from this hybrid seed will produce pollen grains one-half of which will represent yellow corn and one-half white corn. The same is true with regard to the ovaries. While the plant is hybrid, the sexual elements remain pure. When fertilization takes place, whether it be self-fertilization or close-fertilization, four different combinations of male and female elements are possible as shown below:

COMBINATIONS OF GERM-CELLS			CHARACTER OF PROGENY
Yellow	X	Yellow.....	Yellow (pure as regards color)
Yellow	X	White.....	Yellow (hybrid as regards ")
White	X	Yellow.....	Yellow (hybrid as regards ")
White	X	White.....	White (pure as regards ")

All of the kernels resulting from the union of yellow X white and white X yellow germ-cells will appear yellow because of the dominance of that color. The kernels resulting from the union of the germ-cells yellow X yellow will show the yellow color because in this combination the potentiality of white is entirely absent. The white color will be apparent following the combination white X white because here the potentiality of yellow is not present to mask it. We will therefore have on each self-fertilized hybrid ear three yellow kernels to one white kernel. Of

all of the yellow kernels produced on such an ear, one-third will be pure yellow and two-thirds will be hybrid as regards color. All of the white kernels will be pure as regards color.

252. Dominant qualities in corn hybrids. — We have seen that according to Mendel's law opposite qualities of parents are not blended in the hybrid, but are inherited separately, the individual descendants showing only one of these characters. According to this law the dominant character shows in the first-generation hybrid to the exclusion of the other. The recessive character reappears in the second and subsequent generations in one-fourth of the progeny, and thereafter remains pure.

Investigation has shown the following characters in corn to be dominant over their opposites: Yellow endosperm dominant over white endosperm; starch endosperm dominant over sweet endosperm; red pericarp dominant over colorless pericarp; flint quality of grains dominant over dent; flint quality of grains dominant over sweet; dent quality of grains dominant over sweet; blue aleurone dominant over colorless aleurone; podded kernels dominant over naked kernels.

253. Effects of inbreeding. — Experiments conducted by Shull,¹ East,² Montgomery,³ and Halsted⁴ prove conclusively that the immediate effect of inbreeding corn is to decrease the yield. These results indicate that continued inbreeding may in some cases produce absolute sterility. Corn is sometimes self-fertilized for two or three generations by breeders with the object of producing a pure type.

¹ Ann. Rpt. Amer. Breeders Assoc., Vol. VI, 63-72, 1900.

² Conn. Agr. Exp. Sta., Bul. 168, 1911.

³ Nebr. Agr. Exp. Sta., Ann. Rpt. 1912, 183.

⁴ N. J. Agr. Exp. Sta., Bul. 170.

This is probably the quickest way of producing a pure strain of corn. It is accompanied by decreased vigor and yield, the greatest decrease usually taking place the first year of inbreeding.

254. Value of crossing varieties. — Various breeders have demonstrated that in many cases the immediate effect of crossing two different varieties of corn is the production of a hybrid with greater vigor and higher productivity than either of the parents. It has been suggested by Hayes and East¹ that “the production of corn by utilization of the increased vigor due to a first-generation hybrid, is of commercial importance and is worthy of further trial.” In 1892 Morrow and Hunt at the Illinois Experiment Station gave the results of five tests of the comparative yields of first-generation hybrids and their parents. The table on page 208 gives their results:²

255. Method of producing cross-bred seed. — If the farmer or breeder desires to produce each year cross-bred seed for planting purposes the following considerations should be kept in mind in selecting the parent varieties:

(1) The two varieties selected should be of the type desired and preferably should have been grown in the same locality for a number of years.

(2) Better results will be secured if comparatively pure varieties be selected. Investigations on this point indicate that a minimum increase in yield will be secured if the parent varieties are “in a state of hybridity” when crossed.

(3) Varieties should be selected that mature at the same time.

¹ Conn. Agr. Exp. Sta., Bul. 168, 1911.

² Ill. Agr. Exp. Sta., Bul. 25, 1902.

TABLE 14. SHOWING COMPARATIVE YIELDS OF FIRST-GENERATION HYBRIDS AND THEIR PARENTS

VARIETY	BUSHEL ^S OF AIR-DRY CORN
Burr's White.....	64.2
Cranberry.....	61.6
Average.....	62.9
Cross.....	67.1
Burr's White.....	64.2
Helm's Improved.....	79.2
Average.....	71.7
Cross.....	73.1
Leaming.....	73.6
Golden Beauty.....	65.1
Average.....	69.3
Cross.....	86.2
Champion White Pearl.....	60.6
Leaming.....	73.6
Average.....	67.1
Cross.....	76.2
Burr's White.....	64.2
Edmonds.....	58.4
Average.....	61.3
Cross.....	78.5

(4) If corn of a uniform color is desired, yellow and white varieties should not be crossed as the kernels will not be of uniform color in the year following the cross, at which time the beneficial results from crossing will be expected.

The production of crossed seed is not a difficult matter provided the seed-plot is not located near other corn fields.

The following diagram and quotation (Conn. Exp. Sta., Bul. 168) illustrate the method to be used:

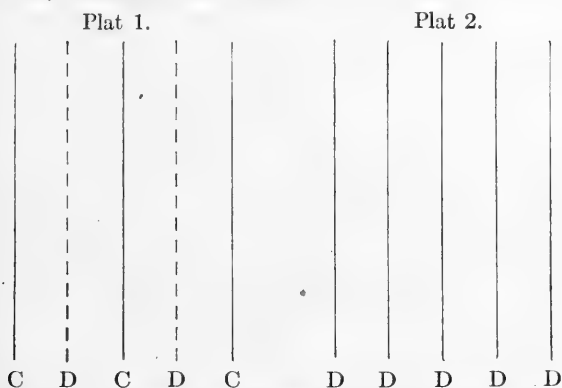

FIG. 39. — Diagram showing method of producing cross-bred seed of corn.

“Plant the varieties in alternate rows in Plat 1, all of one variety as C being planted in the odd rows and the other variety, D, in the even rows. Detassel all of one variety as D. This detasseled variety should be also grown in another isolated plat, Plat 2. Suppose it is determined to use D as the female variety, detassel all of D. The following results will then be obtained at harvest:

Plat 1. D will be cross-pollinated.

Plat 1, C will be self-pollinated or close-pollinated.

Plat 2, D will be self-pollinated or close-pollinated.

“The detasseling should be done before any of the pollen is shed and may be very easily accomplished by taking firmly hold of the young tassel and giving it a steady upward pull. In order to detassel all of a variety it will be necessary to go over the field several times at intervals of a day or two. It is important to have all of the variety detasseled before the shedding of its pollen.

If the varieties differ in date of tasseling it is recommended that the variety which tassels first be used for the female parent, as the silks are receptive, as a rule, for a longer time than during the shedding of the pollen. If the varieties do not differ in the date of maturity, seed may be obtained by the following plan which will necessitate the using of only one plat. To illustrate by the use of the diagram for Plat 1. Reserve some seed of C; detassel all of C this year. On the following year use the reserved seed of C and the open pollinated seed of D for the seed-plot, using D this year for the female parent and reserving enough of D for the following year."

CHAPTER XVII

SOIL AND CLIMATIC ADAPTATIONS OF CORN

EACH crop, according to its physiological requirements, is adapted to make its best growth on a particular soil and under a particular climate. The range of conditions under which a given crop may be profitably grown is more or less limited. It is wider for corn than for any other cereal. Corn is grown in every state and territory in the United States except Alaska, and in both Mexico and Canada. Almost all soil and climatic conditions are represented on the areas producing corn within this range. Nevertheless, the bulk of the production is largely centralized in a somewhat restricted area (Iowa, Illinois, Missouri, Kansas, Nebraska, Indiana, Ohio) where exists the most favorable combination of soil, climate, and topography.

SOIL ADAPTATIONS

With climatic conditions favorable, the factor which influences the yield of corn most is the nature and condition of the soil.

256. Soils adapted to corn.—Corn is successfully grown on a wide variety of soils. Owing to its abundant foliage and the rapidity with which it transpires water, corn will not make a satisfactory growth on soils of low water-holding capacity. They should be deep, friable, and well supplied with decaying vegetable matter. The latter factor is of special importance, not only because

of its relation to water storage in the soil, but because it insures an abundant supply of nitrogen. Corn demands a large supply of nitrogen, flourishing in soils so rich in this constituent as to induce an excessive growth of straw, a tendency to lodge, and a low yield of grain in other cereals. Alluvial river bottom soils, if well drained and supplied with vegetable matter, are ideal for corn. Such soils usually contain a higher percentage of silt than of any other soil separate, mixed with considerable quantities of very fine sand and clay. Soils of this constitution are of that loamy character so admirably adapted to corn growing.

257. Soils not adapted to corn. — A large percentage of the corn crop in the cotton-belt is each year planted on soils that, for various reasons, will not produce a profitable yield. Such soils may be grouped in three classes:

(1) Sandy soils, deficient in vegetable matter and mineral plant-food. Such soils occur in extensive areas throughout the coastal plains region.

(2) Uplands from which the greater part of the top soil has been lost by erosion. Soils of this character are abundant in all sections of the cotton-belt having an uneven topography.

(3) Rich bottom lands which, for lack of drainage, have become cold and sour.

(4) Very stiff compact clays through which the roots cannot penetrate and which, because of their physical character, are very difficultly prepared.

258. Modification of soils for corn. — The undesirable soil conditions enumerated above, can, in most cases, be so modified by suitable methods of soil management as to permit the successful production of corn. The im-

poor sandy soils should be planted frequently to such crops as cowpeas, soybeans, velvet beans, or oats and vetch, and occasionally the entire crop plowed under. In addition it will usually be necessary to apply phosphatic and potassic fertilizers. The eroded uplands should be terraced and such cropping systems practiced as will restore the nitrogen and vegetable matter. The sour bottom lands should be drained and half a ton to a ton of slacked lime added to the acre. The application of rough manures to the compact clays greatly improves their condition, especially when such an application is followed by fall plowing. Until the productiveness of these undesirable corn soils has been increased they should not be planted to corn.

259. Soil type and crop variety. — There is no question but that there is a great difference in varieties of corn in their adaptation to different soils. For example, Hickory King corn will reach normal development on much thinner soil than will Albemarle Prolific. The best use of the different types of corn soil can be made only when the most suitable varieties are grown.

CLIMATIC ADAPTATIONS

260. Factors of climate. — The principal elements combining to determine the climate of a given region are rainfall, sunshine, and temperature. Wind and humidity are minor climatic factors. The adaptability of a given region for a particular crop is determined both by the combination and distribution of these factors. In corn-growing, their distribution is of special importance in determining the length of the growing season. In fact the climate favorable to corn is determined more by the distribution than by the intensity of these factors.

261. Influence of rainfall. — Seasonal rainfall and its distribution is the most important climatic factor in corn production. While corn requires less water to produce one pound of dry matter than many other crops, the large total weight of dry substance to the acre produced by this crop makes necessary large quantities of water. It is estimated that 14 to 20 tons of water must be transpired to produce one bushel of corn. This equals 7 to 10 acre-inches for a yield of 50 bushels to the acre. When it is remembered that this water requirement does not include the loss from run-off, drainage, and evaporation, the importance of an abundant rainfall in corn production is at once appreciated.

In the cotton-belt the May, June, July, and August rainfall is most important in producing corn. The distribution of the rainfall during this season is of utmost importance in determining the character of growth and total yield. Excessive rains in the early part of the growing season favor the development of a shallow root-system which unfits the crop to withstand the frequent dry weather of July and August. Comparatively heavy rains at considerable intervals throughout the entire growing season, with sunshiny weather in the meantime is the condition most favorable to the normal growth of the corn plant. Frequent light showers permit the excessive loss of moisture by evaporation.

262. Influence of sunshine. — The relation of sunlight to the normal growth of the corn plant was discussed in the chapter on the physiology of the corn plant. The effect of sunshine will be in proportion to the number of sunshiny days and the intensity of the sunlight. Corn, being a semi-tropical plant, requires considerable sunshine for its normal growth. Except where extreme cloudiness

prevails there is sufficient sunshine for corn production up to 70 degrees latitude.

263. Influence of temperature. — Corn requires, in addition to a moderately large, well-distributed seasonal rainfall and a large amount of sunshine, a relatively high temperature. While it is difficult to give precise limits to any influence that is one of several absolutely necessary, the direct relation between temperature and yield is more obscure than that between rainfall and yield. In fact a high average temperature and large precipitation are somewhat opposed to each other, as low rainfall during the growing season is usually accompanied by a high average temperature. It is the temperature during the corn growing season, inclusive, rather than the average annual temperature that influences the yield of the crop. Three-fourths of the total corn crop of the United States is produced between the July isotherms 70° F. and 80° F.

264. Length of growing season. — From the standpoint of the farmer there is no factor in the study of climate that should be given more consideration than the average length of the growing season. It serves as a key to accurate knowledge relative to the possibilities of success or failure in the production of crops. Fig. 16 shows the average length of the crop growing season in the cotton-belt to vary from 200 days in the northern limit to 300 days in the southern limit. As we proceed north from the cotton-belt the growing season continues to decrease in length. These figures are based on the average dates of the last killing frost in the spring and the first killing frost in the fall. As a matter of fact, the actual length of the growing season is most often limited by factors other than frost. In the cotton-belt the growing period is usually

limited by the dry period in the fall, making it shorter than the frost limit data indicate.

Corn is unique in being able to adjust itself to the growing season. In the extreme northern section of the United States, some varieties mature in 80 days. In no part of the cotton-belt has corn been able to utilize to advantage a growing season in excess of 200 days. Most varieties mature in 140 to 180 days. As a usual thing, the longer the growing season up to a limit of 180 or 200 days, the greater the yield of corn.

265. Influence of climate upon habit of growth. — Corn adjusts itself readily to changes in its environment. We find, therefore, a marked correlation between climatic conditions and its habit of growth. The greatest variation is found in the size of the plant and in the time of maturity. Southern varieties grow much taller than northern varieties, and the stalks are more massive. Hunt¹ states that "in general it may be said that as we go north or south of a given latitude a variety becomes one day later or earlier for each ten miles of travel, the altitude remaining the same. That is to say a variety which ripens two weeks before a killing frost in a given locality would only barely ripen if taken 140 miles farther north, the altitude remaining the same. Care should be taken, therefore, in selecting new varieties, to get them from the same latitude. If obtained from much farther north they may ripen too early and consequently be too small. If obtained much farther south, they may not ripen."

¹ Hunt's "Cereals in America," p. 205.

CHAPTER XVIII

CROPPING SYSTEMS, MANURES AND FERTILIZERS FOR CORN

ANY system of corn production must ultimately fail unless it maintains the producing power of the land. Successful cropping systems are based upon an accurate knowledge of the reasons for doing things. The ultimate effect of each agricultural practice upon the producing power of the soil must be kept constantly in mind.

In only exceptional cases have the cropping systems employed by southern farmers throughout the cotton-belt maintained the productiveness of the land. This has led to exceptionally low average crop yields. The soil problem, therefore, of the southern farmer is not merely the maintenance of soil fertility. He must adopt systems of soil management under which the land becomes better rather than poorer. The solution of this problem lies in the adoption of well-planned cropping systems, supplemented by the judicious use of manures and fertilizers.

CROPPING SYSTEMS FOR CORN

The advantages of a well-ordered cropping system in maintaining soil fertility are discussed in connection with rotations for cotton, page 96.

266. Continuous corn culture impoverishes soil. — That the continuous growth of corn on the same land will ultimately lead to decreased yields is common knowledge. The Illinois Experiment Station has compared

continuous corn growing with rotations of corn and oats; and corn, oats, and clover with the following results:

TABLE 15. SHOWING AVERAGE CORN YIELDS FOR LAST THREE YEARS WHERE THREE SYSTEMS OF CROPPING ARE COMPARED. (ILL. STA.)¹

CROP YEARS	CROP SYSTEM	13-YEAR EXPERIMENTS. BUSHELS	29-YEAR EXPERIMENTS, BUSHELS
1905-6-7	Corn every year	35	27
1903-5-7	Corn and oats	62	46
1901-4-7	Corn, oats and clover	66	58

The yield of corn on this land before the experiment was started was 70 bushels an acre. The one-crop system has decreased the yield 35 bushels an acre in thirteen years and 43 bushels in twenty-nine years. The yields have also decreased, though less rapidly, where the rotations were practiced. As all crops were removed from the land, it is probable that neither rotation supplied organic matter in sufficient amounts to liberate the mineral matter required by a 70-bushel crop of corn. When all crops are removed, rotation will not maintain soil productiveness.

On soils that are quite deficient in mineral matter, or where all crops are removed from the land, the rotation must be supplemented by manures or fertilizers. This fact is well illustrated by the results of an experiment conducted by the Louisiana Station on hill land originally covered with pine trees and much exhausted by from seventy to eighty years of cotton culture. The experiment consisted of six one-acre plots arranged in three series of two plots each, one unfertilized and the other fertilized for each

¹ Ill. Agr. Exp. Sta., Bul. 125, 1908.

crop in the rotation. The rotation was first year, cotton; second year, corn and cowpeas; third year, oats followed by cowpeas.

In the fertilizing of this rotation the cotton received 30 bushels per acre of a compost made by mixing two tons of acid phosphate with a hundred bushels each of stable manure and cotton seed. The corn received 30 bushels to the acre of a compost made by mixing one ton of acid phosphate with 100 bushels of stable manure and 100 bushels of cotton seed. The oats received 200 pounds of cotton-seed meal and 100 pounds of acid phosphate to the acre, and the cowpeas 50 pounds of acid phosphate and 50 pounds of kainit to the acre. The results for 19 years follow:

TABLE 16. LOUISIANA FIELD EXPERIMENTS AT CALHOUN.
AVERAGE YIELDS TO THE ACRE FOR PERIOD OF 19 YEARS ¹

SERIES	SEED COTTON POUNDS		CORN (BUSHEL)		OATS (BUSHEL)	
	Unferti- lized	Ferti- lized	Unferti- lized	Ferti- lized	Unferti- lized	Ferti- lized
A.	459	1555	9.7	30.4	22.1	49.3
B.	507	1811	8.9	30.5	12.4	32.2
C.	432	1175	9.6	33.5	14.9	44.1
Average . . .	466	1514	9.4	31.4	16.4	41.8
Increase		1048		22.0		25.4

267. The place of corn in a rotation. — Corn will utilize more profitably than most other field crops organic matter that is only partially decayed. It also requires an abundance of nitrogen. For these reasons the rotations through-

¹ La. Agr. Exp. Sta., Bul. 111, 1908.

out the corn-growing regions outside of the cotton-belt are so planned as to bring corn on the land immediately following the hay crop. A good rotation for the corn-belt is corn, two years; wheat or oats, one year; timothy and clover, three years. In the cotton-belt corn usually follows cotton in the rotation, and is followed by fall sown small-grains. When the yield of corn alone is considered this is not the best arrangement. It is given this position because it permits the early preparation of the land for small-grains. Cotton is not generally removed in time to permit the fall seeding of small-grains.

268. Suggested rotations for the cotton-belt. — The rotation most generally recommended for the cotton-belt is (1) cotton; (2) corn; (3) oats or wheat followed by cowpeas. Often cowpeas are sown in the corn at the last cultivation. This is an excellent rotation and applicable to a large part of the cotton-belt.

The North Carolina State Department of Agriculture suggests the following rotation for the cotton district of that state: (1) cotton, with rye or oats as winter cover; (2) cotton, with crimson clover as winter cover; (3) corn with cowpeas, plowed deep in fall after corn is cut off, with rye as winter cover, and back to cotton.

A four-year rotation rather widely practiced in the sugar-cane sections of Louisiana is first, second, and third years, sugar-cane; fourth year, corn with cowpeas.

The number of rotations that can be followed in the production of the corn crop is large. No rotation should be adopted that does not provide a liberal supply of organic matter to the soil. Open sandy soils subject to the rapid loss of organic matter by oxidation are best adapted to short rotations which bring humus supplying crops on the land at rather short intervals.

MANURES AND FERTILIZERS FOR CORN

269. Manures. — The profitable increase in corn yields from adding stable or farm manures is almost universal. Probably the chief reason for this is that the manure supplies organic matter, which when in proper condition may greatly influence the water content of the soil. The value of this indirect effect is evidenced by the fact that manure sometimes greatly increases the yield of corn where commercial fertilizers produce no increase. The by-products of the decomposition of manure also render more available the plant-food constituents already in the soil.

The marked effect of manure on the yield of corn is shown by results from the Ohio, Pennsylvania, and Illinois Stations:

TABLE 17. RESULTS FROM THE OHIO,¹ PENNSYLVANIA,² AND ILLINOIS³ STATIONS SHOWING RESULTS WITH BARNYARD MANURE ON YIELD OF CORN

STATION	ROTATION	YIELD OF CORN BUSHEL TO THE ACRE	
		No treatment	Farmyard manure
Ohio, 13 Yr. Average	Corn, Wheat, Clover	38.8	54.6 (8 tons)
Penn., 25-Yr. Average	Corn, Oats, Wheat, Clover	42.1	57.5 (12 tons)
Ill. New Manito Field, 1907	Corn	8.8	43.5 (6 tons) 64.9 (12 tons)

¹ Ohio Agr. Exp. Sta. Circ., 104, p. 17.

² Penn. Agr. Exp. Sta. Bul., 190.

³ Hopkins' "Soil Fertility and Permanent Agr.," p. 473.

On a large percentage of the farms in the cotton-belt farmers cannot keep sufficient live-stock to depend on barnyard manure as the principal source of organic matter for all of the cultivated land. Hence, it is necessary that the manure be supplemented with green-manures. The following data relative to the use of green-manures in corn production was secured by the Alabama Station:

TABLE 18. RESULTS FROM THE ALABAMA STATION SHOWING VALUE OF STUBBLE AND VINES OF VELVET BEANS AND COWPEAS AS FERTILIZER FOR CORN ¹ 1901

SYSTEM	BU. OF CORN PER ACRE	INCREASE PER ACRE (BUSHELS)
Corn following corn	13.6
Corn following velvet bean stubble	17.9	4.3
Corn following velvet beans, entire growth plowed under	25.9	12.3
Corn after drilled cowpea stubble	11.4	
Corn after drilled cowpeas, all plowed in	20.3	8.9

The profits resulting from the application of vegetable matter to corn land cannot be measured by the crop yield immediately following the application. A marked residual effect is usually noticed for a number of years following the treatment.

270. Lime for corn. — A review of the experimental evidence regarding the use of lime for corn strongly indicates that corn is not a lime-loving plant. According to the Bureau of Soils, United States Department of Agri-

¹ Ala. Agr. Exp. Sta. Bul., 134.

culture (Bul. 64), one hundred and sixty-eight experiments conducted by experiment stations in this country on the use of lime for corn show an average increase of 3.2 bushels an acre at a cost of \$8.91 for the lime. While lime is an essential plant-food, most soils are abundantly supplied in so far as the requirements for growth are concerned. A 50-bushel corn crop requires approximately 12 pounds of lime. When lime is required it is usually as a soil amendment rather than a direct food for the crop.

The soil conditions which would respond profitably to an application of lime in producing corn may be divided into three classes: (1) Low-lying soils that have remained wet for a number of years and, following drainage, remain sour; (2) upland sandy soils to which large quantities of vegetable matter have been added, the decomposition of which would sour the soil; (3) heavy clay soils in humid regions, where the aeration is poor and consequently the plant-food is in an unavailable form.

271. Fertilizers for corn. — The fertilizer practice in the production of corn in the cotton-belt has been much abused. Two mistakes are most often noticed. (1) The application of complete ready mixed fertilizers regardless of the needs of the particular soil in question; (2) depending upon fertilizers to offset the ill-effects of the one-crop system, poor tillage, and lack of drainage. The most profitable returns from fertilizers are possible only when they are employed to supplement the other essential features of good soil management.

272. Plant-food removed by corn. — The requirements of corn for the three plant-food constituents that are recognized as having money values in commercial fertilizers are indicated on page 224:

TABLE 19. APPROXIMATE AMOUNTS OF NITROGEN, PHOSPHORIC ACID AND POTASH REMOVED BY A 50-BUSHEL CROP OF CORN (Pounds)

	NITROGEN	PHOSPHORIC ACID	POTASH
50 bu. grain	47	19	15
3000 lbs. stover	24	14	39
Total in grain and stover	71	33	54

When total yield of dry matter to the acre is considered, corn does not make an excessive demand on the soil for food. Nevertheless, the amounts removed are appreciable. The nitrogen should always be returned in amounts greater than that contained in the crop to offset the loss from leaching. The phosphoric acid and potash should be returned in all cases except where the soil contains large natural supplies of these materials.

It should be noticed that two-thirds of the total nitrogen and the greater part of the phosphoric acid removed from the soil are in the grain. The stover contains nearly three-fourths of the total potash. Even if only the grain was removed and the stover returned to the soil the supply of nitrogen and phosphoric acid in the land would be materially decreased. Sound fertilizer practice, however, is not based on supplying to the soil the plant-food constituents in the same proportion in which they are removed in crops.

273. Soils and fertilizers. — The nature and amount of fertilizing materials most profitable for corn are determined largely by the character of the soil on which the crop is grown. The method of determining the fertilizer needs of soil for cotton is given in paragraph 100. This same principle is equally applicable to corn. That best results

are not necessarily secured when the fertilizing constituents are applied to the land in the same ratio to each other as they occur in the plant has been demonstrated by several experiment stations. The results from the Ohio Station are given:

TABLE 20. FERTILIZER TESTS WITH CONTINUOUS CORN CULTURE AT THE OHIO AGRICULTURAL EXPERIMENT STATION. AVERAGE FOR 16 YEARS, 1894-1909 ¹

Plot No.	FERTILIZING MATERIALS (Pounds per acre)	YIELD PER ACRE		INCREASE						
		Grain (Bu.)	Stover (Lbs.)	Grain (Bu.)	Stover (Lbs.)					
1	None.....	22.22	1441					
2	<table border="0"> <tr> <td rowspan="3" style="vertical-align: middle;">{</td> <td>Acid Phos. 160</td> <td rowspan="3" style="vertical-align: middle;">} Arbitrary quantity</td> </tr> <tr> <td>Mur. Potash 100</td> </tr> <tr> <td>Nitrate Soda 160</td> </tr> </table>	{	Acid Phos. 160	} Arbitrary quantity	Mur. Potash 100	Nitrate Soda 160	42.71	2326	22.08	949
{	Acid Phos. 160		} Arbitrary quantity							
	Mur. Potash 100									
	Nitrate Soda 160									
3	<table border="0"> <tr> <td rowspan="3" style="vertical-align: middle;">{</td> <td>Acid Phos. 60</td> <td rowspan="3" style="vertical-align: middle;">} Ratio in corn plant</td> </tr> <tr> <td>Mur. Potash 30</td> </tr> <tr> <td>Nitrate Soda 160</td> </tr> </table>	{	Acid Phos. 60	} Ratio in corn plant	Mur. Potash 30	Nitrate Soda 160	34.95	1946	15.90	634
{	Acid Phos. 60		} Ratio in corn plant							
	Mur. Potash 30									
	Nitrate Soda 160									
4	None.....	17.46	1246					

274. Relative importance of fertilizing constituents. —

A review of the experimental evidence regarding the relative value of the different fertilizing constituents when applied to corn in the cotton-belt shows that in the majority of cases nitrogenous fertilizers have increased the crop to a much greater extent than other kinds. There are two important reasons why this is true. (1) Corn makes more excessive demands on the soil for nitrogen than for other food elements. (2) Southern soils in general are low in organic matter and therefore deficient in nitrogen.

The profits from the use of phosphatic fertilizers are, as

¹ From Montgomery's "Corn Crops," p. 139.

a rule, greater than from those supplying potash, due doubtless to the greater abundance of potash in most normal soils. The sandy soils of the Coastal Plains region are generally quite deficient in plant-food and respond to the use of a complete fertilizer. The nitrogen supply, however, should be maintained by the use of barnyard manure and leguminous green-manures.

275. When to apply fertilizers. — The usual practice in the cotton-belt is to apply the fertilizer for corn either a short time before or at the time the crop is planted. This is especially true of phosphatic and potassic fertilizers. When rather heavy applications are to be made, say 400 to 800 pounds to the acre, it is good practice to apply a portion of the fertilizer before or at the time of planting, withholding the remainder for intercultural application. In determining the best time to apply fertilizers for corn, one should consider the nature of the materials used. Readily soluble nitrogenous fertilizers, such as nitrate of soda, should not be applied (except in small amounts), before the crop has become well established, and can therefore utilize the fertilizer at once and prevent loss from leaching. It would be wasteful, however, to apply any nitrogenous substance late in the growing season. One of the chief functions of nitrogen is to produce growth. Its late application prevents it from exercising this function.

276. Method of applying fertilizers. — Various methods are employed in applying fertilizers for corn. When heavy applications are to be made, broadcasting the fertilizer on the land after plowing and incorporating it in the soil with a harrow, is an excellent practice. Applications up to 300 pounds an acre are usually drilled in or applied in the hill. Drilling with some form of fertilizer distributor is preferable. A combination method

of broadcasting and drilling is sometimes used. One advantage of the method is that the fertilizer applied in the drill furnishes plant-food during the first growth before the roots are developed and that which is sown broadcast helps the later growth when the roots spread out. Inter-cultural applications may be broadcast between the rows and cultivated in, or they may be drilled in six or eight inches from the row when the corn is eight to twelve inches high.

277. Fertilizer formulas for corn. — The fertilizer formulas here given are merely suggestive. They should not be adhered to too strictly, as the needs of the soil in question must receive first consideration. The ordinary corn fertilizer most commonly used in the cotton-belt contains 8 to 10 per cent available phosphoric acid, 1.65 to 2.5 per cent nitrogen and 1 to 3 per cent potash. The usual application is from 150 to 400 pounds to the acre.

For general use a mixture of acid phosphate and cotton-seed meal makes a good fertilizer for corn. The relative proportion of these materials will depend on the soil.

Well-improved lands, lands that are comparatively new, or well-drained bottom lands are usually benefited by acid phosphate at the rate of 100 to 200 pounds to the acre.

For soils rich in potash, Halligan recommends the following formula for corn:

2 parts cotton-seed meal	}	400 lbs. to the acre.
1 part acid phosphate		

The Texas Station recommends the following formula for corn on worn soils:

Acid phosphate, 14 per cent	900 pounds
Cotton-seed meal	900 pounds
Kainit	150 pounds

The above fertilizer would contain 7.2 per cent phosphoric acid, 1.6 per cent potash and 3.6 per cent nitrogen. It is recommended that it be applied at the rate of 200 to 400 pounds to the acre.

Hutchinson of the Mississippi Station says:

"A mixture of 750 pounds of cotton-seed meal and 1250 pounds of acid phosphate to the ton makes a good fertilizer for this state. From 125 pounds to 200 pounds of this mixture should be used to the acre under cotton and corn and should be applied in the drill or bed at the time of preparing the land for planting."

Duggar, of the Alabama Station suggests the following fertilizer formulas for corn:

- | | | |
|-----|---|-------------------------------|
| (A) | 100 pounds acid phosphate | } (both just before planting) |
| | 50 pounds nitrate of soda | |
| | 50 pounds nitrate of soda, at second cultivation. | |
| (B) | 100 pounds acid phosphate | } (both before planting) |
| | 200 pounds cotton-seed meal | |

For very sandy soils:

- 100 to 200 lbs. acid phosphate
- 100 lbs. nitrate of soda (or 200 pounds cotton-seed meal)
- 50 to 100 lbs. kainit.

278. Some general principles. — Experience and experiment station results in the cotton-belt have revealed some general principles underlying the use of fertilizers in corn production that should be kept in mind.

(1) Fertilizers are most profitable when used in connection with a well-planned cropping-system which supplies the soil with an abundance of organic matter and most of its needed nitrogen.

(2) A suitable cropping-system, including the careful saving of all manure, together with the use of a phosphatic

fertilizer will maintain the normal soils of the cotton-belt at a high level of productiveness.

(3) Nitrogen is too expensive to purchase in commercial fertilizers to supply the entire needs of the corn crop. It should be supplied by growing legumes and applying barnyard manure.

(4) It seldom pays to use fertilizers, (a) where corn is grown continuously; (b) on land that is deficient in organic matter; (c) on land that has been poorly prepared. Under such conditions a relatively small percentage of the fertilizer is used by the crop.

CHAPTER XIX

PREPARING THE SEED-BED FOR CORN

CULTURAL methods for any crop must vary with the local situation. Any discussion of this phase of corn production, to be applicable to the entire cotton-belt, must deal largely with basic principles rather than with details. The basic principles underlying the preparation of the seed-bed for corn are (1) modifying the soil in such a way as to enable it best to meet the special demands of the crop for food and water, and (2) protecting the crop from weeds, insects, or parasites. The farmer himself must determine by study and experience the detailed system whereby these principles are to be most profitably applied on his own farm.

PLOWING THE LAND

279. Destroying the stalks.—The southern corn-grower often follows the undesirable practice of growing corn every year on the same land. Where rotation is practiced, corn most often follows cotton. In either system the old corn or cotton stalks must be disposed of previously to plowing the land for the succeeding corn crop. Often these stalks are burned. Such a practice is never warranted in the cotton-belt where the greatest need of the soil is organic matter. To destroy the stalks so that they can be easily plowed under, one of the following methods may be followed. (1) By use of the stalk-

cutter. This is an implement with one or two heavy revolving cylinders set with knives that cut the stalks in short lengths. The stalk-cutter is sometimes followed with a disk-harrow. (2) By breaking down the stalks with a log or heavy iron rail, and following with a sharp disk to cut them up. (3) Corn stalks may be cut into two or three sections with a hoe and the cotton stalks broken by beating them with a heavy stick during the frosty mornings of winter.

280. Time of plowing. — Soils may be divided into two classes as regards the most desirable time of plowing for corn. (1) Those soils that are best plowed in the fall or early winter. (2) Soils that may be satisfactorily plowed in late winter or early spring.

Soils that are advantageously plowed in the fall or early winter are (1) heavy clays; (2) soils covered with large quantities of stubble or crop residue in any form, and (3) land infested with the larvæ of injurious insects.

Fall plowing makes available the large stores of potential fertility in clay soils. The free circulation of air through these soils during the winter months permits important chemical changes, such as oxidation, to take place whereby those elements of plant-food that are tenaciously held in combination with other matter are changed into new forms easily absorbed by plants. By the same processes compounds deleterious to plant growth are destroyed. The soil is also permitted to absorb readily and store up for future use the winter's heavy rainfall.

Plowing under large quantities of organic matter in the fall or early winter gives sufficient time for this substance to decompose before the growing season. Thus the plant-food constituents contained in the organic matter are available to the crop, and in addition the acid

by-products of this decomposition will have made soluble much of the native plant-food in the soil. The added humus benefits the structure of the soil, increasing its water-holding capacity.

Loose sandy soils, if plowed in the fall, will suffer considerable loss from leaching during the winter months. This is especially true if the land is left bare. Such soils should not be plowed until late winter or early spring. It is not advisable, however, to defer plowing until immediately before planting as the seed-bed will be too loose for best results.

It is often impossible to plow land in season, owing to unfavorable weather conditions. Land should never be plowed when wet enough to prevent proper pulverizing.

281. Depth of plowing. — This must be governed by the character of the soil, its previous treatment, and the time at which the plowing is done. In general, clay soils should be plowed deeper than sands. A very heavy clay soil should be plowed deep at least once each year. Soils of medium texture may produce satisfactorily with deep plowing every two or three years. The practice of deepening clay soils should be gone about cautiously. Plowing up large quantities of inert subsoil at one operation will temporarily decrease productiveness. The increase in depth should be secured gradually by plowing an inch deeper each year until the desired depth has been reached. For best results all land should be occasionally plowed 8 to 10 inches deep.

The earlier in the season at which plowing is done and the greater the amount of vegetable matter to be plowed under, the greater is the increase in depth that can be secured without experiencing any ill effects.

282. Covering rubbish. — An important object of

plowing is to cover weeds, stubble and rubbish of all kinds. This work may be greatly facilitated by the use of various kinds of attachments, the most common of which are: (1) coulters; (2) jointers; and (3) drag-chains. Coulters are of two general types: (a) blade coulters and (b) fin coulters. Blade coulters are attached to the beam or share and adjusted so as to cut the furrow-slice free from the side after the soil has been raised somewhat by the mold-board. The roots are then most easily severed. A fin coulter is merely a knife edge attached to the share. The jointer is used chiefly in plowing sod land. It consists of a miniature mold-board attached to the beam and adjusted so as to cut and turn under the top part of the furrow-slice. The result is that the plow turns a neat clean furrow without leaving a portion of the rubbish exposed. The drag-chain is used primarily in turning under heavy growths of weeds or green-manure crops. It consists of a heavy chain, one end of which is attached to the central part of the beam, the other end being fastened to the double-tree on the furrow side with slack enough to drag down the vegetation on the furrow-slice just ahead of the turning point.

283. Subsoiling. — This operation is defined and the precautions to be taken in connection with the practice are outlined in paragraph 119. A number of experiments have been conducted by southern experiment stations to determine the effects of subsoiling land for corn. Many of these experiments have shown no beneficial effects. In some cases negative effects have been noticed. However, where subsoiling has been practiced in the fall on lands underlain near the surface with an impervious clay subsoil, beneficial results have usually been secured.

PREPARATION OF PLOWED LAND

284. Treatment of plowed land.—The treatment of the land from plowing to planting is given with various types of harrows. Special conditions may require the use of compacting implements. The primary objects sought for in the preparation of plowed land are (1) pulverizing clods, (2) conserving moisture, (3) killing weeds, (4) compacting the subsurface, and (5) leveling the surface. The amount of harrowing that must be given the land after plowing will depend upon (1) the character of soil, (2) the condition of the land when plowed as well as its previous treatment, and (3) the time at which the harrowing is done. Clay soils require more fitting than loams or sands. It is of the utmost importance that clay soils be harrowed as quickly as possible after plowing. One harrowing within a few hours after plowing will accomplish as much as three or four harrowings after the clods are dry. This is especially true of soils plowed in late winter or spring. Fall-plowed soils, if not planted to a cover-crop, are often left in a rough condition until after the rainy season. Under such conditions the tendency to run together in a compact condition is not so great. Heavy soils that have been plowed when too wet or that have been pastured during rainy weather are prepared with extreme difficulty. In fact it is almost impossible to secure an ideal seed-bed under such conditions. This emphasizes the extreme folly of such practices. A good loam or sandy soil, if plowed when in proper condition, may require very little harrowing to secure a good seed-bed.

285. The disk-harrow.—This is unquestionably the best tool for pulverizing to a depth of several inches. The importance of pulverizing all clods in the seed-bed before

planting cannot be overestimated. Large lumps massed together have between them much air space. Such a condition not only allows the rain water to percolate to lower depths too rapidly, but it admits too much surface air which rapidly dries out the lumps and robs the seed-bed of its moisture. A seed-bed must consist of well-firmed fine earth if roots are to penetrate it readily. For pulverizing sod, stubble or corn-stalk land, the full-bladed disk is preferable. For compact soils, the cutaway disk is a good implement.

286. The smoothing harrow. — On land that is free from large clods and trash some form of smoothing harrow is the best implement for smoothing the surface, killing weeds, and conserving moisture. The adjustable slant-tooth and lever forms are more practical and popular. Farmers with sufficient acreage to justify it are advised to use the large four-section harrows because of the high price of farm labor. With such an implement one man and four horses can harrow from thirty to forty acres in a day. These harrows should be more generally used. They leave the ground in a most excellent state of tilth.

287. Special harrows. — Other types of harrows used for special purposes in the preparation of corn land are the spring-tooth harrow, the acme or curved-knife form of harrow, the weeder and the meeker harrow. The spring-tooth harrow has a decided value for stony land or in timbered sections where the teeth are likely to catch on roots. The acme harrow is most useful in the later stages of pulverization on soil free from stone and stalks. It consists of a series of twisted blades which cut the soil and work it over. Where stalks are present they ride over them too easily. The weeder is a modified form of spring-toothed harrow adapted primarily to killing weeds. It

is for shallow tillage on friable, easily worked soil. The meeker harrow is merely a series of lines of small disks arranged on straight axles. It is used primarily for the pulverization of numerous small hard lumps on the surface.

288. Subsurface packers. — A fairly compact seed-bed is desirable at planting time. When plowing is done long in advance, rains usually accomplish this object. Soils that are plowed after the rainy season, or immediately before planting, are much benefited when some implement is used upon them that will bring the furrow-slice in close contact with the subsoil, firm the seed-bed, and leave a loose mulch on top. In arid sections, fall-plowed lands are usually benefited by this treatment. It prevents the rapid drying out of the plowed portion and consequently the loss of much water from the subsoil. An excellent implement for accomplishing this purpose is the Campbell form of subsurface packer. It "consists of small wheels placed five inches apart on an axle. The rim is much thickened and is triangular in shape, with the thin edge outward, so that the effect is to give a decided downward and sidewise pressure, while enough fine earth is left at the immediate surface to serve as a mulch."

When a subsurface packer is not available, a disk-harrow may be made to serve the purpose by having the disks set with very little angle and weighted to force them deeply into the soil.

289. Ridging corn land. — In certain sections of the cotton-belt, notably on the stiff, waxy lands of Alabama, Mississippi, and Texas, some farmers follow a system of ridging or forming beds on which the rows of corn are planted. For poorly drained soils that compact readily after rains this system possesses some advantages, pro-

vided the ridges are not left too high. It provides increased drainage and warmth and obviates, to an extent, the tendency of these soils to become quite compact as a result of the spring rains. It must be remembered, however, that ridged land exposes more surface to evaporation and crops are more subject to drought when this system is followed than when the land is cultivated level. Even where the ridging of the land is necessary, the ridges should be partially harrowed down before planting.

290. Wide beds for corn. — A modification of the ridging system whereby surface drainage is facilitated and the advantages of level planting are partially secured has been tried with excellent results by some of the southern stations. This system is described by Duggar as follows:

“Prepare the field by back-furrowing so as to make eight-foot lands, or lands of double the width desired for a single row. Plant two rows four feet apart on this eight-foot land. This places each row two feet from a water-furrow on one side. The other side of the same row can be tilled level.”

CHAPTER XX

PLANTING AND CULTIVATING THE CORN CROP

UNQUESTIONABLY the two most important reasons for the low yield of corn in the South are the poor cropping systems of the region and lack of care in the preparation of the seed-bed. Until these two serious defects have been corrected the southern corn-grower cannot expect to receive maximum returns for labor expended in planting and cultivating the crop. Likewise the value of a good soil well prepared may be reduced to a minimum by poor methods of planting or a disregard for correct principles of interculture.

PLANTING THE SEED

Poor stands of corn are often due to the planting of seed of low vitality. The impression that there is no need of testing seed corn in the South has become somewhat general. As there are a great many ways in which the vitality of seed corn may be impaired aside from severe freezing, and as the method of testing seed corn is very simple and inexpensive, the planting of untested seed by any farmer, regardless of his locality, cannot be justified.

291. Testing the seed.—The corn must be tested before the seed is shelled. A box or tray approximately three inches deep and of sufficient size is filled with wet sawdust or sand. This is covered with cloth that has been ruled off in two-inch squares, each square being numbered.

The ears to be tested are placed on a table or convenient place and numbered consecutively. Six grains are taken from each ear and placed in the corresponding square on the cloth. In sampling the ears one should take two grains near the butt, two from the middle and two from near the tip. The grains are covered with a second cloth on which is placed a little sawdust. The whole is thoroughly moistened and kept for six or seven days where the temperature is regular from 60 to 70 degrees F. Moisture should be added once a day during the test. All ears that do not show a vigorous germination should be discarded.

292. Methods of planting corn.— There are three methods of planting corn in the cotton-belt. These are: (1) drilling; (2) checking; (3) listing. The most profitable method will be determined by a number of factors, most important of which are soil topography, injury from weeds and grass, moisture supply, and cost of farm labor.

Drilling.— The greater part of the corn crop in the cotton-belt is, at present, planted in drills. The rolling lands so often suffer from washing that it is necessary to preserve them as much as possible by running the rows at right angles to the slope of the hill, rather than by planting the corn in check-rows. Each row forms a miniature terrace and erosion is thus reduced to a minimum or in many cases, entirely prevented. It is also easier to place fertilizer evenly under drills than under hills. Contrary to the rather general impression that heavier yields are made when the corn is planted in drills, which distribute the plants evenly over the ground, than when it is planted in check-rows, nearly all of the experiments so far conducted have shown no difference, or comparatively small differences due to methods of distribution, when the number of plants to the acre remain the same. Land that is

in such a condition as to necessitate planting on narrow beds or ridges makes checking impractical. Also a large percentage of the corn land in the South is cut up into small irregular shaped fields that do not admit of the ready use of any except one-horse drills in planting. The fact that one-horse drills are much cheaper than check-row planters is partially responsible for their more general use. In regions where the land is level or gently sloping, two-horse drills are coming into general use.

Checking corn. — By this practice the grains are planted in hills so that the rows will run both ways, and can be cross-cultivated. Its advantages over drilling relate largely to economy of production rather than to larger yields. It is especially recommended for level lands that are foul, as it avoids the use of the hoe in keeping down weeds between plants in the drill. Corn is usually checked by using a two-horse check-rower. This is an adjustable implement which permits the planter to space the rows and the distance between the hills to suit the requirements of the land. By means of a wire chain stretched across the field one man and team can plant in straight rows in both directions, 12 or 15 acres a day. Corn is sometimes checked by hand, the rows being carefully laid off at uniform distances each way. The seed is dropped where the furrows intersect.

As the price of farm labor in the cotton-belt advances, the practice of checking corn will become more general on the level lands, and the laborious practice of "hoeing corn" will be abandoned.

Listing corn. — The practice of planting corn in a deep furrow made with a double-mold-board plow known as a "lister" has become quite general in the drier regions west of the Mississippi River. Usually the furrows are

opened and the corn planted without any previous preparation of the land. As a rule, this practice cannot be recommended, especially if the soil is stiff and heavy. The land should be plowed in the fall to conserve moisture. If it is not desirable to flat-break the land the lister may be run in the fall and the land kept harrowed during the winter. In the spring the ridges may be split out with the lister and the corn planted.

When planted in a deep furrow the corn is better enabled to endure drought, the plants are not so easily blown down, and weeds in the corn rows are more easily covered by cultivation. The chief advantage is that of inducing the plants to root deeply in the soil. Listing corn should not be attempted except in regions of deficient rainfall, and preferably only on the loamy or sandy soils.

Planting corn in the water furrow is practiced with excellent results on the permeable sandy hill or ridge lands of the South. By back-furrowing, ridges are made about five feet apart. Usually a narrow strip about eight inches wide between the ridges is left unbroken until planting time. This is thrown out with a shovel plow and the seed planted immediately. This method cannot be recommended for heavy soils, or soils well supplied with moisture.

293. Time of planting. — Throughout the cotton-belt it is the general experience that corn planted early yields better than medium or late plantings. While the planting season is much longer in the cotton-belt than in regions farther North, the growing season is so often shortened by the mid-summer and fall drought as to render the late plantings very uncertain. Late planted corn matures in less time than the early plantings. This tends towards decreased yields. Growing conditions are most

favorable in the spring and early summer. Corn should be planted sufficiently early to reap the advantages of these favorable conditions. Also the attacks of bud-worms are often escaped by planting the crop early. Where corn is subject to injury by bud-worms it should be planted either as early as possible or rather late. The late planted corn rapidly grows beyond the stage in which it is attacked by these insects. Also the soil becomes so warm as to discourage them. It is thought that late planting reduces the injury from weevil by reason of the late date of maturity.

While the early plantings, as a rule, give the best results nothing is to be gained by putting seed in soil that is too cold or too wet to favor germination. Planting should always be deferred until the ground is sufficiently dry to work well and warm enough for immediate growth. In the southernmost part of the cotton-belt, corn planting begins in February and becomes general by the first of March. As one proceeds North the average date of the planting season gradually becomes later, being March 15th for the middle part of the Gulf states, and April 1st to 15th for the northern part. The optimum season for planting corn in the different regions of the United States is shown on page 243.

294. Depth of planting. — This varies with the temperature and moisture of the soil. As a rule early planting should be shallow, not over one inch, as at this time only the surface soil is warm enough to germinate the seed. Stiff heavy clays, especially those lacking in humus, should be planted shallow, otherwise rains may so pack the soil as to prevent the seed from coming to a stand. The lighter, sandy soils should be planted deeper to insure sufficient moisture for germination. These soils also warm

TABLE 21. TIME OF PLANTING CORN IN CERTAIN REGIONS ¹

REGION	BEGINNING	GENERAL	ENDING	PLANTING PERIOD, DAYS
Gulf States.	March 15	April 5	May 10	55
Central States: (Virginia to Kansas).	April 15	May 1	May 25	40
Northern States: (New York to Minnesota).	May 10	May 20	June 1	20

up readily in the spring. In dry regions it is often necessary to plant corn three or four inches deep. As a rule planting deeper than two inches is undesirable. When the seed is planted deep much of the food supply stored in the grain must be consumed before the young plant can establish its root-system, reach the surface, and expand its leaves. As the depth to which the seed is covered does not influence the depth of the root-system, the primary consideration is securing sufficient warmth and moisture to insure favorable germination and immediate growth.

295. Importance of getting a stand. — Every missing plant means wasted land and labor and decreased yield. As a rule replanting does not pay. The replants seldom produce much grain owing to the fact that they are surrounded by plants that mature their pollen before the younger silks are formed, and the pollination of the later-planted stalks is incomplete. Also the replants are often cut short by dry weather. Precaution should be taken to secure a favorable stand at the first planting. Where

¹ U. S. Dep't of Agr. Yearbook 1910, p. 491.

a very poor stand has been secured, the better plan would be to make an entire new planting.

296. Distance between rows and hills. — The proper spacing of corn plants is affected so much by local conditions that little specific information on this point can be given. It is a question that each farmer must decide, by observation and experience, for himself. The following general facts should be kept in mind:

(1) For greatest production thicker planting should be practiced on rich soils, and soils supplied with an abundance of moisture, than on poor or droughty soils.

(2) Varieties with small or medium sized stalks should be planted thicker than those with large stalks.

When corn is planted too thick the weight of stover increases and the production of good ears decreases. Too thin spacing will decrease the yield of both stover and grain.

Distances that are widely applicable in the cotton-belt are: (1) for soils of low fertility, rows 5 feet apart and plants 3 feet, or checks approximately 3 feet, 10 inches each way; (2) for soils of medium productivity, rows $4\frac{1}{2}$ feet apart and plants $2\frac{1}{2}$ feet, or checks 3 feet, 4 inches each way; (3) for fertile soils well supplied with moisture, rows 4 feet apart and plants $1\frac{1}{2}$ feet, or checks $3\frac{1}{2}$ feet apart each way with two plants in a hill.

Distance tests at the Alabama and Georgia stations show a small increase in yield from so dividing the space allowed for each plant as to give practically the same distance between plants as between rows. However, wider rows permit of more economical cultivation and as the difference is small it can be well sacrificed.

CULTIVATING THE CROP

297. The objects of interculture in corn production are: (1) the destruction of weeds; (2) the conservation of moisture; (3) increasing the availability of plant-food by soil aeration, and (4) preventing run-off of rainfall by keeping the surface loose and porous.

The relative value of each of the above objects will vary according to locality and season. On all soils in arid regions, except the adobe soils, the conservation of moisture is of first importance whereas the soil aeration resulting from interculture has little or no value owing to the natural high porosity of arid soils. Numerous carefully conducted experiments have shown that in humid regions the destruction of weeds is unquestionably the function of primary importance in crop cultivation. This function may, however, take a secondary place during seasons of limited rainfall or periods of protracted drought. Again on certain compact clays in humid regions, soil aeration may become paramount among the objects of interculture. The studious farmer will become familiar with the objects of interculture and will strive to secure them to the greatest degree without injuriously mutilating the root-system of his crop.

298. Importance of thorough early cultivation. — For best results corn must make a steady vigorous growth from germination to maturity. The effects of an unfavorable condition which checks the early growth of the crop cannot be overcome by any amount of subsequent cultivation. Thrifty, strong, thick corn plants are most generally the result of proper treatment during their early growth.

The seed-bed being properly prepared, cultivation should

begin soon after planting. Horse weeders or the common smoothing harrow should be used as often as needed to break a surface crust or to kill weeds during their early growth. Weeds are most easily and economically destroyed when they are only a few days old. For trashy land the weeder is preferable to the smoothing harrow. The use of the weeder or harrow should be continued until the corn is six or eight inches high. These implements are light and do not penetrate the soil deeply. Consequently wide ones can be used and a large area of land passed over in a day. These are the most economical cultivations that the crop receives.

299. Cultivation by separate rows. — When the corn reaches a height that will not permit the use of weeders or harrows, tillage by separate rows should begin. On level land two-horse cultivators should be used until the corn gets so tall that the rows cannot be straddled without injury to the plants. High-priced labor makes the use of these improved implements imperative. Late cultivations may be given with one-horse implements. When it is necessary to use cultivators while the plants are quite small, fenders should be attached to prevent injuring the plants or covering them with clods.

300. Depth and frequency of cultivation. — Under certain conditions the first cultivation by separate rows may be deep and thorough, as when heavy rains before or after planting have rendered the soil so compact as to form a poorly aerated seed-bed. All other cultivations should be shallow. The object should be to maintain at all times a uniform soil mulch covering the entire space between the rows. The most desirable depth of mulch will depend on conditions. Where rainfall is abundant the mulch should not be deeper than $2\frac{1}{2}$ inches. Where

droughts are common or in regions of scanty rainfall a depth of 3 or 4 inches may be necessary. Whatever the conditions, the desired depth of mulch should be established while the corn is young and no attempt should be made to deepen it later in the season; such a practice is sure to check the growth of the crop by mutilating its root-system.

Corn should be cultivated often enough to keep down weeds and maintain constantly a loose mulch on the soil. In humid regions this usually necessitates cultivating the crop every ten to twelve days. As a rule the cultivations are given less frequently than is desirable.

301. Value of late cultivation.— Most farmers “lay by” corn too soon. Conditions often demand that the crop be cultivated after the plants are tasseling. These late cultivations should be exceptionally shallow. The prejudice that has sprung up against cultivating corn late is due largely to a disregard for proper precautions, especially as regards depth of cultivating. At this season the roots are very near the surface. This is especially true if the later part of the growing season has been excessively rainy.

302. Kinds of cultivators.— Cultivators are of two general types: shovel cultivators and disk cultivators. The evolution of the shovel cultivator is briefly summarized in the following statement by Montgomery:¹

“The first horse cultivators were single shovel plows consisting of a very broad mold-board shovel mounted on a beam, with handles to guide. Later two narrower shovels were substituted for the single broad shovel. Though this was an improvement, it was still necessary to go twice in each row for thorough cultivation. Later two of these

¹ Montgomery, E. G., “Corn Crops,” p. 199.

double shovel plows were rigged on a two-wheel sulky, thus enabling the operator with two horses to cultivate both sides of a row at one time. The corn cultivator is still built essentially on this principle with many types of shovels and improvements for ease in controlling."

One-horse shovel cultivators are still quite extensively used in the cotton-belt. They are usually equipped with many small points, or with various forms of heel-scrapes, or sweeps. These one-horse implements are gradually being replaced by two-horse cultivators. The double cultivators are made either with handles, as walking cultivators, or with a seat, as riding cultivators. Two-rowed cultivators equipped with four gangs of shovels and drawn by three horses are little used as yet, in the cotton-belt. These implements are rapidly coming into favor with the corn growers of the central prairie states.

The kind of shovels that should be used on corn cultivators is determined somewhat by the character of the soil. The object should be to break the soil between the rows thoroughly to the proper depth without leaving it in ridges. This result is usually most satisfactorily accomplished by decreasing the size of the shovels and increasing their number. Sweeps give good results on friable soils. They vary in width from six to thirty inches. When used they should be so adjusted as to allow the soil to pass over them and fall level behind the cultivator. Any form of shovel that will do good work on a single-cultivator can be readily attached to a double-cultivator.

Disk cultivators, when properly operated, do excellent work, especially on soils that are in poor physical condition and need pulverizing.

303. The McIver Williamson method of corn production. — Within recent years much has been written with reference to a system of corn culture originated by McIver Williamson of South Carolina. In devising this method Williamson had for his primary object the stunting of the corn during its early growth so as to prevent the production of stalk at the expense of grain. The essence of the Williamson method is thus summarized by the Georgia Station:¹

“First. Breaking the land broadcast and deeper than is customary. Using disc plow in preference to old two-horse plow.

“Second. No fertilizer at or previous to the time of planting, thus hindering growth.

“Third. Rows six feet apart, plants eleven inches in the drill.

“Fourth. Feeding the plants with an open hand — thus: 200 pounds of cotton-seed meal; 200 pounds of acid phosphate; 400 pounds of kainit, making 800 pounds an acre of high grade material, carefully mixed. In addition to the 800 pounds, fed as the plants grow, 125 pounds of nitrate of soda per acre as a side application.

“Fifth. Planting soon as all danger of frost is passed.

“Sixth. When plants are 12 to 18 inches in height, begin to feed them; then follows rapid and shallow cultivation.”

Several stations have compared the above method of corn production with the ordinary method in which the fertilizers were added before planting, and frequent and thorough cultivation given from the start. The results of these tests have in almost all cases favored the ordinary

¹ Summarized from Bul. 97, Ga. Agr. Exp. Sta.

method. Three years' results from the Georgia Station are given below:

TABLE 22. SHOWING CORN YIELDS FROM WILLIAMSON METHOD AS COMPARED WITH ORDINARY METHOD OF CORN PRODUCTION ¹

METHOD	BUSHEL OF SHELLED CORN PER ACRE			
	1908	1909	1910	AVERAGE
Ordinary Method	34.11	26.19	42.25	34.18
Williamson Method	22.87	34.23	40.78	32.62

NOTE.—For complete discussion of the Williamson method of corn culture, see bulletins 78, 84, 88, and 97 of the Georgia Station.

¹ Summarized from Bul. 97, Ga. Agr. Exp. Sta.

CHAPTER XXI

HARVESTING AND STORING THE CORN CROP

WITHIN the last fifteen years much progress has been made in the methods of harvesting the corn crop in the cotton-belt. Yet it is unquestionably true that the harvesting practices now in general use by the southern corn-growers are more crude and unprofitable than those commonly employed by farmers in any other region of the United States. The primary reasons for the southern farmers' relatively slow progress in corn harvesting methods are: (1) the limited area devoted to corn on the average cotton-belt farm; (2) the poor adaptability of a large percentage of southern farms, as regards size, shape, and topography of fields, to the use of improved machinery; (3) the excessive height to which southern corn grows under certain conditions, rendering the use of the corn harvester impractical; (4) the climatic conditions in the greater part of the cotton-belt are more unfavorable to the proper field curing of corn fodder than in other regions of the United States.

HARVESTING CORN

304. Time of harvesting. — Corn should be harvested when the largest amount of digestible food can be secured. Both the total dry weight and valuable feeding nutrients continue to increase until the crop is

mature as shown by the following data from the Michigan Station:

TABLE 23. YIELD TO THE ACRE OF DRY WEIGHT AND FEEDING NUTRIENTS IN CORN

	DRY MATTER, POUNDS	PROTEIN, POUNDS	NITRO- GEN-FREE EXTRACT, POUNDS	FAT, POUNDS	FIBER, POUNDS
Plants in tassel	3,670	472.7	1,828	67.9	1,010
Ears in milk . .	5,320	576.0	3,212	143.1	1,148
Ears in glazing	7,110	711.0	4,554	199.0	1,294
Ears ripe	8,020	693.0	5,356	242.6	1,413

The foregoing data emphasize the folly of harvesting corn before the ears are hard and glazed, even though the stover is to be utilized for feeding stock.

When the silo first came into use it was thought necessary to fill it with corn cut in a green and very succulent condition. Experience has shown the erroneousness of this idea. The best corn silage is now made when the crop is allowed to stand until it has reached that degree of maturity indicated by rather hard, well dented or glazed kernels and partially dried husks before it is put in the silo. At this stage the crop still contains enough water to pack sufficiently close in the silo to exclude practically all the air and make a silage of high quality.

305. Methods of harvesting. — There are four methods of harvesting corn in the cotton-belt as follows:

(1) Stripping the leaves while green for forage and harvesting the ears later.

(2) Cutting the tops above the ears for forage, the ears being harvested later.

(3) Harvesting the ears and leaving stalks and leaves in the field.

(4) Harvesting entire plant for fodder or silage.

306. Effect of method of harvesting on yield of grain.—

The practice of stripping the blades while they are green, or of cutting the tops above the ear for forage is especially common in the South. These methods are founded upon the belief that the best quality of forage is thus secured and the yield of grain is not affected, whereas it is thought that harvesting of the entire plant as fodder materially reduces the yield of grain. These methods of harvesting have been investigated by a number of stations, especially those located in the cotton-belt, with the result that the loss of shelled corn from stripping and topping while the leaves are still green generally amounted to 10 to 20 per cent. This is not far from the average loss sustained when the entire plant is harvested for fodder. The Mississippi Station,¹ as a result of three years' trials, found a net loss in feeding value, from topping, of more than 20 per cent. The combined results of seven other stations show an average loss from topping of thirteen bushels an acre, which was said to be "more than the feeding value of the 'fodder' secured."

The Florida Station² found that "pulling fodder" promotes the ravages of the weevil by loosening the husks on the ear before the grains become hard.

If the practice of "topping" corn or of "stripping" the blades is deferred until the kernels have become hard and glazed as indicated by the husks and a large percentage of the lower leaves having dried up the yield of grain may be decreased very little if at all. In this

¹ Miss. Agr. Exp. Sta. Bul., 33, p. 53.

² Fla. Agr. Exp. Sta. Bul., 16, p. 8.

event, however, the quality of the forage would be very poor.

The Alabama Station has investigated the yields of corn from different methods of harvesting with the results shown in the following table:

TABLE 24. YIELDS TO THE ACRE OF CORN FROM DIFFERENT METHODS OF HARVESTING¹

METHODS OF HARVESTING	CORN PER ACRE — BUSHELS					
	1896	1897	1900	1904	Average 4 years	Average loss
Only ears harvested . . .	34.4	31.0	46.9	25.7	34.5	...
Tops cut and ears harvested	30.2	29.2	44.3	26.1	32.5	2.0
Entire plant cut and shocked	29.2	29.5	44.3	25.4	32.1	2.4
Blades stripped and ears harvested	45.9	25.5

307. Yields of forage by different methods of harvesting corn. — The decrease in yield of grain due to pulling the blades or cutting the tops from corn is not the only objectional feature about these methods. They are slow, laborious and expensive methods of securing forage. The yield of forage to the acre seldom justifies the expenditure in labor. With the present advance in the price of farm labor, it is quite evident that corn-growers can no longer adhere to these unprofitable practices. The same amount of time expended in growing and harvesting hay crops will be much more remunerative. Yields of cured corn tops, stover and blades from the different methods of harvesting are reported by the Alabama Station:

¹ Ala. Agr. Exp. Sta., Bul. 134, p. 190.

TABLE 25. YIELDS OF CURED CORN TOPS, STOVER AND BLADES ¹

METHODS OF HARVESTING	AVERAGE YIELD OF GRAIN, BU.	YIELDS OF FORAGE TO THE ACRE — POUNDS				
		1896	1897	1900	1904	AVERAGE
Only ears harvested	34.5
Tops cut and ears harvested	32.5	312	509	711	360	473 tops
Entire stalk cut and ears afterwards harvested	32.1	2103	1355	1759	1980	1799 stover
Blades stripped and ears harvested	615'	415	515 blades

With the yields of grain given above, which are far above the average for the cotton-belt states, less than one-fourth ton of tops is secured from an acre and approximately one-fourth ton of blades. The value of the forage thus secured cannot compensate for the loss of grain and the cost of harvesting.

308. Cutting and shocking the entire plant. — Experiments conducted by the Alabama Station indicate that cutting and shocking corn is more profitable than "topping." If done at the proper time, the yield of grain is not materially decreased. By this method all the forage is saved at a minimum expense and the early use of the land for the next crop is secured. Also the old stalks are not left on the land to interfere with the seeding of small grain. Farmers in the more humid sections of the cotton-belt are somewhat averse to cutting and shocking corn owing to the danger of losing the crop by "rotting" before it can be shredded or otherwise housed from the weather. This danger can be much reduced by decreasing both the size of the bundles and the size of the shocks.

309. Harvesting the ears only. — In sections where hay is easily and cheaply produced, harvesting only the

¹ Ala. Agr. Exp. Sta., Bul. 134, p. 190.

ears and leaving the leaves and stalks to be subsequently pastured or to be plowed into the soil, is highly commendable. The ears may be husked directly from the standing stalks and thrown into a wagon at the same operation. A "throwboard" about 30 inches high should be put on the wagon-box on the side opposite the husker. This

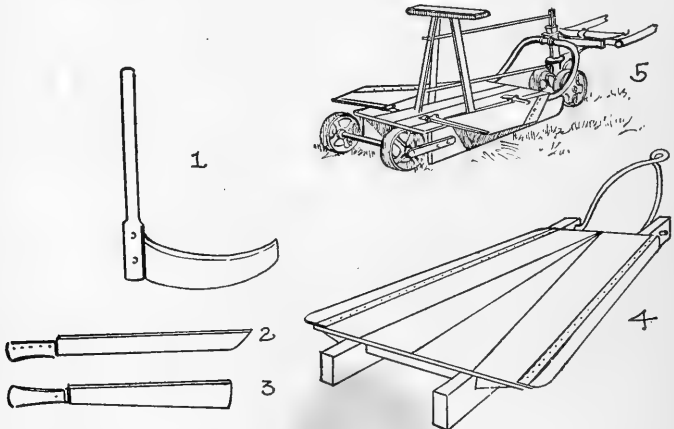

FIG. 40. — Corn harvesting tools: 1, corn hook; 2 and 3, corn knives; 4, a sled cutter; 5, cutter having wheels substituted for the runners and equipped with a seat.

is the method most generally used throughout the corn-belt states.

310. Hand methods of cutting corn. — When cutting and shocking is resorted to in the cotton-belt the cutting is usually done by hand. Various types of hand cutters are used. The short-handled hoe probably came into use first. Later various types of corn knives and corn "hooks" were used. Some of these simple devices are shown in Fig. 40. Where the area to cut does not exceed twenty acres or where the corn is very tall, hand-cutting

is more profitable than maintaining expensive machinery for the purpose. In fact, where farm labor is not exceptionally high harvesting even larger areas by hand is almost as cheap as harvesting by machinery. The advantage of the machine is that it enables the operation to be completed in a shorter time.

311. Comparative cost of harvesting by different methods. — Zintheo¹ has made a study of the comparative cost of harvesting corn by different methods. The following data were obtained from the corn-belt where an average yield of 44 bushels to the acre was being secured:

TABLE 26. COST OF HARVESTING BY DIFFERENT METHODS

Average data for harvesting by hand

Cost of implement	\$ 1.00
Acres one man harvests per day	1.47
Cost of cutting and shocking	1.50 an acre

Average data for harvesting with sled harvester

Cost of implement	\$5 to \$50
Acres two men and one horse harvest per day	4.67
Cost of cutting and shocking	1.18 an acre

Average data for harvesting with corn binder

Cost of implement	\$125.00
Acres cut per day by one man and three horses	7.73
Acres shocked per day, one man	3.31
Cost of cutting and shocking	1.50 an acre

Cost per bushel of picking and husking corn

	Cents
By hand from field	3.5
Team for cribbing	1.
By hand from shock	5.3
Team for cribbing79
By corn picker from field	4.1
By huskers and shredder from shock	4.5

¹ U. S. Dep't of Agr., Office of Exp. Sta., Bul. 173.

312. Corn harvesting machinery. — The simplest horse-drawn implement for harvesting corn is the sled cutter, Fig. 40. One type of sled cutter consists of an ordinary sled with a heavy knife attached in front at the proper height to cut off the corn plants. It is drawn astride of the corn row. Other types have a heavy knife attached to one or both sides and are drawn between the rows of plants. A further improvement is the use of small wheels in place of sled runners. This greatly reduces the draft of pulling the cutter. Usually a man on each side catches the stalks as they are cut. When an armful has been obtained the horse is stopped and the fodder put on the nearest shock. These simple horse drawn cutters can be constructed on the farm at little expense. As there is no expense for twine or repairs, they furnish one of the most economical means of harvesting the corn crop.

About 1895 the corn binder came into use. This machine binds the plants into bundles of convenient size; on it is a bundle-carrier attachment that bunches the bundles, whereby shocking and loading are greatly facilitated. For cutting corn of medium or small size on land that is comparatively level and free of stumps, the corn binder is very satisfactory. On the rich river bottom soils of the cotton-belt the corn grows so tall and bears its ears so high on the stalk as to render the use of the corn binder impractical.

By attaching a "stubble cutter" to the corn binder one may cut the corn stubs as the plants are harvested. This is an excellent practice as it not only hastens the decay of the stubble but leaves the ground in an excellent condition for the succeeding crop.

313. Shocking corn. — Two important precautions must be taken in shocking corn in the humid sections of

the cotton-belt: (1) the plants must be tied in small bundles if the binder is used; (2) the shocks must be small. When cured the fodder may be put in large shocks or stacked. It is of paramount importance that the shocks be so made and tied that they will stand erect and keep the fodder dry. A shocking horse, Fig. 41, is very serviceable for shocking where the corn is cut either by hand or



FIG. 41. — A corn-shocking horse.

with the binder. If a shocking horse is not available, the stalks of four adjoining hills may be twisted together at proper intervals through the field. These four stalks will then form "gallowses" to support the plants in the beginning of the shock. When one cuts corn by hand for small shocks, many unnecessary steps can be saved by following the system outlined in Fig. 42. Hills 1 to 8 make the first arm load and should be cut in consecutive order. Likewise hills 9 to 16 make the second arm load and

so on as indicated until the 64 hills have been cut and shocked.

314. Husking corn. — Much of the corn in the South is stored unhusked owing to the somewhat prevalent belief that the husks serve as a partial protection from the grain-weevil. The correctness of this belief is doubtful as more weevils are transferred to the crib with the un-

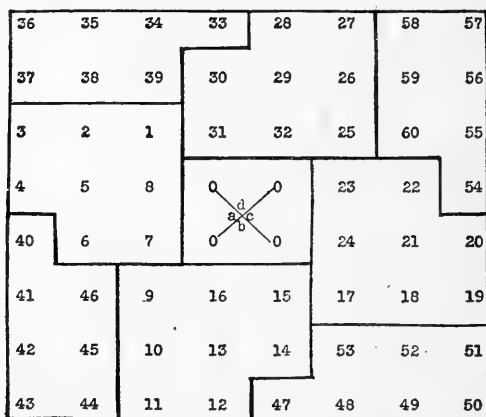

FIG. 42. — Illustrating a method of cutting and shocking checked corn to economize steps.

husked ears than where the husks are removed at a time previous to storing.

Where husking is done before storing one of the following practices is employed, according to the method of harvesting the crop: (1) the ears jerked and afterwards husked; (2) ears husked from the standing stalks; (3) ears husked from the shock; (4) ears husked by means of shredder. A very convenient way is to husk from the standing stalks, the ears being thrown directly into a wagon equipped with a throwboard. Jerking the corn and afterwards husking it requires much additional labor,

the cost of which cannot be offset by the amount of forage furnished by the husks. When husking is done from the standing stalks, "lands" should be laid out and driven around so that the huskers are always on the same side of the wagon. This avoids husking many rows that have been broken down by the wagon. Convenient forms of husking pegs and hooks, are shown in Fig. 43.

315. Shredding corn. — The use of the corn shredder in the cotton-belt is very limited. This machine takes the stalks with the ears and husks and delivers the ears to a basket for storing, and shreds the stalks for feeding. The shredded

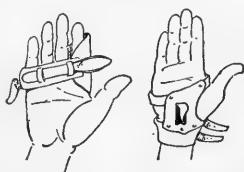

FIG. 43. — Husking peg and husking hook. The former is used for husking fodder corn, the latter for husking standing corn.

stover is delivered to the loft, usually by means of a blowpipe. In the cotton-belt shredding should never be done except when the fodder is very dry; otherwise the shredded fodder will heat. It should always be stored under shelter after shredding.

Many advantages are derived from shredding corn rather than feeding it whole, chief of which are: (1) it may be fed with much less waste, it being estimated that "shredded stover will go 40 per cent farther in feeding cattle than the whole stalks;" (2) it puts the stover in a convenient form for storing and for feeding; (3) the troublesome work of handling manure in which there are long coarse stalks is avoided; (4) the ears are husked with little expense.

STORING CORN

316. Cribs. — Corn ears are usually stored in cribs or bins although rail pens are used for this purpose in

some sections. Storing corn in rail pens is not to be commended.

The principal aims to be kept in mind in constructing corn-cribs in the cotton-belt vary somewhat with conditions. In sections where weevil damage is not great, the primary objects should be good ventilation and protection from rodents, such as rats and mice. Ventilation is usually secured by constructing the sides of the crib of narrow slats nailed in a horizontal position on the inside of the framing. Ventilated sheet-iron cribs are now on the market. Cribs are made rodent-proof in the process of construction by tacking wire netting of about one-fourth inch mesh over the sleepers, the inside of the uprights, and to the joists; the crib is thus lined completely with this material. The wire netting is held in place by putting the flooring and side strips on over it, and tacking the wire well to the joists. The floor should be at least 20 inches from the ground to give good ventilation and avoid making a hiding place for rats.

Where weevils damage the stored corn, the cribs should be tightly constructed so as to permit of the successful use of an insecticide. In storing corn in close cribs one should take precautions to see that the ears are well dried out; otherwise dampness and lack of ventilation will cause the grain to rot in the crib. The treatment of stored grain to prevent weevil damage is discussed in the chapter on insect enemies of corn.

317. Shrinkage of stored corn.—Stored corn may lose in weight after being stored, amounting to 5 to 20 per cent, due primarily to the loss of water. The amount of loss depends upon the moisture content of the corn when stored, the length of the storage period and the humidity of the atmosphere during storage. An average

of eight years' results on the shrinkage of stored corn at the Iowa Station is given:

TABLE 27. AVERAGE OF EIGHT YEARS' RESULTS ON SHRINKAGE OF STORED CORN AT THE IOWA STATION, GIVEN BY MONTHS

MONTH	AVERAGE SHRINKAGE (PER CENT)	AVERAGE SHRINKAGE PER MONTH (PER CENT)
November.....	5.2	5.2
December.....	6.9	1.7
January.....	7.5	.6
February.....	7.8	.3
March.....	9.7	1.9
April.....	12.8	3.1
May.....	14.7	1.9
June.....	16.3	1.6
July.....	17.3	1.0
August.....	17.8	.5
September.....	18.2	.4
October.....	18.2	.0

318. Measuring corn in the crib. — A rule for measuring corn in the crib can be only approximately correct as the moisture content and hence the weight per unit volume of stored corn varies considerably. Usually a bushel of husked ear-corn will occupy approximately $2\frac{1}{2}$ cubic feet of space. C. S. Plumb in his book on "Indian Corn Culture" gives the following rule for measuring husked ear-corn in the crib: "Multiply the length, breadth and height of the crib together in feet to obtain the cubic feet of space it contains. Multiply this product by four (4), strike off the right-hand figure, and the result will be the number of shelled bushels." This rule really figures $2\frac{1}{2}$ cubic feet of corn as a bushel. The legal weight of a bushel of corn when dry and sound is 56 pounds of shelled corn or 70 pounds of ear-corn.

CHAPTER XXII

ANIMAL AND INSECT ENEMIES AND FUNGOUS DISEASES OF CORN

CORN is preyed on by numerous enemies, including crows, rodents, insects, and fungi. Seldom do any of these destroy the entire crop. The corn crop is more easily protected from its enemies than are most other important crops.

ANIMAL ENEMIES

319. Treatment. — Rodents of different kinds, particularly ground squirrels, sometimes dig up and eat the seeds of corn soon after planting. As a partial preventive of this injury the seed may be treated with coal tar before it is planted. The usual method is to stir the seed with a paddle that has been dipped in hot coal tar. This practice is repeated until every seed is covered with a thin coating of the tar. The seed is allowed to dry before being planted. Corn that has been soaked in a strychnine solution may be planted a few days ahead of the regular planting, thus poisoning the rodents.

Crows do some damage, particularly in regions where the acreage in corn is comparatively small. In order to get the kernels they pull up the young plants for a period of ten days after the plants appear above ground. Usually they will not trouble a field for several days after a few of them have been poisoned. Corn that has been soaked for a day or two in a strychnine solution should be placed about

the field soon after the crop is planted and before the crows begin their depredations. Alcohol dissolves strychnine more readily than water and its use is therefore recommended. In small fields, scarecrows, or a string stretched over the field with pieces of paper attached at frequent intervals, are rather effective.

INSECT ENEMIES

320. Causes. — Insect injuries to corn are more common in the southern states than in the northern states. The larger number of these injuries are due to the continuous cultivation of corn on the same land for a number of years. They also occur more frequently after plowing up sod land of long standing. Hence an important feature in the control of many of the insect enemies of corn is the adoption of short systematic rotations accompanied by clean culture of the intertilled crops in the rotation.

321. Corn bud-worms (*Diabrotica 12-punctata*). — These slender worms represent the larval stage of a small beetle commonly known as the twelve-spotted lady bug. These beetles are about one-third inch long, and yellowish green with twelve black spots on the wing coverings. The larvæ are slender thread-like yellowish white worms with a brownish head. They are about one-half inch long. The winter is passed in the adult stage under rubbish or trash or any material that will furnish adequate shelter. The life history of the corn bud-worm is briefly summarized by Sherman as follows:

“The adults pass the winter, emerge very late in the spring, feeding on flowers and foliage, mate, and lay eggs at the base of corn or other plants in which the worms feed; the worms on hatching from the eggs, burrow into the root or stalk of the plant attacked, become grown in

a few weeks, leave the plant and change to the pupa stage in the earth close by, from which the beetles emerge one to two weeks later. Several broods are produced in the course of a season.”¹

The bud-worm injures the corn plants during their early growth, particularly when they are from one to ten inches high. It is worse on low moist bottom lands.

Preventive measures are based largely on the time of planting. Lands subject to the ravages of this insect should not be planted until rather late in the season. Some farmers insist that bud-worm injury can be escaped by either very early or very late planting. Unquestionably the corn planted in midseason suffers most. Any treatment that stimulates a rapid growth of the plants seems to reduce the injury from bud-worms. Small amounts of nitrate of soda are sometimes applied at planting time for this purpose.

322. Cut-worms (*Noctuidæ*). — There are several species of cut-worms that injure corn. They are all thick-bodied caterpillars of a brown, blackish, or grayish color, and constitute the larval stage of night-flying moths. During the winter months the larvæ rest in an inactive state in the soil. When spring comes they feed on any green, succulent young plants that they can find. They eat off the young corn plants near the surface of the ground, often dragging the cut plants partially into the soil. Most of their injury is done at night unless the weather is cloudy, in which case they work during the day also. They are worse on sod land or land that has borne a heavy crop of weeds.

For combating or evading cut-worms the important remedial measures are: (1) Early fall or winter plowing

¹ N. C. Dep't of Agr., Bul. 196, p. 23.

thus destroying the larvæ while they are hibernating; (2) moderately late planting which, to an extent, escapes the early crop of caterpillars; (3) early and frequent cultivation which seems to disturb the cut-worms and thus check their ravages; (4) poisoning, by scattering clover or wheat bran that has been treated with paris-green or arsenate of lead, over the fields as a bait. Usually a mash is made of bran, paris-green and water and sweetened with molasses. This preparation is eaten readily by the worms and is very destructive.

323. Wire-worms (*Elateridæ*).— These slender, smooth, firm-bodied worms are the larvæ of the beetles commonly called "Jack-snappers," "Hominy-beaters" or "Thumping-beaters." The larvæ are of yellowish brown color and range from one to two inches in length. The eggs are usually deposited in sod land, each generation requiring from three to five years to reach complete maturity. Wire-worms may injure corn by eating the seed before it comes up, or by feeding on the roots or "drilling" into the stalks just below the surface of the ground. The latter injury causes the center of the growing plant to die. They are worse on low lands or lands having been in sod.

In sections where wire-worms are destructive the low sod lands should be planted in some crop other than corn for one or two years after it is first plowed. If this cannot be done the sod should be plowed in the fall and disked thoroughly once or twice during the winter. This treatment will either starve or kill by exposure many of the larvæ. Any treatment, such as good fertilization or thorough and frequent tillage, that stimulates growth will enable the corn to recover more quickly from the attacks of wire-worms.

324. The corn ear-worm (*Heliothis obsoleta*). — The description, habits and life history of this insect are given in paragraphs 160 to 164, on the cotton boll-worm which is the same insect as the corn ear-worm. The eggs being laid on the silks, “the larvæ work down the silk, or bore directly through the husk to the forming ear, where they feed on the kernels and soon attain full growth, when they burrow out through the husk and enter the ground to pupate.”¹ The injury is not due alone to the loss of the kernels eaten but also to the fact that the burrows admit water to the ear causing it to rot. No absolute remedy is known. Fall and early winter plowing is recommended in that it destroys some of the insects while in the pupa stage.

325. Chinch bugs (*Blissus leucopterus*). — These insects are described as “small bugs about one-fifth inch long, blackish with white wings, the young bugs reddish.” The adults live over winter in grass or rubbish of any kind. When spring comes they fly in search of food, usually congregating in fields of small-grain where the eggs are deposited. The young bugs feed and grow to maturity on the small-grain. As the crop ripens the bugs go into corn fields in further search of food. Here the second brood of young develops. By means of their beaks the bugs suck the juices from the corn plants.

It is during the time that the chinch bugs are passing from the fields of small-grain to corn that they are most easily destroyed. In making this trip the bugs do not fly, but walk or crawl on the ground. If one or two deep furrows are plowed around the small-grain fields, the dirt being thrown toward the field in which the bugs are congregated, an effective barrier against the insects is formed. Farmers often dig holes twenty feet apart in the bottom of

¹ N. C. Dep't of Agr., Bul. 196, p. 46.

these furrows, a practice that makes them still more effective. The bugs crawl into the furrows and then along the bottom, finally falling into the holes from which they cannot escape. Putting a strip of tar around the field serves the same purpose. When furrows are used the soil in the furrow should be kept well pulverized. A heavy rain may destroy the effectiveness of the barrier, necessitating immediate re-plowing or dragging a log in the furrow.

All grass and rubbish adjacent to corn fields should be burned during the winter as it is here that the bugs seem to hibernate.

326. Grain moths and weevils. — Several species of small moths and weevils injure stored corn. Some of these do damage even before the grain is harvested while others may affect certain corn products such as meal and bran. Of the grain moths the Indian meal snout moth (*Plodia interpunctella*) and the Angumois grain-moth (*Sitotroga cerealella*) are the most important. By far the most destructive of the grain weevils is the rice-weevil (*Calandra oryza*) commonly known as the "black weevil." These insects lay their eggs either on or in the grain or husks and the larvæ eat into the kernels (Fig. 44). There is no absolute means of preventing or remedying the attacks of weevils on corn in the field. The injury can be somewhat decreased by planting late varieties and par-



FIG. 44. — Ear of corn showing characteristic injury by the corn-weevil.

ticularly those with hard grains. The selection of seed with the idea of getting a husk that fits tightly over the end of the ear has been found to decrease weevil injury.

The most effective means of fighting the grain weevils or moths is that of fumigating the stored grain with the vapors of carbon-disulfide (CS_2), which is a very volatile, colorless liquid. In order that this method may be used successfully, the grain must be stored in a bin or crib having unusually tight floors, walls, and roof so that the vapors will be confined until they have thoroughly penetrated the entire mass of grain. Hinds¹ states that "it requires at least forty-five minutes' exposure to a very strong gas to kill the black weevil adults and the smaller brown beetles are still more resistant." The amount of carbon-disulfide to use to a 1000 cubic feet of volume to be fumigated is from ten to twelve pounds for a very tight crib to twenty-five pounds for one that is moderately tight. The liquid may be placed in shallow pans on top of the corn or it may be poured in small holes about the surface made by pulling out a few ears. It evaporates very rapidly and the vapors being heavier than air diffuse downward through the grain. The treatment will not injure the grain either for food or seed. Immediately after the treatment the crib should be tightly closed. The vapors of carbon-disulfide, when mixed with air form a gas that is easily exploded if brought in contact with fire. All lighted cigars, cigarettes, lanterns, and the like, must be kept away while the fumigating is being done.

FUNGOUS DISEASES

Corn is remarkably free from fungous diseases. The

¹ Ala. Agr. Exp. Sta., Bul. 176, p. 65.

ones of importance are corn-smut (*Ustilago zea*) and different kinds of ear-rots.

327. Corn-smut (Fig. 45) often causes enormous enlargements on the ear, tassel, or stem of the corn plant. The infection usually does not occur until the plants are a foot or more high. The spores of the disease are carried over in the soil so that when land becomes infected with corn-smut it is likely to injure the crop each year unless some crop other than corn be grown, or unless precautions are taken to cut out and burn all infected plants before the smut-balls reach that stage of development at which the skin breaks and sets free the spores. The disease may also be carried from year to year in manure which has been made from feeding the diseased plants. No treatment of the seed is effective.



FIG. 45. — Corn-smut.

CHAPTER XXIII

OATS (*Avena sativa*)

THE oat plant is a grass grown for both grain and forage. It is used largely in connection with or interchangeably with corn. Its principal use is as a food for horses, although its use as a food for cattle, sheep, and swine is very general. The oat grain when made into oatmeal and other cereal dishes constitutes an important human food.

328. Origin and botanical classification. — The nativity of the oat plant is rather uncertain, but from the available evidence it is thought to be Tartary in western Asia, or eastern Europe. It came into use at a much later date than did wheat and barley. The early literature of China, India, and other ancient countries of southern Asia make no mention of oats and it is quite certain that this cereal was of minor importance in the early nurture of the human race.

The botanical classification of the cultivated oat is shown: Order — Gramineæ; tribe — Avenæ; genus — *Avena*; species — *sativa*.

Botanists have in the past usually held that all varieties of domesticated oats have descended from the wild oat, *Avena fatua*, a cold climate oat, which species is characterized by the fact that the second flower separates easily from the axis on which it is borne, leaving the axis attached to the first flower. In other wild species, notably *Avena sterilis*, the second flower, when disarticulated, carries

with it the axis on which it was borne. Trabut¹ has recently called attention to the fact that many cultivated varieties of oats, particularly those grown in the Mediterranean region, trace back to *A. sterilis* rather than *A. fatua*; also that the wild species *A. barbata*, a dry-region oat common throughout much of northern Africa, has given rise to some cultivated forms. The special adaptations of the descendants of these wild types are given in the following quotation from Trabut:

“*Avena fatua* gives rise to oats adapted to temperate and mountainous regions; *Avena sterilis*, to oats adapted to the southern countries, and to saline soils; *Avena barbata*, to races adapted to dry countries.”

The oat varieties of the southern United States are all descendants of *Avena fatua*. Among those who have given special study to the genetic history of oats some believe that oat production in the South could be made more profitable by the introduction and acclimatization of some of the cultivated descendants of *Avena sterilis*.

STRUCTURE AND COMPOSITION OF THE OAT

329. The plant. — The oat plant varies in height from two to five feet. The culms are hollow with closed joints. At each joint on the stem is borne a leaf consisting of leaf-sheath and blade. The sheath splits open on the side opposite the blade. The auricles, present in all other small-grains at the junction of the blade and sheath, are either absent or suppressed in oats. The leaf-blade of the oat plant is broader than that of wheat or rye. On its margin are small inconspicuous hairs.

¹ Dr. L. Trabut, “Origin of Cultivated Oats,” Jour. of Her., Vol. 5, No. 2, 12, 56.

330. The panicle. — The flowers and later the grain of oats are borne at the top of the plant on small branches. These branches, which extend in all directions, are arranged in whorls at intervals along the central rachis or flower-stem. There are from three to five of these whorls, the branches varying somewhat in length and position. The entire seed-bearing part is called a panicle. Depending on the arrangement of the branches the panicles may be symmetrical or one-sided, closed or open. It varies in length from eight to twelve inches and bears from fifty to eighty spikelets.

331. The spikelets. — The oat bears its flowers in clusters of two or more, each cluster being subtended by a common pair of glumes (the outer glumes), and the whole attached to the branch by means of a flexible pedicel of variable length. Each cluster including the glumes and pedicel comprises a spikelet. It is seldom that more than two flowers in each spikelet mature, and as the lower one develops into the larger grain, the result is a pair of grains of unequal size, often spoken of as "twin grains." Where only one grain develops in each spikelet, the oats are known as "single" oats. Inside of the large membranous outer glumes are the flowering glumes, one for each flower. Within each flowering glume, and between it and the flower or kernel is a small thin bract called the palea. Before fertilization and the development of the kernel the organs of reproduction are really inclosed within the flowering glume and palea. They consist of three anthers borne on as many filaments which are closely set about the ovary, and which grow very rapidly, thus pushing themselves outside the palea. The ovary bears two feathery stigmas which spread out as the flower develops.

332. Pollination. — The oat is naturally self-pollinated, and there is little danger of crossing between different varieties, even when grown in close proximity. The mixing of varieties is generally the result of carelessness in handling the seed.

333. The grain. — The oat grain, except in hull-less varieties, consists of the flowering glume, palea, and kernel. The flowering glume and palea constitute what is known as the oat hull. This, however, is entirely different from the hull of wheat or corn. In the case of wheat the flowering glume and palea are removed in threshing, while in oats they are so tightly wrapped about the kernel that threshing does not remove them. The proportion of hull to kernel varies considerably in oats and is an important factor in determining quality. As a rule the value of the grain decreases as the proportion of hull to kernel increases. Any unfavorable condition during the time of "filling" will usually decrease the percentage of kernel owing to the fact that the hull develops first.

A measured bushel of oats may vary in weight from 25 to 50 pounds although the usual range is from 30 to 36 pounds. The legal weight of a bushel in most states is 32 pounds. As a rule, oats produced in the cotton-belt are lighter than that produced further north. Elevator companies often resort to the process of "clipping" the grain for the purpose of increasing the weight per bushel. By this process a portion of the hull is removed from the tip of the grain, special machinery being used for this purpose.

334. Composition. — Owing to the large proportion of hull, the oat grain contains a larger amount of fiber and ash than any other cereal. As the proportion of hull is quite variable, depending on variety and season, the

composition of different samples is very ununiform. The average of American analyses is given by Hunt as follows:

TABLE 28. AVERAGE COMPOSITION OF DIFFERENT PARTS OF THE OAT PLANT ¹

	OAT GRAIN	OAT KERNEL	OAT STRAW	OAT HAY (cut in milk)	OAT HULL
Water	11.0	7.9	9.2	15.0	7.3
Ash	3.0	2.0	5.1	5.2	6.7
Protein	11.8	14.7	4.0	9.3	3.3
Crude fiber	9.5	0.9	37.0	29.2	29.7
Nitrogen-free ext.	59.7	67.4	42.4	39.0	52.0
Fat	5.0	7.1	2.3	2.3	1.0

The oat kernel is richer in protein than that of any other cereal. The straw contains a higher percentage of protein and less crude fiber than wheat or rye straw.

The draft on the important fertilizing constituents made by the oat crop is shown below:

TABLE 29. POUNDS OF NITROGEN, PHOSPHORIC ACID AND POTASH REMOVED FROM THE SOIL BY A 40-BUSHEL CROP OF OATS ²

	NITROGEN	PHOSPHORIC ACID	POTASH
Oat grains, 40 bu. (1280 lbs.)	22.53	8.83	6.14
Oat straw (1500 lbs.)	8.40	4.20	24.30
Total crop	30.93	13.03	30.44

¹ Hunt, T. F., "Cereals in America," p. 284.

² Duggar's "Southern Field Crops," p. 5, as calculated from data in Hopkins' "Soil Fertility and Permanent Agriculture."

Nearly three-fourths of the total nitrogen and two-thirds of the phosphoric acid are present in the grain, whereas the straw contains approximately three-fourths of the potash.

VARIETIES OF OATS

In the United States, satisfactory results have been obtained from considerably more than a hundred varieties of oats. Not more than six or eight of these are adapted to the cotton-belt.

335. Classification. — Oat varieties may be divided into several classes, depending on the basis of classification. As regards time of seeding there are spring and winter varieties, the winter oats being seeded in the fall. From the standpoint of the shape of the panicle there are two main classes. These are "spreading oats" in which the branches of the panicle extend in all directions from the rachis, and "side oats" in which the branches all hang to one side of the rachis. Varieties may be further subdivided as regards color of grain into white, yellow, red, gray and black oats, or as regards the shape of grain into varieties with short, plump grains and those having long slender grains. There is also a class of oat varieties called hull-less oats in which the flowering glume and palea are removed in threshing.

In the cotton-belt the varieties used are mostly winter oats with spreading panicles, and of red or gray color. The white and black varieties of both spreading or side oats are usually found in northern regions.

336. Varieties grown in the cotton-belt. — The varieties of oats grown in the cotton-belt belong to one of the following types: (1) Red Rust-proof, to which belong the strains Appler, Red Rust-proof, Bancroft, Culberson,

Thaggard and Hundred Bushel; (2) Burt or May oats; (3) Turf or Grazing oats, of which the Virginia Gray is the representative variety; (4) Beardless Red oats, of which the Fulghum variety is an example.

The type of oats most generally grown in the South is the Red Rust-proof. Next in importance is the Turf or Grazing oats.

The relative productiveness of the four types of oats grown in the cotton-belt, as shown by tests at the Alabama station ¹ is shown below:

<i>Red Rust-proof group or type:</i>	<i>Average percentage indicating relative yields of grain.</i>
Appler (tested 9 years)	110
Red Rust-proof (tested 10 years)	100
Bancroft (tested 4 years)	99
Hundred Bushel (tested 3 years)	98
Culberson (tested 3 years)	95
<i>Fulghum</i> (tested 9 years)	73
<i>Burt</i> (tested 7 years)	70
<i>Turf</i> , Va. Gray or-winter type oat (tested 4 years)	48

337. Red Rust-proof oats.—The typical variety of this group takes the name of the type to which it belongs, namely, Red Rust-proof. It is also called Texas Red Rust-proof, Texas Red, Red, and Red Texas. The Red Rust-proof variety and its various strains are characterized as follows: (1) Greater resistance to rust than other southern types. (2) Greater length of the slender bristles at the base of the larger grain. In other types commonly grown in the south these bristles are either absent or very short. (3) Both grains in each spikelet usually bearded, the beards being long and borne midway between the base and tip of grain, especially on the larger

¹ Ala. Agr. Exp. Sta., Bul. 173, p. 132.

grains. (4) Straw of medium height, straight and stiff, rendering it less liable to lodge than other types. (5) Grains large, plump and of reddish brown color. (6) Early in maturing. Usually Red Rust-proof oats will mature two weeks earlier than Turf oats sown at the same time in the fall. If sowing is delayed until after Christmas, Burt oats sown at the same time will usually mature a few days earlier than the Red oats.

Throughout the entire cotton-belt the Red Rust-proof oats, as a rule produce larger yields when sown in the early fall than when sown after Christmas. As regards hardiness toward cold this type is exceeded only by the winter Turf oat.

The Appler is a very popular strain of the Red Rust-proof oats. It was selected by J. E. Appler of Georgia, and is probably more extensively grown in the cotton-belt than any other selected strain of this type.

The Culberson oat, while being an excellent yielder of grain, is especially valuable for hay or soiling as it produces a large amount of straw.

338. Burt oats. — This variety, sometimes called the Ninety-Day or May, is rather extensively grown in some sections of the cotton-belt. The grains are rather slender and of a pale cream or brownish color. Usually one bearded and one beardless grain are borne per spikelet and the bristles are either very short or absent. The Burt oat is easily winter-killed and for this reason is usually sown after Christmas. The fact that it is early maturing together with its tendency to grow tall makes it popular in some sections, particularly when late sowing must be practiced. Objectionable features of this variety are (1) the ease with which it winter-kills; (2) low productiveness of grain as compared with Red Rust-proof oats; (3) light weight

of grain, and (4) tendency of grain to shatter when harvested.

339. Turf oats. — Only one variety of the Winter Turf type is commonly grown. It is commonly known as Virginia Gray, Turf oats, Grazing oats, or Virginia



FIG. 46. — Plats of winter oats in November at the Maryland Agricultural Experiment Station, College Park. Note the broad and erect habit of the Red Rust-proof variety (on the right) in contrast with the narrow leaves and spreading habit of the Winter Turf (on the left).

Winter oats. This is usually a beardless variety with slender grayish colored grains and weak slender straw that is easily susceptible to rust. Being the hardiest of southern oat varieties the Turf oat is well adapted to fall sowing. The spreading character of the plants makes this variety better adapted to winter grazing and hay production than for grain production. It is a popular variety

for sowing with hairy vetch for hay, particularly on rich soils. Turf oats ripen from ten days to two weeks later than Red Rust-proof oats when sown at the same date in the fall. Experience has shown that in the greater part of the cotton-belt, Turf oats are worthy of consideration only as a grazing or hay crop. In the extreme northern part of the winter-oat belt where Red Rust-proof oats frequently winter-kill, Turf oats are quite generally grown on the richer soils for grain.

340. Beardless Red oats. — This type, of which the Fulghum is a representative variety, is practically free from beards and is as early as the Burt oats. It is closely related to the Red Rust-proof oats, although the kernels are shorter and less plump. It is not extensively grown.

IMPROVEMENT OF VARIETIES

341. Need of improvement. — Little attention has been given to the selection and improvement of oats in comparison with corn and cotton. The low average yield of oats in the cotton-belt is conclusive evidence that improved varieties and better methods of growing and handling the crop are much needed. The improvements most needed in southern varieties are: (1) increased productiveness; (2) increased ratio of kernel to hull; (3) increased weight per bushel. Improvements of secondary value which will also contribute to higher yields are greater strength of straw in some varieties, greater resistance to disease, and increased earliness.

The methods resorted to for improving the oat crop are: the introduction of new seed; mechanical selection; the maintenance of a seed-plot; the isolation of elementary species, and hybridization.

342. Introduction of new seed. — As a result of the

little attention that has been given to the production of new or improved varieties of oats in the United States, many of our best varieties have been introduced from foreign countries. Relief from this source, however, is quite limited. Future progress must be based largely on the selection and improvement of the varieties that we now have. The practice of exchanging seed from one locality to another within the United States or even within the cotton-belt is quite common. Experience and experiments have shown that little permanent improvement can be secured by this practice. On the other hand, it usually results in decreased yields. In an experiment conducted at Amarillo, Texas, by the office of Grain Investigations, Bureau of Plant Industry, Washington, D. C., "home grown seed of Burt oats yielded practically twice as much as an adjoining plot of the same variety from seed which had been grown in central Kansas for two years, though both lots were grown from the same original stock."

343. Mechanical selection. — Running seed oats through a good fanning mill so adjusted as to remove the light-shriveled grains as well as weed seeds and dirt is a very commendable practice. While little permanent improvement can be secured by such treatment, tests have repeatedly shown increased yields due to the removal of the poorly developed seeds that either will not germinate or that produce very weak, unproductive plants.

344. The seed-plot. — The maintenance of a seed-plot is based on the principle of slow and gradual amelioration of the crop by propagating each year from mixed seed secured from a number of select plants that conform to the same type. The first year, seed is selected from a sufficient number of plants, which show superior qualities

under ordinary conditions, to plant the seed-plot. This plot should be large enough to furnish seed for the general crop. At the end of the second year the best plants are selected from the seed-plot to plant the seed-plot of the next year. The remainder of the crop from the seed-plot is used to plant the general crop. This method can be depended on to maintain the excellence of a variety and probably to effect its slow amelioration. Rapid improvement involves a method which gives more attention to the progeny of individual plants.

345. The isolation of elementary species. — This method is based upon the principle that our so-called varieties of small-grain are neither pure nor uniform but are made up of numerous elementary units or types which are extremely variable as regards their excellence. As oats are naturally self-pollinated each elementary type tends to breed true from year to year. Rapid improvement is therefore based upon the isolation of the superior type from the mixture and its subsequent multiplication in a pure form. The breeder goes into the field and after a careful study of the individual plants or types, selects a number of the best individuals. The seed from each individual is kept separate, and the next year is planted either in a row or "centgener" plot to itself. The superiority of the individuals selected is determined by a careful study of the uniformity and productiveness of their progeny. The seed of each superior type that breeds uniformly true is kept to itself and multiplied. This forms the basis of an improved strain. The most rapid and permanent improvement of oats in the past has been accomplished by this method of individual plant selection.

346. Improvement by hybridization. — The improvement of oats by hybridization is rather difficult, not alone

because of the smallness of the reproductive organs but because it also involves complicated problems of selection in order to isolate and fix the valuable types from the multiplicity of forms that occur in the subsequent hybrid generations. For this reason this method should be confined to the professional breeder. Excellent results have recently been secured at several stations from a selection from the hybrid, Burt X Sixty-Day.¹

¹ U. S. Dep't of Agr., Bul. 99.

CHAPTER XXIV

OATS — CLIMATE, SOILS, TILLAGE PRACTICES, AND USES

CONDITIONS are less favorable for the successful production of oats in the cotton-belt than in more northern sections. This fact renders it of paramount importance that the southern oat-grower give special attention to the proper selection of soils and fertilizers for oats, as well as to the best time and manner of seeding.

347. Climate. — For best results with oats the climate needs to be both cool and moist. They grow to perfection under climatic conditions too cool for best results with wheat, barley, or corn. Throughout the greater part of the cotton-belt moisture conditions are quite favorable to oat production, the relatively low average yield of this region being partially the result of the high mean temperature during the oat-growing season. This high mean temperature is the chief factor limiting the number of varieties of oats that can be produced with success in the cotton-belt. It is also thought that this same factor is primarily responsible for the relatively poor quality of southern oats in comparison with the quality of oats produced in the North. On good soils southern varieties will grow large but they are less compact and the grains are less plump and somewhat lighter than northern oats.

348. Soils. — Oats are more often sown on poor soil than any other cereal. The principal reasons for this are: (1) the oat is a strong feeder and a fair crop can be pro-

duced on soils too poor for other crops; (2) on very fertile soils oats lodge more than do the other small grains. While oats are not best suited to extremely fertile soils they, like other crops, will not return the grower a profit on exhausted soils. It should be remembered also that the varieties of oats most commonly grown in the South have short, stiff straw and are not so likely to lodge as northern varieties. Usually any soil that will produce satisfactory yields of corn or cotton will prove quite satisfactory for oats. Sufficient fertility to produce a quick growth and early maturity is essential. It is important that the soil have a high water-holding capacity as the water requirements of oats are large. King has shown that the water requirement for the production of a pound of dry matter in oats is 504 pounds as compared with 277 pounds for corn. On soils containing a high percentage of clay oats are more subject to "spewing out" or winter-killing than on sandy soils.

349. Fertilizers and manures. — The direct application of fertilizers and manures to oats is very uncommon. The belief that fertilizers and manures will cause the oats to lodge or that these materials will pay better when applied to some other crop is almost universal. Unquestionably the oat is not adapted to heavy fertilization. But experiments have shown that this crop will respond very profitably to medium or light applications of fertilizers especially when growing on poor soils. If oats follow corn or some other crop that has been well fertilized, the residues of these fertilizing materials will usually suffice for the oats. If a good crop of legumes, such as cowpeas, precede the oats, all nitrogenous materials in the oat fertilizer should be eliminated. However, on the average soils of the cotton-belt the most universal need of the oat crop is for nitrogen. As this crop makes its growth during the

cooler months of the year, at which time the nitrifying processes in the soil are relatively inactive, the nitrogen should be applied in a quickly soluble form and preferably as a top-dressing about two months before harvest. As a source of nitrogen for oats the relative value of nitrate of soda applied as a top-dressing in the spring, and cottonseed meal, cotton seed, nitrate of soda and manure "incorporated with the soil on the date of sowing the seed" has been investigated by the Alabama Station. Approximately equal amounts of nitrogen were added to all plots "in the presence of uniform amounts of acid phosphate:"

TABLE 30. ALABAMA STATION RESULTS WITH DIFFERENT SOURCES OF NITROGEN FOR OATS ¹

	AMOUNT PER ACRE. POUNDS	TIME OF APPLICATION	INCREASE TO THE ACRE DUE TO NITROGEN — BUSHELS				AVERAGE INCREASE TO THE ACRE, BUSHELS
			1901	1906	1908	1909	
No Nitrogen.
Cotton-seed meal.....	200	Fall	8.0	13.0	6.2	0.3	6.7
Cotton seed ..	434	Fall	7.3	2.2	4.0	2.3	3.9
Nitrate of soda.....	100	Spring	19.4	25.9	8.8	19.8	18.4
Nitrate of soda.....	100	Fall	19.1	24.5	8.3	7.8	14.9
Manure.....	4000	Fall	17.5	21.6	2.2	3.2	11.1

On poor soils from 100 to 200 pounds of acid phosphate to the acre should be applied in addition to the nitrogenous fertilizer. Potash is usually not needed for oats except on very sandy, poor soils. On such soils muriate of potash at the rate from 40 to 60 pounds an acre should be included in the fertilizer mixture. All commercial fertilizers, with the exception of nitrate of soda, are best applied with a

¹ Ala. Agr. Exp. Sta., Bul. 173, p. 135.

fertilizer attachment to the grain drill at the time of sowing the seed. Precautions should be used, however, to prevent large amounts of cotton-seed meal or potash salts from coming in direct contact with the seed. Otherwise germination might be injured.

Heavy applications of manure directly to the oat crop are not advisable. An excellent practice is to apply the manure as a light top-dressing to the oats in late fall or early winter.

350. Place in the rotation. — Wherever possible, oats should follow a cultivated crop in the rotation. In the southern systems of rotation oats usually follow corn rather than cotton as the corn is removed from the land rather early in the fall. An excellent practice is to sow cowpeas in the corn to be used as a seed-crop and the vines plowed under. At the Alabama Station a yield of 13.7 bushels of oats to the acre was secured on land following corn, 19.9 bushels where a crop of cowpeas had been plowed under, and 30 bushels to the acre following peanuts from which the nuts had been picked. Where moisture conditions will permit, the soil should be plowed or disked as soon as the oats are harvested and cowpeas sown for hay, pasture or green-manure. In most sections of the cotton-belt the cowpeas thus sown can be utilized as outlined above in sufficient time for the land to be seeded to oats again in the fall. Following this system and plowing under the cowpea vines, the Arkansas Station found that the increased yield of oats was greater than where 400 pounds of complete commercial fertilizer to the acre were applied.¹ On most soils, this one-year rotation would require the application of mineral fertilizers, preferably to the cowpea crop.

¹ Ark. Agr. Exp. Sta., Bul. 66.

TILLAGE PRACTICES

Tillage practices are, as a rule, poorer for oats than for other field crops, regardless of the fact that oats respond profitably to good treatment.

351. Preparation of the seed-bed. — Oats do better on a seed-bed of medium compactness than on a very loose or very compact one. Deep plowing is not as essential as for corn, cotton, or wheat. Much land is sown to oats in the cotton-belt without plowing. In some cases the oats are sown broadcast and covered with some type of turn-plow. Often the land is disked before the seed is sown and once or twice after sowing. Covering the seed on unplowed land with a turn-plow is very objectionable, as much of the seed is covered too deep and the seed-bed is often left in a loose, cloddy condition. Where the soil is naturally compact, as is generally the case in the cotton-belt, plowing the land before planting is advisable. An excellent practice is to plow and thoroughly pulverize the seed-bed, and sow the seed with a grain drill. Where no grain drill is available, the seed may be sown broadcast after plowing and covered with a disk-harrow. Plowing and harrowing the seed-bed and afterwards planting by the deep-furrow method described later has been found to give excellent results.

352. Time of seeding. — All varieties of southern oats, with the exception of Burt or May oats, are best sown in the early fall throughout the greater part of the cotton-belt. The mistake of deferring planting until quite late in the fall is too common in the South. As winter oats are not so hardy as winter wheat or barley, they require a longer period between sowing and the coming of cold weather so that the plants may become

well rooted. Considerable top growth before cold weather is also desirable, although sufficiently early planting to permit the production of stems before winter will result in winter-killing. Early sown oats are not subject to the ravages of the Hessian Fly as is early sown wheat. In the northern section of the cotton-belt, winter oats should be sown from the 15th to 30th of September. In the central section, including central Texas, most of Mississippi, Alabama, Georgia, and northern Louisiana, the best time of seeding is during the month of October provided the soil is not too dry. Along the Gulf Coast oats are usually seeded in late October or the first half of November. In the cotton-belt fall-sown oats almost invariably yield more than oats sown after Christmas for the following reasons: (1) the plants have a longer time in which to draw food from the soil and make a more vigorous growth; (2) fall-seeding interferes less with other work, and consequently a better prepared seed-bed is furnished; (3) fall-sown oats mature earlier than when sown in the spring. For this reason they are less affected by rust, and less liable to injury by storms; (4) for their best results oats require more cool weather than is permitted by spring sowing.

A seven-year test at the Alabama Station gave an average yield of 26.8 bushels of oats to the acre when they were sown in November as compared with an average yield of 15.5 bushels when they were sown in February.

353. Methods of seeding. — There are three methods of seeding oats in the cotton-belt. These are: (1) broadcast seeding either on plowed or unplowed land; (2) drilling with the ordinary grain drill; and (3) drilling with the "open-furrow" drill, or a one-horse planter.

Many experiments in the cotton-belt have proved that

even on a well-prepared seed-bed, drilled oats yield better as a rule than when sown broadcast and harrowed or plowed in. The reasons for this are: (1) the drilled seed are covered at a uniform depth and a more perfect germination is secured; (2) the drilled seed being placed in the bottom of shallow furrows are less subject to winter-killing; and (3) drilled seed will better withstand dry weather than seed sown broadcast. Drilling as compared with broadcast sowing requires less seed to the acre and often induces better preparation of the seed-bed. In using the grain drill one should be careful to see that none of the drills become clogged, or that the oats do not stick together, resulting in an uneven distribution. This is especially important in sowing seed of the Red Rust-proof type.

354. The open-furrow method of seeding. — The method of seeding oats in the bottom of rather deep furrows, 16 to 24 inches apart, by means of an ordinary single-row planter or a seed-drill especially devised for the purpose was first suggested and tested by the Georgia Station. When a one-horse planter is used the furrows are first opened with a large shovel plow. The recent invention of an "open-furrow" drill which sows several rows at a time will doubtless eliminate the chief objection to the open-furrow method of seeding oats, namely, its slowness. Where fertilizers are needed a drill with a fertilizer attachment may be used, thus distributing the fertilizer in the furrows with the seed.

The main advantage of the open-furrow method of seeding oats is that it permits the roots and crowns of the plants to develop two or three inches below the surface. While the furrows are partially filled by rains and the alternate freezing and thawing of the soil, the plants

are still far enough below the surface to give ample protection from cold. In the early spring the oats may be given a thorough harrowing, which tends to level the land before harvesting and serves as a cultivation for the crop.

Excellent results from this method have been reported by both the Georgia and Alabama Stations. The results of a test at the Alabama Station, in which the open-furrow method of seeding was compared with broadcast sown, and drilling, are given below:

TABLE 31. AVERAGE YIELDS IN BUSHELS OF OATS SOWN BROADCAST, IN DEEP FURROWS AND DRILLED WITH AN EIGHT-INCH DRILL ¹

	BROAD- CAST	EIGHT- INCH DRILL	DRILLED IN OPEN FUR- ROWS	DEEP FURROW FILLED
Average for six years	32.7	34.6
Average for five years	29.0	31.1
Average for four years	33.6	34.7
Average increase over broad- cast sowing		1.1	1.9	2.2

The above averages are based only on the yields during those years in which both methods have been employed.

355. Rate of seeding. — The quantity of seed to sow varies somewhat with the method of sowing, the type of oats sown and the locality. The quantity of seed to the acre usually recommended for all varieties of the Red Rust-proof type is two to two and one-half bushels when broadcast and one and one-half to two bushels when drilled with

¹ Ala. Agr. Exp. Sta. Bul., 173, p. 127.

either the ordinary grain drill or the open-furrow drill. The rate of seeding for the Winter Turf oats is often somewhat less than for the Red Rust-proof type, owing to the hardness of the former and its tendency to stool readily. Late seeding of any variety requires more seed to the acre than early seeding. In the extreme northern part of the cotton-belt where the winters are rather severe, a heavier rate of seeding is advisable than for more southern sections. Owing to the tendency of oats to stool and thus occupy all of the available space, the rate of seeding is subject to considerable variation without materially affecting the yield.

356. Subsequent care. — It is quite common to give the oats no further treatment from seeding until harvest. Special conditions often render advisable certain practices in caring for the crop, the most important of which are here given.

(1) Rolling the land as soon as possible after heaving takes place to settle the lifted plants into closer contact with the soil. Heaving is worse on clay soils and injury will result if such soils are rolled when wet.

(2) Harrowing in the early spring to keep weeds in check and to prevent the excessive loss of moisture by breaking the surface crust. It is important that land seeded by the open-furrow method be harrowed in the spring to partially fill the furrows and level down the ridges between the furrows.

(3) Top-dressing the oats in the fall with barnyard manure or in the spring with 75 to 100 pounds of nitrate of soda to the acre.

(4) Oats sown very early in the fall are sometimes pastured during the winter to prevent the formation of stems before all danger of freezing weather is past. Oats should

not be pastured when the land is wet, nor late enough to prevent abundant stooling or the production of stems in the spring.

USES OF OATS

357. Grain as food. — The grain of oats is used primarily as a feed for horses, first because of its high value as a horse food, and, second, because the market price of oats in the cotton-belt is so high as to prohibit its being fed with profit to other classes of live-stock. Even when oats are fed to horses, the practice of substituting corn or some cheaper food for a part of the oat ration is rather common. Oats do not make a good ration for fattening cattle and its high content of crude fiber renders it inferior as a food for hogs. When the price will justify its use the grain of oats makes a good feed for dairy cows, sheep and poultry.

358. Oat straw. — For stock not at hard work, oat straw makes a valuable roughage. Its feeding value is greater than the straw of wheat, rye, or barley and almost equals that of corn stover. Oat straw is an excellent absorbent and being richer in fertilizing elements than the straw of the other small-grains, it makes an excellent litter for use in stables.

359. Oat hay. — If cut in the early dough stage oats make an excellent hay. On good land, from two to three tons to the acre can be produced. It is cured without difficulty and is eaten greedily by horses, cattle, and sheep. In the South, winter vetch is often grown with the oats for hay.

360. Oats for pasture and soiling. — Excellent winter pasture for all kinds of stock may be furnished by oats. They should not be pastured early in the fall nor too closely

if a crop of grain is desired. Sowing vetch with the oats increases the value of the pasture.

As a soiling-crop, oats will furnish a large amount of green feed, although they come into use a little later than rye. Cutting begins as soon as the heads begin to show and continues until the crop is almost mature.

CHAPTER XXV

OATS — HARVESTING, MARKETING, INSECT ENEMIES AND DISEASES

IN the cotton-belt, oats are usually cut with a grain binder. In special cases, as when the straw is badly lodged or is very short owing to poor soil or dry weather, or when the crop is cut for hay rather than grain, the mower may be used. Small, irregularly shaped areas are best harvested with a mower or with a cradle. In the grain-producing states of the semi-arid West oats are often harvested with a header or sometimes with a combined harvester and thrasher.

361. Time of cutting. — To produce the best quality of grain, oats should be cut when the grain has passed from the "milk" into the hard "dough" stage. As most varieties of southern oats do not shatter badly, cutting is often deferred until the grain has just past the hard dough stage, at which time the heads have turned yellow. If oats are cut before the hard dough stage, the grain will subsequently shrivel and be of light weight. Even when cut for hay, the grain should be permitted to develop as much as possible without allowing the straw to become tough and hard.

362. Shocking. — If the oats are fairly mature when harvested and do not contain a large amount of green weeds, the bundles should be placed in round shocks of ten or twelve bundles each. Each shock should be covered with two bundles as "caps," or with covers made

out of canvas. Carefully built shocks which expose as little grain to the weather as possible produce the best quality of grain. Oats that are green when cut or that contain large quantities of weeds should be placed in long shocks, which may or may not be capped. In sections subject to frequent rains at harvest time capping is advisable. Oats should never be shocked while wet from dew or rain.

Oats that have been cut with the mower should lie in the swath or windrow until they are partially cured; then they should be placed in carefully built cocks. In sections subject to much rain, canvas covers should be provided for these cocks.

363. Stacking. — In the humid part of the cotton-belt it is usually necessary to stack oats intended for grain, particularly if the thrasher cannot be put into the field as soon as the grain is fit to thrash. Stacking should be done as soon as the oats have completely cured out in the shock. Leaving them for a considerable time in the shock where they are unnecessarily exposed to unfavorable weather is responsible for much bleached, sprouted, or bin-damaged grain. The stack should be well built on a base made of poles or rails to prevent the grain from coming in contact with the earth. The bundles should be so placed that only the butts are exposed and with slope enough to prevent water from running back the stems into the stack. The stack should be well capped to shed water.

In dry sections and where thrashing machines are readily available, oats are often thrashed from the shock without stacking. Where this can be done without damaging the grain it is more economical than stacking.

364. Thrashing and storing. — For best results, the grain must be thoroughly dry when thrashed. Care must

be exercised to see that the concaves of the machine are so adjusted as to remove all of the grain from the straw without hulling the grain. The straw is usually stacked or hauled to the barn.

The grain should be stored in well-constructed bins set sufficiently high off the ground that the grain will not absorb moisture. The bins should be well cleaned before filling as grain weevils or other insects often get into the grain from uncleaned bins.

MARKETING

The greater part of the oats produced in the cotton-belt are fed on the farm. In some cases that portion of the crop that is marketed is first run through a fanning mill to remove dirt and weed seeds as well as the light, chaffy grains, with the idea of raising the grade. Often the markets do not pay sufficiently for cleaned seed to justify the farmer for his trouble.

365. Bleached oats. — The large elevator companies sometimes resort to the practice of bleaching oats of inferior quality with sulfur fumes or other chemicals for the purpose of making them resemble a better quality. The profit from this practice is derived (1) by securing low grades of oats and greatly increasing their selling price by changing their appearance and (2) by increasing the original weight by means of the water absorbed during the bleaching process. Investigations have shown that bleaching impairs the vitality of oats but that their feeding value is not greatly reduced.¹ Bleached oats should not be used for seed.

366. Market grades of oats. — On the large markets oats are graded when bought. These market grades differ

¹ U. S. Dep't of Agr. Bur. of Plant Ind., Cir. 74

somewhat with different markets. The grades that were adopted by the Grain Dealers' National Association in 1909 are given below:

WHITE OATS

"No. 1 white oats shall be white, dry, sweet, sound, bright, clean, free from other grain, and weigh not less than 32 pounds to the measured bushel.

"No. 2 white oats shall be 95 per cent white, dry, sweet, shall contain not more than 1 per cent of dirt and 1 per cent of other grain, and weigh not less than 29 pounds to the measured bushel.

"Standard white oats shall be 92 per cent white, dry, sweet, shall not contain more than 2 per cent of dirt and 2 per cent of other grain, and weigh not less than 28 pounds to the measured bushel.

"No. 3 white oats shall be sweet, 90 per cent white, shall not contain more than 3 per cent of dirt and 5 per cent of other grain, and weigh not less than 24 pounds to the measured bushel.

"No. 4 white oats shall be 90 per cent white, may be damp, damaged, musty or very dirty.

"NOTICE. — Yellow oats shall not be graded better than No. 3 white oats.

MIXED OATS

"No. 1 mixed oats shall be oats of various colors, dry, sweet, sound, bright, clean, free from other grain, and weigh not less than 32 pounds to the measured bushel.

"No. 2 mixed oats shall be oats of various colors, dry, sweet, shall not contain more than 2 per cent of dirt and 2 per cent of other grain, and weigh not less than 28 pounds to the measured bushel.

"No. 3 mixed oats shall be sweet oats of various colors, shall not contain more than 3 per cent of dirt and 5 per cent of other grain, and weigh not less than 24 pounds to the measured bushel.

"No. 4 mixed oats shall be oats of various colors, damp, damaged, musty, or very dirty.

RED OR RUST-PROOF OATS

"No. 1 red oats, or rust-proof, shall be pure red, sound, bright, sweet, clean, and free from other grain, and weigh not less than 32 pounds to the measured bushel.

"No. 2 red oats, or rust-proof, shall be seven-eighths red, sweet, dry, and shall not contain more than 2 per cent dirt or foreign matter, and weigh 30 pounds to the measured bushel.

"No. 3 red oats, or rust-proof, shall be sweet, seven-eighths red, shall not contain more than 5 per cent dirt or foreign matter, and weigh not less than 24 pounds to the measured bushel.

"No. 4 red oats, or rust-proof, shall be seven-eighths red, may be damp, musty, or very dirty.

WHITE CLIPPED OATS

"No. 1 white clipped oats shall be white, clean, dry, sweet, sound, bright, free from other grain, and weigh not less than 35 pounds to the measured bushel.

"No. 2 white clipped oats shall be 95 per cent white, dry, sweet, shall not contain more than 2 per cent of dirt or foreign matter, and weigh not less than 32 pounds to the measured bushel.

"No. 3 white clipped oats shall be sweet, 90 per cent white, shall not contain more than 5 per cent of dirt or foreign matter, and weigh not less than 30 pounds to the measured bushel.

"No. 4 white clipped oats shall be 90 per cent white, damp, damaged, musty, or dirty, and weigh not less than 30 pounds to the measured bushel.

MIXED CLIPPED OATS

"No. 1 mixed clipped oats shall be oats of various colors, dry, sweet, sound, bright, clean, free from other grain, and weigh not less than 35 pounds to the measured bushel.

"No. 2 mixed clipped oats shall be oats of various colors, dry, sweet, shall not contain more than 2 per cent of dirt or foreign matter, and weigh not less than 32 pounds to the measured bushel.

"No. 3 mixed clipped oats shall be sweet oats of various colors, shall not contain more than 5 per cent of dirt or foreign matter, and weigh not less than 30 pounds to the measured bushel.

"No. 4 mixed clipped oats shall be oats of various colors, damp, damaged, musty, or dirty, and weigh not less than 30 pounds to the measured bushel.

"NOTE. — Inspectors are authorized when requested by shippers to give weight per bushel instead of grade on clipped white oats and clipped mixed oats from private elevators.

PURIFIED OATS

“All oats that have been chemically treated or purified shall be classed as purified oats, and inspectors shall give the test weight on each car or parcel that may be so inspected.”

INSECT ENEMIES

367. The oat plant is generally exceptionally free from insect injury. In occasional seasons, chinch-bugs, grasshoppers, or green-bugs (*Toxoptera graminum*) do considerable damage. Methods of exterminating chinch-bugs are outlined in the chapter on insect enemies of corn.

Green-bugs are small green colored lice that suck the juices from the young plants. They are most serious in the western and southwestern sections of the country. Green-bugs are usually kept in check by their natural enemies among which is a species of lady bug.

FUNGIOUS DISEASES

The two diseases of paramount importance affecting oats are rust and smut.

368. Oat rust. — There are two distinct kinds of oat rust. One of these (*Puccinia coronata*) occurs chiefly on the leaves and is known as the “crown” rust owing to the fact that the spores at their upper parts have the form of a crown. The other kind of rust (*P. graminis avenæ*) occurs on the stems and is known as “black-stem” rust. Each of these rusts has two stages, the red-rust stage, appearing first, followed by the black-rust stage. For this reason they are often confused by farmers. Both “crown” and “black-stem” rust have been found to be coextensive with the oat crop, usually occurring together and being much more prevalent in humid than in arid sections. The black-stem rust is of extreme importance in

the cotton-belt. The "crown" rust is not a serious disease. It usually appears a little earlier than the stem-rust and little injury is noticed until the latter appears.

There is no known treatment for rust. Some varieties are more resistant to attacks of rust than others and the only relief lies in the growing of these resistant sorts, chief of which is the Red Rust-proof type. These so-called rust-proof oats are not entirely rust-proof as there is nearly always a considerable amount of rust on the plants. In almost any variety there are some plants more resistant to rust than others. As this rust resistance is heritable to a greater or less degree, the possibility of breeding up rust-resistant strains is great. To what character of the plant rust-resistance is due has not been definitely established, but most authorities agree that the cause is physiological rather than morphological.

369. Oat smut. — This disease occurs in two closely related forms both of which are noticeable exclusively in connection with the flowering or seed-producing parts of the plant. The most common and destructive form (*Ustilago avenæ*) is known as loose smut in that it reduces the entire flower-cluster or inflorescence into a black, dusty mass of spores (Fig. 47). In the other form (*Ustilago lœvis*) known as closed smut, the disease destroys only the kernels, changing them into black masses of spores, the glumes not being attacked. This form, therefore, remains inclosed or hidden. In each of these forms infection occurs only during the young seedling stage. The mycelia subsequently grow throughout the entire tissues of the developing plant, finally maturing the spores (or seed) in the flowering portion. As these diseases are propagated from year to year by the spores that are carried over on the seed, they are easily controlled by various seed treatments,

the most common of which are the formalin treatment and the hot-water treatment.

The formalin treatment consists in dipping the seed for ten minutes in a solution containing one pint of formalin to 30 gallons of water. The seed may be put in loosely woven sacks and the entire mass immersed in the solution. The seed is then dried sufficiently to run through the drills, or if immediate sowing is impossible, the seed should be spread and thoroughly dried to prevent germination. If the grain is sown while in a swollen condition, the quantity to the acre should be increased accordingly.

370. The hot-water treatment

consists in immersing the seed for ten minutes in water kept at a temperature of from 132° to 133° F. In order that the temperature of the hot water may not be greatly reduced



FIG. 47. — Smut of oats, showing a smutted head and for comparison a sound oat head.

by using cold seed, the seed should be put into a basket or loosely woven sack and previously dipped into water at a temperature of 110° to 120° F. The temperature of the water is regulated by adding cold or hot water as the case may require. A good thermometer is absolutely necessary for all hot-water treatments, otherwise the vitality of the seed may be destroyed on the one hand, or the treatment may be ineffective on the other.

Copper sulfate solution, often employed for preventing smuts of certain cereals, should never be used for oats as it injures the seed.

CHAPTER XXVI

WHEAT (*Triticum sativum*)

WHEAT is a cereal grass, widely distributed over the civilized world and of vast economic importance. It is grown primarily for its grain, the flour of which is made into various forms of human food. The by-products of wheat are used as feed for live-stock.

371. Antiquity of wheat. — The great antiquity of wheat is evidenced by the fact that it has been found in the prehistoric habitations of man. As far back as the Stone Age one or two small-grained sorts of wheat were used by the earliest Lake Dwellers of western Switzerland. The Chinese grew the crop 3000 years B. C. The most ancient languages mention wheat, although under different names. It is generally agreed that the cultivation of wheat antedates the written history of man.

372. Nativity. — The original habitat of wheat has never been determined with certainty. The most generally accepted belief is that wheat once grew wild in the Euphrates and Tigris valleys. That wheat has been found growing wild in western Asia has been claimed by some but without conclusive evidence.

373. Biological origin. — The biological origin of wheat, like its nativity, is somewhat obscure. Many believe that our cultivated wheat traces back to the wild annual grasses belonging to the genus *Egilops* occurring abundantly in southern Europe.¹ The Minnesota Station² points out the

¹ Dondlinger, P. T., "The Book of Wheat," p. 3.

² Minn. Agr. Exp. Station, Bul. 62, "p. 81."

following different stages in the evolution of wheat: (1) *Ægilops ovata*, a small annual grass of southern Europe, having but one grain in each head; (2) the improved and better developed form of this same species; (3) *Triticum spelta*, the cultivated spelt of Europe; (4) *Triticum polonicum*, Polish wheat; (5) *Triticum sativum*, common wheat.

374. Botanical classification. — Following is shown the botanical classification of common wheat: Order — Gramineæ; tribe — Hordeæ; genus — *Triticum*; species — *sativum*; subspecies — *vulgare*.

Each member of the tribe (Hordeæ) to which wheat, rye, and barley belong produces its inflorescence in the form of a spike, rather than in a panicle as do the members of the tribe (Avenæ) to which oats belong. Other cultivated grasses belonging to the same tribe as wheat are perennial rye-grass (*Lolium perenne*), and Italian rye-grass (*Lolium italicum*). Some troublesome weeds belonging to this tribe are darnel (*Lolium temulentum*), and couch-grass (*Agropyron repens*).

STRUCTURE AND COMPOSITION OF WHEAT

375. Roots. — In germinating, the wheat grain throws out a whorl of 3 to 8 temporary roots. The first of these to appear is called the radicle. Immediately following the appearance of the temporary roots the stalk begins to develop. At each underground joint a whorl of permanent roots is thrown out. The distance between the temporary roots and the joints at which the permanent roots are borne will be governed primarily by the depth of planting. The permanent roots usually occur about one inch below the surface of the soil, irrespective of the depth of planting. No tap-root is produced. The roots are quite fibrous and tend to curve outward for a

short distance from the plant and then descend almost vertically, many of them having been known to grow to a depth of four or five feet.

376. Culms. — The culms of wheat vary in height from three to five feet. They are usually hollow with solid joints, but in a few varieties they are partially or entirely filled with pith. During the early growth of the culm, the joints are very close together but as it elongates the spaces between the joints increase rapidly until the plant has reached its full height. The length of the culms vary with type, variety, soil, fertility, and seasonal conditions. The tendency to lodge is governed primarily by the length of the stems and secondarily by their stiffness or strength. There is not necessarily any direct relation between the yield of grain and the length of culms. The latter character, however, influences the ease of harvesting.

377. Tillering (Fig. 48). — Wheat, like other cereals, throws out branches after the plumule has appeared above ground. Within the axil of each leaf on the culm as well as at each underground node a bud is formed.

Ordinarily only the buds that are covered with soil develop into branches, the others remaining dormant. As each branch may produce a limited number of branches, and as these branches may in turn, produce still other branches, each grain may under favorable conditions, produce a relatively large number of culms. In exceptional cases one grain of wheat has been known to produce as many as fifty spikes. By this characteristic of tillering, wheat and other



FIG. 48. Diagrammatic section through the stem of wheat about 25 days after planting (enlarged). The first bud designed to form a tiller is just starting.

small grains possess considerable power of adapting themselves to their environment. As a rule, the more favorable the conditions are for growth and the thinner the seeding is, the greater is the tendency to tiller. However, very thin

seeding with the idea of inducing tillering is not advisable, as it will usually result in decreased yield.

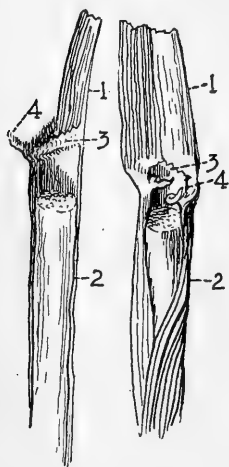

FIG. 49. — A wheat leaf, showing 1, blade; 2, sheath; 3, ligule; and 4, auricle.

378. Leaves. — The wheat leaf (Fig. 49) consists of four principal parts: (1) the blade, or that part of the leaf which hangs free from the stem; (2) the sheath, constituting that part which envelops the stem tightly; (3) the ligule, a thin membrane growing at the juncture of the blade and sheath and also clasping the culm; (4) the leaf-auricle, being a thin outgrowth from the base of the blade. In the case of wheat, small hairs are produced on the edges of the leaf-auricles whereas the auricles of barley and rye are hairless.

Oats usually produce no auricles. The leaf-blade of wheat is usually narrower than that of either barley or oats.

379. The spike (Fig. 50). — The inflorescence of wheat is arranged in a long, narrow, compact cluster at the summit of the stem and is called the "spike" or "head." That part of the stem running through the spike, to which the flower-stems are attached, is called the "rachis." The short joints of the rachis are put together in such a way as to give it a zigzag appearance. The spikelets are produced at these joints on alternate sides of the rachis. The length of the wheat spike varies from $2\frac{1}{2}$ to $4\frac{1}{2}$ inches, the av-

erage length being about $3\frac{1}{2}$ inches. The spike is also variable as regards its form and compactness. It may be tapering from the center toward both tip and base or from the center toward the apex only. Again the spike may be of uniform thickness throughout or, as in the case of the club varieties, decidedly clubbed at the apex. The number of spikelets to a spike is governed by variety, soil, climate, or culture, the usual variation being from 10 to 20, containing a total of 20 to 50 grains.

380. The spikelets. — The spikelets may be termed secondary spikes. Each spikelet is joined to the rachis by a small branch which extends through the center of the spikelet and is known as the “rachilla.” “Inserted on the rachilla are several concave scales which are called the glumes. The two lowest and outermost of these contain no flowers or kernels and are designated as the ‘flowerless glumes.’ Above these, arranged alternately, are borne the flowers, rarely less than two, or more than five. Each flower and, as it matures, each grain, is subtended by a single glume, known as the ‘flowering glume.’ Each flowering glume has a longitudinal nerve which at the summit extends (in the case of bearded varieties) into a prominent ‘awn’ or ‘beard.’ On the inner or creased side of the grain or berry, filling it very closely, and more or less hidden from view by the flowering glume, is borne the ‘palea’ or palet, a thin scale with two nerves. The flowerless and flowering glumes and the paleas are spoken of collectively as the ‘chaff.’” The wheat flower consists of the flowering glume, the palea and the reproductive organs.



FIG. 50. — Front and side view of spikelet of wheat, showing mode of attachment to the rachis.

381. Fertilization. — The wheat flower possesses two erect plume-like stigmas which surmount the ovulary. There are three stamens each bearing an anther. As the flower develops, the filaments bearing the anthers elongate rapidly, pushing the anthers upward so that they suddenly overturn allowing the pollen to fall upon the stigmas. These expansions and processes take place within the closed flower, and thus the wheat is self-fertilized. After

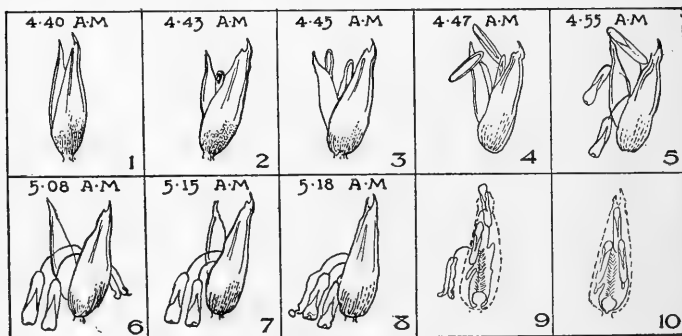

FIG. 51. — Illustrating the opening and closing of the wheat flower: 1 to 5, opening of the flower; 6 to 8, closing of the flower. In 9, the flower is shown as closed, only the anther having escaped; in 10 none of the anthers succeeded in passing out of the enveloping chaff.

fertilization takes place the anthers are pushed outside of the glumes and at this time the wheat is generally recognized as being "in bloom." Rainy weather at the time that fertilization is taking place is said to cause imperfect fertilization, as the inside of the flower is likely to retain some of the water.

382. The grain (Fig. 53). — The wheat grain is a unilocular indehiscent caryopsis of oblong shape with one end slightly pointed, and with a longitudinal furrow on one side, causing a deep infolding of the pericarp. At the base of the grain opposite the furrow is the small embryo or germ.

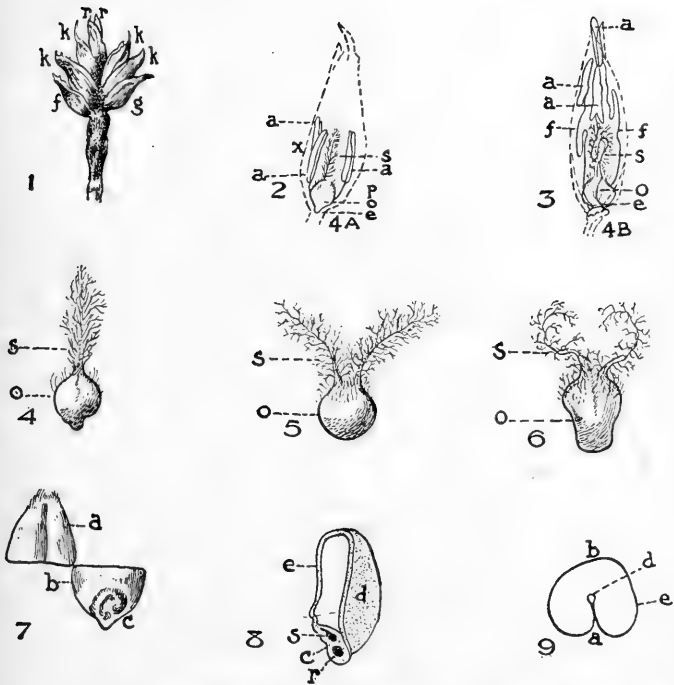

FIG. 52. — The reproductive organs of wheat: (1) Spikelet, natural size, with a few joints of the rachis; *f* and *g* are flowerless glumes; *k*, florets bearing seeds; *r*, rudimentary florets. (2) Longitudinal diagram of flower just before flowering; anthers marked *a*; ovary, *o*; stigma, *s*; filament, *f*. (3) Diagram of flower just after flowering, showing how anthers are held within the envelope. (4) Ovary and stigma just prior to flowering. (5) Ovary and stigma at the time of flowering. (6) Ovary and stigma shortly after flowering. (7), (8), and (9) the mature seed; *a*, the ventral side; *b*, the dorsal side; *c*, the germ or chit; *s*, the stem end of the germ; *r*, the root end; *e*, outer layers of bran; *d*, the incurved surface of bran on the ventral side of the seed. The white portions of (8) and (9) are the floury interior consisting of cells containing the gluten and starch from which white flour is made.

The greater portion of the wheat grain consists of endosperm or starch cells which form the chief constituent of wheat flour. The ratio of embryo to endosperm is about

as one to thirteen. The embryo is composed essentially of two parts, viz., the miniature plant known as the vegetative portion, and the absorbent organ, known as the scutellum, which on the germination of the seed, transfers the substance of the endosperm to the embryo for its nourishment. Surrounding the endosperm and embryo is a single layer of aleurone cells known as the aleurone layer, which makes up about eight per cent of the weight of the grain.

Just outside of and surrounding the aleurone layer is a single layer of collapsed cells called the tegmen or nucellus. This is in turn surrounded by the testa, which covering contains most of the coloring matter of the grain. This coloring matter may vary from the paler shades of yellow through amber to a deep red, and gives the grain its characteristic color so often used in the classification of wheat varieties.

The three layers above described are inclosed in the pericarp or outside covering, which corresponds to the pod in the pea. The nucellus, testa and pericarp constitute what is commonly spoken of as wheat bran.

The wheat grain is very variable as regards size, color, hardness, shape, weight, and composition, all of these char-

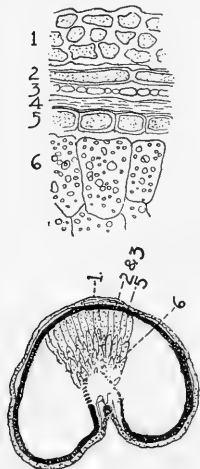

FIG. 53. — Cross-section and transverse section of grain of wheat. Below: transverse section of an unripe grain. (1) Ovary wall or pericarp; (2) outer integument; (3) inner integument; (4) remains of nucellus; (5) aleurone cells; (6) starch cells.

acters being influenced by type, variety, soil, and season.

383. Composition. — The United States Department of Agriculture reports the composition of wheat as follows:

TABLE 32. COMPOSITION OF WHEAT GRAIN AND WHEAT STRAW ¹

	GRAIN (PER CENT)			STRAW (PER CENT)		
	Minimum	Maximum	Average	Minimum	Maximum	Average
Water.....	7.1	14.0	10.5	6.5	17.9	9.6
Ash.....	0.8	3.6	1.8	3.0	7.0	4.2
Protein.....	8.1	17.2	11.9	2.9	5.0	3.4
Crude fiber.....	.4	3.1	1.8	34.3	42.7	38.1
Nitrogen-free extract.....	64.8	78.6	71.9	31.0	50.6	43.4
Fat.....	1.3	3.9	2.1	0.8	1.8	1.3

An important constituent of the protein in the wheat grain is gluten which is a mixture of the proteids gliadin and glutenin. The gluten is directly responsible for that property of wheat flour which causes it to form a porous bread when mixed with water, leavened, and baked. The gluten, being tenacious and elastic, imprisons the carbonic acid gas caused by the fermentive action of the yeast, and the expanding, imprisoned gas causes the bread to rise and become porous. The bread-making qualities of wheat are determined largely by both the amount and quality of the gluten that it contains. The quality of gluten is dependent upon the relative proportions of gliadin and glutenin in its makeup, the most desirable proportion being from 65 to 75 per cent of the former and 25 to 35 per cent of the latter.

The composition of wheat, particularly as regards its protein content, is greatly modified by seasonal conditions and to a less extent by fertilizers. A survey of the experimental evidence on this point reveals that the composition of any given variety will be uniform from year to year

¹ U. S. Dept., of Agr. Office of Exp. Sta. E. S., Bul. 11.

only when grown under the same climatic conditions and allowed to mature fully. Any condition that interrupts maturation will result in a higher percentage of protein in the crop, especially the grain, due to the relatively low starch formation under such conditions. Large, plump kernels produced under favorable conditions usually contain a lower percentage of protein than small, shriveled kernels produced under unfavorable conditions.

TYPES AND VARIETIES OF WHEAT

Wheat varieties are most often classified on the basis of those differences induced by environment rather than on the basis of botanical differences. However, wheat types present botanical relationships of sufficient importance to merit consideration.

384. Botanical classification of wheat types. — There are eight principal types of cultivated wheat. Of these eight types, six are closely related and will therefore cross readily with each other. The classification here given is the one made by Hackel, and is taken from Hunt's "Cereals in America:"

Triticum	{	<i>monococcum</i> (1) einkorn			
		<i>sativum</i>	{	<i>spelta</i> (2) spelt	
				<i>dicoccum</i> (3) emmer	
		<i>tenax</i>	{	<i>vulgare</i> (4) common wheat	
				<i>compactum</i> (5) club or square-head wheat	
				<i>turgidum</i> (6) poulard wheat	
				<i>durum</i> (7) durum wheat	
				<i>polonicum</i> (8) Polish wheat	

All of the subspecies of *Triticum sativum* cross readily with each other. Hunt states that "Einkorn never and Polish wheat rarely, gives rise to a fertile cross with common wheat."

385. Einkorn (*T. monococcum*). — This species has been grown only in an experimental way in the United States. It is a narrow-leaved, slender-stemmed, heavily bearded wheat with flattened, compact spike, and compressed grain that shows an angular form. It most nearly approaches the assumed wild form of wheat and has had no practical value for the American farmer.

386. Spelt. (*T. sativum* var. *spelta*). — This species has been cultivated for centuries in Europe and Africa, it being a very ancient form. Unlike common wheat, the spikelets of spelt do not break away from the rachis leaving the zigzag stem, but in separating, a part of the rachis breaks off and remains attached to each spikelet. There are both winter and spring varieties. The winter beardless variety has proved most profitable. It is little grown in this country and in other countries has been largely replaced by other types.

387. Emmer (*T. sativum* var. *dicoccum*). — This wheat looks very much like spelt and is often confused with it. The stems are usually pithy, leaves covered with velvety hairs, heads flattened, two-rowed, and bearded. Emmer is valuable as a stock food and is better adapted to dry regions than either einkorn or spelt.

388. Common wheat (*T. sativum* var. *vulgare*). — This subspecies is the wheat commonly grown throughout the wheat-growing countries of the world. It is more closely related to the club wheat than to any other subspecies.

389. Club wheat (*T. sativum* var. *compactum*). — This subspecies produces a shorter, more compact spike and a shorter, stiffer straw than common wheat. The apex of the spike is enlarged, and consequently presents a club-shape. This is the common wheat of Chile and the

Pacific coast region of the United States. Both winter and spring varieties are in use, the former being adapted only to mild climates.

390. Poulard wheat (*T. sativum* var. *turgidum*). — A broad-headed, short, stiff-bearded wheat grown in the Mediterranean region. It is much like durum wheat.

391. Durum wheat (*T. sativum* var. *durum*). — This

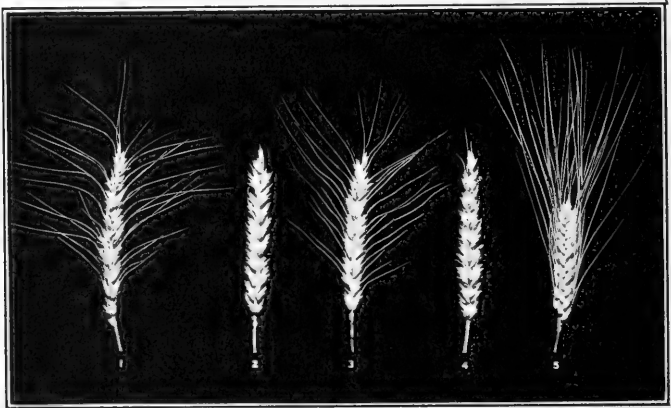

FIG. 54. — Representing heads of five varieties of hard winter and hard spring wheat: (1) Turkey Winter, a hard winter variety; (2) Fife, a hard red spring wheat; (3) Preston, a hard spring wheat; (4) Blue-stem, a hard red spring variety, and (5) a very hard amber spring wheat.

wheat produces the flour from which macaroni is made, its higher gluten content and greater density making it superior for this purpose. It is a tall-growing sort, with broad, smooth leaves and heavily bearded heads resembling barley, with which it is often confused. The grains are large with pointed ends, semi-transparent, and of lower starch content than common wheat. Lyon states that “the qualities that give value to durum wheat are its ability to withstand drought and its resistance to rust.”

In the United States durum wheat is produced principally in North and South Dakota, Minnesota, Nebraska, western Kansas, eastern Colorado, Wyoming and Montana. A small amount is grown in northwestern Texas. One variety of durum wheat has been grown in Texas under the name of Nicaragua wheat.

392. Polish wheat (*T. polonicum*). — This wheat is grown in southern Europe. It is not a productive type, but is thought by some to be fairly well adapted to the arid districts of this country. In Polish wheat the palea of the lowest flower is only half as long as the flowering glume. In common wheat the palea is as long as its glume.

393. Wheat varieties. — More than

a thousand varieties of wheat are known. Most of these belong to the type known as common wheat. From this great number of varieties, not more than fifteen or twenty are important in the cotton-belt. No very satisfactory

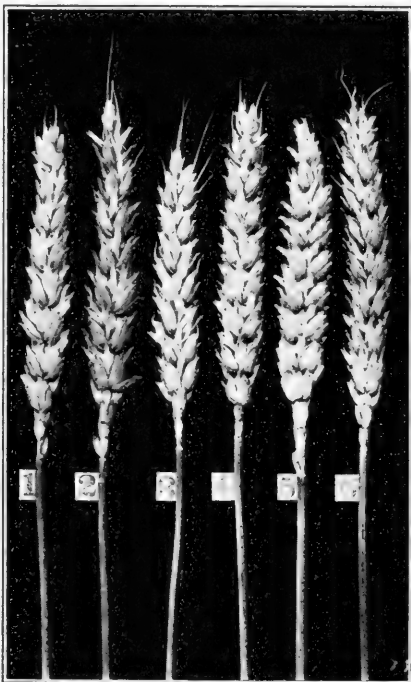

FIG. 55. — Heads of some beardless winter varieties of wheat: 1, Fultz; 2, Leap Prolific; 3, Purple Straw; 4, Poole; 5, Mealy; 6, Dawson Golden Chaff.

classification of wheat varieties has, as yet, been made. The most common classifications are those based on time of sowing, as spring and winter wheat (Fig. 54); on the color of the grain, as red and white wheat; on the density

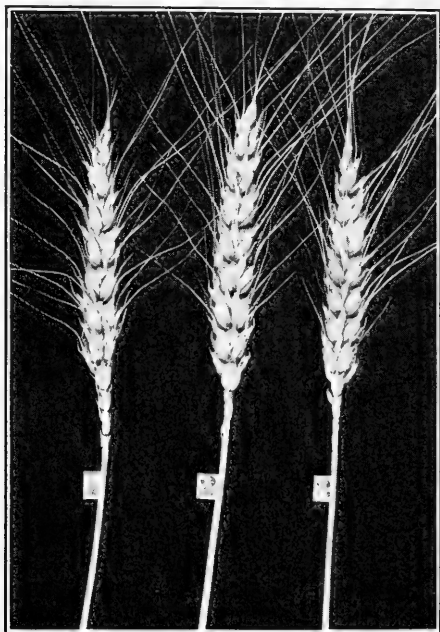

FIG. 56. — Heads of some bearded winter wheat varieties: 1, Turkey; 2, Bearded Purple Straw; 3, Fulcaster.

of the grain, as hard and soft wheat; on the presence or absence of awns, as bearded and beardless wheat, and on the products for which they are grown, as bread and macaroni wheat.

394. Varieties for the cotton-belt (Figs. 55, 56). — Practically all of the wheat grown in the cotton-belt is of

the soft or semi-hard red winter type. In north central Texas and central Oklahoma there is a transition zone in which varieties of either the hard red winter wheat, belonging to the Turkey or Crimean type, or the soft or semi-hard wheats may be grown. However, the latter type of wheat is more commonly grown in this region and gives, on the average, more satisfactory returns than the Turkey wheats.

A list, containing the names of varieties for the cotton-belt that have been found to do well on the average for several seasons is given below. The varieties named are grouped by states, the recommendations being based largely on results obtained by the various southern experiment stations and also by the Bureau of Plant Industry of the United States Department of Agriculture:

STATE	VARIETIES	BEARDED OR BEARDLESS
Alabama	Blue Stem or Purple Straw . . .	Beardless
	Fultz	Beardless
	Golden Chaff	Beardless
	Alabama Red	Beardless
	Red Wonder	Bearded
	Fulcaster	Bearded
Arkansas	Red May	Beardless
	Fultz	Beardless
	Fulcaster	Bearded
Georgia	Fultz	Beardless
	Georgia Red	Beardless
	Blue Stem	Beardless
	Red May	Beardless
	Fulcaster	Bearded
Florida	Wheat not successfully grown	

STATE	VARIETIES	BEARDED OR BEARDLESS
Louisiana (Principally for Grazing)	Red May	Beardless
	Fultz	Beardless
	Purple Straw	Beardless
	Harvest King	Beardless
	Fulcaster	Bearded
Mississippi	Fultz	Beardless
	Blue Stem	Beardless
	Fulcaster	Bearded
North Carolina	Golden Chaff	Beardless
	Purple Straw	Beardless
	Harvest King	Beardless
	Fultz	Beardless
	Red May	Beardless
	Fulcaster	Bearded
	Dietz	Bearded
	Red Wonder	Bearded
Lancaster	Bearded	
Oklahoma (Soft winter varieties)	Red Russian	Beardless
	Early Red Clawson	Beardless
	New Red Wonder	Beardless
	Missouri Blue Stem	Bearded
	Sibley New Golden	Bearded
	Fulcaster	Bearded
Oklahoma (Hard winter varieties)	Turkey Red	Bearded
	Theiss	Bearded
	Pester Boden	Bearded
	Weissenburg	Bearded
	Kharkof	Bearded

STATE	VARIETIES	BEARDED OR BEARDLESS
South Carolina	Red May	Beardless
	Fultz	Beardless
	Lancaster	Bearded
	Red Wonder	Bearded
	Fulcaster	Bearded
Tennessee	Poole	Beardless
	Fulcaster	Bearded
	Mediterranean	Bearded
	Nigger	Bearded
Texas (Soft winter varieties)	Fultz	Beardless
	Poole	Beardless
	German Emperor	Beardless
	Michigan Amber	Beardless
	Mediterranean	Bearded
	Fulcaster	Bearded
Texas (Hard winter varieties)	Defiance	Bearded
	Kharkof	Bearded
	Turkey	Bearded
	Crimean	Bearded

395. Wheat-growing areas of the cotton-belt. — Nearly all of the wheat in the cotton-belt is produced in north-central Texas, northeastern Mississippi, and the central and northern sections of Alabama, Georgia, and South Carolina. Much wheat is produced in the Piedmont and mountain sections of North Carolina, practically all of Tennessee and Virginia, and the central part of Oklahoma. These areas are either partially or wholly outside of the

cotton-belt. Some wheat is produced on the red lands of northern Louisiana.

396. Improvement of varieties.— The principles underlying the improvement of wheat varieties are the same as those discussed in connection with the improvement of oats. The qualities that are especially desired in varieties of wheat for the cotton-belt are high yield, rust-resistance, drought-resistance, earliness, and a higher protein content.

CHAPTER XXVII

WHEAT — CLIMATE, SOILS, ROTATIONS, CULTURAL METHODS AND HARVESTING

THE wheat plant is very sensitive to soil conditions. It is also much affected by climate, particularly as regards the ease with which it succumbs to diseases, especially rust. For these reasons there are vast areas in the cotton-belt that cannot be made to produce wheat successfully.

397. Climate. — The range of climate under which wheat is successfully produced throughout the world is very wide. The bulk of the world's wheat crop, however, is produced in regions having cold winters. The three noted exceptions to this statement are the crops of California, Egypt, and India. In the Northern hemisphere the wheat industry is gradually spreading northward, first as spring-sown varieties which after much selection and manipulation are sown with success in the fall. With proper attention spring wheat can often be changed to winter wheat in a relatively short time. Spring wheat once grew over Iowa, Kansas and Nebraska, where only winter wheat is now grown. This same change is taking place in the Dakotas and Minnesota. These modifications, while partly due to changed cultural methods, show also the great adaptability of wheat to unfavorable climatic conditions. In the preceding chapter reference was made to the influence of climate on the chemical and physical constitution of the wheat kernel. The protein

and starch content of wheat are extremely sensitive to climatic factors, although in an inverse ratio. Low altitudes with an abundance of moisture produce soft wheats, whereas the hard red wheats are found in the relatively dry, elevated plains of the central West. As either ocean is approached the grain becomes softer and of lighter color. An excellent illustration of the influence of climate on the physical properties of wheat is to be found on our Pacific coast. When produced directly on the coast the kernels are soft, dark and thick-skinned. The physical characters shade off gradually to the inland district where the kernels are very hard and thin-skinned. The best quality together with the highest yields of wheat are possible only in regions of cold winters, followed by long, cool, moderately wet spring seasons and dry sunny weather during ripening.

398. Soils. — Wheat makes its best growth on clay or clay loam soils. It will not give profitable returns on deep sandy soils, nor on sour or acid soils. Sandy soils should never be used for wheat growing, and acid soils should be used only after the application of from 1000 to 2000 pounds of slacked lime, or 2000 to 4000 pounds of ground limestone, to the acre. In the cotton-belt the best wheat soils are the reddish clay or clay loams of the Cecil series occurring extensively in the Piedmont region of North Carolina, South Carolina, Georgia, and Alabama, the limestone valleys of the above states, the black waxy lime lands of north central Texas, northeastern Mississippi and central Alabama and the red lands of northern Louisiana. Wheat is a relatively weak feeder and demands a fairly rich soil of good physical constitution. Hence the soils above mentioned must usually be much modified by the addition of vegetable matter in the form of animal or

green manures and in many cases by the application of commercial fertilizers.

399. Rotations. — In the cotton-belt the crop preceding wheat is usually corn in which cowpeas have been sown as a catch-crop between the rows. That it is advisable to have wheat follow a soil-improving crop like cowpeas or soybeans when possible, has been amply demonstrated by both farm experience and carefully conducted experiments. In sections where red clover or crimson clover do well these crops usually follow the wheat in the rotation, the wheat being seeded after corn grown with or without cowpeas. In devising a rotation for wheat the farmer should keep in mind the following: (1) When possible allow the wheat to follow a soil-improving crop; (2) the wheat should not occupy a position in the rotation at which time the soil is foul with weeds, as they may render the soil too loose for best results, or otherwise injure the crop; (3) wheat should not follow oats or rye in the rotation as these crops are likely to be followed by volunteer plants the seeds of which would become mixed with the wheat.

For the red clay and valley lands of the Piedmont section the North Carolina Station suggests the following rotation: First year — wheat with red clover sown in the spring on the fall-sown wheat; second year — red clover with the second crop turned under after maturity of seed for soil improvement and for storing seed in the soil; third year — corn.

Duggar suggests the following rotation for sections where red clover does not thrive: First year — cotton, with crimson clover seeded in September between the rows; second year — cotton; third year — corn with cowpeas between the rows; fourth year — wheat followed by cowpeas.

An excellent three-year rotation adapted to a large part of the wheat-growing area of the cotton-belt is: First year — cotton; second year — corn with cowpeas between the rows; third year — wheat followed by cowpeas.

The Kentucky Station has adopted the following rotation: First year — corn followed by rye for a winter cover-crop; second year — soy-beans or cowpeas; third year — wheat; fourth year — clover.

400. Fertilizers. — Fertilizers, if necessary for wheat, are most profitable when the crop is grown in a rotation that keeps the soil well supplied with decayed vegetable matter. On much of the waxy lime lands of Texas and Alabama direct fertilization of wheat is unnecessary. These soils usually contain an abundance of mineral matter, and the indirect method of fertilizing by growing wheat in a rotation that supplies the soil with organic matter renders this mineral matter available and supplies an abundance of nitrogen. The red clay and valley soils of the Piedmont region are generally well supplied with potash but are rather deficient in phosphoric acid. The amount of nitrogen in these soils varies, of course, with the amount of organic matter present. Wheat following a soil-improving crop on these Piedmont soils will usually need the application of a phosphatic fertilizer only. In the older wheat-growing regions of the cotton-belt, particularly when the wheat is grown on land that has been under cultivation for many years, it is customary to fertilize rather heavily. On such soils liberal fertilization is often profitable, but numerous experiments have clearly demonstrated that the yield does not increase proportionately as the quantity of fertilizer is increased. Care should be exercised to see that the profitable limit is not exceeded.

Burgess, in discussing the fertilization of wheat on the Piedmont soils of North Carolina, says:

“A good application of fertilizer for wheat is 300 to 600 pounds per acre. Where the land has been well prepared and is in good condition, it will pay to fertilize liberally. As a rule, the fertilizer should be applied in the fall at the time of seeding. Good results will be obtained from the use of one-half the nitrogen in the fall along with the phosphoric acid and potash and the other half as a top dressing in the spring after growth has well started from nitrate of soda or sulphate of ammonia. Where wheat or other small grain has been grown in one of the rotations suggested above or similar ones with soil-improving crops, one-half of the nitrogen in the mixtures may be omitted after the rotation has been repeated one or more times, and may be left out altogether after sufficient organic matter, or humus, has been stored in the soil to produce a sufficiently large development of stalk for a good crop of grain. In this case a top dressing of 75 to 100 pounds per acre of nitrate of soda may be given just about the time the plants begin to joint in the spring if the crop is not found growing off nicely.”¹

CULTURAL METHODS

401. Preparing the seed-bed. — The ideal seed-bed for wheat is one that is thoroughly pulverized, well compacted, with a loose mulch on the surface and with a good contact with the subsoil. To accomplish the above results, the land should be plowed as early as practicable after the previous crop has been removed. Following plowing, the disk and smoothing harrow should be used liberally to destroy clods, keep down grass, and to aid the

¹ N. C. Dep't of Agr. Bul., whole no. 159, vol. 32, No. 10.

soil in settling and becoming firm. Running a heavy roller over the soil soon after plowing to break the clods and firm the soil is often advisable. The roller should be followed immediately with a smoothing harrow. In the drier wheat-growing regions the value of early plowing for wheat cannot be overestimated as is shown by an experiment made by the Oklahoma Station,¹ in which plats were plowed on July 19th, August 15th, and September 11th. All plats were seeded September 15th:

Date of Plowing	Yield to the acre, bu.
July 19th,	31.3
August 15th,	23.5
September 11th,	15.3

Plowing to a moderate depth is usually better for wheat than very deep or very shallow plowing. On soils of a rather loose structure and particularly where the preceding crop was corn that received good cultivation, wheat is sometimes drilled in without plowing, the land being disked thoroughly before the crop is seeded so as to make a good seed-bed three or four inches deep. This method of preparation often gives good results, but in the large number of cases plowing before harrowing is advisable and is absolutely essential on compact clay soils. Soils on which very much vegetation in the form of green-manure, weeds or grass is growing should be thoroughly disked before plowing, to cut up the vegetation and render the soil more easily compacted.

402. Date of seeding. — Wheat is hardier toward cold than oats, and may be seeded later. Where the Hessian fly is troublesome, as is the case in North Carolina, northern Georgia, and northern Alabama, it is best to delay seeding until immediately after the first frost,

¹ Okla. Agr. Exp. Sta., Bul. 47, pp. 26-48.

as the fly lays no more eggs after this date. Wheat sown in northern Georgia during the last 10 days in October has been found to escape injury from the Hessian fly. In sections where the Hessian fly does not injure wheat, larger yields can be secured by seeding rather early to allow the plants to make a vigorous root-development before cold weather, and to allow the crop to make the maximum utilization of the plant-food in the soil. Duggar suggests the following periods during which the bulk of the wheat crop should be seeded in Alabama:

North Alabama, October 10th to November 1st.

Central Alabama, November 1st to 15th.

South Alabama, November 15th to 30th.

In the wheat-growing regions of Oklahoma, the winter wheat is sown from the 15th of September to the 15th of October. Field trials by the Oklahoma Station do not indicate much difference between the respective dates. In north Texas wheat is usually seeded during the latter part of October and the first part of November.

403. Rate of seeding. — The usual rate of seeding for wheat is from 4 to 6 pecks to the acre. The greater number of experiments on this point indicate that under favorable conditions, 4 pecks are sufficient when drilled and 5 pecks when broadcast. If the seed-bed is poorly prepared, or a poor quality of seed is used, larger amounts should be sown. Also more seed is required for late sowing than for early sowing and more for poor soil than for rich soil.

404. Methods of seeding. — The methods employed in seeding wheat are (1) broadcast seeding, and (2) seeding in drills 6, 7 or 8 inches apart.

A review of the experimental evidence on drilling versus broadcasting wheat shows many advantages in favor of drilling, chief of which are: (1) Increased yield. The

seed being sown at a uniform depth, germination is also uniform. A smaller percentage of the young plants are injured by dry weather subsequent to seeding. The seed being sown in slight furrows is not so subject to "heaving" or winter-killing. (2) The grain ripens more uniformly. (3) A saving of from one to two pecks of seed wheat to the acre when the seed is drilled.

In drilling wheat, care should be exercised to see that the seed is deposited on the bottom of the furrows opened by the drill. If the seed is caught by the closing furrow before it has reached the bottom, germination is likely not to be uniform. Grains that are placed on the firm soil at the bottom of the furrows are in an ideal position for securing moisture.

405. Wheat-seeding machinery. — The evolution of seeding machines for wheat involves four different stages of improvement. These are (1) the broadcast seeder where gravity alone is utilized for the purpose of distributing the seed; (2) the broadcast seeder in which the seed is brought from the seed cups by feed-wheels attached to a revolving shaft spoken of as "force feed" instead of "gravity feed"; (3) the ordinary drill with force feed, the grain falling into a tube which instead of scattering it, carries it in a steady stream to the bottom of the slight furrows produced by the drill; (4) the drill with attachments to press the soil firmly about the seed, known as the press-drill. This is considered the best machine for seeding wheat.

The wheat drill is made in three different forms as regards the arrangement for depositing the seed in the soil. These are (1) hoe-drills, by which the ground is opened with small shovels, called hoes, the tubes depositing the seed in a stream into the furrow immediately behind each

hoe; (2) disk-drills, and (3) drills with runners or shoes known as shoe-drills. The hoe-drills, while operating under possibly a larger number of conditions than the other types, are heavy of draft and clog easily on filthy land. The disk-drill is preferable to other types where the land contains much litter. Most drills are equipped with fertilizer attachments, and attachments for sowing grass or clover seed can be purchased if desired.

406. Cultivating wheat. — Wheat is often harrowed with an adjustable spike-tooth harrow or weeder in the early spring before the booting stage. This practice is especially beneficial on stiff soils that are deficient in vegetable matter. Drilled wheat is more satisfactorily harrowed than broadcast wheat. The practice of planting wheat in wide drills and cultivating it much as we cultivate corn has been advocated by a few farmers, but has never become common in this country.

407. Pasturing wheat. — Wheat, like oats, furnishes excellent winter pasture for almost all kinds of live-stock. The precautions to be observed in pasturing wheat are the same as for oats, paragraph 360.

HARVESTING WHEAT

408. Methods. — The methods of harvesting, thrashing, and storing wheat are similar to those of oats. In the greater part of the cotton-belt and throughout the entire eastern United States, the self-binder is largely used for cutting the crop. In the Great Plains area west of the Mississippi River both self-binders and headers are used, the latter machines being used principally in the western sections of Kansas, Nebraska and the Dakotas. The combined harvester and thrasher, which cuts, thrashes, and sacks the grain in one operation, is very

generally used on the Pacific coast and in the extreme Northwest.

409. When to harvest. — For the production of grain, wheat should be harvested at that stage of maturity when the grains are still sufficiently soft to be easily indented with the thumb nail, but too hard to be easily crushed between the fingers. At this stage most of the straw will have turned yellow. According to Hunt, "the indications are that if allowed to stand beyond the period of full maturation, a slight decrease in the actual substance of the grain may take place," as the seed continues to respire and give off carbon dioxide, as explained by Deherain.

410. Methods of handling as related to quality of grain. — East of the Mississippi River, most of the wheat in the cotton-belt is either stacked in the open or stored in large barns as soon as it becomes sufficiently dry in the shock. In Texas and Oklahoma and in fact throughout most of the Great Plains regions a large proportion of the wheat crop is thrashed direct from the shock. The wheat is allowed to stand in the shock from three to six weeks or longer, during which time it is often exposed to heavy rainfall. In many cases the shocks are very carelessly constructed and entirely unprotected by cap-bundles. Investigations have shown that the exposure of wheat in the shock to the effect of alternate rain and hot sun "causes the kernels to swell and the branny coats to loosen, destroying the natural color or 'bloom' and giving them what is termed a 'bleached' appearance." As the grade that is given to wheat upon the terminal markets is determined largely by its appearance, condition and test weight a bushel, that portion of the crop that has been affected by exposure as described above, must of necessity be graded lower than wheat marketed in good condition.

As a rule, millers hold that weathered grain is much improved in quality if it is allowed to go through a sweat in the stack. If the grain is thrashed and stored in the bin before it has gone through a sweat, the result is that the grain "sweats" in the bin where the circulation of air is much more limited than in the stack, the heat is not carried away rapidly enough, and the temperature becomes so high as to often result in "heat-damaged or bin-burnt" grain. Unless the period from harvesting to thrashing is quite dry, shock-thrashed wheat almost invariably contains a higher moisture content than stack-thrashed wheat. This, of course, renders the shock-thrashed grain more difficult to keep in good condition when stored.

CHAPTER XXVIII

WHEAT — WEEDS, INSECT ENEMIES AND FUN- GOUS DISEASES

THE injury to growing wheat caused by weeds, insects and diseases is surprisingly large. A very brief description of those pests of greatest economic importance together with the more important remedial measures are given in this chapter.

411. Weeds. — The almost universal occurrence of certain species of weeds in wheat fields not only greatly reduces the yield of wheat but in many cases the grain is much reduced in quality on account of the presence of the weed seeds. Three of these are of primary importance in the cotton-belt and deserve special mention. These are:

- (1) Chess or cheat (*Bromus secalinus*)
- (2) Cockle (*Lychnis Githago*)
- (3) Field garlic (*Allium vineale*).

Chess or *cheat* is an annual grass, growing to a height of two to three feet. The stems are erect and smooth, terminating in a loose, open panicle, the branches of which are somewhat drooping. Its common occurrence in wheat fields has led many farmers to believe that wheat sometimes changes into chess as it grows, a miracle which of course never happens. Wheat and chess are not closely related, belonging to separate tribes in the grass family. The fact that chess often occurs in a wheat field where clean seed was sown is accounted for by the great vitality

of the chess seed. These seed will often remain buried in the soil for several years before coming up. Its great prolificacy as compared with wheat is also responsible for the belief that wheat turns to chess. As chess seed is smaller and lighter than wheat, it can be removed by carefully screening and fanning the seed wheat. Also if the wheat is stirred in water just before sowing the chess seed will rise to the top and can be taken off. Hand-pulling and burning the plants in the field is often resorted to. Land that is badly infested with chess should be planted to intertilled crops until the chess has been eradicated.

Cockle is particularly a weed of grain fields, the seed usually being sown with the seed grain. It grows to a height varying from one to three feet. The stem is slender and erect with a few branches near the top. The flowers are reddish purple and are borne on long, hairy peduncles. The calyx is ovoid, quite hairy and distinctly ten-ribbed. Five long, pointed lobes extend beyond the petals. The seeds are borne in ovoid, one-celled capsules averaging about a half-inch in length. The seeds are black or dark brown, round or somewhat triangular in shape with rows of short teeth on the surface. The seed of cockle is poisonous and when ground with wheat renders the flour unwholesome. For this reason the presence of cockle in wheat will materially reduce the grade of the wheat on the market. The chief means of control is the sowing of clean seed. When cockle is present in the field it should be hand-pulled before the seeds are mature. Badly infested fields should not be sown to grain but planted to intertilled crops.

Field garlic grows from one to three feet tall. The plants spring from "small, ovoid, membranous-coated bulbs." The flowers, which are borne in umbels, are of

pinkish purple color. The seed-head consists of a cluster of small bulbs varying in number from twenty to a hundred. These bulblets get into the grain and greatly reduce its quality. They can be separated at the mill by artificially drying the wheat, and then by passing it through the ordinary cleaning machinery.

412. Insect enemies. — A large number of insects feed on and injure growing wheat. Among the most important insect enemies of wheat in the cotton-belt are the Hessian fly and the chinch-bug.

413. Hessian fly (*Cecidomyia destructor*). — The Hessian fly is a small, dark-colored, mosquito-like gnat about one-eighth inch long. There are four stages to each generation as follows: (1) egg, (2) maggot or larva, (3) pupa, usually spoken of as the flaxseed stage, and (4) the mature winged insect. The eggs are usually deposited on the upper surface of the young leaf or in case of the spring brood they are "sometimes thrust beneath the sheath of the leaf on the lower joints." The eggs hatch into small pinkish larvæ which find their way down to the base of the leaf-sheath. Many plants are completely killed in the fall when the larvæ begin to devour the diminutive culms before the plants have begun to stool. In the spring the injuries produced at the base of the first two or three leaves will cause many of the plants to fall before the grain is ripe. This insect is probably the most injurious insect enemy of growing wheat in the cotton-belt. It is especially prevalent in the Piedmont sections of North Carolina, South Carolina, Georgia, and Alabama. The principal preventive measures are as follows: (1) Late planting of winter wheat. This is undoubtedly the most practical means of preventing damage as wheat sown after the first frost will usually germinate after the Hessian fly has disappeared. (2)

Burning the wheat stubble. It has been noticed that the second brood often develops in the lower joints of the wheat, being left in the stubble at harvest, mostly in the flaxseed stage. (3) Plowing under stubble, and subsequently rolling it to prevent any maturing adults from escaping. (4) Rotation of crops.

414. Chinch-bugs (*Blissus leucopterus*) and weevils. — The chinch-bug is responsible for an enormous annual loss to the wheat crop. This pest is described and certain remedial measures are outlined in the chapter on insect enemies of corn. As the chinch bugs hibernate in old grass and rubbish during the winter months, the importance of burning over all waste land places where they would likely find protection cannot be too strongly emphasized. Also the early planting of such crops as millet, or spring wheat to attract the chinch-bugs in their early flight is recommended by many. After these trap-crops become infested they are plowed under.

Weevils often attack wheat in the shock, stack or bin. In the two former cases no effective treatment can be given. The wheat should be thrashed as early as possible, and the grain placed in tightly constructed, closely covered bins and fumigated with vapors of carbon-disulfide. One pound of carbon-disulfide will treat 30 bushels of wheat (see chapter on Insect Enemies of Corn, p. 270).

415. Fungous diseases. — Four fungous diseases cause serious injury to wheat. Of these four diseases, two are rusts, and two are smuts. One form of rust, *Puccinia rubigo-vera*, occurs principally on the leaves and is known as the early orange leaf-rust. The other form, *Puccinia graminis*, affects principally the stems and is known as the late stem-rust. There is no treatment

for these rusts. They can be controlled to a large extent by growing rust-resistant varieties. For a description of rust see the chapter on Fungous Diseases of Oats, p. 301.

The two common smuts of wheat are the loose smut (*Ustilago tritici*) and the covered smut (*Tilletia foetens*). The latter disease is often called bunt or stinking smut. Both of these diseases are preventable.

416. Loose smut. — This disease turns the entire wheat head, including the chaff, into a black powdery mass which is usually blown away by the wind, leaving only the bare rachis with a few smut spores sticking to it. The seed treatment for this disease is rather difficult on account of the fact that the smut lives over inside the wheat kernel. The spores, which are ripe at flowering time, find lodgment in the flowers of unaffected wheat plants. These spores soon germinate and send a little filament into the young kernel, which later develops into a young smut plant. This, however, does not interfere with the development of the kernel, and the disease is thus carried over inside the kernel to the succeeding crop, where it again becomes evident at flowering time.

This disease can be prevented by subjecting the seed to what is known as the modified hot-water treatment, which is as follows: Soak the seed for not less than four hours or more than six hours in cold water. Remove, drain, and immediately immerse the seed for a moment in water kept at a temperature of about 120° F.; the seed is then immersed for 10 minutes in water kept at a constant temperature of 129° F. Comparatively small quantities of seed should be treated at a time so that all of the seed may become equally heated. Water heated above 129°F. must not be used. This treatment is most safely used in connection

with a seed-plot on which the grain to be used in seeding the general crop is grown.¹

417. Covered smut, stinking smut or bunt. — This smut produces its spores exclusively within the kernel, the chaff being unaffected. When the diseased kernels are examined they are found to be completely filled with a black, dust-like mass, which has a “peculiar fetid odor like that of decaying fish.” In the thrashing and otherwise handling the grains from the diseased crop, the smutted kernels are broken and the spores find lodgment on the sound grains. They are thus carried over to the next crop. As the spores of this disease do not mature until the grains are mature, they are carried over only on the surface of the grains and can be killed by any method that thoroughly disinfects the outside seed-coat. The spores of the loose smut mature when the grain is in bloom and hence get into the flowers, from which they penetrate the young kernels. The important seed treatments for covered smut are the following:

Hot-water treatment. — Soak the seed for 10 to 15 minutes in water kept at a temperature of from 132° to 133° F. The seed should be immediately dried following the treatment.

Formalin treatment. — Thoroughly moisten the seed with a solution made by mixing one pound of formalin to every 45 gallons of water. The grain may be either sprinkled or soaked, the essential point being the thorough wetting of every kernel. If sowing is done immediately the seed should be dried sufficiently to run through the drills. Seed that is to be kept any length of time after being treated should be spread out on a clean floor and thoroughly dried.

¹ Farmers Bul., 507, p. 27.

Copper-sulfate treatment. — Immerse the seed for one to two minutes in a solution made by dissolving one pound of copper sulfate in four gallons of water. Remove and dry the grain; it is then ready to sow.

CHAPTER XXIX

RYE (*Secale cereale*)

RYE is an annual, winter-growing, cereal grass of minor importance in the cotton-belt. The relatively small acreage devoted to this crop in the south is utilized primarily for pasture or soiling purposes. On poor sandy soils it makes an excellent green-manure. When rye is allowed to mature the grain is used as a human food or for stock, the straw being largely used for bedding for domestic animals. Rye straw is also used in the manufacture of paper, and for packing fruit trees and other articles for shipment.

418. Origin and nativity. — According to Hackel, the original species of rye is a perennial grass (*Secale montanum*) once found growing wild in the mountains of the Mediterranean countries from Spain and Morocco to Central Asia. This wild form has a jointed rachis which breaks apart upon ripening. This character and also the perennial habit have been lost under cultivation. The existence of rye in the wild state at the present time is said to be doubtful.

419. Description. — The culms of rye are more slender and much taller than those of wheat, growing sometimes to a height of six to seven feet on rich soils. The inflorescence is a long, slender, distinctly compressed, profusely bearded spike. The spikelets are two-flowered. Each flower produces three stamens. As the two flowers in a spikelet develop about equally the rye spike is distinctly

four-rowed. The flowering glume is always awned and the keel of the glume is strongly barbed. The organs of reproduction are quite similar to those of wheat, except that in rye the anthers are larger. The rye grain is slender, rather dark in color, with a somewhat wrinkled surface, and has a rather shallow longitudinal crease on the side opposite the germ. In comparison with wheat, the rye spike is longer and more flattened; the beards are much longer and less spreading and are loosely arranged in two rows; the individual grains on the head are partially exposed; the grains are longer, more slender, more pointed and have a more wrinkled surface; the longitudinal crease is less distinct and the texture of the grain is harder and tougher, requiring more power to grind it.

The rye grain, on germinating, throws out a whorl of four instead of three temporary roots. This characteristic is thought to account partially for the greater hardness of rye as compared with the other small grains. The young rye plant has a distinctly red tinge which serves to distinguish it from wheat. In the spring the plants take on a grayish green color. The fall growth of rye is more spreading than wheat.

420. Composition. — The following table summarized from Henry's "Feeds and Feeding" shows the composition of rye grain together with that of corn and wheat:

TABLE 33. PERCENTAGE COMPOSITION OF THE GRAIN OF RYE, WHEAT AND CORN

	WATER	PROTEIN	CRUDE FIBER	NITROGEN-FREE EXTRACT	ETHER EXTRACT	ASH
Rye.....	11.6	10.6	1.7	72.5	1.7	1.9
Wheat.....	10.5	11.9	1.8	71.9	2.1	1.8
Dent Corn.....	10.6	10.3	2.2	70.4	5.0	1.5

Rye contains less fat than corn and less protein than wheat. Otherwise the three grains are quite similar in composition. The composition of rye straw varies very little from that of wheat straw. Rye straw is much tougher than wheat straw and is of little value for feeding purposes.

421. Varieties. — Unlike the other cereals, rye has developed very few varieties. Three reasons have been given for this: (1) unlike the other small grains, rye cross-fertilizes freely; (2) the innate tendency of rye toward variation is less than in most other cereals; (3) in the United States no attempt has been made to improve rye, either by selection or by crossing. Both spring and winter forms of rye have been developed, the latter form being raised almost entirely in America. Only one variety is grown throughout the cotton-belt. It is known simply as "Southern Rye."

422. Climate. — While rye is very hardy and naturally a plant of cold climate, it does not seem to be very much influenced by hot weather. Rye can be successfully grown in latitudes too far south for success with wheat. On the other hand, it has been matured in Alaska as a winter grain.

423. Soils and fertilizers. — While rye can be grown on almost any soil provided it is well drained, it makes its best growth on fertile soils containing somewhat less clay than our best wheat soils. In fact rye is admirably adapted to fertile sandy soils. Rye is an exceptionally strong feeder and its ability to grow on soils of low productiveness has made for it the reputation of being the grain of poverty. This reputation has tended to crowd rye off of the most fertile soils and is primarily responsible for the low yields of this crop in the South. It is nevertheless true

that rye will respond as liberally to good culture and judicious fertilization as any other cereal. The principles discussed in the fertilization of oats and wheat are equally applicable to rye.

424. Rotations. — Rye, like practically all other field crops, should be grown in a well-planned rotation. In the cotton-belt rye should fill the place in the rotation that would otherwise be taken by wheat or oats. Rye is especially adapted to short-course rotations in which case it is largely utilized as a winter cover-crop, for winter pasture or for soiling purposes. On poor sandy soils rye often occupies a position in the rotation between two intertilled crops and is plowed under as a green-manure.

425. Seed. — As a rule northern-grown rye should not be sown in the cotton-belt. The plants spread out more closely on the ground than plants from southern-grown seed and is therefore not so good for early winter pasture. Also the crop from northern-grown seed is more subject to rust, the plants are smaller, and the yield usually less than from "Southern rye." Home-grown seed should be sown whenever circumstances permit.

426. Culture. — Rye is most often sown on unplowed land following corn or some other intertilled crop. If sown with the drill the land is well harrowed before seeding. One-horse drills are often used and the rye sown in the standing corn, the drill passing between the rows. Broadcast sowing is very common, particularly when the crop is intended for grazing. For soiling purposes, rye is often sown in drills 18 to 24 inches apart. The sowing season for rye is longer than for any other small grain. For early soiling the crop is sometimes sown as early as September 1st. On poor soils, early sowing is very desirable in order that the crop may get well established before

winter sets in. Rye is sometimes sown as late as December 1st but these very late sowings usually produce small yields. The usual rates of seeding rye are 4 to 6 pecks to an acre for grain and 6 to 8 pecks for pasture. When sown in 18-inch drills, one bushel to the acre is sufficient.

427. Harvesting and handling. — Ordinarily the methods of harvesting rye are the same as for wheat and oats. When rye is sown on very fertile soils the culms often grow to such length as to cause the crop to lodge and tangle. Under such conditions harvesting is attended with special difficulties. The binder is not especially constructed to harvest grain that is seven feet tall and unless the machine has a very long table and the straw is especially dry, the elevators will clog and the tying will be very unsatisfactory. Where the grain is badly lodged, it is often necessary to cut on only one or two sides of the field. The self-rake reaper is sometimes used to cut very heavy rye, the bundles being bound and shocked by hand. Four or five men are necessary to bind rye by hand as fast as a reaper will cut it. This makes this method of harvesting expensive, but special conditions may make it necessary. The precautions to be taken in shocking, threshing, and storing rye are the same as for wheat and oats.

When properly bundled, good rye straw has a high value on the market. "If straw is to sell well, it must be threshed without breaking or tangling and then rebound into bundles before baling. This was done by flailing long after that implement had disappeared for other uses. It is now handled by a special type of threshing machine known as a 'beater.' This has a cylinder about six feet in length run at a very high speed, and armed with only slight corrugations instead of the usual teeth. The bundles are unbound and fed through this, lying parallel to the axis

of the cylinder instead of endwise as is the usual way. In the old style of machines the straw is discharged on a table in shape so that one or two men can rebind it with bands of straw caught up from the bundle. In more modern machines, the binding is done with twine by a modified form of the ordinary binder. The straw is baled in the old type of open-topped box-press, being tramped in bundle by bundle and tramped down. This is peculiarly hard, exhausting work but it seems to be the only acceptable method of baling rye-straw. The bales weigh 200 to 250 pounds.”¹

428. Enemies. — Rye is injured by the chinch-bug and the Hessian fly. Few other insects do serious damage to rye. At least two kinds of rust — the black-stem rust and the orange rust of the leaves, — attack rye. Smut sometimes attacks rye, the treatment being the same as for oat smut, page 302.

Ergot, sometimes known as spurred rye, is probably the greatest enemy of rye, although this disease is not especially prevalent in the cotton-belt. Ergot is caused by a fungus (*Claviceps purpurea*) which attacks the grains, causing them to become greatly enlarged on account of the growth of the fruiting spores. It is claimed that “wide spread disease and trouble” have been produced in European countries as a result of using ergot-infested rye for human food. From a physiological standpoint ergot is rather important, it being used as a medicine in obstetrics. It is said that when fed to animals ergot sometimes causes abortion and also gangrene of the extremities. Rye containing ergot should not be sown and land which has produced the diseased rye should be planted to other crops for two or three years.

¹ Van Wagenen in Bailey’s “Cyclo. of Am. Agr., Vol. 2,” p. 561.

CHAPTER XXX

BARLEY (*Hordeum sativum*)

BARLEY, like rye, is an annual cereal grain of minor importance in the cotton-belt. It belongs to the same tribe as wheat and rye. In Europe where barley is extensively grown, the grain is largely utilized in the production of beer. Much of the grain is also used as a stock food, particularly in the form of barley meal. Malt sprouts and brewers' grains are two important by-products in the production of beverages from barley. They are used as food for domestic animals. Barley straw is at least equal in feeding value to oat straw. The chief use of barley in the cotton-belt is for pasturage and soiling. Barley pasture is considered to be more palatable than that produced by other small-grains.

429. Nativity. — Barley is thought to be native to western Asia, and to have originated from the wild West Asian *Hordeum spontaneum*. Like wheat its culture antedates written history. Down to the close of the fifteenth century barley was universally used as a bread plant throughout the civilized countries of Europe, Asia, and Africa.

430. Description (Figs. 57-59). — The barley plant, aside from the spike, resembles wheat in appearance and habit of growth. Usually the culms are shorter than those of wheat, and the proportion of straw to grain is less than in wheat or oats. The leaves of barley are provided

with larger auricles than those of any of the other small grains.

The barley spike consists of a long, jointed rachis bearing three spikelets at each joint. The spikelets are one-

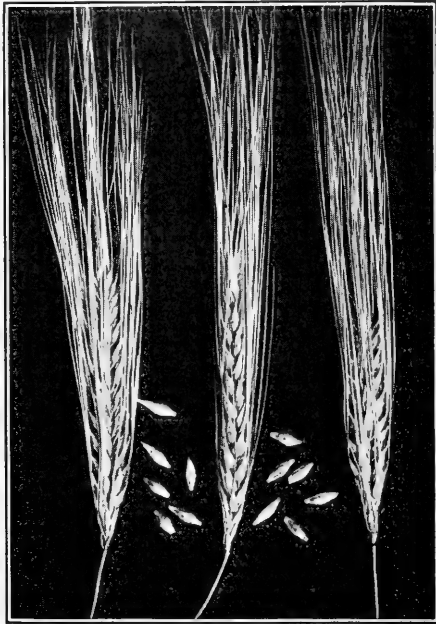

FIG. 57. — Heads of Tennessee Winter barley, side and front views; also detached kernels with the awns removed.

flowered. Each flower produces three stamens and a double, plume-like stigma similar to wheat. The somewhat awl-shaped outer glumes are about three-eighths inch long, each bearing a short, flexible beard about three-fourths inch long. The flowering glume is distinctly five-nerved and in most varieties is prolonged into a stiff beard

six to eight inches long with barbed edges. At maturity, the flowering glume and palea usually adhere tightly to the kernel and are removed with difficulty. Therefore, the barley grain, like the oat grain, consists of the kernel, the palea and the flowering glume. These two latter parts are called the hull or husk. The barley kernel resembles very closely the wheat grain.



FIG. 58. — A grain of 2-rowed barley; A, dorsal view; B, ventral view.

The legal weight of a bushel of barley grain is 48 pounds. The actual weight may vary from 45 to 50 pounds.

431. Composition. — Barley is recognized as a nutritious grain. It is more carbonaceous than either wheat or oats. Hulled barley is very similar in composition to wheat. Ordinarily barley grain is higher than wheat in crude fiber on account of the hull. Unlike oats, the hull of barley is so tough that it is necessary to grind the grain before feeding it to domestic animals. The composition of barley and its by-products as given in Henry's "Feeds and Feeding" is as follows:

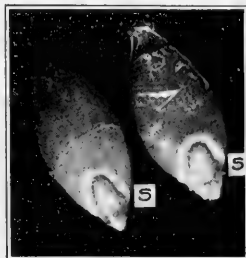

FIG. 59. — High grade barley grains with the glumes removed to show the embryo with its collar-like scutellum (s). The inner envelopes have been removed from the upper part of the grains.

TABLE 34. AVERAGE COMPOSITION OF BARLEY AND ITS BY-PRODUCTS

	PERCENTAGE COMPOSITION					
	WATER	ASH	PROTEIN	CRUDE FIBER	NITROGEN-FREE EXTRACT	ETHER EXTRACT
Barley grain	10.9	2.4	12.4	2.7	69.8	1.8
Barley meal	11.9	2.6	10.5	6.5	66.3	2.2
Barley screenings	12.2	3.6	12.3	7.3	61.8	2.8
Brewers' grain (wet)	75.7	1.0	5.4	3.8	12.5	1.6
Brewers' grain (dry)	8.2	3.6	19.9	11.0	51.7	5.6
Malt-sprouts	10.2	5.7	23.2	10.7	48.5	1.7
Barley straw	8.3	3.8	3.7	42.0	39.5	2.7

432. Types of barley. — Most authorities recognize two well-marked types of barley. These are: (1) six-rowed barley (*Hordeum sativum hexastichon*) and (2) two-rowed barley (*H. sativum distichon*). In the six-rowed type, each of the three spikelets borne at a single joint on the rachis produces one grain. As each joint produces three grains and as these grains are arranged alternately at the various joints of the rachis, they are produced in six distinct rows. Sometimes a four-rowed barley is produced in that the lateral or outside grains of the alternate sets overlap so as to form one instead of two rows on each side. Six-rowed barley may be four-rowed toward the tip of the spike. In the two-rowed type the lateral grains fail to develop, in which case the spike is composed of two rather than six rows of grains. In this type the joints of the rachis are farther apart; hence the spike is longer and less compact than in the six-rowed type. The two-rowed barley is a spring variety and is the kind that is largely grown in Europe for the production of malt, the four- or six-rowed barleys being used as food for domestic animals.

There is a hull-less or naked barley (*H. nudum*) which is also beardless. This type is little grown as it is a poor

yielder. Among the types which retain the hull, there are a few beardless varieties. They mature much earlier than the bearded sorts, but yield poorly and are extremely tender, necessitating sowing after Christmas, even in the central part of the Gulf states.

433. Climate. — Barley is successfully cultivated in a very wide range of climate. While it is successfully produced in cold climates and regions of abundant rains it is best adapted to a warm, dry climate. It usually matures in less time than oats or spring wheat.

434. Soil, fertilizers, and rotation. — The root-growth of barley is less abundant than that of wheat, oats, or rye. It is therefore necessary to sow barley on land that is in a high state of fertility. A rich clay loam usually gives best results. The limestone soils, when well drained give excellent results with barley. The character of fertilization required will be governed largely by the fertility needs of the particular soil in question. Well-rotted barnyard manure usually gives excellent results. The need for commercial fertilizers is the same as for wheat.

Barley should never be grown continuously on the same land. In the cotton-belt it most often follows corn. More care should be given to the preparation of the seed-bed than for oats or rye. In the cotton-belt barley will easily occupy a position in the rotation similar to wheat.

435. Sowing. — In the cotton-belt the greater part of the barley crop is sown in October and November. In the central part of the Gulf states it may be sown at any date between September 1st and December 1st. When sown broadcast for pasture, $2\frac{1}{2}$ bushels of seed to the acre are advisable. For the production of grain, $1\frac{1}{2}$ to 2 bushels to the acre are usually sown. These amounts are

also required when the crop is sown in drills for soiling purposes.

436. Harvesting. — Barley should be harvested before



FIG. 60. — Loose smut of barley, showing five smutted heads at various stages of development and for comparison a sound barley head.

it is entirely ripe, if discoloration from the rain and dews is to be avoided. At this stage the beards will be less annoying than when the crop is dead ripe. If the bundles are promptly shocked and capped, ripening will proceed after harvest, and an excellent quality of grain can be

secured. Barley is usually harvested with the self-binder.

437. Enemies. — Barley probably suffers more from the attacks of chinch bugs than any other cereal. This may be due to the fact that the chinch-bugs are especially fond of this crop. It is thought by some that barley is less able to resist their attacks than the other cereals. The Hessian fly also attacks barley.

Barley is affected by black stem-rust and the orange leaf-rust. There are also two common smuts of barley. These are the covered smut and the loose smut (Fig. 60). The treatment for the covered smut is the same as for covered or stinking smut of wheat, page 339. The loose smut of barley cannot be prevented by the use of formalin. It can be controlled by the modified hot-water treatment, as given for loose smut of wheat, page 338, with the exception that barley is treated for 13 minutes at a temperature of 126° F. instead of 10 minutes at a temperature of 129° F. as for wheat.

CHAPTER XXXI

RICE (Oryza sativa)

RICE is an annual grass belonging to the tribe Oryzeæ. To this tribe also belong the two species of wild rice, *Zizania aquatica* and *Zizania miliacea*. The former grows somewhat extensively in certain marshy regions of northeastern Asia, and under similar conditions in North America, particularly in the region of the Great Lakes. Its seed was once used extensively as a food by the Indians but its tendency to shatter upon ripening has prevented its general cultivation. The latter species occurs commonly in the bayous of Louisiana where it is sometimes used as a hay plant. No use has been made of its seed. The genus *Oryza* to which cultivated rice belongs also contains a number of species of wild rice that are rather generally distributed throughout the tropics of both hemispheres.

Rice is a plant of great antiquity, having been known to the Chinese 2800 years B. C. and used by them in their annual ceremony of sowing five kinds of seed. Rice was introduced into Virginia in 1647. This introduction was of little importance. In 1694 the Governor of South Carolina received a small parcel of rough rice from the captain of a trading vessel bound for Liverpool from Madagascar. The vessel had been blown out of her course, and had put into Charleston for repairs. This small parcel of seed

marks the beginning of the rice industry in this country.

438. Structure. — Rice is grown for its grain, which is used for human food. The plants vary in height from two to five feet, depending upon soil and cultural conditions. The grain is borne on short branches radiating from the upper part of the culm and forming a panicle somewhat similar to oats, although more compact on account of the short length of the pedicels bearing the spikelets. The spikelets of rice are one-flowered and, unlike the other cereals, each flower has six stamens instead of three. The outer glumes are very small, consisting only of two small scales. The flowering glume envelops the kernel and is frequently awned. The rice grain, as threshed, consists of the kernel or caryopsis inclosed in the flowering glume and palea. These outer coverings constitute the hull. The rice kernel has a fluted appearance due to four depressions which traverse the surface longitudinally. The endosperm is quite hard and translucent, and comprises the biggest portion of the kernel. The embryo, which is not imbedded in the kernel, is rubbed off in the process of milling.

The root-system of rice is quite fibrous. Like the other small grains, rice tillers freely under favorable conditions sending up several culms from one grain.

439. Composition. — The rice grain contains a high percentage of starch and a low percentage of ash, protein, crude fiber, and fat. The composition of rice and its products, as determined by McDonnell¹ and reported by Duggar,² is shown on next page:

¹ S. C. Agr. Exp. Sta., Bul. 59.

² Duggar, J. F., "Southern Field Crops," p. 219.

TABLE 35. COMPOSITION OF RICE AND ITS PRODUCTS

	WATER Per Cent	ASH Per Cent	PROTEIN Per Cent	CRUDE FIBER Per Cent	NITRO- GEN FREE EXTRACT Per Cent	FAT Per Cent
Prepared rice.....	12.79	0.40	7.38	0.33	78.84	0.24
Rice polish.....	9.73	5.50	12.73	2.20	59.40	10.44
Rice bran.....	10.05	11.17	11.35	16.10	39.76	11.57
Rice hulls.....	11.11	14.95	1.88	39.11	33.62	0.33
Rough rice.....	5.73	5.89	7.75	8.25	70.13	2.31
Rice straw.....	6.76	12.88	3.00	38.98	42.11	1.27

440. Varieties. — Owing to the great antiquity of rice and the varied conditions of soil, climate and culture under which it has been produced, many varieties have come into existence. Relatively few of these, however, are of great agricultural importance.

The principal varieties of rice grown in the United States are the famous Carolina Gold Seed, the Honduras, the Japan, and the Blue Rose. "White" rice, the original variety introduced into this country in 1694, was generally cultivated in the South Atlantic states during the early period of the rice industry in this country but in recent years has been superseded by the Gold Seed.

Carolina Gold Seed rice, so called from the golden-yellow color of its husk when ripe, ranks among the best rices of the world as regards yield, and size and richness of kernel. In reality there are two varieties of Gold Seed rice, differing only in size of kernel.

The Honduras (Fig. 61) and Japan varieties are grown largely in Louisiana, Texas, and Arkansas. Honduras rice grows taller than the Japan and produces a stiffer culm which renders it less liable to lodge. The kernels are large and polish with a desirable pearly luster, for which reason it usually commands a higher price than the Japan. On the other hand, Japan rice usually yields more than the

Honduras and the grain, being tougher, suffers a smaller percentage of loss from broken grains in milling. The kernels of Japan rice are short and thick. As the grain

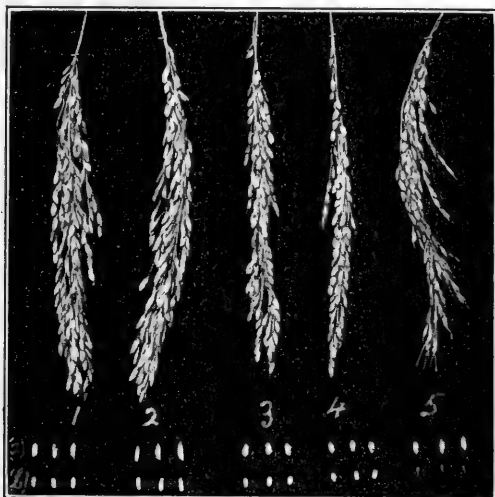

FIG. 61. — Showing typical heads of five varieties of rice together with the unhulled and hulled grains (*a*), and hulled kernels (*b*). 1, Blue Rose; 2, Honduras; 3, Waterbuna (Japan); 4, Shinriki (Japan); 5, Red Rice.

has a very thin hull it yields a small percentage of bran and polish.

Blue Rose rice (Fig. 62) is the most important variety now grown in southeast Texas and southwest Louisiana. It was originated by a planter by the name of Wright, of Crowley, Louisiana, and has come into use only within the last five or six years. It is valued especially as a high-yielding variety and possesses excellent milling qualities, milling a uniformly high percentage of finished rice. It

also has the advantage of not shattering badly at the time of harvest.

441. Upland rice. — For maximum yields and best quality, rice must be grown on low, level lands that permit



FIG. 62. — Blue Rose rice.

of irrigation. However, there are varieties that can be grown on rich uplands without irrigation. Upland rice can be grown with reasonable success over a rather large area of the cotton-belt east of the Mississippi River. However, the yields are usually low and uncertain and

the quality inferior to that of irrigated rice. Upland rice is usually planted in rather close drills and cultivated. These so-called upland varieties succeed better when irrigated.

442. Climatic adaptations. — Rice is a tropical plant but thrives also in semi-tropical regions. It is more resistant to extreme heat than wheat, being quite similar to cotton in its climate range. Roughly speaking, the world's rice crop is produced within the area lying between latitude 40 degrees north and south of the equator in both hemispheres. However, its best development is possible only within those regions having a very moist, insular climate. The bulk of the world's rice crop is produced throughout the warmer parts of China, Japan, India, and the Philippine Islands in Asia, Italy and Spain in Europe, the southern United States in North America, Honduras in Central America, and Brazil, British Guiana and Peru in South America.

443. Irrigation. — The most economical production of high-grade rice is possible only in regions where the crop can be flooded with three to six inches of water during most of the growing period. Lands selected for irrigated rice must, therefore, have slight, if any slope, and must be retentive of water. The fields must be laid off in such a manner that the entire surface of each contour or sub-field will be at practically the same level, otherwise the irrigation water will vary in depth in different parts of the field, and the crop will ripen ununiformly. Where the slope of the land is considerable only small contours are possible. In the level prairie sections each contour often comprises as much as 20 or 30 acres.

Irrigation water is supplied from rivers, bayous, or wells. Usually large canals are constructed from the water source

and extend along one side of the area to be irrigated, or in some cases completely encircle it. On each side of the main canal, and running parallel with it, banks or levees are thrown up which aid in holding the water. The water is either pumped or siphoned into these main canals from which it is distributed, through headgates or through boxes put through the levee known as "trunks," to lateral ditches or small canals. This system of laterals conveys the water to the highest parts of the various fields. In order that the water may be distributed uniformly over the entire area, the fields are subdivided into smaller areas.

In the South Atlantic states, the fields are subdivided by a system of small ditches or canals, a small levee being thrown up on the borders of each. These ditches are usually parallel, about 50 feet apart, and are used for conveying the water both to and from the land.

In the Gulf states, low levees are thrown up on the contour lines, usually with a plow, so as to divide the field into subareas of uniform level. The water is turned into the highest subarea first, from which it flows to the subarea having the next highest level and so on until the entire area has been flooded.

Regardless of the system of irrigation followed, it is of paramount importance that the levees bordering rivers and main canals be sufficiently high to protect the rice against freshets or salt water. The injury to rice from freshets is due not alone to the volume of water, but also to its low temperature. Salt water from the sea often ascends rivers to a considerable distance, especially in periods of continued drought. The admittance of this salt water to rice fields will destroy the crop, although slightly brackish water is not destructive.

RICE PRODUCTION IN THE UNITED STATES

The world's crop of cleaned rice amounts to approximately one hundred and fifty billion pounds annually. Of this amount the United States produces approximately seven hundred million pounds.

444. Rice-growing sections. — Previous to 1880 the bulk of the rice crop in the United States was produced in South Carolina and Georgia. At present Louisiana, Texas, and Arkansas produce more than three-fourths of the crop in this country. This shift in rice production has been due to the opening up, within recent years, of large areas of level prairie land in southwestern Louisiana, southeastern Texas, and southeastern Arkansas, together with the development of a system of irrigation and culture that greatly reduces the cost of production by admitting the use of improved seeding and harvesting machinery.

In addition to these important areas, rice is also produced in eastern Louisiana on low alluvial lands once used as sugar plantations, and on soils of the same character farther up the Mississippi. In southern Louisiana and particularly in the eastern sections of Georgia and South Carolina considerable quantities of rice are still produced on what is termed the "tidal deltas." Lands of this character that are used for rice growing are usually located on some stream, and have an elevation such that they can be flooded from the stream at high tide and drained into it at low tide. Many inland marshes occurring in the more elevated regions of South Carolina and Georgia, and so situated that they can be irrigated from some convenient stream, are used for growing rice.

The areas adapted to upland rice are very extensive inasmuch as this crop can usually be grown on any soil

adapted to wheat or cotton provided the climate is favorable.

445. Drainage. — The fact that rice is a water plant has caused most rice-growers to underestimate the value of good drainage as an aid in producing both maximum yields and a superior quality of grain. Experience has amply demonstrated that good drainage is equally as essential for rice as for wheat and most other field crops. The chief benefits which the rice-grower derives from good drainage are: (1) It permits more thorough preparation of the seed-bed; (2) earlier planting is possible; (3) a better stand is secured; (4) the rapid accumulation of alkali is prevented; (5) it permits the rapid removal of the flood waters before harvest and thereby allows the soil to become sufficiently firm to permit the use of improved machinery in the harvesting of the crop; (6) a more uniform ripening is secured, and consequently a better quality of grain is produced.

Drainage is most easily effected by means of open ditches. Where this system of drainage is employed the main ditches should be at least three feet deep. Tile drainage, while often practicable, is usually not resorted to because of the expense and because the sediment carried by the water during freshet seasons often clogs the drains.

446. Soils, rotations and fertilizers. — The best rice soils are silty loams underlain by a semi-impervious sub-soil. Very loose-structured soils are not suitable for rice as they will not retain the irrigation water. The fertile drift prairie soils of Louisiana and Texas are examples of excellent rice soils. They are composed of a loamy top soil underlain by a rather impervious clay which makes them quite retentive of water.

Rice is seldom grown in a rotation with other crops. The

principal reason for this is that it would reduce the area of rice grown. Nevertheless continuous rice-culture leads ultimately to unprofitable yields. Farmers who have long grown rice continuously on the same land are now being forced to adopt a rotation to free the land of noxious weeds and to add some vegetable matter for the rejuvenation of the soil. An excellent practice is to grow, once every three years, an intertilled crop like corn together with cowpeas seeded at the last cultivation.

While many kinds of fertilizing materials are employed for rice in oriental countries, the land is seldom fertilized for this crop in the United States. This is partially due to the common impression that the flooding of the rice fields restores to the soil as much plant-food as is removed by the crop. If the irrigation water carries a large amount of sediment this is probably true, but it is not the case where flooding is done with pure water. Usually the irrigation water carries a large quantity of potash and a partial supply of nitrogen, but very little phosphoric acid. That the yield of rice may be materially increased by the use of a phosphate fertilizer, and the proper hardening of the grain aided by the use of a potash fertilizer, are indicated by experiments in Louisiana.

While little is known as to the fertilizer requirements of rice, certainly in most cases, the permanent productiveness of rice lands can be maintained only when at least a part of the fertility removed by the crop is replaced. The best method of doing this must be determined by each planter according to his conditions.

447. Preparation of the seed-bed. — Soil conditions, particularly as regards moisture, are so variable in the rice-belt that no one method of preparation is applicable to all cases. In wet culture the land is usually plowed in

the spring a short while before planting. In dry culture the land is best plowed in the fall or winter.

The depth of plowing must vary with conditions. If good drainage facilities have been provided, deep plowing is especially recommended. This should be immediately followed by the harrow. After this treatment, the land, especially if it is porous, should be gone over with a heavy roller. It should be remembered that alkali often accumulates in the subsoil just below the plowline and in such cases a relatively small percentage of the subsoil should be plowed up each year until the desired depth has been reached. Relatively shallow plowing is preferable on poorly drained, persistently wet soils; otherwise the wheels of the binder will sink so deeply into the soil at harvest time as to render the use of this implement impossible.

Maximum yields of rice can be secured only when the soil is in such a condition as will permit the preparation of a relatively deep, thoroughly pulverized, level seed-bed.

448. Planting. — Rice planting begins about March 15th in Louisiana and Texas, and about April 1st in South Carolina and Georgia. The planting season continues until about June 1st. Usually for best results the crop should be planted by April 20th. The Arkansas Station recommends that the crop in that state be sown as early as possible after danger of frost is over and the ground is warm enough to germinate the seed.

Seeding should be done with a grain drill when possible. Broadcast sowing, while still common in many communities, should be discontinued, as by this method a uniform distribution or germination of the seed is almost impossible. Uniform germination is especially important from the standpoint of securing uniform ripening. One to two bushels of seed is the quantity sown to the acre.

The method of planting rice in the South Atlantic states differs somewhat from that employed in the Gulf states. In discussing rice planting in South Carolina Knapp says, "Just prior to seeding the land is thoroughly harrowed, all clods pulverized, and the surface smoothed. Trenches 12 inches apart and 2 to 3 inches deep are made with 4-inch trenching hoes at right angles to the drains, and the seed is dropped in these. This is usually covered, but occasionally a planter, to save labor, stirs the seed in clayed water, enough clay adhering to the kernels to prevent their floating away when the water is admitted."

449. Irrigation practice. — The practices employed in the flooding of rice vary in different sections of the rice-belt. Irrigation water should not be applied to the crop until the plants are 6 to 8 inches high except where the application of water is necessary to germinate the seed. If a good stand has been secured and the crop is making a vigorous growth, thus shading the land completely, the water need not stand more than two inches deep. In case of a thin stand the water should stand from 4 to 6 inches deep. To avoid stagnation and the growth of certain injurious plants, the water should be constantly renewed by permitting a continuous inflow into the high part of the field and a continuous outflow from the lowest part.

In Louisiana and Texas, water for irrigating rice is supplied by rivers, bayous, or deep wells from which it is pumped into the main canals. In lifting this water the centrifugal type of pump has been found most satisfactory. The capacity of centrifugal pumps can be calculated from the following data by Bond of the United States Department of Agriculture:

TABLE 36. DUTY OF CENTRIFUGAL PUMP FOR IRRIGATING.
LIFTING WATER LESS THAN 35 FEET

DIAMETER OF DISCHARGE (Inches)	DISCHARGE PER MINUTE (Gallons)	POWER FOR EVERY FOOT OF LIFT (Horse p'r)	QUANTITY PUMPED PER DAY (Ft. per acre)	AREA IRRIGATED IN 70 DAYS (Acres)
4.....	433	.27	1.87	60
6.....	1025	.56	4.53	158
8.....	1900	.98	8.39	294
10.....	3000	1.54	13.25	464
12.....	4275	2.06	18.89	661
15.....	7000	3.34	30.93	1083
18.....	10000	4.62	44.19	1547
20.....	13000	5.68	57.45	2011

When the plants have reached a height of 6 to 8 inches the field is flooded with water to a depth of 2 to 6 inches. The field is kept flooded until a short while before harvest, when the water is withdrawn and the soil allowed to become firm before the crop is cut.

In South Carolina the usual practice is to let the water on the land for four or five days immediately after planting, to germinate the seed. This is spoken of as the "sprout water." When the grain is well sprouted the water is withdrawn. As soon as the rice has reached the two-leaf stage the "stretch water" is put on to a depth of 10 or 12 inches at first, afterwards being drawn down to about 6 inches where it is held for three or four weeks. The land is then drained and the crop hoed. No more water is admitted until the plants begin to joint, at which time they are again hoed, and the water turned on to remain until about eight days before harvest when it is withdrawn. This last irrigation is known as the "harvest water" or "lay by flow."

450. Harvesting. — Rice should be harvested when the grain is in the stiff dough stage, at which time the straw is beginning to turn yellow. In the prairie districts of Louisiana, Texas, and Arkansas the crop is commonly harvested with the ordinary grain binder. The bundles should be carefully shocked and protected by cap bundles, so as to reduce exposure to the sun as much as possible. Careless shocking results in many sun-cracked grains which usually break in milling.

In the rice-growing districts of the South Atlantic states, the use of the grain binder is often impractical on account of the boggy soil at harvest time or the small size of the fields. In such cases the crop is harvested with a sickle, the cut grain being laid upon the stubble to cure. After a day's curing it is bound into small bundles, removed from the wet field and shocked on dry ground.

451. Thrashing. — The rice crop is now thrashed with steam thrashers, except in special cases, when the primitive method of "flailing" is employed. While the use of the steam thrasher frequently involves the breakage of considerable grain, it furnishes the most economical means of separating the grain from the straw. Without it the present extensive production of rice in this country would be impossible.

If the grain comes from the thrasher in a damp condition, it should be spread out on a floor and thoroughly dried before it is placed in sacks or barrels. Rice is usually sold by the barrel of 162 pounds. A sack is an indefinite quantity but usually contains from 150 to 200 pounds. A bushel of rough rice, or "paddy," is 45 pounds. A pocket of clean rice is 100 pounds.

452. Yield. — Ordinarily the yield of rice grain ranges from 20 to 40 bushels to the acre. By greater care in the

selection of seed and the preparation of the seed-bed, the average yield can be materially increased. In exceptional cases more than 100 bushels have been secured from one acre.

PREPARATION AND USES OF RICE

453. Cleaned rice. — In order to secure cleaned rice the "paddy" or rough rice must be put through a complicated milling process. Modern rice mills comprise a vast network of complicated machinery. In going through these mills the rice is subjected to the following process in the order given:

(1) Screening, which removes trash and foreign particles.

(2) Removal of the hull by "rapidly revolving 'milling stones' set about two-thirds of the length of a rice grain apart."

(3) Separation of the light chaff and the whole and broken kernels by passing the mixed product over horizontal screens and blowers.

(4) Removal of the cuticle or outer coverings of the kernels. To accomplish this the kernels are put in large mortars holding 4 to 6 bushels each and pounded with pestles weighing 350 to 400 pounds.

(5) Separation of the flour and fine chaff removed in (4), from the clean rice, by passing the mixture first over flour-screens and then through the fine-chaff fan.

(6) Cooling. — The partially clean rice is passed to the cooling bins where it remains for 8 or 9 hours until the heat generated in the previous friction process has escaped.

(7) Removal of the smallest rice and what little flour is left by means of brush screens.

(8) Polishing. — This is the final process in the produc-

tion of cleaned rice. It is accomplished by friction between the rice kernels and pieces of extremely soft, tanned moose-hide or sheep-skin loosely tacked around a revolving double cylinder of wood and wire gauze. The object of polishing is to give the rice its pearly luster. The polished rice is now graded by passing it over separating screens composed of different sizes of gauze. It is then barreled and is ready for the market.

454. Classification of rice products. — The products of the rice in milling are classified commercially, as follows:¹ *Head rice*, consisting of whole grains; *straights*, made up mostly of whole grains but grading slightly lower than head rice; *screenings*, consisting of broken rice of which there are several grades; *brewers' rice*, consisting of very finely broken rice used in the manufacture of beer; *rice polish*, consisting of the highly nutritious flour removed from the kernels in the process of polishing; *rice bran*, consisting of the removed cuticle; *rice hulls*, consisting of the removed flowering glume and palea.

455. Uses. — Rice serves as the principal food in the dietary of more than one-half the population of the world. It is usually eaten whole or in soups. Rice is very low in protein and consequently should be eaten in connection with foods rich in this constituent. In China rice is usually eaten in connection with fish or soybeans.

Rice is also used in the manufacture of starch. The lower grades are used in the production of alcoholic beverages.

Rice polish is a valuable stock food being rich in both albuminoids and carbohydrates. It is also used in the manufacture of buttons.

Rice bran, when fresh, makes an acceptable food for

¹Knapp, S. A., "Rice." Cyclo. Am. Agr., Vol. I, p. 537.

all classes of domestic animals. It has a high content of fat and is often fed in connection with cotton-seed meal.

Rice hulls are valued highly as a manure for rice lands. They are of practically no value as a stock food.

ENEMIES OF RICE

456. Weeds. — Red rice, so called because of the red color of the grains, is of more annoyance to rice-growers than any other weed. It is a wild variety of rice and will cross readily with the improved varieties. Contrary to the opinion of many rice-growers, the red rice and the common white rice are two distinct varieties and one will not produce the other. As the red rice is more hardy and persistent than the cultivated varieties it often becomes a serious pest. In the United States where the demand is for white rice, the admixture of red rice grains in white rice reduces greatly its market value.

To keep the field clear of red rice, the grower must exercise the greatest caution to secure and plant seed that is free from it. If red rice has already been introduced into a field it can be eradicated by preventing it from maturing seed.

Many other troublesome grasses and weeds invade rice fields. Some of the methods recommended for ridding rice lands of these pests are: (1) Plowing the field soon after harvest, a treatment causing the weed seeds to germinate, whereupon they are killed by frost, or in some cases mowed and burned. (2) Plowing the field early in the spring, thus inducing the weed seeds to germinate. They are then killed by cultivation before the rice is planted. (3) Planting no rice for a year or two and thus allowing the dry land weeds to crowd out the water weeds.

457. Insects. — Only a few insects attack the rice plant. The one causing greatest injury is the rice water-weevil. While in the larval stage it destroys the roots, and later the adults feed on the leaves. The most practical means of controlling the rice weevil consists in the temporary withdrawal of the water and the drying out of the land. Alternate flooding and drying, when properly carried out, is also recommended.

458. Fungous diseases. — Rice blast (*Piricularia oryzae*) attacks the node in which the rice head is forming, causing the head to fail to fill or to break off. Experts do not agree as to the treatment of this disease. Some of the preventive measures that have been recommended are: the application of lime to the soil, the destruction of stubble and trash by burning over the fields and the use of early maturing varieties.

Rice smut (*Tilletia horrida*) which fills the kernels with a mass of black spores, is sometimes sufficiently prevalent to do serious damage. For its control, either the hot-water treatment, page 339, or the formalin treatment, page 339, is recommended.

CHAPTER XXXII

THE SORGHUMS (Andropogon sorghum)

IN its agricultural or restricted sense the term "sorghum" includes only the saccharine varieties. In this chapter the term will be used in its broad or botanical sense which includes (a) the saccharine sorghums, (b) the non-saccharine sorghums, commonly known as grain-sorghums, (c) the broom-corns, and (d) the grass sorghums, most important of which are Sudan-grass, Johnson-grass, and Tunis-grass. As the members of the latter group are grown for forage only they will not be treated in this text.

459. Biological origin. — Authorities have generally agreed that the cultivated sorghums were originally derived from the well-known wild species, *Andropogon halepensis*, commonly known in the United States as Johnson-grass. However, it has been recently pointed out that the wild forms of sorghum easily separate into two groups.¹ One group includes the perennials with root-stocks like the various varieties of Johnson-grass; the other group includes annuals without root-stocks, such as Sudan-grass and Tunis-grass. These wild annual forms cross readily with the cultivated sorghums, whereas the perennial forms and the cultivated sorghums are crossed with considerable difficulty. It would therefore seem that the original prototype of our cultivated sorghums is to be found among the wild annual forms of *Andropogon sorghum*,

¹ Piper, C. V., "Forage Plants and Their Culture," p. 260.

referred to above. This view has been expressed by Piper in his book on Forage Plants.

460. Geographical origin. — The cultivated sorghums originated in the tropics of the Old World. An independent origin in tropical Africa and in India is held by Ball.¹ Hackel,² as a result of his studies, concludes that the cultivated sorghums originated in Africa. As the wild annual forms of sorghum are confined largely to Africa, the African origin of the cultivated forms seems the most likely.

461. Botanical classification. — Botanically the sorghums are classed as follows: Order — Gramineæ; tribe — Andropogoneæ; genus — *Andropogon*; species — *Sorghum* var. *vulgare*.

As a key to the principal groups of sorghum, the following classification has been proposed by Ball:³

I. Pith juicy.

A. Juice abundant and very sweet.

1. Internodes elongated; sheaths scarcely overlapping; leaves 12–15 (except in Amber varieties); spikelets elliptic-oval to obovate, 2.5–3.5 mm. wide; seeds reddish brown. I. *Sorgo*.

B. Juice scanty, slightly sweet to subacid.

1. Internodes short; sheaths strongly overlapping; leaves 12–15; peduncles erect; panicles cylindrical; spikelets obovate, 3–4 mm. wide; lemmas awnless. II. *Kafir*.
2. Internodes medium; sheaths scarcely overlapping; leaves 8–11; peduncles mostly inclined, often recurved; panicles ovate; spikelets broadly obovate, 4.5–6 mm. wide; lemmas awned. VII. *Milo*.

¹ Ball, Carleton R., U. S. Dep't of Agr. Bur. Plant Ind., Bul. 175, pp. 9–10.

² Hackel, Edward, "The True Grasses," p. 59.

³ Ball, Carleton R., U. S. Dep't Agr. Bur. Plant Ind., Bul. 175, p. 8.

II. Pith dry.

A. Panicle lax, 2.5-7 dm. long; peduncles erect; spikelets elliptic-oval or obovate, 2.5-3.5 mm. wide; lemmas awned.

1. Panicle 4-7 dm. long; rachis less than one-fifth as long as the panicle.

a. Panicle umbelliform, the branches greatly elongated, the tips drooping; seeds reddish, included.

III. Broom-corn.

2. Panicle 2.5-4 dm. long; rachis more than two-thirds as long as the panicle.

a. Panicle conical, the branches strongly drooping; glumes at maturity spreading and involute; seeds white or somewhat buff.

IV. Shallu.

b. Panicle oval or obovate, the branches spreading; glumes at maturity appressed, not involute; seeds white, brown, or reddish.

V. Kowliang.

B. Panicle compact, 1-2.5 dm. long; peduncles erect or recurved; rachis more than two-thirds as long as the panicle.

1. Spikelets elliptic-oval or obovate, 2.5-3.5 mm. wide; lemmas awned.

V. Kowliang.

2. Spikelets broadly obovate, 4.5-6 mm. wide.

a. Glumes gray or greenish, not wrinkled; densely pubescent; lemmas awned or awnless; seeds strongly flattened.

VI. Durra.

b. Glumes deep brown or black, transversely wrinkled; thinly pubescent; lemmas awned; seeds slightly flattened.

VII. Milo.

The above classification does not include the grass sorghums. Of the seven groups included in the above classification, sorgho has been developed primarily for its sugar which is largely used in the form of sirup; kafir, milo, shallu, kowliang, and durra have been developed primarily as grain crops; and broom-corn for the "brush" furnished by the seed-bearing branches of the panicle.

462. Root-system. — Careful studies of the root-systems of sorghum and corn growing under the same con-

ditions show that both sweet and grain-sorghums produce a shallower root-system than corn. As a result of investigations at the Kansas Station, Ten Eyck found the roots of kafir and Folger sorgo largely confined to the upper 18 inches of soil; while corn under the same conditions completely occupied the upper 30 inches of soil. The deepest roots of kafir penetrated to a depth of three feet while corn sent its deepest roots four feet. The roots of kafir were especially fine and fibrous and completely filled the upper 18 inches of soil. While the roots of the sweet sorghum were somewhat less fine and hardly so abundant in the upper soil strata as the kafir roots, they were said to resemble the kafir more than the corn roots.¹

463. Tillers and branches. — A small bud is produced at every node of the sorghum culm except the uppermost node which bears the peduncle and main seed-head. Tillers result from the growth of those buds on the closely crowded lower nodes at the surface of the soil. The number of these lower buds that develop into tillers will depend upon the habit of the variety or the abundance of food and moisture. From one to ten is the usual variation. The tillers are usually shorter and later in maturing than the main stalk. As a rule they produce seed.

In long seasons of abundant moisture the buds borne at the above-ground nodes may develop into branches, by forcing their way out at the top of the leaf-sheaths or by splitting the back of the sheaths. Usually the uppermost bud develops first followed in succession by those at the lower nodes. The number of buds that thus develop into branches will depend upon the length of the growing season and the moisture supply. Each branch is a miniature stalk bearing leaves and a seed-head.

¹ Kans. Agr. Exp. Sta., Bul. 127, pp. 207-208.

464. Drought resistance. — The peculiar adaptation of the sorghums, particularly the grain-sorghums, to agriculture in semi-arid regions, is well known. As to those qualities or factors that enable the sorghums to successfully resist dry, hot weather, our knowledge is less clear. These qualities cannot be attributed to the extensiveness or depth of the root-system as we have already seen that the root-system of sorghum is less extensive than corn, a crop not particularly adapted to dry regions. Observations also indicate that as much water is required to produce a pound of dry matter in sorghum as in corn. It would therefore seem that the rather prevalent belief in the exceptionally low water requirement of sorghum is not tenable. The most probable explanation of the peculiar adaptability of the sorghums to dry, hot regions is to be found (1) in the high degree of resistance of the sorghum plant to injury from dry, hot weather and (2) the ability of the sorghum plant to cease growing and become practically dormant during periods of severe drought, growth being renewed without any apparent injury with the coming of rain.

465. Effects on the soil. — The sorghums, particularly the saccharine varieties, are generally considered to be hard on the land. The reasons for this are not clear. Among the explanations so far advanced the following seem to be the most reasonable: (1) The sorghums seem to concentrate their feeding roots in the upper layers of soil to a greater degree than most other crops, which peculiarity probably results in exhausting the surface soil of its available fertility. (2) Sorghum stubble often breaks up cloddy on account of the fact that the soil is held together by the matted roots. (3) The slowness with which sorghum stubble decays renders its immediate effects less

apparent than that produced by other forms of vegetable matter.

The evil effects of sorghum on the land are usually only temporary, being most marked on the first crop following and completely disappearing in two or three years.

466. Fertilization and crossing. — The sorghums are capable of both self-pollination and cross-pollination. They are normally self-pollinated and are not injured by this process as is corn.

As the light pollen of sorghums is easily carried by the wind, different varieties or types, when planted close together are subject to more or less crossing. Ball¹ found that when different varieties were planted in adjacent rows and flowered at the same time as high as 50 per cent of the seed produced on the leeward row was cross-fertilized. It has been conclusively demonstrated that all of the different types of sorghum, such as saccharine and non-saccharine sorghums, and the broom-corns will intercross readily if grown in close proximity to each other.

467. Breeding (Figs. 63, 64). — Sorghum lends itself easily to improvement by selection. The selection should be made before the plants flower, and the selected plants should be prevented from becoming contaminated by bagging the heads before the stigmas are exposed. The bags should be removed as soon as the seeds have set to prevent the heads from molding.

The producing power of the selected plants is determined by the head-to-row method. This method is carried out in the same manner as the ear-to-row test of corn, page 196, except that in the sorghum breeding-plot no precautions are taken to prevent inbreeding. On the other hand, the best heads in the most productive rows are

¹ Ball, Carleton R., *Am. Breeders' Assoc.*, Vol. VI, p. 193.

bagged each year and used for planting the breeding-plot of the next year.

The qualities selected for in improving the saccharine

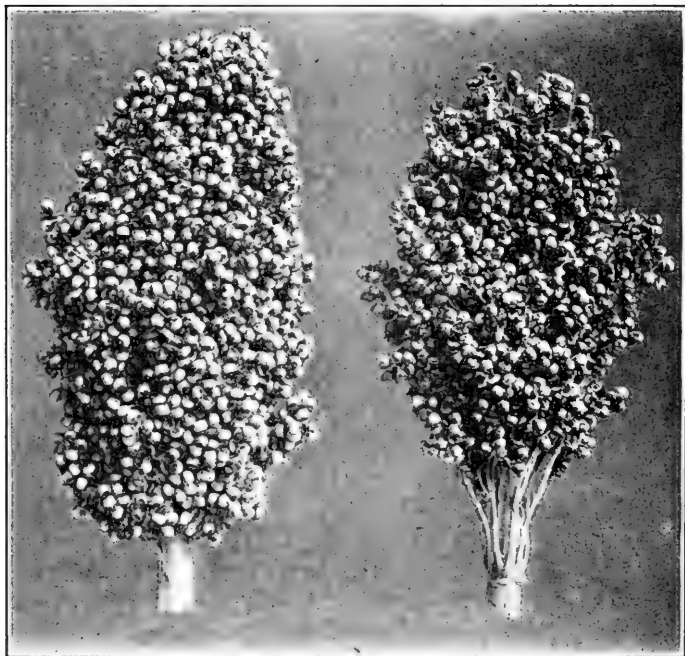

FIG. 63. — Two heads of Milo showing desirable form (on left) and undesirable form (on right).

sorghums are juiciness and high sugar content, yield, disease-resistance, drought-resistance, and erectness.

In the improvement of the grain-sorghums the principal considerations should be (1) increased grain production; (2) increased drought-resistance; (3) increased earliness; (4) dwarf stature; (5) desirable forms of heads; (6) heads fully exerted from the upper leaf-sheath, or boot;

(7) freedom from suckers and branches; (8) freedom from pendent heads; and (9) disease-resistance.

The dwarf stature is usually desirable in the grain-sorghums because it decreases the water requirement of the crop to a unit of grain produced. The tendency to sucker is generally looked upon as an undesirable quality in the grain-sorghums. The suckers are usually shorter and later maturing than the main stalks and less produc-



FIG. 64. — Three plants of Blackhull Kafir, 5.5 feet high, selected for low stature and high yielding power.

tive of grain. Best results are secured when sufficient seed is planted to furnish the desired number of stalks without depending on suckers. Branches are absolutely worthless and should be eliminated. Pendent heads make it difficult to harvest the crop by machinery. All of these characters are to an extent hereditary and can be more or less controlled by selection. Sorghums are crossed artificially with little difficulty. To do this the flowers must be emasculated before the anthers open.

468. Sorghum poisoning. — Many instances are on record of the poisoning of cattle from feeding on the growing plants of both saccharine and non-saccharine sorghums. This injury is due to the formation of prussic acid in the plants, particularly in the leaves, under certain conditions. The poison is produced by the action of an enzyme on one or more of the normally occurring glucosides in the plant. The amount of prussic acid in sorghum usually decreases as the plant matures. The condition that favors the development of prussic acid in sorghum is a stunted growth of the plants produced by hot, dry weather. It is also claimed that young plants of vigorous growth contain a higher content of prussic acid than plants reaching maturity. Cutting poisonous sorghum and allowing it to wilt will eliminate the poisonous property. Sorghum that has been stunted by hot, dry weather should be pastured with great caution.

CHAPTER XXXIII

THE SACCHARINE SORGHUMS

THIS type of sorghum, commonly designated as "sweet sorghum" is characterized by the production of stems having a juicy pith that is high in sugar, and a relatively small seed-crop as compared with the grain-sorghums. The saccharine sorghums were introduced into the United States from China and Natal. In 1853 a variety known as "sorgo" or "Chinese sorgo" was brought to this country from China by way of France. This early Chinese sorgo is the variety from which our well-known and popular Amber sorghum has been derived. Several of our other commonly grown varieties of sweet sorghum, including Orange, Sumac and Gooseneck, have been derived from a collection of Natal varieties, introduced into Europe in 1854 and thence into the United States in 1857. From the time of their introduction in this country up until 1880 the sweet sorghums were grown almost entirely as a sirup crop. This continues as the principal use of these sorghums in the central and southern states east of the Mississippi River. Since 1880 the sweet sorghums have been grown in the region west of the Missouri River and southward in the Great Plains principally as a forage crop.

469. Classification of saccharine sorghums. — The classification here given has been adopted from Ball by Montgomery.¹

¹ Montgomery, E. G., "The Corn Crops," p. 296.

A. Peduncle and panicle erect.

1. Panicle loose, open, branches spreading to horizontal or drooping; rachis two-thirds as long to equaling the panicle.

Empty glumes black, hairy.....I. Amber

Empty glumes black, smooth.....II. Minn. Amber

Empty glumes red.....III. Red Amber

Empty glumes light brown.....IV. Honey

Rachis less than one-half the length of the panicle:—

Panicle light, drooping branches, seeds

orange to red.....V. Collier

Panicle heavy, seeds orange.....VI. Planter's
Friend

2. Panicle close, compact.

Empty glumes equal to seeds, seed red.VII. Orange

Empty glumes half as long as the small

seeds, seeds dark red.....VIII. Sumac

Empty glumes narrow.....IX. Sapling

B. Peduncle recurved (goosenecked) or sometimes erect.

Panicle black, glumes awned.....X. Gooseneck

A brief description of the varieties that are most important in the cotton-belt is given below:

470. Sumac sorghum, often known as "Redtop," produces a very compact, deep red seed-head somewhat similar to Sumac, which character gives it its name. Under average conditions the plants grow 7 to 8 feet high and are rather stout and erect. Sumac sorghum matures in from 105 to 120 days. Owing to its high value for sirup, forage, and silage it is especially popular in the South, particularly throughout the Piedmont region and in Oklahoma and Texas. It is said to be the most uniform of the sweet sorghum varieties.

471. Orange sorghum (Fig. 65) usually does not grow quite as tall as Sumac, and produces rather stout erect stalks, the seed-heads of which are rather long, of medium

compactness, and present an orange tinge due to the partially exserted orange colored seeds. It matures in about the same length of time as Sumac sorghum. Orange sorghum is an excellent variety for sirup production, and being rather leafy, is also a good variety for forage.

472. Amber sorghum is probably the most largely grown variety of sweet sorghum in the United States. It is very early, maturing usually in less than 100 days, and for this reason has practically crowded all other varieties out of the section north of Kansas and the Ohio River, which comprises the northern limit of the sorghum-belt. It is very popular in Kansas, Oklahoma and Texas as a forage crop. Amber sorghum is not a tall growing variety, usually ranging in height from 5 to 7 feet. The seed-head is usually rather loose and black in color. A selection known as Red Amber differs from the parent form only in having red seed-heads.

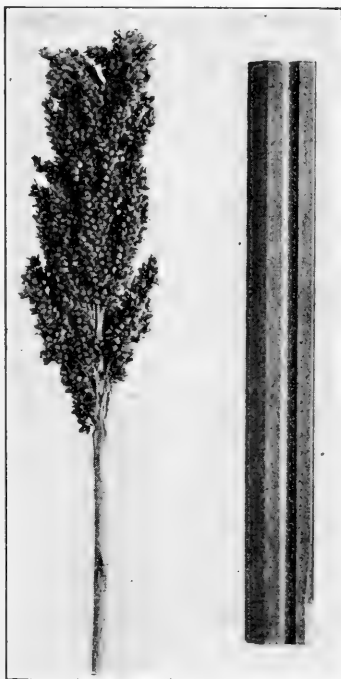

FIG. 65. — A head of Orange sorghum.

473. Gooseneck sorghum is often erroneously called "Texas Seeded Ribbon Cane." The use of the name

“Seeded Ribbon Cane” has caused much confusion among farmers inasmuch as the true sugar-cane (*Saccharum officinarum*) is also commonly known as “Ribbon Cane.” The seed of “Texas Seeded Ribbon Cane” has been widely sold in the past, often with the claim that it was a form of true sugar-cane that both produced seed and could be grown from the seed. Investigation has shown this plant to be the old familiar Gooseneck sorgho. It is in no sense a variety of Ribbon Cane and the application of this name to it should be discontinued. Owing to the popularity of the so-called Texas Seeded Ribbon Cane, seed of other varieties of sweet sorghum have been substituted for it and sold as “Straightneck Seeded Ribbon Cane.” Gooseneck sorghum is the largest and one of the latest varieties of sweet sorghum. The plants grow from 9 to 12 feet tall with from 25 to 50 per cent of the peduncles recurved, which character gives it its name. The stalks are from one to two inches in diameter at the base and are rich in sugar; and hence a very valuable variety for sirup.

474. Honey sorghum, sometimes incorrectly called “Japanese Seeded Cane” was found growing in Texas in 1904. It produces tall stems that are very juicy and sweeter than any other variety known. The stems are very tender and are excellent for sirup making. Honey sorghum is a very late variety requiring from 125 to 140 days to mature.

475. Climatic adaptations. — With few exceptions the climatic adaptations of the saccharine sorghums are similar to those of corn. They are less injured by intense heat or drought than corn but they are easily susceptible to injury both in the spring and fall by even light frosts. In regions of cool summers they are of little value. A warm summer climate is absolutely essential.

476. Soils and fertilizers. — Sweet sorghum may be successfully grown on soils of almost any character provided they are reasonably fertile and well-drained. These crops are strong feeders and excellent drought resisters, which qualities often cause them to be planted on the poorest land of the farm. The fertile soils are often avoided for sorghums grown for forage because the stems are finer on the less productive soils. The tendency of sorghums to produce coarse stems when planted on rich soils can be overcome by sowing the crop thicker. For sirup production a rather fertile, medium textured loam is preferred.

While it is customary to grow the sorghums without fertilizer, they are surface feeders and will respond to judicious fertilization as readily as will corn. The character, amount and method of application of fertilizer for sorghum are the same as for corn.

477. Preparation of the land. — The sweet sorghums require no special preparation of the soil other than that recommended for corn. As the young plants grow very slowly, the seed-bed should be plowed early and harrowed frequently before seeding in order to kill any weeds that may have started.

478. Time, rate, and method of planting. — The sweet sorghums are usually planted from two to four weeks after the earliest corn. In the cotton-belt the greater part of the crop for sirup is planted in May. For forage, sorghum may be planted in the central portion of the Gulf states at any time from April 1st to July 1st, although reduced yields are usually secured from the very late plantings.

When grown for sirup, the rows should be $3\frac{1}{2}$ feet apart and the plants from 4 to 8 inches apart in the row. Planting is best done with an ordinary corn or cotton planter fitted with special sorghum plates. Sometimes the corn-

planting plates are modified for planting sorghum by filling the holes with lead and boring them out to the proper size. In all except the semi-arid region of the cotton-belt surface planting is recommended. The two-row corn planter is largely used for this purpose. In the drier sections of Texas and Oklahoma the seed is often planted in a lister furrow.

479. Cultivation. — The cultivation of sorghum is much the same as for corn. As a rule the weeder or harrow should be used until the plants are large enough to permit the use of any of the common types of cultivators. At least one light harrowing should be given before the plants are up and another when they are large enough to escape injury. Tillage by separate rows should continue until the plants have almost reached the heading stage.

480. Harvesting. — When grown for sirup, sorghum should be harvested when the seed have reached the hard dough stage. The crop increases rapidly in total weight until maturity. The sugar content also increases rapidly from the time the panicles appear until maturity as shown below:

TABLE 37. SUGAR CONTENT OF SORGHUM AT DIFFERENT STAGES OF GROWTH ¹

STAGE OF CUTTING	SUCROSE (Per Cent)	INVERT SUGAR (Per Cent)
Panicles just appearing.....	1.76	4.29
Panicles entirely out.....	3.51	4.50
Flowers all out.....	5.13	4.15
Seed in milk.....	7.38	3.86
Seed doughy, becoming dry..	8.95	3.19
Seed dry, easily split.....	10.66	2.35
Seed hard.....	11.69	1.81

¹ U. S. Dep't of Agr. Farmers' Bul., 477, p. 12 (average of 2740 analyses).

When grown for silage, the sweet sorghums should be cut when the seeds are going out of the soft dough stage. If the seeds are fully ripe many of them will pass through the animal undigested. Sorghum for hay should be harvested when fully headed.

When the crop is utilized for sirup, the leaves are usually stripped while the plants are standing. Whatever the method followed it is important that the canes be stripped before pressing; otherwise the yield of juice is decreased and the percentage of impurities in the juice is increased. The crop is cut by hand or with a corn harvester. If the weather is warm the cut cane should be pressed within one or two days after cutting to prevent the stalks from fermenting. Frosted sorghum should be cut at once and put in large shocks. This should be done without stripping or topping the plants if the shocks are to stand for several days.

481. Manufacturing the sirup. — This process comprises three important steps: (1) The extraction of the juice; (2) clarification of the juice, and (3) evaporation of the juice.

The juice is extracted by running the canes through heavy roller mills run by horse power or by gasoline or steam engines. From 30 to 60 per cent of the juice is extracted, the amount depending on the type of mill used. The three-roller type ordinarily in use extracts about 60 per cent of the juice from the stalks.

The raw juice contains from 20 to 30 per cent of impurities that are removed by clarification. The means of accomplishing this are as follows: (1) Allowing the juice to stand for some time to permit the impurities to settle to the bottom. The juice is carefully drawn off leaving the sediment behind. (2) Heating the juice to coagulate

certain impurities and cause them to rise to the top, whence they are skimmed off. (3) Adding 10 pounds of dry, fine yellow clay to every 50 gallons of juice. The particles of clay, on settling to the bottom carry with them much of the suspended impurities. (4) Filtering the juice. (5) The addition of a small amount of milk, which coagulates and rises to the surface when the juice is heated bringing with it a certain class of impurities. (5) When the juice is somewhat acid, a small amount of lime is added to the heated juice.

Skimming, settling and claying are the means most commonly used for clarifying the juice.

The juice is finally evaporated in large shallow pans. These pans are divided off into compartments and the boiling juice is made to flow from one compartment to another at such a rate as to concentrate it into sirup by the time the outflow is reached.

482. Yield. — Soils of average fertility should produce from 8 to 10 tons of green sorghum. The amount of juice extracted from a ton of cane will vary with the kind of mill used and the quality of the cane. With the better grade of mills from 800 to 1200 pounds of juice should be secured from a ton of canes. This should yield from 15 to 30 gallons of sirup. The sugar content of cane juice varies from 8 to 15 per cent.

483. Enemies. — Two smuts affect the sweet sorghums, viz., the grain smut (*Phacelotheca diplospora*) and the whole-head smut (*P. reiliana*). The damage from these diseases is usually light. Both can be partially checked by crop rotation and care in selecting planting seed. The grain smut can be controlled by the hot-water treatment or the formalin treatment as outlined for oat smut, page 339.

CHAPTER XXXIV

THE NON-SACCHARINE SORGHUMS

THE term "non-saccharine" as applied to the group of sorghums discussed in this chapter is somewhat indefinite as some of the kafirs have a fairly sweet juice and are doubtless capable of being developed into saccharine varieties. The non-saccharine sorghums, with the exception of broom-corn are usually called grain-sorghums, because they are more valuable for grain than for forage. Their growth in the United States on a commercial basis is quite recent, although some of the durras were introduced into California in 1874, kafir being introduced in 1876.

484. The grain-sorghum belt. — Owing to the remarkable drouth resistance of the grain-sorghums and their ability to withstand dry, hot winds they are most completely at home in the United States in that part of the Great Plains region comprising western Texas, the western third of Oklahoma, the western half of Kansas and all of Colorado and New Mexico lying east of the mountains. The most distinctive feature of this region is its climate. The annual rainfall averages about 20 inches, varying from 15 to 25 inches, most of which comes from April to September, inclusive. The summers are hot, and over much of the area steady winds prevail throughout the growing season making evaporation especially rapid. The conditions are often such as to destroy all forms of tender vegetation. Throughout this area

the grain-sorghums are extensively grown as staple crops and are gradually becoming the basis of a great cattle-feeding industry.

485. Groups of non-saccharine sorghums. — The non-saccharine sorghums in the United States are usually divided into five groups as follows: Kafir, durra, shallu, kowliang, and the broom-corns.

486. Kafir. — The kafirs came originally from Natal and the east central coast region of Africa. The seed of two varieties of kafir were exhibited by the Natal Government at the Centennial Exposition at Philadelphia in 1876. From these small quantities of seed the kafir industry in this country has sprung.

The kafir group in the United States includes three varieties. These are White Kafir, Blackhull Kafir, and Red Kafir (Fig. 66). These varieties differ principally in the color of the seed and hulls. In all varieties the heads are erect. Red Kafir usually grows 6 to 7 feet high, while the white and black hull varieties seldom grow higher than 6 feet. Red Kafir is an excellent yielder of both fodder and grain but the seed-coat has an astringent taste which renders it somewhat less desirable as a stock food than the grain of White or Blackhull Kafir. White Kafir is little grown in the United States at the present time because it does not mature well, and the heads, not being well exerted from the leaf-sheath, rot easily in damp weather. Blackhull Kafir is by far the most popular variety, furnishing about nine-tenths of the total kafir crop in this country. Nearly all of the remaining tenth is Red Kafir.

487. Durra (Fig. 67) — The three important varieties of this group are Yellow milo, Brown durra and White durra. The last named variety is often called "Jerusalem corn," "Rice corn" or "Egyptian corn." Another variety

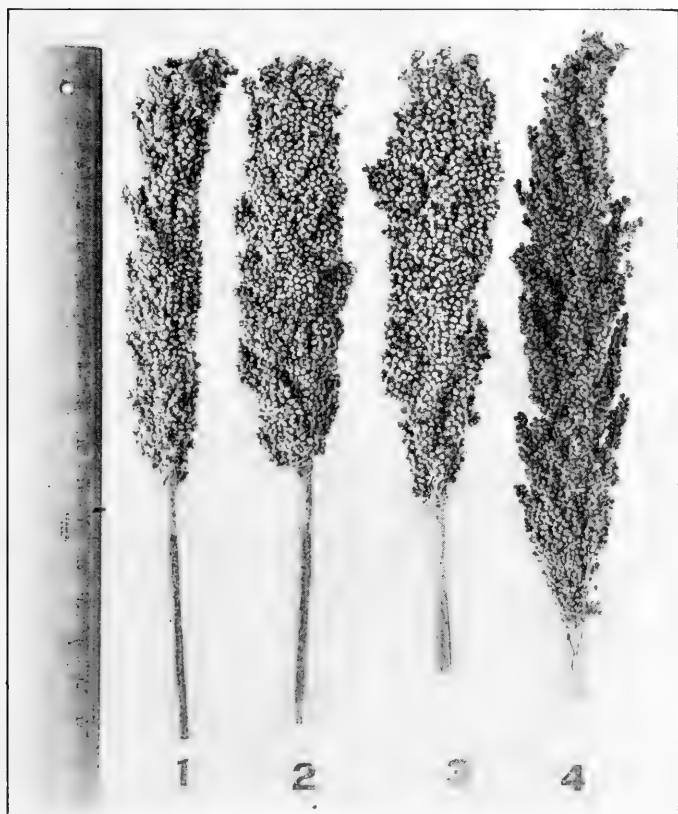

FIG. 66. — Heads of four varieties of kafir: 1, White Kafir; 2, Guinea Kafir (Guinea corn of the West Indies); 3, Blackhull Kafir; 4, Red Kafir.

of durra known as Feterita, and related to milo and White durra, has recently been introduced into the United States from the British Egyptian Sudan, in Africa.

The durras are characterized by the production of large, somewhat flattened seeds (Fig. 68), and with the exception

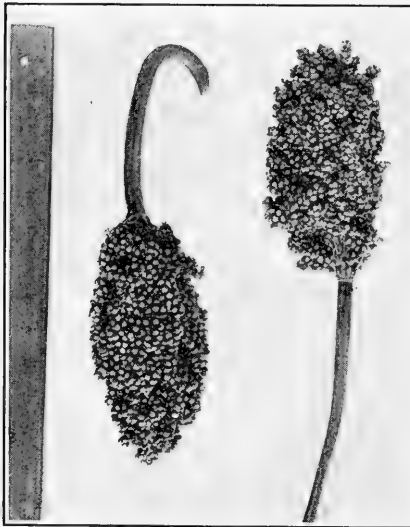

FIG. 67. — Milo heads; one pendent, one erect.

of Feterita, a high percentage of recurved or goose-necked peduncles. As the grain of White durra shatters badly and is frequently injured by insects and disease, it is little grown in this country. Brown durra is grown rather extensively in southern California and to a less extent in Texas. In many respects it resembles milo.

Yellow milo is a very popular grain-

sorghum, owing to the fact that it matures about two weeks earlier than kafir and produces a large, brittle grain that is easily masticated by stock. It is extensively grown in the Pan-handle of Texas and western Oklahoma. Milo is little grown for hay, silage, or soiling as the stalks are not leafy and the crop is usually quite mature when harvested. It is grown almost exclusively as a grain and fodder crop. Yellow milo matures in 90 to 100 days. It can be grown further north and at higher altitudes than kafir. Dwarf

milo is a low growing strain of Yellow milo which has been developed in regions of scanty rainfall. Owing to its extreme drought resistance and excellent grain producing qualities Dwarf milo is now one of the most popular grain-sorghums. There is also a White milo which is closely related to Yellow milo. It differs from Yellow milo mainly in the appearance of the glumes and seed, both of which are white. White milo is meeting with much favor in the grain-sorghum belt.

Feterita is a durra having erect heads, and large, soft,

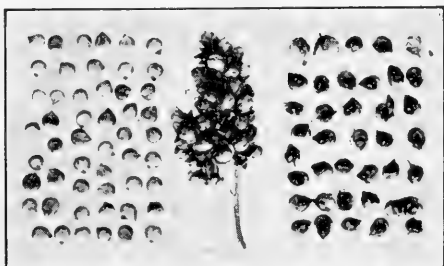

FIG. 68. — Milo seeds, hulled (on left) and unhulled (on right) and a small branch of head.

white grains. It grows from 4 to 7 feet high. Since its introduction into the United States extravagant claims have been made for it by uninformed persons. Experiments by the office of Forage Crop Investigations of the United States Department of Agriculture "show it to be a good grain and forage crop, but not in any way meriting extraordinary praise. It has proved about equal to milo in yield."

488. Shallu (Fig. 69). — This is a peculiar sorghum characterized by slender stems and large loose panicles with drooping branches. The spikelets are somewhat oval in shape and of yellowish color. At maturity the two

empty glumes spread wide apart and become decidedly inrolled or involute, thus completely exposing the hard,

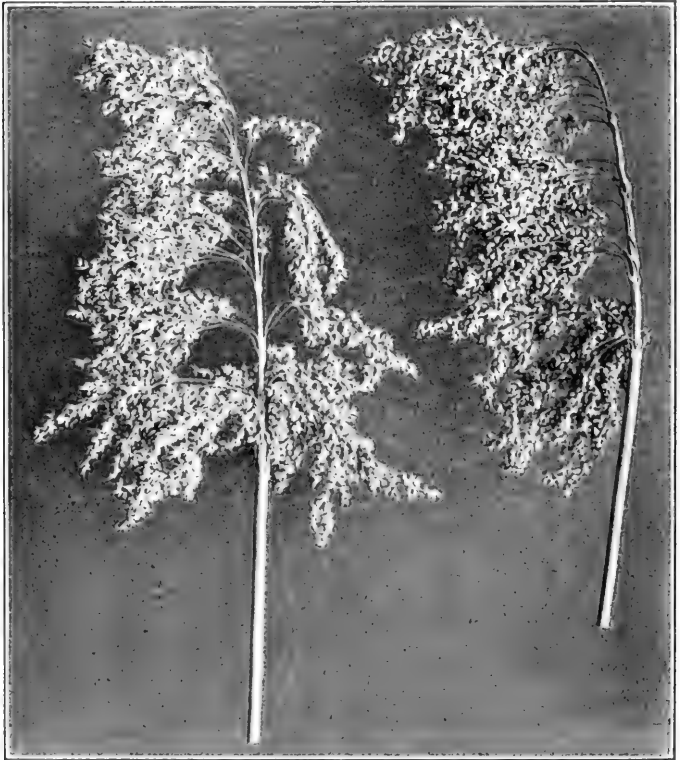

FIG. 69. — Two heads of shallu.

flattened, white or pearly seed. The plants grow from 5 to 7 feet tall.

Shallu was introduced into the United States from India in 1890 by the Louisiana Experiment Station, and later discarded. It is now found growing at scattered points

throughout the grain-sorghum belt under such misleading names as "Egyptian wheat," "California wheat," "Mexican wheat," and others. The seed of this crop has been widely advertised by uninformed seed growers and sold at exorbitant prices. Experiments conducted by the Office of Forage Crop Investigation of the United States Department of Agriculture indicate that shallu is inferior to kafir and milo for grain production and less valuable for forage than the sorgos.

489. Kowliang. — This distinct group of grain-producing sorghums was recently introduced into the United States from northeast China and the adjacent territory of Manchuria by the United States Department of Agriculture to fill the demand for an early ripening grain-sorghum. Tests have shown the kowliangs to be very good grain producers but of little value for forage. In the greater portion of the grain-sorghum belt they are less valuable than milo or kafir. By careful selection it is probable that the kowliangs can be made the basis of important grain crops for the northern part of the Great Plains where early maturing varieties are so essential.

490. Broom-corn (Fig. 70). — This is a non-saccharine sorghum of practically no value for forage, although the matured seed is valuable as a poultry and stock food. The crop is grown almost entirely for the elongated branches of the seed-head which are used in the manufacture of brooms.

The origin of broom-corn is not known. It had its first general culture in Italy. As sorghums have been cultivated in Italy for more than eighteen centuries, it has been suggested that broom-corn has probably been derived by selection from a variety of sweet sorghum having long branches and a shortened rachis.

The panicle of broom-corn is borne on an erect peduncle and consists of a collection of slender seed-bearing branches

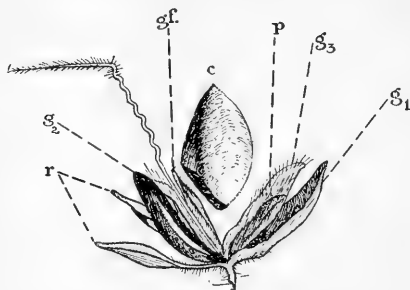

FIG. 70. — Broom-corn fruit with chaff: *r*, two staminate spikelets; *g*¹, lower empty glume; *g*², upper empty glume; *g*³, glume of rudimentary flower; *gf*, flowering glume with awn; *p*, palea; *c*, caryopsis.

from 10 to 28 inches long, attached to a shortened rachis of 1 to 2 inches in length. Broom-corn resembles shallu and kowliang more than other sorghums.

The states of Illinois, Kansas, Missouri, Nebraska, and Oklahoma produce the bulk of the broom-corn crop in this country. In order to produce a "brush" of high quality, dry, clear weather is essential during the maturing and harvesting periods. Rain at this time decreases the value of the crop by discoloring the brush. For this reason broom-corn is best adapted to the central Mississippi valley and the plains of Kansas and Oklahoma and the Panhandle region of Texas.

There are two distinct types of broom-corn, differing mainly as regards height of plant and the length and strength of the brush. Standard broom-corn grows 10 to 15 feet high with a strong brush 20 to 30 inches long. Dwarf broom-corn grows from 4 to 6 feet tall with a brush 12 to 24 inches long. Standard broom-corn is largely produced in central Illinois and is used for the manufacture of large brooms. The dwarf type is largely produced in Kansas, Oklahoma, and Nebraska, and is used in the production of whisk and other small brooms.

491. Culture of the grain-sorghums. — The seed-bed for the grain-sorghums is prepared much as for corn. The land is plowed in either fall or spring, fall plowing usually being preferable. In sections subject to "soil blowing" during the winter months, the fall-plowed land should be left in a rough condition until early spring at which time it should be harrowed and thoroughly prepared for seeding.

492. Time, rate, and method of seeding. — The grain-sorghums are hot weather crops and should be planted from two to four weeks after the usual date of planting corn. In northwest Texas, seeding from April 15 to May 1st usually gives the most satisfactory yields of both grain and forage, while seeding as late as the middle of June is generally undesirable.

Grain-sorghums are usually planted in rows 3 to 3½ feet apart, with the plants from 3 to 10 inches apart in the row. As a rule the durras are left a little thicker in the row than the kafirs. Common distances for durras are from 4 to 8 inches in the row and for kafirs, 6 to 10 inches. As a result of a three years' test at Chillicothe, Texas, the most satisfactory yields of both grain and forage were secured from milo and kafir when planted in rows 3 feet apart and with stalks every 4 inches in the row.¹

Ordinary corn planting machinery is generally used for planting these crops, the only change necessary being the use of special sorghum plates. In regions of very low rainfall listing generally gives better results than surface planting. The latter method is strongly recommended, however, for all regions except those of very scanty rainfall. When the crop is listed extreme care should be

¹ Texas Agr. Exp. Sta., Bul. 132, pp. 16-17.

exercised to prevent the seed from being covered deeper than is necessary for good germination. Otherwise the seed are likely to rot.

493. Cultivation. — In general the cultivation of the grain-sorghums is the same as for corn. During the early growth free use should be made of the weeder and harrow as the young plants are tough and not likely to break.

494. Harvesting the grain-sorghums. — For grain production the grain-sorghums should be allowed to get fully ripe before cutting. Those varieties that shatter badly may be harvested a few days early to prevent waste of seed. For silage these crops should be cut when in the dough stage as hard seeds in silage are likely to go through the animals undigested.

The grain-sorghums may be cut with a corn binder and shocked like corn. When they are grown on a large scale, this is the most economical method of harvesting. Smaller areas may be cut with the sled cutter or by hand. The heads may be subsequently removed by laying the bundles on a block and cutting them off with a broadaxe or saw. The heads are often removed from the standing stalks with a sharp knife. The ordinary grain-header has been recommended for this purpose but the height of the plants and the presence of pendent heads in some varieties prevent its general use. The dwarf type of milo can be harvested readily and rapidly with the grain-header.

The heads are thrashed by running them through an ordinary thrashing machine. If the heads have not been detached from the stalks the ends of the bundles may be inserted in the thrasher and withdrawn when the grain is removed.

495. Culture of broom-corn. — Broom-corn will make a satisfactory yield on any soil well suited to ordinary corn,

provided climatic conditions are favorable. But as the value of the crop is determined as much by the quality and uniformity of the brush as by the yield to the acre, extreme precaution must be taken to have the land as uniform as possible, particularly as regards its productiveness. The land is prepared as for corn and the seed planted at the same season as that recommended for grain-sorghum. For standard broom-corn the rows should be $3\frac{1}{2}$ feet apart with the plants 3 to 5 inches apart in the row. For dwarf broom-corn the rows should be 3 feet apart with the plants 2 to 4 inches apart in the row. A uniform stand is of paramount importance. If the plants do not stand at regular distances in the row, the brush will not be uniform and its value will thereby be greatly reduced. About two quarts of seed are required to plant an acre. The seed may be planted with any form of corn planter equipped with sorghum plates. The cultivation is the same as for corn or the other sorghum types.

496. Harvesting broom-corn. — Harvesting is the most important operation in the production of broom-corn. To produce a brush of high quality, the crop must be cut when just past full bloom but before the seeds have formed. The important qualities sought for are a tough, flexible, uniform brush possessing a green color. If allowed to mature the brush is brittle and loses its green color.

Dwarf broom-corn is harvested by "pulling" the heads by hand, about a foot of the stalk remaining attached. As standard broom-corn grows tall it must be "tabled" before harvesting. "In tabling, one man passes backward between two rows, bending the stalks at a point about 30 inches above the ground toward each other and across the row, so that the heads hang about two feet past the other row. Two men following cut off the heads and place them

evenly, on every other table. Three men can harvest about two acres per day. Later a team with a wagon passes over the empty tables and the brush is collected.”¹

After the brush has been pulled or cut, it is hauled to the drying shed. Here the coarse or knotty brush is separated from the straight heads; the crop is then thrashed. Sorting and thrashing often take place before the brush reaches the drying shed. When large quantities are to be thrashed the broom-corn thrasher should be used. Small quantities may be thrashed by “scraping” the seed from the brush by hand. After the brush has been thrashed, it should be placed under shelter and permitted to dry rapidly, especially if the bright green color is to be maintained. It is then pressed into bales weighing from 300 to 400 pounds each, and is ready for the market.

¹ Montgomery, E. G., “The Corn Crops,” p. 338.

CHAPTER XXXV

SUGAR-CANE (*Saccharum officinarum*)

SUGAR-CANE is a rank-growing, coarse-stemmed perennial grass. It is grown for its stems, the juice of which is extracted for making sugar, sirup, and molasses.

497. Nativity. — The genus *Saccharum* includes about a dozen species, all of which are native to the Old World. The natural habitat of wild sugar-cane is thought to have been southeastern Asia, although it is doubtful whether the wild form has ever been observed by any scientist. The domesticated sugar-cane is a very ancient crop, the origin of its culture having been lost in antiquity. It is probable that sugar-cane is one of the first crops cultivated by tropical people.

DESCRIPTION

498. The plant. — Usually a plant of sugar-cane consists of a number of stalks growing together in a cluster, a habit that is due to the tendency of the main-stem, and oftentimes the secondary stems, to throw up additional stems from the underground nodes. The usual height of the plant is 8 to 12 feet, although in tropical regions it grows taller (Fig. 71).

The duration of the plants varies in different regions. In tropical countries one planting usually furnishes several harvests, the stubble remaining alive from season to season. In the Gulf Coast region of the United States two or three crops are usually secured from one planting, while



FIG. 71. — A field of sugar-cane.

in the pine-belt region east of Louisiana and north of Florida, the plants do not endure the winter and annual planting is necessary.

499. Roots. — The root-system of sugar-cane is fibrous and is confined largely to the upper portion of the soil. Where the water-table is not near the surface a few of the roots penetrate the soil to a depth of several feet. No single prominent tap-root is produced. The roots spring from the joints of the underground nodes of the stem. A band of transparent dots surrounds the stem at each node. It is from these dots on the underground stem that the true roots arise. As a rule the roots branch but little.

The root-system of sugar-cane is especially susceptible to injury by nematodes and fungous pests. The ravages of the nematodes make entrances through which the fungi enter. To avoid these injuries, sugar-cane should not be grown continuously on the same land.

In addition to the roots which spring from the underground nodes, the lower nodes of the above-ground stem are usually well supplied with incipient roots. Most of these roots enter the ground and function actively in promoting the growth of the plant.

500. The leaves. — The leaves of sugar-cane are broad and range in length from two to three feet. Each leaf possesses a central mid-rib somewhat similar to that in the corn leaf. The lower part of the leaf (the sheath) folds around the stem and serves to protect the bud or eye which is borne at the node. As the stem matures the leaf-sheaths fall away from the stem. The falling of a leaf-sheath indicates the maturity of the internode next below this leaf.

501. Inflorescence. — In tropical countries most varieties of sugar-cane "arrow" or throw out a dense silky

panicle at the top of the plant when twelve to thirteen months old, and reach maturity some three months later. The flowers are borne in small spikelets, which are surrounded by long silky hairs. Until recent years it was thought that the flowers of sugar-cane were always infertile. In recent years, however, scientists have succeeded in rearing seedling canes. A very small percentage of the seed produced in a panicle is fertile and the germinating power of these fertile seed decreases rapidly after maturity so that at the end of a few weeks it is often wholly lost.

As a rule sugar-cane does not arrow and produce seed in the United States. In exceptionally mild winters seed may be produced in the extreme southern parishes of Louisiana and in southern Florida.

502. The stem. — The industrial value of sugar-cane is so intimately associated with the structure of the stems and the amount and nature of the juice that a knowledge of these essential features is especially important.

The stems are large, cylindrical, and distinctly jointed. The length of the internodes varies in different varieties and is decreased by any condition unfavorable to the normal development of the plant. The internodes are relatively short at the base of the stem and gradually increase in length toward the upper part.

At each joint on the stem, and occurring alternately on opposite sides, is a bud about the size of half a pea. It is from these buds that the next crop grows when the canes are planted.

The color of the sugar-cane stem varies in different varieties. Purple, striped purple and white, and green are among the most common colors. Many other colors occur, especially in varieties grown in tropical countries.

503. Structure of the stem. — The sugar-cane stem is composed of juice and fiber. The outer part, commonly called the rind, consists of a strong, tough fibrous tissue which gives strength and firmness to the stem. Inclosed by the rind are the white pith-cells which contain the saccharine juice. Numerous fine parallel fibers extend lengthwise the stem through the pith-cells of the internodes and are closely woven together at the nodes. For this reason the nodes are especially dense and fibrous and contain very little juice. These fibrous strands extending throughout the stem contain the vessels or passages through which the water and dissolved plant-food from the soil are brought upward to the leaves, and also the smaller vessels known as "sieve tubes" which convey the digested sap from the leaves to the other parts of the plant.

As the fiber is most compact at the nodes it follows that those stems having numerous nodes close together are lowest in juice. For this reason canes with long internodes are generally desired, other things being equal. It frequently happens, however, that the canes that are low in fiber and therefore high in sugar are less resistant to diseases and the ravages of stalk borers than the more fibrous sorts. In some cases this susceptibility to disease makes it necessary to replace the long-jointed, delicate sorts with varieties having more fiber. Varieties with large stems are generally viewed with more favor than those with small stalks because of their greater strength, and because they contain more available space for the production of juice.

504. Amount and distribution of juice. — The juice often makes up as much as 90 per cent of the weight of the stripped stems. The amount of juice varies with different varieties and under different environmental conditions.

Any condition that retards growth tends to decrease also the percentage of juice contained, although the concentration of the juice is usually increased.

The amount of juice varies in different parts of the same plant and also with the stage of maturity. The juice reaches its maximum near the middle of the stalk and decreases near the ends, the decrease being greatest near the top. The sugar content of the plant is greatest during maturation.

505. Composition of the juice. — The juice of sugar-cane is a solution of certain soluble ingredients, notably sugars, salts, acids, and the like, in the cell-water. As extracted by the mill it contains also some insoluble matter, such as wax, fat, albuminoids, dirt, and particles of fiber. The sugars are the constituents which give the juice its value. The three principal sugars are sucrose ($C_{12} H_{22} O_{11}$), dextrose ($C_6 H_{12} O_6$) and levulose ($C_6 H_{12} O_6$). Sucrose, which crystallizes out as cane-sugar, is the constituent of greatest value. In fact, within the sugar-belt, the presence in the cane of saccharine matters other than sucrose is deprecated by planters, as these substances not only fail to crystallize but their presence causes some of the sucrose to fail to make sugar. In commercial work dextrose (often called grape-sugar) and levulose (often called fructose or fruit-sugar) together with certain other saccharine substances of minor importance, are generally spoken of collectively as glucose. Chemically speaking, the term glucose is applicable to dextrose only.

506. Conditions affecting the composition of the juice. — The Louisiana Station has shown that climate, variety, culture, soil and fertilization are factors that have an influence upon the composition of sugar-cane juice. It was noticed that relatively dry weather during the fall

months accompanied by a relatively high temperature decreased the tonnage of cane produced but increased the percentage of sucrose in the juice, whereas the opposite conditions greatly retarded the ripening of the cane, resulting in the production of a high tonnage of cane having a low sucrose content.¹

The following table illustrates the influence that the variety has upon the composition of sugar-cane juice:

TABLE 38. SHOWING PERCENTAGE OF SUCROSE, GLUCOSE AND ASH IN THE JUICE OF FOUR VARIETIES OF SUGAR-CANE ²

VARIETY	D. 74	D. 95	PURPLE	STRIPED
Sucrose.....	4.88	2.45	2.35	2.03
Glucose.....	3.24	3.87	4.04	4.26
Ash.....	.48	.41	.40	.34

That conditions of cultivation have a marked influence upon the composition of sugar-cane is shown by the following data (Table 39, page 408) from the Louisiana Station secured as a result of the comparative study of plant and stubble canes.

In discussing these results, Browne and Blouin of the Louisiana Station say: "There is, of course, a physiological explanation of these differences. In stubble cane we have a partially dwarfed condition and according to a well-established law, when growth is checked, maturation is hastened. Exactly the same effect is produced by the non-fertilization of cane. Canes grown on the non-manured plots at the sugar experiment station average much less in weight, but are higher in sucrose than canes which have been fertilized."³

¹ La. Sta., Bul. 91, p. 22.

² La. Sta., Bul. 91, p. 23.

³ La. Sta., Bul. 91, p. 25.

TABLE 39. RELATIVE YIELD, AND FIBER AND SUGAR CONTENT OF PLANT AND STUBBLE CANES ¹

		PLANT	1ST YEAR STUBBLE	2ND YEAR STUBBLE
Striped Cane.	Weight stalk	1894 gm.	1262 gm.	1042 gm.
	Fiber	6.56%	7.45%	8.02%
	Sucrose	4.79%	6.03%	8.45%
	Dextrose	2.05%	2.27%	1.97%
	Levulose	1.60%	1.73%	1.64%
D. 74 Cane	Weight stalk	1575 gm.	1497 gm.	1163 gm.
	Fiber	6.28%	7.12%	7.16%
	Sucrose	6.33%	7.36%	8.24%
	Dextrose	1.84%	1.65%	1.83%
	Levulose	1.35%	1.20%	1.12%

507. Relative composition of cane in the Louisiana sugar-belt and in the coastal pine-belt. — Sugar-cane grown on the sandy uplands of the coastal pine-belt is ordinarily richer in total sugars than cane grown on the alluvial lands in Louisiana. This difference is due principally to the shorter growing season in the upland pine-belt which increases the percentage of glucose, or non-crystallizable sugar in the canes. The percentage of sucrose in the cane is about equal in the two regions.

As the greater part of the cane crop grown in the coastal pine-belt is utilized for making sirup, the high glucose content is a decided advantage as it decreases the tendency of the sirup to turn to sugar. The cane crop of this region is not especially suitable for making sugar as the glucose will not crystallize and its presence prevents some of the sucrose from crystallizing.

¹ La. Sta., Bul. 91, p. 24.

VARIETIES AND IMPROVEMENT OF SUGAR-CANE

508. Varieties. — Four varieties of sugar-cane make up the bulk of the crop in the cane-growing regions of the United States. These are the Purple, or Red Cane, the Striped, or true Ribbon Cane and the recent varieties referred to as D. 74 and D. 95. The Purple and Striped varieties were introduced into Louisiana in 1825 by John J. Coiron, a planter. The distribution of these excellent varieties throughout the State gave the sugar industry of that region a substantial impetus. Notwithstanding the large number of varieties that were subsequently introduced, particularly by the Louisiana Sugar Station, the Purple and Striped canes ranked as the best varieties for Louisiana conditions until within recent years when the Louisiana Station introduced from Demerara the two new varieties referred to as D. 74 and D. 95. These latter varieties have received from the Louisiana Station the unqualified recommendation as being better than the Purple and Striped canes for Louisiana conditions. Both are early maturing varieties, reaching maturity in about 10 months even when grown in sections where the entire twelve months is available for their development. Their chief advantages are, (1) high yield, (2) high percentage of crystallizable sugar and (3) high purity of the juice.

“D. 95 is a large, erect, purple cane. It has long joints, large stalks, and pale green foliage; it “suckers” or “rattoons” well and is fully as hardy toward cold as ordinary purple cane.

“D. 74 is a tall, erect, green cane with long joints and a deep green foliage. It “suckers” abundantly and produces large stalks and heavy yields.”¹

¹ J. F. Duggar, “Southern Field Crops,” p. 506.

According to tests made by the Louisiana Station, the Striped cane, when compared with the Purple, grew slightly larger and the stalks were softer and consequently more easily crushed, whereas the Purple cane was hardier and suckered more abundantly than did the Striped cane. The Purple cane is the most popular variety in the Coastal pine-belt. Green cane is a popular variety for chewing purposes.

Little attention seems to have been given to varieties of sugar-cane for the Florida cane region other than that the best growers usually select the light colored canes because they produce a light colored sirup.

509. Japanese sugar-cane. — This variety is sufficiently distinct from the varieties described above to warrant separate discussion. It is especially hardy, and is successfully grown throughout all Florida, southern Georgia, southern Alabama, southern Mississippi, Louisiana, and southern Texas. The stems are slender, which characteristic makes the stripping of the leaves a laborious and expensive operation. Because of the extra labor involved in stripping the leaves and because the stems are harder and more woody than those of other varieties, Japanese cane is not generally recommended for sugar or sirup making. It is most valuable when used as a forage crop for feeding live-stock. It suckers profusely and is therefore an excellent yielder. South of latitude 33 the stubble will generally survive the winter, a single planting usually sufficing for two or more years. It makes excellent winter pasture, and is also valuable either for silage or dry forage.

510. Improvement. — There is much variability among plants of sugar-cane not only as regards vigor of growth but also in the amount and quality of the juice contained. As these differences are often hereditary, much improve-

ment can be accomplished by a careful selection of the seed-canes. The continuous planting of large canes through six generations by the Louisiana Sugar Experiment Station resulted in an average production of 30 tons of cane an acre as compared with an average production of 25.95 tons to the acre for the same period where small canes were planted. All defective, diseased, or immature canes should be discarded if the most profitable results are to be secured. The planting of immature, poorly developed canes results in a very uneven stand and the production of many short-jointed small canes. Early maturity is an important factor in selecting the best plants for conditions in this country.

In recent years much attention has been given to the work of propagating new varieties of cane from seed rather than by planting the stems. As sugar-cane belongs to that group of plants which does not come true to type when grown from seed, a crop of seedlings exhibits an enormous amount of diversity, opening up a wide field for selection. Throughout the tropical cane-growing regions many valuable varieties have been produced by this method. Since 1906 the Louisiana Sugar Experiment Station at Audubon Park, Louisiana, has succeeded in producing a large number of seedling canes, the seed being secured from tropical countries. It is highly probable that as this work continues some of these seedling canes will be developed into excellent varieties.

CHAPTER XXXVI

SUGAR-CANE — CLIMATE, SOILS, ROTATIONS, FERTILIZERS AND TILLAGE PRACTICES

THE area within which sugar-cane can be successfully grown in the United States is limited primarily by climatic conditions, such as temperature, length of the growing season, rainfall and the like. These limiting factors are easily recognized by farmers. The extent to which the essentials of good farm management, including proper cropping systems and good tillage practices, influence the profitable production of sugar-cane has not been so generally recognized.

511. Climate. — Sugar-cane is adapted to a tropical climate, although early maturing varieties are successfully grown in semi-tropical regions. For best results, a growing season of 12 to 14 months is required. The climatic conditions best suited to sugar-cane are found in Cuba, Java, Hawaii, Porto Rico, Philippine Islands, and the Gulf Coast region of the United States, particularly in Louisiana, southern Florida, and southern Texas. In the United States sugar-cane for sirup is also grown as far north as latitude 33, including southern Georgia, southern Alabama, and southern Mississippi. Throughout the greater part of the cane-growing region of the United States, the season does not extend over ten months.

512. Soils. — Sugar-cane is a gross feeder and requires large quantities of water and food. The best soils for this crop are the rich alluvial soils that are well supplied

with the plant-food materials and that have a high water-holding capacity. In the cane-growing regions of the United States, soils of this character are most abundant in Louisiana. While sugar-cane is a heavy consumer of moisture, it must have an open, well-drained soil with the water-table below the feeding area of the roots. If the soil is not naturally well-drained, artificial drainage should be provided. Soils naturally acid are unsuited to sugar-cane. Such soils should receive an application of lime before being planted to this crop.

In the coastal pine-belt of the United States, most of the soils planted to sugar-cane are of a sandy nature. These soils usually require rather heavy applications of manures or fertilizers if profitable crops are to be produced. In Florida the better grades of high pine land produce from 15 to 25 tons of cane. The rolling pine lands are well adapted to sugar-cane without further drainage. The flat-woods' soils, the flat hammock lands and reclaimed marsh lands generally require artificial drainage.

The yield of cane on the sandy soils of the pine-belt is less than on the alluvial soils of Louisiana, but the juice is richer in total sugars, which is a partial compensation for the smaller yields.

513. Rotations. — The highest yields of sugar-cane are produced where the cane is planted on land which has the year previously been planted to cowpeas, velvet beans, or such crops as will add to the supply of organic matter and nitrogen in the soil. The heavy growth of stalks and the practice of burning the leaves rapidly exhausts the soil nitrogen and sugar-cane should never follow itself on the same land, except where it is desirable to grow one or more crops of "stubble" cane. A rotation quite generally practiced by the best sugar-cane planters in

Louisiana is: First year, corn with cowpeas sown broadcast at the last cultivation; second year, sugar-cane from planted cane; third year, sugar-cane from old stubble. On rich land a second crop of "stubble cane" is often grown.

As a rule the entire crop of cowpeas should be plowed under. The Louisiana Sugar Station secured an increase of 7.4 tons of cane to the acre from plowing under the entire growth of cowpeas as compared with plowing under only the cowpea stubble.

The Florida Station recommends sweet potatoes or velvet beans as crops to precede sugar-cane in that State.

514. Fertilizers. — There are few crops so exhaustive of soil nitrogen as sugar-cane. The tonnage of dry matter removed to the acre is greater than is generally taken from the land with other crops. In addition the leaves and tops are usually burned in the field and the nitrogen they contain is thus lost. While in most cases the nitrogen can be profitably returned to the soil in commercial fertilizers it can be even more profitably returned by plowing under, every third or fourth year, a luxuriant growth of cowpeas or velvet beans.

Commercial materials that may be used as sources of nitrogen are cotton-seed meal, dried blood, tankage, nitrate of soda, and sulfate of ammonia. The first three are organic materials. The nitrogen in these materials is not so readily soluble as that in the mineral fertilizers, and for this reason the organic materials are usually preferred on sandy soils that are subjected to heavy leaching. If quick results are desired, the nitrate of soda or sulfate of ammonia should be applied.

The need for phosphoric acid in the sugar-cane belt is quite general and as a rule it is second in importance to nitrogen. It is supplied in the form of acid phosphate.

Most soils in the cane-belt are in less need of potash fertilizers than of nitrogenous or phosphatic materials.

515. Fertilizers for cane in Louisiana. — Experiments at the Louisiana Sugar Station have indicated that as much as 48 pounds of nitrogen and 36 pounds of phosphoric acid to the acre can be applied with profit in commercial fertilizers. To supply the 48 pounds of nitrogen would require either 240 pounds of sulfate of ammonia, 340 pounds of nitrate of soda, 343 pounds of dried blood containing 14 per cent nitrogen or 685 pounds of cotton-seed meal. The 36 pounds of phosphoric acid would require 225 pounds of acid phosphate containing 16 per cent phosphoric acid. A very popular fertilizer in the cane-belt of Louisiana is slaughter-house tankage which contains from 6 to 10 per cent of nitrogen and good quantities of phosphoric acid. It is applied in quantities ranging from 400 to 1,000 pounds to the acre. It is sometimes supplemented with 100 to 300 pounds of acid phosphate to the acre. Very little advantage has been secured from the application of potash fertilizers to cane in Louisiana.

516. Fertilizers for cane in the pine-belt. — Experiments conducted at the McNeill Station in southern Mississippi indicate that 1,000 to 1,500 pounds to the acre of a fertilizer composed of equal parts of acid phosphate and cotton-seed meal may be used profitably for sugarcane. Where the cane follows a leguminous crop it is recommended that the amount of nitrogen in the fertilizer be reduced for the first year. "On the stubble cane of the year following the supply of nitrogen should be increased by using equal parts of meal and phosphate and in case a second year's stubble is grown it would be well to use a mixture of two parts cotton-seed meal and one part of acid phosphate." The bulk of the fertilizer should

be applied in the spring on both sides of the rows just before the dirt is thrown back to the cane.

A series of fertilizer experiments with sugar-cane conducted on poor, sandy pine land in southern Georgia by the United States Department of Agriculture gave results which justified the recommendation of 1,100 pounds of fertilizer to the acre composed of

600 pounds high-grade acid phosphate
 100 pounds cotton-seed meal
 300 pounds nitrate of soda
 100 pounds sulfate or muriate of potash.

Where a crop of velvet beans had been plowed under the following combination of fertilizers gave best results:

1,100 pounds high-grade acid phosphate
 100 pounds nitrate of soda
 100 pounds muriate of potash
 —————
 1,300 pounds, total to the acre.

The recommendations of the Florida Station with reference to fertilizing sugar-cane are given in the following quotation:¹ "On high pine land a fertilizer analyzing 5 per cent of ammonia, 4 per cent of phosphoric acid, and 8 per cent of potash, should be applied at the rate of 600 to 1,000 pounds per acre, ten days before planting. The ammonia should come from an organic source, because of the long season required by the crop for growing. If the crop appears uneven and yellow, and shows an unthrifty appearance, it will be advisable to give a second application of ammonia not later than August 1st. This ammonia should be applied in the form of nitrate of soda at the rate of 200 pounds per acre and broadcasted. It matters little in what form the potash or phosphoric acid

¹ Fla. Agr. Exp. Sta., Bul. 118, p. 53.

is applied because of the gross feeding tendencies of the sugar-cane plant. It is, however, conceded by some growers that a better grade of sirup will be produced by using sulfate of potash, instead of muriate of potash or kainit. This, however, is still an open question."

Many farmers, particularly in the pine-belt, make rather liberal use of stable manure in fertilizing sugar-cane. While this greatly increases the yield it is apt to give the sirup a dark color and inferior flavor.

TILLAGE PRACTICES

517. Preparation of the land. — Soil intended for sugar-cane should be plowed as long in advance of planting time as the previous crop will permit. In Louisiana the land is usually plowed in August or September, especially if the previous crops were corn with cowpeas. In most cases the ordinary mold-board plow is used, although the turning under of green-manure crops can be better accomplished with a disk plow. In three to five weeks after plowing the land is bedded for planting. This consists of forming ridges or high beds usually six feet wide although "ridged rows, five feet apart, are probably productive of the best results."¹ As the cane fields are flat and wet the ridges are necessary to facilitate drainage. As an additional step in draining the land the water-furrows between the ridges are deepened with a double mold-board plow. At suitable intervals, "quarter drains" are constructed at right angles to the ridges and from 4 to 8 inches deeper than the water-furrows. Running parallel with the rows, and 100 to 125 feet apart, deep narrow ditches are constructed into which the "quarter drains" empty.

¹ La. Sugar Exp. Sta., Bul. 129, p. 32.

In the coastal pine-belt, where the soils are usually well drained and likely to be droughty, the land is thoroughly plowed several weeks before planting and is prepared level, no ridges being formed.

518. Time of planting. — In practice the seed-cane is planted in either fall or spring. In Louisiana, southern Mississippi and in parts of Florida fall planting is desirable. Usually better weather conditions for planting are secured in the fall. Fall planting avoids the practice of windrowing or bedding the seed-canes for spring planting. Also fall-planted canes sprout quicker in the spring and fewer eyes are lost during the winter. In Louisiana planting begins in the fall as soon as the plants reach sufficient maturity and continues until the grinding season in November. The areas that are not planted in the fall are planted in February or March. Throughout the greater part of the pine-belt, sugar-cane is planted chiefly in the first half of March.

519. Method of planting. — In planting sugar-cane the practice varies from planting whole cane to planting a single joint every fifteen inches to two feet. In the cane-growing regions of the United States the common practice is to plant the whole cane. There are some planters, however, who believe that the seed-canes should always be cut; otherwise the eyes that sprout first will draw strength from the unsprouted eyes on the same stalk and therefore either prevent their coming up or cause them to produce weak plants. The Louisiana Station has shown this belief to be erroneous. On the other hand, cutting serves to introduce fermentation and decay. If the seed-canes are crooked they should be cut in two or more pieces so that they will lie flat in the furrow.

In Louisiana a furrow is opened in the top of each

bed with a double mold-board plow. This furrow should not be as deep as the water-furrow. The whole cane stalks are laid in the bottom of these furrows in single or double rows. This cane is covered with soil to a depth of from three to four inches, usually with a disk cultivator. As soon as the crop has been planted the middles should be run out with a double mold-board plow and the "quarter drains" and ditches put in good shape to handle the heavy rainfall of winter.

In the coastal pine-belt planting is done chiefly in the spring, from March 1st to 20th, although fall planting is becoming popular in some sections. At the McNeill Station in southern Mississippi best results were secured from fall planting. For fall planting in southern Mississippi, Ferris¹ recommends that the rows be opened 4½ or 5 feet apart with a middle buster or with two furrows from a turn-plow. The seed-cane should be placed in these furrows and covered with three or four inches of soil. If the soil is dry at planting time a heavy roller should follow the covering of the cane to cause the moisture to rise and prevent the seed from being destroyed by "dry rot."

The cane that is planted in the spring receives a shallower covering of soil than that which is planted in the fall. Where it is necessary to cover the canes deeply to protect them from cold weather, part of the soil should be removed before the young plants come up. This can be done by running a spike-tooth harrow over the rows and parallel with them.

520. Keeping seed-cane over winter. — Seed-cane that is to be planted in the spring must be harvested in the fall before frost and must be protected from cold during the winter. In Louisiana this is done by cutting

¹ Miss. Agr. Exp. Sta., Bul. 129, p. 4.

and windrowing the plants in every other water-furrow, the tops being left on the plants. The plants are placed shingle fashion in the furrows so that the tops and leaves protect the stems underneath. The cane is then well covered with soil by means of a turn-plow. If necessary hoes are used to complete the covering. In the spring the soil is partially removed and the cane withdrawn, usually with horses or mules attached to suitable implements.

In the pine-belt the seed-canes are kept in beds that are about six feet wide and eight inches below the surface of the ground. The canes are placed in these beds in even layers, each layer extending ten inches forward of the previous one and the tops thus covering the joints of the lower layers. After being filled the bed is covered with about two inches of soil. Special precautions must be taken to see that water does not stand in the bed at any time; otherwise the eyes will be destroyed by fermentation. It is highly essential, however, that the seed-canes be kept fairly moist to prevent injury from "dry-rot."

The amount of seed-cane required to plant an acre varies from 3 to 4½ tons, depending on the method of planting.

521. Cultivation. — As soon as the cold weather of winter has passed, the surplus soil must be removed from the cane so as to admit the warmth of spring. In Louisiana and southern Mississippi this is accomplished by a process termed "off-barring," which consists in throwing the soil from the sides of the cane rows toward the middle, usually with a two-mule turn-plow. The soil immediately over the cane row is then removed with the exception of a layer an inch, or a little more, in thickness. This is often done

with hoes although there is an implement called the "scraper" especially designed for doing this work, which removes the soil more economically than can be done with hoes. This leaves the cane in a narrow, well-drained ridge which warms up readily and causes the rapid germination of the buds. When the cane has come to a stand the fertilizer should be applied. It is distributed along both sides of the row in the off-bar furrows and also over the row. The soil is then returned to the cane by means of plows and the middles are opened with a double mold-board plow. The subsequent cultivation is effected usually by means of disk cultivators which straddle the rows, and are so adjusted as to throw the soil toward the cane at each working. The middles are kept stirred by the use of special implements called "middle cultivators." "Cultivation should be continued until the cane has reached such a height that the mules and implements can no longer pass through without causing material injury."¹

When a crop of stubble cane is grown the first tillage in the spring consists in loosening the soil with a stubble digger, after the dried tops and leaves of the preceding crop have been burned. Sometimes a "stubble shaver" is used to cut off, below the surface of the soil, the stubble on which the upper eyes have been injured. Stubble cane is fertilized by applying the fertilizer in a furrow near the line of stubble and by covering it with soil.

Throughout the greater part of the pine-belt, the cultivation of sugar-cane is similar to that of corn. The Florida Station recommends that fertilizers for sugar-cane in that State be applied before planting. In this case, and particularly when the cane is planted in the spring, the

¹ La. Sugar Exp. Sta., Bul. 129, p. 34.

first two or three cultivations may be given with the weeder or harrow, run in any direction over the rows. Later cultivations may be given with one or two-horse cultivators adjusted to run shallow. Frequent cultivation should be given until the cane is well grown.

CHAPTER XXXVII

SUGAR-CANE — HARVESTING, USES, INSECT PESTS AND DISEASES

THE primary requisites in securing profits from sugar-cane production are (1) large crops economically produced and, (2) the proper handling of the crop so as to render possible its manufacture into a product of high quality, whether it be sugar or sirup. In order that both of these requisites may be secured, the planter, in addition to knowing how to plant, fertilize, and cultivate the crop, should have a knowledge of the proper time and method of harvesting the crop, and should also be familiar with such practical means of preventing or reducing loss from the insect pests and diseases of sugar-cane as are available.

HARVESTING

522. Time of harvesting. — Sugar-cane must be harvested before frost. But the longer the crop can stand without danger of frost, the higher will be the sucrose content, which not only increases the amount of sugar or sirup secured but also greatly improves the quality of the product. When the plant is grown for sugar the proper stage of maturity for harvesting is indicated by the browning of the lower leaves and the loosening of the leaves on the stalk. Another good rule in the sugar-belt is to allow the crop to stand, if practical, until the fresh juice is thick enough to show a test of 8 degrees on the Baume spindle. In Louisiana the bulk of the crop is

cut in November. That portion of the crop that is to be used for seed-cane is cut earlier than the main crop.

In west Florida, stripping the blades from the stalks begins the last week in October; the date is two weeks later in central Florida. Cutting begins about November 15th in west Florida and ten days later in central Florida.

523. Stripping, topping, and cutting. — Harvesting consists in stripping the blades from the stalks, removing the tops, and cutting the stalks at the surface of the ground. The cane-knife is most commonly used for this purpose. It consists of a "flat piece of steel on a suitable handle with a slight hook on the back for stripping." The blades are removed by two downward strokes with the back of the knife; the third stroke removes the top and the fourth cuts the stalk at the ground. In Louisiana the entire operation is completed as the workman proceeds.

A simple cane stripper has been invented by Wm. House, a farmer of Cairo, Georgia. It is made of "two pieces of thin steel about 15 inches long by 1 inch wide and $\frac{1}{16}$ inch thick, bent and flared at one end so as to slip over and fit around the stalk of cane and securely braded at the other end to a handle three feet long." When this stripper is pressed against the plant the stalk slips into the space made by the curves in the steel blades. The leaves are then removed by one downward stroke. Other laborers follow with knives and remove the tops and cut the stalks.

Machine cutters have been invented but so far no machine has been a great success, owing to the extreme difficulty of handling crooked canes by machinery.

524. Handling the harvested cane. — Immediately after the cane is cut it is started to the mill, as fermenta-

tion soon begins which if allowed to proceed will greatly diminish the sucrose content. Hand labor is commonly used in loading the cane on the carriers that take it to the mill, although mechanical cane loaders are coming into rather wide use in Louisiana. These usually consist of a heavy wagon on which is mounted a swinging boom. From the end of the boom a grapple fork, operated by a gasoline engine, is lowered and lifts the cane from the heaps on the ground to the carts, or from the carts into the railroad cars. Plantation railways are sometimes built in the more important cane-growing regions. Much ingenuity has been exercised in the invention of engines, trucks, and portable rails adapted to this purpose.

Many patterns of unloaders have been invented and are in successful use. The problems of unloading the cane at the mills and transporting it to the rollers are much simpler than those involved in loading and transporting the cut cane from the plantation to the mill.

525. Yields. — From 25 to 30 tons of stripped cane to the acre is considered a good yield in Louisiana. The average yield for the state is about 21 tons to the acre. The amount of sugar secured from a ton of cane varies with the sucrose content of the cane and with the kind of mill used in grinding. As a rule a ton of cane will yield from 150 to 160 pounds of sugar, and in addition 5 or 6 gallons of molasses. In making sirup alone the average acre in the sugar-belt of Louisiana will yield from 500 to 600 gallons.

In the coastal pine-belt, the average yield of cane to the acre is about 15 tons. On reasonably good land a yield of 20 tons of plant cane and 15 tons of stubble cane to the acre may be expected. Throughout this region a ton of cane corresponds roughly to 20 gallons of sirup at a density of

33 degrees Baume, or an average yield of about 300 gallons to the acre.

Certain Hawaiian plantations are said to yield more than 100 tons of sugar-cane and 12 tons of sugar to the acre.

526. Uses. — In all countries where the warm seasons are long, sugar-cane is used almost exclusively for making sugar. In regions where the climate is sufficiently warm to grow sugar-cane, but where frosts occur in the fall before the cane is fully mature the crop is used for making sirup.

Molasses is a by-product in the manufacture of sugar from sugar-cane.

Blackstrap, also made from sugar-cane, is a very inferior grade of molasses used principally as a food for live-stock.

INSECT PESTS

527. The sugar-cane borer (*Diatraea saccharalis*) is unquestionably the most serious insect enemy of sugar-cane with which the Louisiana planter has to deal. It is not generally distributed over the coastal pine-belt. The sugar-cane borer is the caterpillar of a yellowish moth. The eggs are deposited on the foliage and subsequently hatch into small caterpillars which feed on the tender foliage for a few days, finally entering the stalks through the buds or eyes. The remainder of the larval stage is spent in the stalks. These larvæ tunnel up and down the stalks, stunting their growth, weakening them so that they are easily blown over by wind, reducing the sugar content, and making easy the entrance of fungous diseases.

Remedial measures are largely preventive. In regions where this insect is found all tops and leaves of sugar-cane should be burned as soon as sufficiently dry. All shoots that start from the stubble of early cut cane should be destroyed. Fall planting is recommended and only sound

seed-canes should be used. Crop rotation is also advisable but as sorghum, Johnson-grass, and corn are also attacked, the task of starving the insects is often difficult.

528. The southern grass worm (*Laphygma frugiperda*) often does considerable damage to sugar-cane. It can be controlled by spraying the crop with arsenic solution, made by mixing three pounds of lead arsenate paste or one pound of zinc arsenite powder to fifty gallons of water, or by dusting the plants with the latter, using air-slaked lime as a filler.

Another means of destroying these worms is that of attaching a light piece of timber to the cultivator so as to jar the cane, causing the worms to fall to the ground where they are covered with soil by the cultivator.

FUNGOUS DISEASES

529. Origin. — It is only within recent years that fungous diseases have caused serious injury to the sugar-cane of the southern United States. At least one disease, the sugar-cane root-rot, has probably been present in the sugar-belt of Louisiana for many years, but has caused serious injury only in abnormal years. Recently other diseases, notably the red-rot, the rind disease and the pineapple disease have been found to be more or less prevalent in various parts of Louisiana, the red-rot being also prevalent in parts of the coastal pine-belt. As these are fungous diseases to which sugar-cane is subject in its native home, it is quite likely that they have been introduced on seed-canes from the tropics. The interchange of seed among the different planters in this country has served to increase the spread of these diseases.

530. Red-rot of sugar-cane. — This disease is caused by a small fungus, *Colletotrichum falcatum*. It is not

easily recognized in a field of growing cane, the disease being almost entirely on the inside of the stalk. From external appearance the cane may seem perfectly normal. When the diseased stems are split open, irregularly distributed red streaks are noticed in the internal tissue. Usually these red streaks or bands are found extending out from the nodal region.¹ A characteristic of this disease is the occurrence of white spots surrounded by the red tissue.

This disease damages the cane by causing a decrease in its sugar content, and also by growing in the stalks that are to be used for planting, killing the eyes and thus causing a poor stand.

The treatment of the disease consists in destroying all material in the field known to be diseased, and planting seed-canes that are entirely free from the fungus. In fact little damage is done where perfectly healthy canes are planted each season.

531. The rind disease. — This disease is caused by a small fungus, *Melanconium sacchari*. The fruiting pustules of this disease develop "underneath the epidermis of the rind tissue" the spores being finally pushed out to the surface of the stem. "As the spores are held together with a mucilaginous substance, they ooze out in the form of long black strings or hairs."²

The disease causes the cane leaves to dry up prematurely. Finally the whole cane may become discolored and brown. As the eyes are killed, diseased canes when planted give little or no germination. Control measures include the use of resistant varieties, the cleaning up of fields, and the dipping of the seed-canes in bordeaux mixture before planting.

¹ La. Agr. Exp. Sta., Bul. 120, p. 8.

² La. Agr. Exp. Sta., Bul. 120, p. 16.

532. The pineapple disease. — This disease is caused by a small fungus, *Thielaviopsis ethacetica*, which gains entrance to the stalks of cane through wounds in the rind. The fungus spreads rapidly, decomposing the inside tissues of the stalks and killing the eyes. While this disease has been observed in this country only in one or two parishes in Louisiana, in tropical countries it is perhaps the most serious of all sugar-cane diseases, and there is a strong likelihood of its developing rapidly in the sugar-belt of Louisiana.

The fungus causing this disease grows in the soil and for this reason is quite difficult to control. Where the disease is at all prevalent the only remedy is that of treating the seed-cane with a fungicide, as bordeaux mixture, which prevents the entrance of the fungus into the stalks. Planters on whose land this disease has not yet appeared should be on guard against it and take every precaution to prevent its being introduced into their locality.

533. The root-rot disease. — This disease is caused by a mushroom fungus, *Marasmius plicatus*. The fungus kills the cane roots and often grows in between the lower leaf-sheaths. The disease is easily identified by the white strands of mycelium on or in the stalks. The eyes may be killed before germination or the young plants may be killed after germination.

Control measures consist of careful cultivation, disinfection of seed-cane with bordeaux mixture, the use of resistant varieties, the destruction of infected trash, and resting the land from cane.

CHAPTER XXXVIII

PEANUT (*Arachis hypogæa*)

THE peanut, also known as ground-nut, goober, and pindar, forms the basis of an important industry in the southern states. It is grown primarily for its seed which are used for human consumption after being parched, or as a constituent of certain confections. The whole crop is rather extensively utilized as a pasture for hogs. The vines maké an excellent hay.

534. Nativity. — The native home of the peanut is not definitely known. The early investigations by De Candolle point to Brazil as the natural habitat of this plant, as six or seven other closely allied species have been found there. Some botanists have claimed an African origin for the peanut. Corbett¹ points out that "if *Arachis hypogæa* were not of American ancestry it would be the only exception in the group, which seems improbable."

535. Distribution. — The peanut is grown successfully only in warm climates with long growing seasons. It is grown extensively in the warmer portions of India, Africa, and South America. The means of its advent into the United States is not clear. Circumstantial evidence points to the introduction of the peanut into this country during its early colonial history as a result of the early slave trade, as it is known that peanuts were used as staple food for the maintenance of slaves on the voyage across

¹ Peanut — L. C. Corbett, *Bail. Cyclo. of Am. Agr.*, Vol. 2, p. 514.

the Atlantic. Since their introduction into the United States they have been grown principally in Virginia and North Carolina, certain parts of Tennessee, Arkansas, and Alabama, and in a smaller way in almost all sections of the southern states. Virginia and North Carolina produce more than half of the commercial crop of the United States. The rather general distribution of peanuts throughout the Southern States has taken place since 1866, due partially to the knowledge of the edible qualities of this crop secured by the southern soldiers who fought in Virginia and North Carolina.

536. Description. — Botanically the peanut belongs to the family, Papilionaceæ, or pea family. It is an annual with a more or less trailing habit of growth. The plants grow from one to two feet high and produce thick, angular, hairy stems with spreading branches. Each leaf consists of the leaf-stem and two pairs of leaflets. No tendrils are produced. The small yellow flowers are produced more or less clustered in the axils of the leaves. Two kinds of flowers are produced: the male or staminate flowers which are rather showy; and the hidden or cleistogamous pistillate flowers. "The stamens are monadelphous, but the alternate ones are short." When fertilization takes place the male flowers soon wither and fall. Immediately the short, thick peduncles that support the female flowers begin to elongate and turn downward until the sharp-pointed ovaries are thrust into the soil, the result being that the development of the pods takes place underground entirely.

The fruit of the peanut is really not a nut, but merely a ripened pod with edible seeds, the term "nut" having been added on account of the flavor of the seeds which is somewhat similar to that of many true nuts.

The roots are a yellowish color and are abundantly supplied with nodules.

537. Composition. — All parts of the peanut plant are rich in nutritive qualities. The kernel is especially rich in oil. The meal or "cake" left after the oil has been extracted from the kernels is valuable for its high protein content. Peanut hay is almost as high in feeding nutrients as clover hay.

TABLE 40. FOOD CONSTITUENTS IN DIFFERENT PARTS OF PEANUT PLANT ¹

	IN WATER-FREE SUBSTANCE					
	WATER	ASH	PROTEIN	FIBER	NITRO- GEN- FREE EXTRACT	FAT
Peanut kernels	7.9	2.8	29.5	4.3	14.2	49.2
Peanut meal	10.7	5.5	52.5	5.9	27.3	8.8
Peanut vines, cut be- fore blooming	31.2	10.7	12.6	22.3	48.3	6.1
Peanut vines, cut when fruit was ripe	31.9	12.1	10.8	32.3	39.8	5.0

538. Varieties. — There are only five or six distinct varieties of peanuts grown in the United States. These varieties are classified into large-podded and small-podded types. They are further classified into bunch and running varieties. They may be classified according to the color of the skin (testa) on the seed into white and red varieties.

For the production of roasted peanuts the large-podded varieties are preferred. For agricultural purposes and for the production of forage the bunch habit is a decided advantage as such varieties can be more closely planted. The leading varieties of peanuts are briefly described below:

¹ Hunt, "Forage and Fiber Crops in America," p. 235.

Virginia Runner. — This is a large-podded, strong-growing variety, with creeping stems and heavy foliage. The procumbent stems bear pods throughout their entire length. The pods are of light color and usually do not adhere well in digging. The usual number of kernels to the pod is two. The customary weight to the bushel of this and other large-podded varieties is 22 pounds.

Virginia Bunch (Fig. 73). — This variety differs from the Virginia Runner in that the vines are erect and rather dwarf, and the pods are borne in a cluster about the base of the plant. The pods adhere better to the plant when it is dug up than do those of the Virginia Runner.

North Carolina (Fig. 73). — This variety, sometimes called the *Wilmington*, and in some localities known as the African, has procumbent stems and in that respect resembles the Virginia Runner, but the plant is not so large and vigorous and the pods and kernels are smaller. The kernels are especially rich in oil. The weight of a bushel of North Carolina peanuts is 28 pounds.

Tennessee Red (Fig. 73). — This variety bears rather long, slender pods, sometimes five or six peas being crowded together in one pod. It is an excellent variety for stock feeding but the pods do not sell well on the market, owing to the red color of the peas. It is therefore recommended only for stock feeding.

Spanish (Figs. 72, 73). — Owing to its early maturity and excellent yielding qualities, the Spanish peanut has a wider adaptation in the southern states than any other variety. It is a small-podded, upright growing variety, the pods being borne in a cluster about the base of the plant. For the production of stock food the Spanish peanut excels all other varieties in the United States. It frequently yields 50 to 75 bushels of nuts and two tons of hay to the acre.

The nuts sprout more quickly, if left in the soil after maturity, than do those of the larger podded varieties. This is due to the fact that the hull lies in close contact with the peas and moisture is quickly absorbed. Spanish peanuts should be dug or used as hog feed soon after ripening. They are easily harvested, as the pods are clustered around the base of the plant and adhere exceptionally well when the



FIG. 72. — Spanish type of peanut.

plant is dug up. A bushel of Spanish peanuts weighs 28 pounds.

Dixie Giant is a variety of peanuts so called because of the large size of the pods. As it is not a high yielder and requires a long growing season it is not a popular variety.

539. Improvement of varieties. — Peanut plants differ greatly as regards their prolificacy just as do the plants of corn, wheat, or oats. For this reason it is of paramount importance that planting seed be selected from those plants

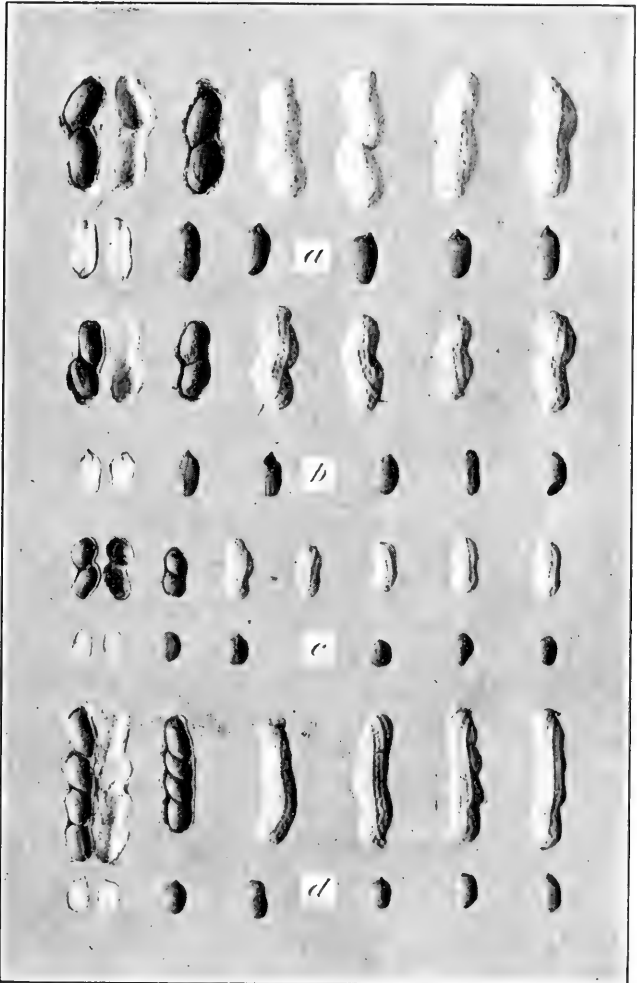

FIG. 73. — Commercial types of peanuts: *a*, Virginia Bunch; *b*, North Carolina; *c*, Spanish; *d*, Tennessee Red.

that produce a large number of mature pods. In this way the plants of low producing power are gradually eliminated and larger yields to the acre are obtained.

CULTURE OF PEANUTS

540. Soil. — Peanuts having the highest market value are produced in light colored soils of a sandy or loamy nature. Reddish colored soils having a high content of iron are likely to stain the pods, in which case the market value of the crop is reduced. The same is true of very dark soils. When the crop is grown for agricultural purposes, the staining of the pods is of little consequence. High yields are often produced on clay soils, and when the crop is grown for hog pasture, as is often the case, the selection of the soil for the crop is a less difficult matter. Peanuts should never be planted on poorly drained or sour soils, or on soils that easily become hard owing to the inability of the ovary-bearing peduncles or "pegs" to enter the soil.

541. Rotations. — The peanut can be made to fit well into a large variety of rotations, but it should invariably follow a clean-cultivated crop which has been kept free from weeds. Among the crops that may precede peanuts in a good rotation are corn, cotton, sweet potatoes, or Irish potatoes. The peanut is also admirably adapted to combination cropping. The most important companion crop is corn which is often planted in alternate rows with the peanuts. In the South Atlantic and Gulf states peanuts are extensively planted between the rows of corn when the latter crop receives its last cultivation. When the corn is harvested the peanut vines are pastured off by cattle. Hogs are then turned in to utilize the remainder of the crop.

The following rotation including peanuts is recommended by Beattie:¹ First year, corn or cotton with cowpeas planted between the rows at the last cultivation; second year, peanuts followed by rye to be used as a winter pasture, and plowed under in the early spring; third year, cowpeas for hog pasture during the autumn months.

542. Lime for peanuts. — Lime is very essential, especially for the production of the large-podded varieties of peanuts. Soils that are deficient in lime produce a large percentage of "pops" or unfilled pods. As a rule, the sandy soils in the southern states are deficient in lime and should receive an application of 1,000 to 1,500 pounds of lime to the acre every four to six years, if profitable yields of peanuts are to be secured. The lime should be applied broadcast and harrowed into the soil before the crop is planted. When a smaller amount of lime is added it is often applied in the drill and incorporated with the soil before the crop is planted, or it may be drilled on top of the row behind the planter, where it will be mixed with the soil in cultivation.

Spanish peanuts, although preferring a lime soil, can be grown successfully on soils containing less lime than would be possible with the large-podded varieties.

543. Fertilizers. — The plant-food constituents most often applied to peanuts are phosphoric acid and potash. The fertilizer should not be highly nitrogenous, since the peanut is a legume drawing its nitrogen largely from the soil air. On exceptionally poor soils, from 30 to 50 pounds of nitrate of soda should be added to the acre to promote the early growth of the plants before they are able to secure their nitrogen from the air. On a soil that is rich in

¹ U. S. Dep't. of Agr., Farmer's Bul. 356, p. 11.

nitrogen the peanuts produce vines at the expense of nuts.

A fertilizer for peanuts applicable to a large percentage of the sandy and loamy soils of the South is 250 pounds of acid phosphate and 50 pounds of muriate of potash to the acre.

Where the land will already produce sufficient vines for a good crop, the North Carolina Department of Agriculture recommends the use of 400 to 500 pounds to the acre of a fertilizer consisting of one-third kainit and two-thirds 14 per cent acid phosphate. This mixture would contain 9.3 per cent of available phosphoric acid and 4 per cent of potash. The fertilizer is usually applied in the drill either before or at the time the crop is planted.

It is the custom in some sections of the South, particularly in Virginia, to distribute calcium sulfate on the rows after the plants have made considerable growth. This often results in an increased yield of nuts, due to the stimulating effect of the calcium sulfate. Unless this practice is supplemented by the use of phosphatic and potassic fertilizers, it will ultimately result in the impoverishment of the soil, especially as regards the phosphoric acid and potash.

544. The use of stable manure. — Fresh manure should not be used on the land immediately before the planting of the peanuts. It results in the abnormal development of the tops and the production of a large percentage of unfilled pods. Large numbers of weed seeds are also added. The best practice is to apply the manure to the crop grown the previous season, or light applications of well-rotted manure may be applied to the land in the fall previously to planting the peanuts. It should be immediately plowed under.

545. Preparing the seed-bed. — All coarse litter, such as corn stalks or cotton stalks should be removed before the land is plowed. Clay soils on which there is considerable vegetable matter are preferably plowed in the fall for peanuts. This permits the vegetable matter to decompose before the crop is planted. Soils thus plowed should be thoroughly disked in the spring before planting.

Sandy or loamy soils are usually plowed in the late winter or early spring. It is best that they be plowed at least a month before planting. This permits the seed-bed to settle and also hastens the germination of weed seeds which can then be easily and cheaply destroyed by means of the harrow before planting.

The depth of plowing will depend somewhat upon the character of the soil and the time of plowing. In general, clay soils should be plowed deeper than sands.

546. Planting. — On well-drained soils, peanuts should be planted level. The usual practice is to open furrows 30 to 36 inches apart in which the fertilizers are drilled, if these materials are to be used. The fertilizers are best distributed by means of a common fertilizer distributor. They are often distributed by hand. It is well to have a cultivator or some other suitable implement follow the fertilizer distributor in order that the fertilizers may be better mixed with the soil.

Soils that are not well drained are usually ridged for peanuts. This is done by means of a small turn-plow or other suitable implement. The ridge is formed immediately over the fertilizer and should be partially harrowed down or flattened by means of a fine-tooth harrow before planting. The peanuts may be planted by hand or by means of a Community planter which is not expensive.

The large-podded varieties should be hulled before

planting. Small-podded varieties such as the Spanish variety are usually planted in the pod. When they are planted in the pod, germination may be hastened by soaking the peanuts in water for a few hours just before planting. Approximately two bushels of unhulled seed, or one-half bushel of hulled peanuts, are required to plant an acre. The plants should be left from seven to twelve inches apart in the row, the distance depending on the variety. The large-podded varieties should have the greater spacing. Planting should not be done until the soil has become thoroughly warm in the spring. Little is to be gained by planting peanuts in a cold soil.

547. Cultivation. — The cultivation of the peanut crop may well begin before the plants are up by running a weeder or section-harrow diagonally across the rows. After the plants are well up, tillage by separate rows begins. There is little difference between the cultural methods for peanuts and for such crops as corn, peas, and the like. It is especially important that such implements be used as will keep the soil thoroughly pulverized close to the plants. This facilitates the entrance of the fruit stems or "pegs" into the soil. Cultivators with small points on the side next to the row are quite satisfactory for this purpose. Hoeing should be done only when necessary to keep down weeds and grass.

548. Harvesting. — An important use of the peanut crop is as a pasture for hogs. When used for this purpose the hogs should be allowed to harvest the crop. When grown for the market, the crop should be dug before frost. The proper stage of maturity for harvesting is indicated by the tendency of the pods about the base of the plant to shed, and the vines to turn yellow.

Various methods of harvesting peanuts for the market

are practiced. In many cases the plants are merely plowed from the ground with a one-horse turning plow and afterwards separated from the soil by hand. Another, and very common, method is to remove the mold-board from a turning plow and run the plowshare under the row on each side at a sufficient depth not to sever the pods from the vines. The side from which the mold-board is removed is kept next to the row. The plants are lifted by hand or by means of forks, and the dirt is carefully shaken from

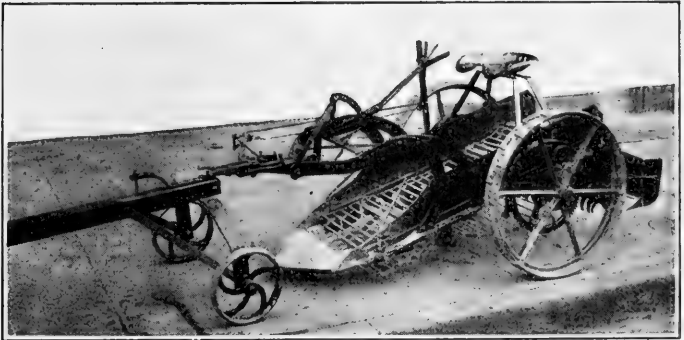

FIG. 74. — Machine potato digger adapted for harvesting peanuts.

them. They are then thrown in small piles to dry. The potato digger may be very satisfactorily used in harvesting peanuts (Fig. 74).

549. Stacking. — As soon as the plants have sufficiently dried, — a process which requires about three or four hours, — they are put in small stacks (Fig. 75). Poles about seven feet long are driven securely into the ground. Around the base of each pole a few pieces of short poles are placed to keep the peanuts off the ground. The peanuts are stacked with the vines out and the nuts in next to the pole. The stacks should be made rather slender and taper-

ing toward the top to shed water. Each stack is usually capped with grass to protect the nuts.

550. Picking. — Peanuts should not be picked from the vines until the pods have become dry and the peas



FIG. 75. — Laborer building a stack of peanut vines, showing method used. Completed stacks in background.

firm. A better grade of peanuts will be secured if picking is deferred until late autumn. The greater part of the crop is picked by hand. Machines are in use for picking peanuts. They are profitable where the crop is grown extensively. Most machines have a tendency to crack a certain amount of the pods.

The picked pods should not be exposed to dampness as to do so discolors them and reduces their market value.

INDEX

(Numbers refer to pages)

- Acme harrow, 235.
Ægilops, 305.
Ægilops ovata, 306.
Alabama argillacea, 137.
Alabama Experiment Station;
17, 40, 41, 98, 222,
228, 244, 254, 270,
278, 287, 290.
Alabama, high ranking cotton
varieties for, 48.
Alabama, high yielding varie-
ties of wheat for, 319.
Alabama, leading varieties of
corn for, 183.
Alfalfa, 2.
Allen, J. B., 52.
Allium vineale, 334.
Amber sorghum, 382, 383.
Andropogon halepensis, 372.
Andropogon sorghum, 372.
Anthonomus grandis, 127.
Arachis hypogæa, 430.
Arkansas Agricultural Experi-
ment Station, 288.
Arkansas, high ranking cotton
varieties for, 48.
Arkansas, high yielding varie-
ties of wheat for, 319.
Arkansas, leading varieties of
corn for, 183.
Avena barbata, 273.
Avena fatua, 272, 273.
Avena sativa, 272.
Avena sterilis, 272, 273.
Ball, Carleton R., 373, 377, 381.
Balls, W., 8, 9, 28.
Barley, climate, 351.
composition, 349.
description, 347.
enemies, 353.
fertilizers, 351.
harvesting, 352.
nativity, 347.
rotations, 351.
soils, 351.
sowing, 351.
types, 350.
value in cotton-belt, 3.
value in United States, 3.
"Benders" cotton, 33.
Bermuda-grass, 2.
Blissus leucopterus, 268, 337.
Bromus secalinus, 334.
Broom-corn, 374, 395.
culture of, 398.
harvesting, 399.
Buckwheat, value in United
States, 3.
Bureau of Plant Industry, 28,
141, 143, 144, 282, 298,
319.
Bureau of Soils, United States
Department of Agri-
culture, 67, 222.
Burgess, J. L., 327.
Calandra oryza, 269.
Catch-crops, 2;

- Cecidomyia destructor*, 336.
Chalcoedermis aeneus, 139.
 Chess or cheat, 334.
 Chinch bugs, 268, 337, 346.
 Classification of field crops, 1.
 by use, 1.
 for the study of cropping systems, 2.
Claviceps purpurea, 346.
 Cleveland, J. R., 52.
 Climate, factors of, 213.
 Club wheat, 315.
 Cockle, 334, 335.
Colletotrichum falcatum, 427.
 Colorado Experiment Station, 151.
 Connecticut Agricultural Experiment Station, 206, 207.
 Cook, J. R., 52.
 Corbett, L. C., 430.
 Corn, barren plants, 190.
 breeding, 187.
 breeding plot, cultivation of, 197.
 breeding plot, harvesting, 198.
 breeding plot, selection of, 196.
 breeding, significance of type in, 187.
 broad breeding defined, 204.
 bud-worms, 265.
 characters, transmission of, 204.
 checking, 240.
 classification, 177.
 climate, influence upon habit of growth, 216.
 climatic adaptations, 213.
 close breeding defined, 204.
 composition, breeding for, 200.
 composition, objects of breeding for, 202.
 composition of, 161.
- Corn (*Continued*).
 composition, other effects of breeding for, 201.
 continuous culture, effect of, 217.
 covering rubbish, 232.
 cribs, 261.
 cropping-systems for, 217.
 cross-bred seed, method of producing, 207.
 crossing varieties, value of, 207.
 cultivation, importance of, 245.
 by separate rows, 246.
 depth and frequency of, 247.
 late cultivation, value of, 247.
 cultivators, kinds, 247.
 cutting and shocking, 255.
 cutting, hand methods, 256.
 cut-worms, 266.
 description of, 150.
 detasseling, 197.
 dominant qualities in, 206.
 double fertilization, 169.
 drilling, 239.
 ear, 158.
 ear, development of, 171.
 ears, harvesting, 255.
 ears, initial choice of, 195.
 ear-worms, 268.
 enemies, animal, 264.
 fertilization, 168.
 fertilizing constituents, relative importance of, 225.
 fertilizer formulas for, 227.
 fertilizers for, 223.
 fertilizers, method of applying, 226.
 fertilizers, principles underlying use of, 228.
 fertilizers, when to apply, 226.

Corn (*Continued*).

- flower, 157.
- flowers, pistillate, 158.
- fungous diseases, 270.
- green-manures for, 222.
- growing season for, 215.
- growth, 165.
 - factors of, 166.
- harvesting, cost of, 257.
- effect on yield, 253.
- methods of, 252.
- time of, 251.
- harvesting machinery, 258.
- high ears, breeding for, 200.
- husking, 260.
- hybridization, objects of, 203.
- improving, methods of, 192.
- inbreeding defined, 204.
- inbreeding, effects of, 206.
- insect enemies, causes, 265.
- interculture, objects of, 245.
- kernels, 159.
- leaf surface, 163.
- leaf surface, figuring, 163.
- leaves, 156.
- leaves, growth of, 167.
- lime for, 222.
- listing, 240.
- low ears, breeding for, 200.
- low yield in cotton-belt, reasons for, 238.
- manures for, 221.
- mass selection, 193.
 - value of, 193.
- measuring in crib, 263.
- modification of soils for, 212.
- narrow breeding defined, 204.
- nativity, 173.
- origin, biological, 174.
- pedigree selection, 194.
- physiology of, 161.
- plants, degrees of relationship among, 204.
- planting, 238.

Corn (*Continued*).

- depth of, 242.
- methods of, 239.
- time of, 241.
- plant-food removed by, 223.
- plowed land, treatment of, 234.
- plowing, depth of, 232.
- plowing, time of, 231.
- preparation of plowed land for, 234.
- rainfall, influence of, 214.
- recessive qualities in, 206.
- reproduction, 168.
- ridging land for, 236.
- roots, adventitious, 153.
- roots, growth of, 166.
- roots, primary, 151.
- roots, structure of, 153.
- roots, temporary, 150.
- root-system, 150.
- rotation, place in, 219.
- rotations suggested for, 220.
- seed-bed, preparation of, 230.
- seed, testing, 238.
- selection, 192.
- shocking, 258.
- shredding, 261.
- shrinkage in storage, 262.
- smut, 271.
- soil adaptations, 211.
- soils and fertilizers, 224.
- soils not adapted to, 212.
- soil type and crop variety, 213.
- southern varieties, defects in, 190.
- spacing, 244.
- stalks, methods of destroying, 230.
- stand, importance of, 243.
- stems, 153.
- stems, growth of, 167.
- stems, structure of, 154.

Corn (*Continued*)

- storing, 261.
- sub-soiling for, 233.
- suckering, tendency to, 191.
- sunshine, influence of, 214.
- temperature, influence of, 215.
- tillers, 156.
- value in cotton-belt, 3.
- value in United States, 3.
- varieties, 182.
- varieties, discussion of, 185.
- water, amount required, 165.
- water requirements, 163.
- wide beds for, 237.
- wire-worms, 267.
- yields of forage by different methods of harvesting, 254.

Cotton, description of, 8.

- acclimatization of, 66.
- acid phosphate for, 86.
- air cavities, 14.
- Amarillo loam and silty clay for, 76.
- Appalachian province, cotton soils of, 73.
- bales, care of, 121.
- bales, size of, 120.
- baling, 120.
- Big-boll type, 45.
- bolts, 16.
 - number of, 17.
- branches, 10.
 - fruiting branches, 12.
 - vegetative branches, 12.
- breeding, 53.
 - need of, 53.
 - reasons for, 53.
- broadcast tillage for, 112.
- "buck shot" land for, 76.
- Cahaba fine sandy loam for, 76.
- characters that determine quality, 56.

Cotton (*Continued*).

- color and cleanliness of fiber, 57.
- length of fiber, 56.
- strength of fiber, 57.
- uniformity of fiber, 56.
- Clarksville soils for, 74.
- climatic adaptations of, 76.
- cluster type, 41.
- Coastal Plain Province, cotton soils of, 69.
- commercial fertilizers for, 83.
- commercial grades, classification of, 121.
- composition of, 22.
- composts for, 95.
- compressing, 121.
- Congaree loam for, 76.
- constituents of, 23.
- cotton-seed meal versus cotton-seed for, 84.
- Crawford stony clay for, 76.
- crossing, method of, 64.
- cultivation, 110, 113, 114.
- Decatur clay loam for, 74.
- DeKalb soils for, 73.
- diseases of, 141.
- drainage for, 102.
- Durant fine sandy loam for, 72.
- egg-cells, 28.
- embryo, 29.
- environment, influence of, 62.
- fall plowing for, 102.
- Fayetteville fine sandy loam for, 73.
- fertility removed by, 81.
- fertilization, 28.
- fertilizer formulas for, 93.
- fertilizer needs, as judged by appearance of plants, 91.
- fertilizer test for, 90.
- fertilizers, nitrogen-supplying materials for, 83.

Cotton (*Continued*).

- fertilizers, method of applying for, 92.
- time of applying for, 92.
- fixation of hybrids, 63.
- flowers, 16.
- forming the ridges for, 107.
- ginning, 118.
- ginning cotton from select plants, 59.
- gins, type of, 118.
- Gossypium, 30.
- Gossypium arboreum, 32, 37.
- Gossypium barbadense, 33, 35.
- Gossypium herbaceum, 31.
- Gossypium hirsutum, 31, 32, 33.
- Gossypium Kirkii, 33.
- Gossypium obtusifolium, 32, 36.
- Gossypium peruvianum, 32, 36.
- Gossypium vitifolium, 36.
- grades, 122.
- grades, values of, 124.
- green-manures for, 96.
- Greenville soil series for, 70.
- growing season, length of, 77.
- guard-cells, functions of, 26.
- Hagerstown loam for, 74.
- harrowing for, 105.
- harvesting, 117.
- heavy seed, advantages of, 108.
- high ranking varieties, 48.
- Houston soils for, 71.
- hybridization of, 62.
- hybridization versus selection, 65.
- hybridizing, reasons for, 63.
- improvement by selection, 58.
- insect enemies of, 127.
- intermediate varieties, 46.
- Kalmia fine sandy loam for, 76.

Cotton (*Continued*).

- King type, 44.
- late tillage, value of, 115.
- leaves, 12.
- functions of, 14.
- limestone valleys and uplands, soils of, 74.
- lint, 18.
- length and strength of, 19.
- loessial region, cotton soils of, 74.
- long-limbed type, 46.
- long-staple upland varieties, 46.
- Louisa soil series for, 73.
- maintenance of fertility for, 82.
- making second generation selections, 61.
- Memphis silt loam for, 75.
- methods of improving, 58.
- Miller soils for, 75.
- multiplication plot, 61.
- nature of hybrids, 63.
- Norfolk soils for, 69.
- numbering second generation selections, 61.
- nutrition, 23.
- absorption of food, 23.
- carbon, taking up of, 24.
- necessary energy, 25.
- Ocklocknee fine sandy loam for, 76.
- Orangeburg soils for, 70.
- organic matter for, 96.
- peduncles, 15.
- phosphatic fertilizers for, 86.
- physiology of, 21.
- picking, 117.
- picking machines, 117.
- planting, methods of, 110.
- planting, time of, 108.
- plants, distance between, 116.
- plowing for, depth of, 104.

Cotton (*Continued*).

- pollen-grains, 28.
- potash fertilizers checkrust, 89.
- potassic fertilizers for, 88.
- protoplasm of, 21.
- qualities associated with high yield, 55.
- qualities sought for, 54.
- rainfall, amount and distribution, 77.
- raw rock phosphate for, 87.
- reproduction, 27.
- reproductive organs, 27.
- ridging versus level preparation for, 106.
- Rio Grande type, 43.
- River Flood Plains Province, soils of, 75.
- root-hairs, 9.
- roots, function of, 10.
- roots, primary, 8.
- roots, secondary, 9.
- roots, types of, 8.
- root-system, 8.
- rotations for, 99.
- rows, distance between, 115.
- Ruston fine sandy loam for, 71.
- seed, 18.
 - quantity of, 109.
 - structure of, 18.
- seed-bed, preparation of, 101.
- selecting best progenies, 60.
- selection of foundation stock, 58.
- semi-cluster type, 42.
- sharkey clay for, 76.
- skeleton, 21.
 - functions of, 21.
- sodium nitrate versus cotton-seed meal for, 83.
- soils, classification of, 68.
- soils, need of for nitrogen, 85.
- soils, need of for phosphoric acid, 88.

Cotton (*Continued*).

- soils, need of for potash, 89.
- soil types for, 67.
- species, 30.
 - number of, 31.
 - classification of, 31.
- American upland cotton, 33.
- Sea Island cotton, 35.
- Peruvian cotton, 36.
- Indian cotton, 36.
- Bengal cotton, 37.
- spring plowing for, 104.
- stable manure for, 94.
- staple, 125.
- stem, 11.
- stomata, 26.
- storm resistance, 15.
- structure of, 21.
- subsoiling for, 105.
- sunshine for, 79.
- Susquehanna fine sandy loam for, 71.
- temperature for, 79.
- testing transmitting power, 60.
- Tifton sandy loam for, 70.
- tillage by separate rows, 112.
- tillage for, 101.
- tillage, frequency of, 114.
- Trinity clay for, 75.
- value in cotton-belt, 3.
- value in United States, 3.
- valuing, points in, 122.
- varieties, classification of, 39.
 - description of, 50.
 - influence of soil and climate on, 39.
 - origin of, 38.
 - stability of, 39.
- variety test, 54.
- vascular system, 14.
- Vernon soils for, 76.
- Victoria soils for, 72.
- water, giving off of, 26.

- Cotton (*Continued*).
 well-defined ideal necessary,
 57.
- Cotton anthracnose, cause, 147.
 occurrence of, 146.
 remedies, 147.
 symptoms, 147.
- Cotton-belt states, rank of, 4.
- Cotton boll-worm, 134.
 damage, 135.
 description of, 134.
 food plants, 135.
 life history, 134.
 means of control, 136.
- Cotton leaf-louse, 138.
- Cotton leaf-worm, 137.
 damage, 138.
 life history and habits, 137.
 means of control, 138.
- Cotton red-spider, 139.
- Cotton root-rot, 143.
 cause, 144.
 remedies, 144.
 symptoms, 144.
- Cotton-wilt, 141.
 remedies, 142.
 symptoms, 142.
- Cover crops, 2.
- Cowpea pod-weevil, 139.
- Crimson clover, 2.
- Crop rotation and soil fertility,
 99.
- Cultivated crops, 2.
- Dent corn, 180.
- DeVries, Hugo, 190, 198, 204.
- Diabrotica 12-punctata, 265.
- Diatraea saccharalis, 426.
- Disk harrow, 234.
- Dondlinger, P. T., 305.
- Dry beans, value in United
 States, 3.
- Dry peas, value in United
 States, 3.
- Duggar, J. F., 19, 31, 40, 41, 85,
 90, 118, 228, 237, 276,
 325, 329, 355, 409.
- Dürra, 374, 390.
- East, E. M., 207.
- Einkorn, 315.
- Elateridæ, 267.
- Emmer, 315.
- Euchlæna mexicana, 174.
- Ergot, 346.
- Feterita, 393.
- Field crops, definition of, 1.
 importance in the cotton-
 belt, 5.
 value in cotton-belt, 3.
 value in United States, 3.
- Field garlic, 334, 335.
- Flax seed, value in United
 States, 3.
- Flint corn, 179.
- Florida Agricultural Experi-
 ment Station, 253, 416.
- Florida, high yielding varie-
 ties of wheat for, 319.
- Furman, Farish, 95.
- Gama grass, 174, 175.
- Georgia Agricultural Experi-
 ment Station, 40, 94,
 100, 244, 292.
- Georgia, high ranking cotton
 varieties for, 49.
- Georgia, high yielding varie-
 ties of wheat for, 319.
- Georgia, leading varieties of
 corn for, 183.
- Glomerella gossypii, 146.
- Gooseneck sorghum, 382, 383.
- Grain crops, 2.
- Grain moths, 269.
- Grain sorghums, 389.
 belt, 389.

- Grain sorghūms (*Continued*).
 cultivation, 398.
 culture, 397.
 groups, 390.
 harvesting, 398.
- Gramineæ, 174.
- Grass crops, 2.
- Great Plains region, cotton soils of, 76.
- Green, J. R., 22.
- Green-bugs, 301.
- Green-manure crops, 2, 97.
- Green-manures and the nitrogen supply, 98.
- Green-manures and the supply of organic matter, 98.
- Hackel, Edward, 373.
- Halligan, J. E., 93, 227.
- Hawkins, W. B., 51.
- Hay and forage, value in United States, 3.
- Heliothis obsoleta, 134, 268.
- Hessian fly, 328, 336, 346.
- Heterodera radiculicola, 145.
- Hinds, W. E., 134, 270.
- Honey sorghum, 384.
- Hopkins, C. G., 200.
- Hordeæ, 306.
- Hordeum nudum, 350.
- Hordeum sativum distichon, 350.
- Hordeum sativum hexastichon, 350.
- Hordeum spontaneum, 347.
- Horticultural crops, definition of, 1.
- Hunt, T. F., 176, 216, 276, 332, 432.
- Hunter, W. D., 129.
- Hutchinson, W. L., 228.
- Illinois Agricultural Experiment Station, 87, 189, 200, 201, 202, 207, 217, 218, 221.
- Interculture, objects of, 110.
- Iowa Agricultural Experiment Station, 263.
- Jackson, T. W., 50.
- Japanese sugar-cane, 410.
- Kafir, 373, 374, 390.
- Kafir and milo, value in United States, 3.
 value in cotton-belt, 3.
- Kansas Agricultural Experiment Station, 375.
- Kentucky Agricultural Experiment Station, 326.
- Kentucky blue-grass, 2.
- King, T. J., 51.
- King, W. H., 286.
- Kowliang, 374, 395.
- Laphygma frugiperda, 427.
- Layton, R. D., 51.
- Leaming, J. L., 194.
- Louisiana Agricultural Experiment Station, 40, 219, 407, 408, 417, 421, 428.
- Louisiana, high ranking cotton varieties for, 49.
- Louisiana, high yielding varieties of wheat for, 320.
- Louisiana, leading varieties of corn for, 183.
- Lychnis Githago, 334.
- Mallow family, 30.
- Marasmius plicatus, 429.
- Maryland Agricultural Experiment Station, 87.
- Maydeæ, 174.
- Mebane, A. D., 52.
- Meeker harrow, 235.
- Melanconium sacchari, 428.
- Mendel, Gregor, 204.
- Mendel's law, 204.

- Mexican cotton boll-weevil, 127.
 damage caused by, 130.
 dissemination of, 129.
 food of, 129.
 hibernation of, 130.
 life history and habits of, 128.
 means of control, 131.
 destroy cotton stalks, 131.
 destroy hibernating places, 132.
 make provision for an early crop, 133.
 proper spacing of plants, 133.
- Michigan Agricultural Experiment Station, 151, 252.
- Milo, 373, 374, 392.
- Minnesota Agricultural Experiment Station, 305.
- Mississippi Agricultural Experiment Station, 192, 228, 253, 419.
- Mississippi, high ranking cotton varieties for, 49.
- Mississippi, high yielding varieties of wheat for, 320.
- Mississippi, leading varieties of corn for, 184.
- Montgomery, E. G., 159, 177, 206, 381, 400.
- Mosaic disease, 148.
 cause, 148.
 occurrence of, 148.
 remedies, 149.
 symptoms, 149.
- Nebraska Agricultural Experiment Station, 206.
- Neocosmospora vasinfecta, 141.
- New Jersey Agricultural Experiment Station, 206.
- New York Agricultural Experiment Station, 151.
- Noctuidæ, 266.
- Non-saccharine sorghum, 638.
- North Carolina Agricultural Experiment Station, 191, 325.
- North Carolina, Coastal Plains Station, high ranking cotton varieties for, 49.
- North Carolina Department of Agriculture, 220, 266, 268, 327, 438.
- North Carolina, high yielding varieties of wheat for, 320.
- North Carolina, leading varieties of corn for, 184.
- North Carolina, Raleigh Station, high ranking cotton varieties, for, 49.
- North Dakota Agricultural Experiment Station, 151.
- Norton, W. A., 50.
- Oats, 272.
 Beardless Red, 281.
 bleached oats, 298.
 Burt oats, 279.
 care of, 293.
 classification, 277.
 classification, botanical, 272.
 climate, 285.
 clipping, 275.
 composition, 275.
 cutting, time of, 296.
 elementary species, isolation of, 283.
 fertilizers, 286.
 grades, 298.
 grain, as food, 294.
 grain, description of, 275.
 harvesting, 296.
 hay, 94.
 hot-water treatment, 303.
 hybridization, 283.

- Oats (*Continued*).
- improvement, by hybridiza-
tion, 283.
 - improvement, need of, 281.
 - improvement of varieties, 281.
 - insect enemies, 301.
 - introduction of new seed,
281.
 - manures, 286.
 - marketing, 298.
 - origin, 272.
 - panicle, 274.
 - plant, description of, 273.
 - pollination, 275.
 - Red Rust-proof, 278.
 - rotation for, 288.
 - rust, 301.
 - seed-bed, preparation of, 289.
 - seeding, methods of, 290.
 - seeding, open furrow method,
291.
 - seeding, rate of, 292.
 - seeding, time of, 298.
 - seed-plot, 282.
 - selection, mechanical, 282.
 - shocking, 296.
 - smut, 302.
 - soils, 285.
 - spikelets, 274.
 - stacking, 297.
 - storing, 297.
 - straw, 294.
 - structure and composition,
273.
 - thrashing, 297.
 - Turf oats, 280.
 - uses of, 294.
 - value in cotton-belt, 3.
 - value in United States, 3.
 - varieties in cotton-belt, 277.
- Ohio Agricultural Experiment
Station, 87, 221.
- Oklahoma Agricultural Experi-
ment Station, 328, 329.
- Oklahoma, high ranking cotton
varieties for, 49.
- Oklahoma, high yielding vari-
eties of wheat for, 320.
- Orange sorghum, 382.
- Oryza sativa, 354.
- Osmosis, 11.
- Ozonium omnivorum, 143.
- Peanut, 430.
- composition, 432.
 - cultivation, 440.
 - culture, 436.
 - distribution, 430.
 - fertilizers, 437.
 - harvesting, 440.
 - improvement, 434.
 - lime for, 437.
 - nativity, 430.
 - picking, 442.
 - planting, 439.
 - rotations, 436.
 - seed-bed, preparation of, 439.
soil, 436.
 - stable manure for, 438.
 - stacking, 441.
 - value in cotton-belt, 3.
 - value in United States, 3.
 - varieties, 432.
- Pennsylvania Agricultural Ex-
periment Station, 87,
221.
- Phacelotheca diplospora, 388.
- Phacelotheca reiliana, 388.
- Pineapple disease, 429.
- Piper, C. V., 372.
- Piricularia oryza, 371.
- Plodia interpunctella, 269.
- Plumb, C. S., 263.
- Pod corn, 178.
- Polish wheat, 317.
- Pop corn, 178.
- Potatoes, value in United
States, 3.

- Poulard wheat, 316.
 Puccinia coronata, 301.
 Puccinia graminis, 337.
 Puccinia graminis avena, 301.
 Puccinia rubigo-vera, 337.
 Purdue University, 161.
- Red clover, 2.
 Red rice, 370.
 Red-rot of sugar-cane, 427.
- Rice, cleaning process, 368.
 cleaned rice, 368.
 climatic adaptations, 359.
 composition, 355.
 diseases, 371.
 drainage for, 362.
 enemies, 370.
 fertilizers, 362.
 growing sections, 361.
 harvesting, 367.
 insects, 371.
 irrigation, 359.
 irrigation practice, 365.
 planting, 364.
 preparation, 368.
 products, classification of, 369.
 relatives, 354.
 rotations, 362.
 seed-bed, preparation of, 363.
 smut, 371.
 soils, 362.
 structure, 355.
 thrashing, 367.
 upland, 358.
 uses, 369.
 value in cotton-belt, 3.
 value in United States, 3.
 varieties, 356.
 weeds, 370.
 yield, 367.
- Rice blast, 371.
 Rice bran, 369.
 Rice hulls, 370.
 Rice polish, 369.
- Rice water-weevil, 371.
 Ricks, J. R., 192.
 Riley, James, 194.
 Rind disease, 428.
 "Rivers" cotton, 33.
 Root-knot, 145.
 cause, 145.
 occurrence, 145.
 remedy, 146.
 symptoms, 146.
- Root-rot disease, 429.
 Rowden Brothers, 52.
 Rublee, C. A., 50.
 Rye, climate, 343.
 composition, 342.
 culture, 344.
 description, 341.
 enemies, 346.
 fertilizers, 343.
 handling, 345.
 harvesting, 345.
 nativity, 341.
 origin of, 341.
 rotations, 344.
 rust, 346.
 seed, 344.
 smut, 346.
 soils, 343.
 straw, 345.
 value in cotton-belt, 3.
 value in United States, 3.
 varieties, 343.
- Saccharine sorghums, 381.
 classification, 381.
 climate, 384.
 cultivation, 386.
 enemies, 388.
 fertilizers, 385.
 harvesting, 386.
 land, preparation of, 385.
 planting, time, rate and
 method, 385.
 sirup, manufacturing, 387.

- Saccharine sorghums (*Cont'd*).
 soils, 385.
 smut, 388.
 yield, 388.
- Saccharum officinarum, 384,
 401.
- Sanderson, E. D., 131.
- Secale cereale, 341.
- Secale montanum, 341.
- Shallu, 374, 393.
- Sherman, Franklin, 265.
- Simpkins, W. A., 51.
- Sitotroga cerealella, 269.
- Smoothing harrow, 235.
- Sodium nitrate, 24.
- Soft corn, 181.
- Sorghums, 372.
 branches, 375.
 breeding, 377.
 classification, botanical, 373.
 crossing, 377.
 drought resistance, 376.
 effects on soil, 376.
 fertilization, 377.
 grain. (See Grain Sorghums,
 389.)
 origin, biological, 372.
 origin, geographical, 373.
 poisoning, 380.
 root-system, 374.
 saccharine. (See Saccharine
 Sorghums, 381.)
 tillers, 375.
 value in cotton-belt, 3.
 value in United States, 3.
- Sorgo, 373, 374.
- South Carolina Agricultural Ex-
 periment Station, 9,
 355.
- South Carolina, high ranking
 cotton varieties for, 50.
- South Carolina, high yielding
 varieties of wheat for,
 321.
- South Carolina, leading varie-
 ties of corn for, 184.
- Southern grass worm, 427.
- Special harrows, 235.
- Spelt, 315.
- Spring-tooth harrow, 235.
- Stalks and litter, disposal of,
 102.
- Sturtevant, E. L., 177, 182.
- Subsurface packers, 236.
- Sugar-beets, value in United
 States, 3.
- Sugar-cane, 401.
 climate, 412.
 composition in sugar-belt and
 pine-belt, 408.
 cultivation, 420.
 cutting, 424.
 diseases, 427.
 fertilizers, 414.
 fertilizers in Louisiana, 415.
 fertilizers in pine-belt, 415.
 handling, 424.
 harvesting, time of, 423.
 improvement, 410.
 inflorescence, 403.
 insect pests, 426.
 juice, amount and distribu-
 tion, 405.
 juice, composition of, 406.
 juice, conditions affecting com-
 position, 406.
 land, preparation of, 417.
 leaves, 403.
 nativity, 401.
 plant, description of, 401.
 planting, method of, 418.
 planting, time of, 418.
 roots, 403.
 rotations, 413.
 seed-cane, method of keeping,
 419.
 soils, 412.
 stem, 404.

- Sugar-cane (*Continued*).
 stem, structure of, 405.
 stripping, 424.
 tillage practices, 417.
 topping, 424.
 uses, 426.
 value in cotton-belt, 3.
 value in United States, 3.
 varieties, 409.
 yields, 425.
- Sugar-cane borer, 426.
- Sumac sorghum, 382.
- Sweet corn, 181.
 varieties of, 186.
- Sweet potatoes, value in United States, 3.
- Tennessee, high ranking cotton varieties for, 50.
- Tennessee, high yielding varieties of wheat for, 321.
- Tennessee, leading varieties of corn for, 184.
- Teosinte, 174.
- Tetranychus gloveri, 139.
- Texas Agricultural Experiment Station, 12, 17, 40, 94, 227, 397.
- Texas, high ranking cotton varieties for, 50.
- Texas, high yielding varieties of wheat for, 321.
- Texas, leading varieties of corn for, 184.
- Thielaviopsis ethacetica, 429.
- Tilletia foeteus, 338, 339.
- Tilletia horrida, 371.
- Timothy, 2.
- Tobacco, value in United States, 3.
- Toole, W. W., 51.
- Toxoptera graminum, 301.
- Trabut, L., 273.
- Tripsacum dactyloides, 174.
- Triticum monococcum, 315.
- Triticum polonicum, 306, 314, 317.
- Triticum sativum, 305, 306, 314.
- Triticum sativum, var. compactum, 315.
- Triticum sativum, var. dicoccum, 315.
- Triticum sativum, var. durum, 316.
- Triticum sativum, var. spelta, 315.
- Triticum sativum, var. turgidum, 316.
- Triticum sativum, var. vulgare, 315.
- Triticum spelta, 306.
- United States Department of Agriculture, 22, 55, 109, 243, 313, 437.
- Ustilago avenæ, 302.
- Ustilago levis, 302.
- Ustilago tritici, 338.
- Ustilago zea, 271.
- Virginia, leading varieties of corn for, 185.
- Watt, Sir George, 18, 28, 31, 36.
- Webber, H. J., 38, 61, 108.
- Weeder, 235.
- Weevils, 269, 337.
- Wheat, antiquity of, 305.
 classification, botanical, 306.
 climate, 323.
 composition, 313.
 culms, 307.
 cultivating, 331.
 cultural methods, 327.
 fertilization, 310.
 fertilizers, 326.
 fungous diseases, 337.
 grain, description of, 310.
 harvesting, 331.

Wheat (*Continued*).

- improvement, 322.
- insect enemies, 336.
- leaves, 308.
- nativity, 305.
- origin, biological, 305.
- pasturing, 331.
- quality as affected by methods of handling, 332.
- reproductive organs, 311.
- roots, 306.
- rotations, 325.
- rust, 337.
- seed-bed, preparation of, 327.
- seeding, date of, 328.
- seeding machinery, 330.
- seeding, methods of, 329.
- seeding, rate of, 329.
- smut, covered, 339.
- smut, loose, 338.
- soils, 324.
- spike, 308.
- spikelets, 309.
- structure of, 306.
- tillering, 307.
- types, 314.
- types, botanical classification, 314.

Wheat (*Continued*).

- value in cotton-belt, 3.
- value in United States, 3.
- varieties, 317.
- varieties for cotton-belt, 318.
- weeds, 334.
- Whitney, Eli, 119.
- Williams, C. B., 20, 191.
- Williamson, McIver, method of corn cultivation, 249.
- Wisconsin Agricultural Experiment Station, 151.
- Zea canina, 173, 177, 178.
- Zea Mays, 150.
- Zea Mays amyloacea, 181.
- Zea Mays amylea-saccharata, 182.
- Zea Mays everata, 178.
- Zea Mays hirta, 182.
- Zea Mays indentata, 180.
- Zea Mays indurata, 179.
- Zea Mays japonica, 182.
- Zea Mays saccharata, 181.
- Zea Mays tunicata, 178.
- Zizania aquatica, 354.
- Zizania miliacea, 354.

THE following pages contain advertisements of a few of the Macmillan books on kindred subjects.

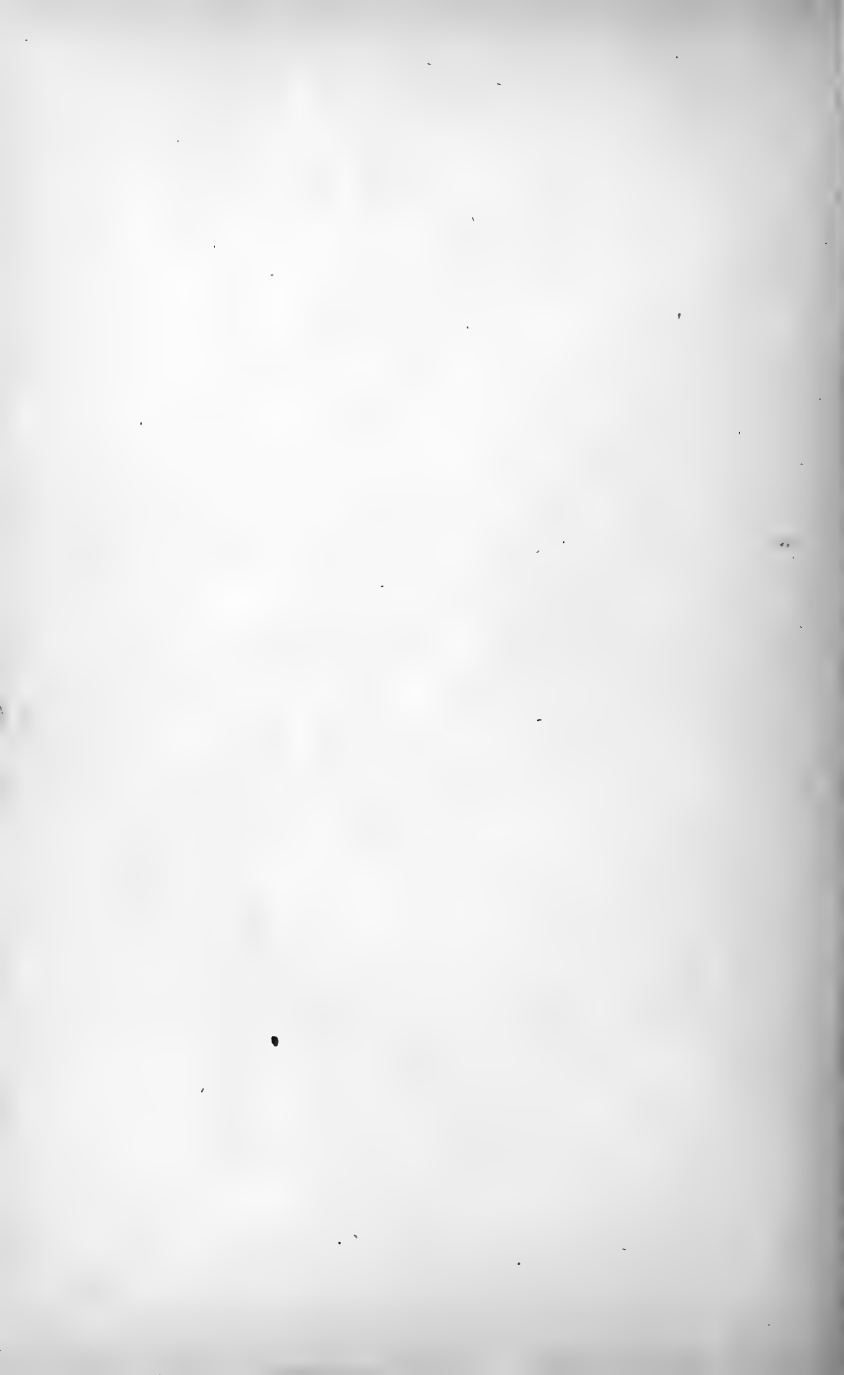

Small Grains

By M. A. CARLETON

Cerealist of the United States Department of Agriculture

Illustrated, cloth, 12mo. \$1.75

Rural Text-Book Series

The cereal grains and buckwheat are described carefully. Their methods of cultivation and of handling and marketing are thoroughly discussed. Among the grains thus treated are wheat, oats, rye, barley, and the minor crops. This book will prove an admirable complement to Montgomery's "The Corn Crops." Both these books are intended primarily for use as texts in college courses, and may very well be used in conjunction in the general course on grain crops. These books also are of distinct interest and value to the farmer.

Weeds

By ADA E. GEORGIA

Of the New York State College of Agriculture at Cornell University

Illustrated, cloth, 12mo. \$2.00

Rural Manual Series

A summary of our present knowledge regarding weeds as they affect horticultural and agricultural practices. The relations of weeds to agriculture are described, and the causes making certain plants weeds are explained. Every separate species of weed known to occur in the United States or Canada is described, and its range and habitat stated. The crops which each species particularly infests and the means of controlling each species are also discussed. Between 300 and 400 original illustrations, made directly from the plants, greatly enhance the practical value of this book.

THE MACMILLAN COMPANY

Publishers

64-66 Fifth Avenue

New York

Field Crops

By GEORGE LIVINGSTON

Assistant Professor of Agronomy, Ohio State University

Illustrated, cloth, 12mo. \$ 1.40

Rural Text-Book Series

This text is intended to meet the needs of agricultural high schools and of brief courses in Field Crops in the colleges. Based on actual experiment, it points out the "better way" of raising field crops; of selecting the field; of preparing the soil; of sowing the seed; of cultivating the plant; of harvesting the crop. It is fully illustrated with reproductions from photographs of unusual excellence.

Southern Field Crops

BY PROFESSOR J. F. DUGGAR

Illustrated, cloth, 12mo. \$ 1.75

Rural Text-Book Series

This work has been prepared with special reference to the needs of high schools and colleges of the Southern States. In a systematic, yet simple manner it discusses each of the important field crops of the South.

Cotton and corn receive most extended treatment. Briefer space is devoted to oats, wheat, rice, the sorghums, sweet potatoes, cassava, peanuts, sugar cane and tobacco.

THE MACMILLAN COMPANY

Publishers

64-66 Fifth Avenue

New York

Forage Plants and Their Culture

By CHARLES V. PIPER, M.S.

Agrostologist in charge of forage crop investigations, Bureau of Plant Industry,
U. S. Department of Agriculture

618 pp., *ill.*, 12mo, \$1.75

Rural Text-Book Series

A clear and concise account of the present knowledge of forage cropping in North America, intended primarily as a text-book for the use of agricultural college students. The author presents the subject in such a way as to make the student realize the shortcomings of the present knowledge on the subject, as well as the progress which has been definitely accomplished. All the plants and crops which are used for forage and for hay are described, and their botanical characteristics and means of cultivation are carefully discussed. Timothy, clovers, blue-grasses, orchard-grasses, southern grasses, sorghums, millets, alfalfa, peas, vetches, soy-beans, and root-crops are all treated. Included are descriptions of plants and seeds, methods of seeding, harvesting, and preserving, and discussions of utility and enemies of these crops. The matter is so well arranged for classroom use that the book is already a standard text for courses in forage crops.

THE MACMILLAN COMPANY

Publishers

64-66 Fifth Avenue

New York

The Corn Crops

A discussion of maize, kafirs, and sorghums as grown in the
United States and Canada

By E. G. MONTGOMERY

Professor of Farm Crops in the New York State College of Agriculture at
Cornell University

347 pp., *ill.*, 12mo, \$1.60

Rural Text-Book Series

The art of crop production is based on an application of the sciences, (*a*) to producing a natural condition as perfectly adapted as possible to the needs of some particular crop, or (*b*) the adaptation of the crop to certain natural conditions.

The study of crop production for any large region involves a study of four general phases of the subject, as: 1. The plant, its structure, physiology, and normal requirements. 2. A general survey of the region where it is proposed to cultivate the plant, to note how the natural conditions found correspond to the needs of the plant. 3. The adaptation of the plant on the one hand to natural conditions and adaptation of soil on the other to the needs of the plant. Maximum production is obtained when perfect adaptation is secured. 4. Protection is necessary against other indigenous plants, fungous diseases, and insects.

The treatment of subjects in the text follows practically the above plan. The plan also allows a wider use of the text for different classes of students. The first two divisions are technical and should only be studied by students who have training in the sciences involved. With less advanced students the work may begin with Part III, Adaptation. The third and fourth divisions deal with the more practical phases of production and are written in a more popular style, in order to make this double use of the book possible.

THE MACMILLAN COMPANY

Publishers

64-66 Fifth Avenue

New York

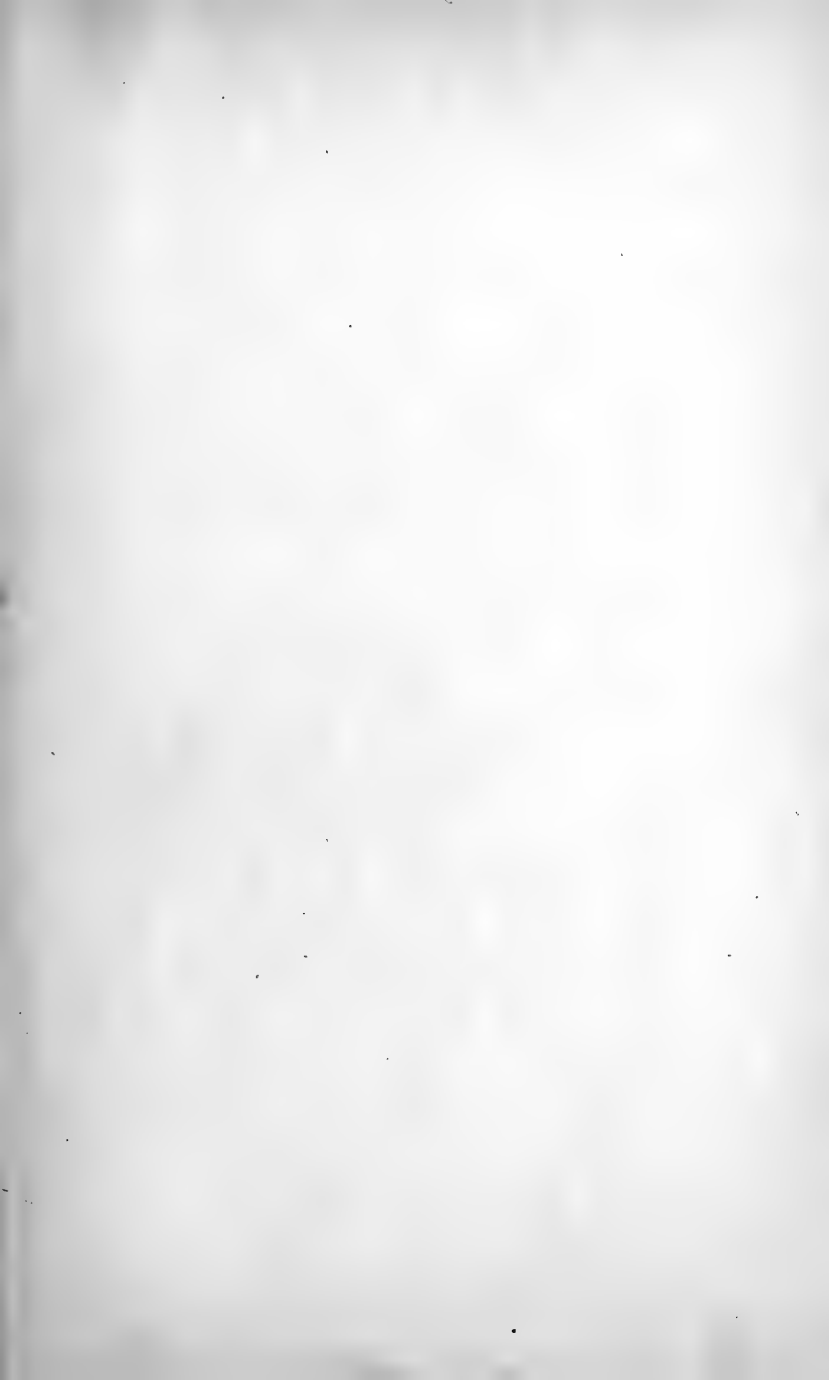

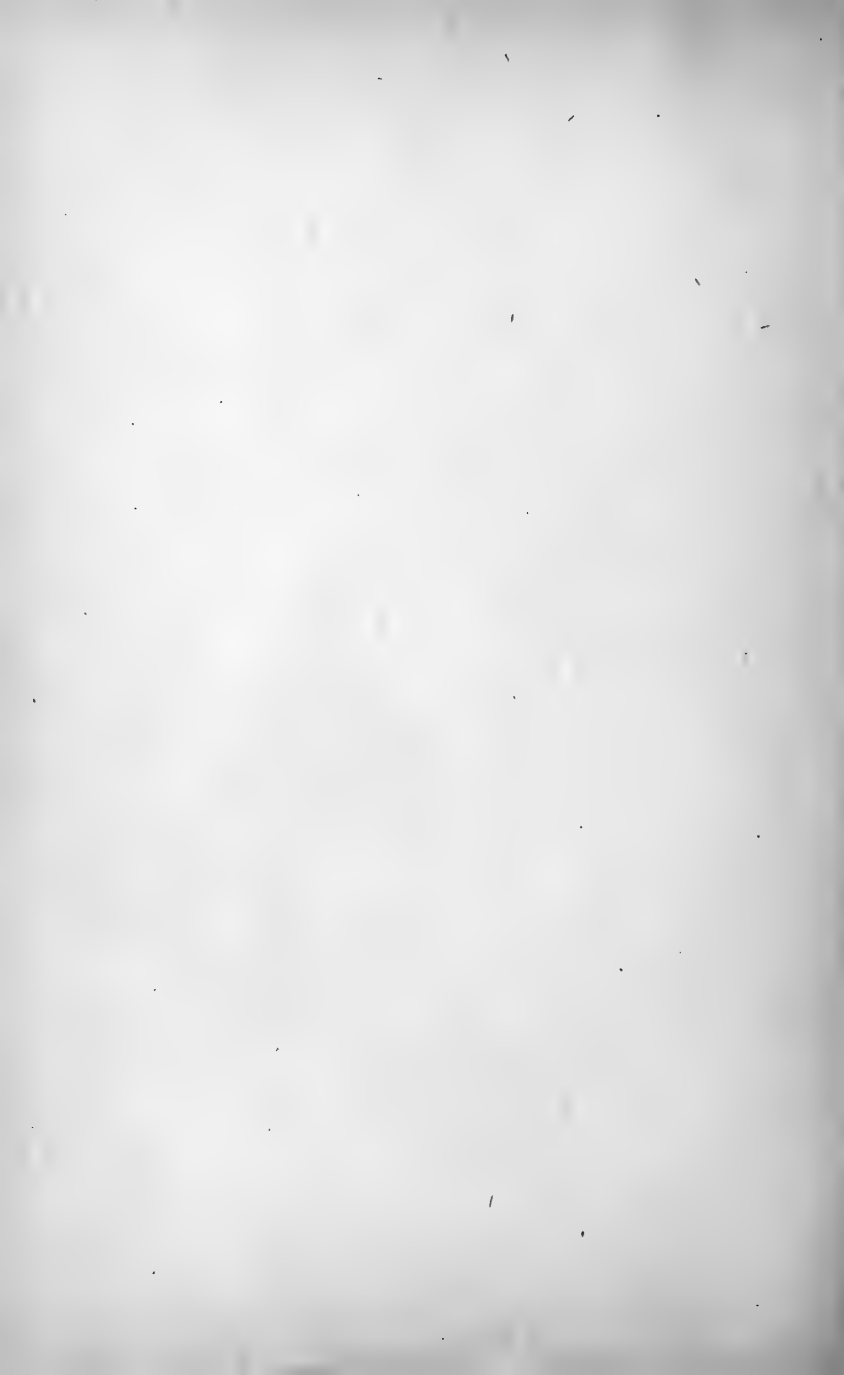

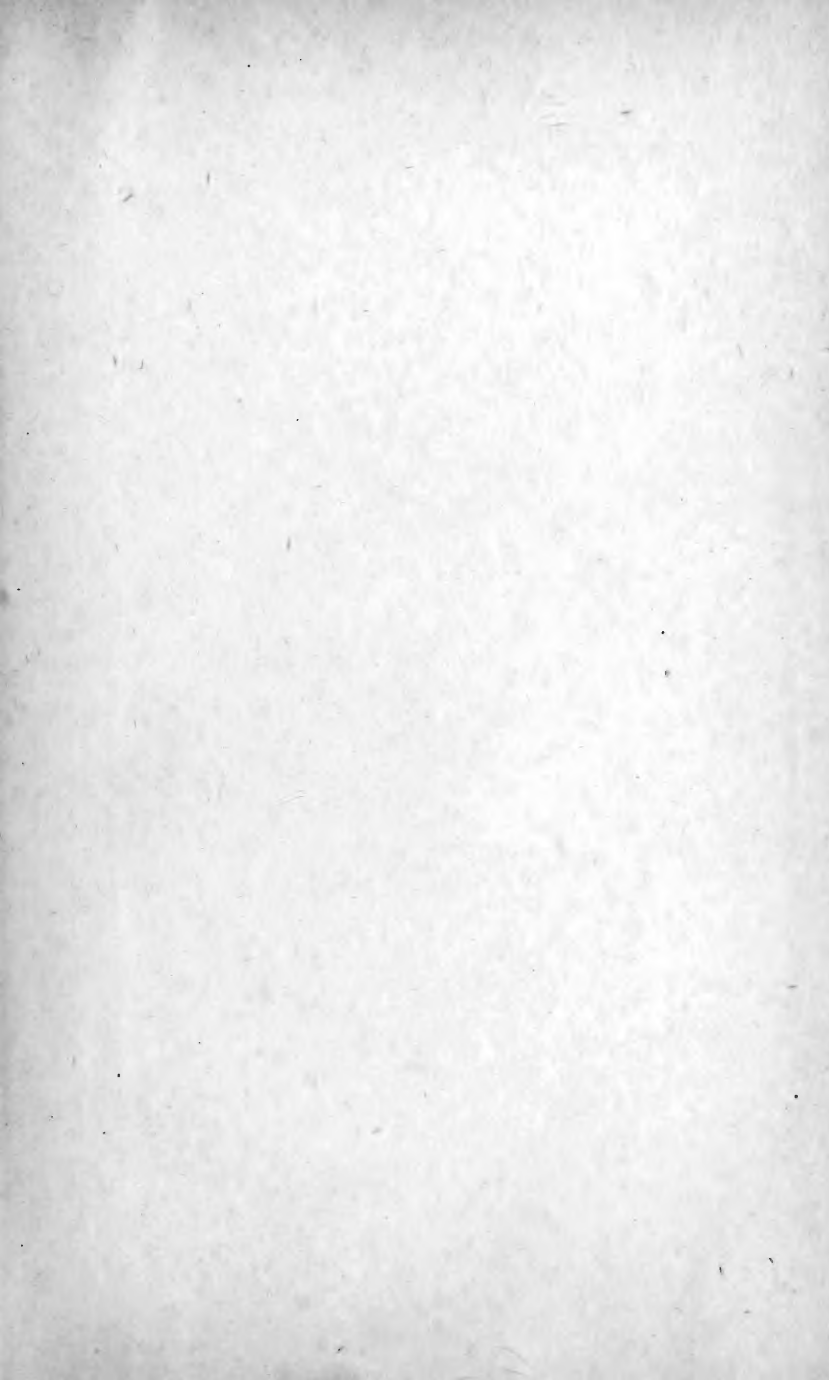

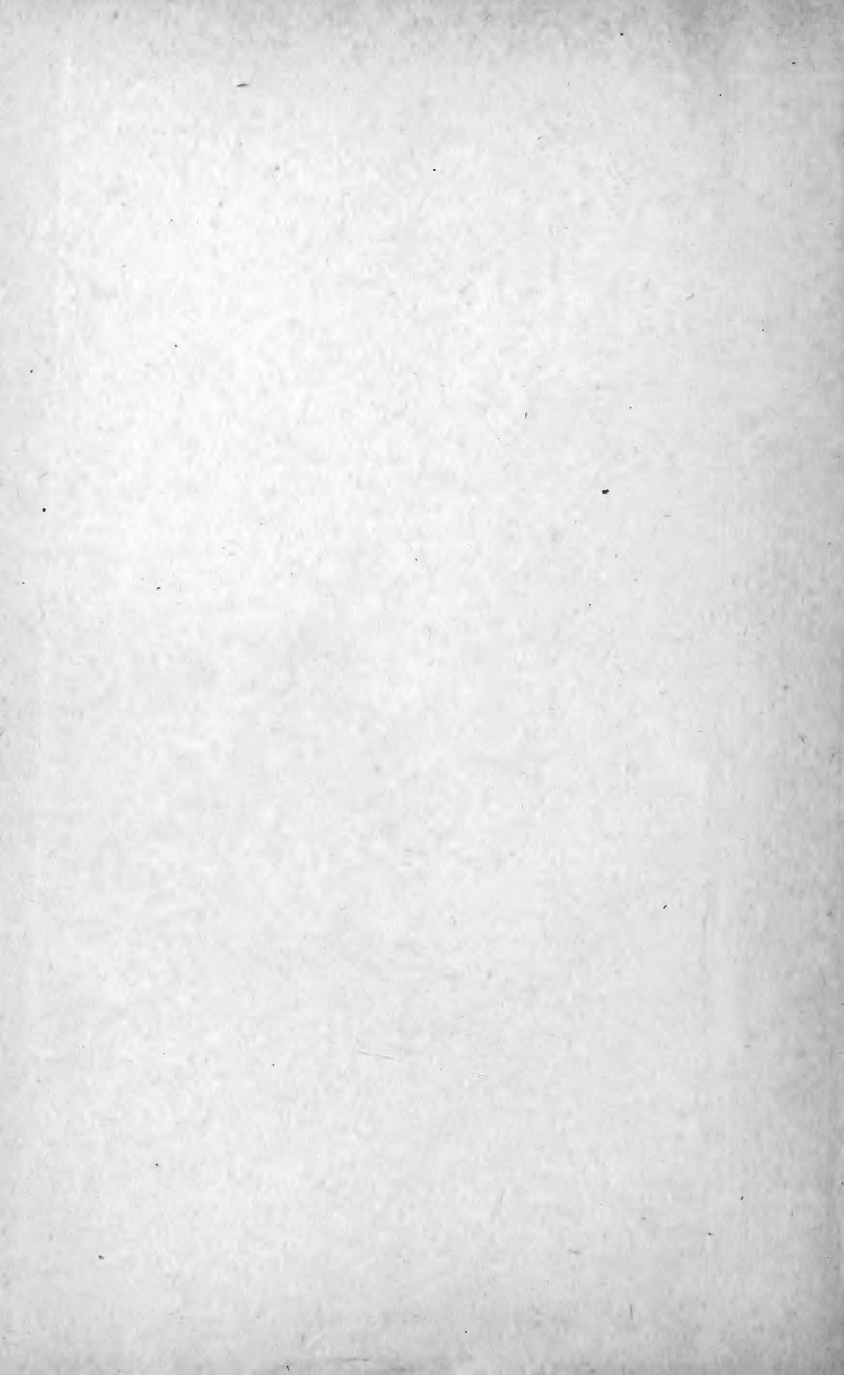

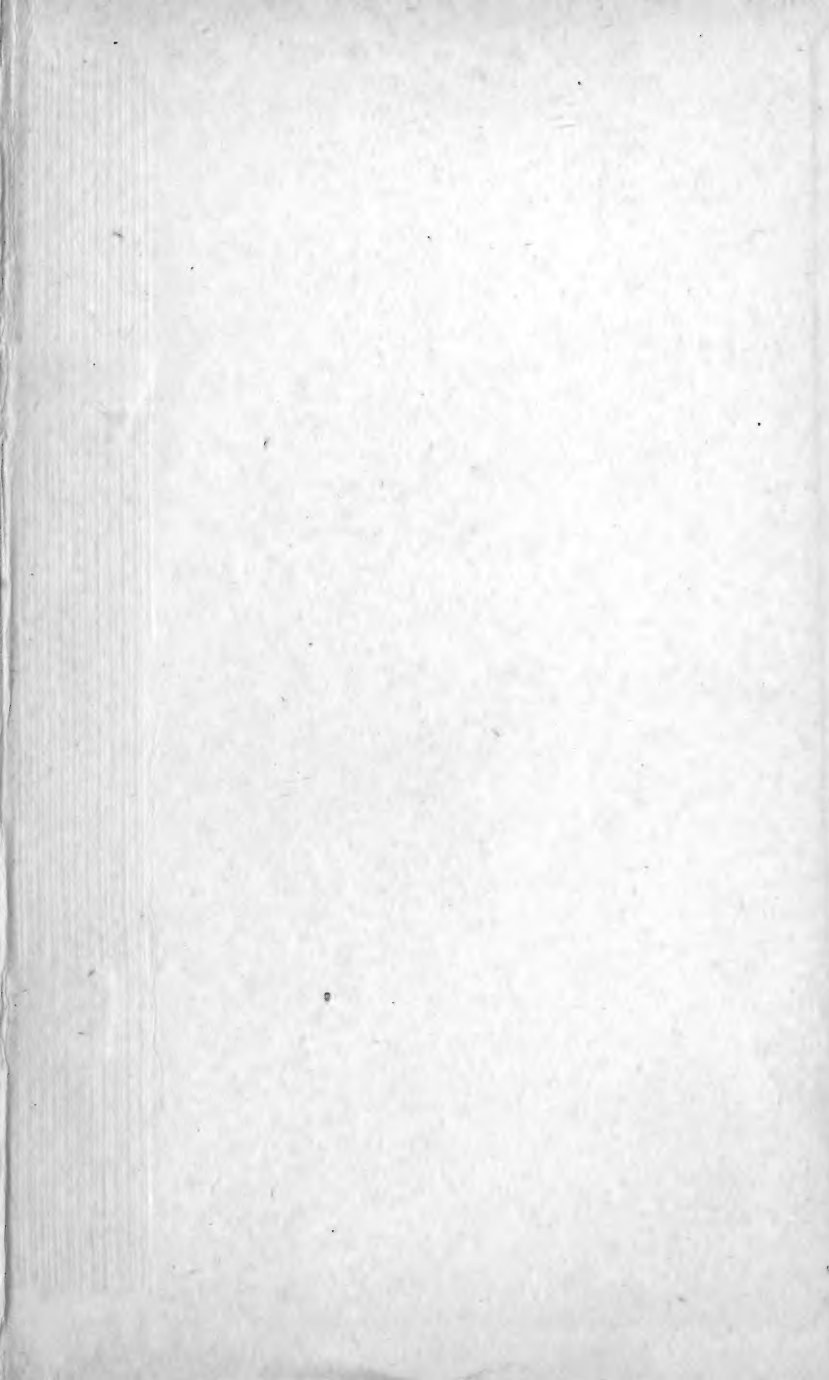

LIBRARY OF CONGRESS



00026813438