











# Fishery Bulletin

Vol. 84, No. 1

January 1986

THELACKER, GAIL H. Starvation-induced mortality of young sea-caught jack mackerel, <i>Trachurus squalirostris</i> , determined with histological and morphological methods	4
RENAUD, MAURICE L. Hypoxia in Louisiana coastal waters during 1983: implications for fisheries	19
LO, N. C. H., and T. D. SMITH. Incidental mortality of dolphins in the eastern tropical Pacific, 1959-72	27
MIDDLETON, ROBERT W., and JOHN A. MUSICK. The abundance and distribution of the family Macrouridae (Pisces: Gadiformes) in the Norfolk Canyon area	35
KEIRANS, WALTER J., SIDNEY S. HERMAN, and R. G. MALSBERGER. Differentiation of <i>Promotus carolinus</i> and <i>Promotus ocellatus</i> eggs in the Heretford Inlet estuary, southern New Jersey, using immunodiffusion	61
HUNT, JOHN H., WILLIAM C. LYONS, and FRANK S. KENNEDY, JR. Effect of exposure and confinement on spiny lobster, <i>Paralithodes argus</i> , used as attractant in the Florida fishery	69
BEACHAM, TERRY D. Type, quantity, and size of food of Pacific salmon ( <i>Oncorhynchus</i> ) in the Strait of Juan de Fuca, British Columbia	77
JONES, CYNTHIA. Determining age of larval fish with the otolith increment technique	91
MOYLE, PETER B., ROBERT A. DANIELS, BRUCE HERBOLD, and DONALD M. BALTZ. Patterns in distribution and abundance of a nonecoevolved assemblage of estuarine fishes in California	107
KRYGIER, E. E., and W. G. PEARCY. The role of estuarine and off-shore nursery areas for young English sole, <i>Parophrys reticulatus</i> Girard, of Oregon	119
STEIMLE, FRANK W., PAUL D. BOEHM, VINCENT S. ZDANOWICZ, and RALPH A. BRUNO. Organic and trace metal levels in ocean quabog, <i>Arctica islandica</i> Linn., from the northwestern Atlantic	133
RALSTON, STEPHEN, REGINALD M. GOODING, and GERALD M. LEDWIG. An ecological survey and comparison of bottom fish resource assessments (submersible versus handline fishing) at Johnston Atoll	141
WILLASON, STEWART W., JOHN FAYUZZI, and JAMES L. COX. Patchiness and nutritional condition of zooplankton in the California Current	157
JOHNSON, P. T., R. A. MacINTOSH, and D. A. SOMERTON. Rhizocephalan infection in blue king crabs, <i>Paralithodes platypus</i> , from Olga Bay, Kodiak Island, Alaska	177

(Continued on back cover)

# U.S. DEPARTMENT OF COMMERCE

Malcolm Baldrige, *Secretary*

## NATIONAL OCEANIC AND ATMOSPHERIC ADMINISTRATION

John V. Byrne, *Administrator*

### NATIONAL MARINE FISHERIES SERVICE

William G. Gordon, *Assistant Administrator*

## Fishery Bulletin

*Fishery Bulletin* is published quarterly by the National Marine Fisheries Service, Department of Commerce, 1315 North Meade Avenue, Seattle, Washington 98109. The first issue of the Bulletin is published in February of each year. The Bulletin is published in Washington, D.C., and is available to the public through the National Oceanic and Atmospheric Administration, Department of Commerce, 1315 North Meade Avenue, Seattle, Washington 98109. The Bulletin is published in English and is available to the public through the National Oceanic and Atmospheric Administration, Department of Commerce, 1315 North Meade Avenue, Seattle, Washington 98109. The Bulletin is published in English and is available to the public through the National Oceanic and Atmospheric Administration, Department of Commerce, 1315 North Meade Avenue, Seattle, Washington 98109. The Bulletin is published in English and is available to the public through the National Oceanic and Atmospheric Administration, Department of Commerce, 1315 North Meade Avenue, Seattle, Washington 98109.

### SCIENTIFIC EDITOR, *Fishery Bulletin*

Dr. William J. Richard  
Southeast Fisheries Center, Miami Laboratory  
National Marine Fisheries Service, NOAA  
Miami, FL 33149-1099

### Editorial Committee

Dr. Bruce B. Collette  
National Marine Fisheries Service

Dr. Donald C. Malin  
National Marine Fisheries Service

Dr. Edward D. Houde  
Chesapeake Biological Laboratory

Dr. Jerome J. Pella  
National Marine Fisheries Service

Dr. Merton C. Topham  
National Marine Fisheries Service

Dr. Jay C. Quart  
National Marine Fisheries Service

Dr. Reuben Larker  
National Marine Fisheries Service

Dr. Carl J. Sinderman  
National Marine Fisheries Service

Mary S. Fukuyama, Managing Editor

*Fishery Bulletin* (ISSN 0161-0699) is published quarterly by the National Marine Fisheries Service, Department of Commerce, 1315 North Meade Avenue, Seattle, Washington 98109. The Bulletin is published in Washington, D.C., and is available to the public through the National Oceanic and Atmospheric Administration, Department of Commerce, 1315 North Meade Avenue, Seattle, Washington 98109.

Copyright © 1999 by the National Marine Fisheries Service. All rights reserved. No part of this publication may be reproduced without the prior written permission of the National Marine Fisheries Service.

Consent to publish in this journal entails the author's irrevocable and exclusive authorization of the publisher to collect any sums or charges for copying or reproduction payable by third parties (as mentioned in article 17, paragraph 2, of the Dutch Copyright Act of 1912 and in the Royal Decree of June 20, 1974 (S. 351) pursuant to article 16b of the Dutch Copyright Act of 1912) and/or to act in or out of court in connection therewith.



# Fishery Bulletin

## CONTENTS

Vol. 84, No. 1

January 1986

THEILACKER, GAIL H. Starvation-induced mortality of young sea-caught jack mackerel, <i>Trachurus symmetricus</i> , determined with histological and morphological methods . . . . .	1
RENAUD, MAURICE L. Hypoxia in Louisiana coastal waters during 1983: implications for fisheries . . . . .	19
LO, N. C. H., and T. D. SMITH. Incidental mortality of dolphins in the eastern tropical Pacific, 1959-72 . . . . .	27
MIDDLETON, ROBERT W., and JOHN A. MUSICK. The abundance and distribution of the family Macrouridae (Pisces: Gadiformes) in the Norfolk Canyon area . . . . .	35
KEIRANS, WALTER J., SIDNEY S. HERMAN, and R. G. MALSBERGER. Differentiation of <i>Prionotus carolinus</i> and <i>Prionotus evolans</i> eggs in the Hereford Inlet estuary, southern New Jersey, using immunodiffusion . . . . .	63
HUNT, JOHN H., WILLIAM C. LYONS, and FRANK S. KENNEDY, JR. Effects of exposure and confinement on spiny lobsters, <i>Panulirus argus</i> , used as attractants in the Florida fishery . . . . .	69
BEACHAM, TERRY D. Type, quantity, and size of food of Pacific salmon ( <i>Oncorhynchus</i> ) in the Strait of Juan de Fuca, British Columbia . . . . .	77
JONES, CYNTHIA. Determining age of larval fish with the otolith increment technique . . . . .	91
MOYLE, PETER B., ROBERT A. DANIELS, BRUCE HERBOLD, and DONALD M. BALTZ. Patterns in distribution and abundance of a noncoevolved assemblage of estuarine fishes in California . . . . .	105
KRYGIER, E. E., and W. G. PEARCY. The role of estuarine and offshore nursery areas for young English sole, <i>Parophrys vetulus</i> Girard, of Oregon . . . . .	119
STEIMLE, FRANK W., PAUL D. BOEHM, VINCENT S. ZDANOWICZ, and RALPH A. BRUNO. Organic and trace metal levels in ocean quahog, <i>Arctica islandica</i> Linné, from the northwestern Atlantic . . . . .	133
RALSTON, STEPHEN, REGINALD M. GOODING, and GERALD M. LUDWIG. An ecological survey and comparison of bottom fish resource assessments (submersible versus handline fishing) at Johnston Atoll . . . . .	141
WILLASON, STEWART W., JOHN FAVUZZI, and JAMES L. COX. Patchiness and nutritional condition of zooplankton in the California Current . . . . .	157
JOHNSON, P. T., R. A. MacINTOSH, and D. A. SOMERTON. Rhizocephalan infection in blue king crabs, <i>Paralithodes platypus</i> , from Olga Bay, Kodiak Island, Alaska . . . . .	177

(Continued on next page)

Seattle, Washington

1986

Notes

WEBER, EARL C., and STEPHEN R. GOLDBERG. The sex ratio and gonad indices of swordfish, <i>Xiphias gladius</i> , caught off the coast of southern California in 1978.....	185
UCHIYAMA, JAMES H., RAYMOND K. BURCH, and SYD A. KRAUL, JR. Growth of dolphins, <i>Coryphaena hippurus</i> and <i>C. equiselis</i> , in Hawaiian waters as determined by daily increments on otoliths .....	186
FROST, KATHRYN J., and LLOYD F. LOWRY. Sizes of walleye pollock, <i>Theragra chalcogramma</i> , consumed by marine mammals in the Bering Sea .....	192
VAN ENGEL, W. A., R. E. HARRIS, JR., and D. E. ZWERNER. Occurrence of some parasites and a commensal in the American lobster, <i>Homarus americanus</i> , from the Mid-Atlantic Bight .....	197
COLLETTE, BRUCE B. Resilience of the fish assemblage in New England tide-pools.....	200
JOHNSON, PHYLLIS T. Parasites of benthid amphipods: ciliates .....	204
MASON, J. C. Fecundity of the Pacific hake, <i>Merluccius productus</i> , spawning in Canadian waters.....	209
SELZER, LAWRENCE A., GREG EARLY, PATRICIA M. FIORELLI, P. MICHAEL PAYNE, and ROBERT PRESCOTT. Stranded animals as indicators of prey utilization by harbor seals, <i>Phoca vitulina concolor</i> , in southern New England .....	217
WARNER, JOHN, and BOYD KYNARD. Scavenger feeding by subadult striped bass, <i>Morone saxatilis</i> , below a low-head hydroelectric dam .....	220
RANCK, CAROL L., FRED M. UTTER, GEORGE B. MILNER, and GARY B. SMITH. Genetic confirmation of specific distinction of arrowtooth flounder, <i>Atheresthes stomias</i> , and Kamchatka flounder, <i>A. evermanni</i> .....	222

The National Marine Fisheries Service (NMFS) does not approve, recommend or endorse any proprietary product or proprietary material mentioned in this publication. No reference shall be made to NMFS, or to this publication furnished by NMFS, in any advertising or sales promotion which would indicate or imply that NMFS approves, recommends or endorses any proprietary product or proprietary material mentioned herein, or which has as its purpose an intent to cause directly or indirectly the advertised product to be used or purchased because of this NMFS publication.



Best NMFS Publications for

83

The Publications Advisory Committee of the National Marine Fisheries Service has announced the best publications authored by the NMFS scientists and published in the *Fishery Bulletin* and the *Marine Fisheries Review* for 1983. Only effective and interpretive articles which significantly contribute to the understanding and knowledge of NMFS mission-related studies are eligible, and the following papers were judged as the best in meeting this requirement:

“Seasonal variation in survival of larval northern anchovy, *Engraulis mordax*, estimated from the age distribution of juveniles” by Richard D. Methot, Jr. appears in *Fishery Bulletin* 81:741-750. Richard D. Methot, Jr., fishery biologist is from the Southwest Fisheries Center’s La Jolla Laboratory, National Marine Fisheries Service, NOAA, 8604 La Jolla Shores Drive, La Jolla, California 92038.

“To increase oyster production in the northeastern United States” by Clyde L. MacKenzie, Jr. appears in *Marine Fisheries Review* 45(3):1-22. Clyde L. Mackenzie, Jr., fishery biologist is from the Northeast Fisheries Center’s Sandy Hook Laboratory, National Marine Fisheries Service, NOAA, Highlands, New Jersey 07732.

AWARDS





# STARVATION-INDUCED MORTALITY OF YOUNG SEA-CAUGHT JACK MACKEREL, *TRACHURUS SYMMETRICUS*, DETERMINED WITH HISTOLOGICAL AND MORPHOLOGICAL METHODS

GAIL H. THEILACKER<sup>1</sup>

## ABSTRACT

Young jack mackerel, *Trachurus symmetricus*, living offshore are starving while those living nearshore are healthy. These results for sea-caught jack mackerel were determined by using histological and morphological criteria that reliably diagnosed the viability of laboratory-raised jack mackerel. Both the histological and morphological indices indicated that 350 km offshore about 70% of the first-feeding jack mackerel were starving. In contrast, 12% of the fish collected near islands and banks were starving. In both habitats, mortality rates decreased to zero for jack mackerel at 2 weeks of age. The accuracy of the techniques for prediction of the nutritional state of wild larvae is discussed and evaluated.

Jack mackerel, *Trachurus symmetricus*, hatch with yolk reserves that last for 5 d at 15°-15.5°C. After the yolk is absorbed, they must eat within 3 d or die of starvation. In addition, growth is retarded in larvae that have experienced only 1 d of starvation, and resumption of normal growth does not occur until 2-3 d after the starvation period (Theilacker 1978, 1981). Thus, in the laboratory, availability of food at the time of first feeding affects growth and survival of young jack mackerel. In the field, the relative importance of starvation as a source of mortality of jack mackerel is unknown. It was first suggested by Hjort (1914) (reviewed by May 1974) that the strength of the year class is determined early in life by the availability of food for larvae at the time of first feeding (the critical period hypothesis). But only recently (O'Connell 1980) has the presence of starving ocean-caught larvae been documented. In this study I give evidence that starvation may be a major cause of natural mortality of young jack mackerel at sea. I use two techniques, developed in the laboratory, to determine the incidence of starvation (Theilacker 1978). The potential use of these techniques to monitor sea samples for larval survival is discussed.

## METHODS

### Collection

In May 1980 a concentration of jack mackerel eggs and larvae was located 350 km off the coast of

California (lat. 31°00'N and long. 120°30'W). A 400 m<sup>2</sup> grid was established which contained 41 stations, 4 mi apart; it took 4 d to sample all stations (Fig. 1). At each station, a standard oblique bongo net tow (Smith and Richardson 1977) and a 1 m net sample were taken. The bongo samples will be used in another study to estimate growth and mortality of jack mackerel larvae (Hewitt et al. in press). The 1 m net (505 μm mesh) was used to sample larvae qualitatively from the upper 50 m of water. Ahlstrom (1959) found that 88% of the larval jack mackerel collected off California were in the upper 50 m, and all the jack mackerel collected by Devonald (1983) were above 42 m. A special collection procedure was used for the samples taken for histological and morphological analyses. Immediately after the net tow, the sample was preserved in Bouin's solution to avoid autolysis of larval tissues (elapsed time was usually 8 min) (Theilacker 1978). The collecting net was not washed down (a procedure required for quantitative samples), and the cod end containing the sample was placed directly into Bouin's solution. The preserved sample was removed from the cod end within an hour. After 2 d, Bouin's solution was replaced by 70% alcohol.

In addition to jack mackerel collections taken in the open ocean 350 km offshore, a few special tows ( $n = 24$ ) for assessment of starvation were made during routine cruises in 1978, 1979, and 1980 near the Channel Islands (Anacapa, Santa Barbara, and San Clemente) and Tanner Bank.

### Preparation of Fish

More than 2,000 jack mackerel were collected in

<sup>1</sup>Southwest Fisheries Center La Jolla Laboratory, National Marine Fisheries Service, NOAA, P.O. Box 271, La Jolla, CA 92038.

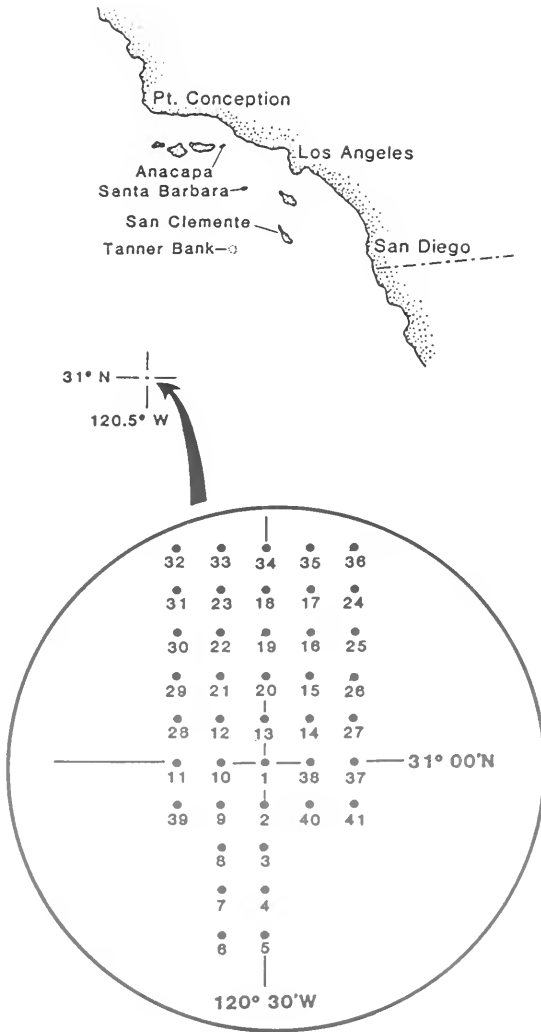

FIGURE 1.—Location of jack mackerel, *Trachurus symmetricus*, collections off the coast of California. Nearshore stations were at Anacapa, Santa Barbara, and San Clemente Islands and at Tanner Bank. The grid of open-ocean stations was 350 km offshore; stations were 4 mi apart.

samples taken offshore; from 0 to 262 fish were caught per sample (Table 1). Larvae sorted from the samples ( $n = 445$ ) were counted and five body measurements taken: standard length (SL, tip of upper jaw to perpendicular at end of notochord); head length (HL, tip of upper jaw to cleithrum); eye diameter (ED); body depth at the pectoral (BD-1); and body depth at the anus (BD-2). After measurement, some larvae ( $n = 369$ ) were prepared for histological examination. When samples contained fewer than 50 jack mackerel, most larvae were examined, but when samples contained more than 100

jack mackerel, about 25% of the fish were examined histologically. Jack mackerel size distribution in the offshore study area (determined for 400 fish taken from stations 16, 23, 34, and 35) was similar among stations and ranged between 2.6 and 4.7 mm SL. To ensure analysis of all ages in the larger samples, fish were taken equally from each of four length classes: <3.0; 3.0–<3.5; 3.5–<4.0; 4.0–<5.0 mm. These larvae were imbedded in paraffin, sectioned at 6  $\mu$ m, and stained with Harris hematoxylin and eosinophloxine B (Theilacker 1978). In my analysis of histological data I combined the first two size classes because the size at first feeding was 3.2 mm.

The prevalence of starvation was assessed for 371 jack mackerel selected from 20 of the 32 positive stations (Table 1). In addition, I analyzed 41 jack mackerel taken in 14 hauls from the inshore stations near the Channel Islands and Tanner Bank.

### Histological Analysis

The histological assessment of nutritional state is based on distinct cellular changes that occur in tissues when larval jack mackerel were deprived of food; these changes are well documented by Umeda and Ochiai (1975), O'Connell (1976), and Theilacker (1978). To determine the condition of individual ocean-caught jack mackerel, I used the histological criteria I developed in the laboratory by starving jack mackerel except I did not grade the pancreas. Grades were assigned to 11 histological characteristics of the brain, digestive tract, liver, and musculature (Theilacker 1978, 1981). Fish identities were unknown during this examination. I classified jack mackerel larvae into four categories (healthy, recovering, starving, and dying) according to their histological scores (the summation of the grades for each of the 11 histological characteristics).

Tissues of jack mackerel from the sea which had tissues similar in appearance to the tissues of feeding, laboratory-raised fish were classified as healthy; sea-caught jack mackerel which resembled laboratory fish that had fasted before eating were classified as recovering (these fish showed signs of feeding and digestion, but also showed signs of starvation); sea-caught larvae which were classified as starving resembled larvae that had been starved in the laboratory for 1–3 d (Theilacker 1978, 1981). I did not observe the dying category in laboratory-starved larvae; this category is described in Results.

### Morphological Analysis

To detect starvation I used a set of morphological

TABLE 1.—Number of jack mackerel collected and the condition of those that were analyzed histologically.

Station No.	Number of fish					
	Sampled	Analyzed	Dying	Starving	Recovering	Healthy
Offshore						
1	0	0				
2	2	1	0	0	1	0
3	0	0				
4	2	0				
5	0	0				
6	0	0				
7	2	1	0	1	0	0
8	2	2	0	0	2	0
9	1	1	1	0	0	0
10	0	0				
11	3	3	3	0	0	0
12	0	0				
13	1	0				
14	1	0				
15	>200	0				
16	>200	0				
17	20	13	0	8	5	0
18	>125	0				
19	43	35	7	0	1	27
20	242	64	8	19	13	24
21	>250	0				
22	>175	0				
23	150	32	1	0	4	27
24	1	0				
25	23	0				
26	4	3	3	0	0	0
27	0	0				
28	262	58	3	36	14	5
29	11	11	1	4	4	2
30	250	57	4	13	18	22
31	32	9	7	1	0	1
32	109	25	0	2	20	3
33	31	23	1	3	10	9
34	38	0				
35	43	0				
36	31	24	3	4	1	16
37	7	5	2	1	2	0
38	2	2	1	0	0	1
39	0	0				
40	1	0				
41	0	0				
Total (Offshore)	>2,264	369	45	92	95	137
Around Islands						
Anacapa	12	12	0	1	0	11
Santa Barbara	3	3	0	0	2	1
San Clemente	17	17	0	1	5	11
Tanner Bank	9	9	0	1	0	8
Total (Nearshore)	41	41	0	3	7	31

characteristics that successfully diagnosed the extent of starvation in 85% of the laboratory-reared jack mackerel (Theilacker 1978). The technique is based on a stepwise discriminant analysis (SWDA) using 11 body part measurements. The analysis allowed me to distinguish between individuals belonging to fed and starved treatments, given a set of morphological measurements that describe the characteristics of the individuals in each feeding treatment. The 11 body part measurements used to distinguish between groups of fed and starved jack

mackerel were 1) head length, 2) eye diameter, 3) body depth at the pectoral, 4) body depth at the anus, 5) head length/standard length, 6) eye diameter/standard length, 7) body depth at the pectoral/standard length, 8) body depth at the anus/standard length, 9) eye diameter/head length, 10) body depth at pectoral/head length, and 11) body depth at anus/head length. Standard length was used in the ratios but not as a unit to allow discrimination between feeding and starving fish of the same length.

## Adjustment for Shrinkage

① In order to use morphological measurements to diagnose starvation of jack mackerel, it is essential to adjust for shrinkage of body measurements. Both handling and preservation cause shrinkage of larval fishes, and the amount of shrinkage varies among body parts. Final fish size is dependent not only on initial size but also on the handling time (which is different for the laboratory and the field) and the type of preservative used (Blaxter 1971; Theilacker 1980a; Hay 1981). The shrinkage of laboratory specimens of jack mackerel preserved in Bouin's solution is known (Theilacker 1980a), but for field-collected specimens the shrinkage caused by the net tow and the subsequent effect of Bouin's preservative must be evaluated.

I conducted laboratory experiments to estimate the amount of shrinkage caused by handling (net retention) and by preservation. Live jack mackerel were pipetted individually (time = 0) onto a slide, and four body measurements were taken before placing the fish into a net container through which 15°C seawater circulated. Standard length, head length, eye diameter, and body depth at the anus were measured. Body depth at the pectoral fin was not measured because it was difficult to measure quickly on live jack mackerel. During net treatments, I usually remeasured each fish four more times at 5-7 min intervals, replacing the fish in the net between each set of measurements. After 25-30 min, the fish were preserved in either Bouin's fixative (used for histological analyses) or 5% buffered Formalin<sup>2</sup> (as per shipboard procedures; Smith and Richardson 1977). Remeasurements after preservation were taken in 3-4 wk.

② Shrinkage of net-captured larval fish has been shown to decrease with increasing fish size. For example, shrinkage of northern anchovy decreased from 19% at 4 mm SL to 8% at 18 mm SL (Theilacker 1980a). The jack mackerel tested in this study ranged between 3.35 and 4.10 mm SL, and within this restricted length group shrinkage was proportional to size. Thus for the shrinkage analyses, all jack mackerel were combined into one group.

For the combined size group, length of the jack mackerel body (Fig. 2) and the head continued to shrink for the duration of the net treatment. Width of the body (Fig. 3) and the eye shrank initially, and then remained relatively constant during additional

treatment. To account for positive correlation between body parts, a multivariate analysis (Table 2) was used to relate the ratio of net-treated size to live size (for each body part) with treatment time. Individual shrinkage was highly variable; for example, shrinkage of body depth varied between 0 and 23% for treatment times between 5 and 20 min (Fig. 3). However, since these were the best estimates of average shrinkage for body parts, the regressions (Table 2) were used to calculate the adjustment factors needed for this study. Factors for each body part

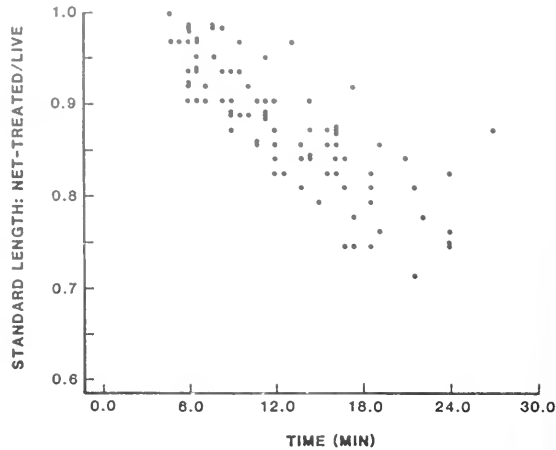

FIGURE 2.—Shrinkage of standard length, shown as the ratio of net-treated size to live size, of individual *Trachurus symmetricus* larvae as a function of net-treatment time; estimated parameters are in Table 4.

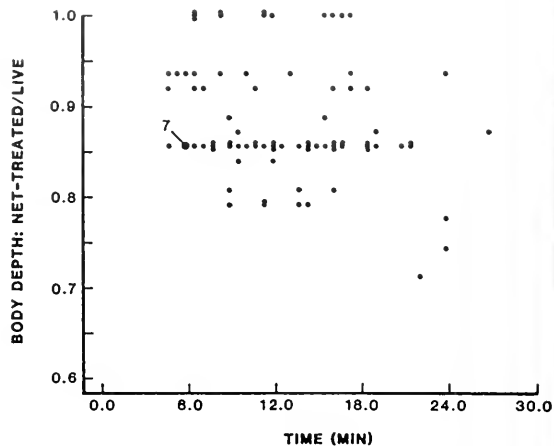

FIGURE 3.—Shrinkage of body depth, shown as the ratio of net-treated size to live size, of individual *Trachurus symmetricus* larvae as a function of net-treatment time; estimated parameters are in Table 4.

<sup>2</sup>Reference to trade names does not imply endorsement by the National Marine Fisheries Service, NOAA.



TABLE 2.—Shrinkage of jack mackerel larvae. Parameters estimated from multivariate linear equations relating the ratio of the net-treated size of a mackerel body part to its live size ( $y$ ) with the net-treatment time ( $x$ ).

y)	Net-treated size/ live size <sup>1</sup>		Ratios		$P^2$	$r^2$
	a	(SE)	b	(SE)		
Standard length (SL)	1.0109	(0.0117)	-0.0105	(0.0008)	<0.001	0.66
Head length (HL)	0.9281	(0.0157)	-0.0038	(0.0011)	0.001	0.12
Eye diameter (ED)	0.9360	(0.0168)	-0.0027	(0.0012)	0.031	0.06
Body depth (BD-2)	0.8980	(0.0177)	-0.0014	(0.0013)	0.280	0.02

<sup>1</sup> $n = 89$ .

<sup>2</sup>Probability that slopes differ from zero.

were calculated by 1) combining the shrinkage ratio at 8 min (average elapsed time for field collections, see Methods) with 2) the average shrinkage in Bouin's preservative after the net treatment, and 3) comparing the combined shrinkage with results from shrinkage determined in the laboratory study (Theilacker 1980a; Table 3). Also given in Table 3 are average shrinkage ratios calculated for specified time intervals.

Adjustment factors for standard length, head length, and eye diameter (Table 3) support the view that shrinkage of field-collected fishes is greater than shrinkage of fishes preserved in the laboratory. Shrinkage of BD-2 was an exception to this pattern, however, as less shrinkage occurred under simulated field conditions (20-23%) than in the laboratory (25%). I (Theilacker 1980a) reported a similar paradox for northern anchovy where simulated-field net treatments caused 8% shrinkage of BD-2 as compared with 10% shrinkage for standard laboratory preservation. Jack mackerel shrinkage was greater in Bouin's solution than in Formalin, results which

are consistent with studies on northern anchovy. Also, as with northern anchovy, Formalin preservation caused a slight increase in the size of the jack mackerel eye (Table 3).

I adjusted the body measurements of the ocean-caught jack mackerel with the shrinkage factors (ratio  $R_s$ , Table 3). Use of these adjustments should equate the morphology of preserved, ocean-caught jack mackerel (this study) with the morphology of preserved, laboratory-raised jack mackerel that were used to develop the morphological SWDA (see Methods: Morphological Analysis). It was necessary to reestimate the SWDA function for this study, although nearly the same analysis was made previously (Theilacker 1978). A new estimate was required because pectoral body depth was not included in the shrinkage measurements in this study; hence, an SWDA function that excluded this measurement was needed. Elimination of pectoral body depth from the analysis reduced the level of predictability from 85% to 78%. This new function was used here to classify the condition of ocean-caught jack mackerel

TABLE 3.—Shrinkage of jack mackerel larvae<sup>1</sup>. Treatment ratio ( $R$ ) is treated size divided by previous size (1.00 = no shrinkage).

Treatment ratio	$R$	$n$	Ratios				
			Mean time	Standard length	Head length	Eye diameter	Body depth
8 min net/live size	<sup>2</sup> $R_1$	89	8	0.93	0.90	0.91	0.89
5-10 min net/live size	$R_2$	36	7.3	0.94	0.90	0.92	0.89
11-15 min net/live size	$R_3$	22	12.6	0.87	0.88	0.88	0.86
16-28 min net/live size	$R_4$	27	19.4	0.81	0.86	0.89	0.88
Bouin's fixative/ net-treated size	<sup>3</sup> $R_5$	15	—	0.91	0.84	0.93	0.91
Formalin fixative/ net-treated size	<sup>3</sup> $R_6$	13	—	0.96	0.93	1.08	0.91
Laboratory-preserved in Bouin's fixative live size	<sup>4</sup> $R_7$	45	—	0.92	0.82	0.90	0.75
Calibration factor = $R_7/R_1 \times R_5$	<sup>5</sup> $R_8$	—	—	1.09	1.08	1.06	0.93

<sup>1</sup>Range in standard length 3.35-4.10 mm.

<sup>2</sup>Calculated from regression (Table 2); ocean-caught fish preserved within 8 min; see text.

<sup>3</sup>Shrinkage in fixative after net treatment.

<sup>4</sup>Data from Theilacker (1980a).

<sup>5</sup>Adjustment factor to equate measurements of field-collected mackerel (this study) with measurements of laboratory-raised mackerel (Theilacker 1978).

after the size of their body parts was adjusted for shrinkage.

## RESULTS

### Habitat Conditions

A larval-density gradient was apparent in the open ocean study area. High densities of jack mackerel larvae (100-300/sample) were found in the central stations and in stations near the western boundary of the grid; lower densities (20-50) were found to the north and east, and densities of larvae approached zero at the southern stations that were occupied at the beginning and again at the end of the 4-d observation period (Fig. 4). Larval densities in the south did not change during this period.

The study area was chosen because temperature, viewed on satellite thermal image of the sea surface, corresponded to the temperature range (15°-16°C) associated with jack mackerel spawning (Farris 1961). Surface temperature in the study area increased from 15.2°C in the north to 16.8°C at the southern stations, with the majority of jack mackerel found in water temperatures of 16.1°-16.6°C. Water temperatures inshore of the grid were about 14°C.

A temperature-salinity curve obtained at station 19 (Fig. 1) agreed well with the curves obtained from inshore stations with the exception of the warm-water portion of the curve, which appeared to be a thin, warm lens of open ocean water intruding coastward over deeper coastal water.

### Histological Assessment of Fish Condition

I used the tissue characteristics of laboratory fish (raised at 15.0°-15.5°C) of known feeding history as the criteria to determine the nutritional condition of the sea-caught jack mackerel. Photomicrographs of the diagnostic tissue characteristics were documented by Theilacker (1978). Many of these characteristics are shown also for wild fish (Fig. 5, see also Figures 6-14). In addition, the wild fish exhibited four tissue conditions that were not observed in the laboratory: lesions in the brain; luminal vacuoles in the midgut; total degeneration of the midgut mucosal cells; and a wavy configuration of the muscle fibers. Each of these conditions will be considered in the following section that describes the tissues of ocean-caught fish. My emphasis will be on those tissue characteristics that diagnose starvation in young jack mackerel.

### Brain

The brain of an ocean-caught jack mackerel was considered normal when the neurons were distinct, round, and closely spaced. In these fish, brain cell division was common, but it was not graded. One percent of the jack mackerel examined had brain lesions of the type (Fig. 6) induced by ultraviolet light in larval northern anchovy, *Engraulis mordax*, and Pacific mackerel, *Scomber japonicus* (Hunter et al. 1979). The grading system classified these jack mackerel ( $n = 3$ ) into the healthy category. In a

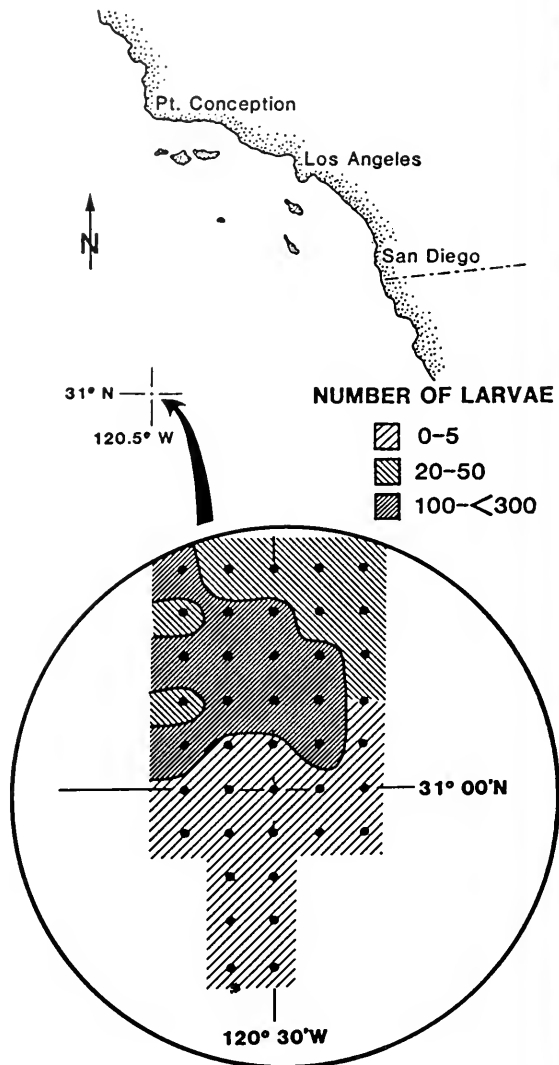

FIGURE 4.—*Trachurus symmetricus* larval density gradient shown as number of larvae collected per sample (not quantitative). Station grid located 350 km off the coast of California.

single specimen, lesions were present not only in the brain but throughout the spinal cord (Fig. 7) as well. In addition, the gut and associated glands had deteriorated to the extent that this fish was considered starving.

An abnormal central nervous system of a jack mackerel larva consisted of vacuolar degeneration and shrinkage of neurons. The degenerating neurons exhibited increased staining (Fig. 8).

### Digestive Track and Associated Glands

The midgut mucosa of young jack mackerel is composed of a single layer of columnar epithelial cells. Older fish (3.7-4.0 mm) showed increased mitotic activity in the basal layer. Microvilli bordered the midgut lumen only in fish that appeared healthy. Mucosal cells were closely united in the fish considered to be normal (Figs. 9, 10). Basal separations between these cells were common, not only in fish that appeared to be starving but also in fish that showed signs of feeding and digestion (Fig. 11). O'Connell (1980) also reported that sea-caught northern anchovy exhibited basal separations between mucosal cells while the apical portions were well joined.

All wild jack mackerel categorized as recovering had basal separations between midgut mucosal cells. Laboratory fish that were artificially starved for 1-2 d before feeding showed these separations for several days after feeding resumed. In the laboratory, larvae did not grow while their tissues were regenerating (Theilacker 1981).

Many sea-caught jack mackerel of all ages had intracytoplasmic vacuoles in the midgut epithelium. Basal and membrane lined, these vacuoles resembled the vacuolar condition found in some recovering, laboratory fish (Theilacker 1981). In addition, many sea-caught larvae had smaller, luminal vacuoles that were found in the laboratory fish (Fig. 12). These luminal vacuoles may indicate a degenerative condition. In higher vertebrates a metabolic imbalance can cause vacuolar degeneration. Vacuolation appears first as numerous small, clear vacuoles dispersed throughout the cytoplasm. As the condition becomes more severe, these minute vacuoles coalesce to form large (sometimes single) clear spaces that displace the nucleus (Anderson 1971). On the other hand, the numerous luminal vacuoles can secrete mucous into the lumen or store fat. Use of a routine mucicarmine staining was negative for the presence of mucous cells. Unfortunately, the presence of fat in the vacuoles could not be tested because fat is removed during tissue preparation by

clearing agents. Neither vacuolar condition was graded.

Another unusual condition of the midgut occurred in many of the smaller wild jack mackerel. In these fish, the margin of the lumen had lost its integrity, microvilli were absent, and the sloughing of the mucosal cells into the lumen (a condition common in starved laboratory jack mackerel) appeared to have progressed until the lumen contained masses of undefinable, cellular material (Fig. 13). O'Connell (1980) described a comparable condition which he found in the midgut of a single, northern anchovy specimen, the smallest examined. All jack mackerel exhibiting this condition were smaller than the size attained at first feeding, indicating shrinkage had occurred. The hindgut also contained necrotic debris, and other diagnostic tissues were in poor condition. These jack mackerel were classified as dying.

Hindgut mucosal cells of wild jack mackerel typically showed eosin-staining inclusions that are reported to be sites of intracellular digestion (Iwai 1968, 1969; Iwai and Tanaka 1968; Watanabe 1981). Inclusions in the wild jack mackerel varied in intensity; in healthy specimens the intensity appeared to be related to time of day (feeding period), increasing during daylight hours and decreasing during the night. Although the presence and intensity of hindgut inclusions were noted, they were not graded. Inclusions were not present in larval teleosts deprived of food in the laboratory (Theilacker 1978; Umeda and Ochiai 1975; O'Connell 1976). However, in many wild jack mackerel showing signs of starvation the presence of pale inclusions indicated that the fish had eaten at some time in the past.

The key diagnostic characteristics of the pancreas were obscure in ocean-caught jack mackerel because of the intensity of staining. In laboratory fish, the pancreas was very sensitive to food deprivation. For example, a breakdown in the symmetry of the acinar secretory unit was detectable after 1 d of food deprivation (Theilacker 1978). In the wild fish, the intensity of the staining of the pancreas was difficult to control (see Fig. 12), and I was not able to obtain consistent results, hence the condition of the pancreas was not evaluated.

The jack mackerel liver was considered normal when hepatocytes had clear, distinct nuclei (Fig. 9). The appearance of the cytoplasm was quite variable; in some larvae very few intracellular spaces existed in the cytoplasm of the hepatocytes whereas in others extensive intracellular spaces existed. Presumably these spaces are areas where glycogen and fat are stored within the cell. This presumed incorporation of stores was most marked in healthy

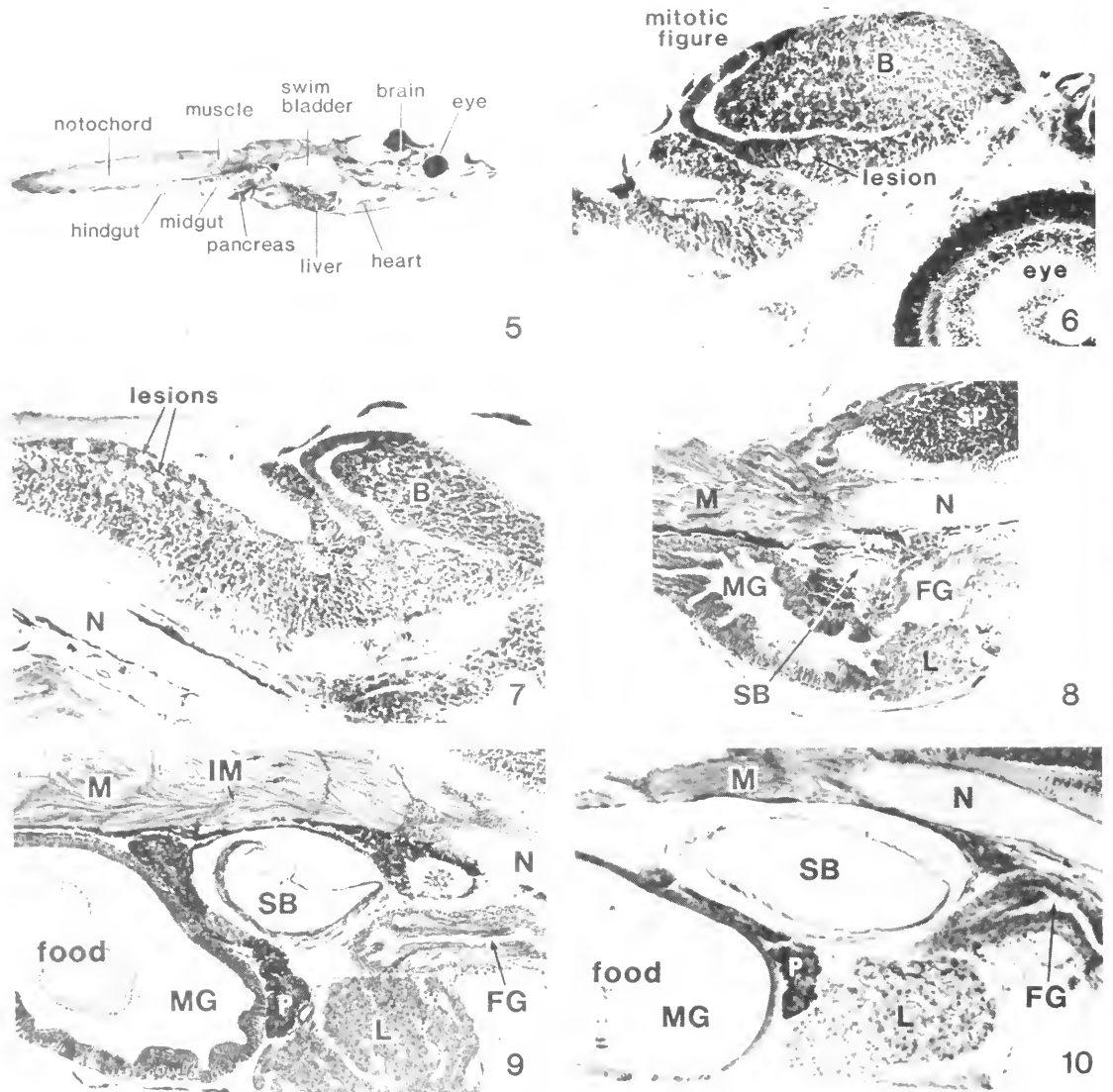

FIGURE 5.—*Trachurus symmetricus* larva, 3.75 mm SL. All 11 histological criteria graded as healthy. Bar = 281  $\mu$ m.

FIGURE 6.—Head of *Trachurus symmetricus* larva graded healthy. Mitotic activity and the location of brain lesions are indicated. Bar = 47  $\mu$ m. B = brain.

FIGURE 7.—*Trachurus symmetricus* larva graded as starving. Lesions present throughout brain and spinal cord. Bar = 47  $\mu$ m. B = brain, N = notochord.

FIGURE 8.—Pectoral area of a dying *Trachurus symmetricus* larva showing darkly stained primitive nerve cells, wavy muscle fibers, necrotic and atrophied liver, and loss of integrity of midgut mucosal cells. Bar = 47  $\mu$ m. FG = foregut, L = liver, m = muscle, MG = midgut, N = notochord, SB = swim bladder, SP = spinal cord.

FIGURE 9.—Pectoral area of healthy *Trachurus symmetricus* larva collected offshore showing parallel muscle fibers and abundant intermuscular tissue, distinct nuclei in liver and midgut, and good cellular integrity. Note deflating swim bladder. Bar = 47  $\mu$ m. FG = foregut, IM = intermuscular tissue, L = liver, M = muscle, MG = midgut, N = notochord, P = pancreas, SB = swim bladder.

FIGURE 10.—Pectoral area of healthy *Trachurus symmetricus* larva collected near San Clemente Island showing abundant glycogen reserves in the liver. Bar = 47  $\mu$ m. FG = foregut, L = liver, M = muscle, MG = midgut, N = notochord, P = pancreas, SB = swim bladder.



jack mackerel collected near islands and banks (Fig. 10) whereas healthy jack mackerel collected offshore showed moderate to little storage (Fig. 9).

At the other end of the grading scale, the shrunken livers of jack mackerel considered to be starving contained darkly stained hepatocytes composed of evenly stained cytoplasm with indistinct, irregular nuclei.

### Musculature

Healthy muscle tissue in jack mackerel had the following characteristics: few spaces between the muscle fibers; distinct and parallel, striated myofibrils; and abundant, basophilic and nucleated intra-

muscular tissue (Fig. 9). Nourishment was considered inadequate in fish exhibiting separated (Figs. 11, 14) and hyaline muscle fibers (Fig. 13) and a reduction (Figs. 11, 14) or absence (Fig. 13) of intramuscular tissue. In some sea-caught jack mackerel, muscle fibers were wavy (Fig. 8). Presence of wavy muscle fibers in wild fish was considered abnormal because it was always associated with the poor condition in the other diagnostic tissues, but this characteristic was not used in classification. In starved laboratory fish, nonparallel fibers were reported (Theilacker 1978, 1981), but the wavy pattern was unusual. There were fish with intermediate spaces between muscle fibers that, according to the scores of the other diagnostic tissues, appeared healthy. The

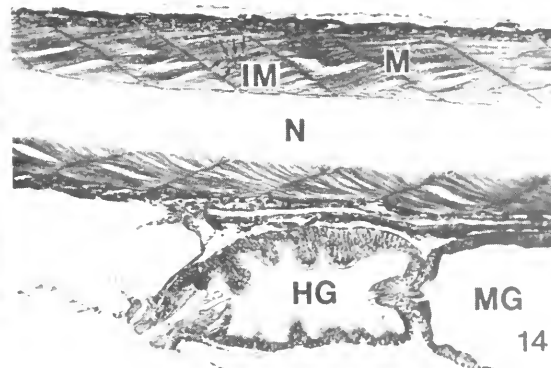
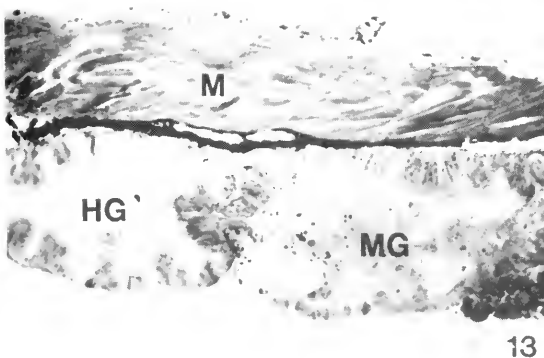
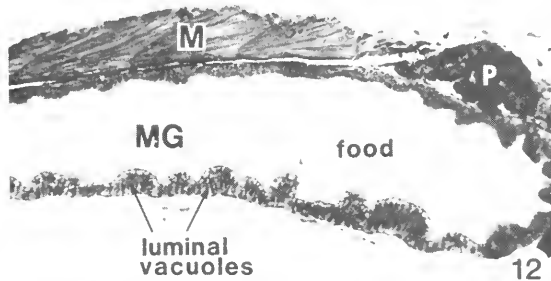
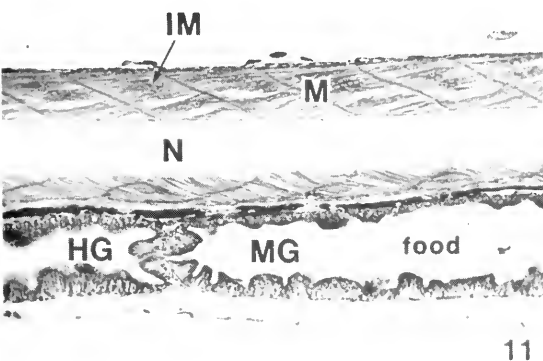

FIGURE 11.—*Trachurus symmetricus* larva graded recovering. Prominent separations between midgut and hindgut epithelial cells, slight muscle fiber separation and intermediate intermuscular tissue containing distinct nuclei. Bar = 47  $\mu$ m. HG = hindgut, IM = intermuscular tissue, M = muscle, MG = midgut, N = notochord.

FIGURE 12.—Healthy *Trachurus symmetricus* larva showing luminal vacuoles in the midgut. This histological characteristic was not graded. Bar = 47  $\mu$ m. M = muscle, MG = midgut.

FIGURE 13.—*Trachurus symmetricus* larva graded dying. No intermuscular tissue; hyaline muscle fibers; total degeneration of midgut mucosa. Bar = 34  $\mu$ m. HG = hindgut, M = muscle, MG = midgut.

FIGURE 14.—Recovering *Trachurus symmetricus* larva showing slight muscle fiber separation and slight reduction of intermuscular tissue. Bar = 47  $\mu$ m. HG = hindgut, IM = intermuscular tissue, M = muscle, MG = midgut, N = notochord.

grading system usually classified these fish into the recovering category.

### General Histological Observations

In jack mackerel that were considered healthy, swim bladder inflation was first noted at 3.4 mm. Swim bladders were inflated in larvae taken at night whereas they were deflated in those taken in the day. The swim bladders of 72% of the fish were deflated by 0700 ( $n = 81$ ) except for fish scored in the starving category where inflation was common at any time of day, which was possibly a symptom of starvation or an additional energy-sparing function of the swim bladder (Hunter and Sanchez 1976).

Theilacker (1978) pointed out that the gallbladder was always enlarged in jack mackerel that were deprived of food in the laboratory, and this condition occurred in sea samples of starved larvae taken in the day. On the other hand, gallbladder enlargement was also found in the healthy fish as well as starved fish collected at night. According to Love (1970), the gallbladder discharges its contents when stimulated by food. Jack mackerel do not eat at night, so the gallbladder of healthy fish may remain distended during the night. Thus enlargement of the gallbladder was not used to diagnose starvation. Theilacker's (1978) samples of fed and unfed fish were taken only during the day, when feeding occurs.

Mitotic figures in the brain of jack mackerel occurred in fish collected at all times of day and night.

On the other hand, mitosis of mucosal cells in the midgut was restricted to the night. It seems that mucosal cells of northern anchovy also divide late at night, when the digestive tracts are empty (O'Connell 1981).

### Evidence for Starvation in the Sea

Results of the histological analysis showed that starvation was a major source of mortality for the smallest jack mackerel larvae (<3.5 mm) as 59% appeared to be dying of starvation, 23% were eating but had fasted previously, and only 19% were classified as healthy. The incidence of starving larvae decreased to 16% in the 3.5-4.0 mm size class and was 3% in the older larvae (Table 4). The numbers of fish used for the histological assessment of starvation was adequate for the smallest (<3.5 mm SL) larval size class (coefficient of variation ranged between 0.09 and 0.15 for the four condition categories), but larger samples would be needed to give a reliable estimate of the fraction starving for the older larvae (>3.5 mm SL) because of the low incidence of starvation.

Despite the fact that jack mackerel abundance decreased from west to east and north to south (Fig. 4), I found no consistent differences in the incidence of starvation between fish taken from areas of high larval density and those taken from areas of low larval density (Fig. 15). Therefore, to estimate mortality due to starvation, I combined all samples collected in the offshore area. To estimate mortality rates on a daily basis, the observed number of fish belong-

TABLE 4.—Histological condition of jack mackerel collected 350 km off the coast of California.

	Dying	Starving	Recovering	Healthy	Total	Daily percent	
						Starving <sup>1</sup>	Dying <sup>2</sup>
Yolk sac	—	—	—	15	15	0	0
<3.5 mm							
Number	43	74	45	38	200		
Duration (d)	1	3	2	6			
Number/d	43	24.7	22.5	6.3	96.5	70	45
3.5-4.0 mm							
Number	2	16	38	54	110		
Duration (d)	1	3	2	3.3			
Number/d	2	5.3	19	16.4	42.7	17	5
4.0-4.5 mm							
Number	0	2	12	45	59		
Duration (d)	—	3	2	3.3			
Number/d	—	0.7	6	13.6	20.3	3	0

<sup>1</sup>Number dying/d + starving/d  
Total

<sup>2</sup>Number dying/d  
Total

ing to each size and health category was divided by the duration—the number of days jack mackerel are expected to remain in each category (Table 4). Durations spanned 1 to 6 d depending on age and condition. For healthy fish, duration is simply the size-class interval divided by the growth rate. Healthy fish belonging to the smallest size group (<3.5 mm) grow at 0.05 mm/d (Theilacker 1978) and begin to eat at 3.2 mm SL. Thus duration for this size interval (0.3 mm) was 6 d. Growth rate for older fish was 0.15 mm/d; the rate was determined for this study by counting daily growth increments in otoliths (Hewitt et al. in press). The duration that a larva remains in one of the starvation states is a function of the persistence of the histological criteria. Young jack mackerel deprived of food in the laboratory show signs of starvation for 3 d before dying, and larvae recovering from a period of starvation show these signs for 2 d (Theilacker 1978, 1981). Older fish may be more resistant to starvation, but as I had no information for older jack mackerel, I used the durations for younger larvae.

For the smallest jack mackerel living 350 km offshore, 45% were dying of starvation per day. Daily mortality dropped rapidly to 5% to zero for older larvae (Table 4). Increasing the durations for the older larvae in the starving and recovering categories (Table 4) decreases this estimate of daily mortality.

Results of the histological examination of jack mackerel collected near islands and banks allow a preliminary assessment of the effects of different

habitats on starvation (Table 5; Fig. 16). A large difference existed in the daily larval mortality caused by starvation between the open ocean and island and bank habitats. In areas near the islands, none of the first-feeding larvae were dying of starvation whereas 45% from the open ocean were dying of starvation.

In addition, healthy larvae taken near islands were apparently more fit than healthy larvae captured in the open ocean, as the larvae from the island habitats had abundant quantities of glycogen in the liver (Fig. 10), whereas livers of larvae from the open ocean rarely contained glycogen stores (Fig. 9). This indicates that food must have been much more abundant in the island habitat because not only were fewer fish starving but the healthy fish were able to store glycogen. The healthy fish from the open sea may have been just able to meet their daily metabolic requirements.

The morphological data gave essentially the same results as did the histological method. On the basis of morphometric evidence, 70% of the first-feeding jack mackerel (<3.5 mm SL) were starving and the number decreased to zero for older jack mackerel (Table 6). Although the results were similar, the morphological categories used to classify the fish were different from the histological ones. In particular, there was no morphological category for dying fish. For the morphometric SWDA, larvae were grouped by feeding treatment (Table 6), and the histological categories (Table 4) were based on the dominant larval tissue conditions determined to characterize a nutritional state. Thus the morphometric SWDA cannot be used to estimate the number of larvae dying per day due to starvation.

## DISCUSSION

### Larval Starvation and Recruitment

Both histological and morphological criteria indicate that starvation is probably a major source of larval jack mackerel mortality at the time of first-feeding but that the survivors of this 6-d period are much less vulnerable to starvation. Prey (mainly young stages of copepods) are more abundant at the nearshore islands and banks off the coast of California than offshore (Beers and Stewart 1967, 1970; Arthur 1976, 1977; Devonald 1983), and survival of first-feeding jack mackerel was higher in the nearshore habitats than offshore. Thus selection of spawning sites may have a great effect on survival. Eggs and larvae of jack mackerel are very widely distributed; they occur from Baja California to British Columbia and up to 400 mi off the coast of

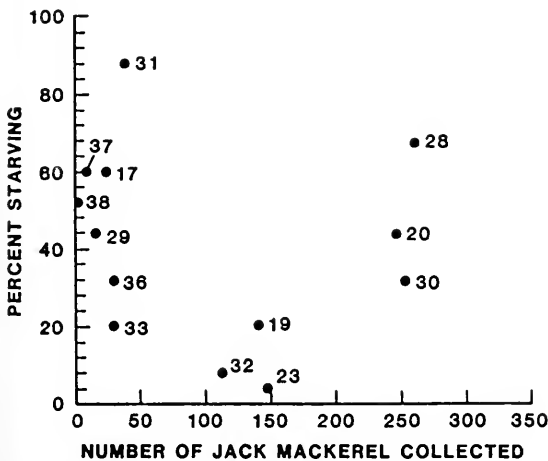

FIGURE 15.—Percentage of starving *Trachurus symmetricus* larvae (number starving/number analyzed) related to the number of larvae collected at each offshore station; station number is indicated.

TABLE 5.—Histological condition of jack mackerel collected near islands and banks off the coast of California.

	Dying	Starving	Recovering	Healthy	Total	Daily percent	
						Starving <sup>1</sup>	Dying <sup>2</sup>
Yolk sac	—	—	—	—	0		
<3.5 mm							
Number	0	2	6	12	20		
Duration (d)	1	3	2	6			
Number/d	—	0.7	3	2	5.7	12	0
3.5-<4.0 mm							
Number	0	1	1	12	14		
Duration (d)	1	3	2	3.3			
Number/d	—	0.3	0.5	3.6	4.4	7	0
4.0-<4.5 mm							
Number	0	0	0	7	7		
Duration (d)	1	3	2	3.3			
Number/d	—	—	—	2	2	0	0
<sup>1</sup> Number dying/d + starving/d							
Total							
<sup>2</sup> Number dying/d							
Total							

TABLE 6.—Predicted condition of field-collected jack mackerel larvae determined with the morphometric technique.

	Starved 3 days	Starved 1 & 2 days	Fed	Total	Daily percent	
					Starving <sup>1</sup>	
<3.5 mm						
Number	48	66	150	264		
Duration (d)	2	2	6			
Number/d	24	33	25	82	70	
3.5-<4.0 mm						
Number	0	1	121	122		
Duration (d)	2	2	3.3			
Number/d	—	0.5	36.7	37.2	1.3	
4.0-<4.5 mm						
Number	0	0	59	59		
Duration (d)	2	2	3.3			
Number/d	—	—	17.9	17.9	0	
<sup>2</sup> Number starved/d						
Total						

<sup>2</sup>Unfed jack mackerel larvae die in 4 d.

California and up to 1,000 mi off Oregon and Washington (reviewed by MacCall and Stauffer 1983). In addition, jack mackerel have a protracted spawning season which extends from March through September. The bank and island habitat must be a very small fraction of the total spawning habitat; thus despite the higher survival in inshore areas, the offshore zone may be the most important. In addition, better feeding conditions around islands may be offset by a greater abundance of predators. Whether the large concentration of starving larval jack mackerel found offshore was an isolated case or a general condition in offshore areas is unknown.

Given that relative recruitment strength of jack mackerel year classes varies greatly and is rarely "average" (Fig. 17; MacCall and Stauffer 1983), the daily mortality rate of about 45% found in this study is not unrealistic. Considering the relatively long lifetime (i.e., 30+ yr) and high fecundity of jack mackerel, one can deduce that the overall mortality may be very high. This study certainly indicates that starvation at the onset of feeding may be an important factor influencing recruitment variation in jack mackerel.

O'Connell's (1980) study of northern anchovy is the only other study in which starvation in the sea has

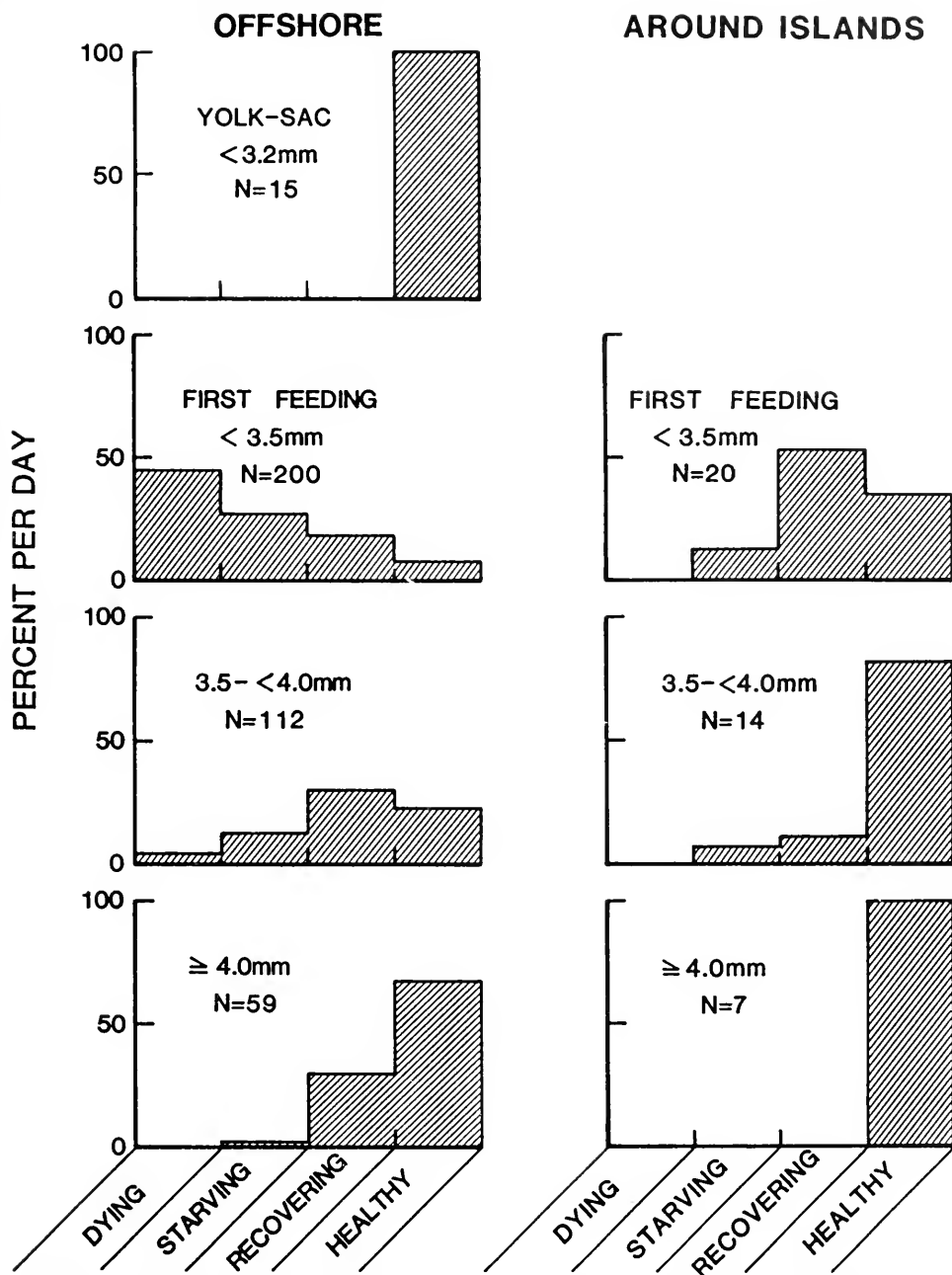

FIGURE 16.—Comparison of the nutritional condition of young *Trachurus symmetricus* collected from offshore and nearshore habitats. Daily percents taken from Tables 2 and 3.

been assessed using histological criteria. O'Connell examined 318 northern anchovy larvae from 64 stations that extended over a large area, 20-350 km off the coast of California. To compare the mortality of northern anchovy with the daily rates I found for jack mackerel, I calculated size-specific daily mor-

tality of northern anchovy by using 1) O'Connell's (1980) histological evaluation, 2) information on time to irreversible starvation to determine durations (Lasker et al. 1970; Hunter 1981; Theilacker and Dorsey 1981), 3) information on shrinkage of ocean-caught northern anchovy to determine size at first

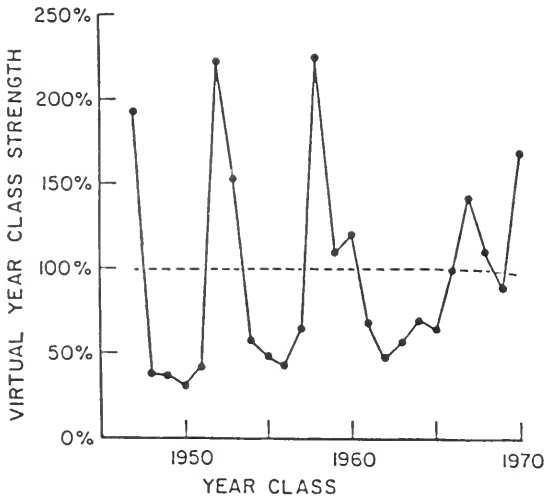

FIGURE 17.—Relative recruitment strengths of jack mackerel year classes in southern California. Virtual year-class strength is measured by the sum of percentage contributions to seasonal landings over the lifetime of the year class. The dashed line indicates average strength (from MacCall and Stauffer 1983; Fig. 4).

feeding (Theilacker 1980a), and 4) a growth rate of 0.37 mm/d for healthy sea-caught northern anchovy (Methot and Kramer 1979). Although the number of first-feeding larvae was low in O'Connell's data ( $n = 23$ ), I calculated a starvation-induced mortality rate of between 35 and 46%/d. Thus my calculations indicate that substantial numbers of northern anchovy larvae as well as jack mackerel larvae are dying at the time of first feeding. This loss rate for northern anchovy is similar to estimated total mortality rate at this stage, 39%/d (Lo in press; 1978 data), which suggests that starvation is the major source of mortality at first feeding. This conclusion for northern anchovy could not be drawn at the time that O'Connell did his work because the data on net shrinkage were not known. The average rates estimated by O'Connell were much lower because he combined larval size classes.

Attempts to assess larval starvation in the sea using morphological criteria are more common (Shelbourne 1957; Honjo et al. 1959; Nakai et al. 1969; reviewed by May 1974; Ehrlich et al. 1976), but they have seldom been successful, probably because of the biases introduced by failure to correct adequately for shrinkage (see next section). Recently Devonald (1983) used a morphometric index with shrinkage adjustments to assess jack mackerel feeding regimes off California. She found good correspondence between jack mackerel condition and prey availability and concluded that feeding conditions were better near islands than in the area

between islands. Several of her samples and my samples were taken concurrently (San Clemente and Tanner Bank; Table 1), and I found that 92% of the jack mackerel from the island habitat were healthy. Thus, my results obtained using histological criteria confirm Devonald's conclusion.

Other techniques used in the past to assess food availability include RNA/DNA (Buckley 1980), food in gut (Rojas de Mendiola 1974; Ciechomski and Weiss 1974; Arthur 1976; Ellertsen et al. 1981), and otoliths. Of course otolith work is critical because estimates of growth rates are essential for assessment of mortality, but it is of no value for assessing growth at the onset of feeding (Methot 1981).

Arthur (1976) conducted the only other study on the feeding of jack mackerel off the coast of California. He found, after examining the stomach contents of 750 specimens from 65 offshore samples, that 60% of the first-feeding jack mackerel and 10% of the older larvae (7 mm) had empty stomachs. This observation lends additional credence to my histological evaluation of jack mackerel collected offshore that shows 59% of the first-feeding fish and 3% of the older fish (>4 mm) were starving.

I believe my estimates of jack mackerel mortality due to starvation are conservative. The assumptions I made about the persistence of starvation and the duration of growth were based on extensive laboratory studies (Theilacker 1978, 1981). Because the majority of jack mackerel were collected at sites warmer (16.1°-16.6°C) than the culture temperature (15°-15.5°C), the durations for growth and starvation may be altered, but the final estimate of mortality due to starvation is higher after the appropriate changes to the durations are made. Furthermore, if net retention of robust fish is greater than retention of thin fish of the same length, starvation may be underestimated. In addition, the selection of unhealthy larvae by predators would also increase the starvation estimate.

Previous evidence supporting the occurrence of starving fish larvae in the ocean has been mainly circumstantial (reviewed by May 1974; Jones and Hall 1974; Lasker 1975). Evidence from this study and O'Connell's (1980) study shows that starvation does occur and that the young stages of jack mackerel and northern anchovy are highly vulnerable.

### Comparison of Morphological and Histological Criteria for Starvation Diagnosis

The incidence of starvation based on mor-

phological criteria was essentially the same as that based on histological criteria. Owing to the relative ease, and low cost of measuring fish compared with a histological examination, the morphological analysis is an attractive approach. On the other hand, histological analysis defines a cause and effect relation between structure and starvation whereas gross morphological measurements provide an index of starvation which is highly vulnerable to errors and biases in calibration and interpretations. Because of the importance of these measurements in recruitment studies, it is appropriate to consider the merits of and potential errors in these techniques in some detail.

① The morphometric approach relies on measurements of fish to compare reared and wild animals at the same developmental stage. Thus shrinkage adjustments are needed to intercalibrate laboratory measurements and field measurements. Fish shrink when collected in a net and preserved, and shrinkage of the size of all body parts is dependent on the time in the net, size of fish, and type of preservative used (Blaxter 1971; Theilacker 1980a; Hay 1981). In this study, tow time was controlled at 5 min and samples were preserved within 8 min. Thus damage to the fish and shrinkage were minimal, but the samples were not quantitative. It is doubtful that the morphometric technique will work with jack mackerel taken in standard, quantitative collections. Quantitative net tows are 20 min, and they include an additional hosing down of the nets before sample preservation (Smith and Richardson 1977). The procedure damages the larvae, causing extensive shrinkage which makes accurate measuring difficult. Further, a long tow time decreases confidence in time-specific shrinkage estimates because fish can be collected at any time during the towing period. Increasing the tow time also causes both the magnitude of the shrinkage correction factor and the standard error of its estimate to increase. For example, in this study, standard length of jack mackerel shrank by an average of  $6.0 \pm 0.6\%$  in 8 min and  $19.0 \pm 1.0\%$  in 20 min.

While laboratory calibration is absolutely essential for the morphometric analysis, no shrinkage calibration is needed for the histological analysis, and it might be possible to use the histological observations on other fishes. Diagnostic criteria for the starving condition of jack mackerel (Theilacker 1978), northern anchovy (O'Connell 1976), and yellowtail, *Seriola quinqueradiata*, (Umida and Ochiai 1975) were similar. In addition, important biological information is gained while using the histological approach whereas gross morphological

indices provide no such information. For example, histological analysis of jack mackerel has revealed a pattern of diel swim bladder inflation and a disruption of this rhythm, accumulation of glycogen reserves, and brain lesions presumably produced by UV radiation (Hunter et al. 1979). There is just no substitute for this extensive biological information. On the other hand, population work requires large samples, and morphological indices are probably the only practical means for working with very large samples. Thus, the optimal experimental design for population work on starvation is probably the use of morphological criteria (calibrated for shrinkage) combined with a smaller subsample of fish which are graded histologically. All work requires special net tows, preservation, procedures, and laboratory calibration.

Caution needs to be exercised when transferring information obtained in the laboratory to the field. Raising larval jack mackerel in small containers is known to affect growth, nutritive condition, and possibly activity (Theilacker 1980b). Additionally, there is evidence that wild fish tend to be thinner than their laboratory counterparts (larval herring, Blaxter 1971; juvenile herring, Balbontin et al. 1973; larval northern anchovy, Arthur 1976). My use of the morphometric SWDA assumes that the morphometric criteria I developed in the laboratory for larval jack mackerel raised in large tanks are applicable to ocean-caught jack mackerel.

## ACKNOWLEDGMENTS

Many thanks to Brian Rothschild who suggested research on the nutritive condition of larval fish and to William T. (Tosh) Yasutake who offered me a personalized course in teleost histology. The offshore collections were made possible by Roger Hewitt's effective planning, the crew of the RV *David Starr Jordan*, and the assistance of Jack Metoyer and Carol Kimbrell. Miguel Carrillo sorted the mackerel, Richard Kiy measured them, and Jack Metoyer prepared them for histological analyses. Metoyer also helped with the shrinkage study. Nancy Lo assisted with all statistical applications. I appreciate John Hunter's and Martin Newman's constructive reviews of the manuscript. Many thanks to the Technical Support Group for typing services.

## LITERATURE CITED

- AHLSTROM, E. H.  
1959. Vertical distribution of pelagic fish eggs and larvae off California and Baja California. U.S. Wildl. Serv., Fish.

- BULL. 60:107-146.
- ANDERSON, W. A. D.  
1971. Degenerative changes and disturbances of metabolism. In W. A. D. Anderson (editor), Pathology, p. 68-95. The C. V. Mosby Co., St. Louis, 6th ed.
- ARTHUR, D. K.  
1976. Food and feeding of larvae of three fishes occurring in the California Current, *Sardinops sagax*, *Engraulis mordax*, and *Trachurus symmetricus*. Fish. Bull., U.S. 74:517-530.  
1977. Distribution, size, and abundance of microcopepods in the California Current system and their possible influence on survival of marine teleost larvae. Fish. Bull., U.S. 75: 601-611.
- BALBONTIN, F., S. S. DE SILVA, AND K. S. EHRLICH.  
1973. A comparative study of anatomical and chemical characteristics of reared and wild herring. Aquaculture 2:217-240.
- BEERS, J. R., AND G. L. STEWART.  
1967. Micro-zooplankton in the Euphotic zone at five locations across the California Current. J. Fish. Res. Board Can. 24: 2053-2068.  
1970. Numerical abundance and estimated biomass of micro-zooplankton. In J. D. H. Strickland (editor), The ecology of the plankton off La Jolla, California, in the period April through September, 1967. Vol. 17 (Part VI), p. 67-87. Bull. Scripps Inst. Oceanogr.
- BLAXTER, J. H. S.  
1971. Feeding and condition of Clyde herring larvae. Rapp. P.-v. Réun. Cons. int. Explor. Mer 160:128-136.
- BUCKLEY, L. J.  
1980. Changes in the ribonucleic acid, deoxyribonucleic acid, and protein content during ontogenesis in winter flounder, *Pseudopleuronectes americanus*, and effect of starvation. Fish. Bull., U.S. 77:703-708.
- CIECHOMSKI, J. D., DE, AND G. WEISS.  
1974. Estudios sobre la Alimentacion de larvas de la merluza, *Merluccius merluccius* Hubbsi de la anchoita, *Engraulis anchoita*, en la mar. Physis. Secr. A Buenos Aires 33:199-208.
- DEVONALD, K. F.  
1983. Evaluation of the feeding success of first-feeding jack mackerel larvae off southern California, and some contributing factors. Ph.D. Thesis, Univ. California, Scripps Inst. Oceanogr., 227 p.
- EHRLICH, K. F., J. H. S. BLAXTER, AND R. PEMBERTON.  
1976. Morphological and histological changes during growth and starvation of herring and plaice larvae. Mar. Biol. (Berl.) 35:105-118.
- ELLERTSEN, B., E. MOKSNESS, P. SOLENDAL, T. STRØMME, S. TILSETH, T. WESTGARD, AND V. ØIESTAD.  
1981. Some biological aspects of cod larvae (*Gadus morhua* L.). ICES Symposium on Early Life History of Fish, Woods Hole, Mass., April 1979. Rapp. R.-v. Réun. Cons. int. Explor. Mer 178:317-319.
- FARRIS, D. A.  
1961. Abundance and distribution of eggs and larvae and survival of larvae of jack mackerel (*Trachurus symmetricus*). U.S. Fish Wildl. Serv., Fish. Bull. 61:247-279.
- HAY, D. E.  
1981. Effects of capture and fixation on gut contents and body size of Pacific herring larvae. Rapp. P.-v. Réun. Cons. int. Explor. Mer 178:395-400.
- HEWITT, R., G. H. THEILACKER, AND N. C. H. LO.  
In press. Causes of mortality in young jack mackerel. Mar. Ecol. Prog. Ser.
- HJORT, J.  
1914. Fluctuations in the great fisheries of northern Europe viewed in the light of biological research. Rapp. P.-v. Réun. Cons. Perm. int. Explor. Mer. 20:1-228.
- HONJO, K., T. KITACHI, AND H. SUZUKI.  
1959. On the food distribution and survival of post larval iwashi-1-Distribution of food organisms, the food of the anchovy and ecologically related species along the southwestern Pacific coast of Honshu, Sept.-Nov. 1958. Reports on the major coastal fish investigations, and the investigations for forecasting of oceanographic conditions and fisheries (preliminary report), February 1959. (Engl. Transl. by S. Hayashi.)
- HUNTER, J. R.  
1981. Feeding ecology and predation of marine fish larvae. In R. Lasker (editor), Marine fish larvae morphology, ecology and relation to fisheries, p. 33-77. Wash. Sea Grant Program, Univ. Wash. Press, Seattle.
- HUNTER, J. R., AND C. SANCHEZ.  
1976. Diel changes in swim bladder inflation of the larvae of the northern anchovy, *Engraulis mordax*. Fish. Bull., U.S. 74:847-855.
- HUNTER, J. R., J. H. TAYLOR, AND H. G. MOSER.  
1979. Effects of ultraviolet irradiation on eggs and larvae of the northern anchovy, *Engraulis mordax*, and the Pacific mackerel, *Scomber japonicus*, during the embryonic stage. Photochem. Photobiol. 29:325-338.
- IWAI, T.  
1968. The comparative study of the digestive tract of teleost larvae—V. Fat absorption in the gut epithelium of goldfish larvae. Bull. Jpn. Soc. Sci. Fish. 34:973-978.  
1969. Fine structure of gut epithelial cells of larval and juvenile carp during absorption of fat and protein. Arch. Hist. Jpn. 30:183-199.
- IWAI, T., AND M. TANAKA.  
1968. The comparative study of the digestive tract of teleost larvae—III. Epithelial cells in the posterior gut of halfbeak larvae. Bull. Jpn. Soc. Sci. Fish. 34:44-48.
- JONES, R., AND W. B. HALL.  
1974. Some observations on the population dynamics of the larval stage in common gadoids. In J. H. S. Blaxter (editor), Early life history of fish, p. 87-102. Springer-Verlag, Berl.
- LASKER, R.  
1975. Field criteria for survival of anchovy larvae: the relation between inshore chlorophyll maximum layers and successful first feeding. Fish. Bull., U.S. 73:453-462.
- LASKER, R., H. M. FEDER, G. H. THEILACKER, AND R. C. MAY.  
1970. Feeding, growth, and survival of *Engraulis mordax* larvae reared in the laboratory. Mar. Biol. (Berl.) 5:345-353.
- LO, N. C. H.  
In press. Egg production of the central stock of northern anchovy, 1951-1982. Fish. Bull., U.S. 83.
- LOVE, R. M.  
1970. The chemical biology of fishes. Acad. Press (Lond.), p. 222-257.
- MACCALL, A. D., AND G. D. STAUFFER.  
1983. Biology and fishery potential of jack mackerel (*Trachurus symmetricus*). Calif. Coop. Oceanic Fish. Invest. Rep. 24:46-56.
- MAY, R. C.  
1974. Larval mortality in marine fishes and the critical period concept. In J. H. S. Blaxter (editor), The early life history of fish, p. 3-19. Springer-Verlag, N.Y.
- METHOT, R. D., JR.  
1981. Growth rates and age distributions of larval and juvenile northern anchovy, *Engraulis mordax*, with inferences on larval survival. Ph.D. Thesis, Univ. California, San Diego, 328 p.



- METHOT, R. D., JR., AND D. KRAMER.  
1979. Growth of northern anchovy, *Engraulis mordax*, larvae in the sea. Fish. Bull., U.S. 77:413-423.
- NAKAI, Z., M. KOSAKA, M. OGURA, G. HAYASHIDA, AND H. SHIMOZONO.  
1969. Feeding habit, and depth of body and diameter of digestive tract of *Shirasu*, in relation with nutritious conditions. J. Coll. Mar. Sci. Technol., Tokai Univ. 3:23-34.
- O'CONNELL, C. P.  
1976. Histological criteria for diagnosing the starving condition in early post yolk sac larvae of the northern anchovy, *Engraulis mordax* Girard. J. Exp. Mar. Biol. Ecol. 25:285-312.  
1980. Percentage of starving northern anchovy, *Engraulis mordax*, larvae in the sea as estimated by histological methods. Fish. Bull., U.S. 78:475-489.
- RAJOS DE MENDIOLA, B. R.  
1974. Food of the larval anchoveta, *Engraulis ringens* J. In J. H. S. Blaxter (editor), The early life history of fish, p. 277-285. Springer-Verlag, N.Y.
- SHELBOURNE, J. E.  
1957. The feeding and condition of plaice larvae in good and bad plankton catches. J. Mar. Biol. Assoc. U.K. 36:539-552.
- SMITH, P. E., AND S. L. RICHARDSON.  
1977. Standard techniques for pelagic fish egg and larva surveys. F.A.O. Fish. Tech. Pap. 175, 100 p.
- THEILACKER, G. H.  
1978. Effect of starvation on the histological and morphological characteristics of jack mackerel, *Trachurus symmetricus*, larvae. Fish. Bull., U.S. 76:403-414.  
1980a. Changes in body measurements of larval northern anchovy, *Engraulis mordax*, and other fishes due to handling and preservation. Fish. Bull., U.S. 78:685-692.  
1980b. Rearing container size affects morphology and nutritional condition of larval jack mackerel, *Trachurus symmetricus*. Fish. Bull., U.S. 78:789-791.  
1981. Effect of feeding history and egg size on the morphology of jack mackerel, *Trachurus symmetricus*, larvae. ICES Symposium on Early Life History of Fish, Woods Hole, Mass., April 1979. Rapp. P.-v. Réun. Cons. int. Explor. Mer 178:432-440.
- THEILACKER, G. H., AND K. DORSEY.  
1980. Larval fish diversity. In Workshop on the effects of environmental variation on the survival of larval pelagic fishes. Intergov. Oceanogr. Comm. Rep. 28:105-142. UNESCO, Paris.
- UMEDA, S., AND A. OCHIAI.  
1975. On the histological structure and function of digestive organs of the fed and starved larvae of the yellowtail, *Seriola quinqueradiata*. [In Jpn., Engl. summ.] Jpn. J. Ichthyol. 21:213-219.
- WATANABE, Y.  
1981. Ingestion of horseradish peroxidase by the intestinal cells in larvae or juveniles of some teleosts. Bull. Jpn. Soc. Sci. Fish. 47:1299-1307.



# HYPOXIA IN LOUISIANA COASTAL WATERS DURING 1983: IMPLICATIONS FOR FISHERIES

MAURICE L. RENAUD<sup>1</sup>

## ABSTRACT

Hypoxic bottom water ( $\leq 2.0$  ppm dissolved oxygen) was present in shallow (9-15 m) waters south of central Louisiana in June and July 1983. It was patchy in distribution from south of Barataria Pass to south and west of Marsh Island. Data suggested that bottom water hypoxia did affect the abundance and distribution of shrimp and bottomfish. Offshore bottom water dissolved oxygen was significantly correlated with 1) combined catches of brown and white shrimp ( $r = 0.56$ ,  $P < 0.002$ ), 2) fish biomass ( $r = 0.56$ ,  $P < 0.001$ ), and 3) vertical density gradient ( $r = -0.73$ ,  $P < 0.001$ ). Several hypoxic stations were in regions designated as potentially hypoxic through a posteriori analysis of satellite data. *Micropogonius undulatus* was the dominant fish species nearshore and offshore. *Penaeus aztecus* and *P. setiferus* were sparsely distributed throughout the study area.

The presence of bottom water hypoxia ( $\leq 2.0$  ppm dissolved oxygen) in the nearshore Gulf of Mexico is a common, recurring, and mostly seasonal (June-August) event. It is generally thought to be associated with temperature and salinity stratification initiated by freshwater runoff and with phytoplankton blooms during hot, calm weather (Fotheringham and Weissberg 1979; Bedinger et al. 1981; Comiskey and Farmer 1981; Turner and Allen 1982a, b; Boesch 1983; Leming and Stuntz 1984). Phytoplankton respiration and decomposition of sinking organic matter are major oxygen consuming processes. High oxygen demand of the organic load in freshwater runoff (Gallaway 1981) and lack of a direct oxygen replenishing mechanism (strong winds) in the presence of vertical stratification contribute to hypoxia formation (Harris et al. 1976; Ragan et al. 1978; Swanson and Sindermann 1979; Harper et al. 1981). Christmas (1973) and Boesch (1983) discussed possible nitrate pollution in rivers and coastal hypoxia. Boesch (1983) presented a brief history of hypoxia in the Gulf of Mexico and evaluated its causes and consequences. The extent to which any factor is involved with hypoxia formation is unknown.

Hypoxia in the Gulf of Mexico has been most noticeable in shallow ( $< 20$  m) Louisiana waters. It has been reported infrequently on the Texas shelf (Harper et al. 1981; Gallaway and Reitsema 1981). Low oxygen levels have also been measured east of the Mississippi River Delta inshore of barrier islands

and in inland bays (May 1973; Christmas 1973) and offshore of Mobile Bay, AL (Turner and Allen 1982b). Abnormally high concentrations of moribund fish and crustaceans near the shoreline ("jubilees") in Alabama have also been linked to hypoxia (May 1973).

Considerable interest in hypoxia has been renewed by a less than average shrimp harvest in 1982 (Klima et al. 1983) and 1983<sup>2</sup>. In this paper I report the locations and extent of Louisiana coastal hypoxia in 1983 and discuss the interrelationships of fish and shrimp abundance and distribution with environmental parameters.

## METHODS

Nearshore data were collected in a 7.3 m Aqua-Sport at a total of 56 stations from nine transects west of the Mississippi River Delta (long.  $89^{\circ}33'W$  to  $90^{\circ}14'W$ ) from 1 to 16 June 1983 (Fig. 1). The transects, perpendicular to shore, ranged from 5 to 8 km in length and 1 to 16 m in depth. The six easternmost transects were sampled twice, with a sampling interval of 14 d. Shrimp and bottomfish were collected at 23 of 56 stations in 15-min tows with a 3.0 m box trawl. Towing speed was about 3 kn. Before each tow, water temperature, salinity, and dissolved oxygen concentration were recorded at 1 m depth intervals with a Hydrolab 8000. Hydrographic profiles were made at the remaining 33 stations.

An offshore study area extending from long.

<sup>1</sup>Southwest Fisheries Center Galveston Laboratory, National Marine Fisheries Service, NOAA, 4700 Avenue U, Galveston, TX 77550.

<sup>2</sup>1983 Gulf Coast Shrimp Data, NOAA, NMFS.

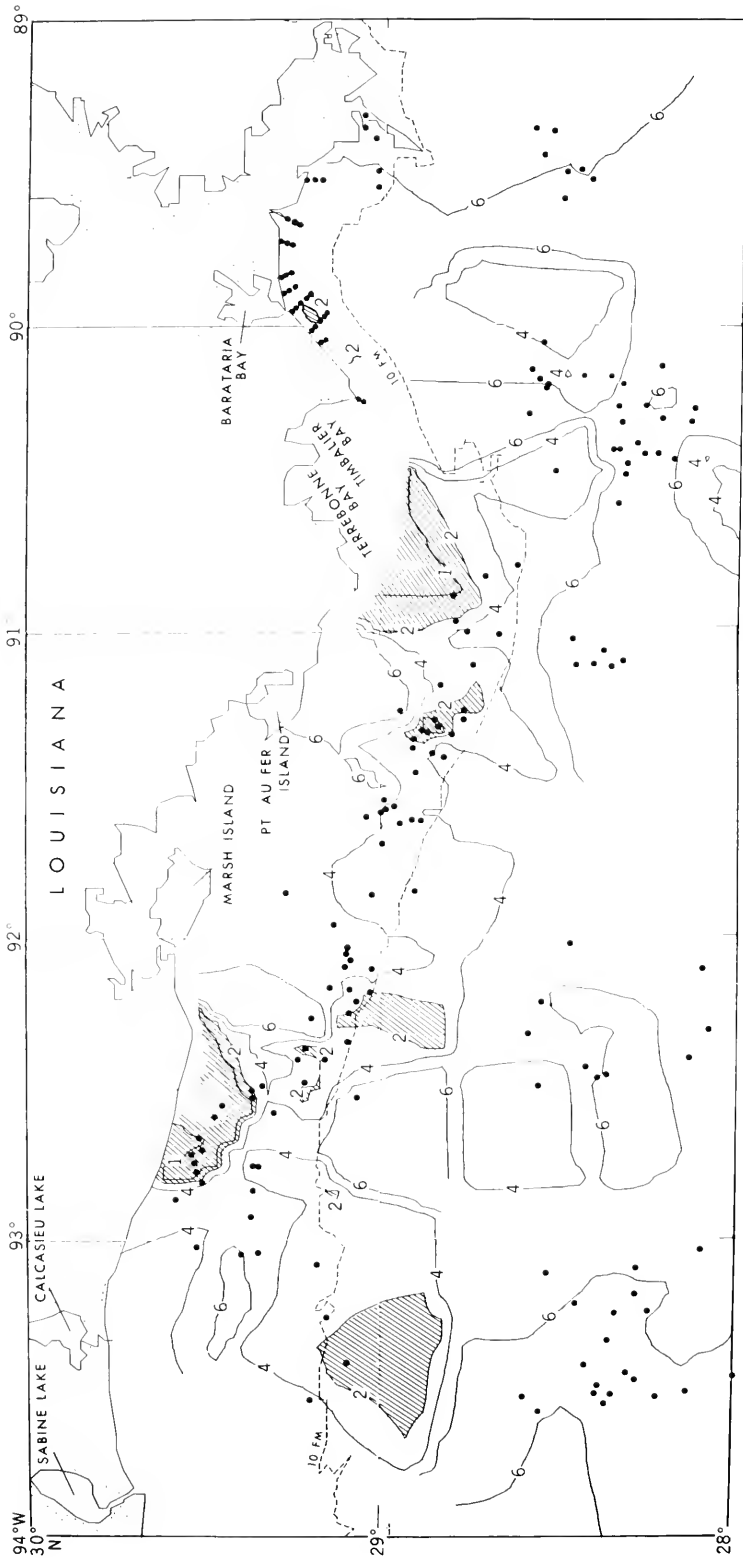

FIGURE 1.—Dissolved oxygen contours in Louisiana coastal waters, June-July 1983. Shaded portions represent dissolved oxygen levels  $\leq 2.0$  ppm; solid circles are station locations.

90°47'W to 93°02'W was sampled with a 24.4 m steel-hull commercial shrimp trawler from 30 June to 6 July 1983 (Fig. 1). Depth varied from 4 to 20 m and distance from shore ranged from 8 to 54 km. Shrimp and bottomfish were collected at 34 of 65 stations in 20-min tows with a 12.2 m semiballoon trawl. The same trawl was used as a midwater shrimp sampler above previously identified hypoxic water. Surface and bottom measurements of water temperature, salinity, and dissolved oxygen concentration were recorded before each tow. Water samples were collected with a Kemmerer bottle. Salinities were measured with a refractometer. Temperature and dissolved oxygen concentration were measured with a YSI Model 51-B. Surface and bottom hydrographic data were collected at the remaining 31 stations. The Southeast Area Monitoring and Assessment Program (SEAMAP)<sup>3</sup> personnel collected similar data off Louisiana in June 1983. SEAMAP dissolved oxygen data were included in the contour analyses.

The Harvard SYMAP program (Dougenik and Sheehan 1975), a Northwest Alaska Fisheries Center Contour Subroutine, and the Galveston Laboratory Generalized Mapping system were utilized to produce a map of dissolved oxygen contours off Louisiana. Koi<sup>4</sup> presents an indepth explanation of these contour mapping programs. Vertical density gradient of the water column, shrimp catch, and fish catch were regressed with bottom water dissolved oxygen concentration. A "best fit" line through the data was determined using the least squares concept.

Surface water temperature (°C) and chlorophyll content (mg/m<sup>3</sup>) were measured off Louisiana by the Coastal Zone Color Scanner (CZCS) aboard the Nimbus-7 satellite. Personnel from the Mississippi Laboratories of the Southeast Fisheries Center, working at the National Space Technology Laboratories, Mississippi, used CZCS and "ground truth" field data to predict potentially hypoxic areas in coastal Louisiana waters.

## RESULTS AND DISCUSSION

Regions of hypoxic bottom water have been detected along portions of the Texas-Louisiana coastline every summer from 1972 to 1983 (Harris

et al. 1976; Ragan et al. 1978; Bedinger et al. 1981; Harper et al. 1981; Reitsema et al. 1982; Boesch 1983). Hypoxia was noted from 16 June to 6 July 1983. It was patchy in distribution and found mainly in 9 to 15 m depths from south of Barataria Pass to south and west of Marsh Island (Fig. 1).

A total of 34 fish and 11 invertebrate species were collected offshore. The Atlantic croaker, *Micropogonius undulatus*, and the Atlantic threadfin, *Polydactylus octonemus*, were the dominant bottomfish at 58% and 30% of the stations, respectively; Atlantic bumper, *Chloroscombrus chrysurus*, was the common pelagic. Brown shrimp, *Penaeus aztecus*; white shrimp, *P. setiferus*; mantis shrimp, *Squilla empusa*; and broken-back shrimp, *Trachypenaeus* sp., were the most common invertebrates collected, but in small quantities. Total crustacean catch was always <5.0 kg/h.

Bottom water dissolved oxygen concentration was significantly correlated with 1) fish biomass ( $r = 0.56$ ,  $P < 0.001$ ) (Fig. 2) and the number of brown and white shrimp present ( $r = 0.56$ ,  $P < 0.002$ ) (Fig. 3). Shrimp and bottomfish were generally absent from hypoxic stations. Atlantic croaker were not at stations with hypoxic bottomwater, and shrimp catches never exceeded 2 kg/h in the areas. Sea catfish, *Arisus felis*; butterfish, *Peprilus paru*; and Atlantic bumper were common in trawls at hypoxic sites. These were also the most abundant fish in mid-

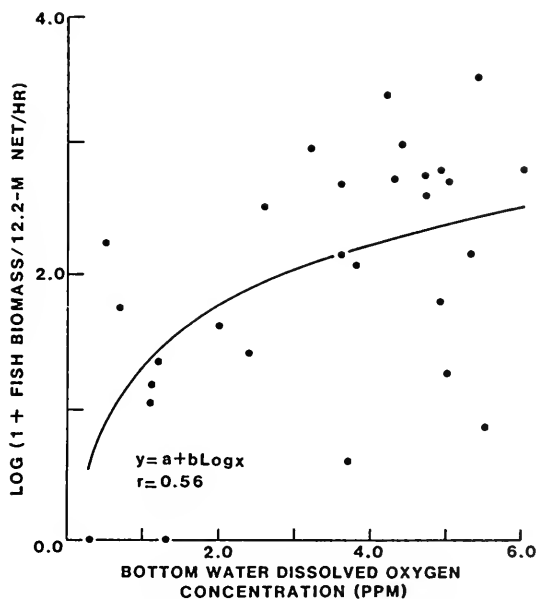

FIGURE 2.—Offshore fish biomass in relation to bottom water dissolved oxygen concentration.

<sup>3</sup>Southeast Area Monitoring and Assessment Program: a State-Federal cooperative research effort organized to assess the distribution and abundance of shrimp and bottomfish in the Gulf of Mexico.

<sup>4</sup>Koi, D. 1985. Generalized geographic mapping system. Unpubl. manuscript, 47 p. Southeast Fisheries Center Galveston Laboratory, National Marine Fisheries Service, NOAA, 4700 Avenue U, Galveston, TX 77550.

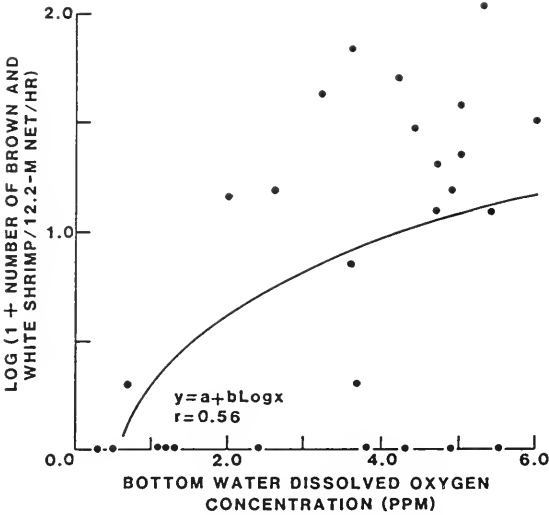

FIGURE 3.—Offshore shrimp abundance in relation to bottom water dissolved oxygen concentration.

water trawls above previously identified hypoxic areas. Therefore, it was concluded that they were captured from the upper water column as the trawl passed through it. Four brown shrimp, three lesser blue crabs, *Callinectes similis*, and one mantis shrimp were the only crustaceans captured in five midwater trawls. The relationship between shrimp and bottomfish abundance and distribution indicates that they do not pass through or over hypoxic water masses. Actual avoidance behavior in the field has not been documented.

Nearshore, a total of 20 fish and 5 invertebrate

species were collected. Atlantic croaker was the dominant species. Brown shrimp were present in low numbers at most stations. White shrimp, blue crabs, *Callinectes sapidus*; lesser blue crabs; and sea bobs, *Xiphopenaeus* sp., were the only other crustaceans collected. A high variability in fish and shrimp abundance was probably due to the low fishing efficiency of the small net at the deeper nearshore stations. As a result, no significant correlation was present at nearshore stations between bottom water dissolved oxygen concentration and fish or shrimp abundance.

Vertical density stratification was present at both nearshore and offshore stations. Dissolved oxygen concentration and vertical density gradient were negatively correlated ( $r = -0.73$ ,  $P < 0.001$ ) (Fig. 4). This agrees with Leming and Stuntz (1984) who found a high correlation between bottom dissolved oxygen content and surface to bottom density gradients off Louisiana in 1982 ( $r = -0.74$ ,  $P < 0.001$ ). Offshore, the mean difference between surface and bottom dissolved oxygen was 6.4 ppm (standard error = 0.40) in hypoxic areas and 1.6 ppm (standard error = 0.08) in nonhypoxic areas. Temperature generally did not vary more than 2°C between the surface and bottom regardless of the area.

During the first week of July, 92% of the hypoxic stations were in areas predicted as potentially hypoxic through a posteriori analyses of remote sensing data. Hypoxic areas were characterized by surface water temperatures near 30°C, which agrees with Leming and Stuntz (1984). They discussed satellite data acquisition, its value in identifying and forecasting hypoxic regions in the Gulf of Mexico,

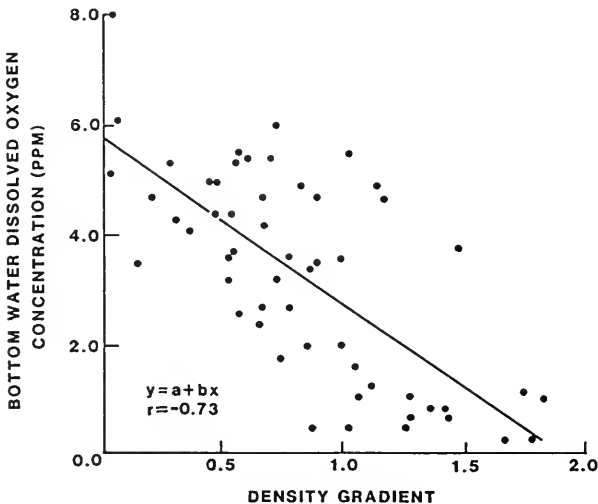

FIGURE 4.—Bottom water dissolved oxygen concentration in relation to vertical density gradient of the water column. Density gradient is expressed as (bottom sigma-t minus surface sigma-t)/depth.

and its implications regarding shrimp management.

The effect of hypoxia on shrimp is not completely understood. It is possible that an extensive area of hypoxic bottom water can act as a physical barrier to juvenile shrimp migration offshore and to postlarval migration into nursery grounds. Limited indirect evidence supports this hypothesis. Gazey et al. (1982) described a shrimp mark-release study in Louisiana. Extensive longshore and offshore movement occurred before the recapture of the shrimp during 1979, when hypoxia was not reported off Louisiana (Fig. 5). In 1978, when hypoxia was widespread along the Louisiana coastline (Fig. 6), shrimp did not move comparable distances. It was possible that hypoxia reduced shrimp movement into offshore waters.

The most extensive occurrence of hypoxic bottom water recorded in Louisiana coastal waters occurred from May 1973 to May 1974 (Flowers et al. 1975; Ragan et al. 1978). It was widespread between Barataria and Timbalier Passes and extended up to 30 km offshore in some regions. Ragan et al. (1978) reported several areas to be anoxic. The duration and severity of this hypoxic condition may have had an impact on the offshore brown shrimp fishery in 1973.

Total brown shrimp catch and CPUE (catch per unit effort) in 1973 were significantly lower (paired *t*-test,  $P < 0.05$ ) than in 1972 (fn. 2). Catch declined 36% (2.8 million kg) and the mean CPUE was reduced by 120 kg/vessel per d. Movement of juvenile brown shrimp to the offshore fishery occurs from May to August (Cook and Lindner 1970). Monthly catch and CPUE of brown shrimp from January through April 1973 did not differ from the same time period in 1972; however, catch and CPUE from May through December were significantly lower (paired *t*-test,  $P < 0.01$ ) in 1973. Postlarval recruitment of brown shrimp occurs from January to May (Baxter and Renfro 1966). An interaction between hypoxia and postlarval recruitment in 1974 might have been responsible for the continued poor harvest of brown shrimp that year. Catch and CPUE were still significantly lower than in 1972 (paired *t*-test,  $P < 0.05$ ). It was not until 1976 that brown shrimp catch surpassed the 1972 levels (Table 1). A decline in total shrimp catch of Louisiana in 1982 may have been related to a large region of hypoxic bottom water reported by Stuntz et al. (1982).

Although hypoxia has not been directly linked to declines in annual catch, its presence during critical

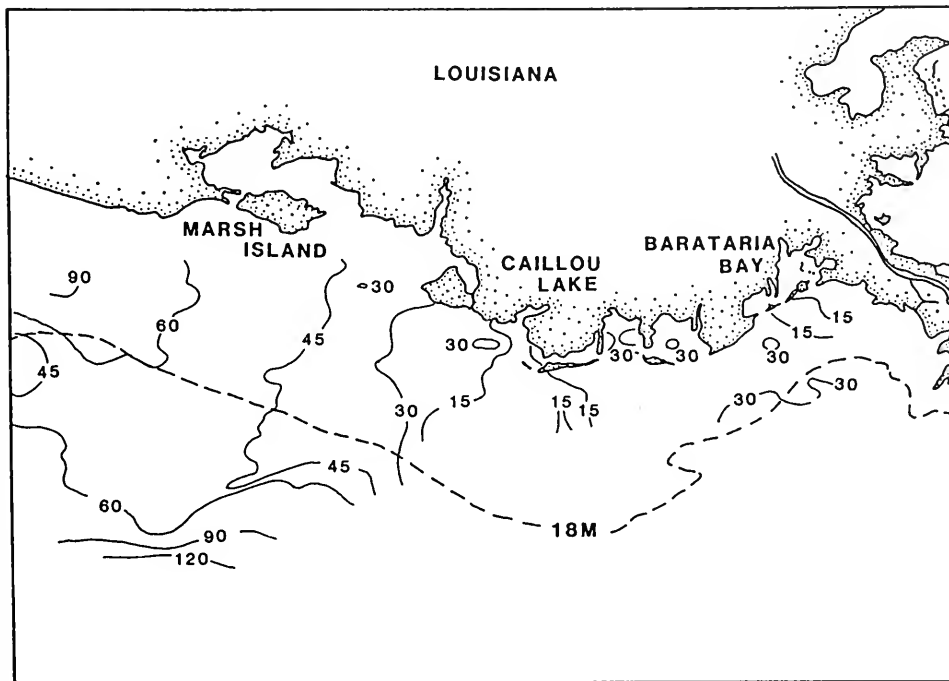

FIGURE 5.—Movement of tagged juvenile brown shrimp from Caillou Lake and Barataria Bay expressed as days at large before recapture (from Gazey et al. 1982). Shrimp were released in July 1979. Hypoxia was not documented off this coastal area in 1979.

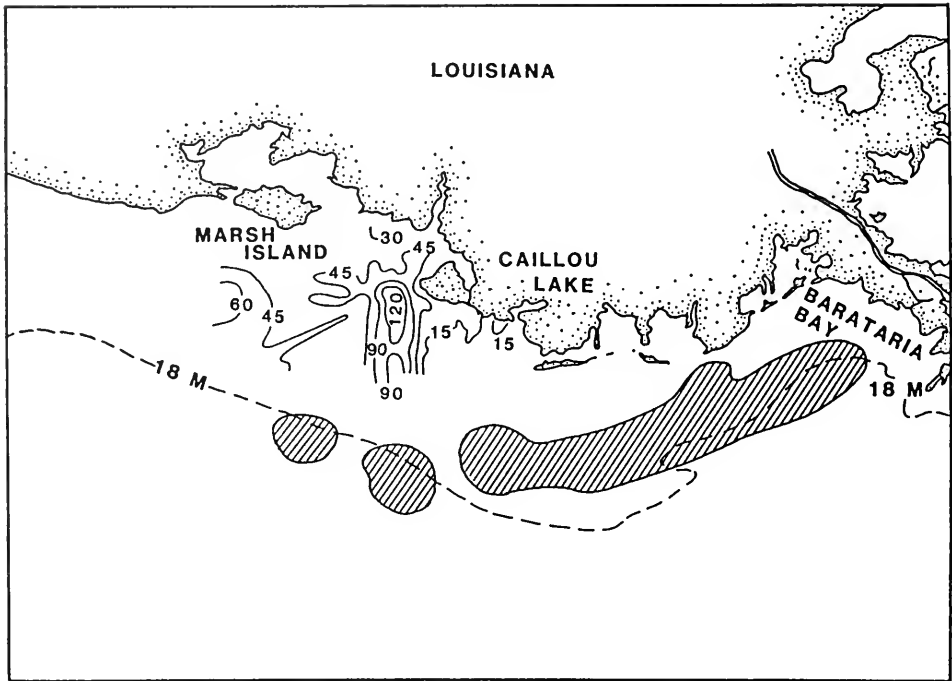

FIGURE 6.—Movement of tagged juvenile brown shrimp from Caillou Lake, expressed as days at large before recapture (from Gazey et al. 1982). Shrimp were released in June 1978. Regions of hypoxic bottom water, noted from June to August, are overlaid onto this map (Fotheringham and Weissberg 1979; Bedinger et al. 1981; Comiskey and Farmer 1981).

TABLE 1.—Louisiana brown shrimp catch data.

		1972	1973	1974	1975	1976	5-yr average
Catch per unit effort (kg/vessel per d)	Jan.-Apr.	190	216	180	196	208	198
	May-Aug.	383	225	249	296	348	300
	Sept.-Dec.	376	233	328	346	268	310
	Annual average	344	223	256	288	302	284
Catch (millions of kg)	Jan.-Apr.	0.831	1.478	0.633	0.645	1.020	0.921
	May-Aug.	4.529	2.630	2.702	2.112	5.966	3.588
	Sept.-Dec.	2.293	0.822	1.578	1.414	2.601	1.742
	Total	7.653	4.930	4.913	4.171	9.587	6.251
Effort (24-h days fished)	Jan.-Apr.	4,379	6,870	3,509	3,288	4,903	4,590
	May-Aug.	11,828	11,722	10,852	7,128	17,127	11,731
	Sept.-Dec.	6,361	3,528	4,805	4,083	9,715	5,698
	Total	22,568	22,120	19,166	14,499	31,745	22,020

<sup>1</sup>CPUE and catch data in 1973 and 1974 were significantly lower than that in 1972 (paired *t*-test,  $P < 0.05$ ).

portions of the shrimp life cycle implicate it as a probable source of variation in annual shrimp yield. Support for this viewpoint has been documented in laboratory experiments which indicate that brown and white shrimp detect and avoid water with low oxygen levels.<sup>5</sup> Brown shrimp were the least tolerant

of the two species. They avoided dissolved oxygen concentrations up to and including 2.0 ppm. White shrimp did not avoid oxygen levels higher than 1.5 ppm. Variable behavior was exhibited by both species at higher treatment levels. Total time (TT) spent in water with 1.5 ppm did not differ between species,

<sup>5</sup>Renaud, M. 1985. Detection and avoidance of oxygen depleted water by *Penaeus setiferus* and *Penaeus aztecus*. Unpubl. manuscr., 16 p. Southeast Fisheries Center Galveston Laboratory, National

Marine Fisheries Service, NOAA, 4700 Avenue U, Galveston, TX 77550.



nor did their response time (RT), i.e., time taken to retreat into normal seawater. However, these measurements were significantly ( $t$ -test,  $P < 0.001$ ) shorter for brown shrimp (TT = 6.2, RT = 3.8 min) versus white shrimp (TT = 20.0, RT = 6.2 min) when tested at 2.0 ppm. Behavioral responses of brown and white shrimp exposed to hypoxic water included 1) an initial increase in activity, 2) walking or swimming retreat, and 3) rapid eye movements. White shrimp also exhibited notable abdominal flexing, periods of exhaustion, and sometimes death. These three latter behaviors were not observed with brown shrimp. Dissolved oxygen levels tested are common along Louisiana's Gulf Coast during the summer and early fall. Therefore it is not unreasonable to assume that similar behavioral responses occur in nature.

Hypoxia in the New York Bight (Swanson and Sindermann 1979) had a severe impact on the commercial fisheries of sedentary species. Surf clam, *Spisula solidissima*; ocean quahog, *Arctica islandica*; and scallop, *Placopectin magellanicus*, abundance was reduced by 92%, 25%, and 12%, respectively, in the affected area. The response of recreational fish species, summer flounder, *Paralichthys dentatus*, and bluefish, *Pomatomus saltatrix*, to low oxygen levels was noted by changes in their distribution patterns during the hypoxic event. Temperature stratification, phytoplankton blooms, spoil deposition, and sewage treatment outflow were alleged major contributors to hypoxia formation in the New York Bight. It was concluded, however, that abnormal climatological and hydrological phenomena were responsible for this hypoxic event. Swanson and Sindermann (1979) stated that effective regulation of waste disposal into riverine and oceanic environments may control or restrict bottom water hypoxia formation.

Future research on the phenomenon of hypoxia should be centered on its predictability; remote sensing has potential in this area. Timely information dissemination on the extent and location of hypoxic areas would help fishermen to avoid areas where low catches might be anticipated or to harvest a crop before it dies or migrates.

## ACKNOWLEDGMENTS

The author expresses his sincere appreciation to 1) the Louisiana Wildlife and Fisheries Department for providing NMFS personnel with services at their Grand Terre Island Marine Laboratory and at their Field Station in Caillou Lake; 2) the Gulf States Marine Fisheries Commission for access to the 1983 SEAMAP data; 3) David Trimm for this major con-

tribution to data collection; 4) Dennis Koi for computer services and related software analyses, especially those relevant to contour mapping; 5) Frank Patella for acquisition and transformation of several years of Gulf coast shrimp data; 6) Tom Leming for satellite data; and 7) Beatrice Richardson for typing the manuscript.

## LITERATURE CITED

- BAXTER, K. N., AND W. C. RENFRO.  
1966. Seasonal occurrence and size distribution of postlarval brown and white shrimp near Galveston, Texas, with notes on species identification. U.S. Fish Wildl. Serv., Fish. Bull. 66:149-158.
- BEDINGER, C. A., R. E. CHILDERS, J. W. COOPER, K. T. KIMBALL, AND A. KWOK.  
1981. Pollution fate and effect studies. In C. A. Bedinger (editor), Ecological investigations of petroleum production platforms in the central Gulf of Mexico, Vol. 1, Part 1, 53 p. Report to the Bureau of Land Management, New Orleans, LA, Contract No. AS551-CT8-17.
- BOESCH, D. F.  
1983. Implications of oxygen depletion on the continental shelf of the northern Gulf of Mexico. Coastal Ocean Pollut. Assess. News 2:25-28.
- CHRISTMAS, J. Y. (editor).  
1973. Cooperative Gulf of Mexico estuarine inventory and study, Mississippi: Phase I, area description, Phase II, hydrology, Phase II, sedimentology, Phase IV, biology. Gulf Coast Research Laboratory, Ocean Springs, MS, 434 p.
- COMISKEY, C. E., AND T. A. FARMER (editors).  
1981. Characterization of base-line oceanography for the Texas region brine disposal sites. Vol. I. Final Report to U.S. Department of Energy, Strategic Petroleum Reserve Office, Wash., D.C., Contract No. DEAC01-774508788, 130 p.
- COOK, H. L., AND M. J. LINDNER.  
1970. Synopsis of biological data on the brown shrimp *Penaeus aztecus* Ives, 1891. In M. N. Mistakidis (editor), Proceedings of the World Scientific Conference on the Biology and Culture of Shrimps and Prawns, p. 1471-1497. FAO Fish. Rep. 57(4).
- DOUGENIK, J. A., AND D. E. SHEEHAN.  
1975. SYMAP User's Manual. Camera Stat of Bedford, Cambridge, MA, 187 p.
- FLOWERS, C. W., W. T. MILLER, AND J. D. GANN.  
1975. Water chemistry. In J. G. Gosselink, R. H. Miller, M. Hood, and L. M. Bahr (editors), Environmental assessment of a Louisiana offshore port and appertinent pipeline and storage facility. Vol. II, App. V, Sect. 1, 86 p. Final Report to Louisiana Offshore Oil Port, New Orleans, LA.
- FOTHERINGHAM, N., AND G. H. WEISSBERG.  
1979. Some causes, consequences and potential environmental impacts of oxygen depletion in the northern Gulf of Mexico. Proc. 11th Annu. Offshore Tech. Conf., April 30-May 3, 1979, 3611:2205-2208.
- GALLAWAY, B. J.  
1981. An ecosystem analysis of oil and gas development on the Texas-Louisiana continental shelf. U.S. Fish Wildl. Serv., Off. Biol. Serv., Wash., D.C., FWS/OBS-81-27, 88 p.
- GALLAWAY, B. J., AND L. A. REITSEMA.  
1981. Shrimp spawning site survey. In W. B. Jackson and E. P. Wilkens (editors), Shrimp and redfish studies; Bryan Mound brine disposal site off Freeport, Texas 1979-1981.

- NOAA Tech. Memo. NMFS-SEFC-67, Vol. IV, 84 p. Available from National Technical Information Service, Springfield, VA 22151.
- GAZEY, W. J., B. J. GALLAWAY, R. C. FECHHELM, L. R. MARTIN, AND L. A. REITSEMA.  
1982. Shrimp mark release and port interview sampling survey of shrimp catch and effort with recovery of captured tagged shrimp. *In* W. B. Jackson (editor), Shrimp population studies: West Hackberry and Big Hill brine disposal sites off southwest Louisiana and upper Texas coasts, 1980-1982, Vol. II, 306 p. NOAA/NMFS Final Report to Department of Energy.
- HARPER, D. E., L. D. MCKINNEY, R. R. SALZER, AND R. J. CASE.  
1981. The occurrence of hypoxic bottom water off the upper Texas coast and its effects on the benthic biota. *Contrib. Mar. Sci.* 24:53-79.
- HARRIS, A. H., J. G. RAGAN, AND R. H. KILGEN.  
1976. Oxygen depletion on coastal waters. La. State Univ. Sea Grant Summ. Rep., Proj. No. R/BOD-1, 161 p.
- KLIMA, E. F., K. N. BAXTER, F. J. PATELLA, AND G. A. MATTHEWS.  
1983. Review of 1982 Texas closure for the shrimp fishery off Texas and Louisiana. NOAA Tech. Memo. NMFS-SEFC-108, 22 p. Available from National Technical Information Service, Springfield, VA 22151.
- LEMING, T. D., AND W. E. STUNTZ.  
1984. Zones of coastal hypoxia revealed by satellite scanning have implications for strategic fishing. *Nature (Lond.)* 310: 136-138.
- MAY, E. B.  
1973. Extensive oxygen depletion in Mobile Bay, Alabama. *Limnol. Oceanogr.* 18:353-366.
- RAGAN, J. G., A. H. HARRIS, AND J. H. GREEN.  
1978. Temperature, salinity and oxygen measurements of surface and bottom waters on the continental shelf off Louisiana during portions of 1975 and 1976. Nicholls State Univ., Prof. Pap. Ser. (Biol.) 3:1-29.
- REITSEMA, L. A., B. J. GALLAWAY, AND G. S. LEWBEL.  
1982. Shrimp spawning site survey. *In* W. B. Jackson (editor), Shrimp population studies: West Hackberry and Big Hill brine disposal sites off southwest Louisiana and upper Texas coasts, 1980-1982, Vol. IV, 88 p. NOAA/NMFS Final Report to Department of Energy.
- STUNTZ, W. E., N. SANDERS, T. D. LEMING, K. N. BAXTER, AND R. M. BARAZOTTO.  
1982. Area of hypoxic bottom water found in northern Gulf of Mexico. *Coastal Ocean. Climatol. News* 4:37-38.
- SWANSON, R. L., AND C. J. SINDERMANN (editors).  
1979. Oxygen depletion and associated benthic mortalities in New York Bight, 1976. NOAA Prof. Pap. No. 11, 345 p. Rockville, MD.
- TURNER, R. E., AND R. L. ALLEN.  
1982a. Bottom water oxygen concentration in the Mississippi River Delta Bight. *Contrib. Mar. Sci.* 25:161-172.  
1982b. Plankton respiration rates in the bottom waters of the Mississippi River Delta Bight. *Contrib. Mar. Sci.* 25:173-179.

# INCIDENTAL MORTALITY OF DOLPHINS IN THE EASTERN TROPICAL PACIFIC, 1959-72

N. C. H. LO<sup>1</sup> AND T. D. SMITH<sup>2</sup>

## ABSTRACT

The estimates of the number of dolphins killed annually from the beginning of the U.S. tuna purse seine fishery in the eastern tropical Pacific are used by the National Marine Fisheries Service in developing management advice for the U.S. purse seine fleet. We estimated the annual number of dolphins killed incidentally in the tuna purse seine fishery for 1959-72. Kill data were available for only a few years prior to 1970. Because no obvious trend was shown with the existing data, kill rates were averaged over those years and stratified by various categories: large and small vessels, sets with large catch of tuna and small catch of tuna, sets which used backdown (a dolphin-releasing procedure), and sets which did not use backdown. These kill rates, combined with estimated number of sets, produced the estimated annual kills. Because data were available only for some of the years, they had to be pooled to obtain annual estimates. As a result, the annual estimates were highly correlated. Because the total as well as the annual estimates are of interest, it is necessary to compute the variance-covariance of the estimated annual kills. The annual kill from 1959 to 1972 varied from 55,000 in 1959 to 534,000 in 1961. There were three distinct maxima of 534,000, 460,000, and 467,000, corresponding to peaks in number of sets made on dolphins in 1961, 1965, and 1970. The total kill from 1959 to 1972 was estimated to be about 4.8 million, with a coefficient of variation of 17%.

The eastern tropical Pacific tuna purse seine fleet began to develop rapidly in the late 1950's and has grown to over 100 U.S.-registered vessels and a substantial number of non-U.S.-registered vessels in recent years. This fleet fishes primarily for yellowfin tuna, *Thunnus albacares*, and skipjack tuna, *Katsuwonus pelamis*. Majority of the yellowfin tuna are taken while the tunas are schooling with dolphins primarily of the species *Stenella attenuata* and *S. longirostris*. Birds and dolphins are frequently used as cues in finding the tuna. During the capture of the tuna, some of the dolphins are killed or drowned by becoming tangled in the net webbing (Perrin 1969). The number of dolphins killed has been estimated to have been greater than one-half million in some of the years in the 1960's (Smith 1983). Currently, fewer animals are killed each year due to improvements in the fishing gear and in procedures to release dolphins.

Estimates of the total number of dolphins killed each year in this fishery are used as a basis for management advice by the National Marine Fisheries Service (NMFS). In this paper we describe in detail the method used in Smith (1983), including

estimation of the variances and covariances of the annual kill estimates so that the variance of the total kill for the period can be estimated. Additionally, we reexamine the data used in previous estimates (Perrin 1970; Perrin and Zweifel 1971<sup>3</sup>; Perrin et al. 1982; Smith 1983; Smith and Lo 1983), and we present revised estimates of the total numbers of dolphins killed.

## MATERIALS AND METHODS

The model used to estimate the total annual incidental kill of dolphins ( $T_t$ ) in the eastern tropical Pacific tuna purse seine fishery is

$$\hat{T}_t = \hat{R}_t \hat{X}_t \quad (1)$$

where  $t$  denotes the year (1959 to 1972),  $R$  denotes the number of dolphins killed per set, and  $X$  denotes the number of sets made involving dolphins. The rate of kill ( $R$ ) varies between larger and smaller vessels, and in dolphin sets where fewer and greater amounts of yellowfin tuna are caught (Lo et al. 1982). In addition, the rate of dolphin kills is generally less if

<sup>1</sup>Southwest Fisheries Center La Jolla Laboratory, National Marine Fisheries Service, NOAA, 8604 La Jolla Shores Drive, La Jolla, CA 92038.

<sup>2</sup>Northeast Fisheries Center Woods Hole Laboratory, National Marine Fisheries Service, NOAA, Woods Hole, MA 02543.

<sup>3</sup>Perrin, W. F., and J. R. Zweifel. 1971. Porpoise mortality in the eastern tropical tuna fishery in 1971. Unpubl. manusc., 22 p. Southwest Fisheries Center La Jolla Laboratory, National Marine Fisheries Service, NOAA, 8604 La Jolla Shores Drive, La Jolla, CA 92038.

backdown, a dolphin-release procedure, is used (Green et al. 1971; Barham et al. 1977; Smith and Lo 1983). To account for these factors affecting rates of dolphin kill, Equation (1) can be reexpressed with the rates and numbers of sets stratified by vessel tuna carrying capacity, catch of fish, and use of backdown procedure:

$$\hat{T}_t = \sum_{i=1}^2 \sum_{j=1}^2 \sum_{k=1}^2 \hat{R}_{tijk} \hat{X}_{tijk} \quad (2)$$

where  $t$  = year

$i$  = 1 for vessel capacity >600 tons; 2 for vessel capacity ≤600 tons

$j$  = 1 for yellowfin tuna catch ≥¼ ton; 2 for yellowfin tuna catch <¼ ton

$k$  = 1 backdown is used; 2 backdown is not used.

Data on the number of dolphins killed during fishing trips in the period from 1964 to 1968 are given in Smith and Lo (1983). Similar but more extensive data (e.g., backdown information) are available in NMFS records for 1971 and 1972. Estimates on the number of sets involving dolphins from 1959 to 1972 are given by Punsley (1983). These data sources have certain limitations which do not allow for the use of the complete stratification scheme in Equation (2). Assumptions are made based on sample sizes and on apparent lack of changes in rates over time to accommodate these limitations.

The mean numbers of dolphins killed (kill-per-set) are shown in Table 1 for each year in which data are available, stratified by vessel size and by catch of fish (successful, ≥¼ ton of yellowfin tuna; unsuccessful, <¼ ton of yellowfin tuna). The definition of suc-

cessful set follows that of Perrin and Zweifel (fn. 3). The vessel class stratification was based on the vessel's fish carrying capacity. The 1964-74 kill data indicate that kill-per-set was different for vessels with ≤600 tons carrying capacity and vessels with >600 tons for unsuccessful sets. For successful sets the optimal vessel class stratification was not clear; either 400, 600, or 800 tons can be used as division points for stratification. For consistency, we adopted the same stratification used for unsuccessful sets. (The results were similar with alternative stratification schemes.) Other factors such as the age of the vessel and the experience of the captain could affect kill rates but were not considered in the stratification because these factors could not be isolated for analysis.

The mean number of dolphins killed varied markedly over the years but without any obvious trends (Table 1). A two-way analysis of variance with the data pooled over years showed statistically significant differences in kill rates in sets made by small and large vessels ( $P < 0.01$ ) and in successful and unsuccessful sets ( $P < 0.01$ ). Thus Equation (2) was simplified by eliminating the time stratification for kill rates, whereas the vessel size and catch strata were retained.

Few observations are available for sets where backdown was not used. In successful sets, backdown was used more than 90% of the time; thus, we have observations on kill rates in only 20 sets where backdown was not used. Thirteen of these sets were made by large vessels and seven by small vessels, and the mean kill rates within vessel size class are highly variable and not significantly different. The overall ratio of the kill rates, pooled over vessel size, when backdown was not used and when it was used is significantly greater than unity, and the annual

TABLE 1.—Average numbers of dolphins killed ( $M$ ) in purse seine sets in the eastern tropical Pacific by year, for small and large vessels making successful (>¼ ton tuna) and unsuccessful (≤¼ ton tuna) net sets. Standard deviation (SD), number of sets ( $N$ ), and number of trips are given.

Vessels and year	Successful sets				Unsuccessful sets				Data source
	$M$	SD	$N$	No. of trips	$M$	SD	$N$	No. of trips	
Small vessels (≤600 tons carrying capacity)									
1964	60	47	20	1	60	—	1	1	Smith and Lo (1983) <sup>1</sup>
1965	26	28	35	1	3	8	11	1	Smith and Lo (1983)
1968	130	114	13	1	4	4	2	1	Smith and Lo (1983)
1971	117	180	19	3	13	10	3	2	Unpubl. NMFS
1972	57	110	103	6	4	10	16	5	Unpubl. NMFS
Total	62	108	190	12	6	13	33	10	
Large vessels (>600 tons carrying capacity)									
1971	41	56	16	2	—	—	—	0	Unpubl. NMFS
1972	37	123	117	6	0.4	1.4	12	5	Unpubl. NMFS
Total	37	119	133	8	0.4	1.4	12	5	

<sup>1</sup>From table 5 of Smith and Lo (1983), omitting incomplete data collected in 1966.

ratios vary without a consistent trend over time (Table 2).

In unsuccessful sets the use of the backdown procedure was more variable because the conditions of the set are more diverse. For example, only a few or no dolphins may be captured, and the net may not be retrieved in the usual manner. Because of this diversity and because so few observations are available, we consider one kill rate for all unsuccessful sets.

Reexpressing Equation (2) to account for a constant ratio of kill rates for successful sets when backdown was used and when it was not used, and for no difference in kill rates for unsuccessful sets, yields

$$\hat{T}_t = \sum_{i=1}^2 \sum_{j=1}^2 \sum_{k=1}^2 \hat{R}_{\bullet ijk} \hat{X}_{tijk}$$

$$= \sum_{i=1}^2 \{ \hat{R}_{\bullet i11} (\hat{X}_{ti11} + C\hat{X}_{ti12}) + \hat{R}_{\bullet i2\bullet} \hat{X}_{ti2\bullet} \} \quad (3)$$

where  $C = R_{\bullet\bullet 12}/R_{\bullet\bullet 11}$  and the subscript  $\bullet$  is used when that stratifying variable is not considered. For example,  $R_{\bullet ijk}$  is the kill-per-set not stratified by year  $t$ , and  $\hat{X}_{ti2\bullet}$  is the total number of sets not stratified by use of backdown.

Estimates of the total number of sets involving dolphins from 1959 to 1972, with approximate variances, are given by Punsly (1983). He also gives partial estimates of the numbers of successful and unsuccessful sets, but does not provide estimates of the numbers of sets by vessel size. Punsly's data did

not indicate the use of the backdown procedure.

The coefficients of variation (CV) of Punsly's estimates are  $\leq 1\%$  in all years except 1959 and 1960, when it was 8%. The percentage of unidentified sets in 1959-61 was higher than subsequent years because set type was not recorded systematically (Hammond<sup>4</sup>). We assume these estimates are in fact constants, because in most years, and in the absence of additional information in 1959-61, the CVs are small compared with the CVs of the kill rates (0.13-1.0, Table 1).

By applying the proportions of successful and unsuccessful dolphin sets from Punsly's partial estimates to his totals, we obtained numbers of successful and unsuccessful dolphin sets. We further prorate these estimated numbers of successful and unsuccessful sets to large and small vessels by multiplying by the estimates of proportions from NMFS (Anonymous 1976<sup>5</sup>) of sets made by vessels of each size class (Table 3). The slight differences between the totals for each year given by Punsly are due to rounding.

The number of sets during which backdown was used can be estimated from the estimated total number of sets involving dolphins (Table 3) and the observed proportion of successful sets in which backdown was used (Table 2). The observed proportions increase from 0.79 in 1964-65 to almost unity (0.96) by 1972. The backdown procedure was reportedly

<sup>4</sup>P. S. Hammond, Sea Mammal Research Unit, British Antarctic Survey, Cambridge, England, pers. commun. 1983.

<sup>5</sup>Anonymous. 1976. Report of the workshop on stock assessment of porpoises involved in the eastern Pacific yellowfin tuna fishery (La Jolla, July 27-31, 1976). Southwest Fish. Cent., Admin. Rep. LJ-76-29, 54 p. + app.

TABLE 2.—Mean number of dolphins killed ( $\bar{A}$ ) during purse seine sets in the eastern tropical Pacific Ocean when the backdown dolphin-release procedure was and was not used. Also given are the ratio of numbers killed with and without backdown ( $\hat{C}$ ), the proportion of successful sets where backdown was used ( $\hat{P}$ ), the number of sets ( $N$ ), number of trips, and standard error in parentheses.

Year	Backdown used						$\hat{C}$	$\hat{P}$
	Yes			No				
	$\bar{A}_{t\bullet 11}$	$N$	No. of trips	$\bar{A}_{t\bullet 12}$	$N$	No. of trips		
1964 <sup>1</sup>	44	16	1	128	4	1	3.0	0.79
1965 <sup>1</sup>	48	6	1	24	2	1	0.50	
1966 <sup>1,2</sup>	—	17	1	—	2	1	—	0.89
1968 <sup>1</sup>	142	11	1	92	1	1	0.65	
1971 <sup>3</sup>	81	30	5	111	4	3	1.40	0.96
1972 <sup>3</sup>	41	193	12	169	9	6	4.10	
Total	50	256	21	131	20	12	2.62	0.93
							(0.80)	

<sup>1</sup>From Smith and Lo (1983).

<sup>2</sup>Kill rates for 1966 omitted because incomplete data were collected.

<sup>3</sup>NMFS records.

<sup>4</sup> $SE(\hat{C}) = \hat{C} [CV^2(\bar{A}_{\bullet\bullet 12}) + CV^2(\bar{A}_{\bullet\bullet 11}) - 2 \text{cor}(\bar{A}_{\bullet\bullet 12}, \bar{A}_{\bullet\bullet 11})]^{1/2}$ ; where  $\hat{C} = \bar{A}_{\bullet\bullet 12}/\bar{A}_{\bullet\bullet 11}$ .

TABLE 3.—Numbers of purse seine sets involving dolphins in the eastern Pacific Ocean, from 1959 to 1972, for small ( $\leq 600$  tons) and large ( $> 600$  tons) vessels, and for successful ( $> 1/4$  tons tuna) and unsuccessful ( $\leq 1/4$  tons) sets, modified from Punsly (1983).

Year	Successful sets		Unsuccessful sets	
	small ( $X_{t21}$ )	large ( $X_{t11}$ )	small ( $X_{t22}$ )	large ( $X_{t12}$ )
1959	326	0	265	0
1960	3,170	0	2,303	0
1961	3,888	32	3,928	0
1962	1,773	5	1,942	19
1963	2,291	10	2,092	23
1964	4,444	45	3,089	64
1965	5,346	27	2,418	29
1966	4,948	44	1,835	25
1967	3,363	2	841	3
1968	2,956	175	982	41
1969	5,365	1,401	1,402	192
1970	4,936	2,313	957	412
1971	1,871	2,602	652	409
1972	2,704	4,982	855	846

developed on one vessel in 1959-60 (Barham et al. 1977) and used by at least three vessels in 1961 (Anonymous 1962). If 79% of the sets in 1964-65 were made using this procedure, as suggested by the very limited available data, a rather rapid increase in usage must have occurred in 1962 and 1963. This is possible because, if properly used, the procedure reduces the amount of handling time of dead dolphins, thus speeding up the fishing operation. As an approximation, we assume that usage increased from 0 to 0.79 linearly from 1959 to 1964-65, and was 0.89 for 1966-71 and 0.96 for 1972.

Denoting the interpolated and extrapolated estimates of the proportion of successful sets using the backdown dolphin release procedure by  $P_t$  gives

$$\hat{X}_{ti11} = \hat{P}_t \hat{X}_{ti1}$$

$$\hat{X}_{ti12} = (1 - \hat{P}_t) \hat{X}_{ti1}$$

Substituting these relationships into Equation (3), with the assumption that the estimated numbers of sets given by Punsley (1983) are constants, the following equations result when the terms are rearranged:

$$\begin{aligned} \hat{T}_t &= \sum_i \{ \hat{R}_{\cdot i11} [X_{ti1} \hat{P}_t + C(1 - \hat{P}_t) X_{ti1}] + R_{\cdot i2} X_{ti2} \} \\ &= \sum_i \{ \hat{R}_{\cdot i11} X_{ti1} [\hat{P}_t + C(1 - \hat{P}_t)] + \hat{R}_{\cdot i2} X_{ti2} \}. \end{aligned} \tag{4}$$

The time series of estimated annual kill ( $\hat{T}_t$ ) from 1959 to 1972 was obtained by pooling the available data over years and strata, resulting in estimates that are not statistically independent. Thus in order to estimate the variance of the total kill of dolphins for the period in addition to the variances it is necessary to determine the covariances among the annual estimates.

We denote the estimates of the total kill of dolphins ( $\hat{T}_t$ ) for each year from 1959 to 1972 by the vector  $\hat{T}$ , and denote the estimates of the variances of the elements of  $\hat{T}$  by the symmetric matrix  $\Sigma_{\hat{T}}$ . The estimate of the kill in each year (Equation (4)) can be expressed in matrix form as the product of a vector of the numbers of sets in each of the four combinations of the vessel size and fishing success classifications ( $X_t$ ), and a vector of the four corresponding kill rates ( $Q_t$ ). Each element of  $\hat{T}$  then can be expressed as a matrix product

$$\hat{T}_t = X'_t \hat{Q}_t \tag{5}$$

where  $X'_t = (X_{t11}, X_{t21}, X_{t12}, X_{t22})$

$$\hat{Q}_t = \begin{bmatrix} \hat{Q}_{t1} \\ \hat{Q}_{t2} \\ \hat{Q}_{t3} \\ \hat{Q}_{t4} \end{bmatrix} = \begin{bmatrix} \hat{R}_{\cdot 111} [\hat{P}_t(1 - \hat{C}) + \hat{C}] \\ \hat{R}_{\cdot 211} [\hat{P}_t(1 - \hat{C}) + \hat{C}] \\ \hat{R}_{\cdot 12} \\ \hat{R}_{\cdot 22} \end{bmatrix} = \begin{bmatrix} \hat{R}_{\cdot 111} f_t \\ \hat{R}_{\cdot 211} f_t \\ \hat{R}_{\cdot 12} \\ \hat{R}_{\cdot 22} \end{bmatrix} \text{ and } f_t = \hat{P}_t(1 - \hat{C}) + \hat{C}.$$

Then the variance-covariance matrix of  $\hat{T}$  is

$$\Sigma_{\hat{T}} = \begin{bmatrix} V(\hat{T}_{59}) \\ \text{Cov}(\hat{T}_{59}, \hat{T}_{60}) & V(\hat{T}_{60}) \\ \vdots & \vdots \\ \text{Cov}(\hat{T}_{59}, \hat{T}_{72}) & \text{Cov}(\hat{T}_{60}, \hat{T}_{72}) & \dots & V(\hat{T}_{72}) \end{bmatrix}$$

$$= \begin{bmatrix} V(X'_{59} Q_{59}) \\ \text{Cov}(X'_{59} Q_{59}, X'_{60} Q_{60}) & V(X'_{60} Q_{60}) \\ \vdots & \vdots \\ \text{Cov}(X'_{59} Q_{59}, X'_{72} Q_{72}) & \text{Cov}(X'_{60} Q_{60}, X'_{72} Q_{72}) & \dots & V(X'_{72} Q_{72}) \end{bmatrix}$$

with  $V(\hat{T}_t) = X'_t \Sigma_{\hat{Q}_t} X_t$   
 as the diagonal elements of  $\Sigma_{\hat{T}}$  (6)

where  $\Sigma_{\hat{Q}_t} = \begin{bmatrix} V(\hat{R}_{\bullet 111} f_t) & \text{Cov}(\hat{R}_{\bullet 111} f_t, \hat{R}_{\bullet 211} f_t) & 0 & 0 \\ & V(\hat{R}_{\bullet 211} f_t) & 0 & 0 \\ & & V(\hat{R}_{\bullet 21\bullet}) & 0 \\ & & & V(\hat{R}_{\bullet 22\bullet}) \end{bmatrix}$  (7)

The diagonal elements of  $\Sigma_{\hat{T}}$  can be computed by noting that  $\hat{R}_{\bullet i2\bullet}$  is uncorrelated with  $\hat{R}_{\bullet i11}$ ,  $\hat{P}_t$ , or  $\hat{C}$ , and the covariance of  $\hat{P}_t$  and  $\hat{C}$  is zero because one  $C$  value is used for all years in 1959-72 and  $\hat{P}_t$  can be different between years.

The off-diagonal elements of  $\Sigma_{\hat{T}}$  are

$$\text{Cov}(\hat{T}_u, \hat{T}_m) = \text{Cov}(X'_u \hat{Q}_u, X'_m \hat{Q}_m) \quad (8)$$

$$= \sum_{i=1}^4 \sum_{j=1}^4 X_{ui} \text{Cov}(\hat{Q}_{ui}, \hat{Q}_{mj}) X_{mj}$$

Expressions for each of the terms in  $\Sigma_{\hat{T}}$  are given in the Appendix.

### RESULTS AND DISCUSSION

The estimates of the total number of dolphins killed incidentally in the tuna purse seine fishery from 1959 to 1972 (Table 4, from Equation (4)) vary from a low of 55,000 in 1959 to a high of 534,000 in 1961. Three distinct maxima of 534,000, 460,000, and 467,000 are apparent (Fig. 1), corresponding to

peaks in numbers of sets made on dolphins in 1961, 1965, and 1970 (Table 3). A total of about 4.8 million dolphins is estimated to have been killed in the whole period (Table 4).

The CVs of the annual estimates decline rapidly

TABLE 4.—Estimated number of dolphins killed by year (Equation (4)), with standard errors (SE) and coefficient of variations (CV).

Year	Number killed	SE	CV
1959	55,000	18	0.32
1960	478,000	146	0.31
1961	534,000	149	0.28
1962	216,000	54	0.25
1963	240,000	54	0.22
1964	390,000	77	0.20
1965	460,000	92	0.20
1966	374,000	58	0.15
1967	257,000	39	0.16
1968	229,000	35	0.15
1969	461,000	68	0.15
1970	467,000	70	0.15
1971	254,000	43	0.17
1972	380,000	61	0.16
1959-72	4,790,000	857	0.18

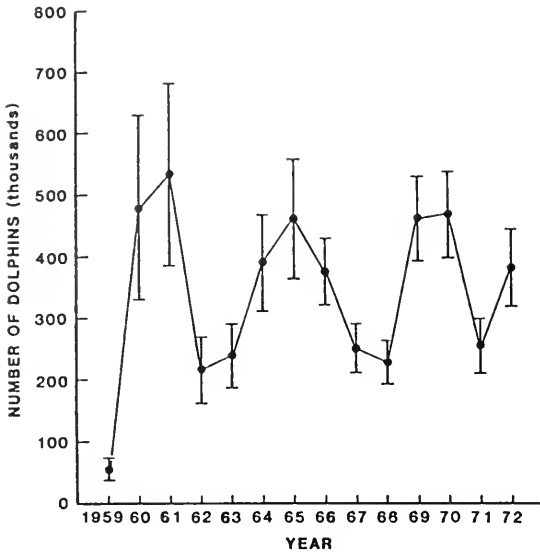

FIGURE 1.—Estimated numbers of dolphins killed in the eastern tropical Pacific tuna purse seine fishery from 1959 to 1972. Standard errors of the estimates shown as vertical bars. From Table 4.

from 32% in 1959 to 15% from 1966 to 1970, and then increase only slightly in 1971 and 1972. The covariances are large (upper triangular matrix, Table 5). They are all positives, and tend to be smaller for pairs of estimates widely spaced in time. The covariances can be examined more easily in terms of correlation coefficients (lower triangular matrix, Table 5). The correlations range from 0.31 to 0.99. The CV of the estimated total is 18%. This is substantially higher than the corresponding value of 6% obtained when the covariances are ignored. Because the total is the sum of 14 numbers, an approximate 95% confidence interval, obtained by add-

ing and subtracting two standard errors, is 3.1-6.5 million dolphins.

The variation in the estimated numbers of dolphins killed over the period 1959-72 is due to several factors: 1) The number of sets made involving dolphins varied from year to year depending on the number of sets of tuna schooling in the absence of dolphins; such tuna are apparently preferred when available. 2) The use of the backdown dolphin-release procedure increased rapidly from 1959 to 1964. However, the development of the backdown dolphin-release procedure is not well known. The available data reflect the tendency of captains to use the technique once it was known. There is little information on how rapidly the procedure became known to other captains and no information on how rapidly they learned to use it effectively. Our assumption of a linear increase probably overestimates the use of backdown initially, but may or may not overestimate its subsequent use. 3) The proportion of successful sets made by small vessels increased from about 50% from 1959 to 1964, to >75% from 1965 to 1972 (Table 1). The higher dolphin kill rate for successful sets results in an increase in estimated dolphin kills as the proportion of successful sets increased. 4) The increase in the proportion of sets which were made by large vessels starting in 1968 results in a decrease in estimated dolphin kill rates due to the lower dolphin kill rate of these vessels.

Several factors which may have affected the numbers of dolphins killed in this period have not been accounted for because of the assumptions made by incomplete data. Chief among these assumptions were 1) the relatively small samples are representative of the fleet as a whole, 2) the kill rates on unsuccessful sets are not affected by the use of backdown, 3) the ratio of kill-per-set in successful sets without backdown to that with backdown is constant

TABLE 5.—Covariances (upper triangular matrix,  $\times 10^{10}$ ) and correlation coefficients (lower triangular matrix) for the estimated total dolphins killed by year, from 1959 to 1972.

	1959	1960	1961	1962	1963	1964	1965	1966	1967	1968	1969	1970	1971	1972
1959		0.41	0.42	0.14	0.13	0.16	0.15	0.11	0.07	0.06	0.13	0.13	0.06	0.04
1960	0.99		3.49	1.24	1.15	1.37	1.32	0.92	0.62	0.56	1.10	1.08	0.54	0.40
1961	0.99	0.99		1.27	1.19	1.45	1.38	0.95	0.64	0.57	1.13	1.11	0.55	0.42
1962	0.97	0.98	0.99		0.44	0.55	0.52	0.34	0.23	0.21	0.41	0.40	0.19	0.15
1963	0.92	0.94	0.96	0.98		0.58	0.53	0.33	0.22	0.20	0.39	0.38	0.18	0.15
1964	0.76	0.79	0.83	0.88	0.95		0.75	0.43	0.29	0.26	0.50	0.49	0.23	0.20
1965	0.79	0.81	0.84	0.88	0.92	0.93		0.56	0.34	0.27	0.51	0.50	0.23	0.20
1966	0.65	0.66	0.67	0.67	0.67	0.62	0.86		0.30	0.21	0.39	0.38	0.17	0.16
1967	0.75	0.76	0.77	0.78	0.78	0.71	0.89	0.93		0.16	0.30	0.29	0.13	0.10
1968	0.74	0.75	0.76	0.77	0.76	0.70	0.77	0.69	0.90		0.31	0.30	0.14	0.10
1969	0.73	0.74	0.75	0.76	0.75	0.68	0.75	0.66	0.87	0.98		0.63	0.33	0.27
1970	0.71	0.72	0.73	0.73	0.72	0.65	0.70	0.62	0.83	0.94	0.98		0.36	0.38
1971	0.58	0.59	0.59	0.59	0.57	0.50	0.54	0.46	0.63	0.75	0.85	0.92		0.25
1972	0.34	0.35	0.36	0.36	0.36	0.34	0.37	0.34	0.39	0.43	0.55	0.65	0.83	



for both large and small vessels for all years, and 4) the kill rate itself for sets with backdown did not change over the years.

Although each of the unaccounted for factors could have an effect on the estimated numbers of dolphins killed, the magnitude of such effects is probably smaller than the magnitude of the effects of vessel size, set success, and use of backdown described in this study. For example, although the kill rate data available are few, there are some additional data which are not available to us, but which are reportedly similar (Smith and Lo 1983). The last three assumptions noted above deal with the dolphin kill rates with and without backdown, and would tend to both increase and decrease the estimates, if they could be taken into account.

Our estimates of the total number of dolphins killed (Table 4) are slightly lower than previous estimates made using the same method (Smith 1979<sup>6</sup>, 1983). The previously estimated total number of dolphins killed from 1959 to 1972 was 5.1 million (total of Smith's [1983] table 4, divided by 0.96 for other species and by 1.048 for injured animals). The difference between the two estimates resulted from the revision of the estimated number of sets that capture tuna associated with dolphins (Punsly 1983) and of the numbers of dolphins killed per set (Smith and Lo 1983).

There are alternate approaches to estimating the numbers of dolphin killed. For example, estimates could be made from data on the numbers of fishing trips made (kill-per-trip), or the number of tons of tuna caught (kill-per-ton). These approaches make different assumptions about the fishing process (Lo et al. 1982; Hammond and Tsai 1983), and require data which are not as precise as are data on the total numbers of sets. For example, fishing trips are difficult to count consistently because they may not be completed within the calendar year and may be ex-

tended by partial unloading of the catch. There are fewer such problems with the data for kill-per-set estimators on the number of dolphins killed, and the problems that exist have already been resolved (Punsly 1983).

## LITERATURE CITED

- ANONYMOUS.  
1962. How tuna seining paid off for the U.S. fleet in 1961. *Fish Boat*, Feb., p. 19-30.
- BARHAM, E. G., W. K. TAGUCHI, AND S. B. REILLY.  
1977. Porpoise rescue methods in the yellowfin purse seine fishery and the importance of Medina panel mesh size. *Mar. Fish. Rev.* 39(5):1-10.
- GREEN, R. E., W. F. PERRIN, AND B. P. PETRICH.  
1971. The American tuna purse seine fishery. In Hilmar Kristjonnsson (editor), *Modern Fishing Gear of the World*, Vol. 3, p. 182-194. *Fish. News (Books) Ltd.*, Lond.
- HAMMOND, P. S., AND K. T. TSAI.  
1983. Dolphin mortality incidental to purse-seining for tunas in the eastern Pacific Ocean, 1979-81. *Rep. Int. Whaling Comm.* 33:589-597.
- LO, N. C. H., J. POWERS, AND B. E. WAHLEN.  
1982. Estimating and monitoring incidental dolphin mortality in the eastern tropical Pacific tuna purse seine fishery. *Fish. Bull.*, U.S. 80:396-401.
- PERRIN, W. F.  
1969. Using porpoise to catch tuna. *World Fishing* 18(6): 42-45.  
1969. The problem of porpoise mortality in the U.S. tropical tuna fishery. *Proceedings of the 6th Annual Conference on Biology, Sonar, and Diving Mammals*, p. 45-48. Stanford Research Institute.
- PERRIN, W. F., T. D. SMITH, AND G. T. SAKAGAWA.  
1982. Status of populations of spotted dolphin, *Stenella attenuata*, and spinner dolphin, *S. longirostris*, in the eastern tropical Pacific. In *FAO, Mammals in the seas*, Vol. IV. Small cetaceans, seals, sirenians, and otters, p. 67-83.
- PUNSLY, R. G.  
1983. Estimation of the number of purse-seiner sets on tuna associated with dolphins in the eastern Pacific Ocean during 1959-1980. *Inter-Am. Trop. Tuna Comm. Bull.* 18:229-299.
- SMITH, T. D.  
1983. Changes in size of three dolphin (*Stenella* spp.) populations in the eastern tropical Pacific. *Fish. Bull.*, U.S. 81:1-14.
- SMITH, T. D., AND N. C. H. LO.  
1983. Some data on dolphin mortality in the eastern tropical Pacific tuna purse seine fishery prior to 1970. *U.S. Dep. Commer., NOAA Tech. Memo. SWFC-TM-NMFS-34*, 26 p.

<sup>6</sup>Smith, T. D. (editor). 1979. Report of the Status of Porpoise Stocks Workshop, August 27-31, 1979, Southwest Fisheries Center, La Jolla, California. *Southwest Fish. Cent., Admin. Rep. LJ-79-41*, 120 p.

## APPENDIX

In Equation (7), the first and second terms on the main diagonal are

$$V(\hat{R}_{\bullet, i11} f_i) = V(\hat{R}_{\bullet, i11})V(f_i) + \hat{R}_{\bullet, i11}^2 V(f_i) + f_i^2 V(\hat{R}_{\bullet, i11}) \quad (\text{A-1})$$

for  $i = 1$  and  $2$ , noting that  $\text{Cov}(\hat{R}_{\bullet, i11} f_i) = 0$ .  
The variance of  $f_i$  is given by

$$\begin{aligned} V(f_i) = & V(\hat{P}_i) (1 + V(\hat{C})) + \hat{P}_i^2 V(\hat{C}) \\ & + \hat{C}^2 V(\hat{P}_i) + V(\hat{C}) - 2V(\hat{P}_i)\hat{C} \\ & - 2V(\hat{C})\hat{P}_i^2 + 2 \text{Cov}(\hat{P}_i, \hat{C}). \end{aligned} \quad (\text{A-2})$$

This last term is assumed to be zero, as noted above. The off-diagonal element in Equation (7) is

$$\text{Cov}(\hat{R}_{\bullet, i11} f_i, \hat{R}_{\bullet, j11} f_j) \approx \hat{R}_{\bullet, i11} \hat{R}_{\bullet, j11} V(f_i) \quad (\text{A-3})$$

for  $i \neq j = 1$  and  $2$ .

In Equation (8), based upon Equation (5)

$$\text{Cov}(\hat{Q}_{ui}, \hat{Q}_{mj}) = \begin{cases} \text{Cov}(\hat{R}_{\bullet, i11} f_u, \hat{R}_{\bullet, j11} f_m) & \text{for } i = 1, 2 \\ & \text{and } j = 1, 2 \\ 0 & i \neq j \text{ for } i = 3, 4 \\ V(\hat{R}_{\bullet, i2\bullet}) & i = j \text{ and } j = 3, 4 \end{cases}$$

where  $\text{Cov}(\hat{R}_{\bullet, i11} f_u, \hat{R}_{\bullet, j11} f_m)$  (A-4)

$$= \begin{cases} [\hat{R}_{\bullet, i11}^2 + V(\hat{R}_{\bullet, j11})] \text{Cov}(f_u, f_m) + f_u f_m V(\hat{R}_{\bullet, i11}) & i = j \\ \hat{R}_{\bullet, i11} \hat{R}_{\bullet, j11} \text{Cov}(f_u, f_m) & i \neq j \end{cases}$$

assuming  $\text{Cov}(\hat{R}_{\bullet, i11}, \hat{R}_{\bullet, j11}) = 0$

and  $\text{Cov}(f_u, f_m) \approx \text{Cov}(\hat{P}_u, \hat{P}_m) [V(\hat{C}) + \hat{C}^2]$  (A-5)  
 $+ V(\hat{C}) \bullet [1 + \hat{P}_u \hat{P}_m - \hat{P}_u - \hat{P}_m].$

# THE ABUNDANCE AND DISTRIBUTION OF THE FAMILY MACROURIDAE (PISCES: GADIFORMES) IN THE NORFOLK CANYON AREA<sup>1</sup>

ROBERT W. MIDDLETON<sup>2</sup> AND JOHN A. MUSICK<sup>3</sup>

## ABSTRACT

The Norfolk Canyon off Virginia and the adjacent slope areas were sampled with 13.7 m otter trawls in June 1973, November 1974, September 1975, and January 1976. Trawl depths ranged from 75 to 3,083 m, and 22 species of macrourids were captured during the study. *Coryphaenoides rupestris* demonstrated seasonal movement to shallower water (ca. 750 m) during winter. *Nezumia bairdii*, *N. aequalis*, and *Coryphaenoides carapinus* exhibited a significant positive correlation between head length and depth ( $r^2 = 0.47, 0.37, \text{ and } 0.35$ , respectively). *Nezumia bairdii* apparently spawns in July or August, and reaches an age of about 11 years. New size records were established for *Nezumia aequalis* (64 mm head length (HL)) and *N. bairdii* (66 mm HL). New depth records were established for *Coelorinchus c. carminatus* and *N. aequalis* (884 and 1,109 m, respectively). The known geographic ranges for *Coelorinchus caribbeus*, *C. occa*, *Nezumia cyrano*, *Coryphaenoides colon*, *Hymenocephalus gracilis*, *H. italicus*, *Bathygadus macrops*, *Macrourus berglax*, and *Gadomus dispar* were extended to the Norfolk Canyon area.

The Macrouridae (Pisces: Gadiformes) includes some of the most abundant archibenthic deep-sea fish species (Marshall 1965, 1971; Marshall and Iwamoto 1973; Iwamoto and Stein 1974) and attains greatest abundance and diversity on the continental slopes of the world oceans (Marshall and Iwamoto 1973). Present knowledge of the life history and ecology of macrourids has been accrued piecemeal from faunal lists and taxonomic works (Gunnerus 1765; Gunther 1887; Gilbert and Hubbs 1920; Farron 1924; Iwamoto 1970; Okamura 1970; Marshall and Iwamoto 1973; Iwamoto and Stein 1974), or from studies on physiology, anatomy, and life history (Kulikova 1957; Marshall 1965; Phleger 1971; Rannou 1975; Rannou and Thiriou-Quiereaux 1975; Haedrich and Polloni 1976; McLellan 1977; Merrett 1978; Smith et al. 1979). The meager literature on reproduction and growth of macrourids and other deep-sea anacanthine fishes has recently been reviewed by Gordon (1979). With the advent of increasing expertise in deepwater trawling, some macrourid species, such as *Coryphaenoides rupestris* and *Macrourus berglax*, have become commercially

important in the western North Atlantic. Experimental commercial trawling was initiated by the Soviet Union in 1962, and many studies directly related to the commercial fishing of macrourids have been subsequently published by Soviet workers (Podrazhanskaya 1967, 1971; Savvatimskii 1971, 1972; Grigor'ev 1972) and to a lesser extent by Polish researchers (Stanek 1971; Nodzinski and Zukowski 1971).

The present study examines the seasonal distribution and abundance of the macrourid species captured in the Norfolk Canyon area. In addition aspects of age, growth, and reproduction of selected dominant species are also described.

## MATERIALS AND METHODS

### Gear

The data presented in this paper were obtained on four cruises to Norfolk Canyon and the adjacent open slope to the south (Fig. 1) conducted by the RV *Columbus Iselin* (June 1973) and RV *James M. Gillis* (November 1974, September 1975, January 1976). On all cruises a 13.7 m semiballoon otter trawl with 1.3 cm (stretched) mesh in the cod end liner and 5.1 cm (stretched) mesh in the wings and body was employed. Steel "china V" doors at the end of 22.9 m bridles were used to permit spreading of the net from a single warp (Musick et al. 1975).

<sup>1</sup>Contribution No. 1226 from the Virginia Institute of Marine Science.

<sup>2</sup>Virginia Institute of Marine Science, College of William and Mary, Gloucester Point, VA 23062; present address: Minerals Management Service, U.S. Department of the Interior, 1951 Kidwell Drive, Vienna, VA 22180.

<sup>3</sup>Virginia Institute of Marine Science, College of William and Mary, Gloucester Point, VA 23062

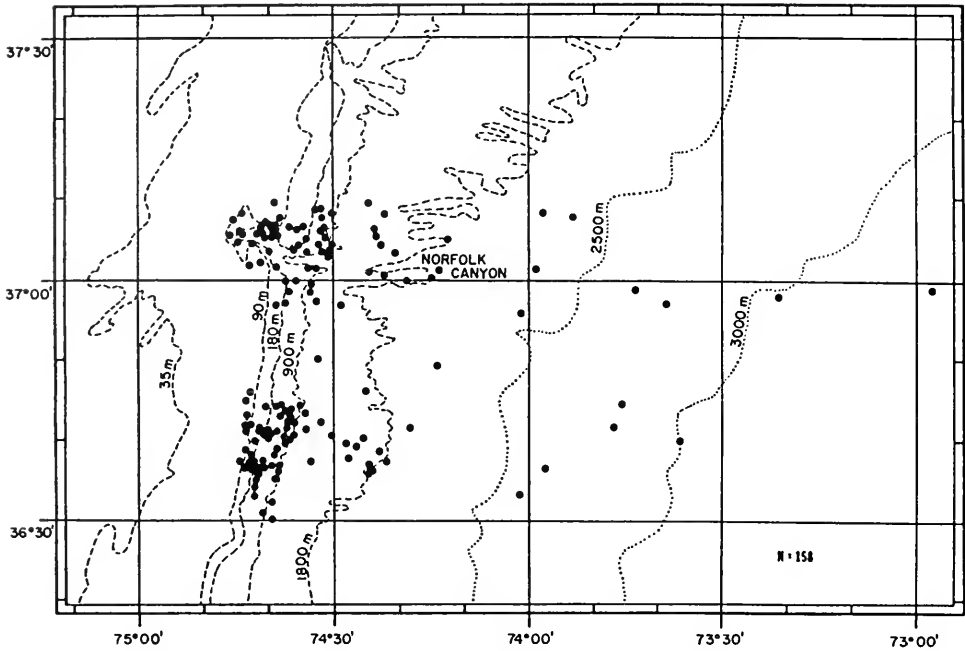

FIGURE 1.—Map of the Norfolk Canyon study area with station locations indicated.

### Sampling Design

Norfolk Canyon and an adjacent open slope were divided into five sampling strata: 75-150 m, 151-400 m, 401-1,000 m, 1,001-2,000 m, and 2,001-3,000 m. Six stations were then randomly assigned in each depth stratum. The duration of all tows in depths of <2,000 m was 0.5 h (bottom time). Where the depth exceeded 2,000 m, the tow times were extended to 1 h. Station depth was determined from a sonic precision depth recorder when the net was set and then every 3 min for the duration of the 0.5 h tows (every 6 min for the 1-h tows). Mean station depth was then determined by averaging the 11 resultant values.

### Data Collection and Analysis

Head lengths instead of total lengths were measured because macrourids have slender whiplike tails that are easily damaged during trawling. The head length (HL) was measured to the closest millimeter, from the tip of the snout to the posterior edge of the opercle using Helios<sup>4</sup> dial calipers. The fish were weighed with an Ohaus dial-a-gram scale. Calibration showed the scale to be accurate within

1.0-1.5 g under all typical shipboard conditions.

The sex and gonadal conditions of freshly captured specimens were noted. Gonadal samples for histological processing were stored in Davidson's preservative and later mounted using standard paraffin techniques. Sections (5 mm) were stained with Mayer's hematoxylin and eosin counterstain.

Saccular otoliths and a scale sample were removed from all *Nezumia bairdii* and stored dry. Representative otolith samples were chosen randomly from individuals over the entire size range of fish captured.

The length-weight relationships for *Nezumia bairdii*, *Coryphaenoides armatus*, and *C. rupestris* were analyzed using log transformed weights regressed against head length (Fig. 2).

Regression analysis of head length on depth of capture was performed for each species to determine any significant change in head length with change in depth. Testing of the hypothesis that  $\beta = 0$  for the regression line ascertained whether there was a significant change of size with changing depth. The coefficient of determination ( $r^2$ ) was also calculated to determine what proportion of the variance of head length could be attributed to change in depth.

The a posteriori Student-Newman-Keuls analysis of means was used as a second method for interpreting the size/depth relationship. This method calculated the mean depth of capture of each head-

<sup>4</sup>Reference to trade names does not imply endorsement by the National Marine Fisheries Service, NOAA.

length interval, combined the head lengths in subsets whose mean depths did not differ significantly from each other, and defined the constituents of each subset.

Due to the large size and thickness of the macrourid otoliths, standard age determination techniques proved unsuccessful (Christensen 1964; McEachran and Davis 1970). Therefore, a thin section was removed from each otolith and, using a dissecting microscope, the number of bands presumed to be annual were counted and recorded.

Gonads of the specimens were classified into reproductive stages for analysis. The criteria for these stages were as follows:

Stage 1—Undeveloped. The gonads were immature and no development was evident. The reproductive organs were difficult to distinguish within the body cavity.

Stage 2—Early Immature. The reproductive organs had enlarged slightly. The sex could be determined, but no vascularization of the ovaries was apparent. The organs of both sexes had a highly translucent appearance.

Stage 3—Immature. The ovaries were enlarged and vascularization had begun. The testes had become discernibly "sausage shaped". The organs of both sexes were opaque.

Stage 4—Late Immature. The reproductive organs of both sexes were full size. The ovaries were about 90% vascularized. The testes had become milky white in color.

Stage 5—Mature. The reproductive organs were developed completely. Ovaries were fully vascularized and had a granular appearance.

Stage 6—Ripe. Advanced spermatogenesis or

oogenesis was evident. The oocytes were fully developed in the females and the male testes contained milky-white seminal fluid.

Stage 7—Spent. The testes and ovaries were spent. The reproductive organs were flaccid and had recently released sperm or eggs.

## RESULTS AND DISCUSSION

### Species Accounts

#### *Coelorinchus c. carminatus* (Goode 1880)

*Coelorinchus c. carminatus* is a relatively shallow water macrourid reported from depths of 89-849 m (Marshall and Iwamoto 1973). In the study area this species was captured in depths of 210-884 m (Fig. 3). Marshall and Iwamoto (1973) reported *C. c. carminatus* from northern Brazil to the Grand Banks, but absent in the Bahama Island chain. The largest specimen captured in our study had a head length of 70 mm, while Marshall and Iwamoto (1973) reported specimens with 73 mm HL.

During our study, a maximum of 188 individuals and 4 kg of *C. c. carminatus* were captured in a 0.5-h trawl. This species also contributed as much as 34.2% of the number and 27.8% of the biomass of benthic fishes captured in individual samples.

Figure 4 shows the depth distribution of *C. c. carminatus* incremented by 2 mm size groups. A slight increase in head length with increase of depth was apparent. The slopes of the regression lines were shown to be significantly different from zero. The coefficient of determination (Table 1) also showed a correlation between head length and depth. There was variability among cruises, but this may be at-

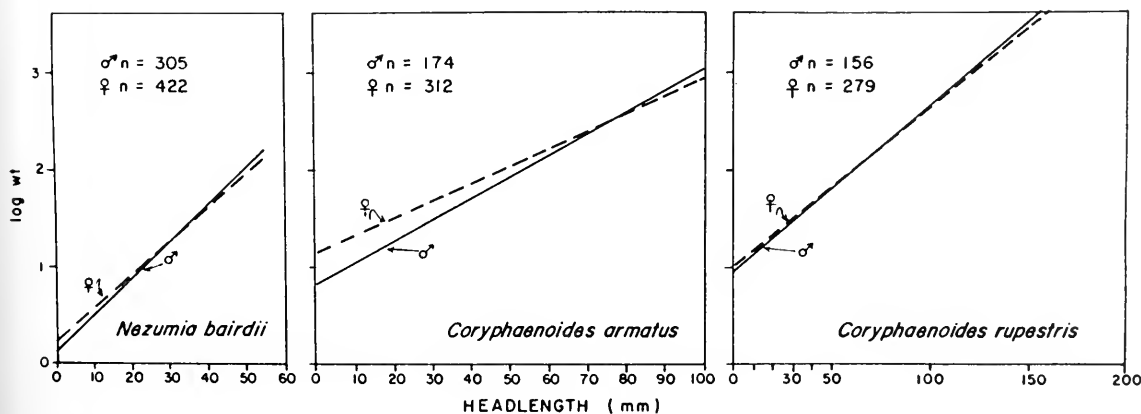

FIGURE 2.—The log (wt) versus head length regressions for *Nezumia bairdii*, *Coryphaenoides armatus*, and *Coryphaenoides rupestris*.

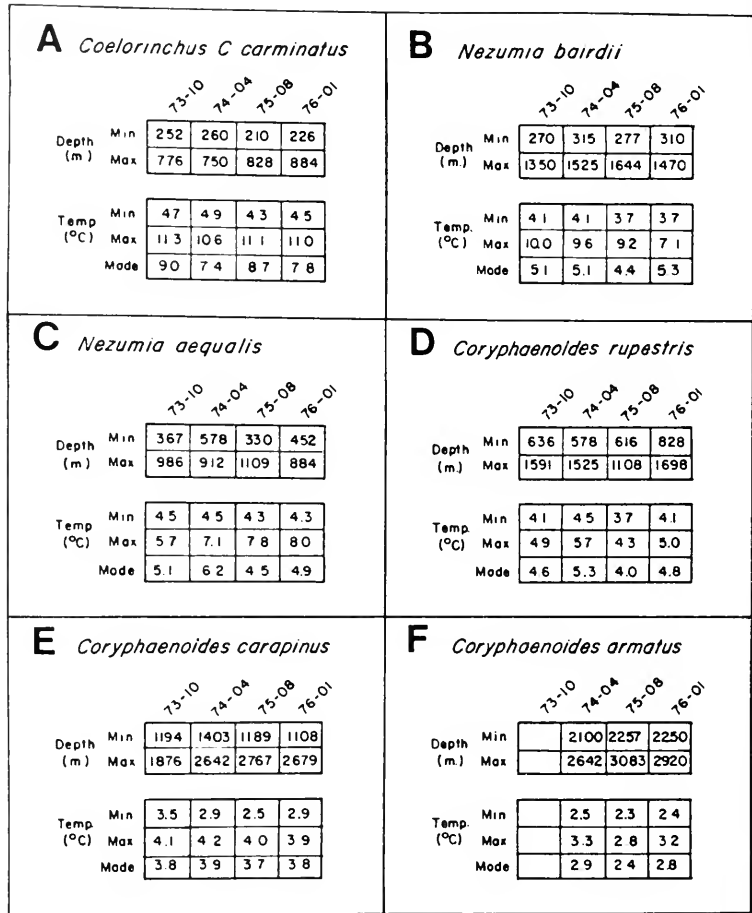

FIGURE 3.—Minimum and maximum depth of capture, with minimum, maximum, and modal temperatures of capture for each species and each cruise.

TABLE 1.—The coefficient of determination ( $r^2$ ) for the change in head length with change in depth regression lines.

Species	Cruises				
	Jan. 76-01	June 73-10	Sept. 75-08	Nov. 74-04	Combined cruises
<i>Coelorinchus c. carminatus</i>	0.006	0.23	0.13	0.44	0.23
<i>Nezumia aequalis</i>	0.45	0.15	0.62	0.14	0.37
<i>Nezumia bairdii</i>	0.12	0.50	0.44	0.49	0.47
<i>Coryphaenoides rupestris</i>	0.04	0.19	0.08	0.11	0.02
<i>C. carapinus</i>	0.59	0.005	0.30	0.37	0.35
<i>C. armatus</i>	0.000	—	0.05	0.000	0.14

tributed to sampling artifacts and the relatively narrow depth range (674 m) of this species.

The analysis of variance showed a significant difference in mean depths of the head length groups ( $F = 35.9$ ,  $F(\text{table}; \alpha = 0.01) = 1.79$ ). The Student-Newman-Keuls test divided the group into two

significantly different subsets; one 10-50 mm HL and the other 51-70 mm HL.

Other macrourids (*N. bairdii* and *N. aequalis*) had high biomass but low numerical abundance at the deep end of their ranges, indicating the presence of a few large specimens there. This was not the case for *C. c. carminatus* (Fig. 5). The occurrence of fish distributing by size can be obscured if the larger members of the population traverse the entire range. The biomass of the species would be elevated at the shallower depths so that a consistent biomass level is present throughout the depth range. Comparison of Figure 4 with Figure 5 shows that although the mean depth of capture for this species increased with head length, the larger fish occurred over the entire depth range. This pattern is important because it shows that for some fishes the "bigger-deeper" phenomenon described by Polloni et al. (1979) may really be a "smaller-shallower" phenomenon. A plot of mean fish weight against depth as used by Polloni

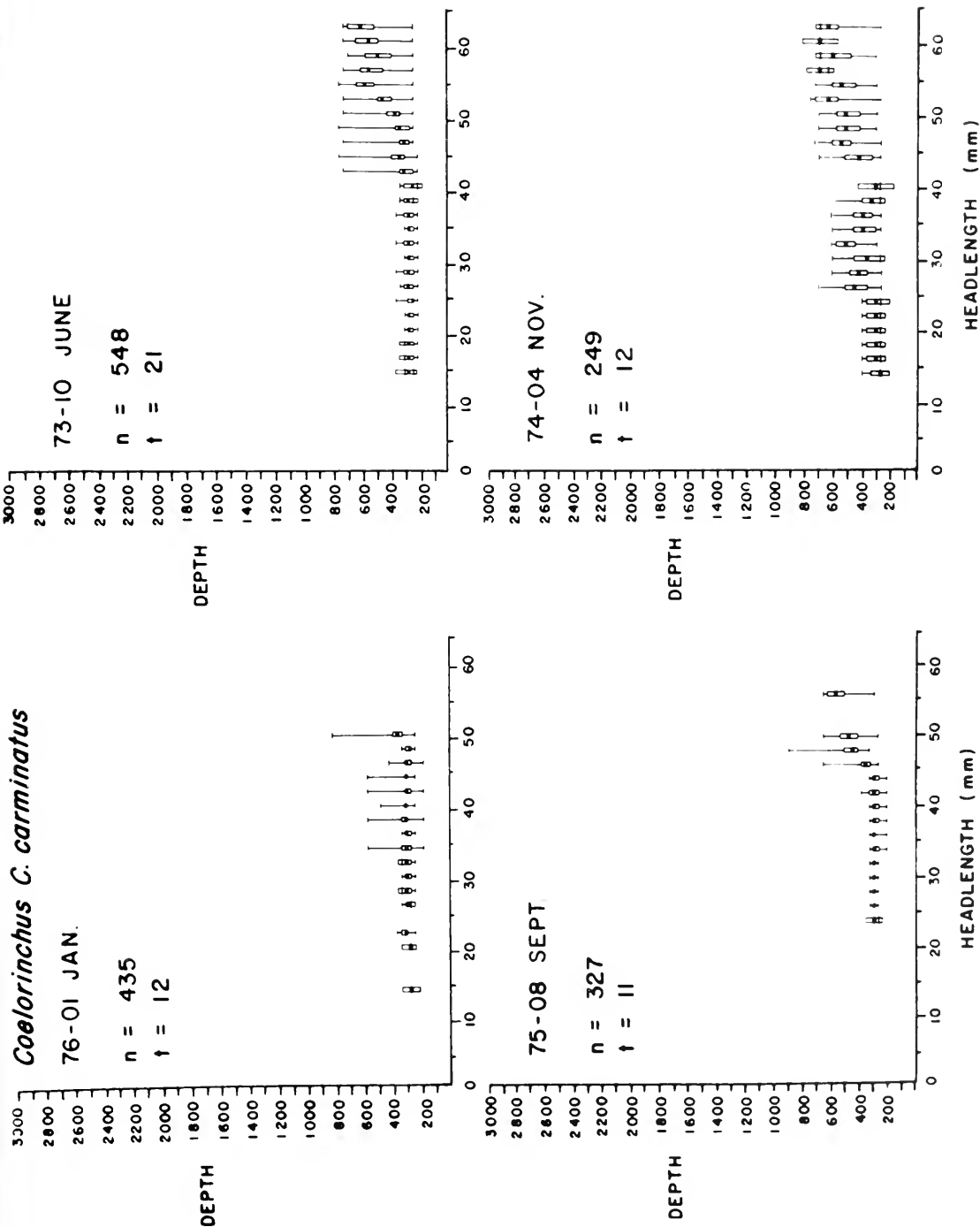

FIGURE 4.—Graph of head length versus depth, by cruise, for *Coelorinchus c. carminatus*. The dot is the mean, the rectangle is the 95% confidence interval, and

the lines each enclose the range. n = the number of specimens and t = the number of trawls.

*Coelorinchus c. carminatus*

FIGURE 5.—The distribution of log transformed ( $\log(x+1)$ ) abundance and weight of *Coelorinchus c. carminatus* at each station, plotted against depth.

et al. (1979) may have a highly positive slope, but these data are impossible to interpret without information about length-frequency patterns with depth.

The temperatures at which *C. c. carminatus* were captured varied from 4.3° to 11.3°C (Fig. 6). The average temperature of collection was 7.6°C.

*Nezumia aequalis* (Gunther 1878)

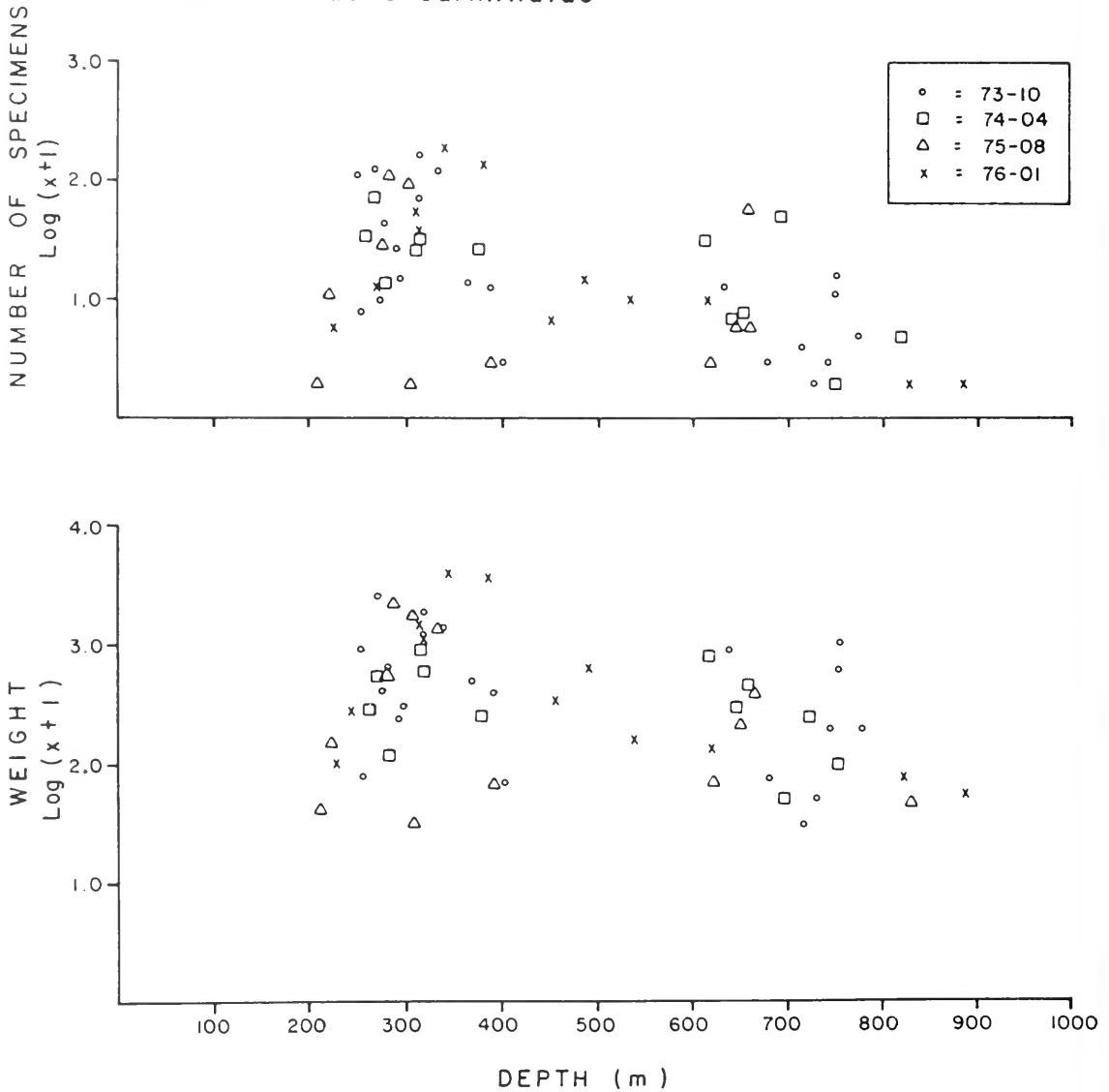
*Nezumia aequalis* is a closely related congener of

*N. bairdii* and is found primarily south of the study area (Marshall and Iwamoto 1973). *Nezumia aequalis* attains a head length of at least 53 mm and has a depth distribution of 200-1,000 m. Its

FIGURE 6.—The temperature range for each species, by cruise. The dot designates the modal temperature, Ccc. - *Coelorinchus c. carminatus*, N.b. - *Nezumia bairdii*, N.a. - *Nezumia aequalis*, Cr. - *Coryphaenoides rupestris*, Cc. - *Coryphaenoides carpinus*, Ca. - *Coryphaenoides armatus*.



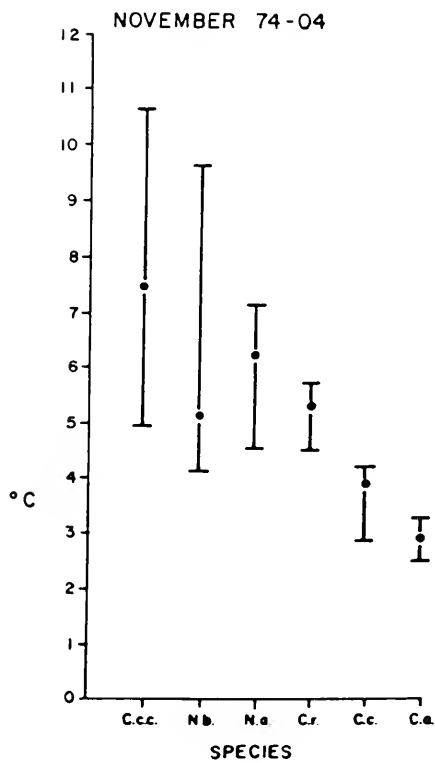
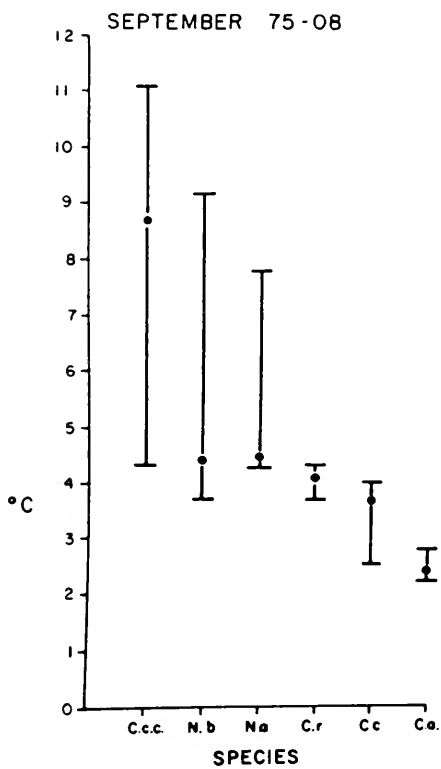
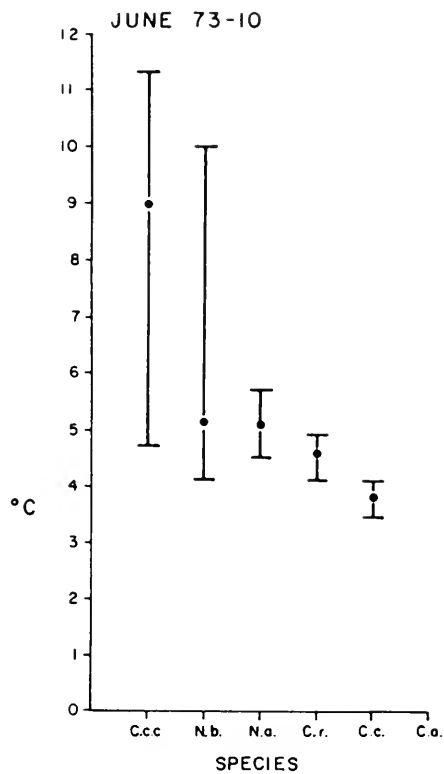
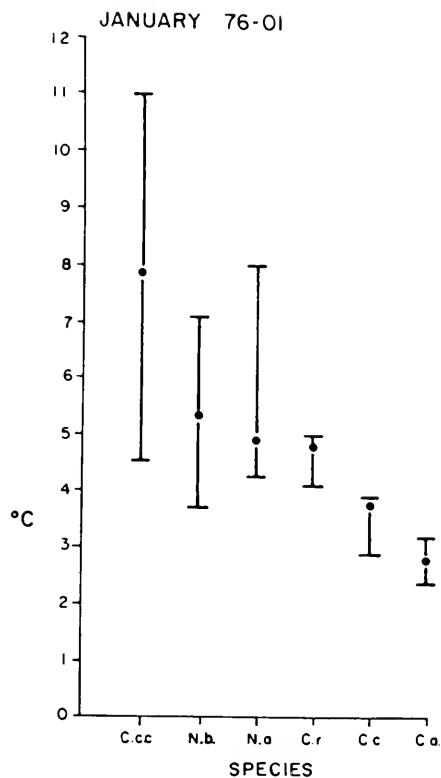

geographic range is listed as from the Faroe bank to northern Angola in the eastern Atlantic, the Mediterranean, and from Davis Straits to northern Brazil in the western Atlantic (Marshall and Iwamoto 1973).

In the Norfolk Canyon area the depth of capture of *N. aequalis* was from 330 to 1,109 m. The greatest number in a trawl was 40 in November of 1974, and the highest biomass per trawl was 300 g in September 1975. *Nezumia aequalis* comprised up to 8.9% of a trawl catch by number and 3.1% by weight. The analysis of variance of the mean depths of the head length groups gave a *F* value of 3.32 (*F*(table;  $\alpha = 0.01$ ) = 2.11). The Student-Newman-Keuls analysis showed only one subset, probably because of the low sample size. Examination of Figure 7 suggests head length increased with depth, and the slope of the line was significantly different from zero.

Although its bathymetric range was extensively sampled, densities were low and few mature specimens were captured (Fig. 8). These findings are in contrast to the distribution and abundance of its congener, *N. bairdii*, suggesting competitive exclusion. Alternately, Norfolk Canyon populations of *N. aequalis* may represent expatriation from denser populations in the Gulf of Mexico or on the Blake Plateau.

The temperature range for *N. aequalis* captured in the Norfolk Canyon area was from 4.3° to 8.0°C (Fig. 6). The average temperature of collection was 5.3°C.

#### *Nezumia bairdii* (Goode and Bean 1877)

*Nezumia bairdii* is a relatively small macrourid with a reported head length of up to 60 mm (Marshall and Iwamoto 1973). During our study the head lengths varied from 12 to 66 mm with the weight of the largest specimen being 295 g. The geographic range of *N. bairdii* extends from the Straits of Florida north to the Grand Banks (Marshall and Iwamoto 1973). *Nezumia bairdii* is captured commonly between 90 and 183 m in the northern part of its range and appears to undergo tropical submergence because it is found primarily between 548 and 731 m in the southern parts of its range. The inclusive depth range is 90-2,285 m (Goode and Bean 1885; Marshall and Iwamoto 1973). One anomalous catch at a depth of 16.5 m was recorded in Vineyard Sound (Bigelow and Schroeder 1953), but this was most likely a discard from a commercial fishing vessel.

Within the study area the depth of capture ranged from 270 to 1,644 m (Fig. 3). The largest catch in

a half hour tow was 76 fish and the greatest biomass per half hour tow was 5.7 kg. *Nezumia bairdii* comprised up to 30% of the demersal fish catch in number and up to 15% of the biomass.

In the January plot (Fig. 9), the head length increased slightly with depth. The regression line of the mean depth of each head length class showed a positive slope significantly different than zero. By June (Fig. 9) the regression line showed a highly significant positive slope and three distinct size groups separated by depth were evident. The first group included those fish <30 mm HL, the second group was from 30 to 42 mm HL, and the third group was >43 mm HL. The head lengths at the start of maturity for females (27 mm) and males (32 mm) correspond well with the dividing line between size groups one and two, as defined by depth distribution. Also, *N. bairdii* females and males can be fully mature at 44 and 45 mm HL, respectively (Fig. 10). These values are close to the division between the second and third size groups noted above. The three size groups appear to reflect maturity stages as well as size differences, and this may contribute to the bathymetric differences. The first group consisted of all immature fish that were not found in deep water in June. The second group could be termed the transitional group because it included fish that were just starting to mature and those more highly developed. Since this group included such a diverse spectrum of maturity, it encompassed portions of the depth ranges of both immature and mature fish. The third group consisted of all mature fish and was not found in water shallower than approximately 600 m in June. In September, the larger fish had reached their deepest limit, and immature *N. bairdii* were virtually absent deeper than 1,000 m. By November (Fig. 9), the largest fish were returning to shallower water to complete what appears to be a seasonal migration cycle.

Examination of histological sections of gonads showed that the only spent *N. bairdii* were captured on the September cruise. Although no ripe fish were caught on any cruise, these spent fish suggest that *N. bairdii* spawns in July or August, coincident with the time when the mature fish are inhabiting their deepest level.

Marshall's (1965) hypothesis concerning reproduction of certain macrourids states that fertilization takes place at the bottom. Subsequently the eggs, which are buoyant, develop and hatch on their way upward to the seasonal thermocline. The larvae then maintain themselves just below the thermocline, in order to take advantage of the plankton that tends to accumulate there in the density gradient. In con-

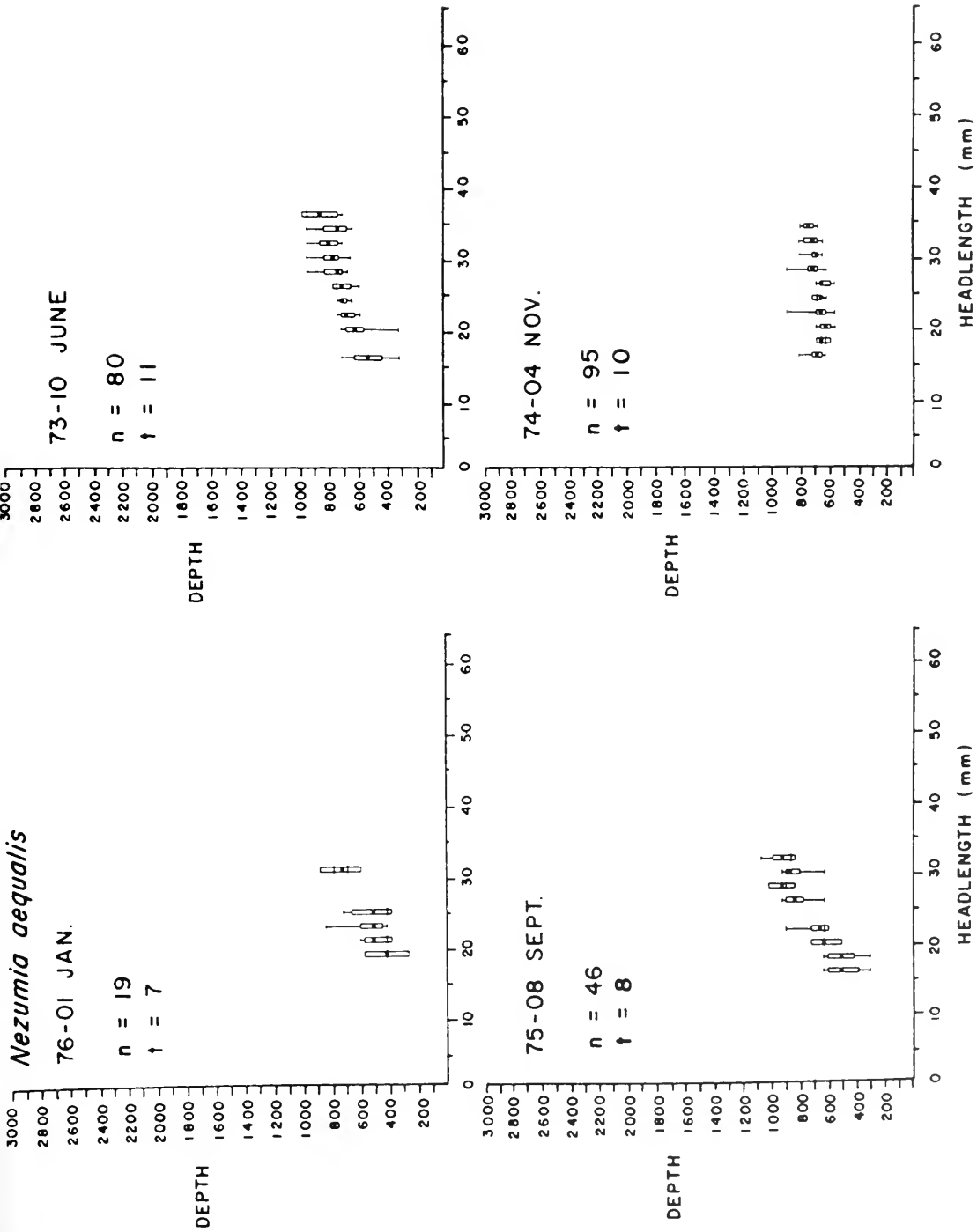

FIGURE 7.—Graph of head length versus depth, by cruise, for *Nezumia aequalis*. The dot is the mean, the rectangle is the 95% confidence interval, and the lines enclose the range. n = the number of specimens and t = the number of trawls.

*Nezumia aequalis*

FIGURE 8.—The distribution of log transformed ( $\log(x+1)$ ) abundance and weight of *Nezumia aequalis* at each station, plotted against depth.

junction with Marshall's hypothesis, the advantages of the type of seasonal migration suggested by our data are twofold. First, the migration concentrates the reproductively mature fish in a limited area thereby increasing the probability of a sexual encounter. Second, it allows additional time for development of eggs on their rise to the upper layers, and concurrently lessens the chance that the egg will

travel through the thermocline and be removed from the area by the more active surface currents (although egg density could be such that neutral buoyancy occurs at the thermocline). If these suggestions hold true, it would be expected that the larvae would benefit from the high productivity and warmer temperatures of the surface waters and have enhanced growth. As productivity declines in the late

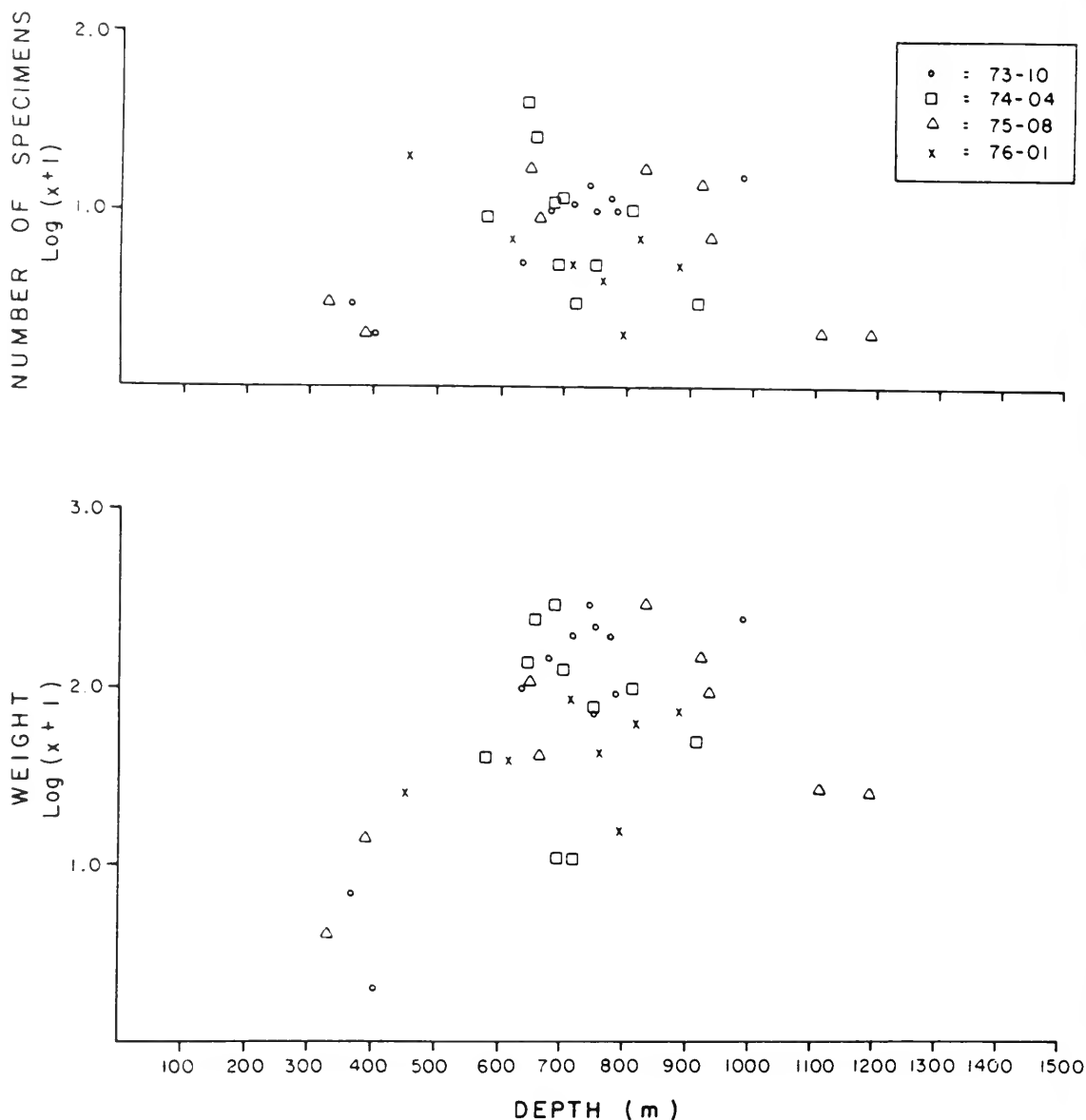
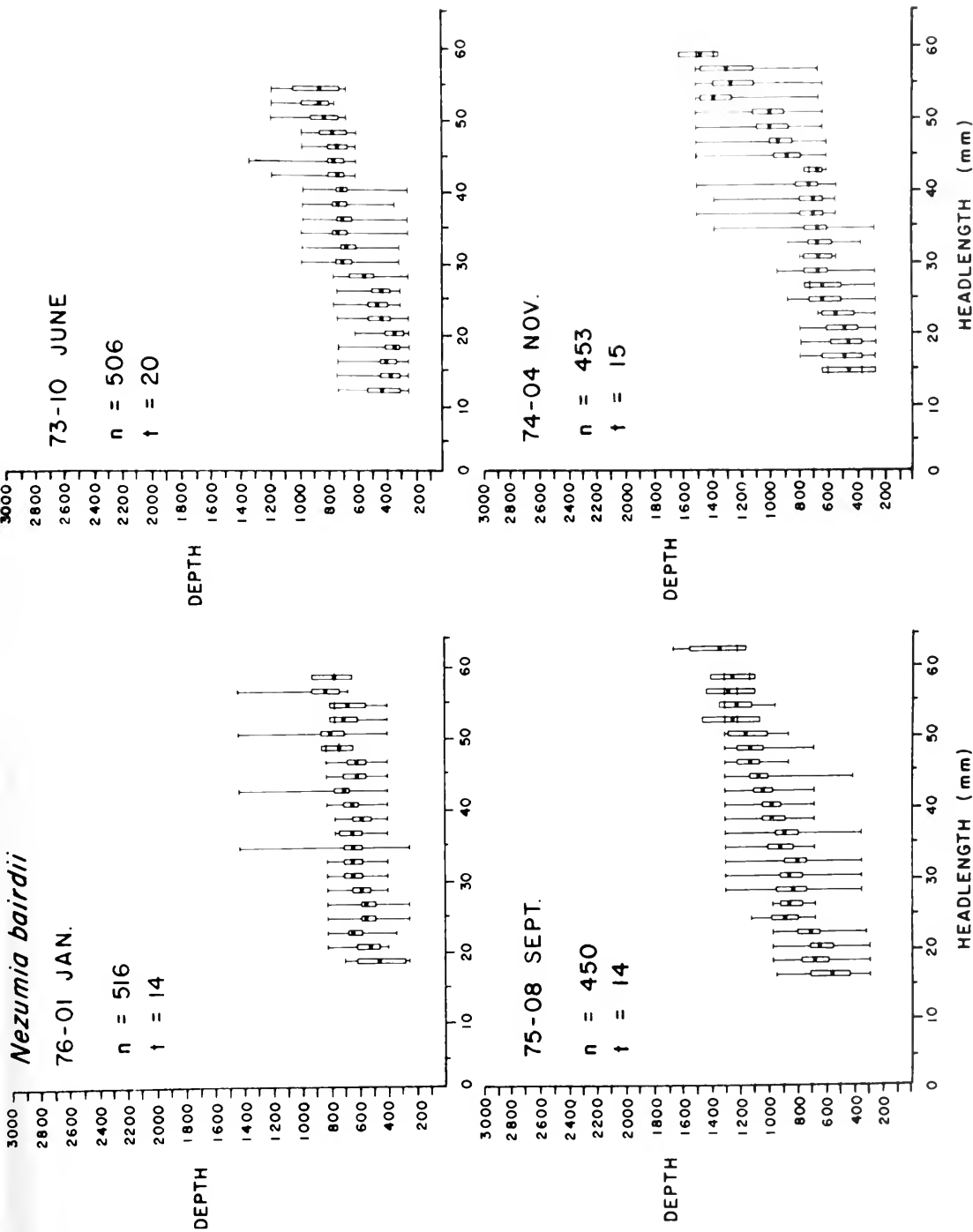

FIGURE 9.—Graph of head length versus depth, by cruise, for *Nezumia bairdii*. The dot is the mean, the rectangle is the range. n = the number of specimens and t = the number of trawls.

fall and the larvae become larger, they would drop out of the water column to the bottom. Length frequencies of *N. bairdii* (Fig. 11) suggested that

recruitment of young occurred between the months of November and January. No small *N. bairdii* were captured benthically between the proposed deep-water spawning time and the shallower January recruitment spike.

The larger *N. bairdii* occurred deeper than the small ones (Figs. 9, 12) demonstrating the "larger-deeper" phenomenon.

The age and growth analysis of *N. bairdii* presented many problems. Due to the thickness of the sacculus otolith a thin cross section had to be removed from each. After examination of the thin sections, two problems became apparent. First, all of the smaller specimens had two hyaline zones. Because the specimens were obtained on the winter (January; 76-01) cruise, all had hyaline zones around the perimeter as expected. There was, in addition, a well-defined hyaline zone in the interior of all the otoliths obtained from the smallest fishes available ( $\leq 27$  mm HL). Subsequently two hypotheses were proposed: 1) a period of hyaline zone formation (slow growth) occurred between June-July (spawning) and January, and 2) young *N. bairdii* were not available to our trawl until the second winter hyaline zone was forming (age about 1.5 yr).

The first hypothesis was discarded because a period of slow growth within the first 6 mo would have no apparent selective advantage. It should be noted, however, that since the larvae of *N. bairdii* were probably pelagic, a change from planktonic feeding to benthic feeding would have occurred during that time. Such an ontogenetic change occurs in related gadid fishes. Musick (1969) described the

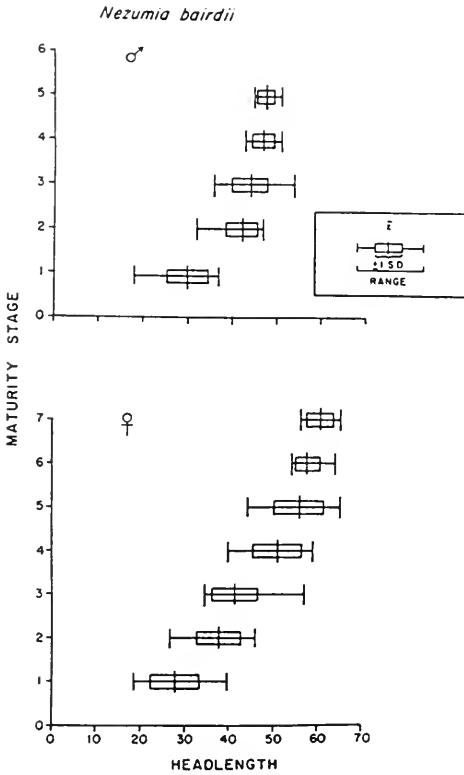

FIGURE 10.—The gonadal maturity stages plotted against head length for *Nezumia bairdii*.

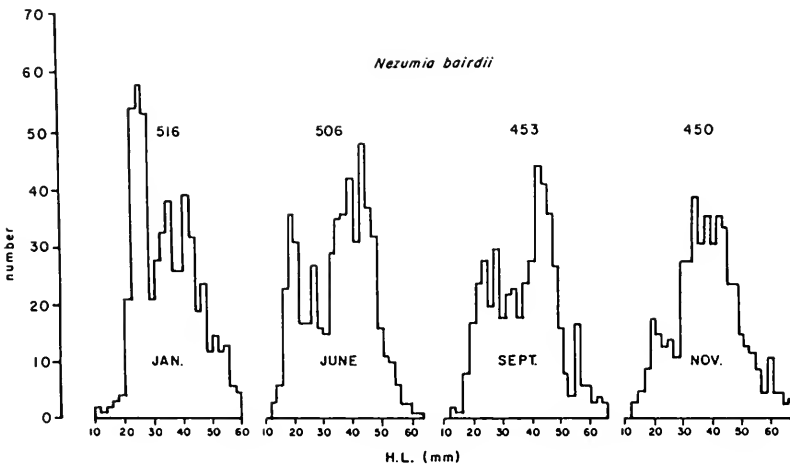

FIGURE 11.—Head length frequency distribution for *Nezumia bairdii* by cruise. The number above each cruise indicates the number of specimens.

ontogenetic transition for *Urophycis chuss* and suggested that the transition from pelagic to demersal adaptations in morphology and behavior occurred within a period of 12-24 h. This short time span would be unlikely to be reflected in macroscopic hyaline band formation. Therefore, the second hypothesis appeared more likely, and led to the conclusion that the juvenile *N. bairdii* remained pelagic until the second winter and then descended from the water column to the bottom where they were captured.

The second problem was that in the older fish (>4 yr) the outer bands were very difficult to define with any degree of confidence. The percentage of unreadable otoliths increased from about 5% in fish  $\leq 4$  yr to about 50% in fish >4 yr. The mean head length of *N. bairdii* with four bands was 42.7 mm, the size at the onset of sexual maturity. Growth may have slowed down to compensate for the energy needed for reproduction, and produced spatially close and obscure hyaline zones. Therefore spawning checks may have had considerable influence on

### *Nezumia bairdii*

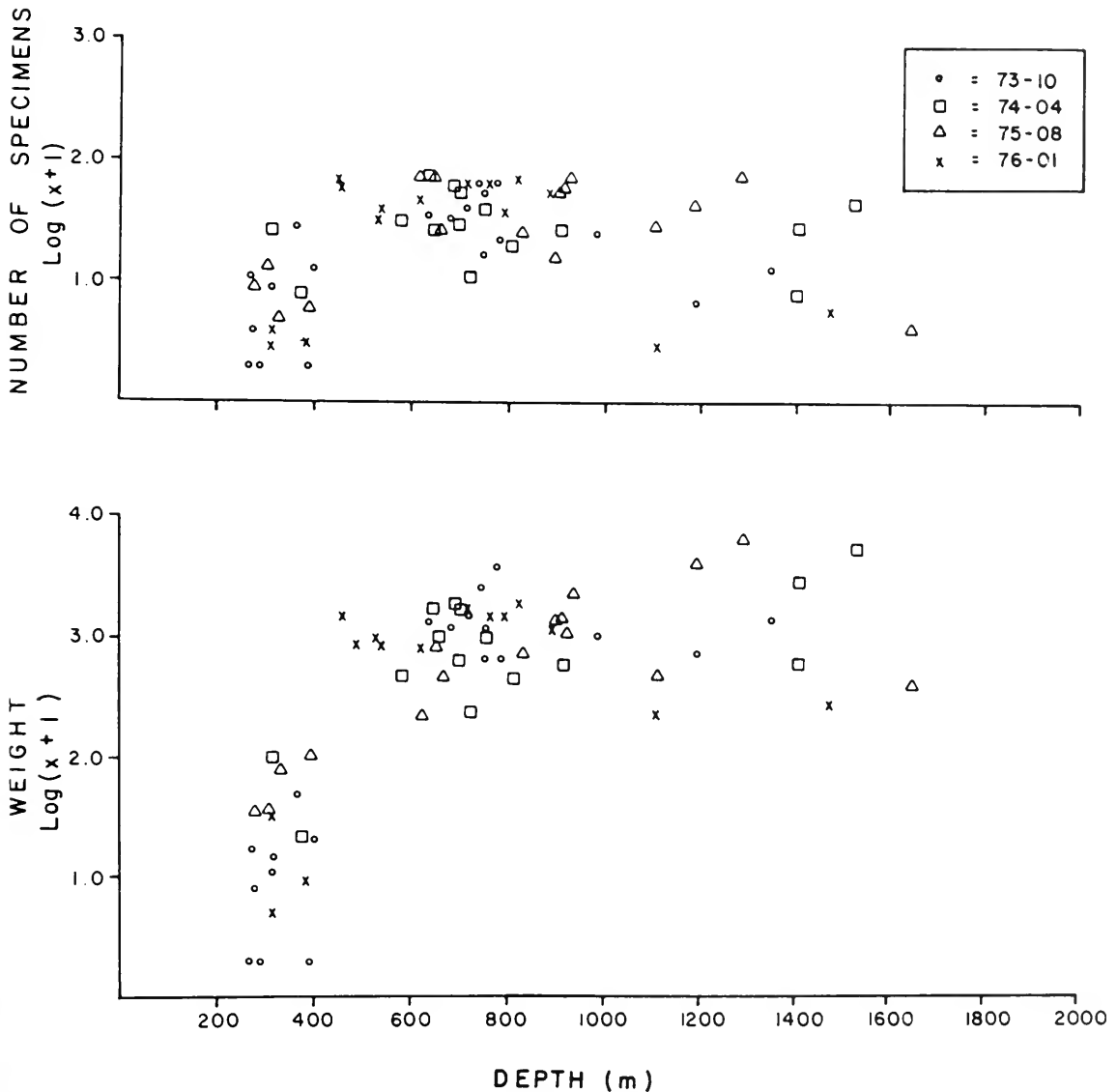

FIGURE 12.—The distribution of log transformed ( $\log(x+1)$ ) abundance and weight of *Nezumia bairdii* at each station plotted against depth.

the interpretation of the hyaline zones.

Using the length at age data, a Walford growth transformation graph was plotted (Beverton and Holt 1957). Instead of calculating the  $L_{\infty}$ , we used our largest specimen (66 mm HL). The estimate of Brody's coefficient ( $K$ ) obtained from this graph was 0.276. Using the Walford graph, the head lengths for those presumed ages  $>4$  yr could be iteratively generated. This method gave a maximum age of approximately 11 yr. The von Bertalanffy growth equation for length was

$$L_t = 66 (L - e^{-0.276 (T+0.16)}).$$

Rannou (1976) studied the age and growth of a congener (*N. sclerorhynchus*) that occupies a similar depth range in the western Mediterranean. He calculated a  $K$  coefficient of 0.16 and an  $L_{\infty}$  of 42.31 mm HL. Thus, although this species is smaller than *N. bairdii*, it has a much slower growth rate, probably attributable to lower productivity in the western Mediterranean compared with the slope off the mid-Atlantic coast of the United States (Koblentz-Mishke et al. 1970).

The length-weight regression for *N. bairdii* (Fig. 2) was analyzed. The solution of the line for *N. bairdii* males was  $\log(\text{weight}) = 0.038(\text{head length}) + 0.083$ ,  $r^2 = 0.810$ , and for females it was  $\log(\text{weight}) = 0.035(\text{head length}) + 0.216$ ,  $r^2 = 0.760$ .

These length-weight relationships are not unlike those summarized by Gordon (1979) for other small macrourids (*Coelorinchus coelorinchus*, *C. occa*, and *Nezumia aequalis*).

In summary, larger *N. bairdii* were captured deeper and the minimum and maximum depths of capture off the mid-Atlantic coast were 270 m and 1,644 m. The fish seasonally migrated to deeper water with the mature fish occurring deeper than immature fish. The males matured at about 45 mm HL and the females became mature at 44 mm HL. *Nezumia bairdii* probably spawned pelagic eggs in July and August and the young apparently remained pelagic until the second winter (January), when they first appeared in bottom trawls. The maximum age of *N. bairdii* was presumed to be 11 yr. The temperature range for *N. bairdii* was from 3.7° to 10.0°C, with the average temperature of capture being 5.3°C (Fig. 6).

#### *Coryphaenoides rupestris* (Gunnerus 1765)

*Coryphaenoides rupestris* is a large macrourid that reaches a total length of about 100 cm (Savvatimskii 1971; Nodzinski and Zukowski 1971; Marshall

and Iwamoto 1973), and is found on both sides of the North Atlantic. In the eastern North Atlantic it ranges from the Trondhjem area to the Bay of Biscay. In the western North Atlantic it is reported to occur from Davis Strait to ca. lat. 37°N (Marshall and Iwamoto 1973), although two specimens (81 and 100 mm HL) were captured by C. Richard Robins<sup>5</sup> at lat. 23°29.8-32.0'N, long. 77°05.5'W. The depth distribution of *C. rupestris* varies from about 180 to 2,200 m (Leim and Scott 1966) with highest abundance occurring between 400 and 1,200 m (Marshall and Iwamoto 1973).

*Coryphaenoides rupestris* is rarely used as a food fish in the United States, but the German Democratic Republic, the Soviet Union, and Poland fish commercially for it in the western North Atlantic. In 1968, the Soviets recorded a harvest of 30,000 tons of *C. rupestris* off Labrador, Baffin Island, and Greenland (Nodzinski and Zukowski 1971). The catches of this macrourid were reported to increase during the second half of the year as the catches of redfish and cod decreased (Savvatimskii 1971).

*Coryphaenoides rupestris* was captured in the Norfolk Canyon area at depths of 578-1,698 m (Fig. 3). Savvatimskii (1971) reported that *C. rupestris* is known to form dense aggregations off the coast of Labrador. In November 1974 an anomalous catch of over 6,000 *C. rupestris* with a total weight  $>1,000$  kg was obtained in a half hour tow in the Norfolk Canyon area. A random subsample of 1,000 specimens was examined and no sexually mature fish were found. Although the head length ranged from 59 to 110 mm, the length-frequency curve was strongly unimodal at 76 mm. The greatest number and biomass of *C. rupestris* caught in "normal" half hour tows was 128 fish comprising 39% of the individuals and 68 kg, and representing 65% of the total catch by weight. The largest specimen captured had a head length of 155 mm.

The head length distribution by depth and by cruise (Fig. 13) suggested a mass movement of *C. rupestris* toward deeper water during the summer months, and a reciprocating movement to shallower water in the winter. In January, the majority of *C. rupestris* was captured between 700 and 800 m, while in June and September there appeared to be a movement toward deeper water. By November the depths of capture decreased and were similar to those of January, and the slope of the head length-depth regression for *C. rupestris* was significantly

<sup>5</sup>C. Richard Robins, Rosenstiel School of Marine and Atmospheric Science, Division of Biology and Living Resources, 4600 Rickenbacker Causeway, Miami, FL 33149.



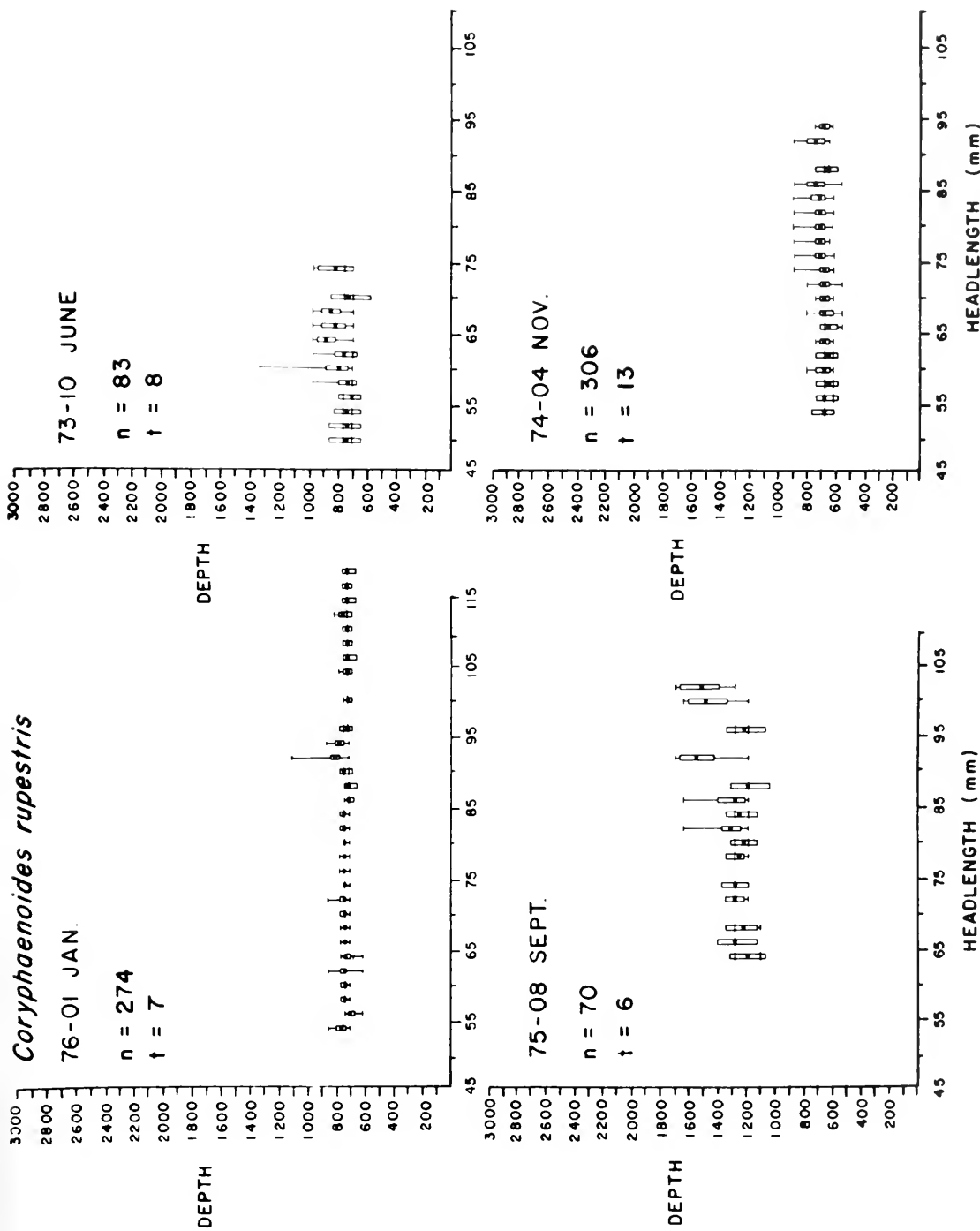

FIGURE 13.—Graph of head length versus depth, by cruise, for *Coryphaenoides rupestris*. The dot is the mean, the rectangle is the 95% confidence interval,

and the lines enclose the range. n = the number of specimens and t = the number of trawls.

different from zero. There was no apparent seasonal size segregation evident as in *Nezumia bairdii*, but the graph of numerical abundance against depth also indicated a general seasonal movement down slope in September (Fig. 14). Similar seasonal movements have been shown by Savvatimskii (1971) off Newfoundland.

Females may be mature from about 104 mm HL and males from 71 mm HL (Fig. 15).

Podrazhanskaya (1971) supported Zarkharov and Mokuu's (1970) theory that *C. rupestris* spawns in Icelandic waters. She stated that *C. rupestris* spawn near Iceland and the Irminger Current could transport the eggs and larvae to Greenland. From Greenland the western branch of the West Greenland Current would transport larvae to Baffin Island where the Labrador Current would move the fish down to the Newfoundland banks. When the fish in the Newfoundland area attain a size of 40-50 cm total length (TL), they start to migrate back to Iceland. Podrazhanskaya gave the modal lengths for *C. rupestris* in each area. The smallest fish (modal TL of 45-47 cm) were found on the Northern Newfoundland bank and the largest (modal TL of 98-100 cm) were found around Iceland. Fish from between Baffin Island and West Greenland had modal lengths

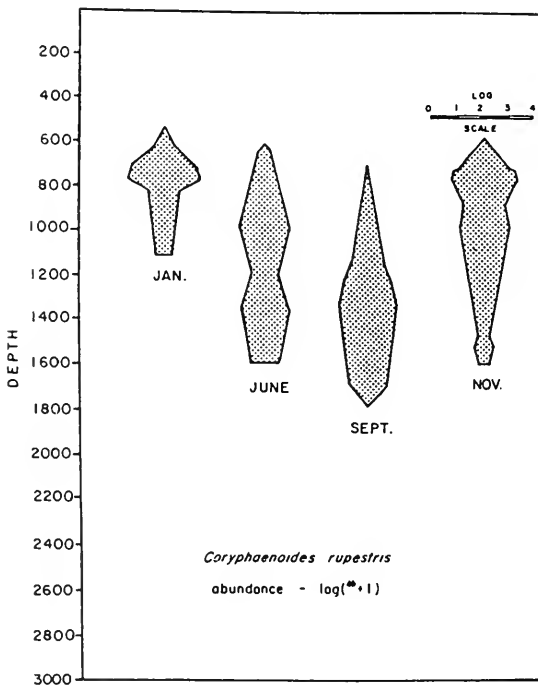

FIGURE 14.—Diagram of depth plotted against the log transformed ( $\log(s+1)$ ) numerical abundance, by cruise, for *Coryphaenoides rupestris*.

of 60-62 and 78-80 cm, respectively. Podrazhanskaya's (1971) modal-length data for each area in conjunction with Savvatimskii's (1971) age and growth data reveal that the modal-length fish off the Newfoundland banks are about 6 yr old, off Baffin Island they are 9-10 yr, around Greenland they are 15-16 yr, and at Iceland they are over 20 yr. If a spawning migration occurs, it does not preclude spawning by some members of the population not undergoing migration, thereby accounting for the small percentage of ripening fish to be found outside of their primary spawning area.

If Podrazhanskaya's migration theory is valid, some interesting observations can be made. First, the *C. rupestris* found on the east coast of the United States may be derived from the larvae that failed to metamorphose by the time they reached the Newfoundland banks and continued to drift southwest. The predominant currents move south and west from Newfoundland to Cape Hatteras (Worthington 1964; Webster 1969; Gatién 1976), thereby affording a means of transport for unmetamorphosed larvae (Wenner and Musick 1979). Additionally, the modal length for the 7,011 *C. rupestris* caught in the Nor-

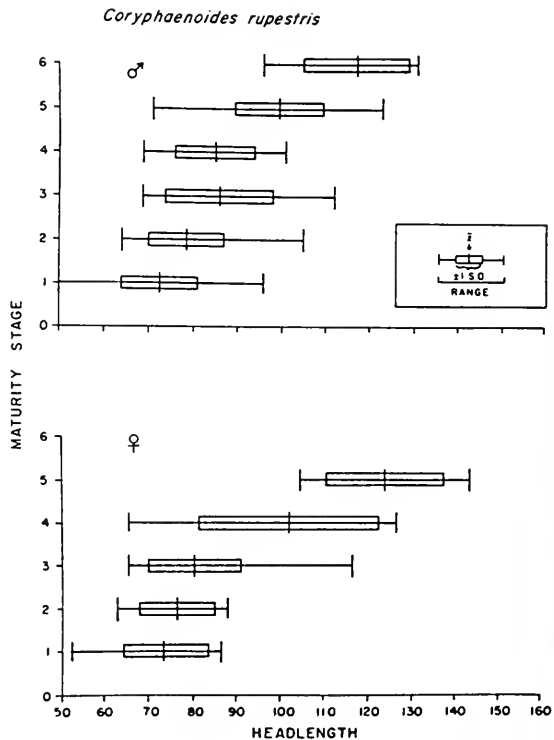

FIGURE 15.—The gonadal maturity stages plotted against head length for *Coryphaenoides rupestris*.

folk Canyon area was 46 cm, exactly that which was found for *C. rupestris* in the Newfoundland bank area. However, no small *C. rupestris* were captured in the Norfolk Canyon area. We found only 2 fish with a head length <40 mm (24 cm TL) and only 10 fish with head length <50 mm (30 cm TL).

The regression line for head length against log (weight) (Fig. 2) was analyzed. The solution for *C. rupestris* males was  $\log(\text{weight}) = 0.023(\text{head length}) + 0.82$ ,  $r^2 = 0.898$ , and for females it was  $\log(\text{weight}) = 0.018(\text{head length}) + 1.16$ ,  $r^2 = 0.885$ .

Unfortunately these length-weight data cannot be compared directly with those summarized by Gordon (1979) because we measured head lengths in our study and he gave standard lengths. We do not have the data at present to compute the regression for head length on standard length for this species.

Temperatures at which *C. rupestris* were captured near Norfolk Canyon ranged from 3.7° to 5.7°C (Fig. 6). The average temperature was 4.9°C.

*Coryphaenoides rupestris* does not follow the "larger-fewer-deeper" pattern shown for *N. bairdii* in Norfolk Canyon because it migrates seasonally (Fig. 16) and the larger specimens traverse the entire bathymetric range (Fig. 13).

In summary, *C. rupestris* migrated seasonally to shallower water in the fall and early winter. Catch per unit effort increased in the fall and winter, and a dense aggregation was found in the fall. Podrazhanskaya's (1971) spawning and migration theory appears feasible but further intensive study is needed. No ripe, running, or spent fish were captured in the Norfolk Canyon area out of 7,011 individuals examined. There was a trend for the larger *C. rupestris* to range deeper but not to the degree that was found in *N. bairdii*. It appears that the distribution of *C. rupestris* was more closely related to temperature than to depth, the species being found mostly within the 4°-5°C range.

#### *Coryphaenoides carapinus* (Goode and Bean 1883)

*Coryphaenoides carapinus* is another small macrourid which grows to about 390 mm TL, and is found on the lower slope and abyss from 1,000 to 3,000 m (Haedrich and Polloni 1976). In the western North Atlantic it has been found between Nova Scotia and Cape Hatteras (lat 37°N) and in the eastern Atlantic from lat. 50°N to the Equator. *Coryphaenoides carapinus* has also been reported from the mid-Atlantic ridge (Marshall and Iwamoto 1973).

In the Norfolk Canyon area *C. carapinus* was cap-

tured at 1,108-2,767 m (Fig. 3). The largest number caught in one trawl was 37 (total weight 550 g). These were captured in September 1975 at a depth of 1,803 m. *Coryphaenoides carapinus* comprised up to 23.4% of a catch in number, but only 4.3% in biomass. The maximum size captured was 90 mm HL.

*Coryphaenoides carapinus* tended to be larger at the lower end of its depth range (Fig. 17). The slope of the regression line for head length with depth was significantly different than zero. The coefficient of determination was 0.346.

Figure 18 displays low numbers and high variability in the capture of *C. carapinus* in relation to depth. The phenomenon of fewer, larger fish at the deeper part of the bathymetric range was evident but obscured because of the relatively small size of *C. carapinus*, low numbers, and contagious distribution.

*Coryphaenoides carapinus* was taken at temperatures of 2.5°-4.2°C with the average temperature being 3.7°C (Fig. 6). Some overlap in distribution with depth and temperature occurred among *C. carapinus*, *C. armatus*, and *C. rupestris*. Because *C. carapinus* is a small species and mostly a benthic feeder (Haedrich and Polloni 1976) and *C. armatus* and *C. rupestris* are large species that forage into the water column (Podrazhanskaya 1971; Haedrich and Henderson 1974; Smith et al. 1979), competitive interaction is probably low.

#### *Coryphaenoides armatus* (Hector 1875)

*Coryphaenoides armatus* is cosmopolitan in distribution, being found in all oceans except the Arctic. It commonly is found from 2,200 to 4,700 m, with a few specimens being captured as shallow as 282 m (Marshall and Iwamoto 1973). Larger individuals have been shown to forage off the bottom for pelagic prey (Haedrich and Henderson 1974; Pearcy 1975; Smith et al. 1979). *Coryphaenoides armatus* attains a size of 165 mm HL and over 870 mm TL (Iwamoto and Stein 1974). The largest specimen captured in Norfolk Canyon was 146 mm HL. Although *C. armatus* is one of the deepest living macrourids, it is rather well-known biologically because of its broad distribution and availability to deepwater trawls (Haedrich and Henderson 1974; Pearcy and Ambler 1974; McLellan 1977; Smith 1978).

*Coryphaenoides armatus* was taken in every successful trawl from 2,100 m to our deepest trawl of 3,083 m in the Norfolk Canyon area and virtually was confined to below the 3°C isotherm (Fig. 3). In

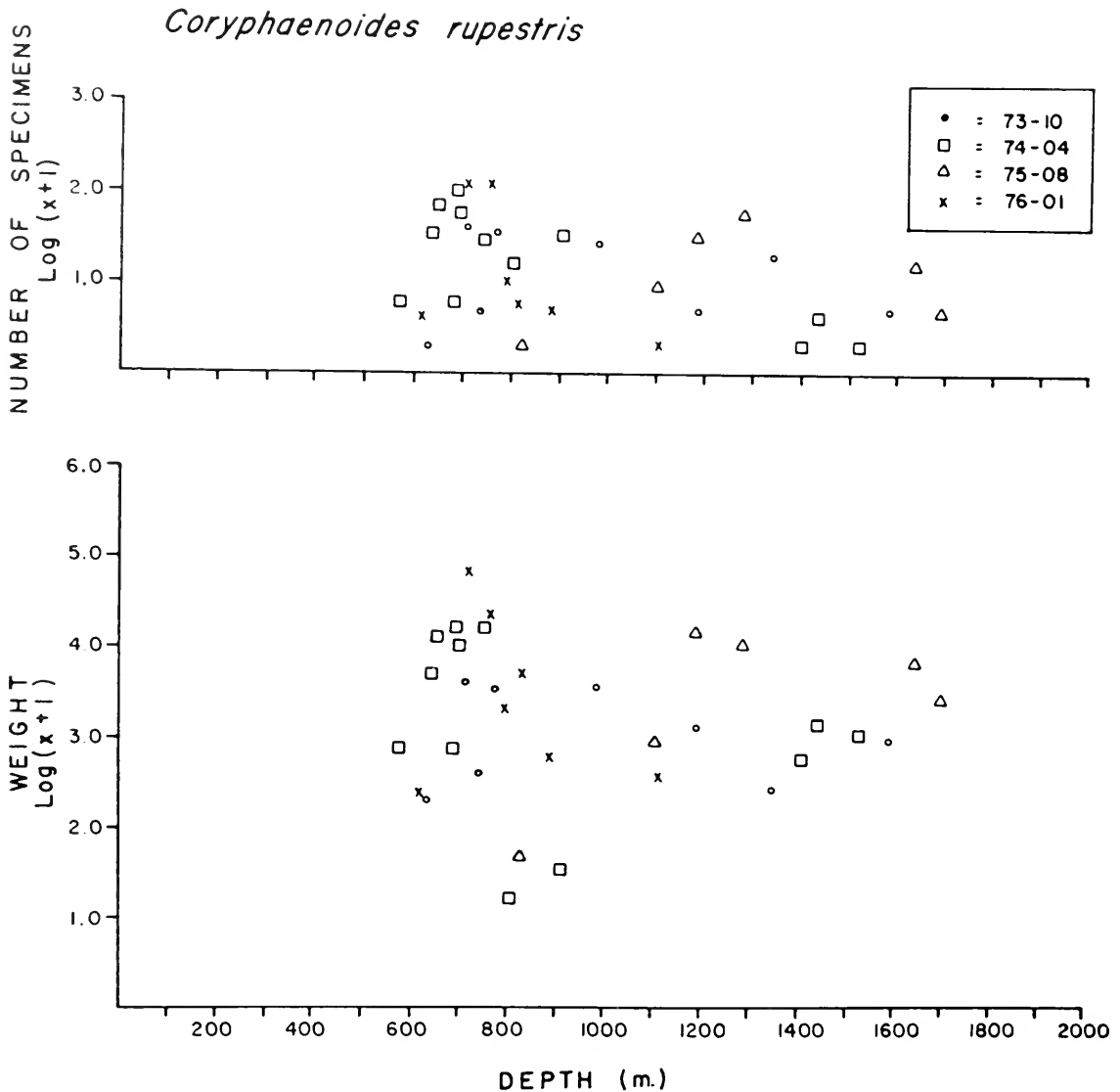

FIGURE 16.—The distribution of log transformed ( $\log(x+1)$ ) abundance and weight of *Coryphaenoides rupestris* at each station, plotted against depth.

one trawl *C. armatus* comprised 92.7% of the benthopelagic fish numbers and 93.4% of the biomass. In a 1-h trawl the maximum number captured was 76 and the maximum biomass was 21.2 kg.

No increase in fish size with increased depth was evident in the data (Fig. 19) (Table 1), and the slope of the regression line for head length with depth was not significantly different from zero. However, known depth range of *C. armatus* was incompletely sampled in this study, and further samples from greater depth may lead to other conclusions.

The distribution of numerical abundance and weight with depth are shown in Figure 20. *Coryphaenoides armatus* increased in abundance from 2,100 to 2,600 m, beyond which its abundance remained constant.

The regression lines for head length against log (weight) were analyzed (Fig. 2). The solution for males was  $\log(\text{weight}) = 0.017(\text{head length}) + 0.956$ ,  $r^2 = 0.967$ , and for females it was  $\log(\text{weight}) = 0.016(\text{head length}) + 1.029$ ,  $r^2 = 0.972$ .

The maturity stages of *C. armatus* against head

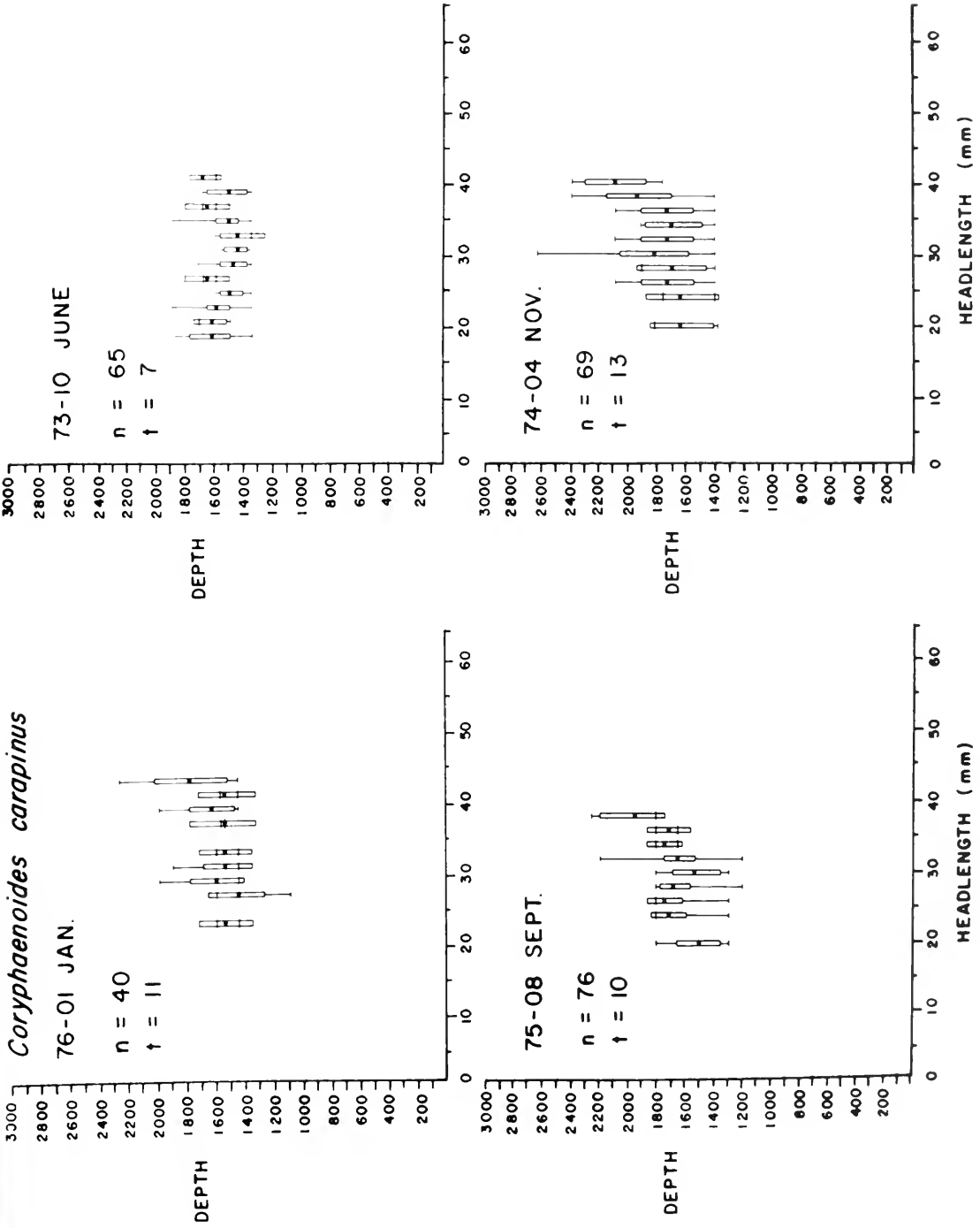

FIGURE 17.—Graph of head length versus depth, by cruise, for *Coryphaenoides carapinus*. The dot is the mean, the rectangle is the 95% confidence interval,

and the lines enclose the range. n = the number of specimens and t = the number of trawls.

*Coryphaenoides carapinus*

FIGURE 18.—The distribution of log transformed ( $\log(x+1)$ ) abundance and weight of *Coryphaenoides carapinus* at each station plotted against depth.

lengths are shown in Figure 21. No mature males were found, but the females matured at about 78 mm HL. *Coryphaenoides armatus* was captured in temperatures ranging from 2.3° to 3.3°C (Fig. 6). The majority of individuals, however, were caught between 2.4° and 2.9°C during the study and the average temperature was 2.6°C.

#### Distribution of Macrourids With Temperature

Depth distribution has been used commonly throughout the literature to delineate the habitat of various fishes, including macrourids (Macpherson 1981). The temperature ranges for each species in

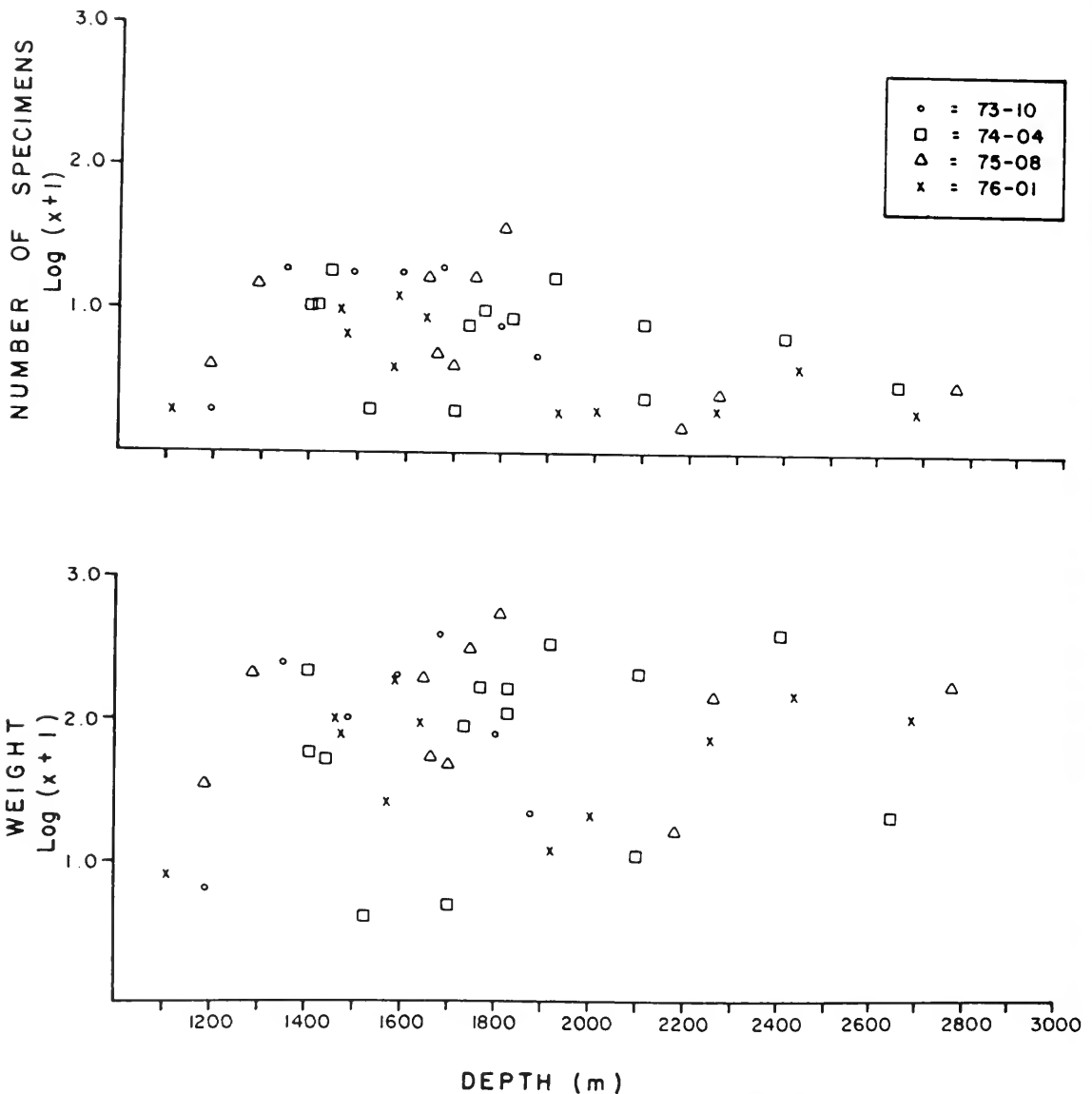
*Coryphaenoides armatus*

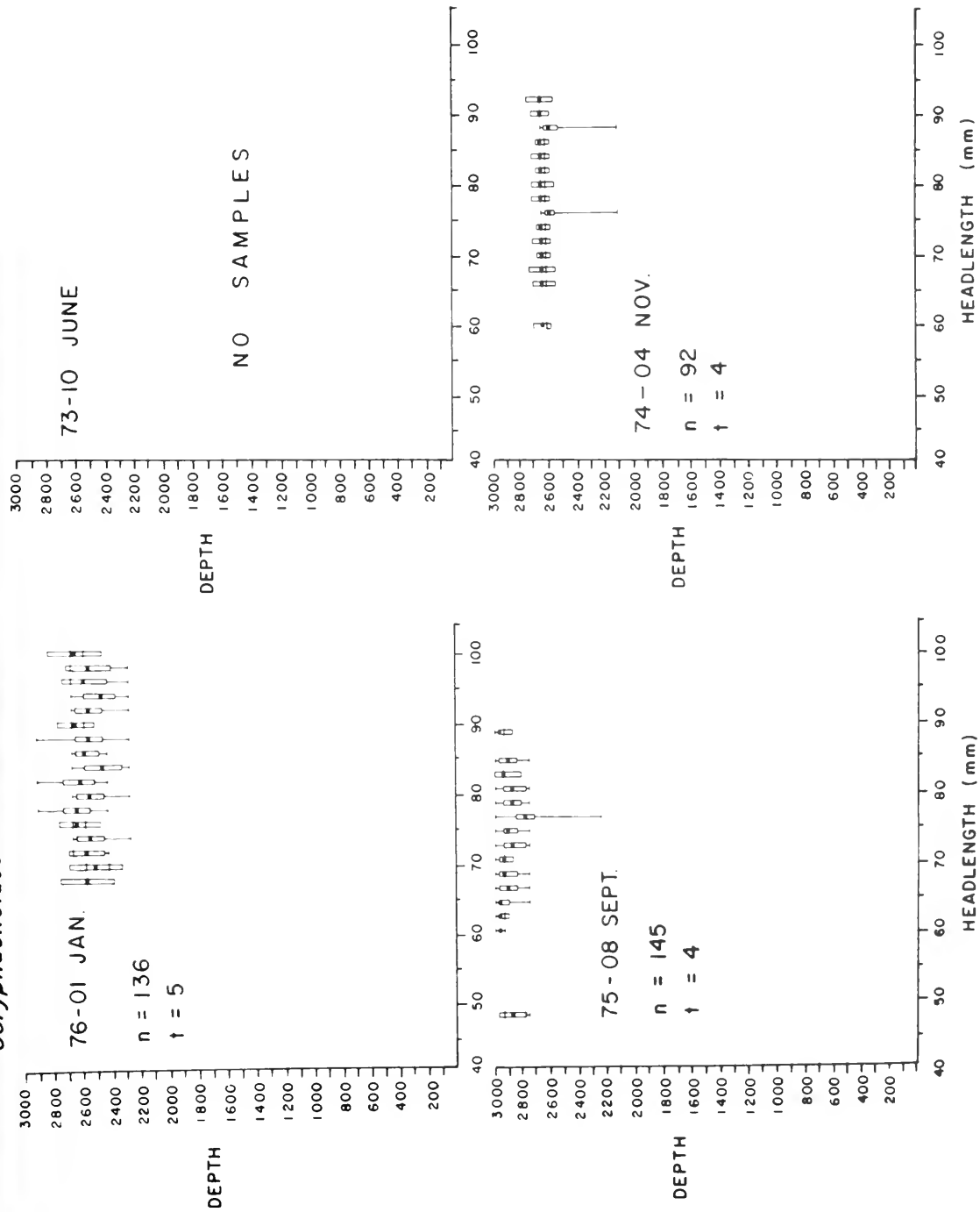

FIGURE 19.—Graph of head length versus depth, by cruise, for *Coryphaenoides armatus*. The dot is the mean, the rectangle is the 95% confidence interval, and the lines enclose the range.  $n$  = the number of specimens and  $t$  = the number of trawls.

*Coryphaenoides armatus*

FIGURE 20.—The distribution of log transformed ( $\log(x+1)$ ) abundance and weight of *Coryphaenoides armatus* at each station plotted against depth.

the present study showed some overlap, but the temperatures at which the population modes were found were fairly discrete except for *Nezumia aequalis*, *Nezumia bairdii*, and *Coryphaenoides rupestris*.

In Figure 6 the relationship of species with temperature is more clearly defined. The minimum temperature of each species remained fairly constant as did the maximum and modal temperature for those species in which there was no indication of seasonal migratory patterns (*Coelorinchus carminatus*, *Coryphaenoides carapinus*, *C. armatus*). The 3.5°C minimum temperature found for *C. carapinus* in June was probably not accurate since

the deepest trawl of that cruise did not encompass the entire range of *C. carapinus*. Similarly, the minimal temperatures for *C. armatus* may not be representative.

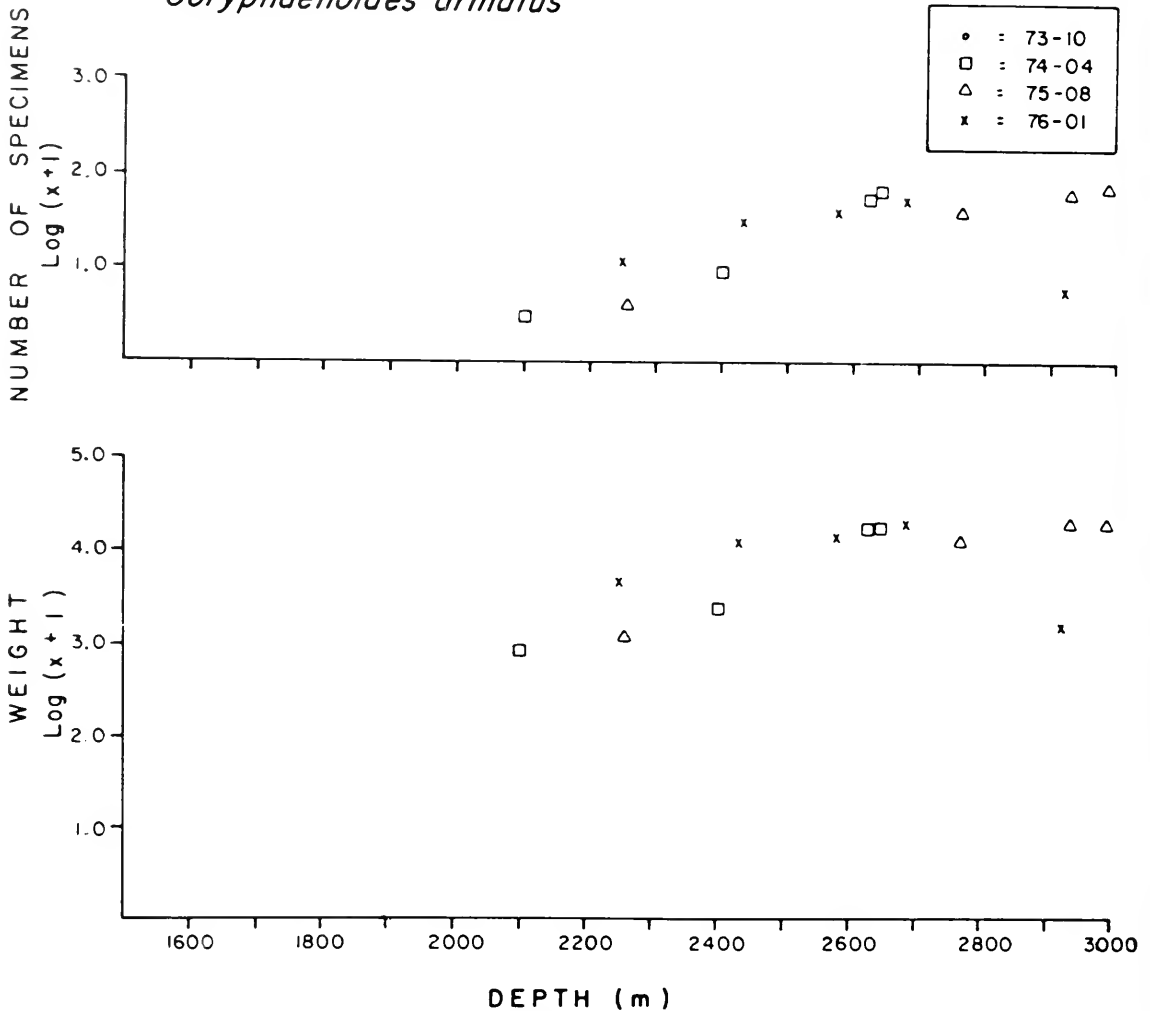
### Competition Among Macrourids

Competition among macrourids in the Norfolk Canyon region is probably minimal because the species differ in body size and feeding strategies or, if feeding strategies are similar, the species have different distributions with temperature and depth. Close congeners such as *Nezumia bairdii* and *N. aequalis* might be expected to occupy similar depth



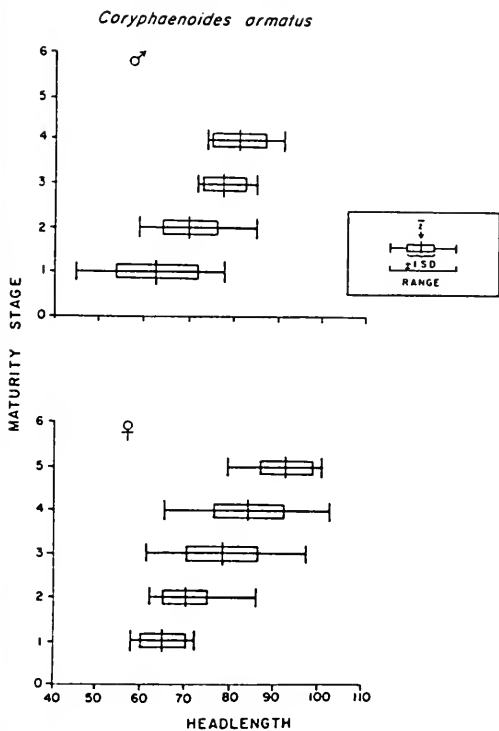

FIGURE 21.—The gonadal maturity stages plotted against head length for *Coryphaenoides armatus*.

and temperature ranges; however, the *N. aequalis* in this area were at the northern limit of their geographic range, occurred in small numbers, and may have been in direct competition with *N. bairdii*. Although *C. rupestris* also occupied the lower section of the two *Nezumia* spp. temperature and depth regimes, direct competition was probably low because of their dissimilarity in mouth size and morphology and related differences in diet (Podrazhanskaya 1971; Geistdoerfer 1975; McLellan 1977).

### Abundance and Density of the Family Macrouridae

In the study area the abundance of macrourids, in water shallower than 2,000 m, was fairly constant with respect to other bottom fishes. The average percent of macrourids by number in each cruise was 16.6% in cruise 73-10 (June), 15.0% in 74-04 (December), 14.6% in 75-08 (September), and 18% in 76-01 (January). The major peaks of abundance were found between 300 and 400 m, where *Coelorinchus c. carminatus* was present, and around 800 m where the complex comprised of *Nezumia aequalis*,

*N. bairdii*, and *Coryphaenoides rupestris* dominated (Fig. 22). In depths of over 2,000 m the numerical dominance of *C. armatus* was evident. Some of the minor inflections can be attributed to the contagious distributions displayed by these fishes.

The graph of macrouid biomass (Fig. 23), as percent of the catch, was similar to that for numerical abundance except for a shift in biomass from 800 m to below 1,000 m between January and June. This was probably because of the seasonal movement of the larger macrouid *Coryphaenoides rupestris*. Between about 1,400 and 2,200 m, macrourids made up a very small portion of the biomass, although their percent by number was comparable with lesser depths. The dominant macrouid in this area, *C. carapinus*, was small, and *Antimora rostrata*, a large morid, was the most abundant member of the benthic fish community from 1,300 to 2,500 m (Wenner and Musick 1977). In depths >2,200 m the biomass of *C. armatus* steeply increased with depth, until it was the predominant member of the benthic community.

All the macrouid species, with the exception of *C. rupestris*, maintained a fairly constant numerical distribution from cruise to cruise. There was apparent variability for *C. carapinus* and *C. armatus*, but this was due to the small number of samples from deeper areas. Distribution of macrourids as the percent of catch revealed a gradual replacement of species with depth, and the predominance of *C. armatus* in depths >2,500 m.

Macrourids made up a major numerical portion of the benthic fish community from 300 m to the deepest station at 3,083 m. Macrourids were also a main component of the biomass of the communities from 300 to 3,083 m, excluding the 1,300-2,500 m range where the morid, *A. rostrata*, dominated.

Although Macrouridae is a dominant family in the Norfolk Canyon area, the potential for a fishery is essentially nonexistent. *Coryphaenoides rupestris* is the only species which attains an appreciable size in the mid-Atlantic area; a modal length of 46 cm TL. However, this size is much smaller than typically found in the North Atlantic and the density of organisms is generally low (normally <0.86 individuals/100<sup>2</sup>). In addition, *C. rupestris* demonstrates a tropical submergence, being found deeper in lower latitudes. The depth range of this species in the Norfolk Canyon area (578-1,698 m), combined with smaller size and lower density of organisms, indicate that a commercial fishery would not be economically feasible.

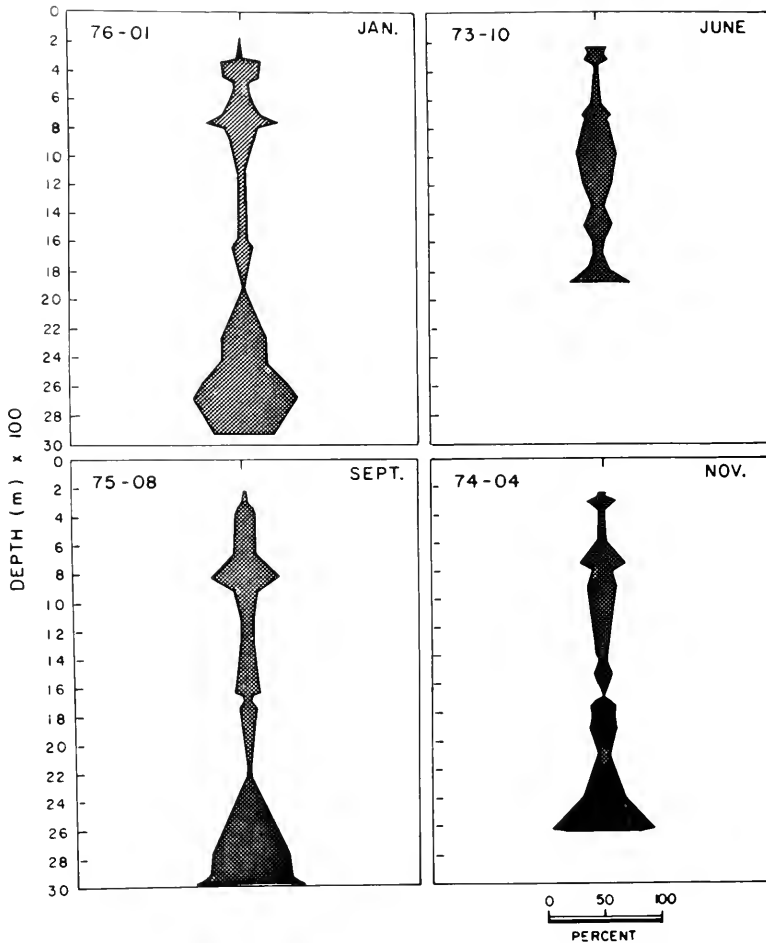

FIGURE 22.—Depth versus relative abundance (as percent, by number, of total capture) for the family Macrouridae, by individual cruise.

### Comparison With Other Studies

The comparison of this study with others in the North Atlantic lends support to Marshall and Iwamoto's (1973) hypothesis that the greatest diversity of macrourids is in the bathyal tropical regions. The number of macrourid species declines from tropical to boreal regions. Marshall and Iwamoto (1973) reported 32 macrourid species from the Caribbean and Gulf of Mexico, but only 22 species were captured during our study (Table 2). Bullis and Struhsaker (1970) found that Macrouridae was one of the dominant families on the western Caribbean slope between 201 and 400 fathoms (368-732 m). The deepest stratum sampled was 451-500 fathoms (825-914 m), and macrourids (9 species) comprised about 67% of the individuals captured within these depths. Within the same depths in the Norfolk Can-

yon area the dominant macrourids (4 species) contributed about 31% to the total catch.

Merrett and Marshall (1981) remarked on the high diversity (and apparent resource partitioning) of macrourids from a tropical upwelling area off northwest Africa and reported 26 species from there. They found 18 species on the slope ( $\leq 1,600$  m), including four species of *Nezumia*. Bathygadine macrourids were important off Africa but virtually absent in our study area. Thus macrourid diversity is probably highest on the continental slope in the tropics, particularly in areas of higher productivity. In addition, high diversity is manifested there at several taxonomic levels, from the species to the subfamily.

Haedrich et al. (1975) reported the capture of 121 macrourid specimens (3 species) in 29 trawls off Southern New England. Their trawl depths ranged from 141 to 1,928 m. Their findings were similar to

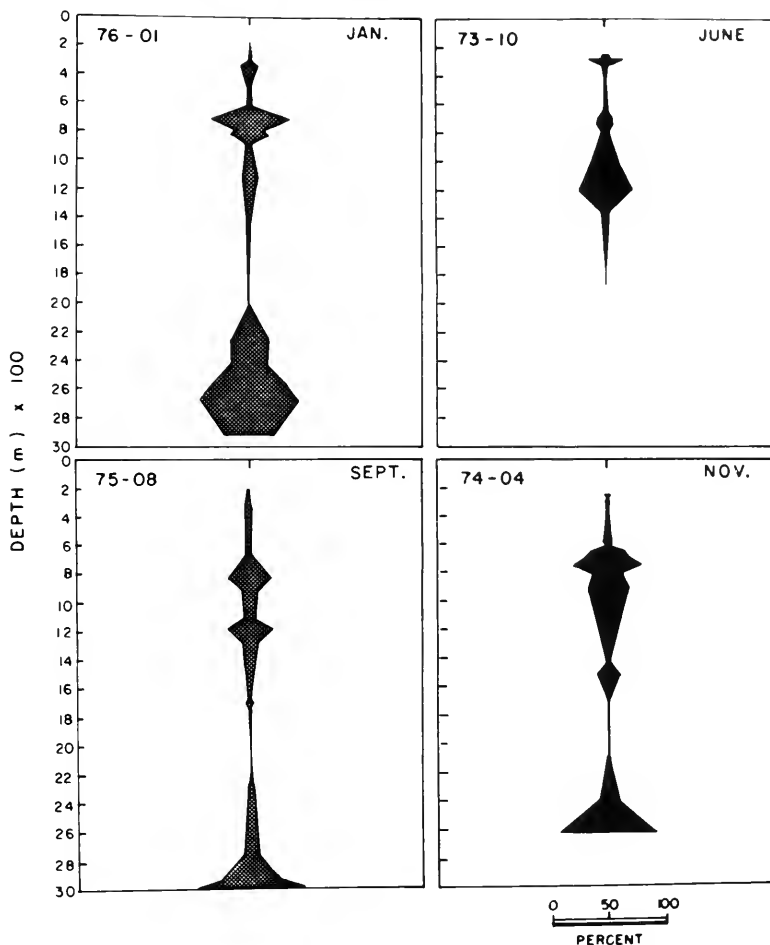

FIGURE 23.—Depth versus relative abundance (as percent, by biomass, of total capture) for the family Macrouridae, by individual cruise.

TABLE 2.—Species captured during study, with total number and total weight.

Species	Total number	Total weight (g)	Species	Total number	Total weight (g)
<i>Coelorinchus c. carminatus</i>	1,827	38,597	<i>Coryphaenoides colon</i> <sup>1</sup>	1	20
<i>Coelorinchus caribbaeus</i> <sup>1</sup>	10	419	<i>Coryphaenoides leptolepis</i>	12	4,922
<i>Coelorinchus occa</i> <sup>1</sup>	1	2	<i>Ventrifossa occidentalis</i>	60	1,449
<i>Nezumia aequalis</i>	285	4,041	<i>Ventrifossa macropogon</i>	1	8
<i>Nezumia bairdii</i>	2,222	72,865	<i>Hymenocephalus gracilis</i> <sup>1</sup>	1	1
<i>Nezumia longebarbatus</i> <sup>2</sup>	12	1,299	<i>Hymenocephalus italicus</i> <sup>1</sup>	1	12
<i>Nezumia sclerorhynchus</i>	1	8	<i>Bathygadus favosus</i>	2	—
<i>Nezumia cyrano</i> <sup>1</sup>	1	—	<i>Bathygadus macrops</i> <sup>1</sup>	1	22
<i>Coryphaenoides rupestris</i>	7,120	1,229,304	<i>Sphagemacurus grenadae</i> <sup>2</sup>	4	30
<i>Coryphaenoides carapinus</i>	213	4,703	<i>Macrourus bergiax</i> <sup>3</sup>	2	4,470
<i>Coryphaenoides armatus</i>	391	120,456	<i>Gadomus dispar</i> <sup>1</sup>	1	—

<sup>1</sup>Range extension from the Gulf of Mexico-Caribbean area.

<sup>2</sup>Also reported by Haedrich and Polloni (1974).

<sup>3</sup>Range extension from Boreal Northwest Atlantic.

those in the present study within the 350-1,100 m depth interval. Respectively, the family Macrouridae accounted for 21% and 22.4% of the fishes captured in these depth intervals.

Haedrich and Krefft (1978) studied the fish fauna in the Denmark Strait and Irminger Sea. In the five fish assemblages that they reported, macrourids were abundant in the 2,026-2,058 m assemblage (22.4%) and very dominant in the 763-1,503 m (48.3%) and 493-975 m (55.4%) assemblages. Macrourids were conspicuously absent from their group three assemblage, although it was well within macrourid depth and temperature range (280-776 m, 1.4°-7.4°C). An interesting aspect of Haedrich and Krefft's (1978) study was evident in their group two assemblage. *Coryphaenoides rupestris* was the highly dominant fish (48.3%) in this group, and the temperature range of this group (3.9°-5.6°C) corresponded closely to the temperature range we found for *C. rupestris* in the present study (3.7°-5.7°C).

Pearcy et al. (1982) summarized data on deep-sea benthic fishes collected over several years off Oregon (Day and Pearcy 1968; Pearcy and Ambler 1974). Iwamoto and Stein (1974) reported 11 species of macrourids from the northeast Pacific and Pearcy et al. (1982) recorded 8 of these off Oregon. A comparison of these data with ours shows that the greatest contrast in the two areas is on the upper and middle slope (500-1,000 m) where five common species are regularly encountered in the western Atlantic (*Coelorinchus c. carminatus*, *Nezumia bairdii*, *C. aequalis*, *Coryphaenoides rupestris*, and *Ventrifossa occidentalis*), but Pearcy et al. (1982) recorded no macrourid as common. This faunal difference may be due to the high density off Oregon of scorpaeniform and lycodine fishes, many of which may fill niches on the upper slope occupied by macrourids elsewhere. The macrourid fauna in depths >2,000 m have many similarities to our study. *Coryphaenoides armatus* becomes increasingly dominant below this depth and often is the only species captured deeper than 3,000 m in both areas (see also Musick and Sulak 1979). Among other macrourid species *Coryphaenoides leptolepis* is usually second or third in abundance at abyssal depths in both regions (Musick and Sulak 1979).

This distribution pattern is very different from that reported for the continental rise in the tropics off west Africa (Merrett and Marshall 1981) where *C. armatus* and other large rat tails were very rare. Marshall and Merrett (1981) speculated that the rarity of large predatory scavengers in the upwelling area they studied might be because of the competitively superior fishes of small size which were

better adapted to use the constant abundant food supply there. This speculation is not supported by data from the southern Sargasso Sea and Bahamas (Musick and Sulak unpubl. data), a tropical region quite low in productivity, in which large rat tails, such as *C. armatus*, are also very rare. The virtual absence of *C. armatus* from tropical abyssal areas may be due instead to some restriction on the life history of the species. Musick and Sulak (1979) have suggested that this species (along with some other large species of predator/scavenger such as *C. rupestris* and *Antimora rostrata*) may migrate to boreal areas to spawn. The tropics may be too far removed from such spawning areas for individuals to successfully return.

## ACKNOWLEDGMENTS

We wish to thank all colleagues formerly or presently with the Virginia Institute of Marine Science for their enthusiastic participation in the deep-sea program, and particularly to Charles Wenner, Richard Carpenter, Douglas Markle, George Sedberry, and Kenneth Sulak. Daniel Cohen of the Los Angeles County Museum of Natural History kindly contributed cogent comments on early stages of this manuscript. Drafts and final copy of this report were prepared by the Virginia Institute of Marine Science Report Center.

## LITERATURE CITED

- BEVERTON, R. J. H., AND S. J. HOLT.  
1957. On the dynamics of exploited fish populations. Fish. Invest. Minist. Agric. Fish. Food (G.B.) Ser. II 19, 533 p.
- BIGELOW, H. B., AND W. C. SCHROEDER.  
1953. Fishes of the Gulf of Maine. U.S. Fish Wildl. Serv., Fish. Bull. 53, 557 p.
- BULLIS, H. R., JR., AND P. T. STRUHSAKER.  
1970. Fish fauna of the Western Caribbean upper slope. Q. J. Fla. Acad. Sci. 33(1):43-76.
- CHRISTENSEN, J. M.  
1964. Burning of otoliths, a technique for age determination of soles and other fish. J. Cons. Int. Explor. Mer 29:73-81.
- DAY, D. S., AND W. G. PEARCY.  
1968. Species associations of benthic fishes on the continental shelf and slope off Oregon. J. Fish. Res. Board Can. 25:2665-2675.
- FARRON, G. P.  
1924. Seventh report on the fishes of the Irish Atlantic Slope. The macrourid fishes (*Coryphaenoididae*). Proc. R. Ir. Acad., 36 Sect. B.
- GATIEN, M. G.  
1976. A study in the slope water region south of Halifax. J. Fish. Res. Board Can. 33:2213-2217.
- GEISTDOEFER, P.  
1975. Ecologie alimentaire des Macrouridae. Teleosteens Gadi-formes. Ph.D. Thesis, Univ. Paris, Paris, France, 315 p.

- GILBERT, C. H., AND C. L. HUBBS.  
1920. The macrourid fishes of the Phillippine islands and the East Indies. U.S. Natl. Mus. Bull. 100, 1(pt. 7):369-582.
- GOODE, G. B., AND T. H. BEAN.  
1885. Descriptions of new fishes obtained by the United States Fish Commission mainly from deep water off the Atlantic and Gulf Coast. Proc. U.S. Natl. Mus. 8:589-605.
- GORDON, J. D. M.  
1979. Phenology of deep-sea anacanthine fishes. In P. J. Miller (editor), Fish phenology: anabolic adaptiveness in teleosts, p. 327-359. Symp. Zool. Soc. Lond., Acad. Press, N.Y.
- GRIGOR'EV, G. V.  
1972. Orazmnozhennii tuporylogo makrurusa severnoi Atlantiki (Reproduction of *Macrurus rupestris* (Gunner) of the northern Atlantic). Tr. Polyarn. Nauchno-Issled. Proektn. Inst. Morsk. Rybn. Khoz. Okeanogr. (PINRO) 289:107-115. (Engl. transl., Fish. Res. Board Can., Transl. Ser. 2529.)
- GUNNERUS, J. E.  
1765. Efterretning OM bergslaxen, en rar norsk fisk, som kunde kaldes: *Coryphaenoides rupestris*. K. Nor. Vidensk. Selsk. Skr. Trondhjem 3(4):40-58.
- GUNTHER, A.  
1887. Report on the deep-sea fishes collected by H.M.S. *Challenger* during the years 1873-76. Report on the scientific results of the voyage of H.M.S. *Challenger*. Zoology 22:1-335.
- HAEDRICH, R. L., AND N. R. HENDERSON.  
1974. Pelagic food of *Coryphaenoides armatus*, a deep benthic rattail. Deep-Sea Res. 21:739-744.
- HAEDRICH, R. L., AND G. KREFFT.  
1978. Distribution of bottom fishes in the Denmark Strait and Irminger. Deep-Sea Res. 25:705-720.
- HAEDRICH, R. L., AND P. T. POLLONI.  
1976. A contribution to the life history of a small rattail fish, *Coryphaenoides carapinus*. Bull. South. Calif. Acad. Sci. 75:203-211.
- HAEDRICH, R. L., G. T. ROWE, AND P. T. POLLONI.  
1975. Zonation and faunal composition of epibenthic populations on the continental slope south of New England. J. Mar. Res. 33:191-212.
- IWAMOTO, T.  
1970. The R/V "Pillsbury" deep sea biological expedition to the Gulf of Guinea, 1964-65. Macrourid fishes of the Gulf of Guinea. Stud. Trop. Oceanogr. Miami 4:316-431.
- IWAMOTO, T., AND D. L. STEIN.  
1973. A systematic review of the rattail fishes (Macrouridae: Gadiformes) from Oregon and adjacent waters. Occas. Pap. Calif. Acad. Sci. No. 111, 79 p.
- KOBLENZ-MISHKE, O. J., V. V. VOLKOVINSKY, AND J. G. KABANOVA.  
1970. Plankton primary production of the world ocean. In W. S. Wooster (editor), Scientific exploration of the South Pacific, p. 183-193. Natl. Acad. Sci., Wash., D.C.
- KULIKOVA, E. B.  
1957. Growth and age of deep water fishes. In B. N. Nikitin (editor), Marine biology, p. 284-290. Tr. Inst. Okeanol. Akad. Nauk. SSSR 20. [Engl. transl., Am. Inst. Biol. Sci. 1959.]
- LEIM, A. H., AND W. B. SCOTT.  
1966. Fishes of the Atlantic Coast of Canada. Fish. Res. Board Can., Bull. 155, 485 p.
- MARSHALL, N. B.  
1965. Systematic and biological studies of the Macrourid fishes (Anacanthini-Teleostii). Deep-Sea Res. 12:299-322.  
1971. Explorations in the life of fishes. Harv. Univ. Press, Camb., 204 p.
- MARSHALL, N. B., AND T. IWAMOTO.  
1973. Family Macrouridae. In Fishes of the western North Atlantic. Mem. Sears Found. Mar. Res., No. 1, part 6, p. 496-662.
- MACPHERSON, E.  
1979. Ecological overlap between macrourids in the western Mediterranean Sea. Mar. Biol. (Berl.) 53:149-159.
- MCEACHRAN, J. D., AND J. DAVIS.  
1970. Age and growth of the striped sea-robin. Trans. Am. Fish. Soc. 99:343-352.
- MCLELLAN, T.  
1977. Feeding strategies of the macrourids. Deep-Sea Res. 24:1019-1036.
- MERRETT, N. R.  
1978. On the identity and pelagic occurrence of larval and juvenile stages of rattail fishes (family Macrouridae) from 60°N, 20°W and 53°N, 20°W. Deep-Sea Res. 25:147-160.
- MERRETT, N. E., AND N. B. MARSHALL.  
1981. Observations on the biology of deep-sea bottom-living fishes collected off northwest Africa (08°27'N). Prog. Oceanogr. 9:185-244.
- MUSICK, J. A.  
1969. The comparative biology of two American Atlantic hakes, *Urophycis chuss* and *U. tenuis* (Pisces: Gadidae). Ph.D. Thesis, Harvard Univ., Cambridge, 150 p.
- MUSICK, J. A., AND K. J. SULAK.  
1979. Characterization of the demersal fish community of a deep-sea radioactive dump site. Contract Report submitted to the U.S. Environmental Agency. Va. Inst. Mar. Sci., 61 p.
- MUSICK, J. A., C. A. WENNER, AND G. R. SEBERRY.  
1975. Archibenthic and abyssobenthic fishes. In May 1974 baseline investigations of deep water dumpsite 106 NOAA evaluation. Rep. 75-1, 388 p.
- NODZYNSKI, J., AND C. ZUKOWSKI.  
1971. Biological and technological characteristics of grenadier family fishes (Macrouridae) of the Northwestern Atlantic. Studia I Materialy Series D, No. 5, p. 1-45.
- OKAMURO, O.  
1970. Fauna Japonica. Macrourina (Pisces). Acad. Press, Tokyo, 179 p.
- PEARCY, W. G.  
1975. Pelagic capture of abyssobenthic macrourid fish. Deep-Sea Res. 23:1065-1066.
- PEARCY, W. G., AND J. W. AMBLER.  
1974. Food habits of deep-sea macrourid fishes off the Oregon Coast. Deep-Sea Res. 21:745-759.
- PEARCY, W. G., D. STEIN, AND R. CARNEY.  
1982. The deep-sea benthic fish fauna of the northeastern Pacific Ocean on Cascadia and Tufts Abyssal Plains and adjoining continental slopes. Biol. Oceanogr. 1:375-428.
- PHLEGER, G. F.  
1971. Biology of macrourid fishes. Am. Zool. 11:419-423.
- POKDRAZHANSKAYA, S. G.  
1967. Feeding of *Macrurus rupestris* in the Iceland area. Ann. Biol. 24:197-198.  
1971. Feeding and migrations of the roundnose grenadier, *Macrourus rupestris*, in the Northwest Atlantic and Icelandic waters. Int. Comm. Northwest Atl. Fish., Redb. Part III, p. 115-123.
- POLLONI, P., R. HAEDRICH, G. ROWE, AND C. H. CLIFFORD.  
1979. The size-depth relationship in deep ocean animals. Int. Rev. Gesamten Hydrobiol. 64:39-46.
- RANNOU, M.  
1975. Donneés nouvelles sur l-activité reproductrice cyclique des poissons benthiques bathyaux et abyssaux. Acad. Sci. Paris, T281, Ser. D, p. 1023-1025.  
1976. Age et croissance d'un poisson bathyal: *Nezumia sclerorhynchus* (Macrouridae Gadiformes) de la mer

- d'Alboran. Cah. Biol. Mar. 17:413-421.
- RANNOU, M., AND C. THIRIOT-QUIEVREUX.  
1975. Structure des otolithes D'un Macrouridae (poisson Gadiforme) Bathyal. Étude au microscope Électronique a Balayage. Ann. Inst. Oceanogr., Paris 51:195-201.
- SAVVATIMSKII, P. I.  
1971. Studies of the age and growth of roundnose grenadier (*Macrourus rupestris*) in the North Atlantic 1967-1970. Int. Comm. Northwest Atl. Fish., Redh. Part III, p. 125-138.  
1972. O vozraste tuporylogo makrurusa severo-zapadnoi Atlantiki i vozmozhnom vliyaniy promysla no ego chislennost' (The age of the rock grenadier in the northwest Atlantic and a possible influence of fisheries on its population numbers). Tr. Polyarn. Nauchno-Issled. Proektn. Inst. Morsk. Rybn. Khoz. Okeanogr. (PINRO) 28:116-127. (Engl. transl., Fish. Res. Board Can., Transl. Ser. 2491.)
- SMITH, K. L., JR.  
1978. Metabolism of the abyssopelagic rattail *Coryphaenoides armatus* measured *in situ*. Nature (Lond.) 274:362-364.
- SMITH, K. L., JR., G. A. WHITE, M. B. LAVER, R. R. MCCONNAUGHEY, AND J. P. MEADOR.  
1979. Free vehicle capture of abyssopelagic animals. Deep-Sea Res. 26A:57-64.
- SOKAL, R. R., AND F. J. ROHLF.  
1969. Biometry: The principles and practice of statistics in biological research. W. H. Freeman and Co, San Franc, 776 p.
- STANEK, E.  
1971. Badania zasobow rybnych wod Labradoru i Nowej Fundlandii (Studies on the fish stocks in the waters off Labrador and Newfoundland). Pr. Morsk. Inst. Rybackiego, p. 121-146. (Engl. trans., Fish. Res. Board Can., Transl. Ser. 2754.)
- WEBSTER, F.  
1969. Vertical profiles of horizontal ocean currents. Deep-Sea Res. 16:85-98.
- WENNER, C. A., AND J. A. MUSICK.  
1979. Biology of the morid fish *Antimora rostrata* in the western North Atlantic. J. Fish. Res. Board Can. 34:2362-2368.
- WORTHINGTON, L. V.  
1964. Anomalous conditions in the slope water area in 1959. J. Fish Res. Board Can. 21:327-333.
- ZAKHAROV, G. P., AND I. D. MOKANU.  
1970. Distribution and biological characteristics of *Macrourus rupestris* of the Davis Strait in August-September 1969. Reports of Pinro Marine Expeditionary Investigations, 3rd cruise of R/V *Perseus III*.

# DIFFERENTIATION OF *PRIONOTUS CAROLINUS* AND *PRIONOTUS EVOLANS* EGGS IN HERFORD INLET ESTUARY, SOUTHERN NEW JERSEY, USING IMMUNODIFFUSION

WALTER J. KEIRANS,<sup>1</sup> SIDNEY S. HERMAN,<sup>2</sup> AND R. G. MALSBERGER<sup>2</sup>

## ABSTRACT

Immunochemical techniques were used to classify the planktonic eggs of *Prionotus carolinus* (northern searobin) and *Prionotus evolans* (striped searobin) collected from a southern New Jersey estuary. Results of immunochemical identifications were compared with identifications based upon the commonly used morphological character of egg oil globule distribution. An average identification error of 22.3% was found when results using this conventional morphological characteristic were compared with immunodiffusion results. Improved accuracy of searobin egg identification can be achieved in future ichthyoplankton studies by using immunochemical techniques. A similar application of immunochemical identification techniques should also better resolve classification uncertainties among other morphologically similar co-temporal and co-spatial planktonic fish eggs.

The accuracy of ichthyoplankton analysis is often limited by the lack of reliable, distinguishing, morphological characteristics that are useful for identifying fish eggs and larvae. Conventional characteristics used to identify fish eggs include egg and oil globule diameters; number, distribution, and pigmentation of oil globules; and pigmentation patterns on developing embryos. However, overlapping diameters of eggs and a similar if not identical number of oil globules with comparable pigmentation and size among closely related species impose a relatively high degree of uncertainty concerning the identity of planktonic fish eggs from many areas. Increased accuracy has been more recently achieved through the analysis of fish eggs using biochemical, immunological, and ontogenetic methods. Morgan (1975) examined electrophoretic patterns of white perch and striped bass egg extracts and found differentiation was possible on this basis. Orłowski et al. (1972) differentiated cunner, *Tautogolabrus adspersus*, from tautog, *Tautoga onitis*, eggs using monospecific antisera in microimmunodiffusion analyses. The technique was especially useful with early stage eggs which were morphologically identical. Ontogenetic methods allow careful study of laboratory-reared eggs and larvae of known parentage to document species-specific developmental histories. These studies may provide new distin-

guishing morphological features for future egg identifications. However, additional means are required where well-documented features shared with other species do not provide adequate differentiation of field-collected eggs.

This paper is a report on the results obtained from a microimmunodiffusion analysis which successfully differentiated the planktonic eggs of the northern searobin, *Prionotus carolinus*, from those of the striped searobin, *Prionotus evolans*, which were collected from the Herford Inlet estuary, southern New Jersey, between May 1973 and September 1974 (Keirans 1977). Identifications based separately upon immunochemical and morphological evidence were also compared to evaluate the reliability of differentiations based entirely upon conventional morphology. *Prionotus* spp. were selected in our study first because the searobins represent a large breeding population which appears co-temporally and co-spatially near shore to provide an abundant source of gravid adults. Eggs of known parentage became readily available for preparation of experimental reagents and specimens. Secondly, this study would expand the application of microimmunodiffusion analysis to species differentiation as an extension of the study of Orłowski et al. (1972), which documented differentiation of eggs from two genera. Finally, the identification of *Prionotus* spp. ova has never been properly resolved.

*Prionotus carolinus* ova were described by Kuntz and Radcliffe (1918) as highly transparent but slightly yellowish spherical eggs ranging from 1.0 to 1.15 mm in diameter. The yolk sphere contained a

<sup>1</sup>Department of Biology, Lehigh University, Bethlehem, PA; present address: E. I. du Pont de Nemours Co., Inc., Glasgow Research Laboratory, Wilmington, DE 19898.

<sup>2</sup>Department of Biology, Lehigh University, Bethlehem, PA 18015.

variable number of 10 to 25 unequal-sized oil globules scattered over the yolk surface which showed some tendency toward aggregation with progressing development. The diameter range was extended from 0.94 mm to 1.20 mm by Bigelow and Schroeder (1953) and Wheatland (1956), respectively. The upper diameter limit extension was verified by Herman (1963). *Prionotus evolans* ova have never been positively identified. Perlmutter (1939) made a tentative identification, later accepted by Marshall (1946), from ripe ova stripped from gravid females collected in Long Island Sound and described as having similar appearance and diameter as northern searobin eggs, but with oil globules clustered at one pole rather than dispersed across the yolk sphere surface. This singular observed morphological difference of oil globule distribution pattern has been used as the primary distinguishing characteristic between ova of *Prionotus carolinus* and *Prionotus evolans*.

## MATERIALS AND METHODS

### Conventional Identifications

Field-collected, buffered Formalin<sup>3</sup>-preserved plankton samples were physically sorted for all ichthyoplankton using forceps under a dissecting microscope, and the criterion of oil globule distribution differences established by Perlmutter (1939) was used to tentatively separate *P. carolinus* from *P. evolans* eggs. The annual cycle and species composition aspects of the field-collected samples using conventional means for egg and larval identifications have been submitted elsewhere for publication.

<sup>3</sup>Reference to trade names does not imply endorsement by the National Marine Fisheries Service, NOAA.

## Immunochemical Identifications

### Antigens and Immunizations

Antigen preparations from both species of searobin eggs were generated using the techniques developed by Orłowski et al. (1972) with ovarian tissue from ripe adults and immature individuals. The four antigen preparations presented in detail in Table 1 were each used to elicit immune responses in at least two New Zealand white rabbits to improve the probability of obtaining useful antisera. Preimmune serum samples were obtained from each animal to establish that no reactivity with antigen existed prior to immunization.

The soluble protein antigens of *Prionotus evolans* (PeSP) and *Prionotus carolinus* (PcSP) were injected intravenously in 4.7 and 4.8 mg protein doses (standard biuret analysis), respectively, to begin the immunization program. Maintenance injections of 2 mg protein followed on a weekly basis. Blood samples were obtained by cardiac puncture 3 wk following the first injection and the presence of precipitating antibody was demonstrated by the standard precipitin ring test (Abramoff and LaVia 1970). Additional monthly cardiac puncture samples were monitored by quantitative double diffusion (Feinberg 1957) until after about 12 wk; a titer of 32 was reached in all animals receiving soluble antigens when sera were tested with 40 µg homologous antigen.

Particulate protein antigens from macerated ovarian tissue of northern (PcPP) and striped (PePP) searobins were prepared in a 1:1 emulsion with Freund's complete adjuvant (Cappell Laboratories). PcPP (8 mg) and PePP (10 mg) protein preparations were injected subcutaneously along several bilateral dorsal sites on New Zealand white rabbits. Rabbits injected with Freund's complete adjuvant developed

TABLE 1.—Antigen characterization and nomenclature.

Species	Antigen source and designation	Range protein concentration (mg/mL)	Method of determination	Immunization route and dose		Titer	
				Initiation	Maintenance	Double-diffusion	Complement fixation
<i>Prionotus carolinus</i> Northern searobin	Mature ova (PcSP)	8-15	Biuret	Intravenous (4.7 mg)	Intravenous (2 mg)	32	
	Immature follicular material (PcPP)	15-40	Microkjeldahl	Subcutaneous (8 mg)	Intravenous (2 mg)		1,280
<i>Prionotus evolans</i> Striped searobin	Mature ova (PeSP)	8-15	Biuret	Intravenous (4.8 mg)	Intravenous (2 mg)	32	
	Immature follicular material (PePP)	15-40	Microkjeldahl	Subcutaneous (10 mg)	Intravenous (2 mg)		1,280



Arthus reactions following a single dose. Subsequent injections were accomplished intravenously using Millipore (0.45  $\mu\text{m}$ ) filtrates of PcPP and PePP. Titers were monitored utilizing the standard complement fixation assay because of the particulate consistency of the macerated antigen preparation (Kabat and Mayer 1961). Maximum titers of 1,280 were obtained after about 10 wk with immunizations using PcPP or PePP.

### Antiserum Specificity

Antisera elicited in response to both soluble and particulate antigens were multicompetent and exhibited cross-reactions with heterologous antigens. The presence of common antigens between the northern searobin and striped searobin ovarian material preparations required the specific adsorption of antisera with these shared antigens to render a given antiserum monospecific (Eisen 1974). Although antisera elicited in response to particulate protein antigens exhibited precipitation reactions in agar with both soluble antigens and extracts of particulate antigens from the two species under consideration, they were not competent in reactions with homologous fish eggs. Therefore, since the selected method for analysis of planktonic eggs was immunodiffusion, only antisera elicited in response to soluble antigens were used in all analyses of unknowns. Specific adsorption of common antigens shared by northern and striped searobins was accomplished by adding PcSP to antisera elicited in response to PeSP and vice versa. Adsorption lots of 1.5 mL anti-PeSP antiserum combined with 70  $\mu\text{L}$  PcSP (0.65 mg protein) were incubated at 4°C for 48 h prior to use. This adsorption eliminated all reactivity of anti-PeSP antisera with both PcSP and known ova of *P. carolinus*, without significantly reducing activity with ova of *P. evolans*. This specifically adsorbed anti-PeSP, which reacted solely with known homologous ova of *P. evolans* under controlled conditions, was used as the basis for differentiation of northern and striped searobin eggs. Species-specific anti-PeSP antisera capable of 100% accuracy in differentiating known ova of both searobins was the reagent selected for use in all immunodiffusion analyses.

### Microimmunodiffusion Analysis

Unknown planktonic fish eggs were analyzed with monospecific anti-PeSP antiserum in a micromodification of the immunodiffusion technique (Ridgeway et al. 1962). Microscope slides (2.5  $\times$  8 cm) were washed, rinsed first in distilled water and then

methanol, and wiped dry. Two milliliters of 1% Noble Agar (Difco) in FA-Bacto buffer (Difco), pH 7.2, were applied across each slide on a leveling table and allowed to harden. Slides were then placed over a template and wells cut using a Brewer needle with beveled inner surface (Ridgeway et al. 1962).

Agar plugs were removed from wells by aspiration. Reagents were applied with either 1 mL syringes (Burron) or sterile capillary pipettes, and 0.005 to 0.01 mL was required to fill each well. A typical testing array appears in Figure 1, where corner wells contain unadsorbed antiserum, the central well contains adsorbed or monospecific antiserum, and remaining wells contain individual fish eggs which have been broken using jeweler's forceps. FA-Bacto buffer was applied to each well following egg disruption, and slides were allowed to incubate in moist chambers for 18 h at 20°C. Slides were then washed for 24 h in FA-Bacto buffer, and stained according to the method of Crowle (1958). Results were always recorded at a fixed time interval following slide preparation to insure comparability from one determination to another.

## RESULTS AND DISCUSSION

A total of 732 searobin ova were recovered from plankton samples collected in the 1973-74 period. The combined morphological characteristics of egg diameter, number, color, and distribution of oil globules, and embryo pigmentation when present, allowed the separation of searobin eggs from those of other species with reasonably high confidence. Preliminary classifications of *Prionotus* ova into either *evolans* or *carolinus* species was based upon differential oil globule distribution patterns reported by Perlmutter (1939). Striped searobin, *P. evolans*, eggs were placed into one grouping based upon a polar or clustered oil globule distribution, and northern searobin, *P. carolinus*, eggs placed into a second group having oil globules generally dispersed across the yolk sphere.

Each tentatively classified egg was then analyzed in the microimmunodiffusion method illustrated in Figure 1, to establish the immunochemical reactivity of soluble egg antigens with adsorbed and unadsorbed anti-PeSP antisera. When soluble *P. evolans* egg antigens were sufficiently concentrated, a classical line of identity was observed with fusion of precipitin bands between adsorbed and unadsorbed anti-PeSP wells. Identification of *P. carolinus* eggs was based upon reactivity with unadsorbed anti-PeSP antiserum and no reactivity with adsorbed anti-PeSP. Previously established reactivity of unadsorbed anti-

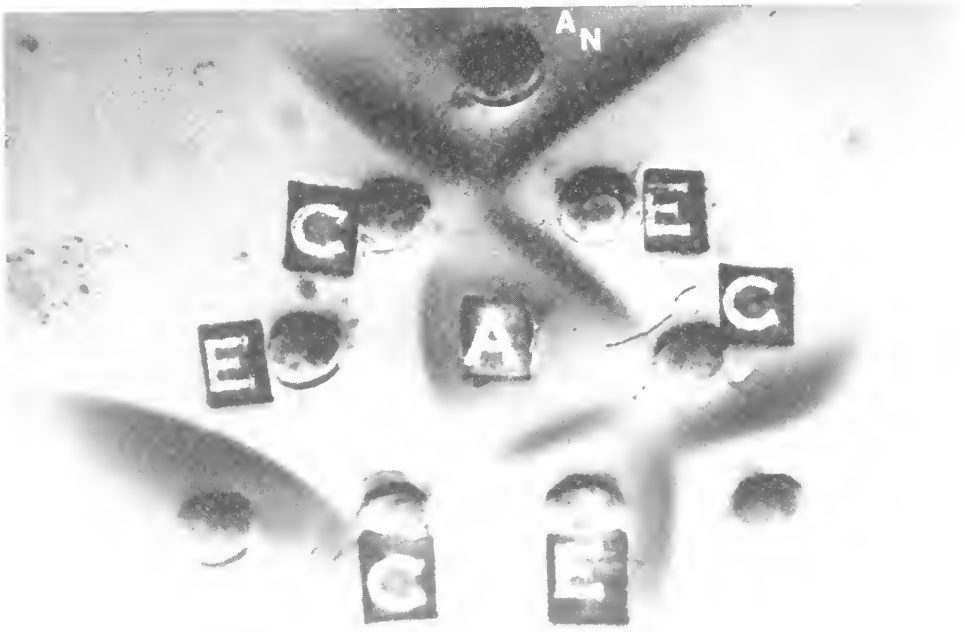

FIGURE 1.—Testing array (10 $\times$ ). C: *Prionotus carolinus* ovum (1.00 mm); E: *Prionotus evolans* ovum (1.00 mm); A<sub>A</sub>: Anti-PeSP antiserum (adsorbed: 0.20 mL antiserum: 0.11 mg PeSP protein); A<sub>N</sub>: Anti-PeSP antiserum (unadsorbed). Specific adsorption of cross-reactive antibodies has occurred with PeSP, rendering anti-PeSP antiserum (A<sub>A</sub>) incompetent to react with antigens of *Prionotus carolinus* ova (C), indicated by the lack of precipitin bands about the central well adjacent to (C) egg wells. Corner wells contain multicompetent, unadsorbed anti-PeSP antisera.

PeSP with known *P. carolinus* eggs was considered sufficiently definitive for its use in differentiating *P. carolinus* from *P. evolans* ova.

The immunochemical classifications derived from this analysis indicated that an average 22.3% misclassification error had been made when eggs were differentiated solely on the basis of oil globule distributions. An approximately equal number of both northern and striped searobin eggs had been mistakenly identified, based upon oil globule distribution patterns. The final classification based upon immunochemical data was 406 ova of *P. carolinus* and 326 ova of *P. evolans*.

It was confirmed that egg diameters could not serve as a reliable characteristic for species classifications by retrospectively analyzing diameters of immunochemically classified eggs according to the period of field collection. The data presented in Table 2 illustrate that no statistical difference exists in the diameter ranges of *P. carolinus* and *P. evolans* eggs for the collection period of this study. However, the trend of declining egg diameters over the spawning season previously documented by other workers is

TABLE 2.—Immunochemical classification of *Prionotus* spp. eggs collected in plankton samples.

Date	Average diameter (mm)	Range (mm)	n
<i>Prionotus carolinus</i>			
1973			
May	1.16	1.02-1.24	4
June	1.06	1.00-1.21	10
July	1.08	1.05-1.10	3
August	1.02	0.92-1.18	312
September	0.99	0.90-1.05	32
1974			
July	0.98	0.95-1.02	13
August	0.96	0.92-1.02	3
September	0.99	0.92-1.02	29
<i>Prionotus evolans</i>			
1973			
May	1.12	1.00-1.25	10
June	1.06	1.00-1.12	35
July	1.08	1.00-1.15	2
August	1.03	0.95-1.12	225
September	0.98	0.90-1.08	26
1974			
July	0.97	0.95-1.00	6
August	1.02	1.02	1
September	0.99	0.92-1.02	21

confirmed. The data also show that in 1973 and 1974, the ratios of eggs collected in plankton samples and identified based upon morphology and immunochemical reactions for northern and striped searobins were 1.1:1 and 1.6:1, respectively. These ratios are similar in magnitude to the ratio of northern and striped searobin adults observed by Marshall (1946). Finally, the data indicate that egg diameter and oil globule distribution cannot serve to reliably distinguish northern from striped searobin eggs. An immunochemical distinction can be made that suggests morphology alone is inadequate to provide a positive identification of *P. evolans* eggs.

The course of future research in immunochemical taxonomy of fish eggs should emphasize an increase in sensitivity, as well as automation of the analysis. At present, the utility of the immunodiffusion method is limited by its labor-intensive nature. Initial stages of the analysis require manual sorting of ova from plankton samples that is tedious, time-consuming, and subject to error. Bowen et al. (1972) initiated studies in which a moderate degree of success was achieved in sorting fish ova from pelagic plankton samples on sucrose density gradients. However, estuarine plankton samples that contained a wide range of particulate materials characterized by different sizes, densities, and shapes, and that also included high levels of detrital materials, disturbed the gradients sufficiently to destroy separation potential. Despite the recognized limitations, there is currently no practical alternative to manual sorting of plankton samples.

Immunodiffusion analysis requires that individual fish eggs be subjected to several manual manipulations, with the final determination in solid media requiring the careful applications of reagents. Screening large numbers of planktonic ova with several different antisera becomes impractical on a large scale. A more rapid and potentially more specific approach to immunochemical ichthyoplankton identifications might employ monoclonal antibodies coupled to fluorescent indicator molecules. The antibody products of fused mouse lymphocytes and myeloma cells may be screened and selected for exquisite specificity to single antigenic determinants or epitopes using egg antigens of known origin, preferably those associated with the chorion surface, to procure a reagent that would specifically label ova without requiring that each egg be mechanically ruptured. Identifications might be based upon the differential fluorescence characteristic of a particular fluorescent label associated with a selected antibody and labelled eggs might be isolated using a fluorescence-activated cell sorter.

The utility of immunochemical identifications with demonstrably superior accuracy to conventional methods has been established with both intergeneric and interspecific differentiations. Several systems remain which might benefit from immunochemical differentiations, such as the complete elucidation of several sciaenid and clupeid species which occur in complex estuarine systems, such as the Chesapeake Bay and Potomac River estuary. Relationships between scombrids, bothids, and pleuronectids with more southerly distributions would serve to delineate adult ratios, population distributions, and spawning seasons. Finally, the capability of the immune system to differentiate among epitopes with relatively small structural difference (Karush 1962) might eventually be applied to the detection of racial differences or subpopulation distinctions among fish ova of the same species.

## ACKNOWLEDGMENTS

The Noyes Foundation provided fellowship funds for the senior author. Michael Criss and Marian Glaspey assisted in collecting the samples.

## LITERATURE CITED

- ABRAMOFF, P., AND M. LAVIA.  
1970. Biology of the immune response. McGraw-Hill, Inc., N.Y., 492 p.
- BIGELOW, H. B., AND W. C. SCHROEDER.  
1953. Fishes of the Gulf of Maine. U.S. Fish Wildl. Serv., Fish. Bull. 53:1-577.
- BOWEN, R. A., J. M. ST. ONGE, J. S. COLTON, JR., AND C. A. PRICE.  
1972. Density-gradient centrifugation as an aid to sorting planktonic organisms. I. Gradient materials. Mar. Biol. (Berl.) 14:242-247.
- CROWLE, A. J.  
1958. A simplified micro double-diffusion agar precipitin technique. J. Lab. Clin. Med. 52:784-787.
- EISEN, H. N.  
1974. Immunology: An introduction to molecular and cellular principles of the immune responses. Med. Dep., Harper & Row, Inc., Hagerstown, MD, 624 p.
- FEINBERG, J. G.  
1957. Identification, discrimination, and quantification in Ouchterlony gel plates. Int. Arch. Allergy 11(3-4):129-152.
- HERMAN, S. S.  
1963. Planktonic fish eggs and larvae of Narragansett Bay. Limnol. Oceanogr. 8:103-109.
- KABAT, E. A., AND M. M. MAYER.  
1961. Complement and complement fixation. Experimental immunochemistry. 2d ed. Chase Thomas Publ., Springfield, IL, 905 p.
- KARUSH, F.  
1962. Immunologic specificity and molecular structure. Adv. Immunol. 2:1-40.
- KEIRANS, W. J., JR.  
1977. An immunochemically assisted ichthyoplankton survey with elaboration on species specific antigens of fish egg

- vitellins; southern New Jersey Barrier Island - Lagoon Complex. Ph.D. Thesis, Lehigh Univ., Bethlehem, PA 169 p.
- KUNTZ, A., AND L. RADCLIFFE.  
1918. Notes on the embryology and larval development of twelve teleostean fishes. Bull. U.S. Bur. Fish. 35:89-134.
- MARSHALL, N.  
1946. Observations on the comparative ecology and life history of two sea robins, *Prionotus carolinus*, and *Prionotus evolans strigatus*. Copeia 1946:118-144.
- MORGAN, R. P. II.  
1975. Distinguishing larval white perch and striped bass by electrophoresis. Chesapeake Sci. 16:68-70.
- ORLOWSKI, S. J., S. S. HERMAN, R. G. MALSBERGER, AND H. N. PRITCHARD.  
1972. Distinguishing cunner and tautog eggs by immunodiffusion. J. Fish. Res. Board Can. 29:111-112.
- PERLMUTTER, A.  
1939. A biological survey of the salt waters of Long Island, 1938. Section I. An ecological survey of young fish and eggs identified from tow-net collection. Suppl. 28th Annu. Rep. N.Y. Conserv. Dep. Part II:11-71.
- RIDGEWAY, G. J., G. W. KLONTZ, AND C. MATSUMOTO.  
1962. Intraspecific differences in serum antigens of red salmon demonstrated by immunochemical methods. Int. North Pac. Fish. Comm. 8:1-13.
- WHEATLAND, S. B.  
1956. Oceanography of Long Island Sound, 1952-1954. VII. Pelagic fish eggs and larvae. Bull. Bingham Oceanog. Coll., Yale Univ. 15:234-314.

# EFFECTS OF EXPOSURE AND CONFINEMENT ON SPINY LOBSTERS, *PANULIRUS ARGUS*, USED AS ATTRACTANTS IN THE FLORIDA TRAP FISHERY

JOHN H. HUNT,<sup>1</sup> WILLIAM G. LYONS,<sup>2</sup> AND FRANK S. KENNEDY, JR.<sup>2</sup>

## ABSTRACT

Traps in the south Florida spiny lobster fishery are baited with live sublegal-sized lobsters (shorts), many of which are exposed for considerable periods aboard vessels before being placed in traps and returned to the sea. Average mortality rate of lobsters exposed ½, 1, 2, and 4 hours in controlled field tests was 26.3% after 4 weeks of confinement. About 42% of observed mortality occurred within 1 week after exposure, indicating exposure to be a primary cause of death. Neither air temperature during exposure nor periodic dampening with seawater had significant effects on mortality rate. Mortality among confined lobsters increased markedly in the Atlantic oceanside but not in Florida Bay during the fourth week of confinement following exposure, probably because more natural food organisms entering traps from nearby seagrass beds delayed starvation at the latter site. Mortality caused by baiting traps with shorts may produce economic losses in dockside landings estimated to range from \$1.5 to \$9.0 million annually.

The fishery for spiny lobster, *Panulirus argus*, in south Florida utilizes a method of baiting traps that is apparently unique among fisheries worldwide. Sublegal [ $<76$  mm carapace length (CL)] lobsters, locally called "shorts", are confined in traps as living attractants for legal-sized lobsters. Shorts have been demonstrated to be effective attractants of other lobsters (Yang and Obert 1978; Lyons and Kennedy 1981; Kennedy 1982). Some use of shorts as bait in the Florida fishery occurred as early as the 1950's (Cope 1959), but use increased appreciably after 1965 when the minimum legal size was reduced from 1 lb (about 79-80 mm CL) to 3 in (76 mm) CL, and the fishery expanded from Atlantic oceanside reefs and flats into Florida Bay where availability of shorts is considerably greater (Lyons et al. 1981). The practice was widespread but illegal during early years of its use (Wolfferts 1974) and only received legal sanction in 1977. Today, bonded fishermen are allowed to possess as many as 200 shorts aboard a vessel for use as bait. Shorts are customarily kept in wooden boxes on deck until replaced in traps, and exposure times vary from several minutes to 1 h or more. As many as 1 million shorts may be confined in traps as bait during peak portions of the harvest season (Lyons and Kennedy 1981).

During 1979, the Florida Department of Natural Resources initiated a study in which baiting practices in the fishery were mimicked under controlled conditions to determine whether starvation occurred among lobsters confined in traps for long periods. So much mortality occurred among tested lobsters during the first 2 wk of confinement that the study was redirected toward causes of that mortality. Exposure was strongly implicated by preliminary results (Lyons and Kennedy 1981). Spokesmen for the fishing industry suggested that observed mortality was caused by other factors related to experimental design, prompting expansion of the program to test those factors.

This report presents results and conclusions from that expanded program. The relationship between exposure and mortality is examined, including influences of season and location. Mortality rates of lobsters held dry or periodically dampened prior to placement in traps are also compared. Results from this study are used in a model which estimates the relative importance of baiting mortality to economics of the fishery.

## METHODS

Mortality rates of spiny lobsters used to bait traps were measured in Florida Bay 3 km north of Vaca Key and in the Atlantic Ocean 6 km south of Vaca Key. The Florida Bay site was located in shallow water ( $\sim 3$  m) with a muddy sand substrate overlain by seagrass beds. The ocean site was located in

<sup>1</sup>Florida Department of Natural Resources, Bureau of Marine Research, Marathon, FL 33050.

<sup>2</sup>Florida Department of Natural Resources, Bureau of Marine Research, St. Petersburg, FL 33701.

deeper water (~8 m) just inside the reef tract; the bottom consisted of a mosaic of scattered seagrasses, small patch reefs, and open areas of coarse sand. Salinities at both sites ranged from 34‰ to 36‰ and water temperature ranged seasonally from 17° to 29°C.

The effect of exposure was examined at both sites. Lobsters were held in shaded boxes for ½, 1, 2, and 4 h and then placed in traps. Entrances were sealed, and no lobsters were added after treatments were established. Each treatment utilized 5 standard wooden slat lobster traps; each trap contained 3 lobsters (total 15 lobsters/treatment) for each exposure period. Control treatments (minimum exposure) also consisted of 5 traps each containing 3 lobsters, but these lobsters remained in traps in which they were originally captured and were exposed only for the time required to clean, seal, and return a trap to the water. Intent was to place sublegal lobsters in all traps, but use of some larger lobsters was necessary to conduct experiments. Traps in oceanside experiments were reinforced with wire mesh sides to reduce damage by loggerhead turtles, *Caretta caretta*; traps in Florida Bay were not reinforced with wire sides.

In Florida Bay, all lobsters exposed  $\geq 1$  h were dampened every ½ h by pouring a bucket of seawater into the porous holding box, whereas equal numbers of lobsters exposed  $\geq 1$  h in oceanside tests were always treated with and without seawater dampening every ½ h to test the effect of dampening. Control and ½-h treatments were the same in dampened (wet) and undampened (dry) tests because their total

exposure periods were less than or equal to the period between dampenings.

After initiation, all experiments were sampled at 1-wk intervals for 4 wk by pulling each trap and counting remaining live lobsters. The mortality estimate is a combination of missing lobsters and those observed to be dead. Several lines of evidence indicate that missing lobsters died and did not escape. Only lobsters too large to fit between trap slats were used in experiments, and trap entrances were boarded shut to seal the ordinary avenue of departure. Additionally, observations made during frequent dives at traps where lobsters died during other experiments indicated that carcasses could be broken up sufficiently by scavengers within 24 h after death to wash through slats when traps were pulled.

All original data, taken as number of living lobsters remaining in a trap each week, were converted to weekly mortality rates calculated as the number of lobsters that died during that week divided by the initial density during that week. This method provided the only independent, non-cumulative estimate of mortality. All other methods biased the data by either increasing the weight given to deaths later in the experiment or altering mortality estimates because of trap losses. Although this method provided unbiased estimates of mortality, data still were not normally distributed, so all testing of treatment means used nonparametric Wilcoxon Two Sample Tests (Sokal and Rohlf 1969) to determine where the differences of significance occurred. Standard notations are used to designate signi-

TABLE 1.—Average weekly spiny lobster mortality (%) for each location, exposure period, and wet or dry treatment.  $N$  = number of traps;  $\bar{x}$  = mean; SE = standard error; W = wet; D = dry.

Treatment	Initial $N$	Week after initial exposure												Cumulative mortality %	
		Week 1			Week 2			Week 3			Week 4				
		$N$	$\bar{x}$	SE	$N$	$\bar{x}$	SE	$N$	$\bar{x}$	SE	$N$	$\bar{x}$	SE		
Florida Bay															
Control	15	15	0.0	0.0	15	0.0	0.0	15	2.2	2.2	15	0.0	0.0	2.2	
½ h	20	20	8.3	5.3	19	3.5	3.5	18	0.0	0.0	17	0.0	0.0	11.8	
1 h W	20	17	7.8	3.5	17	3.9	3.9	16	6.2	3.4	16	6.2	6.2	24.1	
2 h W	20	18	14.8	5.5	18	1.8	1.8	18	1.8	1.8	18	3.7	2.5	22.1	
4 h W	20	20	15.0	5.6	19	5.3	2.9	19	5.3	2.9	18	0.0	0.0	25.6	
Atlantic Reef															
Control	29	28	4.8	2.8	23	1.4	1.4	23	0.0	0.0	27	7.4	3.2	13.6	
½ h	29	29	8.0	3.6	24	1.4	1.4	23	4.3	4.3	27	12.3	4.8	26.0	
1 h W	29	29	16.1	4.8	24	9.7	3.7	19	7.0	4.1	24	12.5	5.2	45.3	
1 h D	29	29	11.5	3.8	24	9.7	5.1	22	4.5	2.5	27	11.1	5.3	36.8	
2 h W	29	29	13.8	5.1	17	3.9	2.7	15	4.4	3.0	20	5.0	2.7	27.1	
2 h D	29	29	16.1	5.4	23	5.8	2.7	22	4.5	2.5	24	5.6	3.3	32.0	
4 h W	29	29	12.6	3.8	23	4.3	3.2	19	8.8	6.2	22	6.1	2.8	31.8	
4 h D	29	29	11.5	4.1	21	7.9	4.5	18	1.8	1.8	23	1.4	1.4	22.6	

ficance at probability levels of 0.05, 0.01, and 0.001.

Weighted cumulative average mortality values were obtained by multiplying the relative effort (%) in each treatment (e.g., site, exposure period  $\geq 1/2$  h) by the cumulative mortality for that treatment and then summing those values.

## RESULTS

The mortality experiment was conducted four times between January and September 1980 in Florida Bay and six times between May 1981 and June 1982 near Atlantic reefs. Wet vs. dry tests were conducted with each oceanside replicate. The unweighted average cumulative mortality calculated from Table 1 for all lobsters exposed  $1/2$ , 1, 2, and 4 h, both sites combined, was 26.3% at the end of 4 wk. Average weighted cumulative mortality in Florida Bay was 20.8%, and that near Atlantic reefs was 31.9%. When weighted for relative effort at each site, the overall mortality rate increased to 28.5%.

No tests were established at oceanside stations during December, January, or February, so effects of air and water temperatures on mortality during exposure were tested only in Florida Bay. Of four tests conducted there, two were established during cool months (January, February; air  $15.2^{\circ}$ - $21.0^{\circ}$ C, water  $17.0^{\circ}$ - $17.5^{\circ}$ C during initiation), and two were established during warm months (May, September; air  $27.6^{\circ}$ - $33.5^{\circ}$ C, water  $29.3^{\circ}$ - $29.5^{\circ}$ C). Mean weekly mortality rates of lobsters during these tests (winter  $\bar{x}$  = 4.4%; summer  $\bar{x}$  = 4.6%) were not significantly different.

Average mortality rates obtained in wet vs. dry treatments (Table 1, Fig. 1) were not significantly different for any exposure or subsequent confinement period. Furthermore, neither wet nor dry treatments consistently caused greater mortality.

Because all Florida Bay lobsters were dampened when exposed  $\geq 1$  h, comparisons of bay vs. ocean mortality rates were made using wet treatments only. All five treatments (Control,  $1/2$ , 1, 2, and 4 h) were combined and overall mean weekly mortality rates were compared. The average weekly mortality rate of lobsters in bay tests ( $\bar{x}$  = 4.5%) differed significantly ( $Z$  = 2.51,  $P$  < 0.05) from that of lobsters tested in the ocean ( $\bar{x}$  = 7.6%).

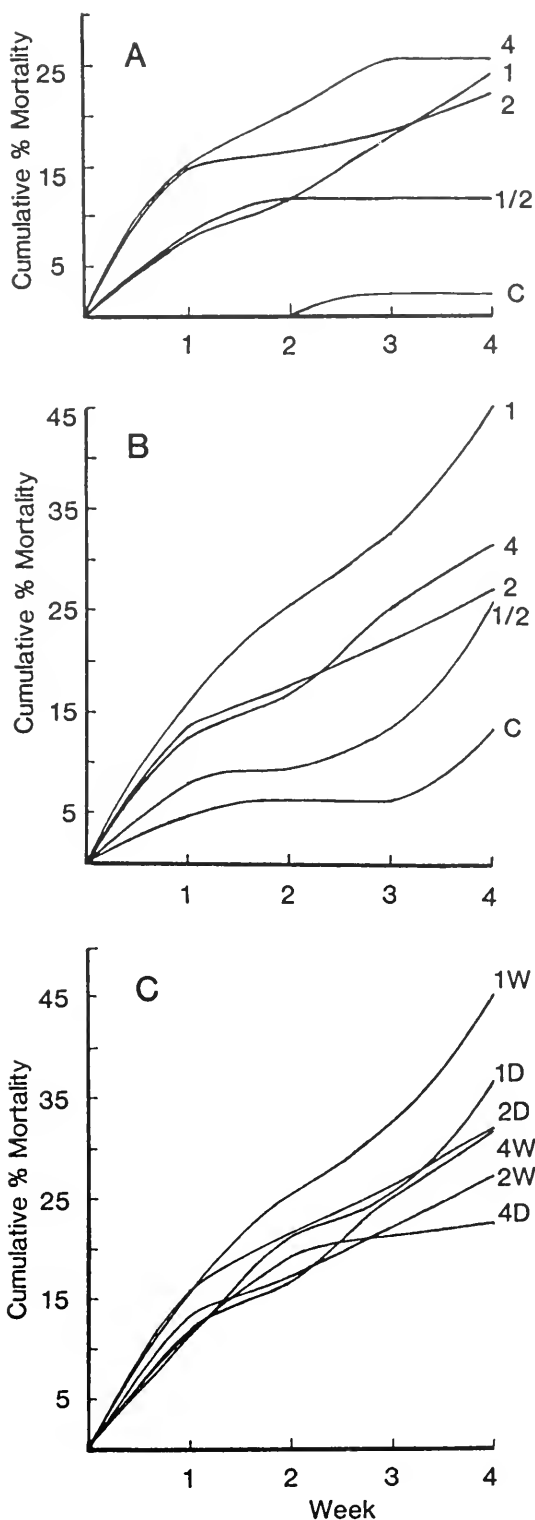

FIGURE 1.—Cumulative mortality rates (%) for exposure tests: A. Florida Bay, wet only; B. Atlantic reefs, wet only; C. Wet (W) vs. dry (D), Atlantic reefs only. C = controls; exposure periods =  $1/2$ , 1, 2, and 4 h.

Comparisons of each exposure period within a treatment with every other exposure period within that treatment are shown in Table 2. In the bay, mortality rates experienced by controls were significantly different than those of lobsters exposed 1, 2, or 4 h. Additionally, lobsters exposed ½ h suffered a significantly lower mortality rate than did those exposed 4 h. However, some of these differences were not significant among lobsters exposed at the Atlantic reef site. Among dampened lobsters tested there, only the mortality rate of those exposed 1 h differed significantly from that of controls and from that of lobsters exposed ½ h. Among undampened lobsters tested at the ocean site, mean mortality rates of controls differed significantly only from those exposed 1 or 2 h. Differences between controls and 1 h exposures were significant in every treatment, but mean mortality rates never differed significantly among lobsters exposed 1, 2, or 4 h.

The mean mortality rate of all tested lobsters during the first week following exposure was 11.2%, which represents about 42% of all mortality; 54% of all mortality in Florida Bay and 38% of all which took place near Atlantic reefs occurred during the first week (Table 1, Fig. 1). High mean weekly mortality rates which occurred during week 1 decreased to much lower levels during week 2 (4.7%) and week 3 (3.9%) in both bay and ocean (Fig. 2). Comparisons of mean mortality rates incurred during week 1 with those of weeks 2 and 3 revealed significant differences in every instance (Table 3). During week 4, the overall rate increased to 6.1% (Fig. 2), but this combined value masked highly divergent changes in rates of mortality at bay and ocean sites.

TABLE 2.—Results of Wilcoxon Two Sample Tests (Z values) from comparisons of mean weekly mortality rates from different exposure periods for various treatments at Florida Bay (Bay) and Atlantic Reef (Ocean) locations. C = controls; exposure = hours.

Tests	Exposure	C	½	1	2	4
Bay wet	C	—				
	½	1.14	—			
	1	2.48*	1.62	—		
	2	2.52*	1.68	0.02	—	
	4	2.93**	2.17*	0.51	0.49	—
Ocean wet	C	—				
	½	1.10	—			
	1	3.07**	2.02*	—		
	2	1.87	0.81	1.17	—	
	4	1.93	0.85	1.16	0.03	—
Ocean dry	C	—				
	½	1.10	—			
	1	2.20*	1.12	—		
	2	2.12*	1.03	0.10	—	
	4	1.17	0.08	1.01	0.92	—

\* =  $P \leq 0.05$ ; \*\* =  $P \leq 0.01$ ; \*\*\* =  $P \leq 0.001$ .

Bayside mortality rates actually decreased slightly, whereas oceanside rates increased dramatically. Statistical comparisons between mean mortality rates during weeks 1 and 4 demonstrate significant differences in the bay but not in the ocean (Table 3). Graphic depictions of cumulative weekly mortality rates (Fig. 1) reveal a decrease in slope after week 1 at both bay and ocean sites. These decreases indicate reduced rates of mortality which persist through the end of the experiment in the bay and through week 3 in the ocean. However, the slope increases sharply during week 4 in most oceanside tests, indicating an additional period of high mortality there.

## DISCUSSION

Exposure unquestionably causes mortality among *Panulirus argus* used to bait traps. Increasing ex-

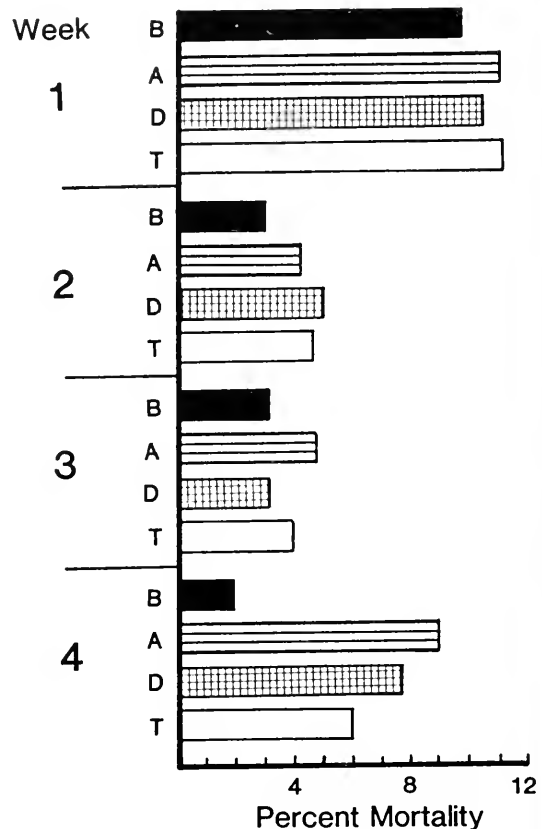

FIGURE 2.—Average weekly mortality rates (%) per treatment type during weeks 1-4, all exposures combined. A = oceanside (Atlantic Ocean) wet; B = bay (Florida Bay) wet; D = oceanside dry; T = all treatments combined.



posure periods up to 1 h resulted in corresponding increases in mortality. Similar mortality has been observed in the Western Australia spiny lobster (*Panulirus cygnus*) fishery (Brown and Caputi 1983; Brown et al. in press). In that fishery, undersize lobsters are not used as bait but are often retained aboard vessels for varying periods during the sorting process. To test effects of that practice, Australian lobsters were tagged, held aboard vessels for 0, ¼, ½, 1, and 2 h, and then released. Recapture rates were markedly lower in exposed groups than in controls. As in our experiments, results from exposure times >1 h were similar to those of 1 h exposures.

The greatest rate of mortality to *Panulirus argus* in our tests occurred during the first week following exposure (Fig. 2). Although physiological causes of mortality have not been determined, several factors may be involved. Dehydration due to desiccation may affect survival, but lobsters dampened at ½ h intervals died at rates similar to those left unattended. One effect of exposure is to dry gills (Anonymous 1980), which may result in respiratory problems. Dehydration and gill damage may cause mortality directly, but more likely are contributory factors to physiological stress caused by buildup of toxic compounds in the blood. Handling stress has been demonstrated to cause temporary acidic conditions in the blood of European lobsters, *Homarus vulgaris* (McMahon et al. 1978). After reimmersion in seawater, lobsters should rehydrate fairly quickly, but effects of physiological stress are likely to linger.

Contrary to prior expectations, mortality rates of dampened lobsters did not differ significantly from those left unattended (dry). Dampening also failed to enhance survival of the northern lobster, *Homarus americanus* (McLeese 1965). McLeese suggested

that a relationship existed between metabolic rate and mortality. An increase in metabolic rate and concurrent more rapid depletion of reserves may have offset advantages of increasing moisture by dampening during our experiments as well.

Exposure was probably the principal cause of mortality among bait lobsters during our tests in Florida Bay. However, a small but distinctly greater level of mortality among all lobsters, including controls during weeks 1-3 and a marked increase in mortality during week 4 at the ocean site, suggest that other factors in addition to exposure were responsible for mortalities there (Figs. 1, 2). When average mortality rates of controls (Table 1) are subtracted from overall average mortality rates of exposed lobsters, resultant values (18.6%, Florida Bay; 18.3%, Atlantic reefs) are nearly equal and probably represent the rates of mortality actually ascribable to exposure at each site. Thus, effects of exposure were similar regardless of where traps were placed.

Mortality due to other effects related to confinement evidently do vary depending upon locations where traps are placed, especially if confinement periods are lengthy. Increased mortality rates such as those we observed during week 4 at the Atlantic reef site may result from starvation. Lyons and Kennedy (1981) presented evidence of weight loss and starvation among lobsters confined at densities of 3 and 5/trap in Florida Bay for 8 wk. Rate of weight loss increased during week 4 among lobsters at densities of 5 but did not increase rapidly until week 6 among lobsters confined at densities of 3. Those tests were conducted in the same portion of Florida Bay where present exposure tests were conducted, an area characterized by muddy sand overlain by seagrass beds. A disparity in available food organisms between this area and that where oceanside tests were conducted may explain differences in mortality during week 4.

Seagrass beds in Florida Bay are lush and heavily covered with epibionts (J. H. Hunt, pers. obs.). These epibionts serve as food for larger organisms which in turn are appropriate food for *Panulirus argus*. Snails in the genera such as *Modulus*, *Turbo*, *Astraea*, and *Cerithium* and crabs in the genera *Mithrax* and *Pitho* are abundant in these grass beds and are frequently seen within or clinging to sides of lobster traps. All of these also occur commonly in stomach contents of *P. argus* in south Florida (W. G. Lyons, pers. obs.). At the ocean site, grass beds are sparse and patchily distributed, and fewer organisms enter traps from the surrounding sand. It seems reasonable to suppose that the weight loss observed to occur among lobsters confined near lush

TABLE 3.—Results of Wilcoxon Two Sample Tests (Z values) from comparisons of mean weekly (1-4) mortality rates for various treatments at Florida Bay (Bay) and Atlantic Reef (Ocean) locations.

Tests	Week	1	2	3	4
Bay wet	1	—			
	2	2.86**	—		
	3	2.40*	0.55	—	
	4	3.58***	0.94	1.48	—
Ocean wet	1	—			
	2	2.72**	—		
	3	3.04**	0.59	—	
	4	0.66	2.08*	2.50*	—
Ocean dry	1	—			
	2	2.40*	—		
	3	3.33***	1.02	—	
	4	1.31	1.14	2.13*	—

\* =  $P \leq 0.05$ ; \*\* =  $P \leq 0.01$ ; \*\*\* =  $P \leq 0.001$ .

grass beds (Lyons and Kennedy 1981) might occur at accelerated rates in the relatively more sparse ocean environment. If food is sufficiently scarce, accelerated weight loss may lead to starvation and increased mortality within the observed 4-wk period.

Traps in these experiments had their entrances boarded over to prevent escape, whereas lobsters that escape from traps used in the fishery are likely to recover from effects of starvation. Escape rates, though, are quite low, ranging from 0.8 to 1.8%/d (Yang and Obert 1978; Davis and Dodrill 1980; Lyons and Kennedy 1981).

We offer no explanation for our observation that highest mortality rates are associated with 1-h exposures nor for the persistent background mortality among oceanside controls. Nevertheless, neither seem to be artifacts of experimental design and, instead, probably represent other yet-to-be understood physiological reactions to stress caused by exposure, handling, or confinement. If so, they represent other effects of baiting with shorts and are justly included among estimates of total fishery-induced mortality.

### Economic Effects of Mortality

Baiting traps with shorts results in significant economic loss to the fishery. Although use of shorts is an effective means of attracting other lobsters without requiring out-of-pocket expenses for bait, each bait lobster that dies is one that potentially will not enter fishery landings. In addition, repair of broken legs, antennae, and other injuries caused by handling may retard growth by as much as 40% (Davis 1981), increasing the time required for a lobster to attain legal size and extending the time during which it may be used as bait. An injured lobster that escapes from a trap where it was placed will direct energy toward repair, not growth, thereby reducing the probability that it will attain legal size during its next molt. If the lobster does not attain legal size, it is again vulnerable to capture and to use as bait. Confinement itself also results in reduced lobster growth rate (Kennedy 1982), which doubtlessly extends the period during which a lobster may be vulnerable to use as bait.

The hidden costs of baiting with shorts needs to be considered in future management efforts. The following model, based only upon observed mortality rates, estimates that cost:

$$Y = A \times B \times C \times D$$

where Y = seasonal mortality of shorts used as bait;  
A = number of traps in the fishery;

B = average number of shorts per trap;

C = season length (in months);

D = average monthly mortality rate.

Because the actual allocation of fishery traps among Florida Bay and Atlantic sites is unknown but believed to be relatively equal, we selected the unweighted average cumulative 4-wk mortality rate to estimate monthly mortality throughout the fishery. By using a range of values for other variables, several estimates of the average number of shorts that die seasonally because of fishery baiting practices may be obtained (Table 4). Thus, if each trap in the fishery is baited with only 1 short/mo and all fishermen leave the fishery after only 4 mo, more than 600,000 sublegal lobsters may die as a result of their use as bait. If all traps are deployed for the full 8 mo and each trap uses 3 shorts as bait, more than 3.6 million shorts may die as a result of that use. Both examples probably represent extreme cases, and actual fishery-induced mortality probably lies somewhere between these estimates.

The problem is really more complex. Some lobsters that die because they were used as bait would probably fall victim to other causes, but natural mortality among lobsters of sizes appropriate for use as bait (65-75 mm CL) may be low, particularly since incidence of their principal predators, large seranids, has been greatly reduced in the fishery area. Furthermore, not all traps are baited with shorts because shorts are not readily available in some peripheral areas of the fishery. Both of these factors suggest that the model may overestimate fishery-induced mortality. However, values used in the model for numbers of shorts per trap are probably low. Fishermen prefer to use 3-5 shorts/trap (Gulf of Mex-

TABLE 4.—Estimates of the economic effect of baiting with shorts in the south Florida spiny lobster fishery.

Average monthly mortality rate <sup>1</sup>	No. of traps in fishery <sup>2</sup>	Season length <sup>3</sup>	No. of shorts/trap <sup>4</sup>	Seasonal mortality of shorts as bait
0.263	573,000	4	1	602,796
0.263	573,000	4	3	1,808,338
0.263	573,000	6	1	904,194
0.263	573,000	6	3	2,712,582
0.263	573,000	8	1	1,205,592
0.263	573,000	8	3	3,616,776

<sup>1</sup>Unweighted average cumulative 4-wk mortality rate from this study.

<sup>2</sup>Number of traps in 1981 (E. J. Little, Jr., Southwest Fisheries Center Resource Statistics Office, National Marine Fisheries Service, NOAA, P.O. Box 269, Key West, FL 33041, pers. commun. November 1982).

<sup>3</sup>The season is 26 July-31 March, 8+ mo; some fishermen begin removing their traps after November, and many have left the fishery by the end of January, causing a considerable reduction in the number of traps fished during February and March.

<sup>4</sup>Conservative estimates; fishermen try to put as many shorts as available into traps.

ico and South Atlantic Fishery Management Councils 1982), and it seems probable from fishermen's comments that virtually no shorts are intentionally released. Similarly, the model only allows one input of bait per month, whereas in reality additional shorts are continually introduced, typically at 1-2 wk intervals, to replace others lost because of death or escape. These factors suggest that the model may underestimate fishery-induced mortality.

Regardless of which values are applied, the model indicates that resultant losses to the fishery are considerable. Since a lobster weighs slightly <1 lb at legal size, fishery-induced mortality may cause losses ranging from 0.6 to 3.6 million lb. At recent ex-vessel prices of \$2.50 per pound, this represents a potential loss to the fishery of \$1.5-\$9.0 million annually. In 1981, total reported commercial lobster harvest was 5.9 million lb valued at \$14.5 million<sup>3</sup>, so the hidden cost of baiting with shorts is considerable.

This loss may be viewed as a necessary cost, albeit large, of doing business in the fishery or as a problem that may be alleviated by alternative management strategies. If the latter course is deemed necessary, use of other baits and installation of escape gaps that allow shorts to escape while retaining legal lobsters in traps (Bowen 1963) are potentially effective strategies to increase harvest of legal lobsters without adversely affecting the population.

## ACKNOWLEDGMENTS

This project was partially funded by a research grant (2-341-R) from PL 88-309 (Commercial Fisheries Research and Development Act) through the Fisheries Management Division, National Marine Fisheries Service, NOAA, U.S. Department of Commerce, and was administered by the Florida Department of Natural Resources (FDNR) Bureau of Marine Research.

R. S. Brown, Western Australia Department of Fisheries and Wildlife, provided unpublished manuscripts of related recent studies of *Panulirus cygnus*. Field assistance was provided by D. G. Barber, S. F. Barber, G. F. Bieber, S. E. Coleman, J. W. Lowry, R. H. McMichael, Jr., G. K. Vermeer, and M. A. Winter, all presently or formerly FDNR employees. G. K. Vermeer, M. A. Winter, and R. G. Muller

(FDNR) provided valuable discussion and other assistance during manuscript preparation. All are gratefully thanked.

## LITERATURE CITED

- ANONYMOUS.  
1980. The fate of undersized rock lobsters returned to the sea. West. Aust. Dep. Fish. Wildl., Fish. Ind. News Serv. (F.I.N.S.) 13:10-12.
- BOWEN, B. K.  
1963. Management of the western rock lobster, (*Panulirus longipes cygnus* George). Proc. Indo-Pac. Fish. Counc. 14: 139-154.
- BROWN, R. S., AND N. CAPUTI.  
1983. Factors affecting the recapture of undersize western rock lobster *Panulirus cygnus* George returned by fishermen to the sea. Fish. Res. 2:103-128.
- BROWN, R. S., J. PRINCE, N. CAPUTI, AND J. JERKE.  
In press. Fishery induced mortality of undersize western rock lobster. West. Aust. Dep. Fish. Wildl. Bull.
- COPE, C. E.  
1959. Spiny lobster gear and fishing methods. U.S. Fish Wildl. Serv., Fish. Leaflet 487, 17 p.
- DAVIS, G. E.  
1981. Effects of injuries on spiny lobster, *Panulirus argus*, and implications for fishery management. Fish. Bull., U.S. 78:979-984.
- DAVIS, G. E., AND J. W. DODRILL.  
1980. Marine parks and sanctuaries for spiny lobster fishery management. Proc. Gulf Caribb. Fish. Inst. 32:194-207.
- GULF OF MEXICO AND SOUTH ATLANTIC FISHERY MANAGEMENT COUNCILS.  
1982. Fishery management plan, environmental impact statement and regulatory impact review for spiny lobster in the Gulf of Mexico and South Atlantic. Gulf of Mexico and South Atlantic Fishery Management Councils, Tampa, Fla., var. p.
- KENNEDY, F. S., JR.  
1982. Catch rates of lobster traps baited with shorts, with notes on effects of confinement. In W. G. Lyons (editor), Proceedings of a workshop on Florida spiny lobster research and management, p. 20. Fla. Dep. Nat. Resour. Mar. Res. Lab., St. Petersburg.
- LYONS, W. G., D. G. BARBER, S. M. FOSTER, F. S. KENNEDY, JR., AND G. R. MILANO.  
1981. The spiny lobster, *Panulirus argus*, in the middle and upper Florida Keys: population structure, seasonal dynamics, and reproduction. Fla. Mar. Res. Publ. 38, 38 p.
- LYONS, W. G., AND F. S. KENNEDY, JR.  
1981. Effects of harvest techniques on sublegal spiny lobsters and on subsequent fishery yield. Proc. Gulf Caribb. Fish. Inst. 33:290-300.
- MCLEESE, D. W.  
1965. Survival of lobsters, *Homarus americanus*, out of water. J. Fish. Res. Board Can. 22:385-394.
- MCMAHON, B. R., P. J. BUTLER, AND E. W. TAYLOR.  
1978. Acid base changes during recovery from disturbance and during long term hypoxic exposure in the lobster, *Homarus vulgaris*. J. Exp. Zool. 205:361-370.
- SOKAL, R. R., AND F. J. ROHLF.  
1969. Biometry: the principles and practice of statistics in biological research. W. H. Freeman and Co., San Franc., 776 p.

<sup>3</sup>Statistical Surveys Branch. 1983. Florida landings 1981. Southeast Fisheries Center National Statistical Office, National Marine Fisheries Service, NOAA, 75 Virginia Beach Drive, Miami, FL 33149.

WOLFFERTS, R. C.

1974. Fishermen's problems in the spiny lobster fishery. *In* W. Seaman, Jr., and D. Y. Aska (editors), Conference proceedings: Research and information needs of the Florida spiny lobster fishery, p. 3 [abstr.], 8, 9. Fla. Sea Grant Rep. SUSF-SG-74-201, Gainesville, FL.

YANG, M. C. K., AND B. OBERT.

1978. Selected statistical analyses of Key West spiny lobster data. *In* R. E. Warner (editor), Spiny lobster research review; proceedings of a conference held December 16, 1976 in Key West, Florida, p. 4-7. Fla. Sea Grant Tech. Pap. No. 4.

# TYPE, QUANTITY, AND SIZE OF FOOD OF PACIFIC SALMON (*ONCORHYNCHUS*) IN THE STRAIT OF JUAN DE FUCA, BRITISH COLUMBIA

TERRY D. BEACHAM<sup>1</sup>

## ABSTRACT

The volume, numbers, and size of prey of sockeye, *Oncorhynchus nerka*; pink, *O. gorbuscha*; coho, *O. kisutch*; and chinook, *O. tshawytscha*, salmon were investigated for troll-caught salmon in the Strait of Juan de Fuca off southwestern Vancouver Island during 1967-68. Sockeye salmon was the least piscivorous species with only 7% of the stomach volume comprised of fish, while chinook salmon was the most piscivorous species at 56%. Sand lance, *Ammodytes hexapterus*, and euphausiids were the most important fish and invertebrate prey, respectively. As predator size increased, mean size of fish prey increased, and predators shifted to species of larger mean size. Similar results were found for the invertebrate prey, with mean number of prey consumed per predator increasing for the larger invertebrate species as predator size increased. Rate of increase in mean length of fish prey was proportional to increasing predator length. The observed increase in invertebrate size with increasing predator length was not statistically significant. Although chinook and coho salmon had similar diets, they were caught at significantly different water depths. *Oncorhynchus* species with fewer, shorter, and more widely spaced gillrakers have higher proportions of fish in their diet than species with numerous, long, and narrow set gillrakers.

The life history of Pacific salmon is quite variable among species, with fry of pink salmon, *Oncorhynchus gorbuscha*, and chum salmon, *O. keta*, migrating to sea soon after emergence from the gravel, while those of sockeye salmon, *O. nerka*, coho salmon, *O. kisutch*, and chinook salmon, *O. tshawytscha*, may spend up to 2 yr in freshwater. Once in the ocean they can migrate a considerable distance from their natal streams and feed on a variety of organisms (Godfrey et al. 1975; French et al. 1976; Major et al. 1978; Takagi et al. 1981). Salmon thus move through a number of habitats during their life cycle and consume a diverse array of prey.

Food preferences of salmon in the range of habitats that they occupy have been an area of continuing investigation (Allen and Aron 1958; Prakash 1962; LeBrasseur 1966; Parker 1971; Eggers 1982). Relative amounts of different prey types eaten in varying environments have been examined, as well as preferences by different sizes of predators in relation to the size and abundance of prey. *Oncorhynchus* species differ considerably in their size, morphology, and ocean distribution (Hikita 1962; Neave et al. 1976; Takagi et al. 1981; Beacham and Murray 1983). Morphological differences and diet partitioning have been reported for many fish species

(Keast and Webb 1966; Hyatt 1979), and diet partitioning may thus be expected among *Oncorhynchus* species. Prey size is related to predator size (O'Brien 1979; Gibson 1980), and differential prey selection among *Oncorhynchus* species may also be apparent.

Stomach contents of sockeye, pink, coho, and chinook salmon were investigated in a research trolling program conducted off southern Vancouver Island in the Strait of Juan de Fuca during 1967-68. The relative importance of different prey types, including fish and invertebrates, in the diet of the four species was studied with respect to prey size, predator size, predator morphology, and diet partitioning in relation to salmonid habitat and morphology.

## MATERIALS AND METHODS

The salmon were obtained by test trolling in the Strait of Juan de Fuca during 19 June-11 October 1967 and 1 May-12 July 1968 (Fig. 1). Detailed methodology of the program has been outlined by Graham and Argue (1972). For each salmon sampled, date, fork length (mm), round weight, and sex were recorded. Stomachs were removed, placed in numbered cloth sample bags along with any food organisms in the mouth cavity, and preserved in 10% Formalin<sup>2</sup> solution.

<sup>1</sup>Department of Fisheries and Oceans, Fisheries Research Branch, Pacific Biological Station, Nanaimo, British Columbia V9R 5K6, Canada.

<sup>2</sup>Reference to trade names does not imply endorsement by the National Marine Fisheries Service, NOAA.

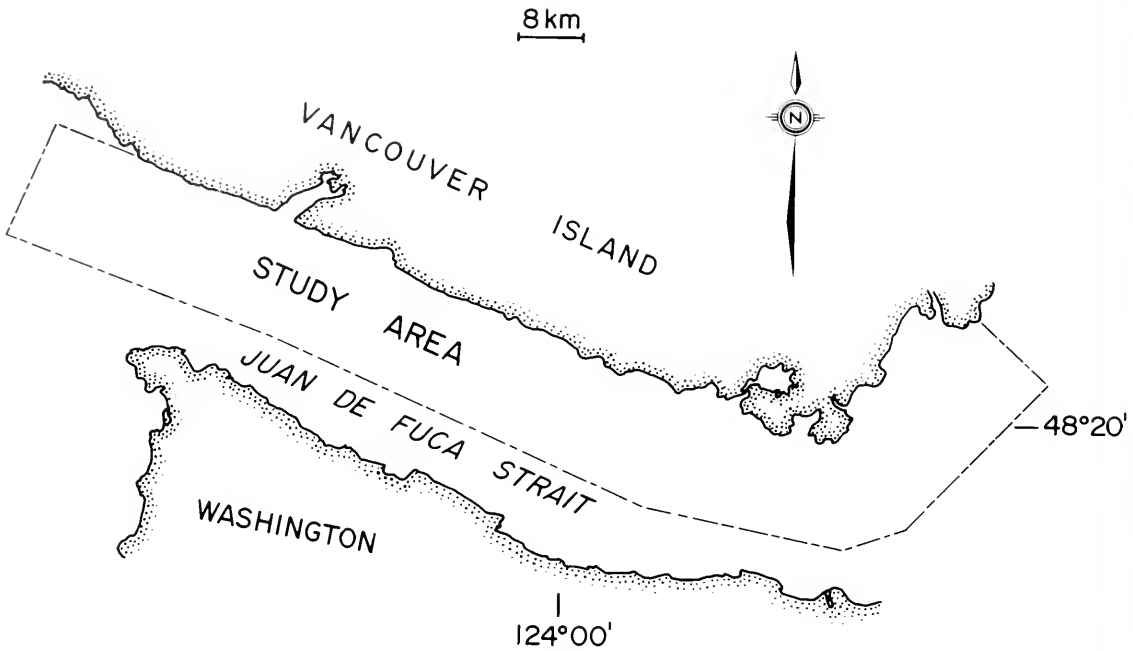

FIGURE 1.—Location of study area in Strait of Juan de Fuca off southwestern Vancouver Island.

Laboratory analysis involved sorting the contents into the classifications outlined in Table 1 by using a low-power binocular microscope. Numbers of organisms in each classification were recorded, if possible, for each individual salmon. Once individuals were counted, displacement volumes (mL) were determined separately for fish contents, for crusta-

cean contents, and for miscellaneous organisms. If organisms were too digested to assign to individual classifications but could be identified as fish or crustaceans, their volumes were included in either the unidentified fish volume or unidentified crustacean volume classification.

Two techniques of data analysis were used.

TABLE 1.—Percentage of salmon sampled with empty stomachs and average number of prey per fish with non-empty stomachs.

Class	N	% empty	Prey type										
			Sand lance	Herring	Rockfish (Sebastes)	Other fish	Euphausiids	Parathermisto	Crab larvae	Mysids	Amphipods*	Crabs	Miscellaneous crustaceans
Sockeye <55 cm	22	46	—	—	—	—	3.7	13.2	5.0	0.3	—	—	0.1
Sockeye >55 cm	117	41	0.2	—	—	—	13.5	8.6	0.4	0.1	—	—	0.4
Total	139	42	0.2	—	—	—	12.1	9.3	1.1	0.1	—	—	0.4
Pink <55 cm	301	26	0.7	—	—	—	9.7	13.7	1.0	0.3	—	0.1	0.3
Pink >55 cm	498	32	0.4	—	—	0.1	15.3	13.1	2.4	0.1	0.1	0.1	0.4
Total	799	30	0.5	—	—	0.1	13.1	13.3	1.9	0.2	0.1	0.1	0.4
Coho <40 cm	1,045	49	0.4	—	—	0.2	6.3	1.2	0.4	1.3	0.1	0.2	0.3
Coho 40-60 cm	1,039	28	5.8	—	0.1	0.3	29.8	0.3	0.9	0.3	—	0.2	0.4
Coho >60 cm	130	32	0.5	0.2	—	—	51.0	0.4	0.6	—	—	—	0.6
Total	2,214	38	3.3	—	—	0.2	22.1	0.7	0.7	0.6	—	0.2	0.4
Chinook <40 cm	607	39	1.1	—	—	0.1	5.4	0.1	0.7	0.4	—	—	0.7
Chinook 40-60 cm	786	36	1.6	0.1	—	0.1	15.3	0.2	0.2	0.6	—	—	0.1
Chinook >60 cm	83	47	0.8	0.3	—	—	62.4	—	0.4	0.1	—	—	—
Total	1,476	38	1.4	0.1	—	0.1	13.6	0.1	0.4	0.5	—	—	0.3

\*Other than *Parathermisto*.

Methodology for the first, percent occurrence of each of the prey types, has been outlined by Hynes (1950). All chi-square tests in the analysis for frequency of occurrence of prey types have one degree of freedom. The second technique involved determining percentage by volume of total stomach contents for fish, crustaceans, miscellaneous organisms, and also for the individual prey classifications. Fish, crustaceans, and miscellaneous organisms were recorded by volume, and thus determining percentage of total stomach volume for each classification was direct. For individual prey types, it was necessary to convert numbers of individual organisms to volumes by calculating the volume displaced by a single organism of each prey type. This was done by selecting individual salmon of each species with only one fish and/or one crustacean prey type in the stomach. The unit volumes for each prey type were then calculated as the sum of the fish or crustacean volumes for the selected fish divided by the number of the prey type under consideration. If there was only one unknown in the stomach contents with prey of known (calculated) volumes (the number of prey types multiplied by their unit volumes), the total volume of known prey was subtracted from the total fish or crustacean volume until only one unknown prey class remained. Then the volume of the prey class in question was obtained and its unit volume calculated. Comparisons of prey size among the species were analyzed by analysis of variance.

For an individual salmon with more than one fish or one crustacean prey class in its stomach, volume of each prey class was determined by multiplying the number of organisms by their unit volume. This total volume obtained was scaled proportionately so that individual components when summed equalled the total known fish or crustacean volume.

## RESULTS

### Volume and Frequency of Food Items

For each species, over 30% of the individuals had empty stomachs (Table 1). In comparing fish with non-empty stomachs, sockeye salmon was the least piscivorous, with a mean 7% fish component in the diet (Fig. 2). In sockeye salmon <55 cm fork length (FL), only 2% of the stomach volume was comprised of fish. At 17% of total food volume, fish was a greater dietary component of pink salmon than of sockeye (Fig. 2). However, the fish component of the diet of sockeye and pink salmon was considerably less than that of coho (46%) and chinook (56%)

salmon. Fish comprised 30% of the stomach content volume of coho <40 cm FL, but almost 50% of the stomach content volume of larger coho. Chinook salmon was the most piscivorous of the four species, and the 56% fish component of the diet was constant for the three size classes of chinook salmon investigated, although the species composition of the fish prey changed.

The relative importance of individual prey types was investigated for the four salmon species. Sand lance, *Ammodytes hexapterus*, was virtually the sole fish component of the diet of sockeye salmon, occurring in 4% of the 81 non-empty sockeye salmon stomachs sampled (Fig. 3). Euphausiids were the most important prey for sockeye, occurring in 58% of non-empty stomachs and comprising 71% of the total volume of food eaten. The hyperiid amphipod *Parathemisto* comprised over 11% of the volume of food eaten. Of the fish prey species, sand lance was again the most important for pink salmon, occurring in 9% of 562 non-empty stomachs and comprising 10% of total stomach contents (Fig. 4). There was no significant difference between sockeye and pink salmon in the frequency of occurrence of sand lance in their diets ( $\chi^2 = 2.65$ ,  $P > 0.05$ ). Fish species other than sand lance (herring, *Clupea harengus*, and rockfish, *Sebastes* sp.) comprised less than 1% of stomach contents of pink salmon. As in sockeye salmon, the dominant invertebrate prey types were euphausiids at 62% of stomach content volume and *Parathemisto* at 14%. Frequency of occurrence of euphausiids ( $\chi^2 = 1.63$ ,  $P > 0.05$ ) and *Parathemisto* ( $\chi^2 = 3.54$ ,  $P > 0.05$ ) were similar for sockeye and pink salmon.

Fish species were a significant food for coho and chinook salmon. For example, sand lance occurred in 27% of 1,364 non-empty stomachs of coho salmon, and also comprised 27% of total stomach volume (Fig. 5). Herring comprised <1% of the stomach content volume of coho <40 cm FL, but 25% of the volume for coho >60 cm FL. The dominant invertebrate prey type was euphausiids, comprising 51% of total stomach contents, while all invertebrate prey types combined comprised only 54%. The relative importance of fish as a prey type was greatest in chinook salmon, with sand lance again the dominant prey species, occurring in 34% of 914 non-empty stomachs, and comprising 35% of total volume of contents (Fig. 6). Sand lance occurred in the diet of chinook and coho salmon at similar frequencies ( $\chi^2 = 0.80$ ,  $P > 0.05$ ), as did herring ( $\chi^2 = 0.08$ ,  $P > 0.05$ ). Herring comprised 9% of the stomach contents for chinook salmon <40 cm FL, but 33% of the stomach contents for chinook salmon >60 cm FL.

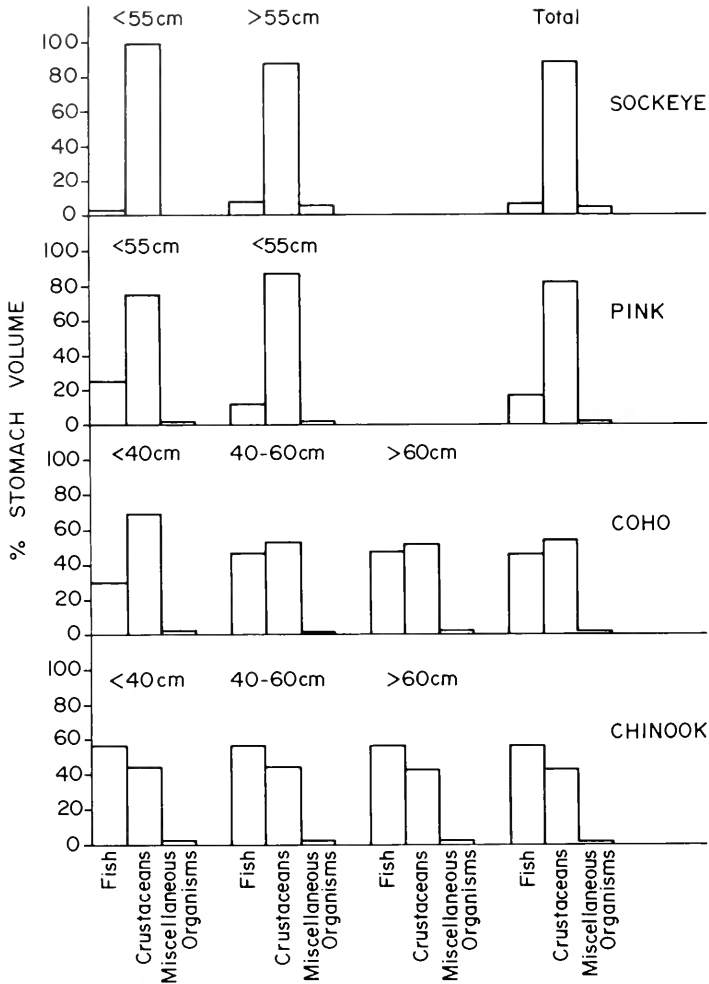

FIGURE 2.—Percentage volumes of stomach contents of the fish, crustacean, and miscellaneous organism component for sockeye, pink, coho, and chinook salmon sampled in Strait of Juan de Fuca during 1967-68.

Coho ate greater numbers of fish than did chinook salmon (Table 1), but chinook had a greater volume of the stomach contents composed of fish (56% chinook, 46% coho). This result suggests chinook eat larger fish than coho (Table 2). As with coho, euphausiids were the dominant invertebrate prey type of chinook salmon, comprising 40% of a total invertebrate volume of 44% of stomach contents. However, euphausiids occurred significantly more often in the diet of coho salmon than in chinook salmon ( $\chi^2 = 4.73$ ,  $P < 0.01$ ).

Fish were a more significant dietary component of chinook and coho salmon than of sockeye and pink salmon. Sand lance occurred significantly more often in the diet of chinook and coho salmon than in the

diet of sockeye and pink salmon ( $\chi^2 = 152.9$ ,  $P < 0.01$ ). Similar results were also found for herring ( $\chi^2 = 18.1$ ,  $P < 0.01$ ), rockfish ( $\chi^2 = 7.2$ ,  $P < 0.01$ ), and mixed fish species ( $\chi^2 = 39.0$ ,  $P < 0.01$ ). Invertebrate prey were more significant in the diet of sockeye and pink salmon than in that of chinook and coho. Euphausiids occurred more frequently in the diet of sockeye and pink salmon ( $\chi^2 = 199.3$ ,  $P < 0.01$ ), as did *Parathemisto* ( $\chi^2 = 619.5$ ,  $P < 0.01$ ), crab larvae ( $\chi^2 = 171.1$ ,  $P < 0.01$ ), and amphipods ( $\chi^2 = 9.2$ ,  $P < 0.01$ ). There was no difference in frequency of occurrence of crabs in the diet ( $\chi^2 = 0.01$ ,  $P > 0.05$ ) which occurred only at low levels or not at all, but mysids occurred more frequently in the diet of chinook and coho salmon than in



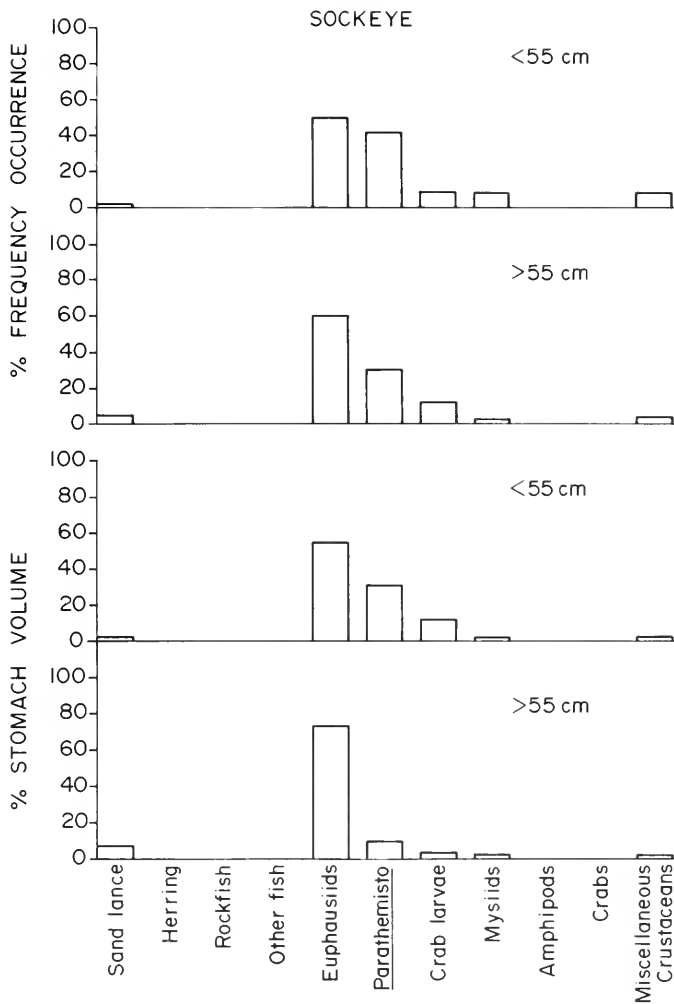

FIGURE 3.—Percentage frequency of occurrence and percentage stomach volume of prey types listed in Table 1 for sockeye salmon.

that of sockeye and pink salmon ( $\chi^2 = 36.0, P < 0.01$ ).

### Predator and Prey Size

The effect of predator size on the abundance and size of prey was examined for each of the four salmon species investigated. Numbers of individuals consumed for each prey type were tallied for each salmon examined. For the fish prey species, only sand lance was consumed at a high enough frequency to enable one to investigate numbers of sand lance consumed versus predator size. For the four salmon species, there was no consistent trend for sand lance in this regard (Table 1). For both chinook and coho

salmon—the two primary sand lance predators—the number of sand lance eaten was greater in the middle size group than in either the small or large size classes. Large chinook and coho salmon switched from sand lance to larger fish species, such as herring (Figs. 5, 6). There were, however, clear trends for some of the invertebrate prey types. The average number of euphausiids eaten per individual predator increased with increasing fish size (Table 1). However, the average number of *Parathemisto* eaten decreased with increasing predator size. The other prey types occurred at a low frequency (Figs. 3-6), and thus it was not possible to determine reliable trends.

As predator size increased, more euphausiids, but

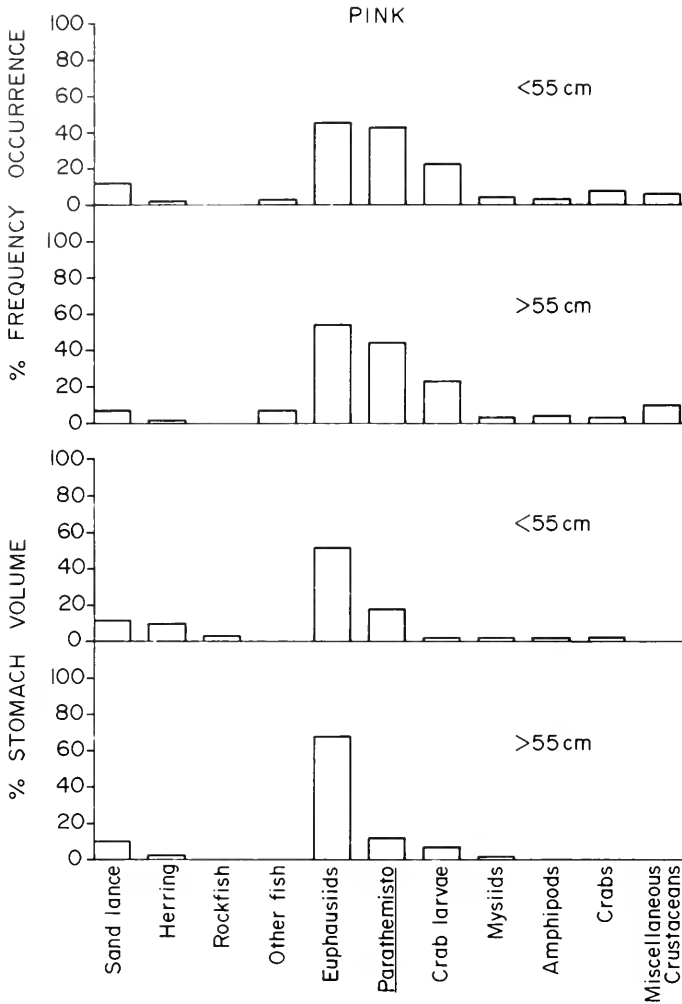

FIGURE 4.—Percentage frequency of occurrence and percentage stomach volume of prey types for pink salmon.

less *Parathemisto*, were eaten per individual predator. The difference in predator response to euphausiids and *Parathemisto* may be examined in relation to the size of the prey. The unit volumes of an individual euphausiid were about four times larger than those of an individual *Parathemisto* (Table 2). In each salmon species examined, as the predators increased in size, they switched from the smaller *Parathemisto* to the larger euphausiids and also crab larvae, consuming greater numbers of the larger prey and decreasing numbers of the smaller prey. Chinook and coho salmon also consumed significantly larger *Parathemisto* than did sockeye and pink salmon ( $F = 4.9$ ;  $df = 3,98$ ;  $P < 0.01$ ). For the invertebrate prey, an increase in predator size

resulted in greater numbers of larger prey being consumed.

As predator size increased, there was an increase in the size of the prey consumed (Table 2). Larger predators consumed larger sand lance and herring. Chinook and coho salmon consumed larger sand lance ( $F = 3.7$ ;  $df = 3,613$ ;  $P < 0.05$ ) and mixed fish species ( $F = 2.9$ ;  $df = 2,128$ ;  $P < 0.05$ ) than did sockeye and pink salmon. In coho and chinook salmon, there was also a tendency for larger salmon to switch prey types from the smaller sand lance to the larger herring and rockfish. Increasing predator size produced shifts in both the type, number, and size of the prey consumed.

Changes in size of prey and predators were in-

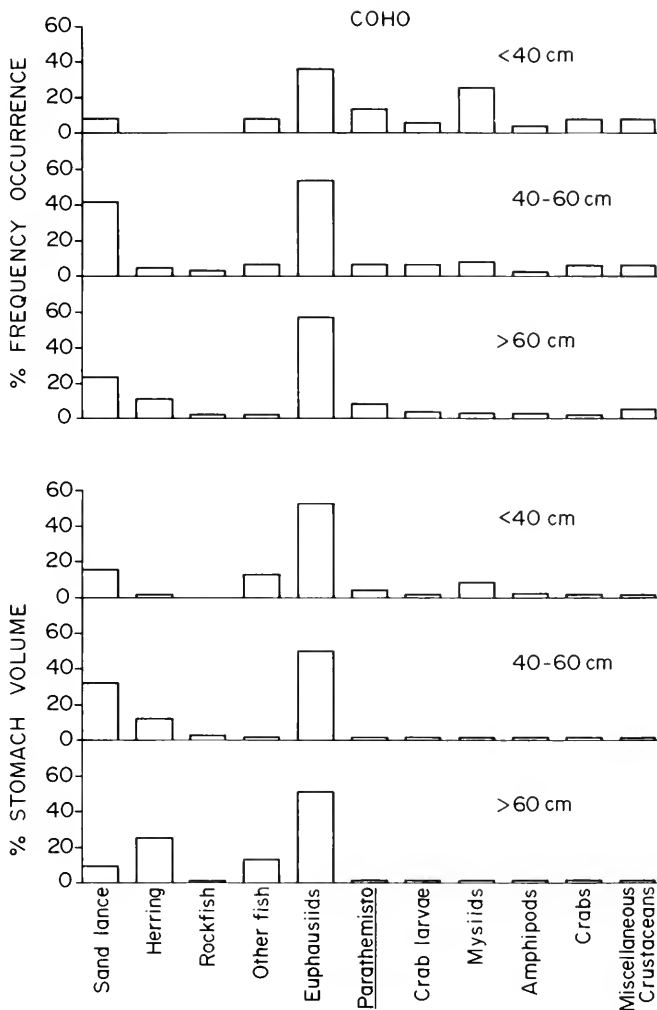

FIGURE 5.—Percentage frequency of occurrence and percentage stomach volume of prey types for coho salmon.

vestigated for the two most frequently occurring fish prey (sand lance, herring) and crustacean prey (euphausiids, *Parathemisto*). Size classes for sockeye and pink salmon were below and above 55 cm FL, and those for chinook and coho salmon below and above 60 cm FL. I assume that the value of the cube root of the volume ratio of the prey is proportional to the prey length ratio, and thus changes in prey size can be compared with changes in predator size.

Mean size of the fish component of the prey increased as predator size increased (Table 3). As the size of pink, coho, and chinook salmon increased by 13%, 65%, and 69%, respectively, the size of the sand lance consumed increased by 16%, 83%, and 83%,

respectively. The size of herring eaten also increased as predator size increased, and for pink and chinook salmon it was about equal to the increase in size of the predator species. When the predator responses to increase in size of both prey species are pooled, there is a weak correlation between increasing predator length and increasing prey length ( $r = 0.69$ ,  $n = 6$ ,  $P > 0.05$ ); but if the coho salmon response to increasing herring size is deleted, the relationship is much stronger between increasing predator and prey size ( $r = 0.98$ ,  $n = 5$ ,  $P < 0.01$ ).

Apparent trends of invertebrate prey size with predator size were not statistically significant. For sockeye and pink salmon, mean size of individuals in the two invertebrate prey classes decreased as

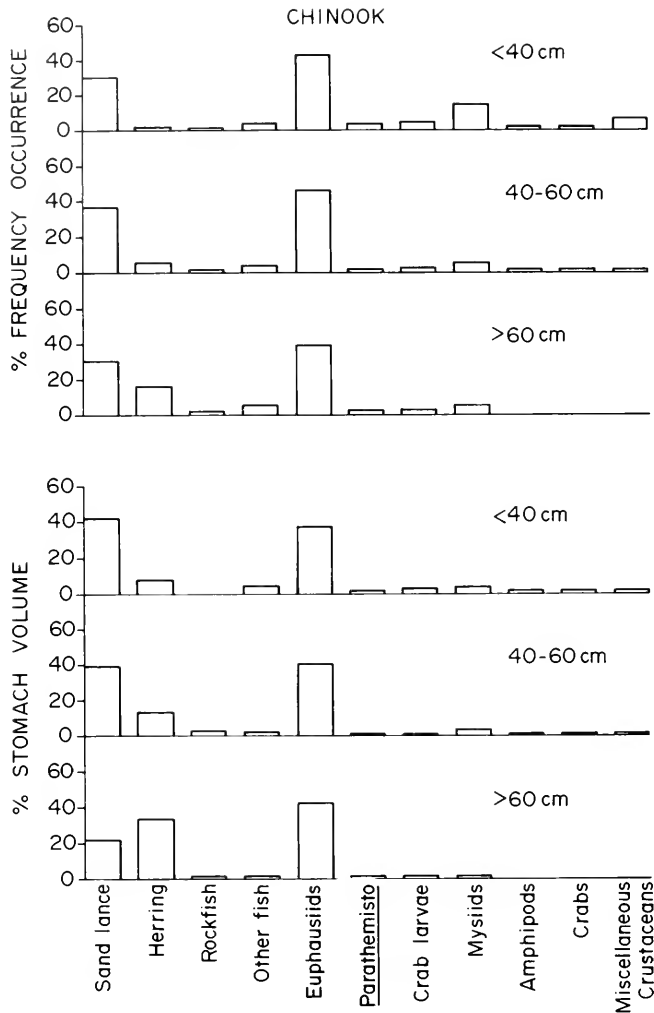

FIGURE 6.—Percentage frequency of occurrence and percentage stomach volume of prey types for chinook salmon.

predator size increased, but not significantly (Table 3) ( $r = -0.24$ ,  $n = 4$ ,  $P > 0.05$ ). For chinook and coho salmon, mean size of the invertebrate prey increased as predator size increased ( $r = 0.42$ ,  $n = 4$ ,  $P > 0.05$ ). However, the increase in prey size was considerably less than the increase in predator size (Table 3).

The results of the previous analyses are summarized as follows. As predator size increased, individual predators selected larger fish prey of one species, but not a greater number of the prey. There was also a shifting from smaller prey species (sand lance) to larger ones (herring, rockfish). As predator size increased, there was a tendency to shift from smaller invertebrate prey (*Parathemisto*) to larger types (euphausiids, crab larvae). Greater numbers

of the larger prey were consumed by an individual predator, while numbers of smaller prey consumed declined. Although larger invertebrate prey types were preferred as predator size increased, larger individuals of each prey class were not necessarily selected by larger predators.

### Species Comparisons

The dietary components of the four species of salmon investigated are different, and there is more than one possible reason for the apparent partitioning of diet among the salmon species. Perhaps because the salmon occupied different depth zones, the differences in diet are attributable simply to dif-

TABLE 2.—Calculated mean volumes (ml) per individual for prey organisms. These values were used to convert prey numbers to prey volumes. Sample sizes are in parentheses.

Class	Sand lance	Herring	Rockfish (Sebastes)	Other fish	Euphausiids	Parthemisto	Crab larvae	Mysids	Amphipods	Crabs	Miscellaneous Crustaceans
<b>Sockeye</b>											
<55 cm	—	—	—	—	1.24 (4)	0.18 (3)	0.17 (1)	—	—	—	—
>55 cm	3.18 (3)	—	—	—	0.81 (29)	0.13 (8)	1.00 (2)	2.86 (1)	—	—	0.07 (2)
Total	3.18 (3)	—	—	—	0.86 (33)	0.14 (11)	0.72 (3)	2.86 (1)	—	—	—
<b>Pink</b>											
<55 cm	3.01 (24)	90.00 (4)	26.00 (1)	4.50 (6)	1.17 (85)	0.27 (48)	0.30 (8)	0.93 (4)	1.00 (1)	—	—
>55 cm	4.75 (20)	120.00 (1)	—	1.68 (18)	0.98 (156)	0.57 (68)	0.57 (18)	0.50 (4)	1.17 (1)	0.50 (4)	0.30 (7)
Total	3.80 (44)	96.00 (5)	26.00 (1)	2.39 (24)	1.05 (241)	0.21 (116)	0.49 (26)	0.72 (8)	1.09 (2)	0.50 (4)	0.30 (7)
<b>Coho</b>											
<40 cm	4.33 (38)	32.50 (2)	—	7.36 (40)	1.27 (161)	0.46 (37)	0.35 (13)	1.00 (86)	0.90 (12)	0.71 (18)	0.19 (95)
40-60 cm	4.40 (289)	170.34 (24)	21.32 (9)	3.39 (36)	1.33 (349)	0.42 (20)	0.64 (17)	2.31 (30)	1.43 (7)	0.86 (18)	0.38 (7)
>60 cm	26.98 (19)	207.50 (10)	12.00 (1)	888.00 (1)	1.44 (48)	0.60 (2)	1.00 (2)	2.00 (1)	3.67 (3)	0.33 (1)	1.00 (2)
Total	5.63 (346)	173.00 (36)	20.39 (10)	16.94 (77)	1.32 (558)	0.45 (59)	0.54 (32)	1.34 (117)	1.45 (22)	0.77 (37)	0.22 (104)
<b>Chinook</b>											
<40 cm	6.09 (106)	57.71 (5)	16.00 (1)	10.08 (14)	1.28 (130)	0.20 (2)	0.55 (8)	1.29 (37)	2.14 (5)	0.70 (2)	0.13 (10)
40-60 cm	9.88 (169)	51.56 (22)	37.00 (6)	6.31 (17)	1.14 (190)	0.38 (7)	0.31 (8)	2.11 (21)	2.00 (1)	1.00 (1)	4.11 (3)
>60 cm	51.40 (12)	245.45 (7)	30.00 (1)	1.00 (1)	1.40 (16)	0.55 (1)	0.68 (1)	2.20 (2)	—	—	—
Total	10.22 (287)	92.38 (34)	33.50 (8)	7.79 (32)	1.21 (336)	0.36 (10)	0.44 (17)	1.66 (58)	2.12 (6)	0.80 (3)	1.05 (13)

TABLE 3.—Mean lengths (cm) of salmon and mean size of prey. Mean lengths of sockeye and pink salmon were for those in the size classes below ( $L_1$ ) and above ( $L_2$ ) 55 cm, whereas those for coho and chinook salmon were those below ( $L_1$ ) and above ( $L_2$ ) 60 cm. The prey ratio  $\sqrt[3]{V_2/V_1}$  is assumed to be indicative of ratios in prey lengths between the two groups of predators. The two most frequent fish and invertebrate prey species listed are euphausiids (EU), *Parathemisto* (PA), sand lance (SL), and herring (HR).

Species	Predator			Prey types	Prey			
	Mean length	$L_2$	$L_1$		Mean volume	$V_2$	$V_1$	$\sqrt[3]{\frac{V_2}{V_1}}$
Sockeye	50.7	58.7	1.16	EU	1.24	0.81	0.65	0.87
				PA	0.18	0.13	0.72	0.90
	51.8	58.5	1.13	SL	3.01	4.75	1.58	1.16
				HR	90.00	120.00	1.33	1.10
Coho	40.0	65.8	1.65	EU	1.17	0.98	0.84	0.94
				PA	0.27	0.17	0.62	0.86
	41.2	69.5	1.69	SL	4.39	26.98	6.15	1.83
				HR	159.73	207.50	1.30	1.09
Chinook	41.2	69.5	1.69	EU	1.31	1.44	1.10	1.03
				PA	.45	.60	1.33	1.10
	41.2	69.5	1.69	SL	8.42	51.4	6.10	1.83
				HR	52.70	245.45	4.66	1.67
41.2	69.5	1.69	EU	1.20	1.40	1.17	1.05	
			PA	0.34	0.55	1.61	1.17	

ferences in prey abundances by depth. The numbers of salmon caught with non-empty stomachs were tabulated by depth zone of capture (Table 4). Coho salmon were most abundant in water depths of <18 m, whereas sockeye and pink salmon were most abundant between depths of 18 and 36 m, and chinook salmon most abundant in depths >18 m. Coho and chinook salmon have similar diets, but are found at significantly different depths ( $\chi^2 = 714.7$ ,  $P < 0.01$ ). Thus partitioning of the diets among salmon species is not related simply to water depth.

Morphological characters of the salmon species were compared with their food preferences. Chinook and coho salmon have fewer, shorter, and more widely spaced gillrakers than those of sockeye and pink salmon (Table 5). As gillrakers are used to strain food organisms from water passing over the gills (Lagler et al. 1962), I expected salmon species feeding on planktivorous prey to have more gillrakers that are longer and more closely set than those in primarily piscivorous salmon species. Similar arguments could be made for tooth size (Table 5). Partitioning of the diet among the species of salmon investigated is clearly a reflection of morphological differences among the species.

## DISCUSSION

The calculation of unit volumes for individual prey classes is an important component of the analysis. Prey types were assumed to be in a similar state of

digestion for the different size classes of each species of salmon so that calculated unit volumes would be comparable. Violation of this assumption may account for the inverse predator-prey size relationship found for sockeye and pink salmon with euphausiids and *Parathemisto*. The analysis of relative sizes of the species eaten assumes that different prey types were not more or less digested than others. This is unlikely to be strictly true, but it was assumed that differential digestability of the prey species did not significantly alter their relative sizes.

Previous work on diet description of *Oncorhynchus* species has indicated that there can be considerable variability in dietary components of a particular species. However, some general conclusions can be drawn. Sockeye salmon are the least piscivorous of the northeast Pacific *Oncorhynchus* species (Allen and Aron 1958; LeBrasseur 1966; Foerster 1968). Euphausiids have been reported consistently as a major contributor to the diet of pink salmon (Maëda 1954; Ito 1964; Takagi et al. 1981). The fish component reported has been variable, ranging from <1% to over 90% of stomach volume (Takagi et al. 1981). Chinook and coho salmon tend to be the most piscivorous (Allen and Aron 1958; Prakash 1962; Reimers 1964; LeBrasseur 1966; Machidori 1972). For chinook salmon, fish were reported to provide

TABLE 4.—Number of salmon caught with non-empty stomachs and depth of water (m) in Strait of Juan de Fuca, British Columbia. Salmon were caught by troll gear. Numbers in parentheses are percent of each species caught in each depth zone.

Depth (m)	Sockeye	Pink	Coho	Chinook
<9.1	8 (9.9)	41 (7.3)	385 (28.1)	20 (2.2)
9.1-18.3	10 (12.3)	95 (16.9)	360 (26.3)	60 (6.6)
18.3-27.4	26 (32.1)	159 (28.3)	269 (19.6)	134 (14.6)
27.4-36.6	23 (28.4)	151 (26.9)	211 (15.4)	267 (29.1)
36.6-45.7	7 (8.6)	65 (11.6)	86 (6.3)	119 (13.0)
45.7-54.8	7 (8.6)	50 (8.9)	58 (4.2)	316 (34.5)
Total	81	561	1,369	916

TABLE 5.—Comparisons of morphometric and meristic characters of Pacific salmon whose dietary components were investigated in this study.

Species	Gillraker			Tooth size <sup>4</sup>
	No. <sup>1</sup>	Spacing <sup>2</sup> · Length <sup>3</sup>	Length <sup>3</sup>	
Sockeye	33.7	close	2.6	smallest
Pink	30.4	moderate	3.4	small
Coho	21.2	wide	2.1	moderate
Chinook	20.7	wide	2.0	large

<sup>1</sup>From Hikita (1962).

<sup>2</sup>From Morrow (1980).

<sup>3</sup>Gillraker length as percent of postorbital-hypural length.

Gillraker length is from Hikita (1962), postorbital-hypural length from Beacham and Murray (1983).

<sup>4</sup>From Vladikov (1962), Hikita (1962).

a larger proportion of the diet of larger chinook salmon than of smaller ones (Milne 1955; Reid 1961). In my study, the fish component of the diet was similar for all size classes of chinook salmon. This may be due to differences in availability of invertebrate prey to the smaller chinook salmon among the studies. For example, Ito (1964) found that squid were the largest dietary component of chinook and coho salmon caught in drift nets in high seas fisheries. Variability in diets of the different species may be due in part to prey abundance, selection by the predator, and possible selectivity by the sampling gear used. Hook and line sampling may select fish of different diets than would perhaps gill nets. Salmon caught by trolling may have a higher component of fish in the diet than those caught by gill nets. In my study, fish did constitute a larger proportion of the diet in larger coho salmon than in smaller ones, as noted for chinook salmon. My study has examined the distribution of prey types and sizes for salmon caught from June to October only. Although the relative proportions of fish and invertebrate prey could change seasonally for the salmon species examined, the relative ranking of the species in terms of proportion of fish in their diet should remain constant.

Availability of prey types can alter markedly the proportions in a predator's diet. Herring comprised over 70% of the stomach contents of troll-caught chinook and coho salmon caught off the east and west coasts of Vancouver Island in 1957 (Prakash 1962). My study showed that during 1967-68, herring comprised <20% of the stomach contents of chinook and coho salmon in the same area. Stock abundances of herring declined rapidly in the late 1960's in British Columbia (Hourston 1978), indicating that during a period of low herring abundance, sand lance became an important dietary component of chinook and coho salmon in this area.

Pink salmon in southern British Columbia and Washington State show 2-yr cycles of abundance, with returns absent in even-numbered years. This pattern of abundance has been suggested to be a result of predation by returning adults of the dominant brood year on fry of the alternate brood year (Ricker 1962). In my study, fish other than sand lance, herring, or rockfish comprised <1% of the stomach contents of pink salmon sampled in 1967. These results suggest that predation by the dominant broodline on the alternate broodline may be neither necessary nor sufficient to account for cycles in pink salmon abundance.

The effect of prey size on selection by planktivorous fish has been examined by Werner and Hall

(1974), O'Brien et al. (1976), O'Brien (1979), Gibson (1980), and Eggers (1982). Eggers found that juvenile sockeye salmon prefer large nonevasive prey, but will eat small and/or evasive prey when the former is not available. I found that as predator size increased, prey size increased also, both in terms of size of individuals within a prey type, and a shifting from smaller to larger prey types. The predators presumably decrease the amount of time and energy needed to ingest a given amount of food by switching from smaller to larger prey, given that the large prey types are sufficiently abundant. Werner and Hall (1974) attributed a preference by predators for only a part of the prey types available as a method for increasing foraging efficiency. These results suggest that the salmon species examined do select prey both for size and availability, presumably to increase foraging efficiency.

Morphological differences and diet partitioning have been previously noted for many fish species (Keast and Webb 1966; Hyatt 1979). As outlined by Hyatt (1979), many planktivorous feeding fish tend to have numerous, well-developed, close-set gillrakers. My study indicated that the more piscivorous chinook and coho salmon have fewer gillrakers than the more planktivorous sockeye and pink salmon. Lake trout, *Salvelinus namaycush*, populations that are more planktivorous also have more and longer gillrakers than less planktivorous ones (Martin and Sandercock 1967). *Oncorhynchus masou* (masou or cherry salmon), found in the western Pacific Ocean, has fewer gillrakers than either chinook or coho salmon (Hikita 1962) and, as an adult, feeds largely on fish (Tanaka 1965). Chum, *O. keta*, salmon have an average of 2-3 more gillrakers than chinook and coho (Hikita 1962), and the diet of chum salmon sampled in the spring and summer during 1956-63 in the North Pacific comprised between 10 and 35% fish (Neave et al. 1976). In the genus *Oncorhynchus*, as gillraker number declines, the proportion of fish in the diet increases. Morphological differences among the species account for a greater partitioning of the diet than do differences in water depths in which the individual species are located.

Pacific salmon are adaptable in their diet, shifting their preferred prey species in relation to prey size and abundance. It seems unlikely that salmon abundance is affected by the abundance of any one type of prey. For example, the decline in abundance of British Columbia herring stocks was not followed immediately by declines in salmon abundance. Growth rates of salmon may be affected by changes in diet and this could have an impact on stock population dynamics.

## ACKNOWLEDGMENTS

I am indebted to those people who collected and sampled the salmon for stomach contents that were analyzed in this paper. Sharon Henderson and Bruce Bernard were invaluable for their assistance in data analysis and computer programming. J. G. McDonald provided the initial suggestion for the study. Clyde Murray and two referees offered many valuable criticisms of the manuscript. Lauri Mackie drafted the figures. The manuscript was prepared with the help of the staff of the Publications Unit of the Pacific Biological Station.

## LITERATURE CITED

- ALLEN, G. H., AND W. ARON.  
1958. Food of the salmonid fishes of the western North Pacific Ocean. U.S. Fish Wildl. Serv., Spec. Sci. Rep. Fish. 237, 11 p.
- BEACHAM, T. D., AND C. B. MURRAY.  
1983. Sexual dimorphism in the adipose fin of Pacific salmon (*Oncorhynchus*). Can. J. Fish. Aquat. Sci. 40:2019-2024.
- EGGERS, D. M.  
1982. Planktivore preference by prey size. Ecology 63:381-390.
- FOERSTER, R. E.  
1968. The sockeye salmon, *Oncorhynchus nerka*. Bull. Fish. Res. Board Can. 162:1-422.
- FRENCH, R., H. BILTON, M. OSAKO, AND A. HARTT.  
1976. Distribution and origin of sockeye salmon (*Oncorhynchus nerka*) in offshore waters of the North Pacific Ocean. Int. North Pac. Fish. Comm. Bull. 34, 113 p.
- GIBSON, R. M.  
1980. Optimal prey-size selection by three-spine sticklebacks (*Gasterosteus aculeatus*): a test of the apparent-size hypothesis. Z. Tierpsychol. 52:291-307.
- GODFREY, H., K. A. HENRY, AND S. MACHIDORI.  
1975. Distribution and abundance of coho salmon in offshore waters of the North Pacific Ocean. Int. North Pac. Fish. Comm. Bull. 31, 80 p.
- GRAHAM, C. C., AND A. W. ARGUE.  
1972. Basic data on Pacific salmon stomach contents and effort for 1967 and 1968 test trolling catches in Juan de Fuca Strait, British Columbia. Can. Dep. Environ. Fish. Serv., MS Rep. 1972-76, 405 p.
- HIKITA, T.  
1962. Ecological and morphological studies of the genus *Oncorhynchus* (Salmonidae) with particular consideration on phylogeny. Sci. Rep. Hokkaido Salmon Hatchery 17, 60 p.
- HOURSTON, A. S.  
1978. The decline and recovery of Canada's Pacific herring stocks. Can. Fish. Mar. Serv. Tech. Rep. 784, 17 p.
- HYATT, K. D.  
1979. Feeding Strategy. In W. S. Hoar and D. J. Randall (editors), Fish physiology, Vol. VIII, Bioenergetics and growth, p. 71-119. Acad. Press, N.Y.
- HYNES, H. B. N.  
1950. The food of freshwater sticklebacks (*Gasterosteus aculeatus* and *Pygosteus pungitius*) with a review of the methods used in studies of the food of fishes. J. Anim. Ecol. 19:36-58.
- ITO, J.  
1964. Food and feeding habits of Pacific salmon (genus *Oncorhynchus*) in their oceanic life. Hokkaido Reg. Fish. Res. Lab. Bull. 29:85-97. (Engl. transl., Fish. Res. Board Can. Transl. Ser., 1309.)
- KEAST, A., AND D. WEBB.  
1966. Mouth and body form relative to feeding ecology in the fish fauna of a small lake, Lake Opinicon, Ontario. J. Fish. Res. Board Can. 23:1845-1874.
- LAGLER, K. F., J. E. BARDACH, AND R. R. MILLER.  
1962. Ichthyology. John Wiley and Sons, Inc., N.Y., 545 p.
- LEBRASSEUR, R. J.  
1966. Stomach contents of salmon and steelhead trout in the northeastern Pacific Ocean. J. Fish. Res. Board Can. 23: 85-100.
- MACHIDORI, S.  
1972. Observations on latitudinal distribution of offshore coho salmon in early summer, with reference to water temperature and food organisms. Jpn. Far Seas Fish. Res. Lab. Bull. 6, p. 101-110.
- MAEDA, H.  
1954. Ecological analyses of pelagic shoals—I. Analysis of salmon gill-net association in the Aleutians. (1) Quantitative analysis of food. Jpn. J. Ichthyol. 3:223-231.
- MAJOR, R. L., J. ITO, S. ITO, AND H. GODFREY.  
1978. Distribution and origin of chinook salmon (*Oncorhynchus tshawytscha*) in offshore waters of the North Pacific Ocean. Int. North Pac. Fish. Comm. Bull. 38, 54 p.
- MARTIN, N. V., AND F. K. SANDERCOCK.  
1967. Pyloric caeca and gill raker development in lake trout, *Salvelinus namaycush*, in Algonquin park, Ontario. J. Fish. Res. Board Can. 24:965-974.
- MILNE, D. J.  
1955. Selectivity of trolling lures. Fish. Res. Board Can. Prog. Rep. Pac. Coast Stn. 103:3-5.
- MORROW, J. E.  
1980. The freshwater fishes of Alaska. Alaska Northwest Publ. Co., Anchorage, AK, 248 p.
- NEAVE, F., T. YONEMORI, AND R. G. BAKKALA.  
1976. Distribution and origin of chum salmon in offshore waters of the North Pacific Ocean. Int. North Pac. Fish. Comm. Bull. 35, 79 p.
- O'BRIEN, W. J.  
1979. The predator-prey interaction of planktivorous fish and zooplankton. Am. Sci. 67:572-581.
- O'BRIEN, W. J., N. A. SLADE, AND G. L. VINYARD.  
1976. Apparent size as the determinant of prey selection by bluegill sunfish (*Lepomis macrochirus*). Ecology 57:1304-1310.
- PARKER, R. R.  
1971. Size selective predation among juvenile salmonid fishes in a British Columbia inlet. J. Fish. Res. Board Can. 28: 1503-1510.
- PRAKASH, A.  
1962. Seasonal changes in feeding of coho and chinook (spring) salmon in southern British Columbia waters. J. Fish. Res. Board Can. 19:851-866.
- REID, G. M.  
1961. Stomach content analysis of troll-caught king and coho salmon, Southeastern Alaska, 1957-58. U.S. Fish Wildl. Serv., Spec. Sci. Rep. 379, 8 p.
- REIMERS, P. E.  
1964. A modified method of analyzing stomach contents with notes on the food habits of coho salmon in the coastal waters of Oregon and southern Washington. Fish. Comm. Oreg. Res. Briefs 10, p. 46-56.
- RICKER, W. E.  
1962. Regulation of the abundance of pink salmon populations.



- In N. J. Wilimovsky (editor), Symposium on Pink Salmon, p. 155-211. Inst. Fish., Univ. Br. Columbia, Vancouver, B.C.
- TAKAGI, K., K. V. ARO, A. C. HARTT, AND M. B. DELL.  
1981. Distribution and origin of pink salmon (*Oncorhynchus gorbuscha*) in offshore waters of the North Pacific Ocean. Int. North Pac. Fish. Comm. Bull. 40. 195 p.
- TANAKA, S.  
1965. A review of the biological information on masu salmon (*Oncorhynchus masou*). Int. North Pac. Fish. Comm. Bull. 16, p. 75-135.
- VLADYKOV, V. D.  
1962. Osteological studies of Pacific salmon of the genus *Oncorhynchus*. Bull. Fish. Res. Board Can. 136, 172 p.
- WERNER, E. E., AND D. J. HALL.  
1974. Optimal foraging and the size selection of prey by the bluegill sunfish (*Lepomis macrochirus*). Ecology 55:1042-1052.



# DETERMINING AGE OF LARVAL FISH WITH THE OTOLITH INCREMENT TECHNIQUE

CYNTHIA JONES<sup>1</sup>

## ABSTRACT

Aging of larval fish from otoliths rests on the assumption that increments are formed daily. Indeed, proper validation of the relationship between increment deposition and age is fundamental to accurate age determination of field-captured fish. To evaluate the universality of daily deposition of otolith increments, the literature was reviewed and exceptions discussed.

Laboratory studies under optimal conditions generally (17 species out of 20) show that larvae deposit daily increments. However, in studies that examined increment deposition under suboptimal or extreme conditions, deposition was not daily in over half of the species. Nondaily deposition caused by extreme conditions (e.g., total starvation, abnormal photoperiod) may not invalidate the otolith increment technique if those conditions do not occur in the field. Nondaily deposition under suboptimal conditions (e.g., low temperature, intermittent starvation) that larvae may face in nature cause concern about this technique for aging field-captured larvae. Deposition in many species has not been examined under suboptimal conditions, nor has the effect of suboptimal conditions been shown on the age at first increment formation. The literature shows that the technique should be validated under both optimal conditions and those that mimic nature.

Otoliths have been used to age fish since Reibisch (1899) first observed annular ring formation in *Pleuronectes platessa* (as reported in Ricker 1975). Assessing age by counting annular rings works well in adults of temperate species where pronounced seasonal changes in growth result in bands (formed from tightly spaced growth increments deposited in the winter) in the otolith which correspond to each year of life. Discovery of fine increments, analogous to annual rings, but instead formed daily, has permitted the age of larval fish to be determined.

While studying temperate water species, Pannella (1971) observed that about 360 fine increments occurred between annular rings and suggested that these were deposited daily. He used this knowledge when reading the otoliths of adult tropical fish (whose otoliths also had fine increments) to show patterns of growth that were grouped into 14- and 28-d cycles (Pannella 1974).

The initial application of the otolith aging technique to larval fish was done by Brothers et al. (1976). Daily increment deposition was verified for northern anchovy, *Engraulus mordax*, and California grunion, *Leuresthes tenuis*, which were reared from eggs in the laboratory. Since this initial application, the otolith increment technique has been used widely to

estimate age in at least 29 species of larval fish. It has been used in freshwater and marine species, and applied to field-captured species, at times without adequate validation.

The ultimate purpose in developing the otolith aging technique for application to young fish is the ability to accurately age field larvae and juveniles. If the technique is to be applied directly to the field, based on conclusions drawn from rearing larvae in the laboratory, then the deposition of increments must be daily under conditions experienced in the field during these early life stages. The applicability of this technique relies on the assumption that 1) either surviving larvae (or sampled larvae) are those that grew under moderately good conditions (few larvae under suboptimal conditions survive) or 2) larvae can encounter suboptimal conditions, a proportion of these larvae will survive, and increment deposition is not affected by these suboptimal conditions. The first assumption is difficult to evaluate without using the hypothesis that increments are daily. The second assumption has been tested and the results can be summarized. The second assumption is based on increment deposition being triggered by a zeitgeber, an external factor that entrains a diel cycle within the larvae.

Validation of daily increment deposition under conditions within the natural range of experience of the larvae is fundamental to accurate estimation of age in field-captured fish. When the estimation technique

<sup>1</sup>Graduate School of Oceanography, University of Rhode Island, Kingston, RI 01882-1197; present address: Department of Natural Resources, Cornell University, Ithaca, NY 14853.

used to age larvae is inaccurate, estimates of growth and mortality, which rely on knowledge of age, will also be inaccurate.

The purpose of this paper is to discuss the use of the otolith increment technique to age larval fish. The published literature is used to evaluate the hypothesis,  $H_0$ : Larval age is equal to otolith increment count (plus age at first increment deposition) under conditions that are encountered in the field. An additional idea can be evaluated: That time of initial increment deposition is influenced by incubation time.

The paper will discuss the factors which affect deposition of increments, validation studies that have been performed, and application of the technique in the field. Factors which are likely to affect increment deposition in the field must be assessed by the validation procedure. In addition, the adequacy of validation that has been performed is evaluated, and ramifications in field applications are discussed.

## FACTORS AFFECTING DEPOSITION RATES

Mechanisms that have been postulated as initiators of differentiation of otolith microstructure are photoperiod, feeding, and temperature. Increment deposition has been tested in the literature under two conditions: 1) tests within the natural range of experience of the fish which could be optimal (non-stressful) and suboptimal (stressful), and 2) abnormal conditions that are wholly outside of their experience.

Taubert and Coble (1977) stated that photoperiod entrained a diel clock that resulted in daily formation of otolith increments. Tanaka et al. (1981) studied the formation of increments in *Tilapia nilotica* using scanning electron microscopy and found that the fast growth (incremental) zone started a few hours after light stimulus and that the slow growth (discontinuous) zone was formed immediately after light stimulus. Neither change in photoperiod length nor feeding time affected increment initiation. Brothers and McFarland (1981), however, reported that the discontinuous zone began near midnight. These results are contradictory, and without further investigations force the conclusion that the temporal formation of increments is species-specific.

Abnormal photoperiods have been shown to disrupt daily increment formation in *Fundulus heteroclitus* (Radtke and Dean 1982) and in *Tilapia mossambica* (Taubert and Coble 1977). Constant light, however, did not disrupt daily increment formation in *Oncorhynchus tshawytscha* (Neilson and Geen

1982) or in *Scophthalmus maximus* (Geffen 1982).

Unlike photoperiod changes, which are regular and gradual in nature, feeding times can occur at irregular intervals and might cause deviations in daily increment deposition. Two studies have tested the effects of feeding within the normal range experienced by fish larvae. Neilson and Geen (1982) found that subdaily increments could be induced through frequent discrete feedings: feeding four times a day resulted in formation of more than one increment in *Oncorhynchus tshawytscha*. Daily and subdaily increments were not distinguished in counts. Tanaka et al. (1981) found conversely that feeding time had no effect on the initiation of increment formation in *Tilapia nilotica*. Larvae were fed once a day, but the times of feeding were changed. Perhaps multiple feeding during the day results in the subdaily increments that sometimes appear in otoliths. The effect of starvation (an extreme circumstance in the field) on increment deposition has been tested in only three species: *Scophthalmus maximus* (Geffen 1982), *Morone saxatilis* (Jones 1984), and *Oncorhynchus nerka* (Marshall and Parker 1982). Geffen raised the turbot larvae on rotifers and *Artemia* until they were 10 d old. Larvae were then starved for 23 d. Jones did not supply exogenous food from hatch onward. Both Geffen and Jones found that starvation disrupted increment formation. Marshall and Parker fed their sockeye salmon larvae for the first 3 wk of life, and then starved them for 2 wk. Marshall and Parker found that starvation over 2 wk had no effect on increment deposition. It is possible that the difference might reflect different age-specific sensitivity to starvation, rather than species-specific responses.

Brothers (1978) has linked temperature as a prime factor in increment deposition. Working with temperate stream populations, he has found that diel temperature changes result in daily increment formation. Brothers (1978) stated that "six or more increments per day may be formed as the result of short term, . . . relatively minor. . . temperature fluctuations." Other investigators (Radtke and Dean 1982; Geffen 1982) found that small temperature changes had no effect on the rate of increment deposition. Apparently, temperature response is also species-specific.

## LABORATORY STUDIES OF INCREMENT DEPOSITION

### Initial Ring Deposition

When fish are raised in the laboratory from eggs

through the larval stages, two parameters fundamental to application of the increment technique to field populations can be determined: 1) age at first increment deposition and 2) testing of daily increment deposition under artificial conditions. Age at initial increment deposition for 18 species of fish is listed in Table 1. Radtke (1978) speculated that in species having slowly developing embryos, initial deposition occurs at, or before, hatch; in species having rapidly developing embryos, initial increment deposition does not occur until yolk-sac absorption or first feeding. This hypothesis is not substantiated in the currently published literature. Information for nine species of laboratory-reared fish larvae (Table 2) shows no such trend for data currently reported in the literature. Even for the same suborder, Clupeoidei, opposite development and initial increment deposition patterns exist for herring (*Clupea harengus*) and the northern anchovy.

### The Case for Daily Increment Deposition

Seventeen species have shown consistent daily deposition of increments under what are presumed to be good conditions for growth. The species that have shown daily increment deposition come from both freshwater and marine habitats and encompass a wide variety of lifestyles. In addition, six species held in the laboratory and sampled over known periods of time demonstrated daily increment deposition (Table 3). Four investigation groups (Struhsaker and Uchiyama 1976 for *Stolephorus purpureus*, Taubert and Coble 1977 for *Lepomis macrochirus*, Campana and Neilson 1982, Wilson and Larkin 1980 for *Oncorhynchus nerka*) brought larvae and juveniles into the laboratory, reared them for a period of time, then correlated increment counts to days of captivity. Schmidt and Fabrizio (1980) took consecutive samples from a field population of *Micropterus salmoides*, which had a short spawning period and correlated the time between samples to the change in mean increment count.

### Lack of Daily Deposition Rates

The most controversial results obtained so far come from studies of increment deposition in larval *Clupea harengus* (Table 1). Agreement for daily increment deposition has not been obtained. Studies that observed daily deposition by Gjsaeter<sup>2</sup> and Gjsaeter and Øiestad (1981) indicate that

increments are deposited with roughly daily periodicity and that initial increment deposition begins at first feeding (4-5 d). Gjsaeter and Øiestad (1981) found that 99 increments were formed in 97-d-old larvae. Gjsaeter, however, cautioned that these results were based on small sample sizes. Lough et al. (1982) reported on larval herring reared in the laboratory that lived until age 18 d. They did confirm that increment deposition began at yolk-sac absorption, but did not find that the increments were daily. In fact, only three increments were laid down within 18 d. Lack of confirmation of daily deposition is easy to dismiss, since the larvae did not survive past 18 d.

However, Geffen (1982) has demonstrated an interaction between growth rate and increment deposition rate. Only under circumstances of very fast growth, 0.42 mm/d (a rate which is faster than growth rates postulated for field animals) did increment deposition approach daily periodicity (0.92 increments/d). It is noteworthy that the growth rates in her study were related to container size; faster growth occurs in bigger containers. The variance of increment count at age is small and homogeneous only under the fastest growth condition (Norway Pond). The increasing variance with age in the other conditions leads to the speculation that some of these larvae were unknowingly starving. However, since the slope of the regression line for the Norway Pond condition is significantly different than 1 increment/d, this result cannot be dismissed. There would be obvious value in repeating these experiments. Geffen also found that increment formation did not begin before yolk-sac absorption and was in agreement with the other investigators on this point. The literature (Table 1) shows only one case (*Oncorhynchus nerka*) where independent investigators have confirmed daily increment deposition (Wilson and Larkin 1980; Marshall and Parker 1982).

Geffen (1982) found that increment deposition was also a function of growth in *Scophthalmus maximus* (Table 4) under various conditions of temperature and photoperiod. Under two conditions—1) 20°C, constant light, and 2) 24°C, 12L:12D—increments were deposited daily. For all other conditions increments were not daily. Under all conditions, deposition rate was a function of length. Although Geffen did not point this out, comparisons of growth at different temperatures can also be drawn from the data. Larvae were grown under 20°C and 24°C, both under a 12L:12D cycle. Larvae grew faster and deposited more increments at 24°C. Such differences in temperature might be used to explain differences in increment deposition except that the other case

<sup>2</sup>Harold Gjsaeter, Institute of Marine Research, P.O. Box 1870 - 5011 Bergen, Norway, pers. commun. February 1983.

TABLE 1.—Otolith increment deposition for laboratory reared larval fish of known age. ff = first feeding, ysa = yolk-sac absorption, ns = not stated.

Species	Source	Are increments daily?	Time of increment initiation	Validation	N	Life history			Rearing conditions		
						Stage	Light	Temp	Feeding	Salinity	Other
<i>Clupea harengus</i>	Gjøsaeter and Øiestad (1981)	yes	after ff	correspondence between age and rings Rings = 99, Age = 97 d	10	eggs-100 d	natural	ns	plankton	ns	
	Gjøsaeter (1981)	yes	4-5 d old or ff	slope = 0.95 rings/d	31	6-135 d	ns	ns	ns	ns	
	Geffen (1982)	no	1st rings at ysa	ring deposition depends on growth rate	227	eggs-100 d	18L/6D	8±14°C	variety	seawater	various container sizes
	Lough et al. (1982)	no	1st ring 4.5 d	1st 3 rings in 18 d	57	eggs-18 d	ns	10°C	plankton	ns	
<i>Engraulis mordax</i>	Brothers et al. (1976)	yes	after ysa	correspondence between age and rings (interaction growth and rings)	88	6-94 d	14L/10D	ns	ns	ns	
	Radtke (1978); Radtke and Dean (1982)	yes	from before hatch	slope = 1 ring/d	280 (temp) 270 (photo-period)	eggs-30 d	several regimes	24°C 30°C	Artemia	30 <sup>0/100</sup>	
	Radtke and Watwood (1980)	yes	day after hatch	correspondence between age and rings	≈40	eggs-30 d	natural	4°C	plankton	18-25 <sup>0/100</sup>	2 tank sizes
<i>Lepomis cyanellus</i>	Taubert and Coble (1977)	yes	after swim up	correspondence between age and rings independent of growth	54	eggs-170 d	15L/9D	24°-27°C	plankton and Artemia		
	Brothers et al. (1976)	yes	at hatching	correspondence between age and rings	15	eggs-26 d	natural	17°-20°C	Artemia	ns	
<i>Menidia menidia</i>	Barkman (1978)	yes	after swim up	slope = 0.97 rings/d independent of growth	55	eggs-68 d	12L/12D	19.4°-21.6°C	Artemia	31 <sup>0/100</sup>	
<i>Morone saxatilis</i>	Jones (1984)	sometimes	at ysa	regression analysis	148	eggs-97 d	14L/10D	18°C	Artemia	0-10 <sup>0/100</sup>	4 L jars
<i>Mugil cephalus</i>	Radtke (1984)	yes	1 day after hatch	regression and correspondence	50	eggs-52 d	ambient	24.0° ± 0.9°C	Rotifers, fish chow	32.0 ± 0.4 <sup>0/100</sup>	500 L tanks (flow through)
<i>Oncorhynchus keta</i>	Volk et al. (1984)	yes	at hatch	regression analysis	32(?)	hatch-190 d	ambient	7.6°-10.2°C	Copepods and pellets	298-336 <sup>0/100</sup>	10 L tanks

TABLE 1.—Continued.

Species	Source	Are increments daily?	Time of increment initiation	Validation	N	Life history Stage	Rearing conditions				
							Light	Temp	Feeding	Salinity	Other
<i>Oncorhynchus nerka</i>	Marshall and Parker (1982)	yes	at hatch but can be interrupted	correspondence between age and rings	≈440	eggs-93 d	natural	ambient >10°C <10°C	fed 3 wk fed versus starved	ns	200 L tanks
<i>Oncorhynchus tshawytscha</i>	Neilson and Geen (1982)	sometimes	1 or more/d	regression and correspondence between age and rings	34 (feeding) 10 (temp) ≈12 (photo-period)	fry-90 d	12L/12D 24D 24L	4°-12°C	excess 1x/d 4x/d	ns	28 L tanks
<i>Pagrus major</i>	Tsuji and Aoyama (1982)	yes	from hatching	slope = ring/d independent of growth	not given	eggs-30 d	24L 12L/12D	20°C	2x/d variety of food	ns	1,000 L tanks
<i>Parophrys vetulus</i>	Laroche et al. (1982)	yes	4-5 d old	correspondence between age and rings	136	eggs-26 d	14L/10D	12°-13°C	variety	seawater	4 and 8-9 L tanks
<i>Pseudopleuronectes americanus</i>	Radtke and Scherer (1982)	yes	after ysa	regression and correspondence between age and rings	≈200	eggs-34 d	12L/12D	5°-8°C	variety	ns	10 L tank
<i>Salmo salar</i>	Geffen (1983)	no	depends on physiology	regressions and ANOVA	36 (temp) 56 (light and temp)	embryos	24D 12L/12D 6L/6D	8°, 10°, and 15°C	Artemia	not applicable	15 cm dishes
<i>Sebastes</i> spp.	Radtke (1980)	yes	from birth	correspondence between age and rings Lab data not presented	not given	not given eggs - ?	12L/12D	ns	ns	ns	30 L tank
<i>Scophthalmus maximus</i>	Geffen (1982)	no	depends on growth	regressions	72	eggs-23 d	24L 6L/6D 12L/12D	20°C 24°C	rotifers and Artemia	seawater	30 L tank
<i>Tilapia mossambica</i>	Rosenberg and Haugen (1982)	yes	at hatch	back-calculated hatch date	62	2-12 d	ambient	18.5°-22.5°C	fed and starved	ns	2,000 m <sup>3</sup> tank
<i>Tilapia mossambica</i>	Taubert and Coble (1977)	yes	when they leave mouth	data not presented	≈300	eggs-60 d	15L/9D	24°-27°C	trout food	ns	60 L tank
<i>Tilapia nilotica</i>	Tanaka et al. (1981)	yes	at hatch	correspondence between age and rings	20 (rings) 80 (feeding)	eggs-28 d	12L/12D 18L/6D 6L/18D	27.5°C	ns	ns	60 L tank





TABLE 2.—Relationship between incubation time, egg size, and initial increment deposition: Determining whether species with long incubation and large eggs initiate increment deposition on or before hatch, while species with short incubation and small eggs initiate increments at first feeding or yolk sac absorption. ysa = yolk sac absorption.

Species	Temperature	Source	Incubation time	Source	Initial increment deposition	Source	Egg size (mm)	Source
<i>Clupea harengus</i>	≈10°C	Blaxter (1969)	≈18 d	Blaxter (1969)	4-5 d ysa	See Table 1	0.9-1.7	Blaxter (1969)
<i>Engraulis mordax</i>	11°-21°C	Lasker (1964)	1-5d	Lasker (1964)	≈5 d	Brothers et al. (1976)	≈2	
<i>Fundulus heteroclitus</i>	24°-30°C	Radtke (1978)	14 d	Radtke (1978)	Before hatch	Radtke (1978)	2	Armstrong and Child (1965)
<i>Gadus morhua</i>	4°C	Radtke and Waiwood (1980)	19 d	Radtke and Waiwood (1980)	1 d	Radtke and Waiwood (1980)	1.1-1.6	Blaxter (1969)
<i>Menidia menidia</i>	19.4°-21.6°C	Barkman (1978)	7-10 d at 23°-25°C	Barkmann and Beck (1976)	Before hatch from regression	Barkman (1978)	1.2	Barkmann and Beck (1978)
<i>Morone saxatilis</i>	18°C	Jones (1984)	2 d	Jones (1984)	6-9 d	Jones (1984)		
<i>Parophrys vetulus</i>	20°C	Laroche et al. (1982)	3-3½ d	Laroche et al. (1982)	4-5 d	Laroche et al. (1982)		
<i>Pseudopleuronectes americanus</i>	5°-8°C	Radtke and Scherer (1982)	14 d at 8°C	McPhee <sup>1</sup>	9-10 d	Radtke and Scherer (1982)	0.8	Smigielski and Arnold (1972)
<i>Tilapia nilotica</i>	27°C	Tanaka et al. (1981)	4 d	Tanaka et al. (1981)	At hatch	Tanaka et al. (1981)		

<sup>1</sup>Grace McPhee, P.O. Box 210972, Auke Bay, AK 99821, per. commun. summer 1983.

TABLE 3.—Otolith increment deposition for larval fish maintained in the laboratory over a known time span.

Species	Source	Known-age span	Are increments daily?	Validation	Number of fish
<i>Lepomis gibbosus</i>	Taubert and Coble (1977)	≈6-176 d	yes after swim up	Correspondence between age and rings	
<i>Lepomis macrochirus</i>	Taubert and Coble (1977)	≈6-125 d	yes after swim up	Correspondence between age and rings	
<i>Micropterus salmoides</i>	Schmidt and Fabrizio (1980)	Between 47 and 81 rings	yes	Correlation between change in ring count and time interval	98
<i>Oncorhynchus nerka</i>	Wilson and Larkin (1980)	Between 14 and 26 rings	yes	Slope = 1 ring/d	100
<i>Platichthys stellatus</i>	Campana and Neilson (1982)	8-10 mo old	yes	Slope = 1 ring/d	13 (in situ) 81 (temp and light)
<i>Stolephorus purpureus</i>	Struhsaker and Uchiyama (1976)		yes	Correspondence between rings and days	174

of daily deposition (24L, 20°C) would be an anomaly under this hypothesis.

Ten studies have investigated deposition rates under suboptimal, extreme or varying conditions (Table 4). These studies are important to the understanding of the underlying mechanisms causing increment deposition. Two studies, one by Radtke and Dean (1982) and one by Taubert and Coble (1977), demonstrated disruption of daily increment formation under extreme or abnormal changes in photoperiod. Taubert and Coble (1977) found that in simulated winter conditions, cold temperature and shorter photoperiod resulted in cessation of incre-

ment formation in *Lepomis cyanellus*. At and below temperatures of 10°C, growth and increment deposition ceased. If such changes occurred gradually, as occurs in the normal lifetime of fish, acclimation to these temperature changes might be expected through most of the temperature range. Within normal physiological limits (especially where some growth continued), increment deposition would be assumed to continue regularly. However, Marshall and Parker (1982) also found that temperatures below 10°C resulted in cessation of increment deposition in sockeye salmon. Hence two studies have shown that increment deposition is not maintained

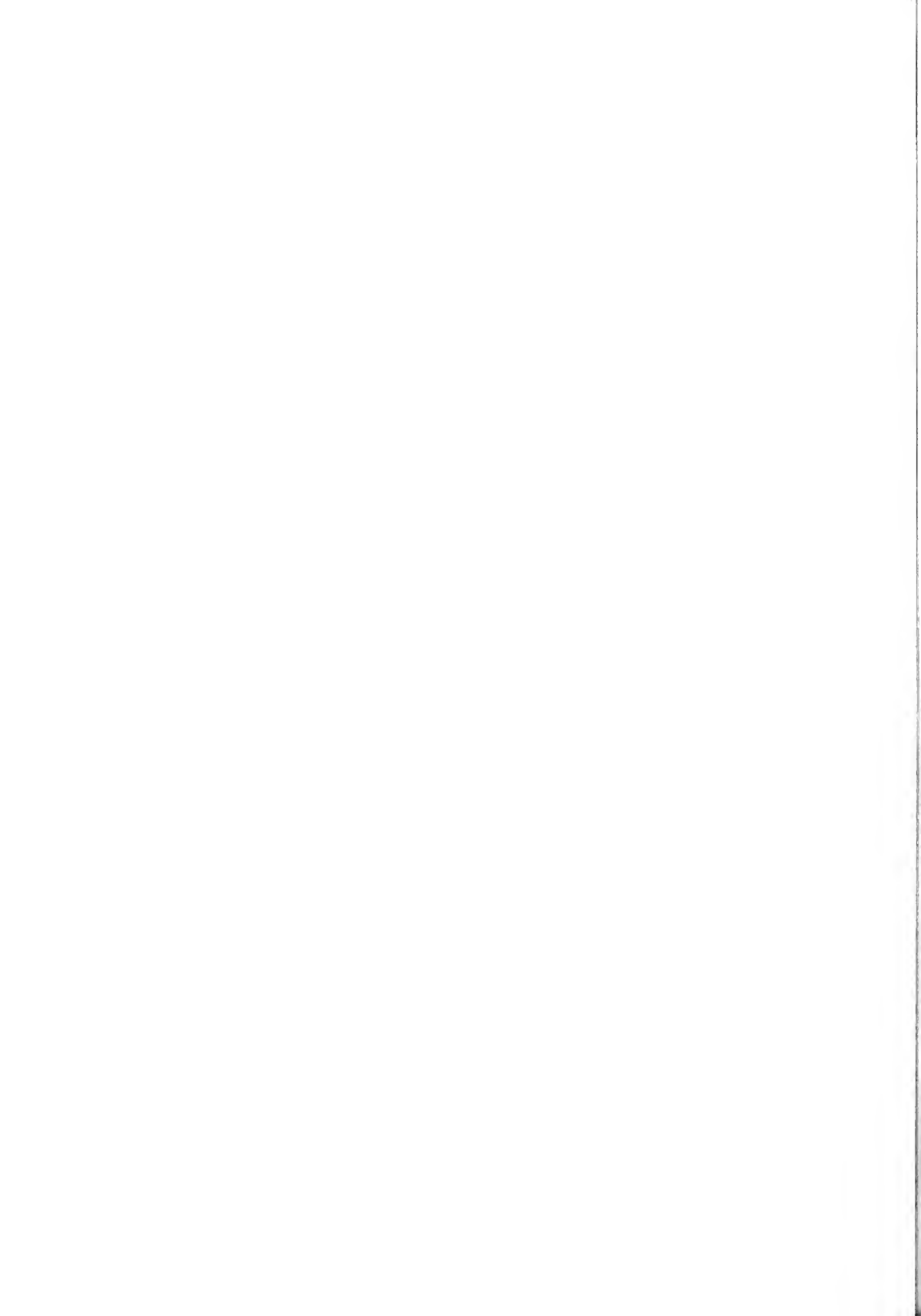

TABLE 4.—Otolith increment deposition for known-age larval fish under experiments where various culture conditions were tested.

Species	Source	Conditions of growth				Effect on increment deposition
		Light	Food	Temp	Other	
<i>Clupea harengus</i>	Geffen (1982)				tank size 120 L, 500 L, 310 m <sup>3</sup> 4,440 m <sup>3</sup>	Increment deposition rate was related to growth rate. Also, larvae grew faster in bigger container and deposited more rings.
<i>Fundulus heteroclitus</i>	Radtke and Dean (1982)	Multiple L/D conditions		24°C 30°C		Temperature affects growth rate, but not increment deposition. Increment deposition rate disrupted under constant dark or under <24-h photoperiod.
<i>Lepomis cyanellus</i>	Taubert and Coble (1977)	15L/9D 10L/14D		4°-25°C		Fewer hours of light and lower temperature resulted in cessation of ring deposition. At 10°C or less, growth ceased, as did increment formation.
<i>Morone saxatilis</i>	Jones (1984)	14L/10D	Fed, starved, intermittent starved, then fed	18°C		Increment deposition rate was disrupted during periods of starvation. Increments not daily in sagittae during 2-3 mo under optimal conditions.
<i>Oncorhynchus nerka</i>	Marshall and Parker (1982)		Fed Starved	<10°C >10°C		Starvation for 10 d did not affect increment deposition. Temperatures <10°C resulted in cessation of increment formation.
<i>Oncorhynchus tshawytscha</i>	Neilson and Geen (1982)	24D 24L 12L/12D	4x/d 1x/d	11°C 5.2°C		Formation of increments was related to feeding frequency. Temperature affected width of increment, not deposition rate. Photoperiod had no effect.
<i>Salmo salar</i>	Geffen (1983)	24D 6L/6D 12L/12D		8°C 10°C 15°C		Rate of ring deposition increased with increased light and temperature.
<i>Scophthalmus maximus</i>	Geffen (1982)	24L 6L/6D 12L/12D	Fed Starved --	20°C 24°C		Daily increments formed under 24L-20°C and 12L/12D-24°C. Starvation and 6L/6D interrupted increment formation. Increment formation related to growth rate.
<i>Tilapia mossambica</i>	Taubert and Coble (1977)	24L 24L/12D 15L/9D	Every 3 h Every 6 h Intermittent			Daily increments formed under 24-h photoperiod, not under 36-h cycle nor constant light. Subdaily increments induced. No effect from feeding cycle.
<i>Tilapia nilotica</i>	Tanaka et al. (1981)	12L/12D 18L/6D 6L/18D	3 h before dark 3 h after light			Formation of increment triggered by light stimulus. Feeding time had no effect under 12L/12D.

below certain temperatures. In two other studies where temperatures ranged from 24°C to 30°C (Radtke and Dean 1982) and from 5.2°C to 11°C (Neilson and Geen 1982), these temperatures affected the growth rate and width of increments, but did not alter the increment deposition rate.

Six studies looked at the relationship between feeding and daily increment deposition. Jones (1984), Geffen (1982), and Marshall and Parker (1982) showed opposite effects of starvation on increment deposition. Jones (1984) found that starvation of young larvae for 2 wk resulted in deposition of only one increment every other day. However, in addition to lengthy starvation, the effect of short-term, intermittent periods of starvation was also studied and

resulted in nondaily increment formation. Geffen (1982) found that starvation interrupted deposition in larval turbot, while Marshall and Parker (1982) found that starvation for 2 wk had no effect on daily deposition in sockeye salmon. Long-term starvation experiments test for interruption of increment deposition under extreme conditions. To age larvae in the field, it is important to determine the minimum number of consecutive days of starvation needed to affect increment deposition. Once these values are known, it is important to determine whether field larvae actually experience these levels of deprivation.

Three studies looked at feeding time or frequency on increment deposition. Neilson and Geen (1982) found that feeding frequency could induce forma-



tion of subdaily increments in *Oncorhynchus tshawytscha*. Both Tanaka et al. (1981) and Taubert and Coble (1977) found that feeding time had no effect on increment deposition in larval mouthbrooders (*Tilapia nilotica* and *T. mossambica*).

Little agreement has been reached in these studies concerning the effect of light, temperature, or feeding on increment formation. The effects of variability in temperature, food, salinity, and other factors (extreme photoperiods would not be encountered) relate directly to the problems of accurately aging larvae from the field. At the moment, environmental effects appear to be species-specific. Indeed, specific tests of the effect of suboptimal conditions (which are likely to occur in the field) on increment deposition have rarely appeared in the literature. Such analyses, conducted for more species, might confirm the conventional wisdom that

deviation from daily deposition rate is abnormal. However, the questions raised by the studies reviewed here (Table 4) remain to be fully addressed or dispelled.

## APPLICATION IN THE FIELD

### Current Applications

The ability to age larval fish precisely provides more accurate estimates of growth, mortality, and the ability to discern the effects of environmental variables on the first year of life. Rapid growth in the first months of life has commonly been thought to be critical to survival. Evidence in support of this hypothesis (Brothers et al. 1983) and contrary to it (Methot 1983) exists.

The otolith increment aging technique has been

TABLE 5.—Application of the otolith increment aging technique in field grown larvae.

Species	Source	Based on prior validations (validations in Table 1)	Validation source	Sample size	Application
<i>Ammodytes dubius</i>	Scott (1973)	no		71	Back-calculated growth.
<i>Clupea harengus</i>	Graham and Joule (1981)	controversial	See Table 1 for details	545	Determine hatching dates and delineate cohorts which are followed through time.
	Townsend and Graham (1981)	found deposition depended on growth rate.		300	Determine hatching dates and assess growth rates of larval cohorts. Noted cessation of growth in winter.
	Lough et al. (1982)	Gjøsaeter and Øiestad (1981) found deposition was daily. See Table 1 for details.		311	Use age to delineate growth. Fit Gompertz function of length-at-age data.
	Jones (1985)			481	Determination of within-season growth differences based on uncertainty in otolith aging.
<i>Engraulis mordax</i>	Methot and Kramer (1979)	yes	Brothers et al. (1976)	587	Fit Gompertz function to length-at-age data to obtain growth rates. Also mention that starvation slowed increment deposition.
<i>Fundulus heteroclitus</i>	Radtke and Dean (1982)	yes	Radtke and Dean (1982)	not given	Compare length-frequency histograms with increment-frequency histograms. Show relationship between hatching and lunar cycle.
<i>Gadus morhua</i>	Gjøsaeter and Tilseth (1981)	yes	Radtke and Waiwood (1980)	30	Regression of age estimated from morphologic development versus increment counts.
	Steffenson (1980)	yes	Radtke and Waiwood (1980)	138	Back-calculated hatch date from increments. Compare these to field observations of spawning time.
<i>Haemulon flavolineatum</i>	Brothers and McFarland (1981)	no, but refers to data as otolith age		≈306	Correspondence between otolith microstructure and events in the life history. Derive "otolith" growth rates.
<i>Halichoeres bivittatus</i>	Victor (1982)	yes	marked juveniles	10	Determine daily deposition of increments and use to determine settling pattern.
<i>Lepomis macrochirus</i>	Taubert and Coble (1977)	yes	Taubert and Coble (1977)	≈150	Allometric relationship between otolith length and fish length tested for 2 lakes.



applied to larval field populations of many species of fish (Table 5). Most applications have been based on laboratory validation of daily increment deposition for the individual species studied. Some have not. Methot and Kramer (1979), based on validation of daily increment deposition by Brothers et al. (1976), obtained growth rates for wild populations of *Engraulis mordax* by fitting a Gompertz function to length-at-age data. Various other field applications of the increment aging technique are listed in Table 5. Of special interest is a comparison of growth estimates for *Parophrys vetulus* from modal progression of length frequencies and otolith increments (Laroche et al. 1982). Growth based on the increment count method was 2-3 times faster. If the increment count method proves to be accurate, then mortality estimates could be considerably changed.

For at least four species listed in Table 5, laboratory validation was not conducted. These applications assume a given age at initial deposition and daily increment deposition thereafter. The validity

of these assumptions depends on the species and on the sensitivity of the application to inexactness in the age estimation. For example, controversial results have been obtained for larval herring, *Clupea harengus*. Geffen (1982) showed that growth rates could be overestimated by as much as three times the actual rate. However, analysis of Gulf of Maine herring data (Jones 1985) showed that differences in growth between larvae hatched early and late in the season could be drawn. Until sensitivity analyses, laboratory verification, or other evidence exists to assure daily increment formation as a universal phenomenon under suboptimal conditions, there will be some doubt about the accuracy of aging field-captured larvae.

### Transition from the Laboratory to the Field

A question that remains to be answered when applying laboratory-derived increment deposition

TABLE 5.—Continued.

Species	Source	Based on prior validations (validations in Table 1)	Validation source	Sample size	Application
<i>Menidia menidia</i>	Barkman et al. (1981)	yes	Barkman (1978)	105 (lab)	Compare growth in lab and field. Calculate hatching dates. Compare growth between early and late hatched larvae.
<i>Morone saxatilis</i>	Brothers et al. (1976)	no		5	Correspondence between increment estimated age and spawning season. Growth through lifetime of juvenile.
<i>Oncorhynchus nerka</i>	Wilson and Larkin (1982)	yes	Wilson and Larkin (1980)	64	Relationship between fish weight and otolith size. Use daily increments as time marker.
<i>Parophrys vetulus</i>	Laroche et al. (1982)	yes	Laroche et al. (1982)	331	Determine growth of aged field larvae and fit Gompertz and von Bertalanffy functions. Compare length-frequency and otolith techniques.
	Rosenberg and Laroche (1982)	yes	Laroche et al. (1982)	233	Growth during metamorphosis. Relate to age and transformation in morphology.
<i>Pseudopleuronectes americanus</i>	Radtko and Scherer (1982)	yes	Radtko and Scherer (1982)	120	Comparison of length-frequency and increment-frequency histograms for field larvae. Daily growth rate calculated. Compare growth rates over time.
<i>Stolephorus purpureus</i>	Struhsaker and Uchiyama (1976)	yes	Struhsaker and Uchiyama (1976)	213	Built growth curves based on age. Discussion of relationship to feeding. Preliminary study of growth rate difference between areas.
<i>Thalassoma bifasciatum</i>	Victor (1982)	yes	Victor (1982)	68	Determine daily increment deposition. Calculate pattern of settlement based on age estimate.
	Victor (1983)		marked juveniles	103	
28 species of coral reef fish	Brothers et al. (1983)	no		210	Determine length of larval life prior to recruitment. Examine otoliths for marker between postlarvae to juvenile.





rates to field populations is the constancy of deposition rates between these environments. Most laboratory studies have occurred under constant temperature and salinity and under conditions of artificial food types and densities and low light intensities compared with the field. Often, increments from otoliths of laboratory-grown larvae are much fainter than those from otoliths of field-captured larvae. Since field conditions can fluctuate to extents that have been shown to cause increment disruption in laboratory situations, a way to verify daily deposition in the field would be an important contribution. A transitional step between the laboratory and the field has been made by Laurence et al. (1979) and Øiestad (1982). Laurence et al. (1979) raised known-age larvae in a flow through enclosure. This study was designed to measure the growth and survival of fish larvae exposed to varying prey concentrations in the field. Modifications of this system could be used to study increment deposition in known-age larvae exposed to field conditions. Øiestad (1982) presented a review of larval fish studies performed in enclosures. Gjøsaeter and Øiestad (1981) reared known-age larvae in large enclosures and determined increment deposition rates (Table 1). Few investigators have used such enclosures for validation of otolith increment deposition rates for field simulated studies. Enclosures should prove particularly valuable for validation and simulation of suboptimal field conditions on growth and increment deposition.

### Statistical Applications

Once the veracity of daily increment deposition is established, a wide variety of statistical methods can be used in otolith studies. Statistical methods that have been employed in larval otolith studies have been linear regressions to establish increment deposition rates and curve fitting techniques to establish growth rates from length-at-age data. Linear regression has also been applied regardless of whether it actually fits the data. It is important to check for lack of fit, selection of the appropriate model, and weighting before applying linear regression blindly. It is recommended that, when possible, confidence intervals and standard deviations be included in the data presentation.

Investigators are beginning to relate increment widths, as indicators of growth, with environmental conditions (Methot and Kramer 1979; Lough et al. 1982). When increment widths are correlated directly with environmental factors, either no correlations are seen (Neilson and Geen 1982) or correlations may be spurious. Problems exist in

measuring the physical conditions to which the larvae have been exposed, especially since larvae may move from one area to another. In addition, there are questions concerning food availability and its concentration and patchiness. Another consideration in relating growth to environmental conditions is that, as the fish grows, the width of the outer increments decreases proportionately to decreases in length. Better results might be obtained either with covariance analysis or by fitting a growth function to data then using the residuals in correlation tests. Investigations of residuals with exploratory techniques such as principal component analysis or canonical correlation might prove fertile.

### Comparison of Scanning Electron and Light Microscopy

Scanning electron microscopy (SEM) has been used to confirm otolith structure (Dunkelberger et al. 1980; Watabe et al. 1982) and to compare increment counts with those obtained by transmitted light microscopy (Radtke and Waiwood 1980; Campana and Neilson 1982; Neilson and Geen 1982; Radtke and Dean 1982; Tsuji and Aoyama 1982; Ralston and Miyamoto 1983). Under optimal conditions, counts using both methods were equivalent except for larval cod. Radtke and Waiwood (1980), using SEM, determined that cod produced daily increments from hatch onward, while Gjøsaeter (1981), using a light microscope, did not observe increment formation until 4-5 d after hatch.

Most investigators did not verify deposition seen with the light transmission microscope with SEM studies. Confirmation with SEM is highly desirable when increments are nondaily. However, extensive use of the technique for field surveys is prohibited by the additional cost and preparation time when compared with light microscopy. In cases where suboptimal or abnormal field conditions may result in nondaily increment formation (Jones 1984), SEM, used in conjunction with ancillary techniques, may assist identification of the proportion of larvae for which age is underestimated with light microscopy.

### CONCLUSIONS

The report of the otolith workshop held in Bergen, Norway (Anonymous 1982) stated that the appearance of increments in otoliths of larval fish living in diverse habitats and representing many families, argues strongly for the universality of this phenomenon. Validation that these increments are, indeed,



deposited daily has been reported in 17 out of 20 species (Table 1) grown under optimal laboratory conditions. However, evidence exists that daily deposition can be interrupted under suboptimal and abnormal conditions, or can be dependent on growth rate (Table 6). When the effect of photoperiod is ignored (changes in photoperiod are very gradual in the field), more than 50% of the tests under suboptimal and extreme conditions have shown nondaily increment deposition rates. For other species, tests under suboptimal conditions were not conducted and the effect of these conditions on increment deposition rate is undetermined. The effect of varying conditions on the age at initial increment deposition has also not been addressed. To apply the otolith aging technique to fish from the natural environment, the scientist must either assume that larvae sampled grew under optimal conditions (those exposed to suboptimal conditions died) or verify that the species almost always deposit daily increments under field encountered conditions, or establish the error bounds for the relationship between age and increment count.

Attempts to clarify the natural phenomena that drive daily increment formation have given conflicting results. Photoperiod, feeding periodicity, and temperature fluctuations have all been cited as causing daily increment formation. When these factors are within normal ranges, it is likely, for most larvae, that deposition is daily. However, for larvae experiencing conditions outside tolerable ranges or abnormal conditions, the period of formation is likely to deviate from daily deposition. It is important to determine whether the minimum exposure to suboptimal conditions which result in nondaily deposition is actually experienced by larvae in the field. These hypotheses are amenable to further testing. More basic research on the causation of increment deposition or more extensive testing under a variety of conditions for a given species will yield more information. In situ testing with known-age larvae in enclosures which closely mimic field conditions could yield valuable results. The Bergen otolith workshop report (Anonymous 1982) has recommended that increment deposition be verified for each new species, under a variety of test conditions.

Two issues, cost effectiveness and accuracy, are important in determining whether the otolith increment technique is preferable to length-frequency analysis. Recommendations made in the report from the Bergen otolith workshop (Anonymous 1982) are that "the precision of an age determination . . . be tested against other available methods . . . by a cost benefit analysis (i.e. is enough precision gained by

TABLE 6.—Incidence of nondaily increment deposition for species reared under suboptimal and extreme conditions. Stars (★) indicate nondaily deposition caused by exposure to suboptimal conditions; triangles (Δ) indicate nondaily deposition caused by exposure to extreme conditions; circles (○) indicates no interruption of daily deposition.

Species	Light	Food	Temp	Tank size
<i>Clupea harengus</i>				★
<i>Fundulus heteroclitus</i>	★, Δ		○	
<i>Lepomis cyanellus</i>	★		★	
<i>Morone saxatilis</i>		★, Δ		
<i>Oncorhynchus nerka</i>		○	★	
<i>O. tshawytscha</i>	○	○	○	
<i>Salmo salar</i>	Δ		★	
<i>Scophthalmus maximus</i>	○, Δ	Δ		
<i>Tilapia mossambica</i>	Δ	○		
<i>T. nilotica</i>	★	○		

using this method to pay the costs and effort in preparation)". A good example would be the results shown in Laroche et al. (1982) when the otolith method was compared with modal progression of length frequencies, estimated growth rates differed by a factor of 2-3. Benefits should also include non-monetary considerations, such as decrease in error which will propagate through estimates based on age determinations (i.e., growth and mortality). Sensitivity analyses can be used to show situations where more accurate estimates are necessary.

Specific recommendations for improving reliability and replicability are discussed in the Bergen otolith workshop report (Anonymous 1982). In addition to these, Brothers<sup>3</sup> has suggested that other otoliths, such as the lapillus, be used in analysis.

Aging by the otolith increment technique is a powerful tool. Not only can population estimates of growth and mortality be refined, but growth of individuals can be obtained. Issues such as the importance of environmental factors to survival, the proportion of fast growing larvae to recruitment, and demonstration of compensation in field larvae may become easier to address with the availability of this technique. However, it is equally important to make sure that the technique is based on good scientific technique.

## ACKNOWLEDGMENTS

I thank David Bengtson, John Forney, Saul Saila, Ann Durbin, and Bernard Skud for their thoughtful review of this manuscript and Walter Berry for his many helpful suggestions and discussions.

<sup>3</sup>Edward Brothers, 3 Sunset West, Ithaca, NY 14850, pers. commun. September 1983.



# LITERATURE CITED

- ANONYMOUS.  
1982. Report on an Otolith Workshop in Bergen, January 18-29, 1982. Dep. Fish. Biol., Univ. Bergen and Inst. Mar. Res., Bergen, Norway, 28 p.
- ARMSTRONG, P. B., AND J. S. CHILD.  
1965. Stages in the normal development of *Fundulus heteroclitus*. Biol. Bull. (Woods Hole) 128:143-168.
- BARKMAN, R. C.  
1978. The use of otolith growth rings to age young Atlantic silversides, *Menidia menidia*. Trans. Am. Fish. Soc. 107: 790-792.
- BARKMAN, R. C., D. A. BENGTSON, AND A. B. BECK.  
1981. Daily growth of the juvenile fish (*Menidia menidia*) in the natural habitat compared with juveniles reared in the laboratory. Rapp. P.-v. Réun. Cons. int. Explor. Mer 178: 324-326.
- BARKMANN, R. C., AND A. BECK.  
1976. Incubating eggs of the Atlantic silverside on nylon screen. Prog. Fish-Cult. 38:148-150.
- BLAXTER, J. H. S.  
1969. Development: eggs and larvae. In W. S. Hoar and D. J. Randall (editors), Fish physiology, Vol. III, p. 177-252. Acad. Press, N.Y.
- BROTHERS, E. B.  
1978. Exogenous factors and the formation of daily and sub-daily growth increments in fish otoliths. [Abstr.] Am. Zool. 18:631.
- BROTHERS, E. B., E. D. PRINCE, AND D. W. LEE.  
1983. Age and growth of young-of-the-year bluefin tuna, *Thunnus thynnus*, from otolith microstructure. In E. D. Prince and L. M. Pulos (editors), Proceedings of the International Workshop on Age Determination of Oceanic Pelagic Fishes: Tunas, billfishes, and sharks, p. 49-59. U.S. Dep. Commer., NOAA Tech. Rep. NMFS 8.
- BROTHERS, E. B., C. P. MATHEWS, AND R. LASKER.  
1976. Daily growth increments in otoliths from larval and adult fishes. Fish. Bull., U.S. 74:1-8.
- BROTHERS, E. B., AND W. N. MCFARLAND.  
1981. Correlations between otolith microstructure, growth, and life history transitions in newly recruited french grunts [*Haemulon flavolineatum* (demarest) Haemulidae]. Rapp. P.-v. Réun. Cons. int. Explor. Mer 178:369-374.
- CAMPANA, S. E., AND J. D. NEILSON.  
1982. Daily growth increments in otoliths of starry flounder (*Platichthys stellatus*) and the influence of some environmental variables in their production. Can. J. Fish. Aquat. Sci. 39:937-942.
- DUNKELBERGER, D. G., J. M. DEAN, AND N. WATABE.  
1980. The ultrastructure of the otolithic membrane and otolith in the juvenile mummichog, *Fundulus heteroclitus*. J. Morphol. 163:367-377.
- GEFFEN, A. J.  
1982. Otolith ring deposition in relation to growth rate in the herring (*Clupea harengus*) and turbot (*Scophthalmus maximus*) larvae. Mar. Biol. (Berl.) 71:317-326.  
1983. The deposition of otolith rings in Atlantic salmon, *Salmo salar* L., embryos. J. Fish Biol. 23:467-474.
- GJØSAETER, H.  
1981. Dagsoeiesing som metode i aldersstudier på fisk, med eksempler på anvendelse på tropiske og boreale arter. Ph.D. Thesis, Univ. Bergen, Bergen, Norway, 172 p.
- GJØSAETER, H., AND V. ØIESTAD.  
1981. Growth patterns in otoliths as an indication of daily growth variations of larval herring (*Clupea harengus*) from an experimental ecosystem. ICES C.M. 1981/H:31.
- GJØSAETER, H., AND S. TILSETH.  
1981. Primary growth increments in otoliths of cod larvae (*Gadus morhua* L.) of the arcto-norwegian cod stock. Fisk. Dir. Skr. Ser. Havunders. 17:287-295.
- GRAHAM, J. J., AND B. J. JOULE.  
1981. Preliminary evaluation of the 1980 larval year class strength of coastal Maine herring. N.A.F.O. (Northwest Atl. Fish. Organ.), Sci. Coun. Rep. Doc. 81/IX/140, 22 p.
- JONES, C. M.  
1984. The otolith increment technique: Application in larval fish. Ph.D. Thesis, Univ. Rhode Island, Kingston, 123 p.  
1985. Within-season differences in growth of larval herring, *Clupea harengus*. Fish. Bull., U.S. 83:289-298.
- LAROCHE, J. L., S. L. RICHARDSON, AND A. A. ROSENBERG.  
1982. Age and growth of a pleuronectid, *Parophrys vetulus*, during the pelagic larval period in Oregon coastal waters. Fish. Bull., U.S. 80:93-104.
- LASKER, R.  
1964. An experimental study of the effect of temperature on the incubation time, development, and growth of Pacific sardine embryos and larvae. Copeia 1964:399-405.
- LAURENCE, G. C., T. A. HALAVIK, B. R. BURNS, AND A. S. SMIGIELSKI.  
1979. An environmental chamber for monitoring "in situ" growth and survival of larval fishes. Trans. Am. Fish. Soc. 108:197-203.
- LOUGH, R. G., M. PENNINGTON, G. R. BOLZ, AND A. A. ROSENBERG.  
1982. Age and growth of larval Atlantic herring, *Clupea harengus* L., in the Gulf of Maine-Georges Bank region based on otolith growth increments. Fish. Bull., U.S. 80:187-199.
- MARSHALL, S. L., AND S. S. PARKER.  
1982. Pattern identification in the microstructure of sockeye salmon (*Oncorhynchus nerka*) otoliths. Can. J. Fish. Aquat. Sci. 39:542-547.
- METHOT, R. D., JR.  
1983. Seasonal variation in survival of larval northern anchovy, *Engraulis mordax*, estimated from the age distribution of juveniles. Fish. Bull., U.S. 81:741-750.
- METHOT, R. D., JR., AND D. KRAMER.  
1979. Growth of the northern anchovy, *Engraulis mordax*, larvae in the sea. Fish. Bull., U.S. 77:413-423.
- NEILSON, J. D., AND G. H. GEEN.  
1982. Otoliths of chinook salmon (*Oncorhynchus tshawytscha*): Daily growth increments and factors influencing their production. Can. J. Fish. Aquat. Sci. 39:1340-1347.
- ØIESTAD, V.  
1982. Application of enclosures to studies on the early life history of fishes. In G. D. Grice and M. R. Reeve (editors), Marine Mesocosms, p. 49-62. Springer-Verlag, N.Y.
- PANNELLA, G.  
1971. Fish otoliths: daily growth layers and periodic patterns. Science 173:1124-1127.  
1974. Otolith growth patterns: an aid in age determination in temperate and tropical fishes. In T. B. Baginall (editor), The Proceedings of an International Symposium on the Aging of Fish, p. 28-39. Unwin Brothers, Surrey, Engl.
- RADTKE, R. L.  
1978. The formation and growth of otoliths in the estuarine fish, *Fundulus heteroclitus*. Ph.D. Thesis, Univ. South Carolina, Columbia, 57 p.  
1980. The formation and growth of otoliths from redfish (*Sebastes* spp.) larvae from the Flemish Cap (Division 3M). N.A.F.O. (Northwest Atl. Fish. Organ.), Sci. Coun. Rep. Doc. 80/IX/153 Ser. N:225, 5 p.  
1984. Formation and structural composition of larval striped



- mullet otoliths. Trans. Am. Fish. Soc. 113:186-191.
- RADTKE, R. L., AND J. M. DEAN.  
1982. Increment formation in the otoliths of embryos, larvae, and juveniles of the mummichog, *Fundulus heteroclitus*. Fish. Bull., U.S. 80:201-215.
- RADTKE, R. L., AND M. D. SCHERER.  
1982. Daily growth of winter flounder (*Pseudopleuronectes americanus*) larvae in the Plymouth Harbor estuary. In Proceedings of the Fifth Annual Larval Fish Conference, p. 1-5. Louisiana Cooperative Fishery Research Unit, Louisiana State University, Baton Rouge, LA.
- RADTKE, R. L., AND K. G. WAIWOOD.  
1980. Otolith formation and body shrinkage due to fixation in larval cod (*Gadus morhua*). Can. Tech. Rep. Fish. Aquat. Sci. No. 929, 10 p.
- RALSTON, S., AND G. T. MIYAMOTO.  
1983. Analyzing the width of daily otolith increments to age the Hawaiian snapper, *Pristipomoides filamentosus*. Fish. Bull., U.S. 81:523-535.
- RICKER, W. E.  
1975. Computation and interpretation of biological statistics of fish populations. Fish. Res. Board Can., Bull 191, 382 p.
- ROSENBERG, A. A., AND A. S. HAUGEN.  
1983. Individual growth and size-selective mortality of larval turbot (*Scophthalmus maximus*) reared in enclosures. Mar. Biol. (Berl.) 72:73-77.
- ROSENBERG, A. A., AND J. L. LAROCHE.  
1982. Growth during metamorphosis of English sole, *Parophrys retulus*. Fish. Bull., U.S. 80:150-153.
- SCHMIDT, R. E., AND M. C. FABRIZIO.  
1980. Daily growth rings on otoliths for aging young-of-the-year largemouth bass from a wild population. Prog. Fish-Cult. 42:78-80.
- SCOTT, J. S.  
1973. Otolith structure and growth in northern sand lance, *Ammodytes dubius*, from the Scotian shelf. Int. Comm. Northwest Atl. Fish., Res. Bull. 10, p. 107-115.
- SMIGIELSKI, A. S., AND C. R. ARNOLD.  
1972. Separating and incubating winter flounder eggs. Prog. Fish-Cult. 34:113.
- STEFFENSEN, E.  
1980. Daily growth increments observed in otoliths from juvenile East Baltic cod. Dana 1:29-37.
- STRUHSAKER, P., AND J. H. UCHIYAMA.  
1976. Age and growth of the nehu, *Stolephorus purpureus* (Pisces: Engraulidae), from the Hawaiian Islands as indicated by daily growth increments of sagittae. Fish. Bull., U.S. 74:9-17.
- TANAKA, K., Y. MUGIYA, AND J. YAMADA.  
1981. Effects of photoperiod and feeding on daily growth patterns in otoliths of juvenile *Tilapia nilotica*. Fish. Bull., U.S. 79:459-466.
- TAUBERT, B. D., AND D. W. COBLE.  
1977. Daily rings of otoliths of three species of *Lepomis* and *Tilapia mossambica*. J. Fish. Res. Board Can. 34:332-340.
- TOWNSEND, D. W., AND J. J. GRAHAM.  
1981. Growth and age structure of larval Atlantic herring, *Clupea harengus harengus*, in the Sheepscot River estuary, Maine, as determined by daily growth increments in otoliths. Fish. Bull., U.S. 79:123-130.
- TSUJI, S., AND T. AOYAMA.  
1982. Daily growth increments observed in otoliths of the larvae of Japanese Red Sea bream *Pagrus major* (Temminch et Schlegel). Bull. Jpn. Soc. Sci. Fish. 48:1559-1562.
- VICTOR, B. C.  
1982. Daily otolith increments and recruitment in two coral-reef wrasses, *Thalassoma bifasciatum* and *Halichoeres bivittatus*. Mar. Biol. (Berl.) 71:203-208.  
1983. Recruitment and population dynamics of a coral reef fish. Science 219:419-420.
- VOLK, E. C., R. C. WISSMAR, C. A. SIMENSTAD, AND D. M. EGGERS.  
1984. Relationship between otolith microstructure and the growth of juvenile chum salmon (*Oncorhynchus keta*) under different prey rations. Can. J. Fish. Aquat. Sci. 41:126-133.
- WATABE, N., K. TANAKA, J. YAMADA, AND J. M. DEAN.  
1982. Scanning electron microscope observations of the organic matrix in the otolith of the teleost fish *Fundulus heteroclitus* (Linnaeus) and *Tilapia nilotica* (Linnaeus). J. Exp. Mar. Biol. Ecol. 58:127-134.
- WILSON, K. H., AND P. A. LARKIN.  
1980. Daily growth rings in the otoliths of juvenile sockeye salmon (*Oncorhynchus nerka*). Can. J. Fish. Aquat. Sci. 37:1495-1498.  
1982. Relationship between thickness of daily growth increments in sagittae and change in body weight of sockeye salmon (*Oncorhynchus nerka*) fry. Can. J. Fish. Aquat. Sci. 39:1335-1339.





# PATTERNS IN DISTRIBUTION AND ABUNDANCE OF A NONCOEVOLVED ASSEMBLAGE OF ESTUARINE FISHES IN CALIFORNIA

PETER B. MOYLE,<sup>1</sup> ROBERT A. DANIELS,<sup>2</sup> BRUCE HERBOLD,<sup>1</sup>  
AND DONALD M. BALTZ<sup>3</sup>

## ABSTRACT

The patterns of distribution and abundance of the fishes of Suisun Marsh, a portion of the Sacramento-San Joaquin estuary in central California, were studied over a 54-month period. Total fish abundance in the marsh exhibited strong seasonality; numbers and biomass were lowest in winter and spring and highest in late summer. Freshwater inflow was highest in the winter and lowest in late summer, when salinities and temperatures were highest. Twenty-one species were collected on a regular basis; the 10 most abundant were *Morone saxatilis*, *Pogonichthys macrolepidotus*, *Gasterosteus aculeatus*, *Hysteroecarpus traski*, *Cottus asper*, *Spirinchus thaleichthys*, *Acanthogobius flavimanus*, *Catostomus occidentalis*, *Lepidocottus armatus*, and *Platichthys stellatus*. Another 21 species occurred in small numbers on an irregular basis. Twenty of the 42 species had been introduced to California since 1879. Of the 21 common species, 14 were residents, 4 were winter seasonals, and 3 were spring/summer seasonals. The resident species fell into two groups: a group of native species that were concentrated in small dead-end sloughs and a group of native and introduced species that were most abundant in the larger sloughs. The seasonal species were also a mixture of native and introduced species. Total fish abundance and species diversity declined through the study period, which seemed to be related to strong year classes of some species early in the study and the prevalence of freshwater conditions late in the study. The structure of the fish assemblage was fairly consistent over the study period but changes are expected in the near future. The structure of the Suisun Marsh fish assemblage was similar to that found in other river-dominated estuaries, despite the mixture of native and introduced species.

The Sacramento-San Joaquin Estuary system is the largest estuary on the west coast of North America. It has been highly modified by surrounding urban, industrial, and agricultural development and by extensive diversion and pollution of the freshwater that flows into it (Conomos 1979). It supports a diverse fish fauna of native and introduced species, but most previous studies have concentrated on species important to sport and commercial fisheries, especially striped bass, *Morone saxatilis*, and, to a much lesser extent, white sturgeon, *Acipenser transmontanus*; chinook salmon, *Oncorhynchus tshawytscha*; American shad, *Alosa sapidissima*; and white catfish, *Ictalurus catus* (Skinner 1972; Moyle 1976). Studies of other species have been few (Ganssle 1966; Turner and Kelley 1966; Baltz and Moyle 1982; Stevens and Miller 1983; Daniels and Moyle 1983), and there have been no community-level analyses equivalent to those conducted on estuarine fish communities in other

parts of the world (e.g., Dahlberg and Odum 1970; Livingston 1976; Sheridan and Livingston 1979; Meeter et al. 1979; Blaber and Blaber 1980; Quinn 1980; Thorman 1982). The fish assemblage of the Sacramento-San Joaquin Estuary system is unusual because few of its component species are likely to have evolved together; it is composed of a mixture of introduced and native freshwater, estuarine, and euryhaline marine species (Table 1). The introduced species come from a number of geographic areas, while most of the native species have their centers of abundance in either the rivers upstream or the saltwater bays downstream from the estuary. There are no really comparable estuaries on the California coast, although some of the much smaller and more saline estuaries south of the Sacramento-San Joaquin Estuary do have fish assemblages composed in part of introduced species (Allen 1982).

We began in January 1979 systematic sampling of the fishes in Suisun Marsh on a monthly basis. Suisun Marsh was chosen as a study site because of its central location on the estuary, its proximity to the University of California, Davis campus, and the availability of earlier data from sporadic sampling by the California Department of Fish and Game. The data indicated that the fish fauna was typical of the

<sup>1</sup>Wildlife and Fisheries Biology, University of California, Davis, CA 95616.

<sup>2</sup>Wildlife and Fisheries Biology, University of California, Davis, CA; present address: Biological Survey, New York State Museum, Albany, NY 12230.

<sup>3</sup>Wildlife and Fisheries Biology, University of California, Davis, CA; present address: Coastal Fisheries Institute, Louisiana State University, Baton Rouge, LA 70803.

TABLE 1.—Fishes collected in Suisun Marsh, Solono County, CA, in decreasing order of numerical abundance in our trawls. The principal environment of each species is coded as follows: A = anadromous, E = estuarine, F = freshwater, M = marine.

Species	Numbers	Origin
Striped bass, <i>Morone saxatilis</i>	24,154	E. North America (E)
Splittail, <i>Pogonichthys macrolepidotus</i>	11,250	Native (E)
Threespine stickleback, <i>Gasterosteus aculeatus</i>	9,956	Native (F-E)
Tule perch, <i>Hysteroecarpus traski</i>	7,693	Native (F-E)
Prickly sculpin, <i>Cottus asper</i>	4,639	Native (F-E)
Yellowfin goby, <i>Acanthogobius flavimanus</i>	1,786	Japan (E-M)
Sacramento sucker, <i>Catostomus occidentalis</i>	1,703	Native (F)
Common carp, <i>Cyprinus carpio</i>	1,573	Asia (F)
Threadfin shad, <i>Dorosoma petenense</i>	1,088	E. North America (E)
Staghorn sculpin, <i>Leptocottus armatus</i>	985	Native (M)
Starry flounder, <i>Platichthys stellatus</i>	849	Native (M)
Longfin smelt, <i>Spirinchus thaleichthys</i>	650	Native (E)
Delta smelt, <i>Hypomesus transpacificus</i>	450	Native (E)
American shad, <i>Alosa spadissima</i>	218	E. North America (A)
Sacramento squawfish, <i>Ptychocheilus grandis</i>	140	Native (F)
Chinook salmon, <i>Oncorhynchus tshawytscha</i>	96	Native (A)
Hitch, <i>Lavinia exilicauda</i>	56	Native (F)
Inland silverside, <i>Menidia beryllina</i>	50	E. North America (F-E)
Goldfish, <i>Carassius auratus</i>	45	Asia (F)
Northern anchovy, <i>Engraulis mordax</i>	34	Native (M)
Sacramento blackfish, <i>Orthodon microlepidotus</i>	25	Native (F)
Pacific herring, <i>Clupea harengus</i>	24	Native (M)
White catfish, <i>Ictalurus catus</i>	23	E. North America (F)
Bluegill, <i>Lepomis macrochirus</i>	16	E. North America (F)
Mosquitofish, <i>Gambusia affinis</i>	15	E. North America (F)
Black crappie, <i>Pomoxis nigromaculatus</i>	14	E. North America (F)
Bigscale logperch, <i>Percina macrolepida</i>	10	Texas (F)
White sturgeon, <i>Acipenser transmontanus</i>	10	Native (E)
Fathead minnow, <i>Pimephales promelas</i>	9	E. North America (F)
Brown bullhead, <i>Ictalurus nebulosus</i>	6	E. North America (F)
Rainwater killifish, <i>Lucania parva</i>	5	E. North America (E)
Green sunfish, <i>Lepomis cyanellus</i>	4	E. North America (F)
Pacific sanddab, <i>Citharichthys sordidus</i>	4	Native (M)
Pacific lamprey, <i>Lampetra tridentata</i>	4	Native (A)
Surf smelt, <i>Hypomesus pretiosus</i>	3	Native (M)
Channel catfish, <i>Ictalurus punctatus</i>	3	E. North America (F)
Black bullhead, <i>Ictalurus melas</i>	3	E. North America (F)
Shiner perch, <i>Cymatogaster aggregata</i>	3	Native (M)
Golden shiner, <i>Notemigonus crysoleucus</i>	3	E. North America (F)
Warmouth, <i>Lepomis gulosus</i>	1	E. North America (F)
Rainbow trout, <i>Salmo gairdneri</i>	1	Native (A)
Longjaw mudsucker, <i>Gillichthys mirabilis</i>	1	Native (M)

freshwater dominated portions of the estuary. The marsh is also of considerable interest because it is the largest brackish-water marsh in California. It is managed primarily as a wintering area for migratory waterfowl, but its importance as a nursery area for striped bass, salmon, and other fishes is being increasingly recognized (Baracco 1980). The purpose of this paper is to analyze the distribution and abundance of the fishes of the marsh in relation to each other, major environmental factors, and major crustacean species, during a 54-mo period.

## STUDY AREA

Suisun Marsh is a large (ca 34,000 ha) tidal marsh located just downstream of the confluence of the Sacramento and San Joaquin rivers (Fig. 1). About

11,000 ha of the marsh consist of sloughs that are influenced by tidal action. The remainder consists of diked wetlands managed to attract wintering waterfowl (Baracco 1980) and for pasturage. The sloughs are shallow (most are <2 m deep) and may fluctuate in depth as much as 1 m during extreme tides. Salinities have ranged from 0 to nearly 17 ppt in recent years, with the highest salinities occurring in late summer of drought years and the lowest salinities occurring annually in winter and spring when river outflows are highest (Baracco 1980). Because increased upstream diversion of water is threatening water quality in the marsh, major modifications to the water distribution system within the marsh are being made to ensure that salinities do not become too high for production of the plants that attract waterfowl.

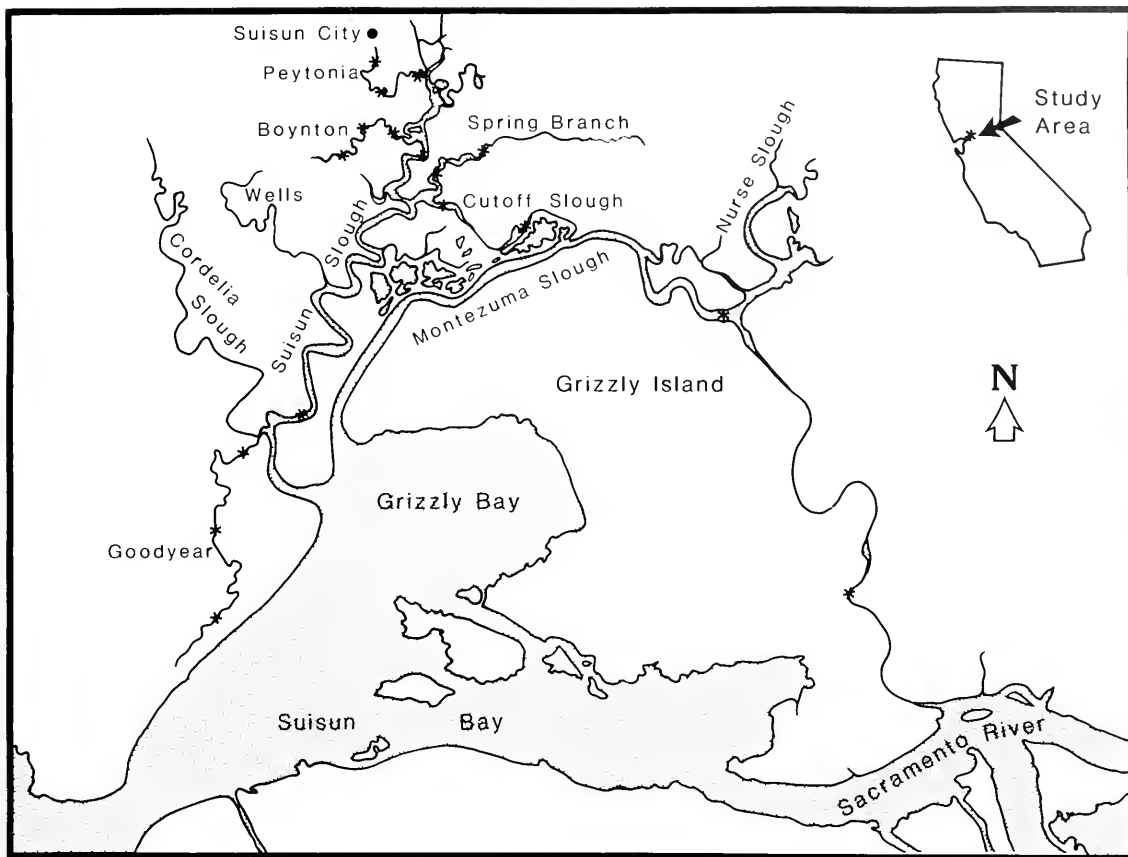

FIGURE 1.—Locations of sample sites (\*) in Suisun Marsh, Sacramento-San Joaquin Estuary, CA.

During this study, two major habitat types were sampled: 1) small dead-end sloughs that were 7-10 m wide and 1-2 m deep and 2) Suisun Slough, which connected all the dead-end sloughs and was 100-150 m wide and 2-4 m deep. A third habitat, Montezuma Slough, was also sampled, but the data were not used here because our methods did not sample it adequately. This slough is deep (3-4 m), wide, and riverlike; it is the marsh's main source of freshwater.

## METHODS

Sampling was conducted monthly at seven locations throughout the marsh (Fig. 1), from January 1979 through June 1983, with the exception of December 1979 and October 1980. Four of the locations were in dead-end sloughs (Peytonia, Boynton, Mallard, and Goodyear), one was a small slough open at both ends (Cutoff), and two were in Suisun Slough. Sampling was conducted biweekly from January 1980 through June 1981, but the samples for each

month were lumped together for analysis, as the samples within months were comparable. All samples were taken during the day, as 24-h studies conducted in April 1979 and 1980 did not exhibit any significant differences between day and night samples.

The principal means of sampling was a four-seam otter trawl with a  $1 \times 2.5$  m opening, a length of 5.3 m, and mesh sizes that tapered down to 6 mm stretch in the bag. At each location, the trawl was towed for either 5 min (small sloughs) or 10 min (Suisun Slough) at about 4 km/h. The longer periods were necessary in large sloughs because of the small catches that prevailed there. Each location was sampled at least twice on each date. This method of sampling was biased because large fishes probably avoided the trawl, and fishes that favor the emergent vegetation were undersampled, as were fishes in the upper part of the water column (Kjelson and Colby 1977). However, these problems were minimized by the narrowness and shallowness of most of the sampling sites; in any case such biases were consis-

tent across the course of this study, so that comparisons should be unaffected. In addition, two locations on the marsh were sampled with a 10 × 1 m, 6 mm mesh, seine, on an irregular basis. An effort was made to seine every month but it was often not possible, as the sites were difficult to seine at extreme high or low tides.

Fishes from each trawl were placed in washtubs of water to minimize mortality and then identified, measured to the nearest millimeter (standard length), and returned to the water as quickly as possible. If more than 100 fish of any one size class of a species were captured, only the first 100 were measured; the rest were counted. Early in the study, samples of all fishes were weighed (wet weight, in gram), and a length/weight relationship developed for each species. This was later used to estimate the biomass of fish in each trawl. The shrimps *Crangon franciscorum* and *Palaemon macrodactylus* in each trawl were also counted. For the opossum shrimp, *Neomysis mercedis*, an index of abundance was used, based on a 1-to-5 scale, where "1" represented <3 individuals; "2", 3-50 shrimp; "3", 50-200, "4", 200-500, and "5", >500. The index was necessary because most *N. mercedis* probably passed through the net due to their small size (3-5 mm). Nevertheless, they were present seasonally in most hauls, at times in enormous numbers.

At each location, salinity and temperature were taken with a YSI S-C-T meter and transparency was measured with a Secchi disk. Tidal height was determined from a tide table. An index of monthly freshwater outflow from the combined Sacramento and San Joaquin Rivers at Chipps Island was obtained from the California Department of Water Resources (unpubl. data).

For analysis, all the data were summarized by site and month. A Spearman rank correlation analysis using data ranked by month ( $N = 52$ ) was used for the initial analysis because many of the variables did not conform to a normal distribution. Because no single transformation could be applied to all the variables, nonparametric statistics were used as the most conservative method. We used 13 variables for the analysis (Table 2). In addition, rank abundance (by numbers) by month for the following species categories was used: 1) total striped bass, 2) yearling and older striped bass, 3) young-of-year striped bass, 4) total splittail, 5) yearling and older splittail, 6) young-of-year splittail, 7) total tule perch, 8) tule perch adults, 9) tule perch young-of-year, 10) total prickly sculpin, 11) yearling and older prickly sculpin, 12) prickly sculpin young-of-year, 13) carp, 14) longfin smelt, 15) delta

smelt, 16) staghorn sculpin, 17) starry flounder, 18) threadfin shad, 19) Sacramento sucker, 20) yellowfin goby, and 21) threespine stickleback. Because only minor differences were found among the correlations associated with adult and juvenile striped bass, tule perch, splittail, and prickly sculpin, only the results for the totals for these species will be presented.

Analyses were also run using the data from each trawl separately. Species were analyzed using both numbers and grams. Because these data were all of species abundances, a log-normal transformation was used to normalize them. The results were similar in most respects to the analyses using ranks so are not presented here. However, because we were uncertain as to the validity of using ranked data for principal components analysis (PCA), we based our discussion on cautious inspection of the correlation matrix as generated. A principal components analysis was run using the correlation matrix (Dixon and Brown 1977) of  $l_n$  numbers of fish per trawl ( $N = 1,238$ ), to produce groups of species that presumably were responding to the environment in the same general ways.

TABLE 2.—Environmental variables used in the correlation analyses.

Variable	Units	Notes
Month series	1-54	January 1979 to June 1983
Water year	1-5	Begins in October of each year
Salinity	ppt	
Temperature	°C	
Secchi depth	cm	
<i>Neomysis mercedis</i> abundance	1-5 index	
Mean monthly outflow	0-11 index	California Department of Water Resources
<i>Crangon franciscorum</i>	No./trawl	
<i>Palaemon macrodactylus</i>	No./trawl	
Fish species	No./trawl	
Total fish numbers	No./trawl	
Total fish biomass	Biomass/trawl	Wet weight
Species diversity	Index	Shannon-Weiner (H)

## RESULTS

### Environmental Variables

Salinity and temperature were negatively correlated with river outflows (Table 3, Fig. 2). Salinity had a strong ( $P < 0.01$ ) positive correlation only with Secchi depth. River outflows generally peaked in February, March, or April, as the result of run-off from melting snow in the Sierra Nevada. Lowest

TABLE 3.—Spearman rank correlation coefficients between fish species ranked by month by numbers and other variables ranked by month. Underlined values are significant at  $P > 0.05$ .

	Striped bass	Spittail	Tule perch	Sacramento sucker	Yellowfin goby	Carp	Prickly sculpin	Stickleback	Delta smelt	Longfin smelt	Threadfin shad	Staghorn sculpin	Starry flounder
Month series	-0.42	-0.72	-0.51	-0.38	-0.53	-0.58	0.16	-0.10	-0.29	-0.09	-0.26	-0.15	-0.21
Temperature	0.54	0.28	0.08	0.21	0.49	0.49	0.41	-0.33	-0.41	-0.28	-0.55	-0.03	0.01
Salinity	0.62	0.24	0.53	0.14	0.43	0.38	-0.36	-0.14	0.18	0.17	0.24	0.13	-0.06
Secchi depth	0.09	-0.09	0.29	-0.18	-0.08	-0.04	-0.54	-0.09	0.33	0.31	0.52	0.06	-0.28
Outflow	-0.74	-0.36	-0.49	-0.27	-0.62	-0.44	0.06	0.04	0.07	-0.12	0.16	-0.06	0.14
<i>Neomysis mercedis</i>	-0.42	-0.02	-0.24	0.09	-0.45	-0.05	0.28	0.23	0.07	-0.25	-0.10	0.07	0.08
<i>Crangon franciscorum</i>	0.27	-0.01	0.05	0.06	0.46	-0.18	-0.03	-0.10	0.01	-0.59	-0.15	0.29	-0.23
<i>Palaemon macrodactylus</i>	0.43	-0.10	0.06	-0.10	0.34	0.20	0.16	-0.18	-0.30	-0.21	-0.32	0.14	0.23
No./trawl	0.67	0.64	0.72	0.53	0.46	0.45	0.07	0.21	0.16	-0.07	0.06	-0.18	-0.10
g/trawl	0.39	0.71	0.53	0.57	0.39	0.81	-0.06	-0.13	0.04	-0.24	0.13	0.04	0.04
Species/trawl	0.42	0.74	0.48	0.56	0.60	0.52	0.24	0.10	0.21	0.15	0.00	0.21	0.43
Diversity (H')	-0.10	0.45	0.23	0.45	0.28	0.35	0.31	0.21	0.26	0.09	0.12	0.36	0.43

flows occurred from August through October. Salinity, temperature, and Secchi depth were generally lowest (0-1 ppt, 8°-11°C, and 17-18 cm, respectively) when outflows were highest, and highest (4-9 ppt, 19°-23°C, and 25-40 cm, respectively) when outflows were lowest. There is, however, considerable year-to-year variation in these cycles. When outflows were comparatively low (1979, 1981), salinities, temperatures, and turbidities peaked at higher levels than they did in high outflow years. Because 1982 and 1983 were exceptionally wet years, virtual freshwater conditions prevailed throughout both years.

### Invertebrates

*Neomysis mercedis* became very abundant in the marsh from April to June, but the population declined rapidly through the summer, reaching a low in October (Fig. 2). This pattern fits with previous studies of this species, which showed that its populations generally followed the mixing zone up and down the estuary and were reduced at temperatures higher than 22°C and salinities >7 ppt (Orsi and Knutson 1979). In this study, *N. mercedis* abundance showed a significant positive correlation with outflows and significant negative correlations with temperature, salinity, and turbidity (Table 4). It also showed a significant negative correlation (Table 3) with two of its major predators in the marsh, striped bass and yellowfin goby (Herbold 1985<sup>4</sup>).

*Palaemon macrodactylus* and *Crangon franciscorum* also showed seasonal patterns of abundance (Sigfreid 1980), but the patterns were much less marked than those of *N. mercedis*. *Palaemon macrodactylus* were most abundant during July through October and least abundant during January and February, while *C. franciscorum* were most abundant in November and December and least abundant in January through March. *Palaemon macrodactylus* abundance therefore showed strong positive correlation with temperature and salinity and a negative correlation with outflows. *Crangon franciscorum* abundance was also negatively correlated with outflows, but had a positive correlation only with salinity.

### Fishes

A total of 42 species, represented by about 67,000 individuals, were collected in the 1,238 trawl hauls made during the study. The four measures of overall fish abundance and diversity showed negative correlations with month series and with years, indicating a general decline through the study period (Table 4, Fig. 3). Numbers, biomass, and number of species had positive correlations with temperature and/or salinity and negative correlations with out-

<sup>4</sup>Herbold, B. 1985. Resource partitioning within a non-coevolved assemblage of fishes. Unpubl. Ph.D. Thesis, Univ. California, Davis.

DELTA OUTFLOW INDEX

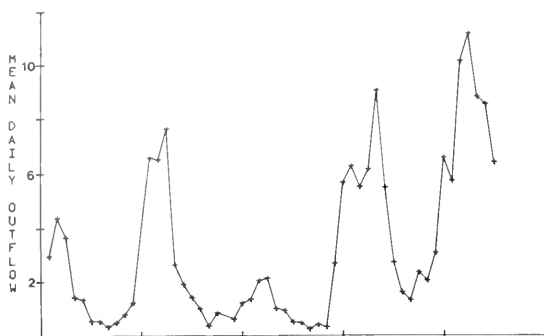

SALINITY

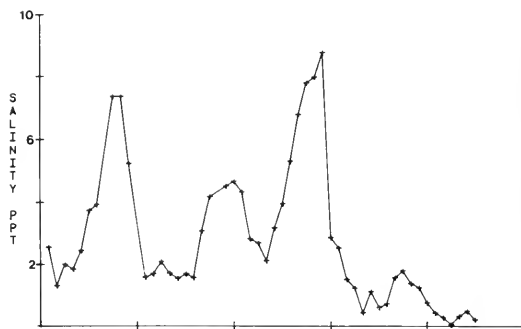

WATER TRANSPARENCY



TEMPERATURE

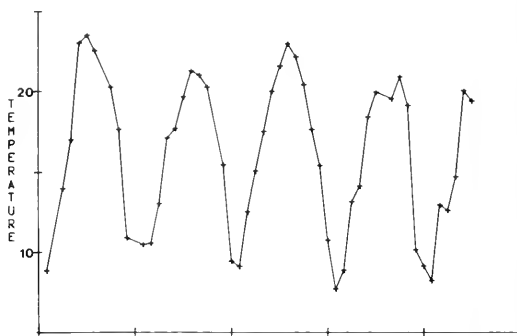

NEOMYSIS

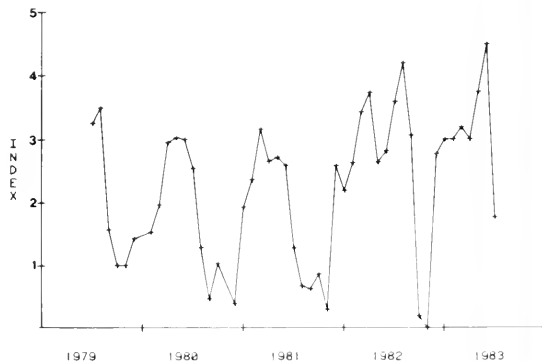

FIGURE 2.—Trends in abiotic factors and *Neomysis mercedis* abundance within Suisun Marsh. Temperature is in °C. Average outflow in 10,000 cubic feet per second of the Sacramento River was calculated by the California Department of Water Resources. Salinity is given in parts per thousand. *Neomysis mercedis* abundance rankings are described in text.

flow, indicating that catches were highest in late summer and lowest in early spring. However, when the patterns of occurrence of the 12 most abundant species were examined, three groups appeared: resident species, winter seasonals, and spring/summer seasonals.

The "resident species" included the native splittail, tule perch, Sacramento sucker, prickly sculpin, and threespine stickleback as well as the introduced striped bass, carp, and yellowfin goby. Two additional

species, native white sturgeon and introduced American shad, probably also belonged in this category, as they were caught at all times of the year but too infrequently to draw any firm conclusions. Splittail, striped bass, tule perch, Sacramento sucker, carp, and yellowfin goby had similar patterns of abundance (Figs. 4, 5) and were correlated ( $P < 0.05$ ) with each other and with total biomass, numbers, and species (Tables 3, 4). All six species usually became more abundant in our catches as the sum-

TABLE 4.—Spearman rank correlation among species ranked by month (lower matrix) by numbers and among environmental and other variables ranked by month (upper matrix). Underlined values are significant at  $P > 0.05$ .

	1	2	3	4	5	6	7	8	9	10	11	12	
13. Striped bass		-0.15	-0.54	-0.10	0.43	0.14	-0.04	-0.04	-0.51	-0.79	-0.80	-0.64	1. Month series
14. Splittail	0.50		0.27	0.19	-0.62	-0.29	0.19	0.44	0.33	0.30	0.37	0.05	2. Temperature
15. Tule perch	0.44	0.38		0.46	-0.78	-0.55	0.42	0.32	0.48	0.37	0.39	0.07	3. Salinity
16. Sacramento sucker	0.19	0.51	0.54		-0.13	-0.43	0.04	-0.24	0.01	0.01	-0.11	-0.19	4. Secchi depth
17. Yellowfin goby	0.68	0.58	0.32	0.22		0.51	-0.52	-0.41	-0.58	-0.34	-0.51	-0.06	5. Outflow
18. Carp	0.46	0.53	0.38	0.46	0.35		-0.56	-0.32	-0.14	-0.03	-0.10	0.16	6. <i>Neomysis</i>
19. Prickly sculpin	-0.14	0.13	-0.13	0.34	0.06	0.11		0.34	0.09	-0.19	0.25	0.01	7. <i>Crangon</i>
20. Stickleback	-0.41	-0.09	0.05	0.07	-0.22	-0.17	0.09		0.12	0.04	0.15	-0.05	8. <i>Palaemon</i>
21. Delta smelt	-0.11	0.08	0.21	0.03	-0.05	-0.15	-0.15	0.40		0.55	0.56	-0.08	9. Numbers/ trawl
22. Longfin smelt	-0.07	-0.01	-0.09	-0.12	0.21	-0.38	-0.15	-0.04	0.43		0.69	0.51	10. Grams/trawl
23. Threadfin shad	-0.17	-0.02	0.38	0.00	-0.24	-0.11	-0.47	0.42	0.36	0.21		0.74	11. Species/trawl
24. Staghorn sculpin	-0.24	-0.13	-0.05	0.06	-0.06	-0.02	0.20	0.18	0.17	0.30	0.01		12. Diversity (H')
25. Starry flounder	-0.09	0.30	0.03	0.30	0.18	-0.14	0.25	0.22	0.10	0.37	0.00	0.07	
	13	14	15	16	17	18	19	20	21	22	23	24	

MEAN BIOMASS PER TRAWL

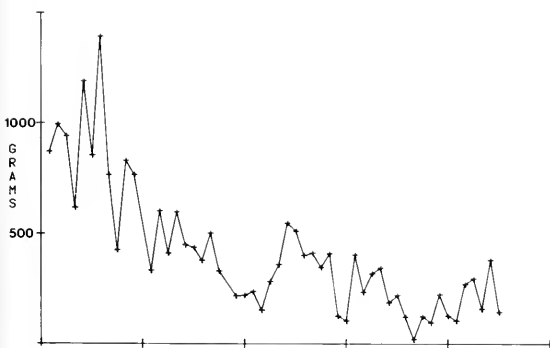

MEAN NUMBER OF FISH PER TRAWL

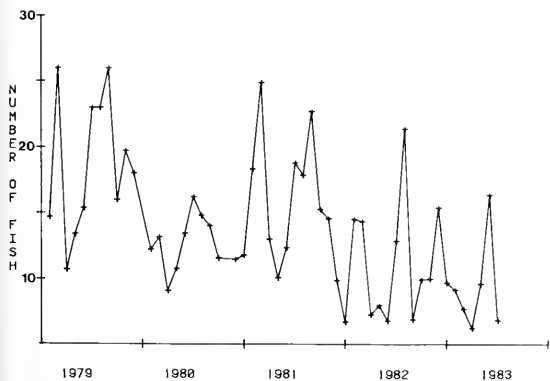

FIGURE 3.—Trends in mean numbers and grams of fish per trawl.

mer progressed although the two introduced species, striped bass and yellowfin goby, tended to peak later than the other species. Consequently, they all showed significant ( $P < 0.05$ ) negative correlations with outflow. All except Sacramento sucker and tule perch had significant positive correlations with salinity and temperature. There was a general decline in fish abundance throughout the 5-yr period. This was reflected in that four of the six species showed a positive correlation with species diversity, and all had a negative correlation with month series.

Prickly sculpin seemed to peak in abundance earlier in the year than the first six species (Fig. 4) but the pattern was obscured by the considerable year-to-year variation in abundance of young-of-year fish. Adults were resident in the marsh but appeared in the trawls on an irregular basis because of their tendency to hide under logs and other objects (Moyle 1976). Overall, prickly sculpin had negative correlations with salinity and Secchi depth, but positive correlations with temperature, *N. mercedis* abundance, and species diversity (Table 3). Threespine stickleback abundance had a negative correlation only with temperature, presumably because their reproductive behavior obscured our ability to catch them. They were most abundant in the trawls in February through May, and the catch consisted primarily of gravid females and schools of young-of-year fish. The males were apparently defending their nesting territories in emergent vegetation. By late summer sticklebacks were rare in the trawls but could be taken in seine hauls made through weedy areas.

The "winter seasonals" were three plankton-

PRICKLY SCULPIN

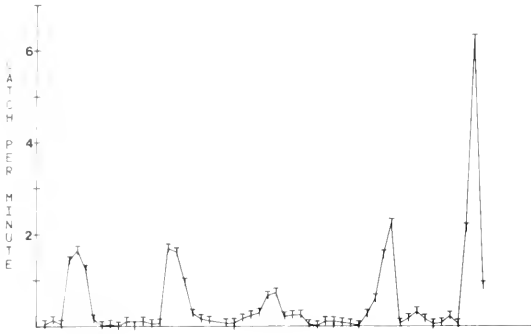

TULE PERCH

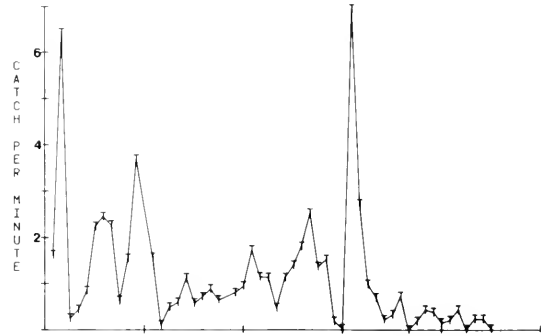

SACRAMENTO SUCKER

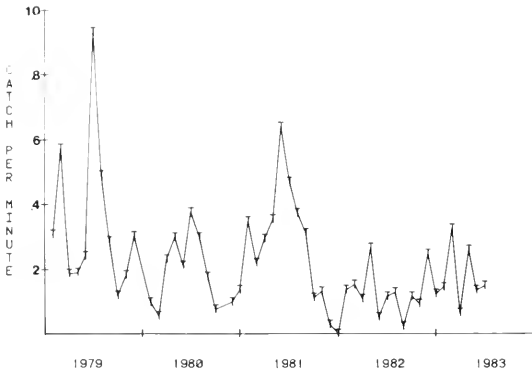

SPLITTAIL

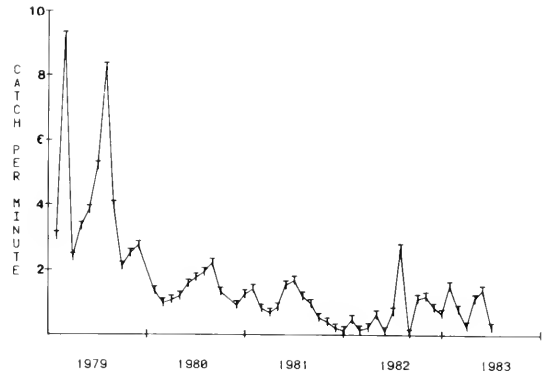

FIGURE 4.—Capture rates of native resident species within Suisun Marsh. Mean catch per effort is described as percent of the total catch for each species.

feeding species, delta smelt (native), longfin smelt (native), and threadfin shad (introduced). All three species tended to be most abundant in November through January, although the pattern was not always consistent (Fig. 6). Threadfin shad were the most erratic of the three species in abundance; they were especially abundant in the summer of 1981. Longfin smelt were largely absent from our samples in 1979 and 1981. Delta smelt abundance was positively correlated ( $P < 0.05$ ) with that of the other two species, although the correlation between longfin smelt and threadfin shad was not significant. All three species had negative correlations with temperature, and positive correlations with Secchi depth.

The "spring/summer seasonals" were staghorn sculpin and starry flounder, both euryhaline marine species that were represented mainly by young-of-year. Their patterns of abundance were not consistent (Fig. 6) and the peaks occurred anytime from March through September. Consequently, staghorn

sculpin did not show any significant correlations with the environmental variables, although starry flounder did show negative correlation with Secchi depth. Both species had a positive correlation with species diversity, presumably because they were rare in our samples during the last 2 years when the marsh was dominated by freshwater.

In addition to the 12 species that appeared regularly in our trawls, there were a number of other species of potential importance to the fish community that were either not sampled adequately by the trawl or were absent because of the effects of the 1976-77 drought. Five species that were not sampled adequately were inland silverside, chinook salmon, Sacramento squawfish, mosquitofish, and rainwater killifish. The silversides were abundant year around in the shallow, sandy or weedy areas found in some sloughs. Silversides appeared in seine hauls in 20 of the 22 mo in which seining was done; they were generally the most abundant fish in these hauls. Juvenile chinook salmon and squawfish were com-



mon in the marsh in February, March, and April (times of high outflows) and were taken mainly in seines. The tendency of the salmon to remain close to the banks and vegetation and to get sucked into

diversions of marsh water consequently has led to the screening of one major diversion in the marsh. Squawfish were abundant in the Sacramento River and juveniles are known to disperse widely during high flows (Smith 1982). Mosquitofish and rainwater killifish were present in ponds adjacent to the sloughs, along with silversides and sticklebacks; mosquitofish were planted in some areas for mosquito control.

### Principal Components' Analysis

The PCA using the numbers per trawl matrix resulted in four components that explained 47% of the variance in the matrix (Table 5). The first component loaded most heavily on tule perch, Sacramento sucker, and splittail, native resident species most abundant in dead-end sloughs, and to a lesser extent on carp and threadfin shad, introduced species common in such sloughs. The second component loaded heavily on striped bass, yellowfin goby, and carp, three introduced species resident throughout the marsh but most frequently captured in the main sloughs; all reached peaks of abundance in late summer. The third component loaded most heavily on prickly and staghorn sculpins, two benthic species that peaked in abundance during the summer months but were relatively scarce during the last 2

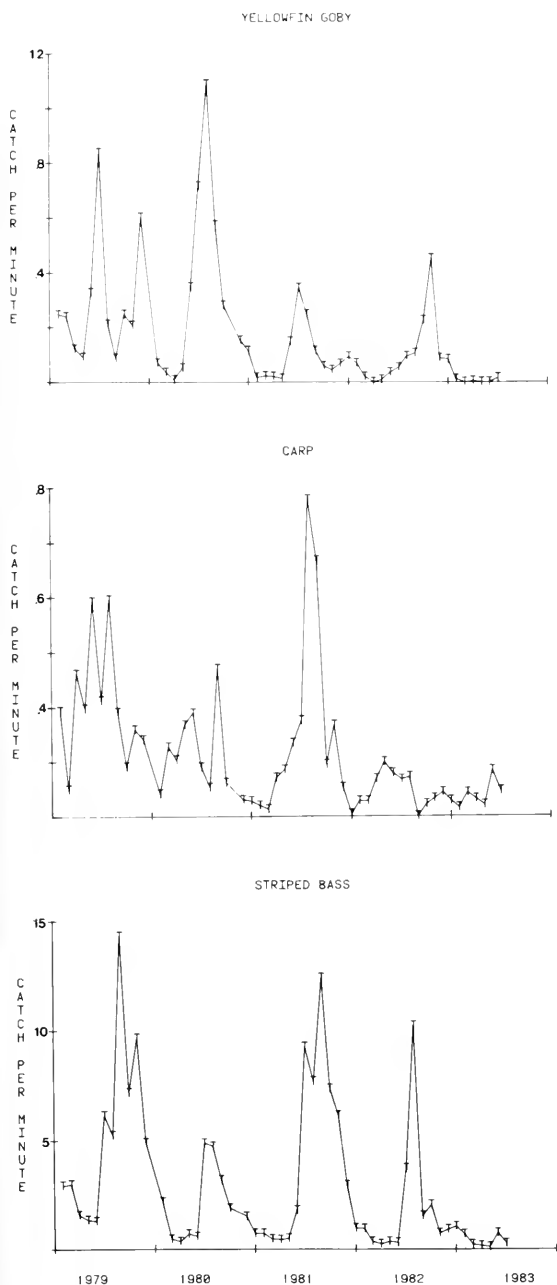
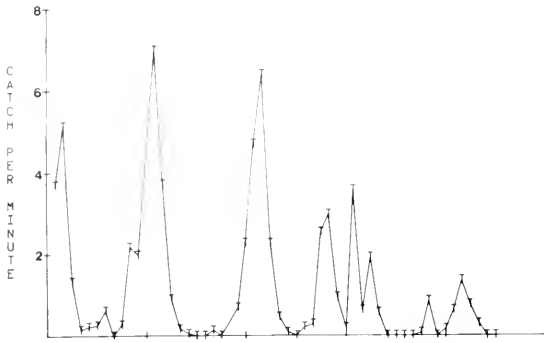

FIGURE 5.—Capture rates of introduced species within Suisun Marsh. Mean catch per effort is described as percent of the total catch for each species.

TABLE 5.—Loadings (rotated) of major fish species on four components produced by a principal components analysis of numbers of fish per trawl ( $n = 1,238$ ). Values over 0.500 are underlined.

	Component 1	Component 2	Component 3	Component 4
Splittail adults	0.487	0.300	-0.024	-0.149
Splittail juveniles	<u>0.549</u>	0.100	0.318	0.149
Striped bass adults	0.058	<u>0.701</u>	0.078	-0.073
Striped bass juveniles	0.183	<u>0.631</u>	-0.157	0.046
Longfin smelt	-0.124	0.029	-0.032	<u>0.747</u>
Delta smelt	0.022	-0.061	-0.027	<u>0.734</u>
Threadfin shad	0.447	-0.286	-0.121	0.319
Common carp	0.403	0.403	0.166	-0.084
Yellowfin goby	-0.011	<u>0.660</u>	0.023	0.016
Tule perch adults	<u>0.827</u>	0.049	0.085	-0.102
Tule perch juveniles	<u>0.833</u>	-0.036	-0.045	-0.017
Sculpin adults	0.254	-0.038	<u>0.377</u>	-0.263
Sculpin juveniles	0.090	0.043	<u>0.780</u>	-0.077
Starry flounder	0.117	0.256	0.107	-0.030
Staghorn sculpin	0.043	0.047	<u>0.727</u>	0.118
Sacramento sucker	<u>0.637</u>	0.197	0.341	0.102
Threespine stickleback	0.039	-0.296	0.486	-0.147
Eigenvalue	2.826	1.874	1.829	1.391
Cumulative proportion of variance explained	0.200	0.304	0.396	0.472

THREADFIN SHAD



LONGFIN SMELT

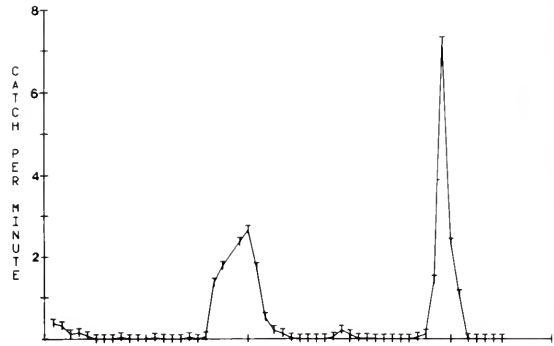

DELTA SMELT

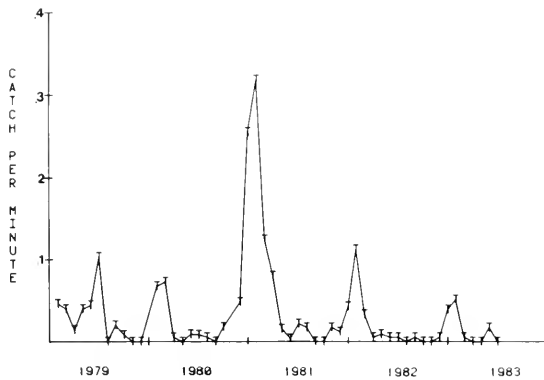

STARRY FLOUNDER

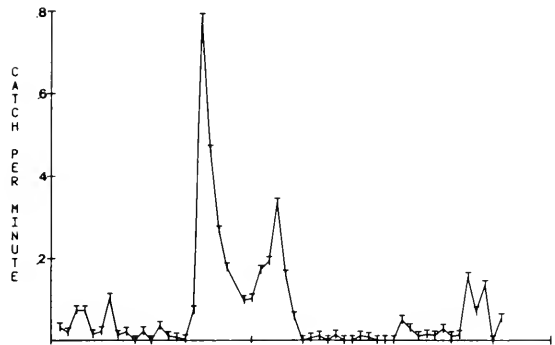

STAGHORN SCULPIN

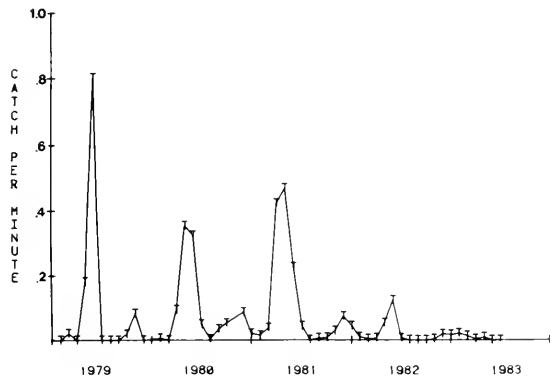

FIGURE 6.—Capture rates of seasonal species within Suisun Marsh. Mean catch per effort for each month described as percent of total for each species.

years of the study. A similar pattern was shown by threespine stickleback, which also had a relatively large positive loading on this component. The fourth component loaded heavily on delta and longfin smelt, and to a lesser extent on threadfin shad. This is the winter seasonal group identified in the previous analysis.

## DISCUSSION

During the 5-yr study period, the fish assemblage of Suisun Marsh had the following characteristics:

1. There was a strong seasonal pattern of total fish

abundance with numbers and biomass lowest in winter and spring and highest in late summer. Fishes were least abundant when river outflows were highest and most abundant when salinities and temperatures were highest.

2. There was an overall decline in fish abundance and species diversity through the study period.

3. Of the 21 species that occurred in the marsh on a regular basis, 14 were residents, 4 were winter seasonals, and 3 were spring/summer seasonals. Another 21 species occurred sporadically, in small numbers. These were mainly marine and freshwater species that presumably could become established in the marsh if environmental conditions changed significantly.

4. The abundant resident species fell into two groups, one made up of native species that concentrated in the small dead-end sloughs and the other a mixture of introduced and native species that were widely distributed in the marsh, but most abundant in the larger sloughs.

5. The structure of the fish assemblage (i.e., the pattern of distribution and abundance) was fairly consistent over the 54-mo period.

The seasonal pattern of fish abundance was due to a number of factors, most importantly 1) variation in sampling efficiency, 2) influxes of young-of-year fish, 3) favorable environmental conditions for most fish species in late summer, and 4) abundance of *Neomysis mercedis*. When outflows were high, water levels in the marsh were high and showed little tidal fluctuation. Therefore trawling was less efficient because there was more water and more flooded vegetation available as cover for fish. However, even under these conditions most of the sampling areas were rarely more than 2 m deep, so our trawl covered at least half the water column, and large catches were common, especially early in the study. Therefore, variation in sampling efficiency may have exaggerated the peaks and valleys of the catch curves (Figs. 4, 5) but was unlikely to obscure the general trends in abundance. Probably the most important contributor to the seasonal patterns was the increase in young-of-year striped bass, splittail, prickly sculpin, and tule perch, in June through August. These species (and others, to a lesser extent) became vulnerable to our trawl at 30-40 mm SL, and catches of several hundred individuals in a 5-min tow were made on occasion. The rapid growth of these species during summer (Daniels and Moyle 1983; Herbold and Moyle, unpubl. data) indicated that environmental conditions, including warm temperatures and moderate salinities, were favorable for

them and for other euryhaline species (e.g., staghorn sculpin, starry flounder). These same conditions also favored *N. mercedis*, a small shrimp that is an important food item in summer diets of most of the fishes (Herbold fn. 4). It is possible that the summer peak in fish abundance may be due also in part to fishes moving in to take advantage of an abundant food resource. The decline in *N. mercedis* abundance in late summer may be related in part to fish predation, although it is presumably related mainly to their seasonal movements within the entire estuary (Orsi and Knutson 1979).

The overall decline in fish abundance over the study period seemed to be due to two factors: variation in reproductive success of major species and the fact that 1982 and 1983 were years of unusually high precipitation and runoff, so freshwater conditions prevailed throughout the summer months of both years. Splittail showed an unusually strong year class in 1978, which dominated the 1979, and, to a lesser extent, 1980 samples (Daniels and Moyle 1983). Catches of splittail in 1979 were typically 2-5 times greater than in subsequent years. Striped bass, tule perch, and carp also showed peaks of abundance in 1979 and had low abundances in 1982-83, with one or two peaks of abundance in between. Except for carp, the peaks were largely due to influxes of young-of-year fish. The reason for the abundance of the 1978 year class of fish was presumably related to 1978 being a year of high, but not excessive, outflows. Increased reproductive success during high outflow years has been documented for striped bass (Stevens 1977), splittail (Daniels and Moyle 1983), American shad, chinook salmon, and longfin smelt (Stevens and Miller 1983). However, under extreme outflow conditions (such as existed in 1982 and 1983), young-of-year fish are apparently carried downstream to areas below the marsh (San Francisco and San Pablo Bay) where chances of survival may be less (Stevens 1977).

Drought also contributed to the variation in the fish fauna. During 1976 and 1977, severe drought reduced freshwater inflows to the marsh, resulting in sustained high salinities. Freshwater fishes declined dramatically during the drought period (Herrgesell et al. 1981) and the fishery for catfish (mainly white catfish and black bullhead) was greatly reduced (Baracco 1980). The catfish populations did not recover during the study period, but the regular appearance of young-of-year white catfish in our trawls in late 1983 indicated a recovery may be in progress. Other freshwater fishes found in the marsh (Table 1) showed no signs of increasing. Most were represented in our samples by <10 individuals that

had presumably been washed into the marsh from freshwater habitats upstream. However, black crappie and perhaps other centrarchids contributed to the local fishery prior to the drought, mainly in the upper ends of the larger sloughs, so a recovery can be expected.

Despite the decline in freshwater fishes during the drought, there was no corresponding major increase in the abundance of euryhaline marine species characteristic of nearby San Francisco Bay (Herrgesell et al. 1981). Marine species (such as northern anchovy, Pacific herring, and shiner perch) generally appeared in our samples in late summer when salinities were highest, in parts of the marsh closest to Suisun Bay.

Considering the annual and long-term variations in fish abundances and the fact that the fish assemblage is made up of a mixture of native and introduced species, the consistency of the assemblage structure during the study is surprising. Coevolution has obviously little role in an assemblage in which the most abundant species (striped bass) entered in 1879 and other abundant species entered in the 1960's (yellowfin goby) and 1970's (inland silversides) (Moyle 1976). The apparent consistency in structure seemed to be the result of 1) two introduced species, striped bass and carp, that were consistently abundant in the marsh, 2) the group of native resident fishes that was persistent in deadend sloughs, and 3) the native fishes that moved in and out of the marsh on a seasonal basis.

This does not mean that the structure observed during this study will persist indefinitely. A number of changes in the fish fauna may already be occurring. For example, the presence of young-of-year white catfish in 1983 and 1984 may signify a shift of the assemblage towards catfishes and centrarchids, such as existed before the 1976-77 drought. Striped bass are presently in a long-term decline in abundance, a trend which seems to be continuing (Kelley et al. 1982). Past history indicates that new introductions of fishes into the system are likely: specifically, the white bass, *Morone chrysops*, has recently become established in part of the San Joaquin drainage and may become a major new predator in the Sacramento-San Joaquin Estuary if planned eradication attempts fail (California Department of Fish and Game unpubl. data). Furthermore, additional diversions of freshwater from the estuary are planned (Herrgesell et al. 1981), and major modifications to the marsh channels are planned or underway (Baracco 1980), so the environment, especially in the dead-end sloughs, may change significantly. It is difficult to predict what the combined effects

of all these changes will be on the present fish assemblage, but extinctions of both native and introduced species in the estuary have occurred in the past (Moyle 1976) and could occur again in the future.

The structure of the fish assemblage of Suisun Marsh is similar in many respects to the structure of the fish assemblages of other large estuaries (e.g., Markle 1976; Meeter et al. 1979), despite the importance of recently introduced species and the stabilizing influence humanity has had on the pattern and amount of freshwater inflow (Kahrl 1978). In most such estuaries, as in the Sacramento-San Joaquin, the assemblages are dominated by juvenile fishes, and most species have substantial populations outside the estuary. As in Suisun Marsh, the fish assemblages of such estuaries are made up of a relatively small number of the species available in nearby marine and freshwater environments. Presumably, the species composition of an estuarine assemblage is determined in large part by the ability of the species to tolerate the particular set of environmental conditions that exist there. Since these conditions may change with short-term climatological changes, the fish assemblages may change as well (Meeter et al. 1979; Marais 1982). Thus coevolution is given little chance to operate in estuarine systems in general. In this context, it is not surprising that the fish assemblage of the Suisun Marsh behaves ecologically in a way similar to fish assemblages in most other estuarine systems. Because resource partitioning is commonly observed among estuarine fishes (Sheridan and Livingston 1979; Whitfield 1980), competition may be an important process in determining the structure of estuarine fish assemblages (Thorman 1982), a hypothesis we are currently investigating in the Suisun Marsh.

## ACKNOWLEDGMENTS

This project was supported by the California Department of Water Resources (DWR) and by the Agricultural Experiment Station, University of California (Project No. 3930-H). It would not have been possible without the support and encouragement of Randall L. Brown, Central District, DWR. Numerous volunteers assisted the sampling effort, but especially Larry Brown, Sonia Cook, Bart Daniel, Lynn Decker, Tim Ford, Bret Harvey, Ned Knight, Tim Takagi, Bruce Vondracek, Eric Wikramanayake, and Wayne Wurtsbaugh. The manuscript was reviewed in various drafts by Larry Brown, Beth Goldowitz, Ned Knight, and Eric Wikramanayake. The manuscript was "processed" by Donna Raymond.

## LITERATURE CITED

- ALLEN, L. G.  
1982. Seasonal abundance, composition, and productivity of the littoral fish assemblage in Upper Newport Bay, California. *Fish. Bull.*, U.S. 80:769-790.
- BALTZ, D. M., AND P. B. MOYLE.  
1982. Life history characteristics of tule perch (*Hysterocarpus traski*) populations in contrasting environments. *Environ. Biol. Fishes* 7:229-242.
- BARACCO, A.  
1980. Aquatic resources of Suisun Marsh with an analysis of the fishery effects of a proposed water quality maintenance plan. Calif. Dep. Fish Game, Anad. Fish. Branch Admin. Rep., 26 p.
- BLABER, S. J. M., AND T. G. BLABER.  
1980. Factors affecting the distribution of juvenile estuarine and inshore fish. *J. Fish. Biol.* 17:143-162.
- CONOMOS, T. J. (editor).  
1979. San Francisco Bay: the urbanized estuary. Pac. Div. AAAS, San Franc., 493 p.
- DAHLBERG, M. D., AND E. P. ODUM.  
1970. Annual cycles of species occurrence, abundance, and diversity in Georgia estuarine fish populations. *Am. Midl. Nat.* 83:382-392.
- DANIELS, R. A., AND P. B. MOYLE.  
1983. Life history of the splittail, (Cyprinidae: *Pogonichthys macrolepidotus*), in the Sacramento-San Joaquin estuary. *Fish. Bull.*, U.S. 81:647-654.
- DIXON, W. J., AND M. B. BROWN (EDITORS).  
1977. Biomedical computer programs, Pseries. Univ. Calif. Press, Berkeley, 880 p.
- GANSSLE, D.  
1966. Fishes and decapods of San Pablo and Suisun Bay. In D. W. Kelley (editor), Ecological studies of the Sacramento-San Joaquin estuary, Part I. Zooplankton, zoobenthos, and fishes of San Pablo and Suisun Bays, Zooplankton and zoobenthos of the Delta, p. 64-94. Calif. Dep. Fish. Game, Fish Bull. 133.
- HERRGESELL, P. L., D. W. KOHLHORST, L. W. MILLER, AND D. S. STEVENS.  
1981. Effects of freshwater flow on fishery resources in the Sacramento-San Joaquin estuary. In R. D. Cross and D. L. Williams (editors), Proceedings of National Symposium on Freshwater Inflow to Estuaries, p. 71-87. U.S. Fish and Wildlife Service OBS 81-4.
- KAHRL, W. J. (EDITOR).  
1978. The California water atlas. Calif. Dep. Water Resour., 118 p.
- KELLEY, D. W., AND THE STRIPED BASS WORKING GROUP.  
1982. The striped bass decline in the San Francisco Bay-Delta Estuary. Calif. State Water Res. Control Board, 58 p.
- KJELSON, M. A., AND D. R. COLBY.  
1977. The evaluation and use of gear efficiencies in the estimation of estuarine fish abundance. In V. F. Kennedy (editor), Estuarine processes, Vol. 2, p. 416-424. Academic Press, N.Y.
- LIVINGSTON, R. J.  
1976. Diurnal and seasonal fluctuations of organisms in a North Florida estuary. *Estuarine Coastal Mar. Sci.* 4:373-400.
- MARAI, J. F. K.  
1982. The effects of river flooding on the fish populations of two eastern Cape estuaries. *S. Afr. J. Zool.* 17:96-104.
- MARKLE, D. F.  
1976. The seasonality of availability and movements of fishes in the channel of the York River, Virginia. *Chesapeake Sci.* 17:50-55.
- MEETER, D. A., R. J. LIVINGSTON, AND G. C. WOODSUM.  
1979. Long-term climatological cycles and population changes in a river-dominated estuarine system. In R. J. Livingston (editor), Ecological processes in coastal and marine systems, p. 315-338. Plenum Press, N.Y.
- MOYLE, P. B.  
1976. Inland fishes of California. Univ. Calif. Press, Berkeley, 405 p.
- ORSI, J. J., AND A. C. KNUTSON, JR.  
1979. The role of mysid shrimp in the Sacramento-San Joaquin estuary and factors affecting their abundance and distribution. In T. J. Conomos (editor), San Francisco Bay: the urbanized estuary, p. 401-408. Pac. Div. AAAS, San Franc.
- QUINN, N. J.  
1980. Analysis of temporal changes in fish assemblages in Serpentine Creek, Queensland. *Environ. Biol. Fishes* 5:117-133.
- SHERIDAN, P. F., AND R. J. LIVINGSTON.  
1979. Cyclic trophic relationships of fishes in an unpolluted, river-dominated estuary in North Florida. In R. J. Livingston (editor), Ecological processes in coastal and marine systems, p. 143-160. Plenum Press, N.Y.
- SIEGFRIED, C. A.  
1980. Seasonal abundance and distribution of *Crangon franciscorum* and *Palaemon macrodactylus* (Decapoda, Caridea) in the San Francisco Bay-Delta. *Biol. Bull. (Woods Hole)* 159:177-192.
- SKINNER, J. E.  
1972. Ecological studies of the Sacramento-San Joaquin Estuary. Calif. Dep. Fish. Game Delta Fish Wildl. Prot. Study Rep. 8, 94 p.
- SMITH, J. J.  
1982. Fishes of the Pajaro River System. Univ. Calif. Publ. Zool. 115:83-170.
- STEVENS, D. E.  
1977. Striped bass (*Morone saxatilis*) year class strength in relation to river flow in the Sacramento-San Joaquin Estuary, California. *Trans. Am. Fish. Soc.* 106:34-42.
- STEVENS, D. E., AND L. W. MILLER.  
1983. Effects of river flow on abundance of young chinook salmon, American shad, longfin smelt, and delta smelt in the Sacramento-San Joaquin River system. *N. Am. J. Fish. Manage.* 3:425-437.
- THORMAN, S.  
1982. Niche dynamics and resource partitioning in a fish guild inhabiting a shallow estuary on the Swedish west coast. *Oikos* 39:32-39.
- TURNER, J. L., AND D. W. KELLEY (EDITORS).  
1966. Ecological studies of the Sacramento-San Joaquin Delta. Part II. Fishes of the Delta. Calif. Dep. Fish Game, Fish Bull. 136, 168 p.
- WHITFIELD, A. K.  
1980. Distribution of fishes in the Mhlanga estuary in relation to food resources. *S. Afr. J. Zool.* 15:159-165.



# THE ROLE OF ESTUARINE AND OFFSHORE NURSERY AREAS FOR YOUNG ENGLISH SOLE, *PAROPHRYS VETULUS* GIRARD, OF OREGON

E. E. KRYGIER<sup>1</sup> AND W. G. PEARCY<sup>2</sup>

## ABSTRACT

Our trawling studies confirm that age group 0 English sole are common in shallow waters along the open coast as well as in estuaries of Oregon. Both areas appear to be important nursery areas for this species. Metamorphosing English sole were recruited to Yaquina Bay over many months between November and June during the 5 years studied. Seasonal trends in abundance of these transforming fish were rather similar to both Yaquina Bay and open coastal stations. Transforming individuals, however, were found earlier in the fall and later in the spring and summer along the open coast than in Yaquina Bay.

Based on catch curves, the densities (no. m<sup>-2</sup>) of juvenile English sole were much higher in Yaquina Bay than along the open coast. Transforming sole (20-25 mm) were an exception. They were sometimes most abundant at the open coast location. Increasing densities of 20-40 mm length fish in the Yaquina Bay catches were accompanied by decreased catches of this size group at the open coast site. This suggests immigration of a broad size range of both transforming and fully transformed individuals into Yaquina Bay.

English sole, *Parophrys vetulus* Girard 1854, is a major component of the catches in the northeastern Pacific trawl fishery, usually ranking second only to Dover sole, *Microstomus pacificus*, in annual landings off Oregon (Barss 1976<sup>3</sup>; Demory et al. 1976<sup>4</sup>). It ranges from Baja California to Unimak Island in western Alaska, with commercial quantities at depths of 128 m or less (Hart 1973). Tagging studies have revealed a series of relatively discrete stocks of English sole off California, Oregon, Washington, and British Columbia (Ketchen 1956; Forrester 1969; Jow 1969; Pattie 1969; Barss 1976 fn. 3).

Spawning of English sole is protracted, usually extending from September through April, and is often variable in seasonal intensity within and among spawning seasons (Budd 1940; Ketchen 1956; Harry 1959; Jow 1969; Laroche and Richardson 1979). Much of this variability among years may be related to upwelling and bottom temperatures (Kruse and Tyler 1983). Spawning concentrations of adult English sole were found in the fall off the central Oregon coast at depths of 70-110 m (Hewitt 1980).

English sole are fecund, producing 327,600-2,100,000 eggs, depending on the size of female (Ketchen 1947; Harry 1959). Eggs are pelagic and hatch in about 4½ d at 10°C (Alderdice and Forrester 1968). Larvae are often abundant during late winter and early spring in coastal waters of Oregon (Richardson and Percy 1977; Mundy 1984). Larval abundance may fluctuate greatly among years, possibly due to annual differences in ocean conditions (Laroche and Richardson 1979; Mundy 1984). The pelagic phase lasts 8-10 wk (Ketchen 1956; Laroche et al. 1982), and most individuals complete metamorphosis and acquire the morphology of benthic pleuronectids at 20 mm SL and 120 d of age (Ahlstrom and Moser 1975; Rosenberg and Laroche 1982).

While early larval stages are rarely found in estuaries (Misitano 1970; Percy and Myers 1974), transforming larvae and early juvenile stages of English sole are common in estuaries (Westrheim 1955; Smith and Nitsos 1969; Olsen and Pratt 1973; Percy and Myers 1974; Misitano 1976; Toole 1980; Bayer 1981) and shallow protected bays (Ketchen 1956; Kendall 1966; Van Cleve and El-Sayed 1969). Young English sole are known to utilize 13 estuaries along the Oregon coast and were absent in only 3 small estuaries surveyed along the southern Oregon coast.<sup>5</sup> Villadolid (1927, as cited by Misitano 1970) captured

<sup>1</sup>College of Oceanography, Oregon State University, Corvallis, OR; present address: Alaska Trollers Association, 130 Seward Street, Juneau, AK 99801.

<sup>2</sup>College of Oceanography, Oregon State University, Corvallis, OR 97731.

<sup>3</sup>Barss, W. H. 1976. The English sole. Oreg. Dep. Fish Wildl., Inf. Rep. 76-1, 7 p.

<sup>4</sup>Demory, R. L., M. J. Hosie, N. Ten Eyck, and B. O. Forsberg. 1976. Marine resource surveys on the continental shelf off Oregon, 1971-74. Oreg. Dep. Fish Wildl., 49 p.

<sup>5</sup>Report of estuary surveys, July-August 1972. Fish Comm. Oreg. Intern. Rep. GS-73-1, 14 p.

0-age English sole in San Francisco Bay but not off the coast.

Based on the incidence of a parasitic infection, apparently acquired only in estuaries, and the absence of 0-age English sole in Demory's (1971) surveys off the northern Oregon-southern Washington coast, Olsen and Pratt (1973) concluded that estuaries are likely the exclusive nursery for English sole on the Oregon coast. Laroche and Holton (1979), however, captured 0-age English sole in shallow waters along the open Oregon coast, indicating that estuaries may not be the only nursery area for English sole off Oregon.

The main objective of our study is to evaluate the relative importance of estuarine and open coastal nursery grounds for young English sole off Oregon.

## METHODS AND MATERIALS

Bottom trawl collections provided most of the information on the distribution and abundance of juvenile English sole. Collections were made in Yaquina Bay and along the open coast outside the bay. These were supplemented with extensive trawl collections farther to the north and south along the open coast and collections in other estuaries.

Fish were collected using a 1.52 m wide, 56 cm high beam trawl (see Krygier and Horton 1975) from the RV *Paiute* and from a 7.3 m dory. Additional collections with a 2.72 m beam trawl (Carey and Heyamoto 1972) were made on the RV *Cayuse*. To retain small, settling fish, fine-mesh (1.5-3.5 mm stretch) liners were used in the trawls. The 1.52 and 2.72 m beam trawls were fitted with a 1.0 or 2.0 m circumference wheel, respectively, and a revolution counter to estimate the area sampled (Carey and Heyamoto 1972; Krygier and Horton 1975). Tows were made at 0.7-1.0 m s<sup>-1</sup>. Tow duration was normally 5-10 min on the bottom in estuaries and 10-20 min along the coast, usually at a 4:1 scope. Most tows were during daylight hours.

Collections for juvenile English sole were made in five different study areas (Fig. 1, Table 1):

### ESTUARINE

1) Yaquina Bay: 1.52 beam trawl collections were made in lower Yaquina Bay from January 1970 through February 1972 by Krygier and Johnson (unpubl. data) and Krygier and Horton (1975) and supplemented by collections in 1977-79. Additionally, we used collections made by Myers (1980) with a 100 m beach seine (11.0 mm stretch mesh in the inner wing and bunt (Sims and Johnsen 1974)).

2) Other estuaries: The 1.52 m beam trawl was

towed from a 7.3 m dory in four estuaries north and south of Yaquina Bay (Tillamook and Siletz Bays, 107.5 and 35.2 km to the north of Yaquina Bay and Alsea Bay and Umpqua River estuary, 21.3 and 105.6 km to the south). Each estuary was divided into seven equal-area portions from which we planned to take three random trawl collections (2 of the 21 trawls in the Umpqua River estuary were not completed).

### COASTAL

3) Moolack Beach: 1.52 m beam trawl collections were made on a monthly or bimonthly basis in shallow (3-31 m depth) nearshore waters in a 1.0 km<sup>2</sup> area just north of Yaquina Head during 1977, 1978, and 1979. Moolack Beach is semiprotected by headlands to the north and south and offshore by a reef that rises from 15 m to 6 m.

4) Grid stations: Collections were taken with a 2.72 m beam trawl, approximately monthly, during 1978 at 1.9, 5.6, and 9.3 km (1, 3, and 5 nmi) offshore along lat. 44°41.6'N, 44°36.6'N, and 44°31.6'N. Thirteen collections were also made in this area with the 1.52 m beam trawl.

TABLE 1.—Summary of collections used in this study.

Area	Net type	No. trawls	Dates (sampling frequency)
Yaquina Bay	1.52 m	178	16 Jan. 70-25 Jan. 71 (weekly or biweekly); 17 Feb. 71-25 Feb. 72 (bimonthly)
	2.1.52 m	26	26 Apr.-28 June 77 (bimonthly)
	2.1.52 m	96	1 Dec. 77-14 Sept. 79 (monthly to bimonthly)
	2.2.72 m	8	16 Nov. 77, 1 Feb. 78, 27 Nov. 78
	beach seine	196	12 July 77-11 Nov. 78 (various: daily, biweekly, weekly, bimonthly)
Moolack	1.52 m	16	28 Apr. 77-23 June 77 (bimonthly)
	1.52 m	76	11 Jan. 78-24 Sept. 79 (bimonthly of monthly)
Grid	1.52 m	13	21 Apr. 77-27 June 77; 15 June 78-28 Sept. 78
	2.72 m	106	17 Nov. 77-25 Oct. 78 (monthly)
North-South	1.52 m	40	2 June 77-13 June 77, 15 June 78-21 July 78
	2.72 m	83	15 May 78, 27 June 78, 25 Oct. 78
Estuaries	1.52 m	82	8-12 May 78, 21 trawls each in Tillamook, Siletz and Alsea; 19 trawls in Umpqua

<sup>1</sup>Net liners 3.5 mm and cod end liner of 1.5 mm stretch mesh, 1970-72.

<sup>2</sup>Net liners 3.2 mm stretch mesh, 1977-79.



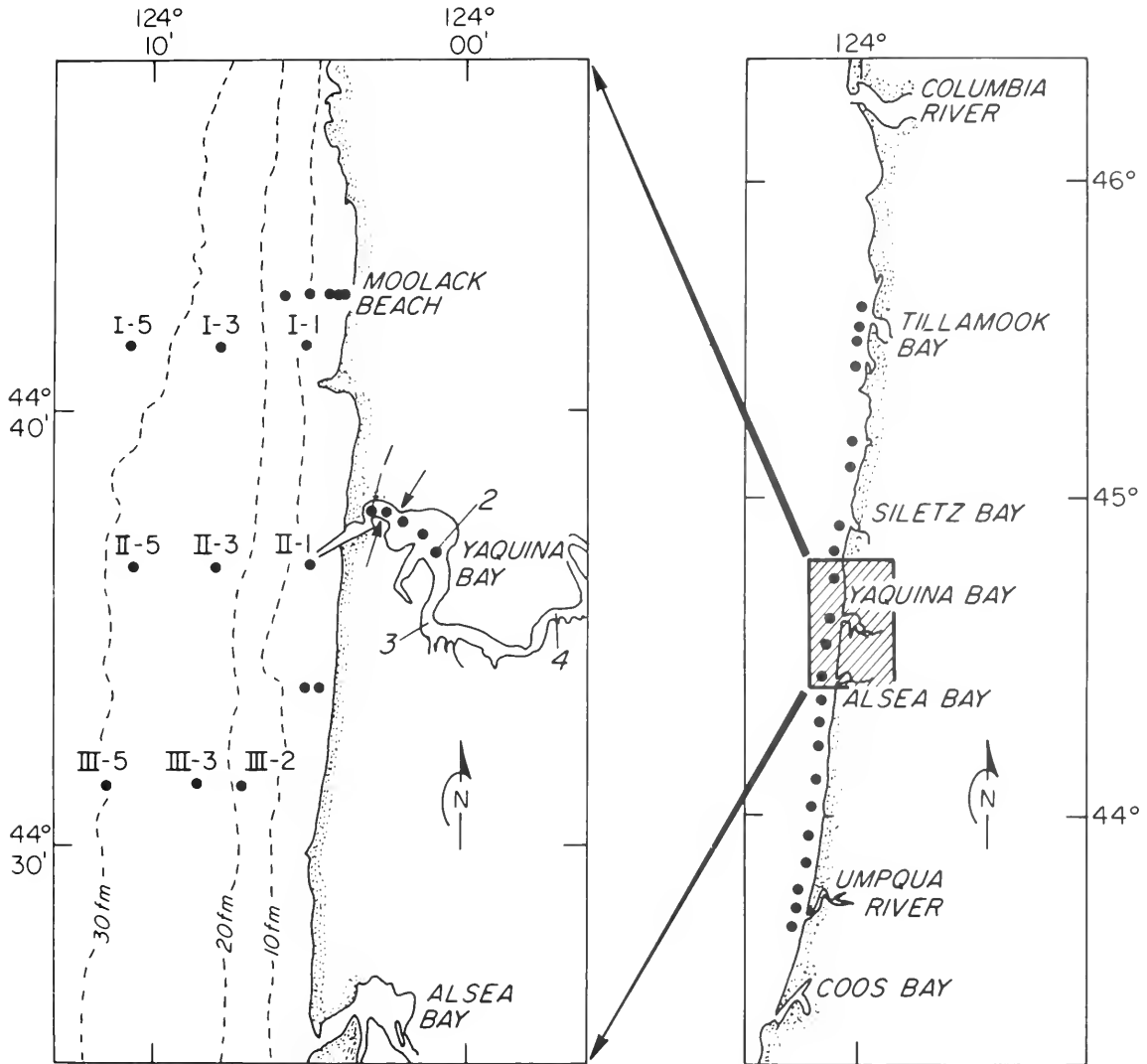

FIGURE 1.—Location of sampling stations in the North-South coastal survey (right) and at Moolack Beach, the grid stations I, II, III, and within Yaquina Bay (left). In Yaquina Bay the numbers 1-4 indicate locations of stations for sampling in 1970-72, the solid dots locations in 1977-79, and the arrows indicate seine stations in 1977.

5) North-south coastal survey: 1.52 m beam trawl collections were made from 111 km to the north (lat. 45°37.5'N) and 111 km to the south (lat. 45°36'N) of Yaquina Bay at 9.3 km intervals (Fig. 1) at depths of 9-18 m in June 1977 and May-October 1978.

Most samples were preserved in 5% Formalin<sup>6</sup> and seawater. In the laboratory, fish were identified, sorted, and standard length (SL) measured to the

nearest millimeter. Nearly all English sole captured in Yaquina Bay were 150 mm SL or less and included 0- and I-age fish (Rosenberg 1982). We call these fishes "juveniles" in this paper.

## RESULTS

### Variability of Catches

The variability of the number of juvenile English sole caught per m<sup>2</sup> in repeated trawls within the same area was low. Coefficients of dispersion ( $s^2/\bar{x}$ )

<sup>6</sup>Reference to trade names does not imply endorsement by the National Marine Fisheries Service, NOAA.

were usually  $<0.1$ , indicating uniform distributions within the small areas (10-100 m<sup>2</sup>) and short intervals of time (1-2 h) sampled. Variability was higher and coefficients of dispersion sometimes differed significantly (chi-square,  $<0.05$ ) from a random (Poisson) distribution among different sampling depths at the same date ( $s^2/\bar{x} = 0.36-1.65$ ) and among different sampling dates within a single depth at Moolack Beach ( $s^2/\bar{x} = 1.2-2.31$ ). Coefficients of dispersion did not significantly differ from randomness either among the grid stations for the same sampling dates ( $s^2/\bar{x} = 0.87-1.82$ ) or among different sampling dates at the same station (0.94-1.97). In general, at the scale of sampling we used, juvenile English sole had even, nonpatchy distributions.

### Gear Comparisons

To compare the relative efficiencies of the 1.52 m beam trawl from the *Paiute* and the 2.72 m beam trawl from the *Cayuse*, 14 pairs of trials were made at the same time, while the vessels trawled on parallel courses within 30 m of each other. No significant differences ( $P > 0.05$ ; Mann-Whitney "U" tests, Tate and Clelland 1957) were found in the catch/m<sup>2</sup> of juvenile English sole  $<150$  mm for any paired trawl comparison.

No significant differences were found in length-frequency distributions of *P. vetulus* captured in 10 of the 14 comparisons [Kolmogorov-Smirnov (K-S) test, Tate and Clelland 1957]. In the four pairs of tows that were significantly different (October 1978) the 2.72 m trawl caught more small ( $\sim 20$  mm SL) English sole per m<sup>2</sup> than the 1.52 m trawl, while both trawls caught similar proportions in the 46-100 mm size range.

Comparisons were made between the sizes of English sole in beach seine samples and midchannel trawl samples in Yaquina Bay on six different dates. Differences were significant (K-S test;  $P < 0.05$ ) for all comparisons because the beam trawl caught a much broader size range of fish, including individuals  $>40$  mm which were rare or absent in the beach seine catches.

### Trends in Catches and Sizes of Fish

Significant (H-test,  $P \leq 0.05$ ) differences in catches/m<sup>2</sup> at different depths at Moolack Beach and the grid stations show that in general the abundance of juvenile English sole in offshore waters was greatest in shallow water and decreased with increasing depth. Average catches/10<sup>3</sup>m<sup>2</sup> ( $\pm 1$  stan-

dard deviation) of English sole  $\leq 150$  mm were 16 ( $\pm 20$ ), 61 ( $\pm 14$ ), 43 ( $\pm 75$ ), and 10 ( $\pm 12$ ) at the 9, 9-17, 12-18, and 18-31 m stations off Moolack Beach, compared with only 3 ( $\pm 3$ ) and 2 ( $\pm 3$ ) at the 40 and 64 m I-3 and I-5 grid stations at about the same latitude.

Newly transformed, benthic English sole ( $<24$  mm) were found at all depths sampled in the Moolack Beach area, but the highest proportion of these recently metamorphosed fish was found at depths  $<18$  m. Within the depth zones sampled the proportion of small English sole  $<30$  mm decreased with depth and fish  $>150$  mm were only captured at depths deeper than 18 m (Fig. 2).

Juvenile English sole  $\leq 150$  mm were found along the entire 222 km coast sampled (Fig. 3). They were usually moderately abundant ( $\geq 0.01$  m<sup>2</sup>) between Siletz Bay and Alsea Bay, and near the Umpqua River and Tillamook Bay. Average catches, however, were higher off Moolack Beach than any other area, averaging 0.21 juvenile English sole/m<sup>2</sup>, an order of magnitude greater than most other offshore areas or the grid stations. Moolack Beach was apparently a region of the open coast with exceptionally high densities of English sole.

Juvenile English sole were generally most abundant at the shallowest depths in these collections, corroborating more intense sampling off Moolack Beach and at the grid stations (Fig. 3). Average catches at depths of 18 m and 36 m decreased about an order of magnitude between May (0.026/m<sup>2</sup>; SD 0.049) and October (0.003/m<sup>2</sup>; SD 0.003).

### Variations in Abundance of Settling Fish

In our samples, metamorphosis or transformation, as indicated by migration of the left eye and by body pigmentation, occurred between 14-26 mm. Most fish had completed metamorphosis by 23 mm. In Yaquina Bay, the metamorphosing individuals first appeared in November of 1971 and 1978 (the 1972 and 1979 year classes) and in January of 1971 and 1978 (1971 and 1978 year classes) (Fig. 4). (In this paper we designate year classes by the year that most juveniles settled to the bottom; e.g., products of spawning during the fall 1978-winter 1979 are called the 1979 year class.) Metamorphosing fish were present in Yaquina Bay until June (1970, 1978, 1979) or July (1971), but none was found after July during the four summer periods sampled.

Maximum densities of these metamorphosing fish were observed between March and May in 1970, 1971, and 1978, but between November and January in 1978-79. Densities were variable. Low densities

MOOLACK BEACH STATIONS

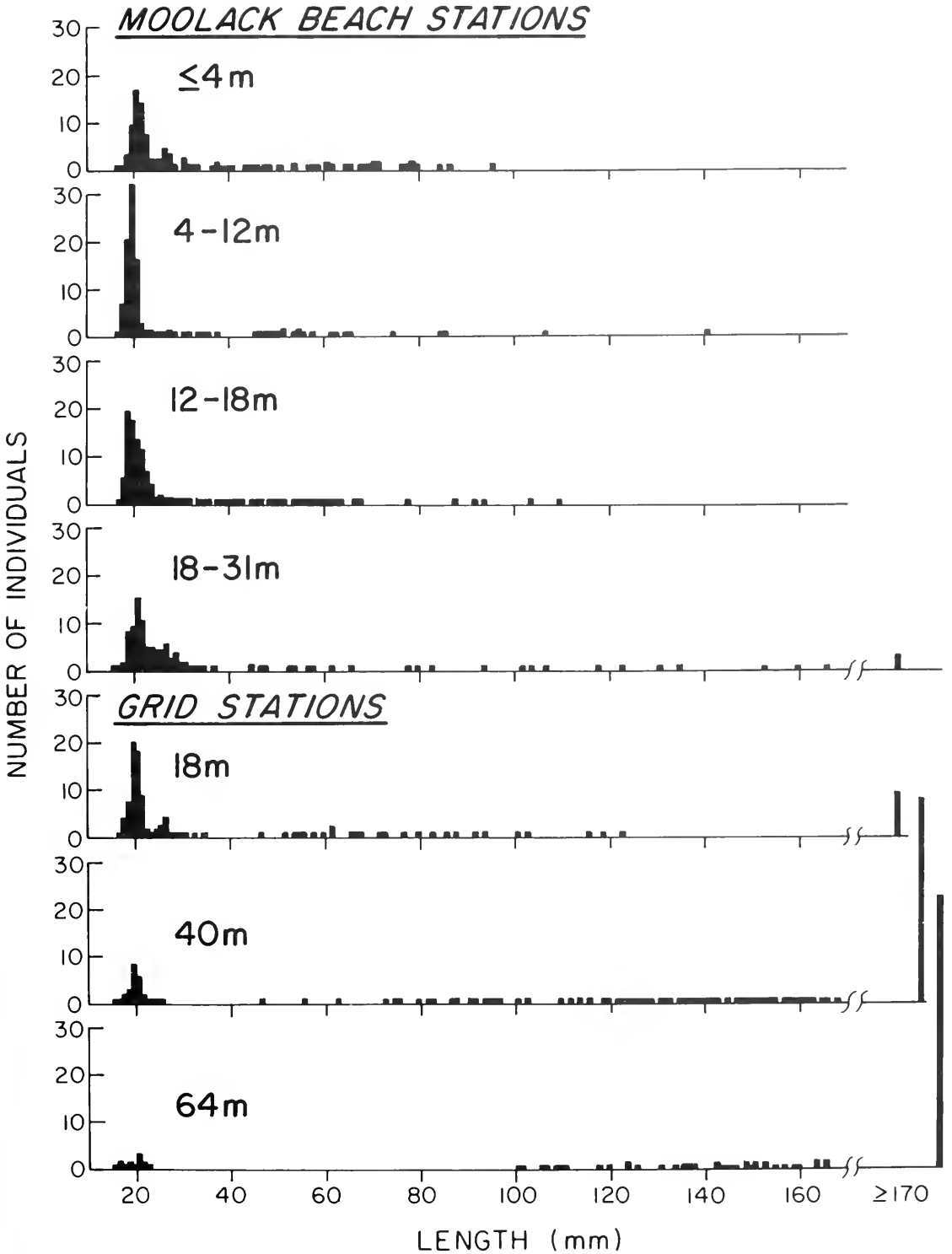

FIGURE 2.—Length-frequency distributions of juvenile English sole caught at different depths at the Moolack Beach (above) and grid stations (below).

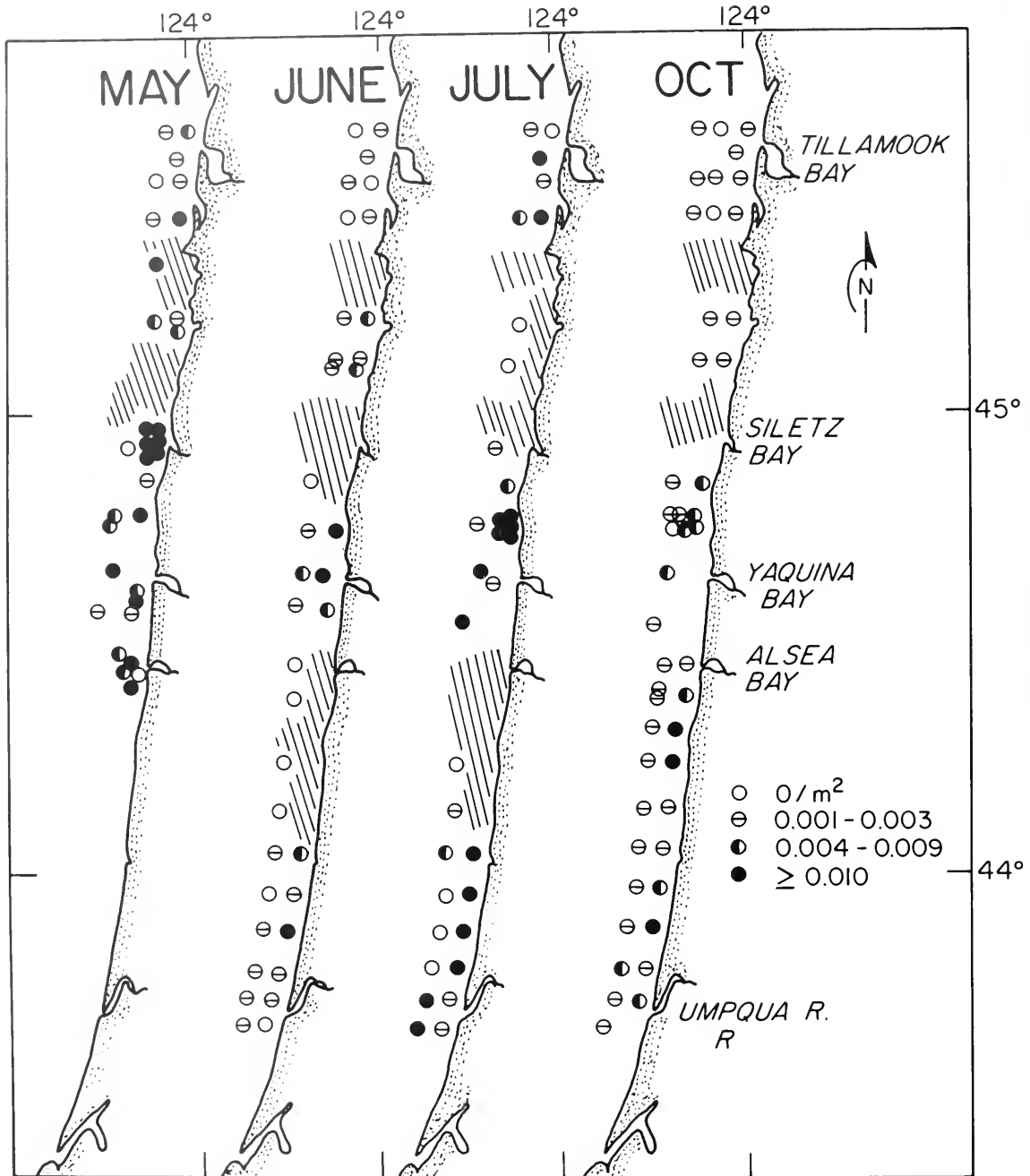

FIGURE 3.—Catches of juvenile English sole (<150 mm) along the open coast during May, June, July, and October 1978. Hatched areas indicate untrawlable grounds due to crab pots or rocky outcrops.

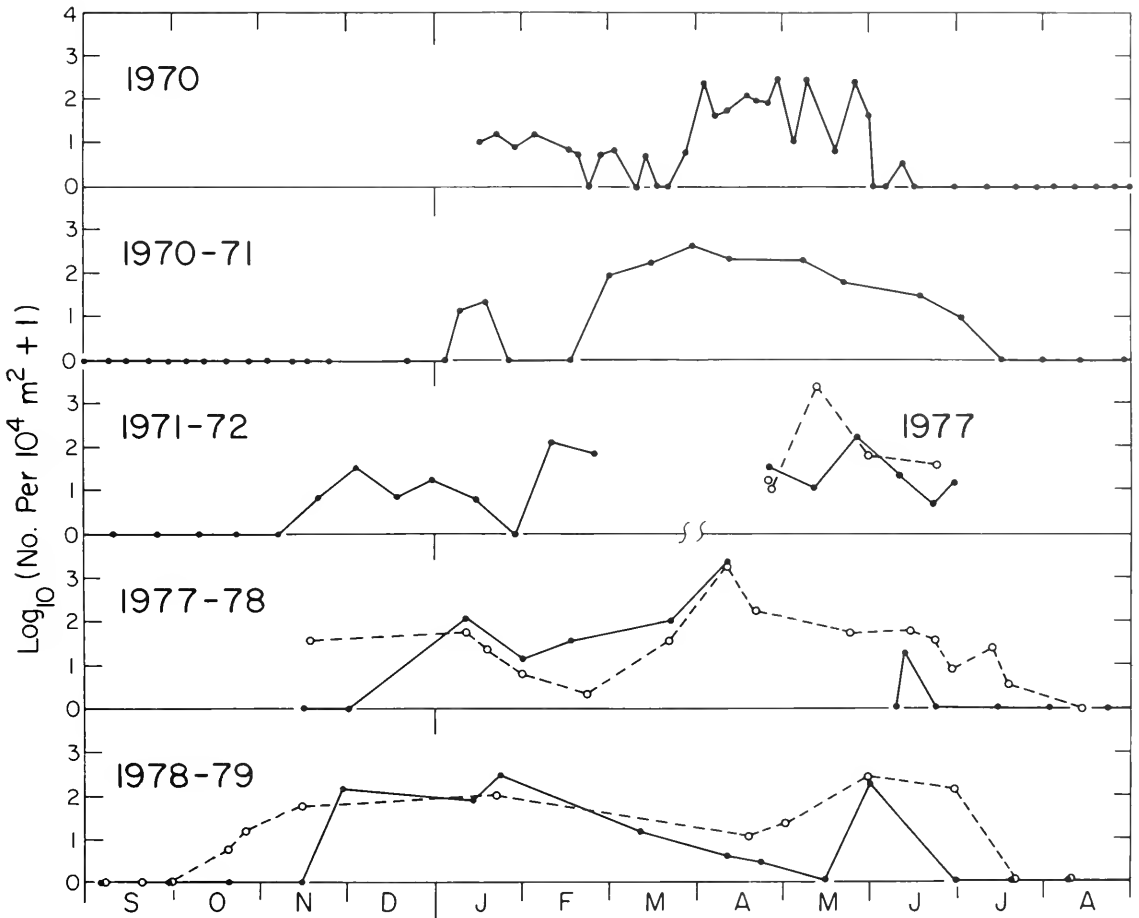

FIGURE 4.—Abundances of settling (<20 mm SL) English sole in Yaquina Bay for 1970-79 (solid line) and Moolack Beach for 1970-79 (dashed line).

occurred during March 1970, January and February 1971, 1972, and April-May 1979, suggesting seasonal variation in spawning activity of adults (see Kruse and Tyler 1983), mortality of planktonic stages, or movement of young into or out of the estuary.

Seasonal trends in catches of transforming English sole in Yaquina Bay and at Moolack Beach for 1978 and 1979 shows that fish  $\leq 20$  mm were found 1-2 mo earlier at Moolack Beach than in Yaquina Bay during both years (Fig. 4). Moreover,

continued at Moolack Beach from 18 to 50 d after settling fish were no longer found within the estuary. To our surprise, similar densities of settling fish were caught in both areas. Seasonal trends were sometimes similar, suggesting a common source of larvae and similar processes affecting variations in recruitment of metamorphosing fish at both the open-coast and estuarine areas.

The catches/m<sup>2</sup> of age groups 0 and I English sole (20-150 mm) are plotted as catch curves for each 5 mm size group (Fig. 5) where

$$\text{no. m}^2 = \frac{\sum \text{of the number of individuals in each 5 mm size group}}{\text{total area sampled in m}^2 \text{ during sampling periods in which year class occurred}}$$

recruitment of the 1978 and 1979 year classes con-

Trends in the abundance of English sole were often

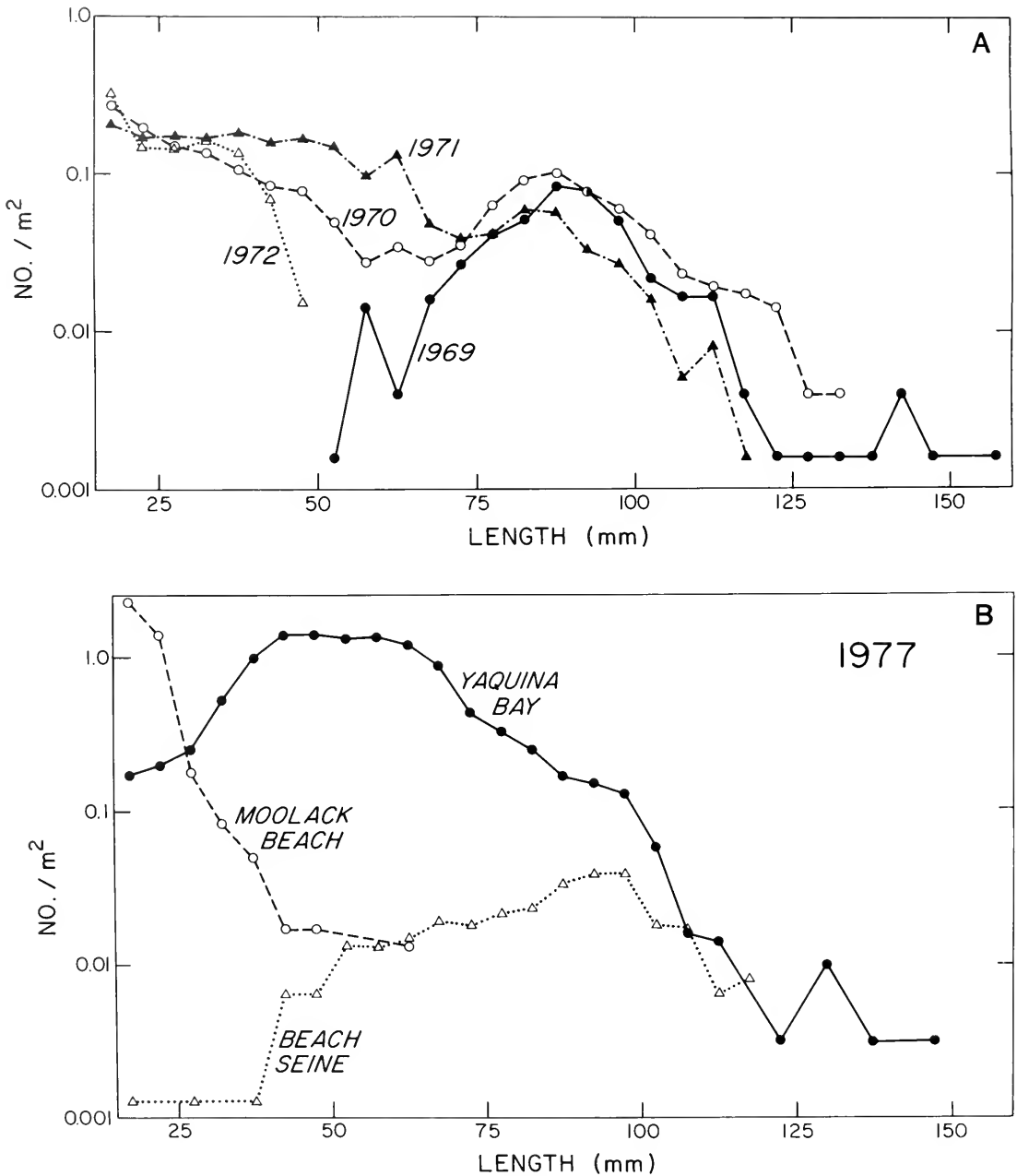
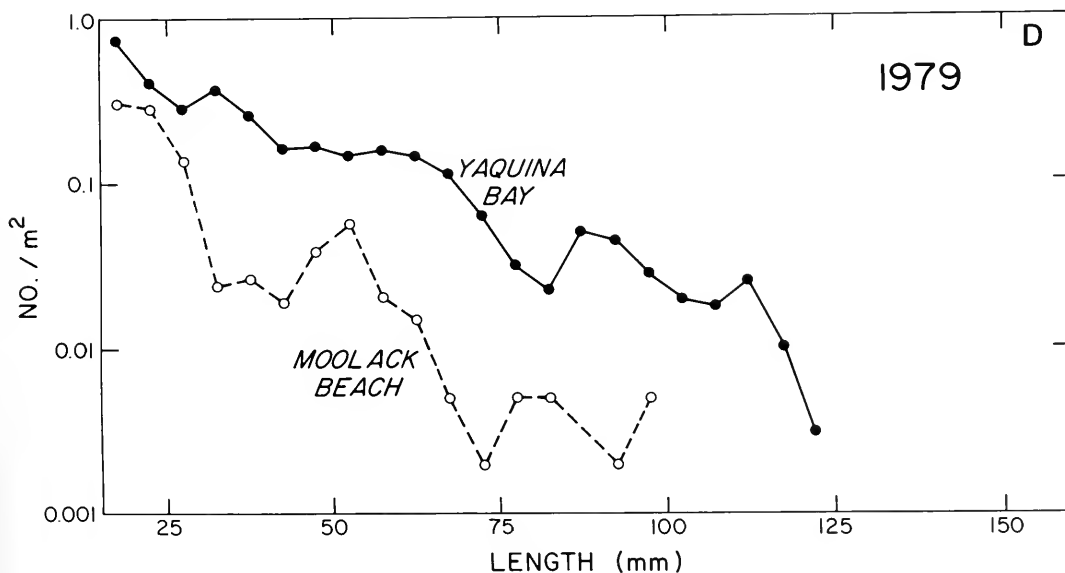
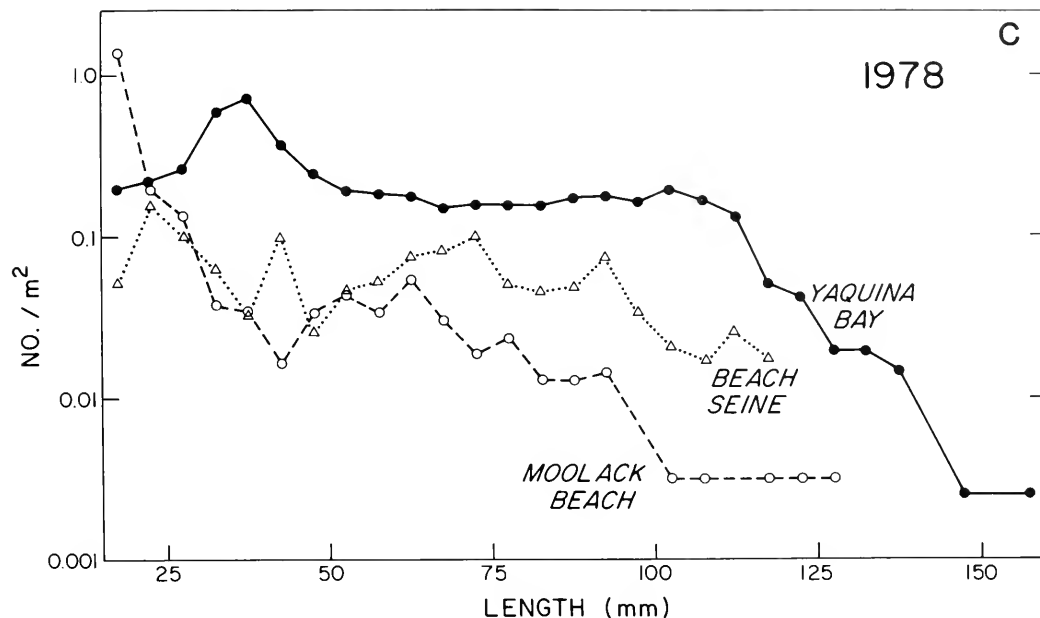

FIGURE 5.—Abundances of young English sole year classes as a function of length. (A) 1969-72, (B) 1977,

similar for the four year classes sampled between 1969 and 1972 in Yaquina Bay (Fig. 5A). Abundances of recently recruited individuals 20-45 mm in length were similar among the 1970, 1971, and 1972 year classes. The 1969, 1970, and 1971 year classes also increased in numbers/m<sup>2</sup> between 75 and 90 mm before declining to low catches at larger sizes. Abun-

dances of small fish of the 1969 year class are low because this year class was only sampled in 1970, when most fish were >75 mm.

Catches/m<sup>2</sup> of the 1977 and 1978 year classes in Yaquina Bay were generally larger than the 1969, 1970, 1971, 1972, and 1979 year classes (Fig. 5A, B, C). The 1977 cohort differed from other year



(C) 1978, (D) 1979 year classes. Note that some curves are based on incomplete sampling of all seasons.

classes by having a large peak of abundance for 30-70 mm individuals, and the 1978 year class had much higher abundance of large (100-140 mm) individuals than other year classes.

Obviously the trends shown by these catch curves cannot be explained by mortality alone. Immigration of young benthic English sole into our sampling area

of Yaquina Bay is suggested by the increased catches of 75-100 mm individuals of the 1970 and 1971 year classes and increased catches of 20 to 40-45 mm individuals of the 1978 and 1979 year classes.

Beam trawls catches at Moolack Beach for the 1977, 1978, and 1979 year classes and beach seine catches in Yaquina Bay for part of the 1977 year class

and the 1978 year class indicate that the abundance of newly recruited, settling fish (<24 mm) of the 1977 and 1978 year classes was higher at Moolack Beach than in Yaquina Bay (Fig. 5B, C). These high catches at Moolack Beach were followed by a steep decline in catches to the 41-44 mm size class. English sole larger than 30 mm were consistently less abundant at Moolack Beach than in Yaquina Bay. Densities increased in Yaquina Bay concurrent with the steep decline of 20-44 mm individuals at Moolack Beach. These trends suggest immigration of young fish from the shallow waters of the open coast to Yaquina Bay over a range of sizes, from 20 to 40 mm.

Two peaks occurred in the beach seine catches of the 1978 year class: at 20-25 and 40-45 mm. The first peak coincides with the sizes that decreased markedly in abundance at Moolack Beach. The second peak coincides with low abundance of 40-45 mm fish at Moolack, and with a decrease in catches of these sizes of fish at the trawl stations in Yaquina Bay. These trends of trawl-caught fish suggest that immigration from Moolack Beach first occurred to the shallow waters of the bay and then to the deeper trawl stations. The peak in the catches of 40-45 mm fish at seine stations may be caused by immigration into these shallower waters of metamorphosed individuals from either the offshore areas or deep areas of Yaquina Bay.

### Abundances and Sizes in Five Estuaries

Age-0 English sole were present in all five estuaries sampled with trawls during May and June 1978. The mean abundance of young English sole, which ranged from 0.7/m<sup>2</sup> in Tillamook Bay to 0.02/m<sup>2</sup> in the Umpqua estuary, generally decreased from the northern to the southern estuaries (Table 2). The exception was Yaquina Bay. It was latitudinally the middle estuary, yet abundance of English sole there ranked above that in Siletz Bay. No consistent relationship was observed between mean abundances and the area of estuaries, river flows, tidal prisms, or flushing times using the data of Choi (1975) or Starr (1979)<sup>7</sup>.

A broad size range of fish was caught in Tillamook, Siletz, and Alsea Bays, while we caught few individuals larger than 36 mm in the Umpqua River estuary (Table 3). In Yaquina Bay, a higher proportion of large individuals (>65 mm) was found than in the other estuaries. A much broader range of sizes

TABLE 2.—Mean abundance and standard deviation of 0-age English sole in five estuaries north and south of Yaquina Bay and along the open coast between 9 and 37 m, April-June 1978.

Location	Date: 1978	No. of hauls	No./m <sup>2</sup>	SD (s)
<b>Estuary</b>				
Tillamook Bay	8 May	21	0.715	0.916
Siletz Bay	9 May	21	0.184	0.206
Yaquina Bay	10 April; 12 July	6	0.332	0.251
Alsea Bay	10 May	21	0.059	0.075
Umpqua River estuary	12 May	19	0.016	0.037
<b>Ocean Off</b>				
Tillamook Bay	15 May; 17 June	12	0.005	0.013
Siletz Bay	16 May; 29 June	9	0.019	0.020
Alsea Bay	22, 29 June	3	0.001	0.001
Umpqua River estuary	28 June			
North of Newport	16, 23 May; 29 June	14	0.006	0.011
South of Newport	18 June	9	0.003	0.004

was captured in these estuaries than in open coastal areas on the dates sampled.

### Growth

Despite prolonged recruitment of young English sole in Yaquina Bay (Fig. 4) distinct length modes were usually present for each sampling date. Growth rates in Yaquina Bay, estimated by following the progression of length modes of cohorts over time, were generally greatest (0.46-0.49 mm/d) during the late spring to early fall, while growth rates in winter were lower (0.26-0.32 mm/d) (Table 4). The growth rate from January to July 1970 was 0.47 mm/d, similar to the spring-fall estimates. Growth rates were estimated only for the spring-fall period off Moolack Beach. These were similar to those for Yaquina Bay fish but more variable, ranging from 0.28 to 0.42 mm/d.

### DISCUSSION

Larvae of English sole are abundant in coastal waters off Oregon, ranking first among the flatfishes in some years (Richardson 1977<sup>8</sup>; Richardson and Pearcy 1977; Mundy 1984). Young larvae (<10 mm) of English sole are rare in estuaries of the Oregon-California coast as evidenced by plankton samples

<sup>7</sup>Starr, R. M. 1979. Natural resources of Siletz estuary. *Oreg. Dep. Fish Wildl., Estuary Inventory Rep.* 2(4):1-44.

<sup>8</sup>Richardson, S. L. 1977. Larval fishes in Ocean waters off Yaquina Bay, Oregon: Abundance, distribution and seasonality, January 1971 to August 1972. *Oreg. State Univ. Sea Grant Publ.* ORESU-F-77-003.



of only 6 larvae in 393 tows in Yaquina Bay (Pearcy and Myers 1974), 22 larvae in 84 tows in the lower Columbia River (Misitano 1977), and 4 larvae in 89 tows from Humboldt Bay (Eldridge 1970; Misitano 1970, 1976). However, young larvae are common in offshore collections (Porter 1964; Pearcy and Myers 1974; Laroche and Richardson 1979), and transforming larvae (19-22 mm) are frequent in collections from Humboldt Bay and the Columbia River estuary (Eldridge 1970; Misitano 1970, 1976). Thus young *P. vetulus* that enter estuarine nurseries do so as large transforming larvae or after completion of metamorphosis.

Our data confirm the above findings. We found that settlement of metamorphosing English sole to the bottom was common both in the Yaquina Bay

estuary and at Moolack Beach along the open coast. Transforming individuals along the coast were caught in largest numbers/m<sup>2</sup> at depths of 16 m or less, but they were also captured at the deepest stations sampled (Fig. 2). Since small larvae were rare in Yaquina Bay (Pearcy and Myers 1974), these trends suggest movement into the bay of transforming larval stages. Boehlert and Mundy (in prep.)<sup>9</sup> have subsequently confirmed that small juveniles as well as transforming larvae of English sole recruit to Yaquina Bay.

Although densities of transforming larvae were sometimes higher at Moolack Beach than in Yaquina Bay, densities of juvenile fish >30 mm were usually over an order of magnitude higher in Yaquina Bay than at Moolack Beach, indicating either immigra-

TABLE 3.—Length distribution of English sole caught in the five estuaries, Moolack Beach and grid stations, 10 April-12 June 1978.

Location	No. of fish	Standard lengths (mm)														
		14-20	21-25	26-30	31-35	36-40	41-45	46-50	51-55	56-60	61-65	66-70	71-75	76-80	81-85	86-90
Tillamook 8:V:78	2,979	904	1,619	296	48	19	23	26	31	13	4	4	2			
Tillamook 9:V:78																
Siletz Bay 10:V:78	673	242	256	72	36	13	13	21	14	5		1				
Alsea Bay 12:V:78	306	41	98	49	25	20	15	19	27	9	1		1			1
Umpqua River estuary 10:IV:78	54	30	12	5	4			1						1	1	
Yaquina Bay 12:VI:78	163	46	16	1	6	11	11	11	23	18	11	6	2	1		
Yaquina Bay 10:IV:78	156	2	6	9	9	18	6	6	12	17	23	18	16	8	3	3
Moolack Beach 12:VI:78	221	209	9	3												
Moolack Beach 23:V:78	24	5	12	5		1			1							
Offshore grid	47	42	5													

TABLE 4.—Growth of juvenile English sole estimated from modal progression of size-frequency histograms from catches in Yaquina Bay and Moolack Beach, 1970-79.

Area and date	mm/d (slope)	r <sup>2</sup>
Yaquina Bay		
Jan. 1970-July 1970	0.46	0.98
Dec. 1971-Feb. 1972	0.26	0.92
Jan. 1972-Feb. 1972	0.32	0.91
Jan. 1978-Apr. 1978	0.31	0.91
Apr. 1970-Oct. 1970	0.46	0.96
May 1971-Oct. 1971	0.47	0.98
Mar. 1979-Sept. 1979	0.49	0.96
Moolack Beach		
Aug. 1978-Oct. 1978	0.41	0.98
May 1978-Oct. 1978	0.28	0.93
Apr. 1979-Sept. 1979	0.38	0.96
May 1979-Aug. 1979	0.42	0.99
June 1979-Sept. 1979	0.36	1.00

tion into the bay from the open coast during or after metamorphosis, or dispersal or higher mortality rates of young along the open coast than in the estuary. Increasing densities in Yaquina Bay, concurrent with decreasing densities at Moolack Beach, suggest immigration into the bay over an extended range of sizes from 25 to 40 mm.

The mechanisms for such movements are not fully understood, but vertical movement of young fish off the bottom during periods of flood tide has been shown to effect transport into estuaries in several

<sup>9</sup>Boehlert, G. W., and B. C. Mundy. Recruitment dynamics of the English sole, *Parophrys vetulus*, to a west coast estuary. Unpubl. manusc., 16 p. Southwest Fisheries Center Honolulu Laboratory, National Marine Fisheries Service, NOAA, P.O. Box 3830, Honolulu, HI 96812.

flatfish species. Cruetzberg et al. (1978) suggested that immigration of plaice, *Pleuronectes platessa*, larvae is based on such a "selective tidal transport," and that starvation induces the swimming behavior resulting in transport by currents. De Veen (1978) concluded that juvenile sole (*Solea solea*) use tidal transport to enter the Wadden Sea in the spring. Metamorphosing larvae of the stone flounder, *Kareius bicoloratus*, also immigrate into estuarine nurseries with tidal currents; they were most abundant in plankton net collections during flood tides at night in an estuary of Sendai Bay, Japan (Tsurata 1978). Misitano (1976) captured metamorphosing English sole in a 1 m midwater trawl, especially after dark, in Humboldt Bay. Boehlert and Mundy (fn. 9) found that transforming English sole larvae were usually most abundant during flood tides at night in the moored plankton net that was nearest the bottom in the lower portion of the Yaquina Bay estuary and that recruitment to the bay was correlated with on-shore Ekman transport.

Our estimates of growth from modal progressions length-frequency histograms [averaging 0.40 mm/d ( $s = 0.10$ ) for Yaquina Bay and 0.37 mm/d ( $s = 0.06$ ) for Moolack Beach] were considerably higher than Rosenberg's (1982) estimates even for the same years (Table 4). Rosenberg studied growth of 0-age English sole using fortnightly otolith rings as an aging technique. He calculated that fish, 140-480 d of age, collected during 1978 and 1979 in Yaquina Bay and at Moolack Beach grew about 0.28 mm SL/d. Estimates of growth rates of juvenile English sole from length data by Westrheim (1955) in Yaquina Bay, as well as by Smith and Nitsos (1969) in Monterey Bay, and Van Cleve and El-Sayed (1969) and Kendall (1966) in Puget Sound were more similar to our estimates than those of Rosenberg (1982, table 2). The differences in apparent growth rates between length frequency and otolith measurements are difficult to explain. Avoidance of nets by larger sole (e.g., Kuipers 1975), emigration of larger fish out of the sampling area in the late summer, and prolonged immigration of small fish into the estuary, are likely. Any of these would result in an underestimates of growth by the length-frequency method (see Rosenberg 1982 for opposite explanations). Differential mortality of small fish (Rosenberg 1982) or methodological difficulties in analyzing otolith growth increments may also help explain the differences.

Our study confirms the observations of Laroche and Holton (1979) that small 0-age English sole are not found exclusively in estuaries along the Oregon coast, and that average sizes of English sole increase with depth at Moolack Beach. Laroche and Holton

(1979) suggested that even low density or localized utilization of the extensive unprotected offshore areas along the coast could be an important factor in determining the English sole production off Oregon. To evaluate this possibility, we determined total areas within the range of our sample depths in the lower reaches of the five estuaries and multiplied these areas by the average catch/m<sup>2</sup> of 0-age English sole (<90 mm) to obtain an estimate of total number of young English sole in each estuary. The average catch was also determined from 47 collections between 9 and 36 m where we found highest catches of 0-age fish, along 448 km of the open coast from our May-June catches (Table 2). The average catch/m<sup>2</sup> of 0-age sole in the five estuaries usually was many times that along the open coast. But because of the large differences in areas, the estimate for total abundance of 0-age sole during the May-June period on the open coast was about  $643 \times 10^5$ , considerably higher than the estimate for the five estuaries,  $140 \times 10^5$ . Most of the fish caught during this period, however, were transforming or recently metamorphosed juveniles that could have entered estuaries later in the year. This may in part explain the 17-fold decrease in average abundance of small sole along the open coast between 16-23 May ( $\bar{x} = 0.039$ ,  $n = 18$ ,  $s = 0.11$ ) and 28-29 June ( $\bar{x} = 0.002$ ,  $n = 29$ ,  $s = 0.004$ ) in the vicinity of Tillamook and Siletz Bays. Our estimate of total abundance along the coast in June is  $70 \times 10^5$ , about half the estimate for the five estuaries about a month and one-half earlier. Because of our small sample sizes, lack of sampling in some estuaries and open coast areas, and temporal differences (and associated mortality) among samples, these estimates must be considered crude. Nevertheless, they suggest that shallow waters of the open coast are important initial settling areas for English sole and that both estuaries and the open coast are nursery grounds for fully transformed 0-age sole.

We need data on the growth and survival from estuarine and open coastal areas to evaluate their importance as nursery grounds and to assess their relative contributions to the commercially harvested and spawning population. Olsen and Pratt (1973) used parasites as indicators of English sole nursery grounds. The incidence of *Echinorhynchus lageniformis*, an acanthocephalan that they considered was acquired only in estuaries, averaged 29.9% in 0-age English sole <117 mm SL captured in Yaquina Bay and 28.5% in 0-age fish collected offshore at depths of 10-80 m near the entrance of Yaquina Bay during November and December, a period after most 0-age fish had emigrated from the bay. They con-

cluded from these similar incidences of infection that there was no sizable influx of 0-age English sole to their offshore study area other than from estuarine nursery grounds. Their results imply that any 0-age fish that reside along the open coast during the spring and summer have much higher mortality rates than estuarine residents and do not contribute significantly to the offshore population of 0-age fish.

Growth rates of 0-age English sole from Moolack Beach and Yaquina Bay, however, do not support this hypothesis. They appear to be similar (Rosenberg 1982; Table 4). Our catch curves (Fig. 5C, D) also provide no evidence for grossly higher mortality rates at Moolack Beach. The total declines in abundances per m<sup>2</sup> are fairly similar for English sole 50-100 mm, presumably a size range that occurs after immigration into the estuary but before emigration of larger sizes out of the estuary in the fall.

The fact that 0-age English sole immigrate from offshore into estuaries where they are found in high concentrations suggests that this behavior is adaptive. Standing stocks and productivity of small benthic food organisms are undoubtedly higher in estuaries than along the open coast, but because of the higher concentrations of young flounder in Yaquina Bay than Moolack Beach (Fig. 5), competition for food probably results in similar growth rates in these two habitats. The rapid decreases in the estuarine densities of 0-age English sole during the fall and winter months are evidence of emigration out of estuaries to offshore areas. In Yaquina Bay, we found a decrease in density of 0-age fish in the late fall as well as a decrease in average size at this time. Frequently age-0 (20-55 mm) and age-I (75-115 mm) fish were both present in the winter, with the age-I fish disappearing entirely from catches in the spring. Westrheim (1955) and Olsen and Pratt (1973) also found decreases in catch per effort and average sizes of young English sole that indicated definite emigration from Yaquina Bay after October. Forsberg et al. (1975)<sup>10</sup> reported emigration of English sole from Tillamook Bay in early fall with few individuals remaining in November.

According to Bayer (1981), small English sole were common at intertidal stations in Yaquina Bay most of the year, but they were absent during November and were less common during other fall months. Toole (1980) also found that English sole disappeared from intertidal areas in early fall at an average size of 68 mm SL and subsequently resided in subtidal

channels until they were about 120 mm SL in Humboldt Bay. He associated these different distributions with changes in feeding habits, and possibly with a reduction in intraspecific competition among small and large 0-age English sole. Indeed, emigration out of bays and estuaries in the fall may be related to limitations in the carrying capacity for high densities and standing stocks of young English sole.

We conclude that estuarine and offshore nursery grounds combine to significantly increase the survival and total population size of 0-age fish. Utilization of these two diverse habitats may also improve the chances for good survival of young fish from at least one habitat even when adverse conditions affect the other.

## LITERATURE CITED

- AHLSTROM, E. H., AND H. G. MOSER.  
1975. Distributional atlas of fish larvae in the California Current region: flatfishes, 1955 through 1960. Calif. Coop. Oceanic Fish. Invest., Atlas 23:1-207.
- ALDERICE, D. F., AND C. R. FORRESTER.  
1968. Some effects of salinity and temperature on early development and survival of the English sole (*Parophrys vetulus*). J. Fish. Res. Board Can. 25:495-521.
- BAYER, R. D.  
1981. Shallow-water intertidal ichthyofauna of the Yaquina estuary, Oregon. Northwest Sci. 55:182-193.
- BUDD, P. L.  
1940. Development of the eggs and early larvae of six California fishes. Calif. Dep. Fish Game, Fish Bull. 56, 53 p.
- CAREY, A. G., JR., AND H. HEYOMOTO.  
1972. Techniques and equipment for sampling benthic organisms. In A. T. Pruter and D. L. Alverson (editors), The Columbia River estuary and adjacent ocean waters, bioenvironmental studies, p. 378-408. Univ. Wash. Press, Seattle.
- CHOI, B.  
1975. Pollution and tidal flushing predictions for Oregon's estuaries. M.S. Thesis, Oregon State Univ., Corvallis, 163 p.
- CREUTZBERG, F., A. TH. G. W. ELTINK, AND G. J. VAN NOORT.  
1978. The migration of plaice larvae, *Pleuronectes platessa*, into the western Wadden Sea. In D. S. McLusky and A. J. Berry (editors), Physiology and behavior of marine organisms, p. 243-252. Proc. 12th Eur. Symp. Mar. Biol., Stirling, Scotl. Pergamon Press, N.Y.
- DEMORY, R. L.  
1971. Depth distribution of some small flatfishes off the northern Oregon-southern Washington coast. Res. Rep. Fish. Comm. Oreg. 3:44-48.
- DE VEEN, J. F.  
1978. On selective tidal transport in the migration of North Sea plaice (*Pleuronectes platessa*) and other flatfish species. Neth. J. Sea Res. 12:112-147.
- ELDRIDGE, M.  
1970. Larval fish survey of Humboldt Bay. M.S. Thesis, Humboldt State Coll., Arcata, 52 p.
- FORRESTER, C. R.  
1969. Results of English sole tagging in British Columbia waters. Pac. Mar. Fish. Comm. Bull. 7:1-10.
- HARRY, G. Y., JR.  
1959. Time of spawning, length at maturity, and fecundity of

<sup>10</sup>Forsberg, B. O., J. A. Johnson, and S. M. Klug. 1975. Identification and notes on food habits of fish and shellfish in Tillamook Bay, Oreg. Fish Comm. Oreg. Contract Rep., 85 p.

- the English, petrale, and Dover soles (*Parophrys vetulus*, *Eopsetta jordani*, and *Microstomus pacificus*, respectively). Oreg. Fish Comm., Res. Briefs 7(1):5-13.
- HART, J. L.  
1973. Pacific fishes of Canada. Fish. Res. Board Can. Bull. 80, 740 p.
- HEWITT, G. R.  
1980. Seasonal changes in English sole distributions: An analysis of the inshore trawl fishery off Oregon. M.S. Thesis, Oregon State Univ., Corvallis, 59 p.
- JOW, T.  
1969. Results of English sole tagging off California. Pac. Mar. Fish. Comm. Bull. 7:15-33.
- KENDALL, A. W., JR.  
1966. Sampling juvenile fishes on some sandy beaches of Puget Sound, Washington. M.S. Thesis, Univ. Washington, Seattle, 77 p.
- KETCHEN, K. S.  
1947. Studies on lemon sole development and egg production. Fish. Res. Board Can., Prog. Rep. Pac. 73:68-70.  
1956. Factors influencing the survival of the lemon sole (*Parophrys vetulus*) in Hecate Strait, British Columbia. J. Fish. Res. Board Can. 13:647-694.
- KRUSE, G. H., AND A. V. TYLER.  
1983. Simulation of temperature and upwelling effects on the English sole (*Parophrys vetulus*) spawning season. Can. J. Fish. Aquat. Sci. 40:230-237.
- KRYGIER, E. E., AND H. F. HORTON.  
1975. Distribution, reproduction, and growth of *Crangon nigricauda* and *Crangon franciscorum* in Yaquina Bay, Oregon. Northwest Sci. 49:216-240.
- KUIPERS, B.  
1975. On the efficiency of a two-meter beam trawl for juvenile plaice (*Pleuronectes platessa*). Neth. J. Sea Res. 9:69-85.
- LAROCHE, J. L., AND S. L. RICHARDSON.  
1979. Winter-spring abundance of larval English sole, *Parophrys vetulus*, between the Columbia River and Cape Blanco, Oregon during 1972-75 with notes on occurrences of three other pleuronectids. Estuarine Coastal Mar. Sci. 8:455-476.
- LAROCHE, J. L., S. L. RICHARDSON, AND A. A. ROSENBERG.  
1982. Age and growth of a pleuronectid, *Parophrys vetulus*, during the pelagic larval period in Oregon coastal waters. Fish. Bull., U.S. 80:93-104.
- LAROCHE, W. A., AND R. L. HOLTON.  
1979. Occurrence of 0-age English sole, *Parophrys vetulus*, along the Oregon coast: An open coast nursery area? Northwest Sci. 53:94-96.
- MISITANO, D. A.  
1970. Aspects of the early life history of English sole (*Parophrys vetulus*) in Humboldt Bay, California. M.S. Thesis, Humboldt State Coll., Arcata, 57 p.  
1976. Size and stage of development of larval English sole, *Parophrys vetulus*, at time of entry into Humboldt Bay. Calif. Fish Game 62:93-98.  
1977. Species composition and relative abundance of larval and post-larval fishes in the Columbia River estuary, 1973. Fish. Bull., U.S. 75:218-222.
- MUNDY, B. C.  
1984. Yearly variation in the abundance and distribution of fish larvae in the coastal upwelling zone off Yaquina Head, Oregon from June 1969 to August 1972. M.S. Thesis, Oregon State Univ., Corvallis, 158 p.
- MYERS, K. W. W.  
1980. An investigation of the utilization of four study areas in Yaquina Bay, Oregon, by hatchery and wild juvenile salmonids. M.S. Thesis, Oregon State Univ., Corvallis, 234 p.
- OLSEN, R. E., AND I. PRATT.  
1973. Parasites as indicators of English sole (*Parophrys vetulus*) nursery grounds. Trans. Am. Fish. Soc. 102:405-411.
- PATTIE, B. H.  
1969. Dispersal of English sole, *Parophrys vetulus*, tagged off the Washington coast in 1956. Pac. Mar. Fish. Comm. Bull. 7:11-14.
- PEARCY, W. G., AND S. S. MYERS.  
1974. Larval fishes of Yaquina Bay, Oregon: A nursery ground for marine fishes? Fish. Bull., U.S. 72:201-213.
- PORTER, P.  
1964. Notes on fecundity, spawning and early life history of petrale sole (*Eopsetta jordani*) with descriptions of flatfish larvae collected in the Pacific Ocean off Humboldt Bay, California. M.S. Thesis, Humboldt State Coll., Arcata, 98 p.
- RICHARDSON, S. L., AND W. G. PEARCY.  
1977. Coastal and oceanic fish larvae in an area of upwelling off Yaquina Bay, Oregon. Fish. Bull., U.S. 75:125-145.
- ROSENBERG, A. A.  
1982. Growth of juvenile English sole, *Parophrys vetulus*, in estuarine and open coastal nursery grounds. Fish. Bull., U.S. 80:245-252.
- ROSENBERG, A. A., AND J. L. LAROCHE.  
1982. Growth during metamorphosis of English sole, *Parophrys vetulus*. Fish. Bull., U.S. 80:150-153.
- SIMS, C. W., AND R. H. JOHNSON.  
1974. Variable-mesh beach seine for sampling juvenile salmon in Columbia River estuary. Mar. Fish. Rev. 36(2):23-26.
- SMITH, J. G., AND R. J. NITSOS.  
1969. Age and growth studies of English sole, *Parophrys vetulus*, in Monterey Bay, California. Pac. Mar. Fish. Comm. Bull. 7:73-79.
- TATE, M. W., AND R. C. CLELLAND.  
1957. Nonparametric and shortcut statistics in the social, biological, and medical sciences. Interstate Printers and Publishers Inc., Danville, IL, 171 p.
- TOOLE, C. L.  
1980. Intertidal recruitment and feeding in relation to optimal utilization of nursery areas by juvenile English sole (*Parophrys vetulus*: Pleuronectidae). Environ. Biol. Fishes 5: 383-390.
- TSURUTA, Y.  
1978. Field observations on the immigration of larval stone flounder into the nursery ground. Tohoku J. Agric. Res. 29: 136-145.
- VAN CLEVE, R., AND S. Z. EL-SAYED.  
1969. Age, growth, and productivity of an English sole (*Parophrys vetulus*) population in Puget Sound, Washington. Pac. Mar. Fish. Comm. Bull. 7:51-71.
- WESTRHEIM, S. J.  
1955. Size composition, growth and seasonal abundance of juvenile English sole (*Parophrys vetulus*) in Yaquina Bay. Oreg. Fish. Comm. Res. Briefs 6(2):4-9.

# ORGANIC AND TRACE METAL LEVELS IN OCEAN QUAHOG, *ARCTICA ISLANDICA* LINNÉ, FROM THE NORTHWESTERN ATLANTIC

FRANK W. STEIMLE,<sup>1</sup> PAUL D. BOEHM,<sup>2</sup> VINCENT S. ZDANOWICZ,<sup>1</sup>  
AND RALPH A. BRUNO<sup>1</sup>

## ABSTRACT

Chemical contamination of biological resources is an important problem for resource managers. This study reports on body burden levels of several contaminants of concern: polychlorinated biphenyls (PCB), polynuclear aromatic hydrocarbons (PAH) of both petroleum and combustion sources, total petroleum hydrocarbons, and seven trace metals (Ag, Cd, Cr, Cu, Ni, Pb, and Zn) in a resource species, the ocean quahog, collected between Virginia and Nova Scotia. Organic and trace metal contaminants were detected, at low levels, in all samples examined, with highest levels being generally found in samples from the inner New York Bight and Rhode Island Sound. The highest PCB and PAH values were 27 and 55 ppb, respectively; Ag, Cd, and Cr values were generally <5 µg/g dry weight; Cu, Ni, and Pb generally <15 µg/g dry weight with a few exceptions; and Zn ranged from 50 to 153 µg/g dry weight.

The ocean quahog, *Arctica islandica* Linné, is a large, bivalve mollusc found on both sides of the North Atlantic. In the northwestern Atlantic, it occurs from just north of Cape Hatteras, NC, to Newfoundland, Nova Scotia, being most abundant on the middle to outer continental shelf at depths between about 30 and 150 m (Merrill et al. 1969). The species is edible and some commercial harvesting has occurred since 1943 in the Rhode Island area; however, intensive fishing for this species did not begin until the 1970s when surf clam, *Spisula solidissima* (Dillwyn), stocks, an inshore species, were drastically reduced by overfishing (Ropes 1979).

*Arctica islandica* generally inhabit silty sand sediments of the middle to outer continental shelf that are less influenced by waves and strong currents than shallower areas. Areas of silty sand are thought to be at least partially depositional in nature, i.e., fine organic-rich particles tend to accumulate. It is generally agreed that many chemical pollutants, introduced to the marine environment via impacted estuaries and coastal areas, ocean dumping, and atmospheric sources, often are bound to and associated with fine organic and inorganic particle aggregates, both in the water column and at the sediment surface. These aggregates ultimately can accumulate in these natural depositional areas as the results of some recent studies show that contaminants ap-

parently are accumulating in silty areas relatively remote from most possible sources, e.g., organic contaminants found south of Cape Cod, MA, in the middle to outer continental shelf (Boehm 1983a). Some authors have also reported a trend of increasing sediment trace metal levels with depth on the Middle Atlantic shelf (Harris et al. 1977), but the specific sources of these contaminants are still unknown.

Because *A. islandica* is a common, sedentary, long-lived (Thompson et al. 1980) inhabitant of these silty sands that frequently contain higher levels of contaminants than coarser sands, the species may be particularly susceptible to contamination. Wenzloff et al. (1979) reported "greater average concentration of silver, arsenic, cadmium, copper, and zinc . . . in ocean quahogs than in surf clams" for the Middle Atlantic. Surf clams are generally found in shallower, medium sand areas. Thus, *A. islandica* may be a good offshore "indicator" species to monitor for trends in marine chemical pollution. Although some studies on contaminant body burdens of *A. islandica* have been reported (ERCO 1978<sup>3</sup>; Sick 1978, 1981; Wenzloff et al. 1979; Reynolds 1979; Payne et al. 1982), these studies have been limited generally to a particular restricted area, have not examined both types of contaminants or only a few components of each contaminant class, or have examined only certain tissues, not whole body levels.

The present study provides body burden data over

<sup>1</sup>Northeast Fisheries Center Sandy Hook Laboratory, National Marine Fisheries Service, NOAA, Highlands, NJ 07732.

<sup>2</sup>Battelle, New England Marine Research Laboratory, 397 Washington Street, Duxbury, MA 02332.

<sup>3</sup>ERCO (Energy Resources Company). 1978. New England OCS Environmental Benchmark. Draft Final Rep., Vol. II, to U.S. Dep. Inter., Bur. Land Manage, Miner. Manage Serv., 628 p.

a wide range of this species' occurrence in the northwestern Atlantic and includes information on organic, i.e., polychlorinated biphenyls (PCB), polynuclear aromatic hydrocarbons (PAH) from combustion and petroleum sources, and bulk levels of the petroleum hydrocarbon (PHC) class, and seven trace metal contaminants. The study includes the first known set of PCB data for this species.

## MATERIALS AND METHODS

Ocean quahog samples were obtained at random stations from wide areas on the continental shelf of the northwestern Atlantic (Fig. 1). These were collected from annual, summer hydraulic dredge shellfish surveys of NOAA's Northeast Fisheries Center from 1981 and 1982. At most stations, 10-12 medium-sized clams were selected, as available. Half of the collection was prepared for organic analysis by wrapping them in aluminum foil that had been prewashed with spectral grade acetone followed by dichloromethane; the remaining half for trace metals were placed in polyethylene plastic bags. All were quickly frozen at  $-20^{\circ}\text{C}$ . In certain areas where there were not sufficient samples at a particular station to provide material for both organics and trace metal analyses, samples were collected at a nearby station, with similar environmental characteristics, to complete the collection for the area. These paired station samples were not intermixed.

### Chemical Analysis - Organics

In the laboratory, the thawed whole meats of each of the five or six individual clams in each station sample were removed from the shells, pooled, and homogenized in a high-speed blender. A 100 g (wet weight) aliquot was removed from the homogenate and processed according to the extraction, fractionation, and analytical methodology described by Warner (1976), as modified by Boehm et al. (1982). After aqueous caustic (0.5N KOH) digestion of the tissue for 12 h, the digestate was back-extracted three times with hexane. The hexane extract was concentrated by rotary evaporation, then fractionated on a 5% deactivated alumina/activated silica gel column. The first eluting fraction from the alumina/silica column ( $f_1$ ) contained the saturated PHC; the second fraction ( $f_2$ ) contained the PCB and PAH. Quantitation procedures closely followed those by Boehm (1983b). PHC factors were quantified using the internal standard method whereby all peaks are quantified relative to androstane in the  $f_1$  fraction and 0-terphenyl in the  $f_2$  fraction.

PCBs were quantified relative to the internal standard tetrazene (2, 3, 5, 6 tetrachloronitrobenzene). The average relative response factors of two or three isomers in each of the di-, tri-, tetra-, penta-, hexa-, hepta- and octachlorobiphenyls groups were applied to the sum of the peaks in each grouping. Thus, PCBs were quantified by isomer group rather than according to the Aroclor<sup>4</sup>-type quantification (Duinker et al. 1980, 1983; Boehm 1983b). PHCs were determined by the total of  $f_1$  and  $f_2$  fractions, as analyzed by high resolution (fused silica capillary) gas chromatography with flame ionization detection (GC<sup>2</sup>/FID). A Hewlett Packard model 5840A gas chromatograph was used for all GC<sup>2</sup> determinations. A 30 m fused silica SE-30 (0.25 mm i.d.; J and W Scientific) column was used to analyze the saturated hydrocarbon ( $f_1$ ) fraction. A 30 m SE-52 fused silica column was used to analyze the aromatic/olefinic ( $f_2$ ) fraction by GC<sup>2</sup>/FID and the same fraction by gas chromatograph/mass spectrometer (GC/MS) (see below). The  $f_2$  fractions were analyzed by GC<sup>2</sup>/ECD (electron capture detection) to obtain the PCB concentrations. PCBs were analyzed on a 30 m SE-52 fused silica column. The  $f_2$  fraction was also analyzed by a Finnegan MAT model 4530 computer-assisted GC/MS system for PAH determinations. GC/MS conditions were as follows: ionization voltage, 70 eV; electron multiplier voltage 2,000 volts; scan conditions 45-450 amu at 400 amu/s.

### Chemical Analysis - Trace Metals

Whole clams, 5 or 6 per station, were thawed, and the whole body removed from the shells. Each individual clam was weighed in Pyrex beakers and dried for 16-20 h at  $105^{\circ}\text{C}$ . Twenty mL of 70% trace metal grade nitric acid were added to each beaker, which was covered with a Pyrex watch glass and heated ( $70^{\circ}$ - $75^{\circ}\text{C}$ ) on a ceramic hot plate until dry. After cooling to room temperature, another 20 mL of concentrated nitric acid were added and the dissolution continued. After 3 or 4 repeated acid additions and evaporations, 10 mL of 30% hydrogen peroxide were added, the solutions evaporated to near dryness and removed from the heat. When cooled, samples were filtered through Whatman #4 filter paper and brought to a final volume of 25 mL in a Pyrex glass-stoppered graduated cylinder by adding 5% (w/v) nitric acid. Analysis was performed on a Perkin Elmer model 5000 atomic absorption (AA) spectrophotometer employing an air-acetylene flame and conven-

<sup>4</sup>Reference to trade names does not imply endorsement by the National Marine Fisheries Service, NOAA.

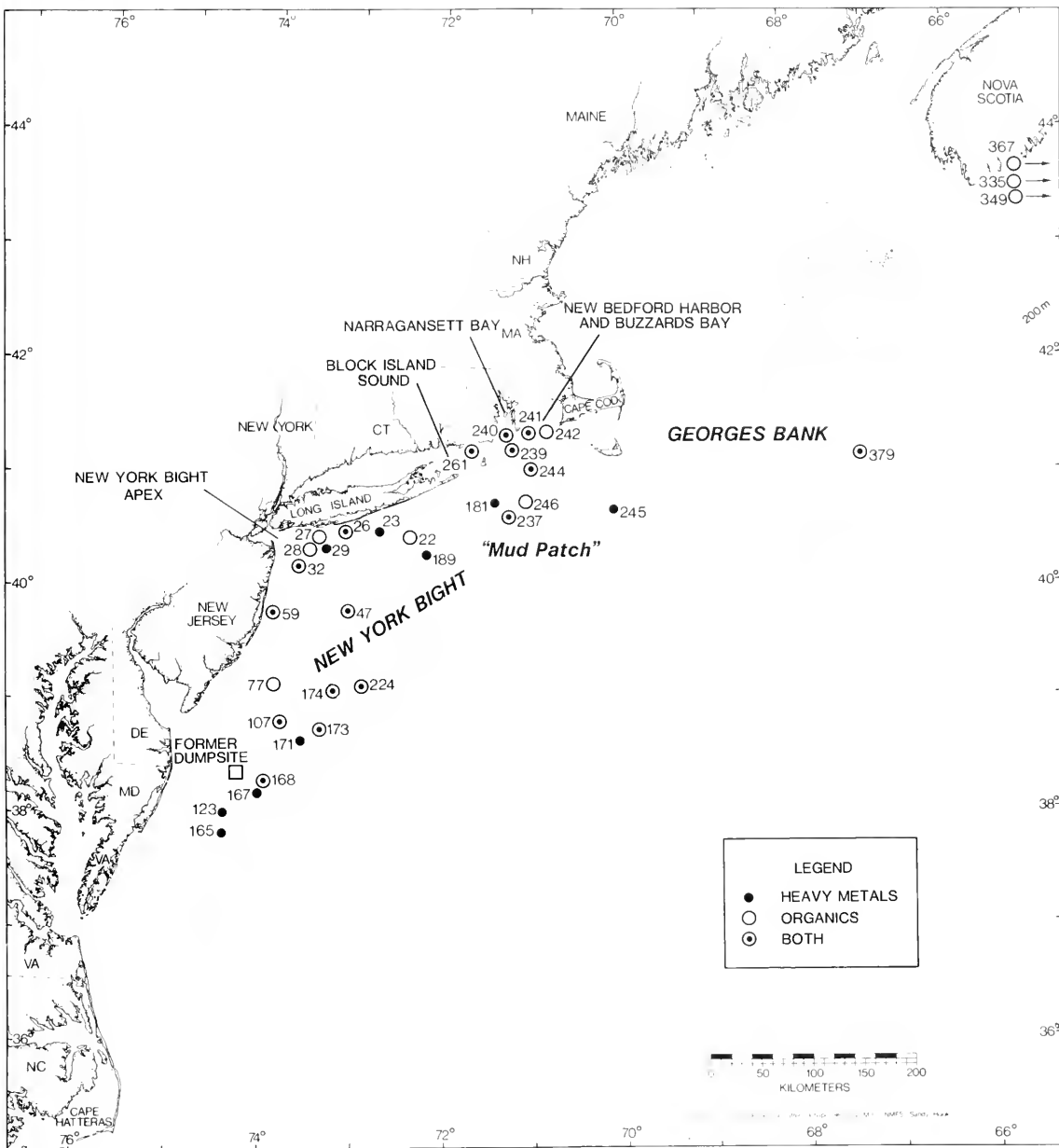

FIGURE 1.—Station locations' collections of *Aretica islandica*. Stations 367, 335 and 349 are on the Scotian Shelf at the following coordinates: Station 367 (lat.  $43^{\circ}44'N$ , long.  $61^{\circ}08'W$ ), Station 335 ( $43^{\circ}25'N$ ,  $61^{\circ}42'W$ ) and Station 349 ( $43^{\circ}21'N$ ,  $61^{\circ}23'W$ ).

tional AA techniques. Reagent blanks were carried through the same procedure. All reagents used were of trace metal analytical grade. Deionized water was of 18 megohm purity. The National Bureau of Standards (NBS) SRM 1566, freeze-dried oyster homogenate, was used as the tissue standard. Recoveries were at least 80% of this standard in all cases.

## RESULTS

The analytical results for organic contaminants are presented in Tables 1 (PHC and PCB) and 2 (PAH). PHC values are given as total saturated and aromatic hydrocarbons as determined by GC<sup>2</sup>. PCB values are given as total tri-, tetra-, penta-, hexa-, and hepta-

TABLE 1.—PHC (petroleum hydrocarbon) and PCB (polychlorinated biphenyl) levels in northwestern Atlantic *Arctica islandica*.

Area and station	PHC ( $\mu\text{g/g}$ wet weight)			PCB (ng/g wet weight)					
	Saturated	Aromatic	Total	Cl <sub>3</sub>	Cl <sub>4</sub>	Cl <sub>5</sub>	Cl <sub>6</sub>	Cl <sub>7</sub>	Total
Inshore New York Bight									
22	0.2	1.3	1.5	4.8	5.1	1.6	4.4	0.2	16.1
26	6.0	0.9	6.9	0.4	0.3	0.2	0.5	0.1	1.5
27	0.4	0.8	1.2	7.2	2.8	1.6	1.8	<0.1	13.4
28	0.2	0.9	1.1	6.7	4.2	2.6	6.5	0.1	20.2
32	3.2	4.1	7.3	5.4	5.1	4.1	10.7	0.7	26.8
47	<0.1	0.2	0.2	1.1	0.4	0.1	0.3	—	1.9
59	3.1	1.5	4.6	3.4	3.6	3.0	5.7	0.5	16.4
Offshore NJ-VA									
77	1.7	0.7	2.4	5.6	1.2	2.9	2.3	0.3	12.2
107	0.2	0.8	1.0	8.0	1.7	0.8	2.8	0.2	13.3
168	0.2	1.1	1.3	2.3	1.3	1.0	3.5	0.5	8.5
173	0.4	0.5	0.9	4.4	4.5	1.3	3.4	—	14.0
174	1.0	0.3	1.3	2.6	0.8	0.4	1.5	<0.1	5.5
224	1.7	0.2	1.9	2.3	1.5	0.5	0.5	<0.1	4.9
Inshore S. New England									
237	0.1	0.8	0.9	1.0	0.6	<0.1	<0.1	—	1.7
246	1.2	0.4	1.6	2.0	2.8	2.2	1.5	—	8.5
244	2.2	1.3	3.5	4.9	9.5	2.3	3.8	—	20.4
261	2.0	0.4	2.4	3.4	3.5	2.1	3.1	<0.1	12.1
239	2.9	1.1	4.0	1.4	2.1	1.6	1.9	<0.1	7.0
240	2.8	0.9	3.7	2.2	2.6	2.7	3.5	<0.1	11.0
241	2.3	1.6	3.9	4.1	6.6	6.2	6.3	0.2	23.2
242	1.9	1.8	3.7	2.9	4.6	5.9	6.5	0.2	20.1
Georges Bank									
379	0.8	1.1	1.9	0.7	1.2	0.9	1.0	<0.1	3.8
Scotian Shelf									
367	0.6	0.2	0.8	0.8	0.5	0.4	0.3	0.3	2.2
335	1.1	0.1	1.2	0.9	0.4	0.5	2.3	0.1	4.2
349	4.5	0.6	5.1	0.8	0.9	0.4	0.1	—	2.2

chlorobiphenyls (Cl<sub>3</sub>-Cl<sub>7</sub>), as well as total PCB. PAH values are presented as individual compounds (e.g., naphthalene) or as homologous series ( $\Sigma$ N). Table 3 lists the mean trace metal concentrations and standard deviations; data are presented on a dry weight basis to simplify comparisons with other studies.

## DISCUSSION

PCB levels observed in this survey ranged from 2 to 30 ng/g (ppb) wet weight (Table 1). These values are in general agreement with other data reported for PCB levels in other coastal bivalves (Giam et al. 1976; Goldberg 1978; Gadbois 1982), but are lower than those (to 400 ppb) reported for estuarine species (Goldberg 1978; MacLeod et al. 1981; O'Connor et al. 1982; ERCO 1983). However, we have found little data on PCB levels in offshore molluscs nor any other data on PCB levels in *A. islandica* for comparison. None of the *A. islandica* levels approach the current 2 ppm (= 2,000 ppb) U.S. Food and Drug Administration (FDA) "seafood action limit" for human consumption.

In spite of the wide geographical range sampled, PCB levels were relatively uniform with only an

order of magnitude difference between the high and low values. Clearly the Georges Bank (station 379) and remote Nova Scotia (stations 367, 335, 349) ocean quahogs were minimally contaminated, with their levels (2-5 ppb) reflecting the global PCB transport phenomena. The ocean quahogs in the nearshore New York Bight, Rhode Island Sound, and Buzzards Bay were more contaminated, with values up to 25 ppb. It is not surprising as previous biogeochemical studies in the western North Atlantic have clearly shown that several major urban pollutant sources influence the nearshore environment. For example, inputs of PCBs are specifically known to occur in the New York Bight, from estuarine fluxes and via direct ocean dumping (Boehm 1983b) and in Buzzards Bay, MA, from industrial inputs to the New Bedford Harbor region (Weaver 1982). Somewhat surprising were the elevated levels at some stations on the outer New Jersey shelf (12-16 ppb) and in the Hudson Canyon area (20 ppb). Offshore transport of PCB material towards these stations via riverine fluxes followed by southerly transport along the New Jersey shore and down-canyon transport of ocean-dumped material are possible modes of transport to these stations (Boehm 1983b).



TABLE 2.—PAH (polynuclear aromatic hydrocarbon) levels in northwestern Atlantic *Arctica islandica* (ng/g wet weight).

Area and station	N	ΣN	P	ΣP	ΣDBT	ΣF	Σ202	Σ228	Σ252	B(a)P	ΣPAH	PPI <sup>1</sup>
Inshore New York Bight												
22	nd	nd	4.0	11.9	2.0	1.2	5.5	1.1	<1	<1	23	40
26	nd	nd	1.1	1.1	nd	nd	1.1	nd	nd	nd	3.3	0
27	1.0	4.5	2.1	9.1	2.7	1.2	2.7	<1	<1	nd	22	54
28	9.1	12.0	1.3	5.2	<1	nd	1.8	nd	nd	nd	20	72
32	nd	nd	3.9	12.4	nd	nd	11.1	14.1	17.3	6.0	55	7
47	4.3	5.1	2.9	2.9	nd	nd	3.1	3.0	4.0	2.0	18	28
59	1.0	5.3	1.0	11.5	<1	nd	1.5	<1	nd	nd	20	77
Offshore NJ-VA												
77	<1	3.7	3.3	9.2	<1	1.0	2.4	<1	nd	nd	18	65
107	<1	6.7	2.5	10.0	2.5	3.5	1.5	<1	<1	nd	26	77
168	nd	nd	1.8	1.8	nd	nd	2.4	nd	nd	nd	4.2	0
173	1.3	5.9	1.8	6.2	1.3	2.0	2.3	<1	nd	nd	19	72
174	<1	4.0	1.0	5.0	<1	nd	4.0	1.0	1.0	nd	16	56
224	1.4	6.1	2.0	7.8	2.1	1.5	1.3	<1	<1	<1	21	74
Mud Patch												
237	<1	<1	2.8	5.0	<1	nd	5.7	3.7	5.4	2.5	19	31
246	nd	11.9	2.2	11.5	1.0	1.3	3.3	nd	nd	nd	29	81
Inshore S. New England												
244	nd	nd	nd	nd	2.4	nd	1.7	<1	<1	<1	6.1	39
261	nd	nd	3.6	9.2	<1	<1	3.3	nd	nd	nd	15	51
239	nd	nd	1.6	1.9	nd	nd	2.9	<1	1.2	<1	7.0	4
240	<1	3.3	1.8	5.6	<1	<1	2.8	<1	<1	<1	16	51
241	nd	nd	nd	5.0	nd	nd	4.0	1.0	1.0	<1	12	42
242	nd	nd	<1	<1	nd	nd	1.5	nd	nd	nd	2.5	40
Georges Bank												
379	nd	nd	<1	<1	nd	nd	<1	nd	nd	nd	<1	0
Scotian Shelf												
367	1.0	1.0	1.5	1.5	nd	nd	1.1	nd	nd	nd	3.6	28
335	nd	nd	nd	nd	nd	nd	nd	nd	nd	nd	nd	0
349	4.3	5.1	2.9	2.9	nd	nd	3.1	3.0	4.0	2.0	18	28

Wet weight concentrations = dry weight concentration × 7.

N = naphthalene.

ΣN = total naphthalenes (C<sub>10</sub>-C<sub>14</sub>).

P = phenanthrene.

ΣP = total phenanthrenes (C<sub>10</sub>-C<sub>14</sub>).ΣDBT = total dibenzothiophenes (C<sub>10</sub>-C<sub>13</sub>).ΣF = total fluorenes (C<sub>10</sub>-C<sub>13</sub>).

Σ202 = fluoranthene + pyrene.

Σ228 = benzo(a)fluoranthene + chrysene.

Σ252 = benzo(a)fluoranthene + benzopyrenes.

B(a)P = benzo(a)pyrene.

nd = not detected (&lt;1 ng/g wet weight).

PPI = percent petroleum index =  $\frac{\Sigma N + \Sigma DBT + (\Sigma P - P) + \Sigma F}{\Sigma PAH}$ 

ΣPAH = ΣN + ΣP + ΣDBT + ΣF + Σ202 + Σ252 + Σ228

<sup>1</sup>From Boehm (1983a).

Trends in the PHC and PAH data reveal large-scale homogeneity in the concentrations observed. PAH levels ranged from nondetectable to 55 ppb, the highest values occurring at the station 32 samples from the New York Bight, where the highest PCB level (27 ppb) was also observed. Although our sampling on Georges Bank consisted of only one station, results were similar to those of a more extensive study by Payne et al. (1982), the only other study of *A. islandica* we could locate that includes PHC data. If the entire Northeast region is considered a sample set, then the PAH values were  $16.7 \pm 12.0$ . However, the composition of the PAH which com-

prises the total PAH number varied considerably, ranging from 0 to 81% "petroleum" PAH (Table 2). The percent petroleum index (PPI), developed by Boehm (1983a, b), estimates the relative contributions of uncombusted fossil fuels, e.g., petroleum, and from combustion sources to the total PAH assemblage. This index, presented in Table 2, is based on the relative abundance of petroleum constituents, such as naphthalene, fluorenes, dibenzothiophenes, and alkylated phenanthrenes, to the total PAH mix. The differences in PPI values for the various samples cannot, at this time, be ascribed to specific transport or selective uptake factors. However, a knowl-

TABLE 3.—*Arctica islandica* trace metal body burdens (mean and standard deviation,  $\mu\text{g/g}$ -dry weight) in areas of the northwest Atlantic; N = number of individual clams examined at each site. Results of analysis of SRM 1566 are also included; 5-8 NBS (National Bureau of Standards) samples were examined for each metal (nd = nondetectable).

Area and station	Ag		Cd		Cr		Cu		Ni		Pb		Zn		
	N	X	$\pm$ SD	X	$\pm$ SD	X	$\pm$ SD	X	$\pm$ SD	X	$\pm$ SD	X	$\pm$ SD		
Georges Bank															
379	6	0.79	0.25	1.36	0.33	3.07	1.38	10.30	2.22	3.46	1.17	4.08	2.07	61.8	11.4
Nantucket															
245	5	0.96	0.09	2.75	0.66	2.98	0.83	7.25	1.41	9.54	3.81	5.02	2.21	88.3	21.3
S. New England															
237	6	2.65	2.08	3.22	0.65	2.72	0.65	12.76	3.30	27.19	8.18	6.90	1.87	153.9	87.6
181	6	1.14	0.95	3.49	1.39	2.24	0.23	11.70	2.97	21.84	7.22	11.03	4.48	124.7	30.8
244	6	0.56	0.14	1.36	0.47	2.19	1.02	6.49	3.29	4.47	1.75	2.99	1.33	84.1	25.7
Rhode Island Sound															
239	6	0.79	0.25	1.36	0.33	3.07	1.38	10.30	2.22	3.46	1.17	4.08	2.07	61.8	11.4
240	6	1.76	0.65	1.39	0.48	4.02	1.26	11.47	2.92	6.28	1.61	6.71	2.51	87.4	12.8
241	6	1.59	0.93	0.96	0.14	3.96	2.23	12.47	3.80	5.83	2.42	4.61	1.71	126.3	55.4
Block Island Sound															
261	6	1.53	1.82	1.94	0.68	4.56	0.33	10.22	1.55	11.64	3.28	10.17	2.48	101.9	32.6
S. Long Island															
189	6	0.74	0.60	2.48	0.63	1.88	0.59	8.78	0.94	18.73	4.75	3.30	0.80	128.4	35.2
23	6	1.18	0.53	2.17	0.67	1.09	0.19	10.31	3.27	17.28	6.07	3.41	1.12	120.2	19.6
26	6	0.84	0.45	1.43	0.56	5.47	1.22	15.78	5.83	9.87	2.73	8.66	3.25	117.6	35.7
29	6	5.25	1.64	1.06	0.29	4.78	3.35	13.65	3.20	8.93	5.06	9.67	4.11	100.7	49.9
New Jersey Shelf															
32	6	0.52	0.26	0.67	0.35	2.38	0.20	8.16	5.38	4.47	2.90	3.46	2.24	50.2	22.0
47	5	0.53	0.36	1.20	0.42	1.46	0.83	8.37	2.49	9.87	5.09	3.11	0.87	84.1	31.8
59	3	0.44	0.15	0.23	0.05	0.90	0.09	6.01	1.37	6.01	1.68	1.64	0.28	62.2	18.8
174	6	1.50	0.91	2.19	0.93	1.87	0.65	4.08	0.82	7.79	2.70	4.16	1.60	50.8	6.0
224	6	0.46	0.13	3.06	0.91	1.78	0.43	5.63	1.02	14.91	6.92	5.60	2.23	91.9	33.9
Delmarva Shelf															
107	6	0.39	0.25	1.87	0.62	2.44	0.90	4.16	1.02	10.27	2.52	4.80	2.77	58.9	14.2
173	5	0.44	0.30	2.34	1.54	1.62	0.48	4.46	1.76	11.14	4.94	4.35	2.32	61.4	26.2
171	6	0.51	0.12	1.66	0.56	1.71	0.44	5.25	1.57	10.91	3.21	3.55	1.09	75.8	31.8
167	6	0.52	0.29	1.59	0.48	1.98	0.56	7.04	4.36	9.45	4.20	3.54	1.21	76.2	43.4
168	5	2.22	1.36	3.08	1.03	2.38	0.68	5.19	1.79	13.74	5.34	6.51	2.57	74.6	14.8
123	6	2.40	1.68	2.53	0.58	3.34	1.01	4.98	1.16	14.13	3.95	5.91	1.58	77.9	20.6
165	5	0.54	0.36	2.09	0.68	2.36	0.78	6.44	2.39	11.48	4.78	4.35	2.21	74.4	28.5
NBS SRM 1566															
—	8	0.71	0.24	2.86	0.19	1.07	0.52	49.50	4.00	1.72	0.35	nd	—	772.0	53.0

edge of a baseline PPI value can be important for discerning the source of any change in contaminant levels in benthic animals.

In a similar manner, the PCB value has been separated, by virtue of the use of capillary GC, into isomeric groupings (Table 1). Again, there were differences in PCB composition between samples. For example, samples from stations 22, 28, 32, and 244 were largely comprised of tri-, tetra-, and hexachloro PCB isomers, while those from stations 107 and 27 contained significantly greater quantities of the trichlorobiphenyls. Aroclor 1016 and 1242 contain proportionately more of the  $\text{Cl}_1$  to  $\text{Cl}_4$  isomers while Aroclor 1254 contains a greater abundance of  $\text{Cl}_4$  to  $\text{Cl}_6$  isomers. In the future, it may be possible to ascribe the differences in the PCB composition in animals to possible sources through capillary GC/ECD measurements.

Highest trace metal concentrations in *A. islandica* varied from metal to metal (Table 3); however, high-

est mean Ag, Cr, Cu, and Pb concentrations were found in New York Bight (stations 26 and 29), while Ni and Zn were highest in the "Mud Patch" (stations 181 and 237) with the highest Cd values off Delaware (Table 3). Lowest concentrations, overall, were observed at midshelf stations off New Jersey and Maryland (with the exception of stations 167, 168, and 123 that could have been influenced by dumping at a nearby dumpsite) and station 379, on Georges Bank. Comparison of these data with those of Wenzloff et al. (1979), who analyzed metals in ocean quahogs from the New York Bight to an area off Chesapeake Bay, was attempted for temporal trends. Unfortunately, the Wenzloff et al. (1979) data were obtained from only foot muscle composites of 5 or 6 quahogs at each station, reported as means of all composites per half degree of latitude; hence, a direct comparison was not possible. The geographic pattern, a decrease in metal concentrations with latitude believed present in the Middle Atlantic Bight

by Wenzloff et al. (1979), was not apparent from the present data or from the studies summarized in Table 4. Results of other studies involving whole body analysis (Table 4) suggest that Cd, Ni, and Zn could also be high on Georges Bank; otherwise, the values presented do not support any consistent latitudinal trends.

Results indicate, however, on a local level, elevated trace metal levels were also usually associated with known areas of inputs, e.g., waste dumpsites or adjacent to heavily industrialized coastal areas, such as the New York Bight apex (station 29), or natural depositional areas where trace metals from unknown sources are apparently accumulating, e.g., the "Mud Patch" (stations 181, 237).

The uptake and accumulation of trace metals by marine organisms are known to be affected by a number of variables. These variables include season, age, size, temperature, and interactive effects of several metals (Phillips 1977), and can be sources of some of the variability shown between the results of studies in the same area. Methodology is another source of variability between the results of each study, especially when intercalibrated results with standards are not available. It is interesting to note that an expected close correlation between trace metal levels in the sediment and in *A. islandica* tissues was not evident in at least one study (Reynolds 1979), suggesting that the water and food or

other suspended material could be the primary source of contaminants to this filter-feeding species.

In conclusion, a set of measurements of several organic and seven trace metal contaminant levels in the commercially valuable ocean quahog have been obtained from a wide range of northwestern Atlantic locations. This set can be used as a base to monitor long-term changes in the assimilated levels and distributions of these compounds in this species and the risk to its health of future use as food. The levels found were well below the FDA seafood action limit, but elevated values were associated with impacted coastal habitats and possibly waste dumpsites.

## ACKNOWLEDGMENTS

This study would not have been possible without the generous cooperation of the Northeast Fisheries Center's Resource Survey Group, specifically Thomas Azarovitz, Charles Byrne, Donald Fletcher, Malcolm Silverman, and others, who supplied us with the samples from annual clam assessment surveys. We also express our thanks to John B. Pearce and John O'Reilly for their support, and to Catherine Noonan, Maureen Montone, and Michele Cox for their assistance in preparing the manuscript. The paper was improved significantly from the comments of Donald Gadbois, Richard Greig, Carl Sindermann, Robert Reid, and unidentified reviewers. Funding for

TABLE 4.—Comparison of mean trace metals levels ( $\mu\text{g g}^{-1}$  dry wt.) in *Arctica islandica* of the northwest Atlantic.

Area and reference	Ag	Cd	Cr	Cu	Ni	Pb	Zn	Tissue type
Georges Bank-Nantucket								
Sick (1978)	0.1	1.1	0.9	3.5	12.4	0.35	252	Whole body
Erco (1978)		5.1	3.9	7.6	21.0	1.00	260	Whole body
Payne et al. (1982)		4.5	1.7	5.4	27.0	3.50	150	Whole body
Present study - stn. 379	0.8	1.4	3.1	10.3	3.5	4.1	62	Whole body
Block Island Sound								
Steimle et al. (1976)		1.8		31	18.0	18.0	183	Whole body
Rogerson and Galloway (1979) <sup>1</sup>		1.4	8.1	23	11.8	10.2	138	Whole body
Present study - stn. 261		1.9	4.6	10	11.6	10.2	102	Whole body
Southern Long Island								
Guarimo et al. (1979) <sup>1</sup>		3.0	5.6	17.4	27.9	14.1	122	?
Present study - stn. 189		2.5	1.9	8.8	18.7	3.3	128	Whole body
New York Bight								
Wenzloff et al. (1979) <sup>1</sup>	15.8	3.5	<7.5	43.2	<5.0	9.8	107	Foot muscle
Sick (1981)	0.7	7.9		5.3				"muscle"
Present study - stn. 23, 26, 29, 32, 47	1.7	1.3	3.0	11.3	10.1	5.7	95	Whole body
Off Delaware								
Reynolds (1979)		2.4		7.7	9.0			Whole body
Present study - stn. 123, 167, 168		2.4		5.7	12.4			Whole body
Chesapeake Bight								
Wenzloff et al. (1979) <sup>1</sup>	9.3	3.3	<8.0	34.6	<4.7	8.5	98	Foot muscle
Present study - stn. 107 and south	1.0	2.2	2.3	5.4	11.6	4.7	71	Whole body

<sup>1</sup>Original wet weight data converted into dry weight by multiplying by 8.

chemical analyses was provided, in part, by NOAA's Northeast Monitoring Program.

## LITERATURE CITED

- BOEHM, P. D.  
1983a. Chemical contaminants in Northeastern United States marine sediments. U.S. Dep. Commer., NOAA Tech. Rep. NOS 99, 82 p.  
1983b. Coupling of organic pollutants between the estuary and the continental shelf and the sediments and water column of the New York Bight region. *Can. J. Fish. Aquat. Sci.* 40(Suppl. 2):262-276.
- BOEHM, P. D., J. E. BARAK, D. L. FIEST, AND A. A. ELSKUS.  
1982. A chemical investigation of the transport and fate of petroleum hydrocarbons in littoral and benthic environments: The *Tsesis* oil spill. *Mar. Environ. Res.* 6:157-188.
- DUINKER, J. C., M. T. J. HILLEBRAND, AND J. P. BOON.  
1983. Organochlorines in benthic invertebrates and sediments from the Dutch Wadden Sea; Identification of individual PCB components. *Neth. J. Sea. Res.* 17:19-38.
- DUINKER, J. C., M. T. J. HILLEBRAND, K. H. PALMORK, AND S. WILHELMSSEN.  
1980. An evaluation of existing methods for quantitation of polychlorinated biphenyls in environmental samples and suggestions for an improved method based on measurement of individual components. *Bull. Environ. Contam. Toxicol.* 25: 956-964.
- ERCO (ENERGY RESOURCES COMPANY).  
1983. Levels of selected organic pollutants in soft clams, *Mya arenaria*, from the New Bedford area. Final Rep., Contract No. NA-81-FA-C-00013, to Natl. Mar. Fish. Serv., Northeast Fish. Cent., Highlands, NJ 07732, 16 p.
- GADBOIS, D.  
1982. PCBs and PAH in biota. In R. N. Reid, J. E. O'Reilly, and V. S. Zdanowicz (editors), *Contaminants in New York Bight and Long Island Sound sediments and demersal species, and contaminant effects on benthos*. Summer 1980, p. 37-46. U.S. Dep. Commer., NOAA Tech. Memo. NMFS-F/NEC-16, Woods Hole, MA.
- GIAM, C. S., H. S. CHAN, AND G. S. NEFF.  
1976. Concentrations and fluxes of phthalates, DDTs, and PCBs to the Gulf of Mexico. In H. L. Windom and R. A. Duce (editors), *Marine pollutant transfer*, p. 375-386. E. D. Heath and Co., Lexington, MA.
- GOLDBERG, E. D.  
1978. The mussel watch. *Environ. Conserv.* 5:101-125.
- GUARINO, C. F., M. D. NELSON, AND S. S. ALMEIDA.  
1979. Ocean dispersal as an ultimate disposal method. *J. Water Pollut. Control Fed.* 51(4):773-782.
- HARRIS, R., R. JOLLY, R. HUGGETT, AND G. GRANT.  
1977. Trace metals. In *Chemical and Biological Benchmark Studies on the Middle Atlantic Outer Continental Shelf*, Ch. 8. Final Rep. to Bur. Land Manage., U.S. Dep. Inter., by Va. Inst. Mar. Sci., Gloucester Point, VA 23062.
- MACLEOD, W. D., L. S. RAMOS, A. J. FRIEDMAN, D. G. BURROWS, P. G. PROHASKA, D. L. FISHER, AND D. W. BROWN.  
1981. Analysis of residual chlorinated hydrocarbons, aromatic hydrocarbons, and related compounds in selected sources, sinks, and biota of New York Bight. U.S. Dep. Commer., NOAA Tech. Memo. OMPA-6, Boulder, CO, 128 p.
- MERRILL, A. S., J. L. CHAMBERLIN, AND J. W. ROPES.  
1969. Ocean quahog fishery. In F. E. Firth (editor), *The encyclopedia of marine resources*, p. 125-129. Van Nostrand Reinhold Co., N.Y.
- O'CONNOR, J. M., J. B. KLOTZ, AND T. J. KNEIP.  
1982. Sources, sinks, and distribution of organic contaminants in the New York Bight ecosystem. In G. F. Mayer (editor), *Ecological stress and the New York Bight: Science and management*, p. 631-654. Estuarine Research Foundation, Columbia, SC.
- PAYNE, J. R., J. L. LAMBACH, R. E. JORDAN, G. D. McNABB, JR., R. R. SIMS, A. ABASUMAVA, J. G. SUTTON, D. GENERRO, S. GAGNER, AND R. F. SHOKES.  
1982. Georges Bank monitoring program, analysis of hydrocarbons in bottom sediments and analysis of hydrocarbons and trace metals in benthic fauna. Final Rep. July 1981-May 1982 to U.S. Dep. Inter., Miner. Manage. Serv., Wash., D.C., 189 p. Science Application, Inc., La Jolla, CA 92039.
- PHILLIPS, D. J. H.  
1977. The use of biological indicator organisms to monitor trace metal pollution in marine and estuarine environments—a review. *Environ. Pollut.* 13:281-317.
- REYNOLDS, B. H.  
1979. Trace metal monitoring at two ocean disposal sites. U.S. Environ. Prot. Agency, ERL, Narragansett, RI, EPA 600/3-79-037, 64 p.
- ROGERSON, P. F., AND W. B. GALLOWAY.  
1979. Preparation and characterization of a marine reference material for trace element determinations. In F. Jacoff (editor), *Advances in marine research—Proceedings of a symposium*, p. 1-8. U.S. Environ. Prot. Agency, ERL, Narragansett, RI, EPA 600/9-79-035.
- ROPES, J. W.  
1979. Biology and distribution of surf clams (*Spisula solidissima*) and ocean quahogs (*Arctica islandica*) off the northeast coast of the United States. In *Proceedings of the Northeast Clam Industries: Management for the future*, p. 47-66. Mass. Coop. Ext. Serv., Univ. Mass., Amherst, MA.
- SICK, L. V.  
1978. Trace metal analysis of zooplankton and macrobenthic tissues from Georges Bank. Sea Grant Rep. CMS-1-78, Coll. Mar. Stud., Univ. Del., Lewes, DE, 57 p.  
1981. Seasonal and geographical dynamics of trace metal composition in the benthic community of the New York Bight. Final Rep. to NOAA, MESA, New York Bight Proj., Stony Brook, NY, 128 p.
- STEIMLE, F. W., C. J. BYRNE, R. N. REID, AND T. R. AZAROVITZ.  
1976. Hydrology, sediments, macrofauna and demersal finfish of an alternate disposal site (East Hole in Block Island Sound) for the Thames River (Conn.) dredging project. Final Rep. to U.S. Navy, New London, CT, Informal Rep. #110, 63 p. NOAA, NMFS, MACFC, Sandy Hook Laboratory, Highlands, NJ.
- THOMPSON, I., D. S. JONES, AND D. DREIBELBIS.  
1980. Annual internal growth banding and life history of the ocean quahog *Arctica islandica* (Mollusca:Bivalvia). *Mar. Biol. (Berl.)* 57:25-34.
- WARNER, J. S.  
1976. Determination of aliphatic and aromatic hydrocarbons in marine organisms. *Anal. Chem.* 48:578-583.
- WEAVER, G.  
1982. Status report on PCB pollution in New Bedford, Massachusetts. Mass. Executive Off. Environ. Aff., Boston, MA, 69 p.
- WENZLOFF, D. R., R. A. GREIG, A. S. MERRILL, AND J. W. ROPES.  
1979. A survey of heavy metals in the surf clam, *Spisula solidissima*, and the ocean quahog, *Arctica islandica*, of the Mid-Atlantic coast of the United States. *Fish. Bull., U.S.* 77:280-285.

# AN ECOLOGICAL SURVEY AND COMPARISON OF BOTTOM FISH RESOURCE ASSESSMENTS (SUBMERSIBLE VERSUS HANDLINE FISHING) AT JOHNSTON ATOLL

STEPHEN RALSTON,<sup>1</sup> REGINALD M. GOODING,<sup>1</sup> AND GERALD M. LUDWIG<sup>2</sup>

## ABSTRACT

The deep slope (100-365 m) environment at Johnson Atoll in the central Pacific was surveyed with a submersible and the standing crop of commercially important bottom fishes (i.e., lutjanids, serranids, and carangids) estimated by visual quadrat censusing. Results are compared with an assessment made by hook-and-line fishing.

Overall, 69 species of fish were recorded from the submersible and 10 from fishing. Well over half of the sightings from the submersible were new locality records. Bottom fish abundance estimates (fish/hectare and fish/line-hour) varied by site but agreed broadly with one another. Together they are used to estimate catchability (0.0215 hectare/line-hour), which is shown to vary through the day.

Bottom fish were contagiously dispersed along both vertical and horizontal dimensions, with increased numbers of the snapper *Pristipomoides filamentosus* in upcurrent localities. On a finer scale this species and *Etelis coruscans* were aggregated near underwater promontories and headlands, but at different depths.

Numerous observations concerning the deep slope environment of this central Pacific Ocean atoll are included.

Perhaps the most widespread precept in fisheries today is the supposition that catch rate is proportional to stock abundance (Gulland 1974; Ricker 1975; Pitcher and Hart 1982). Even so, there are numerous studies which demonstrate exceptions to this assumption (see for example MacCall 1976; Bannerot and Austin 1983). A departure from linearity in the relationship of these two variables reflects varying catchability. This variation may be due to schooling behavior, gear saturation, or any number of other factors which affect catch per unit effort (CPUE) in addition to stock abundance (Rothschild 1977). It is often difficult, if not impossible, to evaluate the validity of the linearity assumption in most practical situations. A multiple approach to stock assessment has often been suggested as a means of circumventing this problem, including the use of hydroacoustics (Barans and Holliday 1983; Thorne 1983), underwater television-diver surveys (Powles and Barans 1980), and submersibles (Uzmann et al. 1977) to corroborate CPUE data. Consistency in results among a set of independent assessment techniques is necessary for validation and verification of data.

Submersibles in particular have also proven useful in studying the distribution of fishes in various deep-water habitats (Brock and Chamberlain 1968; Strassburg et al. 1968; Colin 1974; Shipp and Hopkins 1978), in identifying nursery grounds of commercially important rockfish species (Carlson and Straty 1981), and in assessing the effectiveness of baited longline gear (High 1980; Grimes et al. 1982). In many situations submersibles provide an ideal means of independent assessment (Uzmann et al. 1977) if questions concerning bias in visual surveys can be adequately addressed (Colton and Alevizon 1981; Sale and Douglas 1981; Brock 1982).

The purpose of this study was to examine the distribution and abundance of tropical deep slope bottom fishes (i.e., lutjanids, serranids, and carangids) at Johnston Atoll in the central Pacific Ocean with a research submersible and to compare the results with an assessment made by fishing. This comparison provides not only a basis for testing the validity of a CPUE statistic, but also for estimating the catchability coefficient. Both are important issues because of the widespread use of hook-and-line catch and effort statistics in resource assessments of bottom fish stocks worldwide (Moffitt 1980; Ralston 1980; Ivo and Hanson 1982; Ralston and Polovina 1982; Munro 1983; Forster 1984). Of special interest was determining the relationship between CPUE and visual estimates of bottom fish standing stock.

<sup>1</sup>Southwest Fisheries Center Honolulu Laboratory, National Marine Fisheries Service, NOAA, Honolulu, HI 96812.

<sup>2</sup>U.S. Fish and Wildlife Service, Honolulu, HI 96850; present address: Florida Fishery Research Station, U.S. Fish and Wildlife Service, P.O. Box 1669, Homestead, FL 33030.

In addition, a variety of observations made from the submersible substantially improved our understanding of factors controlling the distribution and abundance of the entire deep slope fauna at Johnston Atoll.

## DESCRIPTION OF THE STUDY AREA

A National Wildlife Refuge since 1926, Johnston Atoll is located 1,250 km southwest of Oahu, HI. The atoll's physical environment has been reviewed by Amerson and Shelton (1976) and is summarized here.

Located between lat.  $16^{\circ}40' - 16^{\circ}47'N$  and long.  $169^{\circ}24' - 169^{\circ}34'W$  (Fig. 1), Johnston Atoll lies in the North Pacific central water mass, where salinities range from 34.8 to  $35.3\text{‰}$ . Surface water temperatures show little seasonality, ranging from  $25^{\circ}$  to  $27^{\circ}C$ . The atoll is directly in the path of the westerly flowing North Equatorial Current, with surface currents typically 0.5 kn (0.25 m/s). Deeper layers flow smoothly past the atoll, but an island wake

forms in lee surface waters, with effects evident up to 600 km downstream (Barkley 1972).

The atoll is composed of a coral platform, encompassing over  $130\text{ km}^2$  of reef under water  $<30\text{ m}$  deep. A narrow lagoon lies between the northwest barrier reef and Johnston and Sand Islands to the southeast (Fig. 1). The atoll is unusual in that the main outer reef extends only about one quarter of the way around its perimeter (Fig. 1). A large portion of the atoll lies exposed to prevailing easterly weather conditions without benefit of barrier reef protection. Evidence suggests that subsidence and tilting of the reef platform to the southeast created this unusual condition.

The climate is tropical marine, i.e., there is little seasonal variation in temperature and windspeed, but substantial variation in rainfall. A 4-mo "winter" season extends from December to March, when temperatures drop slightly, winds become more variable, and precipitation increases. The mean annual air temperature is  $26.3^{\circ}C$ , with a daily range of  $4.0^{\circ} - 4.5^{\circ}C$ . Daily maximum and minimum temper-

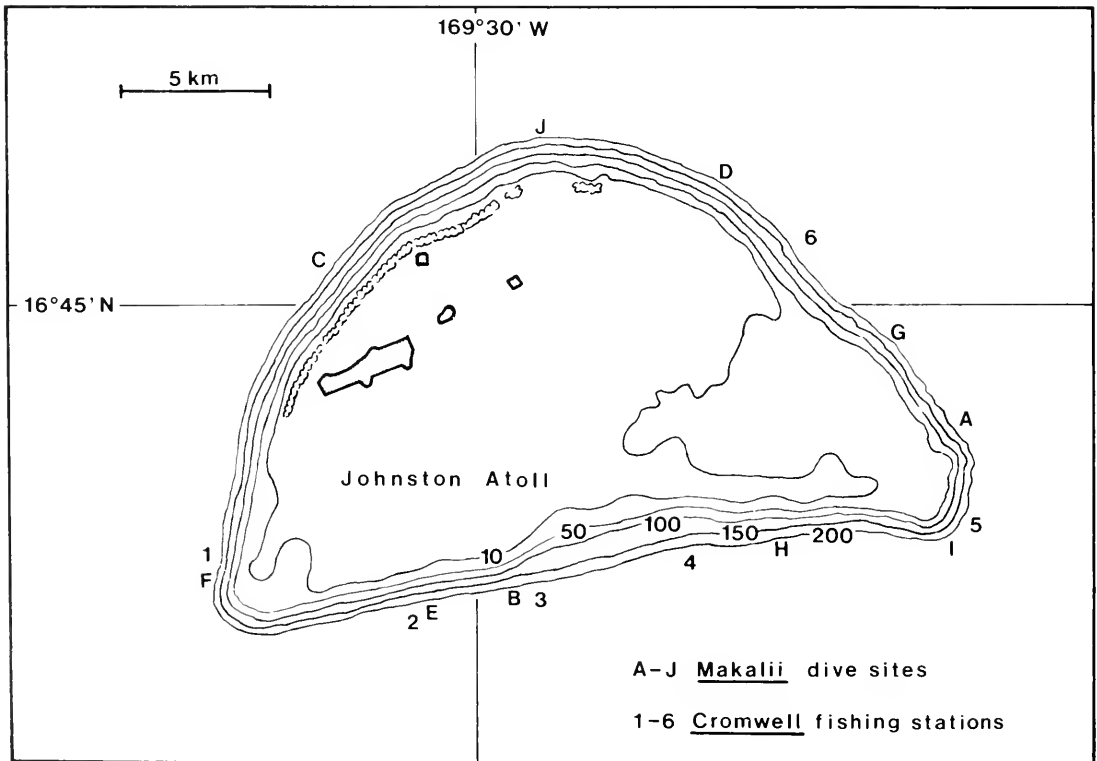

FIGURE 1.—Map of Johnston Atoll. The lines encircling the atoll are isobaths of constant depth (fathoms). The four shaded areas at the upper left are emergent lands (Johnston, Akau, Hikina, and Sand Islands). Letters (A-J) indicate the 10 dive sites of the *Makalii* during the study. Numbers (1-6) indicate fishing stations of the *Townsend Cromwell*.

atures vary little throughout the year, as do sea surface temperatures, which are in near equilibrium with the air. Strong easterly trade winds prevail all year but increase during the summer period. Annual mean wind speed at Johnston Island is 13 kn (7.5 m/s) and monthly means range from 11 to 14 kn (5.5-7.0 m/s).

## METHODS

### *Makalii*

The *Makalii* is operated by the National Undersea Research Laboratory at the University of Hawaii. It is a two-man, battery powered, 1-atmosphere submersible which is 4.8 m long, with a pressurized capsule 1.5 m in diameter. When carrying a pilot and one observer, its normal operating speeds range from 1 to 3 kn (0.5-1.5 m/s). Maximum dive duration is 4-5 h and depth capability is 365 m. Equipment carried in this study included hydraulic manipulator, internal and external color video cameras, 2 video monitors, video recorder, video flood lights, Photo-sea<sup>3</sup> 35 mm still camera with strobe, current and temperature meters, and a dictaphone tape recorder. In addition, the *Makalii* is equipped with an environmental monitoring system for continuous recording of temperature, salinity, conductivity, oxygen, solar radiation, and depth.

All three authors participated as observers during a series of dives at Johnston Atoll over the 2-wk period between 22 September and 5 October 1983. Once on station, a launch-recovery-transport platform was submerged to 20 m and divers released the *Makalii*, usually in 120 m of water. The submersible descended until encountering the bottom and locating the atoll's shelf break. Observations made on fishes during the dives were voice and video recorded for later analysis. Slope angle was periodically measured with a hand-held inclinometer.

Visual estimates of the density of commercially important bottom fishes (sensu Ralston and Polovina 1982) were made by a series of "quadrat" samples. These fishes included *Cookeolus boops*, *Epinephelus quernus*, *Aphareus furcatus*, *A. rutilans*, *Etelis carbunculus*, *E. coruscans*, *Pristipomoides auricilla*, *P. filamentosus*, *P. zonatus*, *Carangoides orthogrammus*, *Caranx lugubris*, *Seriola dumerili*, and *Pontinus macrocephalus*.

During quadrat sampling the observer would look out his port and count the total number of bottom

fish, without regard to species, over an area of the bottom judged to be 30 m<sup>2</sup>. Quadrat areas always lay on the oblique planar surface of the slope face and were away from the immediate vicinity of the submersible. A sampling period consisted of four counts systematically performed, one every 15 s. To the extent possible, each count was made at an instant in time. All bottom fish seen in the water column above the sample area were included in counts.

The submersible progressed stepwise down the slope (100-365 m) in a clockwise direction around the atoll, with the observer's starboard port always oriented to the slope face. Upon reaching the *Makalii*'s depth limit, a slow stepwise ascent would begin to 100 m, where the dive would end. Descents generally lasted 2.5 h and ascents 1.5 h. Thus the entire vertical distribution of the deep slope was sampled more or less equally (i.e., observations were not concentrated in any particular depth zone).

### *Townsend Cromwell*

The National Oceanic and Atmospheric Administration's (NOAA) RV *Townsend Cromwell* is 50 m long and when rigged for bottom handline fishing carries four hydraulic fishing gurdies (Charlin motors and Pacific King fishing reels), each with 365 m of braided prestretched 90 kg Dacron line. The terminal rig is composed of four No. 28 Tonkichi round fishing hooks and a 2 kg weight. Stripped squid was used for bait and fishing was conducted only during the day.

The vessel spent 3 d (3-5 November 1983) at Johnston Atoll sampling deep slope bottom fish by drift fishing. After wind and current directions had been determined, the vessel was positioned over the desired depth and fishing lines were dropped. Fishing continued until the vessel drifted over an unsuitable water depth, when lines were retrieved and the *Townsend Cromwell* repositioned. Single drifts were the fundamental sampling unit by which catch and effort statistics were summarized. Six fishing stations were occupied (Fig. 1), one during the morning and afternoon of each day. Fork length to the nearest millimeter and depth of capture were recorded for all fish landed.

## RESULTS

### *Makalii*

Ten dives were completed at Johnston Atoll (Fig. 1). Due to precipitous dropoffs which occur through-

<sup>3</sup>Reference to trade names does not imply endorsement by the National Marine Fisheries Service, NOAA.

out the study area (100-365 m), the length of the atoll's 183 m (100 fathom) isobath (64 km) provides a convenient measure of total deep slope habitat (Ralston and Polovina 1982). The average point-to-point distance covered by the submersible during one 4-h dive was 2.27 km ( $s = 0.56$  km). An aggregate 22.7 km were thus surveyed during this study, comprising 35% of the deep slope habitat at the atoll.

### Temperature

Ambient temperature and depth were recorded often during dives, from which temperature-depth profiles were later constructed. The results are summarized in Figure 2. The solid line represents median temperatures at depth, with the shaded area encompassing the range of temperatures observed among all 10 dives. Surface water temperature was typically 27°C and the mixed layer 100 m deep. A second weak thermocline was found around 240 m. Although its depth varied somewhat (220-245 m), it was present around the entire atoll, i.e., both windward and leeward exposures, and was observed as a shimmering layer below the submersible as it descended. This effect is believed due to refraction of light passing through variable density water, a result of the thermocline in association with a decrease in salinity.<sup>4</sup> Ambient water temperature usually had dropped to 8.5°C at a depth of 350 m.

### Slope Angle

The relationship between the bottom's slope and depth was also measured. These data were summarized after each dive and bottom contours plotted. Overall, there was little variation in slope angle around the atoll, i.e., the general pattern was one of uniformity at all sites visited. Figure 3 presents pooled results for all slope angle-depth determinations. In the figure, horizontal and vertical scales are equal and the composite contour of the bottom (100-365 m) at Johnston Atoll is shown in profile. The slope was stratified into three 50-fathom depth zones for later analysis.<sup>5</sup> The slope angle between 50 and 100 fathoms averages  $\Theta_1 = 25^\circ$  (Table 1). Similarly,  $\Theta_2 = 47^\circ$  and  $\Theta_3 = 59^\circ$ . There is a definite trend at Johnston Atoll for the slope to steepen with in-

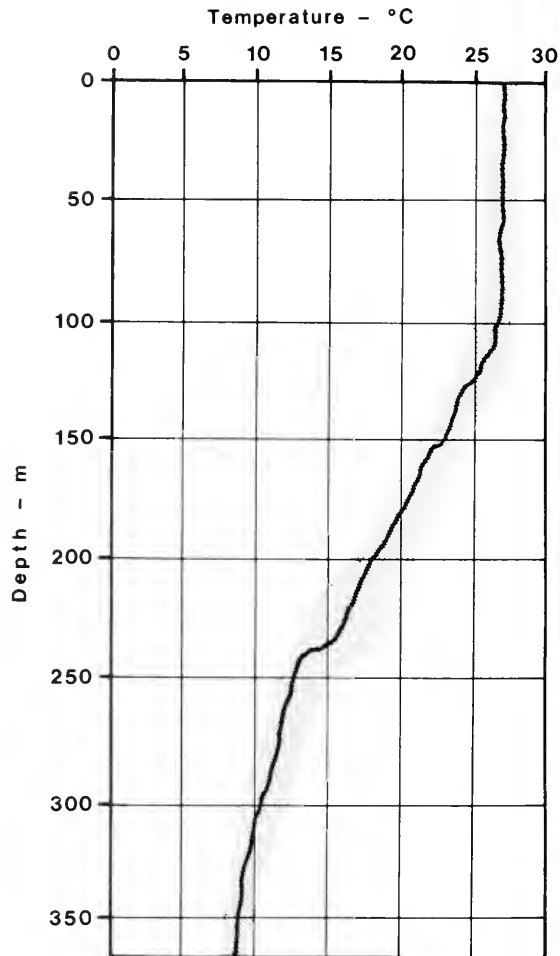

FIGURE 2.—The pooled relationship ( $n = 10$ ) between temperature and water depth at Johnston Atoll. Solid line = median values; shaded area = range of values.

TABLE 1.—Total habitat areas stratified by depth zones at Johnston Atoll.

Depth stratum (fathoms)	Digitized horizontal planar areas (ha)	Slope angle	Oblique planar habitat areas (ha)
Emergent lands	305 (1%)	—	—
0-10	15,012 (60%)	—	—
10-50	6,123 (24%)	—	—
50-100	1,624 (7%)	25°	1,785
100-150	964 (4%)	47°	1,418
150-200	1,020 (4%)	59°	1,962
Total	25,048 (100%)	—	5,165

<sup>4</sup>E. Chave, Hawaii Undersea Research Laboratory, University of Hawaii, Honolulu, HI 96822, pers. commun. June 1984.

<sup>5</sup>Stratification of depth into zones was performed using units of fathoms (1 fathom = 1.83 m) because nautical charts, hydrographic surveys, and fathometers are so measured. For the sake of brevity and clarity, isobaths and depth strata will henceforth be given only in this unit of measure.

creasing depth, at least between 100 and 365 m.

In the shallowest regions surveyed (<125 m) the bottom was a monotonous sandy plain in the shoreward direction, but at 125 m it began to slope steeply



downward. Although not easily seen in the figure, a small but prominent ledge 5-10 m high encircled the atoll between 130 and 140 m. Somewhat deeper, between 180 and 275 m, the bottom was uniform in slope and its surface relatively smooth and devoid of features. Slope angles approached the vertical at most sites in the 300-350 m depth range, with overhanging caves formed by subaerial dissolution.<sup>6</sup> At the deepest points visited (360 m) the bottom became less precipitous, and in some areas a sediment-laden terrace had formed along the base of the deep dropoff.

Based on estimates of slope angle, existing charts, and a hydrographic survey by the *Townsend Cromwell*, habitat areas for the three depth zones were determined. The positions of the 10 and 100-fathom isobaths were already known, but they were refined and the locations of the 50-, 150-, and 200-fathom isobaths estimated. Figure 1 is a simplified representation of a much larger chart which was digitally analyzed to determine the horizontal (i.e., level) areas bounded by isobaths (Table 1). The results show that emergent lands (Johnston, Akau, Hikina, and Sand Islands) account for only 1% (305 ha) of the level planar area of the atoll. The largest area (60%) lies between sea level and 10 fathoms. The

total horizontal extent of the atoll is about 25,000 ha.

These results can be misleading, however, because a vertical slope provides no horizontal habitat area, and yet both reef fish diversity and standing crop are known to be positively correlated with topographic relief (Luckhurst and Luckhurst 1978; Gladfelter et al. 1980; Carpenter et al. 1981). At Johnston Atoll the structural complexity of the substratum frequently increased with slope angle. A better estimate of total habitat is the area of bottom irrespective of slope angle, estimated by dividing the horizontal planar area of a depth stratum by the cosine of the slope angle within it. This adjustment almost doubles the estimate of total habitat area in the 150-200 fathom zone, simply due to the precipitous dropoff found there. A composite 5,165 ha of habitat occurs between 50 and 200 fathoms.

### General Observations

While this study focused primarily on the deep-water ichthyofauna of Johnston Atoll, many observations were made on the oceanographic, geologic, and biotic characteristics of the study area. These are briefly recounted here.

Currents running in directions parallel to the slope were frequently encountered. They were generally weak and did not exceed 0.3 kn (0.15 m/s). They sometimes exhibited reversals with depth. During

<sup>6</sup>Keating, B. H. Geologic history and evolution of Johnston Island: Submersible dive results. Manuscr. in prep. University of Hawaii, Honolulu, HI 96822.

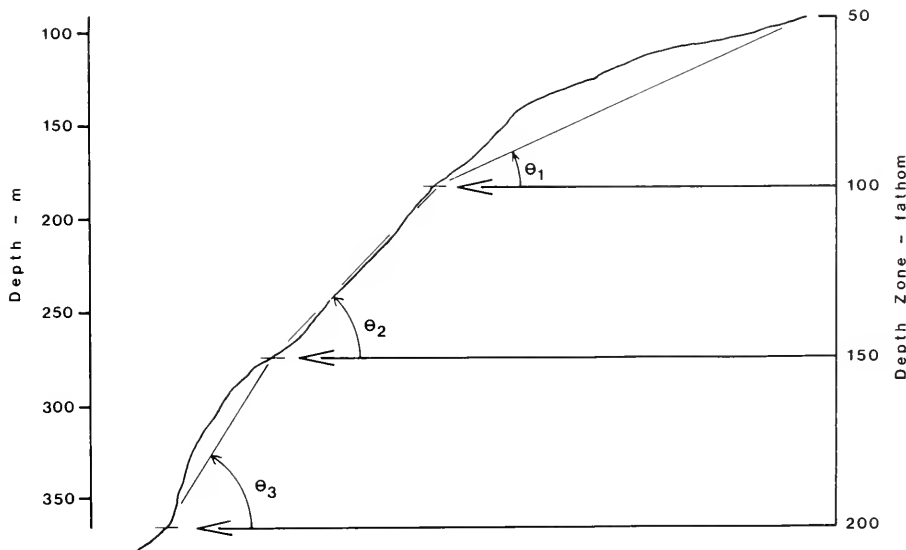

FIGURE 3.—Composite reconstruction of the deep slope at Johnston Atoll. Horizontal and vertical scales equal. Average slope angles ( $\theta$ ) were measured for each of three 50-fathom depth strata.

dive F, for example (Fig. 1), a 0.2 kn (0.10 m/s) current was observed at 125 m running south (i.e., counterclockwise when viewed from above). There was no current between 180 and 275 m. At 300 m, however, a 0.1 kn (0.05 m/s) current was observed, traveling in a northerly direction (i.e., clockwise). A similar depth-related current reversal was observed during dive C, although on this occasion the shallower current (170 m) ran clockwise and the deeper one (290 m) counterclockwise. In contrast, a weak downslope current (0.1 kn or 0.05 m/s) was observed but once (dive E at 305 m). No upwelling currents were encountered.

Geologically, the deep slope of Johnston Atoll was grossly similar at all points visited. The low escarpment at 130 m was most likely due to erosion of an ancient limestone reef. This feature was characterized by mounds of coral rubble, boulders, small undercut caves, and a profusion of fishes. Below it the slope angle was remarkably uniform, with low topographic relief. The bottom was still composed of limestone and showed severe biological and chemical weathering (i.e., dissolution) along the slope gradient, being pitted and striated with numerous shallow depressions. Few sediments or boulders were observed. At a depth of 240 m topographic relief increased, as large slab boulders became increasingly prominent. Subaerial dissolution had produced low shallow limestone caves, and fine sediments were more common. Between 290 and 335 m the slope was very steep, with a well-developed system of sharp ridges and deep erosional channels. The substratum had the superficial appearance of dark basalt but was composed of thin manganese crusts overlying ancient limestone reef materials (Keating see footnote 6). Fine sediments spilled down the channels in the slope and piled up at the base of the deep dropoff (350 m). More limestone boulders were arrayed along this deep terrace and fine sediments covered the bottom.

As expected, few fleshy macroalgae were seen. The only algae encountered regularly were two corallines, *Halimeda* sp. and an unidentified crustose species. The former occurred in small scattered clumps between 100 and 200 m, with loose remnant exoskeletal "sands" found in sediment pockets as deep as 290 m. The crustose form was abundant between 150 and 250 m where it covered much of the slope face. Otherwise, an unidentified species of brown algae seen on dive H between 150 and 250 m was the only other algae seen. A more detailed description of the algal biota at Johnston Atoll is in preparation.<sup>7</sup>

In contrast to the depauperate flora, the inverte-

brate fauna was rich. Listed here are those forms seen often enough to constitute indicator species for particular depth strata. In addition to these a great many others were observed and photographed. In the Cnidaria, three stony corals were especially plentiful: *Leptoseris hawaiiensis* (115-165 m), *Stylaster* sp. (135-245 m), and *Madracis* sp. (140-200 m). Several species of black corals (Order Antipatharia) were also common. Of the crustaceans, a single large *Panulirus marginatus*, previously known only from one specimen (Brock 1973), was observed in a small hole during dive A at 122 m, and at least two types of galatheid crab were very abundant in small holes pitting the reef slope between 230 and 350 m. In deep water the remaining attached valves of dead rock oysters were seen in patches along the base of the deep dropoff (350 m), as was an unidentified species of solitary tunicate (335-365 m). Echinoids were particularly abundant immediately below the shelf break; e.g., *Diadema* cf. *savignyi* (110-170 m), *Chondrocidaris gigantea* (120-160 m), and heart urchins (Brissidae, 130-200 m). Other than galatheid crabs, the 220-310 m zone was largely barren and devoid of megabenthos.

### Ichthyofauna

A total of 69 fish species in 29 families were observed during *Makalii* dives (Table 2). Overall, the proportional representation of different families was similar to that of the shallow water community (Gosline 1955; Randall et al. in press), although the representation of genera was grossly different. Seranid species were most numerous with nine species observed (eight in the anthiine subfamily). Lutjanids were also abundant (eight species), but no members of the ubiquitous genus *Lutjanus* were seen. Forty of the species listed in Table 2 (58%) are new records for Johnston Atoll (Randall et al. in press). Photographs of several fishes observed during dives are presented in Figure 4.

An indication of species' depth distributions is given in Table 2. Because no observations were made in <100 m, upper limits can be misleading. This is particularly true of shallow-water species which penetrated to the 135 m escarpment but not beyond, including: *Triaenodon obesus*, *Paraperceis schauinslandi*, *Aphareus furcatus*, *Chromis verater*, *Parupeneus cyclostomus*, *P. multifasciatus*, *Forcipiger flavissimus*, *Holacanthus arcuatus*, *Bodianus bilu-*

<sup>7</sup>C. Agegian, University of Hawaii, Honolulu, HI 96822, pers. commun. June 1984.

TABLE 2.—Fishes encountered during dives (100-365 m) of the *Makalii* at Johnston Atoll. Included for each species are the minimum and maximum depths (m) of observation as well as the median and range of the depth distribution. Under the sighting column a value of 1 indicates a species was seen repeatedly (>5 times) during each dive of the submersible, 2 means the species was occasionally seen on each dive (<5 times), 3 signifies sightings on most dives but not all (i.e., species seen on several occasions), and 4 indicates rarity (see only once or twice during all dives). An asterisk to the left of a species name signifies a new record for Johnston Atoll (Randall et al. in press).

Family-species	Min-max	Median (range)	Sighting	Family-species	Min-max	Median (range)	Sighting
Carcharhinidae				Carangidae			
<i>Carcharhinus amblyrhynchos</i>	90-275	185(185)	1	<i>Carangoides orthogrammus</i>	105-170	135(65)	2
<i>Carcharhinus</i> sp. (probably <i>galapagensis</i> )	225-250	225(25)	3	<i>Caranx lugubris</i>	105-355	190(250)	1
<i>Triaenodon obesus</i>		120	4	<i>C. melampygy</i>	130-230	135(100)	2
Mobulidae				<i>Decapterus</i> sp.		100	4
<i>Manta</i> sp.		120	4	* <i>Elagatis bipinnulata</i>	90-150	120(60)	3
Muraenidae				* <i>Seriola dumerili</i>	120-335	215(215)	1
* <i>Gymnothorax berndti</i>	220-260	260(40)	3	Apogonidae			
* <i>G. nudivomer</i>	120-205	179(85)	2	* <i>Epigonus</i> sp.	330-365	355(35)	2
* <i>G. nuttingi</i>	185-300	250(115)	3	Pomacentridae			
Ophichthidae				<i>Chromis verater</i>	120-140	130(20)	3
<i>Myrichthys maculosus</i>	150-215	185(65)	4	Mullidae			
Synodontidae				<i>Parupeneus cyclostomus</i>		125	4
Unidentified synodontid		240	4	<i>P. multifasciatus</i>		125	4
Holocentridae				Chaetodontidae			
* <i>Myripristis chryseres</i>	135-240	155(105)	2	* <i>Chaetodon modestus</i>	125-255	190(130)	2
* <i>Neoniphon aurolineatus</i>		150	4	* <i>C. tinker</i>	105-160	145(55)	3
* <i>Pristilepis oligolepis</i>	165-345	230(180)	3	<i>Forcipiger flavissimus</i>	125-145	130(20)	4
Ophiidiidae				* <i>Heniochus diphreutes</i>	120-215	135(95)	2
<i>Brotula</i> sp. ( <i>multibarbata</i> or <i>townsendi</i> )		230	4	Pomacanthidae			
Priacanthidae				<i>Geniacanthus</i> sp.		150	4
* <i>Cookeolus boops</i>	165-260	220(95)	1	* <i>Holacanthus arcuatus</i>	130-150	135(20)	3
Serranidae				Labridae			
* <i>Anthias fuscinus</i>	135-280	215(145)	1	<i>Bodianus bilunulatus</i>	130-135	130(5)	3
* <i>A. ventralis</i>		105	4	<i>Cheilinus unifasciatus</i>		120	4
<i>Callanthias</i> sp.	240-330	285(90)	4	* <i>Polylepion russelli</i>	245-280	275(35)	3
* <i>Epinephelus quernus</i>	135-350	230(215)	1	Acanthuridae			
* <i>Grammatonotus laysanus</i>	310-350	335(40)	3	* <i>Acanthurus dussumieri</i>		130	4
* <i>Holanthias elizabethae</i>	155-260	230(105)	1	* <i>Naso hexacanthus</i>	120-165	150(45)	2
* <i>H. fuscipinnis</i>	160-215	170(55)	1	* <i>Naso</i> sp.	120-175	135(55)	1
<i>Luzonichthys</i> sp. (perhaps <i>earlei</i> )		105	4	Zanclidae			
* <i>Plectranthias helena</i>	215-220	215(5)	3	<i>Zanclus cornutus</i>		125	4
Mugiloididae				Scorpaenidae			
* <i>Parapercis roseoviridis</i>	215-270	245(55)	2	* <i>Pontinus macrocephalus</i>	200-365	305(165)	2
* <i>P. schauinslandi</i>	105-170	145(65)	1	* <i>Scorpaena colorata</i>		272	4
Lutjanidae				<i>Scorpaena</i> sp.	225-355	290(130)	2
<i>Aphareus furcatus</i>	105-145	135(40)	2	Triglidae			
* <i>A. rutilans</i>	190-250	220(60)	2	* <i>Satyrichthys engyceros</i>	355-365	365(10)	4
* <i>Etelis carbunculus</i>	245-365	310(120)	3	Bothidae			
* <i>E. coruscans</i>	250-355	270(105)	3	<i>Bothus mancus</i>	270-350	310(80)	4
* <i>Pristipomoides auricilla</i>	215-250	230(35)	3	Balistidae			
* <i>P. filamentosus</i>	120-260	205(140)	3	* <i>Sufflamen fraenatus</i>	105-170	140(65)	1
* <i>P. zonatus</i>	205-295	240(90)	1	<i>Xanthichthys auromarginatus</i>	115-155	135(40)	1
* <i>Symphysanodon maunaloae</i>	230-365	300(135)	1	Monacanthidae			
Emmelichthyidae				Unidentified monacanthid		125	4
* <i>Erythrocles scintillans</i>	295-320	300(25)	4	Tetraodontidae			
				* <i>Canthigaster</i> sp. (likely <i>inframacula</i> )	260-270	265(10)	4
				Unidentified tetraodontid	135-150	145(15)	4
				Ostraciidae			
				<i>Ostracion</i> sp.		135	4
				Diodontidae			
				<i>Diodon hystrix</i>		135	4

*nulatus*, *Acanthurus dussumieri*, *Zanclus cornutus*, *Xanthichthys auromarginatus*, and *Diodon hystrix*. These fishes accounted for an increase in diversity at the 135 m dropoff. Similarly, due to the submersible's 365 m depth limit, lower bounds for some species are likely in error (e.g., *Symphysanodon mau-*

*naloae*, *Epigonus* sp., *Pontinus macrocephalus*, and *Satyrichthys engyceros*). Nonetheless, due to the large depth range sampled (100-365 m), the data still provide useful estimates of the depth distributions for most of the species listed.

The data suggest that large species have great

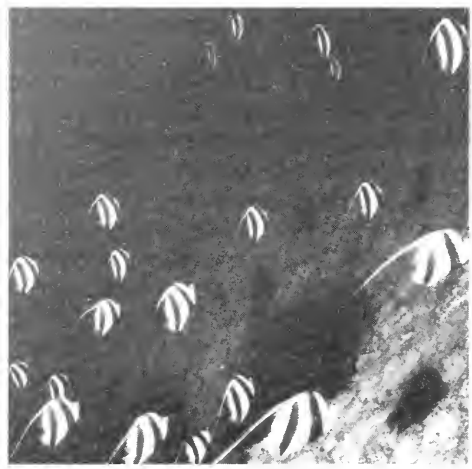
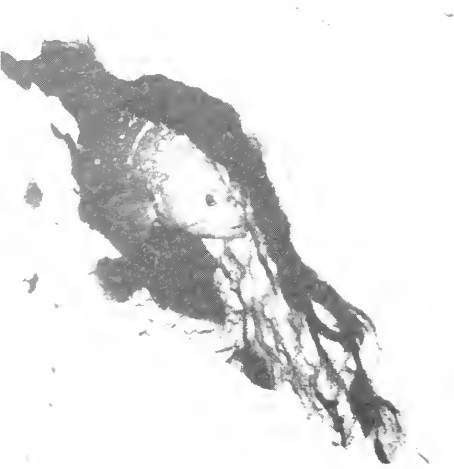

depth ranges. For example, all species with depth ranges exceeding 200 m are large (i.e., *Caranx lugubris*, *Epinephelus quernus*, and *Seriola dumerili*). Moreover, among extensively observed species, a significant Spearman correlation exists between ranked average weight and depth range ( $r_s = 0.52$ ,  $df = 25$ ,  $P < 0.01$ ). This finding should be viewed with caution because of potential biases in depth distributions (see above).

The last column in Table 2 gives sighting scores for all species. Those assigned a value of 1 indicate species dominating the deep slope fish community in terms of species sightings. Note that some species were seen infrequently, but when encountered they were observed in large numbers (e.g., *Elagatis bipinnulata*, Fig. 4). Similarly, *Pristipomoides filamentosus* was not seen on every dive and was thus assigned an abundance score of 3. In spite of this, when seen, it was abundant and it was the most frequently caught while fishing (see next section). Sighting scores therefore do not indicate relative species' contributions to total standing crop biomass of the deep slope fish fauna.

#### Quadrat Sampling

A total of 974 quadrat sample counts were made during the 10 submersible dives. No attempt was made to estimate abundance separately for each species. Rather, the total number of bottom fish was recorded, regardless of species composition. Although severely reducing the detail of the data base, this did have the desirable effect of averaging biases due to attraction or repulsion of fishes to and from the *Makalii*. It was evident, for example, that some species were attracted to the submersible and followed it about (e.g., *Seriola dumerili* and *Caranx lugubris*), whereas others were repelled and actively avoided the submersible's lights (e.g., *Pristipomoides filamentosus* and *Etelis coruscans*). Still others did not seem to be greatly influenced (e.g., *Cookeolus boops*, *Epinephelus quernus*, *Pristipomoides zonatus*, and *Pontinus macrocephalus*). By pooling species quadrat counts, the abundance of some species was overestimated, some underestimated, and some estimated without bias. Due to averaging, we believe that pooled counts provide the best available

estimates of total bottom fish density along the deep slope of Johnston Atoll.

Some 367 bottom fish were counted in quadrat samples, resulting in a mean encounter rate of 0.38 fish/quadrat. The data were fitted to the Poisson distribution to ascertain the dispersion pattern. A chi-square goodness of fit test yielded  $\chi^2 = 325.32$ ,  $df = 3$ ,  $P \ll 0.005$ , demonstrating nonrandom dispersion. The variance to mean ratio calculated from the frequency distribution of bottom fish/quadrat observations was 4.64 and was significantly greater than 1 ( $P \ll 0.005$ ), indicating strong contagion.

One of the principal explanations for this result is shoaling by *Pristipomoides filamentosus* and *Etelis coruscans*. Both are large species, which formed aggregations of up to 100 individuals well off the bottom (20 m) in the vicinity of underwater headlands and promontories. These monospecific groups appeared to feed in open water on plankton, consistent with previous dietary studies of *P. filamentosus* (Kami 1973; Ralston<sup>8</sup>). When either was observed, there was an increased likelihood of encountering conspecifics. As a consequence 10 or more *P. filamentosus* were seen in one quadrat on 7 occasions.

Another factor contributing to clumping was nonrandom distribution with depth (Fig. 5). This figure presents the relationship between mean number of bottom fish per count and depth (vertical bars = standard errors). Note the two abundance peaks, the first at about 170 m and the second at 250 m. The former was due primarily to large numbers of *Caranx lugubris* and *P. filamentosus*. The location of the second peak was just below the second thermocline and was largely the result of local increases in numbers of *Epinephelus quernus* and *P. zonatus*.

The mean numbers of bottom fish per quadrat, stratified into 50-fathom depth intervals, are also shown in Figure 5 (i.e., 0.57, 0.47, and 0.06 fish/count). These data were converted to densities (1 quadrat = 0.003 ha) such that from 50 to 100 fathoms an average of 190 bottom fish are estimated to occur per hectare of habitat. Similarly, in the two deeper strata, estimated densities of 156 and 20 bottom fish/ha occur.

Given estimates of bottom fish density and depth-specific estimates of total available habitat (Table 1), estimates of the total standing crop of bottom fishes at Johnston Atoll indicate that about 339,000 fish occurred in the 50-100 fathom zone, 221,000 between

FIGURE 4.—Johnston Atoll deep slope fishes. A. *Caranx lugubris* with wire coral; B. *Epinephelus quernus* peering out of cave; C. *Seriola dumerili* (foreground) and *Caranx lugubris* (background); D. school of *Elagatis bipinnulata* with *Carangoides orthogrammus* (above); E. *Heniochus diphreutes* with black coral; and F. aggregation of *Myripristis chryseres* and *Neoniphon aurolineatus*.

<sup>8</sup>Ralston, S. Unpubl. data. Southwest Fisheries Center Honolulu Laboratory, National Marine Fisheries Service, NOAA, Honolulu, HI 96812.

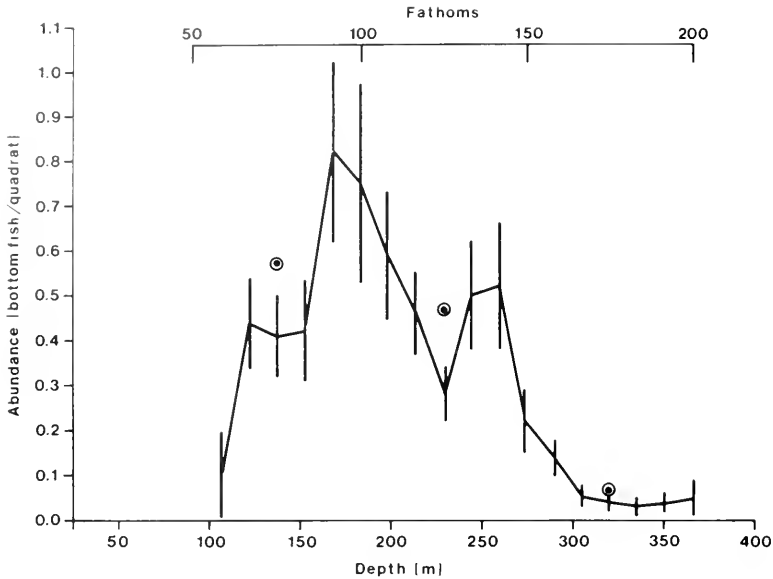

FIGURE 5.—The abundance of bottom fish (see text) in relation to depth. Solid line represents fish densities with changing depth (measured in meters or fathoms). Error bars are standard errors of means. Three 50-fathom depth zones are indicated, and mean fish densities within these are shown as circled points.

100 and 150 fathoms, and only 39,000 in the deepest (150-200 fathom) zone. Roughly 600,000 commercially exploitable bottom fish are estimated to comprise the deep-sea hook-and-line resource at Johnston Atoll. Because the fish are spread over a total habitat of 5,165 ha (Table 1), this corresponds to average densities of 118 bottom fish/ha.

### Townsend Cromwell

Anywhere from 2 to 4 lines were deployed while fishing, resulting in an aggregate 41.8 line-h of fishing effort spread over 23 vessel drifts. A catch of 133 fishes (Table 3) produced an overall CPUE of 3.18 fish/line-h. Another 12 fish were hooked but lost to sharks before landing. All species caught while fishing were observed from the submersible with the exception of the bramid, *Eumegistus illustris*. Deep-water lutjanids predominated (69%), but substantial numbers of serranids (22%) and carangids (8%) were caught, a composition typical of tropical deep slope fisheries worldwide (Talbot 1960; Ralston and Polovina 1982; Munro 1983; Forster 1984).

#### Species Composition By Location

Examination of catch data suggested a difference in species composition between upcurrent (sites 5

TABLE 3.—Species composition of the bottom fish catch from the Townsend Cromwell at Johnston Atoll.

Family-species	Catch (n)	Percent	Average size (cm FL)
Lutjanidae (snappers)			
<i>Pristipomoides filamentosus</i>	43	32	54.4
<i>P. zonatus</i>	35	26	40.8
<i>P. auricilla</i>	5	4	34.6
<i>Etelis carbunculus</i>	5	4	51.2
<i>E. coruscans</i>	4	3	72.7
Subtotal	92	69	
Serranidae (groupers)			
<i>Epinephelus quernus</i>	29	22	69.8
Carangidae (jacks)			
<i>Caranx lugubris</i>	7	5	48.1
<i>Carangoides orthogrammus</i>	2	2	43.5
<i>Seriola dumerili</i>	2	2	79.5
Subtotal	11	9	
Bramidae (pomfrets)			
<i>Eumegistus illustris</i>	1	1	70.3
Grand total	133	101	

and 6) and downcurrent (sites 1-4) locations (Fig. 1). Landings were pooled into these two classes, and also by species category into *Pristipomoides filamentosus*, *P. zonatus*, *Epinephelus quernus*, and "others". The resulting  $2 \times 4$  contingency table showed a lack of statistical independence between locations and species ( $\chi^2 = 22.36$ ,  $df = 3$ ,  $P < 0.005$ ). Examin-

ing individual contingency table cells showed that the greatest contribution to the total chi-square was for *P. filamentosus* (58% of total). Specifically, under the hypothesis of independence, 16.5 were expected downcurrent but only 5 were caught, while 26.5 were expected upcurrent where 38 were landed. The apparent surplus of *P. filamentosus* along the eastern exposure, where trade winds prevail and oceanic currents first impact the atoll (Barkley 1972), may relate to this fish's habit of feeding on large deepwater plankton, especially salps (genus *Pyrosoma*). Bray (1981) has shown that small resident planktivores will travel to the upcurrent edge of a reef to access pelagic plankton. The distribution of *P. filamentosus* at Johnston Atoll may represent a similar situation on a much larger scale.

### Bottom Fish Catch Rate

One-way analysis of variance (ANOVA) of CPUE data was used to examine whether geographical differences exist in bottom fish abundance, i.e., the two treatment classes were upcurrent and downcurrent regions (see above). The ANOVA was insignificant ( $F = 1.62$ ,  $df = 1, 21$ ,  $P = 0.21$ ), although the mean catch rate along the eastern exposure (5.6 bottom fish/line-h) was 60% greater than downcurrent (3.5 bottom fish/line-h). This result suggests the lack of significance may have been due to small sample size.

The CPUE data were analyzed by time of day to determine if catchability fluctuates through the day. The results in Figure 6 show that fishing was distinctly better during the morning than afternoon. In this figure individual values of drift CPUE ( $n = 23$ ) have been plotted against the midpoint of the drift time interval. The solid line represents aggregate catch rates, calculated by pooling both catch and effort statistics from all areas into 1-h intervals and then forming CPUE ratios. Different symbols represent each of six separate fishing locations (Fig. 1). Note that catch rates were highest when fishing began each day and consistently declined to a low during the midafternoon. The data further indicate that catch rates may increase again with the onset of the evening crepuscular period, although the data are meager. This pattern was evident both within and among the six sites fished and, when averaged out, resulted in morning catch rates 2.07 times greater than afternoon rates.

### Catchability

Having the *Makalii* and *Townsend Cromwell* at Johnston Atoll at similar times prompts comparison

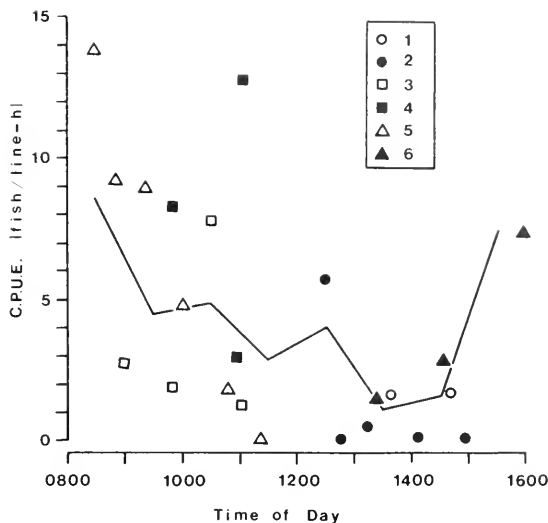

FIGURE 6.—The effect of time of day on the catch rate of bottom fish at Johnston Atoll. Catch rates calculated for each drift of the vessel and presented for each of six different fishing stations (see Figure 1).

of the assessment techniques. We assume that in the 1-mo interim between visits no changes occurred in overall levels of abundance, because Johnston Atoll is a National Wildlife Refuge where no fishing is permitted and the fishes are typically long lived (Ralston and Miyamoto 1983; Ralston see footnote 8). Any differences in assessment are then likely due to differences in method.

To compare surface estimates of bottom fish abundance with those derived from submersible surveys, we matched fishing stations (numbers) with submersible dives (letters) which occurred nearby (Fig. 1). Specific pairings were F-1, E-2, B-3, H-4, I-5, and D-6. For each dive the overall abundance of bottom fish was estimated by forming the ratio of total fish counted to total number of quadrat counts, and then converting to density measured in bottom fish/ha. The CPUE statistics were used to estimate abundance for each fishing station, after correcting for fluctuating catchability (Fig. 6). The result is presented in Figure 7. There is a positive correlation between CPUE and bottom fish density ( $r = 0.54$ ), although it is insignificant.

One means of estimating catchability,  $q$ , is to determine the slope of the regression of CPUE on stock density. We estimated the functional regression (Ricker 1973) of the data presented in Figure 7 (solid line) and determined that  $q = 0.0215$  ha/line-h. A second estimate of  $q$  is obtained by forming the ratio of the average catch rate of bottom fish at the atoll

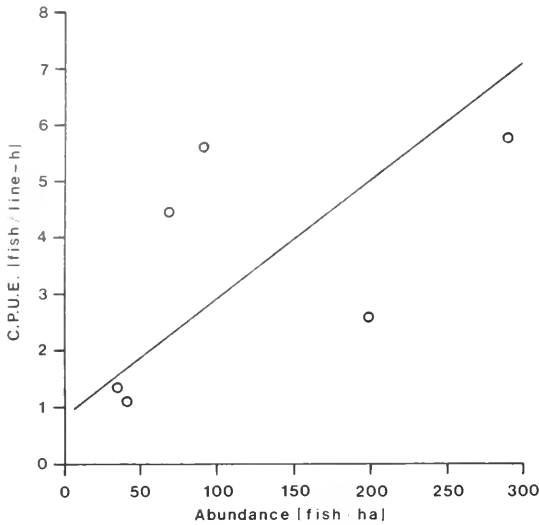

FIGURE 7.—The relationship between Townsend Cromwell CPUE and Makalii abundance estimates. Line fitted by functional regression. See text for further discussion.

(3.18 fish/line-h) to the average density of bottom fish viewed from the submersible (118 bottom fish/ha). The resulting estimate of  $q$  is 0.0269 ha/line-h.

## DISCUSSION

The most enlightening aspect of this study was our ability to perform an in situ assessment of factors controlling the distribution and abundance of the deep slope biota at Johnston Atoll. Organisms showed not only distinct zonal patterns with depth but clumped dispersion along horizontal gradients as well.

The fish fauna of Johnston Atoll is often considered a depauperate outlier of the Hawaiian fauna (Gosline 1955; Randall et al. in press). In a later paper, Gosline (1965) examined vertical zonation in Hawaiian fishes, arguing that depth zonation patterns are often sharply demarcated in intertidal and shallow-water habitats, but these become increasingly attenuated with depth. The results of our study and Randall et al. (in press) support his conclusion (see also Forster 1984). Some deep slope species have extremely broad depth ranges (exceeding 200 m), yet few representatives of the shallow-water community extend appreciably beyond the 130 m escarpment encircling the atoll. Other investigators have noted that many Hawaiian species, which are commonly thought of as strictly associated with coral reefs, penetrate to depths well in excess of those favoring the growth of scleractinian corals (Brock and Cham-

berlain 1968; Strasburg et al. 1968; Clarke 1972). Yet the distributions of these fishes are limited largely to areas near the shelf break or shallower, while a true deep slope ichthyofauna, comprised largely of anthiids and lutjanids, exists along outer reef drop-offs at both Johnston Atoll and in the Hawaiian Islands.

Distributional patterns of fishes were nonrandom along horizontal gradients as well, as was readily apparent in the atoll-wide distribution of *Pristipomoides filamentosus*. Based simply on catch totals, 60% more *P. filamentosus* were expected to occur on the upcurrent exposure of the atoll than downcurrent, although 760% more were observed there, illustrating the clumped dispersion pattern which characterized this species during fishing surveys. Contagion was also evident in quadrat samples. Future studies would be well advised to incorporate statistical models consistent with these findings, including use of the negative binomial distribution to describe spatial patterns.

On a more local scale, it was clear from submersible observations that *P. filamentosus* and *Etelis coruscans* were concentrated near underwater headlands. Brock and Chamberlain (1968) made similar observations on deepwater populations of *Chaetodon miliaris*, attributing the very localized distribution of this species to increased accessibility of its food (plankton) in the vertical turbulence plumes formed by the impact of currents on underwater promontories. Because of its known planktivorous food habits, this hypothesis could explain abundance patterns of *P. filamentosus*. Moreover, fishermen emphasize the importance of currents in locating feeding aggregations of both *P. filamentosus* and *E. coruscans*. These two species taken together comprise the most important species landed in the Hawaiian deep-sea hook-and-line fishery, both in terms of yield and economic value. The relative abundance of these species in the deepwater bottom fish community may be due to their utilization of an allochthonous plankton resource transported to neritic waters from the open sea.

## Bottom Fish Abundance

Certain methodological problems hindered this study and should be reviewed before comparing the abundance estimates from the two surveys. Any technique, including those used here, has its own specific combination of advantages and disadvantages.

There is ample reason to suspect bias in assessments based on underwater visual surveys. Sale and Douglas (1981) have shown that a single visual fish



census seldom records all individuals present at the time of the census. Similarly, Colton and Alevizon (1981) showed that a quarter of the community they studied was characterized by significant diurnal changes in abundance. They concluded that unless sampling time is carefully controlled and standardized, results from visual abundance surveys may be seriously biased. Standardization was achieved in this study because all 10 dives started between 0840 and 0950 in the morning and each lasted 4 h. Furthermore, Brock (1982) showed that large, conspicuous, diurnally active species are accurately censused with visual assessment techniques, although the most abundant are often underestimated. With the exception of *Cookeolus boops*, which, although nocturnal, shelters in the open along the slope face, all of the species included in the quadrat sampling fit these criteria. Biases which frequently accompany visual assessments have thus been considered and minimized here.

Another factor which may have affected the results of *Makalii* surveys is attraction and repulsion of certain species to and from the submersible. Previous investigators have typically ignored this problem (Uzmann et al. 1977; High 1980; Powles and Barans 1980; Carlson and Straty 1981), while at the same time acknowledging that some species are attracted (e.g., black sea bass, southern porgy, Pacific halibut, sculpin, and yelloweye rockfish) or repelled (e.g., squid, herring, mackerel, butterflyfish, and wolf eel) to submersibles and divers. Nevertheless, as pointed out by Uzmann et al. (1977), one can at least observe the reactions of species to the submersible's presence, giving the viewer the opportunity to evaluate potential sources of error. We have attempted to address this problem by pooling counts for all species. While admittedly this procedure may not remove all bias, it is our feeling that in the absence of more quantitative information, little else can be done to improve the data. Studies are now being implemented to specifically evaluate the degree of attraction or repulsion of different species to the *Makalii*.

Provided an awareness of these concerns, the results presented here support the contention that the catch of bottom fish/line-h is a suitable CPUE statistic. This conclusion is based on the data presented in Figure 7, where CPUE generally increases with fish density and the regression intercept passes close to the origin. Although the relationship is statistically insignificant, this is likely due to small sample size ( $n = 6$ ). Moreover, differences in bottom fish abundance between upcurrent and downcurrent locations were shown to result largely from the contagious dispersion of *Pristipomoides filamentosus*

along the eastern side of the atoll, where its primary food resource first becomes available for consumption.

The estimation of catchability for deep-sea hook-and-line gear is a useful application of the dual sampling program presented here. The results suggest relatively great sensitivity of bottom fish stocks to exploitation pressure, a finding consistent with previous and ongoing studies (Ralston 1984). If we use  $q = 0.0215$  ha/line-h as an estimate of catchability, we conclude that 1 line-h of *Townsend Cromwell* fishing effort removes about 2.2% of the bottom fish inhabiting 1 ha of habitat. A similar finding was reported by Polovina<sup>9</sup>, who estimated  $q$  from the same vessel for a Mariana stock of bottom fish. Removals such as this are not insubstantial and underscore the importance of developing methods of stock assessment which can be used early in the development of a fishery and in the absence of conventional data sources. A combination of surface platform surveys with submersible ground-truthing is certainly a promising assessment technique to pursue (Uzmann et al. 1977).

## ACKNOWLEDGMENTS

We would like to thank the U.S. Army Corps of Engineers Pacific Ocean Division, the U.S. Army Toxic and Hazardous Materials Agency, and the National Undersea Research Program at the University of Hawaii for making this study possible. Special thanks go to the staff of the Hawaii Undersea Research Laboratory Program and the *Makalii* operations crew for help in coordinating the dive program and in meeting our needs for logistical support.

## LITERATURE CITED

- AMERSON, A. B., JR., AND P. C. SHELTON.  
1976. The natural history of Johnston Atoll, central Pacific Ocean. *Atoll Res. Bull.* 192:1-479.
- BANNEROT, S. P., AND C. B. AUSTIN.  
1983. Using frequency distributions of catch per unit effort to measure fish-stock abundance. *Trans. Am. Fish. Soc.* 112:608-617.
- BARANS, C. A., AND D. V. HOLLIDAY.  
1983. A practical technique for assessing some snapper/group-er stocks. *Bull. Mar. Sci.* 33:176-181.
- BARKLEY, R. A.  
1972. Johnston Atoll's wake. *J. Mar. Res.* 30:201-216.
- BRAY, R. N.  
1981. Influence of water currents and zooplankton densities

<sup>9</sup>Polovina, J. J. A variable catchability version of the Leslie model with application to an intensive fishing experiment on a multispecies stock. Manuscr. submitted to U.S. Natl. Mar. Fish. Serv., Fish. Bull.

- on daily foraging movements of blacksmith, *Chromis punctipinnis*, a planktivorous reef fish. Fish. Bull., U.S. 78:829-841.
- BROCK, R. E.  
1973. A new distributional record for *Panulirus marginatus* (Quoy & Gaimard, 1825). Crustaceana 25:111-112.  
1982. A critique of the visual census method for assessing coral reef fish populations. Bull. Mar. Sci. 32:269-276.
- BROCK, V. E., AND T. C. CHAMBERLAIN.  
1968. A geological and ecological reconnaissance off western Oahu, Hawaii, principally by means of the research submarine "Asherah." Pac. Sci. 22:373-394.
- CARLSON, H. R., AND R. R. STRATY.  
1981. Habitat and nursery grounds of Pacific rockfish, *Sebastes* spp., in rocky coastal areas of southeastern Alaska. Mar. Fish. Rev. 43(7):13-19.
- CARPENTER, K. E., R. I. MICALT, V. D. ALBALADEJO, AND V. T. CORPUZ.  
1981. The influence of substrate structure on the local abundance and diversity of Philippine reef fishes. In E. D. Gomez, C. E. Birkeland, R. W. Buddemeier, R. E. Johannes, J. A. Marsh, Jr., and R. T. Tsuda (editors), The reef and man, p. 497-502. Proceedings of the Fourth International Coral Reef Symposium, Vol. 2. Mar. Sci. Cent., Univ. Philippines, Quezon City.
- CLARKE, T. A.  
1972. Collections and submarine observations of deep benthic fishes and decapod Crustacea in Hawaii. Pac. Sci. 26:310-317.
- COLIN, P. L.  
1974. Observation and collection of deep-reef fishes off the coasts of Jamaica and British Honduras (Belize). Mar. Biol. (Berl.) 24:29-38.
- COLTON, D. E., AND W. S. ALEVIZON.  
1981. Diurnal variability in a fish assemblage of a Bahamian coral reef. Environ. Biol. Fishes 6:341-345.
- FORSTER, G. R.  
1984. The distribution of fishes on the outer reef slopes of Aldabra (Indian Ocean) in relation to bottom temperatures. Environ. Biol. Fishes 10:129-136.
- GLADFELTER, W. B., J. C. OGDEN, AND E. H. GLADFELTER.  
1980. Similarity and diversity among coral reef fish communities: A comparison between tropical western Atlantic (Virgin Islands) and tropical central Pacific (Marshall Islands) patch reefs. Ecology 61:1156-1168.
- GOSLINE, W. A.  
1955. The inshore fish fauna of Johnston Island, a central Pacific atoll. Pac. Sci. 9:442-480.  
1965. Vertical zonation of inshore fishes in the upper water layers of the Hawaiian Islands. Ecology 46:823-831.
- GRIMES, C. B., K. W. ABLE, AND S. C. TURNER.  
1982. Direct observation from a submersible vessel of commercial longlines for tilefish. Trans. Am. Fish. Soc. 111:94-98.
- GULLAND, J. A.  
1974. The management of marine fisheries. Univ. Washington Press, Seattle, 198 p.
- HIGH, W. L.  
1980. Bait loss from halibut longline gear observed from a submersible. Mar. Fish. Rev. 42(2):26-29.
- IVO, C. T. C., AND A. J. HANSON.  
1982. Aspectos da biologia e dinamica populacional do pargo, *Lutjanus purpureus* Poey, no norte e nordeste do Brasil. Arq. Cienc. Mar 22(1/2):1-41.
- KAMI, H. T.  
1973. The *Pristipomoides* (Pisces: Lutjanidae) of Guam with notes on their biology. Micronesica 9:97-118.
- LUCKHURST, B. E., AND K. LUCKHURST.  
1978. Analysis of the influence of substrate variables on coral reef fish communities. Mar. Biol. (Berl.) 49:317-323.
- MACCALL, A. D.  
1976. Density dependence of catchability coefficient in the California Pacific sardine, *Sardinops sagax caerulea*, purse seine fishery. Calif. Coop. Oceanic Fish. Invest. Rep. 18:136-148.
- MOFFITT, R. B.  
1980. A preliminary report on bottomfishing in the North-western Hawaiian Islands. In R. W. Grigg and R. T. Pfund (editors), Proceedings of the Symposium on Status of Resource Investigations in the Northwestern Hawaiian Islands, April 24-25, 1980, University of Hawaii, Honolulu, Hawaii, p. 216-225. Sea Grant Misc. Rep. UNIHI-SEAGRANTMR-80-04.
- MUNRO, J. L. (editor).  
1983. Caribbean coral reef fishery resources. ICLARM Studies and Reviews 7, Manila, 276 p.
- PITCHER, T. J., AND P. J. B. HART.  
1982. Fisheries ecology. Avi Publ. Co. Inc., Westport, Conn., 414 p.
- POWLES, H., AND C. A. BARANS.  
1980. Groundfish monitoring in sponge-coral areas off the southeastern United States. Mar. Fish. Rev. 42(5):21-35.
- RALSTON, S.  
1980. An analysis of the Hawaiian offshore handline fishery: A progress report. In R. W. Grigg and R. T. Pfund (editors), Proceedings of the Symposium on Status of Resource Investigations in the Northwestern Hawaiian Islands, April 24-25, 1980, University of Hawaii, Honolulu, Hawaii, p. 216-225. Sea Grant Misc. Rep. UNIHI-SEAGRANTMR-80-04.  
1984. Biological constraints on production and related management issues in the Hawaiian deepsea handline fishery. In R. W. Grigg and K. Y. Tanoue (editors), Proceedings of the Symposium on Resource Investigations in the Northwestern Hawaiian Islands, May 25-27, 1983, University of Hawaii, Honolulu, Hawaii, p. 248-264. Sea Grant Misc. Rep. UNIHI-SEAGRANTMR-84-01.
- RALSTON, S., AND G. T. MIYAMOTO.  
1983. Analyzing the width of daily otolith increments to age the Hawaiian snapper, *Pristipomoides filamentosus*. Fish. Bull., U.S. 81:523-535.
- RALSTON, S., AND J. J. POLOVINA.  
1982. A multispecies analysis of the commercial deep-sea handline fishery in Hawaii. Fish. Bull., U.S. 80:435-448.
- RANDALL, J. E., P. S. LOBEL, AND E. H. CHAVE.  
In press. Annotated checklist of the fishes of Johnston Island. Pac. Sci.
- RICKER, W. E.  
1973. Linear regressions in fishery research. J. Fish. Res. Board Can. 30:409-434.  
1975. Computation and interpretation of biological statistics of fish populations. Fish. Res. Board Can. Bull. 191, 382 p.
- ROTHSCHILD, B. J.  
1977. Fishing effort. In J. A. Gulland (editor), Fish population dynamics, p. 96-115. John Wiley and Sons, N.Y.
- SALE, P. F., AND W. A. DOUGLAS.  
1981. Precision and accuracy of visual census technique for fish assemblages on coral patch reefs. Environ. Biol. Fishes 6:333-339.
- SHIPP, R. L., AND T. S. HOPKINS.  
1978. Physical and biological observations of the northern rim of the De Soto Canyon made from a research submersible. Northeast Gulf Sci. 2(2):113-121.

STRASBURG, D. W., E. C. JONES, AND R. T. B. IVERSEN.

1968. Use of a small submarine for biological and oceanographic research. *J. Cons. Cons. Perm. Int. Explor. Mer* 31:410-426.

TALBOT, F. H.

1960. Notes on the biology of the Lutjanidae (Pisces) of the East African coast, with special reference to *L. bohar* (Forsk.) *Ann. S. Afr. Mus.* 45:549-573.

THORNE, R. E.

1983. Hydroacoustics. *In* L. A. Nielsen, D. L. Johnson, and

S. S. Lampton (editors). *Fisheries techniques*, p. 239-259. Am. Fish. Soc., Bethesda, MD.

UZMANN, J. R., R. A. COOPER, R. B. THEROUX, AND R. L. WIGLEY.

1977. Synoptic comparison of three sampling techniques for estimating abundance and distribution of selected megafauna: Submersible vs camera sled vs otter trawl. *Mar. Fish. Rev.* 39(12):11-19.



# PATCHINESS AND NUTRITIONAL CONDITION OF ZOOPLANKTON IN THE CALIFORNIA CURRENT

STEWART W. WILLASON, JOHN FAVUZZI, AND JAMES L. COX<sup>1</sup>

## ABSTRACT

Zooplankton and water samples were collected from 81 stations off the California coast in April 1981 during CalCOFI cruise 8104 aboard the RV *David Starr Jordan*. Abundance, weight (wet and dry), digestive enzyme activity (laminarinase), and biochemical composition of three zooplankton species were determined. The indices measured provided estimates of zooplankton nutritional history on time scales of 1 day to 3 weeks.

Upwelling was taking place along the California coast, from Point Conception to San Francisco during the study period. The resulting low surface temperatures were most evident south of San Francisco and just north of Point Conception. Just south of these areas patches of high phytoplankton standing crop (up to 14.7 mg chlorophyll *a*/m<sup>3</sup>) were found. The two herbivorous species, *Euphausia pacifica* and *Calanus pacificus*, showed highest laminarinase activity in areas with the highest density of phytoplankton: enzyme activity was particularly high in the waters off Point Conception. Zooplankters in the southern and offshore regions of the sampling grid showed very low digestive enzyme activity. The larger size (weight) and higher lipid content of *C. pacificus* near Point Conception and south of San Francisco in comparison to animals in other parts of the California Current suggest that animals in these areas experience prolonged periods of better nutrition. *Nematocelis difficilis*, which is not a herbivore, did not show these patterns. This study illustrates the importance of upwelling regions, such as Point Conception, and shows the large spatial variability of trophic interactions within the California Current System.

The nearshore, pelagic marine environment is extremely variable and heterogeneous. Spatial heterogeneity of physical conditions elicit behavioral or physiological responses from marine organisms which contribute to biological patchiness (Haurey et al. 1978; Steele 1978). Patchiness of pelagic marine organisms occurs on all temporal and spatial scales (Haury et al. 1978); one of the most important of these is the mesoscale (a few kilometers to 100's of kilometers, and a few weeks to months). Mesoscale processes, such as coastal upwelling, play a major role in structuring the physical and biological environment at all scales (Haury 1982). Although upwelling regions are very productive (e.g., Ryther 1969), trophic interactions within these important areas are poorly understood.

Along the California coast episodic upwelling takes place during the spring and summer months (Reid et al. 1958; Bernstein et al. 1977; Owen 1980; Lasker et al. 1981; Parrish et al. 1981). Upwelling results in mesoscale phytoplankton patchiness along the coast and in the southward flowing California Current (Owen 1974; Cox et al. 1982; Smith and Baker 1982; Pelaez and Guan 1982). It is thought that phytoplankton patchiness in this area influences the sur-

vival and physiological condition of larval fish populations (Lasker 1975; Lasker and Smith 1977; Lasker and Zweifel 1978; O'Connell 1980). In addition, nutrition of herbivorous zooplankton (estimated by digestive enzyme activity) is influenced by phytoplankton patchiness (Cox et al. 1982; Cox et al. 1983; Willason and Cox in press).

This study investigates the impact that mesoscale and larger scale phytoplankton patchiness have on zooplankton populations within the California Current along the central and southern California coast. Results of measurements of temperature, phytoplankton biomass, zooplankton abundance, and zooplankton nutrition are presented. Nutritional status was evaluated using intrinsic properties which reflect previous feeding conditions. Short-term feeding history was estimated from measurements of the activity of the digestive enzyme, laminarinase. Although digestive enzyme levels of zooplankton do not always provide a good measure of instantaneous digestive or feeding rates (Hassett and Landry 1983; Head et al. 1984; Willason and Cox in press), the level of activity in field captured animals does give an indication of relative feeding history on the order of 1 to 5 d (Cox 1981; Cox and Willason 1981; Cox et al. 1983; Willason 1983). Longer term nutritional condition was assessed from biochemical composition and animal size (wet and dry weight) measurements.

<sup>1</sup>Marine Science Institute, University of California, Santa Barbara, CA 93106.

Lipid content, size, and water content of a zooplankton species reflect feeding history on the order of 1 to 3 wk (Omori 1970; Lee et al. 1970, 1971; Bamstedt 1975; Childress 1977; Boyd et al. 1978; Vidal 1980; Hakanson 1984). Spatial patterns derived from these data are used to estimate relative differences in feeding and nutritional condition of zooplankton from different areas within the California Current. An understanding of the interrelationships of these variables in different areas may provide insights into mechanisms which generate and maintain physical and biological mesoscale features.

## METHODS

### Species Studied

Two euphausiid species, *Euphausia pacifica* Hansen and *Nematoscelis difficilis* Hansen, and the copepod, *Calanus pacificus* Brodsky, were chosen for the present study because 1) all are common in the California Current region (Fleminger 1964; Brinton 1967b), 2) all have been used in previous digestive enzyme studies (Cox 1981; Cox and Willason 1981; Hassett and Landry 1982, 1983; Cox et al. 1983; Willason 1983; Willason and Cox in press), and 3) a large base of information exists on the sizes, feeding rates, and energetics of these zooplankters (Brinton 1967a; Mullin and Brooks 1976; Vidal 1980; Ross 1982; Cox et al. 1983; Torres and Childress 1983; Willason 1983; Hakanson 1984; Willason and Cox in press). *Euphausia pacifica*, the most abundant euphausiid in the California Current (Brinton 1967b; Brinton and Wyllie 1976; Youngbluth 1976), and *C. pacificus*, the most abundant copepod along the California coast (Fleminger 1964; Star and Mullin 1981), are considered primarily herbivorous (Mullin and Brooks 1976; Ross 1982; Willason and Cox in press). By contrast, *N. difficilis* does not appear to be a herbivore (Nemoto 1967; Mauchline and Fisher 1969; Willason and Cox in press).

### Sample Collection

The sampling program was conducted off the California coast from 7 to 27 April 1981 in conjunction with the California Cooperative Fisheries Investigation (CalCOFI) survey. Zooplankton and water samples were collected from 81 stations during CalCOFI cruise 8104 aboard RV *David Starr Jordan*. Figure 1 shows the stations sampled and the sampling sequence during the cruise. The grid covered an area of about 270,000 km<sup>2</sup>; nearshore stations were sometimes within 1 km of the coast and offshore

stations were located up to 300 km from the coast.

Although the mean flow of the California Current is south through the sampling grid at this time of the year (Lynn et al. 1982), smaller regions within the grid are often subjected to different hydrographic influences. For example, the waters of the offshore regions intergrade with the waters of the Central Pacific Gyre (Bernstein et al. 1977); the nearshore region south of Point Conception (the Southern California Bight) is characterized by a semipermanent, counterclockwise eddy and is hydrographically distinct from the other areas of the grid (Owen 1980); and the nearshore area adjacent to and north of Point Conception is characterized by periods of intense coastal upwelling during the spring and summer months (Parrish et al. 1981). To compare the biological and nutritional properties of zooplankton in the different hydrographic regions, the sampling grid was divided into four sections: southern nearshore (I), northern nearshore (II), southern offshore (III), and northern offshore (IV) (Fig. 1).

Surface chlorophyll a concentration (depth of 2 m) was used as an indicator of phytoplankton standing crop. Previous studies have shown that there are positive correlations between surface chlorophyll a, integrated chlorophyll a, and primary production in the waters of the California Current (Lorenzen 1970; Hayward and Venrick 1982). Measurements of surface chlorophyll a, therefore, give a relative approximation of phytoplankton biomass within the sampling grid.

Two replicate water samples (0.25 to 2.0 L) for chlorophyll a analysis were taken at each of the 81 stations from a depth of about 2 m using the ship's seawater pumping system. Each sample was filtered through a 4.5 cm Whatmann GF/C filter; two drops of a seawater-saturated MgCO<sub>3</sub> solution were added during filtrations. The filters were folded in half and stored frozen in aluminum foil at -20°C. An additional 15 water samples were taken for chlorophyll a analysis along the cruise track adjacent to and immediately south of the Point Conception region while the ship was under way. Measurements of surface water temperature ( $\pm 0.1^\circ\text{C}$ ) were also taken at each station using a glass mercury thermometer.

Paired bongo nets (designated net 1 and net 2) with mouth openings of 0.396m<sup>2</sup> and mesh openings of 505  $\mu\text{m}$  were used for the collection of zooplankton samples. A General Oceanics<sup>2</sup> flowmeter was mount-

<sup>2</sup>Reference to trade names does not imply endorsement by the National Marine Fisheries Service, NOAA.

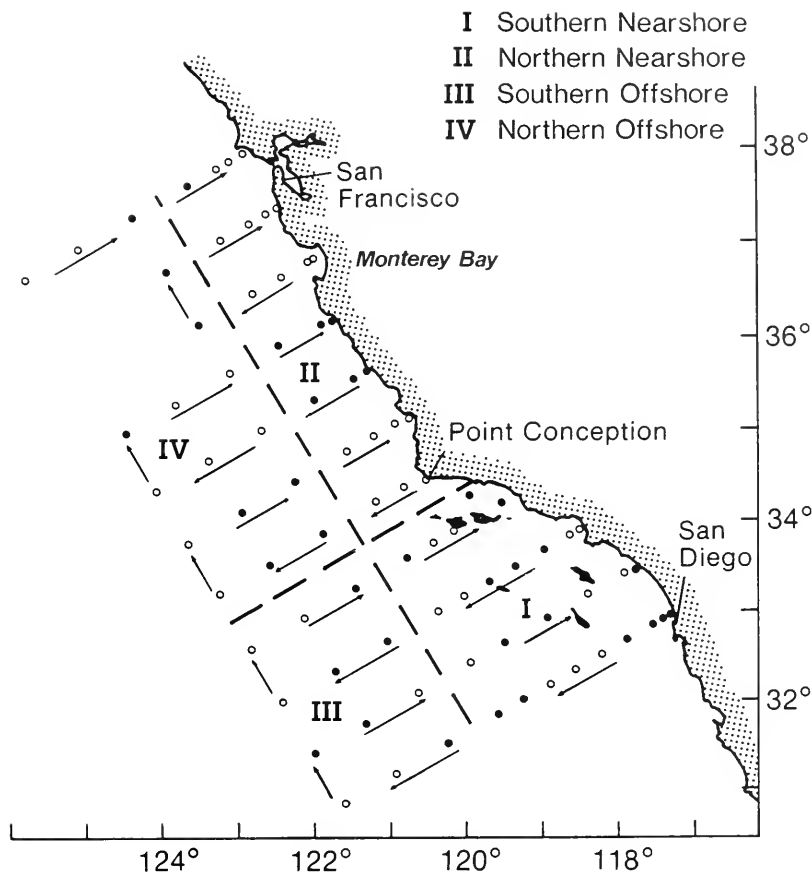

FIGURE 1.—Sampling grid. Open circles are day stations and closed circles are night stations. Arrows show the sampling sequence. The first station, adjacent to San Diego, was occupied on 7 April 1981. The last station, just north of San Francisco, was occupied on 27 April 1981.

ed inside the mouth of each net to measure the volume of water filtered. An oblique net tow was made to a depth of about 210 m at each station (bottom depth permitting); each net filtered about 400 m<sup>3</sup> of water. Ship speed during the net tows was 1.5 to 2.0 kn. Thirty-six stations were occupied at night (after sunset and before sunrise) and 45 were occupied during the day.

The euphausiids, *Euphausia pacifica* and *Nematoscelis difficilis*, and the copepod, *Calanus pacificus*, were separated from the catch of net 1 immediately after collection. Adult euphausiids were sorted for males and females and copepods sorted for females and stage V copepodites. Specimens of *E. pacifica* and *N. difficilis* were considered adults if they were larger than 11 mm and 15 mm, respectively (Brinton and Townsend 1981). Fifty undamaged animals of each species and sex (or stage) were saved from each net tow if adequate numbers were captured. For

*C. pacificus*, which were very abundant, 50 females and stage V's were saved from 72 and 75 of the 81 stations, respectively. Two replicate groups of 50 females of *C. pacificus* were taken from 7 stations and two replicate groups of 50 stage V copepodites from 9 stations. After sorting, animals from each net tow were wrapped in parafilm in groups (5 to 50 animals of each sex or stage) and frozen at -20°C for biochemical analyses in the laboratory. Catches from net 1 that could not be sorted on the ship (10 of the 81 stations sampled) were frozen whole at -20°C and sorted in the laboratory after the cruise. The entire catch of net 2 was preserved in Formalin immediately after collection.

The abundances (numbers per 1,000 m<sup>3</sup>) of adult euphausiids at each station were estimated by counting all adults captured in net 1 and dividing by the volume of water filtered. Copepod abundances (numbers per 1 m<sup>3</sup>) were estimated by counting all

females and stage V copepodites in triplicate aliquots taken from the preserved catches of net 2.

### Sample Analyses

All frozen samples were analyzed in the laboratory within 6 wk of the time of collection. Plant pigments were extracted from the filters in 90% acetone in darkness at 4°C for 48 h. Chlorophyll a concentration was determined by the method of Strickland and Parsons (1972) using a model 10-005 Turner Designs fluorometer. The two chlorophyll a measurements from each station were averaged.

Groups of frozen animals (separate species and sexes) were thawed in the laboratory, blotted lightly to remove excess water, and weighed ( $\pm 0.01$  mg). Animals were then freeze-dried for 24 h at  $-50^\circ\text{C}$  and reweighed. Groups were then immediately ground in cold (4°C) succinic acid buffer (pH 5.0) using a Polytron grinder (for euphausiids) or a hand glass tissue grinder (for copepods). Homogenates were analyzed for total proteins by the Lowry method using Sigma protein standard (Merchant et al. 1964). Laminarinase activity (LA) of the homogenates was determined by the methods described by Cox (1981) and Willason (1983). LA was expressed as a function of the animal's wet weight:  $\mu\text{g}$  glucose produced per gram wet weight per minute of incubation. Copepod homogenates were also analyzed for total lipids using stearic acid as the standard (Bligh and Dyer 1959; Marsh and Weinstein 1966).

### Data Analysis

Willason and Cox (in press) found that *E. pacifica* exhibits a diel rhythm in enzyme activity associated with feeding activity at night. Thus, to compare LA of *E. pacifica* collected at different times of the day from different localities, enzyme levels had to be standardized with respect to the time of capture. Calibration factors, which convert the LA of *E. pacifica* collected at different times to a standardized maximum value (between 0200 and 0800 h), were derived from the results of the 24-h time-series collections in Willason and Cox (in press). These factors are based on the average relative increases and decreases of enzyme activity over a 24-h period (Table 1). LA of *N. difficilis* and *C. pacificus* do not show diel changes (Cox et al. 1983; Willason and Cox in press) and, therefore, were not standardized.

The data set for each station consists of surface temperature, surface chlorophyll a, zooplankton abundance, LA, individual wet and dry weights, protein content, and lipid content (copepods only). To

permit parametric statistical comparisons between the various biological and physical properties and between regions, chlorophyll a, zooplankton abundance, and zooplankton LA were normalized by log transformation. The log transformed values were used for all parametric statistical tests. Zooplankton wet weight, dry weight, protein content, and lipid content were found to be normally distributed by probit analysis and were not log transformed. Non-transformed values from all data sets were used to construct contour maps. The contour maps are intended to show general trends and patchiness within the sampling grid.

TABLE 1.—Correction factors for standardizing laminarinase activity (LA) of *Euphausia pacifica*. These factors account for diel changes in LA and are based on the time of capture. They were derived from the 24-h time-series collections of Willason and Cox<sup>1</sup>. LA was standardized to the 0200-0800 time period. LA of euphausiids captured during other time periods was multiplied by the corresponding factor.

Time period	Correction factor	
	Females	Males
2000-0200	1.042	1.132
0200-0800	1.000	1.000
0800-1400	1.253	1.281
1400-2000	1.486	1.453

<sup>1</sup>Willason, S. W., and J. L. Cox. In press. Diel feeding, laminarinase activity and phytoplankton consumption by euphausiids. Biol. Oceanogr.

## RESULTS

### Surface Water Temperature and Surface Chlorophyll a

Surface water temperatures along the California coast during April 1981 ranged from 9.6° to 16.0°C. The coldest water was located in the northern near-shore region and the warmest was found in the southern offshore region (Table 2, Fig. 2). Two small areas showed very low surface water temperatures: close to the shore along the central coast of California and just off San Francisco Bay (Fig. 2). A cold water plume extended from Point Conception south into the Southern California Bight.

Chlorophyll a concentrations showed greater than 100-fold variation between stations and were inversely correlated with surface water temperatures ( $r = 0.83$ ,  $P < 0.001$ ). Lowest values, 0.09 to 0.16 mg chlorophyll a/m<sup>3</sup>, were found in the southern offshore region. Highest concentrations occurred in the northern nearshore region (Table 2, Fig. 3). Within



TABLE 2.—Mean surface water temperature and mean surface chlorophyll a. Chlorophyll a expressed as  $\text{mg}/\text{m}^3$ . The numbers in parentheses are one standard deviation.

	Southern Nearshore (I)	Southern Offshore (III)	Northern Nearshore (II)	Northern Offshore (IV)
Temperature ( $^{\circ}\text{C}$ )	14.85 (0.72)	15.03 (0.49)	11.56 (0.82)*	13.68 (0.78)
Chlorophyll a	0.659 (0.88)	0.141 (0.04)	5.110 (4.42)	0.485 (0.29)
Log Chlorophyll a	-0.378 (0.38)	-0.883 (0.12)	0.555 (0.39)*	-0.404 (0.31)
No. of stations	27	12	25	17

\* indicates value(s) significantly different from those of other regions ( $P < 0.05$ , t-test).

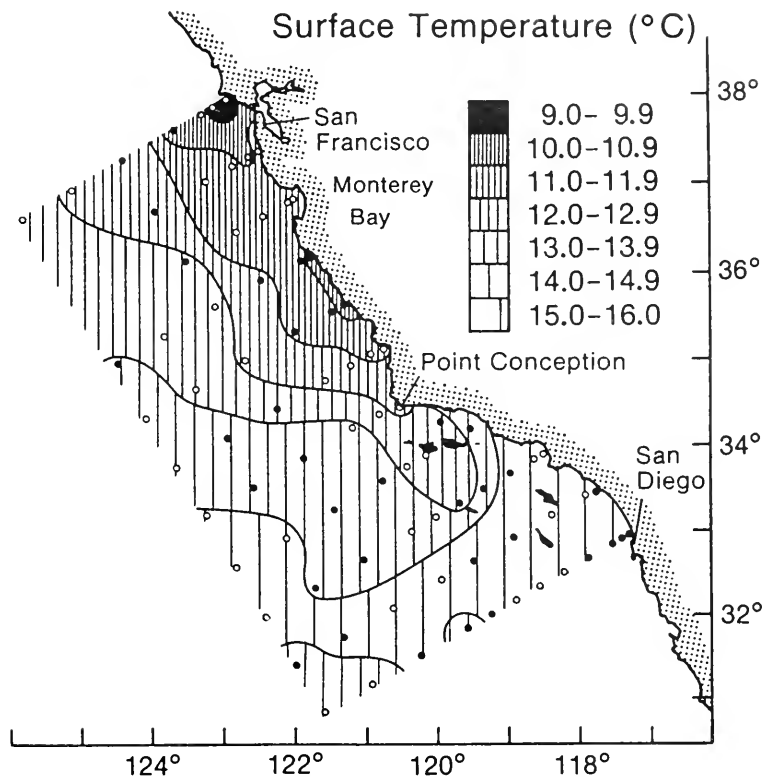

FIGURE 2.—Surface water temperatures ( $^{\circ}\text{C}$ ) along the California coast.

this region two areas of very high chlorophyll a (up to  $14.7 \text{ mg}/\text{m}^3$ ) were found: near Point Conception and just south of San Francisco Bay. These areas were located just south of the areas of coldest surface waters.

### Euphausiid Distribution and Abundance

*Euphausia pacifica* adults were captured at 43 of the 81 stations sampled and *Nematoscelis difficilis* adults were captured at 38 stations. As there was no significant difference between numbers of males and females captured of either species ( $P > 0.3$ , Wilcoxon test), the abundances shown in Figures 4 and 5 represent the sum of both sexes. Both the number of specimens of *N. difficilis* captured at each

station ( $P < 0.01$ , t-test) and the proportion of stations where individuals were caught ( $P < 0.01$ ,  $\chi^2$  test) were greater at night. For *E. pacifica*, there were no significant day-night differences in the numbers of animals captured ( $P > 0.2$ , t-test), however, like *N. difficilis*, the proportion of stations where individuals were captured was greater at night ( $P < 0.05$ ,  $\chi^2$  test). The day-night differences may represent net avoidance by euphausiids or under-sampling during the day because of vertical migration. Thus, the data presented in Figures 4 and 5 represent general trends and are intended to show relative differences between areas. Because euphausiids were captured at only about one half of the stations, statistical comparisons were made only between the north and south (i.e., nearshore and

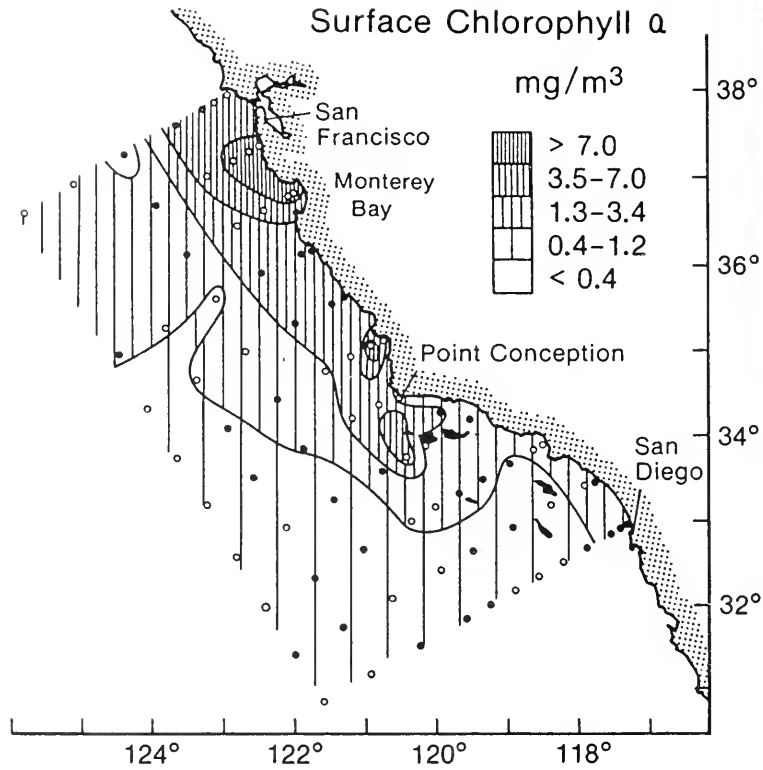

FIGURE 3.—Surface chlorophyll a. Expressed as mg chlorophyll a per m<sup>3</sup>.

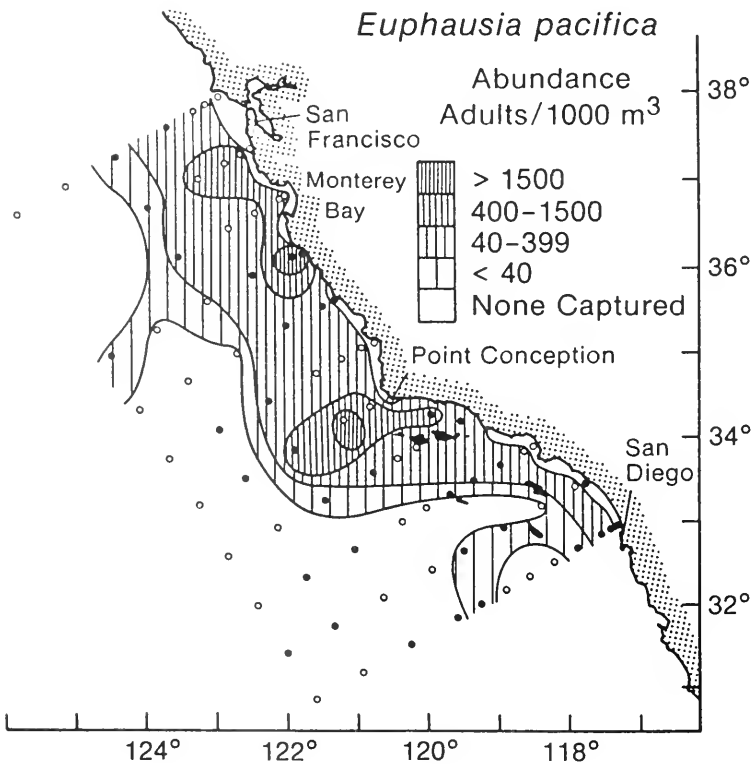

FIGURE 4.—*Euphausia pacifica* abundance. Expressed as number of adults per 1,000 m<sup>3</sup>.

offshore regions for the north and south were combined).

Specimens of *E. pacifica* were captured in significantly greater numbers north of Point Conception (Table 3) and were rare or absent at most offshore stations (regions III and IV). This species was especially abundant off Point Conception and just south of Monterey Bay along the central coast (Fig. 4).

These two areas were located close to the areas of highest chlorophyll a concentration. The abundance of *E. pacifica* was significantly correlated with chlorophyll a over the entire grid (Table 4).

The distribution of *N. difficilis* (Fig. 5) was quite different from that of *E. pacifica*. This species was captured at only 30% of the stations where *E. pacifica* was found and was distributed farther off-

TABLE 3.—Mean abundance and laminarinase activity (LA) of *Euphausia pacifica* and *Nematoscelis difficilis* in the north and south regions. Numbers in parentheses are one standard deviation. Log values were used for statistical comparisons.

	South Regions (I & III)		North (Regions II & IV)	
	Males	Females	Males	Females
<i>Euphausia pacifica</i>				
Abundance (No./1,000 m <sup>3</sup> )	96.07 (100.4)	96.41 (102.5)	200.6 (234.4)	270.2 (337.3)
Log abundance	1.604 (0.623)*	1.647 (0.666)*	2.035 (0.551)	2.119 (0.579)
LA	122.5 (47.8)	165.1 (59.9)	109.7 (68.9)	153.2 (111.9)
Log LA	2.058 (0.167)	2.186 (0.183)	1.965 (0.263)	2.099 (0.269)
No. of stations	16	15	27	27
<i>Nematoscelis difficilis</i>				
Abundance (No./1,000 m <sup>3</sup> )	13.71 (12.78)	18.06 (16.07)	55.11 (70.31)	75.17 (83.84)
Log abundance	1.001 (0.327)*	1.061 (0.461)*	1.530 (0.441)	1.657 (0.453)
LA	167.3 (87.5)	208.6 (102.9)	104.4 (41.9)	130.4 (55.1)
Log LA	2.172 (0.237)*	2.270 (0.207)*	1.992 (0.174)	2.041 (0.191)
No. of stations	16	18	20	19

\* indicates value(s) significantly different between north and south ( $P < 0.05$ , *t*-test).

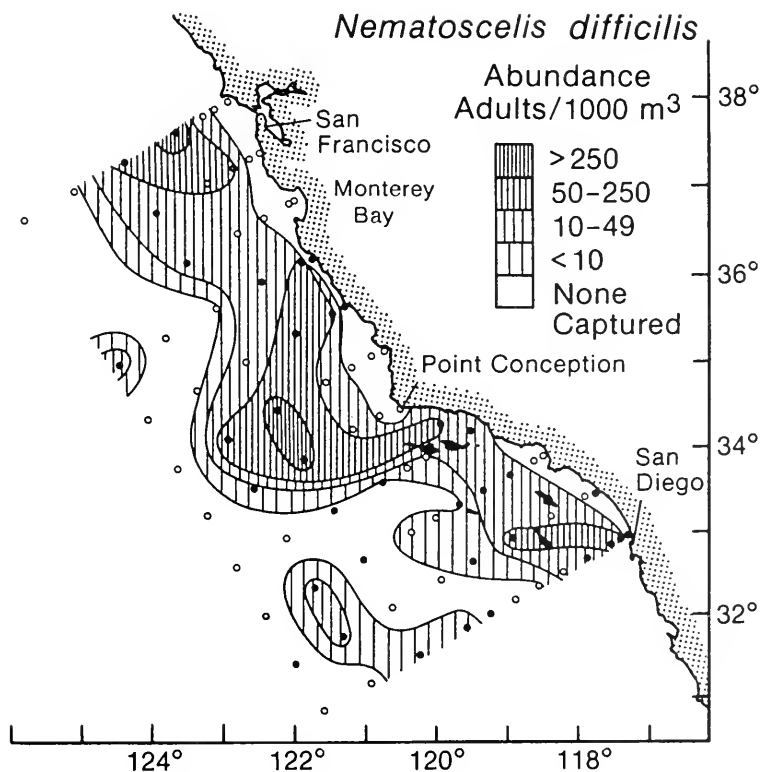

FIGURE 5.—*Nematoscelis difficilis* abundance. Expressed as number of adults per 1,000 m<sup>3</sup>.

shore. As with *E. pacifica*, both sexes of *N. difficilis* were found in significantly greater numbers in the north (Table 3). The abundance of *N. difficilis* was not correlated with surface chlorophyll a (Table 4).

### Euphausiid Laminarinase Activity

Similar to the results of Willason (1983) and Willason and Cox (in press), males of both euphausiid species showed significantly less LA than females ( $P < 0.01$ , both cases, Wilcoxon test). Males in this study had about 70% (*Euphausia pacifica*) or 80% (*Nematoscelis difficilis*) of the LA of females (Table 3). To simplify the presentation of the data on the

contour maps, LA values of males and females at each station were averaged.

The values of LA for *Euphausia pacifica* within the sampling grid ranged from 50 to 430. Euphausiids with the lowest LA values were found in offshore areas and in the nearshore area along the central coast. *Euphausia pacifica* with the highest levels of LA were found just south of San Francisco Bay and adjacent to the south of Point Conception (Fig. 6). These areas overlapped with and extended just south of the regions of highest surface chlorophyll a. There was a positive correlation between LA of *E. pacifica* and chlorophyll a over the entire grid (Table 4).

TABLE 4.—Correlations between chlorophyll a, zooplankton abundance, and laminarinase activity (LA) for *Euphausia pacifica*, *Nematoscelis difficilis*, and *Calanus pacificus*. For euphausiids, abundance and LA values used in the analyses are the averages of males and females. Numbers in parentheses refer to the number of samples used in regression analyses.

Correlation	Correlation coefficients			
	<i>E. pacifica</i> (43)	<i>N. difficilis</i> (38)	<i>C. pacificus</i> ♀ (81)	<i>C. pacificus</i> ♂ (81)
Chlorophyll a vs. abundance	0.61	0.27	0.24	0.31
Chlorophyll a vs. LA	0.57	0.03	0.53	0.62
LA vs. abundance	0.40	0.14	0.38	0.48

<sup>1</sup>Correlation coefficients which were not significant at the 95% level.

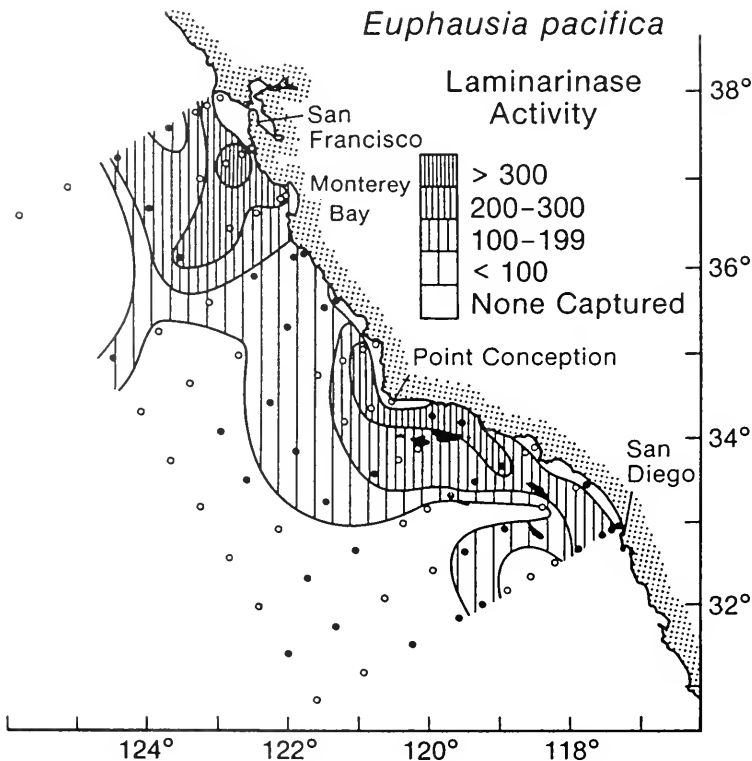

FIGURE 6.—*Euphausia pacifica* laminarinase activity (LA). Expressed as  $\mu\text{g}$  glucose per gram wet weight per minute.

The values of LA for *Nematoscelis difficilis* were in the same range as those of *Euphausia pacifica* (50 to 400), but showed a different distributional pattern (Fig. 7). Regions of highest activity were located in three small areas: adjacent to San Diego, in the Santa Barbara Channel (just south of Point Conception), and in an area about 150 km off Monterey Bay. Both males and females of *N. difficilis* had significantly higher levels of LA in the southern portion of the grid (Table 3). LA of *N. difficilis* was not correlated with chlorophyll a (Table 4). *Nematoscelis difficilis* with high LA were often found in areas with very low phytoplankton biomass and vice versa.

### Euphausiid Size and Chemical Composition

Mean wet and dry weights, water content, and protein content (expressed as percent dry weight and percent wet weight) of *Euphausia pacifica* and *Nematoscelis difficilis* are presented in Table 5. Female *E. pacifica* and both sexes of *N. difficilis* had significantly higher wet and dry weights in the north. The water content of both euphausiid species ranged from 76.5 to 81.7% and was very similar between

species, sexes, and regions (Table 5). Protein content was also very similar between species, sexes, and regions. The protein values reported here (51 to 56% of dry weight) are within the range of previously reported values (Childress and Nygaard 1974).

### Copepod Distribution and Abundance

Female and stage V copepodites of *Calanus pacificus* were captured at all 81 stations sampled. There were no significant differences between day and night catches for either *C. pacificus* ( $P < 0.01$ , *t*-test). For comparisons between regions, mean abundances were calculated using both the log transformed and nontransformed values (Table 6). The log transformed values were used for statistical comparisons. The overall abundances of females and stage V copepodites were similar to one another in all regions ( $P > 0.1$ , *t*-test, all cases). Both *C. pacificus* stages were significantly more abundant in the two nearshore regions (I and II) than in the two offshore regions (III and IV) (Table 6). Figures 8 and 9 show that the distributions of females and stage V *C. pacificus* were patchy within regions. Copepods were particularly abundant in the area close to and just south of Point Conception. An extremely dense aggrega-

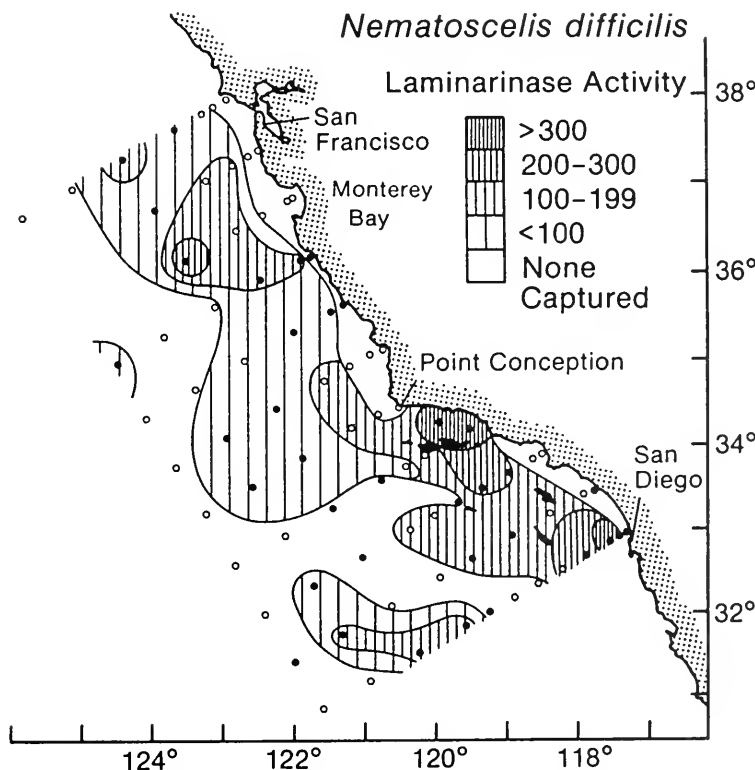

FIGURE 7.—*Nematoscelis difficilis* laminarinase activity (LA). Expressed as  $\mu\text{g}$  glucose per gram wet weight per minute.

TABLE 5.—Mean individual wet weight, dry weight, % water, and protein content of *Euphausia pacifica* and *Nematoscelis difficilis* from the north and south. Numbers in parentheses are one standard deviation.

	South (Regions I & III)		North (Regions II & IV)	
	Males	Females	Males	Females
<i>Euphausia pacifica</i>				
Wet weight (mg)	31.01 (11.55)	32.57 (10.81)*	37.73 (11.24)	42.38 (12.11)*
Dry weight (mg)	6.48 (2.38)	6.75 (2.53)*	7.91 (2.57)	8.98 (2.41)*
% water	79.10	79.28	79.04	78.81
Protein (% dry wt)	54.57	56.16	52.62	52.26
Protein (% wet wt)	11.40	11.62	11.05	11.02
No. of stations	16	15	27	27
<i>Nematoscelis difficilis</i>				
Wet weight (mg)	27.63 (7.07)*	34.73 (11.28)*	35.23 (7.26)*	43.59 (8.72)*
Dry weight (mg)	5.96 (2.21)	7.22 (2.49)*	7.43 (2.22)	9.19 (2.78)*
% water	78.43	79.22	78.82	78.94
Protein (% dry wt)	56.59	51.23	52.92	54.96
Protein (% wet wt)	12.22	10.65	11.17	11.58
No. of stations	16	18	20	19

\* indicates value(s) significantly different between north and south ( $P < 0.05$ ,  $t$ -test).

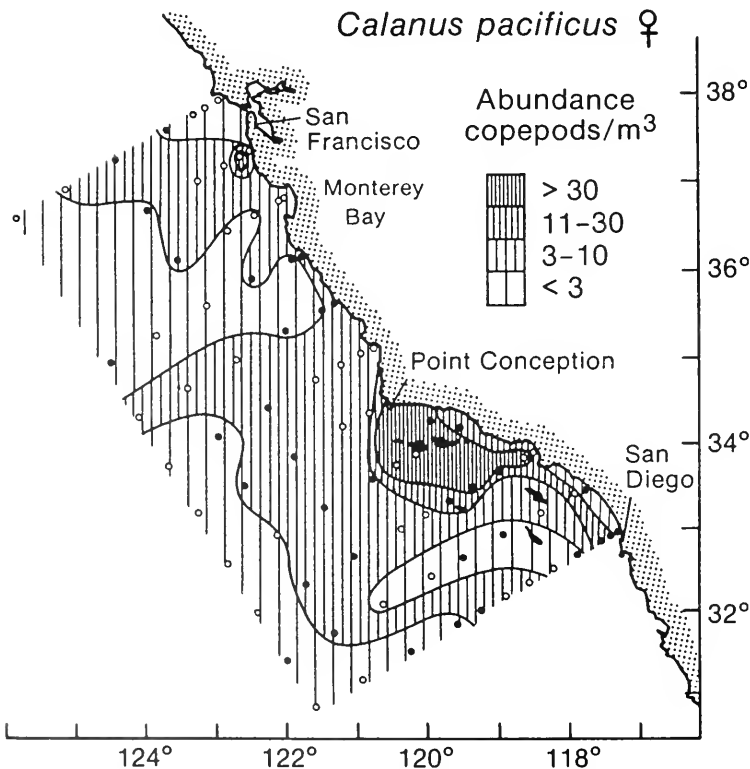

FIGURE 8.—*Calanus pacificus* females, abundance. Expressed as number of copepods per  $m^3$ .

tion of stage V *C. pacificus* (474 copepods/ $m^3$ ) was found at the station adjacent to Point Conception. The areas where *C. pacificus* showed the highest abundances were located near regions of high chlorophyll *a* concentration. However, the abundances of both *C. pacificus* stages were poorly correlated (although significant at the 95% level) with chlorophyll *a* over the entire grid (Table 4).

### Copepod Laminarinase Activity

LA of female and stage V copepodites was much higher than the levels of both euphausiid species when expressed on a per weight basis. Like the euphausiid results, there was large variability in the LA of *C. pacificus* among stations. For example, LA of stage V copepodites ranged from <150 at offshore

TABLE 6.—*Calanus pacificus*. Mean abundance and laminarinase activity (LA) of stage V copepodites and females from each region. Numbers in parentheses are one standard deviation. Log values were used for statistical comparisons.

	Southern Nearshore (I)	Southern Offshore (III)	Northern Nearshore (II)	Northern Offshore (IV)
Stage V copepodites				
Abundance (No./m <sup>3</sup> )	22.89 (32.11)	1.70 (0.86)	26.07 (93.90)	1.82 (1.44)
Log abundance	0.924 (0.681)*	0.175 (0.233)	0.571 (0.733)*	0.139 (0.299)
LA	825.4 (455)	538.6 (254)	1,527.5 (792.1)	933.2 (659.4)
Log LA	2.845 (0.272)	2.688 (0.201)	3.129 (0.231)*	2.891 (0.258)
Females				
Abundance (No./m <sup>3</sup> )	14.21 (14.72)	2.54 (2.21)	6.67 (10.79)	3.05 (2.03)
Log abundance	0.807 (0.692)*	0.253 (0.411)	0.621 (0.400)*	0.343 (0.351)
LA	927.6 (466.2)	635.2 (413.5)	1,272.9 (610.3)	1,041.5 (547.5)
Log LA	2.913 (0.281)	2.734 (0.222)	3.072 (0.204)*	2.856 (0.261)
No. of stations	27	12	25	17

\* indicates value(s) significantly greater than those of other regions ( $P < 0.05$ , t-test).

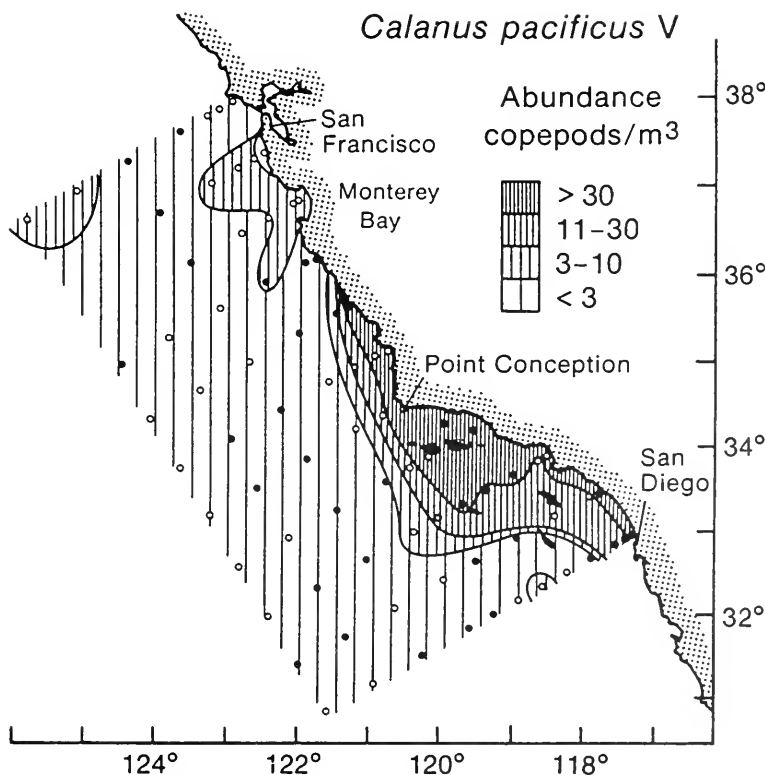

FIGURE 9.—*Calanus pacificus* Stage V copepodites, abundance. Expressed as number of copepods per m<sup>3</sup>.

stations to 3,855 at the station adjacent to Point Conception. LA of replicate groups of 50 copepods from the same station were very similar indicating that the variability was due to differences between stations ( $P < 0.05$ , ANOVA).

*Calanus pacificus* LA also showed large differences among the four hydrographic regions. Both females and stage V copepodites from the northern nearshore region (II) had significantly higher levels

of LA than copepods from the other regions (Table 6). Copepods in the southern offshore region had the lowest levels. The contour maps of *C. pacificus* LA show patches of copepods with high LA located adjacent to and just south of Point Conception and off Monterey Bay (Figs. 10, 11). These areas were located near the regions of highest *E. pacifica* LA (Fig. 6) and close to the regions of highest chlorophyll a (Fig. 3). There were significant positive cor-

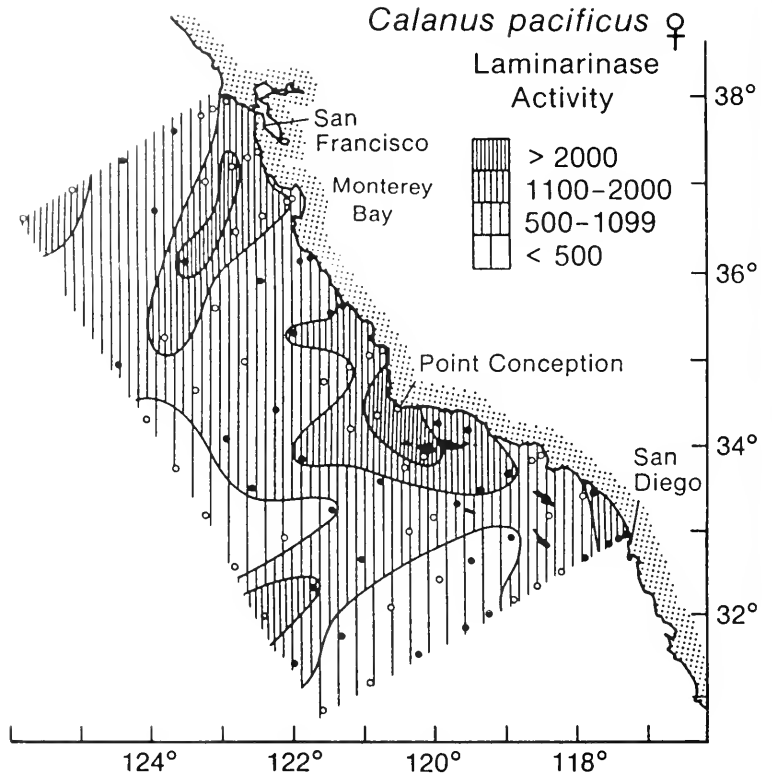

FIGURE 10.—*Calanus pacificus* females, laminarinase activity (LA). Expressed as  $\mu\text{g}$  glucose per gram wet weight per minute.

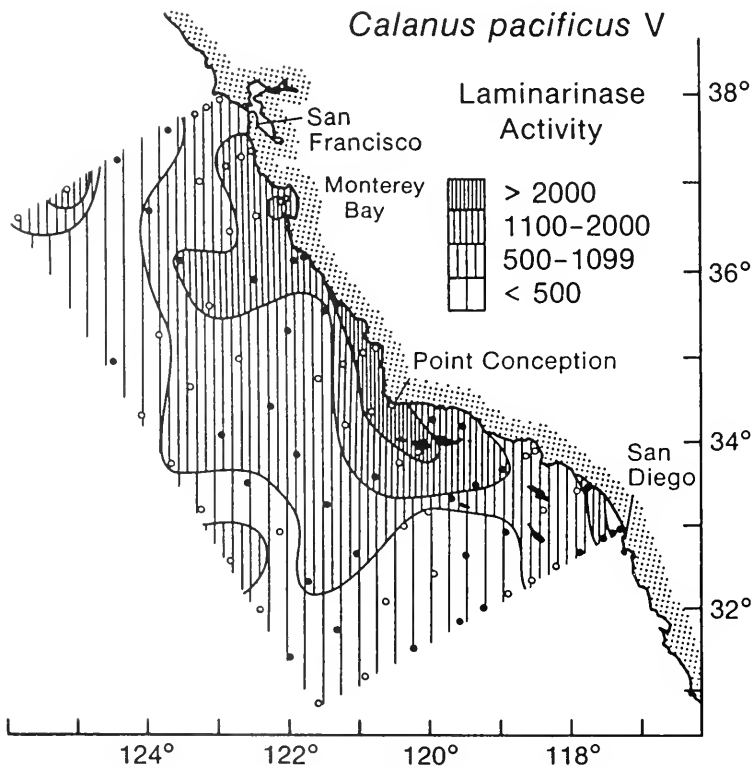

FIGURE 11.—*Calanus pacificus* Stage V copepodites, laminarinase activity (LA) Expressed as  $\mu\text{g}$  glucose per gram wet weight per minute.



relations between the LA of both *C. pacificus* stages and the concentration of chlorophyll *a* (Table 4).

### Copepod Wet and Dry Weights

The largest female and stage V *C. pacificus* in terms of weight were located in the northern near-shore region and the smallest copepods were found in the southern regions (Table 7). The average water content of both *C. pacificus* stages from the four regions was inversely related to the average dry weights. Specimens of *C. pacificus* with the lowest water content were found in the northern nearshore region and those with highest water content were located in the southern offshore region (Table 7).

Figures 12 and 13 show the distribution of wet weights of *C. pacificus* females and stage V copepodites, respectively. Since wet and dry weights were highly correlated ( $r = 0.81$  and  $0.83$ ,  $P < 0.001$ ) only wet weights are shown. Both figures show a band of large copepods in the nearshore region along the central coast. The figures also show the variation in size of each stage between areas. Copepods (both stages) in the "heavy band" along the central coast were almost twice the weight of copepods at some of the offshore and southern stations.

### Copepod Protein and Lipid Content

Total protein content ( $\mu\text{g}$  per copepod) of both *C.*

*pacificus* stages was highest in the northern near-shore region and lowest in the two southern regions (Table 7). This appears to reflect differences in copepod size between regions as there were highly significant correlations between the protein content and the wet weight for both female ( $r = 0.82$ ,  $P < 0.001$ ) and stage V *C. pacificus* ( $r = 0.69$ ,  $P < 0.001$ ). Protein content was not mapped since the patterns were very similar to those of wet weight.

Protein content of *C. pacificus*, expressed as percent of wet weight, was quite similar between regions: 8.9 to 10.5% for stage V copepodites and 9.3 and 10.8% for females (Table 7). However, both stages from the southern offshore region did show slightly higher protein content when expressed as percent dry weight. This probably reflects the high water content of copepods from the southern offshore region.

The distributions of lipid content of female and stage V *C. pacificus* were very patchy and showed greater than fourfold variation between areas (Figs. 14, 15). Copepods with highest lipid values were found in the area surrounding Point Conception and off San Francisco Bay. Although copepod size (wet weight) probably influenced the total lipid content of *C. pacificus* to some extent, the variability of lipid content cannot be attributed solely to weight. Lipid content, unlike protein content, was poorly correlated with wet weight ( $r = 0.26$  for females and  $r = 0.38$  for stage V copepodites).

TABLE 7.—*Calanus pacificus*. Mean wet weight, dry weight, percent water, protein content, and lipid content for stage V copepodites and females from each region. Numbers in parentheses are one standard deviation.

	Southern Nearshore (I)	Southern Offshore (III)	Northern Nearshore (II)	Northern Offshore (IV)
Stage V copepodites				
Wet weight ( $\mu\text{g}$ )	471 (81)	447 (83)	555 (92)*	465 (95)
Dry weight ( $\mu\text{g}$ )	98 (21)	88 (23)	125 (26)*	98 (25)
% water	79.20	80.31	77.54	78.89
Protein ( $\mu\text{g}/\text{copepod}$ )	41.88 (12.24)	44.82 (9.31)	52.15 (11.26)	48.58 (8.02)
Protein (% dry wt)	44.12	49.25	42.75	48.10
Protein (% wet wt)	8.89	10.03	9.40	10.45
Lipid ( $\mu\text{g}/\text{copepod}$ )	19.74 (7.82)	13.94 (4.96)	29.33 (7.72)*	15.74 (5.71)
Lipid (% dry wt)	20.78	15.32	24.04	15.58
Lipid (% wet wt)	4.19	3.12	5.28	3.38
Females				
Wet weight ( $\mu\text{g}$ )	1,023 (170)	1,083 (160)	1,278 (180)*	1,125 (190)
Dry weight ( $\mu\text{g}$ )	191 (47)	185 (38)	263 (40)*	225 (29)
% water	81.34	82.83	79.40	80.20
Protein ( $\mu\text{g}/\text{copepod}$ )	94.92 (22.71)	100.84 (24.84)	137.81 (26.40)*	115.62 (23.33)
Protein (% dry wt)	49.70	54.51	52.74	51.38
Protein (% wet wt)	9.28	9.31	10.78	10.28
Lipid ( $\mu\text{g}/\text{copepod}$ )	26.71 (13.31)	21.96 (9.00)	35.27 (11.47)	30.19 (10.21)
Lipid (% dry wt)	13.81	11.69	13.41	13.47
Lipid (% wet wt)	2.61	2.03	2.76	2.68
No. of stations	27	12	25	17

\* indicates value(s) significantly greater than those of other regions ( $P < 0.05$ , *t*-test).

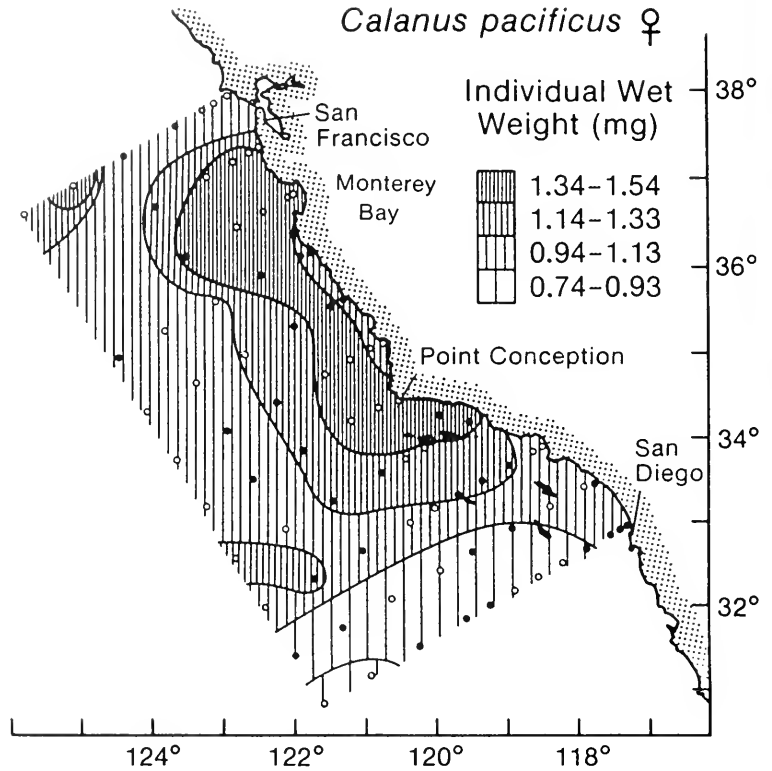

FIGURE 12.—*Calanus pacificus* females. Average individual wet weight in mg.

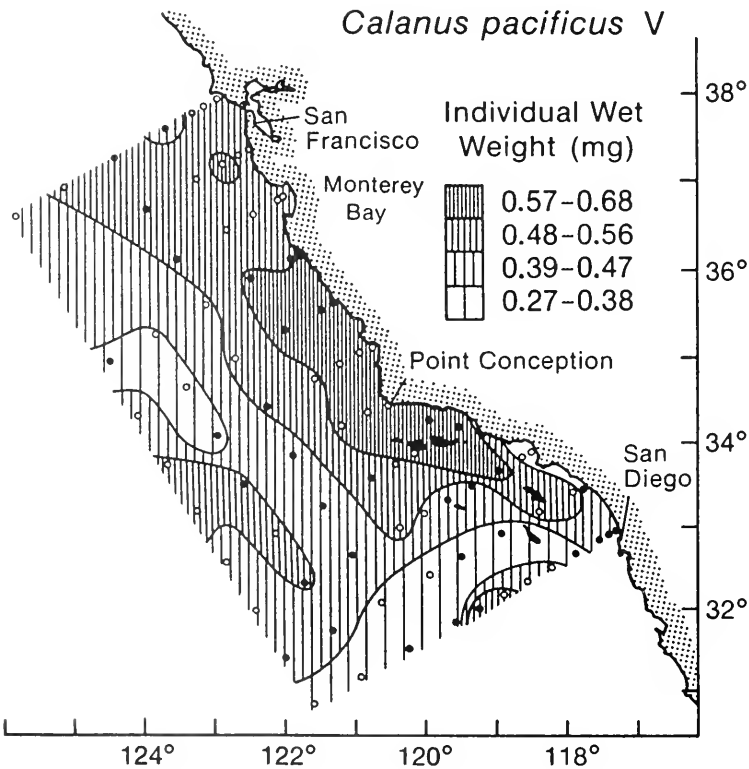

FIGURE 13.—*Calanus pacificus* Stages V copepodites. Average individual wet weight in mg.

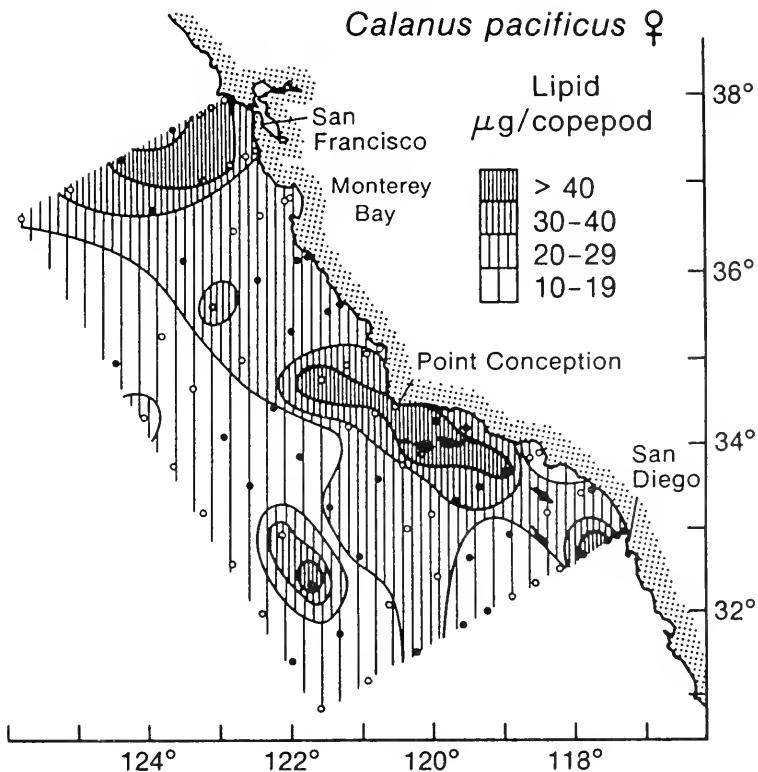

FIGURE 14.—*Calanus pacificus* females. Average lipid content per copepod in μg.

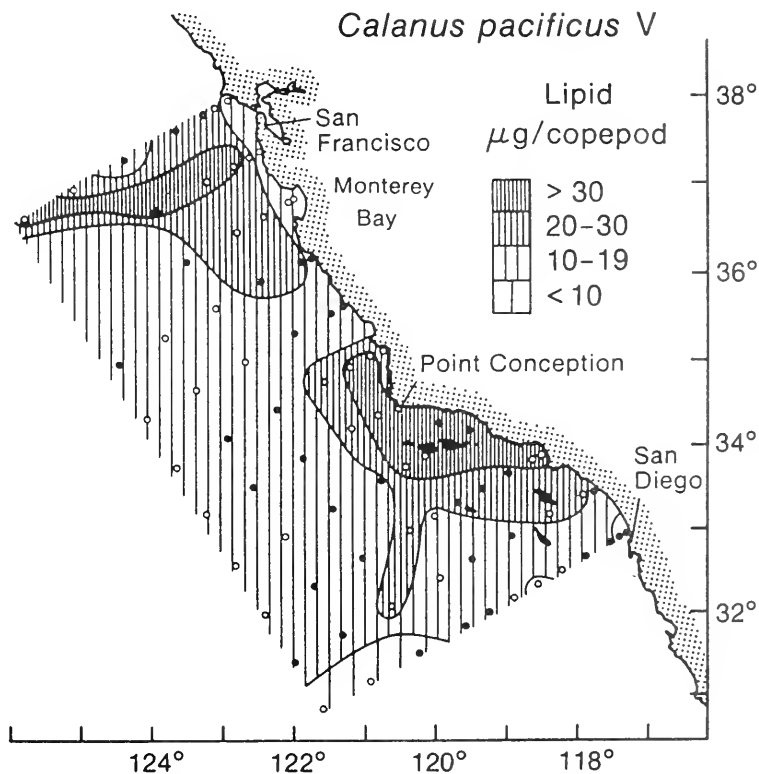

FIGURE 15.—*Calanus pacificus* Stage V copepodites. Average lipid content per copepod in μg.

Lipid content of female *C. pacificus*, expressed as percent dry weight or percent wet weight, was lowest in the southern offshore region, but was quite similar between the other three regions (Table 7). Lipid content (percent dry or wet weight) of stage V copepodites from the northern nearshore region was higher than the other regions. This stage showed the lowest lipid content in the southern offshore region (Table 7).

## DISCUSSION

Upwelling was taking place along the California coast during April 1981. The resulting coastal low surface water temperatures were most evident in the northern part of the sampling grid, especially just north of Point Conception. An upwelling index calculated for this region during mid-April was higher than the 20-yr mean (Howe et al. 1981). The cold-water plume extending into the Southern California Bight (Fig. 2) is a common phenomenon that occurs when cold, upwelled water from the Point Conception region becomes entrained into the southward flowing California Current (Reid et al. 1958; Bernstein et al. 1977; Lasker et al. 1981). The distribution of phytoplankton biomass (estimated by surface chlorophyll a) was the most obvious biological feature associated with coastal upwelling. Phytoplankton patchiness in turn influenced zooplankton biomass and nutritional parameters. The following discusses 1) the relationships between various biological properties influenced by upwelling and 2) the persistence and consequences of biological meso-scale patchiness within the California Current System.

The distributions and abundances of both euphausiid species were similar to previous reports (Brinton 1962, 1967b, 1976, 1981; Brinton and Wyllie 1976; Youngbluth 1976). *Euphausia pacifica* is generally more abundant than *Nematoscelis difficilis*, and the center of its distribution is located closer to the coast. The abundance of *E. pacifica* within the sampling grid was positively correlated with phytoplankton biomass, as has been noted by Youngbluth (1976). Other herbivorous euphausiids (e.g., *Thysanoessa raschii* and *T. inermis*) also show this same relationship (Sameoto 1976).

The distribution and abundance of *Calanus pacificus* stages were also similar to previous reports (Fleminger 1964; Longhurst 1967). Both females and stage V copepodites were most abundant close to the coast near upwelling regions. In contrast to *E. pacifica*, abundances of the two *C. pacificus* stages showed rather poor (but significant at 95% level) correla-

tions with phytoplankton biomass ( $r$  values of 0.24 and 0.31). This result was surprising since both species are considered herbivores. The weak correlations between *C. pacificus* abundance and phytoplankton standing crop probably resulted from small-scale heterogeneity and poor mobility of the *C. pacificus* population. Populations of *C. pacificus* along the California coast show a great deal of small-scale patchiness on the order of 10's to 100's of meters (Mullin and Brooks 1976; Star and Mullin 1981; Cox et al. 1982). Grazing by copepods within these patches can greatly reduce the local phytoplankton standing crop. When samples are taken on scales of 1 km or less, a poor or inverse correlation between phytoplankton and zooplankton biomass results (Mackas and Boyd 1979; Star and Mullin 1981). Zooplankton samples in this study were collected from net tows that covered distances of about 1 km or less. Thus, the poor correlations in the present study confirm results of previous studies and can be explained on the basis of the sampling procedure.

Laminarinase activity (LA) of *C. pacificus* and *E. pacifica* was positively related to phytoplankton standing crop. However, a strong relationship between these variables did not exist for either species (correlation coefficients between 0.53 and 0.62). These results were expected because, although most studies agree that zooplankton digestive enzyme activity and feeding rates are closely linked, enzyme levels do not always represent instantaneous ingestion rates nor are they always related to the food environment at the time of collection (Head and Conover 1983; Hassett and Landry 1983; Head et al. 1984; Willason and Cox in press).

We propose three, non-exclusive explanations for the observed weak correlations between LA and phytoplankton biomass. First, time lags of 1 to 7 d in the response of zooplankton digestive enzymes to changing food concentrations (Mayzaud and Poulet 1978; Cox and Willason 1981; Willason 1983) can influence the association between enzyme levels and the food environment. Because the standing stock of phytoplankton is often very patchy and can change rapidly, especially in upwelling regions, zooplankters are probably continually acclimating to new conditions and an equilibrium may seldom be reached between enzyme activity, feeding rates, and food concentration.

Second, phytoplankton concentration may occasionally be high in terms of chlorophyll a, but poor in quality resulting in low consumption rates and low digestive enzyme activity. Herbivorous zooplankton feeding rates have been shown to be greatly de-

pressed by the presence of unpalatable or toxic phytoplankton (Fielder 1982).

Third, recent evidence indicates that zooplankton digestive enzymes do not show a substrate-specific response. Head and Conover (1983) found that LA in *C. hyperboreus* was induced in animals which were fed an algae that did not contain laminarin. Willason (1983) found that levels of laminarinase in *E. pacifica* increased when animals consumed small, nonreactive charcoal particles. This increase in activity, however, was less than that of animals given phytoplankton as a food source. Hence, some types of nonphytoplankton food, such as detrital particles or fecal pellets, may also elicit a positive digestive enzyme response. However, since *E. pacifica* and *C. pacificus* are primarily herbivorous and are found close to the coast where phytoplankton is abundant, LA of these zooplankters is probably, for the most part, controlled by phytoplankton consumption.

Because of large-scale patchiness within the sampling grid, relationships between the various biological properties are much clearer when stations were grouped and regions or mesoscale features compared. Mesoscale patches (100 to 200 km) of *C. pacificus* and *E. pacifica* with high LA values were clearly associated with areas of highest phytoplankton standing crop: south of San Francisco Bay and particularly in the area adjacent to and just south of Point Conception. Although laminarinase levels may not always accurately represent the feeding conditions at a single station (because of the reasons stated above), large-scale comparisons indicate that digestive enzyme levels of herbivorous zooplankton are strongly influenced by overall food concentration within an area. This suggests that animals near the coastal upwelling regions were feeding at higher rates than animals from other areas of the sampling grid.

In contrast to *E. pacifica*, neither the abundance nor the LA of *N. difficilis* were correlated with phytoplankton standing crop. These differences between the two euphausiid species are due most likely to different feeding modes or different food preferences. *Nematoscelis difficilis*, unlike *E. pacifica* and *C. pacificus*, is probably not a herbivore. Nemoto (1967) concluded that its mouthparts were very different from those of most herbivorous euphausiids, and Willason and Cox (in press) found that phytoplankton was only a small part of the diet of *N. difficilis*. What is puzzling, however, are the high levels of LA we sometimes found in *N. difficilis*, a range of values similar to those of *E. pacifica*. Laminarinase levels in *N. difficilis* are apparently controlled by consumption of a food source other than phytoplankton. Since we

did not examine the gut contents of *N. difficilis* nor quantify potential food other than phytoplankton, the type of food eaten by *N. difficilis* could not be determined.

Based on the weight and biochemical composition of *C. pacificus*, the areas of high feeding activity along the California coast appear to have been persistent for periods of at least 1 to 2 wk. *Calanus pacificus* from the northern nearshore region and from the area near Point Conception were heavier, had a lower water content, and a higher lipid content than copepods from other areas. This indicates that these copepods have had prolonged exposure to better feeding conditions. The use of zooplankton biochemical composition and weight as indices of relative "physiological" or "nutritional" state has been documented in laboratory experiments. Vidal (1980) showed a direct relationship between food concentration and weight of adult and stage V *C. pacificus*. Since *C. pacificus* completes a life cycle in about 30 d (Vidal 1980; Huntley and Brooks 1982) and has a fixed number of molts to maturity, 1 or 2 wk at higher food concentrations can have a large impact on adult size. The lipid content of a zooplankton species represents an energy reserve and is an excellent indicator of nutritional state. Lipid content increases in well-fed animals and decreases in starved animals (Lee et al. 1970, 1971; Mayzaud 1976; Hakanson 1984). During periods of starvation, crustaceans in the laboratory also show an increase in water content (Hiller-Adams and Childress 1983).

Two field studies have shown that changes in food quality and quantity can cause physiological or nutritional changes in zooplankton populations (Omori 1970; Boyd et al. 1978). In both of these cases, zooplankters were displaced from their optimal habitat to areas of lower food concentration by currents or eddies. The displaced zooplankters showed a lower lipid content and a higher water content presumably due to suboptimal nutrition. This may be what happened to individuals of *C. pacificus* in the offshore areas of the California Current. These copepods weighed less and were in poorer physiological condition (high water content and low lipid content) than *C. pacificus* located close to the upwelling regions. Although the origins of these copepods are not known, physical processes within the California Current System such as eddy extensions (Bernstein et al. 1977; Pelaez and Guan 1982; Haury 1984) or offshore surface transport mechanisms (Parrish et al. 1981) could displace zooplankters such as *C. pacificus* to the food-poor offshore waters.

Because euphausiids were captured at only about

one-half of the stations, comparisons of weight and water content between specific regions were difficult. Although the average weight of adults of both euphausiid species were greater in the northern area (nearshore and offshore combined), water content of both species was similar in all areas. The weight and biochemical composition of adult euphausiids may be less susceptible to short-term changes in food concentration than copepods because of their larger size and longer life cycle (>1 yr, Ross 1982).

Thus far, it is apparent that processes which occur in relatively small areas along the California coast, in particular the area near Point Conception, have a considerable influence on the nutritional state of two common herbivorous zooplankters, *E. pacifica*, and *C. pacificus*. What are the long-term implications of this mesoscale patchiness?

The regions of high phytoplankton standing crop found in April 1981 appear to be relatively predictable from year to year. Although upwelling events in these areas are episodic and seasonal, previous studies have shown similar patterns. CalCOFI surveys (Owen 1974) and recent satellite imagery (Smith and Baker 1982; Pelaez and Guan 1982) indicate that in past years Point Conception and the area off Monterey Bay have consistently been regions of high phytoplankton production during the spring and summer months. This enhanced production has undoubtedly influenced zooplankton populations in preceding years in much the same way that was found during the present study. Previous investigations concerning zooplankton distributions and grazing activity along the California coast support this conclusion (Fleminger 1964; Brinton 1976, 1981; Cox et al. 1982, 1983).

Although reproduction was not estimated, it is likely that well-fed zooplankters in the California Current produce more eggs than poorly fed animals. This has clearly been demonstrated in the laboratory for copepods (Marshall and Orr 1955; Checkley 1980) and has been suggested for euphausiids (Brinton 1976). Larger individuals of a species also produce more eggs (Brinton 1976; Nemoto et al. 1972; Ross et al. 1982). Thus, the larger, better fed copepods and euphausiids near Point Conception and off Monterey Bay probably have a higher reproductive output than animals from other areas. There is some evidence which suggests that enhanced reproduction of zooplankton takes place near Point Conception. Arthur (1977) noted that the highest densities of copepod nauplii in the Southern California Bight were located in a cold-water upwelling plume extending south from Point Conception. In addition, eggs and larvae of *E. pacifica* are more abundant in the

Southern California region following periods of upwelling (Brinton 1976).

In summary, our results show that upwelling and phytoplankton variability have a significant impact on the herbivorous zooplankton in the California Current. Not only did we find patchiness of zooplankton abundances, but more importantly, zooplankton nutritional states were also highly variable (i.e., mesoscale and larger scale patchiness of trophic interactions). Zooplankton in upwelling regions appear to experience better feeding conditions for periods of up to several weeks. Prolonged periods of better feeding conditions in specific areas should influence secondary production as well. This implies that the relatively small, productive regions along the California coast, south of San Francisco Bay and particularly the area near Point Conception, have a disproportionately large impact on the biology of marine organisms within the California Current System.

## ACKNOWLEDGMENTS

We thank M. Page, T. Bailey, L. Haury, D. Morse, and R. Trench for critical review of the manuscript. We also thank P. Smith and the research staff at the Southwest Fisheries Center in La Jolla for support during CalCOFI cruise 8104 and for providing access to preserved samples. This work was supported by NSF grants OEC 79-9317 and OEC 81-09934 and by the Marine Science Institute at the University of California, Santa Barbara.

## LITERATURE CITED

- ARTHUR, D. K.  
1977. Distribution, size, and abundance of microcopepods in the California Current system and their possible influence on the survival of marine teleost larvae. *Fish. Bull.*, U.S. 75:601-611.
- BAMSTEDT, U.  
1975. Ecological aspects of individual variations in weight and protein and lipid content of *Euchaeta norvegica* (copepoda). *Sarsia* 59:31-46.
- BERNSTEIN, R. L., L. BREAKER, AND R. WHRITNER.  
1977. California Current eddy formation: ship, air, and satellite results. *Science* 195:353-359.
- BLIGH, E. G., AND W. J. DYER.  
1959. A rapid method of total lipid extraction. *Can. J. Biochem. Physiol.* 37:911-917.
- BOYD, S. H., P. H. WIEBE, AND J. L. COX.  
1978. Limits of *Nematoscelis megalops* in the northwestern Atlantic in relation to Gulf Stream cold core rings. II. Physiological and biochemical effects of expatriation. *J. Mar. Res.* 36:143-159.
- BRINTON, E.  
1962. The distribution of Pacific euphausiids. *Bull. Scripps Inst. Oceanogr., Univ. Calif.* 8:51-270.

- 1967a. Vertical migration and avoidance capability of euphausiids in the California Current. *Limnol. Oceanogr.* 12:451-483.
- 1967b. Distributional atlas of Euphausiacea (Crustacea) in the California Current region, Part I. *Calif. Coop. Oceanic Fish. Invest. Atlas*, Vol. 5, 275 p.
1976. Population biology of *Euphausia pacifica* off southern California. *Fish. Bull., U.S.* 74:733-762.
1981. Euphausiid distributions in the California Current during the warm winter-spring of 1977-78, in the context of a 1949-1966 time series. *Calif. Coop. Oceanic Fish. Invest. Rep.* 22:135-154.
- BRINTON, E., AND A. W. TOWNSEND.  
1981. A comparison of euphausiid abundances from bongo and 1-m nets. *Calif. Coop. Oceanic Fish. Invest. Rep.* 22:111-125.
- BRINTON, E., AND J. G. WYLLIE.  
1976. Distributional atlas of euphausiid growth stages off southern California, 1953-1956. *Calif. Coop. Oceanic Fish. Invest. Atlas* Vol. 24, 289 p.
- CHECKLEY, D. M., JR.  
1980. The egg production of a marine planktonic copepod in relation to its food supply: Laboratory studies. *Limnol. Oceanogr.* 25:430-446.
- CHILDRESS, J. J.  
1977. Physiological approaches to the biology of midwater organisms. In N. R. Andersen and B. J. Zahuranec (editors), *Oceanic sound scattering prediction*, Vol. 5, p. 301-324. Plenum Press, N.Y.
- CHILDRESS, J. J., AND M. NYGAARD.  
1974. Chemical composition and buoyancy of midwater crustaceans as a function of depth of occurrence off Southern California. *Mar. Biol. (Berl.)* 27:225-238.
- COX, J. L.  
1981. Laminarinase induction in marine zooplankton and its variability in zooplankton samples. *J. Plankton Res.* 3:345-356.
- COX, J. L., L. R. HAURY, AND J. J. SIMPSON.  
1982. Spatial patterns of grazing-related parameters in California coastal surface waters, July 1979. *J. Mar. Res.* 40:1127-1153.
- COX, J. L., AND S. W. WILLASON.  
1981. Laminarinase induction in *Calanus pacificus*. *Mar. Biol. Lett.* 2:307-311.
- COX, J. L., S. W. WILLASON, AND L. HARDING.  
1983. Consequences of distributional heterogeneity of *Calanus pacificus* grazing. *Bull. Mar. Sci.* 33:213-226.
- FIEDLER, P. C.  
1982. Zooplankton avoidance and reduced grazing responses to *Gymnodinium splendens* (Dinophyceae). *Limnol. Oceanogr.* 27:961-965.
- FLEMINGER, A.  
1964. Distributional atlas of calanoid copepods in the California Current region, Part I. *Calif. Coop. Oceanic Fish. Invest. Atlas*, Vol. 2, 313 p.
- HAKANSON, J. L.  
1984. The long and short term feeding condition in field-caught *Calanus pacificus*, as determined by the lipid content. *Limnol. Oceanogr.* 29:794-804.
- HASSETT, R. P., AND M. R. LANDRY.  
1982. Digestive carbohydrase activities in individual marine copepods. *Mar. Biol. Lett.* 3:211-221.
1983. Effects of food-level acclimation on digestive enzyme activities and feeding behavior of *Calanus pacificus*. *Mar. Biol. (Berl.)* 75:47-55.
- HAURY, L. R.  
1982. Mesoscale processes: The biological and physical connections. [Abstr.] *EOS* 63-68. *Trans. Am. Geophys. Union.*
1984. An offshore eddy in the California Current System Part IV: Plankton distributions. *Prog. Oceanogr.* 13:95-111.
- HAURY, L. R., J. A. MCGOWAN, AND P. H. WIEBE.  
1978. Pattern and processes in the time-space scales of plankton distributions. In J. H. Steele (editor), *Spatial patterns in plankton communities*, p. 277-327. Plenum Press, N.Y.
- HAYWARD, T. L., AND E. L. VENRICK.  
1982. Relation between surface chlorophyll, integrated chlorophyll and integrated primary production. *Mar. Biol. (Berl.)* 69:247-252.
- HEAD, E. J. H., AND R. J. CONOVER.  
1983. Induction of digestive enzymes in *Calanus hyperboreus*. *Mar. Biol. Lett.* 4:219-231.
- HEAD, E. J. H., R. WANG, AND R. J. CONOVER.  
1984. Comparison of diurnal feeding rhythms in *Temora longicornis* and *Centropages hamatus* with digestive enzyme activity. *J. Plankton Res.* 6:543-551.
- HILLER-ADAMS, P., AND J. J. CHILDRESS.  
1983. Effects of prolonged starvation on O<sub>2</sub> consumption, NH<sub>4</sub><sup>+</sup> excretion, and chemical composition of the bathypelagic mysid *Gnathophausia ingens*. *Mar. Biol. (Berl.)* 77: 119-127.
- HOWE, J. T., D. B. GIBSON, T. O. EVANS, L. BREAKER, R. C. WRIGLEY, AND W. W. BROENKOW.  
1981. Biological and physical oceanographic observations pertaining to the trawl fishery in a region of persistent coastal upwelling. *NASA Tech. Mem.* 81332.
- HUNTLEY, M., AND E. R. BROOKS.  
1982. Effects of age and food availability on diel vertical migration of *Calanus pacificus*. *Mar. Biol. (Berl.)* 71:23-31.
- LASKER, R.  
1975. Field criteria for survival of anchovy larvae: The relation between inshore chlorophyll maximum layers and successful first feeding. *Fish. Bull., U.S.* 73:453-462.
- LASKER, R., AND P. E. SMITH.  
1977. Estimation of the effects of environmental variations on the eggs and larvae of the northern anchovy, *Engraulis mordax*. *Calif. Coop. Oceanic Fish. Invest. Rep.* 19:128-137.
- LASKER, R., AND J. R. ZWEIFEL.  
1978. Growth and survival of first-feeding northern anchovy larvae (*Engraulis mordax*) in patches containing different proportions of large and small prey. In J. H. Steele (editor), *Spatial pattern in plankton communities*, p. 329-354. Plenum Press, N.Y.
- LASKER, R., J. PELÁEZ, AND R. M. LAURS.  
1981. The use of satellite infrared imagery for describing ocean processes in relation to spawning of the northern anchovy (*Engraulis mordax*). *Rem. Sens. Environ.* 11:439-453.
- LEE, R. F., J. C. NEVENZEL, G. A. PAFFENHOFER, AND A. A. BENSON.  
1970. The metabolism of wax esters and other lipids by the marine copepod, *Calanus helgolandicus*. *J. Lipid Res.* 11: 237-240.
- LEE, R. F., J. HIROTA, AND A. M. BARRETT.  
1971. Distribution and importance of wax esters in marine copepods and other zooplankton. *Deep-Sea Res.* 18:1147-1165.
- LONGHURST, A. R.  
1967. Diversity and trophic structure of zooplankton communities in the California Current. *Deep-Sea Res.* 14:393-408.
- LORENZEN, C. J.  
1970. Surface chlorophyll as an index of the depth, chlorophyll content, and primary productivity of the euphotic layer. *Limnol. Oceanogr.* 15:479-480.

- LYNN, R. J., K. A. BLISS, AND L. E. EBER.  
1982. Vertical and horizontal distributions of seasonal mean temperature, salinity, sigma-t, dynamic height, oxygen, and oxygen saturation in the California Current, 1950-1978. Calif. Coop. Oceanic Fish. Invest. Atlas, Vol. 30, 513 p.
- MACKAS, D. L., AND C. BOYD.  
1979. Spectral analysis of zooplankton spatial heterogeneity. Science 204:62-64.
- MARSH, J. B., AND D. B. WEINSTEIN.  
1966. Simple charring method for determination of lipids. J. Lipid Res. 7:574-576.
- MARSHALL, S. M., AND A. P. ORR.  
1955. The biology of a marine copepod, *Calanus finmarchicus*. Oliver and Boyd, Edinb., 188 p.
- MAUCHLINE, J., AND L. R. FISHER.  
1969. The biology of euphausiids. Adv. Mar. Biol. 7:1-454.
- MAYZAUD, P.  
1976. Respiration and nitrogen excretion of zooplankton. IV. The influence of starvation on the metabolism and the biochemical composition of some species. Mar. Biol. (Berl.) 37:47-58.
- MAYZAUD, P., AND S. A. POULET.  
1978. The importance of the time factor in the response of zooplankton to varying concentrations of naturally occurring particulate matter. Limnol. Oceanogr. 23:1144-1154.
- MERCHANT, D. J., R. H. KAHN, AND W. H. MURPHY, JR.  
1964. Handbook of cell and organ culture. Burgess Publ., Minneap., 269 p.
- MULLIN, M. M., AND E. R. BROOKS.  
1976. Some consequences of distributional heterogeneity of phytoplankton and zooplankton. Limnol. Oceanogr. 21:784-796.
- NEMOTO, T.  
1967. Feeding pattern of euphausiids and differentiations in their body characteristics. Inf. Bull. Planktol. Jpn., Commem. No. Y. Matusue, p. 157-171.
- NEMOTO, T., K. KAMADA, AND K. HARA.  
1972. Fecundity of a euphausiid crustacean, *Nematoscelis difficilis*, in the North Pacific Ocean. Mar. Biol. (Berl.) 14:41-47.
- O'CONNELL, C. P.  
1980. Percentage of starving northern anchovy, *Engraulis mordax*, larvae in the sea as estimated by histological methods. Fish. Bull., U.S. 78:475-489.
- OMORI, M.  
1970. Variations of length, weight, respiration rate, and chemical composition of *Calanus cristatus* in relation to its food and feeding. In J. H. Steele (editor), Marine food chains, p. 113-126. Oliver and Boyd, Edinb.
- OWEN, R. W., JR.  
1974. Distribution of primary production, plant pigments, and secchi depth in California Current 1969. Calif. Coop. Oceanic Fish. Invest. Atlas 20:98-117.  
1980. Eddies of the California Current system: physical and ecological characteristics. In D. M. Power (editor), The California Islands: Proceedings of the Multidisciplinary Symposium, p. 237-263. Santa Barbara Mus. Nat. Hist.
- PARRISH, R. H., C. S. NELSON, AND A. BAKUN.  
1981. Transport mechanisms and reproductive success of fishes in the California Current. Biol. Oceanogr. 1:175-203.
- PELÁEZ, J., AND F. GUAN.  
1982. California Current chlorophyll measurements from satellite data. Calif. Coop. Oceanic Fish. Invest. Rep. 23: 211-225.
- REID, J. L., G. I. RODEN, AND J. G. WYLLIE.  
1958. Studies on the California Current system. Calif. Coop. Oceanic Fish. Invest. Rep. 6:27-57.
- ROSS, R. M.  
1982. Energetics of *Euphausia pacifica* I. Effects of body carbon and nitrogen and temperature on measured and predicted production. Mar. Biol. (Berl.) 68:1-13.
- ROSS, R. M., K. L. DALY, AND T. S. ENGLISH.  
1982. Reproductive cycle and fecundity of *Euphausia pacifica* in Puget Sound, Washington. Limnol. Oceanogr. 27:304-314.
- RYTHER, J. H.  
1969. Photosynthesis and fish production in the sea. Science 166:72-76.
- SAMEOTO, D. D.  
1976. Distribution of sound scattering layers caused by euphausiids and their relationships to chlorophyll a concentrations in the Gulf of St. Lawrence Estuary. J. Fish. Board Can. 33:681-687.
- SMITH, R. C., AND K. S. BAKER.  
1982. Oceanic chlorophyll concentrations as determined by satellite (Nimbus-7 coastal zone color scanner). Mar. Biol. (Berl.) 66:269-279.
- STAR, J. L., AND M. M. MULLIN.  
1981. Zooplankton assemblages in three areas of the North Pacific as revealed by continuous horizontal transects. Deep-Sea Res. 28A:1303-1322.
- STEELE, J. H.  
1978. Some comments on plankton patches. In J. H. Steele (editor), Spatial patterns in plankton communities, p. 1-20. Plenum Press, N.Y.
- STRICKLAND, J. D. H., AND T. R. PARSONS.  
1972. A practical handbook of seawater analysis. Fish. Res. Board Can., Bull. 167, 310 p.
- TORRES, J. J., AND J. J. CHILDRRESS.  
1983. The relationship of oxygen consumption to swimming speed in *Euphausia pacifica* I. Effects of temperature and pressure. Mar. Biol. (Berl.) 74:79-86.
- VIDAL, J.  
1980. Physioecology of zooplankton. I. Effects of phytoplankton concentration, temperature, and body size on the growth rate of *Calanus pacificus* and *Pseudocalanus* sp. Mar. Biol. (Berl.) 56:111-134.
- WILLASON, S. W.  
1983. Spatiotemporal patterns of grazing and laminarinase activity of zooplankton off the California coast. Ph.D. Thesis, Univ. of California, Santa Barbara, 176 p.
- WILLASON, S. W., AND J. L. COX.  
In press. Diel feeding, laminarinase activity, and phytoplankton consumption by euphausiids. Biol. Oceanogr.
- YOUNGBLUTH, M. J.  
1976. Vertical distribution and diel migration of euphausiids in the central region of the California Current. Fish. Bull., U.S. 74:925-936.



# RHIZOCEPHALAN INFECTION IN BLUE KING CRABS, *PARALITHODES PLATYPUS*, FROM OLGA BAY, KODIAK ISLAND, ALASKA

P. T. JOHNSON,<sup>1</sup> R. A. MACINTOSH,<sup>2</sup> AND D. A. SOMERTON<sup>3</sup>

## ABSTRACT

An isolated population of blue king crabs, *Paralithodes platypus*, in Olga Bay, Kodiak Island, was sampled quarterly during 1980-81. It was found to contain abnormal mature females with degenerate ovaries and/or no sign of having extruded ova following molt. Histological studies of these females and of males and females collected subsequently in April 1982 showed that rhizocephalan internas (roots) were present in up to 50% of the population. Both males and females were infected, but male gonads and secondary sexual characteristics were apparently unaffected. Presence of the rhizocephalan was strongly related to ovarian abnormalities. Evidence suggests that infected females can molt, but do not extrude or retain embryos. The Olga Bay rhizocephalan is not related to *Briarosaccus callosus*, which parasitizes several species of Alaskan king crabs, including the blue king crab. Externas of the Olga Bay parasite were not found. The possible relationship of this rhizocephalan to the genus *Thompsonia*, which has minute multiple externa that might be missed during gross examination, and the possibility that the blue king crab is an abnormal host that does not allow development of externas are discussed.

Molting, mating, and extrusion of ova occur annually in red king crabs, *Paralithodes camtschatica*, and biennially in blue king crabs, *P. platypus*. Because embryos of both species hatch within about 1 yr, empty embryo cases are carried on blue king crabs in the second year (Powell and Nickerson 1965; Sasakawa 1973, 1975; Somerton and MacIntosh in press). Somerton and MacIntosh (1982)<sup>4</sup> studied an isolated population of blue king crabs in Olga Bay (Kodiak Island, AK) and found abnormal females that were of mature size but lacked external evidence of having extruded eggs or that had apparently degenerate ovaries. This paper reports results of gross and histological examination of blue king crabs from the aberrant Olga Bay population and from three apparently normal eastern Bering Sea populations. A rhizocephalan, which was found only in the Olga Bay crabs, appears to be responsible for the abnormal reproductive pattern.

## MATERIALS AND METHODS

Blue king crabs in Olga Bay were sampled quarterly: spring (March-April 1980), summer (June 1980), autumn (October 1980), and winter (January 1981). Seasonal sample sizes ranged from 155 to 229 crabs, and a total of 422 males and 337 females was examined. Both sexes were measured to the nearest millimeter in carapace length (see Wallace et al. 1949, for measurement). Carapace lengths ranged from 12 to 162 mm for males and 16 to 143 mm for females. Data were taken on external egg clutches of females by relative volume, color of embryos, and presence or absence of eyespots on embryos. Presence or absence of empty embryo cases on non-ovigerous females was also noted.

For the purposes of this paper, "oogonia" are stem cells; "oocytes" are developing cells before full maturity; and "ova" are cells that have completed vitellogenesis, have a thick chorion, and are ready for fertilization. "Embryo" refers to an external, fertilized, and developing egg or ovum.

The entire ovary and a pleopod with attached embryos or empty embryo cases (if present) were removed from each female considered to be mature or in the prepubertal stadium (>68 mm carapace length (CL)). These were preserved in 10% freshwater (river water) Formalin<sup>5</sup> solution buffered with sodium

<sup>1</sup>Northeast Fisheries Center Oxford Laboratory, National Marine Fisheries Service, NOAA, Oxford, MD 21654.

<sup>2</sup>Northwest and Alaska Fisheries Center Kodiak Laboratory, National Marine Fisheries Service, NOAA, P.O. Box 1638, Kodiak, AK 99615.

<sup>3</sup>Northwest and Alaska Fisheries Center, National Marine Fisheries Service, NOAA, 7600 Sand Point Way, N.E., Seattle, WA 98115.

<sup>4</sup>Somerton, D. A., and R. A. MacIntosh. 1982. Aspects of the life history of the blue king crab (*Paralithodes platypus*) in Alaska. Document submitted to the annual meeting of the International North Pacific Fisheries Commission, Tokyo, Japan, October 1982.

<sup>5</sup>Reference to trade names does not imply endorsement by the National Marine Fisheries Service, NOAA.

borate (10 g/L solution). The wet weight of preserved ovaries was recorded to the nearest g and diameters of a sample of oocytes/ova were recorded to the nearest 0.1 mm using a stereomicroscope.

Because many of the ovaries appeared abnormal and could not be classified easily by oogenetic stage, histological examination was undertaken of ovaries and pleopods from the largest sample, collected in January 1981 (Table 1). To provide material for a more detailed examination, the Olga Bay population was sampled again in April 1982, and three apparently normal Bering Sea populations of blue king crabs were also sampled (Table 1). Except as indicated, tissues taken in these collections included portions of the central nervous system, gut, hepatopancreas, gills, eyestalks, epidermis, heart, antennal gland, bladder, ovary, female pleopods, anterior vas deferens, and, in some cases, testis and hemopoietic tissue.

Except for the January samples from Olga Bay (fixed in borate Formalin), all tissues were fixed in Helly's solution (containing zinc chloride rather than

mercuric chloride) for 3-4 d, washed 1-2 h in 50% ethyl alcohol, and stored in 70% ethyl alcohol until being processed by standard histological methods.

To provide a basis for comparison, ovaries and pleopods of 11 female red king crabs collected at Olga Bay, January 1981, and fixed in borate Formalin, and tissues from two blue king crabs collected at Glacier Bay, AK, infected with the rhizocephalan *Briarosaccus callosus*, and fixed in Helly's solution, were also prepared for histological examination.

## RESULTS

### Prevalence of the Rhizocephalan

The roots (internas) of a rhizocephalan were associated with either or both the ovary and the pleopod in 52% of the 104 blue king crab females taken from Olga Bay in January 1981, and with various tissues in 40% of the 15 females and 33% of the 15 males taken from Olga Bay in April 1982 (Table 2). The rhizocephalan was also found in 1 of the 11 red king

TABLE 1.—Origins of blue king crabs examined histologically.

Location	Date	Number of specimens	Carapace length (mm)
Olga Bay	8-14 Jan. 1981	104 females (ovaries and pleopods)	69-136
Olga Bay	5-9 Apr. 1982	15 males	88-151
		15 females	90-128
Pribilof Is.	25 June-3 July 1982	10 males	83-155
		10 females (plus ovaries and pleopods from an additional 10 females)	96-145
Pribilof Is.	21 Feb. 1983	10 females	113-137
St. Matthew I.	10-13 July 1983	17 males	68-158
		9 females	61-129
St. Lawrence I.	5-11 Sept. 1982	5 males	85-106
		5 females	79-104

TABLE 2.—Rhizocephalans in individual male and female blue king crabs, Olga Bay, Kodiak Island, AK, April 1982.

Sex	Intensity of infection	Degenerate roots	Major areas parasitized (in tissue sections)					
			Nerve cord, assoc. bladder	Bladder in other areas	Gut	Gonad	Antennal gland	Hepato-pancreas
Female	± <sup>1</sup>		+ <sup>2</sup>					
	+		+	+	+	+	+	+
	+	+ <sup>3</sup>	+	+	+			
	++	+	+			+		
	+++	+	+	+	+	+	+	+
Male	±			+				
	+		+		+			+
	+	+	+	+	+			+
	++	+	+	+	+		+	+
	+++	+	+	+	+	+	+	+

<sup>1</sup>± = light infection; + to +++ = medium to very heavy infection.

<sup>2</sup>+ = parasite present.

<sup>3</sup>+ = present.

crab females taken from Olga Bay in January 1981. Rhizocephalan externas were never detected. Rhizocephalan tissue was not found in any of the 76 blue king crabs collected from the Bering Sea and examined by us.

Data on females collected from Olga Bay in January 1981 and April 1982 were combined and then separated into various categories of reproductive condition, based on both histological condition and reproductive features of the ovary and on external reproductive features. Females in all categories were further classified by the presence or absence of rhizocephalan infection, as determined histologically (Table 3).

The effect of the rhizocephalan on female reproduction was examined by testing the independence of probable future reproductive success and rhizocephalan presence. Based on ovarian categories (Table 3), probable future reproductive success was judged as either successful (no degenerating gonadal cells) or unsuccessful (ovary empty or ovary with degenerate gonadal cells). Independence of probable future success and rhizocephalan presence was rejected for both measures, implying that rhizocephalan infestation significantly reduces the probability of future reproductive success ( $\chi^2 = 16.81$ ,  $df = 1$ ,  $P < 0.001$  for empty ovary;  $\chi^2 = 20.41$ ,  $df = 1$ ,  $P < 0.001$  for ovary with degenerate gonadal cells).

Three of the external categories of females (Table 3) represent crabs at different times after extrusion of ova. Embryos begin to develop eyes about 4 mo after extrusion. Hatching occurs slightly more than 12 mo after extrusion. Following hatching, empty embryo cases persist on the pleopod setae until the crab molts again, usually slightly <12 mo later (Somerton and MacIntosh in press). Therefore, the

generalized time since extrusion for the uneyed, eyed, and empty-embryo-case categories is 0-4 mo, 4-14 mo, and 14-24 mo, respectively. If parasitic attacks are random and prevent successful extrusion and embryo attachment, then prevalence of the parasite should be low for females with uneyed embryos and should increase with time. Independence between prevalence and time since extrusion (using uneyed and empty-embryo-case categories) was rejected ( $\chi^2 = 7.79$ ,  $df = 1$ ,  $P < 0.01$ ).

Females are grasped by males and held in a "precopulatory embrace" before molting and mating. Of the 10 grasped females collected January 1981, 5 showed no evidence of previous reproductive activity, and 5 had empty embryo cases. None were infected with the rhizocephalan, although three of the females with empty embryo cases had some degenerate gonadal cells.

Based on the April 1982 sample, which includes males, independence between sex and rhizocephalan presence was not rejected ( $\chi^2 = 0.14$ ,  $df = 1$ ,  $P = 0.75$ ). The rhizocephalan, therefore, does not appear to discriminate by host sex.

Presence of the rhizocephalan apparently did not affect the gonads of males. Both infected and non-infected males had numerous spermatophores in the anterior vas deferens. Spermatocytes, some of them dividing, and developing and mature sperm were present in the four crabs whose testes were sampled (one parasitized and three nonparasitized). In the field, we saw no males exhibiting female secondary sexual characteristics.

## Histological Observations

Rhizocephalan roots occupied the hemal spaces of the pleopods, were associated with the exterior of the ovary, and occasionally lay within internal hemal spaces of the ovary of infected females collected in January 1981. Roots were associated with various tissues of males and females collected from Olga Bay in April 1982 (Table 2). Hemal sinuses of the ovary and those abutting the gut, the bladder, and the thoracic ganglia were the most frequently invaded sites. Roots lay within the glia of the thoracic ganglia of one crab, but otherwise were confined to hemal spaces and did not invade tissues.

Roots were cylindrical and surrounded by a PAS-positive cuticle of variable thickness (Figs. 1, 3). Cells within the roots usually had large vesicular nuclei, and refractile spherules were sometimes present in the cytoplasm. Usually the roots were tubular, with a defined lumen, and those with large, empty lumens often had a flattened epithelium. Loosely anasto-

TABLE 3.—Prevalence of rhizocephalan infection in female blue king crabs (>68 mm CL) collected in Olga Bay, Kodiak Island, AK, January 1981 and April 1982.

	Parasitized		Not parasitized
	n	%	
Ovarian categories			
Ovary empty	15	71	6
Ovary with gonadal cells <sup>1</sup>			
With some degenerate cells	38	64	21
No degenerate cells	7	18	32
External categories			
Clean pleopod setae	19	51	18
Ovigerous			
Uneyed embryos	1	10	9
Eyed embryos	12	48	13
Previously ovigerous (embryo cases)	27	59	19

<sup>1</sup>Oocytes and/or ova.

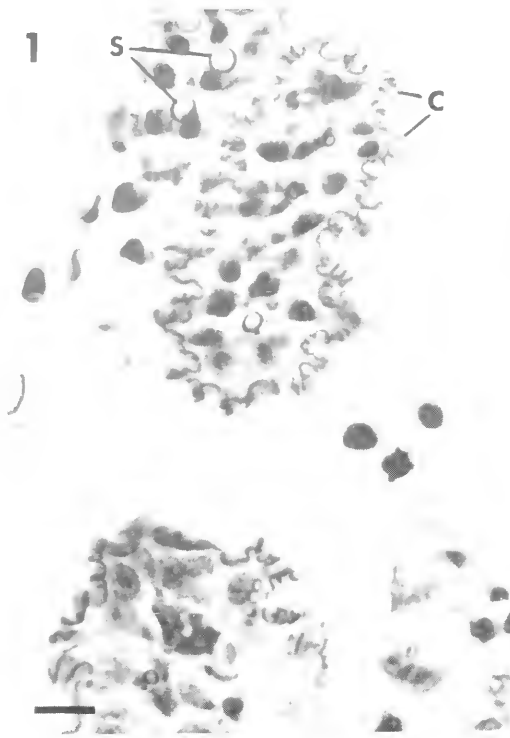

FIGURE 1.—Olga Bay rhizocephalan: Cross sections of roots with occluded lumens. PAS. C, cuticle; S, refractile cytoplasmic spherules. Bar = 10  $\mu$ m.

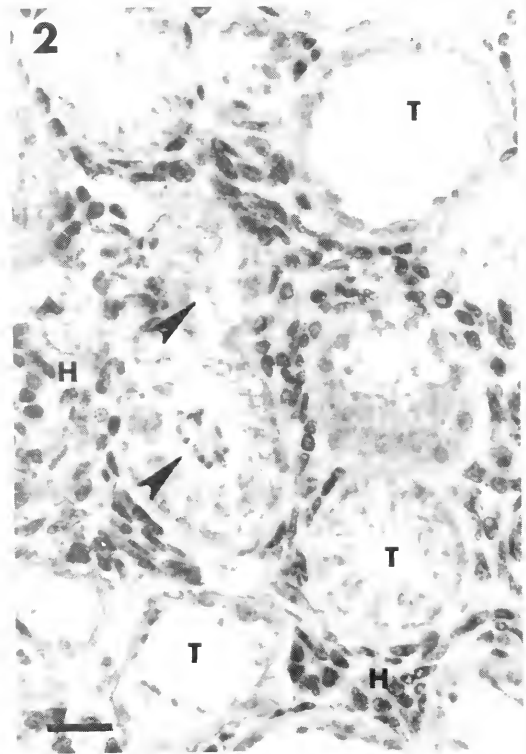

FIGURE 2.—Olga Bay rhizocephalan: Normal roots, lying in an area invaded by hemocytes. Note variable size of the lumen and one tubule with a group of small, central nuclei and another with anastomosing cells in the lumen (arrows). PAS. H, hemocytes; T, tubular roots. Bar = 20  $\mu$ m.

mosing cells filled the lumen of some tubules, and a defined epithelium was not present in these (Fig. 2). Roots with narrow or occluded lumens often had smaller, denser nuclei in the epithelium, or an additional interior layer or group of cells with small, dense, or condensed nuclei (Fig. 2). The occluded roots may represent the distal, growing portions of the organism.

Intensity of infection varied (Table 3). In all of the heavier infections and most of the medium ones, portions of the roots were degenerate or necrotic (Fig. 3). Host hemocytes had aggregated in such areas and often had encapsulated the degenerate roots. In heavy infections with many degenerating and necrotic roots, blackened areas, probably due to melanin deposition in the roots, were visible with the naked eye in the tissues. Sometimes hemocytes had invaded the lumens of degenerate and necrotic roots, and other roots had been reduced to amorphous material surrounded by hemocytes (Fig. 3). In all cases, roots of normal appearance were also present in the same areas. In only one instance were normal roots surrounded by hemocytes (Fig. 2). Prob-

ably the section had been cut just peripherally to a large area of degenerating roots.

Ovaries of 88% (53/60) of parasitized females as opposed to 46% (27/59) of normal females either contained no oocytes or had some or all degenerate oocytes (Fig. 4). Figure 5 shows a normal ovary with previtellogenic oocytes. Grasped females all had normal oocytes that were in late vitellogenesis and enclosed by a thick chorion. Of the 10 grasped females, 9 were in the premolt condition, and the 10th, a precocious juvenile 77 mm CL, was in the intermolt.

None of the parasitized crabs were in advanced premolt, although some were judged to be in early premolt because the pleopod epidermis was thickened, and occasionally a developing epicuticle was present.

Excepting the ovary, tissues and organs appeared normal in the parasitized crabs. Whether or not there was reduced lipid storage in the hepatopancreas was not evident by histological examination of the present series.

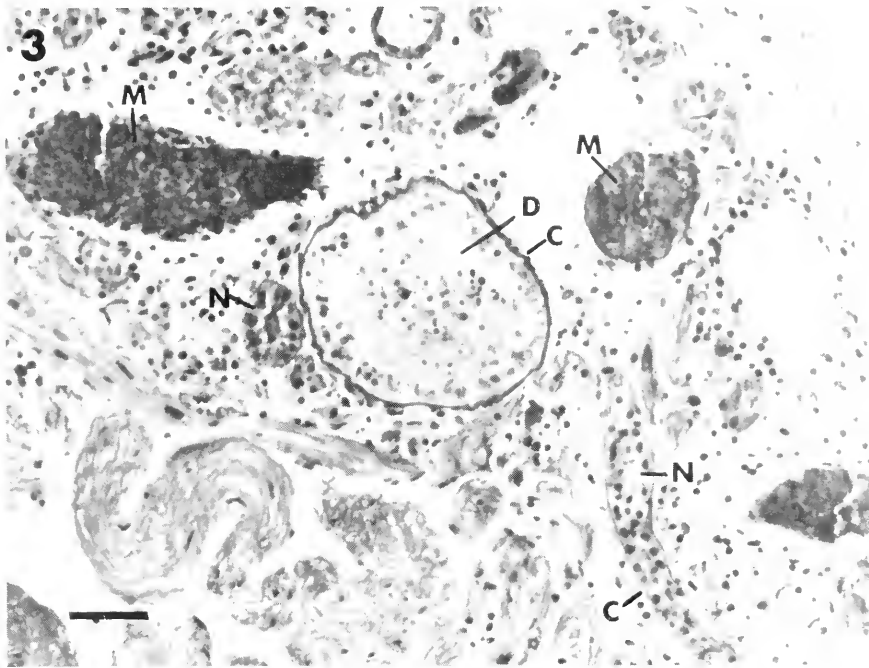

FIGURE 3.—Olga Bay rhizocephalan: Degenerating and normal roots. PAS. N, normal tubule; C, cuticle; D, tubules with sloughing epithelium; M, completely necrotic tubule; H, hemocytes. Bar = 0.05 mm.

## DISCUSSION

The presence of the rhizocephalan in female blue king crabs appears to impair reproductive function. Most parasitized crabs have empty ovaries or ovaries that contain degenerate gonadal cells. We assume that these traits are linked to reproductive failure, although there are also unparasitized crabs within each category. It is not unusual to find a few retained ova—destined to be resorbed—in a normal post-extrusion ovary. Therefore, these crabs are also a source of degenerate gonadal cells. The 2-yr reproductive cycle of the blue king crab might also lead to presence of degenerate gonadal cells that had been produced early in the cycle and had become senescent. This speculation remains to be investigated.

The increase in the incidence of infection over time in postextrusion crabs also suggests reproductive impairment. Not only is the prevalence very low (10%) among females that had recently extruded (with uneyed embryos), it is zero among grasped premolt females that were presumably about to molt, mate,

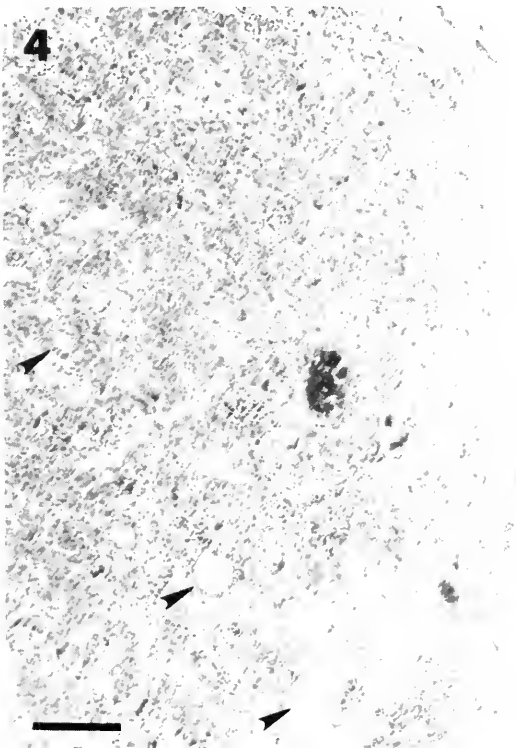

FIGURE 4.—Olga Bay rhizocephalan: Empty ovary of an infected crab. Arrows point to roots of the parasite. PAS. Bar = 0.2 mm.

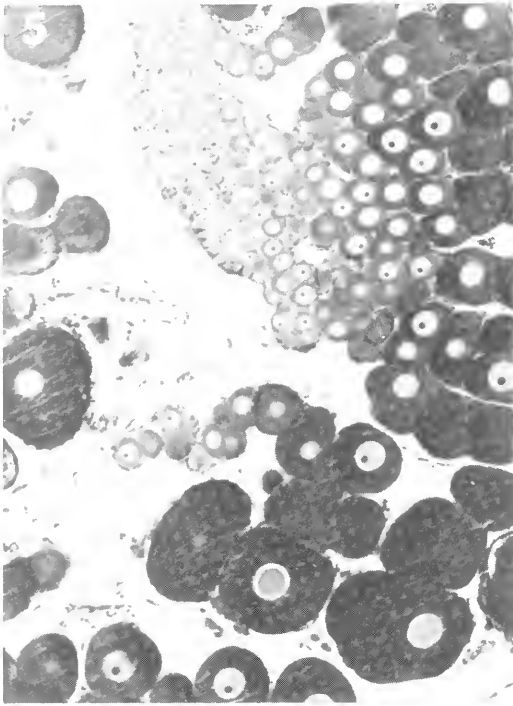

FIGURE 5.—Normal ovary with oogonia and previtellogenic oocytes. PAS. Same scale as Fig. 4.

and extrude. These facts suggest that the rhizocephalan might preclude mating and subsequent extrusion and attachment of fertilized ova.

The external category of reproductive condition we term "clean pleopod setae" would normally be associated with immature crabs. In this study, it contained both small females and females of mature size (total size range 69-133 mm CL). The average size at maturity of females in Alaskan populations lacking the rhizocephalan ranges from 80 to 96 mm (Somerton and MacIntosh 1983). Crabs larger than 114 mm could reasonably be expected to be carrying embryos or empty embryo cases, but 10 crabs in the combined January-April sample (9 of which had the rhizocephalan) were not. Two of the parasitized females were soft-shelled, suggesting that molting can occur in parasitized females.

Presence of the rhizocephalan in male crabs from Olga Bay apparently did not interfere with normal gonadal function. Species of *Sacculina* and many other rhizocephalans cause a varying degree of external feminization and gonadal dysfunction of their male hosts (Reinhard 1956). For example, *Thompsonia mediterranea* causes external appendages of males of *Callinassa truncata* to approach the

female condition (Caroli 1931), but a species of *Thompsonia* parasitizing *Portunus pelagicus* does not affect males (Phang 1975). *Briarosaccus callosus* parasitizes the blue, red, golden (*Lithodes aequispina*), and deep-sea (*Lithodes couesi*) king crabs in the Gulf of Alaska (McMullen and Yoshihara 1970; Somerton 1981; Hawkes et al. 1985). Meyers<sup>6</sup> found testicular regression and broadening of the abdomen in *Briarosaccus*-infected male blue king crabs from Glacier Bay.

High prevalences of infection with rhizocephalans have been reported previously in other decapod species, so the high prevalence in blue king crabs of Olga Bay is not surprising. McMullen and Yoshihara (1970) found 14 of 21 golden king crabs, captured near Kodiak Island, infected with *B. callosus*, and Hawkes et al. (1985) reported 76% prevalence of the same species in blue king crabs from Glacier Bay; Phang (1975) reported prevalences between 24% and 68% of *Thompsonia* sp. in groups of *Portunus pelagicus* captured near Singapore; and Perry (1984) said that sometimes over 50% of blue crabs sampled from a single population in the Gulf of Mexico were infected with *Loxothylacus texanus*.

Although nearly 800 blue king crabs were sampled from Olga Bay at quarterly intervals, no rhizocephalan externas were observed, and the one red king crab female found infected with what appeared to be the same rhizocephalan also lacked an externa. Due to the absence of externas, the Olga Bay rhizocephalan cannot be indentified with certainty. Its roots are similar histologically to those of other rhizocephalans [*Thompsonia* (Potts 1915); *Sacculina* (Fischer 1927; Dornesco and Fischer-Piette 1931); and *Peltogaster* and *Gemmosaccus* (Nielsen 1970)], corresponding best with the roots of *Thompsonia*, which have a thinner cuticle than the others (Potts 1915). Roots of the Olga Bay parasite differ histologically in several ways from those of *Briarosaccus callosus*. They are of lesser diameter, have a thinner cuticle, lack large peripheral nuclei, often have a large lumen and flattened epithelium, and seldom have the cytoplasmic vacuoles (probably representing lipid storage) that are common in the *B. callosus* roots. (Compare Figures 1, 2, and 3 with Figure 6.) The Olga Bay parasite and *B. callosus* also differ in that the roots of *B. callosus* are a bright green when fresh (Hawkes et al. 1985) and blue-green when fixed in Helly's solution, whereas the roots of the Olga Bay parasite are colorless.

<sup>6</sup>T. Meyers, Assistant Professor of Fisheries, School of Fisheries and Science, University of Alaska, 11120 Glacier Highway, Juneau, AK 99801, pers. commun. October 1984.

The lack of obvious externas on the parasitized crabs is puzzling. One possibility is that externas are produced but are inconspicuous and/or evanescent. Most rhizocephalans produce easily detected externas that emerge from the venter of the abdomen. Species of *Thompsonia*, however, produce multiple small externas 1-4.5 mm long and no more than 1.1 mm in diameter. These externas occur on the appendages and venters of the thorax and abdomen, depending on the species, and those of at least one of the species are easily dislodged (Häfele 1911; Potts 1915; Phang 1975). If few and scattered externas of the *Thompsonia* type were present, they could have escaped notice on animals as large as the blue king crabs investigated. The second possibility is that externas are not developed in the blue king crab. Host ranges of rhizocephalans are often broad, but some of the host/parasite associations may be accidental or not fully evolved. *Sacculina carcini* is known to react differently in different species of crabs. In *Carcinus maenas* multiple broods of larvae are produced by *S. carcini*, but if the host is *Portunus holsatus*, it breeds but once and then is shed, which suggests that *C. maenas* is a natural host but *P. holsatus* is an adventitious and not entirely com-

petent one (Baer 1951). Perhaps the Olga Bay parasite is not a usual parasite of the blue king crab, and although the interna develops extensively and causes severe damage to female gonads, externas cannot be produced in this species. The fact that some roots of the parasite were degenerating or necrotic in most infected crabs suggests that parasites do die within the blue king crab, and that infections might be lost before externas are formed.

## ACKNOWLEDGMENTS

We are grateful to E. Munk, J. Bowerman, and R. Otto of the Kodiak Laboratory for assistance with fieldwork; to S. Meyers, also of the Kodiak staff, for laboratory assistance; to G. Roe and C. Smith of the Oxford Laboratory for preparing tissues for histological examination; to R. Otto for reviewing the manuscript; to T. R. Meyers, University of Alaska, Juneau, for providing tissues of blue king crabs infected with *Briarosaccus callosus*; and finally, to Bill Pinnell and Morris Talifson of Olga Bay, without whose logistic support and hospitality the fieldwork would have been twice as difficult and infinitely less enjoyable.

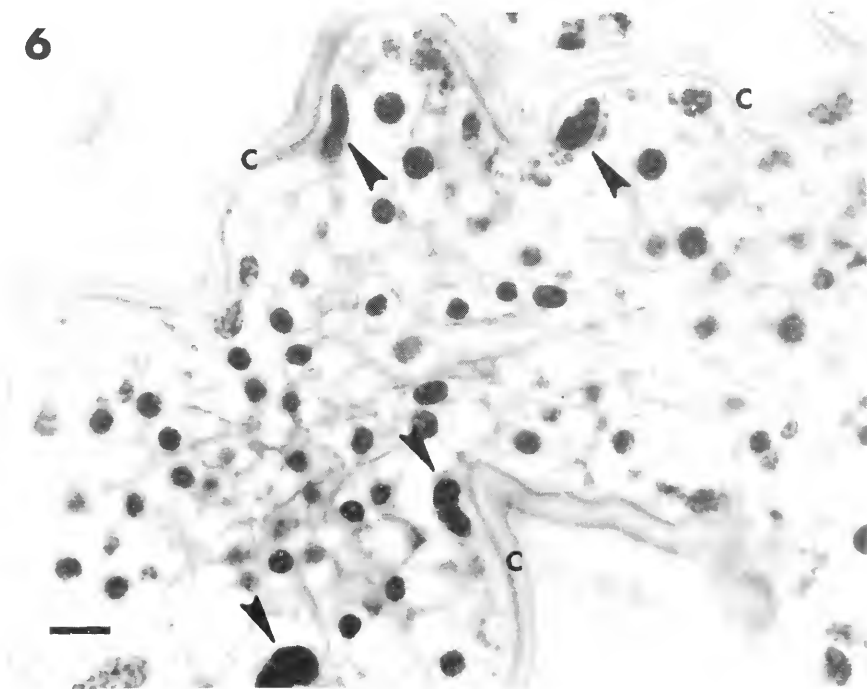

FIGURE 6.—*Briarosaccus callosus*: Roots. Note lack of a central lumen and the very large, peripheral nuclei (arrows), Feulgen. C, cuticle. Bar = 10  $\mu$ m.

## LITERATURE CITED

- BAER, J. G.  
1951. Ecology of animal parasites. Univ. Illinois Press, Urbana, IL, 224 p.
- CAROLI, E.  
1931. Azione modificatrice dei Bopiridi e dei Rizocefali sui caratteri sessuali secondarii delle Callianasse. Arch. Zool. Ital. 16:316-322.
- DORNESCO, G. T., AND E. FISCHER-PIETTE.  
1931. Données cytologiques sur les "racines" de la Sacculine, Crustacé parasite. Bull. Histol. Appl. 8:213-221.
- FISCHER, E.  
1927. Sur le tissu constituant les "racines" endoparasitaires de la Sacculine. C. R. Soc. Biol. 96:329-330.
- HÄFELE, F.  
1911. Anatomie und Entwicklung eines neuen Rhizocephalen: *Thompsonia japonica*. Beiträge zur Naturgeschichte Ostasiens. Abh. Bayer. Akad. Wiss. Math.-phys. Kl., Suppl.-Bd. 2, Abh. 7, p. 1-25.
- HAWKES, C. R., T. R. MEYERS, AND T. C. SHIRLEY.  
1985. Parasitism of the blue king crab, *Paralithodes platypus*, by the rhizocephalan, *Briarosaccus callosus*. J. Invertebr. Pathol. 45:252-253.
- McMULLEN, J. C., AND H. T. YOSHIHARA.  
1970. An incidence of parasitism of deepwater king crab, *Lithodes aequispina*, by the barnacle *Briarosaccus callosus*. J. Fish. Res. Board Can. 27:818-821.
- NIELSEN, S.-O.  
1970. The effects of the rhizocephalan parasites *Peltogaster paguri* Rathke and *Gemmosaccus sulcatus* (Lilljeborg) on five species of paguridan hosts (Crustacea Decapoda). Sarsia 42:17-32.
- PERRY, H. M.  
1984. A profile of the blue crab fishery of the Gulf of Mexico. Gulf States Mar. Fish. Comm., Spec. Publ. 9, 80 p.
- PHANG, V. P. E.  
1975. Studies on *Thompsonia* sp. a parasite of the edible swimming crab *Portunus pelagicus*. Malay. Nat. J. 29:90-98.
- POTTS, F. A.  
1915. On the rhizocephalan genus *Thompsonia* and its relation to the evolution of the group. Pap. Dep. Mar. Biol. Carnegie Inst. Wash. 8:1-32.
- POWELL, G. C., AND R. B. NICKERSON.  
1965. Reproduction of king crabs, *Paralithodes camtschatica* (Tilesius). J. Fish. Res. Board Can. 22:101-111.
- REINHARD, E. G.  
1956. Parasitic castration of Crustacea. Exp. Parasitol. 5: 79-107.
- SASAKAWA, Y.  
1973. Studies on blue king crab resources in the western Bering Sea. I. Spawning cycle. [In Jpn.] Bull. Jpn. Soc. Sci. Fish. 39:1031-1037. (Engl. transl. NOAA Lang. Serv. Branch.)  
1975. Studies on blue king crab resources in the Western Bering Sea. II. Verification of spawning cycle and growth by tagging experiments. [In Jpn.] Bull. Jpn. Soc. Sci. Fish. 41: 937-940. (Engl. transl. NOAA Lang. Serv. Branch.)
- SOMERTON, D. A.  
1981. Contribution to the life history of the deep-sea king crab *Lithodes couesi*, in the Gulf of Alaska. Fish. Bull., U.S. 79: 259-269.
- SOMERTON, D. A., AND R. A. MACINTOSH.  
1983. The size at sexual maturity of blue king crab, *Paralithodes platypus*, in Alaska. Fish. Bull., U.S. 81:621-628.
- SOMERTON, D. A., AND R. A. MACINTOSH.  
In press. Reproductive biology of the blue king crab, *Paralithodes platypus*, in the eastern Bering Sea. J. Crustacean Biol.
- WALLACE, M. M., C. J. PERTUIT, AND A. H. HVATUM.  
1949. Contributions to the biology of the king crab *Paralithodes camtschatica* (Tilesius). U.S. Fish Wild. Serv., Fish. Leaflet. 340, 49 p.



## NOTES

### THE SEX RATIO AND GONAD INDICES OF SWORDFISH, *XIPHIAS GLADIUS*, CAUGHT OFF THE COAST OF SOUTHERN CALIFORNIA IN 1978

In the tropical and subtropical Pacific, swordfish, *Xiphias gladius*, about to spawn are found throughout the year but are most abundant from March to July (Palko et al. 1981). There is, however, little information on the reproductive potential of swordfish during their summer and autumn migrations into the Southern California Bight, a temperate region encompassing the principal U.S. west coast swordfish fishing grounds. In 1978 scientists from the Southwest Fisheries Center collected the gonads of swordfish harpooned in the Bight (from Point Conception to the United States-Mexico border) in order to determine sex ratios, gonad indices, and the reproductive condition of these fish.

#### Methods

Ninety swordfish were sampled from 25 August through 20 November 1978. After capture their gonads were preserved in 10% Formalin<sup>1</sup> and, in the laboratory, were weighed to the nearest gram and their sex determined visually. Ovarian sections used in the histological analysis were obtained from segments removed from the centers of the ovaries. Segments were imbedded in Paraplast and 8  $\mu$ m sections were cut, stained in iron hematoxylin, and counterstained in eosin.

Two gonad indices were calculated for each pair of ovaries to permit comparisons with two existing studies on the sexual maturity of Pacific swordfish. The first (from Uchiyama and Shomura 1974) is simply the percentage of the fresh weight of the ovaries to the total weight of the fish:

$$GI = \frac{WT-O}{WT-F} \times 100 \quad (1)$$

where  $GI$  = gonad index,  
 $WT-O$  = fresh weight of both ovaries, and  
 $WT-F$  = fresh weight of whole fish.

The second index (from Kume and Joseph 1969) is

$$GI = (W/L^3) \times 10^4 \quad (2)$$

where  $GI$  = gonad index,  
 $W$  = fresh weight of both ovaries in grams, and  
 $L$  = post-orbital fork length in centimeters.

Because the gonads used in this study were preserved, and thus subject to shrinkage and loss of weight, it was necessary to estimate their fresh weight using the relationship (from Uchiyama and Shomura 1974):

$$Y = e \frac{\ln X - 0.155}{0.969} \quad (3)$$

where  $Y$  = estimated fresh weight of ovaries, and  
 $X$  = weight of preserved ovaries.

The estimated weight loss due to preservation was as high as 7%.

#### Results and Discussion

All 90 swordfish collected were mature with fork lengths ranging from 133 to 218 cm. Of these, 23 (26%) were males and 67 (74%) were females for a sex ratio of 0.34:1 (M:F). Although the proportion of females varied among months, our sample sizes were too small to demonstrate such variation.

Female swordfish in our sample all had gonad indices that were considerably lower than those of comparable studies. Uchiyama and Shomura (1974) collected 16 pairs of ovaries from swordfish caught near Hawaii and found three pairs to be ripe. These had gonad indices (from Equation (1)) of 6.4, 8.4, and 9.8 whereas our highest value (from Equations (1) and (3)) was 1.0. Kume and Joseph (1969) examined 362 pairs of ovaries from swordfish captured in the eastern Pacific (east of long. 130°W) and found two ripe specimens whose gonad indices (from Equation (2)) were 10.8 and 11.1. By comparison, the highest from our study (from Equations (2) and (3)) was 1.8. These results indicate swordfish in the Southern California Bight during our sampling period were not spawning.

A histological analysis was performed on a subset of 16 pairs of ovaries from our sample. Histological analyses can be used to determine not only if a fish

<sup>1</sup>Reference to trade names does not imply endorsement by the National Marine Fisheries Service, NOAA.

is in spawning condition but, also, if it has recently spawned (Hunter and Macewicz 1985). Ovaries from our sample contained no mature oocytes and, in addition, did not contain abundant atretic oocytes indicative of the resorption process. Instead the ovaries were in the regressed stage and contained primary oocytes lining connective tissue septa. These results indicate that the swordfish were reproductively inactive during the sampling period and for at least a month or two before capture. Although this conclusion does not preclude the possibility of spawning early in the year, swordfish then are scarce. Also water temperatures favorable for spawning (Palko et al. 1981) are not widespread in the summer and autumn, and are virtually nonexistent the remainder of the year.

#### Acknowledgments

The authors are indebted to the cooperating commercial swordfish fishermen and the scientific observers, particularly Dimitry Abramenkoff and Lynn Shipley, who conducted field sampling. The comments of Gary Sakagawa, Norm Bartoo, and Pierre Kleiber were greatly appreciated.

#### Literature Cited

- HUNTER, J. R., AND B. J. MACEWICZ.  
1985. Rates of atresia in the ovary of captive and wild northern anchovy, *Engraulis mordax*. Fish. Bull., U.S. 83:119-136.
- KUME, S., AND J. JOSEPH.  
1969. Size composition and sexual maturity of billfish caught by the Japanese longline fishery in the Pacific Ocean east of 130 W. Bull. Far Seas Fish. Res. Lab. (Shimizu) 2:115-162.
- PALCO, B. J., G. L. BEARDSLEY, AND W. J. RICHARDS.  
1981. Synopsis of the biology of the swordfish, *Xiphias gladius* Linnaeus. U.S. Dep. Commer., NOAA Tech. Rep. NMFS Circ. 441, 21 p.
- UCHIYAMA, J. H., AND R. S. SHOMURA.  
1974. Maturation and fecundity of swordfish, *Xiphias gladius*, from Hawaiian waters. In R. S. Shomura and F. Williams (editors), Proceedings of the International Billfish Symposium Kailua-Kona, Hawaii, 9-12 August, 1972. Part 2. Review and contributed papers, p. 142-148. U.S. Dep. Commer., NOAA Tech. Rep. NMFS SSRF 675.

EARL C. WEBER

Southwest Fisheries Center La Jolla Laboratory  
National Marine Fisheries Service, NOAA  
8604 La Jolla Shores Drive  
La Jolla, CA 92038

STEPHEN R. GOLDBERG

Department of Biology  
Whittier College  
Whittier, CA 90608

## GROWTH OF DOLPHINS, *CORYPHAENA HIPPURUS* AND *C. EQUESELIS*, IN HAWAIIAN WATERS AS DETERMINED BY DAILY INCREMENTS ON OTOLITHS

The dolphin, *Coryphaena hippurus*, and pompano dolphin, *C. equiselis*, are widely distributed pelagic fishes in tropical and subtropical oceans (Beardsley 1967; Rose and Hassler 1968; Shcherbachev 1973). In Hawaiian waters *C. hippurus* is caught throughout the year, but its abundance fluctuates. Small fish (<2.3 kg) are plentiful in summer and large fish (13.6-18.1 kg) are more abundant from February to April (Squire and Smith 1977). *Coryphaena hippurus* is important to the commercial and recreational fisheries; *C. equiselis*, a smaller fish with a maximum length of 74 cm (Herald 1961), is occasionally caught by recreational fishermen. Although much is known about the life history of *C. hippurus* in the Atlantic (Palko et al. 1982), the biology of the Hawaiian population has been only sketchily investigated. Little is known about *C. equiselis*.

At least three age and growth studies on *C. hippurus* have been reported. Annual marks on scales have been used to age *C. hippurus* off Florida (Beardsley 1967) and North Carolina (Rose and Hassler 1968) in the western North Atlantic Ocean. Wang (1979) used monthly modal progression of length-frequency distributions to estimate the growth rate of *C. hippurus* off eastern Taiwan in the western Pacific Ocean. The estimated growth rates of *C. hippurus* off Florida and North Carolina differed slightly, but the growth rate of *C. hippurus* in the western Pacific Ocean was reported to be about twice as great as those in the western North Atlantic Ocean.

The purpose of this study was to validate estimates of age and growth of larval and juvenile *C. hippurus* and *C. equiselis* based on microstructure of otoliths (sagittae) from fish of known age reared in captivity. Otoliths from wild specimens captured in Hawaiian waters were also used as a source of age and growth information and these data were fitted to the von Bertalanffy growth model. Ages of cultured and captured wild specimens were estimated by enumerating presumed daily increments on the sagitta following Pannella (1971). The daily nature of the increments was validated by counts from sagittae of fish reared in captivity and whose age was known. Knowledge of growth rates of both species of dolphins are useful to mariculturists who would like to compare the growth rates of wild and cultured individuals. Information on the growth rate of *C. hippurus* can also be of use to managers of Hawaiian fishery resources.

## Materials and Methods

### Validation

Fertilized eggs of *C. hippurus* and *C. equisetis* were obtained between January 1982 and February 1983 from captive broodstock held at the University of Hawaii's Waikiki Aquarium (WA); the Kewalo Research Facility (KRF) of the Southwest Fisheries Center Honolulu Laboratory, National Marine Fisheries Service; and The Oceanic Institute, Waimanalo, HI. Larvae of both species were reared at the WA in 4,000 L circular fiber glass tanks with flow-through water exchange and under shaded natural light condition. Water temperature ranged between 23° and 27°C. Both species were fed an unlimited supply (a density of 1-5/mL) of cultured copepod, *Euterpina acutifrons*, and *Artemia* sp. until they were large enough to accept chopped fish and squid (about 30 d after hatching), which were then provided several times during the day. These fish were fed to satiation. One 167-d-old and three 191-d-old *C. hippurus* were reared at the KRF under similar environmental conditions and feeding regime as at the WA.<sup>1</sup> These juvenile *C. hippurus* were transferred to 8 m diameter tanks when they were about 25 cm long.

One to three larvae of *C. equisetis* were sampled on the day of hatching (D-0), and each day thereafter (D-1, D-2, D-4, etc.). However, after the fourth day, there were few survivors, so only a single specimen was taken at intervals of 4 d from D-19. Three larvae of *C. hippurus* were sampled on D-4 and single specimens were sampled at various intervals or obtained after accidental deaths for validating the growth increments. Other larvae were sampled from other batches on D-0, D-1, and D-2 for measurements. Specimens were sampled around noon. Total length of the larvae was measured under a microscope with an ocular micrometer while the specimen was alive or within an hour after death. To facilitate measurement, each larva was put on a glass slide, extended to its full length, and measured. For the examination of otoliths, the larva on the slide was immersed in 70% ethanol and allowed to fix for an hour. The larva was then removed from the ethanol bath, blotted, and mounted in Euparal,<sup>2</sup> a water soluble mounting medium, and covered with a cover slip.

Otoliths could be examined in the squashed whole mount without extracting them.

After measuring the fork length of juvenile and adult dolphins with a caliper to the nearest millimeter, otoliths were extracted, cleaned, and mounted whole. To extract the otoliths, the head was removed from the body, and the flesh removed from the head to expose the skull. With a saw or knife, most of the supraoccipital and roof of the skull were removed. After careful removal of the brain, the sagittae (largest of the three otoliths) could be found in the sacculi located anteriorly on the right and left sides of the first vertebra at the caudal end of the brain cavity. Under a dissecting microscope, the sagitta was teased out of the sacculus, and extraneous tissues were brushed away. The pair of sagittae was then placed on a clean glass slide, permitted to dry, and mounted in Euparal. Segments of monofilament line slightly thicker than the sagittae were placed on both sides of the sagittae to prevent the cover slip from crushing it.

After clearing for a month, presumed daily increments on a sagitta were enumerated using a compound binocular microscope with transmitted light at 600× magnification. Increments were counted starting from the core out to the edge of the postrostrum, or from the core to the tip of the rostrum. Usually, counts could not be made in a direct line from the core to the edge of the rostrum or postrostrum of the sagitta; rather, a somewhat circuitous route was taken from one area of the sagitta to another by following a prominent growth increment. Increments were also counted inward from the edge to the core. Two independent age estimations were made separately on the rostrum and postrostrum on a sagitta to verify the age of fish. In some samples, it was possible only to make a single age estimate since the sagitta was incomplete, having just a rostrum or postrostrum. The reader had no information such as specimen size or previous counts to prevent bias in the counting.

The arithmetic mean of 3-14 counts was used to estimate a fish's age. The number of counts from the rostrum and postrostrum varied from as few as 3 for a larva to 14 for a sagitta of a juvenile. The relationship between counts of otolith increments and days was assessed for both species by regression analysis.

### Growth of Wild Specimens

Juveniles of both species were dip netted from Kaneohe Bay, HI. Large juveniles and adults of both species were obtained from private and chartered

<sup>1</sup>Thomas K. Kazama, Southwest Fisheries Center Honolulu Laboratory, National Marine Fisheries Service, NOAA, Honolulu, HI 96812, pers. commun. October 1984.

<sup>2</sup>Reference to trade names does not imply endorsement by the National Marine Fisheries Service, NOAA.

sport fishing boats in Honolulu, and *C. hippurus* specimens were also obtained from cruises of the NOAA ship *Townsend Cromwell* to the Northwestern Hawaiian Islands from October 1976 to September 1981. Fork lengths were measured to the nearest millimeter with calipers. The extraction and slide preparation of sagittae, and counting method were the same as described for the validation experiments above. But before reading the sagittae of fish caught in the wild, the sagitta of a known-age fish was re-examined to review the difference between known daily increments and subdaily increments. Concentric daily increments, which consist of an inner light band and an outer dark band, were distinguished from subdaily increments by carefully focusing to the plane of maximum clarity. The dark band of the subdaily increment appeared less defined than the dark band of daily increments. Misinterpretation and counting subdaily increments as daily increments could result in an overestimation of age. The mean of 10-20 counts was used as the age estimate of older fish.

Age estimates of wild fish were fitted to the von Bertalanffy growth model using NLIN Procedure, a nonlinear regression routine (SAS Institute 1982). The three juvenile *C. hippurus* whose sex was un-

determined were added to both the male and female groups when fitting the curves.

## Results

### Validation

Fertilized eggs of *C. equiselis* and *C. hippurus* began to hatch after 48-50 h at 24°25°C and all hatched within 2 h. The larvae of both species were 4.0-4.6 mm TL and had two pairs of otoliths, the sagitta and lapillus, at time of hatching. Otoliths of *C. equiselis* and *C. hippurus* on D-0 ranged from 16 to 20  $\mu\text{m}$  in diameter and consisted of the core and primordium. An hour after hatching, the larvae were from 5.2 to 5.4 mm TL but did not grow during the next 3 d and even shrank from 0.1 to 0.2 mm. Otoliths of both species on D-1 had a dark ring near the edge which the otoliths of D-0 larvae did not have and were 22-24  $\mu\text{m}$  in diameter. The sagittae of both species on D-4 had four increments (Fig. 1) and were now slightly larger than the lapillus. Sagittal diameters were 29-36  $\mu\text{m}$  for *C. equiselis* and 34-41  $\mu\text{m}$  for *C. hippurus*.

Mean counts of growth increments on the sagittae of 10 *C. hippurus* (Table 1) and 13 *C. equiselis*

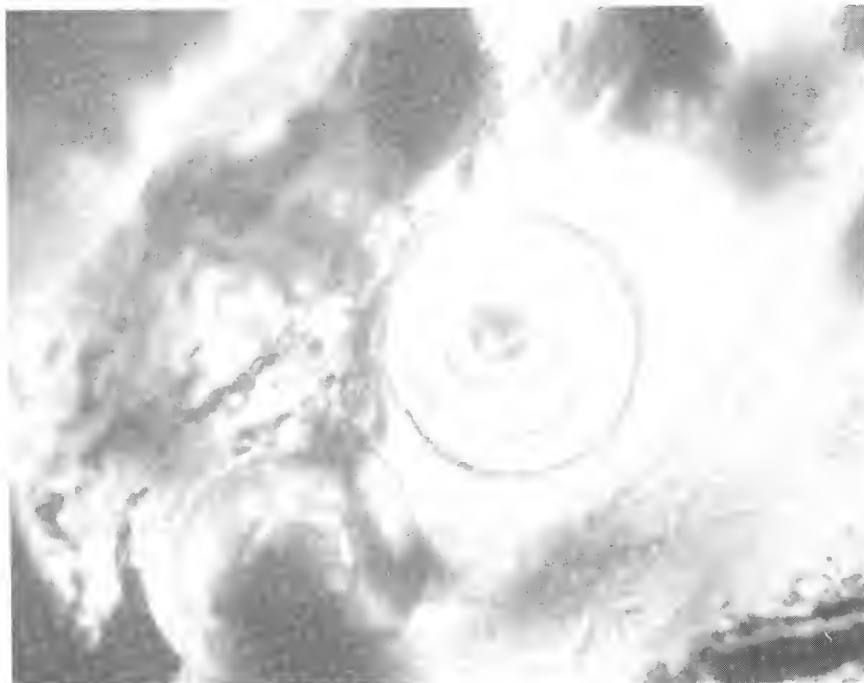

FIGURE 1.—Sagitta of a day-4 *Coryphaena hippurus* larva. Diameter of sagitta is 17  $\mu\text{m}$ .

TABLE 1.—Mean of counts on known age sagittae of *Coryphaena hippurus*.

Known age	Mean increment counts	SD	No. of counts	Total length (mm)	Fork length (mm)
0	0			5.3	
1	1			—	
4	4	0.00	3	6.7	
4	4	0.00	3	6.8	
4	4	0.00	3	6.8	
20	20.0	± 1.26	5	—	
35	33.6	± 2.06	9	—	—
47	45.2	± 3.16	10	—	95.0
167	166.8	± 7.14	11	—	383.0
191	190.3	± 6.92	6	—	510.0
191	191.0	± 0.71	4	—	554.0
191	192.8	± 7.44	5	—	491.0

(Table 2) were plotted against corresponding known ages (Figs. 2, 3). The relationships of mean increment counts ( $Y$ ) to known age ( $X$ ) were  $Y = -0.5295 + 1.0035X$  ( $r = 0.999$ ,  $P < 0.01$ ) for 10 *C. hippurus* and  $Y = -0.6986 + 1.0164X$  ( $r = 0.997$ ,  $P < 0.01$ ) for 13 *C. equiselis*. These results demonstrated that growth increments are formed daily, and validated their use for aging wild fish up to 191 d for *C. hippurus* and 63 d for *C. equiselis*.

### Growth of Wild Specimens

Because of sexual dimorphism, separate von Bertalanffy growth parameters were calculated for male

TABLE 2.—Mean counts on known age sagittae of *Coryphaena equiselis*.

Known age	Mean increment counts	SD	No. of counts	Total length (mm)	Fork length (mm)
0	0			4.0	
1	1	0.00	3	—	
1	1	0.00	3	—	
4	3	0.00	3	4.6	
4	4	0.00	3	5.2	
19	19	0.00	3	14.2	
23	23.6	± 2.23	8	23.0	
27	21.5	± 1.59	14	25.2	
31	31.7	± 1.38	7	—	29.5
36	35.3	± 2.45	10	—	48.0
51	51.7	± 2.13	13	—	82.0
52	53.6	± 4.81	14	—	72.0
63	63.3	± 3.19	14	—	89.0
63	63.4	± 8.59	13	—	112.0

and female *C. hippurus* (Table 3). The male and female von Bertalanffy growth curves and 18 age-length relationships of *C. hippurus* are shown in

TABLE 3.—Von Bertalanffy growth parameters calculated from captured wild specimens of *Coryphaena hippurus*.

Sex	Number	Parameter	Estimate	SE
Male	10	$t_0$	0.0790 yr	0.0305
		$K$	1.1871	0.5218
		$L_\infty$	189.9301 cm FL	48.9702
Female	9	$t_0$	0.0731 yr	0.0126
		$K$	1.4110	0.2454
		$L_\infty$	153.2676 cm FL	14.2168

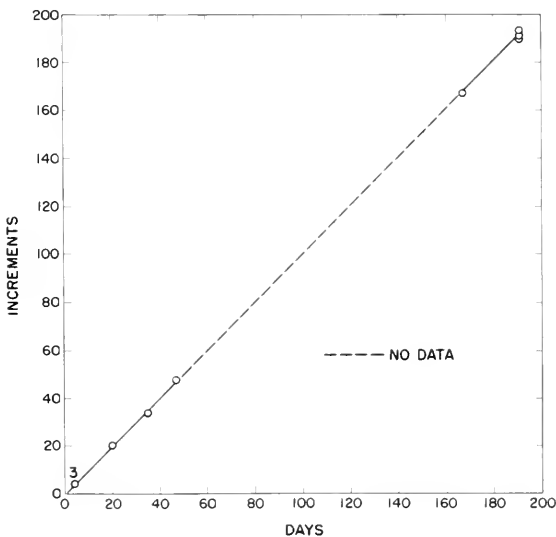

FIGURE 2.—Validation of daily increments on sagittae of *Coryphaena hippurus* by relationship of known age ( $X$ ) to mean increment count ( $Y$ ) up to 191 d ( $r = 0.999$ ).

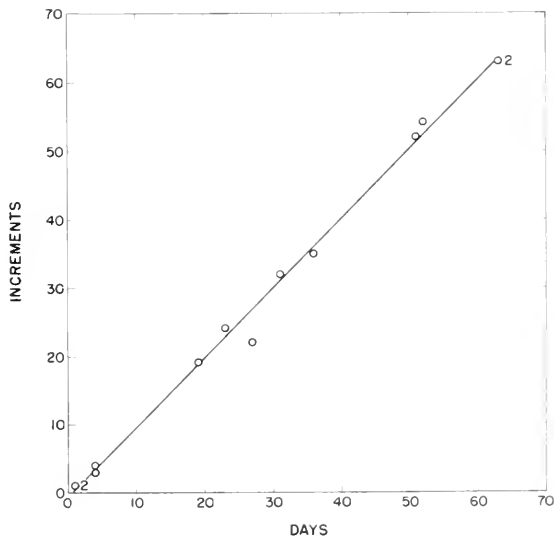

FIGURE 3.—Validation of daily increments on sagittae of *Coryphaena equiselis* by relationship of known age ( $X$ ) to mean increment count ( $Y$ ) up to 63 d ( $r = 0.997$ ).

Figure 4. A single set of growth parameters (Table 4) was calculated for *C. equiselis* since the largest specimen in the sample had just reached sexual maturity, and the calculation of separate growth curves by sex was not warranted. The von Bertalanffy growth curve and 13 age-length relationships of *C. equiselis* are shown in Figure 5.

## Discussion

### Validation

A pair of otoliths was present at the time of hatching for both dolphins, and the first increment was formed on the otoliths on D-1, identical to *Katsuwonus pelamis*, another tropical pelagic species (Radtke 1983). The strong correlation of mean increment counts of sagittae to known age of fish validated the use of growth increments in the aging of *C. equiselis* up to 63 d and *C. hippurus* up to 191 d. Since regular incremental formation began on D-1, no adjustment is required to the incremental counts

of wild fish sagittae to estimate age. Ideally, validation of daily increments should cover 1) the time when the first daily increment is formed, 2) the regularity in the formation of increments in all stages of life, and 3) events such as spawning, migration, and periods of starvation which may affect the regularity of increment formation. Having achieved only part of these requirements, validation of daily increments on otoliths should continue as older known-age specimens become available, and the effects of spawning and starvation on increment formation should also be examined.

### Growth of Wild Specimens

The plot of age-length relationships of male *C. hippurus* showed that there was at least one extreme variant. This 111.0 cm FL male greatly affected the growth curve, resulting in a lower estimated  $L_{\infty}$  and causing most of the male age estimates to fall below the growth curve (Fig. 4). Thus, age-length relations of wild *C. hippurus* should be examined further to shed light on the extent of variation in size at given ages. Additional age determinations might also improve the confidence intervals of the von Bertalanffy growth parameters.

Growth rates of *C. hippurus* to age 1 around Hawaii appeared to be greater than those reported from the western North Atlantic Ocean. Beardsley (1967) reported a mean length of 72.5 cm in age group 1 for *C. hippurus* off Florida. Rose and Hassler (1968) reported a mean length of 65.3 cm at the end of 1 yr for fish off North Carolina. Around Hawaii male *C. hippurus* were estimated to attain

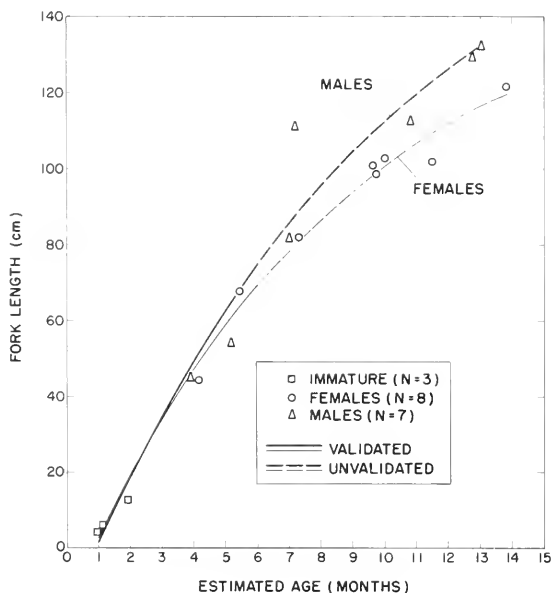

FIGURE 4.—Von Bertalanffy growth curves of male and female *Coryphaena hippurus* in Hawaiian waters.

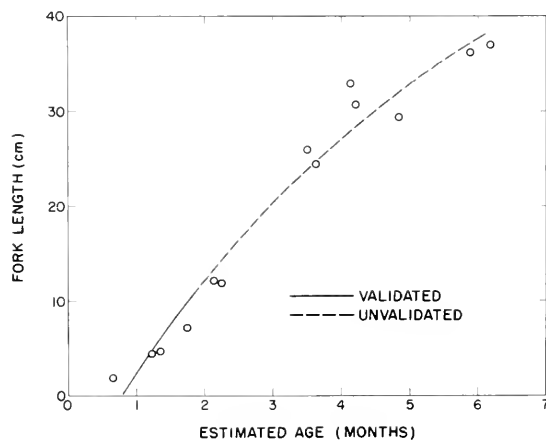

FIGURE 5.—Von Bertalanffy growth curve of *Coryphaena equiselis* in Hawaiian waters derived from 13 age estimates.

TABLE 4.—Von Bertalanffy growth parameters calculated from captured wild specimens of *Coryphaena equiselis*.

Number	Parameter	Estimate	SE
13	$t_0$	0.0648 yr	0.0131
	$K$	2.1734	0.9750
	$L_{\infty}$	61.3914 cm FL	17.8000

## Literature Cited

a length of about 126 cm at 1 yr and about 112 cm for females. The slower growth rate of *C. hippurus* in the western North Atlantic Ocean may be the result of a decrease in feeding rate when water temperature goes below 23.0°C and a cessation of feeding at 18.0°C (Hassler and Hogarth 1977). *Coryphaena hippurus* feed throughout the year in Hawaii and can be expected to grow continuously.

Wang (1979) used the monthly progression of modes in length-frequency distributions to estimate growth rates of about 10 cm/mo from February through June for *C. hippurus* between 50 and 100 cm FL. This growth rate is similar to that found for *C. hippurus* in Hawaiian waters.

Growth rates of captive *C. hippurus* were similar to those of wild fish in Hawaiian waters. Beardsley (1967) reported rapid growth rates of three captive *C. hippurus*. These fish grew from about 35 to 125 cm in 7 to 8 mo.<sup>3</sup> Soichi (1978) reported that 11 *C. hippurus* 35-50 cm TL grew to a mean 123 cm TL in 7-8 mo. Their observations also support our estimates of rapid growth for *C. hippurus* around Hawaii.

*Coryphaena equiselis* appeared to grow as rapidly as *C. hippurus* during the first 4 mo, then grew at a slower rate (Fig. 5). At about 4 mo, *C. equiselis* reached sexual maturity. *Coryphaena hippurus* also reached sexual maturity at 4-5 mo, but have been observed to mature as early as 3 mo in captivity.

The daily regularity of increment formation has been demonstrated from D-1 to D-191 for *C. hippurus* and from D-1 to D-63 for *C. equiselis*. So the use of daily increment counts on the sagitta of wild fish for estimating age has only been partially validated for these dolphins. The age-length relationships are valid for the first 6 mo for wild *C. hippurus* and the first 2 mo for wild *C. equiselis*. Thus, the von Bertalanffy growth curves calculated for wild *C. hippurus* in Hawaiian waters should be viewed with caution despite good agreement with several other growth observations in the literature.

### Acknowledgments

Our thanks to Richard W. Brill, Richard E. Brock, Leighton R. Taylor, and Jerry A. Wetherall for their critical reviews of this manuscript. Carol Hopper greatly assisted our sampling efforts for wild-caught specimens and Thomas K. Kazama provided the oldest known-age *C. hippurus*.

<sup>3</sup>A length-weight relationship (Gibbs and Collette 1959) was used to estimate lengths in centimeters from weights, given in pounds, by Beardsley (1967).

- BEARDSLEY, G. L., JR.  
1967. Age, growth, and reproduction of the dolphin, *Coryphaena hippurus*, in the Straits of Florida. *Copeia* 1967: 441-451.
- GIBBS, R. H., JR., AND B. B. COLLETTE.  
1959. On the identification, distribution, and biology of the dolphins, *Coryphaena hippurus* and *C. equiselis*. *Bull. Mar. Sci. Gulf Caribb.* 9:117-152.
- HASSLER, W. W., AND W. T. HOGARTH.  
1977. The growth and culture of dolphin, *Coryphaena hippurus*, in North Carolina. *Aquaculture* 12:115-122.
- HERALD, E. S.  
1961. Living fishes of the world. Doubleday and Co., Inc., Garden City, NY, 304 p.
- PALKO, B. J., G. L. BEARDSLEY, AND W. J. RICHARDS.  
1982. Synopsis of the biological data on dolphin-fishes, *Coryphaena hippurus* Linnaeus and *Coryphaena equiselis* Linnaeus. U.S. Dep. Commer., NOAA Tech. Rep. NMFS Circ. 443, 28 p. [Also FAO Fish. Synop. 130.]
- PANNELLA, G.  
1971. Fish otoliths: Daily growth layers and periodical patterns. *Science* (Wash., D.C.) 173:1124-1127.
- RADTKE, R. L.  
1983. Otolith formation and increment deposition in laboratory-reared skipjack tuna, *Euthynnus pelamis*, larvae. In E. D. Prince and L. M. Pulos (editors), Proceedings of the International Workshop on Age Determination of Oceanic Pelagic Fishes: Tunas, Billfishes, and Sharks, p. 99-103. U.S. Dep. Commer., NOAA Tech. Rep. NMFS 8.
- ROSE, C. D., AND W. W. HASSLER.  
1968. Age and growth of the dolphin, *Coryphaena hippurus* (Linnaeus), in North Carolina waters. *Trans. Am. Fish. Soc.* 97:271-276.
- SAS INSTITUTE.  
1982. SAS user's guide: Statistics. SAS Institute Inc., Cary, NC, 584 p.
- SHCHERBACHEV, YU. N.  
1973. The biology and distribution of the dolphins (Pisces, Coryphaenidae). [In Russ.] *Vopr. Ikhtiol.* 13:219-230. (Engl. transl. in *J. Ichthyol.* 13:182-191.)
- SOICHI, M.  
1978. Spawning behavior of the dolphin, *Coryphaena hippurus*, in the aquarium and its eggs and larvae. [In Jpn., Engl. summ.] *Jpn. J. Ichthyol.* 24:290-294.
- SQUIRE, J. L., JR., AND S. E. SMITH.  
1977. Anglers' guide to the United States Pacific coast: marine fish, fishing grounds & facilities. U.S. Dep. Commer., NOAA, NMFS, 139 p.
- WANG, C. H.  
1979. A study of population dynamics of dolphin fish (*Coryphaena hippurus*) in waters adjacent to eastern Taiwan. [In Chin., Engl. abstr.] *Acta Oceanogr. Taiwan.* 10:233-251.

JAMES H. UCHIYAMA

Southwest Fisheries Center Honolulu Laboratory  
National Marine Fisheries Service, NOAA  
PO. Box. 3830, Honolulu, HI 96812

RAYMOND K. BURCH  
SYD A. KRAUL, JR.

Waikiki Aquarium, University of Hawaii  
2777 Kalakoa Avenue  
Honolulu, HI 96815

**SIZES OF WALLEYE POLLOCK,  
THERAGRA CHALCOGRAMMA, CONSUMED  
BY MARINE MAMMALS IN THE BERING SEA**

In the Bering Sea at least 11 species of marine mammals, 13 seabirds, and 10 fishes are known to feed on walleye pollock, *Theragra chalcogramma* (Frost and Lowry 1981a). Walleye pollock are a major food of most pinnipeds, particularly in the southern Bering Sea (Lowry and Frost 1981), and are sometimes eaten by several species of baleen and toothed whales (Frost and Lowry 1981b).

In recent years, walleye pollock have been the principal target species in the Bering Sea commercial groundfish fishery. Annual catches have been as high as 1,840,000 t in 1972 (Bakkala et al. 1981). While there can be little doubt that both the fishery and marine mammal predation affect pollock stocks and perhaps also one another, the interactions are poorly understood at present (Lowry et al.<sup>1</sup>; Swartzman and Harr 1983).

An important aspect of marine mammal-fishery interactions is the size composition of fishes eaten in relation to that of the commercial catch. For example, if a marine mammal consumes fishes smaller than those taken by the fishery, the fishery would be unlikely to influence availability of food to the predator unless it affected recruitment. If marine

mammals and the fishery remove fishes of similar sizes, competition would be expected (IUCN<sup>2</sup>).

Stomach contents of marine mammals seldom contain intact fishes in a condition suitable for measuring. However, the sagittal otoliths of species such as walleye pollock are easily identified (Frost 1981), and equations are available that estimate the length and weight of fishes from otolith lengths (Frost and Lowry 1981a). We present here information on the sizes of walleye pollock consumed by marine mammals in the Bering Sea, based on otoliths from gastrointestinal tracts.

**Methods**

Specimens were collected during the months of March to October 1975-81, at the locations shown in Table 1. With the exception of a minke whale, *Balaenoptera acutorostrata*, which was stranded on shore, all specimens were from animals collected for scientific purposes. Stomachs were removed and opened, and the contents gently washed on a 1 mm mesh sieve. Otoliths were sorted from other ingesta and identified using the descriptions of Morrow (1979) and Frost (1981). Since fresh walleye pollock otoliths have fine lobulations around their perimetry (Frost 1981) which disappear during digestion, degraded otoliths were easily detected by compari-

<sup>1</sup>Lowry, L. F., K. J. Frost, D. G. Calkins, G. L. Swartzman, and S. Hills. 1982. Feeding habits, food requirements, and status of Bering Sea marine mammals. North Pac. Fish. Manage. Council Doc. 19 and 19A, Anchorage, Alaska, Contract 81-4, 574 p.

<sup>2</sup>IUCN. 1981. Report of IUCN workshop on marine mammal-fishery interactions, La Jolla, Calif., 30 March-2 April. IUCN, Gland, Switzerland, 68 p.

TABLE 1.—Location and dates of capture of marine mammals from which otoliths of walleye pollock were obtained.

Species	Dates	Location	No. of specimens	No. of otoliths measured
Harbor seal, <i>Phoca vitulina richardsi</i>	13 Apr. 1979	Otter Island	4	23
	9 Oct. 1981	Port Heiden	1	12
Spotted seal, <i>Phoca largha</i>	6 May 1978	61°42.3N, 175°36.0W	1	11
	23 May 1978	63°25.8N, 173°05.6W	1	10
Ribbon seal, <i>Phoca fasciata</i>	19-20 Apr. 1976	57°20.1N-57°28.0N 172°30.9W-173°07.5W	5	256
	21-22 Mar. 1977	58°51.0N-58°56.0N 172°40.0W-173°08.0W	4	67
	5-31 May 1978	61°23.0N-64°39.4N 169°07.0W-176°08.8W	10	145
Stellar sea lion, <i>Eumetopias jubatus</i>	20 Mar. 1976	56°04.8N, 168°32.9W	1	274
	13 Apr. 1979	Otter Island	1	6
	24 Mar.,	59°30.0N-60°11.5N	32	497
	10-11 Apr. 1981	176°43.5W-179°55.0W		
	30 Mar.-4 Apr. 1981	59°08.0N-60°13.0N 165°45.0E-170°46.0E	56	638
Minke whale, <i>Balaenoptera acutorostrata</i>	5 Aug. 1975	Unalaska Island	1	121



son with those taken from trawl-caught fishes. The maximum length of nondegraded otoliths was measured to the nearest 0.1 mm using vernier calipers. When more than 20 otoliths occurred in a single stomach, a subsample of 20 was measured.

Very few otoliths were found in the stomachs of ribbon, *Phoca fasciata*, and spotted, *P. largha*, seals. For those species, additional otoliths were obtained from small intestines which were split along their entire length and examined for parasitological studies. There was no significant difference between sizes of otoliths obtained from stomachs and intestines of ribbon seals (Frost and Lowry 1980). Too few otoliths were retrieved from spotted seal stomachs to test their sizes relative to otoliths from intestines. However, otoliths from intestines were of the same general size range and condition as those from stomachs. We therefore pooled the measurements of otoliths from stomachs and intestines.

The fork lengths and weights of walleye pollock consumed were estimated from equations in Frost and Lowry (1981a).

## Results

We measured a total of 2,060 otoliths from 117 individual marine mammals belong to 5 species (Table 1). Most of the otoliths were from the stomachs and small intestines of 19 ribbon seals and 90 Steller sea lions, *Eumetopias jubatus*. Ribbon seals, spotted seals, and a minke whale fed primarily on walleye pollock <20 cm long (Table 2, Fig. 1). Harbor seals, *Phoca vitulina richardsi*, fed on a wide size range of pollock, including equal numbers of fishes 8-15 cm and 20-35 cm long and a few individuals 45-56 cm in length. Most pollock eaten by sea lions (76%) were 20 cm or longer. Young sea lions ( $\leq 4$  yr) collected in 1981 (all were males) ate significantly smaller fish ( $\bar{x} = 22.4$  cm,  $n = 37$ ) than did older animals ( $\bar{x} = 26.9$  cm,  $n = 51$ ;  $P < 0.005$ ).

There were some differences in sizes of pollock consumed at different localities and in different years. The sizes of pollock eaten by harbor seals collected at Otter Island in 1979 ranged from 10.3 to 56.3 cm ( $\bar{x} = 31.8$  cm), while those eaten by a seal collected at Port Heiden in 1981 were all <12.6 cm long ( $\bar{x} = 10.6$  cm). Two sea lions collected in 1976 and 1979 near the Pribilof Islands had eaten pollock averaging 46.9 cm in length (range 18.4-61.4 cm), while those collected in 1981 to the west had eaten substantially smaller pollock averaging 25.2 cm in length (range 8.3-64.2 cm). In Figure 1, the smaller size mode corresponds to 1981 collections and the larger mode to those from 1976 and 1979. In 1981

sea lions collected in the central Bering had eaten larger pollock than those off the Kamchatka Peninsula ( $\bar{x} = 26.8$  cm vs. 23.5 cm;  $P < 0.001$ ). This was not attributable to different age or size composition of the samples, since the difference was apparent for older sea lions ( $\geq 5$  yr;  $\bar{x} = 27.8$  cm vs. 25.6 cm;  $P < 0.01$ ) as well as the samples as a whole, and the mean age and standard length of all sea lions  $\geq 5$  yr in the Kamchatka sample ( $\bar{x}$  age = 9.1 yr,  $\bar{x}$  SL = 297 cm,  $n = 27$ ) was greater than that of the central Bering sample ( $\bar{x}$  age = 8.2 yr,  $\bar{x}$  SL = 282 cm,  $n = 25$ ).

## Discussion

Of the marine mammal species we examined, ribbon seals, spotted seals, and a minke whale ate almost exclusively small pollock, whereas Steller sea lions and harbor seals ate pollock of a wide range of sizes. There are few other data available on the sizes of pollock consumed by marine mammals in the Bering Sea. Nemoto (1959) indicated that the length of pollock eaten by fin whales, *Balaenoptera physalus*, never exceeded 30 cm, while larger pollock were sometimes eaten by humpback whales, *Megaptera novaeangliae*. Fiscus et al. (1964) reported that in 1962 northern fur seals, *Callorhinus ursinus*, ate mostly whole pollock <30-35 cm long. McAlister et al.<sup>3</sup> found intact pollock in fur seal stomachs collected in the eastern Bering Sea, July-September 1974, to range from 10 to 35 cm, with a mean length of 19.3 cm. Most specimens were between 16 and 21 cm long. In 1981, Loughlin<sup>4</sup> collected fur seals north of Unalaska Island and found the average size of pollock consumed to be 30.4 cm. Antonelis<sup>5</sup> found that bearded seals, *Erignathus barbatus*, collected near St. Matthew Island in the central Bering Sea had eaten only small pollock ( $\bar{x}$  length = 8.2 cm).

It is unknown whether the consumption patterns described above are a result of actual size selection of prey or if they result from coincidental distribution of predators and prey size classes. The overall density of pollock and distribution by age classes are far from uniform in the southern Bering Sea (Smith 1981; Bakkala and Alton<sup>6</sup>). The sizes of fishes con-

<sup>3</sup>McAlister, W. B., G. A. Sanger, and M. A. Perez. 1976. Preliminary estimates of pinniped-fish relationships in the Bering Sea. Unpubl. background paper, 19th meeting North Pac. Fur Seal Comm., Moscow, 1976.

<sup>4</sup>T. R. Loughlin, National Marine Mammal Laboratory, 7600 Sand Point Way N.E., Seattle, WA 98115, pers. commun. November 1983.

<sup>5</sup>G. Antonelis, National Marine Mammal Laboratory, 7600 Sand Point Way N.E., Seattle, WA 98115, pers. commun. December 1983.

<sup>6</sup>Bakkala, R., and M. Alton. 1983. Evaluation of demersal trawl survey data for assessing the condition of eastern Bering Sea

TABLE 2.—Summary of sizes of walleye pollock consumed by marine mammals in the Bering Sea.

Marine mammal species	Size of walleye pollock consumed			
	Fork length		Weight of mean length fish (g)	Mean weight of fishes consumed (g)
	Mean (cm)	Range (cm)		
Ribbon seal	11.2	6.5-34.4	8.6	11.2
Spotted seal	10.9	8.0-15.0	7.9	8.4
Harbor seal	24.5	8.2-56.3	83.8	174.3
Steller sea lion	29.3	8.2-64.2	140.5	204.3
Minke whale	14.5	11.8-17.5	18.3	18.7

<sup>1</sup>The weight of the mean length fish does not correspond to the mean weight of fishes consumed due to the exponential nature of the length-weight relationship for fishes and the distribution of lengths of fishes consumed.

sumed generally agree with the basic distribution pattern for pollock in that sea lions collected near the continental slope ate many large pollock, while ribbon and spotted seals collected north of St. Matthew Island ate almost entirely small pollock. However, concurrent sampling of prey in stomachs and those available in the environment suggest that some selection does occur. Fur seals were found to eat smaller pollock than those caught in otter trawls taken nearby ( $\bar{x}$  length = 30.4 cm in seals, 38.3 cm in trawls), while sea lions appeared to select larger fishes ( $\bar{x}$  length = 29.9 cm in sea lions, 25.5 cm in trawls) (Loughlin fn. 4). Such comparisons must be interpreted with caution since demersal trawl samples underestimate the abundance of young pollock, most of which occur several meters off the bottom (Traynor<sup>7</sup>).

Other information also indicates that marine mammals sometimes select fishes of certain size classes. The sizes of arctic cod, *Boreogadus saida*, caught in otter trawls in the northern Bering Sea were compared with the estimated lengths of fishes eaten by spotted and ribbon seals collected in the same area and time period (Frost and Lowry 1980; Bukhtiyarov et al. 1984). While the distribution of trawl-caught fishes was distinctly bimodal, seals ate predominantly fishes of the larger size classes. Saffron cod, *Eleginus gracilis*, eaten by adult white whales, *Delphinapterus leucas*, in the Kotzebue Sound region of the southern Chukchi Sea were larger than those eaten by younger animals collected at the same location on the same dates (Seaman et al. 1982). We obtained similar results in this study for young versus old sea lions. Pitcher (1981) found that pollock eaten by sea lions were significantly longer ( $\bar{x}$  = 29.8 cm)

than those eaten by harbor seals ( $\bar{x}$  = 19.2 cm;  $P < 0.001$ ) collected in the same general locations in the Gulf of Alaska.

The factors involved in the apparent size selection of prey are poorly known for marine mammals. A strict relationship between the size of predators and the size of their prey is not to be expected in such behaviorally complex and morphologically diverse animals. For example, the prey of ringed seals, *Phoca hispida*, range in length from 1 cm (euphausiids) to at least 121 cm (wolfish, *Anarhichas* sp.) (Frost and Lowry 1981c). The largest animal we examined in this study, a minke whale 7.3 m long, ate uniformly small pollock. Age-related differences in sizes of fishes eaten by sea lions and belukha whales are more likely due to morphological and behavioral development than to size relationships per se. Although size may affect a sea lion's ability to catch large pollock, and old sea lions are larger than young ones ( $\bar{x}$  SL = 212 cm for sea lions age 1-4 yr,  $n = 33$  vs.  $\bar{x}$  SL = 289 cm for those  $\geq 5$  yr,  $n = 52$ ), the size range of pollock eaten by both young and old sea lions was similar. The largest pollock (64 cm) represented in our samples was eaten by a 215 cm long, 3-yr-old sea lion which indicates that physical differences due strictly to predator size are not the sole factor influencing preference for a particular prey size. Aspects of feeding strategy, including size selectivity, are the result of a complex and interacting suite of morphological, physiological, and behavioral adaptations which allow an organism to gather food in the most efficient manner (Schoener 1971).

Size-specific feeding may have important consequences for predators. For example, the length of 1-yr-old pollock fluctuates markedly among years, as does the numerical abundance of the first year class. In 1976 abundance was low (729 million individuals in the NMFS Bering Sea survey area) and fishes were small ( $\bar{x}$  = 11.6 cm), while in 1974 abundance was high (2,840 million individuals) and fishes were

pollock. Unpubl. Rep., 43 p. Northwest and Alaska Fisheries Center, NMFS, NOAA, Seattle, WA.

<sup>7</sup>Traynor, J. J. 1983. Midwater pollock (*Theragra chalcogramma*) abundance estimation in the eastern Bering Sea. Unpubl. Rep., 7 p. Northwest and Alaska Fisheries Center, NMFS, NOAA, Seattle, WA.

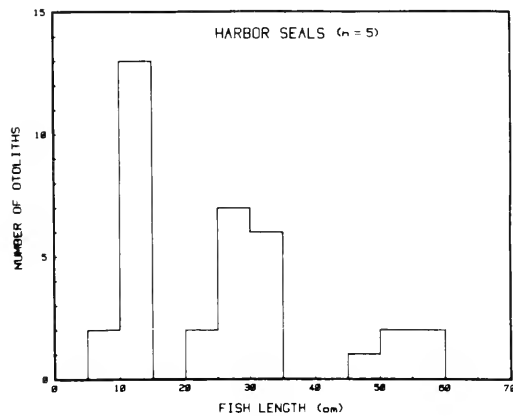
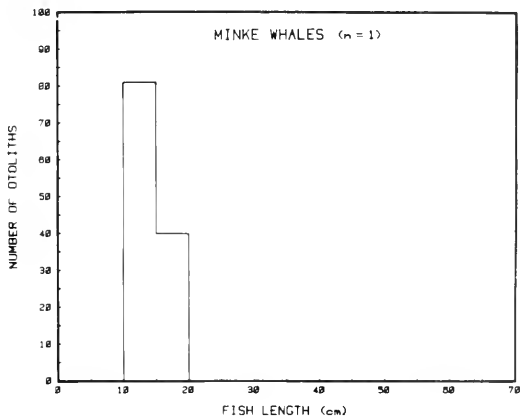
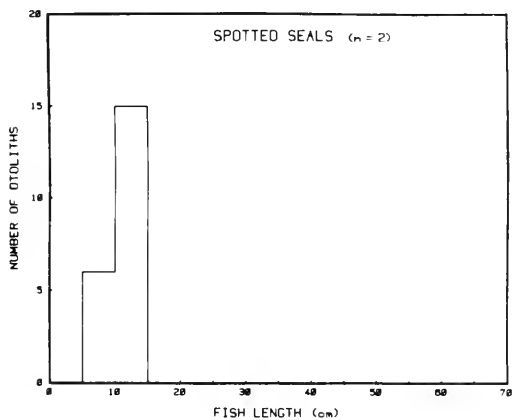
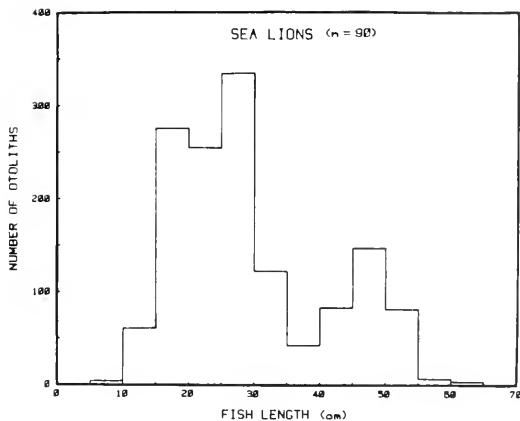
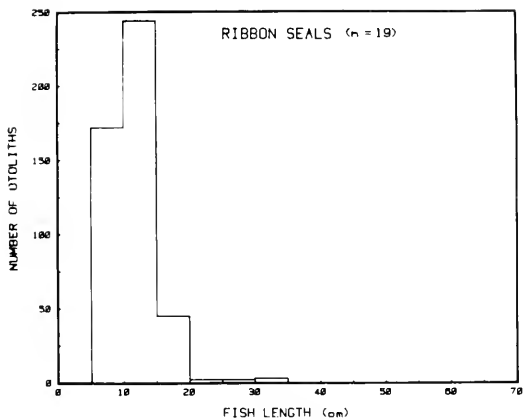

FIGURE 1.—Size distributions of walleye pollock eaten by five species of marine mammals collected in the Bering Sea, 1975-81.

considerably larger ( $\bar{x} = 15.9$  cm) (Smith 1981). The corresponding average individual weights can be estimated as 9.5 and 23.7 g, giving an estimated biomass of age 1 pollock about 10 times greater in 1974 than in 1976. Therefore, the total food available to predators that specialize on small pollock can vary markedly, as can the energy obtained from each fish consumed. Lengths and population sizes of older pollock also vary somewhat among years (Smith 1981); however, predators feeding on large pollock will undoubtedly be exploiting several age classes.

Three species of marine mammals—harbor seals, sea lions, and fur seals—consume age classes of pollock that are also exploited by the commercial fishery (Table 3). A major effect of the pollock fishery has been a reduction in the abundance of older, larger individuals (Pereyra et al.<sup>8</sup>). Major declines in abundance of sea lions and fur seals in the eastern Bering Sea have been reported since the 1950's (Braham et al. 1980; Fowler 1982). Although the evidence is equivocal, especially for the fur seal (see Swartzman and Haar 1983), reduced food availability due to expansion of the pollock fishery has been suggested as a possible cause of the decline in populations. The present population status of other pollock-eating marine mammals in the Bering Sea is not known.

The sizes of fishes consumed by marine mammals are obviously very important for determining the nature and magnitude of marine mammal-fishery interactions. It is particularly important to recognize that because of different feeding strategies, changes

in fish stock characteristics caused by fishing may benefit some marine mammal species while having no effect or being detrimental to others.

### Acknowledgments

Support for this study was provided by the U.S. Bureau of Land Management Outer Continental Shelf Environmental Assessment Program and the Federal Aid in Wildlife Restoration Program. Numerous colleagues, particularly John J. Burns and Larry M. Shults, assisted in the collection and processing of specimens. We are particularly grateful to Donald G. Calkins, Thomas R. Loughlin, and George Antonelis for providing us unpublished information. Graphics and statistical analyses were done by Jesse Venable. Clifford H. Fiscus made helpful comments on an earlier draft of the manuscript. We also thank two anonymous reviewers whose comments substantially improved the manuscript.

### Literature Cited

- BAKKALA, R., K. KING, AND W. HIRSCHBERGER.  
1981. Commercial use and management of demersal fish. *In* D. W. Hood and J. A. Calder (editors), *The eastern Bering Sea shelf: oceanography and resources*, Vol. 2, p. 1015-1036. U.S. Dep. Commer., Off. Mar. Pollut. Assessment, NOAA, Rockville, MD.
- BRAHAM, H. W., R. D. EVERITT, AND D. J. RUGH.  
1980. Northern sea lion population decline in the eastern Aleutian Islands. *J. Wildl. Manage.* 44:25-33.
- BUKHTIYAROV, Y. A., K. J. FROST, AND L. F. LOWRY.  
1984. New information on foods of the spotted seal, *Phoca largha*, in the Bering Sea in spring. *In* F. H. Fay and G. A. Fedoseev (editors), *Soviet-American cooperative research on marine mammals*, Vol. 1 - Pinnipeds, p. 55-59. U.S. Dep. Commer., NOAA Tech. Rep. NMFS 12.
- FISCUS, C. H., G. A. BAINES, AND F. WILKE.  
1964. Pelagic fur seal investigations, Alaska waters, 1962. U.S. Fish Wildl. Serv., Spec. Sci. Rep. Fish. 475, 59 p.
- FOWLER, C. W.  
1982. Interactions of northern fur seals and commercial fisheries. *Trans. N. Am. Wildl. Nat. Resour. Conf.* 47:278-292.
- FROST, K. J.  
1981. Descriptive key to the otoliths of gadid fishes of the Bering, Chukchi, and Beaufort Seas. *Arctic* 34:55-59.
- FROST, K. J., AND L. F. LOWRY.  
1980. Feeding of ribbon seals (*Phoca fasciata*) in the Bering Sea in spring. *Can. J. Zool.* 58:1601-1607.
- 1981a. Trophic importance of some marine gadids in northern Alaska and their body-otolith size relationships. *Fish. Bull.* U.S. 79:187-192.
- 1981b. Foods and trophic relationships of cetaceans in the Bering Sea. *In* D. W. Hood and J. A. Calder (editors), *The eastern Bering Sea shelf: oceanography and resources*, Vol. 2, p. 825-836. U.S. Dep. Commer., Off. Mar. Pollut. Assessment, NOAA, Rockville, MD.
- 1981c. Ringed, Baikal, and Caspian Seals. *In* S. H. Ridgway and R. J. Harrison (editors), *Handbook of marine mammals*, Vol. 2, Seals, p. 29-53. Acad. Press, N.Y.
- \*Pereyra, W. T., J. E. Reeves, and R. G. Bakkala. 1976. Demersal fish and shellfish resources of the eastern Bering Sea in the baseline year 1976. Processed Rep., 619 p. Northwest and Alaska Fisheries Center, NMFS, NOAA, Seattle, WA.

TABLE 3.—Age-class distribution of walleye pollock consumed by marine mammals in the Bering Sea, and caught in the commercial fishery in 1978, based on length-at-age data from Smith (1981).

Predator species	Percent of fishes in age class									
	1	2	3	4	5	6	7	8	9	≥10
Harbor seal	43	20	23	—	—	3	0	3	3	6
Spotted seal	100	—	—	—	—	—	—	—	—	—
Ribbon seal	98	1	1	—	—	—	—	—	—	—
Steller sea lion	21	40	14	3	5	6	4	2	2	3
Fur seal <sup>1</sup>	49	44	7	—	—	—	—	—	—	—
Minke whale	100	—	—	—	—	—	—	—	—	—
Commercial fishery <sup>2</sup>	2	20	40	18	20	(>5 yr old)				

<sup>1</sup>from McAlister et al. 1976.

<sup>2</sup>from Smith 1981.

LOWRY, L. F., AND K. J. FROST.

1981. Feeding and trophic relationships of phocid seals and walrus in the eastern Bering Sea. In D. W. Hood and J. A. Calder (editors), *The eastern Bering Sea shelf: oceanography and resources*, Vol. 2, p. 813-824. U.S. Dep. Commer., Off. Mar. Pollut. Assessment, NOAA, Rockville, MD.

MORROW, J. E.

1979. Preliminary keys to otoliths of some adult fishes of the Gulf of Alaska, Bering Sea, and Beaufort Sea. U.S. Dep. Commer., NOAA Tech. Rep., NMFS Circ. 420, 32 p.

NEMOTO, T.

1959. Food of baleen whales with reference to whale movements. *Sci. Rep. Whales Res. Inst.* 14:149-291.

PITCHER, K. W.

1981. Prey of the Steller sea lion, *Eumetopias jubatus*, in the Gulf of Alaska. *Fish. Bull.*, U.S. 79:467-472.

SCHOENER, T. W.

1971. Theory of feeding strategies. *Annu. Rev. Ecol. Syst.* 2:369-404.

SEAMAN, G. A., L. F. LOWRY, AND K. J. FROST.

1982. Foods of belukha whales (*Delphinapterus leucas*) in western Alaska. *Cetology* 44:1-19.

SMITH, G. B.

1981. The biology of walleye pollock. In D. W. Hood and J. A. Calder (editors), *The eastern Bering Sea shelf: oceanography and resources*, Vol. 1, p. 527-551. U.S. Dep. Commer., Off. Mar. Pollut. Assessment, NOAA, Rockville, MD.

SWARTZMAN, G. L., AND R. T. HAAR.

1983. Interactions between fur seal populations and fisheries in the Bering Sea. *Fish. Bull.*, U.S. 81:121-132.

KATHRYN J. FROST

LLOYD F. LOWRY

*Alaska Department of Fish and Game*  
1300 College Road  
Fairbanks, AK 99701

northern and central New Jersey, coastal lobsters are scarce or absent south of Cape May, NJ. There is an active offshore commercial lobster fishery along the edge of the continental shelf south to Norfolk Canyon (Fig. 1).

## Materials and Methods

To determine whether offshore lobsters in the Mid-Atlantic Bight have larval *Ascarophis* sp., we examined the guts of 218 American lobsters, *Homarus americanus*, collected from August 1975 through March 1977. Lobsters from this region had not been examined previously for parasites.

One hundred and ninety-seven of the lobsters examined were caught in lobster traps or trawl nets by commercial and research vessels in Norfolk and Washington Canyons and from the shelf and slope between and adjacent to those canyons (areas III-V, Fig. 1) at depths of 73-402 m. The remaining 21 lobsters were caught by trawl nets from research vessels off the coasts of Delaware and New Jersey at depths of 57-95 m (area VIII, Fig. 1).

The intestines and rectum were excised from live lobsters on shipboard (70% of the samples) or in the laboratory at the Virginia Institute of Marine Science, split longitudinally, and fixed in 10% Formalin<sup>2</sup> or in Davidson's fixative. No free parasites were found in the gut contents. In the laboratory, the gut was transferred to 35% glycerine in 70% ethanol, and part of the ethanol evaporated in a 55°C oven. Pieces of the gut were then laid open, pressed between two 35 × 50 mm slides, and examined for the presence of cysts. This procedure followed the recommendation of J. R. Uzmans<sup>3</sup>.

## Results

Thirty-nine American lobsters were infected with larval *Ascarophis* sp., encapsulated in the anterior wall of the rectum (Table 1). The proportion of infection in 218 lobsters (17.9%) from the Mid-Atlantic Bight was similar to that reported by Uzmans (1967b), when examined in a 2 × 2 contingency table and using Yates' correction for continuity (Elliott 1971). Uzmans (1967b) reported 77 infections in 314 lobsters (24.5%) collected east and south of southern New England. However, Boghen (1978) reported infection in the gills of 82 out of 233 lobsters (35.2%)

<sup>2</sup>Reference to trade names does not imply endorsement by the National Marine Fisheries Service, NOAA.

<sup>3</sup>J. R. Uzmans, Northeast Fisheries Center Woods Hole Laboratory, National Marine Fisheries Service, NOAA, Woods Hole, MA 02543, pers. commun. June 1974.

<sup>1</sup>Contribution No. 1277, Virginia Institute of Marine Science, Gloucester Point, VA 23062.

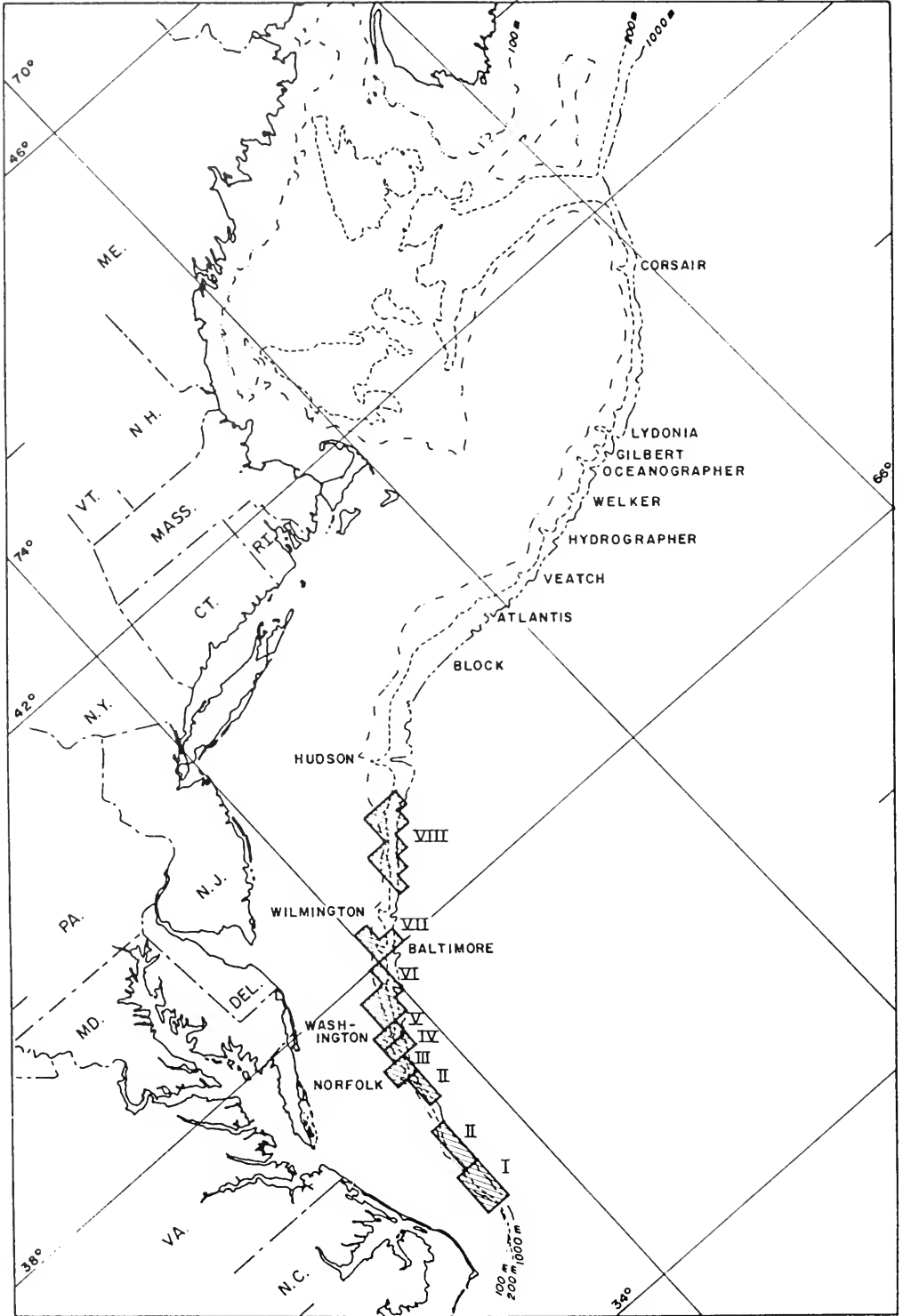

FIGURE 1.—Canyons and lobster sampling sites along the edge of the continental shelf, between Cape Hatteras and the eastern edge of Georges Bank.

TABLE 1.—Prevalence of American lobsters infected with nematodes, *Ascarophis* sp., in the Mid-Atlantic Bight, August 1975-March 1977.

Date	Area <sup>1</sup>	No. lobsters sampled (No. infected)			Prevalence of infection (%)		
		M	F	Sexes combined	M	F	Sexes combined
Aug., Sept. 1975	III	26(1)	236(6)	63(7)	3.8	16.2	11.1
Dec. 1975	III	18(3)	18(2)	36(5)	16.7	11.1	13.9
Jan. 1975	III	3(1)	16(5)	19(6)	33.3	31.3	31.6
Jan. 1976	IV	11(1)	13(1)	24(2)	9.1	7.7	8.3
Apr. 1976	III	6(3)	9(2)	15(5)	50.0	22.2	33.3
Apr. 1976	V	4(2)	16(4)	20(6)	50.0	25.0	30.0
July 1976	V	7(1)	5(2)	12(3)	14.3	40.0	25.0
Oct. 1976	V	3(0)	5(2)	8(2)	0.0	40.0	25.0
Nov. 1976	VIII	11(1)	6(2)	17(3)	9.1	33.3	17.6
Mar. 1977	VIII	2(0)	2(0)	4(0)	0.0	0.0	0.0
Total		91(13)	127(26)	218(39)	14.3	20.5	17.9

<sup>1</sup> III. Norfolk Canyon and adjacent slope  
 IV. Between Norfolk and Washington Canyons  
 V. Washington Canyon

VIII. Between Wilmington and Hudson Canyons.

<sup>2</sup>One 86 mm female contained 33 acanthocephalan cysts, *Corynosoma* sp.

from Northumberland Strait, southern Gulf of St. Lawrence. That higher proportion of infection was highly significantly different from that reported off southern New England and in the Mid-Atlantic Bight.

Mid-Atlantic Bight lobsters examined for parasites ranged from 49 to 179 mm carapace length (CL) (Table 2). Larval *Ascarophis* sp. were found in 13 (14.3%) of 91 male lobsters and in 26 (20.5%) of 127 female lobsters. No significant difference in prevalence of infection between males and females, when size was ignored, could be demonstrated with a 2 × 2 contingency table analysis. This agrees with the absence of sex specificity in the canyon lobsters

TABLE 2.—Numbers of American lobsters examined and prevalence of infection by the larvae of the nematode *Ascarophis* sp. in the Mid-Atlantic Bight.

Size range, CL mm	No. examined			No. infected			Percent of group infected	Percent of total infected	No. larvae, range
	M	F	Sum	M	F	Sum			
40-49	0	2	2	0	2	2	100.0	0.9	1-12
50-59	5	7	12	2	1	3	25.0	1.4	1-9
60-69	9	21	30	1	8	9	30.0	4.1	1-13
70-79	27	29	56	4	7	11	19.6	5.0	1-4
80-89	20	37	57	2	4	6	10.5	2.8	1-5
90-99	16	19	35	3	3	6	17.1	2.8	1-8
100-109	7	8	15	1	1	2	13.3	0.9	2-3
110-119	2	2	4	0	0	0			
120-129	2	1	3	0	0	0			
130-139	0	0	0	0	0	0			
140-149	1	1	2	0	0	0			
150-159	0	0	0	0	0	0			
160-169	1	0	1	0	0	0			
170-179	1	0	1	0	0	0			
Total	91	127	218	13	26	39		17.9	
110-149	5	4	9	0	0	0			
150-179	2	0	2	0	0	0			

reported by Uzmann (1967b) and also reported from Northumberland Strait by Boghen (1978).

Almost one-half (46.3%) of all infections occurred in the 60-79 mm size classes; intensity of infection ranged from 1 to 13 (mean 3.0) (Table 2). None of the 11 lobsters >110 mm CL contained parasites. Boghen (1978) reported 51.3% infection in the 60-69.9 mm range. When the occurrences of parasites in males and females are arranged in three size groups, 40-59, 60-79 and 80-109 mm, and statistically examined with a 2 × 3 contingency table, no departure from the expected 1:1 ratio was observed.

A single specimen of the commensal polychaete, *Histriobdella homari*, was obtained from the gills of a female lobster, 82 mm CL, caught in Norfolk Canyon in June 1974. Gills of four other lobsters were excised, placed in dilute seawater in specimen bowls, and refrigerated overnight. The polychaete was found in the sediment collected from one gill. Because of the small number of lobster gills examined, an estimate of prevalence is inappropriate. Previously, *Histriobdella* was reported by Uzmann (1967a) in the gills and by Simon (1968) in the gills and bodies of New England lobsters, and by Boghen (1978) in the branchial chamber and gills of lobsters from Northumberland Straits.

One female lobster, 86 mm CL, caught in Norfolk Canyon in August 1975, was infected with cysts of an acanthocephalan, *Corynosoma* sp. Thirty-three cysts were found in the intestinal wall and in the mesenteries along the outside of the intestine. Adult *Corynosoma* sp. are parasites of mammals and aquatic birds; crustaceans are first intermediate hosts and fishes are second intermediate hosts (Yamaguti 1963).

According to Uzmann (1970), *Corynosoma* sp. is a discriminator of coastal lobster stocks. Therefore its presence in a lobster taken in Norfolk Canyon indicates that migration from inshore to offshore waters occurs. Montreuil (1954) reported that the acanthocephalan infections in lobsters from the Magdalen Islands, Gulf of St. Lawrence, varied with the sex of the lobster and by season: 20% of females and 20% of males had cysts seemingly acquired towards the end of summer and early fall. Boghen (1978) attributed the absence of cysts in his Northumberland Strait samples to the fact that the lobsters were collected before the end of summer.

## Discussion

The variety of animal parasites and their intensity of infection are small in the Mid-Atlantic Bight lobsters. Differences in the occurrence and rates of

infection of *Ascarophis* and *Corynosoma* and of the commensal *Histriobdella* reported from American lobsters of the Mid-Atlantic Bight, southern New England waters, and the Gulf of St. Lawrence, are not large and could be attributed to differences in sample sizes or season of sampling. Peculiarly, cysts of the sporozoan *Porospora* sp. were not seen in Mid-Atlantic Bight lobsters, but occurred in most lobsters in the Gulf of St. Lawrence (Montreuil 1954; Boghen 1978) and were reported by Uzmann (1970) from southern New England waters. Cysts of the trematode *Stichocotyle* sp. were reported by Nickerson (1895) from Penobscot Bay, ME, and from lobster dealers in Boston, MA; by Linton (1940) from an un-stated region, probably Woods Hole, MA; by Uzmann (1970) from southern New England waters; and by Montreuil (1954) from southern Nova Scotia or southeastern New Brunswick. Nickerson (1895) found the cysts only in the intestinal tract at the union of the intestine and rectum.

#### Literature Cited

- BOGHEN, A. D.  
1978. A parasitological survey of the American lobster *Homarus americanus* from the Northumberland Strait, southern Gulf of St. Lawrence. *Can. J. Zool.* 56:2460-2462.
- ELLIOTT, J. M.  
1971. Some methods for the statistical analysis of samples of benthic invertebrates. *Freshw. Biol. Assoc., Sci. Pub.* 25, 148 p.
- LINTON, E.  
1940. Trematodes from fishes mainly from the Woods Hole region, Massachusetts. *Proc. U.S. Natl. Mus.* 88:1-172.
- MONTREUIL, P.  
1954. Parasitological investigations. *Rapp. Ann. Stn. Biol. Mar. Dep. Peches Quebec, Contrib.* 50:69-73.
- NICKERSON, W. S.  
1895. On *Stichocotyle nephropsis* Cunningham, a parasite of the American lobster. *Zool. Jahrb., Abt. Anat. Ontog. Tiere* 8:447-480.
- SIMON, J. L.  
1968. Incidence and behavior of *Histriobdella homari* (Annelida: Polychaeta), a commensal of the American lobster. *Bioscience* 18:35-36.
- USPENSKAYA, A. B.  
1953. The life cycle of nematodes of the genus *Ascarophis* van Beneden (Nematodes - Spirurata). [In Russ.] *Zool. Zh.* 32: 828-832. (Translated by J. M. Moulton, Bowdoin College, Brunswick, ME, 1966).
- UZMANN, J. R.  
1967a. *Histriobdella homari* (Annelida: Polychaeta) in the American lobster, *Homarus americanus*. *J. Parasitol.* 53: 210-211.  
1967b. Juvenile *Ascarophis* (Nematoda: Spiruroidea), in the American lobster, *Homarus americanus*. *J. Parasitol.* 53: 218.  
1970. Use of parasites in indentifying lobster stocks. (Abstr.) *In* Section II, Proceedings of the Second International Congress of Parasitology, p. 349. *J. Parasitol.* 56(4).

YAMAGUTI, S.

1963. Classification of the Acanthocephala. *Systema Helminthum*, Vol. V, Acanthocephala. Interscience Publ., 423 p.

W. A. VAN ENGEL

R. E. HARRIS, JR.

D. E. ZWERNER

*Virginia Institute of Marine Science  
School of Marine Science  
College of William and Mary  
Gloucester Point, VA 23062*

#### RESILIENCE OF THE FISH ASSEMBLAGE IN NEW ENGLAND TIDEPOOLS<sup>1</sup>

Factors regulating density and species composition of tidepool fishes have been little studied, particularly in comparison to other elements of the intertidal community (Gibson 1982). Twenty-two collections of fishes were made in two tidepools at the Marine Science and Maritime Studies Center of Northeastern University at Nahant, MA, during summers from 1967 to 1985. Initially, the purpose was simply to demonstrate to my summer class in ichthyology the technique of collecting fishes with rotenone. After several years, it became apparent that there would be interest in examining long-term effects of repeated poisoning of the same pools. The purpose of this paper is to report the data from this series of samples and to compare the resilience of this New England tidepool fish fauna with studies done in the Gulf of California (Thomson and Lehner 1976), the central California coast (Grossman 1982), and South Africa (Beckley 1985). Unfortunately, there are no other similar tidepools in the area, so it was not possible to make control collections from unsampled pools.

#### Methods

The same two tidepools were sampled each summer from 1967 to 1985. The tidepools are located on the ocean side of East Point, in Broad Sound. The higher pool is at about 2 m elevation and is about 1 m deep at high tide; the lower pool is slightly below 1 m elevation, contains extensive red and brown algal growth, and is shallower. Average tidal amplitude is slightly over 3 m. One collection was made each year except for 1969, 1982, and 1983 when two collections were made, spaced about 2 wk apart. Collections

<sup>1</sup>Contribution No. 134 from the Marine Science Institute, Northeastern University, Nahant, MA 01908.



were made with rotenone (about 1 qt Noxfish<sup>2</sup>) at low tide in August, except in 1983 and 1985, when they were made in July and in 1984 when they were made in September. Specimens were taken by dip net from the pools by my students and me. An attempt was made to collect and then count and measure (mm SL) all fishes. Sometimes I used a face mask to find fishes at the bottom of the pool which was closer to the ocean. Many invertebrates also were killed, but no attempt was made to record numbers. The most abundant invertebrates in the 1984 collection were the green crab, *Carcinus maenas* (Linnaeus), and the sea urchin, *Strongylocentrotus droebachiensis* (Müller). Also collected were amphipods, *Gammarus angulosus* (Rathke), *Calliopius laeviusculus* (Kröyer), and *Gammarus oceanicus* Segerstrale; isopods, *Idotea baltica* (Pallas); and scale worms, *Harmothoe imbricata* (Linnaeus).

### Results

Thirteen species of fishes were collected (Table 1). The number of species per collection varied from 3 to 8 ( $\bar{x}$  5.3). One species, the rock gunnel, *Pholis gunnellus* (Linnaeus), was collected in all 22 samples. Young cunner, *Tautoglabrus adspersus* (Walbaum), were found in all but two collections. The grubby, *Myoxocephalus aeneus* (Mitchill), and the threespine stickleback, *Gasterosteus aculeatus* Linnaeus, were present in 17 and 15 collections, respectively. The radiated shanny, *Ulvaria subbifurcata* (Storer), was taken 12 times. The seasnail, *Liparis atlanticus* (Jordan and Evermann), was taken in 10 collections, the mummichog, *Fundulus heteroclitus* Linnaeus, in 8. The American eel, *Anguilla rostrata* (LeSueur), was taken four times; young lumpfish, *Cyclopterus lumpus* Linnaeus, three times. Four of the 13 species were taken only once or twice: the Atlantic tomcod, *Microgadus tomcod* (Walbaum); Atlantic silverside, *Menidia menidia* (Linnaeus); ninespine stickleback, *Pungitius pungitius* (Linnaeus); and northern pipefish, *Syngnathus fuscus* Storer. I can detect no long-term change in species composition or number of individuals over the 19-yr period.

The number of specimens per sample varied from 17 to 1,850 ( $\bar{x}$  197.5), but the mean is distorted by the 1,842 young (9-28 mm SL) *Tautoglabrus adspersus* taken in sample 16. Deleting this number, the figures are 17-343 ( $\bar{x}$  119.2). Thus, a "typical" sample would consist of 41 *Pholis gunnellus*, 49 young *Tautoglabrus adspersus*, 12 *Myoxocephalus aeneus*,

7 *Gasterosteus aculeatus*, and 2 *Fundulus heteroclitus*. One other species might be present, 1 or 2 specimens of any of the other 8 species, most likely *Ulvaria subbifurcata* or *Liparis atlanticus*.

There is great variation from collection to collection in numbers of specimens of the most abundant 4 species: 2-232 *Pholis gunnellus*; 2-1,842 *Tautoglabrus adspersus*; 1-127 *Myoxocephalus aeneus*; and 1-44 *Gasterosteus aculeatus*. *Ulvaria subbifurcata*, *Liparis atlanticus*, *Cyclopterus lumpus*, and *Fundulus heteroclitus* showed much less variation, 1-12 per collection. The other 5 species were uncommon, numbering 1-4 specimens.

### Discussion

To evaluate short-term effects, comparisons can be made between pairs of collections made in 1969, 1982, and 1983 at 2-3 wk intervals. The number of species decreased from 8 to 6 in the 1969 pair and from 7 to 5 in 1982, but the number increased from 3 to 5 in 1983. Four of the 8 species in the first sample in 1969, and 3 of the 7 species in the first sample in 1982, numbered only 1 or 2 specimens, as did one of the species in the second sample of 1983. Numbers of individuals were about the same in the 1969 pair of collections (over 50) and the 1983 pair (74 and 86), but decreased (54 to 17) in the second collection of the 1982 pair. Rapid recolonization of the tidepools clearly takes place. Differences in thoroughness of collecting, plus apparent random variation in the 7 least commonly taken species, can explain the few differences between the paired collections.

Thomson and Lehner (1976) sampled a large tidepool in the Gulf of California 11 times over the period 1966-73. The period of time between sampling ranged from 13 to 78 wk. Number of species ranged from 16 to 26, total 50; number of individuals 435-2,627, total 11,701. No decrease in number of species or individuals over time is apparent from their data (Thomson and Lehner 1970:table 1).

Grossman (1982) sampled a series of rocky tidepools with quinaldine at Dillon Beach in northern California 15 times from January 1979 to May 1981. The period of time between sampling ranged from 4 to 21 wk. Number of species per sample varied from 9 to 18 (excluding the first sample, 12-18), total 29 species; number of individuals was 71-517 per sample [not 520 as in Grossman's (1982) table 3], total 2,853 individuals. The structure of this rocky intertidal fish taxocene was persistent over 29 months through 15 defaunations (Grossman 1982:table 3).

Beckley (1985) sampled three South African pools

<sup>2</sup>Reference to trade names does not imply endorsement by the National Marine Fisheries Service, NOAA.

TABLE 1.—Abundance and size range (mm SL) of 13 species of fishes collected in two tidepools at Nahant, MA, from 1967 to 1985.

Species	1	2	3	4	5	6	7	8	9	10	11
<i>Pholis gunnellus</i>	11	2 (94-155)	21 (42-162)	20 (40-145)	36 (34-167)	67 (44-160)	33 (42-148)	6 (46-138)	8 (41-103)	8 (49-127)	13 (54-141)
<i>Tautoglabrus adspersus</i>	18	2 (77-96)	18 (10-17)	32 (18-30)		28 (11-20)	48 (9-28)	160 (10-27)	42 (12-28)	6 (11-26)	68 (10-32)
<i>Myoxocephalus aeneus</i>	3 (70-105)	4 (61-81)	1 (78)	2 (34-75)	7 (52-67)	20 (53-102)	14 (36-92)	2 (69-91)			
<i>Gasterosteus aculeatus</i>		3 (34-52)	5 (47-59)		10 (21-59)	2 (54-62)	42 (12-34)	15 (14-60)	2 (28-59)	3 (49-57)	1 (27)
<i>Ulvaria subbifurcata</i>	2	1 (48)	1		2 (31-71)	1 (20)					
<i>Liparis atlanticus</i>	2		1			3 (23-28)	2				
<i>Fundulus heteroclitus</i>		11 (20-78)	6 (52-65)	"abdt."	4 (22-72)	7 (13-61)				6 (38-85)	
<i>Anguilla rostrata</i>				2 (60-80)				1 (89)			
<i>Cyclopterus lumpus</i>			1 (15)				3 (14-25)				
<i>Microgadus tomcod</i>				3							
<i>Pungitius pungitius</i>		2 (46-47)									
<i>Menidia menidia</i>											
<i>Syngnathus fuscus</i>											
No. spp.	5	7	8	6	5	7	7	5	3	4	3
No. spec.	36	25	54	51+	59	128	143	184	52	23	82
No. collectors	5	15	8	7	12	8	9	4	8	6	10
Field no.	1231	1250	1359	1367	1531	1534	1543	1563	1567	1648	1652
Date	8/16	8/29	8/7	8/21	8/6	8/17	8/22	8/17	8/15	8/14	8/19
Year	1967	1968	1969	1969	1970	1971	1972	1973	1974	1975	1976

TABLE 1.—Continued.

Species	12	13	14	15	16	17	18	19	20	21	22	No. of samples
<i>Pholis gunnellus</i>	12 (49-151)	50 (88-168)	183 (39-170)	57 (44-155)	2 (98-100)	25 (46-144)	10 (100-155)	52 (30-150)	32 (49-146)	13 (38-140)	232 (35-153)	22
<i>Tautoglabrus adspersus</i>	177 (9-65)	56 (11-29)	5 (26-42)	19 (9-24)	1,842 (9-28)	16 (9-23)	4 (11-13)	12 (9-10)	46 (9-18)	315 (10-31)		20
<i>Myoxocephalus aeneus</i>		16 (29-81)	127 (26-72)	20 (17-73)		5 (54-72)	1 (92)	10 (46-71)	3 (66-75)	1 (41)	23 (50-78)	17
<i>Gasterosteus aculeatus</i>	1 (59)		13 (16-24)	44 (17-58)	6 (23-28)	3 (25-26)					1 (56)	15
<i>Ulvaria subbifurcata</i>	2 (35-59)	2 (21-79)	12 (20-87)	1 (84)		2 (27-32)	1 (80)		4 (22-27)		7 (20-96)	12
<i>Liparis atlanticus</i>			1 (32)			1 (36)	1 (38)			4 (25-28)	11 (17-53)	10
<i>Fundulus heteroclitus</i>		2 (14-72)				2 (48-74)						8
<i>Anguilla rostrata</i>			1 (145)						1 (294)			4
<i>Cyclopterus lumpus</i>											9 (10-14)	3
<i>Microgadus tomcod</i>		1 (88)										2
<i>Pungitius pungitius</i>												1
<i>Menidia menidia</i>			1 (78)									1
<i>Syngnathus fuscus</i>												1
No. spp.	4	6	8	5	3	7	5	3	5	4	6	13 spp.
No. spec.	192	127	343	132	1,850	54	17	74	86	343	283	4,345 spec.
No. collectors	7	6	4	9	7	7	1	10	3	2	7	
Field no.	1657	1663	1752	1760	1769	1774	1775	1777	1780	1801	1802-3	
Date	8/20	8/15	8/16	8/19	8/15	8/17	8/31	7/19	7/27	9/4	7/6	
Year	1977	1978	1979	1980	1981	1982	1982	1983	1983	1984	1985	

with rotenone over a 2-yr period at intervals of 1 mo, 3 mo, and 6 mo. She found rapid recolonization but with lower densities of recolonizers in winter than in summer. During 26 monthly samples, only one of the original species did not recolonize the pool, while 13 additional species were found. In Pool 2, which was sampled in 3-mo intervals, 14 species were taken in the initial sample, 7-12 in subsequent samples. Three of the original 14 species failed to recolonize, but 8 additional species were taken. During four repeat visits to Pool 3, the number of species varied between 9 and 14, all but 1 species recolonized the pool, and 5 additional species were recorded.

My study and those of Thomson and Lehner (1976), Grossman (1982), and Beckley (1985) indicate great resilience of species of tidepool fishes in tropical and temperate waters. Recolonization is quite rapid, within a matter of weeks.

#### Acknowledgments

I thank the students and teaching assistants in my ichthyology course for helping to collect the material. James Dooley made the second 1982 collection. N. W. Riser of the Marine Science and Maritime Studies Center identified the invertebrates. Comments on drafts of this note were provided by G. D. Grossman, J. Randall, N. W. Riser, V. G. Springer, and A. B. Williams.

#### Literature Cited

- BECKLEY, L. E.  
1985. Tidepool fishes: Recolonization after experimental elimination. *J. Exper. Mar. Biol. Ecol.* 85:287-295.
- GIBSON, R. N.  
1982. Recent studies on the biology of intertidal fishes. *Oceanogr. Mar. Biol. Ann. Rev.* 20:363-414.
- GROSSMAN, G. D.  
1982. Dynamics and organization of a rocky intertidal fish assemblage: the persistence and resilience of taxocene structure. *Am. Nat.* 119:611-637.
- THOMSON, D. A., AND C. E. LEHNER.  
1976. Resilience of a rocky intertidal fish community in a physically unstable environment. *J. Exper. Mar. Biol. Ecol.* 22:1-29.

BRUCE B. COLLETTE

*Marine Science and  
Maritime Studies Center,  
Northeastern University,  
Nahant, MA 01908*

and

*Systematics Laboratory,  
National Marine Fisheries Service,  
National Museum of Natural History,  
Washington, DC 20560*

## PARASITES OF BENTHIC AMPHIPODS: CILIATES

Benthic gammaridean amphipods were sampled during a 2½-yr period as a part of the Northeast Monitoring Program (NEMP) of the Northeast Fisheries Center, National Marine Fisheries Service. The amphipod survey was designed to determine the kinds of parasites and pathological conditions occurring in amphipod populations that live in and on the sediments of the continental shelf from Maine to North Carolina. Microsporidians of the sampled amphipods have been discussed by Johnson (1985), and this paper presents and discusses data on host distribution, prevalence, effects on the host, and probable relationships, of ciliates parasitizing amphipods from the same samples.

#### Materials and Methods

Benthic amphipods were collected from 35 stations, mainly on the Georges Bank and Mid-Atlantic Bight (Fig. 1). Amphipods were sampled during 11 cruises, July 1980-November 1982 (Table 1). Each station was sampled from 1 to 10 times during the survey. The 11 stations indicated by solid circles on Figure 1 had the most consistent and numerous populations of amphipods, were sampled at least five times each, and yielded the majority of data presented here. A Smith-McIntyre grab and occasionally an epibenthic sled or scallop dredge were used to obtain the samples. Up to 30 individuals of each species present in a sample, and sometimes more depending on numbers present, were prepared for histological study. Details of collecting procedures and preparation of the amphipods for study are given by Johnson (1985).

#### Results

Host and geographic distribution of ciliate infection is given in Table 1. Ciliate-infected amphipods were taken in samples from at least one station on every cruise. There was no indication that prevalence was influenced by the season of the year or location of the positive stations. The majority of infected specimens were *Ampelisca agassizi* (Judd), but prevalence of ciliate infection was lower in *A. agassizi* than in the other species found infected (*Pontogeneia inermis* Krøyer, *Phoxocephalus holbolli* Krøyer, *Harpinia propinqua* Sars, and unidentified haustoriids) (Table 2). In three instances, at station 33, cruise G; station 48, cruise I; and station 57, cruise E, individuals of *H. propinqua* or *P. holbolli* were infected

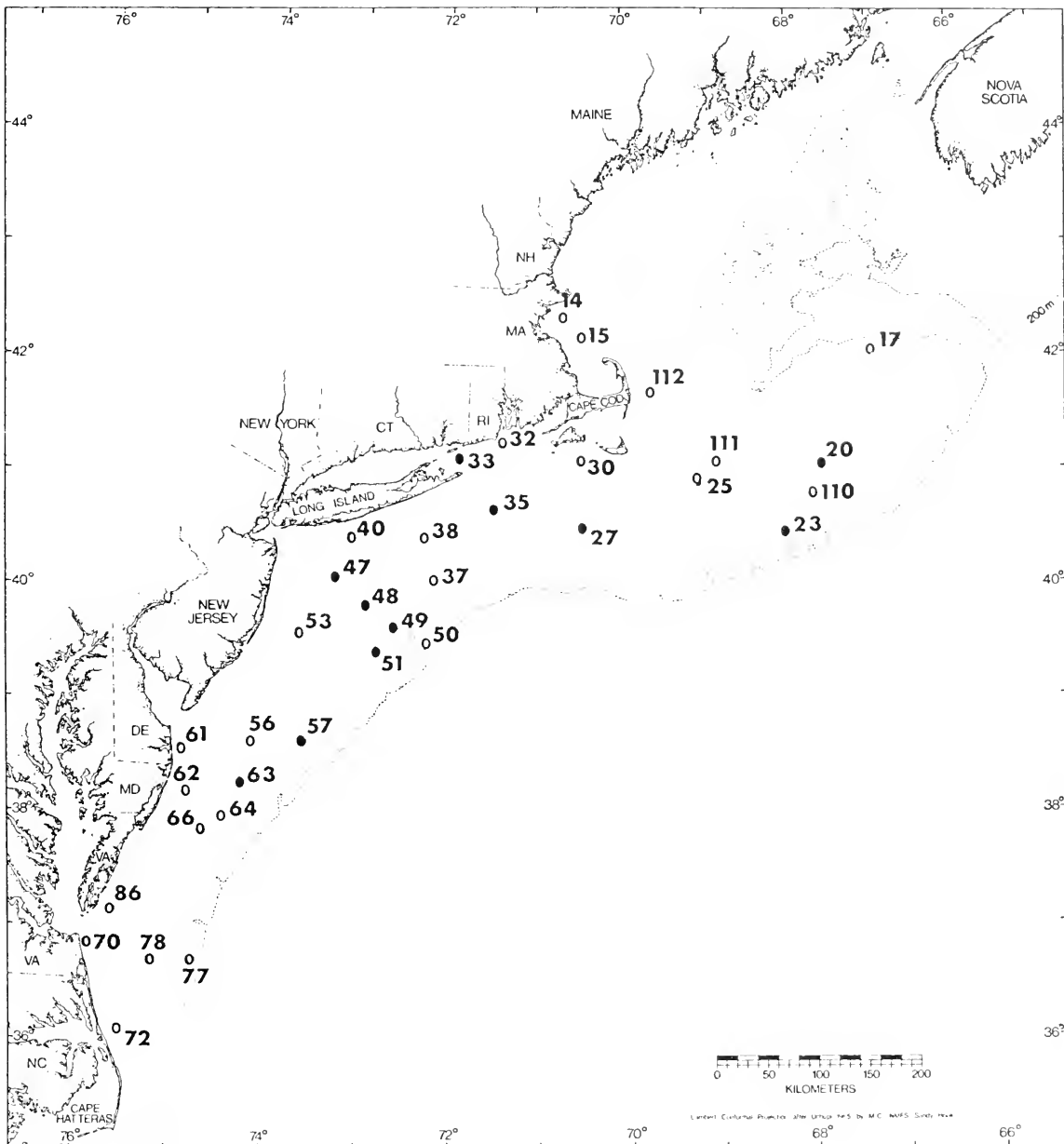

FIGURE 1.—Number designations and positions of Northeast Monitoring Program (NEMP) benthic stations where gammaridean amphipods were sampled during the survey.

but *A. agassizi* collected at the same times were not.

Except for *A. agassizi*, all the species with ciliate infections were rare (Table 2). The most numerous species collected, after *A. agassizi*, were *Leptocheirus pinguis* Stimpson, which made up 11% of the total collected (2,655/24,244), and *Unciola* species (probably all *U. irrorata* Say and *U. inermis* Shoemaker), which made up 10% of the total (2,356/24,244).

Despite their abundance, these species were never found infected with ciliates. Considering all amphipods sectioned and examined, overall prevalence of ciliate infection was 0.6% (41/7,363).

Light infections consisted mainly of large ciliates. Heavier infections had medium to small ciliates, but

TABLE 1.—Stations with ciliate-infected amphipods, by cruise and host species.

Station	Cruise <sup>1</sup>										
	A	B	C	D	E	F	G	H	I	J	K
20	PI <sup>2</sup>	— <sup>3</sup>	—	—	—	—	—	—	—	—	—
23	AA <sup>2</sup>	AA	AA	—	—	AA	—	—	—	—	—
25	—	—	—	—	PH <sup>2</sup>	—	—	—	—	—	—
33	—	AA	AA	AA	AA	AA	HP <sup>2</sup>	—	—	—	—
35	—	AA	—	AA	—	—	—	—	—	AA	—
37	—	—	—	AA	—	—	—	—	—	—	—
38	—	—	—	—	AA	—	—	—	—	—	—
48	—	—	—	—	AA	—	—	—	HP	—	—
49	—	—	—	—	—	—	—	—	AA	—	—
50	—	—	—	AA	—	—	—	—	—	—	—
51	AA	—	—	—	—	—	—	—	AA	—	—
57	—	—	—	—	AA	PH	—	—	AA	—	AA
62	HAU <sup>2</sup>	—	—	—	—	—	—	—	—	—	—
78	—	—	—	—	—	—	—	—	HAU	—	—

<sup>1</sup>Dates of cruises: A, July 1980; B, Sept. 1980; C, Dec. 1980; D, Apr. 1981; E, July 1981; F, Aug. 1981; G, Nov. 1981; H, Jan. 1982; I, Mar. 1982; J, Aug. 1982; K, Nov. 1982.

<sup>2</sup>Infected amphipods present at the station: PI = *Pontogeneia inermis*; AA = *Ampelisca agassizi*; PH = *Phoxocephalus holbolli*; HP = *Harpinia propinqua*; HAU = unidentified haustoriids.

<sup>3</sup>— = station sampled, no ciliate infections found.

sometimes large forms were also present. The largest ciliates were in the gill of a specimen of *Pontogeneia inermis* (Fig. 2). Measured in paraffin sections, they were about 17  $\mu\text{m} \times 80 \mu\text{m}$ . Large forms in other infected amphipods were 16-20  $\mu\text{m} \times 40$ -50

$\mu\text{m}$ . The majority of small- and medium-sized ciliates were 17-30  $\mu\text{m}$  in the greater dimension; none were less than 14  $\mu\text{m}$  (Fig. 3). Ciliates were elongate-spindle-shaped, with pointed or sharply rounded ends in *P. inermis*, and oval to subspherical in the other amphipods. The macronucleus of the large ciliates in *P. inermis* was sometimes ribbonlike (Fig. 2), and macronuclei of the smaller ciliates in *P. inermis* and those from the other amphipod species were elongate cylinders or elongate ovals in section (Fig. 3).

None of the infections showed recent evidence of host reaction against the ciliates. The melanized nodules and small hemocytic encapsulations occasionally seen in infected amphipods did not contain recognizable ciliates, and may have been due to other causes.

Few pathological effects were visible in ciliate-infected tissues. Two infected subadult males of *A. agassizi* had karyorrhexis and probable lysis in the transverse abdominal muscles, and one heavily infected female of *A. agassizi*, which had a few early embryos in the brood pouch, also had retained necrotic, mature ova in the ovaries. All infected amphipods had material in the gut, indicating that feeding was continuing. Hemocytes were present in



FIGURE 2.—*Pontogeneia inermis*: large and small ciliates in the gill. L, large form; S, small form. Bar = 10  $\mu\text{m}$ .

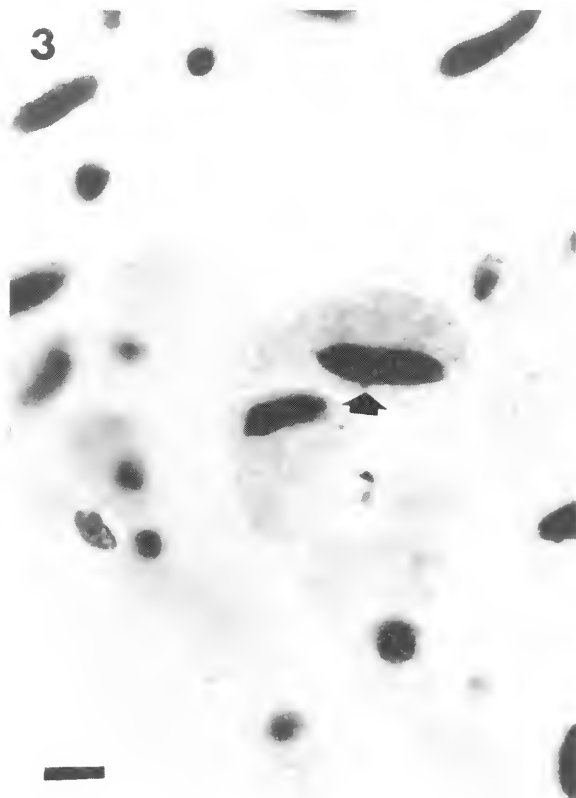

FIGURE 3.—*Ampelisca agassizi*: medium-sized ciliates. The small, pale micronucleus is visible close to the macronucleus in one of the ciliates (arrow). Bar = 10 $\mu$ m.

light to medium infections, but essentially missing in heavy infections. None of the ciliates were positioned in such a way that they appeared to have been phagocytizing hemocytes or other cells at the time of fixation. The granular inclusions commonly present in the cytoplasm of the ciliates bore no resemblance to food vacuoles or phagocytized material.

### Discussion

Two groups of ciliates contain species that parasitize crustaceans. *Paranophrys*, in crabs, lobsters, and possibly isopods, and *Parauronema*, in penaeid shrimp, belong in the class Oligohymenophora, order

Scuticociliatida (Corliss 1979). They are apparently opportunistic parasites (Bang 1970; Sindermann 1977; Couch 1978; Armstrong et al. 1981; Hibbitts and Sparks 1983). The remaining parasites are members of the class Kinetofragminophora, order Apostomatida (Corliss 1979). Typical apostomes are obligate commensals of aquatic crustaceans and have a life cycle geared to their hosts' molting cycles (Bradbury 1966, 1973), but some apostomes have become internal parasites of various invertebrates, including polychaetes, cephalopods, ophiurans, coelenterates, ctenophores, and isopod, amphipod, and decapod crustaceans (Corliss 1979).

Because specialized fixation and staining of whole

TABLE 2.—Species of amphipods infected by ciliates: proportion of the amphipod population and prevalence of ciliate infection.

Species of amphipod	Percent prevalence at positive stations	Proportion of the total amphipods collected
<i>Ampelisca agassizi</i>	3.8% (31/812)	54.3% (13,165/24,244)
<i>Harpinia propinqua</i>	18.2% (2/11)	0.6% (146/24,244)
Haustoriidae spp.	5.4% (3/56)	0.9% (225/24,244)
<i>Phoxocephalus holbolli</i>	9.5% (2/21)	0.5% (125/24,244)
<i>Pontogeneia inermis</i>	10.3% (3/29)	0.7% (164/24,244)

ciliates is necessary for firm identification (Corliss 1979), the amphipod ciliates can be only provisionally assigned to a ciliate group, as is true in other studies based on fixed and embedded material (Sparks et al. 1982; Hibbits and Sparks 1983). On the basis of similarities in hosts and morphology, the amphipod ciliates discussed here are like the apostome genus *Collinia*, whose members parasitize amphipods (Summers and Kidder 1936; de Puytorac and Grain 1975). Like *Collinia*, size of individual ciliates from the benthic amphipods varied greatly and there was no indication that the ciliates were phagocytic. *Paranophrys* and *Parauronema*, on the other hand, belong to a group that ingests particulate material. *Paranophrys* is known to ingest hemocytes and other cells of its hosts, and does not exhibit major size differences (Bang 1970; Sparks et al. 1982; Hibbits and Sparks 1983). Provisionally, the ciliates of benthic amphipods are being considered apostomes.

Whether more than one species of ciliate was involved in the infections is uncertain, but probably the ciliate of *Pontogeneia inermis* represented a species apart from the others. Its very large forms with the ribbonlike macronucleus were not duplicated in other infections.

Although more *A. agassizi* were found infected with ciliates than any other species of amphipod, this was apparently because it was the most abundant and widespread of the susceptible species sampled. *A. agassizi* had the lowest overall prevalence of ciliate infection and sometimes was not parasitized when other species in the same samples were parasitized. There are at least two possible explanations for the odd host distribution of the amphipod ciliates. First, the ciliates might be highly host specific, each amphipod species having its own species of ciliate. Second, the ciliates might be either primary parasites of some other member(s) of the benthic community, or incompletely adapted to a parasitic existence, and thus only occasionally parasitizing the least resistant species of the sampled amphipods. *Unciola* species and *Leptocheirus pinguis* were often the most abundant amphipods at certain stations, but ciliates were never found in individuals of these species, suggesting that they are resistant to ciliate attack. Conversely, the relatively high prevalence of ciliates in the rare species of amphipods could indicate less resistance than is exhibited by most of the species of amphipods sampled.

Presumably, infected amphipods would eventually die of their ciliate infections because of the massive loss of hemocytes. The infrequency of ciliate infection, except in certain rare species, indicates that

these parasites are not important in regulating the general amphipod populations they infect.

### Acknowledgments

Thanks are due the following: Frank Steimle and Robert Reid of the Northeast Fisheries Center, Sandy Hook Laboratory, and Linda Dorigatti, Gretchen Roe, and Sharon MacLean of the Oxford Laboratory collected the amphipods; Ann Frame, Sandy Hook Laboratory, provided advice and training in identification of amphipods; Linda Dorigatti identified material from cruises A to C, and she, Gretchen Roe, Dorothy Howard, and Cecelia Smith, Histology Section, Oxford Laboratory, prepared the specimens for histological examination.

### Literature Cited

- ARMSTRONG, D. A., E. M. BURRESON, AND A. K. SPARKS.  
1981. A ciliate infection (*Paranophrys* sp.) in laboratory-held Dungeness crabs, *Cancer magister*. J. Invertebr. Pathol. 37:201-209.
- BANG, F. B.  
1970. Disease mechanisms in crustacean and marine arthropods. In S. F. Snieszko (editor), a Symposium on Diseases of Fishes and Shellfishes, p. 383-404. Am. Fish. Soc., Wash., D.C., Spec. Publ. No. 5.
- BRADBURY, P. C.  
1966. The life cycle and morphology of the apostomatous ciliate, *Hyalophysa chattoni* n.g., n. sp. J. Protozool. 13: 209-225.  
1973. The fine structure of the cytostome of the apostomatous ciliate *Hyalophysa chattoni*. J. Protozool. 20:405-414.
- CORLISS, J. O.  
1979. The ciliated Protozoa. Characterization, classification and guide to the literature. 2d ed. Pergamon Press, Oxford, 455 p.
- COUCH, J. A.  
1978. Diseases, parasites, and toxic responses of commercial penaeid shrimps of the Gulf of Mexico and South Atlantic coasts of North America. Fish. Bull., U.S. 76:1-44.
- DE PUYTORAC, P., AND J. GRAIN.  
1975. Etude de la tomitogenèse et de l'ultrastructure de *Collinia orchestia*, cilié apostome sanguicole, endoparasite du crustacé *Orchestia gammarella* Pallas. Protistologica 11: 61-74.
- HIBBITS, J., AND A. K. SPARKS.  
1983. Observations on the histopathology caused by a parasitic ciliate (*Paranophrys* sp.?) in the isopod *Gnorimosphaeroma oregonensis*. J. Invertebr. Pathol. 41:51-56.
- JOHNSON, P. T.  
1985. Parasites of benthic amphipods: microsporidians of *Ampelisca agassizi* (Judd) and some other gammari-deans. Fish. Bull., U.S. 83:497-505.
- PUYTORAC, P. DE, AND J. GRAIN. See DE PUYTORAC, P., AND J. GRAIN.  
SINDERMANN, C. J.  
1977. Ciliate disease of lobsters. In C. J. Sindermann (editor), Disease diagnosis and control in North American marine aquaculture, p. 181-183. Elsevier Sci. Publ. Co., Amsterdam.



SPARKS, A. K., J. HIBBITS, AND J. C. FEGLEY.

1982. Observations on the histopathology of a systemic ciliate (*Paranophrys* sp.?) disease in the Dungeness crab, *Cancer magister*. J. Invertebr. Pathol. 39:219-228.

SUMMERS, F. M., AND G. W. KIDDER.

1936. Taxonomic and cytological studies on the ciliates associated with the amphipod family Orchestiidae from the Woods Hole district. II. The coelozoic astomatous parasites. Arch. Protistenkd. 86:379-403.

PHYLLIS T. JOHNSON

Northeast Fisheries Center Oxford Laboratory  
National Marine Fisheries Service, NOAA  
Oxford, MD 21654

## FECUNDITY OF THE PACIFIC HAKE, *MERLUCCIUS PRODUCTUS*, SPAWNING IN CANADIAN WATERS

Previous studies on the fecundity of Pacific hake, *Merluccius productus*, have been concentrated on the coastal stock in Baja California (MacGregor 1966, 1971; Ermakov et al. 1974), although large-scale spawning events have been recorded as far north as lat. 38°N, near San Francisco, CA (Stepanenko 1980). The present work was undertaken in conjunction with ichthyoplankton surveys, aimed at estimating the released egg production and spawning biomass of the Pacific hake stock resident in the Strait of Georgia, a semi-closed marine basin in British Columbia (Thomson 1981). The spawning season extends from February through June, peaks in early April, and is 90% complete by mid-May (Mason et al. 1984).

In comparison with the coastal stock of some 1-2 million metric tons (t) (Bailey et al. 1982), this inshore stock, of about 140,000 t, is subject to modest annual exploitation (1-500 t) and resides in a semi-estuarine environment on the known northernmost edge of the reproductive range. The coastal stock undertakes a northward feeding migration after the spring spawning and reaches the southwest coast of Vancouver Island by late summer (Bailey et al. 1982). There is no evidence of intermingling between these two stocks, based on their distributional patterns. The inshore stocks in the Strait of Georgia and Puget Sound may undergo some exchange, possibly due to surface transport of larvae produced in the central Strait of Georgia (Mason et al. 1984). The Puget Sound and coastal stocks have been identified as genetically distinct by Utter and Hodgins (1971), but the two inshore stocks in Puget Sound and

the Strait of Georgia have not been similarly compared.

Histological analysis has indicated that only one mode of oocytes develops in Georgia Strait hake. However, like the Baja, California form and hake species elsewhere, some Strait of Georgia hake show evidence of ovarian resorption following spawning (Foucher and Beamish 1980). The quantitative significance of resorption relative to individual and stock fecundities, or to their potential physiological and environmental correlates have not yet been examined. This report considers the "apparent fecundity" as an annual expression of reproductive potential applicable to the stock in the Strait of Georgia, determines that fecundity, and concludes that ovarian resorption is of minor consequence in the stock.

### Materials and Methods

The ovaries of 97 Pacific hake females 39-82 cm FL were collected during late February and early March of 1980 and 1981, 71 of which were collected in 1981 (McFarlane et al. 1983). Unspawned females were selected in maturity stages  $R^2$  and  $R$  (Foucher and Beamish 1977) when the ovary is yellow and opaque, has prominent blood vessels, and fills one-third to one-half of the coelomic cavity. No ovaries contained translucent oocytes which signify imminent spawning. Fresh ovaries were preserved in 10% formaldehyde solution. In the laboratory, the preserved ovaries were transferred to modified (Simpson 1951) Gilson's fluid for several months to allow breakdown of connective tissue.

Ovaries were then washed thoroughly in cold water over a series of stainless steel screens of 40  $\mu$ m and larger aperture, and gently broken up by hand when necessary to separate the hardened eggs from the ovarian tissue. The mesh size of the finest screen was determined by the difficulty encountered in separating oocytes <40  $\mu$ m diameter from ovarian tissue. The cleaned eggs were then stored in 5% formaldehyde solution in preparation for analysis.

Eggs from a single ovary were transferred to a 20 L glass reservoir filled to either 10 or 15 L. While the reservoir was being stirred vigorously with a wooden paddle in a rotating figure-eight pattern, a second worker extracted 50 1-2 mL volumetric subsamples using Stempel pipettes and transferred them to petri dishes. Under the dissecting microscope at 50 $\times$  magnification, all eggs in five subsamples were sized and counted in 20  $\mu$ m intervals of oocyte diameter. These results were then combined to construct oocyte size-frequency histograms and

to allot proportions of the combined egg count to the various size intervals. All eggs were counted in the remaining 45 subsamples to provide with the previous 5 subsamples, 50 counts of eggs per unit volume. The total number of eggs in the ovary was calculated from the product of mean subsample count per milliliter and the reservoir volume prior to subsampling. The number of eggs in various size categories was obtained by applying the appropriate proportional value to the estimated total number of eggs in the ovary. Subsample egg counts averaged between 50 and 150 eggs, with the majority falling within 75 and 100. Size-frequency histograms were based on 250-750 sized eggs with the majority based on 375-500 sized eggs. Initial procedural evaluation indicated that 200 sized eggs was sufficient to obtain a replicable size-frequency distribution.

Eighteen ovaries from postspawned females were collected on 3 July 1981 and were similarly processed.

Prespawning females collected in 1981 were aged by the otolith break and burn method (Chilton and Beamish 1982).

## Results and Discussion

### Frequency Distributions of Oocyte Diameter for Prespawners

Most of the 97 ovaries of prespawners examined contained a pronounced bimodal distribution of oocyte diameters with peaks at about 100  $\mu\text{m}$  and between 500 and 600  $\mu\text{m}$  (Figs. 1-3). Oocytes <150  $\mu\text{m}$  in diameter contained no yolk materials and are taken to constitute a reserve fund for subsequent years (Foucher and Beamish 1980). Oocytes >150  $\mu\text{m}$  diameter were undergoing vitellogenesis, and a few ovaries contained nonhydrated oocytes reaching 700-750  $\mu\text{m}$  diameter. Hydrated eggs were not seen in these ovaries collected in early March and hydration probably does not occur in oocytes <700  $\mu\text{m}$ , although hydrated oocytes from 350 to 950  $\mu\text{m}$  diameter were found by Foucher and Beamish (1980). This apparent discrepancy may reflect their underestimation of oocyte diameters in histological preparations of translucent oocytes due to the plane of sectioning.

The unimodal distribution of yolked oocytes, also reported for *M. m. hubbsi* in the Argentine Sea (Christiansen and Cousseau 1971) does not complement the findings of MacGregor (1966, 1971). He found that ovaries of prespawning coastal hake taken off Baja California contained distinct groups of "small" and "large" yolked oocytes, of which only the

latter were destined for release. Furthermore, Ermakov et al. (1974) reported 21% of the 93 female Pacific hake taken off Baja California in 1972 had unimodal, 55% bimodal, 18% trimodal, and 6% quadrimodal oocyte distributions. Similarly, their subsequent sample of 45 ovaries collected in the Oregon-Washington region in late November contained 22% unimodal, 65% bimodal, and 6% trimodal distributions, with major peaks at 200 and 600  $\mu\text{m}$  diameter. Nearly half of the ovaries collected and examined by Ermakov et al. (1974) did not contain a bimodal distribution of yolked oocytes, although these authors concluded that asynchronous development of yolked oocytes indicated the probability of multiple spawnings, most likely two batches within the spawning season.

### Estimates of Total Fecundity

Standard errors of mean egg counts for total fecundity estimates of total fecundity (oocytes  $\geq 40$   $\mu\text{m}$  diameter) ranged between 0.4 and 4.4% of the means and were <3% in nearly 70% of the 97 ovaries processed. The variability of the enumeration technique compares favorably with that reported by Mason et al. (1983) in an analysis of the fecundity of the sablefish, *Anoplopoma fimbria*, and with that reported by Pitt (1963) on the fecundity of the American plaice, *Hippoglossoides platessoides*, using Wiborg's whorling vessel (Wiborg 1951).

The estimates of total fecundity (oocytes  $\geq 40$   $\mu\text{m}$  diameter) increased with fork length according to the equation  $F = 0.3081\text{FL}^{3.7605}$ , [where FL = fork length in centimeters]. The correlation coefficient ( $r$ ) for the regression was 0.93. An insignificant  $F$  ratio from analysis of variance of slope and intercept values allowed pooling of the 1980 and 1981 data.

The smallest and largest Pacific hake females in the sample (39 and 82 cm FL) contained estimated total oocyte complements of 202,100 and 3,009,900 oocytes  $\geq 40$   $\mu\text{m}$ , respectively. All 97 fecundity estimates fell within the range of 165,700 and 3,108,000 oocytes  $\geq 40$   $\mu\text{m}$ .

### Estimates of Fecundity Within Size Classes of Oocytes

The estimated number of oocytes with 20  $\mu\text{m}$  intervals of diameter were summed within five intervals and regressed against fork length to examine the correlation coefficients (Table 1). Coefficients declined progressively with increased oocyte diameter, reflecting increasing variability among

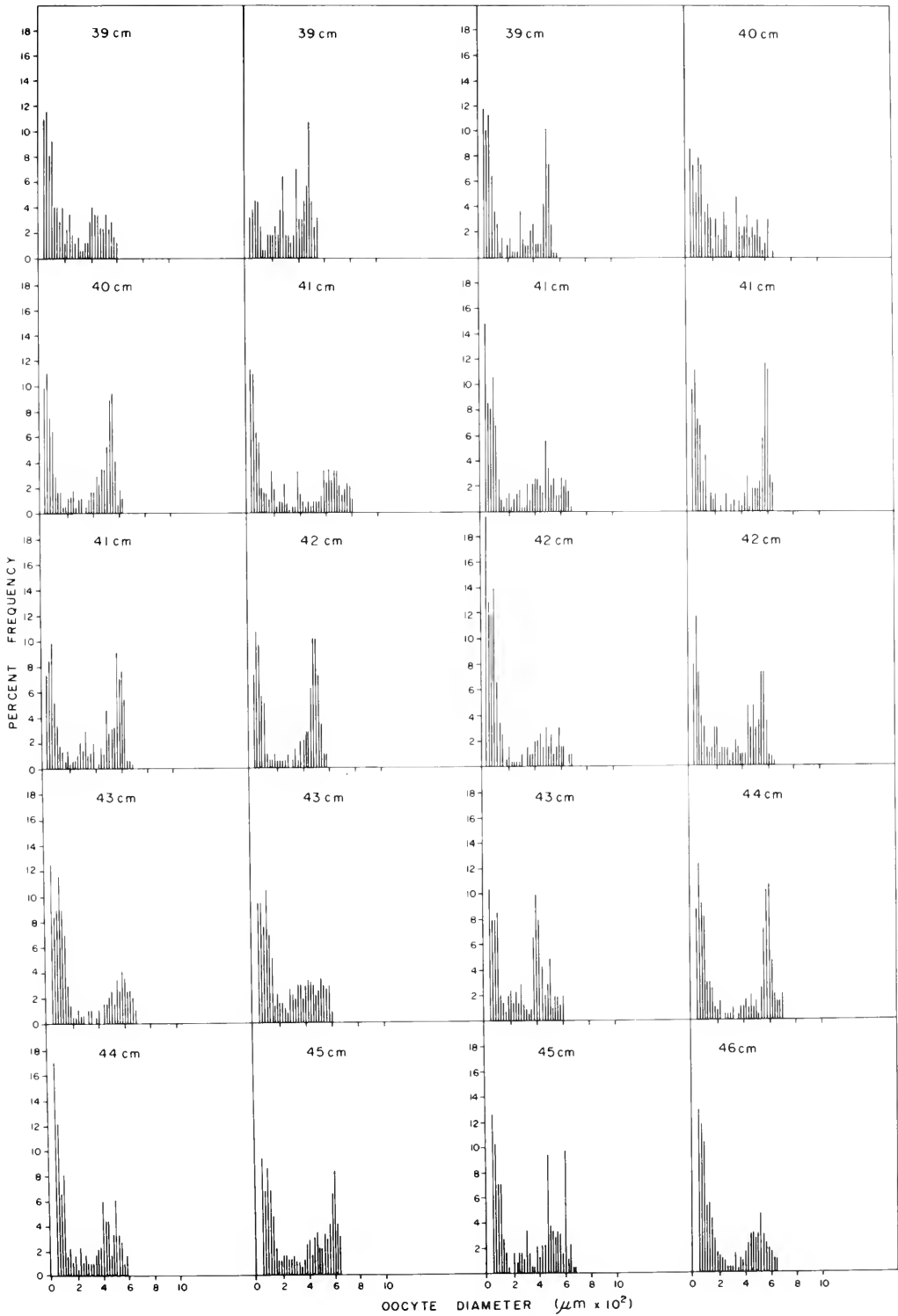

FIGURE 1.—Representative frequency distributions of oocyte diameter from ovaries of Pacific hake 39-46 cm FL.

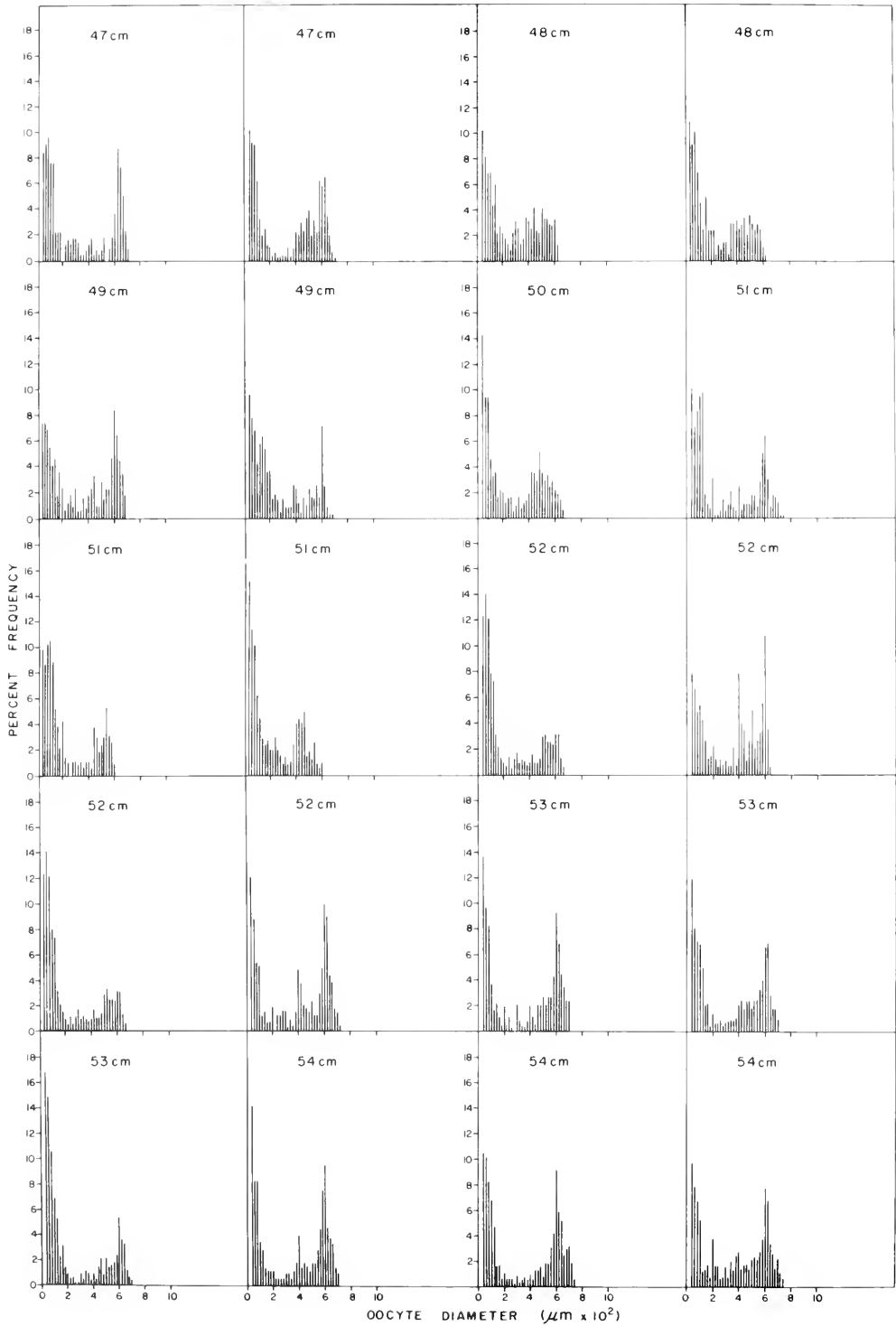

FIGURE 2.—Representative frequency distributions of oocyte diameter from ovaries of Pacific hake 47-54 cm FL.

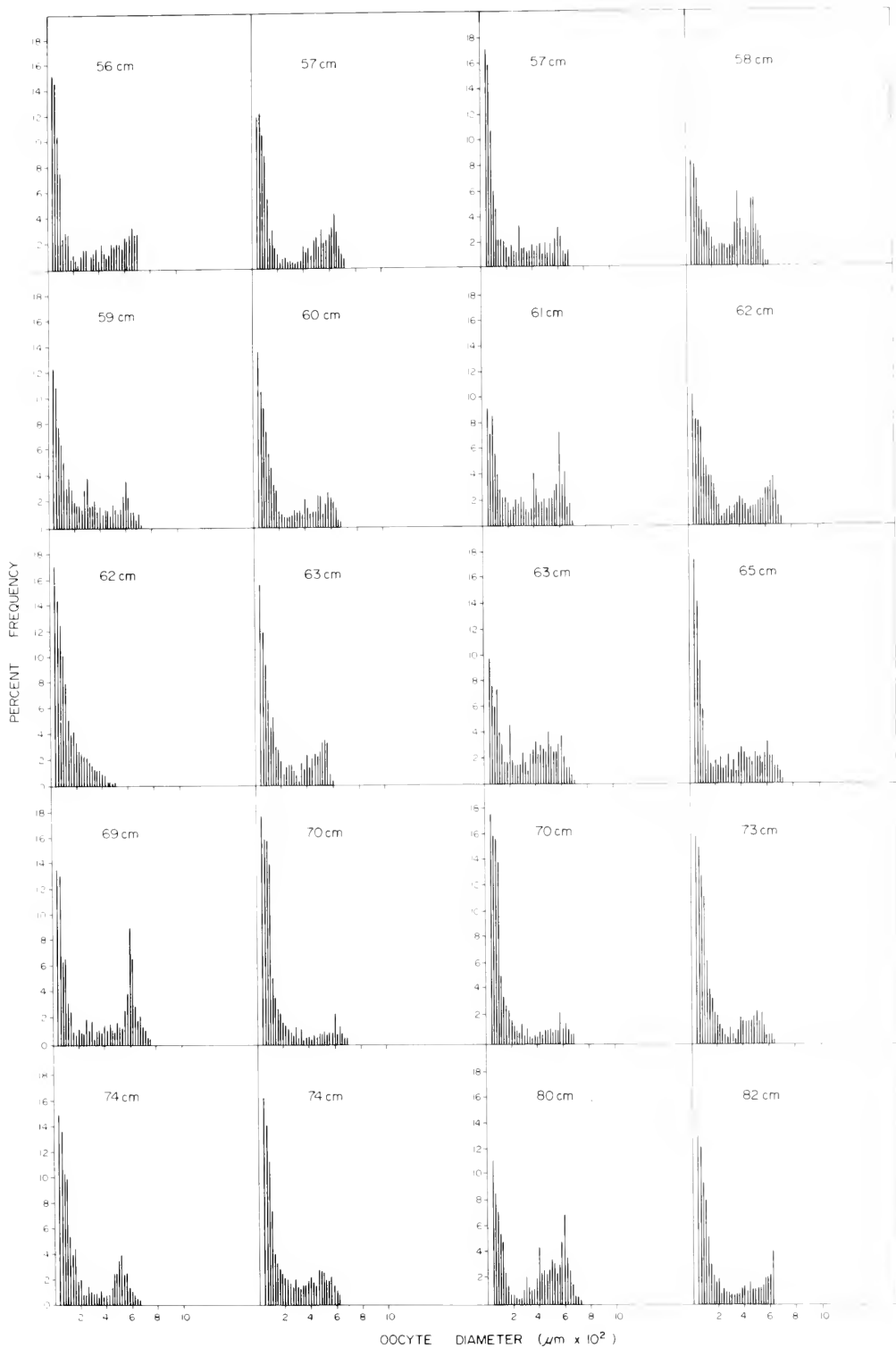

FIGURE 3.—Representative frequency distributions of oocyte diameter from ovaries of Pacific hake 56-82 cm FL.

TABLE 1.—Regression equations for oocytes of several size classes, and some combinations of same, found in prespawned ovaries of Pacific hake from the Strait of Georgia, B.C.

Oocyte diameter ( $\mu\text{m}$ )	Oocyte description	Regression equation ( $F = aFL^b$ )	Correlation coefficient ( $r$ )
40-780	all oocytes	$F = 0.3081FL^{3.7605}$	0.93
40-180	unyolked reserve	$F = 0.0692FL^{3.9766}$	0.88
200-380	small, yolked	$F = 0.0446FL^{3.7097}$	0.86
400-580	medium, yolked	$F = 0.2078FL^{3.4174}$	0.71
600-780	large, yolked	$F = 0.0008FL^{4.6370}$	0.65
400-780	medium plus large yolked	$F = 0.1872FL^{3.5640}$	0.75
200-780	all yolked	$F = 0.5501FL^{3.3896}$	0.81

females in the number of maturing oocytes as their maturity stage advanced towards hydration. This may be both a reflection of the range in stage of maturity among individual females at a common time of collection, and variation among females in the proportion of yolked oocytes destined for hydration and release.

Apparent fecundity taken as the number of yolked oocytes  $\geq 200 \mu\text{m}$  was best expressed by the equation  $F_a = 0.5501FL^{3.3896}$ . The averaged female hake in the Strait of Georgia stock (43.3 cm FL) contained an estimated 193,868 yolked oocytes  $\geq 200 \mu\text{m}$  and had a relative apparent fecundity of 382.3 eggs/g. In comparison, an uncommonly large female (80 cm FL) could contain more than 1.5 million yolked oocytes for a specific fecundity of 477 oocytes/g (Table 2).

Pacific hake in the Strait of Georgia grow rapidly to age 4, showing almost linear growth in length (McFarlane et al. 1983). Thereafter, growth decreases rapidly and is accompanied by considerable individual variation in annual growth. The largest female in the sample (82 cm FL) was age 18 whereas another female age 15 was only 49 cm FL. Not surprisingly, age was weakly related to apparent fecundity and wide individual differences in ap-

parent fecundity are evident within age classes (Fig. 4).

### Frequency Distributions of Oocyte Diameter in Postspawners

Gonads of 276 adult Pacific hake, trawl-caught on 3 July 1981, were staged superficially for maturity after Foucher and Beamish 1977. All gonads were in postreproductive state. The ovaries of 18 of 111 females retained for microscopic analysis were distributed within the various maturity states with these results: spent (1), recovering (7), and resting (10). Yolked oocytes (200-500  $\mu\text{m}$ ) were found in 7 ovaries: spent (1), recovering (4), and resting (2). Number of oocytes  $\geq 200 \mu\text{m}$ , expressed as a percentage of the oocytes  $< 200 \mu\text{m}$  (40-180  $\mu\text{m}$ ) was  $< 3\%$  in 6 of these fish, and 11% in the seventh, compared with 85-90% in prespawned ovaries collected in March (Table 2).

These results support previous conclusions that not all yolked oocytes larger than 200  $\mu\text{m}$  diameter are released, as suggested by Foucher and Beamish (1980) and MacGregor (1966). They also suggest that resorption in postspawned females probably does not exceed about 5% of the yolked oocytes destined for release.

The female Pacific hake in the Strait of Georgia appears to use progressively less of the reserve fund of unyolked oocytes present during gonadal maturation in subsequent spawnings (Table 2), although relative and apparent fecundity increases with increased fork length. This can be illustrated by comparing females  $< 55$  cm FL (Figs. 1, 2) with larger females (Fig. 3). The number of reserve fund oocytes in the size fraction 40-180  $\mu\text{m}$  increases at a faster rate, almost doubling the relative fecundity for reserve fund oocytes in this size fraction by 80 cm FL than does production of larger oocytes. The reserve fund may have several origins, and cytological evidence was presented by Foucher and Beamish (1980) that the fund may be supplemented by cells of follicular origin in the postspawned ovary. Such a mechanism to increase potential fecundity would appear to be rather redundant if significant resorption of yolked oocytes commonly occurs.

### Stock Differences in Fecundity and Estimates of Spawning Stock

Methodological differences or lack of disclosure, and lack of substantiated assessment of stock-specific resorption following spawning, render it impossible to draw very useful comparisons of fecun-

TABLE 2.—Total and relative (oocytes/g body weight) fecundity estimates at fork length for unyolked (40-180  $\mu\text{m}$  diameter) and yolked (200-780  $\mu\text{m}$  diameter) oocytes found in prespawned ovaries of Pacific hake from the Strait of Georgia, B.C.

Fork length (cm)	Unyolked oocytes		Yolked oocytes		% yolked of unyolked
	Total	Relative	Total	Relative	
40	162,502	406	148,178	370	91.1
45	259,580	455	220,887	388	85.3
50	394,666	507	315,679	403	79.5
55	576,544	551	436,089	417	75.7
60	814,896	598	585,684	430	71.9
65	1,120,308	645	768,233	443	68.7
70	1,504,260	693	987,611	455	65.7
75	1,979,132	739	1,247,812	466	63.1
80	2,558,196	786	1,552,943	477	60.7

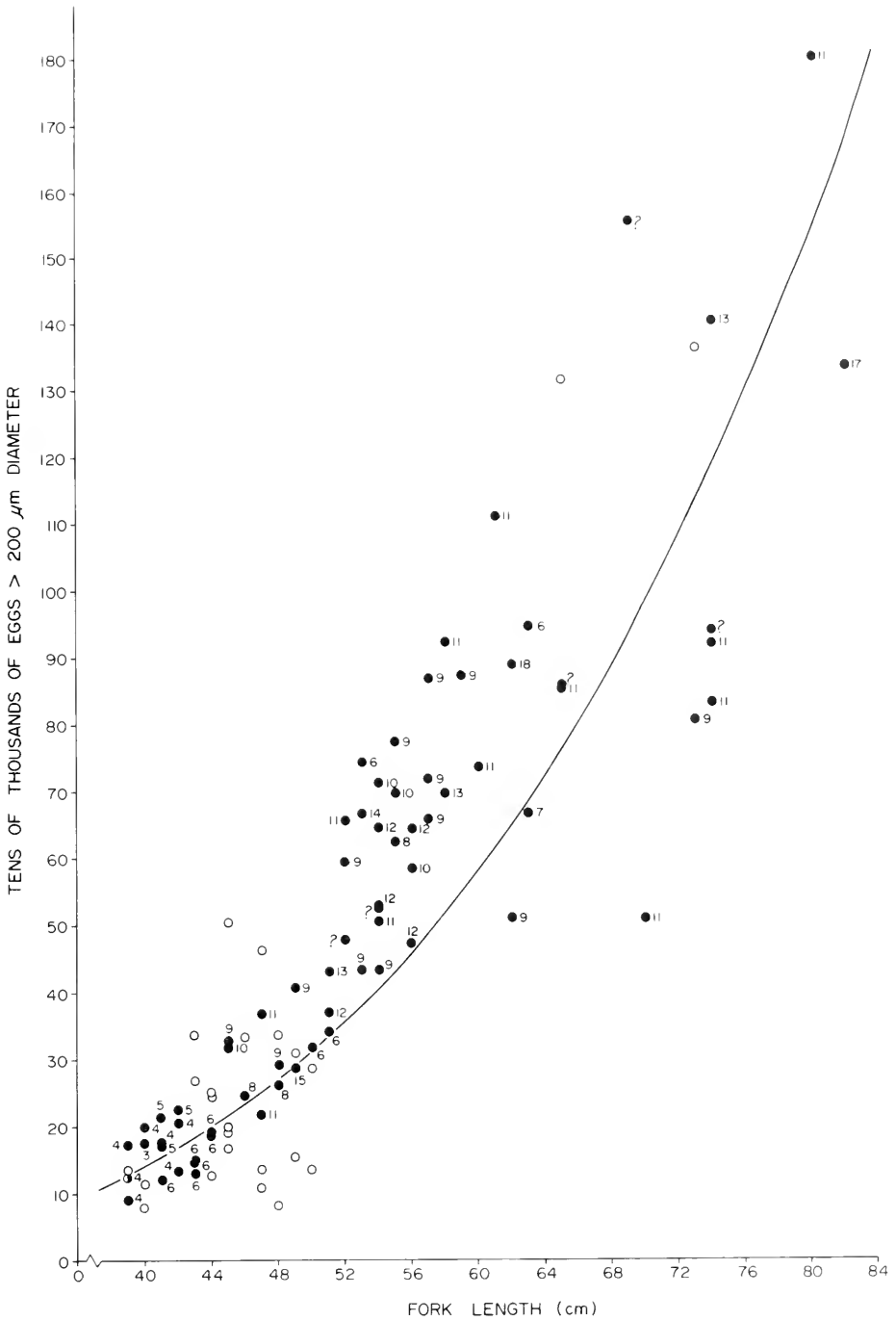

FIGURE 4.—Estimated number of yolked oocytes  $\geq 200 \mu\text{m}$  diameter in 97 hake ovaries from the Strait of Georgia, B.C., plotted against fork length of female hake. Numbers adjacent to individual plots indicate estimated age of female; open circles - 1980 females, closed circles - 1981 females.

dity between coastal and inshore stocks of Pacific hake at this time. Ermakov et al. (1974) excluded oocytes <100  $\mu\text{m}$  diameter, thus excluding a large fraction of unyolked oocytes constituting the reserve fund. Their estimates of total fecundity (comparable fork length) are one-half to one-third of those reported here for hake in the Strait of Georgia ( $\geq 40$  mm) and are also lower than the present estimates for apparent fecundity (oocytes  $\geq 200$   $\mu\text{m}$  diameter).

MacGregor (1966, 1971) counted advanced, yolked oocytes (>600  $\mu\text{m}$ ) only, premised on his assumption that only these cells were destined for release. On the basis of relative fecundity (eggs per gram), for yolked oocytes >580  $\mu\text{m}$  diameter of comparable size to MacGregor's "large, yolked" or "advanced" oocytes, the female Pacific hake in the Strait of Georgia are considerably less fecund (54-164 eggs/g) over the fork length range of 40-80 cm than are Baja California hake which averaged 216 eggs/g (MacGregor 1971). However, the lack of distributional bimodality in the Canadian ovaries renders such a comparison unrealistic, for a common size threshold for resorption, even if appropriate, cannot be applied conveniently to individual ovaries.

We can state with reasonable certainty that resorption of yolked oocytes is a common occurrence in both coastal and inshore stocks of Pacific hake, as has been found in other forms of *Merluccius* (Hickling 1930; Christiansen 1971). The influence of ovarian resorption on annual fecundity of stock and on the magnitude of released egg production from individual females remains unknown. It follows that the application of existing fecundity information to problems of assessing magnitude of Pacific hake spawning stock from released egg production, as determined through ichthyoplankton surveys, should reflect these reservations.

For the Pacific hake stock in the Strait of Georgia, British Columbia, resorption may not involve more than 5-10% of the apparent fecundity. Hence, spawning biomass estimates based on released egg production and the apparent fecundity could be rendered conservative by the observed extent of resorption in this stock.

#### Acknowledgments

Staff of the Groundfish Program at Nanaimo are thanked for collecting biological materials and related statistics at sea, and for aging the female Pacific hake used in the study (Aging Unit). Particular appreciation is extended to Susan Johnston for her able assistance in the laboratory and to R.

Foucher for helpful discussion and comments on the original draft.

#### Literature Cited

- BAILEY, K. M., R. C. FRANCIS, AND P. R. STEVENS.  
1982. The life history and fishery of Pacific whiting, *Merluccius productus*. NOAA, NMFS, Proc. Rep. 82-03, NWAFC, Seattle, 81 p.
- CHILTON, D. E., AND R. J. BEAMISH.  
1982. Age determination for fishes studied by the Groundfish Program at the Pacific Biological Station. Can. Spec. Publ. Fish. Aquat. Sci. 60, 102 p.
- CHRISTIANSEN, H. E.  
1971. La reproducción de la merluza en el Mar Argentino (*Merlucciidea*, *Merluccius merluccius hubbsi*). 1. Descripción histológica del ceceo del ovario de merluza (Reproduction of the hake in the Argentine Sea. 1. Histological description of the spawning cycle of the hake). Bol. Inst. Biol. Mar., Mar del Plata 20:1-41. (Engl. transl., Can. Fish. Mar. Serv., Transl. Ser. 4003.)
- CHRISTIANSEN, H. E., AND M. B. COUSSEAU.  
1971. La reproducción de la merluza en el Mar Argentino (*Merlucciidea*, *Merluccius merluccius hubbsi*). 2. La reproducción de la merluza y su relación con otros aspectos biológicos de la especie (Reproduction of the hake in the Argentine Sea. 2. Hake reproduction and its relationship with other biological aspects of the species). Bol. Inst. Biol. Mar., Mar del Plata 20:41-73. (Engl. transl., Can. Fish. Mar. Serv., Transl. Ser. 4003.)
- ERMAKOV, J. K., V. A. SNYTKO, L. S. KODOLOV, I. I. SEROBABA, L. A. BORETS, AND N. S. FADEEV.  
1974. Biological characteristics and conditions of the stocks of Pacific hake, sea perches, sablefishes, and walleye pollock in 1972. Engl. transl., Can. Fish. Mar. Serv. Transl. Ser. 3066, 37 p.
- FOUCHER, R. P., AND R. J. BEAMISH.  
1977. A review of oocyte development in fishes with special reference to Pacific hake (*Merluccius productus*). Can. Fish. Mar. Serv. Tech. Rep. 755, 16 p.  
1980. Production of nonviable oocytes by Pacific hake (*Merluccius productus*). Can. J. Fish. Aquat. Sci. 37:41-48.
- HICKLING, C. F.  
1930. The natural history of the hake. Part III. Seasonal changes in the condition of the hake. Fish. Invest. Minist. Agric. Fish. Food (G.B.), Ser. II, XII(1):1-78.
- McFARLANE, G. A., W. SHAW, AND R. J. BEAMISH.  
1983. Observations on the biology of Pacific hake, walleye pollock, and spiny dogfish in the Strait of Georgia, February 20-May 2, and July 3, 1981. Can. MS Rep. Fish. Aquat. Sci. 1722, 109 p.
- MACGREGOR, J. S.  
1966. Fecundity of the Pacific hake, *Merluccius productus* (Ayres). Calif. Fish Game 52:111-116.  
1971. Additional data on the spawning of the hake. Fish. Bull., U.S. 69:581-585.
- MASON, J. C., R. J. BEAMISH, AND G. A. McFARLANE.  
1983. Sexual maturity, fecundity, spawning, and early life history of sablefish (*Anoplopoma fimbria*) off the Pacific coast of Canada. Can. J. Fish. Aquat. Sci. 40:2126-2134.
- MASON, J. C., A. C. PHILLIPS, AND O. D. KENNEDY.  
1984. Estimating the spawning stocks of Pacific hake (*Merluccius productus*) and walleye pollock (*Theragra chalcogramma*) in the Strait of Georgia, B.C. from their released egg production. Can. Tech. Rep. Fish. Aquat. Sci. 1289, 51 p.



- PITT, T. K.  
1964. Fecundity of the American plaice, *Hippoglossoides platessoides* (Fabr.) from Grand Bank and Newfoundland areas. J. Fish. Res. Board Can. 21:597-612.
- SIMPSON, A. C.  
1951. The fecundity of the plaice. Fish. Invest. Ministr. Agric. Fish. Food (GB), Ser. II, 17(5):1-27.
- STEPANENKO, M. A.  
1980. Reproductive conditions and the assessment of the spawning part of the Pacific hake, California anchovy, horse-mackerel, and some other fish species in the California Current Zone in 1979. Pac. Inst. Fish. Oceangr. (TINRO), Manusc. Rep., 29 p.
- THOMSON, R. E.  
1981. Oceanography of the British Columbia coast. Can. Spec. Publ. Fish. Aquat. Sci. 56, 219 p.
- UTTER, F. M., AND H. O. HODGINS.  
1971. Biochemical polymorphisms in the Pacific hake (*Merluccius productus*). Rapp. P.-v. Réun. Cons. int. Explor. Mer 161:87-89.
- WIBORG, K. F.  
1951. The whirling vessel: An apparatus for the fractioning of plankton samples. Rep. Norw. Fish. Mar. Invest. 9(13): 1-16.

J. C. MASON

Department of Fisheries and Oceans  
Fisheries Research Branch  
Pacific Biological Station  
Nanaimo, British Columbia V9R 5K6, Canada

### STRANDED ANIMALS AS INDICATORS OF PREY UTILIZATION BY HARBOR SEALS, *PHOCA VITULINA CONCOLOR*, IN SOUTHERN NEW ENGLAND

Since Federal protection began in 1972, the New England population of harbor seals, *Phoca vitulina concolor*, has more than doubled (Gilbert and Stein 1981<sup>1</sup>; Payne and Schneider 1984), increasing at a site in southeastern Massachusetts at an average rate of 11.9% per year (Payne and Schneider 1984). One of the primary management concerns regarding the New England seal population is the increasing potential for conflict between commercial fisheries and harbor seals (Prescott et al. 1980<sup>2</sup>).

Seals have been shown to be significant consumers

of marine production (Brodie and Pasche 1982) and have been implicated as competitors for commercially valuable fish stocks, impacting fisheries through direct predation, gear damage, and entanglement (Boulva and McLaren 1979; Everitt and Beach 1982; Brown and Mate 1983). Despite the significant increase in harbor seal abundance, only anecdotal information exists on the diet of harbor seals along the eastern United States. To assess the impact of this common predator on fish and squid, information is required on the food species exploited.

In the past, seals were killed to facilitate quantitative analysis of their stomach contents (Imler and Sarber 1947; Spalding 1964; Boulva and McLaren 1979; Pitcher 1980a), although this procedure is impractical in New England. Two alternatives to this method are the analysis of the stomachs of stranded animals, and the examination of seal feces collected on accessible haul-out sites (Pitcher 1980b; Treacy and Crawford 1981; Brown and Mate 1983).

The first alternative for determining the food habits of the southern New England seal population was provided by the more than 500 harbor seals that have been found stranded south of Maine since 1977. The stranded seals were collected by the New England Aquarium (NEA), Boston, MA. The majority (59%) of the seals were collected between January and March (Table 1) along the perimeter of Cape Cod Bay, MA, primarily on the eastern side. This corresponds to the time when the peak number of seals occur south of Maine (Schneider and Payne 1983). Most of the stranded seals (65%) came from one year, 1980 (Table 1), when over 445 seals died of acute pneumonia associated with influenza virus (Geraci et al. 1982).

Upon necropsy at the NEA, most of the stomachs and intestinal tracts of the stranded seals were found to be empty. Only 63 stomachs contained food matter, and the contents from those were frozen for later

TABLE 1.—Monthly distribution of stranded *P. v. concolor* containing prey items examined 1977-83.

Month	1977	1978	1979	1980	1981	1982	1983	Total
Jan.	1			15			1	17
Feb.				7	2		1	10
Mar.				10				10
Apr.				1				1
May				1	1	2	1	6
June		1				2	1	4
July						1		1
Aug.				2		1	1	4
Sept.				3		2		5
Oct.				1				1
Nov.				1				1
Dec.			2			1		3
Totals	1	1	3	41	3	9	5	63

<sup>1</sup>Gilbert, J. R., and J. L. Stein. 1981. Harbor seal populations and marine mammal fisheries interactions. National Marine Fisheries Service, NOAA, Northeast Fisheries Center, Contract No. NA-80-FA-C-00029, Woods Hole, MA 02345, 55 p.

<sup>2</sup>Prescott, J. H., S. D. Kraus, and J. R. Gilbert. 1980. East Coast/Gulf Coast Cetacean and Pinniped Workshop. Marine Mammal Commission (MMC), Final Report, Contract 79/02. (Available National Technical Information Service, Springfield, VA 22151 as PB80-160104, 142 p.)

examination. In the fall of 1983, we pilot-tested the analysis of stomach contents from stranded seals using those 63 stomach samples as an indicator of prey utilization. The objectives of this study were 1) to identify prey items selected by seals in southern New England and 2) to determine whether stomach contents from stranded animals can provide accurate information on the utilization of most kinds of prey.

### Methods

The stomachs were thawed and the contents washed with water through a series of nested sieves (1.80, 1.00, and 0.50 mm<sup>2</sup>). Identifiable materials were rough-sorted into fish and fish components, invertebrates and invertebrate components. Intact specimens and cephalopod beaks were preserved in a 70% ethanol-30% glycerin solution. Persistent prey hard parts (primarily otoliths) were removed and stored dry in glass vials.

Otoliths from the stomach samples were identified against a reference collection at the National Marine Fisheries Service, Northeast Fisheries Center (NMFS/NEFC), Woods Hole, MA. Cephalopod beaks were identified against a reference key (Clarke 1962).

To estimate the size of fish taken by harbor seals, otoliths removed from the stomach samples were measured under a dissecting microscope using vernier calipers. Regression equations relating otolith length to fish length (Frost and Lowry 1980; Brown and Mate 1983) were calculated using measurements obtained from the reference collection of fishes collected in the Gulf of Maine, located at the NMFS/NEFC. Fork lengths were estimated for four prey species.

### Results

Fifty-three stomachs (84%) held identifiable food items (Table 2). Cephalopod beaks were recovered from 35 stomachs, representing at least 168 individuals and 2 species. Thirty-three stomachs contained beaks from the short-finned squid, *Illex illecebrossus*, with a range of 1-22 beaks per stomach. Beaks of the long-finned squid, *Loligo pealei*, were found in two stomachs, ranging from 4 to 5 beaks per stomach, and accounted for only 5% of the squid recovered. The two species were not found together in any of the stomachs. Twenty-nine stomachs contained squid remains and no other type of prey. Six stomachs contained both squid and fish remains.

Seventeen stomachs contained some fish remains, including intact specimens, copious semidigested flesh, and 121 free otoliths. In total, seven species

and five families were represented. Fourteen stomachs held otoliths from only one species of fish, while seven stomachs contained otoliths from more than one fish species.

Four species of Gadidae comprised the majority of all fish species found in the stomachs of the stranded seals. A total of 86 otoliths in six stomachs were recovered. Haddock, *Melanogrammus aeglefinus*, was the most frequently found gadid (45 otoliths in four stomachs) with a maximum of 24 otoliths recovered from a single stomach. Silver hake, *Merluccius bilinearis*, remains were found only slightly less frequently (34 otoliths from three stomachs). Pollock, *Pollachius virens*, otoliths were found in one stomach (five otoliths), and two red hake, *Urophycis chuss*, otoliths of equal length were recovered from one stomach, presumably from a single fish.

Fifteen free otoliths and three intact specimens of American sand lance, *Ammodytes americanus*, were recovered from two stomachs, and three stomachs contained otoliths from members of the flatfish family Pleuronectidae.

Two stomachs contained shells: the Atlantic mussel, *Mytilus edulis*, and the common slipper shell, *Crepidula fornicata*.

The estimated mean fork length for the four gadid prey species ranged from 170 to 340 mm (Table 3). Regressions were not available to estimate the lengths of the sand lance found in the stomachs; however, studies on sand lance in Cape Cod Bay found a mean size of 93 mm SL (Richards 1982).

TABLE 2.—Analysis of stomach contents from stranded harbor seals, *P. v. concolor*, in Southern New England, 1977-83.

Species	Stomach (N = 63)		
	Frequency N	%	Min. no. animals
Cephalopoda:			
<i>Illex illecebrossus</i>	33	58.4	159
<i>Loligo pealei</i>	2	3.7	9
Mytilidae:			
<i>Mytilus edulis</i>	2	3.7	12
Calyptraeidae:			
<i>Crepidula fornicata</i>	2	3.7	10
Clupeidae:			
<i>Clupea harengus</i>	1	1.8	1
Gadidae:			
<i>Melanogrammus aeglefinus</i>	4	5.6	23
<i>Pollachius virens</i>	1	1.8	3
<i>Urophycis chuss</i>	1	1.8	1
Merlucciidae:			
<i>Merluccius bilinearis</i>	3	5.6	17
Ammodytidae:			
<i>Ammodytes americanus</i>	2	3.7	11
Pleuronectidae:			
<i>Pseudopleuronectes americanus</i>	3	5.6	10
Unidentified pisces	11	20.8	

TABLE 3.—Estimated sizes of four fish prey species of harbor seals in Southern New England, based on regression equations relating otolith length (OL) to fish fork length (FL).

Species	Regression equation	$r^2$	n	Estimated prey size (FL, mm)	
				Range	Mean
<i>Melanogrammus aeglefinus</i>	FL = 3.4(OL) - 9.32	0.97	45	110-310	230
<i>Merluccius bilinearis</i>	FL = 22.4(OL) - 1.44	0.98	34	30-460	170
<i>Pollachius virens</i>	FL = 4.9(OL) - 22.58	0.95	5	160-310	280
<i>Urophycis chuss</i>	FL = 25.0(OL) + 0.63	0.96	2		340

## Discussion

Analyzing stomach contents from stranded animals to determine prey preference or selection does yield a partial list of prey species exploited; however, several apparent biases prohibit the realization of accurate quantitative results. Therefore, the utility of this method is questionable.

The limited number of stomachs containing food was likely due to the weakened condition of seals prior to stranding and their inability to obtain food. The stomachs that did contain food all came from stranded animals, and therefore may not reflect on what a healthy seal was feeding. The stranded seals were generally animals with debilitating conditions like lungworm and heartworm, and may not have been able to feed in usual feeding areas, or secure usual prey, and thus were probably less selective about prey items.

For example, the shells found in the two stomachs may represent prey items desirable only to a disease-weakened seal. The size and number of these shells suggest that they were not ingested incidentally. Comparing the stomach contents to a "condition index", such as length vs. girth or blubber thickness, might indicate whether the stranded animals are less selective about prey species than healthy ones.

The abundance of squid beaks found in the stomachs suggests that squid are an important part of the diet of harbor seals along coastal New England; however, our own finding of squid beaks in 56% of 63 stomachs may be inflated. Boulva and McLaren (1979) found squid remains in 20.6% of 279 stomachs examined from eastern Canada, and Pitcher (1980b) similarly found cephalopod beaks in 21.1% of 351 harbor seals collected in the Gulf of Alaska. Seals have been shown to retain, then regurgitate, cephalopod beaks rather than pass them through their digestive tract (Miller 1978<sup>3</sup>; Pitcher

1980b). Retention of squid beaks will tend to over-represent the utilization of squid as a prey species (Pitcher 1980a). The retention of beaks during a period of fasting prior to death may also account for the large percentage (41%) of stomachs containing squid beaks and no other type of prey remains.

Large fish may be underrepresented if the heads (i.e., otoliths) are not eaten (Boulva and McLaren 1979; Brown and Mate 1983). Pitcher (1980b) suggested that seals often fragment large fish while eating them, usually discarding the head.

Finally, the relationship between the time when prey was eaten and when the stomach was collected may determine what types of prey remains will be recovered (Frost and Lowry 1980; Pitcher 1980a; Brown and Mate 1983). For example, the low number of sand lance otoliths found in the stomachs may not accurately represent the importance of sand lance as a prey species of harbor seals in southern New England because otoliths of the size of the ones recovered are very small and delicate and may not remain for long in the seal stomachs once freed from the skull (Smith and Gaskin 1974).

Thus, using only frequency of occurrence as a measure of prey preference or selection may be misleading by overemphasizing the importance of some species. For example, based on number, cephalopods were the major prey item; however fewer otoliths representing fish of greater weight may show that fish indeed are more important. The full importance of fish or squid in the diet of seals can be accurately described only if quantitative assessments such as weight or volume of food items in the stomachs can be determined (Rae 1973; Frost and Lowry 1980).

In summary, given a large sample of animals the analysis of stomach contents from stranded seals does provide information on the types of prey selected. However, the analysis of stomach contents from stranded seals greatly overemphasizes cephalopod remains while likely underrepresenting most

<sup>3</sup>Miller, L. K. 1978. Energetics of the northern fur seal in relation to climate and food resources of the Bering Sea. Marine Mammal Commission, Final Report, Contract MM5AC025. (Available

National Technical Information Service, Springfield, VA 22151 as PB-275 296, 32 p.)

species of fish prey due to an extended period of fasting prior to stranding. We consider comparative frequencies of selected prey to be too biased to be useful in any ranking of prey items. Therefore, this technique of analyzing prey utilization should be considered only if the examination of feces or the stomach contents from seals that were healthy when collected are not possible options.

### Acknowledgments

We wish to thank all those from the New England Aquarium, Marine Mammal Rescue and Release Program, who helped collect the stranded animals. Paul J. Boyle and Kevin D. Powers commented on previous drafts of this manuscript. Research was conducted with the New England Aquarium's Edgerton Research Laboratory. This study was funded by National Marine Fisheries Service/Northeast Fisheries Center, Contract No. NA-82-FA-00007.

### Literature Cited

BOULVA, J., AND I. A. MCLAREN.  
1979. Biology of the harbor seal, *Phoca vitulina*, in Eastern Canada. Fish. Res. Board Can., Bull. 200:1-24.

BRODIE, P. F., AND A. J. PASCHE.  
1982. Density-dependent condition and energetics of marine mammal populations in multispecies fisheries management. In M. C. Mercer (editor), *Multispecies approaches to fisheries management advice*, p. 35-38. Can. Spec. Publ. Fish. Aquat. Sci. 59.

BROWN, R. F., AND B. R. MATE.  
1983. Abundance, movements, and feeding habits of harbor seals, *Phoca vitulina*, at Netarts and Tillamook Bays, Oregon. Fish. Bull., U.S. 81:291-301.

CLARKE, M. R.  
1962. The identification of cephalopod "beaks" and the relationship between beak size and total body weight. Bull. Br. Mus. (Nat. Hist.), Zool. 8:421-480.

EVERITT, R. D., AND R. J. BEACH.  
1982. Marine mammal-fisheries interactions in Oregon and Washington: An overview. In K. Sabol (editor), *Transactions of the North American Wildlife and Natural Research Conference*, p. 265-277. Wildl. Manage. Inst., Wash., DC.

FROST, K. J., AND L. F. LOWRY.  
1980. Feeding of ribbon seals (*Phoca fasciata*) in the Bering Sea in Spring. Can. J. Zool. 58:1601-1607.

GERACI, J. R., D. J. ST. AUBIN, I. K. BARKER, R. G. WEBSTER, V. S. HINSHAW, W. J. BEAN, H. L. RUHNKE, J. H. PRESCOTT, G. EARLY, A. S. BAKER, S. MADOFF, AND R. T. SCHOOLEY.  
1982. Mass mortality of harbor seals: pneumonia associated with influenza A virus. Science 215:1129-1131.

IMLER, R. H., AND H. R. SARBER.  
1947. Harbor seals and sea lions in Alaska. U.S. Fish. Wildl. Serv., Spec. Sci. Rep. 28, 23 p.

PAYNE, P. M., AND D. C. SCHNEIDER.  
1984. Yearly changes in abundance of harbor seals at a winter haul-out site in Massachusetts. Fish. Bull., U.S. 82:440-442.

PITCHER, K. W.  
1980a. Food of the harbor seal, *Phoca vitulina richardsi*, in

the Gulf of Alaska. Fish. Bull., U.S. 78:544-549.

1980b. Stomach contents and feces as indicators of harbor seal, *Phoca vitulina*, foods in the Gulf of Alaska. Fish. Bull., U.S. 78:797-798.

RAE, B. B.  
1973. Further observations on the food of seals. J. Zool. (Lond.) 169:287-297.

RICHARDS, S. W.  
1982. Aspects of the biology of *Ammodytes americanus* from the St. Lawrence River to Chesapeake Bay, 1972-75, including a comparison of the Long Island Sound postlarvae with *Ammodytes dubius*. J. Northwest Atl. Fish. Sci. 3:93-104.

SCHNEIDER, D. C., AND P. M. PAYNE.  
1983. Factors affecting haul-out of harbor seals at a site in southeastern Massachusetts. J. Mammal. 64:518-520.

SMITH, G. J. D., AND D. E. GASKIN.  
1974. The diet of harbor porpoises (*Phocoena phocoena* (L.)) in coastal waters of eastern Canada, with special reference to the Bay of Fundy. Can. J. Zool. 52:777-782.

SPALDING, D. J.  
1964. Comparative feeding habits of the fur seal, sea lion, and harbour seal on the British Columbia coast. Fish. Res. Board Can., Bull. 146, 52 p.

TREACY, S. D., AND T. W. CRAWFORD.  
1981. Retrieval of otoliths and statoliths from gastrointestinal contents and scats of marine mammals. J. Wildl. Manage. 45:990-993.

LAWRENCE A. SELZER

Manomet Bird Observatory, Manomet, MA 02345

GREG EARLY

PATRICIA M. FIORELLI

New England Aquarium, Boston, MA 02110

P. MICHAEL PAYNE

Manomet Bird Observatory, Manomet, MA 02345

Present address:

Boston University Marine Program, Woods Hole, MA 02345.

ROBERT PRESCOTT

Massachusetts Audubon Society,  
South Wellfleet, MA 02663

### SCAVENGER FEEDING BY SUBADULT STRIPED BASS, *MORONE SAXATILIS*, BELOW A LOW-HEAD HYDROELECTRIC DAM<sup>1</sup>

A spawning run of striped bass, *Morone saxatilis*, has not been found in the Connecticut River, but subadults from other rivers were reported in the lower 100 km of the river in the 1930's (Merriman

<sup>1</sup>Contribution No. 84 of the Massachusetts Cooperative Fishery Research Unit, which is supported by the U.S. Fish and Wildlife Service, Massachusetts Division of Fisheries and Wildlife, Massachusetts Division of Marine Fisheries, and the University of Massachusetts.

1941). Subadults enter the river in the spring and summer, often in enough abundance to support a sport fishery in Connecticut (Moss 1960). No striped bass were passed upstream in the two Holyoke Dam fish lifts located at river km 140 from the initial operation in 1955 until 1979, when 103 were lifted. Each year from 1980 to 1984, 110-510 striped bass have used the fish lifts (O'Leary 1985). In 1982, 83.5% of the fish were age II; 16.5% were age III; and none were sexually mature (Warner 1983).

Because the striped bass did not migrate into the river to spawn, they probably entered to feed. The food of striped bass has been extensively studied, but there is no published report about the food of young fish that gather below a hydroelectric dam. We studied the food of the striped bass that were lifted at Holyoke Dam in 1982.

### Methods

The stomachs of fish were removed and frozen, and the contents were examined in the laboratory with a dissecting microscope. Stomach contents were classified as small forage fish, body parts of large fish (i.e., fish larger than the striped bass could eat whole), insects, plant material, and empty. Body parts were the scales, bones, flesh, and ovaries of adult alosids (i.e., American shad, *Alosa sapidissima*, and blueback herring, *A. aestivalis*), and pieces of adult sea lamprey, *Petromyzon marinus*. The body parts originated from the following sources: fish that were injured or killed while attempting to pass the dam or to use the fish lifts, American shad that were discarded below the dam by sport fishermen, or turbine-induced injuries or mortalities of fish that passed through the hydropower turbine at the dam (Bell and Kynard 1985).

When possible, small forage fish were identified to species and measured for total length. Insects were identified to order. We compared the frequency of occurrence of the four foods eaten by striped bass that were lifted early (25 May-14 June), when average daily passage of adult alosids in the lifts was about 28,000, with the foods eaten by striped bass that were lifted late (after 21 June), when the average daily lift of alosids was about 3,000.

### Results and Discussion

We examined 78 stomachs of striped bass—65 (83%) contained food. Sixty-nine percent of the stomachs with food contained the body parts of large fish (Fig. 1a). Of the stomachs with the body parts of large fish, 93% contained the scales of adult

aloids, with many containing over 20 scales; 16% contained the body parts of adult sea lampreys.

Small forage fish were second in the frequency of occurrence at 61%, and insects were third at 21% (Fig. 1a). Elvers of the American eel, *Anguilla rostrata*, (96 mm mean total length, range: 70-125 mm,  $N = 24$ ) dominated the small forage fish category, occurring in 58% of the stomachs that contained forage fish. Elvers, migrating upstream from the ocean, may be delayed and concentrated by Holyoke Dam; perhaps striped bass follow the elvers upriver—both species occur in the fish lifts at the same time. Cyprinids were identified in six of the stomachs with forage fish. All had a 2,4-4,2 tooth formula and were probably spottail shiners, *Notropis hudsonius*, a commonly observed minnow. Insects in stomachs were mayfly nymphs, order Ephemeroptera, but only one or two mayflies were found in any stomach.

There was a significant difference in the frequency of the four food groups in fish collected early and late ( $\chi^2 = 12.6$ ,  $P < 0.01$ ). Fish parts dominated the stomach contents of early-lifted fish, whereas in late-lifted fish 54% contained parts of large fish, but 77% contained small forage fish (Fig. 1b). Fifteen percent of the stomachs of early-lifted fish were empty,

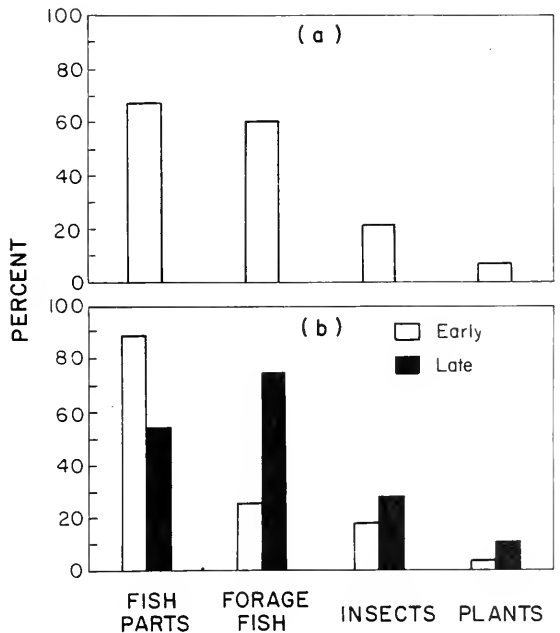

FIGURE 1.—Percent occurrence of the four major foods in the stomachs of striped bass passed by the Holyoke fish lifts a) in all of 1982 and b) in fish sampled early (25 May-14 June,  $N = 39$ ) and late (after 21 June,  $N = 26$ ) 1982.

and 19% of the stomachs of late-lifted fish were empty.

Food of the striped bass at Holyoke Dam was dominated by the body parts of adult American shad, blueback herring, and sea lamprey when many individuals of these species were being lifted, and dominated by forage fish and insects, when the alosids and sea lampreys were scarce (Fig. 1b). The reduced incidence of feeding on the body parts of large fish by striped bass lifted after 21 June was probably the result of a dramatic reduction in the availability of this food that occurred when the run of anadromous alosids diminished.

Hollis (1952) found alosid scales in the stomachs of adult striped bass captured below Conowingo Dam on the Susquehanna River in Maryland, but he dismissed these as accidental. In our study, alosid body parts occurred in stomachs too frequently to be accidental. Many authors consider the food that is selected by striped bass to be directly related to the availability (Hollis 1952; Thomas 1967; Schaefer 1970). During the run of anadromous fish at Holyoke Dam, the most abundant food that is available for striped bass is likely the body parts of dead or injured American shad, blueback herring, and sea lamprey, although we were not able to confirm this by sampling below the dam. About 900,000 adult alosids were passed upstream in the fish lifts in 1982, and injuries and mortalities were commonly observed at the dam and fish lifts. Subadult striped bass may typically concentrate below hydroelectric dams and feed on the parts of fish (anadromous or freshwater species) that die or sustain injury while attempting to move upstream or downstream of the dam.

#### Acknowledgments

This research was supported by Federal Aid Project AFS-4-R-21 and Dingell-Johnson Project 5-29328 to the Massachusetts Division of Fisheries and Wildlife and the Massachusetts Cooperative Fishery Research Unit.

#### Literature Cited

- BELL, C. E., AND B. KYNARD.  
1985. Mortality of adult American shad passing through a 17-megawatt Kaplan turbine at a low-head hydroelectric dam. *North Am. J. Fish. Manage.* 5:33-38.
- HOLLIS, E. H.  
1952. Variations in the feeding habits of the striped bass, *Roccus saxatilis* (Walbaum), in Chesapeake Bay. *Bull. Bingham Oceanogr. Collect., Yale Univ.* 14:111-131.
- MERRIMAN, D.  
1941. Studies on the striped bass (*Roccus saxatilis*) of the Atlantic coast. *U.S. Fish Wildl. Serv., Fish. Bull.* 50:1-77.
- MOSS, D. D.  
1960. A history of the Connecticut River and its fisheries. *Conn. Board Fish. Game, Hartford*, 12 p.
- O'LEARY, J. O.  
1985. Connecticut River anadromous fish investigations. *Mass. Coop. Fish. Res. Unit, Univ. Mass., D-J Proj. F-45-R-2 Rep.*, 19 p.
- SCHAEFER, R. H.  
1970. Feeding habits of striped bass from the surf waters of Long Island. *N.Y. Fish Game J.* 17:1-17.
- THOMAS, J. L.  
1967. The diet of juvenile and adult striped bass, *Roccus saxatilis*, in the Sacramento-San Joaquin River system. *Calif. Fish Game* 53:49-62.
- WARNER, J. P.  
1983. Demography, food habits, and movements of striped bass, *Morone saxatilis* Walbaum, in the Connecticut River, Massachusetts. *M.S. Thesis, Univ. Massachusetts, Amherst*, 94 p.

JOHN WARNER  
BOYD KYNARD

Massachusetts Cooperative Fishery Research Unit  
204 Holdsworth Hall  
University of Massachusetts  
Amherst, MA 01003

#### GENETIC CONFIRMATION OF SPECIFIC DISTINCTION OF ARROWTOOTH FLOUNDER, *ATHERESTHES STOMIAS*, AND KAMCHATKA FLOUNDER, *A. EVERMANNI*

The uncertain taxonomic status of two morphological types of *Atheresthes* (family Pleuronectidae) has led to some problems in fisheries surveys and stock assessments. Although data collection would be simplified if these types were conspecific morphs, a single classification would mask differences of distribution and abundance if each type actually represented a distinct species. Each type is described as a separate species: arrowtooth flounder, *A. stomias*, and Kamchatka flounder, *A. evermanni*, based on morphological differences in gill raker count, dorsal and anal fin rays, caudal vertebrae number, eye-dorsal fin distance, and relative position of the upper eye (Norman 1934; Wilimovsky et al. 1967). However, the differences are subtle, and both types have generally been considered *A. stomias* in fisheries surveys (e.g., Smith and Bakkala 1982).

*Atheresthes stomias* occurs in the eastern Bering Sea and eastern North Pacific Ocean from about St. Matthew Island, southward through the eastern Bering Sea and Gulf of Alaska, and along the North American coast to central California (Hart 1973). *Atheresthes evermanni* is distributed in the western

Bering Sea and western North Pacific Ocean from the Anadyr Gulf, south along the Kamchatka Peninsula, through the Sea of Okhotsk, and to northern Japan (Andriyashev 1939; Wilimovsky et al. 1967). The geographic ranges of the two types overlap in some areas of the Aleutian Islands and eastern Bering Sea.

Biochemical data have recently provided valuable insights towards clarifying genetic relationships among fishes. Findings have ranged from identifying previously unknown species (e.g., Shaklee et al. 1982) to grouping taxa previously considered distinct (e.g., Wishard et al. 1984). Biochemical data were therefore used to clarify the taxonomic status of *A. stomias* and *A. evermanni* through an electrophoretic examination of known individuals of both types. The level of genetic difference observed in this study is compared with that found between two other groups of marine fishes of the Bering Sea and the North Pacific Ocean.

### Materials and Methods

Collections were made in the Bering Sea near Unalaska Island by National Marine Fisheries Service research vessels *Oregon* (lat. 53°45'N, long. 166°56'W, August 1980) and *Miller Freeman* (lat. 54°44'N, long. 166°29'W, February 1981). The 12 Kamchatka flounder (4 taken in 1980 and 8 in 1981) included males and females with fork lengths ranging from 24 to 43 cm. The 13 arrowtooth flounder, taken only in 1981, also included both sexes and ranged in fork lengths from 33 to 43 cm. Morphological types were distinguished by the gill raker counts and position of the upper eye. In specimens identified as Kamchatka flounder, the upper eye did not reach the edge of the head and the mean total gill raker count was 12.4. The upper eye of specimens identified as arrowtooth flounder reached the edge of the head, breaking the dorsal profile, and the mean total gill raker count was 15.3. Fish were frozen intact at -20°C following collection and remained frozen up to 30 mo until tissues were removed for electrophoretic analysis.

Sample preparation and electrophoresis followed methods given by Utter et al. (1974). Buffer systems included 1) a discontinuous tris-citric acid (gel pH 8.2), lithium hydroxide-boric acid (tray pH 8.0) buffer, described by Ridgway et al. (1970); 2) a tris-boric acid - 0.004 M EDTA (pH 8.5) buffer, described by Markert and Faulhaber (1965); and 3) an aminopropylmorpholine-citric acid - 0.01 M EDTA (pH 6.5) buffer, described by Clayton and Tretiak (1972).

Procedures of visualizing enzyme activities follow-

ing electrophoresis were those outlined by May et al. (1979). We followed the criteria of Allendorf and Utter (1979) for the inference of Mendelian inheritance in the absence of breeding data. Genetic data were collected from 22 protein systems (Table 1). A system of nomenclature suggested by Allendorf and Utter (1979) was used where the most common allelic form of a locus was designated as 100, and other allelic forms were assigned values based on their mobility relative to the common form. Alleles migrating cathodally were given negative values.

Phenotypic frequencies of the overall sample (all specimens of both presumed species pooled together) at each polymorphic locus were tested for expected binomial (i.e., Hardy-Weinberg) distributions using a G statistic for goodness of fit (Sokal and Rohlf 1969; Goodenough 1978). Multiple allelic cases were collapsed to two allelic classes to allow for small sample sizes. A contingency table analysis of allelic frequencies testing the null hypothesis of no difference between the two groups also used the G statistic,

TABLE 1.—Protein systems used in this study including tissues and appropriate buffer systems for detection of suitable activity.

Protein system	Enzyme commission number	Tissues <sup>1</sup>	Buffer <sup>2</sup>
Acid phosphatase (ACP)	3.1.3.2	M,L,H	1,2,3
Adenosine deaminase (ADA)	3.5.4.4	M,E	1
Alcohol dehydrogenase (ADH)	1.1.1.1	L	3
Aldolase (ALD)	4.1.2.13	M	1,3
Aspartate aminotransferase (AAT)	2.6.1.1	M	1,2
Creatine kinase (CK)	2.7.3.2	M	1,3
Esterase (EST)	3.1.1.1	L,H,E	3
General protein (GP)		M,E	2,3
Glucosephosphate isomerase (GPI)	5.3.1.9	M,E	1
Glyceraldehydophosphate dehydrogenase (GAP)	1.2.1.12	E,M	1,3
Glycerol-3-phosphate dehydrogenase (G3P)	1.1.1.8	M	3
Glycylleucine peptidase (GL)	3.4.11	E,M	1,2
Isocitrate dehydrogenase (IDH)	1.1.1.42	M,H,E	3
Lactate dehydrogenase (LDH)	1.1.1.27	M,E	3
Leucylglycylglycine peptidase (LGG)	3.4.11	M	1
Malate dehydrogenase (MDH)	1.1.1.37	H,L,E,M	3
Malate dehydrogenase (ME) (decarboxylating - NADP+)	1.1.1.40	M	2
Mannosephosphate isomerase (MPI)	5.3.1.8	M	2
Phosphoglucosmutase (PGM)	2.7.5.1	M	1
6-phosphogluconate dehydrogenase (PGD)	1.1.1.44	M,E	3
Phosphoglycerate kinase (PGK)	2.7.2.3	M	3
Superoxide dismutase (SOD)	1.15.1.1	M,H	1,3

<sup>1</sup>M = muscle, L = liver, H = heart, E = eye.

<sup>2</sup>1 = discontinuous tris citrate, lithium borate; 2 = continuous tris, borate, EDTA; 3 = continuous amine citrate, EDTA.

with Yates correction for small sample sizes (Sokal and Rohlf 1969). Nei's (1978) measure of genetic distance for small sample sizes was calculated between the two groups.

### Results and Discussions

Data were collected from 22 enzyme systems encoding the following 32 presumed loci (polymorphic loci having one or more variant alleles are indicated by \*): AAT\*, ACP-1, ACP-2\*, ADA\*, ADH\*, ALD, G3P-1\*, G3P-2, CK-1, CK-2, EST, GAP-1\*, GAP-2, GL-1, GL-2, IDH\*, LDH-1\*, LDH-2, LDH-3, LGG\*, MDH-1, MDH-2, MDH-3, ME, PGD\*, PGM-1, PGM-2, GPI-1, GPI-2\*, PGK\*, MPI, SOD.

Allelic distributions for the 13 polymorphic loci indicate considerable similarity for most of the systems but some distinct differences as well, based on the contingency analysis (Table 2). The nonsignificant differences observed at nine of the loci are not highly informative given the limited number of individuals that were sampled.

However, the differences that were statistically significant provide considerable information. The most striking difference is at the ADH locus, where no alleles were shared between the 12 arrowtooth and the 10 Kamchatka flounders. These data alone confirm the genetic distinctness of the two types. The allelic distribution between the two forms is almost as distinct at the GAP-1 locus; a lesser, but significant difference also exists at the ACP-2 locus. Gel banding patterns observed for these three loci are shown in Figure 1.

Not surprisingly, the genotypic frequencies at the ADH and GAP-1 loci also deviated significantly ( $P < 0.001$ ) from the ratios of a binomial expansion of allelic frequencies (Hardy-Weinberg equilibrium expected in a single, randomly mating population). This difference resulted from excesses of homozygous and deficits of heterozygous classes, a situation expected in population mixtures (i.e., the Wahlund effect, see Futuyma 1979).

The distinct genotypic distribution of the two forms at the ADH and GAP-1 loci, coupled with their sympatric occurrence and subtle but consistent morphological identities, support their present taxonomic status as distinct congeneric species. However, the value of genetic distance observed, 0.052, is rather low for distinct species suggesting recent speciation (Avise 1976).

Recent genetic studies of two other pleuronectid species sampled from the same geographic region indicate only conspecific variation. The Alaska Peninsula separates two population groups of yellowfin

sole, *Limanda aspera*, at a mean genetic distance of 0.005 (Grant et al. 1983). No significant differences of allelic frequencies were detected in Pacific halibut, *Hippoglossus stenolepis*, sampled in the Bering Sea and the North Pacific Ocean (Grant et al. 1984). These various outcomes among confamilial groupings undoubtedly reflect the past and present actions of numerous variables; two major factors are differing capabilities for gene flow based on distinct life history patterns, and differing times and degrees of isolation imposed by glaciation events within the past 2 million years (discussed by Grant and Utter 1984).

Finally, the possibility of hybridization and introgression between the two species of *Atheresthes* should be examined through more extensive sampling of these two forms over a broader geographic range. The distinct distribution of ADH alleles excluded a hybrid origin of any individuals in this study.

TABLE 2.—Observed number and (in parentheses) within group frequency of alleles of 13 polymorphic loci in samples of arrowtooth and Kamchatka flounder.

Locus	Allele	Observed alleles (frequencies)		P <sup>1</sup>	Subunit structure <sup>2</sup>
		Arrowtooth	Kamchatka		
AAT	92	2(0.100)	no data		d
	100	10(0.500)			
	106	8(0.400)			
ACP-2	100	20(0.769)	22(1.000)	<0.05	m
	109	6(0.231)	0(0.000)		
ADA-1	100	24(0.923)	19(0.792)	ns	m
	108	2(0.077)	5(0.208)		
ADH	-100	24(1.000)	0(0.000)	<0.001	d
	-75	0(0.000)	1(0.050)		
	-13	0(0.000)	19(0.950)		
G3P-1	100	24(1.000)	19(0.950)	ns	d
	150	0(0.000)	1(0.050)		
GAP-1	13	0(0.000)	9(0.375)	<0.001	t
	70	0(0.000)	12(0.500)		
	100	26(1.000)	3(0.125)		
GPI-2	100	25(0.962)	24(1.000)	ns	d
	107	1(0.038)	0(0.000)		
IDH	70	0(0.000)	3(0.125)	ns	d
	100	26(1.000)	21(0.875)		
LDH-3	100	26(1.000)	22(0.917)	ns	t
	117	0(0.000)	2(0.083)		
LGG	86	1(0.038)	0(0.000)	ns	d
	100	25(0.962)	22(1.000)		
PGD	75	4(0.154)	0(0.000)	ns	d
	100	22(0.846)	22(1.000)		
PGM-1	84	0(0.000)	1(0.042)	ns	m
	100	23(0.885)	22(0.916)		
	105	3(0.115)	0(0.000)		
	113	0(0.000)	1(0.042)		
PGK	100	26(1.000)	19(0.950)	ns	m
	133	0(0.000)	1(0.050)		

<sup>1</sup>Contingency tests of allelic frequencies using the G-statistic with Yates correction for small sample sizes, assuming all samples drawn from the same population; ns = not significant.

<sup>2</sup>Protein subunit structure based on observed banding patterns of variants; m = monomer, d = dimer, t = tetramer.



Literature Cited

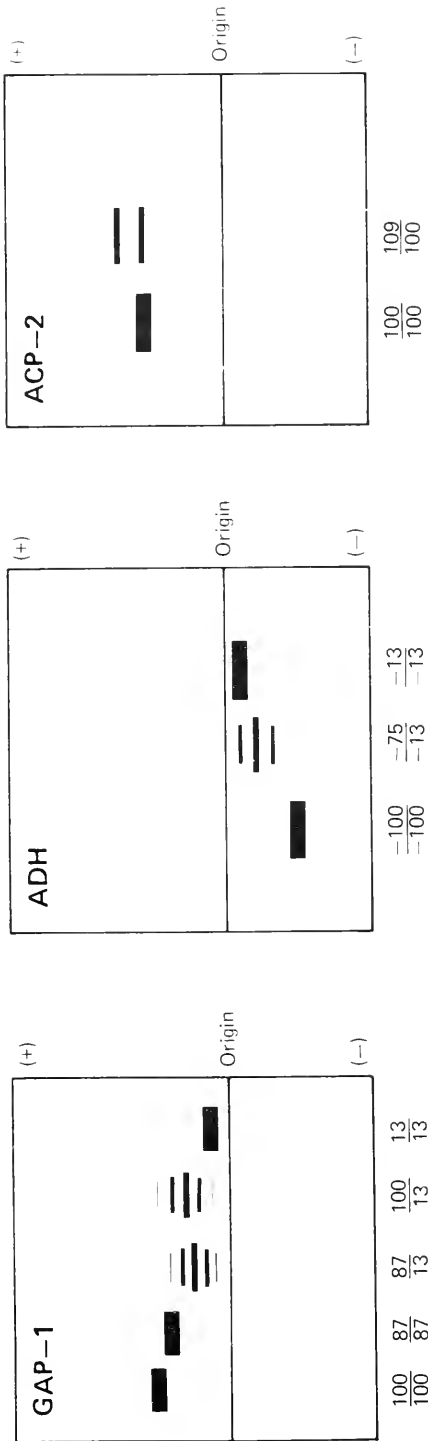

FIGURE 1.—Starch gel banding patterns of variants observed for three loci in *Atheresthes*: GAP-1, ADH, and ACP-2.

ALLENDORF, F. W., AND F. M. UTTER.  
 1979. Population genetics. In W. S. Hoar, D. J. Randall, and J. R. Brett (editors), *Fish physiology*, Vol. 8: bioenergetics and growth, p. 407-454. Acad. Press, N.Y.

ANDRIYASHEV, A. P.  
 1939. Ocherk zoogeografii i proiskhozhdeniya fauny ryb Beringova morya i sopedel'nykh vod (Survey of zoogeography and origin of ichthyofauna of the Bering Sea and adjacent waters). [In Russ.] Izd. Leningr. Gos. Univ., Leningr., 187 p. (Transl. Northwest and Alaska Fisheries Center, NMFS, 2725 Montlake Blvd. E., Seattle, WA 98112, 284 p.)

AVISE, J. C.  
 1976. Genetic differentiation during speciation. In F. J. Ayala (editor), *Molecular evolution*, p. 106-122. Sinauer Assoc. Inc., Sunderland, MA.

CLAYTON, J. W., AND D. N. TRETIAK.  
 1972. Amine-citrate buffers for pH control in starch gel electrophoresis. *J. Fish. Res. Board Can.* 29:1169-1172.

FUTUYMA, D. J.  
 1979. *Evolutionary biology*. Sinauer Assoc. Inc., Sunderland, MA, 565 p.

GOODENOUGH, U.  
 1978. *Genetics*. Holt, Rinehart, and Winston, N.Y., 840 p.

GRANT, W. S., R. BAKKALA, F. M. UTTER, D. J. TEEL, AND T. KOBAYASHI.  
 1983. Biochemical genetic population structure of yellowfin sole, *Limanda aspera*, of the North Pacific Ocean and Bering Sea. *Fish. Bull., U.S.* 81:667-677.

GRANT, W. S., AND F. M. UTTER.  
 1984. Biochemical population genetics of Pacific herring, *Clupea pallasii*. *Can. J. Fish. Aquat. Sci.* 41:856-864.

GRANT, W. S., D. J. TEEL, T. KOBAYASHI, AND C. SCHMITT.  
 1984. Biochemical population genetics of Pacific halibut (*Hippoglossus stenolepis*) and comparison with Atlantic halibut (*H. hippoglossus*). *Can. J. Fish. Aquat. Sci.* 41:1083-1088.

HART, J. L.  
 1973. Pacific fishes of Canada. *Fish. Res. Board Can. Bull.* 180, 740 p.

MARKERT, C. L., AND I. FAULHABER.  
 1965. Lactate dehydrogenase isozyme patterns of fish. *J. Exp. Zool.* 159:319-332.

MAY, B., J. E. WRIGHT, AND M. STONEKING.  
 1979. Joint segregation of biochemical loci in Salmonidae: Results from experiments with *Salvelinus* and review of the literature on other species. *J. Fish. Res. Board Can.* 36: 1114-1128.

NEI, M.  
 1978. Estimation of average heterozygosity and genetic distance from a small number of individuals. *Genetics* 89: 583-590.

NORMAN, J. R.  
 1934. A systematic monograph of the flatfishes (Heterosomata). Vol. I. Psettoidea, Bothidae, Pleuronectidae. *Br. Mus. (Nat. Hist.), Lond.*, 459 p. [Reprinted, 1966, by Johnson Reprint, N.Y.]

RIDGWAY, G. J., S. W. SHERBURNE, AND R. D. LEWIS.  
 1970. Polymorphism in the esterases of Atlantic herring. *Trans. Am. Fish. Soc.* 99:147-151.

SHAKLEE, J. B., C. S. TAMARU, AND R. S. WAPLES.  
 1982. Speciation and evolution of marine fishes studied by the electrophoretic analysis of proteins. *Pac. Sci.* 36:141-157.

SMITH, G. B., AND R. BAKKALA.  
 1982. Demersal fish resources of the eastern Bering Sea: spring 1976. U.S. Dep. Commer., NOAA Tech. Rep. NMFS

SSRF-754, 129 p.

SOKAL, R. R., AND F. J. ROHLF.

1969. Biometrics. The principles and practice of statistics in biological research. W. H. Freeman, San Franc., 776 p.

UTTER, F. M., H. O. HODGINS, AND F. W. ALLENDORF.

1974. Biochemical genetic studies of fishes: potentialities and limitations. *In* D. C. Malins and J. R. Sargent (editors), Biochemical and biophysical perspectives in marine biology, Vol. 2, p. 213-238. Acad. Press, N.Y.

WILIMOVSKY, N. J., A. PEDEN, AND J. PEPPAR.

1967. Systematics of six demersal fishes of the North Pacific Ocean. Fish. Res. Board Can., Tech. Rep. 34, 95 p.

WISHARD, L. N., J. E. SEEB, F. M. UTTER, AND D. STEFAN.

1984. A genetic investigation of suspected redband trout populations. *Copeia* 1984:120-132.

CAROL L. RANCK

*Northwest and Alaska Fisheries Center  
National Marine Fisheries Service, NOAA  
2725 Montlake Boulevard East  
Seattle, WA 98112*

*Present address: Rufus Field Station  
National Marine Fisheries Service, NOAA  
P.O. Box 67, Rufus, OR 97050*

FRED M. UTTER  
GEORGE B. MILNER  
GARY B. SMITH

*Northwest and Alaska Fisheries Center  
National Marine Fisheries Service, NOAA  
2725 Montlake Boulevard East  
Seattle, WA 98112*

## ERRATA

### *Fishery Bulletin: Vol. 83, No. 1*

Pérez Farfante, Isabel. "The rock shrimp genus *Sicyonia* (Crustacea: Decapoda: Penaeoidea) in the eastern Pacific," p. 1-79.

Page 4, figure legend was omitted and should be added as follows:

FIGURE 1.—Lateral view of generalized *Sicyonia* showing terms used in description.

### *Fishery Bulletin: Vol. 83, No. 3*

Lester, R. J. G., A. Barnes, and G. Habib. "Parasites of skipjack tuna, *Katsuwonus pelamis*: fishery implications," p. 343-356.

Page 347; Table 2, No. 6, *Syncoelium filiferum*:

J should read 0.2 and K should read 6.9.



# INFORMATION FOR CONTRIBUTORS TO THE *FISHERY BULLETIN*

Manuscripts submitted to the *Fishery Bulletin* will reach print faster if they conform to the following instructions. These are not absolute requirements, of course, but desiderata.

## CONTENT OF MANUSCRIPT

The **title page** should give only the title of the paper, the author's name, his affiliation, and mailing address, including ZIP code.

The **abstract** should not exceed one double-spaced page.

In the **text**, *Fishery Bulletin* style for the most part follows that of the *U.S. Government Printing Office Style Manual*. Fish names follow the style of the American Fisheries Society Special Publication No. 42, *A List of Common and Scientific Names of Fishes from the United States and Canada*, Fourth Edition, 1980.

**Text footnotes** should be typed separately from the text.

**Figures and tables**, with their legends and headings, should be self-explanatory, not requiring reference to the text. Their placement should be indicated in the right-hand margin of the manuscript.

Preferably **figures** should be reduced by photography to 5 1/4 inches (for single-column figures, allowing for 50% reduction in printing), or to 12 inches (for double-column figures). The maximum height, for either width, is 13 inches. Photographs should be printed on high-quality or glossy paper.

Do not send original drawings to the Scientific Editor; if they, rather than the photographic reductions, are needed by the printer, the Scientific Publications Office will request them.

Each **table** should start on a separate page. Consistency in headings and format is desirable. Vertical rules should be avoided, as they make the tables more expensive to print. Footnotes in tables should be numbered sequentially in arabic numerals. To avoid confusion with powers, they should be placed to the *left* of numerals.

**Acknowledgments**, if included, are placed at the end of the text.

Literature is cited in the text as (Lynn and Reid (1968)) or (Lynn and Reid 1968). All papers referred to in the text should be listed alphabetically by the senior author's surname under the heading "Literature Cited." Only the author's surname and initials are required in the **literature cited**. The accuracy of the **literature cited** is the respon-

sibility of the author. Abbreviations of names of periodicals and journal serials should conform to *Serial Sources for the BIOSIS Data Base*. *Chemical Abstracts* also use the system which was developed by the American Standard Association.

Common **abbreviations and symbols**, such as mm, mg, g, ml, mg, °C (for Celsius), %, °, and so forth, should be used. Abbreviate units of measure only when used with numerical. Periods are only rarely used with abbreviations.

We prefer that **measurements** be given in metric units; other equivalent units may be given in parentheses.

## FORM OF THE MANUSCRIPT

The original of the manuscript should be typed, double-spaced, on white bond paper. Please triple-space above heading. We would rather receive good duplicated copies of manuscript than carbon copies. The sequence of the material should be:

TITLE PAGE  
ABSTRACT  
TEXT  
LITERATURE CITED  
TEXT FOOTNOTES  
APPENDIX  
TABLES (Each table should be numbered with an arabic numeral and heading provided)  
LIST OF FIGURES (Entire figure legends)  
FIGURES (Each figure should be numbered with an arabic numeral; legends are desired)

## ADDITIONAL INFORMATION

Send the ribbon copy and two duplicated or carbon copies of the manuscript to:

Dr. William J. Richards, Scientific Editor  
*Fishery Bulletin*  
Southeast Fisheries Center Miami Laboratory  
National Marine Fisheries Service, NOAA  
75 Virginia Beach Drive  
Miami, FL 33149-1099

Fifty **separates** will be supplied to an author free of charge and 50 supplied to his organization. No covers will be supplied.

Notes

WEBER, EARL C., and STEPHEN R. GOLDBERG. The sex ratio and gonad indices of swordfish, <i>Xiphus gladius</i> , caught off the coast of southern California in 1978	185
UCHIYAMA, JAMES H., RAYMOND K. BURCH, and SYDA KRAUL, JR. Growth of dolphins, <i>Coriophæna hipparys</i> and <i>C. equisetis</i> , in Hawaiian waters as determined by daily increments on otoliths	186
FROST, KATHRYN J., and LLOYD F. LOWRY. Sizes of walleye pollock, <i>Theragra chalcogramma</i> , consumed by marine mammals in the Bering Sea	192
VAN ENGEL, W. A., R. E. HARRIS, JR., and D. E. ZWERNER. Occurrence of some parasites and a commensal in the American lobster, <i>Homarus americanus</i> , from the Mid Atlantic Bight	197
COLLETTE, BRUCE B. Residence of the fish assemblage in New England tide pools	200
JOHNSON, PHYLLIS T. Parasites of benthic amphipods (Ciliates)	204
MASON, J. C. Fecundity of the Pacific hake, <i>Merluccius productus</i> , spawning in Canadian waters	209
SELZER, LAWRENCE A., GREG EARLY, PATRICIA M. FIORELLI, P. MICHAEL PAYNE, and ROBERT PRESCOTT. Stranded animal as indicator of prey utilization by harbor seals, <i>Phoca vitulina concolor</i> , in southern New England	217
WAKNER, JOHN, and BOYD KYNARD. Scavenger feeding by subadult striped bass, <i>Morone saxatilis</i> , below a low head hydroelectric dam	220
RANCK, CAROLL, FRED M. UTTER, GEORGE E. MILNER, and GARY B. SMITH. Genetic confirmation of specific distinction of arrowtooth flounder, <i>Atheresthes stomus</i> , and Kamchatka flounder, <i>A. aceratum</i>	222



# Fishery Bulletin

Vol. 84, No. 2

April 1986

HUMES, ARTHUR G. Copepodids and adults of <i>Leptinogaster major</i> (Williams, 1907), a poecilostomatoid copepod living in <i>Mya arenaria</i> L. and other marine bivalve mollusks. . . . .	227
MYRICK, A. C., JR., A. A. HOHN, J. BARLOW, and P. A. SLOAN. Reproductive biology of female spotted dolphins, <i>Stenella attenuata</i> , from the eastern tropical Pacific. . . . .	247
SYKES, STEPHEN D., and LOUIS W. BOESFORD. Chinook salmon, <i>Oncorhynchus tshawytscha</i> , spawning escapement based on multiple mark-recapture of carcasses. . . . .	261
PAYNE, P. MICHAEL, JOHN R. NICOLAS, LORETTA O'BRIEN, and KEVIN D. POWERS. The distribution of the humpback whale, <i>Megaptera novaeangliae</i> , on Georges Bank and in the Gulf of Maine in relation to densities of the sand eel, <i>Ammodytes americanus</i> . . . . .	271
BAYER, RANGE D. Seabirds near an Oregon estuarine salmon hatchery in 1982 and during the 1983 El Niño. . . . .	279
WILKINS, MARK E. Development and evaluation of methodologies for assessing and monitoring the abundance of widow rockfish, <i>Sebastes entomelas</i> . . . . .	287
NELSON, WALTER R., and DEAN W. AHRENHOLZ. Population and fishery characteristics of gulf menhaden, <i>Brevoortia patronus</i> . . . . .	311
HAWKES, CLAYTON, R., THEODORE R. MEYERS, and THOMAS C. SHIRLEY. Length-weight relationships of blue, <i>Paralithodes platypus</i> , and golden, <i>Lithodes aequispinna</i> , king crabs parasitized by the rhizocephalan, <i>Briarosaccus callosus</i> Boschma. . . . .	327
DOHL, THOMAS P., MICHAEL L. BONNELL, and R. GLENN FORD. Distribution and abundance of common dolphin, <i>Delphinus delphis</i> , in the Southern California Bight: a quantitative assessment based upon aerial transect data. . . . .	333
KENNEY, ROBERT D., and HOWARD E. WINN. Cetacean high use habitats of the northeast United States continental shelf. . . . .	345
CUMMINGS, WILLIAM C., PAULO THOMPSON, and SAMUEL J. HA. Sounds from Bryde, <i>Balaenoptera edeni</i> , and finback, <i>B. physalus</i> , whales in the Gulf of California. . . . .	359
PEREZ, MICHAEL A., and ELIZABETH E. MOONEY. Increased food and energy consumption of lactating northern fur seals, <i>Callorhinus ursinus</i> . . . . .	371
BIGG, MICHAEL A. Arrival of northern fur seals, <i>Callorhinus ursinus</i> , on St. Paul Island, Alaska. . . . .	383

(Continued on back cover)

# U.S. DEPARTMENT OF COMMERCE

Malcolm Baldrige, *Secretary*

## NATIONAL OCEANIC AND ATMOSPHERIC ADMINISTRATION

Anthony J. Calio, *Administrator*

### NATIONAL MARINE FISHERIES SERVICE

William G. Gordon, *Assistant Administrator*

## Fishery Bulletin

The *Fishery Bulletin* carries original research reports and technical notes on investigation in fishery science, engineering, and economics. The Bulletin of the United States Fish Commission was begun in 1881, it became the Bulletin of the Bureau of Fisheries in 1904 and the Fishery Bulletin of the Fish and Wildlife Service in 1941. Separates were issued as documents through volume 46, the last document was No. 1103. Beginning with volume 47 in 1931 and continuing through volume 62 in 1963, each separate appeared as a numbered bulletin. A new system began in 1963 with volume 63 in which papers are bound together in a single issue of the bulletin instead of being issued individually. Beginning with volume 70, number 1, January 1972, the *Fishery Bulletin* became a periodical, issued quarterly. In this form, it is available by subscription from the Superintendent of Documents, U.S. Government Printing Office, Washington, DC 20402. It is also available free in limited numbers to libraries, research institutions, State and Federal agencies, and in exchange for other scientific publications.

### SCIENTIFIC EDITOR, *Fishery Bulletin*

Dr. William J. Richards  
Southeast Fisheries Center Miami Laboratory  
National Marine Fisheries Service, NOAA  
Miami, FL 33149-1099

### Editorial Committee

Dr. Bruce B. Collette  
National Marine Fisheries Service

Dr. Jay C. Quast  
National Marine Fisheries Service

Dr. Reuben Lasker  
National Marine Fisheries Service

Dr. Carl J. Sindermann  
National Marine Fisheries Service

Mary S. Fukuyama, *Managing Editor*

The *Fishery Bulletin* (ISSN 0090-0656) is published quarterly by the Scientific Publications Office, National Marine Fisheries Service, NOAA, 7609 Sand Point Way, NE, BIN C15700, Seattle, WA 98115. Second class postage is paid in Seattle, Wash., and additional offices. POSTMASTER: send address changes for subscriptions to Superintendent of Documents, U.S. Government Printing Office, Washington, DC 20402.

Although the contents have not been copyrighted and may be reprinted or freely reference to source is appreciated.

The Secretary of Commerce has determined that the publication of this periodical is necessary in the transaction of the public business required by law of this Department. Use of funds for printing of this periodical has been approved by the Director of the Office of Management and Budget through 1 April 1986.



# Fishery Bulletin

## CONTENTS

Vol. 84, No. 2

April 1986

HUMES, ARTHUR G. Copepodids and adults of <i>Leptinogaster major</i> (Williams, 1907), a poecilostomatoid copepod living in <i>Mya arenaria</i> L. and other marine bivalve mollusks . . . . .	227
MYRICK, A. C., JR., A. A. HOHN, J. BARLOW, and P. A. SLOAN. Reproductive biology of female spotted dolphins, <i>Stenella attenuata</i> , from the eastern tropical Pacific . .	247
SYKES, STEPHEN D., and LOUIS W. BOTSFORD. Chinook salmon, <i>Oncorhynchus tshawytscha</i> , spawning escapement based on multiple mark-recapture of carcasses . . . . .	261
PAYNE, P. MICHAEL, JOHN R. NICOLAS, LORETTA O'BRIEN, and KEVIN D. POWERS. The distribution of the humpback whale, <i>Megaptera novaeangliae</i> , on Georges Bank and in the Gulf of Maine in relation to densities of the sand eel, <i>Ammodytes americanus</i> . . . . .	271
BAYER, RANGE D. Seabirds near an Oregon estuarine salmon hatchery in 1982 and during the 1983 El Nino . . . . .	279
WILKINS, MARK E. Development and evaluation of methodologies for assessing and monitoring the abundance of widow rockfish, <i>Sebastes entomelas</i> . . . . .	287
NELSON, WALTER R., and DEAN W. AHRENHOLZ. Population and fishery characteristics of gulf menhaden, <i>Brevoortia patronus</i> . . . . .	311
HAWKES, CLAYTON, R., THEODORE R. MEYERS, and THOMAS C. SHIRLEY. Length-weight relationships of blue, <i>Paralithodes platypus</i> , and golden, <i>Lithodes aequispina</i> , king crabs parasitized by the rhizocephalan, <i>Briarosaccus callosus</i> Boschma . . . . .	327
DOHL, THOMAS P., MICHAEL L. BONNELL, and R. GLENN FORD. Distribution and abundance of common dolphin, <i>Delphinus delphis</i> , in the Southern California Bight: a quantitative assessment based upon aerial transect data . . . . .	333
KENNEY, ROBERT D., and HOWARD E. WINN. Cetacean high-use habitats of the northeast United States continental shelf . . . . .	345
CUMMINGS, WILLIAM C., PAUL O. THOMPSON, and SAMUEL J. HA. Sounds from Bryde, <i>Balaenoptera edeni</i> , and finback, <i>B. physalus</i> , whales in the Gulf of California . . . . .	359
PEREZ, MICHAEL A., and ELIZABETH E. MOONEY. Increased food and energy consumption of lactating northern fur seals, <i>Callorhinus ursinus</i> . . . . .	371
BIGG, MICHAEL A. Arrival of northern fur seals, <i>Callorhinus ursinus</i> , on St. Paul Island, Alaska . . . . .	383

(Continued on next page)

Seattle, Washington

1986

LO, NANCY C. H. Modeling life-stage-specific instantaneous mortality rates, an application to northern anchovy, <i>Engraulis mordax</i> , eggs and larvae . . . . .	395
SEN, A. R. Methodological problems in sampling commercial rockfish landings . . .	409
POLOVINA, JEFFREY J. A variable catchability version of the Leslie model with application to an intensive fishing experiment on a multispecies stock . . . . .	423
MATSUURA, YASUNOBU, and NELSON TAKUMI YONEDA. Early development of the lophid anglerfish, <i>Lophius gastrophysus</i> . . . . .	429
SQUIRES, DALE. Ex-vessel price linkages in the New England fishing industry ..	437
LEBER, KENNETH M., and HOLLY S. GREENING. Community studies in seagrass meadows: A comparison of two methods for sampling macroinvertebrates and fishes . . . . .	443

Notes

OXENFORD, HAZEL A., and WAYNE HUNTE. A preliminary investigation of the stock structure of the dolphin, <i>Coryphaena hippurus</i> , in the western central Atlantic . . . . .	451
FORWARD, RICHARD B., JR., BLANCA ROJAS de MENDIOLA, and RICHARD T. BARBER. Effects of temperature on swimming speed of the dinoflagellate <i>Gymnodinium splendens</i> . . . . .	460
GRAHAM, JEFFREY B., RICHARD H. ROSENBLATT, and DARCY L. GIBSON. Morphology and possible swimming mode of a yellowfin tuna, <i>Thunnus albacares</i> , lacking one pectoral fin . . . . .	463
RATTY, F. J., Y. C. SONG, and R. M. LAURS. Chromosomal analysis of albacore, <i>Thunnus alalunga</i> , and yellowfin, <i>Thunnus albacares</i> , and skipjack, <i>Katsuwonus pelamis</i> , tuna . . . . .	469
STIER, KATHLEEN, and BOYD KYNARD. Abundance, size, and sex ratio of adult sea-run sea lamprey, <i>Petromyzon marinus</i> , in the Connecticut River . . . . .	476
MASON, J. C., and A. C. PHILLIPS. An improved otter surface sampler . . . . .	480
GROVER, JILL J., and BORI L. OLLA. Morphological evidence for starvation and prey size selection of sea-caught larval sablefish, <i>Anoplopoma fimbria</i> . . . . .	484
Notices . . . . .	490

The National Marine Fisheries Service (NMFS) does not approve, recommend or endorse any proprietary product or proprietary material mentioned in this publication. No reference shall be made to NMFS, or to this publication furnished by NMFS, in any advertising or sales promotion which would indicate or imply that NMFS approves, recommends or endorses any proprietary product or proprietary material mentioned herein, or which has as its purpose an intent to cause directly or indirectly the advertised product to be used or purchased because of this NMFS publication.

**COPEPODIDS AND ADULTS OF  
LEPTINOGASTER MAJOR (WILLIAMS, 1907), A POECILOSTOMATOID  
COPEPOD LIVING IN MYA ARENARIA L. AND  
OTHER MARINE BIVALVE MOLLUSKS**

ARTHUR G. HUMES<sup>1</sup>

**ABSTRACT**

The five copepodid stages and adults of *Leptinogaster major* (Williams, 1907), a poecilostomatoid copepod (family Clausidiidae) living in the mantle cavity of *Mya arenaria* L. and other marine bivalve mollusks along the coast of eastern North America from Prince Edward Island, Canada, to Louisiana, are described. Copepodid I is *Saphirella*-like in body form. In the adult female the maxilliped is present though much reduced. Sexual differentiation first occurs in Copepodid IV, where the male and female maxillipeds are differently formed.

The poecilostomatoid copepod *Leptinogaster* (= *Myochoeres*) *major* (Williams, 1907) has been reported from the mantle cavity of various marine bivalve mollusks along the eastern shore of North America, from Prince Edward Island, Canada (J. C. Medcof in correspondence with M. S. Wilson) to Louisiana (Causey 1953). This copepod has undergone several name changes, but it seems generally agreed now that it properly belongs in the genus *Leptinogaster* (see Bocquet and Stock 1958, and Table 1). The seasonal population changes and host relationships of this species have been described by Humes and Cressey (1960), who listed as hosts *Mya arenaria* L., *Tagelus gibbus* (Spengler), *Venus mercenaria* L., and *Ensis directus* (Conrad). Other hosts include *Mactra solidissima* Dillwyn (reported by Williams 1907), *Dosinia gibbus* Reeve (reported by Pearse

1947), and *Pholas costata* L. (reported by Causey 1953). For a list of bivalve hosts and localities see Table 2.

The copepodid development of *Leptinogaster* has not been fully described. Bocquet and Stock (1958) mentioned finding copepodids of *Leptinogaster histrio* (Pelseneer 1929) and figured the maxillipeds of an unknown stage (their fig. 3d, e); they also reported a Copepodid V of *Leptinogaster* sp. and il-

TABLE 1.—Taxonomic history of *Leptinogaster major* (Williams, 1907).

*Lichomolgus major* Williams, 1907, p. 77, pl. III, 8 figs.; Sharpe 1910, p. 408, placed in Lichomolgidae.  
*Mycicola major*, C. B. Wilson, 1932, p. 347, fig. 208, genus wrongly assigned; Monod and Dollfus 1934, p. 316, placed in Clausiidae; Deevey 1948, p. 22, 1960, p. 34; Sewell 1949, p. 156, placed in Lichomolgidae; Causey 1953, p. 12.  
*Mycicola spinosa* Pearse, 1947, p. 5, figs. 26-31, placed in Mycolidae.  
*Myochoeres major*, M. S. Wilson, 1950, p. 299; M. S. Wilson and Illg 1955, p. 136, 138; Allen 1956, p. 62, placed tentatively in Lichomolgidae; Bocquet and Stock 1957a, p. 213, 221, placed in Clausidiidae; Humes and Cressey 1958, p. 932, 934, placed in Clausidiidae; Băcescu and Por 1959, p. 20, placed in Clausidiidae; Humes and Cressey 1960, p. 307-325.  
*Leptinogaster major*, Bocquet and Stock, 1958, p. 86-88, placed in Clausidiidae; Gooding 1963, p. 132-136, pl. 17, figs. a-n.

TABLE 2.—Localities and hosts of *Leptinogaster major*.

Locality	Host(s)	Source
Ellerslie, Prince Edward Island, Can.	<i>Mya arenaria</i> L.	J. C. Medcof in correspondence (23 May 1950) with M. S. Wilson
Bideford River, Prince Edward Island, Can.	<i>Mya arenaria</i> L.	J. C. Medcof in correspondence (31 July 1948) with M. S. Wilson
Cotuit, MA	<i>Mya arenaria</i> L. <i>Tagelus gibbus</i> (Spengler) <i>Venus mercenaria</i> L. <i>Ensis directus</i> (Conrad)	Humes and Cressey (1960)
Marthas Vineyard, MA	in plankton	Deevey (1948)
Wickford and Matunuck, RI	<i>Mya arenaria</i> L. <i>Venus mercenaria</i> L. <i>Mactra solidissima</i> Dillwyn	Williams (1907)
Delaware Bay	in plankton	Deevey (1960)
Beaufort, NC	<i>Tagelus gibbus</i> (Spengler) <i>Dosinia discus</i> Reeve <i>Venus mercenaria</i> L.	Pearse (1947)
Grand Isle, LA	<i>Pholas costata</i> L.	Causey (1953)

<sup>1</sup>Boston University Marine Program, Marine Biological Laboratory, Woods Hole, MA 02543.

lustrated its maxilliped (their fig. 6b, c). Gooding (1963) described features of Copepodid I of *Leptinogaster major*.

Before her death Mildred S. Wilson had studied specimens of *Leptinogaster* (= *Myochoeres*) *major* that had been sent to her from Rhode Island and Prince Edward Island, and had prepared the first draft of a redescription. She recognized the need for a thorough redescription of this species whose original description by Williams (1907) is very incomplete. Although she wrote (1950) that a detailed description of adults and developmental forms was then in preparation, this study apparently was never completed. In a letter to J. C. Medcof dated 24 August 1948 she stated that she had found two early stages of *Myochoeres*. Presumably descriptions of these copepodids would have been part of her projected study if she had lived.

During the study by Humes and Cressey (1960) a large number of *Leptinogaster major* (1,535) were collected from *Mya arenaria* over a period of almost 2 yr at Cotuit, MA. The copepodids and adults described below came from collections made during the summer of 1957. All five copepodid stages, distinguished on the basis of the number of body segments, as well as adults, were obtained. This paper deals with the detailed description of the external morphology of these immature stages and adults.

Although the copepodids described here were not obtained by rearing, it seems certain that the copepodids found in such large numbers are those of *Leptinogaster major*. No other species of copepods occurred in the *Mya arenaria* examined.

## MATERIALS AND METHODS

The copepodids and adults described here were selected from a pool of 305 copepodids and 195 adults found in 125 *Mya arenaria* during May-September at Cotuit, MA. The successive Copepodids I-V and the adults were cleared in lactic acid and sorted by size and external morphology into their respective groups.

All measurements and dissections were made on specimens cleared in lactic acid, following the method of Humes and Gooding (1964). The body length does not include the setae on the caudal rami. The measurements of certain parts, such as the length of the first antenna, maxilliped, and various setae and claws, and the dimensions of leg 5, the caudal ramus, and the urosomal segments, are based on dissected specimens from which the drawings were made, and may be considered representative

of nearly average body size. Such measurements are intended more to show relative changes in size during successive instars rather than to represent absolute size. The drawings were made with the aid of a camera lucida. The abbreviations used are as follows:  $A_1$  = first antenna,  $A_2$  = second antenna, L = labrum, MD = mandible,  $MX_1$  = first maxilla,  $MX_2$  = second maxilla,  $P_3$  = leg 3,  $P_4$  = leg 4, and  $P_5$  = leg 5.

## DESCRIPTIONS

### Copepodid I

#### Figures 1a-n, 2a-c

Size.—Length 0.57 mm (0.45-0.60 mm) and greatest width 0.17 mm (0.16-0.18 mm) based on 38 specimens.

Body form (Fig. 1a, b, c).—*Saphirella*-like, with cephalosome bluntly pointed anteriorly. Five body segments including and posterior to segment bearing leg 1. Anal segment with 4 groups of spines, 2 ventral groups and 2 ventrolateral groups (Fig. 1d).

Caudal ramus (Fig. 1e).—Relatively short,  $36 \times 18 \mu\text{m}$ , ratio 2:1, with 6 setae. Outer lateral seta  $18 \mu\text{m}$ , dorsal seta  $20 \mu\text{m}$ , 4 terminal setae from outer to inner 23, 17, 39, and  $176 \mu\text{m}$ , the last with minute lateral spinules.

Rostrum (Fig. 1f).—Broad ridge, prominent in lateral view (Fig. 1g).

First antenna (Fig. 1h).—Five-segmented,  $83 \mu\text{m}$  long. Armature: 2, 2, 3 + 1 aesthete, 2 + 1 aesthete, and 5 + 1 aesthete. All setae smooth.

Second antenna (Fig. 1i).—Indistinctly 4-segmented, last segment obscure. First segment with 1 distal seta. Second segment with 1 seta and group of small spines. Third segment with outer row of spines and 2 slender inner setules, with outer stout curved seta having expanded serrate distal half and 1 short inner blunt seta. Fourth segment small and indistinctly set off from third segment, with 1 blunt short seta, 1 long stout smooth seta, 1 slender smooth seta, and 1 long stout seta with prominent lateral setules.

Labrum (Fig. 1j).—Broad, with ventral surface bearing 2 medially interrupted rows of spines and with posteroventral margin having row of small

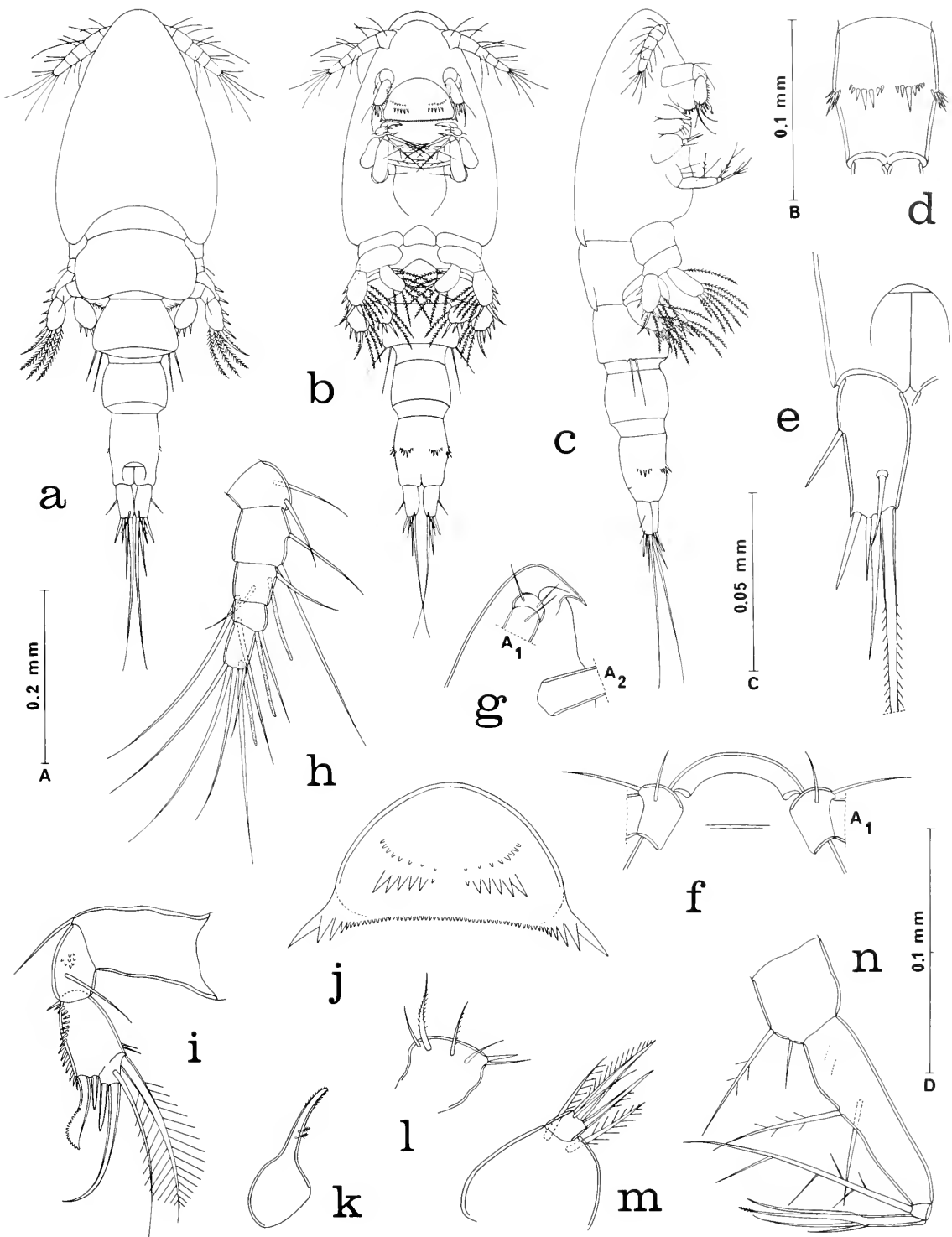

FIGURE 1.—Copepodid I of *Leptinogaster major*: a, dorsal (scale A); b, ventral (A); c, lateral (A); d, anal segment, ventral (B); e, caudal ramus, dorsal (C); f, rostral area, ventral (D); g, rostral area, lateral (B); h, first antenna, dorsal (D); i, second antenna, dorsal (C); j, labrum, in situ, ventral (C); k, mandible, ventral (C); l, first maxilla, ventral (C); m, second maxilla, ventral (C); n, maxilliped, posterior (C).

spines, these spines becoming much larger at both corners.

Mandible (Fig. 1k).—Simple form, small, about 42  $\mu\text{m}$  long, with expanded base but slender distal portion bearing 2 minute setae midway and having minutely pectinate tip.

Paragnath.—Minute smooth lobe.

First maxilla (Fig. 1l).—Small lobe bearing 6 setae.

Second maxilla (Fig. 1m).—Two-segmented, large first segment with 2 setae, small second segment with 3 setae.

Maxilliped (Fig. 1n).—Elongate, slender, 4-segmented. First segment with 2 setae. Elongate second segment with 2 setae and 2 small setules. Small third segment with 1 long seta having few prominent lateral setules. Fourth segment bearing 3 setae near midregion and extended beyond as setiform process with few minute barbs near tip.

Leg 1 (Fig. 2a).—Both rami 1-segmented. Formula for armature: coxa 0-0; basis 1-0; exopod III,I,4; endopod 1,5,1. Exopod with 3 outer spines having prominent lateral spinules and terminal outer spine and adjacent seta with outer denticulations.

Leg 2 (Fig. 2b).—Both rami 1-segmented. Armature: coxa 0-0; basis 1-0; exopod III,I,3; endopod III,2,1. Exopod spines with lateral spinules or denticulations as in leg 1; endopod spines finely barbed.

Leg 3 (Fig. 2c).—Consisting of 2 setae, 70 and 57  $\mu\text{m}$ , with 2 very small spines near their insertions.

Legs 4, 5, and 6.—Absent.

## Copepodid II

### Figures 2d-m, 3a-e

Size.—Length 0.68 mm (0.59-0.72 mm) and greatest width 0.19 mm (0.18-0.20 mm), based on 31 specimens.

Body form (Fig. 2d).—No longer *Saphirella*-like. Suggesting form of later instars. Six body segments including and posterior to segment bearing leg 1. Segment bearing leg 4 ventrally with 2 transverse rows of spines (Fig. 2e). Anal segment ventrally with distal spines in addition to 4 groups of proximal

spines. Ventrolateral areas of cephalosome at level of mouthparts with strip of small spinules (Fig. 3a).

Caudal ramus.—Similar to Copepodid I but few small ventral spines distally.

Rostrum (Fig. 2f).—Suggesting rounded form seen in later instars.

First antenna (Fig. 2g).—Five-segmented, 107  $\mu\text{m}$  long. Armature: 2, 3, 3 + 1 aesthete, 2 + 1 aesthete, and 6 + 1 aesthete.

Second antenna (Fig. 2h).—Four-segmented. Third segment with 2 strong recurved outer clawlike spines. Small fourth segment with 4 smooth setae, 2 middle setae curved.

Labrum (Fig. 2i).—Posteroventral margin sharply pointed. No surficial or marginal ornamentation.

Mandible (Fig. 2j).—Elongate, 43  $\mu\text{m}$ , distally with 3 elements, 2 helmet-shaped and 1 stoutly spiniform, all with minute marginal barbs.

Paragnath.—As an adult (see Fig. 7f).

First maxilla (Fig. 2k).—Small lobe bearing 5 setae.

Second maxilla (Fig. 2l).—Two-segmented, its form suggesting later instars. First segment expanded with outer patch of small spines. Second segment clawlike, 30  $\mu\text{m}$  long, with 1 inner seta.

Maxilliped (Fig. 2m).—Delicately sclerotized and weakly 4-segmented, length 40  $\mu\text{m}$ . Relative positions of maxillipeds and head appendages as in Figure 3a.

Leg 1 (Fig. 3b).—Both rami 2-segmented. Armature: coxa 0-0; basis 1-I; exopod I-0; III,5; endopod 0-1; I,5.

Leg 2 (Fig. 3c).—Both rami 2-segmented. Armature: coxa 0-0; basis 1-0; exopod I-0; III,4; endopod 0-1; III,3.

Leg 3 (Fig. 3d).—Both rami 1-segmented. Armature: coxa 0-0; basis 1-0; exopod III,4; endopod III,3.

Leg 4 (Fig. 3e).—Consisting of 2 setae, 52 and 39  $\mu\text{m}$ .

Legs 5 and 6.—Absent.

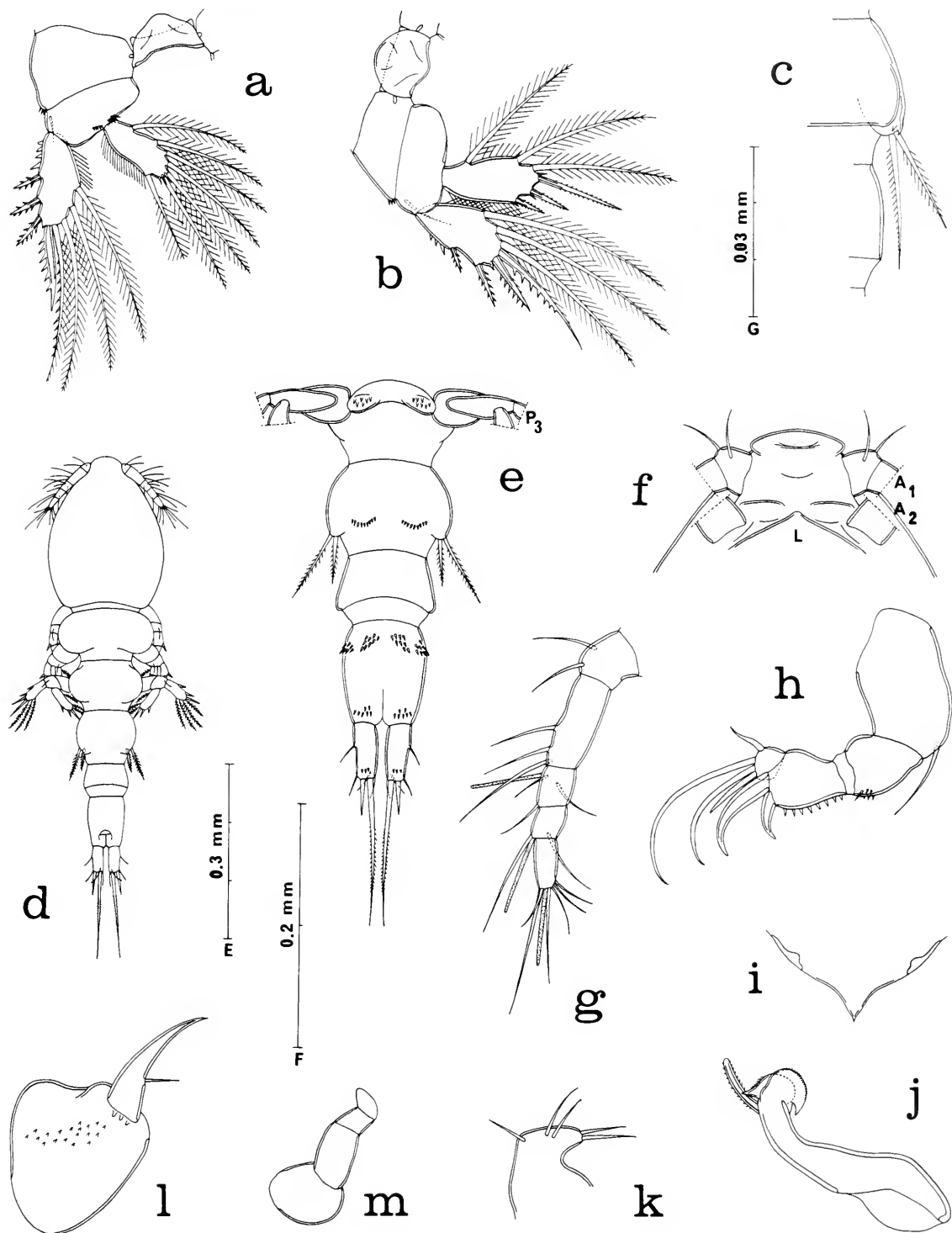

FIGURE 2.—Copepodid I of *Leptinogaster major*, a-c: a, leg 1 and intercoxal plate, anterior (scale B); b, leg 2 and intercoxal plate, anterior (B); c, leg 3, dorsal (B). Copepodid II of *Leptinogaster major*, d-m: d, dorsal (E); e, body posterior to leg 4, ventral (F); f, rostral area, ventral (B); g, first antenna, dorsal (D); h, second antenna, anteromesial (C); i, labrum, ventral (D); j, mandible, ventral (G); k, first maxilla, anterior (C); l, second maxilla, posteroventral (C); m, maxilliped (C).

### Copepodid III

Figures 3f-k, 4a-d

Size.—Length 0.85 mm (0.72-0.95 mm) and greatest width 0.24 mm (0.21-0.26 mm), based on 37 specimens.

Body form (Fig. 3f).—Spinules on ventral surface of segment of leg 5 (Fig. 3g) continuous across segment. Seven body segments including and posterior to segment bearing leg 1. (One specimen,  $0.62 \times 0.24$  mm, with segments behind leg 4 telescoped as in Figure 3h.)

First antenna (Fig. 3i).—Five-segmented, 145  $\mu$ m long. Armature: 3, 10, 3 + 1 aesthete, 2 + 1 aesthete, and 7 + 1 aesthete.

Second antenna (Fig. 3j).—Similar to Copepodid II but outermost seta on fourth segment longer and recurved.

Maxilliped.—As in Copepodid II.

Leg 1 (Fig. 3k).—Both rami 2-segmented. Armature: coxa 0-0, basis 1-I; exopod I-0; III, 5; endopod 0-1; I,6.

Leg 2 (Fig. 4a).—Both rami 2-segmented. Armature: coxa 0-0; basis 1-0; exopod I-0; III,6; endopod 0-1; III,4.

Leg 3 (Fig. 4b).—Both rami 2-segmented. Armature: coxa 0-0, basis 1-0; exopod 0-1; II,5; endopod 0-1; III,3.

Leg 4 (Fig. 4c).—Both rami 1-segmented. Armature: coxa 0-0; basis 1-0; exopod II,4; endopod III,3. (Distal outer seta on exopod somewhat spiniform.)

Leg 5 (Fig. 4d).—Represented by 2 setae, 42 and 29  $\mu$ m.

Leg 6.—Absent.

### Copepodid IV, female

Figures 4e-k, 5a-c

Size.—Length 1.19 mm (0.93-1.33 mm) and greatest width 0.32 mm (0.28-0.35 mm), based on 42 specimens.

Body form (Fig. 4e).—Eight body segments including and posterior to segment bearing leg 1. Spinules on ventral surface of segment bearing leg 5 and on anal segment (Fig. 4f) as in Copepodid III.

First antenna (Fig. 4g).—Five-segmented, 179  $\mu$ m long, but slight notch on posterior edge of second segment suggesting division of segment. Armature: 4, 15, 4 + 1 aesthete, 2 + 1 aesthete, and 7 + 1 aesthete.

Maxilliped (Fig. 4h).—Two-segmented, weakly sclerotized, distal segment lobelike. Relative position of maxillipeds as in Figure 4i.

Leg 1.—Both rami 2-segmented. Armature (as in Copepodid III): coxa 0-0; basis 1-0; exopod I-0; III,5; endopod 0-1; I,6.

Leg 2 (Fig. 4j).—Both rami 2-segmented. Armature: coxa 0-0; basis 1-0; exopod I-0; III,6; endopod 0-1; II,6. Distalmost outer seta on endopod somewhat spiniform.

Leg 3 (Fig. 4k).—Both rami 2-segmented. Armature: coxa 0-0; basis 1-0; exopod I-0; III,6; endopod 0-1; II,5. Distalmost outer seta on endopod somewhat spiniform.

Leg 4 (Fig. 5a).—Both rami 2-segmented. Armature: coxa 0-0; basis 1-0; exopod I-0; III,5; endopod 0-1; III,3.

Leg 5 (Fig. 5b).—Two-segmented, but first segment, armed with 1 seta, not clearly set off from body; second segment oval,  $60 \times 30 \mu$ m, bearing 3 spines and 1 seta, with few small spinules near insertion of proximalmost and distalmost spines.

Leg 6 (Fig. 5c).—Represented by 1 seta 32  $\mu$ m long, with minute spinules near insertion.

### Copepodid IV, male

Figure 5d-g

Size.—Length 1.07 mm (0.90-1.19 mm) and greatest width 0.28 mm (0.25-0.31 mm), based on 38 specimens.

Body form.—As in female, with same number of body segments and similar arrangement of ventral spinules (Fig. 5d).



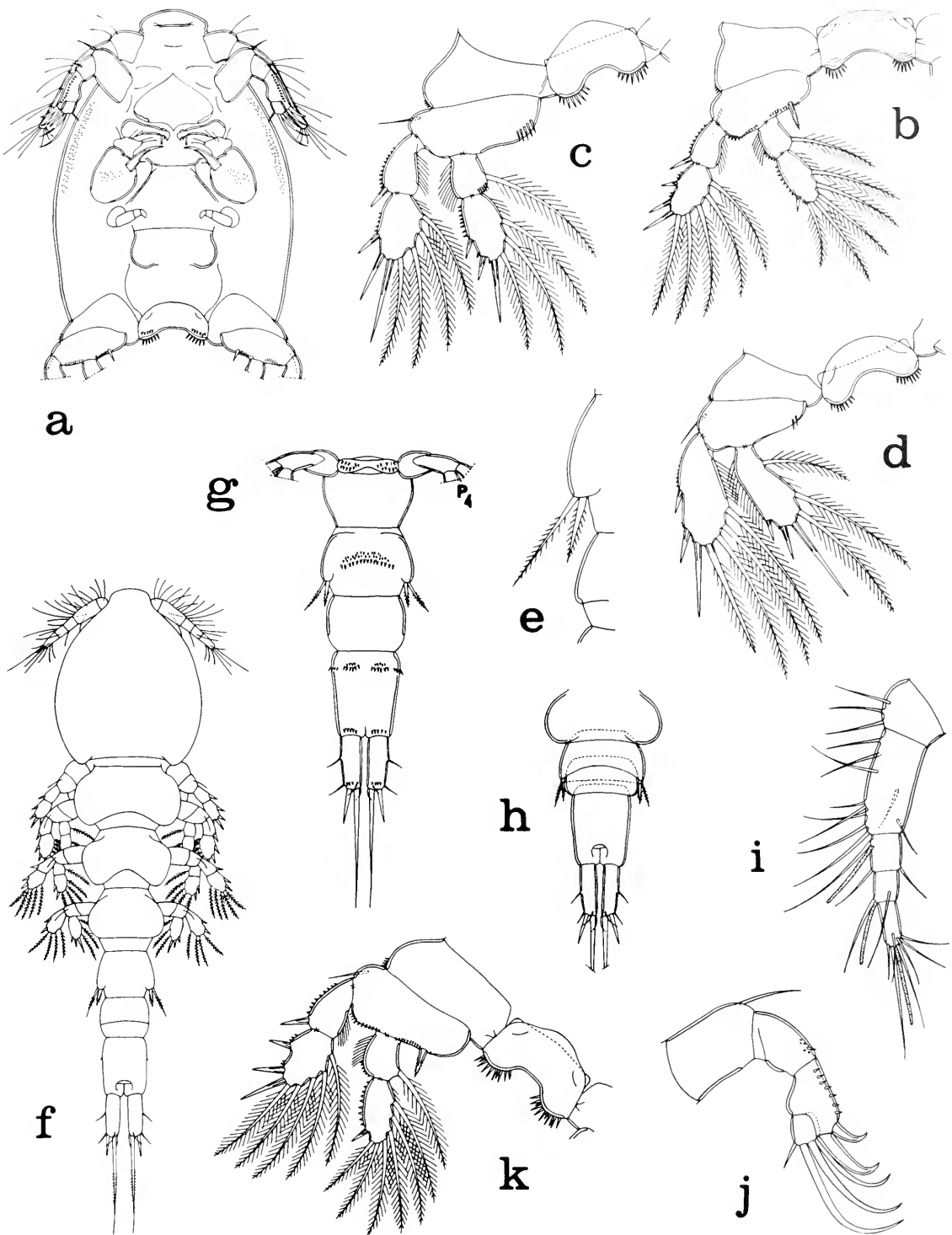

FIGURE 3.—Copepodid II of *Leptinogaster major*, a-e: a, cephalosome, ventral (scale F); b, leg 1 and intercoxal plate, anterior (B); c, leg 2 and intercoxal plate, anterior (B); d, leg 3 and intercoxal plate, anterior (B); e, leg 4, ventral (B). Copepodid III of *Leptinogaster major*, f-k: f, dorsal (E); g, body posterior to leg 4, ventral (A); h, posterior part of body showing telescoped segments, dorsal (A); i, first antenna, ventral (B); j, second antenna, anteromesial (D); k, leg 1 and intercoxal plate, anterior (B).

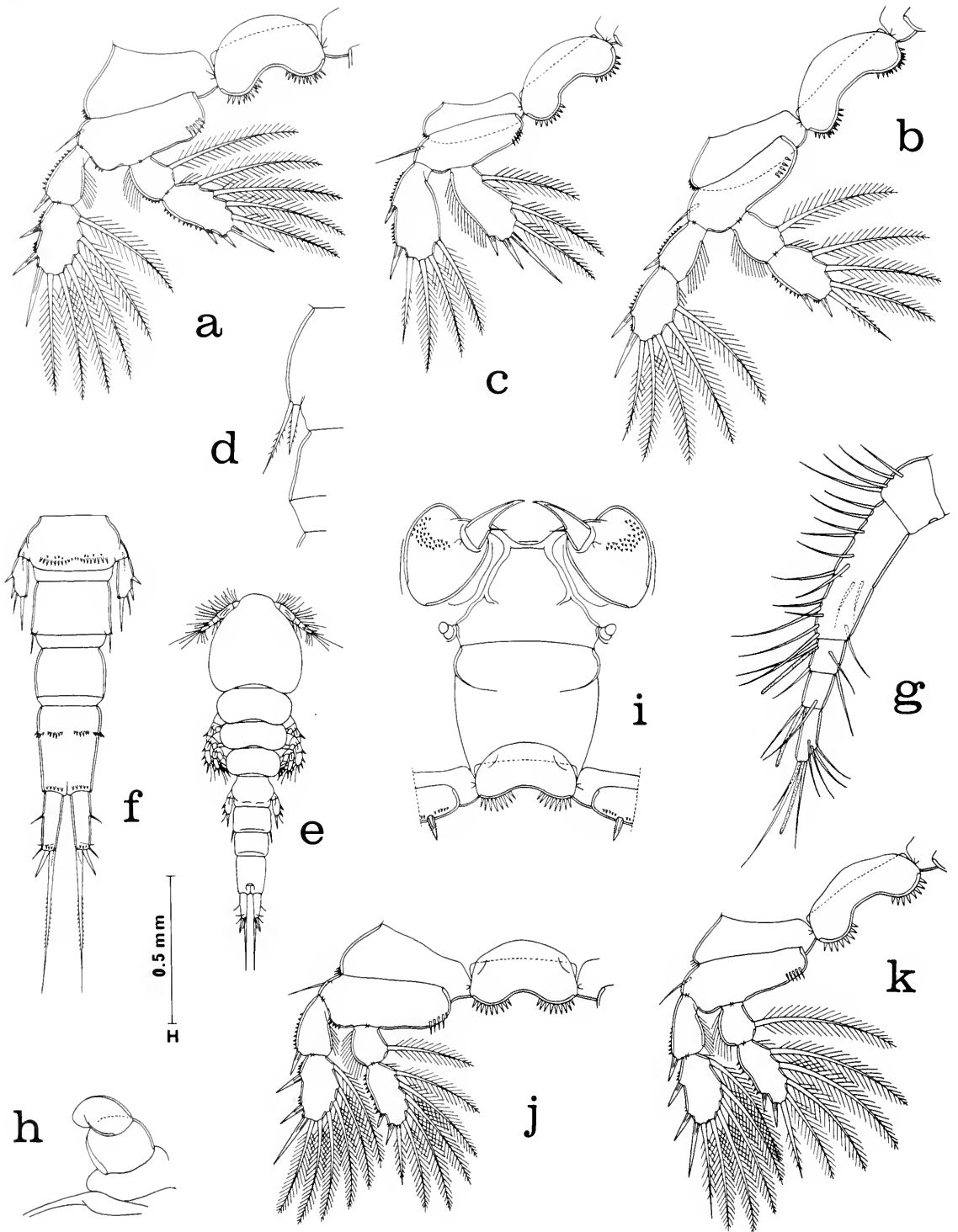

FIGURE 4.—Copepodid III of *Leptinogaster major*, a-d: a, leg 2 and intercoxal plate, anterior (scale B); b, leg 3 and intercoxal plate, anterior (B); c, leg 4 and intercoxal plate, anterior (B); d, leg 5, ventral (B). Copepodid IV of *Leptinogaster major*, female, e-k: e, dorsal (H); f, urosome, ventral (E); g, first antenna, ventral (B); h, maxilliped, ventral (C); i, ventral region from second maxillae to first pair of legs, showing maxillipeds (F); j, leg 2 and intercoxal plate, anterior (F); k, leg 3 and intercoxal plate, anterior (F).

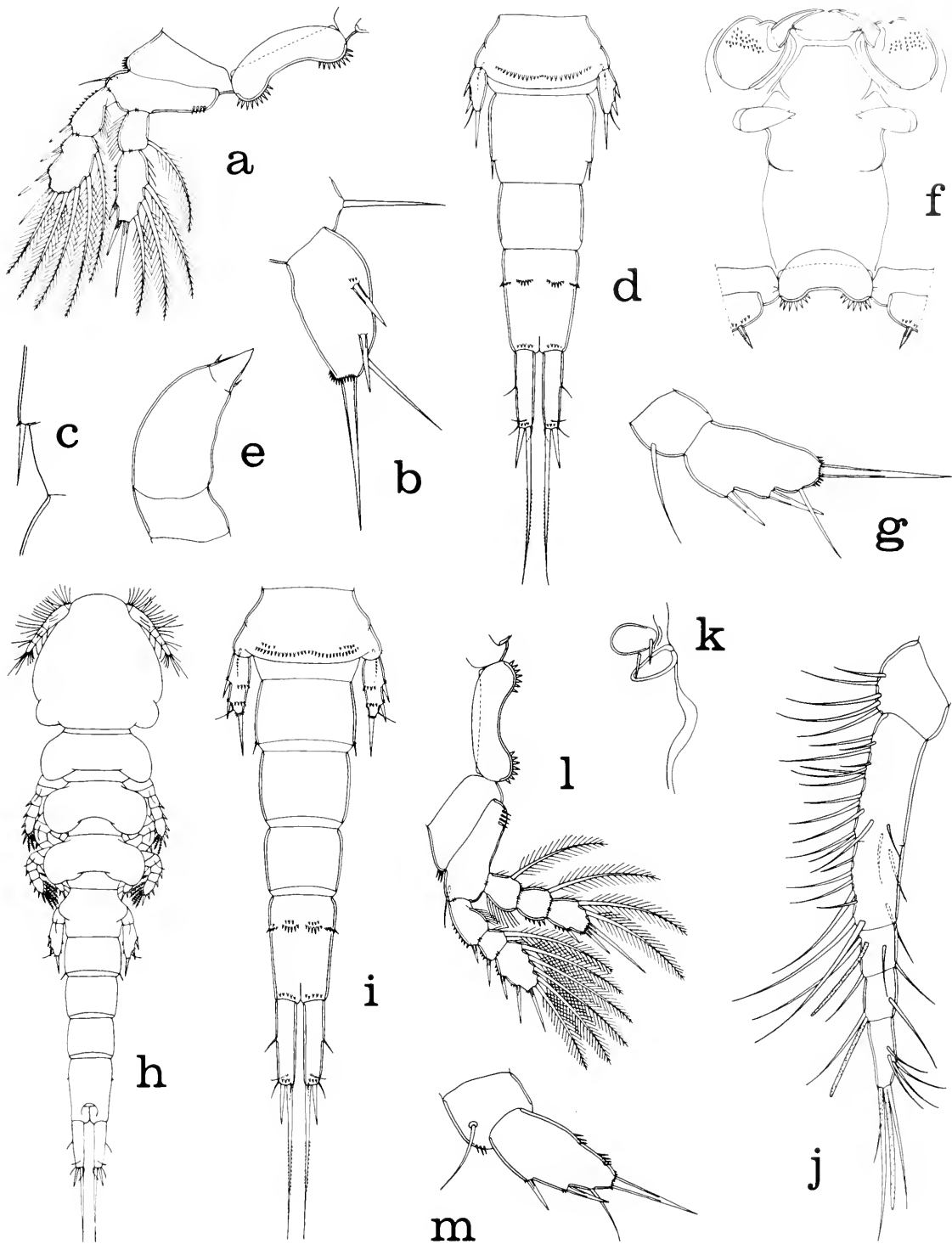

FIGURE 5.—Copepodid IV of *Leptinogaster major*, female a-c: a, leg 4 and intercoxal plate, anterior (scale F); b, leg 5, lateral (D); c, leg 6, ventral (D); male, d-g: d, urosome, ventral (A); e, maxilliped, ventral (C); f, ventral region from second maxillae to first pair of legs, showing maxillipeds (F); g, leg 5, dorsal (D). Copepodid V of *Leptinogaster major*, female, h-m: h, dorsal (H); i, urosome, ventral (E); j, first antenna, posteroventral (B); k, maxilliped, ventral (C); l, leg 4 and intercoxal plate, anterior (A); m, leg 5, dorsal (F).

Maxilliped (Fig. 5e).—Three-segmented, 50  $\mu\text{m}$  long, with small pointed third segment weakly set off from second segment and bearing 2 small setae. Relative position of maxillipeds as in Figure 5f.

Leg 5 (Fig. 5g).—Two-segmented. First segment set off from body. Second segment  $55 \times 29 \mu\text{m}$ . Armature similar to female.

Leg 6 (Fig. 5d).—Represented by single seta.

### Copepodid V, female

#### Figures 5h-m, 6a-c

Size.—Length 1.62 mm (1.42-1.87 mm) and greatest width 0.41 mm (0.37-0.44 mm), based on 13 specimens.

Body form (Fig. 5h).—Nine body segments including and posterior to segment bearing leg 1. Segment of leg 5 and more posterior segments as in Figure 5i.

Caudal ramus (Fig. 5i).—Noticeably longer than in preceding instars.

First antenna (Fig. 5j).—Incompletely 6-segmented. Armature: 5, 15 + 9, 4 + 1 aesthete, 2 + 1 aesthete, and 7 + 1 aesthete.

Maxilliped (Fig. 5k).—Reduced to slightly raised lobe with 2 small setae.

Leg 1.—Both rami 3-segmented. Armature (as in adult): coxa 0-0; basis 1-1; exopod I-0; I-1; III,5; endopod 0-1, 0-1; I,5.

Legs 2 and 3.—Both rami 3-segmented. Armature (as in adult): coxa 0-0; basis 1-0; exopod I-0; I-1; III,6; endopod 0-1; 0-2; III,3.

Leg 4 (Fig. 5l).—Both rami 3-segmented. Armature: coxa 0-0; basis 1-0; exopod I-0; I-1; III,5; endopod 0-1; 0-1; III,2. Distalmost spine on exopod more slender than other exopod spines; outer of 2 terminal spines on endopod only about one-half length of inner terminal spine.

Leg 5 (Fig. 5m).—Second segment  $99 \times 49 \mu\text{m}$ . Few outer spinules on first segment. Two groups of spinules on inner side of second segment. Principal armature as in Copepodid IV.

Leg 6 (Fig. 5i).—Represented by 1 seta with minute spinule near its insertion.

### Copepodid V, male

#### Figure 6a-c

Size.—Length 1.41 mm (1.22-1.57 mm) and greatest width 0.34 mm (0.31-0.39 mm), based on 30 specimens.

Body form.—As in female, with same number of body segments. Similar arrangement of ventral spinules on urosomal segments (Fig. 6a).

Maxilliped (Fig. 6b).—Four-segmented. First segment with 1 inner seta. Long second segment and short third segment unarmed. Pointed fourth segment with 2 setae.

Legs 1-4.—Similar to those of female. Endopod of leg 2 (Fig. 6c) not showing sexual dimorphism.

Leg 5.—As in female; second segment  $75 \times 31 \mu\text{m}$ .

Leg 6.—Represented by single seta with few very small spinules near its insertion.

### Adult Female

#### Figures 6d-m, 7a-l, 8a-e, 9a-j

Size.—Length 2.18 mm (1.92-2.45 mm) and greatest width 0.52 mm (0.47-0.56 mm), based on 10 specimens. Dorsoventral thickness at level of leg 1, 0.25 mm.

Body form (Fig. 6d, e).—Elongate and flattened dorsoventrally. Nine body segments including and posterior to segment bearing leg 1. Urosome 5-segmented (Fig. 6f). Segment bearing leg 5  $220 \times 319 \mu\text{m}$  in dorsal view, smooth on dorsal surface, but ventral surface with transverse groups of spines (Fig. 6g); dorsally this segment with posterodorsal hump (Fig. 6e, h). Genital segment  $270 \times 264 \mu\text{m}$ , wider in anterior half than in posterior half. Three post-genital segments from anterior to posterior  $143 \times 165$ ,  $143 \times 160$ , and  $200 \times 143 \mu\text{m}$ . Genital areas situated dorsolaterally, each area (Fig. 6i) bearing 2 very small setae about  $16 \mu\text{m}$  long. Ventral surfaces of genital segment and first and second post-genital segments smooth. Anal segment ventrally with few small spines at postero-outer corners, with row of 5 spines on each side distally, and with 2

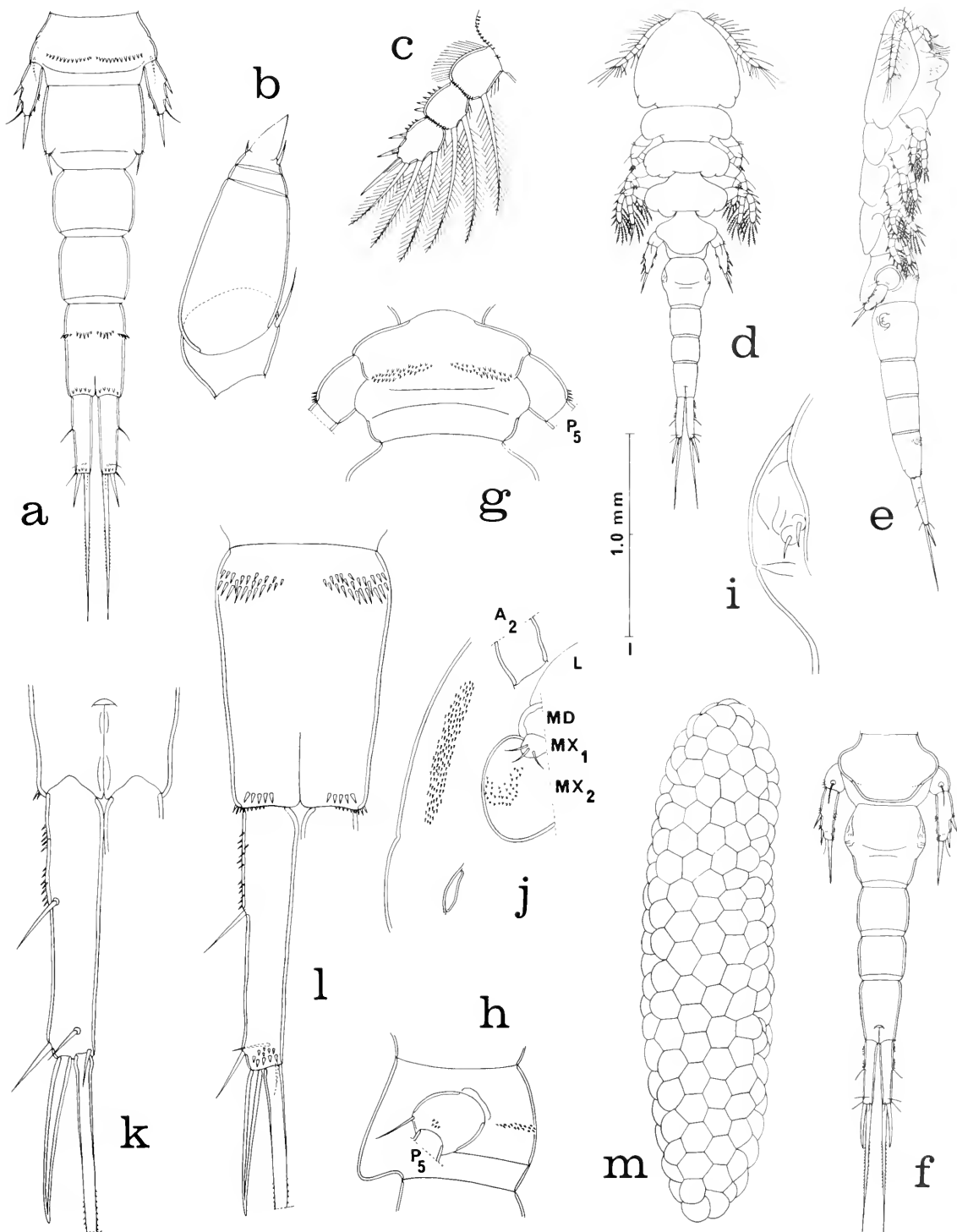

FIGURE 6.—Copepodid V of *Leptinogaster major*, male, a-c: a, urosome, ventral (scale E); b, maxilliped, ventral (D); c, endopod of leg 2, anterior (F). Adult female of *Leptinogaster major*, d-m: d, dorsal (I); e, lateral (I); f, urosome, dorsal (H); g, segment bearing fifth pair of legs, ventral (A); h, segment bearing leg 5, lateral (E); i, genital area, dorsal (B); j, patch of spinules and sclerotized area on side of cephalosome, ventral (E); k, caudal ramus, dorsal (F); l, anal segment and caudal ramus, ventral (F); m, egg sac, ventral (E).

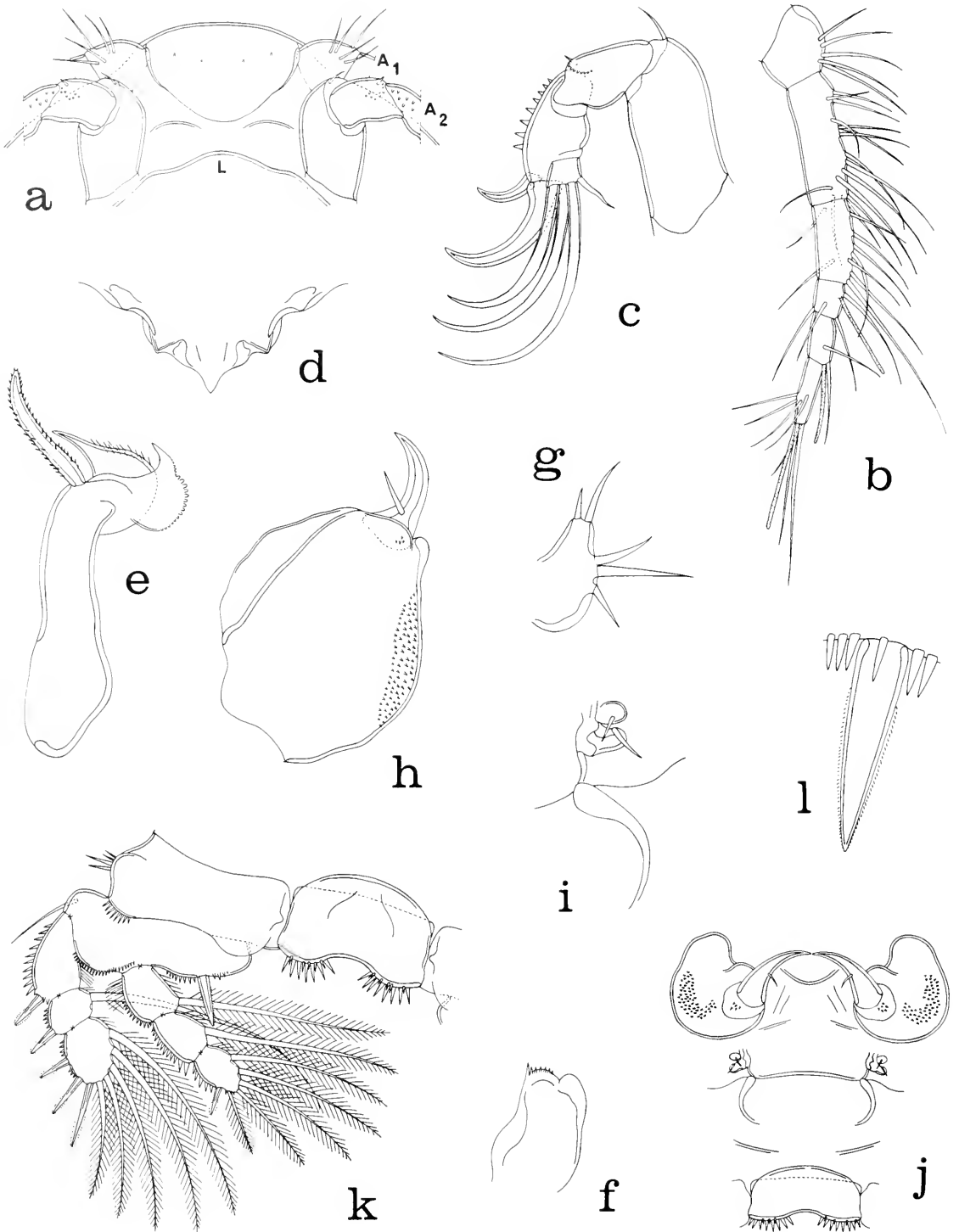

FIGURE 7.—Adult female of *Leptinogaster major*: a, rostrum, ventral (scale F); b, first antenna, posteroventral (F); c, second antenna, posteromesial (B); d, labrum, ventral (B); e, mandible, anteroventral (C); f, paragnath, ventral (D); g, first maxilla, anterior (D); h, second maxilla, posterior (B); i, maxilliped, ventral (D); j, ventral region from second maxillae to first pair of legs, showing maxillipeds (E); k, leg 1 and intercoxal plate, anterior (F); l, inner spine on basis of leg 1, anterior (G).

prominent groups of spines anteriorly. Cephalosome ventrally with elongate oblique strip of small spines between edge of body and region of mouthparts, and with small elongate oval sclerotized area lateral to level of maxillipeds (Fig. 6j).

Caudal ramus (Fig. 6k, l).—Elongate, 221  $\mu\text{m}$  long, greatest width 44  $\mu\text{m}$ , least width 35  $\mu\text{m}$ , ratio about 5.5:1. Outer lateral seta 50  $\mu\text{m}$ . Dorsal seta 26  $\mu\text{m}$ . Outermost terminal seta 52  $\mu\text{m}$ . Innermost terminal seta 26  $\mu\text{m}$ . Outer of 2 median terminal setae 130  $\mu\text{m}$  and almost spinelike. Inner of 2 median terminal seta 440  $\mu\text{m}$ , with extremely small lateral spinules. Other setae smooth. Outer margin of ramus proximal to outer lateral seta with 2 groups of spinules. Distal end of ramus ventrally with patch of small spines.

Egg sac (Fig. 6m).—Elongate, various sacs 693  $\times$  209  $\mu\text{m}$ , 781  $\times$  242  $\mu\text{m}$ , 860  $\times$  220  $\mu\text{m}$  (as in figure), and 1,023  $\times$  231  $\mu\text{m}$ , average dimensions 839  $\times$  226  $\mu\text{m}$ ; containing many small eggs with diameter 47-57  $\mu\text{m}$ .

Rostrum (Fig. 7a).—Broad with weakly sclerotized rounded posteroventral margin.

First antenna (Fig. 7b).—Six-segmented, 320  $\mu\text{m}$  long. Lengths of segments (measured along their posterior nonsetiferous margins): 29 (49  $\mu\text{m}$  along anterior margin), 88, 55, 26, 36, and 52  $\mu\text{m}$ , respectively. Armature: 5, 15, 9, 4 + 1 aesthete, 2 + 1 aesthete, and 7 + 1 aesthete. All setae smooth.

Second antenna (Fig. 7c).—Four-segmented. First segment with distal seta. Second segment with distal seta and crescentic row of small spines. Third segment with outer marginal row of spines and 2 large recurved clawlike spines, 34 and 70  $\mu\text{m}$ . Small fourth segment 13  $\times$  21  $\mu\text{m}$ , bearing 3 long recurved almost clawlike setae and 1 smaller inner seta.

Labrum (Fig. 7d).—Posteroventral edge sharply pointed medially. No surface ornamentation.

Mandible (Fig. 7e).—Elongate with distal end bearing 2 helmet-shaped elements and 1 stout pectinate spine.

Paragnath (Fig. 7f).—Small lobe with few distal spinules.

First maxilla (Fig. 7g).—Small lobe bearing 5 setae.

Second maxilla (Fig. 7h).—Two-segmented. Large first segment with patch of outer spinules (Fig. 7j). Second segment clawlike and bearing 1 seta.

Maxilliped (Fig. 7i).—Reduced to 2 small setae, located as in Figure 7j.

Legs 1-4 (Figs. 7k, 8a, b, c).—Intercoxal plates with 2 groups of spines on distal (ventral) margin. Exopods and endopods 3-segmented. Armature as follows (Roman numerals indicating spines, Arabic numerals representing setae):

P <sub>1</sub>	coxa	0-0	basis	1-I	exp	I-0;	I-1;	III,5
					enp	0-1;	0-1;	I,5
P <sub>2</sub>	coxa	0-0	basis	1-0	exp	I-0;	I-1;	III,6
					enp	0-1;	0-2;	III,3
P <sub>3</sub>	coxa	0-0	basis	1-0	exp	I-0;	I-1;	III,6
					enp	0-1;	0-2;	III,3
P <sub>4</sub>	coxa	0-0	basis	1-0	exp	I-0;	I-1;	III,5
					enp	0-1;	0-1;	III,2

Leg 1 (Fig. 7k).—Coxa with 2 groups of outer spines. Basis with row of small spines between bases of rami and another row near large inner spine. This inner spine delicately barbed (Fig. 7l) and 33  $\mu\text{m}$  long; smaller spines near its base 7.5  $\mu\text{m}$ . First segment of endopod with outer margin having hairlike setules along proximal half but small spines along distal half.

Leg 2 (Fig. 8a).—Basis without inner spine. First segment of endopod with hairlike setules along outer margin.

Leg 3 (Fig. 8b).—Fine ornamentation resembling that of leg 2.

Leg 4 (Fig. 8c).—Coxa with only 1 group of outer spines.

Leg 5 (Fig. 8d).—Two-segmented. First segment 130  $\times$  125  $\mu\text{m}$ , with distal outer seta and group of spines. Second segment elongate, 161  $\times$  68  $\mu\text{m}$ , with 2 outer smooth spines, 52 and 55  $\mu\text{m}$ , distal smooth seta 70  $\mu\text{m}$ , and terminal finely barbed spine 147  $\mu\text{m}$ . These 3 spines with small spines near their insertions. Two groups of small spines on inner side of segment.

Leg 6 (Fig. 6i).—Probably represented by 2 setae on genital area.

Color.—Living specimens in transmitted light with opaque gray body, eye red.

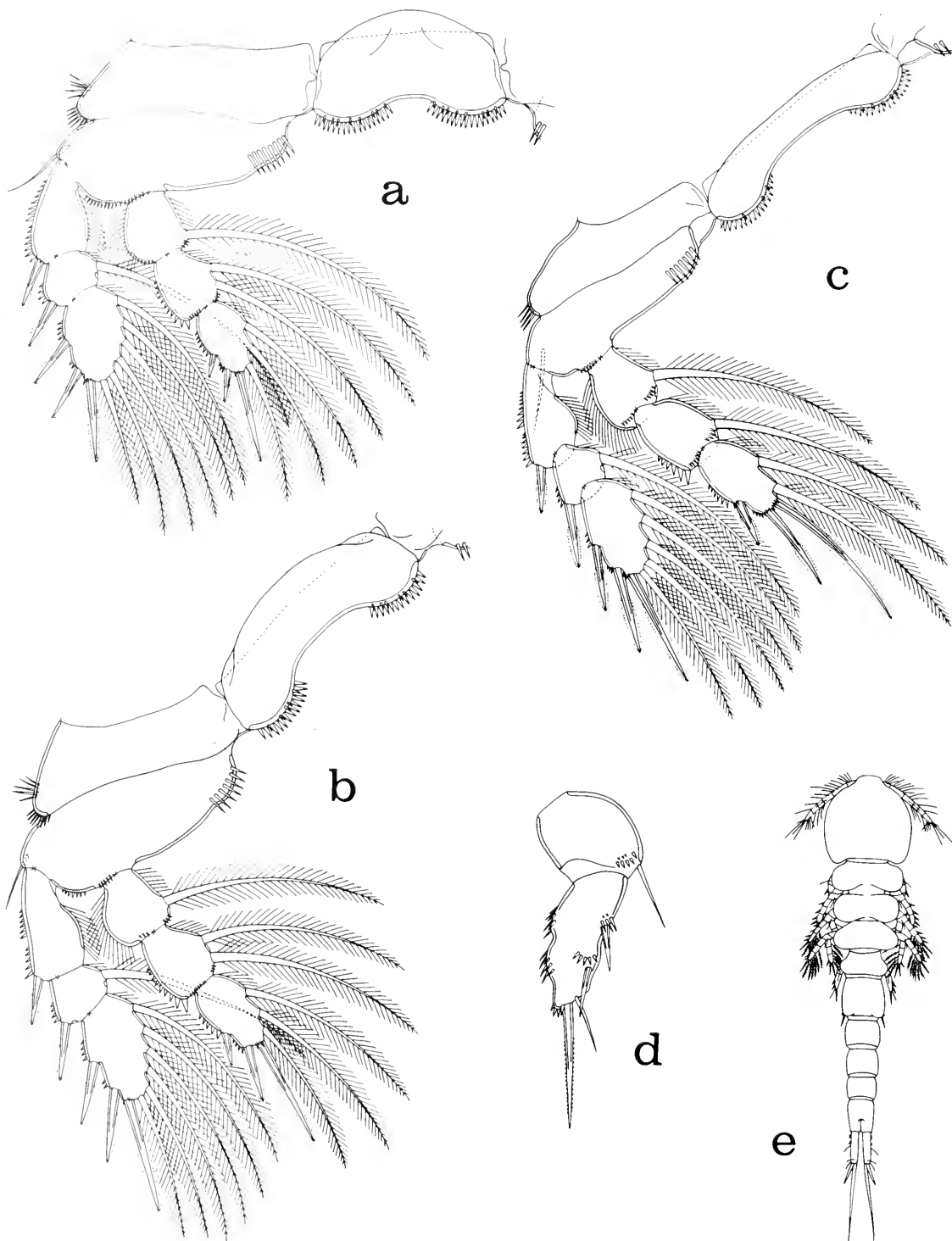

FIGURE 8.—Adult female of *Leptinogaster major*, a-d: a, leg 2 and intercoxal plate, anterior (scale F); b, leg 3 and intercoxal plate, anterior (F); c, leg 4 and intercoxal plate, anterior (F); d, leg 5, lateral (A). Adult male of *Leptinogaster major*: e, dorsal (I).



## Adult Male

### Figures 8e, 9a-j

Size.—Length 1.82 mm (1.70-2.04 mm) and greatest width 0.43 mm (0.40-0.47 mm), based on 10 specimens.

Body form (Fig. 8e).—Similar to female but 10 body segments including and posterior to segment of leg 1. Urosome (Fig. 9a) 6-segmented. Segment of leg 5  $135 \times 236 \mu\text{m}$  in dorsal view, with spines on ventral surface as in female. Four postgenital segments from anterior to posterior  $140 \times 166$ ,  $135 \times 143$ ,  $113 \times 128$ , and  $151 \times 109 \mu\text{m}$ . Anal segment with spines as in female. Cephalosome ventrally with outer strip of small spines and small sclerotized area as in female.

Caudal ramus (Fig. 9a).—As in female but dimensions  $174 \times 38 \mu\text{m}$ , ratio 4.6:1.

Rostrum, first antenna, second antenna, labrum, mandible, paragnath, first maxilla, and second maxilla as in female.

Maxilliped (Fig. 9b).—Four-segmented. First segment with 1 inner smooth seta  $50 \mu\text{m}$ . Elongate second segment with 2 inner setae and 2 groups of short spines. Small third segment unarmed. Claw  $208 \mu\text{m}$ , proximal part representing fourth segment bearing 3 setae. Concave margin of claw striated.

Legs 1-4.—With segmentation and armature as in female, and ornamentation as in that sex except for endopod of leg 2.

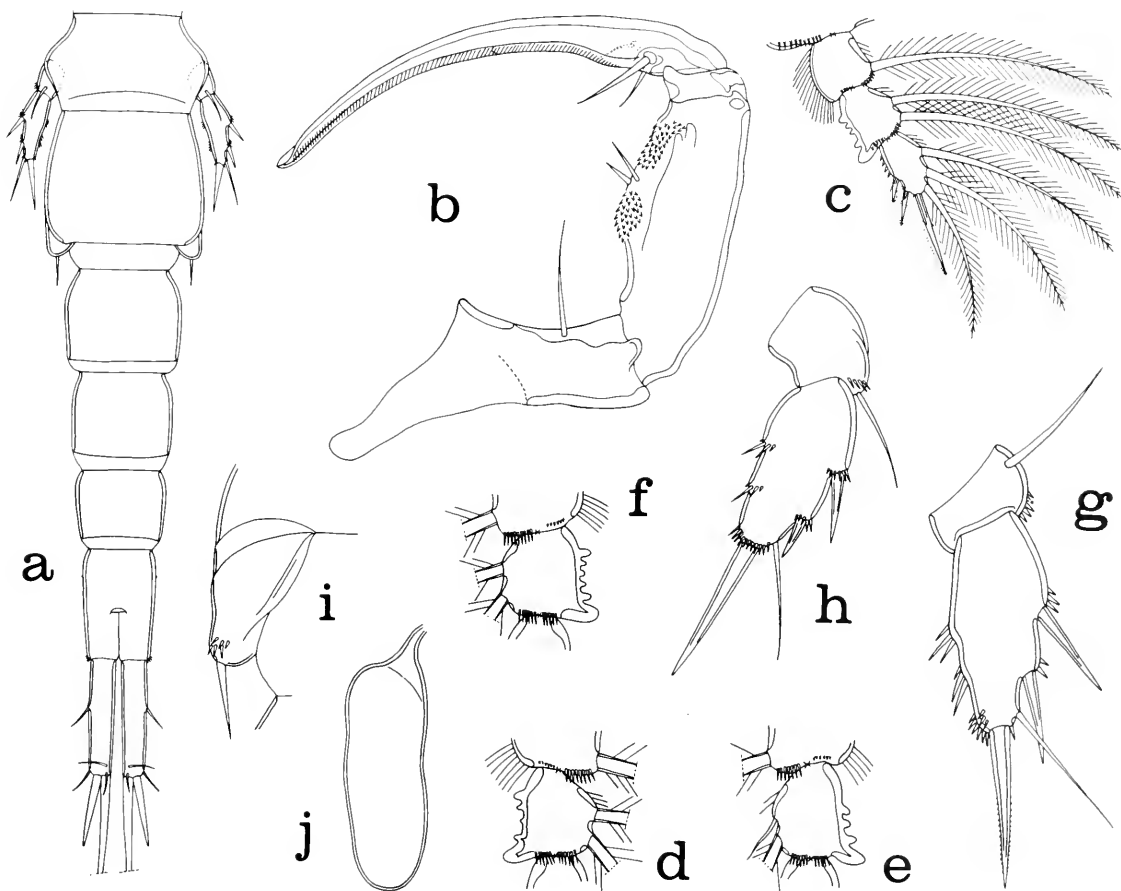

FIGURE 9.—Adult male of *Leptinogaster major*: a, urosome, dorsal (scale H); b, maxilliped, posterior (B); c, endopod of leg 2, anterior (F); d, second segment of endopod of right leg, anterior (B); e, second segment of endopod of left leg (same individual as in d), anterior (B); f, second segment of endopod of leg 2, anterior (B); g, leg 5, dorsal (B); h, leg 5, ventrolateral (B); i, leg 6, ventral (F); j, spermatophore, attached to female, ventral (A).

Leg 2 (Fig. 9c).—Endopod showing sexual dimorphism in having variable nodose outer margin on second segment (Fig. 9d, e, f). Number of nodes from 4-6, and not always same in 1 individual, as in Fig. 9d, e.

Leg 5 (Fig. 9g, h).—Resembling that of female. Second segment in 2 individuals  $101 \times 47 \mu\text{m}$  (Fig. 9g) with 4 major elements from proximal to distal 45, 42, 80, and  $78 \mu\text{m}$ , and  $86 \times 42 \mu\text{m}$  (Fig. 9h) with elements 22, 26, 65, and  $73 \mu\text{m}$ .

Leg 6 (Fig. 9i).—Represented by single smooth seta  $49 \mu\text{m}$  and adjacent group of small spines on corner of genital area.

Spermatophore (Fig. 9j).—Elongate, approximately  $220 \times 78 \mu\text{m}$  without neck.

Color.—As in female.

## DISCUSSION

This study permits certain observations to be made concerning the postnaupliar development of *Leptinogaster major*. A summary of these is given in Table 3.

1) All five copepodid stages are present in the mantle cavity of *Mya arenaria*.

2) The presence of Copepodid I in *Mya* suggests that either the last nauplius molts outside the clam and then enters, or that this nauplius enters the clam and then molts.

3) Copepodid I is *Saphirella*-like in body form; Copepodid II and later copepodids have a body form more like the adult.

4) The number of body segments increases from 5 in Copepodid I to 9 in the adult female and 10 in the adult male.

5) The armature of the caudal ramus remains unchanged from Copepodid I onward, but the caudal ramus lengthens in successive copepodid stages and in the adults.

6) The first antenna is slow in reaching final form, being 5-segmented in Copepodid I and not reaching its fully 6-segmented condition until the adult.

7) The second antenna has an indistinct fourth segment in Copepodid I, but is clearly 4-segmented thereafter.

8) The labrum of Copepodid I is broad and ornamented with spines, but in Copepodid II and subsequently it is pointed and smooth.

9) The mandible of Copepodid I is a simple

blade, but in Copepodid II and succeeding stages there are 3 terminal elements as in the adult.

10) The first maxilla of Copepodid I is similar to that of Copepodid II and following stages.

11) The second maxilla has terminal setae in Copepodid I but a terminal claw thereafter.

12) The maxilliped in Copepodid I is elongate and 4-segmented with long setae, but in Copepodid II and Copepodid III it is small with 4 weak unarmed segments. From this point on, the maxilliped in the female shows further reduction, while in the male it undergoes enlargement and specialization. In the female of Copepodid IV it is minute, 2-segmented, and unarmed; in Copepodid V and in the adult it is reduced to 2 small setae. In the male of Copepodid IV the maxilliped is 3-segmented, pointed, with 2 setae; in Copepodid V it is 4-segmented, pointed, with 3 setae; in the adult male it is 4-segmented with a long terminal claw.

13) The full complement of 4 biramous 3-segmented legs is not reached until Copepodid V.

14) The inner spine on the basis of the endopod of leg 1 first appears in Copepodid II.

15) Leg 5 is absent in Copepodid I and Copepodid II, is represented by 2 setae in Copepodid III, and abruptly becomes 2-segmented with full armature in Copepodid IV.

16) Sexual dimorphism in legs 1-4 occurs only in the endopod of leg 2 in the adult male.

17) Sexual differentiation during copepodid development first occurs in Copepodid IV, where the male and female maxillipeds are differently formed.

The maxilliped in the adult female is said to be absent in *Leptinogaster histrio* (Bocquet and Stock 1958; Băcescu and Por 1959), in the genus *Myocheres* (Wilson 1950), in *Leptinogaster inflata* (Allen 1956), in *Leptinogaster scobina* (Humes and Cressey 1958), and in *Leptinogaster dentata* (Humes and Cressey 1958). The maxilliped has now been traced throughout copepodid development, and it is apparent that a remnant of this appendage exists in the adult female of *L. major*.

This discovery prompted a reexamination of adult females of two species of *Leptinogaster*, *L. scobina* and *L. dentata*. In both the maxilliped is represented by two very small setae, as in *L. major*. It is not surprising that these setae were overlooked, since they are very minute and readily seen only in well-cleared specimens.

Although the remaining species of *Leptinogaster*, *L. histrio* (Pelseneer, 1929), *L. pholadis* (Pelseneer, 1929), *L. inflata* (Allen, 1956), and a new species con-

TABLE 3.—Comparison of selected external features during copepodid stages and adults of *Leptinogaster major*.

	Copepodid I	Copepodid II	Copepodid III	Copepodid IV ♀	Copepodid IV ♂	Copepodid V ♀	Copepodid V ♂	Adult ♀	Adult ♂
No. of body segments	5	6	7	8	8	9	9	9	10
First antenna	5-segmented	5-segmented	5-segmented	5-segmented	5-segmented	incompletely 6-segmented	incompletely 6-segmented	6-segmented	6-segmented
Second antenna	indistinctly 4-segmented	4-segmented	4-segmented	4-segmented	4-segmented	4-segmented	4-segmented	4-segmented	4-segmented
Labrum	broad, spined	pointed, smooth	pointed, smooth	pointed, smooth	pointed, smooth	pointed, smooth	pointed, smooth	pointed, smooth	pointed, smooth
Mandible	simple blade	3 terminal elements	3 terminal elements	3 terminal elements	3 terminal elements	3 terminal elements	3 terminal elements	3 terminal elements	3 terminal elements
Second maxilla	terminal setae	terminal claw	terminal claw	terminal claw	terminal claw	terminal claw	terminal claw	terminal claw	terminal claw
Maxilliped	slender, 4-segmented, long setae	small, 4 weak unarmd segments	small, 4 weak unarmd segments	minute, 2 weak unarmd segments	3-segmented, pointed, 2 setae	2 setae on slight lobe	4-segmented, pointed, 3 setae	2 setae	4-segmented, long terminal claw
Rami of leg 1	1-segmented	2-segmented	2-segmented	2-segmented	2-segmented	3-segmented	3-segmented	3-segmented	3-segmented
Rami of leg 2	1-segmented	2-segmented	2-segmented	2-segmented	2-segmented	3-segmented	3-segmented	3-segmented	3-segmented, sexual dimorphism in endopod
Rami of leg 3	2 setae only	1-segmented	2-segmented	2-segmented	2-segmented	3-segmented	3-segmented	3-segmented	3-segmented
Rami of leg 4	absent	2 setae	1-segmented	2-segmented	2-segmented	2-segmented	3-segmented	3-segmented	3-segmented
Leg 5	absent	absent	2 setae	2-segmented	2-segmented	2-segmented	2-segmented	2-segmented	2-segmented
Leg 6	absent	absent	absent	1 seta	1 seta	1 seta	1 seta	2 setae on genital area	1 seta

tained in Gooding's thesis (1963) have not been re-examined, it appears likely that the presence of a very reduced maxilliped in the adult female is a generic character in *Leptinogaster*.

Gooding (1963:218-220) discussed the generic status of *Saphirella* T. Scott, 1894, pointing out that species of *Saphirella* may represent Copepodid I stages of clausidiids. In his thorough description of Copepodid I of *Leptinogaster* a significant difference seems to be in the body length, which Gooding gave as 0.45 mm, while in this study the length is 0.57 mm (0.45-0.60 mm).

Although the genus *Leptinogaster* has been assigned to various families (Table 1), its presently agreed location appears to be in the Clausidiidae Embleton, 1901, along with *Clausidium* Kossmann, 1874, *Conchyltiurus* Bocquet and Stock, 1957a, *Giardella* Canu, 1888, *Hemicyclops* Boeck, 1873, *Hersiliodes* Canu, 1888, and *Hippomolgus* G.O. Sars, 1917. [According to the phylogenetic analysis of Ho (1984), the genus *Myzomolgus* Bocquet and Stock, 1957b, should be removed from the Clausidiidae and placed close to the Catiniidae Bocquet and Stock, 1957b.] The family Clausidiidae, containing seven genera of certain status, shows several features: first antenna 6- or 7-segmented; second antenna 4-segmented with third segment having in some cases prehensile elements and fourth segment without a strong claw; mandible with spine (or spinelike process) and 2 or 3 accessory elements (setae, spines); labrum with rounded margin, mostly entire without median indentation, except triangular in *Leptinogaster*; first maxilla often with 2 lobes, but with 1 lobe having 2 groups of setae in *Leptinogaster* and 1 lobe with a few setae in *Clausidium*; maxilliped in female mostly 2-, 3-, or 4-segmented, but in *Leptinogaster* reduced to 2 setae; maxilliped in male 2- or 3-segmented plus claw (in *Hippomolgus* male unknown); legs 1-4 biramous and 3-segmented (endopod of leg 1 bearing suckers in *Clausidium*); leg 5 2-segmented (though in some first segment not clearly separated from body).

*Leptinogaster* falls within this concept of the family Clausidiidae. Neighboring families have fundamentally different features, e.g., the Clausiidae (first antenna 3-6 segmented; legs 1-4 showing various degrees of reduction (as characterized by Wilson and Illg (1955)), the Mycolidae (3-segmented second antenna with strong terminal claw, maxilliped in female a small unarmed lobe), and the Ergasilidae (second antenna with a strong terminal claw, maxilliped often absent in female, legs 1-4 with some reduction). More information on the developmental stages of the members of these families

would contribute greatly to understanding their interrelationships.

## ACKNOWLEDGMENTS

I thank Roger F. Cressey who aided in the collection of the copepods from *Mya* at Cotuit in 1957 and who provided M. S. Wilson's notes and correspondence concerning *Leptinogaster* (= *Myochoeres*) *major* which are in the custody of the National Museum of Natural History, Smithsonian Institution. I thank also Geoffrey A. Boxshall, British Museum (Natural History), and Paul L. Illg, University of Washington, for helpful suggestions.

## LITERATURE CITED

- ALLEN, J. A.  
1956. *Myochoeres inflata* a new species of parasitic copepod from the Bahamas. J. Parasitol. 42:60-67.
- BĂCESCU, M., AND F. POR.  
1959. Cyclopoide comensale (Clausidiide si Clausiide) din Marea Neagră și descrierea unui gen nou, *Pontoclausia* gen. nov. In Omagiu lui Traian Săvălescu cu prilejul împlinirii a 70 e ani, p. 11-30. Acad. Rep. Pop. Rom.
- BOCQUET, C., AND J. H. STOCK.  
1957a. Copépodes parasites d'invertébrés des côtes de France I. Sur deux genres de la famille des Clausidiidae, commensaux de mollusques: *Hersiliodes* Canu et *Conchyltiurus* nov. gen. Proc. K. Ned. Akad. Wet., Ser. C Biol. Med. Sci. 60: 212-222.  
1957b. Copépodes parasites d'invertébrés des côtes de France. IVa. Le double parasitisme de *Sipunculus nudus* L. par *Myzomolgus stupendus* nov. gen., nov. sp., et *Catinia plana* nov. gen., nov. sp., copépodes cyclopoïdes très remarquables. Proc. K. Ned. Akad. Wet., Ser. C Biol. Med. Sci. 60:410-431.  
1958. Copépodes parasites d'invertébrés des côtes de la Manche, IV. Sur les trois genres synonymes de copépodes cyclopoïdes, *Leptinogaster* Pelseneer, *Strongylopleura* Pelseneer et *Myochoeres* Wilson (Clausidiidae). Arch. Zool. Exp. Gen. 96:71-89.
- BOECK, A.  
1873. Nye Slaegter og Arter af Saltvands-Copepoder. Forh. Vidensk.-Selsk. Christiania (1872), p. 35-60.
- CANU, E.  
1888. Les copépodes marins du Boulonnais. III. Les Hersiliidae, famille nouvelle de copépodes commensaux. Bull. Sci. Fr. Belg. 19:402-432.
- CAUSEY, D.  
1953. Parasitic Copepoda from Grand Isle, Louisiana. Occas. Pap. Mar. Lab., La. State Univ. No. 7, 18 p.
- DEEVEY, G. B.  
1948. The zooplankton of Tisbury Great Pond. Bull. Bingham Oceanogr. Collect., Yale Univ. 12:1-44.  
1960. The zooplankton of the surface waters of the Delaware Bay region. Bull. Bingham Oceanogr. Collect., Yale Univ. 17:5-53.
- EMBLETON, A. L.  
1901. *Goidelia japonica* - a new entozoic copepod from Japan, associated with an infusorian (*Trichodina*). Trans. Linn. Soc. Lond. 2d Ser., Zool. 28:211-228.

- GOODING, R. U.  
1963. External morphology and classification of marine poecilostome copepods belonging to the families Clausidiidae, Clausiidae, Nereicolidae, Eunicicolidae, Synaptiphilidae, Catinidae, Anomopsyllidae, and Echiurophilidae. Ph.D. Thesis, Univ. Washington, Seattle, 247 p.
- HO, J.-S.  
1984. New family of poecilostomatoid copepods (Spiophanicolidae) parasitic on polychaetes from southern California, with a phylogenetic analysis of nereicoliform families. *J. Crustacean Biol.* 4:134-146.
- HUMES, A. G., AND R. F. CRESSEY.  
1958. Copepod parasites of mollusks in West Africa. *Bull. Inst. Fr. Afr. Noire* 20(A):921-942.  
1960. Seasonal population changes and host relationships of *Myocheeres major* (Williams), a cyclopoid copepod from pelecypods. *Crustaceana* 1:307-325.
- HUMES, A. G., AND R. U. GOODING.  
1964. A method for studying the external anatomy of copepods. *Crustaceana* 6:238-240.
- KOSSMANN, R.  
1874. Ueber *Clausidium testudo*, einen neuen Copepoden, nebst Bemerkungen über das System der halbparasitischen Copepoden. *Verh. Phys.-Med. Ges. Würzburg, n.f.* 7:280-293.
- MONOD, T., AND R.-PH. DOLLFUS.  
1934. Des copépodes parasites de mollusques (deuxième supplément). *Ann. Parasitol. Hum. Comp.* 12:309-321.
- PEARSE, A. S.  
1947. Parasitic copepods from Beaufort, North Carolina. *J. Elisha Mitchell Sci. Soc.* 63:1-16.
- PELSENEER, P.  
1929. Copépodes parasites de mollusques. *Ann. Soc. R. Zool. Belg.* (1928) 59:33-49.
- SARS, G. O.  
1917. An account of the Crustacea of Norway with short descriptions and figures of all the species. *In* Vol. VI Copepoda Cyclopoida Parts XI and XII Clausidiidae, Lichomolgidae (part), p. 141-172. Bergen Museum, Bergen.
- SCOTT, T.  
1894. Report on Entomostraca from the Gulf of Guinea, collected by John Rattray, B.Sc. *Trans. Linn. Soc. Lond.* 2d Ser., Zool. 6:1-161.
- SEWELL, R. B. S.  
1949. The littoral and semi-parasitic Cyclopoida, the Monstriloida and Notodelphyoida. *Sci. Rep. John Murray Exped.* 9(2):17-199.
- SHARPE, R. W.  
1910. Notes on the marine Copepoda and Cladocera of Woods Hole and adjacent regions, including a synopsis of the genera of the Harpacticoida. *Proc. U.S. Nat. Mus.* 38:405-436.
- WILLIAMS, L. W.  
1907. A list of the Rhode Island Copepoda, Phyllozoa, and Ostracoda, with new species of Copepoda. *In* Thirty-seventh Annual Report of the Commissioners of Inland Fisheries of Rhode Island, p. 69-79. Spec. Pap. 30.
- WILSON, C. B.  
1932. The copepods of the Woods Hole region Massachusetts. *U.S. Nat. Mus. Bull.* 158, 635 p.
- WILSON, M. S.  
1950. A new genus proposed for *Lichomoligus major* Williams (Copepoda, Cyclopoida). *J. Wash. Acad. Sci.* 40:298-299.
- WILSON, M. S., AND P. L. ILLIG.  
1955. The family Clausiidae (Copepoda, Cyclopoida). *Proc. Biol. Soc. Wash.* 68:129-141.



# REPRODUCTIVE BIOLOGY OF FEMALE SPOTTED DOLPHINS, *STENELLA ATTENUATA*, FROM THE EASTERN TROPICAL PACIFIC

A. C. MYRICK, JR., A. A. HOHN, J. BARLOW, AND  
P. A. SLOAN<sup>1</sup>

## ABSTRACT

Reproductive parameters were estimated from about 4,700 female spotted dolphins collected in the eastern tropical Pacific from 1973 to 1981. From this sample, specimens for which ages were estimated were divided into two subsets and were used to estimate age-specific rates for the northern offshore stock of this species. The youngest sexually mature individual was 10 years old; the oldest immature was 17 years; the youngest and oldest pregnant individuals were 10 and 35 years, respectively. There was high individual variability in the accumulation of corpora with age; the ovulation rate appears to slow abruptly after the eighth ovulation. Average age at attainment of sexual maturity (ASM) for all years ranged from 10.7 to 12.2 years ( $\bar{x}$  = 11.4 years) for two sets of age estimates; no significant temporal change in ASM was detected. Correlation between color phase and state of sexual maturity suggests that color phase may be a good indicator of maturity for this stock. The average annual pregnancy rate was about 0.33; this rate did not change significantly with age. The calving interval was 3.03 years (SE = 0.205). The lactation period was 1.66 years, but there was a significant increase noted in the percent lactating from 1973 to 1981. A low percentage of postreproductive females was found in the sample (0.4%) indicating that reproductive senescence is of little importance in reproductive rates of this stock.

Purse seine operations of the yellowfin tuna fishery in the eastern tropical Pacific Ocean (ETP) have caused high mortality of the spotted dolphin, *Stenella attenuata* (Perrin 1969a, 1970). Estimated incidental kills for the northern offshore stock of spotted dolphins were between 100,000 and 400,000 annually throughout the 1960's and early 1970's (Smith 1983). Since 1968, research efforts by the National Marine Fisheries Service (NMFS) have focused on assessing the biological consequences of the large incidental kill of this and other affected dolphins using specimens and data collected by NMFS observers aboard U.S. tuna seiners. Perrin et al. (1976) presented the first comprehensive description of spotted dolphin life history and reproduction for specimens from the ETP. The accumulation of thousands of additional specimens, the sharp decline in dolphin mortality (Smith 1983; Hammond and Tsai 1983), and the improvements made in estimating age since that study (Myrick et al. 1983) have made a new analysis necessary.

The purpose of this paper is to estimate the reproductive parameters of the female spotted dolphin, based on analyses which include more data and a better age estimating method than previous

studies. Reproductive features of the male spotted dolphin (Hohn et al. 1985) and temporal trends in reproduction in the northern offshore stock (Barlow 1985) are discussed in separate papers.

## MATERIALS AND METHODS

### Samples

The specimens were analyzed as three samples. The "overall" sample contained about 4,700 specimens that had been collected from 1973 through 1981. A second sample for which ages were estimated contained 580 specimens selected randomly from more than 3,500 specimens collected in 1973 through most of 1978 (the 1973-78 aged sample). The randomly chosen 1973-78 aged sample did not include any of the specimens studied by Perrin et al. (1976). The third sample (the 1981 aged sample) was composed of 226 specimens which had been collected in 1981 and for which ages were estimated. It included almost all specimens for which ovaries and teeth were collected in that year. The two aged samples, referred to collectively as the aged sample, are subsets of the overall sample. In several analyses the 1973-78 aged sample was divided into 1973-74 and 1975-78 subsamples in an effort to detect possible temporal changes in reproductive rates. Only the

<sup>1</sup>Southwest Fisheries Center La Jolla Laboratory, National Marine Fisheries Service, NOAA, P.O. Box 271, La Jolla, CA 92038.

northern offshore stock of spotted dolphins (as defined by Smith 1983) is treated in this analysis. The geographic boundary used to divide it from a southern stock is lat. 1°S (Henderson et al. 1980).

### Life History Data

Data and specimens were collected by biological technicians aboard tuna purse seine vessels in the ETP. Biological data used in this analysis are body length, color phase, reproductive condition (pregnant, lactating, or resting), and corpora counts for each specimen (see Perrin et al. [1976] for a description of collection and examination procedures). Although there is no certainty that all ovarian corpora persist for life in all delphinids (Perrin and Reilly 1984), corpora counts were used with age to estimate ovulation rates. Counts included corpora albicantia (CAs), corpora lutea (CLs), and in some cases corpora atretica (atretic follicles). Only specimens that had both ovaries examined were included in the ovulation rate analyses.

### Age Estimates

Ages were estimated for about 800 specimens (from 1973 to 1978 and 1981 samples) by counting growth layer groups (GLGs, Perrin and Myrick 1980) in the dentine and cementum of decalcified and hematoxylin-stained thin sections (Myrick et al. 1983). Tooth readings were made independently by two readers (A. C. Myrick and A. A. Hohn), without referring to field or laboratory data on size or reproductive condition. For the 1973-78 sample, a tooth of each specimen was read at least three times by each reader. Age estimates by each reader were significantly different (Reilly et al. 1983). To minimize the differences, the mean of the multiple age esti-

mates by each reader was calculated and the average of the two means was used as the estimate of a specimen's age. For the 1981 sample a tooth from each specimen was read once by each reader after calibration tests showed that differences in estimates between readers were acceptably small (Reilly et al. 1983). An average of these two readings was used for specimen age.

We consider the method we used to estimate ages improved over that used by Perrin et al. (1976) because

- 1) the preparation technique we used provides superior resolution of GLGs (Myrick et al. 1983);
- 2) the new method of reading utilizes GLGs in the cementum as well as in dentine and allows a more accurate estimate of maximum age for adults (Myrick et al. 1983; see also Kasuya 1976);
- 3) calibration of GLGs in tetracycline-labeled teeth of Hawaiian spinner dolphins, *Stenella longirostris* (Myrick et al. 1984), has provided a basis for interpreting dental layering within an absolute-time framework (Myrick et al. 1983; Myrick et al. 1984). Perrin et al. (1976) used the term tooth layers in lieu of known time units.

## RESULTS AND DISCUSSION

### Composition of Samples

Chi-square (contingency) tests were used to evaluate whether fractions of mature, pregnant, and lactating females in the 1973-78 aged sample were a representative subset of the overall sample for those years. For all three tests, differences were not significant ( $P > 0.05$ ).

Reproductive statistics showed some differences between years (Table 1). Chi-square tests were carried out for homogeneity between 1973-74 and

TABLE 1.—Number of sexually mature, pregnant only, lactating only, simultaneously pregnant and lactating, and "resting" female spotted dolphins, and the proportion of the sample pregnant or lactating in the aged and overall samples. The proportion pregnant and proportion lactating include the simultaneously pregnant and lactating specimens.

Years	Number					Proportion	
	Sexually mature	Pregnant only	Lactating only	Pregnant and lactating	Resting	Pregnant	Lactating
Aged							
1973-74	188	57	87	7	38	0.34	0.50
1975-78	205	48	100	13	44	0.30	0.55
1981	149	34	86	9	17	0.29	0.64
Total	542	139	273	29	99	0.31	0.56
Aged and unaged							
1973-81	2,979	780	1,480	151	568	0.31	0.55



1981 aged samples and between 1975-78 and 1981 aged samples for numbers of specimens pregnant, lactating, and resting. These tests revealed significant differences (1973-74 vs. 1981:  $\chi^2_2 = 7.46$ ,  $P = 0.024$ ; 75-78 vs. 1981:  $\chi^2_2 = 6.16$ ,  $P = 0.046$ ). These differences are the result of an increase in the relative frequency of lactating females (see section on Lactation Period). There were no differences in percent pregnant during this time (see also Barlow 1985).

## Ovulation Rate

### Individual Variability

Perrin et al. (1976) found high variability in the number of corpora (corpora atretica included) for a given age (in tooth layers). Nevertheless, by fitting a power curve to the average number of corpora as a function of average reproductive age, they determined that the average ovulation rate slowed abruptly from about "four during the first layer, [to] two during the second, and about one per layer thereafter" (Perrin et al. 1976, p. 261).

The sexually mature specimens in the combined aged samples were used in our study to plot average frequency of corpora (corpora atretica excluded) on estimated age (Fig. 1). Regressions for the 1973-74 sample and for the 1981 sample are not significantly different; when the samples are pooled, the resulting slope is 0.61 corpora/yr. A plot of number of corpora on age for all individuals ( $n = 542$ ) in

mature age classes (10 through 38 yr old) for all aged specimens (Fig. 2) showed a significant slope ( $P < 0.0001$ ) but a low correlation ( $r^2 = 0.397$ ), indicating high individual variability. For example, the sample included 12- and 13-yr-olds with 7 or 8 corpora, and 21-yr-olds with 4 or fewer corpora. A 38-yr-old had only 11 corpora (Table 2). These results support those of Sergeant (1962), Brodie (1971), Kasuya et al. (1974), and Perrin et al. (1976), that great individual variation occurs in ovulation rates among odontocetes.

TABLE 2.—Summary of age-related reproductive statistics for female spotted dolphins taken in 1973-78 and 1981.

Variable	Estimated age (years)
Range of ages with no corpora	0-17
Oldest with one corpus	23
Youngest with one corpus	10
Youngest pregnant	10
Oldest pregnant	35
Average age pregnant	18
Oldest simultaneously pregnant and lactating	29
Oldest lactating	36
Youngest lactating	10
Oldest	38

### Changes in Rate

Ovulation rate apparently decreases with reproductive age. If ovulation and mortality rates were

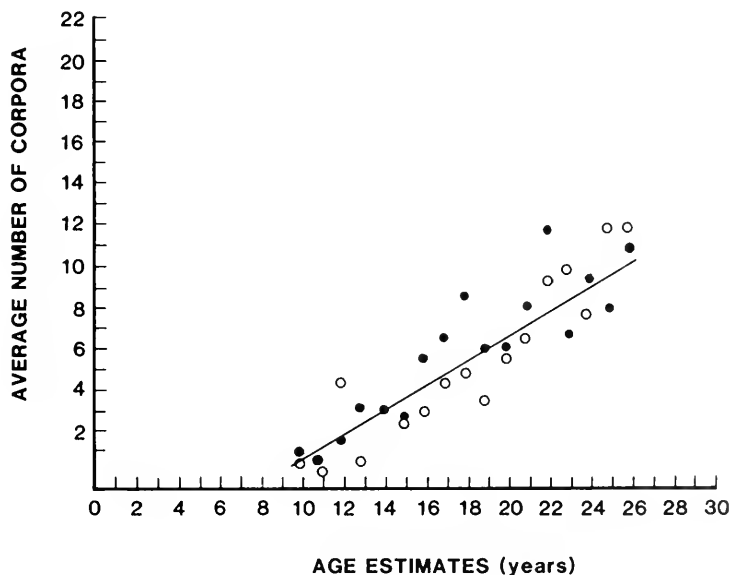

FIGURE 1.—Linear regression of number of corpora on estimated age as gross estimates of ovulation rates in female spotted dolphins. Points represent averages for 1-yr age classes (1973-78 samples = closed circles; 1981 sample = open circles).

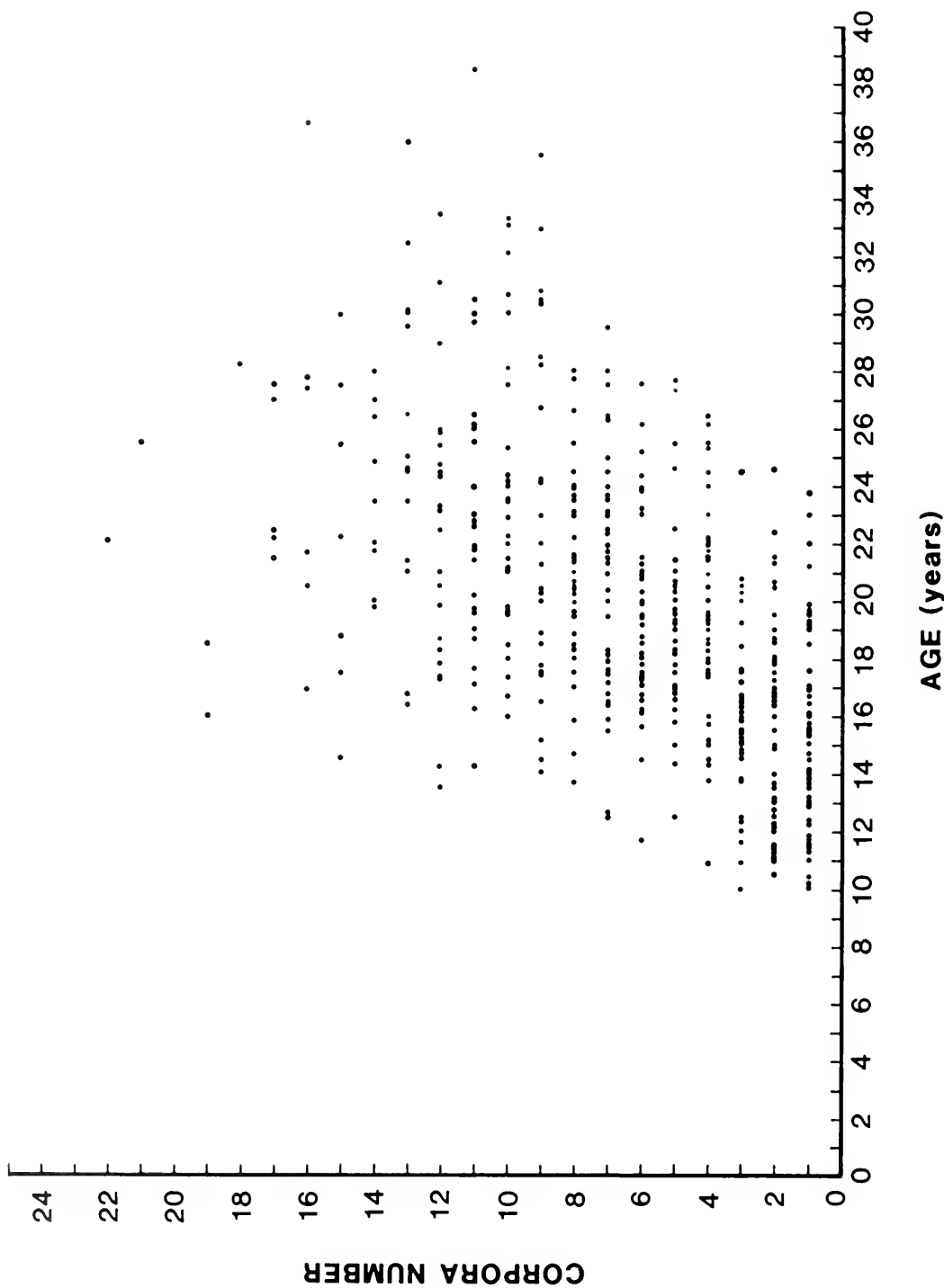

FIGURE 2.—Plot of total corpora (excluding corpora atretica) on estimated age for 542 mature female spotted dolphins collected in 1973-78 and 1981.

constant, a semilog plot of the frequency distribution of corpora counts would be linear. The slope of this line would be negative, and its value would be determined by mortality and ovulation rates. The observed shape of the log-frequency distribution of corpora counts for spotted dolphins (Fig. 3) suggests that ovulation and/or mortality rates are not constant. After about eight ovulations, log-frequencies decrease monotonically and nearly linearly. For up to the first eight ovulations, the rate is apparently much higher (presuming, again, that mortality rates do not change with the number of ovulations and that all CAs persist for life [Perrin and Reilly 1984]). This supports the findings of Perrin et al. (1976) that ovulation rates decrease with reproductive age in spotted dolphins.

### Sexual Maturity

The age at which a female first ovulates is considered the age at attainment of sexual maturity (DeMaster 1978, 1984). Using the aged samples, we estimated average age at sexual maturity (ASM) using two methods. For these estimates, ages were grouped by 1-yr intervals: age-class 1 included specimens 0-1.0 yr, age-class 2 from 1.1 to 2.0 yr, etc. The mean age of sexually mature females was 18.7 yr.

#### Method-One

ASM was estimated from both readers' age esti-

mates using a variation of the method described by DeMaster (1978). Age-specific maturation rates were used to calculate mean ASM as

$$\text{ASM} = \sum_{x=1}^w (x - 0.5) P_x$$

where  $x$  is age class,  $P_x$  is the probability of first ovulating in age class  $x$ , and  $w$  is the maximum age in the sample. The term  $(x - 0.5)$  was substituted for DeMaster's  $(x)$  so that the mean age in an age-class interval would be represented by the midpoint of that interval. The terms  $P_x$  were estimated as

$$P_x = f(x + 1) - f(x),$$

where  $f(x)$  is the probability of being mature at age  $x$ . The function  $f(x)$  was estimated as the best least-squares fit of a curve (York 1983) to the observed values of percent mature by age class. A 3-parameter sigmoid curve based on a modification of the logistic equation was found to give an adequate fit of the data (Fig. 4).

ASMs were calculated separately for the aged samples, 1973-74, 1975-78, and 1981. There were no significant differences among these samples ( $P > 0.05$ ). The ASM for all samples combined was 10.7 (var. = 0.03) to 12.2 (var. = 0.05) yr for the two readers. The average of these two ASM estimates was 11.4 yr. The precision between readers in age estimates of the 1981 specimens was greater than

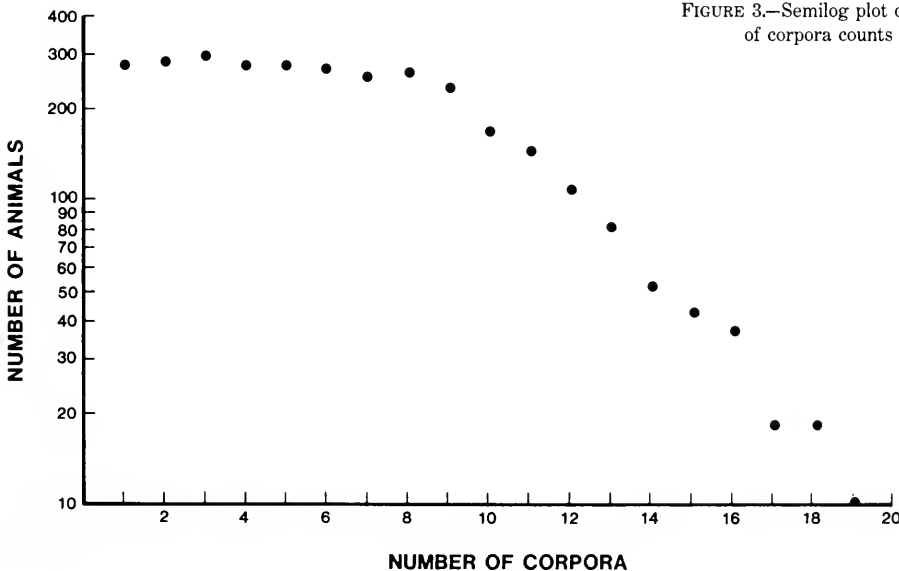

FIGURE 3.—Semilog plot of the frequency distribution of corpora counts for female spotted dolphins.

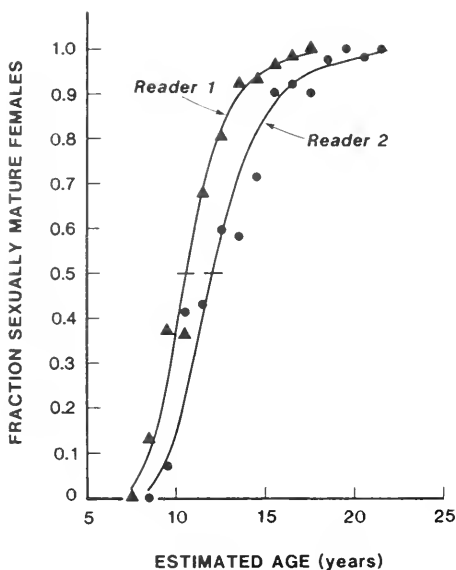

FIGURE 4.—Fraction of sexually mature female spotted dolphins versus age based on estimates of two readers. Logistic curves are fitted to the data. Bars predict ages at which 50% are sexually mature.

for the 1973-78 specimens (Reilly et al. 1983); the mean ASM range for the 1981 sample was 11.6-11.7 yr.

#### Method Two

The second method we used for estimating ASM was to interpolate, from a maturation curve, the age at which 50% of the specimens were mature. Again, sigmoid curve fits of the percent of mature specimens as a function of age were used for the maturation curves. For all aged samples combined, the method predicts an ASM of 10.6-12.0 yr (for the two readers), with an average of 11.3 yr.

Our overall estimates of ASM (11.3 or 11.4 yr) differ markedly from the ASM estimated for ETP spotted dolphins by Perrin et al. (1976) which was 9 tooth layers, "5.1 to 8.3 yr, depending on [which] layering hypothesis is used" (p. 250). Our estimates also differ from the ASM estimate for spotted dolphins off the Japanese coast by Kasuya (1976) which was 9 yr.

#### Biases in ASM

All of the above estimates of ASM are dependent on two important assumptions. First, we assume that counts of dentinal and cemental GLGs give precise

and unbiased estimates of age. Second, we assume that our samples are unbiased with respect to the maturity of the specimens collected. Potential biases would result if the assumptions were invalid. Because age estimates of the two readers differ significantly (Reilly et al. 1983), the difference in ASM estimates for the readers (1.5 yr) should be taken as a minimum range in the ASM estimates.

#### Color Pattern and Maturity

Perrin (1969b) described the ontogenetic development of color pattern in spotted dolphins in the ETP: he divided the development into five sequential phases (neonatal, two-tone, speckled, mottled, and fused) based on patterns of ventral and dorsal spots. Kasuya et al. (1974) described color-phase changes in western Pacific spotted dolphins using somewhat different definitions than those of Perrin (1969b), although the description indicated that the ontogenetic changes were similar to those observed by Perrin. Perrin (1969b) found a close correlation between size and color pattern and (for a smaller sample) between sexual maturity and color pattern. Kasuya et al. (1974) found that the development of the adult color pattern in spotted dolphins from the western Pacific coincides with the attainment of sexual maturity.

In our sample of spotted dolphins, there was considerable overlap in age and length between animals with different color patterns, but a correlation between color pattern and state of maturity was evident. In females from the aged sample, speckled animals ranged from 3 to 18 yr, mottled from 6 to 32 yr, and fused from 10 to 38 yr. A similar overlap occurred in body-length distribution from the overall sample of females, 135-200 cm ( $n = 166$ ), 140-210 cm ( $n = 179$ ), and 155-220 cm ( $n = 188$ ) for speckled, mottled, and fused specimens, respectively. However, 96% of fused animals ( $n = 2,764$ ), 50% of mottled animals ( $n = 857$ ), and only 4% of speckled animals ( $n = 559$ ) were sexually mature.

In addition, for a given length or age class, females with a fused color pattern appeared to have been mature for a longer time than animals with a mottled pattern. For females of similar lengths, mature specimens with a fused color pattern had more corpora than those with a mottled color pattern (Fig. 5). Similarly for the aged sample, the fused specimens within a given length group tended to have more total corpora than mottled specimens, and when specimens in the same body length categories were of similar ages, fused animals had more total corpora.

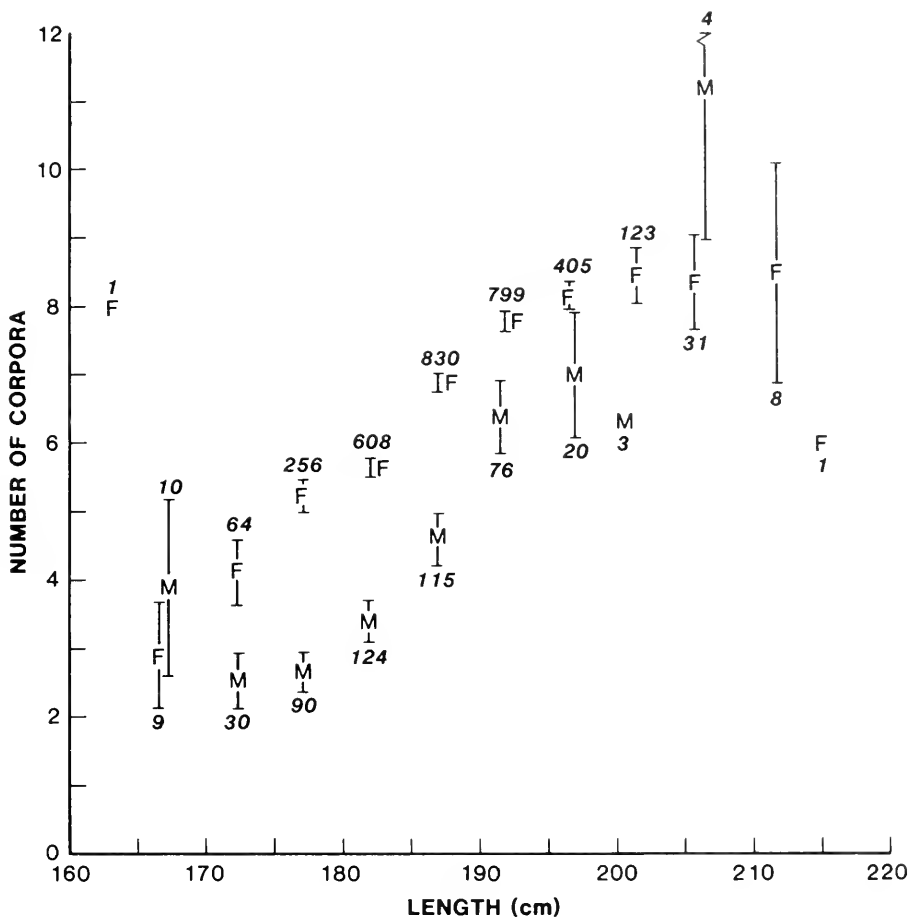

FIGURE 5.—Average number of corpora for mottled (M) and fused (F) color-phase specimens within each 5 cm length grouping for the overall sample of female spotted dolphins. Bars represent one standard error from the mean. Sample sizes are shown.

These results suggest that color phase may indicate sexual maturity more accurately than either age or length. Perrin (1969b) found 0% speckled ( $n = 5$ ), 60% mottled ( $n = 16$ ), and 100% fused ( $n = 33$ ) females to be sexually mature. Using color phases that roughly correspond to the late mottled and fused stages of Perrin (1969b), Kasuya et al. (1974) found that 93% ( $n = 30$ ) of the spotted dolphins in the third stage and 100% in the last (fourth) stage of dorsal spotting were sexually mature. A similar relationship between maturity and color pattern exists in male spotted dolphins in the ETP (Hohn et al. 1985). Assuming that the proportion of mature specimens in a given color phase does not change within a population, it would be possible to estimate the percentage of sexually mature specimens in a sample without having to examine the ovaries for corpora.

### Pregnancy Rate

The annual pregnancy rate (APR) of a population is the fraction of mature females that would be expected to give birth in any given year. APR can be estimated as the average fraction of mature females that are pregnant divided by the gestation time in years. The variance of this estimate is approximated by

$$\text{var}(\text{APR}) = (-P/T_G)^2 \text{var}(T_G) + (1/T_G^2) P(1 - P)/n_p$$

where  $P$  is the proportion pregnant,  $T_G$  is the gestation time, and  $n_p$  is the sample size used to estimate  $P$  (Perrin and Reilly 1984). We use 0.958 yr (11.5 mo) as the gestation period for spotted

dolphins (Perrin et al. 1976). The variance in gestation time has not been calculated. We can, however, reasonably estimate that 95% confidence limits would span 0.1 yr. From this we estimate the var ( $T_G$ ) to be 0.000625.

For the aged sample, 31.1% of the sexually mature specimens ( $n = 542$ ) were pregnant. For the overall sample during the same years, 31.6% of the sexually mature specimens ( $n = 2,458$ ) were pregnant and for all aged and unaged mature specimens from 1973 through 1981 inclusive ( $n = 2,979$ ), 31.3% were pregnant (Table 1). By dividing the fraction of pregnant females by the gestation period (0.958), annual pregnancy rates of 0.325 and 0.330 were obtained for the aged and overall samples, respectively. The var(APR) for the overall sample is 0.0005.

To determine whether pregnancy rates changed with age, we estimated percent pregnant for four age-class intervals using the 1973-78 and 1981 samples combined. Sample size was small for estimating age-specific rates with much precision. Nevertheless, we detected neither a sustained increase nor a sustained decrease in the percent of pregnant females with age (Fig. 6); the variability in the percent of pregnant females with age can be accounted for by random sampling ( $\chi^2_3 = 4.6$ ,  $P > 0.50$ ). This result differs from that of Perrin et al. (1976) which indicated a significant reduction in pregnancy rate with age.

## Calving Interval

Calving interval is an estimate of the mean period between births for mature females. Typically, it is estimated as the inverse of the annual pregnancy rate (Perrin and Reilly 1984). The principal requirements for calculating the calving interval are unbiased estimates of gestation time and of the fraction of mature females that are pregnant. The standard error in an estimate of calving interval (CI) by these methods is approximated by

$$SE(CI) = (APR-4) \text{ var}(APR)$$

(Perrin and Reilly 1984).

Given our calculated APR estimate of 0.330 for the overall sample, the calving interval is 3.03 yr. The standard error of this estimate is about 0.205. Although it is difficult to prove that our estimates of the percent of pregnant females are unbiased, support for such a position is given by Barlow's finding that the percent of pregnant females varies little with sampling conditions (including sampling season, geographic area, dolphin school size, and dolphin killer-set) (Barlow 1985). However, if annual variability in the percent of pregnant females is important, binomial sampling theory is likely to underestimate our certainty in estimating the percent of pregnant females, APR, and calving interval. Because no significant trends were detected in the percentage

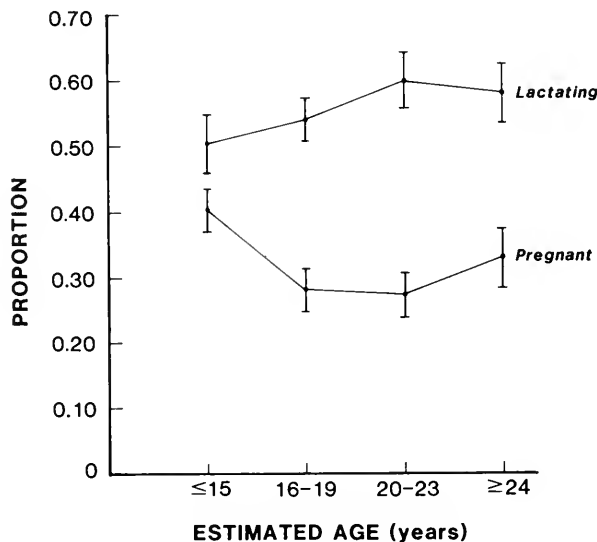

FIGURE 6.—Proportion lactating and proportion pregnant as a function of age for sexually mature female spotted dolphins, in 1973-78 and 1981. Bars represent one standard error from the mean ( $n = 542$ ).

of pregnant females from 1974 to 1983 (Barlow 1985) and because no significant changes were found in pregnancy rates with age, estimates of calving interval were not calculated for any of these possible stratifications.

Previous estimates of calving interval for *S. attenuata* include 2.5 yr for the southern offshore ETP stock, 2.7-3.4 yr for the northern offshore ETP stock, and 3.5-3.9 yr for a western North Pacific population (all values taken from Perrin and Reilly 1984, table 6). Our estimate, 3.06 yr, is thus close to previous estimates for the ETP northern stock and falls between the estimates for two other populations.

### Lactation Period

The calving cycle in mammals can be thought of as a gestation period, a lactation period, and (in some cases) a resting period. Since gestation and lactation can overlap, the calving interval can be less than the sum of the gestation and lactation periods.

In this study, the duration of the lactation period was estimated as the fraction of mature females that are lactating multiplied by the calving interval in years. Again, the assumption is that all reproductive stages of mature females are sampled without bias. The estimated lactation period for the overall sample is 1.66 yr.

Unlike the percent pregnant, the percentage of lactating females has apparently increased over the years between 1973-74 and 1981 (Table 1). Collaborative evidence is provided by Barlow (1985). Barlow's weighted regression of the percent of lactating females regressed against year predicts values of 46% lactating for 1971 and 69% for 1983. These correspond to a change in mean lactation period from 1.4 to 2.1 yr.

There were no significant differences in proportion of lactating females in different age-classes for all aged samples combined ( $\chi^2_3 = 2.58$ ,  $P > 0.25$ ) (Fig. 6).

Evidence exists for considerable individual variability in calving interval and lactation period. The sum of the estimated gestation time (0.958 yr) plus the mean lactation period (1.66 yr) is about 2.6 yr; the mean calving interval, estimated as the inverse of APR, is roughly 3 yr. We might predict from this that individuals would never be simultaneously pregnant and lactating. In fact, 16% of the sampled pregnant females were lactating. This is implicit evidence of individual variability.

### Postreproductive Females

Several criteria have been used to identify postreproductive female odontocetes. Perrin et al. (1976) described postreproductive spotted dolphins and Perrin et al. (1977) described postreproductive spinner dolphins, *S. longirostris*. Both studies were based on the presence of atrophic ("regressed" or "withered") ovaries. In both cases, the incidence of postreproductive females was 1% or less of the sample. In pilot whales, *Globicephala macrorhynchus*, Marsh and Kasuya (1984) found changes in the histology of the ovary, such as a decrease in the volume of the cortex and sclerosis of the arterial walls that are age related and associated with senescence. Senescent females were characterized on the basis of follicle abundance and the incidence of follicular atresia.

Postreproductive females also occurred in our sample. Nine of the mature females collected from 1973 to 1982 had atrophic ovaries and thus are considered to have been reproductively senescent. Their mean ovary weights and maximum follicle diameters were significantly different from the means of the other mature females collected during these years (*t*-test,  $P < 0.005$ ) (Table 3, Fig. 7). None was lactating.

Evidence of decreased fertility was found in some females without atrophic ovaries. Two groups were extracted from the aged sample: 1) those specimens that had 20 or more corpora (all but one was 20 yr old or older), and 2) those specimens that were 20 yr old or older and had only four or fewer total corpora (including atretica). Of the first group ( $n = 12$ ), the mean maximum follicle diameter was larger than that of the atrophic-ovary sample (*t*-test,  $P < 0.005$ ), but the mean weights for both ovaries combined were not significantly different (Table 4). Atretic corpora constituted 24% of the total corpora, less than the frequency of atresia found in the atrophic ovaries (39%). The two specimens in this sample with the highest proportion of corpora atretica also had ovaries with maximum follicle diameter and ovary weights within the range of the atrophic ovaries; in addition, they had no CLs (corpora lutea) or Type 1 corpora. We consider these two females to have been postreproductive. Of the second group ( $n = 14$ ), the mean maximum follicle diameter and ovary weight were not different from those in the sample with more total corpora, but were markedly different from those of the atrophic ovaries (*t*-test,  $P < 0.025$ ). None of these ovaries contained corpora atretica.

Comparison of females in the two groups provides evidence that when the complement of follicles has nearly been expended (through ovulation or atresia), fertility diminishes. Of the first group, 5 of the 12

TABLE 3.—Combined ovary weights, maximum follicle diameter, and corpora counts in "non-atrophic" (normal) ovaries with no corpus luteum ( $n = 3,455$ ) and atrophic ovaries ( $n = 9$ ) of sexually mature female spotted dolphins collected in 1973-82.

Variable	Non-atrophic ovaries		Atrophic ovaries	
	Mean	SE	Mean	SE
Combined ovary weight	4.9	0.05	3.0	0.30
Maximum follicle diameter	2.8	0.06	0.4	0.07
Total corpora excluding atretica	6.8	0.09	12.4	1.36
Total corpora including atretica	7.5	0.11	20.9	1.13
Corpora atretica	0.7	0.04	8.4	1.67
Percent of corpora atretic	6.4	0.30	40.0	7.6

TABLE 4.—Mean age, maximum follicle diameter, ovary weight, corpora counts, and reproductive states for female spotted dolphins. Type 1 and Type 2 corpora defined by Perrin et al. (1976).

	Age years	Maximum follicle diameter (mm)	Combined ovary weights (g)	Total corpora <sup>1</sup>	Corpora atretica	Percent atretic	Type 1 corpora	Type 2 corpora	Pregnant/lactating (%)
A. Females with 20 or more corpora ( $n = 12$ )									
Mean	20.2	2.7	4.2	21.3	4.7	21.9	0.5	1.4	40
SE	1.0	0.5	0.5	0.3	0.8	3.6	0.2	0.4	
B. Females 20 yr or older with four or fewer corpora ( $n = 14$ )									
Mean	22.6	2.5	5.1	2.7	0	0	0.9	0.9	100
SE	0.5	0.3	0.6	0.3	0	0	0.2	0.2	

<sup>1</sup>Includes atretica.

specimens were pregnant or lactating. All 14 of the second group were pregnant or lactating. Thus, the first group shows reduced fertility when compared with the second group. Marsh and Kasuya (1984) described an age-related decline in follicle abundance in pilot whales, stating that when follicles are "depleted" the animals become senescent. The reduction in fertility indicated in our sample of spotted dolphins is not strictly age-related; it is more dependent on the number of corpora (including corpora atretica) already present in the ovaries. This has been shown to be true in western Pacific spotted dolphins (Kasuya et al. 1974) and in sperm whales (Best 1967).

In addition to the postreproductive females with atrophic ovaries, four mature females with normal-appearing ovaries had no macroscopic follicles (one of the atrophic ovaries contained no macroscopic follicles). This is similar to the condition described by Marsh and Kasuya (1984). The ovaries of these specimens weighed from 2.2 to 5.9 g, had no CLs or Type 1 or Type 2 corpora, and contained 8-22 total corpora, 12% of which were atretic. None were lactating. They are considered to have been postreproductive also.

Spotted dolphin specimens were judged to have been senescent when they had atrophic ovaries or

lacked macroscopic follicles. Such specimens have in common: 1) the absence of CLs and Type 1 corpora, 2) a large number of total corpora, 3) a high frequency of atresia (a relatively large proportion of the total corpora), and 4) a maximum follicle diameter of 0.5 mm or less. The incidence of obvious senescence in the sample of spotted dolphins (0.4%) is much less than that in pilot whale samples studied (5% in *Globicephala melaena* from the northern Atlantic Ocean [Sergeant 1962] and 25% in *G. macrorhynchus* from the western Pacific [Marsh and Kasuya 1984]). This may be indicative of inherent differences in the social structure or longevity between pilot whales and spotted dolphins.

## CONCLUSIONS

Several of our analyses have yielded results similar to those reported previously for spotted dolphins by others, notably Perrin et al. (1976) and Kasuya et al. (1974). We found ovulation rates to have high individual variability with a markedly higher rate of corpus formation in the earlier reproductive years that decreases after a fixed number of ovulations has occurred.

The conclusions reached by Perrin (1969b) and particularly by Kasuya et al. (1974) with regard to the close correlation between color pattern and sexual maturity in spotted dolphins are also supported by our study. Ninety-six percent of the fused, 50% of the mottled, and only 4% of the speckled specimens were sexually mature. Fused specimens had more corpora and appeared to have been sexually mature longer than mottled specimens of the same age or length.

Our estimated length of the calving interval (3.03 yr) is within the range of earlier estimates calculated for this stock by Perrin and Reilly (1984). It is also within the range of estimates for two other spotted dolphin stocks.

Some of our analyses, however, produced results



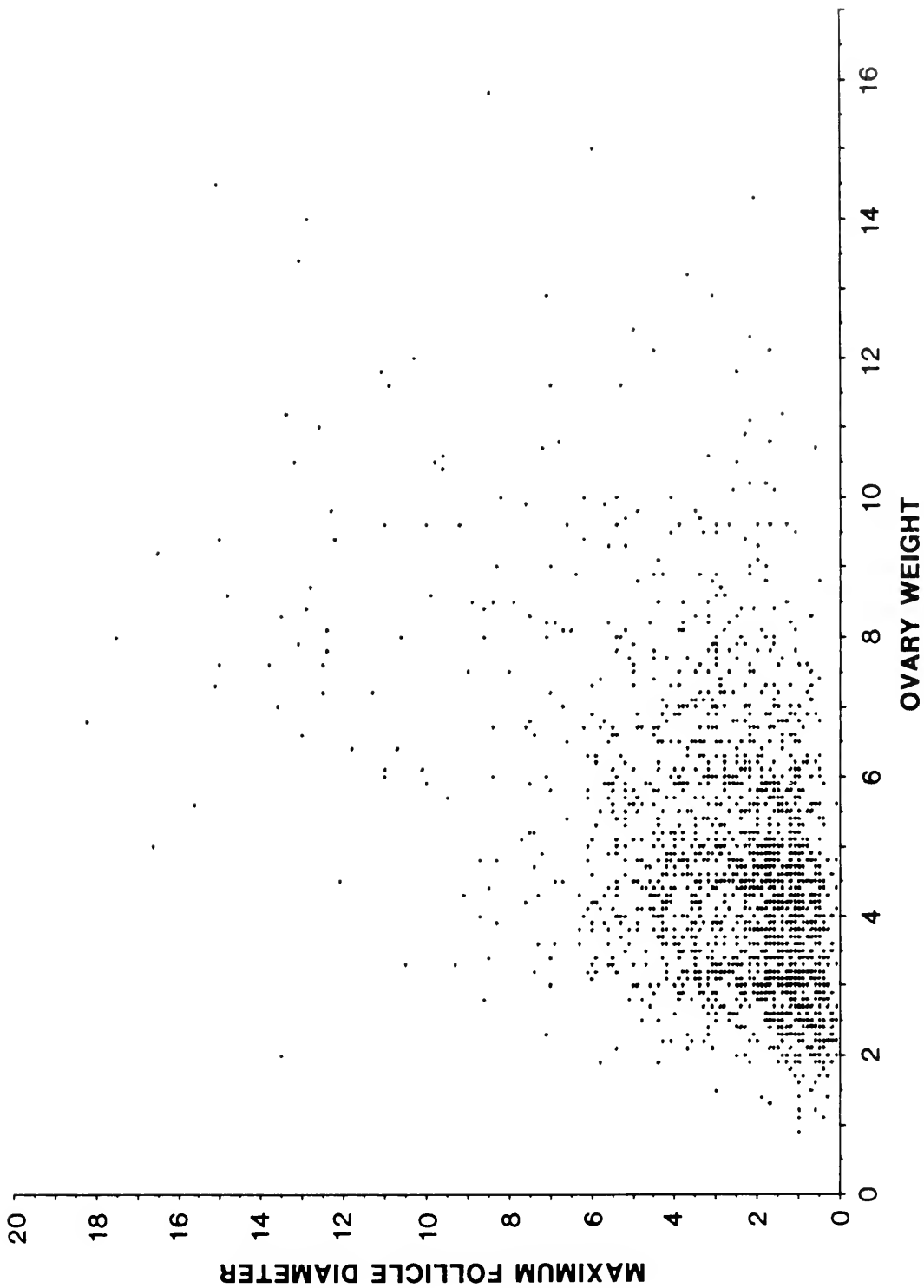

FIGURE 7.—Plot of maximum follicle diameter (mm) on combined ovary weight (g) for 3,464 female spotted dolphins.

that contradict earlier findings. Based on the more reliable method of estimating age in spotted dolphins, we believe that our findings present a clearer picture of the reproductive information than has been reported previously. Our aged samples showed that the youngest sexually mature female was 10 yr old—the same age as the youngest pregnant and the youngest lactating specimens. This suggests that some females must become sexually mature before the age of 10, even though mature specimens younger than 10 were not found in our sample. The average age of a pregnant female in our sample was about 18 yr, and some females of about 35 yr old were pregnant or nursing. These values are substantially higher than estimated previously for this stock (Perrin et al. 1976), but they are similar to, though still somewhat higher than, estimates for the western Pacific stock (Kasuya 1976).

The ASM estimate in this study (about 11.4 yr) is higher than that estimated by Perrin et al. (1976). Our calculations showed no significant difference between the ASM calculated for the 1973-74 sample (taken during years of heavy fishing mortality) and the ASM for the 1981 sample (taken after at least 5 yr of reduced fishing mortality).

An ASM of 11.4 yr means that the youngest average age of first parturition would be 12.3 yr (11 mo later). Since not all females would conceive at first ovulation, the actual average age would be greater than this. The implication of this protracted period before reproduction and a long (3.03 yr) calving interval is that spotted dolphin survival rates must be very high in order to maintain a stable population level.

There is a significant depression in the age structure of the 1973-78 and 1981 aged sample in the 6-12 yr age classes (Hohn and Myrick in prep.<sup>2</sup>). Similar age-structure patterns, interpreted as reflecting some sort of schooling segregation, have been encountered in studies of other delphinids (see review by Perrin and Reilly 1984). If animals at or near the age of sexual maturity have been regularly under-sampled because their schools were not targets of purse seines (Hohn and Scott 1983), the ASMs calculated for the aged samples could be upwardly biased. However, there is no evidence that the depression in the age structure represents missing animals that were sexually mature.

The annual pregnancy rate averaged 0.33 from

1973 through 1981. There were no sustained upward or downward changes in age-specific pregnancy rates with increased age. A similar result was shown by Kasuya (1976) for the western stock, although his values were somewhat lower than the rates we have estimated for the northern offshore stock. Our estimates are different from those of Perrin et al. (1976) who reported high pregnancy rates among younger specimens and a decreasing rate with increased age.

The implications of an apparent progressive increase in the lactation period are enigmatic. It is probable that the increase in lactation period reflects the decrease in per capita mortality of calves due to the more efficient releasing procedures employed by the purse seine fleet from the mid-1970's onwards. Decreased mortality of nursing calves would be reflected by an apparent increase in the number of lactating females because fewer nursing periods were ended prematurely.

Our study of postreproductive specimens suggests that fertility diminishes as the complement of follicles for a female becomes expended through ovulation or atresia. Female spotted dolphins with atrophic ovaries or with no macroscopic follicles are reproductively senescent. Although the expenditure of follicles progresses with age, reduction in fertility is not strictly age related. The occurrence of reproductive senescence in spotted dolphins in this study was negligible and the number of specimens in this state probably is of limited importance to estimates of reproductive parameters.

## ACKNOWLEDGMENTS

We thank D. DeMaster, W. F. Perrin, and S. Reilly for their helpful comments and recommendations on early drafts of the manuscript. We are grateful to J. Bengtson, D. Chapman, F. Hester, J. Mead, A. York, and R. Wells for their very thorough reviews. J. Walker and S. Chivers assisted in organizing and accessing the life history data and S. Chivers helped with the analyses. D. Stanley and M. Kimura prepared the tooth sections for the aged subsamples. Special thanks go to H. Orr who prepared the figures and to H. Becker and S. Richardson and the SWFC Technical Support Staff who typed parts of the manuscript. D. DeMaster, N. Lo, and S. Reilly assisted in statistical testing of some of the samples. J. Michalski edited the final draft.

## LITERATURE CITED

<sup>2</sup>Hohn, A. A., and A. C. Myrick, Jr. The age structure of northern offshore dolphins, *Stenella attenuata*, from the eastern tropical Pacific. Manusc. in prep. Southwest Fisheries Center La Jolla Laboratory, National Marine Fisheries Service, NOAA, P.O. Box 271, La Jolla, CA 92038.

BARLOW, J.

1985. Variability, trends, and biases in reproductive rates of

- spotted dolphins, *Stenella attenuata*. Fish. Bull., U.S. 83:657-669.
- BEST, P. B.  
1967. The sperm whale (*Physeter catodon*) off the west coast of South Africa. I. Ovarian changes and their significance. S. Afr. Div. Sea Fish. Invest. Rep. 61:1-27.
- BRODIE, P. F.  
1971. A reconsideration of aspects of growth, reproduction, and behavior of the white whale (*Delphinapterus leucas*) with reference to the Cumberland Sound, Baffin Island, population. J. Fish. Res. Board Can. 28:1309-1318.
- DEMASTER, D. P.  
1978. Calculation of the average age of sexual maturity in marine mammals. J. Fish. Res. Board Can. 35:912-915.  
1984. Review of techniques used to estimate the average age at attainment of sexual maturity in marine mammals. In W. F. Perrin, R. L. Brownell, Jr., and D. P. DeMaster (editors), Reproduction in whales, dolphins and porpoises, p. 175-179. Rep. Int. Whaling Comm. (Spec. Issue No. 6).
- HAMMOND, P. S., AND K. T. TSAI.  
1983. Dolphin mortality incidental to purse-seining for tunas in the eastern Pacific Ocean, 1979-1981. Rep. Int. Whaling Comm. 33:589-597.
- HENDERSON, J. R., W. F. PERRIN, AND R. B. MILLER.  
1980. Rate of gross annual production in dolphin populations (*Stenella* spp. and *Delphinus delphis*) in the eastern tropical Pacific 1973-78. SWFC, NMFS, NOAA, Admin. Rep. LJ-80-02, 51 p.
- HOHN, A. A., J. BARLOW, AND S. J. CHIVERS.  
1985. Reproductive maturity and seasonality in male spotted dolphins, *Stenella attenuata*, in the eastern tropical Pacific. Mar. Mammal Sci. 1(4):273-293.
- HOHN, A. A., AND M. D. SCOTT.  
1983. Segregation by age in schools of spotted dolphin in the eastern tropical Pacific. [Abstr.] Fifth Bienn. Biol. Mar. Mammals, p. 47.
- KASUYA, T.  
1976. Reconsideration of life history parameters of the spotted and striped dolphins based on cemental layers. Sci. Rep. Whales Res. Inst. (Tokyo) 28:73-106.
- KASUYA, T., N. MIYAZAKI, AND W. H. DAWBIN.  
1974. Growth and reproduction of *Stenella attenuata* in the Pacific coast of Japan. Sci. Rep. Whales Res. Inst. (Tokyo) 26:157-226.
- MARSH, H., AND T. KASUYA.  
1984. Changes in the ovaries of the short-finned pilot whale, *Globicephala macrorhynchus*, with age and reproductive activity. In W. F. Perrin, R. L. Brownell, Jr., and D. P. DeMaster (editors), Reproduction in whales, dolphins and porpoises, p. 311-335. Rep. Int. Whaling Comm. (Spec. Issue No. 6).
- MYRICK, A. C., JR., A. A. HOHN, P. A. SLOAN, M. KIMURA, AND D. STANLEY.  
1983. Estimating age of spotted and spinner dolphins (*Stenella attenuata* and *Stenella longirostris*) from teeth. U.S. Dep. Commer., NOAA Tech. Memo. NMFS SWFC-30, 17 p.
- MYRICK, A. C., JR., E. W. SHALLENBERGER, I. KANG, AND D. B. MACKAY.  
1984. Calibration of dental layers in seven captive Hawaiian spinner dolphins, *Stenella longirostris*, based on tetracycline labeling. Fish. Bull., U.S. 82:207-225.
- PERRIN, W. F.  
1969. Using porpoise to catch tuna. World Fishing 18(6): 42-45.  
1970a. Color pattern of the eastern Pacific spotted porpoise *Stenella graffmani*; Lonnberg (Cetacea, Delphinidae). Zoologica (NY) 54:135-149.  
1970b. The problem of porpoise mortality in the U.S. tropical tuna fishery. In Proceeding of the 6th Annual Conference on Biological Sonar and Diving Mammals, p. 45-48. Stanford Res. Inst., Menlo Park, CA.
- PERRIN, W. F., J. M. COE, AND J. R. ZWEIFEL.  
1976. Growth and reproduction of the spotted porpoise, *Stenella attenuata*, in the offshore eastern tropical Pacific. Fish. Bull., U.S. 74:229-269.
- PERRIN, W. F., D. B. HOLTS, AND R. B. MILLER.  
1977. Growth and reproduction of the eastern spinner dolphin, a geographical form of *Stenella longirostris* in the eastern tropical Pacific. Fish. Bull., U.S. 75:725-750.
- PERRIN, W. F., AND A. C. MYRICK, JR. (editors)  
1980[1981]. Age determination of toothed whales and sirenians. Rep. Int. Whaling Comm. (Spec. Issue No. 3), 229 p.
- PERRIN, W. F., AND S. B. REILLY.  
1984. Reproductive parameters of dolphins and small whales of the family delphinidae. In W. F. Perrin, R. L. Brownell, Jr., and D. P. DeMaster (editors), Reproduction in whales, dolphins and porpoises, p. 97-133. Rep. Int. Whaling Comm. (Spec. Issue No. 6).
- REILLY, S. B., A. A. HOHN, AND A. C. MYRICK, JR.  
1983. Precision of age determination of northern offshore spotted dolphins. U.S. Dep. Commer., NOAA Tech. Memo. NMFS SWFC-35, 27 p.
- SERGEANT, D. E.  
1962. The biology of the pilot or pothead whale *Globicephala melana* (Traill) in Newfoundland waters. Fish. Res. Board Can. Bull. 132:1-84.
- SMITH, T. D.  
1983. Changes in size of three dolphin (*Stenella* spp.) populations in the eastern tropical Pacific. Fish. Bull., U.S. 81:1-13.
- YORK, A. E.  
1983. Average age at first reproduction of the northern fur seal (*Callorhinus ursinus*). Can. J. Fish. Aquat. Sci. 40: 121-127.



# CHINOOK SALMON, *ONCORHYNCHUS TSHAWYTSCHA*, SPAWNING ESCAPEMENT BASED ON MULTIPLE MARK-RECAPTURE OF CARCASSES

STEPHEN D. SYKES AND LOUIS W. BOTSFORD<sup>1</sup>

## ABSTRACT

Mark-recapture data from a population of chinook salmon, *Oncorhynchus tshawytscha*, carcasses were collected for escapement estimates in a northern California stream. Escapement was taken to be immigration into the population of carcasses. Results from three methods of estimating total immigration into this population—Jolly-Seber, Manly and Parr, and Jolly-Seber with a modified data set—were compared to a weir count. Sources of violations of modeling assumptions, age-dependent catchability, and survival were identified, but the estimates appeared to be relatively insensitive to these. The effect of lower sampling intensity, which exacerbates effects of age-dependent catchability, was evaluated through simulation. The third method appears to be the best of the three because 1) it requires the least sampling effort, 2) it is the most robust with respect to violations of the assumption of equal catchability, and 3) it enables reanalysis of previously collected data. Standard errors and 95% confidence intervals of estimates obtained by the third method were computed by simulation. Since the distribution of estimates is asymmetrical, these confidence limits are preferred over standard expressions.

Pacific salmon fisheries are currently managed by attempting to allow a specified number of fish to escape the fishery, migrate upstream and spawn. Proper management therefore requires accurate estimates of this escapement. Since Pacific salmon die immediately after spawning, escapement can be estimated from the number of carcasses that accumulate during a spawning season. The California Department of Fish and Game (CDF&G) estimates escapement of chinook salmon, *Oncorhynchus tshawytscha*, each year using the methods of Schaeffer (Schaeffer 1951; Darroch 1961) and Peterson (Seber 1982) to analyze mark-recapture data from surveys of accumulated carcasses. Since the fish enter the stream to spawn during the sampling periods, the assumption of a closed population required by the Peterson estimate does not hold. The Schaeffer method is designed to estimate numbers from a stratified two sample experiment in which fish are tagged at different locations (or different times at one location as fish migrate upstream) and are sampled at the same locations (or an upstream point) at a later time. CDF&G carcass surveys, on the other hand, involve sampling the same unstratified stretch of spawning stream several times. The results described here are part of an attempt to develop an accurate, efficient, and robust procedure for estimating escapement from carcass data. A

technique that allows not just estimates for current and future years, but also could be used to analyze mark-recapture data taken by CDF&G in past years was desired.

Parker (1968) and Stauffer (1970) used standard Jolly-Seber methods to estimate spawning run sizes from mark-recapture data obtained from carcass counts. However, they did not examine departures from modeling assumptions by collecting appropriate data in the field or statistically testing assumptions. Also, an independent count of the population size was unavailable, hence actual errors in their estimates could not be computed. In addition, carcasses were carefully replaced where they had been found after sampling and tagging, hence captured carcasses would have a high probability of being recaptured. Thus, their results were probably biased because of heterogeneous capture probabilities.

To develop the estimation technique a mark-recapture experiment was performed in the Bogus Creek spawning area of the Upper Klamath River drainage during the 1981 chinook salmon spawning run. As a check on the estimates, a counting weir was placed at the mouth of Bogus Creek. Salmon were counted while they were in the weir trap, and were subsequently released upstream. This mark-recapture study differed from the usual mark-recapture studies of fish and wildlife populations in that the population was composed of carcasses (i.e., individuals enter the population by dying and leave by predation and decay). Thus, the age of a carcass,

<sup>1</sup>Department of Wildlife and Fisheries Biology, University of California, Davis, CA 95616.

as used here, refers to time since death rather than time since recruitment.

The procedures followed here differed from previous CDF&G surveys in that more data were taken than were actually needed for the estimate so that departures from model assumptions could be examined. The additional data enabled simulation of the sampling procedure to estimate bias and variances, and allowed us to determine the sources of failure of assumptions. We were also able to develop estimates from which some sources of bias had been removed.

## METHODS

The study was conducted on a chinook salmon spawning area of a small northern California

stream, Bogus Creek (Fig. 1). The stream was sampled over a 6.5-mi reach from a counting weir upstream to Bogus School road. Sampling was begun on 15 September 1981, at the very beginning of the spawning run, and discontinued on 12 November 1981, by which time very little spawning activity was apparent. The stream was sampled weekly during that period; sampling took 2 d during the peak of the run, with one half of the stream being sampled per day. The stream was sampled by two people walking upstream and capturing with a gaff any carcasses seen. Data on each capture were described as follows:

Place of capture: Edge top, edge bottom, middle top, middle bottom, snagged, dry or buried.  
Size: Small (<65 cm), medium minus (65-69 cm),

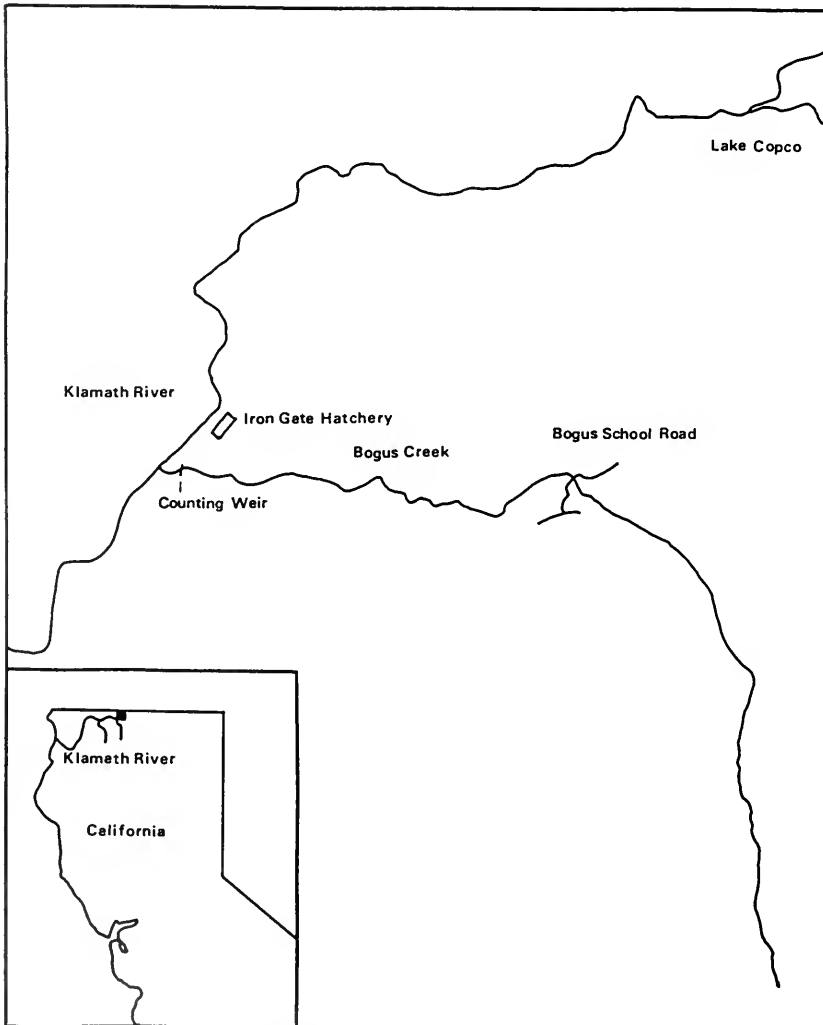

FIGURE 1.—Study area in northern California.

medium (70-80 cm), medium plus (81-85 cm), or large (>85 cm).

Sex: Male or female.

Condition: Alive, fresh (eyes clear), decayed minus (eyes cloudy, flesh firm), decayed (flesh soft), decayed plus (flesh very soft), or skeleton (flesh falling off).

Carcasses were individually tagged with fingerling fish tags which were attached around the maxillary bone. Data on place of release for each released carcass were recorded as follows:

Pool, pool/riffle, or riffle.

The presence or absence of obstructions which would trap and remove a carcass.

The speed of water flow.

Thus movements of individual carcasses and their condition, both of which might affect catchability and survival, could be examined on an individual basis. During the sampling process about one-third of the unmarked, captured carcasses was randomly removed from the population by cutting the fish in two. This was done because of limited time available for recording data. These individuals were considered "trap mortalities" (i.e., they are counted in the sample size but not in the total releases for that time period). Because the mark-recapture methods used allow for capture loss, removal of these fish has no effect on errors other than lowering sample sizes.

Two existing methods, those of Jolly and Seber (Seber 1982) and Manly and Parr (1968), and a third, a modified Jolly-Seber method, were used to estimate population sizes, recruitment, survival, and their standard errors (when expressions were available). The corrected estimates of Seber (1982) were used for the Jolly-Seber method. When survival was estimated as greater than unity, or immigration as <0.0, those values were replaced with 1.0 and 0.0 respectively in subsequent calculations. In the third method, standard Jolly-Seber estimates were calculated after modifying the mark-recapture data so that all decayed (decayed minus or worse) carcasses (marked and unmarked) were assumed to have been destroyed upon capture. This method simulates the way CDF&G has traditionally collected data.

After these estimates had been calculated, the estimated escapement,  $E$ , was calculated as the number present at the first sample period, plus the number of individuals immigrating during each subsequent period.

$$\hat{E} = n_1 + ((\hat{N}_2 - R_1 * \hat{\Phi}_1)/(\hat{\Phi}_1)^5) + \hat{D}_2 + \hat{D}_3 + \hat{D}_4 \quad (1)$$

where  $n_1$  = the number sampled at the first sample time,

$R_1$  = the number tagged and released at the first sample time,

$\hat{N}_2$  = the estimated population size at sample time two,

$\hat{D}_i = \hat{B}_i/(\hat{\Phi}_i)^5$ ,

$\hat{\Phi}_i$  = the survival rate from  $i$  to  $i + 1$ , and

$\hat{B}_i$  = the estimated number of carcasses still present at the sample time  $i + 1$  which immigrated between  $i$  and  $i + 1$ .

In this expression the initial number present at time period 1 is conservatively taken to be the sample size at time period 1 ( $n_1$ ). The number immigrating during the subsequent period is taken to be the estimated population at time period 2, minus the number of tagged fish which had been accounted for in the first sample. Immigration during the next two periods are standard estimates. Each immigration rate is divided by the square root of the survival rate (the survival rate for half the sample period), to account for fish that enter the population and leave it between sampling periods, and thus are never sampled (Stauffer 1970).

Estimates of immigration during the last time period are not computed in standard multiple mark-recapture experiments; however, this immigration ( $B_4$  here) can be estimated from the standard Jolly-Seber expression (Seber 1982), if the final numbers ( $N_5$ ) and survival rate ( $\Phi_4$ ) can be estimated. If survival varies little from sample to sample,  $\Phi_4$  can be estimated by assuming that mortality is equal to the value estimated over an earlier period in this study. Since survival varied little between sampling periods and the  $\chi^2$  test of Seber (1982) failed to reject the null hypothesis of constant survival ( $\chi^2 = 0.4648$ ,  $df = 2$ ), we estimated survival from period 3 to period 4 as the average of  $\hat{\Phi}_1$ ,  $\hat{\Phi}_2$ , and  $\hat{\Phi}_3$ . To estimate  $N_5$ , we estimated the capture probability at sample period 5 ( $P_5$ ) as the ratio of the number of carcasses released at sample 4 and recaptured at sample 5 ( $r_4$ ) to the number released at sample 4 ( $R_4$ ) times survival to sample 5 ( $\hat{\Phi}_4$ ),

$$\hat{P}_5 = r_4/(R_4 * \hat{\Phi}_4). \quad (2)$$

We then estimated the population size at sample 5

( $\hat{N}_5$ ) as the sample size ( $n_5$ ) divided by the capture probability ( $\hat{P}_5$ ).

Standard errors and 95% confidence limits for the third method were obtained by simulation. The sampling process was simulated by generating a population of carcasses based on population size estimates from the third method. We then sampled the population by comparing a uniformly distributed random number with the appropriate probability of capture [see Sykes (1982) for a more detailed description of the simulation process, and a Fortran program].

From each simulation we calculated Jolly-Seber estimates of survival, immigration, population sizes, and their standard errors. An estimate of  $E$  was then calculated as above. This simulation process was repeated 1,000 times. In addition to calculating the average and standard error of each of these estimates, 95% confidence limits were calculated by Buckland's (1980) method 1. To obtain 95% confidence limits by this method, one adds the difference between the average of the 25th and 26th lowest estimates (out of 1,000) and the average value to the field estimate to obtain the upper bound and subtracts the difference between the average of the 25th and 26th highest estimates and the average value to obtain the lower bound.

All three methods assume that all individuals are equally catchable. The methods based on the Jolly-Seber model also assume that all individuals have equal probabilities of survival. Since violation of these assumptions could result in biased estimates, we determined whether catchability and survival varied and the effects of these on the estimates.

Several statistical tests can be used to check for differential catchability and mortality, but only among animals that are already marked. Two  $\chi^2$  tests, which compare expected frequencies of capture histories with actual frequencies (Seber 1982; Jolly 1982) were calculated from the unmodified field data. The test of Leslie and Carothers (Carothers 1971) was not performed because of the small number of sampling periods. Since both tests yielded expected values less than unity, pooled  $\chi^2$  values were also calculated, using a conservative df value of  $df = (\text{number of pools} - 1)$ . For Seber's test, all values less than unity were pooled; for Jolly's, each value less than unity was pooled with the next highest value.

Following Leslie et al. (1953, cited by Seber 1982) we tested for homogeneity of catchability and survival by comparing estimates of population parameters obtained by different methods. These methods differ in sensitivity to survival and capture heterogeneity, hence the presence of heterogeneity

should cause differences in estimates of the same parameter by the different methods. We tested the unmodified field data by calculating the following parameter estimates as per Leslie et al. (1953):

- $\hat{v}_i$ : the estimated number of new marks released at time  $i$
- $\hat{\Phi}_i$ : the estimated survival for the subpopulation of marked carcasses, and
- $\hat{N}_i$ : the number of marked carcasses.

and compared them with, respectively,

- $v_i$ : the actual number of new marks released at time  $i$
- $\hat{\Phi}_i$ : the Jolly-Seber estimate of survival, and
- $\hat{M}_i$ : the Jolly-Seber estimate of the number of marked carcasses.

If differential catchability or survival, when present, results in significant bias, these estimates will be different.

Since only marked (and thus decayed) carcasses are considered in the statistical tests discussed thus far, these tests do not address the potential for age-dependent catchability. To evaluate possible effects of age-dependent catchabilities we "corrected" the sample size  $n_i$  by reducing it to account for the fact that fewer fresh (shiny, silver colored) carcasses would have been captured if they had not been more visible than decayed (dull brown colored) carcasses. We then recalculated the escapement estimates using the corrected sample size. We used two ratios of average fresh to decayed catchability: 2.0 and 1.4. Since visibility only differed among carcasses on the stream bed, and only 30% of the captures were on the stream bed, these values represented actual ratios for carcasses on the stream bed of approximately 6.7 and 4.7, respectively.

To evaluate the potential advantage of increasing the efficiency of the third method by lowering the sampling effort we examined the effect of lowered sampling intensity on behavior of the three estimators. Lower effort would most likely result in less searching on the bottom of the stream for carcasses. We therefore simulated lowered sampling by generating new capture histories for each individual according to the following set of rules: 1) If an individual was buried at a capture event, that and all subsequent captures were ignored, 2) captures of decayed carcasses on the stream bed and surface were ignored according to comparison of a uniform random number with the appropriate decrease in capture probability, and 3) the next cap-



ture of an individual whose previous bottom capture was ignored was considered to be a bottom capture, as movement was probably the result of the previous capture event.

### RESULTS

Total escapement estimates for the three methods and the weir count of fish moving into the spawning area are presented in Table 1. All three methods result in escapement estimates that are close to the weir count. The third method is the most efficient

TABLE 1.—Estimates of total escapement and the estimates used to compute them for each of the three methods.

	Jolly-Seber	Manly and Parr	Method 3
$\hat{N}_2$	999	1,076	1,063
SE $\hat{N}_2$	95	128	139
$\hat{N}_3$	2,302	2,312	1,886
SE $\hat{N}_3$	166	184	161
$\hat{N}_4$	1,845	1,853	1,452
SE $\hat{N}_4$	67	72	93
$\hat{B}_2$	1,801	1,740	1,459
SE $\hat{B}_2$	174	( <sup>1</sup> )	183
$\hat{B}_3$	150	136	371
SE $\hat{B}_3$	128	( <sup>1</sup> )	179
$\hat{\phi}_2$	0.7617	0.7789	0.7297
SE $\hat{\phi}_2$	0.353	( <sup>1</sup> )	0.439
$\hat{\phi}_3$	0.7878	0.7940	0.8578
SE $\hat{\phi}_3$	0.0305	( <sup>1</sup> )	0.0548
$\hat{n}_1$	87	87	87
$[\hat{N}_2 - R_1 \hat{\phi}_1] / \hat{\phi}^{0.5}$	1,042	1,139	1,142
$\hat{D}_2$	2,062	1,970	1,708
$\hat{D}_3$	169	151	401
$\hat{D}_4$	84	91	170
$\hat{E}$	3,445	3,438	3,508

Weir count: 3,642

<sup>1</sup>Estimate of these standard errors are not available.

in the sense that it requires the least sampling effort.

For the third method, Jolly-Seber estimates and associated estimated standard errors, computed from the survey data along with the average value, standard errors, and 95% confidence limits obtained from simulation, are presented in Table 2. Estimated standard errors and simulated standard errors are in close agreement, except that the distribution of estimates around the mean value is clearly asymmetrical. Since they are based on simulation of the actual process rather than approximate analytical expressions, confidence limits obtained from simulation are presumably more realistic than those estimated by the methods of Jolly and Seber.

The sum of the estimated escapement by time  $i + 2$  is plotted with the sum of the weir count at time  $i$  in Figure 2. Since the numbers of fish which migrated through the weir correlates well with the estimated number of fish that died 2 wk later, most salmon probably spawned and died within 2 wk of having entered the stream. Since the estimate of immigration during the last sampling interval seems to fit the known number of fish immigrating, the assumption of constant survival seems to be a good one. It is clear that our criteria for stopping sampling when most spawning activity had ceased resulted in an estimate of the complete run. Sampling for another week would have removed the need to make any assumptions in estimating  $B_4$ , but since this value will always be small in relation to the total escapement, the increase in accuracy does not seem worth the additional effort.

Data regarding the condition of carcasses at the time of capture reflect a declining trend in catch-

TABLE 2.—Estimates of escapement ( $\hat{E}$ ), population size ( $\hat{N}$ ), immigration ( $\hat{B}$ ), survival ( $\hat{\phi}$ ), and associated standard errors obtained from a Jolly-Seber analysis of data for method three. Also shown are the computed mean, standard error, and 95% confidence intervals obtained by simulation.

	Field estimate	Simulation value			
		Mean	SE	Upper 95% C.I.	Lower 95% C.I.
$\hat{N}_2$	1,063	1,041	145	+ 222	- 344
SE $\hat{N}_2$	139	138	43	+ 66	- 100
$\hat{N}_3$	1,886	1,889	166	+ 289	- 360
SE $\hat{N}_3$	161	165	28	+ 46	- 62
$\hat{N}_4$	1,452	1,458	94	+ 167	- 199
SE $\hat{N}_4$	93	94	19	+ 33	- 43
$\hat{\phi}_2$	0.7297	0.7327	0.0459	+ 0.0892	- 0.0929
SE $\hat{\phi}_2$	0.0439	0.0447	0.0021	+ 0.0039	- 0.0046
$\hat{\phi}_3$	0.8578	0.8559	0.0551	+ 0.1003	- 0.1127
SE $\hat{\phi}_3$	0.0548	0.0554	0.0090	+ 0.0145	- 0.0205
$\hat{B}_2$	1,459	1,446	193	+ 360	- 415
SE $\hat{B}_2$	183	189	29	+ 46	- 68
$\hat{B}_3$	371	377	143	+ 307	- 252
SE $\hat{B}_3$	179	143	22	+ 36	- 53
$\hat{E}$	3,508	3,503	100	+ 186	+ 192

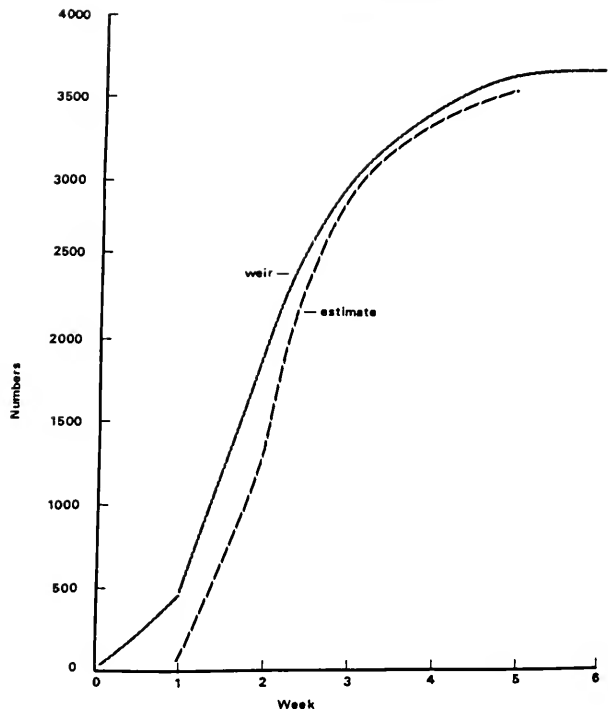

FIGURE 2.—Total numbers of fish immigrating as of week  $i$  by the weir count and total numbers of fish estimated by method three to have died as of week  $i + 2$ .

ability and/or survival with condition among “marked” (and thus decayed) animals (Fig. 3). For each week, smaller and more decayed carcasses appear to have lower recapture rates. (Note that since this figure represents catchability at and after the earliest time of recapture, these data do not reflect catchabilities of fresh fish. Also, recapture rates for week 3 are higher than those for week 4 because there is one more opportunity for recapture.) These low recapture rates can be the result of either lower survival or lower catchability of smaller and more decayed carcasses. The effects of these differences in catchability on absolute numbers of recaptures would be small because of the small number of carcasses in the lower capture probability categories. Note also in Figure 3 that recapture rates of fresh carcasses vary less with size than decayed carcasses.

The expected and actual values for the tests for differential catchability and mortality, the contribution of each difference to the  $\chi^2$  value, and the normal and pooled  $\chi^2$  values are presented in Tables 3 (Seber 1982) and 4 (Jolly 1982), respectively. Although the fit between expected and observed values appears to be quite good, the total differences are statistically significant, hence catchability is not strictly homogeneous.

The comparison of estimated and actual parameters as suggested by Leslie et al. (1953, cited by

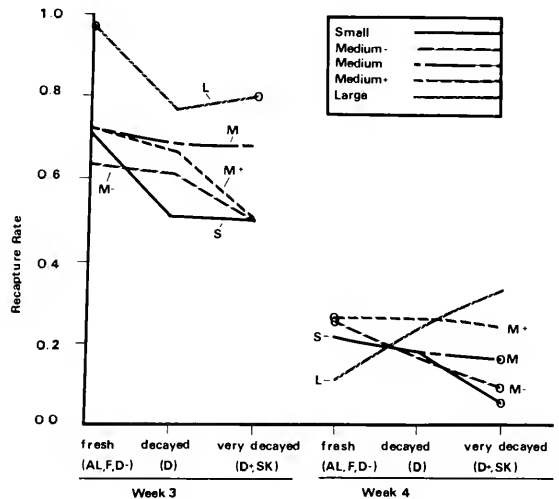

FIGURE 3.—Fraction of marked fish recaptured by size, condition, and week of release. Circled data points have sample sizes of numbers of fish recaptured  $< 10$ . Where  $< 5$  fish were released, that point was not plotted. Note that all fish are decayed upon recapture. The “fresh” category here includes alive, fresh and decayed minus; the “decayed” category includes decayed and the “very decayed” category includes decayed plus and skeleton.

Seber 1982) is presented in Table 5. The close agreement between both sets of estimates indicates any

TABLE 3.—Expected  $[E(b_w)]$  and actual ( $b_w$ ) numbers of individuals with the specific capture history  $w$  and the contribution of the difference between these values to the  $\chi^2$  test of Seber (1982). The listed capture histories indicate the fish was caught only at those times.

$w$	$E(b_w)$	$b_w$	$[E(b_w) - b_w]^2/E(b_w)$
2	120.22	116	0.1480
3	247.59	248	0.0007
4	589.01	588	0.0017
1,2	17.78	22	1.0000
1,3	2.37	2	0.0585
1,4	4.56	7	1.3121
1,5	0.30	2	9.4810
2,3	34.88	36	0.0362
2,4	66.97	68	0.0160
2,5	4.46	8	2.8045
3,4	359.38	355	0.0535
3,5	23.95	19	1.0225
4,5	150.07	153	0.0572
1,2,3	5.16	4	0.2603
1,2,4	9.91	9	0.0827
1,2,5	0.66	0	0.6601
1,3,4	3.44	2	0.6052
1,3,5	0.20	0	0.2295
1,4,5	1.16	0	1.1606
2,3,4	50.62	58	1.0749
2,3,5	3.37	5	0.7843
2,4,5	17.06	10	2.9266
3,4,5	91.56	102	1.1894
1,2,3,4	7.49	5	0.8267
1,2,3,5	0.50	0	0.4490
1,2,4,5	2.52	4	0.8636
1,3,4,5	0.88	0	0.8774
2,3,4,5	12.90	10	0.6511
1,2,3,4,5	1.91	2	0.0045
Pooled	$\chi^2 = 28.68$	df = 14	$\alpha = 0.025$
	$\chi^2 = 17.06$	df = 10	$\alpha = 0.10$

TABLE 4.—Expected and actual numbers of individuals caught at sample  $i$  and  $j$  ( $m_{ij}$ ), regardless of their capture history before  $i$  and after  $j$ , and the contribution of the difference between these values to the  $\chi^2$  test for equal catchability and survival of Jolly (1982).

$i,j$	$E(m_{ij})$	$m_{ij}$	$[E(m_{ij}) - m_{ij}]^2/E(m_{ij})$
1,3	6.95	4	1.2510
2,3	117.05	120	0.0743
1,4	5.74	7	0.2752
2,4	96.74	91	0.3410
3,4	529.51	534	0.0380
1,5	0.31	2	9.2562
2,5	5.20	8	1.5064
3,5	28.49	24	0.7066
Pooled	$\chi^2 = 13.44$	df = 3	$\alpha = 0.005$
	$\chi^2 = 6.34$	df = 2	$\alpha = 0.05$

differential catchability or survival that does exist (as indicated by  $\chi^2$  tests and differential recapture rates) does not significantly bias resultant estimates.

Values of  $\hat{E}$  computed from data "corrected" for age-dependent catchability are presented in Table 6. Again, it appears that if age-dependent catchability is present, it has little effect on the estimates. Also, that our estimates correlate well with the weir count estimates, whereas "corrected" estimates are

TABLE 5.—Estimates of the number of marks released ( $v_i$ ), survival ( $\phi_i$ ), and the marked population size ( $\hat{n}_i$ ) for the standard Jolly-Seber method and the same estimates ( $\hat{v}_i, \hat{\phi}_i, \hat{N}_i$ , respectively) for the test for equal catchability and survival of Leslie et al. (1953, cited by Seber 1982).

Sample	$v_i$	$\hat{v}_i$	SE $\hat{v}_i$	$\phi_i$	$\hat{\phi}_i$	$\hat{N}_i$	$\hat{N}_i$
1	84	—	—	0.7995	—	67	—
2	311	—	—	0.7617	—	288	319
3	724	680	44	0.7878	0.7969	797	796
4	741	756	214	—	—	1,201	1,234
5	—	—	—	—	—	—	—

far too low, indicates that this bias was probably not present in our sampling process. Thus biases encountered here are insignificant, both in relation to possible imprecision in estimating the percent run and area covered, and the estimated standard errors.

Estimates computed to evaluate the effects of lowering sampling intensity are shown in Table 7. Simulations are listed according to the percent of top and the percent of bottom captures ignored for that simulation. The estimates obtained by the third

TABLE 6.—Escapement estimates obtained by correcting for differential catchability of fresh and decayed carcasses for three methods of estimating escapement. For each correction, the ratio of the average fresh to decayed catchabilities that was assumed to obtain the corrected estimate is given.

Assumed fresh/decayed Catchabilities	Corrected escapement		
	Jolly-Seber	Manly and Parr	Method 3
Original estimate	3,445	3,438	3,508
1.4/1.0	3,446	3,471	3,274
2.0/1.0	3,321	3,319	3,262

TABLE 7.—Escapement estimates obtained by simulation of reduced sampling effort for three methods of estimating escapement. For each simulation the fraction of decayed top carcass captures and the fraction of decayed bottom carcass captures ignored is given.

Fraction of decayed Carcass captures ignored		Escapement estimate		
		Jolly-Seber	Manly and Parr	Method 3
Original estimate		3,445	3,438	3,508
0.0	0.4	3,740	3,765	3,676
0.0	1.0	3,944	4,058	3,777
0.2	0.4	3,890	3,917	3,977
0.4	0.6	4,844	4,934	4,364

method are less biased than those obtained by the other two methods.

## DISCUSSION

The estimates of total immigration are all remarkably close to the weir count. This accuracy is even more remarkable in light of the fact that CDF&G has traditionally used a correction factor of 0.95 to account for an estimated 5% of the spawning grounds that is not sampled on Bogus Creek. Inclusion of this factor brings all of the estimates to within 1.4% of the weir count. Since the third method provides a high degree of precision (Table 2) at much less sampling cost, it is preferable over the other two methods. We can compare the precision of the third method with the Jolly-Seber and Manly and Parr methods by comparing the standard error estimates that are available for those two methods (Table 1). The Jolly-Seber method is more precise in estimates of  $N$ ,  $B$ , and  $\Phi$ . This is expected, since both the Manly and Parr method and the third method use fewer individuals in estimates than the Jolly-Seber method does. However, the precision of the third method is more than adequate: 95% confidence intervals are +5.3% and -5.5% of the escapement estimate.

The detected violations of assumptions, age-dependent catchability and heterogeneity of capture probabilities and survival, are those that would be expected on the basis of physical considerations.

Survival of carcasses is a function of two processes: fresh carcasses being removed by carnivores, and old carcasses decaying and becoming buried in the stream bed. Rates of disappearance could thus be affected by condition, and therefore age and size, of carcasses. Older carcasses and smaller carcasses, which decay more quickly and are buried more easily than larger carcasses, would be expected to have lower survival rates.

Catchability is a function of both visibility and location, both of which would be expected to vary with condition and size of carcasses. This causes two different types of problems: age-dependent catchability and size-dependent catchability. Shiny, fresh carcasses were much more visible on the bottom of the stream than the brown, decayed carcasses. Carcasses on the stream surface were in general visible regardless of their condition. Since carcasses lost their high visibility in about a week, no marked carcasses will be in this high visibility category, and unmarked carcasses will on the average be more catchable than marked carcasses. This can be thought of as age-dependent catchability. Size-dependent catchability stems from the fact that decayed individuals that were large were more visible than those that were small. This can be viewed as capture heterogeneity. Since fresh fish were high visible regardless of their size, this heterogeneity existed only among decayed individuals. Based on these considerations we would expect catchability to vary with age and size according to Figure 4.

While both Jolly's (1982) and Seber's (1982) tests indicate differential catchability and/or mortality are present, the issue of real importance is the amount of any resulting bias. Manly (1970) concluded that if age-specific mortality is present in a sampled population, Manly and Parr (1968) estimates should fare better than those of Jolly and Seber (Seber 1982). Both methods, however, are biased for the case in which mortality increases with age; in fact, Manly's (1970) estimates of bias for additions ( $B$ ) are greater for Manly and Parr estimates than for Jolly-Seber estimates for those simulations with parameters closest to our population. Survival, population size, and catchability estimates were negatively biased by only 1 or 2%. Seber (1982) pointed out that Jolly-Seber estimates should be relatively unbiased even with differential mortality if mark status and mortality were not correlated. Both estimators, then, should have relatively unbiased estimates of survival and catchability for "marked" animals. A positive bias in estimates of immigration,  $B$ , (and consequently in  $\hat{E}$ ) would arise primarily from applying mortality of marked animals to the entire population, when marked animals are in general older, and thus have lower survival than unmarked animals.

The age-dependent catchability detected in this study would be expected to result in a positive bias in the estimate of total escapement,  $E$ . Because each capture sample includes fresh, recently immigrated individuals, and recapture samples include older, decayed individuals, we expect  $N$  to be overestimated (i.e.,  $n/N > m/M$  in Jolly-Seber and  $pN < n$  in Manly and Parr), which results in estimates of  $B$  and  $E$  being positively biased also. Since bias from age-dependent catchability in  $N$  decreases as  $M$  ap-

proaches  $N$ , and removing carcasses after capture in the third method decreases the ratio of marked to total carcasses, we would expect the third estimator to be more biased by age-dependent catchability problems than the first two methods.

However, the simulations of lower sampling intensity, which would exacerbate the effects of age-dependent catchability, show that the estimate obtained by the third method is more robust with regard to lowered sampling intensity. This unexpected result is probably due to compensating effects which decrease bias in  $E$ . The two most important components of  $E$  are the second ( $(N_2 - R_1) / \hat{\Phi}_1^{1.5}$ ) and third ( $\hat{D}_2$ ). In the standard estimates these values both increase with increases in the number of captures ignored. In the third method, however, the second component increases, but the third decreases. This is because as catchability declines, fewer marks are captured and "removed", hence more carcasses are available for later capture. This is not the case in the first two methods because marked carcasses are not removed at capture. Since in the third method the composition of  $M$  and  $N$  is relatively unchanged at the second sample period, but at the third sample period,  $M$  increases relative to  $N$  (because of the increase in the number of decayed marks present), the estimate of population size at the third sample period will be less biased than the estimate for the second sample period. This results in a negative bias in the estimated immigration from time period two to three. This compensation makes the third method more robust with respect to age-dependent catchability problems than the other two methods. Bias in the estimates is not severe until large numbers of capture events are ignored (Table 7). While all three methods produce accurate estimates, even when lowered sampling exacerbates differential catchability problems, the magnitude of the bias relative to standard errors can be substantial. For this reason, samples must be carefully taken if estimates from different streams or different years (which will have different biases because of different conditions) are to be compared statistically.

Heterogeneity of capture probabilities affects Jolly-Seber and Manly and Parr estimates in the same manner. Since in the Jolly-Seber method the individuals marked and released at sample  $i$ ,  $R_i$ , are on the average younger than the individuals marked and released prior to sample  $i$ ,  $M_i$  is a low estimate (i.e.,  $r/R > z/(M - m)$ , or  $M > (Rz/r) + m$ ). This decreases the positive bias in  $N$  which is caused by age-dependent catchability. Since bias in  $M$  increases as more individuals are marked, we expect

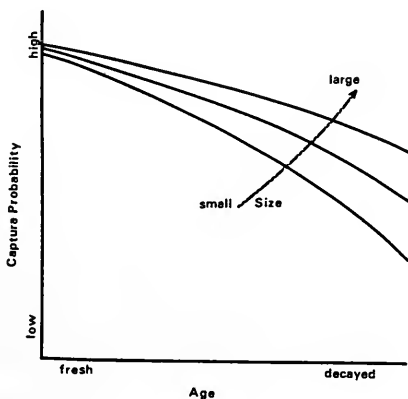

FIGURE 4.—Expected changes in capture probabilities with age at different sizes.

estimates of  $M$  from the third method to be less biased than those from the first two.

Usually, capture heterogeneity leads to the more catchable animals joining the marked population, and we expect marked animals to be more catchable than unmarked animals. Capture heterogeneity, however, is only prevalent among decayed individuals who are all less catchable than fresh, unmarked individuals. Thus, capture heterogeneity, by placing the more catchable decayed individuals in the marked population, results in the capture probability of marked animals being closer to the capture probability of unmarked animals. This reduces the negative bias in population size ( $N$ ), immigration ( $B$ ), and escapement ( $E$ ) estimates, which was caused by age-dependent catchability. Again, the third method, by removing decayed individuals and decreasing the fraction of the population which is decayed, will not be affected by capture heterogeneity as strongly as the other two methods.

Manly and Parr estimators will have the same ameliorating affects because of capture heterogeneity as their Jolly-Seber counterparts. Since the estimate of catchability,  $p$ , should be accurate for the more catchable animals, estimated survival should be accurate for that group. Bias would result from correlations between catchability and survival. Also, since  $p$  is estimated for marked (and thus decayed) individuals, using the more catchable decayed individuals to estimate  $p$  brings the estimated catchability closer to the actual catchability of the unmarked individuals. Again, this reduces the bias in  $\hat{N}$ ,  $\hat{B}$ , and  $\hat{E}$  which is caused by age-dependent catchability.

There are other approaches to estimating parameters from populations with age-dependent survival and capture rates. By placing carcasses in two readily identifiable age classes, fresh (and thus <1 wk old) or decayed (and thus older than 1 wk), Pollock's (1981) modified Jolly-Seber analysis of the data could have been made. Since this method requires recaptures of decayed individuals, it could not be used to analyze data from previous surveys, and it would require more sampling effort in future surveys than the method 3 estimate. If different age classes have sufficiently different capture or survival rates, then this method will provide more accurate estimates. If not, then it will yield the same estimate as the third method, but would have higher variances, as more parameters are estimated.

## ACKNOWLEDGMENTS

We would like to thank L. B. Boydston of the California Department of Fish and Game for making us aware of this problem, for many helpful discussions, and for assisting in data collection. S. Sykes was supported by the California Department of Fish and Game during the sampling. We are grateful for the comments by K. Pollock, T. Schoener, and N. Matloff on an earlier version of this manuscript. We would also like to thank Ivan Paulsen for assistance in data collection.

## LITERATURE CITED

- BUCKLAND, S. T.  
1980. A modified analysis of the Jolly-Seber capture-recapture model. *Biometrics* 36:419-435.
- CAROTHERS, A. D.  
1971. An examination and extension of Leslie's test of equal catchability. *Biometrics* 27:615-630.
- DARROCH, J. N.  
1961. The two-sample capture-recapture census when tagging and sampling are stratified. *Biometrika* 48:241-260.
- JOLLY, G. M.  
1982. Mark-recapture models with parameters constant in time. *Biometrics* 38:301-321.
- MANLY, B. F. J.  
1970. A simulation study of animal population estimation using the capture-recapture method. *J. Appl. Ecol.* 7:13-39.
- MANLY, B. F. J., AND M. J. PARR.  
1968. A new method of estimating population size, survivorship, and birth rate from capture-recapture data. *Trans. Soc. Br. Entomol.* 18:81-89.
- PARKER, R. R.  
1968. Marine mortality schedules of pink salmon of the Bella Coola River, central British Columbia. *Can. J. Fish. Res. Board* 25:757-794.
- POLLOCK, K. H.  
1981. Capture-recapture models allowing for age-dependent survival and capture rates. *Biometrics* 37:521-529.
- SCHAEFER, M. B.  
1951. Estimation of the size of animal populations by marking experiments. *U.S. Fish Wildl. Serv., Fish. Bull.* 52: 191-203.
- SEBER, G. A. F.  
1982. The estimation of animal abundance and related parameters. MacMillan Publishing Co, Inc, N.Y. 654 p.
- STAUFFER, G.  
1970. Estimates of population parameters of the 1965 and 1966 adult Chinook salmon runs in the Green-Duwamish River. M.S. Thesis, Univ. Washington, Seattle, 155 p.
- SYKES, S. D.  
1982. Multiple mark-recapture estimators of salmon spawning runs sizes. M.S. Thesis, Univ. California, Davis, 64 p.

# THE DISTRIBUTION OF THE HUMPBACK WHALE, *MEGAPTERA NOVAEANGLIAE*, ON GEORGES BANK AND IN THE GULF OF MAINE IN RELATION TO DENSITIES OF THE SAND EEL, *AMMODYTES AMERICANUS*

P. MICHAEL PAYNE,<sup>1</sup> JOHN R. NICOLAS,<sup>2</sup> LORETTA O'BRIEN,<sup>2</sup>  
AND KEVIN D. POWERS<sup>1</sup>

## ABSTRACT

The distribution of the humpback whale, *Megaptera novaeangliae*, (based on shipboard sighting data) is significantly correlated ( $r = 0.81$ ,  $df = 13$ ) with the number of sand eel, *Ammodytes americanus*, per standardized tow (based on NMFS/NEFC groundfish surveys) by strata within the Gulf of Maine. A demonstrated increase in the number of humpback whale sightings in the southwest Gulf of Maine since 1978 concurrent with an increase in the number of sand eel in the same area supports the hypothesis that within the Gulf of Maine the present distribution of humpback whales is due to the distribution of their apparent principal prey, the sand eel. A similar correlation between humpback whale sightings and sand eel abundance on Georges Bank was not significant ( $r = 0.24$ ,  $df = 18$ ) despite dense patches of sand eel in that region. Therefore, within the combined Gulf of Maine-Georges Bank regions, factors other than simply prey availability must influence the feeding distribution of the humpback whale. We argue that the bottom topography of the Gulf of Maine and the foraging behavior of the whales are critical factors influencing their present feeding distribution.

In the northwest Atlantic, the major summer concentrations of humpback whales, *Megaptera novaeangliae*, occur off the coasts of Newfoundland-Labrador and off the coast of New England in the Gulf of Maine which includes Georges Bank (Katona et al. 1980; Whitehead et al. 1982). During this period feeding is their principal activity. The major winter concentrations in the western North Atlantic occur along the Antillean Chain in the West Indies, principally on Silver and Navidad Banks which lie north of the Dominican Republic (Winn et al. 1975; Balcomb and Nichols 1978; Whitehead and Moore 1982). During this season conception and calving are their primary activities; food does not seem to be an important determinant of the humpbacks in these areas (Whitehead and Moore 1982).

Humpbacks have been generally considered coastal animals (Mackintosh 1965). However, their migratory routes between regions of winter breeding and summer feeding in the northwest Atlantic (based on sighting data) occur in deeper, slope waters off the continental shelf (Hain et al. 1981; Kenney et al. 1981; Payne et al. 1984). Several possible offshore routes between winter and summer grounds suggest reasonably distinct stocks (Katona

et al. 1980). Kenney et al. (1981) suggested that for the Gulf of Maine stock, the Great South Channel (Fig. 1) is the major exit-entry between the Gulf of Maine feeding area and the deeper, offshore migration route.

Humpback whales have been described as generalists in their feeding habits (Mitchell 1974). The reported prey of humpbacks in the Gulf of Maine are Atlantic herring, *Clupea harengus*; Atlantic mackerel, *Scomber scombrus*; pollock, *Pollachius virens*; and the American sand eel, *Ammodytes americanus* (Gaskin 1976; Katona et al. 1977; Watkins and Schevill 1979; Kraus and Prescott 1981). In recent years, observations of feeding humpbacks indicate that sand eels have become an increasingly important prey item in the Gulf of Maine (Overholtz and Nicolas 1979; Hain et al. 1982; Mayo 1982).

Kenney et al. (1981) hypothesized that the observed distribution of the Gulf of Maine humpback stock was due to the distribution of sand eel, their apparent principal prey species. However, the present distribution of the humpback whale in the Gulf of Maine and throughout the remaining shelf waters of the northeastern United States is not so clearly related to the distribution of sand eel as was suggested. Although we recognize an important predator-prey interaction between humpbacks and sand eel, we hypothesize that behavior and bottom

<sup>1</sup>Manomet Bird Observatory, Marine Mammal and Seabird Studies, Box 936, Manomet, MA 02345.

<sup>2</sup>Northeast Fisheries Center Woods Hole Laboratory, National Marine Fisheries Service, NOAA, Woods Hole, MA 02543.

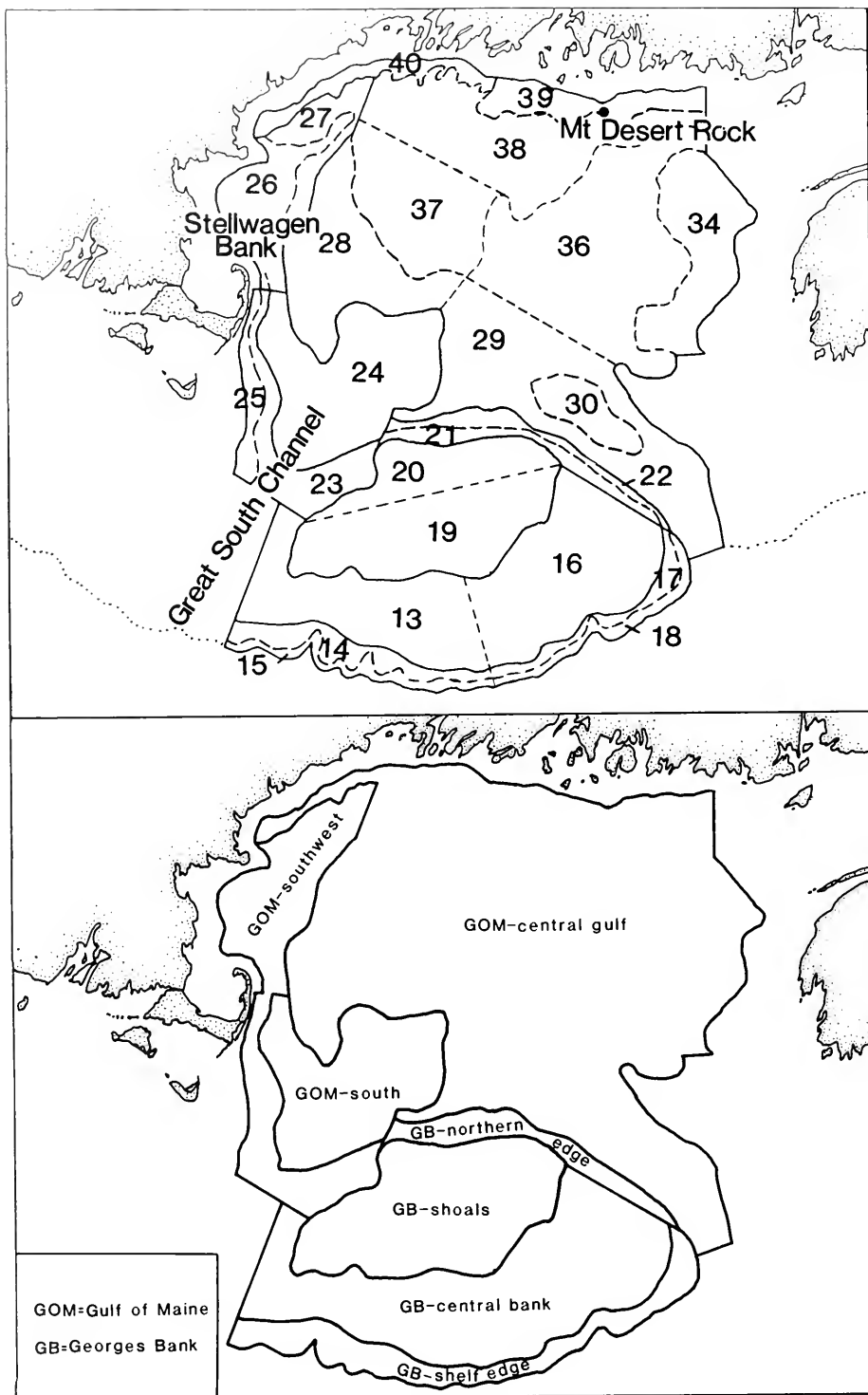

FIGURE 1.—The geographical areas and NMFS/NEFC bottom-trawl survey strata in the study area (upper) and the combined strata into regions (lower) referred to throughout the text.



topography are also critical factors in the foraging strategy of humpbacks, hence the present distribution of these whales. We base this hypothesis on observed sightings of humpbacks throughout the shelf waters of the northeastern United States in relation to sand eel abundance, and on an apparent shift in the center of feeding areas used by humpbacks in the Gulf of Maine since the mid-1970's.

## METHODS

The collection of fisheries data used in these analyses was carried out by National Marine Fisheries Service/Northeast Fisheries Center (NMFS/NEFC) scientists and technicians on domestic research vessels during standardized spring bottom-trawl surveys. These surveys measure trends in fin-fish population abundance and have been used to monitor changes in the size and composition of fin-fish biomass (Clark and Brown 1977; Grosslein et al. 1980).

Meyer et al. (1979) found that spring (March-May) bottom-trawl surveys accurately reflect trends in sand eel abundance. Therefore, the fisheries data we examined were from these surveys, 1978-82. The stratified mean catch per tow of sand eel was calculated for each region and considered proportional to the population size within each region. We transformed the mean catch into logarithmic values; then, using a two-way analysis of variance (F-statistic), we compared sand eel population size by region and year.

The survey area includes shelf waters from Cape Hatteras north to Nova Scotia and has been spatially stratified by the NMFS/NEFC, based principally on depth and latitude (Grosslein 1969). Sampling stations are randomly assigned within a stratum and the number of stations allocated to strata approximately in proportion to the area of each stratum (Grosslein 1969). In this study, individual stratum have been combined into regions (Fig. 1), in a manner consistent with NMFS/NEFC management units. The two important regions emphasized are the Gulf of Maine and Georges Bank.

Sightings of humpback whales were recorded by observers from the Manomet Bird Observatory (MBO) on NMFS/NEFC research vessels conducting standardized surveys. Observations were recorded continuously along the predetermined cruise path between the sampling stations (following Payne et al. (1984)) in 15-min periods where each period represents a transect. Thus, the duration of each observation period was constant, but the linear km surveyed within each 15-min period depended upon

vessel speed. The location (latitude-longitude) of each 15-min observation and the location and number of humpback whales observed were recorded and assigned to appropriate regions to facilitate direct comparisons between the observed number of humpbacks per linear km (humpbacks/effort) and potential prey densities.

Humpback whales are generally present in the study area from spring through fall (March-November) and absent during the winter (CETAP 1982). Therefore, sighting data and effort for winter months were excluded from the analyses. We also examined sighting data collected only during optimum sea conditions less than Beaufort (Kenney et al. 1981) (<16 nmi/h). Difference between the number of humpbacks/effort sighted by region and year were also compared by a two-way analysis of variance (F-statistic).

A coefficient of correlation ( $r$ ) from the linear regression between the stratified mean catch of sand eel (log) and the number of humpbacks/effort was used to determine whether concentrations of humpback whales co-occurred with patches of sand eel within regions of the Gulf of Maine and Georges Bank.

A  $P < 0.05$  was considered statistically significant.

## RESULTS

### Distribution of Sand Eel

The stratified mean number of sand eel varied significantly between regions on Georges Bank ( $F = 14.14$ ,  $df = 3, 12$ ) and in the Gulf of Maine ( $F = 16.90$ ,  $df = 2, 8$ ). On Georges Bank, sand eel were very abundant on the shoals with catches ranging from 1.117 sand eel/tow (log value) in 1978 to 2.846 (log value) in 1982 (Table 1). Sand eel were absent from most tows along the northern and shelf edges. Sand eel were also abundant in the southwest Gulf of Maine ranging from 0.670 sand eel/tow (log value) in 1978 to 2.422 in 1981 (Table 1). Sand eel were not abundant in the deeper, central Gulf of Maine. This patchy distribution reflects a known preference of the sand eel for sand-bottom substrates (Bigelow and Schroeder 1953) characteristic of submarine banks and shoals. No significant differences were found between the stratified mean catch per tow (log value) by year.

### Distribution of Humpback Whales

Since 1978, the observed number of humpbacks/effort in the Gulf of Maine has steadily increased

TABLE 1.—Stratified mean number of sand eel per tow  $\pm$  SE (in parentheses) and the number of sampling tows (lower number) by region and year.

Region	1978	1979	1980	1981	1982
Georges Bank shoals	1.117 (0.233) 15	1.200 (0.305) 30	2.752 (0.590) 15	1.850 (0.499) 15	2.846 (0.691) 15
northern edge	0.000 — 9	0.256 (0.211) 16	0.000 — 8	0.747 (0.464) 8	0.000 — 8
shelf edge	0.100 (0.707) 15	0.000 — 14	0.000 — 14	0.000 — 10	0.000 — 14
central bank	0.941 (0.182) 21	0.410 (0.202) 38	0.236 (0.132) 18	0.654 (0.396) 19	0.034 (0.341) 19
Gulf of Maine central gulf	0.000 — 64	0.012 (0.012) 61	0.141 (0.101) 47	0.055 (0.545) 45	0.000 — 47
southern	0.000 — 9	0.625 (0.422) 12	0.116 (0.115) 6	1.077 (0.617) 6	0.116 (0.115) 6
southwest	0.670 (0.371) 20	1.286 (0.289) 34	1.240 (0.384) 16	2.422 (0.756) 18	0.860 (0.318) 21

(Table 2). Over 90% of the humpbacks/effort observed each year in the combined Georges Bank-Gulf of Maine waters were seen in the Gulf of Maine. The increased number of humpbacks/effort observed was significantly different between regions in the Gulf of Maine ( $F = 7.098$ ,  $df = 2, 8$ ). The greatest concentrations of humpbacks in the Gulf of Maine are located in the southwest region (Table 2). Between 1978 and 1982, 82% of the total humpbacks/effort in the Gulf of Maine were observed in the southwest region. The importance of this region for feeding humpbacks has been previously reported (Kenney et al. 1981; Hain et al. 1982).

Although there were no significant differences between the number of humpbacks/effort seen by year ( $F = 0.824$ ,  $df = 4, 12$ ) or region ( $F = 0.609$ ,  $df = 3, 12$ ) on Georges Bank, the number of humpbacks/effort observed on the bank has steadily declined since 1978. Sixty percent of the humpbacks/effort observed on Georges Bank between 1978 and 1982 occurred during 1978 (Table 2).

We examined the apparent increase in the southwest Gulf of Maine more thoroughly by dividing it into two smaller components (Table 3), a southern which extends from the Great South Channel north along the outside of Cape Cod (NMFS/NEFC strata 23, 25, from Figure 1) and a northern which centers on Stellwagen Bank (NMFS/NEFC strata 26, 27, from Figure 1). The number of humpbacks/effort observed within the southwest Gulf of Maine-north-

ern segment steadily increased by an order of magnitude from  $1.86 \times 10^{-2}$  whales/effort in 1978 to  $29.01 \times 10^{-2}$  whales/effort in 1982. Therefore, the observed increase in the number of humpbacks/effort in the southwest Gulf of Maine since 1978 has occurred primarily in the northern half of this region (NMFS/NEFC strata 26, 27).

TABLE 2.—The number of humpback whales per linear km  $\times 10^{-2}$  (humpbacks/effort) seen during shipboard observations and the total number of linear km surveyed (in parentheses) by region and year.

Region	1978	1979	1980	1981	1982
Georges Bank shoals	— (480.9)	0.189 (529.0)	— (190.0)	— (342.6)	— (744.5)
northern edge	1.500 (200.0)	— (176.8)	— (66.5)	— (89.8)	— (222.7)
shelf edge	— (230.0)	— (213.6)	— (115.6)	— (207.0)	0.225 (198.6)
central bank	0.168 (593.6)	0.285 (701.9)	0.299 (334.4)	— (895.9)	0.116 (863.5)
Gulf of Maine central gulf	0.750 (933.1)	0.119 (841.7)	— (966.0)	0.855 (467.6)	— (1,172.8)
southern	2.449 (489.8)	0.828 (482.8)	— (267.6)	0.393 (254.2)	1.662 (223.5)
southwest	1.174 (681.2)	2.817 (745.4)	7.679 (547.0)	11.172 (454.9)	6.814 (692.5)

TABLE 3.—The number of humpback whales per linear km  $\times 10^{-2}$  (humpbacks/effort) seen during shipboard observations and the total number of linear km surveyed (in parentheses) within the partitioned southwest Gulf of Maine.

Region	1978	1979	1980	1981	1982
Northern (strata 26, 27)	1.864 (34.9)	2.655 (263.6)	10.794 (333.5)	22.469 (252.6)	29.014 (299.6)
Southern (strata 23, 25)	0.556 (359.3)	3.113 (481.8)	2.811 (213.5)	1.987 (202.3)	3.308 (392.9)

### Correlation Between Humpback Whale Distribution and Sand Eel Abundance

A significant correlation ( $r = 0.81$ ,  $df = 13$ ) exists between the observed number of humpbacks/effort and the log-mean number of sand eel/tow by region within the Gulf of Maine (Fig. 2). This indicates that within the Gulf of Maine the distribution of humpback whales do co-occur with dense patches of sand eel in that region. The greatest densities of sand eel in the Gulf of Maine and the greatest observed numbers of humpbacks/effort have both occurred in the southwest Gulf of Maine since 1978. This supports the hypothesis by Kenney et al. (1981) that within the Gulf of Maine, the

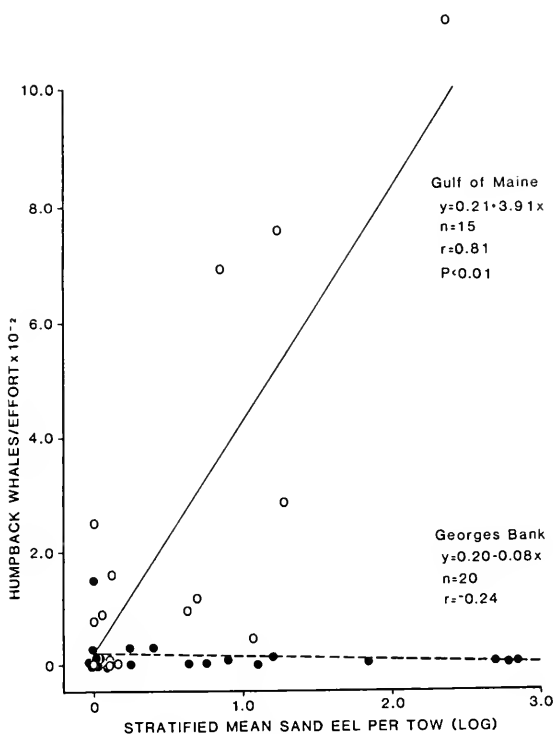

FIGURE 2.—The regression and correlation coefficient ( $r$ ) between the stratified mean number of sand eel/tow (log value) and the number of humpback whales/effort  $\times 10^{-2}$  by region and year on Georges Bank (closed circles) and in the Gulf of Maine (open circles).

observed distribution of the humpback whale was due to the distribution of sand eel.

However, the correlation between the observed number of humpbacks/effort and the log mean number of sand eel/tow by region on Georges Bank (Fig. 2) was not significant ( $r = 0.24$ ,  $df = 18$ ). The mean number of sand eel/tow (log value) on Georges Bank was greatest on the shallow shoals. Only one humpback whale was observed on the shoals between 1978 and 1982. Our data does not support any co-occurrence between humpback whale distribution and sand eel abundance on Georges Bank despite dense patches of sand eel in that region.

## DISCUSSION

Our data suggest that the distribution of humpback whales in the Gulf of Maine-Georges Bank region is presently centered in the southwest Gulf of Maine. This distribution is correlated with dense concentrations of sand eel, a principal prey item, which has dramatically increased throughout shelf

waters of the eastern United States including the southwest Gulf of Maine since the mid-1970's (Meyer et al. 1979; Sherman et al. 1981). This increase in sand eel followed a decline of Atlantic herring stocks from the mid-1960's to the mid-1970's (Anthony and Waring 1980; Grosslein et al. 1980), and possible replacement by sand eel of depleted fish stocks in the northwest Atlantic (Sherman et al. 1981). The correlations between the humpback distribution in the Gulf of Maine and sand eel abundance supports the theory by Kenney et al. (1981) that the present distribution of the whales in that region is due to the distribution of sand eel. A demonstrated shift in the humpback distribution since the mid-1970's from the upper Gulf of Maine-lower Bay of Fundy southward into the southwest Gulf of Maine also supports this theory.

A 10-yr summary of observations from Mt. Desert Rock, ME (MDR, Fig. 1) in the northern Gulf of Maine shows a dramatic decrease in the number of humpback sightings/observer hour since 1977 (Mullane and Rivers 1982). The maximum number of humpbacks observed in that summary occurred in 1975 (98 whale sightings, 0.123 humpbacks/observer hour). Only 10 humpbacks were seen from 1978 to 1982, and the maximum number of humpbacks/effort since 1975 has been 0.005/observer hour in 1982. This decline in the number of humpbacks at MDR coincides with the increased numbers of humpbacks observed in the southwest Gulf of Maine. Twelve of the 17 humpbacks photo-identified from 1975 to 1977 at MDR have subsequently been seen in the southwest Gulf of Maine, principally on Stellwagen Bank. At least three of these whales have been observed during three different years on Stellwagen Bank since they were first identified at MDR (Mullane and Rivers 1982). In comparison, only one whale identified at MDR has consistently returned to the coastal waters of eastern Maine and New Brunswick. Katona et al. (1977) also listed the Grand Manan Banks, Briers Island-St. Mary's Bay, Nova Scotia, and the lower Bay of Fundy as areas of humpback congregations. However, humpbacks were not common in the Bay of Fundy during 1981 and 1982 (Kraus and Prescott 1981, 1982).

Shifts in the distribution of humpbacks caused by changes in the distribution and density of prey species have been shown elsewhere (Lien and Merdsoy 1979; Whitehead et al. 1980). We believe that the correlations between humpbacks/effort and mean sand eel catches in the southwest Gulf of Maine, and the demonstrated decline of humpbacks throughout the upper Gulf of Maine-lower Bay of Fundy concurrent with an increase in the numbers

of humpbacks in the southwest Gulf of Maine reasonably explains the present distribution of humpbacks within the Gulf of Maine. However, it does not adequately explain the paucity of humpbacks on Georges Bank (Table 2) and throughout the remaining shelf waters of the northeastern United States (Hain et al. 1981; Kenney et al. 1981; Payne et al. 1984), areas where sand eel have also increased since 1975. The nonsignificant correlation between humpbacks/effort and the log-mean catches of sand eel/tow on Georges Bank suggests that factors other than simply food concentrations, perhaps behavioral or environmental, may influence the humpback's feeding strategy and location.

Sutcliffe and Brodie (1977) reported that humpbacks are led into ecological or oceanographic boundaries (i.e., isopleths or shelf-edges) and feed in patchy areas of dense prey aggregations along these boundaries. A change in depth on the shelf is often accompanied by a concentration of near-surface zooplankton; in general, the more abrupt the change, the greater the concentration (Sutcliffe and Brodie 1977). Concentrations are especially noticeable along the edge of banks where the availability of prey is most affected (Jaansgard 1974). Reay (1970) found that sand eel concentrations are greatest on the edges of sandy banks where currents and prey (zooplankton) are optimum; thus the whales, in seeking the highest concentrations of prey, feed most frequently along the edges of the banks (Sutcliffe and Brodie 1977; Brodie et al. 1978). Observations of feeding humpbacks in the Gulf of Maine have occurred primarily along the edge of submarine banks or canyons (Hain et al. 1982; CETAP 1982).

If bottom topography influences feeding behavior of humpbacks (by concentrating prey), then the paucity of humpbacks on Georges Banks and throughout the mid-Atlantic Bight regions becomes more understandable. The floor of the broad mid-Atlantic Bight is gently sloping continental shelf with no relief until it steepens sharply at the shelf break, at about 200 m depth, to form the continental slope. Since the feeding behaviors for humpbacks described by Hain et al. (1982) occur principally over a shelf-floor with rugged relief, the strategies used by humpbacks seem most efficient in these waters. This also explains the present lack of sightings in the mid-Atlantic shelf waters and the offshore migration route between calving and feeding areas. It seems energetically advantageous for the humpback, a relatively slow-moving whale, to migrate over deep water with little apparent feeding, then feed on the densely concentrated prey along the bottom profiles of the Gulf of Maine.

We maintain that humpbacks are merely utilizing the first concentrations of prey available to them in spring, after they reach shelf-waters from their offshore migration route between winter-calving and summer-feeding grounds. The humpbacks seem to use the Great South Channel as an entry-exit into the Gulf of Maine (as hypothesized by Kenney et al. (1981)), and follow the bottom profile northward, using this profile to their feeding advantage until they reach the dense concentrations of sand eel available within the southwest Gulf of Maine. The quantities of sand eel available to humpbacks at this location have allowed the whales to remain throughout the feeding season; therefore, the recent paucity of sightings in the northern Gulf of Maine.

## ACKNOWLEDGMENTS

The authors wish to thank T. R. Azarovitz, S. K. Katona, P. Major, M. P. Pennington, M. P. Sissenwine, G. Waring, H. Whitehead, and anonymous reviewers for criticizing previous drafts of this manuscript. The study was funded by the National Marine Fisheries Service, Northeast Fisheries Center, Woods Hole, MA.

## LITERATURE CITED

- ANTHONY, V. C., AND G. WARING.  
1980. The assessment and management of the Georges Bank herring fishery. *Int. Counc. Exp. Sea, Rapp. P.-v. Réun.* 177:72-111.
- BALCOMB, K. C., AND G. NICHOLS.  
1978. Western north Atlantic humpback whales. *Rep. Int. Whaling Comm.* 28:159-164.
- BIGELOW, H. B., AND W. C. SCHROEDER.  
1953. Fishes of the Gulf of Maine. *U.S. Fish Wildl. Serv., Fish. Bull.* 53:1-577.
- BRODIE, P. F., D. D. SAMEOTO, AND R. W. SHELDON.  
1978. Population densities of euphausiids off Nova Scotia as indicated by net samples, whale stomach contents, and sonar. *Limnol. Oceanogr.* 23:1264-1267.
- CETAP.  
1982. A characterization of marine mammals and turtles in the mid- and north Atlantic areas of the U.S. outer continental shelf. *Final Rep. Cetacean and Turtle Assessment Program, Univ. Rhode Island, Bur. Land Manage. Contract No. AA551-CT8-48, 450 p.* U.S. Dep. Inter., Wash., D.C.
- CLARK, S. H., AND B. E. BROWN.  
1977. Changes in biomass of finfishes and squid from the Gulf of Maine to Cape Hatteras, 1963-74, as determined from research vessel survey data. *Fish. Bull., U.S.* 75:1-21.
- GASKIN, D. E.  
1976. The evolution, zoogeography, and ecology of Cetacea. *Oceanogr. Mar. Biol., Annu. Rev.* 14:247-346.
- GROSSLEIN, M. D.  
1969. Groundfish survey program of BCF Woods Hole. *Commer. Fish. Rev.* 31(8-9):22-35.

- GROSSLEIN, M. D., R. W. LANGTON, AND M. P. SISENWINNE.  
1980. Recent fluctuations in pelagic fish stocks of the Northwest Atlantic, Georges Bank region, in relation to species interactions. *Rapp. P.-v. Réun. Cons. Perm. int. Explor. Mer* 177:374-404.
- HAIN, J. H., G. R. CARTER, S. D. KRAUS, C. A. MAYO, AND H. E. WINN.  
1982. Feeding behavior of the humpback whale, *Megaptera novaeangliae*, in the western north Atlantic. *Fish. Bull., U.S.* 80:259-268.
- HAIN, J. H. W., R. K. EDEL, H. E. HAYS, S. K. KATONA, AND J. D. ROANOWICZ.  
1981. General distribution of cetaceans on the continental shelf waters of the northeastern United States. In A characterization of marine mammals and turtles in the mid- and north Atlantic areas of the U.S. outer continental shelf, p. II-1-257. *Ann. Rep. 1979, Cetacean and Turtle Assessment Program, Univ. Rhode Island, Bur. Land Manage. Contract No. AA551-CT8-48, U.S. Dep. Inter., Wash., D.C.*
- JANGAARD, P. M.  
1974. The capelin (*Mallotus villosus*): biology, distribution, exploitation, utilization and composition. *Bull. Fish. Res. Board Can.* 186, 70 p.
- KATONA, S., W. STEINER, AND H. E. WINN.  
1977. Marine mammals. In Center for natural areas, a summary and analysis of environmental information on the Continental Shelf from the Bay of Fundy to Cape Hatteras, Vol. 1, No. 2, p. 1-167. *Final Rep. Bur. Land Manage., U.S. Dep. Inter., Wash., D.C., Contract No. AA550-CT6-45.*
- KATONA, S. K., P. HARCOURT, J. S. PERKINS, AND S. D. KRAUS.  
1980. Humpback whales: A catalog of individuals identified by fluke photographs. College of the Atlantic, Bar Harbor, ME.
- KENNEY, R. D., D. R. GOODALE, G. P. SCOTT, AND H. E. WINN.  
1981. Spatial and temporal distribution of humpback whales in the CETAP study area. In A characterization of marine mammals and turtles in the mid- and north Atlantic areas of the U.S. outer continental shelf, p. V-1-9. *Ann. Rep. 1979, Cetacean and Turtle Assessment Program, Univ. Rhode Island, Bur. Land Manage. Contract No. AA551-CT8-48, U.S. Dep. Inter., Wash., D.C.*
- KRAUS, S. D., AND J. H. PRESCOTT.  
1981. Distribution, abundance and notes of the large cetaceans of the Bay of Fundy, summer and fall 1980. *Natl. Mar. Fish. Serv., Northeast Fish. Cent. Contract No. NA-80-FA-2-00048, 65 p.*  
1982. The North Atlantic right whale (*Eubalaena glacialis*) in the Bay of Fundy, 1981, with notes on distribution, abundance, biology and behavior. *Natl. Mar. Fish. Serv., Northeast Fish. Cent. Contract No. NA-81-FA-C-00030, 105 p.*
- LEIN, J., AND B. MERDSOY.  
1979. The humpback is not over the hump. *Nat. Hist.* 88(6): 46-49.
- MACKINTOSH, N. A.  
1965. The stocks of whales. Fishing News (Books) Ltd., Lond., 232 p.
- MAYO, C. A.  
1982. Observations of cetaceans: Cape Cod Bay and Southern Stellwagen Bank, Massachusetts, 1975 - 1979. *Natl. Tech. Inf. Serv. Rep. No. PB82-186263, 68 p.*
- MEYER, T. L., R. A. COOPER, AND R. W. LANGTON.  
1979. Relative abundance, behavior, and food habits of the American sand lance, *Ammodytes americanus*, from the Gulf of Maine. *Fish. Bull., U.S.* 77:243-253.
- MITCHELL, E.  
1974. Trophic relationships and competition for food in Northwest Atlantic whales. In M. D. B. Burt (editor), *Proceedings of the Canadian Society of Zoologists annual meeting, June 2-5, p. 123-133.*
- MULLANE, S. J., AND A. RIVERS.  
1982. Mt. Desert Rock, Maine - Annual report. Allied Whale, College of the Atlantic, Bar Harbor, Maine, 27 p.
- OVERHOLTZ, W. J., AND J. R. NICOLAS.  
1979. Apparent feeding by the fin whale, *Balaenoptera physalus*, and humpback whale, *Megaptera novaeangliae*, on the American sand lance, *Ammodytes americanus*, in the northwest Atlantic. *Fish. Bull., U.S.* 77:285-287.
- PAYNE, P. M., L. A. SELZER, AND A. R. KNOWLTON.  
1984. Distribution and density of cetaceans, marine turtles, and seabirds in the shelf water of the northeastern United States, June 1980 - December 1983, based on shipboard observation. *Natl. Mar. Fish. Ser., Northeast Fish. Cent. Contract No. NA-81-FA-C-00023, 246 p.*
- REAY, P. J.  
1970. Synopsis of biological data on North Atlantic sand eels of the genus *Ammodytes*: *A. tobianus*, *A. dubius*, *A. americanus*, and *A. marinus*. *FAO Fish. Synop. No. 82, 28 p.*
- SHERMAN, K. C., C. JONES, L. SULLIVAN, W. SMITH, P. BERREIN, AND L. EJSTMONT.  
1981. Congruent shifts in sand eel abundance in western and eastern North Atlantic ecosystems. *Nature* 291:486-489.
- SUTCLIFFE, W. H., AND P. F. BRODIE.  
1977. Whale distribution in Nova Scotia Waters. *Fish. Mar. Serv. Tech. Rep. 722, 83 p.* Fisheries and Marine Service, Bedford Institute of Oceanography, Dartmouth, Nova Scotia.
- WATKINS, W. A., AND W. E. SCHEVILL.  
1979. Aerial observation of feeding behavior in four baleen whales: *Eubalaena glacialis*, *Balaenoptera borealis*, *Megaptera novaeangliae*, and *Balaenoptera physalus*. *J. Mammal.* 60:155-163.
- WHITEHEAD, H., P. HARCOURT, K. INGHAM, AND H. CLARK.  
1980. The migration of humpback whales, past the Bay de Verde Peninsula, Newfoundland, during June and July, 1978. *Can. J. Zool.* 58:687-692.
- WHITEHEAD, H., AND M. J. MOORE.  
1982. Distribution and movements of West Indian humpback whales in winter. *Can. J. Zool.* 60:2203-2211.
- WHITEHEAD, H., R. SILVER, AND P. HARCOURT.  
1982. The migration of humpback whales along the northeast coast of Newfoundland. *Can. J. Zool.* 60:2173-2179.
- WINN, H. E.; R. K. EDEL, AND A. G. TARUSKI.  
1975. Population estimate of the humpback whale (*Megaptera novaeangliae*) in the West Indies by visual and acoustic techniques. *J. Fish. Res. Board Can.* 32:499-506.



# SEABIRDS NEAR AN OREGON ESTUARINE SALMON HATCHERY IN 1982 AND DURING THE 1983 EL NINO

RANGE D. BAYER<sup>1</sup>

## ABSTRACT

In the summer of 1982, 14.4 million salmon, *Oncorhynchus* sp., smolts were released at the Yaquina Estuary, OR; and in the summer of 1983, 12.8 million salmon smolts were released. Within hours after release, fish-eating seabirds aggregated at the estuary mouth. In 1982, the number of no seabirds was significantly correlated with the number of days since a release. In 1983, however, numbers of common murrelets, *Uria aalge*; gulls, *Larus* sp.; and brown pelicans, *Pelecanus occidentalis*, were significantly inversely correlated with the date of a release, and the number of cormorants, *Phalacrocorax* sp., was significantly more abundant the second day after a release. In contrast, numbers of Caspian terns, *Sterna caspia*, and pigeon guillemots, *Cepphus columba*, showed no relationship with releases in 1983.

There were significantly more cormorants and marbled murrelets, *Brachyramphus marmoratus*, in 1983 than in 1982. There were also significantly more murrelets in 1983 than in 1982 before 1 August, but fewer afterwards. Gull and brown pelican numbers were about the same between years, but significantly fewer pigeon guillemots were present in 1983 than in 1982.

Seabirds have been estimated to consume 29% of the pelagic fish production within 45 km of a British seabird colony (Furness 1984b), and several simulation models for various geographical areas indicate that 20-30% of the annual pelagic fish production may be preyed upon by seabirds (Furness 1984a). Since the mortality of salmon, *Oncorhynchus* sp., smolts as a result of predation and environmental factors is greater shortly after they first enter the ocean than after they move offshore (Parker 1962, 1968), the impact of seabird predation on salmon smolts just released along a coast could also be significant.

El Nino is the intrusion of anomalously warm water off the coast of Peru and Ecuador (Barber and Chavez 1983); an El Nino of varying intensity occurs on the average of every 3-5 yr (Quinn et al. 1978; Duffy 1983a). Along the Oregon coast, warm-water conditions concurrent with an El Nino appear much more rarely, and in the last century have occurred only in 1983, 1957-1958, and perhaps in 1941 (Huyer 1983; Reed 1983). The impact of seabirds on hatchery-released salmon smolts would be expected to be greater in years of anomalously warm water associated with El Nino, when natural prey for seabirds become rare and seabirds starve or have low nesting success (Boersma 1978; Duffy 1983a, b; Ainley 1983; Schreiber and Schreiber 1984).

Here, I correlate bird numbers with salmon smolt releases at Yaquina Estuary, OR, and examine variation in bird numbers between the summer of 1982 and the summer of 1983, when warm water associated with an El Nino was present.

## STUDY AREA AND METHODS

Yaquina Estuary (Fig. 1) is located on the mid-Oregon coast and is a drowned river valley. It has an intertidal and submerged area of 15.8 km<sup>2</sup> (Oregon State Land Board 1973). During this study, all releases were from the site designated as OAF in Figure 1.

The most abundant seabird nesting nearby was the common murre, *Uria aalge*, but western gulls, *Larus occidentalis*; Brandt's cormorants, *Phalacrocorax penicillatus*; pelagic cormorants, *P. pelagicus*; and pigeon guillemots, *Cepphus columba*, also nested there (Table 1; Pitman et al. in press). Within Ya-

TABLE 1.—Distance of nesting birds from the mouth of Yaquina Estuary in 1979 (calculated from Pitman et al. in press).

	Cumulative number of nesting birds				
	≤7 km	≤20 km	≤25 km	≤45 km	≤50 km
common murrelets <sup>1</sup>	2,800	26,800	26,800	26,800	22,000
western gulls	398	528	536	541	1,231
cormorants	418	653	1,581	1,727	3,041
pigeon guillemots	45	191	201	206	220

<sup>1</sup>Includes all breeding and nonbreeding adults at colony.

<sup>2</sup>Estimated for 1983 (USFWS, aerial survey; pers. obs.).

<sup>3</sup>Includes 1983 as well as 1979 estimates.

<sup>1</sup>Oregon Aqua-Foods, Inc., 2000 Marine Science Drive, Newport, OR 97365; present address: P.O. Box 1467, Newport, OR 97365.

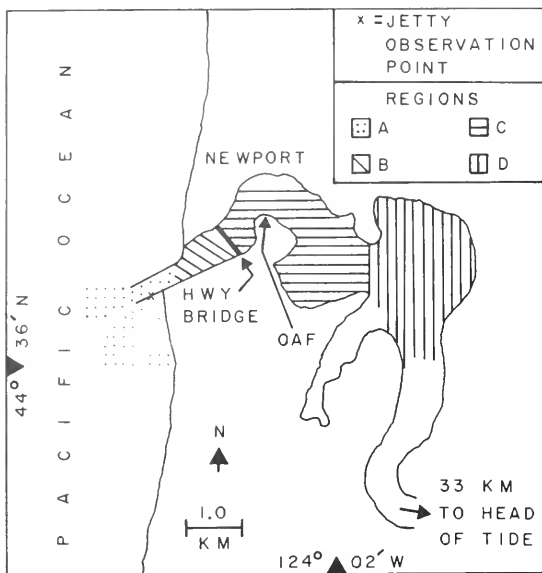

FIGURE 1.—Yaquina Estuary study regions. OAF indicates site of smolt releases.

quina Estuary, <30 pairs of western gulls (Bayer 1983) and an undetermined number of pigeon guillemots also nested in association with manmade structures. The typical nesting phenology of these birds at Yaquina Head (which is about 6.5 km north of Yaquina Estuary) has been examined by Scott (1973) and Bayer (1983) with murrens beginning to fledge young in early July, gulls and pelagic cormorants in late July, and Brandt's cormorants and pigeon guillemots in early to mid-August. However, it would be invalid to assume that nesting in 1983 followed the chronologies of typical years because nesting success for cormorants and murrens was abnormally low in 1983 with eggs and young being abandoned (Bayer<sup>2</sup>). Although the nesting success of gulls was not unusually low in 1983 (Bayer fn. 2), the chronology of their nesting might have been different than in 1982. Thus, comparing 1982 and 1983 bird numbers at Yaquina Estuary for the same stage of the nesting cycle would be tenuous. Brown pelicans, *Pelecanus occidentalis*, and Caspian terns, *Sterna caspia*, do not nest in this area.

I divided the estuary and the area around its mouth into four censusing regions (Fig. 1) with region A having an area of about 1.8 km<sup>2</sup>; region B, 0.5 km<sup>2</sup>; region C, 3.0 km<sup>2</sup>; and region D, 3.2

km<sup>2</sup>. I censused birds from observation points where I could overlook the estuary or estuary mouth with a 20× telescope when glare, heat waves, and water conditions did not obscure birds. I censused the areas around the mouth of the jetties from an observation point about halfway out on the south jetty (Fig. 1). The boundaries of region A were estimated by using the distance to the first navigation buoys to the west of the jetties as a radius that was about 1.5 km from the observation point and 1.0 km from the end of the jetties to estimate the outer boundary. All taxa except pigeon guillemots were censused during a single continuous sweep of nonoverlapping portions of a region; pigeon guillemots were enumerated during two sweeps per portion with the maximum number of the two sweeps recorded.

I censused "active" (see below) gulls and cormorants, nonflying common murrens and pigeon guillemots (including guillemots standing on stationary objects), roosting Caspian terns, all brown pelicans, and all marbled murrelets, *Brachyramphus marmoratus*. "Active" gulls were those that flew over or sat in the water (gulls sitting on stationary roosts were not included). Gull species included western, glaucous-winged, *L. glaucescens*, and western × glaucous-winged gull hybrids (Hoffman et al. 1978). Cormorants present were usually either Brandt's or pelagic cormorants, but some double-crested cormorants, *P. auritus*, were also included. "Active" cormorants were those on the water surface or those making short flights in association with a feeding flock; cormorants on transit flights through a region or roosting on stationary objects were not counted. Only nonflying murrens and guillemots were included because others flew through regions A and B without landing (and feeding). Although roosting Caspian terns were obviously not feeding, they were recorded because their numbers were an index of the total numbers present and because it was not possible to count foraging (i.e., flying) Caspian terns accurately. There were 166 censuses during 37 d from 1 June to 16 September 1982 at regions A-D during variable tidal conditions, and 39 censuses within 2 h of low tides before 1500 Pacific Daylight Time (PDT) during 39 d from 1 June to 30 August 1983 at regions A-C. Each census took 45-75 min, depending upon the number of birds present.

Comparisons of bird numbers between 1982 and 1983 were only made for censuses within 2 h of low tides before 1500 PDT. Comparisons were made during the 1 June to 30 August period for brown pelicans, "active" cormorants, "active" gulls, and

<sup>2</sup>Bayer, R. D. In prep. Breeding success of seabirds along the mid-Oregon coast concurrent with the 1983 El Nino. Unpubl. manuscr. P.O. Box 1467, Newport, OR 97365.



pigeon guillemots because the numbers of these birds during this period did not show any signs of seasonal variation. But for common murrelets, the periods of comparison were 1 June-31 July and 1-30 August, and the periods for Caspian terns were 1 June-10 July, 11 July-5 August, and 6-30 August. The periods for common murrelets and Caspian terns were chosen because in one or both years there were marked seasonal changes in bird numbers between or among these periods.

The number of days postrelease refers to the number of daylight periods after a smolt release (Myers 1980). For example, if smolts were released on Monday night or early Tuesday morning, then Tuesday after dawn would be considered as 1-d postrelease (i.e., the first day, or first daylight period, after a release).

If variances were not significantly different, then the student's *t*-test for two means or the analysis of variance (ANOVA) for three or more means were calculated to determine statistical differences between or among means. If variances were significantly different, the Mann-Whitney U test or normalized Mann-Whitney *z* test (Zar 1974, p. 109-113) for two samples or the Kruskal-Wallis rank H or  $H_c$  (if ranks were tied) test (Zar 1974, p. 139-142) for three or more samples was used. All tests were two-tailed.

## RESULTS AND DISCUSSION

### Smolt Releases

Oregon Aqua-Foods, Inc. (OAF) has released 2 million or more salmon smolts (almost all coho salmon, *Oncorhynchus kisutch*) each year since 1977 into Yaquina Estuary between June and August. In 1982 and 1983, the proportion that were coho salmon was 98% and 94%, respectively; the remainder were chinook salmon, *O. tshawytscha*. Un-

til 1983, these releases were under variable tidal conditions in the evening just after dark to minimize bird predation of smolts as they were released. In 1983, salmon smolts were released either in the evening or early morning on the ebbing tide while it was still dark.

Salmon smolts do not immediately swim to the ocean after they are released. Myers (1980) found that the number of OAF smolts in the Yaquina Estuary declined exponentially after a release. During June-August releases in 1978, half the smolts left the estuary within an average of 3.9 d (SE = 0.7 d, range 1.7-9.0 d,  $N = 9$  releases) with a few smolts remaining in the estuary several months (calculated from Myers 1980). There are no data to determine if the smolt residency time in the estuary differed between 1982 and 1983.

In 1982 and 1983 from June through August, the interval between releases averaged <2.5 d, and an average of 0.2-0.3 million fish were released each time (Table 2). Although the average release interval was longer and the number of fish per release usually greater in 1983, these differences were not significant (Table 2). But the biomass of fish per release was significantly greater in 1983 than in 1982 in the June-July and June-August periods (Table 2). Overall, 1.6 million fewer fish were released in 1983 than 1982, but the total biomass released was almost 38 metric tons (t) greater (Table 2); this resulted from smolts weighing more on the average in 1983 (32.9 g/smolt) than in 1982 (26.7 g/smolt) (calculated from Table 2).

### Bird Predation of Salmon Smolts

Although all birds in this study except marbled murrelets were observed with salmon smolts in their bills, the importance of smolts in these birds' diets was not documented in this study. However, Matthews (1983) found that coho salmon smolts com-

TABLE 2.—Releases of salmon smolts in 1982 and 1983 at Yaquina Estuary. Total = total number or biomass of fish released during a period. Differences between years tested with student's *t*, Mann-Whitney U, or normalized Mann-Whitney *z* test. NS = not significant.

Period	Year	Releases <i>N</i>	Release interval (d)			No. fish/release (millions)			Fish biomass/release (t)			
			$\bar{x}$	SD	<i>P</i>	$\bar{x}$	SD	<i>P</i>	$\bar{x}$	SD	<i>P</i>	Total
June-July	1982	30	2.0	1.2		0.3	0.1	9.6	7.5	2.4		225.3
	1983	25	2.4	1.7	NS	0.4	0.1	NS 9.0	11.3	4.6	<0.01	268.4
August	1982	20	1.6	0.7		0.2	0.1	4.7	7.9	3.4		158.6
	1983	12	2.4	1.6	NS	0.3	0.2	NS 3.7	12.8	9.0	NS	153.0
June-August	1982	50	1.8	1.0		0.3	0.1	14.4	7.7	2.8		383.9
	1983	37	2.4	1.6	NS	0.3	0.2	NS 12.8	11.8	6.3	<0.01	421.4

posed 13% of 287 prey items of common murres collected within 2 km of the Yaquina's jetties during the summer of 1982.

Salmon smolts appeared to be most vulnerable to predation soon after a release. When they first entered the estuary after exiting a pond through a large tube, smolts seemed disoriented and milled around the surface where they could easily be caught by birds. Night releases allowed smolts several hours to become adjusted before becoming vulnerable to predators at daylight. (The only somewhat significant nocturnal bird predator were heerman's gulls, *L. heermanni*, but they usually numbered <50 birds, were not present for every release, and were present mainly in late July and August.)

Within about 4 h after daylight after a release, some smolts were observed jumping at the mouth of the jetties in regions A and B, where birds also concentrated. For censuses of regions A-D within 2 h of low tides and within 2 d of a release in 1982, an average of 97.9% (SD = 6.3, N = 17 d) of the common murres, 91.5% (SD = 16.2, N = 17 d) of the "active" gulls, and 90.5% (SD = 26.8, N = 8 d) of the "active" cormorants censused were at regions A and B. But regions A and B accounted for only about 27% of the area of regions A-D. Evidently, the turbulent action of the estuarine water entering the ocean and/or the funneling effect of the jetties (Fig. 1) caused the smolts to be particularly vulnerable to predators there.

During the first 12 h of daylight after a release, some smolts within 0.5 km of the release site were still vulnerable to bird predation as many smolts were near the water surface. Many jumped out of the water, and some rolled on their sides exposing their silver undersides, which were highly conspicuous against the dark water background. Gulls often sat on the water and grasped a fish as it jumped into the air. Schools of smolts also milled near the surface where they were clearly visible to humans (and presumably birds).

### Within-Day Variation in Bird Numbers

Bird abundance was clearly not constant within a day, and taxa did not reach maxima synchronously (Fig. 2). Censuses within 2 h of early low tides (i.e., low tides before 1500 PDT) averaged closer to the maximum number censused daily for all taxa, and censuses near high tide were usually closer to the daily maximum than counts within 2 h of evening low tides (i.e., after 1800 PDT) for all taxa except brown pelicans (Table 3). But differences in censuses among tidal conditions within a day were only sig-

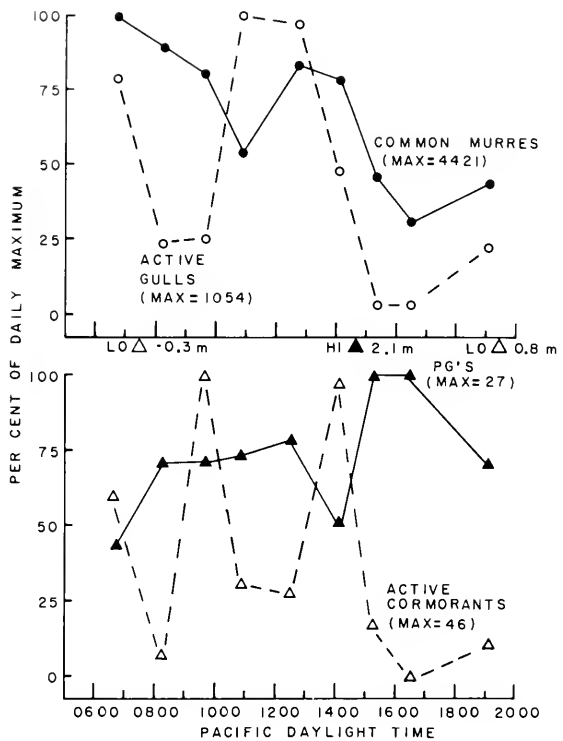

FIGURE 2.—Percentage of daily maximum number of common murres, "active" gulls, "active" cormorants, and pigeon guillemots (PG's) observed on 5 August 1982 (which was two days postrelease) at regions A-D. Times and heights of measured low (LO) and high (HI) tides are indicated by open and closed triangles, respectively. MAX = maximum number of birds seen on 5 August.

nificant for common murres and "active" gulls (Table 3).

A single census at any time of day is unlikely to estimate accurately the maximum number of birds of any taxon present that day (Table 3). The average census only ranged from 10.8% to 63.7% of the daily maximum (Table 3). The best censuses to use for estimates would be those within 2 h of a morning or afternoon low tide because their averages (44-64% of daily maxima) were greater than for high and evening low tides, and their CV's (41-82%) were generally lower than for other tides (Table 3).

### Daily Variation in Bird Numbers

On a day to day basis, bird numbers could often be seen to increase in the first day postrelease and then to decline (Fig. 3). However, the degree of increase was variable. Overall, murres, "active" gulls in 1983, and brown pelicans exhibited the same pat-

TABLE 3.—Percentage of daily maximum number of birds observed within 2 h of actual high tides, early low tides (i.e., time of low tide before 1500 PDT), and late low tides (i.e., time of low tide after 1800 PDT). Censuses between 6 July and 17 September 1982 at regions A-D with 9-11 censuses/d (i.e., 13-14 h period).  $N$  = total censuses; CV = coefficient of variation.

	Percent of daily maximum birds within 2 h of									
	High tide			Early low tide			Late low tide			
	Days	$N$	$\bar{x}$	CV (%)	$N$	$\bar{x}$	CV (%)	$N$	$\bar{x}$	CV (%)
common murres	9	31	130.8	92.5	24	163.7	55.3	11	120.3	100.0
"active" gulls	10	35	237.9	81.5	28	249.5	71.9	11	218.1	100.0
brown pelicans	6	21	339.1	79.0	14	344.0	81.8	8	349.1	58.9
"active" cormorants	4	14	432.6	112.6	7	461.3	65.3	6	410.8	142.6
pigeon guillemots	3	10	52.9	58.8	8	58.0	41.0	3	53.9	93.8

<sup>1</sup>Heterogeneity, Kruskal-Wallis  $H_c = 16.36$ ,  $P < 0.01$ .

<sup>2</sup>Heterogeneity, Kruskal-Wallis  $H_c = 7.62$ ,  $P < 0.10$ .

<sup>3</sup>Heterogeneity, Kruskal-Wallis  $H_c = 0.80$ ,  $P > 0.10$ .

<sup>4</sup>Heterogeneity, Kruskal-Wallis  $H_c = 5.62$ ,  $P > 0.10$ .

<sup>5</sup>Heterogeneity, Kruskal-Wallis  $H_c = 1.87$ ,  $P > 0.10$ .

tern of more birds present the first day after a release than later; this pattern, however, was significant only in 1983 (Tables 4, 5). In contrast, only "active" cormorants were more numerous the second day after a release than on the first day; however, the differences in cormorant numbers among days were only significant in 1983 (Table 5).

Numbers of pigeon guillemots and Caspian terns did not show any indication of dependence on the number of days postrelease. The differences in pigeon guillemot numbers in the 1 June-30 August period among 1, 2, and 3-6 d postrelease was insignificant (1982:  $F = 0.23$ ,  $df = 2, 34$ ;  $P > 0.10$ ; 1983: Kruskal-Wallis  $H_c = 0.61$ ,  $P > 0.10$ ). Sample sizes were too small to test differences for Caspian terns in 1982, but in 1983 variation with 1, 2, and 3-6 d postrelease was insignificant in either the 1 June-14 July period (when there were few Caspian terns (Kruskal-Wallis  $H_c = 2.74$ ,  $P > 0.10$ )) or the 15 July-30 August period (when they were abundant (Kruskal-Wallis  $H_c = 2.74$ ,  $P > 0.10$ )).

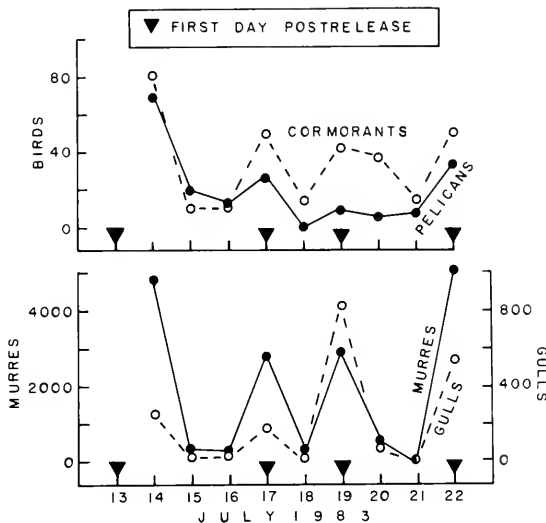

FIGURE 3.—Number of brown pelicans, "active" cormorants, "active" gulls, and common murres with relation to dates of salmon smolt releases during 14-22 July 1983 censuses that were within 2 h of low tides before 1500 PDT.

TABLE 4.—Numbers of common murres at regions A-C in 1982 and 1983 during the 1 June-31 July period when murres were abundant and the 1-30 August period when murres were infrequent in 1983.  $N$  = number of censuses (1 census/d within 2 h of low tides before 1500 PDT); MAX = maximum number of birds counted.

Year	1 June-31 July												1-30 August			
	1-d postrelease				2-d postrelease				3-6 d postrelease				1-3 d postrelease			
	$N$	$\bar{x}$	SD	MAX	$N$	$\bar{x}$	SD	MAX	$N$	$\bar{x}$	SD	MAX	$N$	$\bar{x}$	SD	MAX
1982	8	123,053	967	4,310	6	131,823	2,114	5,988	2	141,276	824	1,858	4	51,860	2,091	4,419
1983	13	263,710	2,746	9,638	8	362,462	2,063	6,206	6	465,611	711	1,972	10	5106	280	901

<sup>1</sup>Heterogeneity among days: Kruskal-Wallis  $H = 4.88$ ,  $P > 0.10$ .

<sup>2</sup>1982 vs. 1983: Mann-Whitney  $U = 52$ ,  $P > 0.10$ .

<sup>3</sup>1982 vs. 1983: student's  $t = 2.12$ ,  $df = 12$ ,  $P < 0.10$ .

<sup>4</sup>1982 vs. 1983: not tested because of small sample sizes in 1982.

<sup>5</sup>1982 vs. 1983: Mann-Whitney  $U = 38$ ,  $P < 0.02$ .

<sup>6</sup>Heterogeneity among days: Kruskal-Wallis  $H = 8.91$ ,  $P < 0.05$ .

TABLE 5.—Comparison of bird numbers at regions A-C during 1 June-30 August period in 1982 with 1983. Day(s) = days post-release of salmon smolts,  $N$  = number of censuses (1 census/d within 2 h of low tides before 1500 PDT), and MAX = maximum number of birds counted.

	Days(s):	"active" gulls			brown pelicans			"active" cormorants		
		1	2	3-6	1	2	3-6	1	2	3-6
1982	$N$	10	7	2	10	7	3	9	7	3
	Birds ( $\bar{x}$ )	1391	1381	1445	231	211	27	318	328	347
	SD	272	294	36	36	10	10	13	41	38
	MAX	919	729	470	106	30	19	38	110	88
1983	$N$	20	9	9	20	9	9	20	9	9
	Birds ( $\bar{x}$ )	1400	1332	126	225	217	27	346	381	321
	SD	349	450	25	19	22	8	33	90	15
	MAX	1,311	1,200	77	84	69	20	128	286	52

<sup>1</sup>1 d vs. 2 d vs. 3-6 d: 1982, Kruskal-Wallis  $H_c = 0.44$ ,  $P > 0.10$ ; 1983, Kruskal-Wallis  $H_c = 14.62$ ,  $P < 0.01$ . 1982 vs. 1983: 1 d, student's  $t = 0.07$ ,  $df = 28$ ,  $P > 0.10$ ; 2 d, student's  $t = 0.25$ ,  $df = 14$ ,  $P > 0.10$ .

<sup>2</sup>1 d vs. 2 d vs. 3-6 d: 1982, Kruskal-Wallis  $H_c = 2.44$ ,  $P > 0.10$ ; 1983, Kruskal-Wallis  $H_c = 8.71$ ,  $P < 0.02$ . 1982 vs. 1983: 1 d, Mann-Whitney  $U = 107$ ,  $P > 0.10$ ; 2 d, Mann-Whitney  $U = 32.5$ ,  $P > 0.10$ ; 3-6 d, Mann-Whitney  $U = 14$ ,  $P > 0.10$ .

<sup>3</sup>1 d vs. 2 d vs. 3-6 d: 1982, Kruskal-Wallis  $H_c = 1.84$ ,  $P > 0.10$ ; 1983, Kruskal-Wallis  $H_c = 6.14$ ,  $P < 0.05$ . 1982 vs. 1983: 1 d, Mann-Whitney  $U = 142.5$ ,  $P < 0.02$ ; 2 d, Mann-Whitney  $U = 49$ ,  $P < 0.10$ ; 3-6 d, Mann-Whitney  $U = 20$ ,  $P > 0.10$ .

## Yearly Variation in Bird Numbers

Cormorants were significantly more abundant for 1 and 2 d postrelease in 1983 than in 1982 but not for 3-6 d postrelease (Table 5). Brown pelicans were about as numerous in 1983 as in 1982 in the 1 June-30 August period (Table 5).

Gulls were not significantly more abundant in 1983 than in 1982 in the 1 June-30 August period (Table 5), and their nesting success was also not lower in 1983 than in other years (Bayer fn. 2). But Caspian terns were significantly more abundant during the 11 July-5 August period (when many emigrated) in 1983 than in 1982 (Bayer 1984).

There were an average of about 650 more common murre per census in 1983 than in 1982 during the 1 June-31 July period for either 1 or 2 d post-release, but the differences were only significant for 2 d postrelease (Table 4). In contrast, there were more murre in 1982 than in 1983 during this period for 3-6 d postrelease, but there were only two samples in 1982 (Table 4).

In the 1-30 August period, there were significantly fewer murre in 1983 than in 1982 (Table 4). The low numbers in 1983 resulted from the mass exodus of murre after 31 July, whereas in 1982 murre numbers did not decline as dramatically until after 12 August. In fact, there were still more murre present within 2 h of low tides on 3 and 16 September 1982 (186 and 318 murre, respectively) than in 10 censuses on different days between 1 and 18 August

1983 (i.e.,  $\leq 56$  murre). The early exodus of murre in 1983 probably resulted from them migrating north early because they were unusually numerous in inland marine waters of Washington during the summer of 1983 (Mattocks et al. 1983).

During the June through August period at regions A-C, pigeon guillemot numbers were about 29% greater during 1982 ( $\bar{x} = 23.9$ ,  $SD = 11.0$ ,  $N = 13$  d) than in 1983 ( $\bar{x} = 17.1$ ,  $SD = 7.8$ ,  $N = 35$  d), a significant difference ( $t = 2.39$ ,  $df = 46$ ,  $P < 0.05$ ). This decrease could have resulted from the large number of mortalities in the spring of 1983 (Hodder<sup>3</sup>).

Marbled murrelets were not observed in any of 120 censuses of regions A-D in the June through 20 August period of 1982. In 1983 at regions A-C, they were observed in only 1 of 21 censuses in June and August, but an average of 3.9 murrelets/census ( $SD = 8.7$ , range 0-32,  $N = 17$  censuses) were counted in July. The difference in the number of murrelets per census in July was significantly greater in 1983 than in 1982 (normalized Mann-Whitney  $z = 2.18$ ,  $P < 0.05$ ). They were only observed at region A.

## CONCLUSIONS

It is not possible to relate the number of birds nesting near the Yaquina Estuary with the number feeding there for several reasons. First, the number of nesting and nonbreeding birds is unknown, so it is not possible to determine what proportion of the birds censused were nonbreeders. Second, censuses of feeding birds represent the number of birds feeding at only one point in time, but nesting birds probably fed serially at the Yaquina Estuary (i.e., birds came and went as individuals or small flocks not as massive synchronous flocks). With serial use, the number of nesting birds using the Yaquina Estuary could be much larger than indicated by censuses. Unfortunately, birds would have to be individually recognizable to determine the degree of serial use, and this was beyond the scope of this study.

It also was not possible to tell from how far nesting birds came to feed at the Yaquina Estuary in either year because birds were not individually marked. Murre, however, may have come from long distances. In both years, the average number of murre one day after a salmon release (Table 4) was greater than the number of murre at a colony <7 km away (Table 1), and the maximum number

<sup>3</sup>J. Hodder, Institute of Marine Biology, Charleston, OR 97420, pers. commun., 1984.

of murrees simultaneously seen at the Yaquina (Table 4) was greater than the number of murrees at colonies within 45 km of the Yaquina (Table 1).

It was somewhat surprising that more cormorants and common murrees were not at the Yaquina Estuary in 1983, because they then had a poor nesting season, probably as a result of a food shortage (Bayer fn. 2). There are several possible reasons why there were not more cormorants and murrees counted in 1983. First, the number of salmon smolts available at the Yaquina Estuary might have been insufficient or the distance between the Yaquina and their nesting site too great for these birds to be dependent solely on salmon smolt releases. If the salmon smolt releases had been oftener and nearer to bird nesting colonies, the numbers of birds present could have been much greater. Second, there may have actually been many more birds in 1983 than in 1982, but a single census per day regime was inadequate to measure this (Table 3). Censuses throughout the day in 1983 or measurements of the serial use of the Yaquina Estuary in 1982 and 1983 might have indicated that there were dramatically more birds using the Yaquina in 1983 than in 1982. Finally, the lack of there not being a greater influx of birds in 1983 might be because many of the murrees and cormorants that normally remained near the Yaquina dispersed to avoid the generally poor feeding conditions between releases. Many Oregon pelagic and Brandt's cormorants had abandoned nesting by mid-July 1983 (see Bayer fn. 2; Hodder fn. 3), and many murrees may have left the Oregon coast before it became apparent at the Yaquina Estuary at the end of July. Early dispersal or migration is known for southern seabirds during an El Nino (Duffy 1983a; Schreiber and Schreiber 1984).

## ACKNOWLEDGMENTS

I am grateful to Bill McNeil, Vern Jackson, Rob Lawrence, Mike Bauman, and Andy Rivinus of Oregon Aqua-Foods for facilitating the logistics and funding of this project; to Dan Varoujean for advice about censusing murrees prior to the 1982 field season; and to Jan Hodder, Dan Matthews, Daniel W. Anderson, Peter Stettenheim, and two anonymous reviewers for constructive comments on an earlier draft of this manuscript.

## LITERATURE CITED

- AINLEY, D.  
1983. El Nino in California? Point Reyes Bird Observ. Bull. 62:1-4.
- BARBER, R. T., AND F. P. CHAVEZ.  
1983. Biological consequences of El Nino. *Science* 222:1203-1210.
- BAYER, R. D.  
1983. Nesting success of western gulls at Yaquina Head and on man-made structures in Yaquina Estuary, Oregon. *Murrelet* 64:87-91.  
1984. Oversummering of whimbrels, Bonaparte's gulls, and Caspian terns at Yaquina Estuary, Oregon. *Murrelet* 65:87-90.
- BOERSMA, P. D.  
1979. Breeding patterns of Galapagos penguins as an indicator of oceanographic conditions. *Science* 200:1481-1483.
- DUFFY, D. C.  
1983a. Environmental uncertainty and commercial fishing: effects on Peruvian guano birds. *Biol. Conserv.* 26:227-238.  
1983b. The foraging ecology of Peruvian seabirds. *Auk* 100: 800-810.
- FURNESS, R. W.  
1984a. Modelling relationships among fisheries, seabirds, and marine mammals. In D. N. Nettleship, G. A. Sanger, and P. F. Springer (editors), *Marine birds: their feeding ecology and commercial fisheries relationships*, p. 117-126. Proc. Pacific Seabird Group, 6-8 January 1982, Can. Wildl. Serv., Can. Minist. Supply Cat. No. CW66-65/1984.  
1984b. Seabird-fisheries relationships in the northeast Atlantic and North Sea. In D. N. Nettleship, G. A. Sanger, and P. F. Springer (editors), *Marine birds: their feeding ecology and commercial fisheries relationships*, p. 162-169. Proc. Pacific Seabird Group, 6-8 January 1982, Can. Wildl. Serv., Can. Minist. Supply Cat. No. CW66-65/1984.
- HOFFMAN, W., J. A. WIENS, AND J. M. SCOTT.  
1978. Hybridization between gulls (*Larus glaucescens* and *L. occidentalis*) in the Pacific Northwest. *Auk* 95:441-458.
- HUYER, A.  
1983. Anomalously warm water off Newport, Oregon, April 1983. *Trop. Ocean-Atmos. Newsl.* 21:24-25.
- MATTOCKS, P., JR., B. HARRINGTON-TWEIT, AND E. HUNN.  
1983. Northern Pacific Coast region. *Am. Birds* 37:1019-1022.
- MATTHEWS, D. R.  
1983. Feeding ecology of the common murre, *Uria aalge*, off the Oregon coast. M.S. Thesis, Univ. Oregon, Eugene, 108 p.
- MYERS, K. W.  
1980. An investigation of the utilization of four study areas in Yaquina Bay, Oregon, by hatchery and wild juvenile salmonids. M.S. Thesis, Oregon State Univ., Corvallis, 234 p.
- OREGON STATE LAND BOARD.  
1973. Oregon estuaries. State of Oregon, Div. State Lands.
- PARKER, R. R.  
1962. Estimations of ocean mortality rates for Pacific salmon (*Oncorhynchus*). *J. Fish. Res. Board Can.* 19:561-589.  
1968. Marine mortality schedules of pink salmon of the Bella Coola River, central British Columbia. *J. Fish. Res. Board Can.* 25:757-794.
- PITMAN, R. L., M. R. GRAYBILL, J. HODDER, AND D. H. VAROUJEAN.  
In press. The catalog of Oregon seabird colonies. U.S. Dep. Fish Wildlife, USFWS FWS/OBS.
- QUINN, W. H., D. O. ZOPF, K. S. SHORT, AND R. T. W. KUO YANG.  
1978. Historical trends and statistics of the Southern Oscillation, El Nino, and Indonesian droughts. *Fish. Bull., U.S.* 76:663-678.

REED, R. K.

1983. Oceanic warming off the U.S. West Coast following the 1982 El Nino. *Trop. Ocean-Atmos. Newsl.* 22:10-12.

SCHREIBER, R. W., AND E. A. SCHREIBER.

1984. Central Pacific seabirds and the El Nino Southern Oscillation: 1982 to 1983 perspectives. *Science* 225:713-716.

SCOTT, J. M.

1973. Resource allocation in four syntopic species of marine diving birds. Ph.D. Thesis, Oregon State Univ., Corvallis, 107 p.

ZAR, J. H.

1974. *Biostatistical analysis*. Prentice-Hall, Englewood Cliffs, N.J., 620 p.

# DEVELOPMENT AND EVALUATION OF METHODOLOGIES FOR ASSESSING AND MONITORING THE ABUNDANCE OF WIDOW ROCKFISH, *SEBASTES ENTOMELAS*

MARK E. WILKINS<sup>1</sup>

## ABSTRACT

Rapid expansion of a new fishery for widow rockfish, *Sebastes entomelas*, stocks off the Pacific coast of the United States began in 1979. Within 3 years, landings rose from <1,000 t to almost 30,000 t of a species for which little information on abundance or life history was available. It was known that widow rockfish occurred in irregularly distributed, dense, midwater, and semidemersal schools primarily during the night, which posed problems in directly assessing this resource. Therefore, a project was designed to further investigate the habits and distribution of the species and develop an adequate assessment methodology.

Line transect survey methods, using sector scanning sonar to estimate the number of schools per unit area and standard hydroacoustic echo integration techniques to estimate school biomass, were used in study areas off Washington and Oregon. The applicability of this methodology will depend on our ability to resolve technical problems and minimize the effects of distributional variability by refining survey design. The need for more sophisticated sonar equipment to improve data collection and processing, the extreme temporal and spatial variability of widow rockfish school size and location, and the difficulty of identifying the species composition of observed schools are matters of special concern.

The rockfish (genus *Sebastes*) of the Pacific Ocean are comprised of over 65 species exhibiting a wide array of colors, sizes, body forms, behavior, and life history characteristics. Members of this family are generally demersal or semidemersal and school over hard substrate on the continental shelf and slope. The widow rockfish, *Sebastes entomelas*, is atypical. As an adult it aggregates in dense midwater schools during the night.<sup>2</sup> These schools tend to disappear from established fishing grounds at dawn or shortly thereafter, becoming less vulnerable to the fishery.

The role of this species in the Pacific coast groundfish fishery changed from an undesirable incidental catch in 1978 to a major target species by 1980. Advances in fishing technology and product handling and marketing, as well as new vessels seeking alternative fisheries, promoted an increase in landings from 1,107 t in 1978 to 28,419 t in 1981 (Table 1).

By 1981, schools were becoming more difficult to locate and there was concern that the resource was being overharvested. The fishery began expanding into new areas to maintain profitable catch rates. During late 1981 and early 1982, most of the widow

rockfish were being taken from the vicinities of Bodega Bay and Monterey, CA, though fishing was taking place as far north as Cape Flattery, WA.

The rapid growth of this new fishery resulted in large catches from a resource about which little was known. Research on this species prior to 1979 was limited to general descriptions of distribution, habitat, and biological characteristics (Hitz 1962; Phillips 1964; Pereyra et al. 1969). Scientists began gathering data in 1978 to determine the impact of the fishery on the condition of the stock, to define the distribution and size of the stock, and to establish a baseline of biological characteristics of the species. Commercial landings have been sampled by State

TABLE 1.—Landings of widow rockfish by state for years 1973-83 in metric tons.

Year	Washington	Oregon	California	Total
1973	81	15	29	125
1974	18	7	47	72
1975	13	11	57	81
1976	51	55	147	253
1977	277	34	267	578
1978	428	472	207	1,107
1979	1,697	1,960	636	4,293
1980	6,632	8,718	4,808	20,677
1981	7,211	14,689	6,519	28,419
1982	6,030	9,262	10,270	25,562
1983	3,293	3,151	3,455	9,899

<sup>1</sup>This also included 519 t of joint venture and foreign catch.

<sup>1</sup>Northwest and Alaska Fisheries Center Seattle Laboratory, National Marine Fisheries Service, NOAA, 7600 Sand Point Way N.E., Building 4, BIN C15700, Seattle, WA 98115.

<sup>2</sup>Groundfish Management Team. 1981. Status of the widow rockfish fishery. Unpubl. manuscript, 41 p. Pacific Fishery Management Council, 526 S.W. Mill Street, Portland, OR 97201.

and Federal agencies in Washington, Oregon, and California for information on size and age composition, sex ratio, maturity, feeding habits, morphometrics, meristics, and fecundity.

Widow rockfish abundance was estimated by the Groundfish Management Team (fn. 2, 1982<sup>3</sup>) of the Pacific Fisheries Management Council, using cohort and stock reduction analyses (SRA) (Kimura and Tagart 1982). These stocks were found to have been fished down from their virgin level and were thought to be approaching a biomass level which would, under prudent management, produce a maximum sustainable yield of about 12,000 t in the INPFC (International North Pacific Fisheries Commission) Columbia and Eureka areas.

Research surveys were needed to complement these analyses by providing independent estimates of abundance, describing the distribution, and collecting biological information not available from fishery data (for example, data on prerecruits and fish in areas which will not support a profitable fishery). Widow rockfish present special problems to those seeking to estimate their abundance through research surveys. The species is not usually available to bottom trawls, precluding traditional "area-swept" trawl surveys, and its tightly clustered distribution and inconsistent schooling behavior reduce the effectiveness of traditional hydroacoustic surveys.

In 1980, the Northwest and Alaska Fisheries Center (NW AFC) began developing a practicable method to survey widow rockfish stocks. Scientists needed to understand the distribution and behavior of widow rockfish to determine which survey methods might be most appropriate to measure the size of the resource. The first objective of the project, therefore, was to study aspects of the behavior, distribution, and biology of the species. The distribution of its characteristic nighttime aggregations relative to features of submarine topography was of particular interest. The distribution of this species is highly variable both on a diel basis and over longer periods, and the reasons for this variability were also of interest. Another question concerned what proportion of the total resource is present in detectable schools and how that proportion changes in space and time. Clark and Mangel (1979) described a theoretical situation in yellowfin tuna stock dynamics wherein detectable, fishable schools are constantly being replenished from an undetectable portion of

the population. They discussed the implications of this behavior in a fishery. If such a phenomenon could be confirmed in widow rockfish, determining the detectable proportion of the population might enable us to estimate the absolute size of the resource.

The second objective of the project was to investigate methodologies with potential for estimating widow rockfish stock size, considering the species' behavior and distribution patterns. The final objective was to evaluate the effectiveness of the chosen technique when actually implemented.

The project was conducted in three phases: 1) an examination of the biology and behavior of widow rockfish on commercial fishing grounds, 2) the development of a practical survey method for assessing distribution and abundance, and 3) an evaluation of the feasibility and effectiveness of applying such assessment methodology to widow rockfish on a routine coastwide monitoring basis. Field studies were initiated in March 1980 and concluded in April 1982. Behavior studies were conducted during August 1980 and April 1981. Field work focusing on methodology development took place during late March 1980 and mid-March 1981, and the trial assessment survey took place during mid-March to early April 1982. All field work was conducted off Oregon and southern Washington (Fig. 1).

The purpose of this report is to document the work done to date on the development of widow rockfish assessment methodologies, to evaluate the utility of those methods for routine assessment and monitoring of widow rockfish stocks and other species exhibiting a similar behavior, and to recommend means of enhancing future assessment efforts.

## BEHAVIOR STUDIES (1980-81)

The nature of the fishery made it apparent that the behavior of widow rockfish differed from that of other commercially important species of the genus *Sebastes*. Extremely large widow rockfish catches were taken by midwater trawlers operating almost exclusively at night and fishing on very dense midwater schools in only a few small areas along the coast.

The first phase of the project studied the behavior and habits of widow rockfish to determine their distribution patterns, using demersal and midwater trawls and hydroacoustic observations. This included determining where the fish go when the dense, midwater schools disperse; whether there are components of the stock other than the typical midwater aggregations; and at what period in their daily cycle

<sup>3</sup>Groundfish Management Team. 1982. Status of the widow rockfish fishery. Unpubl. manuscript, 22 p. Pacific Fishery Management Council, 526 S.W. Mill Street, Portland, OR 97201.



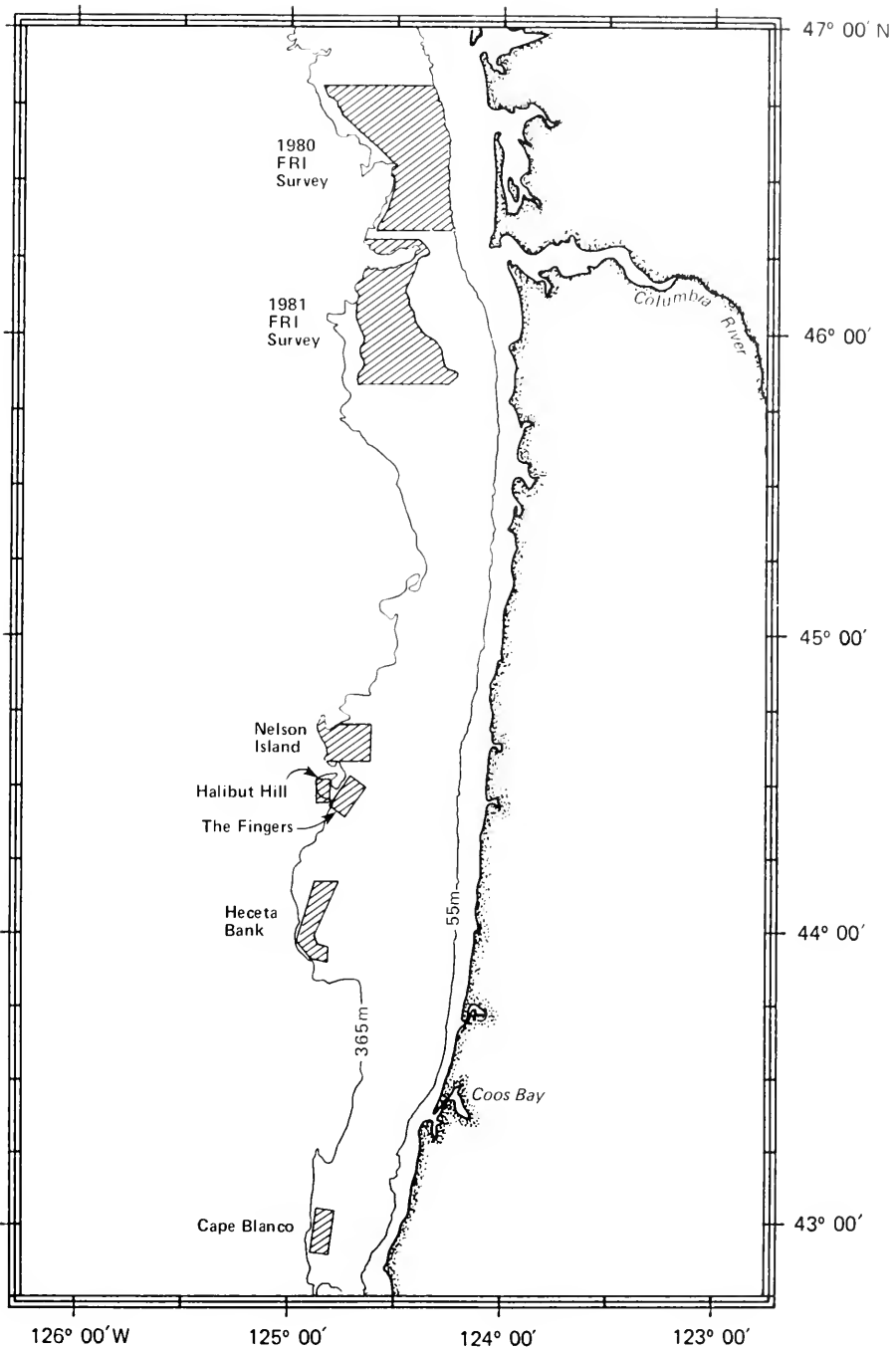

FIGURE 1.—Widow rockfish survey areas off the coasts of Washington and Oregon occupied during field work conducted between 1980 and 1982.

their availability is most stable. Other objectives were to investigate the possible causes of their diel aggregation habits and to develop an ability to distinguish widow rockfish schools from those of other species on the basis of echosign<sup>4</sup> characteristics and test fishing.

## Methods

The behavior study was initiated 11-13 August 1980 aboard the chartered trawlers *Pat San Marie* and *Mary Lou*. Concurrently, scientists aboard the NOAA RV *Miller Freeman* conducted a conventional echo integration survey in the study area and made four midwater tows to identify the species composition of the schools sighted. The survey was repeated during 10-26 April 1981 aboard the NOAA RV *Chapman* and included 7 d of hydroacoustic and sonar observations.<sup>5</sup> Descriptions of the vessels, trawls, and hydroacoustic equipment employed appear in Tables 2, 3, and 4, respectively.

Demersal trawl stations were located around a seabed rise known as Nelson Island off Newport, OR, to determine if significant quantities of widow rockfish occurred on or near the bottom in an area where they were known to form dense midwater aggregations. A 4 × 4 station grid with interstation distances of 4.6 km (Fig. 2) was established between the depths of 110 and 360 m with the rise at the center. Two trawl hauls were attempted at each station: one during daylight and one during darkness.

<sup>4</sup>"Echosign" can be defined as the echo return output (paper echograms, video chromosome displays, etc.) of an echo sounder aimed at targets in the water column.

<sup>5</sup>Thomas, G. L., C. Rose, and D. R. Gunderson. 1981. Rockfish investigations off the Oregon coast, annual report. Unpubl. manuscr., 20 p. Univ. Wash., Fish. Res. Inst., FRI-UW-8119.

When significant midwater fish schools were observed, they were sampled with midwater trawl gear for species composition.

The contents of each trawl haul were sorted by species, weighed, counted, and recorded. Otoliths were removed from samples selected for age determination and stage of maturity was recorded for some individuals. Stomach sample collections, stratified by fish length, were also taken and preserved for feeding studies.<sup>6</sup> No meaningful description of age and length composition was possible because of the small catches.

Consultations with fishermen, observation trips aboard commercial trawlers, and observations during research operations provided further information about school characteristics and diel behavior patterns of widow rockfish and other species on and around widow rockfish fishing grounds.

## Results

Twenty-seven demersal tows were completed during the August 1980 widow rockfish behavior study, including 12 at night and 15 during the day. The trawl was damaged during two night hauls. The widow rockfish catch was small, with 1 or 2 specimens in six hauls and 20 specimens in one of the night hauls during which the trawl was damaged (Fig. 3, 1980). Therefore, no conclusions about diel movement patterns were possible from the 1980 study.

The *Miller Freeman* transected the Nelson Island area during the same study period and found one

<sup>6</sup>Adams, P. B. 1984. The diet of widow rockfish (*Sebastes entomelas*) in northern California. Unpubl. manuscr. Southwest Fisheries Center Tiburon Laboratory, National Marine Fisheries Service, NOAA, 3150 Paradise Drive, Tiburon, CA 94920.

TABLE 2.—Vessels used during the widow rockfish assessment project.

Vessel	Length (m)	Main engine (hp)	Survey type	Agency <sup>1</sup>	Dates
<i>Muir Milach</i>	26	800	Hydroacoustic sonar	FRI	19 Mar.-2 Apr. 1980
<i>Pat San Marie</i>	31	765	Behavior	NWAFc	11-13 Aug. 1980
<i>Mary Lou</i>	26	700	Behavior	NWAFc	11-13 Aug. 1980
<i>Miller Freeman</i>	66	2,200	Behavior and hydroacoustic sonar	NWAFc	11-13 Aug. 1980
<i>Alaska</i>	30	600	Hydroacoustic sonar	FRI	12-23 Mar. 1981
<i>Chapman</i>	39	1,165	Behavior and hydroacoustic sonar	NWAFc	7-26 Apr. 1981
<i>Ocean Leader</i>	36.5	1,125	Hydroacoustic sonar	NWAFc	14 Mar.-7 Apr. 1982

<sup>1</sup>FRI = Fishery Research Institute; NWAFc = Northwest and Alaska Fisheries Center.

TABLE 3.—Fishing gear used during the widow rockfish assessment project.

Trawl type	Vessels	Doors and accessory gear	Approximate fishing dimensions
Bottom trawl Northeastern	<i>Pat San Marie</i> and <i>Mary Lou</i>	1.5 × 2.1 m steel V-doors, 55 m triple dandyines, 32 mm mesh cod end liner, roller gear	9.1 m headrope height, 13.4 m wingspread
	<i>Muir Milach</i> and <i>Chapman</i>	Same as above but with 1.8 × 2.7 m steel V-doors 2,500 lb	6.10 m headrope height, 16.7 m wingspread (Wathne <sup>1</sup> )
	<i>Alaska</i>	Same as above but with 1.6 × 2.9 m aluminum V-doors	(not measured)
Midwater trawl Alaska Diamond	<i>Chapman</i>	1.8 × 2.7 m steel V-doors, 55 m double dandyines with 4 sets of 5.5 m bridles, 125 kg weights attached to the bottom of each wingtip, 32 mm mesh cod end liner	11.0-14.6 m vertical opening 15.2 m wingspread
	<i>Alaska</i>	Same as above but with 1.6 × 2.9 m aluminum V-doors	Same as above
Norsenet	<i>Miller Freeman</i>	6 m <sup>2</sup> Waco doors, 75 m double dandyines, 46 mm mesh cod end covered with a double braided 144 mm mesh bag	18-20 m vertical opening
No. 7 Gourock rope wing	<i>Muir Milach</i>	4.6 m <sup>2</sup> Suberkrub doors, 73.2 m double dandyines, 114 mm mesh cod end (no liner)	18.3 m vertical opening, wingspread not measured
No. 8 Gourock rope wing	<i>Ocean Leader</i>	4.5 m <sup>2</sup> Suberkrub doors, 100 m dandyines 200 kg weights attached to the bottom of each wing, 32 mm mesh cod end liner	21.3 m vertical opening, wingspread not measured

<sup>1</sup>Wathne, F., Northwest and Alaska Fisheries Center, 2725 Montlake Blvd. E., Seattle, WA 98115, pers. commun. June 1981.

TABLE 4.—Hydroacoustic equipment used during widow rockfish behavior and assessment surveys, 1980-82. FRI = Fisheries Research Institute; NWAFC = Northwest and Alaska Fisheries Center.

Vessel:	<i>Muir Milach</i> (FRI)	<i>Miller Freeman</i> (NWAFC)	<i>Alaska</i> (FRI)	<i>Chapman</i> (NWAFC)	<i>Ocean Leader</i> (NWAFC)
Dates used	19 March- 2 April 1980	11-13 August 1980	12-23 March 1981	21-26 April 1981	14 March- 7 April 1982
Echo sounder and transducer	Simrad <sup>1</sup> EK-38 11° beam at -3dB	Simrad EK-38 12° beam at -3dB	Simrad EK-38 11° beam at -3dB	Simrad EK-38 11° beam at -3dB	Biosonics 101 7° beam at -3dB
Towed V-fin transducer housing	2-ft Braincon	2-ft Braincon	2-ft Braincon	2-ft Braincon	2-ft Braincon
Tape recorder	TEAC 3440A reel-to-reel	cassette	TEAC 3440A reel-to-reel	TEAC 3440A reel-to-reel	cassette
Chart recorder	Simrad wet paper	Simrad dry paper	Simrad wet paper	Simrad wet paper	EPC 1600 dry paper
Portable echo integrator	Biosonics 120	NWAFC acoustic research container system	Biosonics 120	Biosonics 120	Biosonics 120
Computer	Not used	NWAFC acoustic research container system	Not used	Not used	Radio Shack TRS-80
Sonar system	C-Tech LSS-68 68 kHz sector scanning	Not used	C-Tech LSS-68 68 kHz sector scanning	Simrad SQ searchlight beam	Furuno FSS-75 75 kHz sector scanning
Video camera and recorder	RCA C004 camera Panasonic recorder	Not used	RCA C004 camera Panasonic recorder	RCA C004 camera Panasonic recorder	RCA C004 camera Panasonic recorder

<sup>1</sup>Reference to trade names does not imply endorsement by the National Marine Fisheries Service, NOAA.

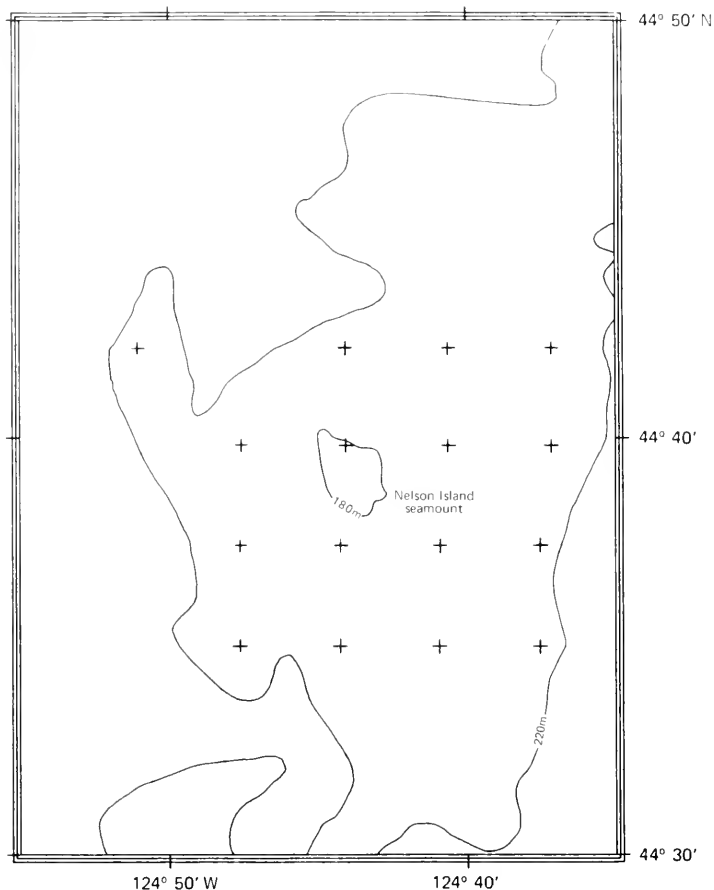

FIGURE 2.—The demersal trawl station grid occupied during 1980 and 1981 widow rockfish behavior studies on the Nelson Island ground off Newport, OR. The 16 trawl stations are marked with a (+).

school of widow rockfish, which was sampled with midwater trawl gear (Fig. 4). It was not possible to stay in contact with the school long enough to observe diel changes in behavior.

When the study was repeated in April 1981, only 4 of 20 demersal tows contained widow rockfish. Two of these tows contained only a single specimen each, while the others contained 20 and 28 specimens. Results again indicated that widow rockfish were relatively unavailable to demersal trawl gear and that their distribution was somewhat more closely associated with Nelson Island during the night than during the day (Fig. 3, 1981).

It is important to be able to distinguish widow rockfish from other species on the basis of echosign in order to draw conclusions about their behavior, distribution, and abundance. Commercial fishermen targeting on this species have shown that this can

be done. We characterized the echosign produced by widow rockfish and other species occurring on widow rockfish grounds using echograms obtained aboard research and commercial vessels and through discussions with commercial fishermen on echograms and corresponding catches. Widow rockfish schools most frequently appeared on echograms as tall, slender columns suspended over an irregular bottom (Fig. 5). These were often accompanied by less dense layers probably composed of salps and other zooplankton. Widow rockfish were sometimes present during evening and morning in smaller schools high in the water column (Fig. 6). Shortbelly rockfish, *Sebastes jordani*, and redstripe rockfish, *S. proriger*, have similar echosign characteristics and are most likely to be confused with widow rockfish off the Oregon coast (Figs. 7, 8). Other midwater targets in the area were identified as layered schools of

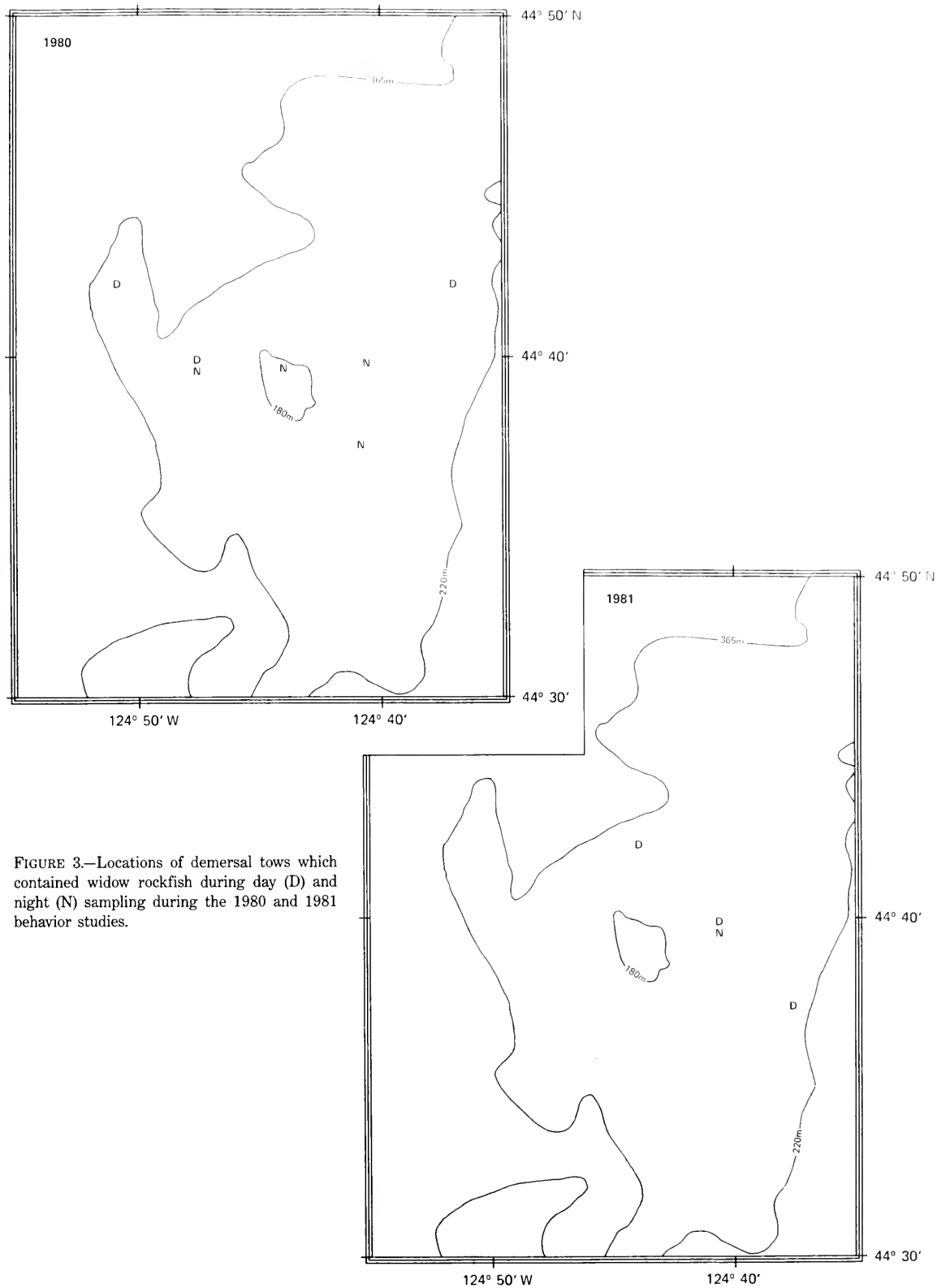

FIGURE 3.—Locations of demersal tows which contained widow rockfish during day (D) and night (N) sampling during the 1980 and 1981 behavior studies.

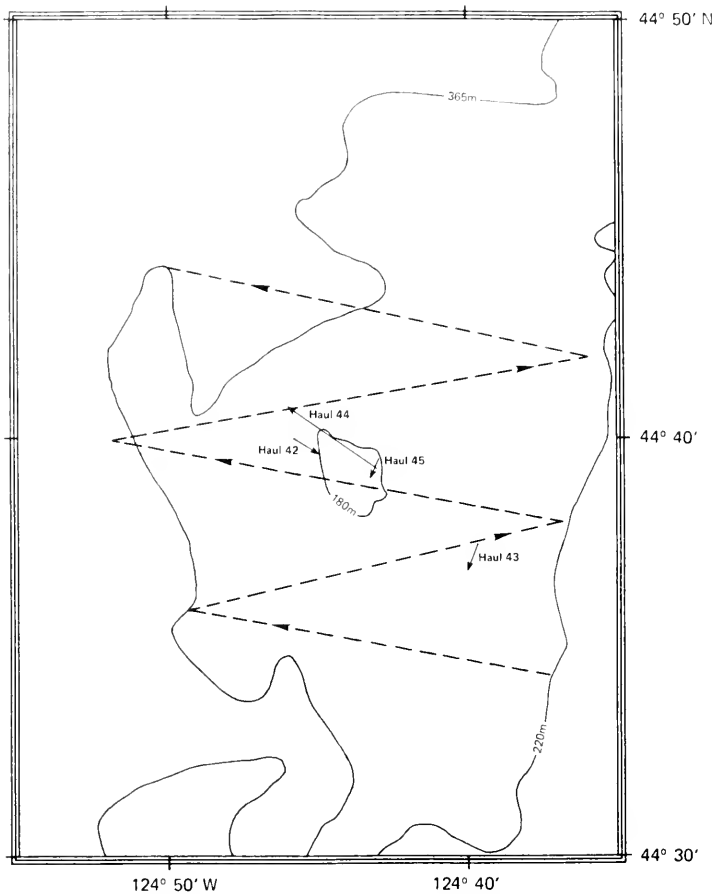

FIGURE 4.—Hydroacoustic transects (dashed lines) and midwater trawl hauls (solid arrows) conducted by the RV *Miller Freeman* during the 1980 behavior study. Only haul 43 contained widow rockfish (1,247 kg).

Pacific whiting, *Merluccius productus*, (Fig. 8) or less dense layers of zooplankton.

The formation and dispersal of widow rockfish aggregations was observed during the research cruises. During a typical night, small schools would appear in late evening (from 2000 to 2400) either near bottom or high in the water column. As the night progressed, these schools tended to grow and those high in the water would settle toward the bottom. Peak school size and density usually occurred between 0200 and dawn. Shortly after daybreak, most schools would separate into smaller schools and rise off the bottom. The schools would sometimes move over deeper water while maintaining their nighttime configuration.

Departures from the typical behavior patterns have been reported. For example, while observing widow rockfish schools over the continental shelf (not

aggregating around a seamount), Gunderson et al.<sup>7</sup> noted a progressive offshore shift in the location of the schools during one night. By sunrise most of the schools were located near the edge of the shelf. Most of these schools dispersed after dawn, but some remained on the bottom in the area (in one case as late as 1037 when observations were terminated). This apparent shift may have been related to diurnal vertical migration behavior (Pereyra et al. 1969).

## METHODOLOGY DEVELOPMENT (1980-81)

The methodology development was conducted by

<sup>7</sup>Gunderson, D. R., G. L. Thomas, P. Cullenberg, and R. E. Thorne. 1981. Rockfish investigations off the coast of Washington and Oregon. Final report. Unpubl. manuscript, 45 p. Univ. Wash., Fish. Res. Inst., FRI-UW-8125.



FIGURE 5.—Echogram showing the typical configuration of widow rockfish schools at night (arrows).

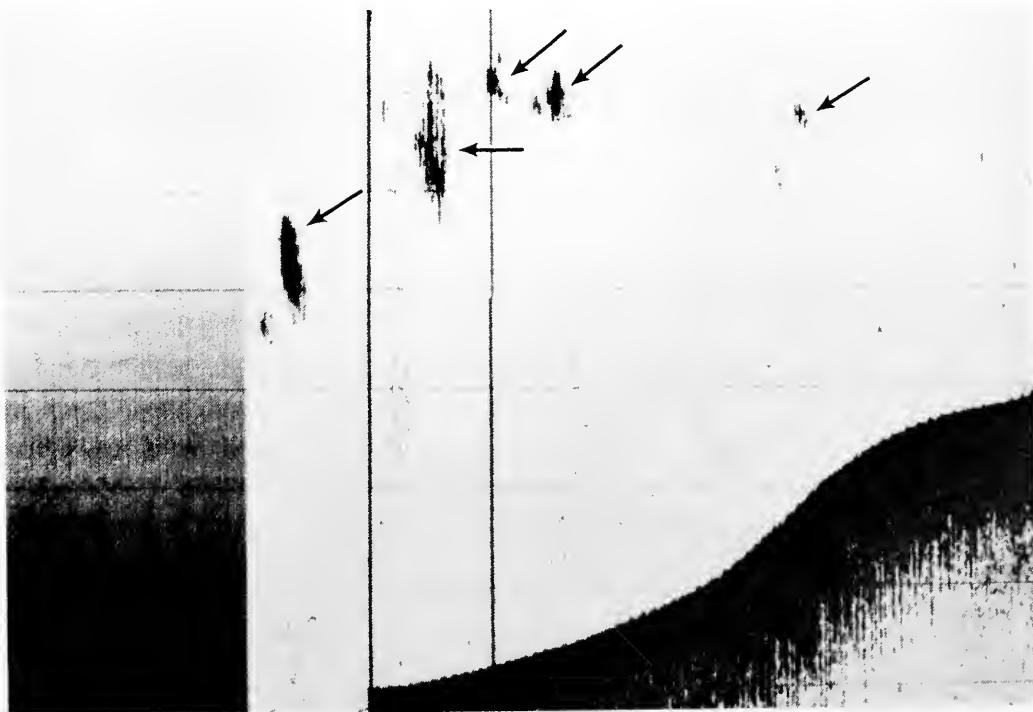

FIGURE 6.—Echogram showing the configuration of "evening and morning" widow rockfish schools (arrows).

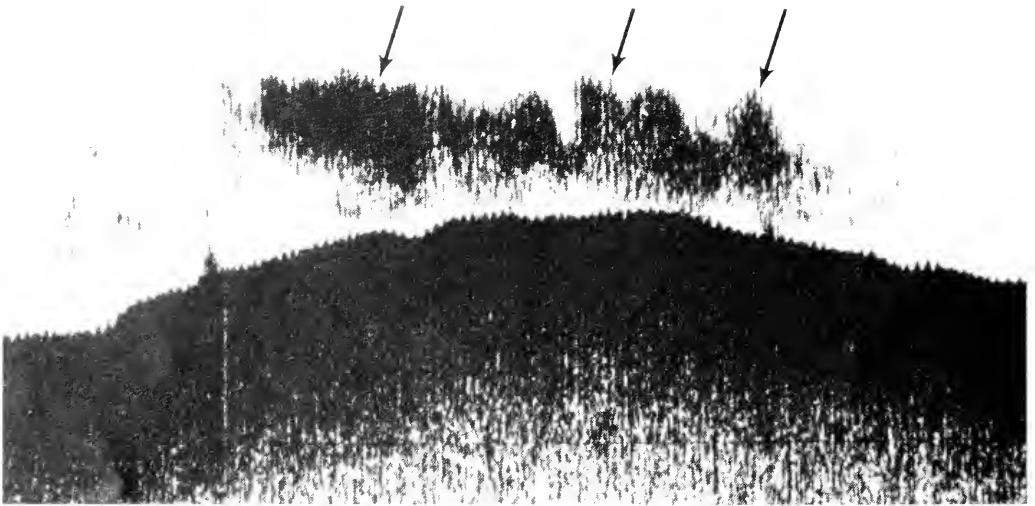

FIGURE 7.—Echogram showing the typical configuration of shortbelly rockfish schools (arrows).

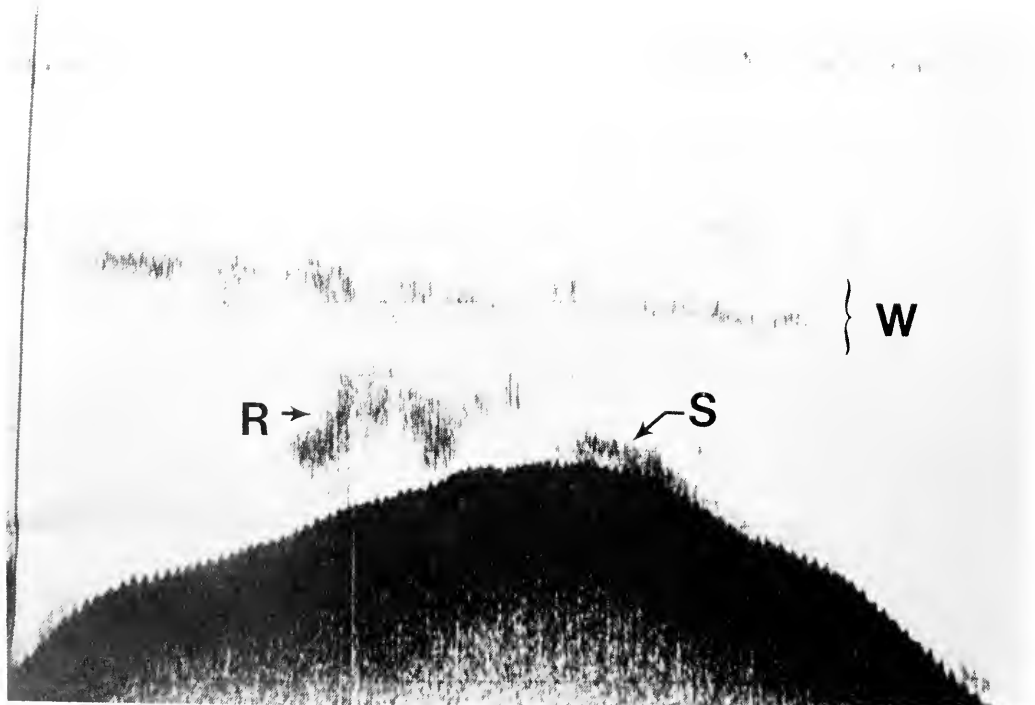

FIGURE 8.—Echogram showing configuration of Pacific whiting (W), redstripe rockfish (R), and shortbelly rockfish (S) schools.



the University of Washington's Fishery Research Institute (FRI) under contract with the NWAFC (Gunderson et al. fn. 7, 8). The objectives of the work were to evaluate the applicability of several resource assessment techniques and refine the most promising approaches. In particular, it involved a comparison of three methods of quantifying widow rockfish abundance in small areas off southern Washington and northern Oregon: conventional echo integration, line transect survey theory (Burnham et al. 1980; Seber 1980), and line intercept survey theory (Seber 1973, 1980).

## Methods

This study involved three research cruises off southern Washington and northern Oregon. Tables 2-4 present the dates of these cruises and specifica-

tions of the vessels, fishing gear, and hydroacoustic equipment employed. The field work entailed systematically transecting the survey areas, simultaneously recording data from quantitative echo integration equipment and sector scanning sonar. Data were collected on the number of fish schools, their perpendicular distance from the transect, their depth below sea surface, the size and density of selected schools, and the distribution of schools in relation to various features of submarine topography. The echo integration system was used in a conventional manner to obtain a measure of the density of fish within a relatively narrow acoustic beam of  $10^{\circ}$ - $11^{\circ}$  directly below the vessel (Fig. 9). Sector scanning sonar cannot measure fish density, but by employing an array of transducers radiating an acoustic signal over a  $200^{\circ} \times 9^{\circ}$  semicircular wedge perpendicular to the path of the vessel (Fig. 9), it can be used to count schools within about 100-200 m to each side of the vessel, measure their dimensions, and determine their perpendicular distance from the transect. The sonar's transducer array was aimed straight downward for these studies. The entire wedge was

<sup>8</sup>Gunderson, D. R., G. L. Thomas, P. Cullenberg, D. M. Eggers, and R. E. Thorne. 1980. Rockfish investigations off the coast of Washington. Annual report. Unpubl. manuscr., 68 p. Univ. Wash., Fish. Res. Inst., FRI-UW-8021.

### ECHOSOUNDER

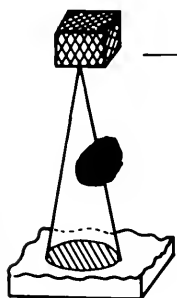

### SONAR

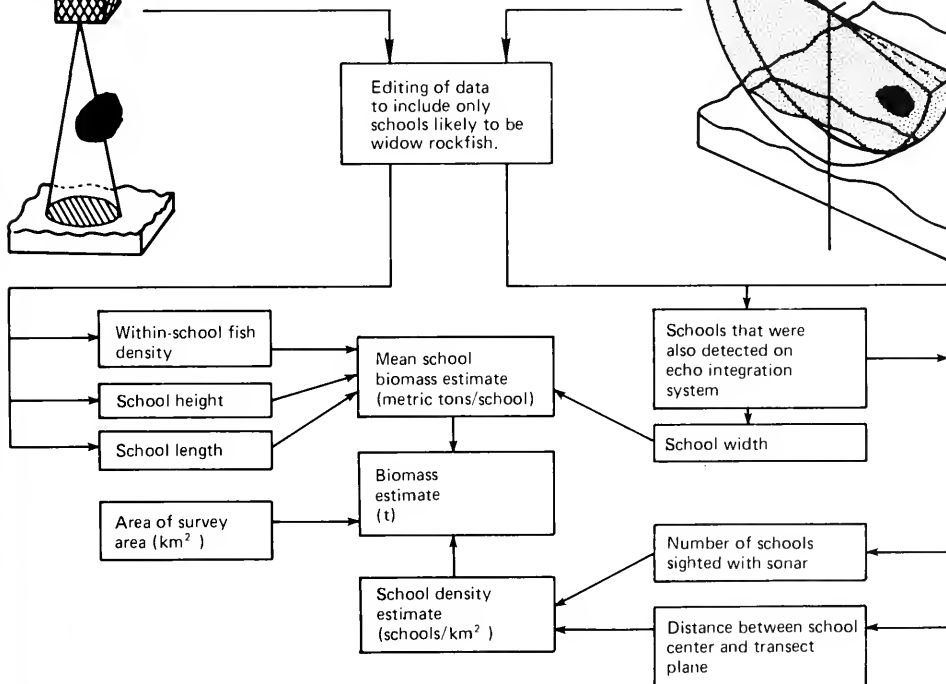
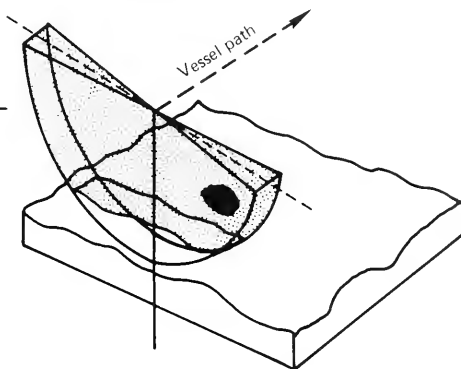

FIGURE 9.—Schematic diagram depicting the analysis of echo sounder and sonar data collected during hydroacoustic line transect surveys.

displayed simultaneously on a 10-in diameter cathode ray tube (CRT) screen which provided information on the location and size of fish schools within its 200-400 m wide path (Fig. 10).

Data was collected electronically during the echo integration and sonar surveys. Echo sounder return signals were processed by an echo integrator capable of measuring voltages in variable-sized depth intervals. The echo integrator produced periodic printouts of summed integrated voltage values which corresponded to relative fish densities along the transect in various depth intervals. Analog data (receiver output voltages) were recorded onto magnetic tape as a back-up procedure and for further processing. The sonar CRT display screen was video-taped for playback and data reduction in the NWAFC laboratory.

Survey design of the 1980 and 1981 FRI studies off southern Washington was generally similar, though some aspects differed. In 1980, preselected tracklines were run and were between lat.  $46^{\circ}20'N$  and  $46^{\circ}48'N$  and between 55 and 183 m isobaths at intervals of 3.7 km. When a significant aggrega-

tion of fish was encountered, its bounds were determined by making several mapping runs perpendicular to the main trackline. Trawling followed to determine the species composition of the aggregation and to collect biological samples. Most of the 1980 work was done during daylight with the intent of mapping and measuring yellowtail rockfish, *Sebastes flavidus*, schools. After encountering numerous widow rockfish schools at night, it became apparent that this species' schooling behavior was better suited for evaluating this methodology. Thereafter, three nights were spent transecting a smaller "widow rockfish subarea". Diel behavior and distribution were examined by making several repetitions of three selected tracklines. Near the end of this cruise an area occupied by a dense aggregation of widow rockfish schools was encountered. A short nonrandom transect was run to obtain comparable line intercept and line transect results.

In 1981, tracklines spaced every 3.7 km were transected between the depths of 128 and 220 m off northern Oregon between lat.  $45^{\circ}50'N$  and  $46^{\circ}18'N$ .

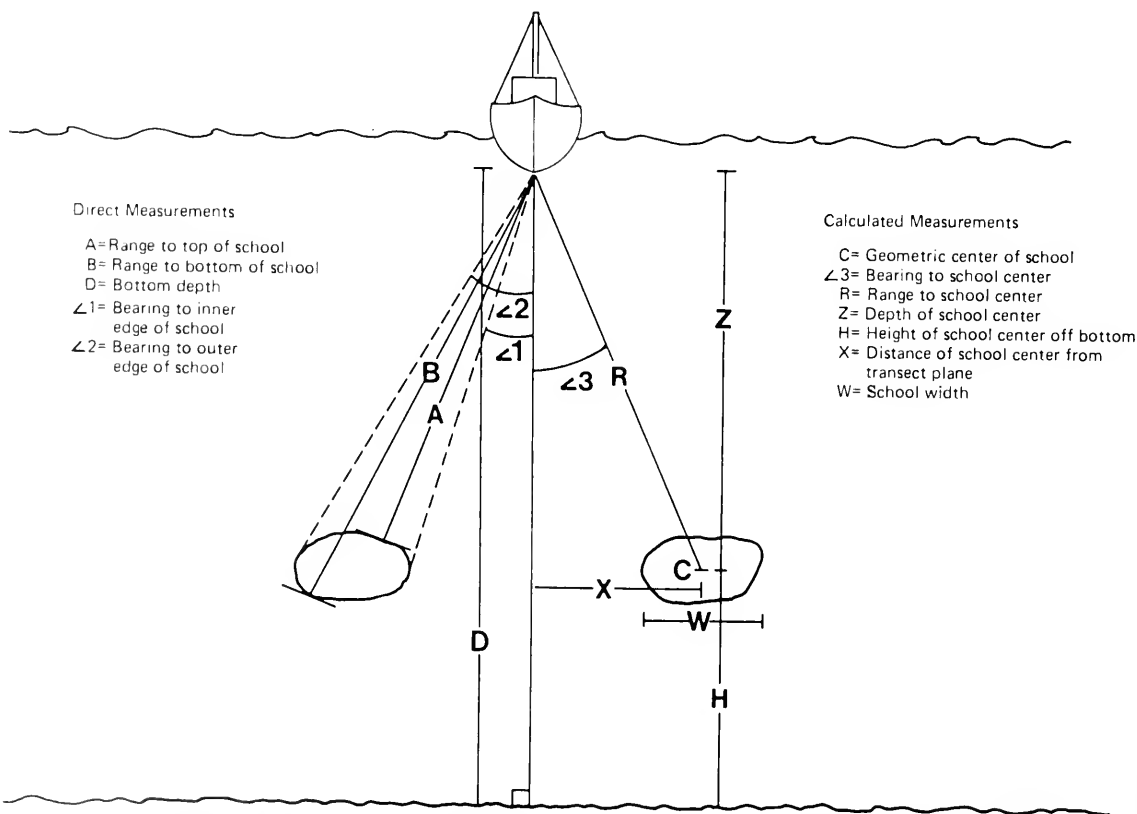

FIGURE 10.—Measurements and calculated dimensions of fish schools from videotaped sonar records.

The same procedures were used as in 1980 except that nearly all operations were conducted after dark and no mapping runs were made to define the bounds of school groups. A diel variability study was conducted on 20 March 1981 between the hours of 0153 and 1037, consisting of 13 replicates of track-line 21.

The conventional analysis of echo sounder data (integration) is based on the principle that the acoustic intensity of a signal reflected from fish targets is proportional to the density of fish in the region irradiated by the echo sounder. Detailed descriptions of the technique can be found in Moose and Ehrenberg (1971), Forbes and Naaken (1972), and Thorne (1977). During the 1980 and 1981 surveys, density estimates from this method were obtained by averaging returning acoustic signals over a series of transmissions (25 transmissions over 12.5 s during the *Muir Milach* cruise and 40 transmissions over 50 s during the *Alaska* and *Chapman* cruises). These averages were then converted from relative to absolute densities ( $\text{kg}/\text{m}^2$ ) for various depth intervals using calibration data and a scaling factor based on an average target strength of  $-35 \text{ dB}/\text{kg}$ .<sup>9</sup> Absolute abundance (biomass) was estimated by extrapolating absolute density estimates to the survey area.

Each survey area was systematically transected using the echo sounder and sonar to search for fish schools and, thereby, to derive line intercept and line transect estimates of school abundance (schools/ $\text{km}^2$ ). Data on school dimensions and density were collected from those schools sighted. With the line intercept method, only the presence of a school (as detected by the echo sounder) and its width were used to estimate school abundance. This technique is based on the theory that, for systematically located transects, the probability of intersecting school  $i$  equals  $w_i/W$ , where  $w_i$  is the width of school  $i$  and  $W$  is the distance between adjacent transects. The number of schools per unit area ( $D$ ) can then be estimated by

$$\hat{D} = \sum_{j=1}^n \frac{1}{w_j L} \quad (\text{Seber 1980})$$

where  $n$  = number of schools measured on a transect of length  $L$   
 $w_j$  = width of  $j^{\text{th}}$  school.

<sup>9</sup>The target strength value used in these analyses ( $-35 \text{ dB}/\text{kg}$ ) was not derived during work on widow rockfish. Since accurate target strength estimation was not necessary for evaluating the utility of the methodology, we used a value which had been estimated for Pacific whiting (Dark et al. 1980) which has a similar scattering cross section.

The line intercept method was applied only to data collected from the nonrandom run made on the night of 27-28 March 1980. The data from this line were subdivided into two artificial transects of unequal length and the jackknife method (Seber 1980) was used to estimate  $D$  and its variance. This technique is described fully by Gunderson et al. (fn. 8).

Line transect theory is based on the premise that the probability of sighting a given object (or school) is a function of its perpendicular distance from the transect. A "detection function" is derived from school sighting data which relates the probability of a school being sighted to its distance from the transect. This function is used to expand the number of schools actually sighted to obtain an estimate of school abundance. The advantage of this method is that not all schools within sighting range need to be detected in order to estimate the number of schools in the area.

Using line transect estimation, the school abundance (schools per unit area) was estimated by

$$\hat{D} = \frac{n \hat{f}(0)}{2L}$$

where  $\hat{D}$  = estimated number of schools per unit area

$n$  = number of schools sighted

$L$  = length of transect

$\hat{f}(0)$  = "detection function"—a parameter estimated from probability function for the perpendicular distances off transect of schools sighted.

The assumptions necessary for the use of this method are

- 1) Schools directly on the transect plane will always be sighted.
- 2) Schools are sighted in the position they occupied prior to the approach of the vessel, i.e. there is no avoidance of or attraction to the vessel.
- 3) Perpendicular distances off transect are measured precisely, particularly near the transect plane.
- 4) The detection function remains constant.

The computer program TRANSECT (Laake et al. 1979) was used to estimate the probability density function of the perpendicular distance of schools from the transect. The estimator model used is based on a nonparametric Fourier series expansion fit to data sets of observed perpendicular distances of

schools off the transect plane. Quinn (1979) and Burnham et al. (1980) showed that this model is robust and flexible and provides the best fit to the detection function in most applications. This estimator, at zero distance, is

$$\hat{f}(0) = \frac{1}{w^*} + \sum_{k=1}^m \hat{a}_k$$

where  $w^*$  = truncation width, or the effective limit of the range of detection, beyond which all observations are discarded and

$$\hat{a}_k = \frac{2}{nw^*} \left[ \sum_{i=1}^n \cos \left( \frac{k\pi x_i}{w^*} \right) \right] \quad (\text{Burnham et al. 1980})$$

where  $n$  = number of schools observed  
 $x_i$  = perpendicular distance off transect for the  $i^{\text{th}}$  school  
 $k$  = term number = 1,2,3, . . .  $m$  [The number of terms ( $m$ ) is determined by a stopping rule in the computer program TRANSECT].

TRANSECT also computes the school abundance estimate  $\hat{D}$  and its variance which is estimated by the equation:

$$\text{var}(\hat{D}) = (\hat{D})^2 \left[ \frac{\text{var}(n)}{n^2} + \frac{\text{var}[\hat{f}(0)]}{[\hat{f}(0)]^2} \right].$$

Mean school biomass estimates were derived from density information (from echo sounder data), school dimension information (from sonar data), and an assumed target strength of  $-35$  dB/kg. These estimates were used in the line transect and line intercept analyses. All information on schools detected by the hydroacoustic systems was edited to discriminate widow rockfish from other species using judgments based on school form, density, location, and test trawl records. Data on each school identified as widow rockfish were then integrated to obtain mean within-school density. The CRT display of the sector scanning sonar provided representations of the size, shape, and position of fish schools within its range of detection. The dimensions of all schools identified as widow rockfish were measured on the screen of a video monitor using the slow motion and freeze-frame features of the video recorder-player.

Dimensions measured directly included depth of school from the surface, distance off bottom, width, thickness, radial distance from vessel, and bearing to the right or left of a vertical line below the vessel (Fig. 10). The perpendicular distance of the school from the vertical plane of the vessel's path ("distance off transect") was calculated from the radial distance and bearing. All distances were measured or calculated to the apparent geometric center of each school (Burnham et al. 1980). The length of each school was calculated from the product of vessel speed and the duration that the school was being detected by the sonar, and was corrected to account for the variable sonar beam width parallel to the vessel's path due to depth.

The biomass of individual schools was estimated by the formula

$$\hat{b}_i = t_i l_i w_i d_i$$

where  $\hat{b}_i$  = estimated biomass of school  $i$   
 $t_i$  = average thickness of school  $i$ , top to bottom (echo sounder data)  
 $l_i$  = length of school  $i$ , parallel to transect (sonar data)  
 $w_i$  = average width of school  $i$  perpendicular to transect plane (sonar data)  
 $d_i$  = mean integration density for school  $i$  ( $\text{g}/\text{m}^3$ ) assuming a target strength of  $-35$  dB/kg (see footnote 9) (echo sounder data).

The mean school biomass ( $MSB$ ) was estimated from the individual school biomass estimates; its variance was determined from

$$\text{var}(M\hat{S}B) = \sum_{i=1}^N \frac{(\hat{b}_i - M\hat{S}B)^2}{N(N-1)}$$

where  $N$  = number of schools averaged for  $MSB$ .

Total biomass estimates from the line transect and line intercept methods were calculated for each survey area using the formula

$$\hat{B} = A \hat{D} (M\hat{S}B)$$

where  $\hat{B}$  = estimated total biomass for the survey area, and  
 $A$  = total area ( $\text{km}^2$ ) of the survey area.

The variance of these estimates was determined from

$$\begin{aligned} \text{v\`ar } \hat{B} = & A^2 [(\hat{D})^2 \text{v\`ar}(M\hat{S}B) + (M\hat{S}B)^2 \text{v\`ar}(\hat{D}) \\ & - \text{v\`ar}(M\hat{S}B) \text{v\`ar}(\hat{D})] \quad (\text{Goodman}) \text{ 1960} \end{aligned}$$

## Results

Twenty one trawl hauls were made during the 1980 FRI survey aboard the *Muir Milach*; 6 with bottom gear and 15 with midwater gear. Widow rockfish were caught only in midwater hauls and comprised 99% of those catches. The most abundant species in the bottom tows were spiny dogfish, *Squalus acanthias*, and black rockfish, *Sebastes melanops*. The acoustic survey consisted of 22 systematic transects covering about 550 km and employed sonar and echo integration equipment. Twenty six schools were sighted and measured to provide data for a line transect estimate of school abundance. During the nonrandom transect run on the night of 27-28 March 1980, 73 schools were sighted and measured for use in developing line transect and line intercept estimates of school abundance in a small subarea.

Only four trawl hauls were attempted during the 1981 FRI survey due to severe gear damage. Red-stripe rockfish, *Sebastes proriger*, comprised 90% or more of the two catches which contained fish (one midwater haul and one bottom haul). The midwater haul was made quite close to bottom near midnight

and contained small quantities of sharpchin rockfish, *Sebastes zacentrus*; widow rockfish; and greenstriped rockfish, *S. elongatus*, suggesting an association of these species in nearbottom schools at night. Fifteen systematic transects were covered during this survey (about 400 km) during which 49 schools were sighted and measured. One of the transects was replicated 13 times during one night to observe the behavior of a group of schools over the continental shelf just south of the Columbia River. These schools were not gathered around a prominent bottom feature. As the night progressed they moved deeper and further offshore, reaching the shelf break about sunrise. After sunrise most of the schools dispersed, though some remained on bottom at least until observations ceased at 1037 (Gunderson et al. fn. 7).

During the 1981 NMFS cruise, quantitative hydroacoustic data were collected from 21 transects on the Nelson Island, The Fingers, Heceta Bank, and Cape Blanco grounds (Fig. 1, Table 5) using echo integration (Thomas et al. fn. 5). The searchlight-beam sonar available on the *Chapman* was inadequate to identify school types or provide estimates of school density. This is because it employed only a single transducer programmed to sweep back and forth and did not provide continuous coverage of the area within its range. Therefore, all density and biomass figures for this survey refer to total nekton rather than widow rockfish.

TABLE 5.—The mean fish and nekton density (g/m<sup>3</sup>) and biomass (metric tons) by location, date, and transect estimated by a conventional echo integration survey performed aboard the NOAA RV *Chapman*, 21-26 April 1981.<sup>1</sup>

Location	Date	Trans- sect	Transect length (km)	Density	Mean density $\bar{D}$	V\`ar $\bar{D}$	Area (km <sup>2</sup> )	Biomass $\bar{B}$	V\`ar $\bar{B}$
Crater	4/21	1	18.56	1.78	2.82	2.45	228.87	646	$1.28 \times 10^5$
	4/22	2	17.11	5.86					
	4/22	3	15.02	0.66					
Cape Blanco	4/23	4	4.19	16.17	6.47	11.31	200.81	1,301	$4.56 \times 10^5$
	4/23	5	4.35	26.22					
	4/23	6	4.67	4.50					
	4/23	7	5.32	1.12					
	4/23	8	6.11	1.79					
	4/24	9	2.44	1.63					
	4/24	10	3.87	0.34					
	4/24	11	3.87	0.06					
Heceta Bank	4/24	12	17.59	4.67	4.89	9.44	87.15	427	$7.17 \times 10^4$
	4/25	13	18.37	0.12					
	4/25	14	15.30	10.88					
The Fingers	4/25	15	14.74	1.78	1.73	0.19	75.11	130	$1.07 \times 10^3$
	4/25	16	14.74	1.01					
	4/25	17	12.22	2.54					
Crater	4/26	18	5.57	0.00	1.79	2.83	34.78	62	$3.43 \times 10^3$
	4/26	19	6.96	0.00					
	4/26	20	6.28	6.75					
	4/26	21	5.63	0.26					

<sup>1</sup>Thomas, G. L., C. Rose, and D. R. Gunderson. 1981. Rockfish investigations off the Oregon coast, annual report. Unpubl. manusc., 20 p. Univ. Wash., Fish. Res. Inst. FRI-UW-8119.

The results of echo integration, line intercept, and line transect analyses were compared using data collected during the 1980 and 1981 FRI cruises (Gunderson et al. fn. 7, 8). Large differences were seen between echo integration and line transect estimates in a situation where schools were relatively small and scarce (1980 transect data, Table 6). The principal reason for this is that the threshold echo voltage required to trigger the sonar CRT display was higher than that needed to detect a school on the echo integration system, so many of the sparser schools detected by the echo sounder were not detected with the sonar. In situations where schools were larger and more plentiful (1980 nonrandom runs and 1981 transects) all three methods produced similar estimates. The precision of abundance estimates generated by line transect and line intercept methods is usually comparable to that of conventional echo integration methods and can exceed it in some cases (Gunderson et al. fn. 7). The major factors which led us to concentrate our efforts on line transect surveys were the ability to cover large areas rapidly and the ability to expand the number of schools sighted by a detection function, yielding more accurate estimates of school abundance.

## APPLICATION OF ASSESSMENT METHODOLOGY

By 1982 the aforementioned studies had provided a foundation of information on which to expand developmental research. The behavioral observations suggested that widow rockfish aggregations were

most stable and susceptible to assessment during the night. Line transect estimation of school abundance through the use of sonar and echo integration equipment was found to be the most effective of the techniques compared, especially when school abundance was likely to be low. The next step in the project was to evaluate the feasibility of applying the line transect survey method in a comprehensive survey to assess and monitor widow rockfish stocks.

## Methods

The trawler *Ocean Leader* was chartered to survey five areas off Oregon (Fig. 1) where widow rockfish had been caught consistently between 1980 and 1982. Specifications of the vessel, fishing gear, and hydroacoustic equipment used appear in Tables 2-4. The proximity of alternative grounds was important for the success of the survey, should widow rockfish not be found in one or more of the areas. At each of the grounds the survey procedure was as follows:

- 1) The ground was systematically surveyed with hydroacoustic equipment during the night to determine whether fish schools were in the area. The locations of schools suspected to be composed of widow rockfish, or species likely to be confused with widow rockfish, were noted. The final boundaries of the study area were then delineated.
- 2) The study area was surveyed at night along parallel tracklines about 1 km apart using the line transect survey technique. The tracklines were replicated as many times as practical throughout

TABLE 6.—Summary of estimates of school abundance ( $\bar{D}$ ), mean school biomass ( $M\hat{S}\bar{B}$ ), and total biomass ( $\hat{B}$ ) for widow rockfish. Coefficients of variation (CV) are given for each estimate.<sup>1</sup>

	$\bar{D}$ (schools/ nm <sup>2</sup> )	CV	$M\hat{S}\bar{B}$ (t)	No. of schools	CV	$\hat{B}$ (t)	CV
1980							
Transect data							
26 schools, 2 transects							
Line transect estimate	69.5	0.84	0.12	15	0.20	204	0.84
Echo integration estimate						778	0.16
Nonrandom run data							
73 schools, 1 transect							
Line transect estimate	242.2	0.19	0.85	16	0.50	5,003	0.53
Line intercept estimate	248.9	0.10	0.85	16	0.50	5,139	0.51
Echo integration estimate						6,453	—
1981							
Transect data							
29 schools, 3 transects							
Line transect estimate	12.1	0.24	0.62	27	0.33	342	0.40
Echo integration estimate						342	0.77

<sup>1</sup>Gunderson, D. R., G. L. Thomas, P. Cullenberg, and R. E. Thorne. 1981. Rockfish investigations off the coast of Washington and Oregon. Final report. Unpubl. manuscr., 45 p. Univ. Wash., Fish. Res. Inst. FRI-UW-8125.

the night to provide information on variability of abundance and distribution within a given night. Selected study areas were again surveyed after an interlude of several days to study variability over longer periods.

- 3) Fish aggregations noted during transecting were sampled with midwater trawls for species identification. This was done on alternate nights so as not to impede the progress of the acoustic assessment portion of the survey. Biological data (e.g., size composition, maturity, stomach contents) were collected from widow rockfish in the catches.

## Results

About 725 km of transects were covered in the five study areas during the 12 nights of hydroacoustic data collection. Ten midwater trawl hauls were made to identify species present in various schools. Widow rockfish schools were seen in all areas, but were sparse on the Cape Blanco, Heceta Bank, and The Fingers grounds. The Halibut Hill ground, only recently exploited, contained the highest density of widow rockfish schools and also the largest average school size. After editing videotaped sonar records, 127 schools were identified as widow rockfish; data from 37 of these were integrated on the echo sounder system and used to calculate school biomass estimates. Ideally, a mean school biomass would have been derived for each ground, but because few schools were observed there, school biomass estimates were pooled and averaged for the Nelson Island, The Fingers, and Heceta Bank grounds. No measurable widow rockfish schools were seen during surveys of the Cape Blanco ground. School abun-

dance was estimated for each area by treating each pass through the area as a replicate and pooling data from all replicates within the area. School abundance (excepting Cape Blanco) ranged from 0.6035 schools/km<sup>2</sup> on The Fingers ground to 1.4810 schools/km<sup>2</sup> on the Halibut Hill ground. Area biomass estimates are summarized in Table 7. The total estimated biomass for the five survey areas was about 830 t; 50% at Halibut Hill ground, 30% at Heceta Bank, 11% at The Fingers, and 9% at Nelson Island.

Sampling was concentrated on the Halibut Hill ground, where widow rockfish schools were largest and most plentiful, in order to investigate the diel and night-to-night variability in school abundance. The survey of this ground was repeated seven times; three times each night on 26-27 March and 31 March-1 April and once on 30 March. Separate sighting functions for each night were estimated by pooling observations. Corresponding school abundance and mean school biomass estimates were then calculated for each night. School abundance ranged from 0.39 schools/km<sup>2</sup> on 26-27 March to 4.50 schools/km<sup>2</sup> on 30 March. Mean school biomass tended to decline as school abundance increased, however, so biomass estimates for each of the sampling periods changed less than either school abundance or mean school biomass (Table 8). It was not possible to analyze the Halibut Hill data on a replicate-by-replicate basis because few schools were sighted during any single replicate. The number of sightings per replicate ranged from 4 to 34. Burnham et al. (1980) cautioned that such stratification procedures for line transect surveys should be "severely limited to those few surveys where the number of objects seen on replicate lines is fairly large (perhaps at least in the 20 to 30 range)".

TABLE 7—Summary of estimates of school abundance ( $D$ ), mean school biomass ( $M\hat{S}B$ ), and biomass ( $\hat{B}$ ) in each of four study areas covered during the 1982 widow rockfish assessment feasibility survey.

Study area	$\hat{D}$ (schools km <sup>2</sup> )	$\hat{V}ar(\hat{D})$	$M\hat{S}B$ (t school)	$\hat{V}ar(M\hat{S}B)$	Area (km <sup>2</sup> )	$\hat{B}$ (t)	$\hat{V}ar(\hat{B})$	$CV(\hat{B})$ [ $\hat{V}ar(\hat{B})$ ] <sup>1/2</sup> $\hat{B}$
Heceta Bank	0.9490	0.0305	1.968 (6 schools)	0.656	68.60	245.76	6,758.37	0.335
The Fingers	0.6035	0.0711	6.409 (4 schools)	5.486	40.47	92.20	2,212.03	0.510
Nelson Island	0.7587	0.3010	3.924 (2 schools)	9.514	27.44	78.59	3,467.75	0.749
3 above areas pooled <sup>1</sup>			3.775	1.151				
Halibut Hill	1.4810	0.2028	9.639 (25 schools)	21.668	28.81	411.27	51,758.47	0.553

<sup>1</sup>School biomass data from Heceta, The Fingers, and Nelson Island were pooled to provide a mean school biomass which was used to calculate total biomass in each area.

TABLE 8.—Summary of estimates of school abundance ( $\bar{D}$ ), mean school biomass ( $M\bar{S}\bar{B}$ ), and biomass ( $\bar{B}$ ) of widow rockfish on the Halibut Hill ground during replicates on 26-27 March, 30 March, and 31 March-1 April 1982.

Sampling period	No. of replicates	No. of schools sighted/replicate	$\bar{D}$ (schools/km <sup>2</sup> )	V $\bar{a}r(\bar{D})$	$M\bar{S}\bar{B}$ (t/school)	V $\bar{a}r(M\bar{S}\bar{B})$	Area (km <sup>2</sup> )	$\bar{B}$ (t)	V $\bar{a}r(\bar{B})$	$CV(\bar{B})$ [V $\bar{a}r(\bar{B})$ ] <sup>1/2</sup>
										$\bar{B}$
26-27 March	3	9	0.394	0.1264	21.674 (MSB based on 8 schools)	153.878	28.81	245.96	52,852.69	0.935
		14								
		13								
30 March	1	34	4.499	0.8908	0.729 (MSB based on 7 schools)	0.160	28.81	94.49	2,962.75	0.576
31 March- 1 April	3	9	1.325	0.1687	0.935 (MSB based on 9 schools)	0.088	28.81	35.69	238.52	0.433
		11								
		11								

Variations in the pattern of school abundance over the course of a night were common. Echograms recorded during the seven replicates of one transect on the Halibut Hill ground (Fig. 11) illustrate one case when abundance was high early in the night and decreased toward dawn (26-27 March). The opposite trend of low abundance increasing toward dawn is illustrated (31 March-1 April) in the same figure.

## DISCUSSION

The objectives of this 3-yr project were to study the schooling behavior of widow rockfish to provide the background needed to design effective abundance estimating surveys; then to develop an appropriate survey methodology for the species; and, finally, to test the feasibility of implementing such a survey. Substantial progress was made toward satisfying these objectives. The studies of widow rockfish habits and distribution have provided a base for designing surveys which cover its range and produce the best likelihood of encountering the exploitable population at a time when it will be most available.

Understanding the schooling and dispersal behavior of widow rockfish was important to develop an appropriate survey approach for estimating abundance. The nighttime aggregations which are the targets of the commercial fishery tend to disperse about daybreak, perhaps scattering throughout the water column or seeking shelter near the bottom. If the latter had been the case, more conventional survey methods (i.e., bottom trawl or conventional echo integration surveys) might have been more appropriate.

Although daytime concentrations of widow rockfish were observed, bottom trawl catches during the 1980 and 1981 surveys showed that this species is relatively unavailable to bottom trawls in an area

where widow rockfish are known to aggregate at night.<sup>10</sup> This is substantiated by low incidences of widow rockfish in catches of other bottom trawl surveys during periods when midwater trawlers were making large landings. Consequently, when midwater schools disappear during the day, it is unlikely that they disperse along the bottom. In recent years, skippers of midwater trawlers have commented that widow rockfish are becoming more evasive and dive below their nets to avoid capture. Some skippers have taken advantage of this behavior by purposely driving the schools toward bottom with engine noise where they capture them with bottom trawls equipped with roller gear. Although these are classified as bottom trawl landings, the fishermen are, in a sense, capturing midwater schools. Fishermen have also reported encountering daytime aggregations of this species over the continental slope in waters deeper than they are usually found at night (>500 m) and some have been able to catch them on or near the bottom during the day. Thus the distribution of widow rockfish relative to the sea bottom is quite unpredictable during the daytime. These schools are also not as large as those that occur at night. The appropriate time to survey this resource thus appeared to be at night. The line transect survey method, adapted for use with sector scanning sonar and echo integration equipment, was chosen over conventional echo integration and the line intercept method because of its ability to survey areas more quickly and thoroughly.

Application of the method exposed several problems affecting the precision and accuracy of the abundance estimates. The estimation of school abundance was hampered primarily by limitations of the sonar equipment and by small samples. We were not

<sup>10</sup>Observations of midwater echosign and landing information from commercial vessels fishing in the area confirmed that the usual dense midwater widow rockfish aggregations were present in the area at night during the 1981 bottom trawl survey.



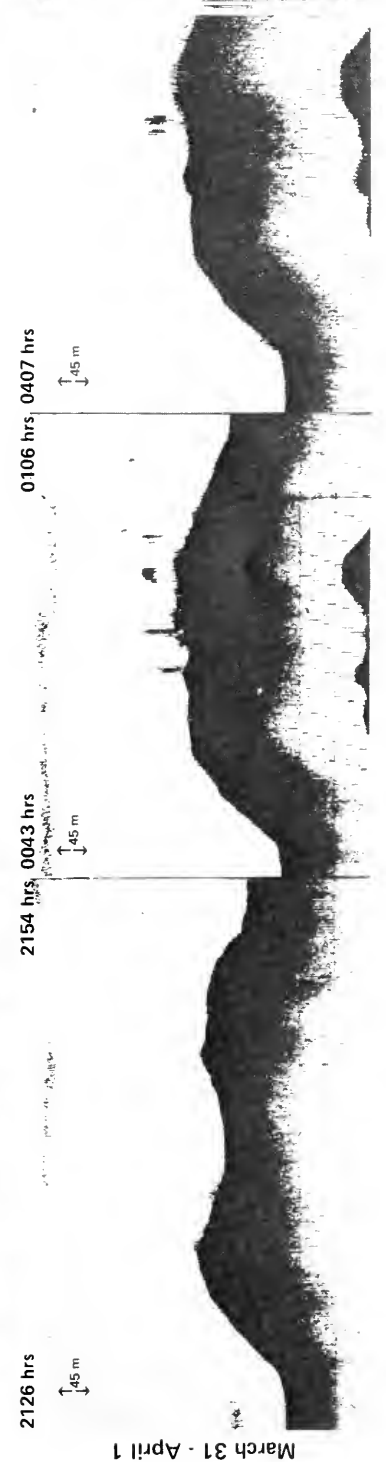
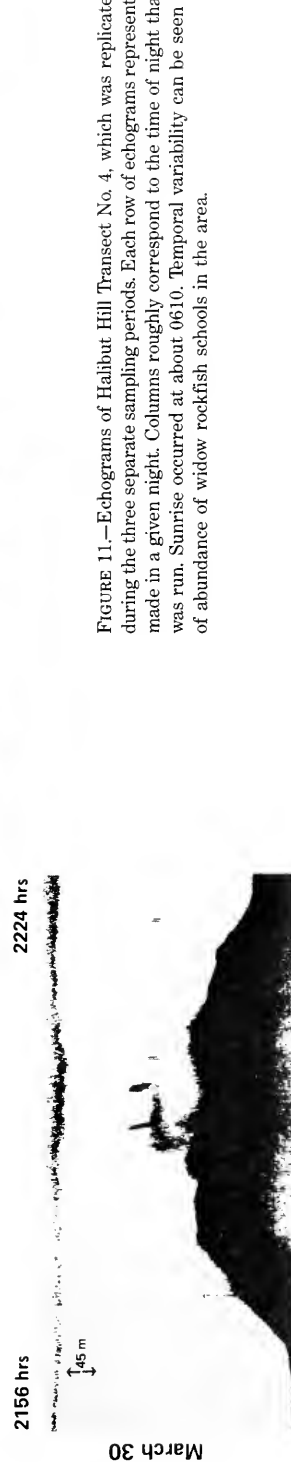

FIGURE 11.—Echograms of Halibut Hill Transect No. 4, which was replicated seven times during the three separate sampling periods. Each row of echograms represents all replicates made in a given night. Columns roughly correspond to the time of night that the transect was run. Sunrise occurred at about 0610. Temporal variability can be seen in the pattern of abundance of widow rockfish schools in the area.

able to calibrate the sonar systems so that the sensitivity of all transducers in the array were equal. Hence, the probability of detecting a given school in one sector of the sonar display was not necessarily the same as detecting it at an equal distance in another sector. The inability to calibrate the transducers may have compromised our ability to detect all schools directly below the transect. This is the most important assumption of line transect surveys; school abundance estimates will be biased downward if it is violated. Intercalibration of the transducers would also help establish a more accurate detection function which would apply throughout the sonar's range.

The limited lateral resolution of sector scanning sonar hampers the accurate measurement of school width, an important value for determining mean school biomass. Each transducer in the fan-shaped array acts as an independent echo sounder and if any portion of a school enters the radiation pattern, the entire width of the  $9^{\circ}$ - $10^{\circ}$  sector sampled by that beam will be displayed as a reflective target (Fig. 12). This results in an overestimation of school width and a distortion of the school's size and location, yielding overestimates of biomass and inaccurate measures of distance from the transect plane. The detection function will be altered by these inaccuracies and may modify estimates of school abun-

dance depending on the magnitude and the direction of the errors. The distortion may be aggravated by interference of side lobes in the directivity pattern of individual transducer beams (Fig. 13). Even these lower power lobes can produce echo signals if very dense targets are encountered and may interfere with the acoustic signals from adjacent transducers.

Another weakness of sector scanning sonar in this application is insufficient detection sensitivity. This weakness became apparent during calculations of the lengths of individual schools. Lengths were calculated twice for each school, once based on echo sounder data and again based on sonar data. The theoretically correct method would employ the sonar data because schools could be detected further to each side of the vessel. The echo sounder could only detect the portion of the school within the  $10^{\circ}$ - $11^{\circ}$  beam directly below the vessel. Consequently, if a large part of the school was outside the beam, its length was underestimated. In practice, however, the length estimates based on sonar detections were usually shorter than those based on echo sounder data (Table 9) due to the lower sensitivity of the sonar system. The sonar-based lengths were chosen, however, because they measured the dimensions of the part of the school having densities above the threshold required to trigger the sonar. This is probably

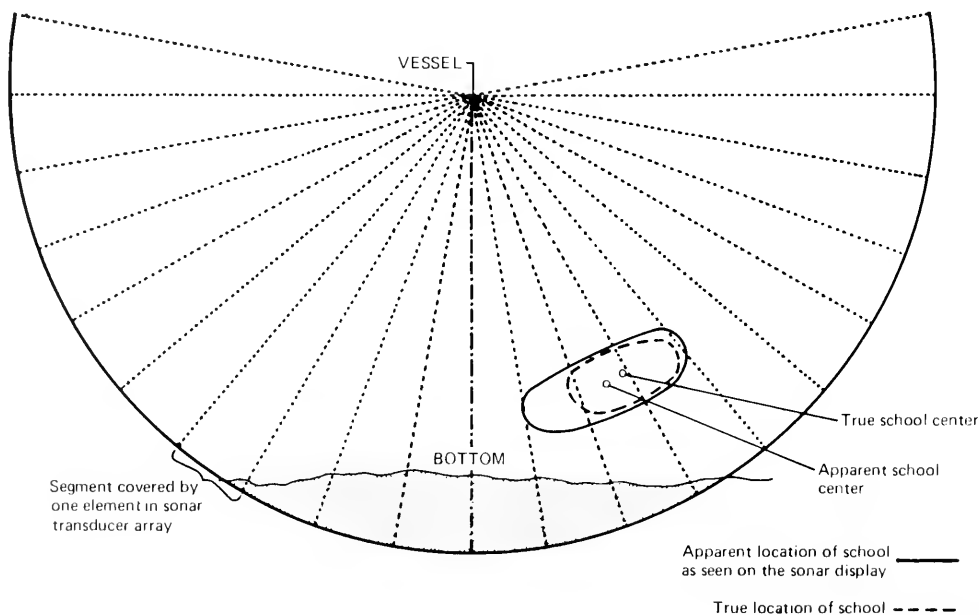

FIGURE 12.—A facsimile of the sector scanning sonar output display exemplifying biases in apparent school locations resulting from the limited resolution of the instrument.

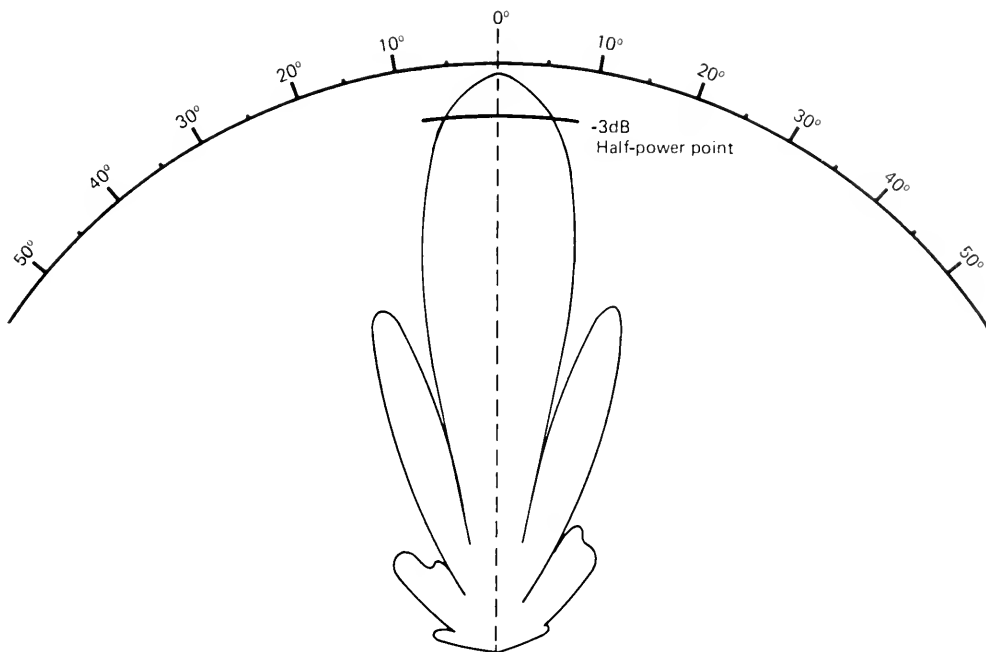

FIGURE 13.—The theoretical directivity pattern of one transducer element of the sector scanning sonar showing side lobes which may interfere with the signals received by adjacent transducers.

a more proportional measurement of school length than the echo sounder-based lengths. The accuracy of school dimension measurements could be improved by using more sensitive and specialized sonar equipment.

These problems with the limitations of sector scanning sonar should not be difficult to overcome. More sensitive quantitative sonar equipment is now available or relatively easy to develop. Lateral resolution may remain a problem because of the difficulty and expense of producing narrow-beam transducers, but the errors it causes are relatively unimportant.

The accuracy of mean school biomass estimates would be improved by target strength studies specific to widow rockfish. Calculation of average fish density within each school was relatively straightforward but involved assuming a target strength of  $-35$  dB/kg. Ideally, the target strength should be calculated specifically for widow rockfish but such specialized work was beyond the scope of this study.

The ability to distinguish widow rockfish schools from those of other species using hydroacoustic equipment is an important element of this technique. Through these studies, our ability to correctly identify widow rockfish echo sign has been improved. The accuracy of species identification varies depending on the nature of the species complex in

the survey area. Where shortbelly and redstripe rockfish are present, the potential for misidentification increases. Technological improvements in sonar equipment may help to reduce this problem. The density of a school is an important criterion for distinguishing widow rockfish from other species and newer sonar equipment includes density-graded color video displays. Other techniques, such as underwater photography or remote video camera vehicles, might also improve our ability to identify species. I believe, however, that test fishing will always be a necessary component of hydroacoustic resource assessment surveys.

Surveys of widow rockfish resources must be designed with the behavior and distributional variability of the species in mind. The diel behavior of the species indicates that the most effective sampling period is at night, but even then unpredictable behavior places special demands on survey design. Observations from hydroacoustic transects which were replicated on several nights (Fig. 11) show that long-term variability in abundance (e.g., night-to-night or week-to-week) is even more marked than that over a shorter time. These results are substantiated by other surveys (see footnotes 5, 7, and 8) and illustrate the difficulty of estimating widow rockfish abundance. Long-term variability is also a factor in area-swept bottom trawl surveys. The

TABLE 9.—Comparison of school length measurements (m) derived from echo sounder versus sector-scanning sonar data collected aboard the *FV Ocean Leader*, 14 March-7 April 1982.

School	Density (kg/m <sup>2</sup> )	Length from echo sounder	Length from sonar
1	0.1292	48.5	45.0
2	0.0265	85.8	2.1
3	1.4860	66.2	5.8
4	1.6996	51.8	19.2
5	0.6374	37.4	74.0
6	0.3559	37.4	79.6
7	1.2415	59.9	52.3
8	0.7513	93.2	66.5
9	0.2119	117.5	118.1
10	0.7567	81.9	236.2
11	0.0686	526.9	497.5
12	0.0453	45.0	31.9
13	0.0490	96.9	353.1
14	0.0068	138.0	18.7
15	1.1400	511.9	393.2
16	0.6089	189.7	64.2
17	0.3055	76.6	18.4
18	0.4564	84.6	70.6
19	0.2154	27.8	93.0
20	0.0080	62.5	116.6
21	0.0487	103.0	16.9
22	0.1057	130.3	49.3
23	0.0936	147.5	28.5
24	0.1730	27.4	9.9
25	0.0103	46.8	39.6
26	0.1262	53.6	40.9
27	0.0182	67.7	43.9
28	0.1013	30.1	124.9
29	0.0830	67.7	84.2
30	0.0430	67.7	189.4
31	0.0208	48.9	33.5
32	0.0117	23.8	41.4
33	0.0128	22.4	14.8
34	0.1808	106.4	50.2
35	0.1809	292.2	216.7
36	0.0424	81.0	66.4
37	3.3097	158.3	101.6
$\bar{x}$	0.3990	105.8	94.8
s	0.6587	113.5	112.2

assumption is that the variability has a strong random component and catch per unit effort values are consequently unbiased. The same situation may well be true here, in which case an important component of the survey design would be multiple replication to obtain good estimates of both long- and short-term variance.

Burnham et al. (1980) reported that good results from line transect surveys require observation of a minimum of about 40 objects per replicate. Fitting the observed perpendicular sighting distances to a detection function becomes less reliable with a smaller number of objects. Widow rockfish abundance is now low on all major grounds and the recommended minimum number of schools was not observed during any single replicate in the 1982 survey, but by pooling replicates a sufficient data-

base was constructed. Sample sizes could be increased through more intense sampling. A time-stratified analysis of the data would be desirable to define within-night variability, but this would place even further demands on a sampling program.

Surveys of the type used for widow rockfish must cover the geographic range of the species of interest more thoroughly than most other survey methods. The dynamic behavior of widow rockfish suggests that the survey method should cover large areas in a relatively short time in order to survey a given fishing ground at least once during the night. Because of day-to-day variability, surveys should include sampling each area during several nights over a 1- or 2-wk period. Most areas containing fishable widow rockfish concentrations have probably been identified and there are a limited number of these grounds (probably 12-20); nearly all are characterized by ridges or rises on the outer continental shelf or upper slope and are relatively small in area. Intensive sampling of widow rockfish, therefore, is more feasible than for most other groundfish species inhabiting less well-defined areas.

Because widow rockfish schools are continually forming and breaking up, there may be a significant portion of the population which is not schooling at any given time and is therefore not susceptible to these survey techniques. This project did not answer whether this is so, but nothing was found to suggest that widow rockfish are significantly detectable by trawl or hydroacoustic surveys in any form other than midwater schools. Until more is learned about the proportion of the stock occurring as schools, surveys must be considered as yielding minimum biomass estimates. Clark and Mangel (1979) proposed a study of rates of school formation and dispersal to explain and evaluate a similar relationship between overall stock size and the proportion of a yellowfin tuna stock occurring as schools. Such a technique should receive further consideration in this situation, but present low widow rockfish school abundance (schools/km<sup>2</sup>) and lack of a consistent pattern of school formation and dispersal would probably make its application in widow rockfish assessment difficult. This question is analogous to that of defining catchability coefficients (i.e., what proportion of those fish in the path of a net are actually captured) for quantitative trawl surveys. Changes in relative abundance can be monitored by such surveys without knowing the catchability if one assumes that the available proportion of the population is constant.

Results of other analyses of widow rockfish be-

havior and stock size should be used to evaluate survey methodology. The groundfish management team of the Pacific Fisheries Management Council (see footnotes 2 and 3) used stock reduction and cohort analyses to estimate the abundance of this species. In an area comparable to our 1982 survey area, the widow rockfish biomass was estimated to be 21,664 t at the beginning of 1982. This estimate is based in part on commercial landing information and, consequently, the definition of the grounds to which it applies is somewhat vague. The fishery-based estimates are much higher than those derived from the 1982 survey data (about 830 t). The relatively low sensitivity of the sonar systems used would result in underestimating biomass and is undoubtedly responsible for much of this difference. The discrepancy is also partly due to the fact that our survey methods only estimate the portion of the stock present as detectable schools and are therefore a measure of relative, rather than absolute, abundance. This is true to some extent for most types of surveys.

Innovations are also needed to resolve the technical problems related to data collection, identification of school species composition, and survey design. Some suggestions include

- 1) a two-vessel survey to improve the efficiency of data collection—such a technique would separate the chore of delineating areas of widow rockfish aggregations, estimating school abundance, and test fishing from that of estimating mean school biomass (Gunderson et al. fn. 7);

- 2) a means of recording a time base on both the audio and video tape records of the echo sounder and sonar to simplify finding the same school on each system for school dimension measurements; and

- 3) a method of estimating all school dimensions and the density within the school from a single data collection system—this would entail development of a sophisticated, quantitative sonar-integration system with the capability of recording the output onto videotape (Ehrenberg 1979).

Such refinements could probably be implemented with relative ease. The methodology should be re-evaluated when these technological and sampling improvements have been made. Widow rockfish management could have been significantly improved with the knowledge of stock size from an effective resource assessment survey. There are also other species which exhibit similar behavior and which, although presently unexploited, need to be assessed

(e.g., shortbelly, redstripe, and black rockfish). This methodology could probably be easily adapted for surveying these resources.

## CONCLUSIONS

Based on the results of research conducted during this project, the line transect survey method using a sector scanning sonar and a quantitative echo sounder appears to be the best means of assessing widow rockfish abundance with research surveys. A weakness of this method is that it only measures the portion of the population existent as distinguishable schools and that portion may be quite variable. It also relies heavily on subjective experience for identifying the species composition of schools. Its strengths are that large areas can be covered quickly and it is not necessary that all schools within sighting range be detected in order to estimate school abundance. It appears that this could be a useful assessment method for widow rockfish and for several other Pacific coast groundfish species which are not yet being seriously exploited. The effectiveness of the technique could be enhanced by employing or developing more sensitive and specialized quantitative sonars and by improving the methods of data collection. The technological and survey design problems encountered should be relatively easy, though somewhat costly, to resolve. The method should then be reevaluated to determine its utility. As the technique is used, scientists will gain a better understanding of the behavior and habits of the target species.

## ACKNOWLEDGMENTS

The work described in the developmental section was ably conducted by Donald R. Gunderson and Gary L. Thomas and their associates at the Fisheries Research Institute, University of Washington College of Fisheries, Seattle, WA, under contract to the National Marine Fisheries Service (contract no. 79-ABC-00203). Much of the information presented in that section is extracted from their contract reports. The hydroacoustic expertise during the 1982 survey work was provided by the Pelagic Resources Assessment Task of the Resource Assessment and Conservation Engineering (RACE) Division, Northwest and Alaska Fisheries Center, NMFS; in particular, Edmund Nunnallee, Jimmie J. Traynor, and John Garrison. I am especially grateful to Nunnallee for advice and guidance during the analysis of echo sounder and sonar data. I also wish to thank Thomas A. Dark, RACE Division, and Nunnallee and Traynor

for their thoughtful and constructive review of this manuscript.

## LITERATURE CITED

- BURNHAM, K. P., D. R. ANDERSON, AND J. L. LAAKE.  
1980. Estimation of density from line transect sampling of biological populations. *Wildl. Monogr.* 72, 202 p.
- CLARK, C. W., AND M. MANGEL.  
1979. Aggregation and fishery dynamics: a theoretical study of schooling and the purse seine tuna fisheries. *Fish. Bull.*, U.S. 77:317-337.
- DARK, T. A., M. O. NELSON, J. J. TRAYNOR, AND E. P. NUNNALLEE.  
1980. The distribution, abundance and biological characteristics of Pacific whiting, *Merluccius productus*, in the California-British Columbia region during July-September 1977. *Mar. Fish. Rev.* 42(3-4):17-33.
- EHRENBERG, J. E.  
1979. The potential of the sector-scanning sonar for in situ measurements of fish target strengths. *In* Proceedings of the 1979 Institute of Acoustics Meeting on sector scanning sonars. Lowestoft, England.
- FORBES, S. T., AND O. NAKKEN (editors).  
1972. Manual of methods for fisheries resource survey and appraisal. Part 2. The use of acoustic instruments for fish detection and abundance estimation. *FAO Man. Fish. Sci.* 5, 138 p.
- GOODMAN, L. A.  
1960. On the exact variance of products. *J. Am. Stat. Assoc.* 55:708-713.
- HITZ, C. R.  
1962. Seasons of birth of rockfish (*Sebastes* spp.) in Oregon coastal waters. *Trans. Am. Fish. Soc.* 91:231-233.
- KIMURA, D. K., AND J. V. TAGART.  
1982. Stock reduction analysis, another solution to the catch equation. *Can. J. Fish. Aquat. Sci.* 39:1467-1472.
- LAAKE, J. L., K. P. BURNHAM, AND D. R. ANDERSON.  
1979. User's manual for program *TRANSECT*. Utah State Univ. Press, Logan, 26 p.
- MOOSE, P. H., AND J. E. EHRENBERG.  
1971. An expression for the variance of abundance estimates using a fish echo integrator. *J. Fish. Res. Board Can.* 28: 1293-1301.
- PEREYRA, W. T., W. G. PEARCY, AND F. E. CARVEY, JR.  
1969. *Sabastodes flavidus*, a shelf rockfish feeding on mesopelagic fauna, with consideration of the ecological implications. *J. Fish. Res. Board Can.* 26:2211-2215.
- PHILLIPS, J. B.  
1964. Life history studies on ten species of rockfish (genus *Sabastodes*). *Calif. Dep. Fish Game, Fish Bull.* 126, 70 p.
- QUINN, T. J., II.  
1979. The effects of school structure on line transect estimators of abundance. *In* G. P. Patil and M. L. Rosenzweig (editors), *Contemporary quantitative ecology and related ecometrics*, p. 473-491. *Int. Coop. Publ. House*, Fairland, MD.
- SEBER, G. A. F.  
1973. *The estimation of animal abundance and related parameters*. Hafner Press, N.Y., 506 p.
1980. Some recent advances in the estimation of animal abundance. *Univ. Wash., Wash. Sea Grant Tech. Rep.* 80-1, 101 p.
- THORNE, R. E.  
1977. A new digital hydroacoustic data processor and some observations on herring in Alaska. *J. Fish. Res. Board Can.* 34:2288-2294.

# POPULATION AND FISHERY CHARACTERISTICS OF GULF MENHADEN, *BREVOORTIA PATRONUS*

WALTER R. NELSON<sup>1</sup> AND DEAN W. AHRENHOLZ<sup>2</sup>

## ABSTRACT

Landing data from 1964 to 1978 for the purse seine fishery in the north-central Gulf of Mexico for gulf menhaden, *Brevoortia patronus*, were analyzed to determine growth rate, yield-per-recruit and spawner-recruit relationships, and maximum sustainable yield (MSY). Estimates of stock size, year-class size, and rates of fishing were obtained from cohort analysis. The fishery is characterized by high rates of both fishing and natural mortality. During the period studied, an average of 40% of the population of age-1 and older fish were taken by the fishery and 47% was lost to other causes annually. Although there was substantial scatter about the fitted curve, a Ricker-type spawner-recruit relationship was found to be suitable. The number of age-1 recruits fluctuated annually between 7.5 and 25.4 billion during the period studied. Maximum biomass of a year class is reached at an age of about 1.5 years. Yield-per-recruit estimates were obtained for an array of fishing mortalities and ages of entry. A deterministic simulation model incorporating growth, the spawner-recruit relationship, and age-specific rates of fishing provided an estimate of MSY at 585,118 t with 127% of the current mean rate of fishing. Implications for the current and future status of this fishery are discussed.

Gulf menhaden, *Brevoortia patronus*, are filter-feeding, surface-schooling clupeids that are subjected to an intensive purse seine fishery in the northern Gulf of Mexico. Although annual landings have fluctuated, there has been a general increase since the inception of the modern fishery in 1946 to a high of 820,000 metric tons (t) in 1978. The fishery consists of about 80 refrigerated vessels serving 11 reduction plants at 6 ports in Mississippi and Louisiana. The fishing season is currently set by State law from mid-April to mid-October. Although a majority of the catch is taken off Louisiana and Mississippi, vessels range west into eastern Texas coastal waters and east to the coastal waters of the Florida panhandle. Vessels, aided by spotter aircraft, land from 6,000 to 10,000 t/6-mo fishing season. Excellent background information and descriptions of the fishery have been published by Christmas and Etzold (1977) and Nicholson (1978).

Considerable literature exists on the general biology of gulf menhaden (Reintjes et al. 1960; Reintjes 1964; Reintjes and Keney 1975; Christmas and Etzold 1977); however, information is scarce on the population dynamics of gulf menhaden and on the dynamics and impact of the fishery. Chapoton (1972)

and Schaaf (1975a) estimated maximum sustainable yield (MSY). Ahrenholz (1981) described recruitment patterns and estimated natural and fishing mortality rates from returns of tagged juvenile and adult menhaden.

Gulf menhaden have a life history similar to many other estuarine-dependent coastal species. Spawning takes place in coastal and offshore waters in the winter (Christmas and Waller 1975<sup>3</sup>; Lewis and Roithmayr 1981). Larvae move onshore into Gulf estuaries in winter and early spring, transform to juveniles, and remain in the nursery areas until the following fall. Juveniles move offshore during the winter and back into coastal waters the following summer. Spawning occurs for the first time at the end of their second year.

A joint State-Federal-Industry plan developed for gulf menhaden identified the lack of a reliable measure of effective effort and questionable MSY estimates as major concerns in evaluating the gulf menhaden stock and fishery (Christmas and Etzold 1977). Problems encountered in determining the status of gulf menhaden stocks and estimating a long-term yield from catch-effort data on schooling species subjected to a purse seine fishery are compounded by the "dynamic aggregation process" described by Clark and Mangel (1979). Basically, they

<sup>1</sup>Southeast Fisheries Center Beaufort Laboratory, National Marine Fisheries Service, NOAA, Beaufort, NC; present address: Southeast Fisheries Center Miami Laboratory, National Marine Fisheries Service, NOAA, 75 Virginia Beach Drive, Miami, FL 33149.

<sup>2</sup>Southeast Fisheries Center Beaufort Laboratory, National Marine Fisheries Service, NOAA, Beaufort, NC 28516-9722.

<sup>3</sup>Christmas, J. Y., and R. S. Waller. 1975. Location and time of menhaden spawning in the Gulf of Mexico. Unpubl. manuscript, 20 p. Gulf Coast Research Laboratory, Ocean Springs, MS 39564.

hypothesized that surface schooling species are more susceptible to fishing effort than nonschooling species, and indicators of abundance such as catch and catch per unit effort (CPUE) are not reliable when the "intrinsic schooling rate is greater than the intrinsic (population) growth rate". Thus, severe stock depletion could occur in the gulf menhaden fishery before indications of such a situation were evident from catch and CPUE data. The dynamic aggregation process may be further aggravated when the vessels are assisted by spotter aircraft which greatly reduce search time.

We have attempted to estimate characteristics of the gulf menhaden stock, such as population size, biomass, growth rate, spawner-recruit relationship, and to determine characteristics of the fishery, such as fishing mortality, catchability coefficient, yield-per-recruit, equilibrium yield levels, and MSY. These characteristics were determined through application of cohort analysis, yield-per-recruit and spawner-recruit models, and a deterministic simulation model of the Gulf of Mexico population and fishery. Our overall objectives are to evaluate the status of the gulf menhaden stock, determine the impact of the fishery, and provide an outlook for the stock and fishery for resource managers and the purse seine fishing industry in the Gulf of Mexico.

## GULF MENHADEN DATA BASE

The National Marine Fisheries Service (formerly Bureau of Commercial Fisheries) has maintained a sampling program for gulf menhaden since 1964. Details of the sampling methodology are given by Nicholson (1978) and Huntsman and Chapoton

(1973), and a description of the aging technique is provided by Nicholson and Schaaf (1978). Vessel landings by trip have been recorded, along with pertinent data on vessel size and characteristics. Overall summaries of landings by year and nominal effort (measured in vessel-ton-weeks) are available back to 1945, but the basis for the bulk of this analysis is the catch and effort data (1964-79) and estimated number of fish landed at age for these years (Table 1).

## WEIGHT-LENGTH RELATIONSHIP AND GROWTH

Estimates of growth rate are needed for yield analyses and estimates of size at age are needed to determine the spawner-recruit relationship. Although some calculations use length and others weight, all growth estimates were calculated for length, and when required, weight was estimated from the weight-length relationship.

For each age group, there was no major systematic variation in the mean length over the 15 yr period (Fig. 1). In addition, no density-dependent correlations were detectable for mean length at age on stock size or on year-class size, estimated from the subsequent cohort analysis. Hence there appeared to be little, if any, potential gain in estimate accuracy by computing and using year-class specific growth rates when reconstructing the historical population biomass and average size at age for the subsequent spawner-recruit analysis, or to incorporate a density-dependent growth function in the subsequent population simulations for total yield.

Estimates of overall mean length at age for each quarter for the year classes that had passed com-

TABLE 1.—Catch, effort, and estimated number of gulf menhaden landed at age for the 1964-79 fishing seasons (1964-78 for number at age).

Year	Catch (metric tons × 10 <sup>3</sup> )	No. of vessels <sup>1</sup>	Effort (vessel-ton- weeks × 10 <sup>3</sup> )	Number at age × 10 <sup>6</sup>					Total
				0	1	2	3	4	
1964	409.4	76	272.9	6.3	3,135.6	1,365.2	108.1	3.9	4,619.1
1965	463.1	82	335.6	46.6	4,888.1	966.3	69.9	1.5	5,972.4
1966	359.1	80	381.3	46.8	3,126.8	850.2	30.5	0.5	4,054.8
1967	317.3	76	404.7	18.7	4,129.2	309.9	10.5	—	4,468.3
1968	373.5	69	382.3	35.4	3,311.5	850.0	27.0	0.2	4,224.1
1969	523.7	72	411.0	10.8	5,766.8	1,011.1	30.4	—	6,819.1
1970	548.1	73	400.0	49.2	3,256.4	2,197.2	34.4	—	5,537.2
1971	728.2	82	472.9	25.3	5,763.3	1,838.1	166.2	3.7	7,796.6
1972	501.7	75	447.5	17.6	3,146.3	1,615.6	68.7	4.4	4,852.6
1973	486.1	65	426.2	57.2	3,012.4	1,082.7	108.2	1.3	4,261.8
1974	578.6	71	485.5	20.0	3,747.3	1,399.0	60.2	—	5,226.5
1975	542.6	78	536.9	96.4	2,512.3	1,453.1	428.2	0.8	4,490.8
1976	561.2	81	575.9	1.8	4,517.7	1,273.1	190.2	—	5,982.8
1977	447.1	80	532.7	1.6	4,800.2	1,209.6	104.3	7.3	6,123.0
1978	820.0	80	574.3	0.0	6,784.7	2,578.8	48.3	3.6	9,415.4
1979	777.9	77	533.9	—	—	—	—	—	—

<sup>1</sup>Includes only vessels that fished 9 or more weeks.



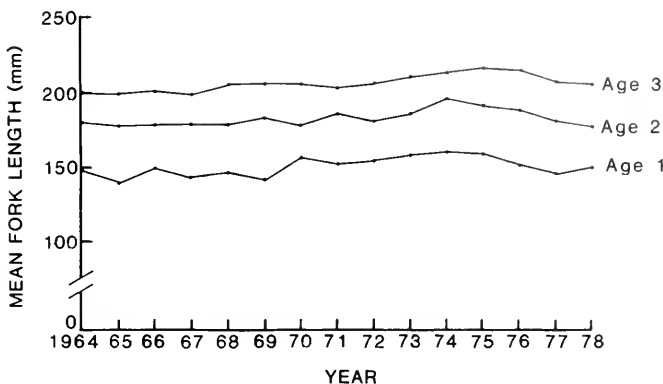

FIGURE 1.—Mean length of gulf menhaden at ages 1-3 taken from commercial landing samples (April-June), 1964-78.

pletely through the fishery were used in the growth computations (Table 2). The von Bertalanffy growth-length equation

$$l_t = L_\infty(1 - e^{-K(t-t_0)}) \quad (1)$$

where  $l_t$  = fork length (mm) at time  $t$  (years),  
 $L_\infty$  = theoretical length at  $t = \text{infinity}$  (asymptote),  
 $K$  = growth coefficient,  
 $t_0$  = theoretical age when length = 0

was fitted to the data by the computer program BGC3 (Abramson 1971). Although the data points appear stepped between whole age units, they are reasonably well described by the fitted curve (Fig. 2).

TABLE 2.—Mean length and number of fish sampled at age from 1963 to 1974 year classes of gulf menhaden.

Age	Mean fork length (mm)	Number
1.125	121.7	59
1.375	148.3	43,284
1.625	160.5	57,286
1.875	161.3	1,538
2.125	—	—
2.375	182.9	16,687
2.625	190.6	16,452
2.875	194.4	260
3.125	—	—
3.375	210.5	1,063
3.625	216.4	1,368
3.875	220.2	14
4.125	—	—
4.375	227.8	16
4.625	227.5	32
4.875	—	—

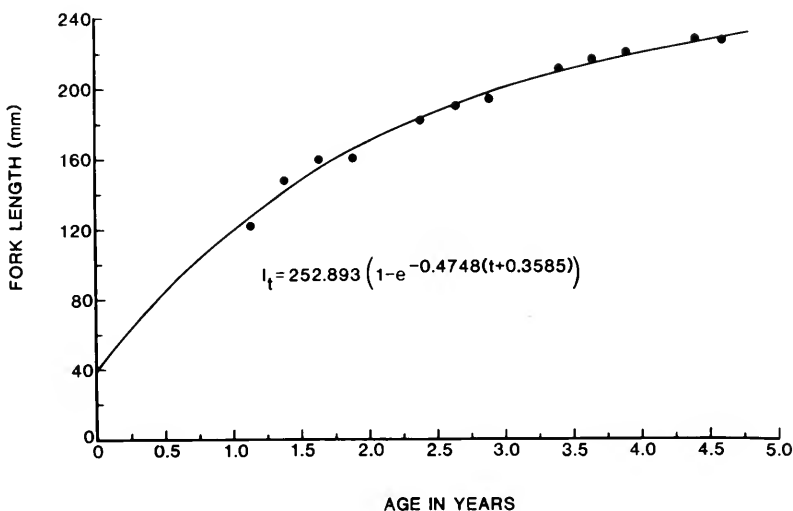

FIGURE 2.—Von Bertalanffy growth curve fitted to average length at age data for gulf menhaden sampled from commercial landings, 1963-74 year classes.

Weight-length regression coefficients were calculated for each of three 2-mo intervals for the major portion of the fishing season for each year class, 1960-77. No systematic variation in the parameter estimates was apparent within years by 2-mo intervals, so the data were pooled between seasons and years. An overall weight-length relationship was obtained from a GM-functional regression (Ricker 1973) on the pooled data. The results are

$$\log_e w = 3.2669 \log_e l - 12.1851 \quad (2)$$

where  $w$  = weight in g, and  
 $l$  = fork length in mm.

The correlation coefficient ( $r$ ) was 0.976 and the sample size was 168,397.

### COHORT ANALYSIS

Estimates of mortality rates and population sizes were obtained by using the Cohort Analysis technique developed by Murphy (1965) and later modified by Tomlinson (1970). Calculations were made with the computer program MURPHY (Tomlinson 1970). This technique does not involve estimates of CPUE. The backward estimation procedure was used. Since the catch equations and general method of application are given in Tomlinson's paper, discussion here will be limited to the source and nature of input data and parameters.

The calendar year was divided into four periods (quarters) of approximately equal length:

- Quarter 1 = 1 January to 3 April,
- Quarter 2 = 4 April to 3 July,
- Quarter 3 = 4 July to 3 October,
- Quarter 4 = 4 October to 31 December.

Numbers of fish at each age landed quarterly were sums of weekly estimates obtained by sampling methods outlined by Nicholson (1978). Annual summaries of these data were given earlier (Table 1).

An estimate of the annual rate of instantaneous natural mortality ( $M$ ) was obtained from an analysis of mark-recapture data (Ahrenholz 1981).  $M$ , equal to 1.1 (0.275 per quarter), was assumed to be constant for all ages and seasons.

Because backward sequential computations, using a range of trial estimates of input  $F$  (instantaneous fishing mortality) for the oldest age, tend to converge on the correct value of  $F$  for the youngest and forward calculations tend to diverge (unless true starting values are used), it is desirable to begin with

the oldest age for which reliable landing data are available (Ricker 1975). Because of aging difficulties (Nicholson and Schaaf 1978), we assumed that catch estimates of older fish, mainly age 4, were not reliable, hence for most year classes estimates of the annual rate of instantaneous fishing mortality ( $F$ ) for age-2 fish were derived from catches of age 2 and age 3 from

$$F_n = (\log_e C_n - \log_e C_{n+1}) - M \quad (3)$$

where  $C$  = annual catch in numbers at age ( $n$ ) from a given cohort.

Initial starting values of  $F$  for the oldest age group landed in a year class were adjusted by trial and error until the sum of the quarterly  $F$ 's for age-2 fish were virtually equal to the estimate of annual  $F_2$  derived from Equation (3). This technique was applicable for all year classes except 1960 and 1961, where no 2-yr-old fish were available in the landing data, the 1976 year class where no 3-yr-old fish were available in the landing data, and the 1972 year class, where the 2-yr-old fish apparently were not fully recruited. For the 1960 and 1961 year classes, trial and error adjustments were made to the starting  $F$  value until the annual  $F_3$  estimate for the 1961 year class and the annual  $F_4$  estimate of the 1960 year class were virtually equal to the unweighted mean  $F_3$  estimate derived from the sequential computations of the 1963-71 and 1973-75 year classes. Similarly, the mean  $F_2$  estimate was used for the 1976 year class and the mean  $F_3$  estimate for the 1972 year class.

Estimates of number-at-age by quarter by year class obtained from cohort analysis permitted the reconstruction of population structure for the exploited gulf menhaden stock from 1964 to 1977 (Table 3). Numbers of newly recruited age-1 fish varied as much as threefold between years. Because age-1 fish were numerically the most abundant age group each year, the population size fluctuated in close concert with their numbers (Fig. 3).

Resultant age-specific annual  $F$ 's by fishing season demonstrate that 1-yr-olds are incompletely recruited to the fishery and that age 2's are fully recruited (Table 4). These results are in accord with those of Ahrenholz (1981), who concluded that fish from more distant eastern and western areas of the Gulf of Mexico (Gulf) shifted toward the more heavily fished central Gulf areas as they aged. The slightly higher values for both the weighted and unweighted mean  $F$ 's for 3- and 4-yr-olds could be due to either small numbers of fish from the most distant eastern

TABLE 3.—Population size (in millions) of gulf menhaden on 4 April estimated by cohort analysis, 1964-77.

Year	Age			
	1	2	3	4
1964	8,189.2	2,048.0	156.8	5.5
1965	9,796.0	1,329.2	105.0	7.4
1966	5,703.8	1,111.9	41.9	5.2
1967	9,215.6	548.5	14.4	0.0
1968	9,256.7	1,249.0	47.6	0.3
1969	19,311.9	1,539.6	44.6	0.0
1970	12,454.5	3,817.6	59.4	0.0
1971	15,860.1	2,635.0	289.3	4.7
1972	9,580.3	2,704.4	97.0	25.6
1973	15,793.9	1,796.2	181.5	2.6
1974	15,107.1	3,849.3	99.6	0.0
1975	10,220.9	3,324.1	668.4	5.5
1976	11,467.8	2,216.2	435.6	0.0
1977	18,584.2	1,739.4	181.4	57.9

FIGURE 3.—Population number of gulf menhaden as of 4 April 1964-77, Estimated from cohort analysis on 1960-76 year classes.

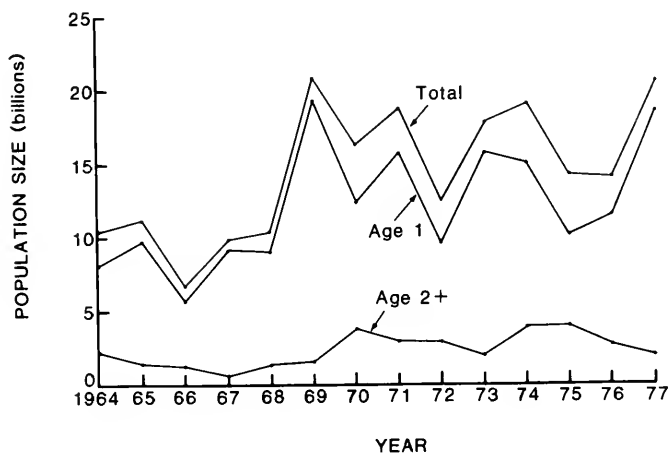

TABLE 4.—Annual instantaneous fishing mortality rate (*F*) for gulf menhaden for ages 1-3, by year, 1964-77, and fishing mortality rate applied at age 4 (age 3 for year classes without age-4 landings) to initiate the cohort analysis.

Year	<i>F</i>			
	Age 1	Age 2	Age 3	Age 4
1964	0.7182	1.8706	1.9547	1.9504
1965	1.0757	2.3576	1.9112	0.3546
1966	1.2431	3.2468	2.5992	0.1399
1967	0.8991	1.3447	2.7786	0.0000
1968	0.6938	2.2323	1.4032	<sup>1</sup> 0.6065
1969	0.5211	2.1553	1.6225	0.0000
1970	0.4521	1.4760	1.4392	0.0000
1971	0.6681	2.2033	1.3287	<sup>1</sup> 0.4097
1972	0.5740	1.6024	2.5195	0.2688
1973	0.3120	1.7933	2.0281	1.2313
1974	0.4140	0.6507	1.7885	0.0000
1975	0.4287	0.9322	1.9484	0.1950
1976	0.7860	1.4030	0.9184	0.0000
1977	0.4375	2.1293	1.4229	0.1923
Mean <i>F</i> (unweighted)	0.6588	1.8141	1.8331	1.8106

<sup>1</sup>Initial *F* set equal to 10.0.

and western areas reaching the more intensively fished waters, or simply a sampling variance. The *F* estimates from cohort analysis for age-3 and age-4 fish are somewhat suspect, especially for age 4, since the cohort analysis technique used (iterating to a preset *F*<sub>2</sub>) actually makes the *F*<sub>3</sub> and *F*<sub>4</sub> estimates of a forward computational nature, rather than backward as for age 1. The divergent nature of the estimates is clearly evident in the values for age 4, although the mean value is realistic for subsequent yield computations, and numbers of fish at this age are of very low magnitude as well.

Because a year class is well represented in the fishery for only 3 yr, a short time span is available for the convergence of estimates of numbers and fishing mortality. This short time span was ap-

parently adequate, however, as cohort runs on the year classes with 4-yr-olds in the landings, using starting estimates of *F* for age 4 obtained from catch curves, converged to very similar estimates to those obtained by the analysis used here. Ulltang (1977) emphasized that when *F* is high, convergence is rapid.

The short-term impact of the fishery on the stock can be assessed by comparing the estimated number-at-age in the population for any given year with the number-at-age landed by the fishery, or simply by using the estimated rate of fishing and calculating the exploitation rate (*u*) by

$$u_n = (F_n (1 - e^{-(F_n + M)})) / (F_n + M). \quad (4)$$

From 1964 to 1977 the fishery took an average of 31% of the 1-yr-olds in the population and about 61% of the older fish each year. At these exploitation rates

the population loses 52% of the age-1 fish and 35% of the older fish to natural mortality.

The short-term impact on the entire population was determined by 1) calculating a mean  $F$  weighted by the number of individuals taken by age for ages 1-3 and then estimating  $u$  by Equation (4) and 2) directly comparing numbers landed with the reconstructed population sizes. The average annual loss of individuals from the population to the fishery was about 40% by both methods. However, recruitment is only partial at age 1, and  $u$  is much higher at older ages. Natural mortality losses averaged about 47%/year for the overall population. In the absence of fishing, annual losses to natural mortality would be about 67% for all ages.

A measure of how a unit of fishing effort affects the population is commonly quantified through its effect on  $F$ . Traditionally this effect, the catchability coefficient ( $q$ ), is assumed to be a constant. The total fishing effort times this constant should equal  $F$  for the year:

$$F = qf \quad (5)$$

where  $f$  = a unit of fishing effort (here, a vessel-ton-week).

Estimates of  $q$  for the 1964-77 fishing years were obtained by solving for  $q$  in the above equation for the population  $F$  for ages 1-3 ( $\bar{F}_{1,3}$ ) weighted by number taken at age, and also for the population total  $F$  (Table 5). The resultant  $q$ 's are quite variable (in excess of fourfold). Estimates of  $q$  were plotted against corresponding population size to determine

if the catchability coefficients were independent of this variable (Fig. 4). An inverse relationship was noted, a situation which also exists for the Atlantic menhaden (Schaaf 1975b). The data were fitted to the power function to demonstrate the curvilinear inverse relationship.

## SPAWNER-RECRUIT RELATIONSHIP

The cohort analysis provides estimates of population size at ages 1-4 from 1964 to 1977. All fish mature by the end of their second year, and spawning apparently reaches a peak in December and January (Lewis and Roithmayr 1981). Therefore, estimates of number-at-age in the population as of 1 January were used to provide estimates of spawning stock size and subsequent recruitment (Table 6). Spawning stock was identified as all fish that had reached at least their second birthday by 1 January. Lewis and Roithmayr also showed that length accounted for a greater porportion of the variance in fecundity than either age or weight. Our fecundity estimates, assuming a 1:1 sex ratio, were based on Lewis and Roithmayr's relationship:

$$\log_e E = -9.8719 + 3.8775 (\log_e l) \quad (6)$$

where  $E$  = fecundity in number of eggs and  
 $l$  = fork length in millimeters.

Because there was little variation in size at age by year class, and the differences noted were not related to population size, estimates of mean length-at-age were obtained from the overall von Bertal-

TABLE 5.—Estimated gulf menhaden population size as of April 4, number caught by year, population exploitation rate ( $u$ ), estimated population fishing mortality rate ( $F$ ), population catchability coefficient ( $q$ )  $\times 10^{-3}$ , weighted annual mean fishing mortality rate from cohort analysis ( $\bar{F}_{1,3}$ ), and the corresponding  $\bar{F}_{1,3}$  catchability coefficient ( $q$ )  $\times 10^{-3}$  calculated from vessel-ton-weeks (Table 1), 1964-77.

Year	Population size (millions) age 1-4	Number caught (millions) age 1-4	Population				
			$u$	$F$	$q \times 10^{-3}$	$\bar{F}_{1,3}$	$q_{1,3} \times 10^{-3}$
1964	10,399.5	4,612.8	0.444	1.10	4.03	1.0886	3.99
1965	11,237.6	5,925.8	0.527	1.46	4.35	1.2946	3.86
1966	6,862.8	4,008.0	0.584	1.78	4.67	1.6785	4.40
1967	9,778.5	4,449.6	0.455	1.14	2.82	0.9346	2.31
1968	10,553.6	4,188.7	0.397	0.93	2.46	1.0176	2.64
1969	20,896.1	6,808.3	0.326	0.70	1.70	0.7687	1.87
1970	16,331.5	5,488.0	0.336	0.73	1.83	0.8682	2.17
1971	18,789.1	7,771.3	0.414	0.99	2.09	1.0455	2.21
1972	12,407.3	4,835.0	0.390	0.90	2.01	0.9456	2.11
1973	17,774.2	4,204.6	0.237	0.47	1.10	0.7377	1.73
1974	19,056.0	5,206.5	0.273	0.56	1.15	0.4935	1.02
1975	14,218.9	4,394.4	0.309	0.66	1.23	0.7433	1.38
1976	14,119.6	5,981.0	0.424	1.02	1.77	0.9215	1.60
1977	20,562.9	6,121.4	0.298	0.63	1.18	0.7890	1.48

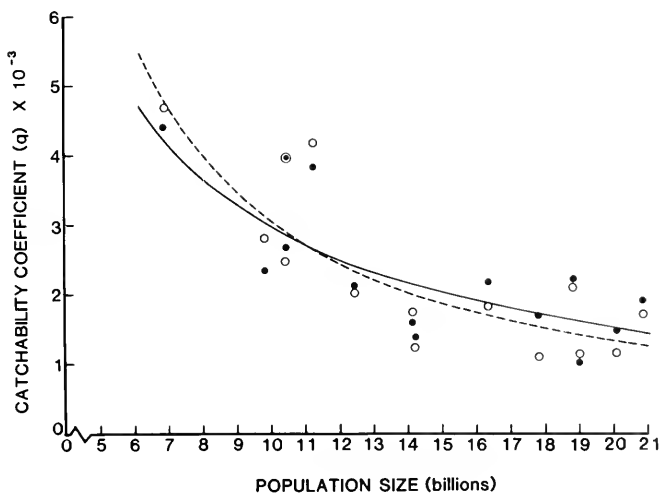

FIGURE 4.—Catchability coefficients calculated from population fishing mortalities (open circles, dashed line), and from cohort annual weighted mean fishing mortalities (dots, solid line) plotted on population number estimated as of 4 April, for the 1964-77 fishing seasons (see Table 5).

TABLE 6.—1 January estimates of number of spawners, number of eggs produced by the spawning stock, biomass of the spawning stock, and number and biomass of recruits at age 1 for gulf menhaden. Preliminary estimates in parentheses.

Year	No. at age (millions)			Total spawners (millions)	No. of eggs (trillions)	Spawning biomass (t)	Resultant recruitment (millions)	Recruitment biomass (t)
	2	3	4					
1964	2,696.3	206.4	7.2	2,909.9	36.1	305,468	12,896.7	410,630
1965	1,749.9	138.2	9.7	1,897.8	23.7	200,150	7,519.5	239,421
1966	1,463.9	55.1	6.8	1,525.8	18.4	156,705	12,138.2	386,480
1967	722.2	19.0	—	741.2	8.8	75,118	12,186.7	388,025
1968	1,644.3	62.6	0.4	1,707.3	20.5	174,454	25,424.7	809,522
1969	2,026.9	58.7	—	2,085.6	24.8	211,752	16,396.8	522,074
1970	5,026.0	78.2	—	5,104.2	60.0	513,461	20,889.9	665,134
1971	3,472.8	382.4	6.2	3,861.4	49.0	412,808	12,618.5	401,773
1972	3,565.3	127.7	33.7	3,726.7	45.2	384,521	20,796.4	662,157
1973	2,365.8	239.0	3.4	2,608.2	32.8	277,323	19,889.0	633,266
1974	5,067.7	131.1	—	5,198.8	61.7	526,725	13,456.1	428,442
1975	4,376.3	879.9	7.3	5,263.5	70.5	588,668	(15,097.7)	(480,711)
1976	2,917.7	573.5	—	3,491.2	46.6	389,073	(24,466.7)	(779,020)
1977	(2,290.0)	238.8	76.2	(2,605.0)	(34.3)	(286,686)		
1978	(5,258.5)	(90.6)	19.2	(5,368.3)	(63.6)	(543,194)		

anffy growth function presented earlier. Thus, length-at-age estimates are taken as constants, and differences in among year estimates of egg production are due to differences in both total numbers and age composition of the spawning stock (Table 6). Similarly, the weight-length relationship was used in conjunction with the mean length-at-age estimates to obtain weight-at-age estimates for computation of spawning and recruitment biomass (Table 6).

Least-square regressions of second and third degree polynomials were run with numbers of recruits on number of spawners to determine the

general shape of the spawner-recruit relationship. Dome-shaped functions provided the least residual sum of squares, indicating that a Ricker-type curve (Ricker 1975) is appropriate. A Ricker-type function has been applied to Atlantic menhaden data (Nelson et al. 1977), and the same criteria appear to apply to gulf menhaden data, i.e., that there is a size-dependent fecundity relationship and that adult menhaden are filter feeders which are known to ingest their own eggs. Additionally, the calculation of an index of density dependence, as detailed by Cushing (1971) ( $\log_e$  recruitment regressed on  $\log_e$  spawning stock), provides a slope of 0.159. This slope,

plus the average fecundity of gulf menhaden (about 25,000 eggs/female) places the gulf menhaden among Cushing's clupeoid groups which have a slightly domed spawner-recruit curve. Accordingly, a spawner-recruite relationship was applied of the form:

$$R = Se^{(S_r - S)S_M} \quad (7)$$

where  $R$  = recruitment at age 1  
 $S$  = spawning stock size  
 $e$  = base of natural logarithm  
 $S_r$  = maximum equilibrium stock  
 $S_M$  = spawning stock size yielding maximum absolute recruitment.

The model, fitted by a nonlinear least squares technique (Marquardt 1963), predicts an average maximum recruitment of 18.4 billion individuals at a spawning stock of 3.22 billion (Table 7). The curve is a reasonably good fit (Fig. 5), considering the variability inherent in clupeoid recruitment. Data were available over a wide range of spawning stock sizes and recruitment levels. Although recruitment tended to fluctuate widely at lower spawning stock sizes, estimates appear to converge at higher spawning stock levels, indicating the possibility of a strong density-dependent response as spawning stock size increases. The Ricker function appears to describe the data, thus an estimate of spawning stock size permits a general estimate of anticipated recruitment at moderate to high numbers of spawners.

Because fecundity increases with age and because

age structure of spawners varies from year to year, estimates of the number of eggs produced should provide a more accurate estimate of spawning stock size than estimates of the numbers of spawners. When the Ricker equation was fitted to number of eggs and number of recruits, the estimate of optimum spawning stock size was similar to the estimate based on the number of spawners and recruits (Table 7) ( $S_M$  of 39.66 trillion eggs = 2.3 billion spawners). The unrealistic replacement level ( $S_r$ ) of 283.32 trillion eggs was generated by scaling factors involved in the comparison of unequal spawner and recruit units (Ricker 1975). Applying the function to spawning and recruitment biomass also provided similar estimates of maximum recruitment and optimum spawning stock size (Table 7,

TABLE 7.—Ricker spawner-recruit estimates of maximum equilibrium stock ( $S_r$ ), stock size for maximum recruitment ( $S_m$ ), and recruitment at  $S_m$ , for models incorporating number of spawners on number of recruits, number of eggs on number of recruits, and spawning biomass on recruitment biomass, 1964-76 year classes of gulf menhaden.

	Maximum equilibrium stock ( $S_r$ )	Stock for maximum recruitment ( $S_m$ )	Recruitment at $S_m$
No. of spawners on no. of recruits	8.83 billion	3.22 billion	18.42 billion
No. of eggs on no. of recruits	283.32 trillion	39.66 trillion	18.48 billion
Spawning biomass on recruit biomass	524,172 t	336,011 t	588,236 t

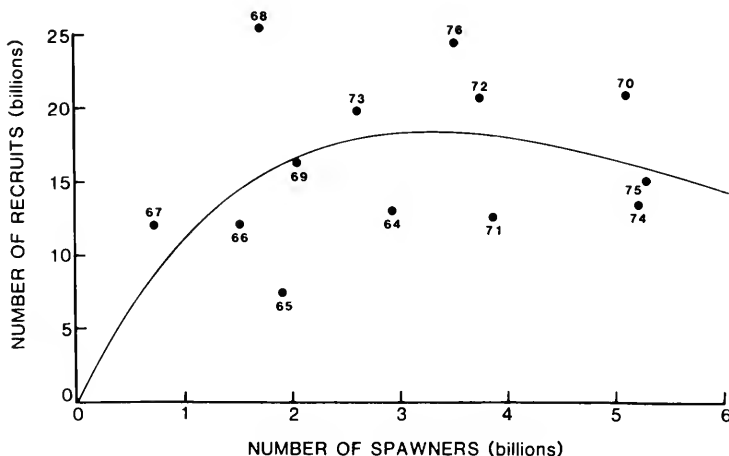

FIGURE 5.—Ricker spawner-recruit relationship for number of spawners and recruits at age 1, estimated as of 1 January, for the 1964-76 gulf menhaden year classes.

Fig. 6). The maximum recruitment level of 588,236 t is equal to about 18.5 billion recruits. The optimum spawning stock biomass of 336,011 t is equal to about 3.2 billion spawners, assuming the age distribution for the spawning stock is average. The function for biomass accounts for changes in age structure of the spawning stock and since age-2 fish consistently represent over 90% of the spawners, differences between plots of numbers and biomass (Figs. 5, 6) are minor.

Spawning stock size has generally remained within a range of potentially good recruitment and has not undergone years of extreme highs or lows (Figs. 5, 6). Trends indicating a steady decrease or increase in stock size and recruitment are not apparent, although the general increased level of recruitment in recent years may be part of a cyclic recruitment fluctuation that is found in many stocks.

### YIELD-PER-RECRUIT

We applied what is essentially a Ricker type yield-per-recruit model that was initially developed to evaluate a multiple-gear fishery (M-GEAR) and later modified to accommodate a multiple-area fishery (M-AREA) (Lenarz et al. 1974; Epperly et al. 1979<sup>4</sup>). Yield is summed by time intervals, and individual weights and estimates of natural and fishing mortality can be inserted for each interval (Ricker 1975). An option developed by Epperly et al. (fn. 4) allows

<sup>4</sup>Epperly, S. P., W. H. Lenarz, L. T. Massey, and W. R. Nelson. 1979. A generalized computer program for yield per recruit analysis of a migrating population with area specific growth and mortality rates. Unpubl. manuscript, 14 p. Southeast Fisheries Center Beaufort Laboratory, National Marine Fisheries Service, NOAA, Beaufort, NC 28516.

for calculation of biomass within intervals by either exponential or arithmetic means. We applied the model in its simplest form: one set of growth data because the stock was not divided into subareas, constant natural mortality rate, and the exponential growth mode for biomass calculation. The year was divided into quarters to simulate the seasonal nature of the fishery (Table 8). Quarterly fishing mortality rates were developed from the cohort analysis. Estimates were obtained for periods of low population size and high fishing mortality (1964-68), high population size and low fishing mortality (1974-77), and "average" population size and mortality (1964-77) (Table 8). Age of entry into the fishery was

TABLE 8.—Input array of quarterly length (mm), weight (g), and fishing mortality rates ( $F$ ) used in the calculation of yield-per-recruit of gulf menhaden under average fishing conditions (1964-77), years of low stock size (1964-68), and years of high stock size (1974-77).

Age	Months	$\bar{L}$	$\bar{W}$	$\bar{F}$ (64-77)	$\bar{F}$ (64-68)	$\bar{F}$ (74-77)
0.50	July-Sept.	84.7	10.1	0.0013	0.0018	0.0008
0.75	Oct.-Dec.	103.5	19.5	0.0003	0.0001	0.0005
1.00	Jan.-Mar.	120.2	31.8	0.0002	0.0004	0.0000
1.25	Apr.-June	135.1	46.6	0.1850	0.2677	0.1244
1.50	July-Sept.	148.2	63.2	0.4437	0.6315	0.3593
1.75	Oct.-Dec.	160.0	81.0	0.0299	0.0264	0.0329
2.00	Jan.-Mar.	170.4	99.5	0.0002	0.0000	0.0000
2.25	Apr.-June	179.6	118.2	0.4478	0.5652	0.3683
2.50	July-Sept.	187.8	136.8	1.2213	1.5858	0.8253
2.75	Oct.-Dec.	195.1	154.9	0.1448	0.0594	0.0852
3.00	Jan.-Mar.	201.6	172.3	0.0003	0.0000	0.0000
3.25	Apr.-June	207.3	188.9	0.4500	0.5407	0.2966
3.50	July-Sept.	212.4	204.5	1.2722	1.5752	1.0670
3.75	Oct.-Dec.	216.9	219.1	0.1106	0.0133	0.1557
4.00	Jan.-Mar.	221.0	232.7	0.0000	0.0000	0.0000
4.25	Apr.-June	224.5	245.2	0.1605	0.3085	0.0488
4.50	July-Sept.	227.7	256.7	1.6501	2.3018	0.0480
4.75	Oct.-Dec.	230.5	267.2			

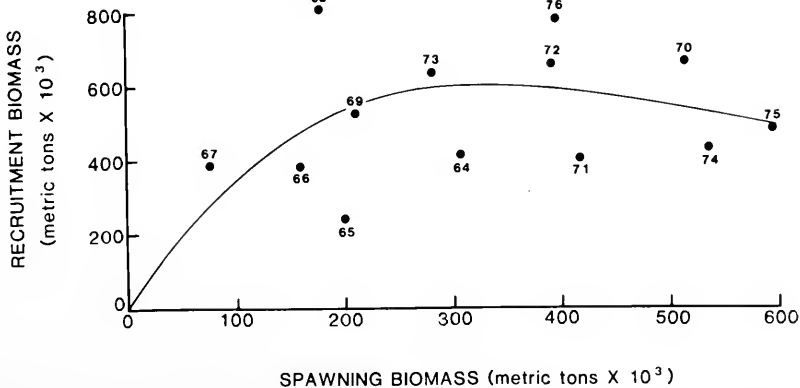

FIGURE 6.—Ricker spawner-recruit relationship for biomass of spawners and recruits at age 1, estimated as of 1 January, for the 1964-76 gulf menhaden year classes.

0.5 yr of age, the age at which gulf menhaden first appear in the catch in extremely small numbers and have a very low fishing mortality rate. Fishing mortality occurs principally during the 2d and 3d quarters of the year (April-September) (Table 8). Various multiples of the average fishing mortality at each age were used to simulate effects of increased or decreased fishing mortality (Table 9).

landings in the fishery of 487,736 t by only 2.6% for 1964-77.

Yield-per-recruit for the years of higher and lower levels of fishing mortality (Table 8) was estimated to be 18.20 and 15.78 g under  $F$ -multiples of 1.00 and age of entry at 0.5. Trends were identical to those for average 1964-77 conditions, and thus are not presented in further detail.

TABLE 9.—Estimates of gulf menhaden yield-per-recruit (g) under average conditions of growth and as multiples of average fishing mortality rate ( $F$ -multiple = 1.00), 1964-77, at varying age of entry.

Age at entry	Multiplier of fishing mortality									
	0.25	0.33	0.50	0.66	0.75	1.00	1.25	1.50	1.75	2.00
4.50	0.96	1.19	1.60	1.90	2.04	2.34	2.54	2.69	2.79	2.86
4.25	1.06	1.31	1.75	2.07	2.21	2.52	2.73	2.87	2.98	3.05
4.00	1.06	1.31	1.75	2.07	2.21	2.52	2.73	2.87	2.98	3.05
3.75	1.18	1.46	1.96	2.31	2.48	2.84	3.09	3.28	3.43	3.55
3.50	2.73	3.32	4.28	4.93	5.21	5.80	6.20	6.47	6.67	6.81
3.25	3.32	4.01	5.10	5.81	6.12	6.74	7.15	7.43	7.63	7.78
3.00	3.32	4.01	5.10	5.81	6.12	6.74	7.15	7.43	7.63	7.79
2.75	3.63	4.38	5.58	6.38	6.73	7.45	7.96	8.33	8.62	8.86
2.50	6.39	7.62	9.51	10.71	11.23	12.27	12.95	13.41	13.74	13.98
2.25	7.43	8.80	10.86	12.12	12.66	13.71	14.37	14.82	15.14	15.37
2.00	7.43	8.80	10.86	12.12	12.66	13.71	14.37	14.82	15.14	15.37
1.75	7.52	8.91	10.99	12.27	12.82	13.89	14.57	15.04	15.38	15.63
1.50	8.91	10.52	12.93	14.43	15.07	16.36	17.22	17.83	18.30	18.67
1.25	9.45	11.13	13.62	15.15	15.80	17.09	17.94	18.53	18.97	19.30
1.00	9.45	11.13	13.62	15.15	15.80	17.09	17.94	18.53	18.97	19.30
0.75	9.45	11.13	13.62	15.16	15.80	17.09	17.94	18.53	18.97	19.30
0.50	9.45	11.13	13.62	15.15	15.80	17.09	17.93	18.52	18.95	19.28

The yield-per-recruit increases only slightly with a delayed age-of-entry and then drops rapidly because of the high rate of natural mortality. The model predicts maximum cohort biomass at an age of 1.5, before gulf menhaden are fully recruited into the fishery. The high natural mortality rate requires that substantial fishing mortality be applied at a young age if gulf menhaden are to be harvested near their peak biomass.

A three-dimensional representation of yield-per-recruit (Table 9) is helpful in depicting the seasonal nature of the fishery (Fig. 7). Since most of the fishing mortality on age-1, -2, and -3 fish is applied during the 2d and 3d quarters (ages of X.25 and X.50), the impact of delaying recruitment past those quarters results in a sharp decline in yield-per-recruit, due to the high rate of natural mortality.

Predicted catches based on yield-per-recruit were compared with actual catch during 1964-77. Average recruitment at age 1 (16,030 billion), estimated from the cohort analysis, was back calculated to age 0.5, the age of initial entry, and multiplied by the 17.09 g/recruit predicted by the model. The resultant estimate of 474,829 t differs from the average

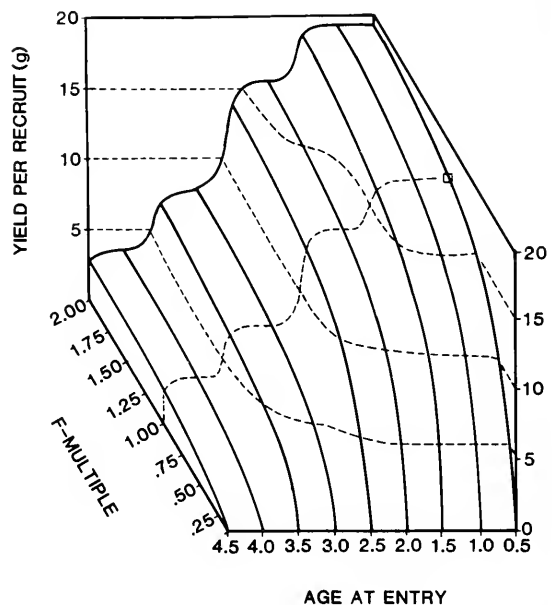

FIGURE 7.—Yield-per-recruit of gulf menhaden under average conditions of growth and with multiples of average fishing mortality by 3-mo interval ( $F$ -multiple = 1.0) for the 1964-77 fishing seasons (average conditions indicated by  $\square$ ).



## SUSTAINABLE YIELD AND POPULATION SIMULATION

Production functions were developed from the 1946-79 catch and effort data to provide an estimate of maximum sustainable yield (MSY) for gulf menhaden. Application of a standard parabolic surplus production model (Schaefer 1954, 1957) yields an MSY estimate of 553,000 t at 555,000 vessel-ton-weeks. Past updates of MSY for the Gulf fishery have shown continual increases as additional years are added. Chapoton (1972) estimated an MSY of 430,000 t for the 1946-70 period, and Schaa's (1975a) estimate of 478,000 t included the 1971 and 1972 catch and effort.

For the years in which estimates of catchability coefficient ( $q$ ) were calculated (1964-77) nominal effort was adjusted to the mean population  $q$  of that period. For that time period, mean catchability coefficient was divided by the estimate of population  $F$  each year, to provide an estimate of effort adjusted for "average" conditions from 1964 to 1977.

A parabolic surplus production function was applied to the 1946-79 data set, with adjusted effort used instead of nominal effort for 1964-77. The results were similar to model results using nominal effort with an estimated MSY of 541,904 t at an effort of 505,483 vessel-ton-weeks (Fig. 8). A generalized stock production model (PRODFIT) which allows the shape of the curve to vary based on a least squares fit to the data (Fox 1975) was also applied, yielding an estimate of MSY of 636,886 t at an effort of 531,201 vessel-ton-weeks (Fig. 8).

The two curves provide estimates that vary by about 95,000 t with the PRODFIT model indicating a sharp drop in yield after MSY is exceeded.

An estimate of MSY based on biological characteristics should be more reliable than one based on yield and nominal effort, particularly when there is not a clear nominal effort-effective effort relationship. Accordingly, we applied a population simulation model (Walters 1969) for the 1964-77 period which incorporated our estimates of growth, spawner-recruit relationship, fishing mortality, and natural mortality. This estimated the impact of fishing mortality on stock and yield at an array of fishing mortality rates. The model can also iterate to MSY. Underlying assumptions of the Walters' model are that the 1) spawner-recruit relationship incorporated is realistic, 2) array of  $F$ 's accurately reflect the distribution of fishing effort and availability at age, and 3) time increment estimates of weight are sufficiently brief to realistically estimate both population and catch biomass during the

fishing periods. The model calculates population biomass, yield, residual spawners of age 2 and greater, and incoming recruitment. We used weight-at-age data described in the section on average size and growth (Equations (1) and (2)), and used the spawner-recruit relationship developed for the number of spawners and recruits (Equation (7)). The instantaneous natural mortality rate was 1.1 as discussed earlier. Fishing mortality could not precisely mimic that for the fishery, because the program requires either zero fishing mortality or a constant fishing mortality for any within-year increment. However, it does allow for an array of multipliers at a given fishing mortality, providing different  $F$ 's for each age, if desired. Therefore, we were able to vary fishing mortality by age, but used either zero or a constant fishing mortality for quarterly increments within each year. Since fishing mortality was essentially zero on age-0 fish and was inconsistent between years, a fishing mortality rate of zero was applied to that age group. For age groups 1-4, all of the fishing mortality was by definition imposed equally in quarters 2 and 3 (April-June, July-September), and no fishing mortality was applied in quarters 1 and 4, even though we knew that fishing mortality during the July-September period was consistently higher than that observed for the

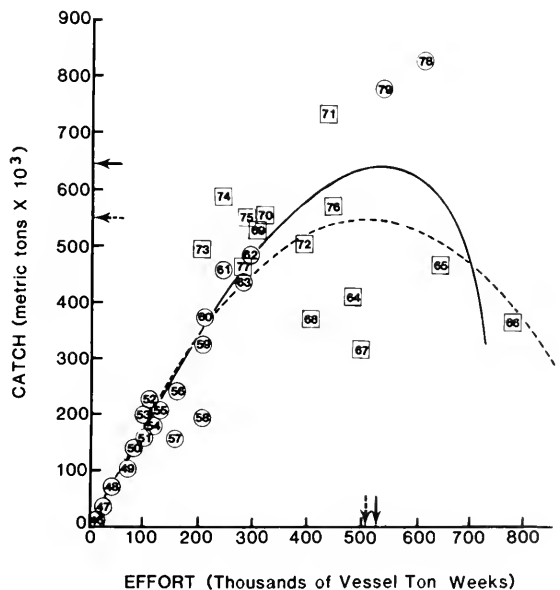

FIGURE 8.—Parabolic (dashed line) and prodfit (solid line) surplus production function models fitted to catch and effort data for the gulf menhaden fishery from 1946 to 1979, with 1964-77 data being estimates of effective effort, based on adjustments from calculated catchability coefficients for those years.

previous quarter (i.e., the same nominal effort was applied to a smaller population). The result was that yield was overestimated for April-June and underestimated for July-September, but estimated reasonably accurately for the season.

We attempted to simulate reality by using multiples of the fishing mortality distribution that we observed in the 1964-77 data base. Fishing mortality imposed to mimic current conditions was obtained by taking the mean fishing mortality at age by quarter from the cohort analysis conducted on the 1960-76 year classes (1964-77 fishing years). The mean mortality on ages 2-4 fish was used, along with a mortality obtained from a scaling factor of 0.362 for age 1 (Table 10). Input population size to start the simulation runs was the mean population number-at-age as of 1 January, the arbitrarily assigned birth date of gulf menhaden. Those numbers were 16,030 million, 2,813 million, 227.9 million, and 10.78 million for ages 1-4. The model was run over a range from 0 to 2.75 times the average fishing mortality and was also used to iterate to MSY under the current distribution of fishing mortality by age (Table 10).

The overall catch-effort curve from multiple runs indicates that the fishery is operating slightly before the MSY level (Fig. 9, Table 10). At the current  $F$ -multiple of 1.0, the fishery should sustain an average yield of about 565,581 t, assuming no variance in recruitment from the hypothetical spawner-recruit curve.

The model predicts a MSY of about 585,118 t at 127% of the average fishing mortality for the 1964-77 fishing seasons. We feel that this model,

which incorporates a spawner-recruit relationship and recruitment pattern plus growth and natural mortality rates, provides a better estimate of long-term MSY than does a model based on a simple catch-effort production function. Considerable fluctuation in yield will result from fluctuations in recruitment, but the long-term MSY estimate appears to be realistic, provided that the estimated spawner-recruit relationship is valid and that the basic pattern of recruitment remains unchanged.

The Walters' model also identifies the level of fishing mortality at which the population is no longer sustainable, i.e., a biological break-even point. The extinction point occurs at an  $F$ -multiple of 2.50 (150% greater than current fishing mortality), although the model indicates that such extinction would involve a gradual decline over a period of many years, again assuming that "average" conditions prevailed (Fig. 9). Increasing the fishing mortality beyond an  $F$ -multiple of 2.50 results in a more rapid rate of extinction (Table 10).

Results of low and high  $F$ -multiple levels show steep slopes on the ascending and descending limbs of the production function curve (Fig. 9). The ascending limb behaves similarly to the curves in the yield-per-recruit model as fishing mortality rates go from low to current levels (Fig. 7). At mortality rates higher than current levels, however, the yield-per-recruit model cannot be used to evaluate potential yield because of the impact of heavy fishing mortality on the spawning stock and the subsequent reduction in recruitment. For example, under the average recruitment level of 16.03 billion fish at age

TABLE 10.—Annual age-specific fishing mortality rates for gulf menhaden, expressed as multiples of the average fishing mortality rate at age, 1964-77, ( $F$ -multiple = 1.00), actual fishing mortality rates at age used in the population simulation model, sustainable yield, population biomass, and years to stabilization.

$F$ -multiple	Actual $F$ at age			Sustainable yield level (t)	Population biomass (t)	Years to stabilization
	0	1	2-4			
0	0	0	0	0	1,268,348	97
0.25	0	0.1647	0.4550	266,878	1,151,345	53
0.50	0	0.3294	0.9100	419,813	1,072,885	35
0.75	0	0.4941	1.3650	512,568	1,009,288	27
1.00	0	0.6588	1.8200	565,581	945,740	8
1.25	0	0.8236	2.2750	585,010	871,695	20
1.27 (MSY)	0	0.8367	2.3114	585,118	865,300	22
1.50	0	0.9883	2.7300	569,823	778,012	32
1.75	0	1.1530	3.1850	514,388	655,278	42
2.00	0	1.3177	3.6400	409,304	492,702	78
2.25	0	1.4824	4.0950	241,462	277,288	210
2.50	0	1.6471	4.5500	0	0	<sup>1</sup> >300
2.75	0	1.8118	5.0050	0	0	<sup>1</sup> 250

<sup>1</sup>To extinction.

1 (28.34 billion at age 0.5) and an  $F$ -multiple of 2.00, the yield-per-recruit model predicts a total yield of 546,395 t; the population simulation model predicts a gradual decline from current levels and stabilization at about 409,304 t. Thus, when using average recruitment levels and yield-per-recruit results, estimates of yield at  $F$ -multiple levels higher than about 1.75 times the average fishing mortality for the 1964-77 period will be unrealistic.

The impact of increasing levels of fishing mortality on the stock is also reflected in estimates of population biomass under an array of  $F$ -multiples (Table 10). Biomass estimates were based on predicted population size as of 1 January (i.e., after recruitment and before application of fishing mortality). These estimates show a pre-exploitation population biomass exceeding 1.268 million t, followed by an accelerating decline as increased fishing mortality takes progressively larger fractions of the population and disproportionately larger fractions of older and heavier fish.

### STATUS AND OUTLOOK FOR THE GULF MENHADEN FISHERY

The gulf menhaden population appears to be healthy, highly productive, and capable of supporting yearly harvests exceeding 500,000 t, although con-

siderable variation can be expected. It has shown a general increase in abundance through the period covered in this report, although this increase may be a portion of a general cycle of this clupeid stock.

The high natural mortality rate indicates that fishing mortality has to be applied at a fairly high rate and on young fish to avoid loss of surplus biomass. Peak cohort biomass is reached at an age of 1.5 yr. It is not all available to the fishery, because age-1 fish are only partially recruited. Partial recruitment appears to have some benefit in that it affords some protection for the spawning stock.

Recruitment fluctuation appears to be greater at low spawning stock sizes. Initial spawning before full recruitment would assure moderate to high levels of recruitment and reduce chances for large recruitment fluctuation. Therefore, if recruitment failure were to occur, it would likely arise from biotic or environmental factors rather than from excessive fishing mortality.

Significant increases in fishing mortality are unlikely to occur, given the present distribution and operating procedure of the fishery, unless there is a series of recruitment failures. The current fleet of about 80 purse seine vessels appears to be more than adequate to harvest the recruited gulf menhaden stock during years of low to moderate stock size, and

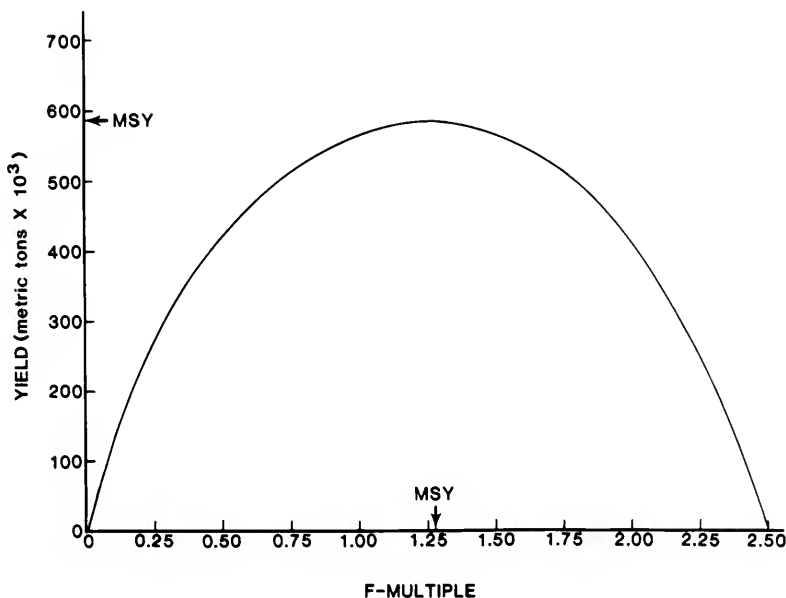

FIGURE 9.—Sustainable yield predicted by a deterministic population simulation model of the gulf menhaden fishery at multiples of the average fishing mortality ( $F$ -multiple = 1.00) for the 1964-77 fishing season (see Table 10 for scaling values).

capable of taking advantage of those years when a large harvestable stock is available (1971, 1978, and 1979). Total mortality rates (averaging 83% for age-1 fish and 95% for ages 2-4 fish) are extremely high. Major expansions of the fleet and processing facilities necessary to substantially increase the fishery's share of population biomass would require enormous capital investment. Based on results of the simulation model, large increases in fishing effort would also result in an overall average decline in landings that would likely be followed by an economically forced reduction in effort. Under present circumstances, we do not envision the sustained intensification of effort necessary to drive the gulf menhaden stock to biological extinction.

The simulation model estimates that the effort currently applied in the fishery is probably very close to that which is necessary to produce MSY (Fig. 9), while it exceeds the necessary level in the catch-effort production function (Fig. 8). Assuming that the simulation model reasonably approximates average conditions, some increase in overall yield could be obtained through a modest increase in effort, which has in fact occurred in more recent years.

Based on recruitment levels for 1964-77, it is evident that considerable variation will occur around a long-term sustainable yield level, regardless of the level of fishing mortality. We varied recruitment level in the population simulation model through periods of high (25 billion) and low (10 billion) levels of recruitment to provide estimates of the yield from

the fishery under good and poor recruitment regimes, and to observe the rate of response to recruitment changes. The results range from an approximate high of 757,000 t to a low of 303,000 t at the high and low recruitment levels (Fig. 10). Since only age-1 and age-2 fish predominate in the fishery, only 2 years were required for the full impact of a change in recruitment to be shown, with a majority of the impact occurring in the first year. We then allowed the average spawner-recruit relationship to operate, stabilizing yield at 565,580 t. Actual low yield predictions are probably underestimated, in that fishing mortality increases in years of low stock size, and the fishery would produce higher yield than through the fishing mortality imposed under average conditions. Nevertheless, these extremes are near the actual ranges in yield observed in the fishery during the study period (316,100-820,000 t) and should provide reasonable estimates of mean yield and range expected in future years.

Since considerable variation does exist around the spawner-recruit curve and simulations were all conducted in deterministic fashion, the model was run with recruitment varying randomly between the recruitment extremes calculated from our data set (7.5 billion-25.0 billion). The results of that simulation (Fig. 10) provide a long-term (50 yr) average of 467,459 t, but it varies from 718,000 to 263,000 t. We anticipate that the fishery will continue to operate somewhat in this fashion, unless there is a cyclic environmental or biological influence on recruitment.

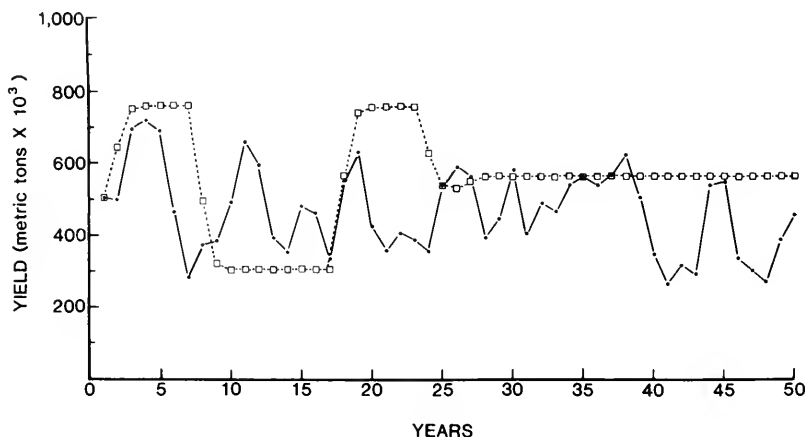

FIGURE 10.—Annual yield of the gulf menhaden fishery projected by the population simulation model when upper and lower values of recruitment from the 1964-77 year classes are inserted (dashed line) and when recruitment varies randomly within limits of observed recruitment for the same data set (solid line).

## SUMMARY

The fishery for gulf menhaden appears to be at parity with the stock. There is ample capacity to harvest available biomass and segments of the stock are not available to the fishery until after spawning has occurred. The fishery appears to be near the level of estimated maximum sustainable yield, but will be subject to wide ranges in annual yield. Substantially increased effort will likely reduce long-term average yield, but should not drive the stock to biological extinction. Maintenance of current catch and stock conditions is dependent on the biology of gulf menhaden, the pattern of recruitment, and on maintaining the current fishing strategy. Major changes in the operation of the fishery, such as an expansion of effort east and west of the present range, or offshore on winter spawning concentrations, will change the basis on which these analyses were formulated, and would have consequences which are not predictable at this time.

## LITERATURE CITED

- ABRAMSON, N. J.  
1971. Computer programs for fish stock assessment. FAO Fish. Tech. Pap. 101, 154 p.
- AHRENHOLZ, D. W.  
1981. Recruitment and exploitation of Gulf menhaden, *Brevoortia patronus*. Fish. Bull., U.S. 79:325-335.
- CHAPOTON, R. B.  
1972. The future of the Gulf menhaden, the United States' largest fishery. Proc. Gulf Caribb. Fish. Inst. 24:134-143.
- CHRISTMAS, J. Y., JR., AND D. J. ETZOLD.  
1977. The menhaden fishery of the Gulf of Mexico United States: a regional management plan. Gulf Coast Res. Lab. Tech. Rep. Ser. 1, 53 p.
- CLARK, C. W., AND M. MANGEL.  
1979. Aggregation and fishery dynamics: a theoretical study of schooling and the purse seine tuna fisheries. Fish. Bull., U.S. 77:317-337.
- CUSHING, D. H.  
1971. The dependence of recruitment on parent stock in different groups of fishes. J. Cons. Int. Explor. Mer 33:340-362.
- FOX, W. W., JR.  
1975. Fitting the generalized stock production model by least-squares and equilibrium approximation. Fish. Bull., U.S. 73:23-37.
- HUNTSMAN, G. R., AND R. B. CHAPOTON.  
1973. Biostatistical data acquisition in the menhaden fisheries. Trans. Am. Fish. Soc. 102:452-456.
- LENARZ, W. H., W. W. FOX, JR., G. T. SAKAGAWA, AND B. J. ROTHCHILD.  
1974. An examination of the yield per recruit basis for a minimum size regulation for Atlantic yellowfin tuna, *Thunnus albacares*. Fish. Bull., U.S. 72:37-61.
- LEWIS, R. M., AND C. M. ROITHMAYR.  
1981. Spawning and sexual maturity of Gulf menhaden *Brevoortia patronus*. Fish. Bull., U.S. 78:947-951.
- MARQUARDT, D. W.  
1963. An algorithm for least-squares estimation of nonlinear parameters. SIAM J. App. Math. 11:431-441.
- MURPHY, G. I.  
1965. A solution of the catch equation. J. Fish. Res. Board Can. 22:191-202.
- NELSON, W. R., M. C. INGHAM, AND W. E. SCHAAF.  
1977. Larval transport and year-class strength of Atlantic menhaden, *Brevoortia tyrannus*. Fish. Bull., U.S. 75:23-41.
- NICHOLSON, W. R.  
1978. Gulf menhaden, *Brevoortia patronus*, purse seine fishery: catch, fishing activity, and age and size composition, 1964-73. U.S. Dep. Commer., NOAA Tech. Rep. NMFS SSRF 722, 8 p.
- NICHOLSON, W. R., AND W. E. SCHAAF.  
1978. Aging of Gulf menhaden, *Brevoortia patronus*. Fish. Bull., U.S. 315-322.
- REINTJES, J. W.  
1964. Annotated bibliography on biology of menhadens and menhadenlike fishes of the world. U.S. Fish. Wildl. Serv., Fish. Bull. 63:531-549.
- REINTJES, J. W., AND P. M. KENEY.  
1975. Annotated bibliography on the biology of the menhadens, genus *Brevoortia*, 1963-1973. U.S. Dep. Commer., NOAA Tech. Rep. NMFS SSRF 687, 92 p.
- REINTJES, J. W., J. Y. CHRISTMAS, JR., AND R. A. COLLINS.  
1960. Annotated bibliography on biology of American menhaden. U.S. Fish Wildl. Serv., Fish. Bull. 60:297-322.
- RICKER, W. E.  
1973. Linear regressions in fishery research. J. Fish. Res. Board Can. 30:409-434.  
1975. Computation and interpretation of biological statistics of fish populations. Bull. Fish. Res. Board Can. 191, 382 p.
- SCHAAF, W. E.  
1975a. Status of the Gulf and Atlantic menhaden fisheries and implications for resource management. Mar. Fish. Rev. 37(9):1-9.  
1975b. Fish population models: potential and actual links to ecological models. In C. S. Russell (editor), Ecological modeling in a resource management framework, p. 211-239. Resources for the Future, Washington, D.C.
- SCHAEFFER, M. B.  
1954. Some aspects of the dynamics of populations important to the management of the commercial marine fisheries. Inter-Am. Trop. Tuna Comm. Bull. 1:27-56.  
1957. A study of the dynamics of the fishery for yellowfin tuna in the eastern tropical Pacific Ocean. Inter-Am. Trop. Tuna Comm. Bull. 2:247-268.
- TOMLINSON, P. K.  
1970. A generalization of the Murphy catch equation. J. Fish. Res. Board Can. 27:821-825.
- ULLTANG, Ø.  
1977. Sources of errors in and limitations of virtual population analysis (cohort analysis). J. Cons. Int. Explor. Mer 37:249-260.
- WALTERS, C. J.  
1969. A generalized computer simulation model for fish population studies. Trans. Am. Fish. Soc. 98:505-512.



# LENGTH-WEIGHT RELATIONSHIPS OF BLUE, *PARALITHODES PLATYPUS*, AND GOLDEN, *LITHODES AEQUISPINA*, KING CRABS PARASITIZED BY THE RHIZOCEPHALAN, *BRIAROSACCUS CALLOSUS* BOSCHMA

CLAYTON R. HAWKES, THEODORE R. MEYERS, AND THOMAS C. SHIRLEY<sup>1</sup>

## ABSTRACT

Length-weight relationships and condition factors of nonparasitized blue king crabs, *Paralithodes platypus*, and golden king crabs, *Lithodes aequispina*, in southeastern Alaska were compared with crabs parasitized by the rhizocephalan, *Briarosaccus callosus*. Species, sex, and shell condition were considered in all analyses. Parasitized male blue king crabs and parasitized male golden king crabs weighed significantly less than nonparasitized individuals. Golden king crabs may be more resistant to infection and the effects of *B. callosus* parasitism than blue king crabs. They had a lower prevalence of infection, and the percent difference between the body mass of parasitized and nonparasitized crabs was considerably less. In both crab hosts the prevalence of infection was greater in samples where sublegal or smaller size classes of adults were included in analyses, suggesting that crab growth was reduced by the parasite.

A parasite of lithodid crab species in Alaska is the rhizocephalan barnacle, *Briarosaccus callosus* Boschma (Boschma and Haynes 1969; Boschma 1970; McMullen and Yoshihara 1970; Somerton 1981; Hawkes et al. 1985). The parasite's distribution in Alaskan waters, its life history, and its effects on king crab hosts are almost unknown except that parasitized crabs become castrated (Boschma and Haynes 1969; McMullen and Yoshihara 1970). The prevalence of this barnacle parasite varies between areas and species and is especially high in southeastern Alaska. Parasitism by *B. callosus* might decrease the productivity of king crab stocks through sterilization and may also reduce crab growth rates. Therefore, parasitized crabs of the same size as nonparasitized crabs may weigh less. In this study we examined the influence of *B. callosus* on the length-weight relationships and condition factors of parasitized and nonparasitized blue king crab, *Paralithodes platypus*, and golden king crab, *Lithodes aequispina*.

## MATERIALS AND METHODS

Two methods were used to compare the growth of parasitized and nonparasitized crabs. A Fulton's condition factor ( $w/l^3 \times 10^{-4}$ , where  $w$  = weight in grams and  $l$  = carapace length in mm) was used for

comparing different individuals of the same species (Ricker 1975). This method assumes that all body parts grow isometrically. The second method used for comparison assumes allometric growth, where different body parts grow at different rates. Constants were determined empirically by linear regression using the model,  $w = AL^B$ , and logarithms of the carapace lengths and body weights (Everhart et al. 1976, p. 70-71). The length-weight relationships of parasitized and nonparasitized crabs were compared with analysis of covariance (ANCOVA). All mean values ( $\bar{X}$ ) are given  $\pm 1$  standard deviation. Probabilities  $<0.05$  are considered significant and those  $<0.01$  are considered highly significant.

The analysis of length-weight relationships was based on wet weights taken in the field (nearest 25 g) and in the laboratory (nearest gram). Crabs with missing or partially regenerated appendages were not weighed. Carapace lengths were measured to the nearest 1 mm (Wallace et al. 1949). Shell condition was classified according to a four point scale (Somerton and MacIntosh 1983). A new shell condition is found in crabs that have recently molted, and skipmolt crabs are those that have not molted within the last year. Skipmolts or old shell crabs were identified by worn spines and dactyl tips and accumulations of shell epifauna. Infections were diagnosed grossly by the presence of externae or scars, indicative of lost externae. A scar is a short chitinous brown pedicel from which an externa was attached and protrudes from underneath the abdomen.

<sup>1</sup>School of Fisheries and Science, University of Alaska, Juneau, 11120 Glacier Highway, Juneau, AK 99801.

## Blue King Crab

Male and female blue king crab of various sizes from Muir and Adams Inlets in Glacier Bay (Fig. 1) were measured, weighed, and examined for *B. callosus* by the authors in March 1984. Commercial gear was used but with modified escape ports to prevent loss of juvenile crabs. Data on large male blue king crabs from Lynn Canal and Glacier Bay were also gathered at dockside areas before sale to processors or the public. Since state regulations for southeastern Alaska restrict the commercial harvest of blue king crabs to males  $\geq 165$  mm in carapace width, all commercial samples, therefore, excluded females and smaller adult males.

## Golden King Crabs

Male and female golden king crabs of various sizes

were collected by the authors from Lynn Canal near Haines, AK (Fig. 1), using standard pot gear in May 1984. Commercial catches in November 1983 provided legal sized ( $\geq 178$  mm carapace width) males.

## RESULTS

The prevalences of *B. callosus* in the commercial catches of male blue king crabs were 6.3% and 11.6% for Lynn Canal and Glacier Bay, respectively. Samples from Glacier Bay, which contained males and females of all sizes, had a prevalence of 76%. The prevalence in varisized male and female *L. aequispina* collected from the Haines area was 20%.

Linear length-weight relationships of log transformed data best defined our data, since no trends were present in the residuals (differences between predicted lines and actual data) of parasitized or non-parasitized crabs.

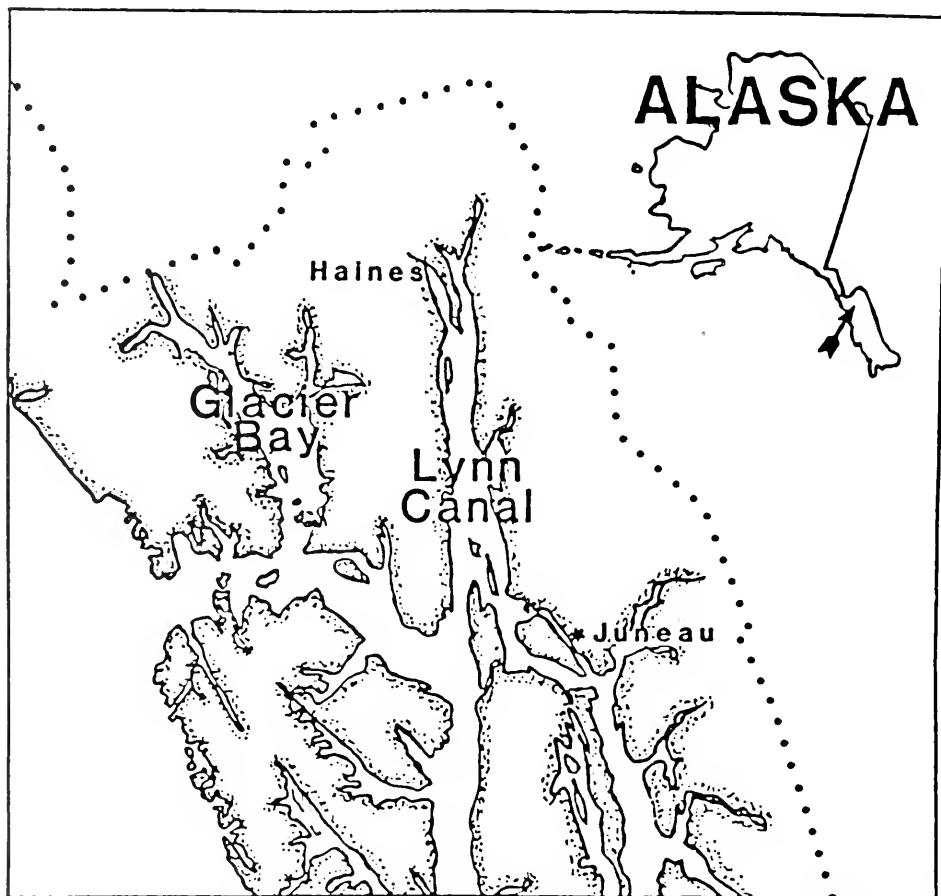

FIGURE 1.—Sampling sites of blue, *Paralithodes platypus*, and golden, *Lithodes aequispina*, king crabs in southeastern Alaska.



## Blue King Crab

Glacier Bay and Lynn Canal blue king crab data were pooled. The populations were considered to be identical because the two groups were regarded as having the same linear relationship (ANCOVA). Smaller crabs (<134 mm in carapace length) not common to data sets from both areas and skipmolts were eliminated from this analysis.

Significantly (chi-square test) more skipmolts were found among the nonparasitized crabs (45/237) than the parasitized crabs (9/131). Because skipmolts tend to be heavier than new shell crabs (Somerton and MacIntosh 1983), skipmolting was analyzed as a possible source of bias. In male blue king crabs the new shell crabs had a higher mean weight than the skipmolts at greater carapace lengths, while the skipmolts had a higher mean weight at the smaller lengths (Fig. 2). Although individual linear relationships did not describe the data as well as a common line, the skipmolts were eliminated from further analyses of both blue and golden king crab data.

Subsequently, in the length-weight relationships of male blue king crabs pooled from both areas, with small crabs represented in each group, the nonparasitized crabs were heavier at a highly significant level than the parasitized crabs (ANCOVA) (Fig. 3). Non-

parasitized males were 8.7% heavier than parasitized crabs. Nonparasitized male blue king crabs also had a significantly (*t*-test) higher condition factor ( $8.5 \pm 0.8$ ) than parasitized crabs ( $7.2 \pm 0.6$ ), indicating that nonparasitized crabs were heavier for a given length. Condition factor did not vary with size in nonparasitized blue king crabs but the slope was significant and negative for the parasitized crabs. This indicates that the condition factor of parasitized blue king crabs decreased with increased size.

Only five nonparasitized female blue king crabs were available for length-weight relationships and condition factor comparisons. More samples are needed for further analysis of female blue king crabs.

## Golden King Crabs

Males with carapace lengths common to both parasitized and nonparasitized crabs, 117 to 159 mm, provided linear relationships that were parallel and significantly different (Fig. 4). *Briarosaccus callosus* was not present in any of the large commercial-size crabs sampled in 1983; therefore, these samples were excluded from analysis. The percent weight difference between parasitized and nonparasitized male golden king crabs was about 2.6%. Weight conversion in parasitized male *P. platypus* of similar sizes

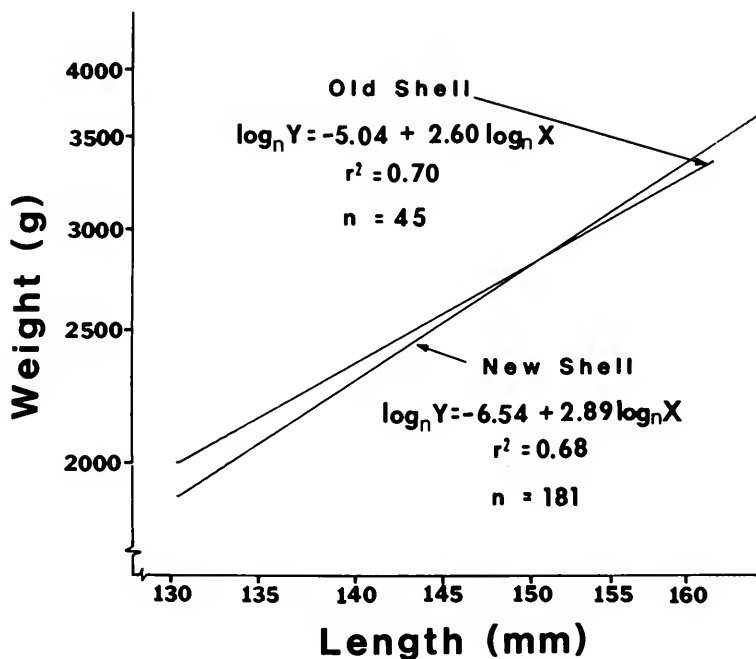

FIGURE 2.—Length-weight linear relationships of new shell and skipmolt nonparasitized male *Paralithodes platypus*.

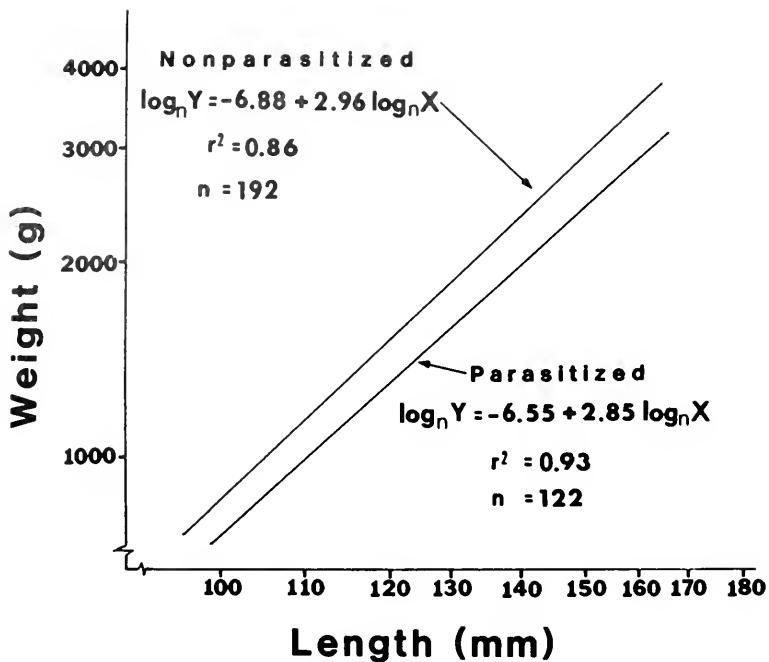

FIGURE 3.—Length-weight linear relationships of parasitized and nonparasitized male *Paralithodes platypus* with skipmolts eliminated.

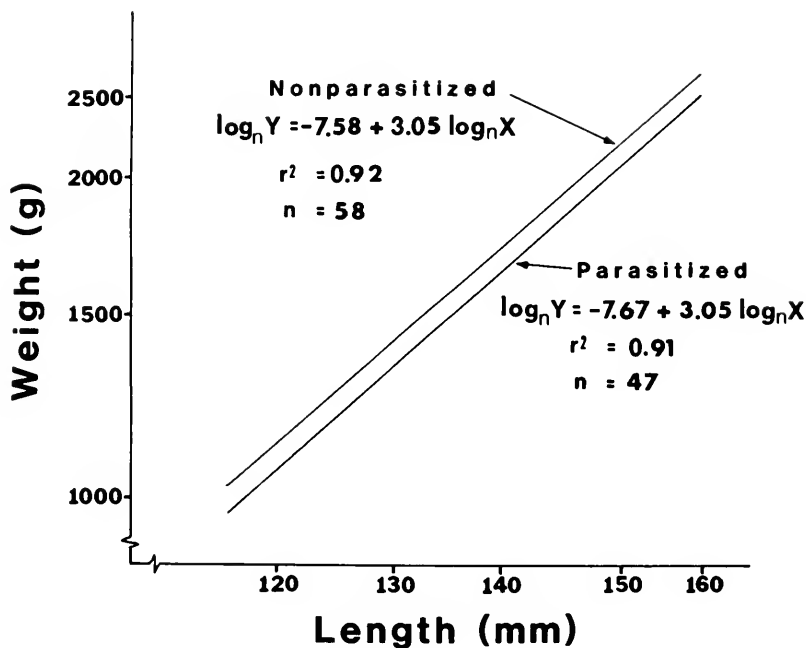

FIGURE 4.—Length-weight linear relationships of parasitized and nonparasitized male *Lithodes aequispina* after elimination of 1983 data.

was inhibited considerably more than in parasitized male *L. aequispina*. The condition factor for nonparasitized male *L. aequispina* ( $6.5 \pm 0.5$ ) was also greater at a highly significant level than for male parasitized crabs ( $6.1 \pm 0.4$ ). The condition factor in parasitized and nonparasitized male golden king crabs did not vary significantly with size.

Nonparasitized female *L. aequispina* ( $n = 77$ ) were heavier than parasitized females ( $n = 43$ ) over most of the length range. The linear relationships were significantly different but not parallel, preventing a comparison of the intercepts. Condition factors were not significantly different between the parasitized ( $5.9 \pm 0.5$ ) and nonparasitized ( $5.7 \pm 0.4$ ) females. Condition factors varied significantly with size and in the nonparasitized crabs but not in the parasitized crabs.

## DISCUSSION

Weights and, consequently, condition factors were significantly lower in male blue and golden king crabs parasitized by *B. callosus*. A difference in mean weight was also present in female blue king crabs that were parasitized, although an adequate comparable sample size of nonparasitized females was not available. The prevalence of the parasite was considerably greater in king crab populations where sublegal or smaller size classes of adult crabs were included in the sample number. In blue king crabs from Glacier Bay, the inclusion of females in the sample also raised prevalence figures since females had a significantly higher prevalence of barnacle parasitism than male crabs. A potential reason for increased barnacle prevalence in smaller crabs could include differential mortality such that fewer parasitized crabs survive to larger size classes. Other explanations include reduced molting frequencies, reduced number of instars and/or reduced growth represented by a reduction in relative molt increment (Hawkes et al. in press). However, reduced weights in parasitized crabs within the same size classes as nonparasitized individuals suggest that growth of the host crab is decreased by *B. callosus*. The higher parasite prevalence in smaller crabs also supports this conclusion.

Parasitized crabs may develop significantly less body tissue after molting, which is likely to be a cumulative effect occurring over more than one season. Although the complete life history of *B. callosus* is unknown, other species of Rhizocephala are known to require at least 9 to 12 mo to reach reproductive maturity and develop an externa in host crabs (Ritchie and Høeg 1981). In males that be-

come castrated and weight loss of testes is insignificant in total body mass (0.2%) and does not account for the weight difference observed. Also testes weigh less than the interna and externa of the parasite. In female king crabs a considerable amount of the wet body weight can be attributed to the egg clutch and ovaries. Consequently, gonadal atrophy, nonovigerous conditions and reduced somatic growth rates all may account for the lesser weights observed in parasitized female king crabs.

The percentages of weight difference between parasitized and nonparasitized males was considerably different between the two species of king crabs. Golden king crab was less affected by the parasite, sustaining less growth inhibition due to barnacle parasitism than parasitized blue king crabs. Parasitized golden king crabs have significantly higher hemolymph protein concentrations in comparison to either their nonparasitized conspecifics or parasitized blue king crabs. The additional protein may be attributed to the presence of lectins, specific carbohydrate-binding proteins suspected of playing a role in crustacean immunity (Shirley et al. 1985).

If we are correct, reduced crab growth as an effect of *B. callosus* parasitism would conflict with data from other peltogastrid rhizocephalans (O'Brien and Van Wyk 1985). Other rhizocephalan species tend to be more prevalent on larger crab hosts, making enhanced growth or enhanced survivorship a plausible effect of parasitism. Another explanation is that parasitized crabs have less somatic growth and, as a result, have fewer molts. Molting is a time of greatest mortality for most decapods, and those with lower molting frequencies would have greater survival. The probability of infection may also be greater in certain size classes. Behavioral differences or sampling bias could affect the parasite's relative frequency within the host population. Sacculinidae appear to be distributed differently within host populations (O'Brien and Van Wyk 1985). *Pugettia producta* is a majid crab from California and does not molt after reaching maturity. When parasitized by the rhizocephalan *Heterosaccus californicus*, there is no significant effect on molt increments of juveniles and the pubertal molt increment is not affected in adults. However, *P. producta* that are parasitized pass through fewer instars before reaching maturity, and the mean size of these individuals is significantly less than in nonparasitized crabs (O'Brien 1984). Blue crabs, *Callinectes sapidus*, also have retarded growth when parasitized by *Loxothylacus texanus*, with most adults appearing as miniature adult females (Overstreet 1978).

Prevalence of the parasite as a function of host size and field length-weight comparisons are still only indirect measurements of host growth. Consequently, further laboratory studies measuring growth directly in parasitized king crabs are needed to positively prove our hypothesis.

## ACKNOWLEDGMENTS

We thank R. Hakala of the FV *Fortune* and J. Donahue of the FV *Stormfront* for assistance with field sampling and use of their vessels. Steve Ignell of the National Marine Fisheries Service's Auke Bay Laboratory was also very helpful as a consultant on statistical procedures. Funding was received from the Research Council of the University of Alaska, Juneau, and the Alaska Fisheries Research Center of the University of Alaska (Project number RC/84-04). A research fellowship was provided by Alaska Sea Grant for the senior author (CRH).

## LITERATURE CITED

- BOSCHMA, H.  
1970. Notes on Rhizocephala of the genus *Briarosaccus*, with a description of a new species. Proc. K. Ned. Akad. Wet. C73:233-242.
- BOSCHMA, H., AND E. HAYNES.  
1969. Occurrence of the rhizocephalan *Briarosaccus callosus* Boschma in the king crab *Paralithodes camtschatica* (Tilesius) in the Northeast Pacific Ocean. Crustaceana 16: 97-98.
- EVERHART, W. H., A. W. EIPPER, AND W. D. YOUNGS.  
1976. Principles of fishery science. Comstock Publ. Assoc., Ithaca, N.Y., 288 p.
- HAWKES, C. R., T. R. MEYERS, AND T. C. SHIRLEY.  
1985. Parasitism of the blue king crab, *Paralithodes platypus*, by the rhizocephalan *Briarosaccus callosus* Boschma. J. Invertebr. Pathol. 45:252-253.  
In press. Growth of Alaskan blue king crabs, *Paralithodes platypus* (Brandt), parasitized by the rhizocephalan *Briarosaccus callosus* Boschma. Crustaceana.
- MCMULLEN, J. C., AND H. T. YOSHIHARA.  
1970. An incidence of parasitism of deepwater king crab, *Lithodes aequispina*, by the barnacle *Briarosaccus callosus*. J. Fish. Res. Board Can. 27:818-821.
- O'BRIEN, J.  
1984. Precocious maturity of the majid crab, *Pugettia producta*, parasitized by the rhizocephalan barnacle, *Heterosaccus californicus*. Biol. Bull. 166:384-395.
- O'BRIEN, J., AND P. VAN WYK.  
1985. Effects of crustacean parasitic castrators (epicaridean isopods and rhizocephalan barnacles) on growth of crustacean hosts. In A. Wenner (editor), Crustacean issues 3, Factors in adult growth, p. 191-218. A.A. Balkema Publs., Rotterdam, Neth.
- OVERSTREET, R. M.  
1978. Marine maladies? Worms, germs, and other symbionts from the Northern Gulf of Mexico. Miss.-Ala. Sea Grant Consortium, MASGP-78-021, 140 p.
- RICKER, W. E.  
1975. Computation, and interpretation of biological statistics of fish populations. J. Fish. Res. Board Can. Bull. 191, 382 p.
- RITCHIE, L. E., AND J. T. HØEG.  
1981. The life history of *Lernaediscus porcellanae* (Cirripedia: Rhizocephala) and co-evolution with its procellanid host. J. Crustacean Biol. 1:334-347.
- SHIRLEY, S. M., T. C. SHIRLEY, AND T. R. MEYERS.  
1985. Hemolymph studies of blue (*Paralithodes platypus*) and golden (*Lithodes aequispina*) king crab parasitized by the rhizocephalan barnacle, *Briarosaccus callosus*. In Proceedings of the International King Crab Symposium, p. 341-352. Alaska Sea Grant Rep. 85-12.
- SOMERTON, D. A.  
1981. Contribution to the life history of the deep-sea king crab, *Lithodes couesi*, in the Gulf of Alaska. Fish. Bull., U.S. 79:259-269.
- SOMERTON, D. A., AND R. A. MACINTOSH.  
1983. Weight-size relationships for three populations in Alaska of the blue king crab, *Paralithodes platypus* (Brandt, 1850) (Decapoda, Lithodidae). Crustaceana 45:169-175.
- WALLACE, M., C. J. PERTUIT, AND A. R. HVATUM.  
1949. Contribution to the biology of the king crab, *Paralithodes camtschatica* Tilesius. U.S. Fish. Wildl. Serv. Leaflet 340, 50 p.

# DISTRIBUTION AND ABUNDANCE OF COMMON DOLPHIN, *DELPHINUS DELPHIS*, IN THE SOUTHERN CALIFORNIA BIGHT: A QUANTITATIVE ASSESSMENT BASED UPON AERIAL TRANSECT DATA

THOMAS P. DOHL, MICHAEL L. BONNELL, AND R. GLENN FORD<sup>1</sup>

## ABSTRACT

On 35 aerial transect surveys of the Southern California Bight, 157 sightings of common dolphin, *Delphinus delphis*, schools were observed and mapped for distributional analysis. Sightings were pooled into 30' of latitude by 30' of longitude sampling quadrats, and density estimates were obtained by fitting a Fourier series to a frequency distribution of perpendicular sighting distances. Two distinct seasonal distributions are represented by density contour maps: a winter-spring distribution when schools were confined to the easternmost and warmest waters of the area, and a summer-autumn distribution when schools were widespread. Mean seasonal population estimates were 15,448 for winter-spring and 57,270 for summer-autumn (cv of 0.36 and 0.17, respectively). During the warmer water months, the common dolphin population expands its use of the Southern California Bight. They enter from the south, apparently following the major undersea ridges and escarpments, and flow through the Southern California Bight in a generalized counterclockwise fashion. Observational evidence suggests that there is mixing of both the nearshore and pelagic forms of this species in the offshore waters over the Santa Rosa-Cortés Ridge and Patton Escarpment.

The common dolphin, *Delphinus delphis*, is the most abundant cetacean in the waters of the Southern California Bight (SCB). On an annual basis the numbers of common dolphins exceed, on average, the combined total of all other cetaceans in this area by 2.75 times (Dohl et al. 1980).

Common dolphins inhabit subtropical waters of Mexico and the SCB throughout the year (Norris and Prescott 1961). Density estimates for this species and other dolphins (*Stenella* sp.) in waters offshore of Mexico and Central America were calculated by the National Marine Fisheries Service in 1974 (Smith 1981). The distribution of common dolphins in the eastern parts of the Southern California Bight was described by Evans (1975).

In order to understand the role of the common dolphin in the ecology of the SCB and to understand when and where this population is mostly vulnerable to human activities, we have constructed a spatial-seasonal distributional model with two aims: 1) to generate population estimates for the entire area and 2) to describe the general features of seasonal distribution patterns. This is the first study to examine the spatial heterogeneity of common dolphin distribution in the SCB and to generate confidence limits for density and seasonal mean population size estimates.

From April 1975 through March 1978, nearly 110,000 nmi (200,000 km) of combined aerial and ship surveys were conducted within the SCB for the Department of the Interior, Bureau of Land Management (now the Minerals Management Service). During this marine mammal and seabird study, a total of 505 schools of 134,675 *Delphinus delphis* were recorded.

This paper is primarily concerned with one subset of the 3 yr, common dolphin sighting data base. To avoid the statistical pitfalls of pooling data obtained from a variety of platforms performing their missions at different speeds, at different altitudes, and over varying portions of the study area, we restricted these analyses to 35 monthly flights flown at 1,000 ft above sea level (ASL). Each of these surveys required about 15 overwater flight hours and covered about 1,350 nmi (2,500 km) of trackline. All species of cetaceans encountered were recorded as to location, number, behavior, direction of movement, and number of juveniles. Common dolphins were encountered 157 times in this flight series, for a total of 46,153 animals or 69% of all cetaceans observed.

The results of the distributional study and accompanying figures were derived from the 1,000 ft ASL aerial survey data defined above. However, material in the Discussion section draws upon observations made from all survey platforms used during this study.

<sup>1</sup>Institute for Marine Sciences, University of California, Santa Cruz, CA 95064.

## METHODS

Aerial surveys were flown at an altitude of 1,000 ft ASL (328 m) at about 90 kn (167 km/h) in a high-wing, twin-engine Cessna<sup>2</sup> 337. The crew consisted of a pilot and three experienced marine mammal observers, one acting as recorder. Surveys were flown along 15 parallel, predetermined tracklines, separated by 15 nmi and extending from the shore to a maximum distance of 100 nmi (185 km; Fig. 1). Tracklines were oriented from northeast to southwest and were roughly perpendicular to the shoreline, as well as to most major features of submarine topography in the study area. Whenever possible, all transect lines were surveyed on each 3-d flight. Transect lines were not replicated on a single survey, nor were they flown in a predetermined order or direction. The first line flown on a given day was occasionally dictated by weather or military activity in the area; subsequent lines were chosen to optimize coverage and simplify logistics.

Observers searched unbounded corridors on each side of the aircraft trackline. Sightings were recorded

and coded for computer entry at the time of occurrence. The aircraft was diverted to circle those schools located off the trackline for positive identification, animal count, and photographs. The total animal count recorded for each school was a consensus of the observers on board, derived from multiple orbits of the school. Any additional sightings obtained while "off transect" were not included in later density calculations due to the possibility that the secondary sighting was prompted by the first. All transect segments where observer effectiveness might have been hampered by fog and/or sea state were deleted from the data base; only transect segments where visibility exceeded 1 nmi and the sea state was Beaufort 3 (few, scattered whitecaps) or less were retained.

Aerial photographs were used to validate observer estimates of school size. The aerial photographs were taken on 9" × 9" film from a vertically mounted camera and on 4" × 5" and 35 mm films in hand-held cameras for oblique views. The large, 9" × 9" vertical photographs soon proved to be the most useful and were used almost exclusively for count verification. Observer counts and film counts on average-sized schools (up to 100 animals) varied only slightly, but not in a consistent manner. The 3-5%

<sup>2</sup>Reference to trade names does not imply endorsement by the National Marine Fisheries Service, NOAA.

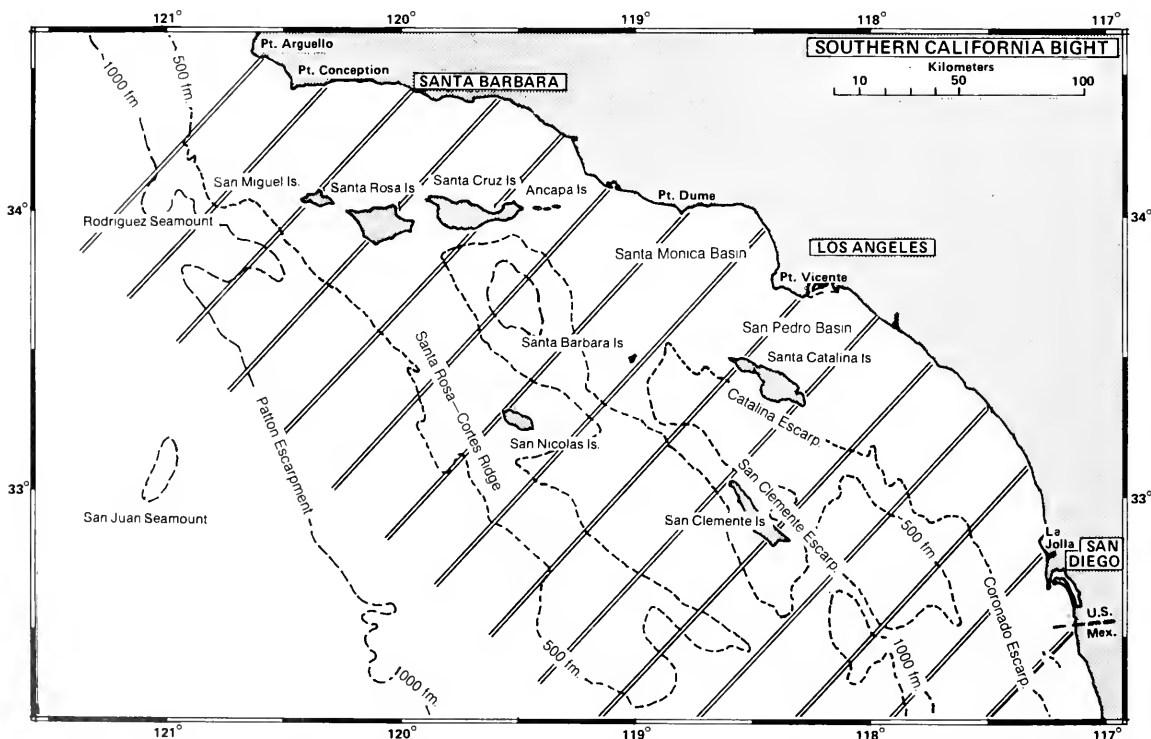

FIGURE 1.—Map of the Southern California Bight study area showing aerial survey tracklines.

variations in counts occurred randomly, with no pattern to indicate in which method the higher counts would occur. Small schools of <100 animals represented most of the sightings (53%). In medium-sized schools, up to 300 animals, the variation was higher (about 11%), and the photographs indicated probable observer underestimation in 62% of the counts. The largest underestimates occurred in large schools, >300 animals, and were found in 76% of the observer counts. These underestimates ranged up to 30% in some circumstances. Within the large-school category, two subcategories became evident: 1) Dispersed schools with multiple discrete subgroups of animals gave the observers less of a problem than 2) the tightly grouped, rapidly moving, compact schools. The dispersed large schools yielded underestimate values in the range of 14-16%, while the compact, large groups were usually 21-23%. Extremely large schools of over 1,000 animals were responsible for the highest error values of up to 30%; these schools accounted for only 6.6% of total sightings.

Generally, we found that aerial estimates were lower than numbers based on photographs and that the larger the school, the higher the difference. We attribute some of the difference to the time lag between when the count was made while circling the school and the photo run over the center of the school. Results of photo runs made either before or after the counting effort did not vary significantly, but occasionally, continued circling scattered larger schools into several smaller subgroups.

Sea surface glare affected observation efficiency to some degree on about 10% of all survey days. Due to the orientation of transect lines, glare conditions could impair the search ability of only the left-side observer on southwest-bound legs (up to 26% of total search effort per survey day). Holt (1984<sup>3</sup>) found density estimates of dolphin schools to be 39% lower under poor sun conditions than during good sun conditions. Using his figure, we calculate that our overall seasonal density estimates might be low by about 1%. Because of the lack of any systematic bias resulting from glare affecting density estimates in one particular region or season more than another, we made no corrections to adjust for this slight underestimate.

The perpendicular distance from the trackline to the sighting was calculated from the declination angle obtained using a hand-held inclinometer. Per-

pendicular distances were recorded for 112 sightings of common dolphin schools, representing 74.2% of all sightings used in density calculations.

## Distributional Model

Inspection of the first year's common dolphin sighting numbers and plots of monthly distribution indicated seasonal fluctuations of residency within the Southern California Bight.

Examination of the 3-yr database showed two distinct seasons of occupancy for the species in the SCB (Fig. 2). A comparison of the two sets of data on a monthly basis show a significant statistical difference ( $F_{(1,34)} = 7.66, P < 0.01$ ). In view of these observations, two seasons were defined for the development of the distributional model: a summer-autumn season (July through December) when common dolphin sightings were widespread in the SCB, and a winter-spring season (January through June) when most schools were confined to the southeastern portion of the surveyed area. Common dolphin sightings were assigned by their latitude and longitude to 30' × 30' grid-cells (sampling quadrats) centered on degree and half-degree lines of latitude and longitude. Data were pooled to provide seasonal estimates of common dolphin abundance for each 30' × 30' grid-cell. The estimate of density of groups in cell  $i$ ,  $D_i$ , was calculated from the relationship:

$$\hat{D}_i = n_i \hat{f}(0) / 2L_i \quad (\text{Burnham et al. 1980}) \quad (1)$$

where  $n_i$  is the number of groups encountered,  $\hat{f}(0)$  is the probability density function of perpendicular distances evaluated at the  $y$ -intercept, and  $L_i$  is the sum of all transect lengths in cell  $i$  contributing to the seasonal estimate. The value of the  $\hat{f}(0)$  term was calculated using the nonparametric Fourier-series estimator of Crain et al. 1978 (see Burnham et al. 1980 for a complete discussion of this estimator). Computations were made employing the program TRANSECT (Laake et al. 1979). For calculation of the  $\hat{f}(0)$  term, the perpendicular distance of each sighting was reduced by one-half the width of the exclusion area under the aircraft, where visibility was obstructed by the fuselage (total exclusion area = 530 ft at 1,000 ft ASL). This approach, in effect, moves the transect centerline outboard to the point of nearest possible sighting distance—a point where it is assumed that all animals present will be seen and counted. The question of how to deal with the problem of restricted downward visibility and line transect theory has been considered by others; however, the best treat-

<sup>3</sup>Holt, R. S. 1984. Testing the validity of line transect theory to estimate density of dolphin schools. U.S. Dep. Commer., NOAA Admin. Rep., NMFS-SWFC LJ-84:31, 56 p.

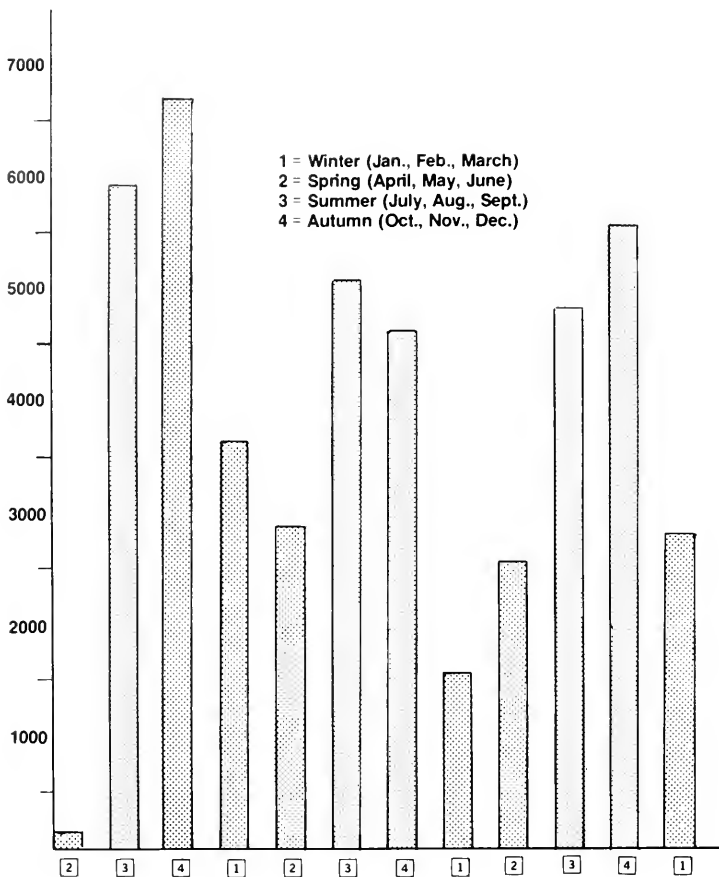

FIGURE 2.—Comparison of total counts of common dolphins on aerial surveys of the Southern California Bight by season, 1975-78.

ment of the subject, in print, is found in two papers by Leatherwood et al. (1982, 1983).

Because sample size was small in each grid-cell and in each season, data were combined to calculate a single value of  $\hat{f}(0)$ . The pooling of data was based on the assumption that the sightability of common dolphin groups did not vary between seasons or between regions of the surveyed area. Violation of this assumption would lead to biases in the estimates of relative densities between seasons or regions, although it would not necessarily effect mean population size estimates. The assumption of seasonal homogeneity was tested using a single classification ANOVA (two groups, unequal samples; Sokal and Rohlf 1969, p. 208). No significant difference between the distribution of perpendicular sighting distances collected in summer-autumn and winter-spring seasons was found ( $F_{1,111} = 2.01, P = 0.18$ ). The same test was used to compare frequency distributions with distance of sightings collected in

calmer inshore waters, with sightings collected in rougher offshore waters, since this seemed to be the most likely source of bias in sightability. No significant difference was found between the distribution of perpendicular sighting distances in the two sub-regions ( $F_{1,108} = 1.78, P = 0.20$ ).

The rescaled frequency distribution of perpendicular sighting distance is shown in Figure 3. The probability density function,  $f(x)$ , is from a three-term, Fourier-series model, which provides the best fit to these data ( $\chi^2 = 6.026, df = 3, P = 0.11$ ). Data were truncated at 6,600 ft in order to remove two extreme values. Intervals were specified, by inspection of the data, in order to smooth the function and minimize the effects of "heaping" in perpendicular distance measurements (Burnham et al. 1980, p. 47).

For estimation of common dolphin density (animals/km<sup>2</sup>) in a given grid-cell for a given season, we multiplied the density of groups in a given cell



by the mean group size throughout the SCB obtained for that season. The small sample size in any cell and the very large variability in the size of groups necessitated pooling of all sightings within a season to calculate mean group size. The mean group size in summer and autumn was  $338 \pm 38$  SE ( $n = 115$ ), while that of winter and spring was  $231 \pm 73$  SE ( $n = 36$ ). While not significantly different ( $F_{1,149} = 1.42, P > 0.25$ ), we used separate mean group size in calculations of seasonal abundance. We tested the assumption that mean group size in each season was constant throughout the SCB, using a bootstrap procedure (Efron 1982). For a given season, cell  $i$  contained  $n_i$  observations of groups of mean size  $\bar{s}_i$ . For each cell  $i$ , we randomly drew 10,000 sets of values of size  $n_i$  from the group size distribution based on all observations recorded in that season, computed the mean of this subsample, and formed a frequency distribution of these mean values. If the percentile ranking of the observed mean group size in cell  $i$  was  $>97.5\%$  or  $<2.5\%$ ,  $\bar{s}_i$  was assumed to be a nonrandom sample. For the summer-autumn season, only 1 cell of the 26 cells containing observations of common dolphins had means which differed significantly from the rest of the surveyed area. Similarly, for the winter-spring season, only 1 cell in 10 showed a significant dif-

ference from the overall group size distribution. Therefore, group size homogeneity was assumed for these data, and a single seasonal value of mean group size ( $\bar{s}$ ) was used in all calculations of cell density for each season.

If  $\hat{f}(0)$  and  $\bar{s}$  may be assumed to be homogeneous, the remaining source of between-cell variability is the density of groups. We tested the hypothesis that the density of groups is homogeneous through the SCB as follows: taking the mean number of sightings of common dolphin schools per kilometer of transect for the entire surveyed area,  $\lambda^*$ . We computed the expected number of cells containing a specified number of sightings of groups, using the formula:

[Expected number of cells with  $k$  sightings] =

$$\sum_{i=1}^{i=m} e^{-\lambda^* L_i} (\lambda^* L_i)^k \quad (2)$$

where  $m$  is the total number of cells sampled,  $k$  is the specified number of sightings of groups, and  $L_i$  is the length of trackline surveyed in cell  $i$ . The expected number of cells containing  $k$  sightings were compared with the observed number for all  $k$  using a chi-square test. No significant spatial heterogeneity was evident for data collected in summer and autumn ( $\chi^2 = 5.06, df = 5, P > 0.5$ ). However, the winter and spring distribution showed clear heterogeneity in the density of groups by cell ( $\chi^2 = 12.85, df = 3, P < 0.005$ ).

We used the method of Chernoff and Moses (1959) to place confidence limits on the estimate of the number of groups per km of transect in cell  $i$ ,  $\hat{\lambda}_i$  (see also Clopper and Pearson 1934). We used a computer program which finds a density value,  $\Gamma_1$ , such that the probability of observing  $n_i$  or more groups in a transect segment of length  $L_i$  is 0.025; this is the lower confidence bound on  $\hat{\lambda}_i$ . Similarly, we find a density value,  $\Gamma_2$ , such that the probability of observing  $n_i$  or fewer groups is 0.025; this forms the upper bound on  $\hat{\lambda}_i$ .  $\Gamma_1$  and  $\Gamma_2$  are defined as satisfying the equations:

$$\sum_{k=n_i}^{k=\infty} \frac{e^{-\Gamma_1 L_i} (\Gamma_1 L_i)^k}{k!} = 0.025 \quad (3)$$

and

$$\sum_{k=0}^{k=n_i} \frac{e^{-\Gamma_2 L_i} (\Gamma_2 L_i)^k}{k!} = 0.025. \quad (4)$$

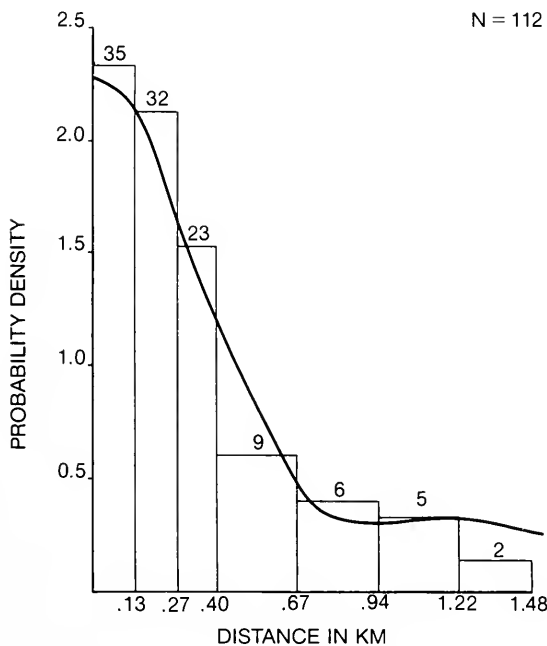

FIGURE 3.—Probability density function  $f(X)$  fit to histogram of sighting frequency and perpendicular distance (rescaled; see text).

Such confidence limits are asymmetric about  $\hat{\lambda}_i$  and decrease in size with increasing transect coverage. They have the important properties that  $\Gamma_2$ , the upper limit, tends to be large when the transect length  $L_i$  is small, even when the number of groups observed is zero, and the lower limit  $\Gamma_1$  is bounded by zero.

Population size estimates were made for each cell  $i$  in each season from the relationship  $\hat{N}_i = \hat{D}_i \cdot \bar{s} \cdot A_i$ , where  $N_i$  is the cell population,  $D_i$  is the estimated density of groups based on Equation (1) (groups/km<sup>2</sup>),  $\bar{s}$  is the seasonal mean group size, and  $A_i$  is the open-water area of cell  $i$ . Total population size in each season, ( $\hat{N}$ ), was estimated as from the sum of populations in each cell, and from the theoretical formula:

$$\hat{N} = \frac{n \cdot \hat{f}(0)}{2L} \cdot \bar{s} \cdot A \quad (5)$$

where  $n$  is the total number of groups observed,  $L$  is the total transect length,  $s$  is the seasonal mean

group size, and  $A$  is the areal extent of the study area. The variance of  $\hat{N}$  was estimated from the relationship (K. Burnham<sup>4</sup>).

$$\text{var}(\hat{N}) = A^2 \cdot \text{var}(\hat{D}_i) \quad (6)$$

where  $\text{var}(\hat{D}_i) = (\hat{D}_i)^2 \frac{\text{var}(n)}{(E(n))^2} + \frac{\text{var}(\hat{f}(0))}{(E(\hat{f}(0)))^2} + \frac{\text{var}(\bar{s})}{(E(\bar{s}))^2}$ . The variance of  $n$  was calculated assum-

ing that  $n$  had a Poisson distribution; if this assumption holds,  $\text{var}(n) = n$  (Burnham et al. 1980). The variance of  $\hat{f}(0)$  was calculated by program TRANSECT, using the method of Burnham et al. (1980). Variance of  $\bar{s}$  was estimated as the standard error of the mean group size. The formula for variance requires that  $\hat{f}(0)$  and  $\bar{s}$  be independent, an assumption that may be violated due to the differen-

<sup>4</sup>K. Burnham, Department of Statistics, School of Physical and Mathematical Sciences, North Carolina State University, Raleigh, NC 27650-5457, pers. commun.

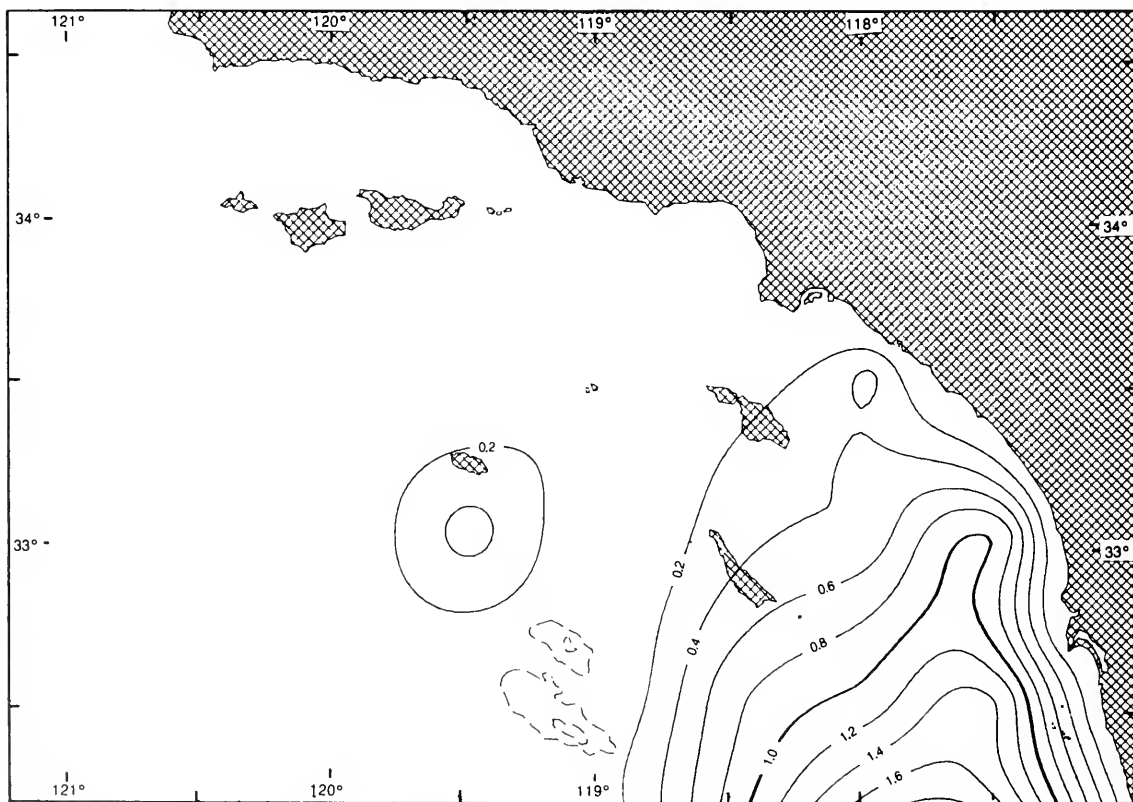

FIGURE 4.—Common dolphin distribution in the Southern California Bight, winter and spring, 1975-78. Density contours show animals/km<sup>2</sup>.

tial sightability of large and small groups (discussed below). Because we could not be sure that the assumptions of the theoretical formula were met, we also calculated the variance of population size for the summer-autumn season, using a jackknife estimator (Miller 1974; Burnham et al. 1980). Pseudovalues of the area-wide population were generated by sequentially deleting pairs of surveys from the database. All sources of variance were considered in estimation of total variance:  $\hat{f}(0)$ , mean group size, and spatial variability of sightings. Because of the small number of perpendicular sighting distances for winter-spring season (31), we were unable to obtain a stable value of  $\hat{f}(0)$ , thus precluding the estimation of jackknife variance of that season.

Distribution maps were prepared using Surface Display Library software (Dynamic Graphics, Inc., Berkeley, CA). Contour lines, generated by linear interpolation between density values assigned to grid-cell centerpoints, were smoothed using a cubic spline function.

## RESULTS

Two distinct seasonal distributions were found for common dolphins in the Southern California Bight (SCB). In winter and spring months (January through June), common dolphin sightings were almost completely confined to the eastern part of the SCB (Fig. 4). Within the area occupied, three cells in the southernmost rank and one shore-bounded cell north of San Diego showed significantly higher density than the overall seasonal mean ( $P > 0.95$  in all cases). In summer and autumn months (July through December), common dolphin sightings were widespread from Rodriguez Seamount and the Patton Escarpment in the west to the mainland shore in the east (Fig. 5). Cell density estimates in this season were relatively homogeneous throughout the area. Only a single cell in the San Diego Basin could be shown to be significantly higher than the seasonal mean at the  $P > 0.95$  level. Nevertheless, we believe that the clustering of moderately high-density cells east of Santa Catalina and San

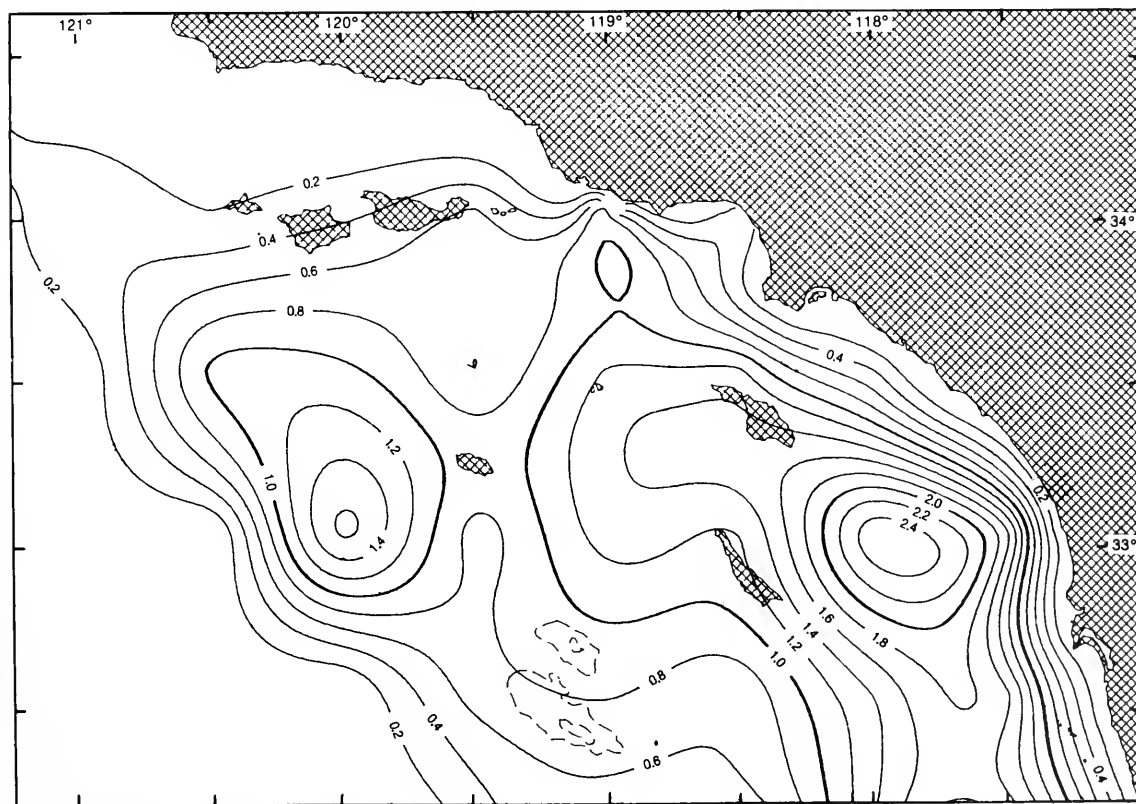

FIGURE 5.—Common dolphin distribution in the Southern California Bight, summer and fall, 1975-78. Density contours show animals/km<sup>2</sup>.

Clemente Islands and west of San Nicolas Island represents a real distributional pattern.

Cell-density estimates and 95% confidence limits are provided in Tables 1 and 2. Confidence limits were calculated considering only sampling error due to number of groups sighted (Equations (3) and (4)) and not uncertainty in  $\hat{f}(0)$  or mean group size. Sampling error associated with the number of groups sighted was the dominant source of variation in cell-by-cell estimates of density, typically exceeding variance of the  $\hat{f}(0)$  term by three times and variance associated with mean group size by five times. It should be remembered that the density estimates are mean values computed from pooled data collected over a several month period in 3 successive years.

From these density estimates, we computed

seasonal mean population size estimates. By calculating population size as the sum of the numbers in each 30' x 30' cell, we estimate a winter-spring population of 15,448 animals. This figure is a mean population occurring in the months of January through June and includes months of higher and lower numbers. Using Equation (5), we calculate a theoretical winter-spring population size of 18,933 animals. This second estimate for the SCB, based on pooled data, may be high because survey effort was 6.7% greater in the higher density parts of the study area in winter and spring. Based on Equation (6), the coefficient of variation of the winter-spring population was 36%. The coefficients of variation for number of groups,  $\hat{f}(0)$ , and mean group size were 16%, 8%, and 31%, respectively. The relatively large variability in mean group size was due to a

TABLE 1.—Relative abundance of common dolphins in the winter and spring. Mean density (animals/km<sup>2</sup>) is provided for each 30' x 30' cell; latitude and longitude indicate center point of cell. Upper and lower values are 95% confidence limits derived from the spatial variability of sightings along aerial transect lines.

	121°00'	120°30'	120°00'	119°30'	119°00'	118°30'	118°00'	117°30'
34°30'	7.41	1.71	1.33	2.42				
	0.00	0.00	0.00	0.00				
	0.00	0.00	0.00	0.00				
34°00'	3.42	1.05	0.81	0.62	0.86	1.28		
	0.00	0.00	0.00	0.00	0.00	0.00		
	0.00	0.00	0.00	0.00	0.00	0.00		
33°30'		5.32	1.19	0.90	1.05	0.48	1.09	1.81
		0.00	0.00	0.00	0.19	0.10	0.43	0.00
		0.00	0.00	0.00	0.05	0.00	0.19	0.00
33°00'			4.89	1.71	0.76	1.14	1.38	2.00
			0.00	0.48	0.00	0.33	0.48	0.95
			0.00	0.14	0.00	0.10	0.19	0.48
32°30'				1.24	0.71	1.95	2.57	2.80
				0.00	0.00	0.76	1.09	1.38
				0.00	0.00	0.33	0.48	0.67

TABLE 2.—Relative abundance of common dolphins in the summer and fall. Mean density (animals/km<sup>2</sup>) is provided for each 30' x 30' cell; latitude and longitude indicate the center point of cell. Upper and lower values are 95% confidence limits derived from the spatial variability of sightings along aerial transect lines.

	121°00'	120°30'	120°00'	119°30'	119°00'	118°30'	118°00'	117°30'
34°30'	3.53	1.45	1.32	3.12				
	0.00	0.00	0.00	0.05				
	0.00	0.00	0.00	0.14				
34°00'	1.80	1.04	1.25	1.52	2.15	2.08		
	0.35	0.21	0.35	0.62	0.83	0.35		
	0.07	0.07	0.07	0.28	0.35	0.07		
33°30'		5.82	2.70	1.73	2.70	2.15	1.25	2.56
		1.04	1.04	0.62	1.25	1.25	1.42	0.48
		0.28	0.42	0.21	0.55	0.76	0.14	0.14
33°00'			4.92	2.29	2.91	2.56	4.09	2.98
			1.66	0.76	1.32	1.25	2.56	1.66
			0.62	0.28	0.62	0.62	1.59	0.90
32°30'				2.49	2.08	1.94	3.39	3.12
				0.69	0.83	0.69	1.45	1.66
				0.21	0.35	0.21	0.62	0.90

single sighting of 2,450 animals; we choose not to treat this observation as an outlier because the occasional occurrence of very large groups is typical of this species.

For the summer-autumn season of greatest abundance, the stock size estimate based on summing individual cell populations and the estimate derived from Equation (5) were 57,270 and 46,675, respectively. The theoretical estimate based on pooled data may be low because survey effort was 7.8% greater in the lower density parts of the study area in the summer-autumn season (i.e., the offshore waters in the west). The coefficient of variation computed from the theoretical variance formula (Equation (6)) was 17%. Coefficients of variation for number of groups,  $\hat{f}(0)$ , and mean group size were 9%, 8%, and 11%, respectively. The jackknife estimator gave a higher coefficient of variation for population size of 27%. Components of this estimate for number of groups,  $\hat{f}(0)$ , and mean group size were 15%, 18%, and 14%, respectively. Differences between the two types of estimators may be due, in part, to the inherently conservative nature of the jackknife (Efron 1982), but probably result primarily from within-survey correlation of variables. In addition, the jackknife estimate of  $\hat{f}(0)$  relied on a smaller subset of sighting distances measured only during summer-autumn surveys ( $n = 81$ ).

## DISCUSSION

Even in an area as heavily utilized as the Southern California Bight, sightings of common dolphin schools are not common events. For this reason it was necessary to pool aerial survey data collected over several months in each of three years to describe their distribution in statistical terms. The two seasonal views of common dolphin distribution in the SCB are shown for contrast in Figures 4 and 5. It is apparent that the population makes seasonally greater use of the SCB in summer and autumn months. The months of greatest numbers, based on sightings per km of trackline, were September through November. During these months, the population far exceeds the mean value of 57,000 and probably approaches 100,000 animals.

A potential source of bias in our mean population size estimates was the differential sightability of groups of various sizes. The detection function for common dolphin sightings declined sharply beyond about 1,650 ft (500 m), suggesting that mostly large or conspicuous groups were seen at relatively great distances. The Fourier estimator is robust to variation in sighting efficiency (Burnham et al. 1980). For

comparison, the  $\hat{f}(0)$  term of 2.29 for common dolphins was quite close to the  $\hat{f}(0)$  estimate of 2.16 more recently obtained for 136 sightings of Pacific white-sided dolphin schools on aerial surveys offshore of central and northern California (Dohl et al. 1983). However, variable sighting effectiveness may also bias the estimation of mean group size. Holt and Powers (1982) found that smaller groups of dolphins were more likely to be missed on aerial surveys than larger groups, resulting in a 25% overestimation of mean group size. For our data on common dolphins, we did not find a significant difference in mean group size between sightings within the first 1,650 ft and beyond due to high variability in sightings size ( $213 \pm 46$  SE,  $n = 65$ , compared with  $308 \pm 49$  SE,  $n = 50$ ;  $F_{1,113} = 1.94$ ,  $P = 0.18$ ). Nevertheless, our calculations show that stratification of mean group size by distance from the trackline (<1,650 ft and >1,650 ft) would result in an 18% decrease in mean density values.

The distribution shown for summer and autumn can be viewed as a composite of monthly distributions. Common dolphin distribution expands from the southeast into the central and western parts of the SCB in late spring and early summer and recedes toward the east and south in late autumn and early winter. Common dolphin movement into and out of the SCB appears to be temperature related. As sea surface temperatures (SST) rise in late spring-early summer, animals begin to be sighted more often along the Coronado Escarpment. Peak numbers of common dolphins were found in open water regions of the SCB 3-5 wk after intrusion of the warmer waters. During cool-water months, when SSTs down to 10.0°C were recorded and the SCB-wide mean was 14.6°C, no animals were observed in waters cooler than 14.0°C.

Distributional patterns of the common dolphin within the SCB may be changing. Hui (1979) analyzed data collected on Naval Ocean Systems Center (NOSC) surveys from 1968 through 1976 and showed no common dolphin sightings north of Point Vicente (lat. 33°45'N) or west of approximately San Nicolas Island. Our surveys in summer and autumn months found 29.9% of all sightings and 30.8% of all animals occurred in the northern and western portion of the SCB—an area largely unsampled by the NOSC surveys. Hui's results agreed with those of Evan's (1975), who found only a small fraction of the total sightings recorded on aerial and shipboard surveys to occur in this northern and western portion of the SCB; however, aerial sampling effort in Evan's earlier study also favored the inshore and southern portions of the SCB.

Based upon the distribution of sightings on our bimonthly aerial surveys, movement of common dolphins into the SCB appeared to follow the network of escarpments and seamounts noted by Evans (1971). The major corridor was along the Coronado Escarpment to Thirty-Mile Bank, up to the Catalina Escarpment, around both sides of Santa Catalina Island, along the western margins of the San Pedro and Santa Monica basins to Santa Cruz and Santa Rosa Islands (Fig. 1). The population front then advanced westward along the southern margin of these islands until reaching the Santa Rosa-Cortés Ridge where it shifted south, spreading out along the western slope of this prominent underwater feature. Some elements of this influx stopped and along the way, increasing summer-autumn populations significantly in the San Pedro Channel, Gulf of Santa Catalina, and, to a lesser extent, in near-shore waters from Dana Point to La Jolla. A secondary pathway was from Forty-Mile Bank in the south, up the San Clemente Escarpment west of San Clemente Island to reach the Santa Rosa-Cortés Ridge area.

During periods of peak occupancy common dolphin sightings west of long.  $119^{\circ}\text{W}$  were distributed along the western slope of the Santa Rosa-Cortés Ridge centered at lat.  $33^{\circ}00'\text{N}$ , long.  $120^{\circ}00'\text{W}$ . As waters cooled, the distributional center shifted eastward to locate over the eastern slope of the Santa Rosa-Cortés Ridge at  $33^{\circ}00'\text{N}$ ,  $119^{\circ}20'\text{W}$ , while a smaller element moved northwesterly to a new location around  $33^{\circ}30'\text{N}$ ,  $120^{\circ}30'\text{W}$ . With continued cooling of the western waters, the majority of the animals along the eastern edge of the Ridge appeared to move southeasterly to merge with existent populations south and east of San Clemente Island. The remaining small number of animals wintering-over moved westward, centering near  $33^{\circ}00'\text{N}$ ,  $119^{\circ}30'\text{W}$ , south of San Nicolas Island.

The destination of common dolphins that moved northwesterly from the summering grounds over the western edge of the Santa Rosa-Cortés Ridge is unknown. However, several pieces of incomplete evidence lead us to believe that they are part of a "pelagic" population that returns in late autumn or early winter to offshore waters over the Rodriguez Seamount or Patton Escarpment. During several midsummer ship surveys and three aerial surveys of offshore waters over the Patton Escarpment and San Juan Seamount, we recorded sightings of large schools of robust-bodied, brilliantly marked, "pelagic" common dolphins. On two occasions, our crew on the catch boat head-netted, brought on

board, photographed, measured, tagged, freeze-branded, and released, examples of these "pelagic" animals from within schools containing predominantly the paler, smaller, nearshore variety of *Delphinus*. Ships' logs indicate that the presence of these "pelagic" animals increased with distance from shore, and percentages as high as 50% were found in mixed schools of common dolphins at the western boundary of catch trips, usually south of lat.  $33^{\circ}45'\text{N}$  and west of long.  $120^{\circ}00'\text{W}$ . West of the Patton Escarpment, mixed schools were not noted, and the few schools encountered contained only "pelagic" animals (Dohl unpubl. data).

In summary, this study establishes an extended distributional range of the common dolphin within the SCB, identifies areas of significantly greater seasonal use, and provides seasonal mean population estimates. Our results confirm the findings of earlier studies that common dolphins move into the SCB following major features of underwater topography in response to increasing seasonal water temperatures. Observations on surveys also seem to indicate that most of the population moves through the SCB in a generalized counterclockwise direction, and that the western summer-autumn population is augmented by an influx of "pelagic" animals from far offshore.

## ACKNOWLEDGMENTS

The original data for this paper were collected under contract to the University of California, Santa Cruz, from the Minerals Management Service (formerly a part of Bureau of Land Management), U.S. Department of the Interior.

The analysis of these data and the development of the distributional model described here were supported by Woodward-Clyde Consultants (WCC), Walnut Creek, CA, by a contract from the Minerals Management Service, Department of the Interior.

We are grateful to the many individuals involved in the collection of these data: J. D. Bryant, R. C. Guess, J. D. Hall, L. J. Hobbs, M. W. Honig, K. S. Norris, and P. N. Sund. We also thank T. P. Winfield and R. K. Christiansen at WCC for technical assistance, and particularly K. P. Burnham, T. D. Smith, and R. S. Holt for valuable assistance and comments on the manuscript.

## LITERATURE CITED

- BURNHAM, K. P., D. R. ANDERSON, AND J. L. LAAKE.  
1980. Estimation of density from line transect sampling of biological populations. *J. Wildl. Manage. Monogr.*

- 72, 202 p.
- CHERNOFF, H., AND L. E. MOSES.  
1959. Elementary decision theory. John Wiley and Sons, Inc., New York, NY.
- CLOPPER, C., AND E. S. PEARSON.  
1934. The use of confidence or fiducial limits illustrated in the case of the binomial. *Biometrika* 26:404-413.
- CRAIN, B. R., K. P. BURNHAM, D. R. ANDERSON, AND J. L. LAAKE.  
1978. A Fourier-series estimator of population density for line transect sampling. Utah State Univ. Press, Logan, 25 p.
- DOHL, T. P., K. S. NORRIS, R. C. GUESS, J. D. BRYANT, AND M. W. HONIG.  
1980. Cetacea of the Southern California Bight. Part II of summary of marine mammal and seabird surveys of the Southern California Bight Area, 1975-1978. Final Report to the Bureau of Land Management, 414 p. [Available at U.S. Dep. Commer., Natl. Tech. Inf. Serv., Springfield, VA as NTIS Rep. #PB81248189.]
- DOHL, T. P., R. C. GUESS, M. L. DUMAN, AND R. C. HELM.  
1983. Cetaceans of central and northern California, 1980-1983: Status, abundance, and distribution. Final report to the Minerals Management Service, Contract #14-12-0001-29090, 284 p.
- EFRON, B.  
1982. The jackknife, the bootstrap, and other resampling plans. The Society for Industrial and Applied Mathematics, Philadelphia, PA.
- EVANS, W. E.  
1971. Orientation behavior of delphinids: radio-telemetric studies. *Ann. New York Acad. Sci.* 188:142-160.  
1975. Distribution, differentiation of populations, and other aspects of the natural history of *Delphinus delphis Linnaeus* in the northeastern Pacific. Ph.D. Thesis, Univ. California, Los Angeles, 164 p.
- HOLT, R. S., AND J. E. POWERS.  
1982. Abundance estimation of dolphin stocks involved in the eastern tropical Pacific yellowfin tuna fishery determined from aerial and ship surveys to 1979. U.S. Dep. Commer., NOAA Tech. Memo. NMFS-SWFC-23, 95 p.
- HUI, C. A.  
1979. Undersea topography and distribution of dolphins of the genus *Delphinus* in the Southern California Bight. *J. Mammal.* 60:521-527.
- LAAKE, J. L., K. P. BURNHAM, AND D. R. ANDERSON.  
1979. User's manual for program TRANSECT. Utah State Univ. Press, Logan, 26 p.
- LEATHERWOOD, S., A. E. BOWLES, AND R. R. REEVES.  
1983. Endangered whales of the eastern Bering Sea and Shelikof Strait, Alaska: Results of aerial surveys, April 1982 through April 1983, with notes on other marine mammals seen. Final report to NOAA/OCSEAP, Juneau, AK.
- LEATHERWOOD, S., I. T. SHOW, JR., R. R. REEVES, AND M. B. WRIGHT.  
1982. Proposed modification of transect models to estimate population size from aircraft with obstructed downward visibility. *Int. Whaling Comm.* 32:577-580.
- MILLER, R. G.  
1974. The jackknife—a review. *Biometrika* 61:1-15.
- NORRIS, K. S., AND J. H. PRESCOTT.  
1961. Observations on Pacific cetaceans of California and Mexican waters. *Univ. Calif. Publ. Zool.* 63:291-402.
- SMITH, T. D.  
1981. Line-transect techniques for estimating density of porpoise schools. *J. Wildl. Manage.* 45:650-657.
- SOKAL, R. R., AND F. J. ROHLF.  
1969. *Biometry*. W. H. Freeman and Co., San Franc., 776 p.





# CETACEAN HIGH-USE HABITATS OF THE NORTHEAST UNITED STATES CONTINENTAL SHELF<sup>1</sup>

ROBERT D. KENNEY AND HOWARD E. WINN<sup>2</sup>

## ABSTRACT

Results of the Cetacean and Turtle Assessment Program previously demonstrated at a qualitative level that specific areas of the continental shelf waters off the northeastern U.S. coast consistently showed high-density utilization by several cetacean species. We have quantified, on a multispecies basis and with adjustment for level of survey effort, the intensity of habitat use by whales and dolphins, and defined areas of especially high-intensity utilization. The results demonstrate that the area off the northeast United States, which is used most intensively as cetacean habitat, is the western margin of the Gulf of Maine, from the Great South Channel to Stellwagen Bank and Jeffreys Ledge. Secondary high-use areas include the continental shelf edge and the region around the eastern end of Georges Bank. High-use areas for piscivorous cetaceans are concentrated mainly in the western Gulf of Maine and secondarily at mid-shelf east of the Chesapeake region, for planktivores in the western Gulf of Maine and the southwestern and eastern portions of Georges Bank, and for teuthivores along the edge of the shelf. In general, habitat use by cetaceans is highest in spring and summer, and lowest in fall and winter.

From October 1978 through January 1982, the Cetacean and Turtle Assessment Program (CETAP) at the University of Rhode Island conducted surveys of the waters of the U.S. continental shelf from Cape Hatteras, NC, to the northern Gulf of Maine. The purpose of these surveys was to provide data on the distribution and abundance of whales, dolphins, and sea turtles inhabiting the northeast shelf for input to decision-making relative to offshore oil and gas resource development. Twenty-six species of cetaceans were observed during the study, and their distributions have been described in some detail (CETAP 1982). Each species exhibited a distinctive pattern of distribution in space and time, inhabiting some small portion(s) of the study area at higher relative densities.

When comparing distributions of individual species, there appear to be specific geographic areas which consistently contained higher abundances of several cetacean species. This phenomenon had been noted during the CETAP study (CETAP 1982), but had not been analyzed quantitatively. An individual species approach to the analysis of such multispecies phenomena has certain limitations. One cannot simply combine the sighting distributions of several species; the different cetacean species vary widely

in size and may have quite different ecological requirements. An additional complication in a study of habitat use, based on sighting data, is introduced by the uneven allocation of sighting effort. One cannot be certain whether a lack of sightings is due to absence of whales or absence of observers, or, conversely, whether a concentration of sightings represents a real concentration of whales or simply a concentration of effort. Thus it is difficult to simply or directly combine single-species sighting distributions in any sort of multispecies habitat use analysis. In this paper, we have attempted to synthesize, from the CETAP individual species sighting data, a measure of the intensity of habitat use by the total cetacean fauna in the study area which accounts for both interspecific differences and differences in allocation of effort. These results then serve to delineate those specific habitat areas which are used at particularly high levels by whales and dolphins off the northeastern United States.

An underlying assumption in this paper is that a habitat which is occupied by whales or dolphins is necessarily utilized by them. Previous results from CETAP data have shown that the distribution of sightings of a particular species where definite feeding behavior was observed tended to closely mirror the overall sighting distribution for that species. Only feeding activity at or very near the surface can be seen by observers on ships or airplanes, but much feeding behavior likely occurs below the surface. For some species, observations of surface feeding are very rare. In addition, cetaceans are large mammals

<sup>1</sup>This report has been reviewed by the Minerals Management Service and approved for publication. Approval does not signify that the contents necessarily reflect the views and policies of the Service, nor does mention of trade names or commercial products constitute endorsement or recommendation for use.

<sup>2</sup>Graduate School of Oceanography, University of Rhode Island, Narragansett, RI 02882-1197.

with high metabolic rates and accordingly high feeding rates. They are estimated to consume prey equivalent to 1.5-4% of their body weight daily (Sergeant 1969; Lockyer 1981), with some estimates for smaller species as much as 10% of body weight per day (e.g., Smith and Gaskin 1974). The CETAP study concluded that cetaceans "would be expected to feed virtually every day while in the study area" and that "each species of cetacean was likely feeding, either at the surface or below, in any area in which it was seen regularly" (CETAP 1982, p. 417). For the purposes of the current study, we have also followed this reasoning and assumed that a habitat which is being occupied by one or more cetacean species is therefore being utilized by those species as a feeding area.

## METHODS

The CETAP study area was defined as the waters of the U.S. continental shelf north of Cape Hatteras, from the shoreline to 5 nmi (9.3 km) seaward of the 1,000 fathom (1,829 m) isobath. Surveys were conducted from October 1978 through January 1982. Data collected from two types of surveys have been used in this analysis:

1) *Dedicated aerial surveys*: Random transect aerial surveys were conducted in defined blocks within the study area, including both regular surveys throughout the year and special surveys targeted at endangered species, particularly right whales. The primary objective of these surveys was to estimate the absolute abundance, e.g., the total number of individuals in the population, of each species in the study area, using line transect census methods (Burnham et al. 1980; Scott and Gilbert 1982). This methodology requires consistent use of rigorously standardized sampling, e.g., use of the same platform, even allocation of sampling across the different blocks, and random selection of transects within a block.

The two aircraft used for these surveys were a Beechcraft<sup>3</sup> AT-11 and a Cessna 337-G Skymaster, both twin-engine planes. The AT-11 crew consisted of a pilot, a navigator, and four observers; two observers at a time were stationed in a clear acrylic observation bubble in the nose of the plane. The Skymaster carried a pilot, a navigator, and two observers, who sat in the rear seats and watched out the side windows. All surveys were conducted at an

altitude of 750 ft (229 m) and a groundspeed of 120 kn (222 km/h).

For any particular survey, a series of parallel track lines was flown. For the regular surveys, the lines sampled were randomly chosen from a pool of lines running northwest-southeast (roughly perpendicular to the bathymetry) and spaced at 2 nmi intervals throughout the block to be sampled. For the endangered species surveys, the lines were systematically spaced at a predetermined interval, with the first line placed at a randomly determined distance from the edge of the block.

2) *Platforms of opportunity (POP) surveys*: Trained observers were placed aboard various ships and aircraft operating within the study area in order to collect distributional data to supplement the dedicated surveys. The platforms most often used included Coast Guard cutters, U.S. and foreign oceanographic and fisheries research vessels, and Coast Guard fisheries patrol and thermography aircraft. The track of the ship or aircraft was wholly determined by its primary mission. These data could not be used in abundance estimation because effort was not allocated randomly or evenly, and the platforms used were not exactly comparable.

Observers on both types of surveys recorded a variety of information. The data collected included date, time, latitude and longitude, platform heading, beginning and end of periods when the observer(s) were actively on watch, and environmental information (air temperature, water temperature, depth, weather, visibility, sea state, wind direction, and cloud cover). The data were recorded at each sighting, as well as at periodic intervals (typically 5 min for aerial and 30 min for shipboard surveys) during all on-watch periods. This allowed for subsequent reconstruction of flight-cruise tracks. Additional data recorded at sightings included species, reliability of identification, number of animals, distance from the platform, animal heading, and behaviors.

The data were transcribed from the field forms to coding forms, keypunched, and input to a computer data base. A number of quality control steps were included in the process, and all discovered errors were corrected. In addition to the two types of survey data described above, historical sighting data collected prior to CETAP and opportunistic sighting data provided by fisherman, mariners, whale-watchers, fish-spotters, pilots, etc. are included in the CETAP data. None of these data have associated track-line information, and are therefore not included in this paper. After completion of the CETAP

<sup>3</sup>Reference to trade names does not imply endorsement by the National Marine Fisheries Service, NOAA.

study, the entire data base was archived on magnetic tape at the University of Rhode Island Academic Computer Center. The data base is very large, comprising nearly 70,000 entries and 112 variables; it includes almost 25,000 sightings of cetaceans, sea turtles, or other large marine animals (e.g., sharks, ocean sunfish, swordfish, rays, etc.).

For this paper, the study area was partitioned into blocks measuring 10 minutes of latitude by 10 minutes of longitude. The area of the blocks ranges from about 243 km<sup>2</sup> at the northern extreme of the study area to about 281 km<sup>2</sup> at the southern end, due to the curvature of the earth's surface and resulting convergence of the meridians toward the north pole. The data were further grouped by calendar seasons across all the years of sampling. All dedicated aerial and POP data which met defined criteria were included in the analysis. These criteria included observer(s) formally on watch, clear visibility of at least 2 miles, and sea states of Beaufort 3 or lower. Although the dedicated aerial and POP data were not directly compatible for the purpose of absolute abundance estimation, we are justified in combining them for this analysis. An examination of sighting effort in the 1979 CETAP data (Hain et al. 1981) demonstrated a significant correlation between numbers of sightings and length of line surveyed for both aerial and POP surveys. Re-analysis of these same data shows that the average number of sightings per mile of track line surveyed was somewhat higher for the POP surveys, but that the difference is not statistically significant at the 5% level (paired Student's *t*-test). Since we are in effect using the number of sightings per unit length of track line as a measure of relative abundance in this analysis, the two data types can be combined.

To remove any bias due to uneven allocation of sighting effort among the blocks, the effort was first quantified. A computer program was developed which calculated the length of track line surveyed each season within each of the 10-minute blocks, including only line segments surveyed within the criteria defined above. Each line surveyed is recorded in the data base as a sequence of latitude-longitude positions. For any pair of successive positions, the length of track line between the points (*D*, in km) can be calculated by:

$$D = 111.12 \arccos [\sin (X_1) \sin (X_2) + \cos (X_1) \cos (X_2) \cos (Y_2 - Y_1)],$$

where  $X_1$  and  $X_2$  are the latitudes of the two positions, and  $Y_1$  and  $Y_2$  are the corresponding longitudes. This calculates great circle distance. Flight

or cruise tracks would actually be rhumb lines rather than great circles, but the algorithm required to calculate rhumb line distance is much more complex. Furthermore, for two points around 10 km apart, typical of track line segments in the data, great circle and rhumb line distance differ by <1 m, an error of <0.01%.

For a pair of points within a single 10-minute block, the length of the intervening line segment is simply assigned to that block. The difficulty arises for successive points located in separate blocks. It is then necessary to find the point(s) of intersection where the track line crosses any block boundary(ies). The bulk of the computer program is concerned with this procedure. For a pair of points in separate blocks, the equation describing the great circle through the points is defined. The point where that line crosses a boundary is then determined by inserting the latitude or longitude value defining the boundary into the great circle equation, and then solving for the other coordinate. The line segment which originally spanned two or more blocks is thereby partitioned into smaller segments, each wholly contained in a single block, whose lengths are then calculated as above. The final step in the procedure is to sum the lengths of all the line segments within the block, which represents the amount of sighting effort expended in the block.

All cetacean sightings made during track segments meeting the defined criteria were also extracted from the data base. These data were summarized to produce, for each species, the total number of individual animals sighted in each block and season. (This is not to say that this number represents all different individuals. An individual may be sighted repeatedly by different surveys, but this is taken into account by the correction for effort.) In order to combine different species, the number of animals of a particular species was multiplied by the species' estimated average body weight to calculate biomass sighted per block and season. The biomass data for each species were then partitioned into three feeding classes—piscivorous, teuthivorous, and planktivorous—based upon the estimated percentages of each species' diet composed of fish, squid, and zooplankton, respectively. In an earlier analysis of prey consumption by cetaceans in the CETAP study area, Scott et al.<sup>4</sup> classified each species into a single category based on its principal prey type;

<sup>4</sup>Scott, G. P., R. D. Kenney, T. J. Thompson, and H. E. Winn. 1983. Functional roles and ecological impacts of the cetacean community in the waters of the northeastern U.S. continental shelf. Paper presented at 1983 annual meeting, International Council for the Exploration of the Sea, ICES C.M. 1983/N:12.

however, we felt that using the estimated proportion of the diet comprised of the different prey types was a more realistic representation of what was actually occurring in the ecosystem. The body weight and prey preference estimates were taken from Kenney et al. (1985), who had based their estimates on an extensive literature review. For three species not included in that reference—beluga, false killer whale, and rough-toothed dolphin—body weight and prey preference estimates were based on Watson (1981) and Nishiwaki (1972). For the categories of sightings which were not completely identified, the body weight and prey percentages were calculated as averages for all species included in the category and weighted by the number of sightings of each. (It might be argued that the unidentified categories should be excluded totally and that their inclusion introduces too much uncertainty. However, we felt that excluding them would eliminate many potentially valuable observations and that including them would provide a closer measure of habitat use. Some of the categories can be narrowed to only a couple of species, and the number of sightings overall is a valid basis for estimating the probability of an unidentified sighting being a particular species.)

The biomass data were then summed for all species in each block and season, as well as for the piscivorous, teuthivorous, and planktivorous subsets. Values for endangered species biomass were also calculated by summing the data for right, humpback, blue, fin, sei, and sperm whales, as well as for the estimated proportion of the unidentified categories made up of these species. The biomass data for each block and season were then divided by the corresponding effort data, resulting in values of biomass per unit effort (BPUE) in units of kilograms of cetacean sighted per kilometer of track line surveyed (kg/km). The final data set therefore had, for each block, BPUE values for all cetaceans, for endangered species only, and for the piscivorous, teuthivorous, and planktivorous components of the cetacean fauna for each season and for the entire year.

The simplest technique for looking at the pattern of high-intensity habitat use by cetaceans is to plot the blocks with the highest values of BPUE. Obviously, the blocks with the highest BPUE values within any of the individual data sets are those with the highest intensity of habitat use. The question becomes one of defining the cutoff point in each distribution for selecting the highest values. The frequency distributions of each of the BPUE data sets were examined for any patterns which might be useful as an objective criterion to define a lower

bound for the high-use blocks (e.g., bimodal distributions, or 2 standard deviations above the mean of a normal distribution). Log-survivorship plots (plotting BPUE vs. log of the number of blocks with higher BPUE values; see Fagen and Young 1978) were also tried to look for changes in slope which could serve as a means of numerically defining this boundary. When these techniques failed to select any specific value for the cutoff point, we opted to use simple percentile rankings to classify the blocks for plotting the results.

The final step in the analysis was to develop an index which would serve to define those areas which are most important as cetacean habitat. By "important" we include both the level of habitat use and the management priority of the individual species. Habitat requirements for an individual probably depend heavily upon prey type, so each of the data sets for the three feeding classes were included in this process. Since management objectives concentrate on the endangered species, the endangered species data sets were also included. Since the endangered species data are also part of the feeding type data, the former are in effect being included twice. This gives the endangered species extra weight in the index, in accord with both their endangered status and management focus. For each seasonal set of BPUE data for the endangered species and the three feeding classes, blocks were assigned points as follows: 5 if the BPUE was greater than the 99th percentile value for that data set, 3 if it was between the 95th and 99th percentiles, 1 if between the 90th and 95th percentiles, and 0 otherwise. The value of the index for a block is then the sum of these point values for all data sets. Since there were four seasons and four BPUE variables used, the maximum possible value for the index in any block would be 80 ( $4 \times 4 \times 5$ ). For lack of a more concise term, we shall refer to this as Habitat Use Index, although it does have the additional dimension of focus on endangered species. Since this index is based on only the top 10% of each of the 16 individual data sets, it provides a simple way to point out those blocks which repeatedly stand out as high-use habitat in more than one season and/or for more than one prey type.

## RESULTS

During the CETAP study, observers on dedicated aerial or POP surveys operating within the defined survey criteria made 5,304 sightings of 26 different species of whales and dolphins. These include sighting of individuals in three genera—*Globicephala*, *Mesoplodon*, and *Kogia*—which could only be iden-

tified in the field to genus. In addition, there were 2,039 sightings of 30 more or less unidentified categories of cetaceans, bringing the grand total to 7,343 sightings. Table 1 lists all the observed cetacean species and unidentified categories, with numbers of sightings of each. It also shows, for each species, the values used in this analysis for estimated

average body weight and percentage of diet comprised of the three major prey types.

Overall, 1,476 10-minute blocks were sampled by CETAP dedicated and POP surveys, with a total of over 373,000 km of track line surveyed within acceptable criteria. Somewhat fewer blocks were sampled during any one season. Sighting effort was most in-

TABLE 1.—List of cetacean species and unidentified categories sighted by CETAP dedicated aerial and POP surveys on the northeast U.S. shelf, showing number of sightings, estimated body weight, and estimated percentage of the diet comprised of fish, squid, and zooplankton. Endangered species are identified by \*.

Species or category	No. of sightings	Body weight (kg)	Percent of diet			Species or category	No. of sightings	Body weight (kg)	Percent of diet		
			Fish	Squid	Zoo-plankton				Fish	Squid	Zoo-plankton
Right whale, <i>Balaena glacialis</i> *	173	40,000	0	0	100	Spinner dolphin, <i>S. longirostris</i>	3	50	20	80	0
Humpback whale, <i>Megaptera novaeangliae</i> *	409	25,000	95	0	5	Harbor porpoise, <i>Phocoena phocoena</i>	584	45	95	5	0
Sperm whale, <i>Physeter catodon</i> *	258	20,000	20	80	0	Unidentified (unid.) whale	263	25,000	71	12	17
Blue whale, <i>Balaenoptera musculus</i> *	2	70,000	0	0	100	Unid. large whale, not <i>B. glacialis</i>	139	27,900	70	11	19
Fin whale, <i>B. physalus</i> *	946	30,000	90	0	10	Unid. large whale, not <i>P. catodon</i>	2	26,700	77	12	11
Sei whale, <i>B. borealis</i> *	62	13,000	0	0	100	Unid. rorqual, not <i>P. catodon</i>	5	29,200	78	0	22
Minke whale, <i>B. acutorostrata</i>	215	4,500	95	0	5	Unid. rorqual, not <i>B. acutorostrata</i>	30	24,800	88	0	12
Beaked whale, <i>Mesoplodon</i> sp.	11	1,200	0	100	0	Unid. rorqual, not <i>M. novaeangliae</i>	62	27,900	87	0	13
Goosebeaked whale, <i>Ziphius cavirostris</i>	4	1,900	0	100	0	<i>P. catodon</i> or <i>M. novaeangliae</i>	6	24,800	86	0	14
Northern bottlenose whale, <i>Hyperoodon ampullatus</i>	4	4,700	5	95	0	<i>P. catodon</i> , <i>M. novaeangliae</i> , or <i>B. glacialis</i>	2	23,100	66	31	3
Beluga whale, <i>Delphinapterus leucas</i>	1	420	100	0	0	<i>B. musculus</i> , <i>physalus</i> , or <i>borealis</i>	6	26,600	52	25	23
Pygmy/dwarf sperm whale, <i>Kogia</i> sp.	1	300	0	100	0	Unid. medium whale	127	29,000	84	0	16
Pilot whale, <i>Globicephala</i> sp.	537	850	0	100	0	Unid. beaked whale	68	4,080	81	15	4
Killer whale, <i>Orcinus orca</i>	4	3,000	90	10	0	Unid. beaked whale or <i>P. catodon</i>	19	2,090	1	99	0
False killer whale, <i>Pseudorca crassidens</i>	1	500	50	50	0	<i>Mesoplodon</i> sp. or <i>Z. cavirostris</i>	2	17,600	18	72	0
Pygmy killer whale, <i>Feresa attenuata</i>	1	150	100	0	0	Unid. blackfish	2	1,390	0	100	0
Gray grampus, <i>Grampus griseus</i>	421	340	0	100	0	Unid. large blackfish	4	863	1	99	0
Bottlenose dolphin, <i>Tursiops truncatus</i>	828	150	100	0	0	<i>Globicephala</i> sp. or <i>P. crassidens</i>	1	864	1	99	0
White-beaked dolphin <i>Lagenorhynchus albirostris</i>	10	150	50	50	0	Unid. dolphin	6	849	0	100	0
Atlantic white-sided dolphin, <i>L. acutus</i>	374	120	90	10	0	Unid. dolphin, not <i>G. griseus</i>	785	133	74	26	0
Rough-toothed dolphin, <i>Steno bredanensis</i>	1	100	50	50	0	Unid. beaked dolphin	120	117	85	15	0
Saddleback dolphin, <i>Delphinus delphis</i>	340	65	85	15	0	Unid. dolphin, not <i>G. griseus</i>	161	96.7	90	10	0
Striped dolphin, <i>Stenella coeruleoalba</i>	63	55	40	60	0	Unid. long-beaked dolphin	11	112	84	16	0
Spotted dolphin, <i>S. attenuata</i> or <i>plagiodon</i>	51	50	20	80	0	<i>Lagenorhynchus</i> sp. <i>Lagenorhynchus</i> sp. or <i>T. truncatus</i>	10	121	89	11	0
						<i>L. acutus</i> or <i>D. delphis</i>	2	141	96	4	0
						<i>Stenella</i> sp.	23	93.8	88	12	0
						<i>Stenella</i> sp., not <i>S. longirostris</i>	86	52.7	31	69	0
						<i>Stenella</i> sp. or <i>T. truncatus</i>	64	52.8	31	69	0
						<i>S. coeruleoalba</i> or <i>T. truncatus</i>	8	126	83	17	0
						<i>S. attenuata/plagiodon</i> or <i>T. truncatus</i>	1	136	91	9	0
						<i>Stenella</i> sp. or <i>D. delphis</i>	3	138	90	10	0
							21	59.6	61	39	0

tense during spring, followed in descending order by summer, fall, and winter. Table 2 summarizes the sighting effort by season and for the entire year.

The BPUE data are summarized in Table 3. The distributions of BPUE values for all categories and seasons were very similar. Each distribution was highly skewed toward lower values. This can be seen from the table; mean values ranged between 33 and 423 kg/km, but maximum values were as high as 33,747 kg/km. In 20 of the 25 cases, the median value was 0, and in 9 of these the 75th percentile value was also 0, indicating that no cetaceans of that particular category were seen in one-half or three-quarters, respectively, of the blocks surveyed. In fact, in two cases (endangered species and planktivores sighted in winter) even the 90th percentile value was

0; no endangered or plankton-feeding cetaceans were observed in 9 out of 10 blocks surveyed in the winter.

The overall pattern of high habitat use by cetaceans is depicted in Figure 1, which shows those 10-minute blocks with the top 10% of the whole-year BPUE values (all species combined). The figure also identifies locations to be used for geographic reference. Three principle high-use areas can be delineated: 1) the western margin of the Gulf of Maine, from the Great South Channel northward to Jeffreys Ledge, 2) the eastern portions of Georges Bank, along with the Northeast Channel and relatively deep basin north of the bank, and 3) the continental shelf edge. There are also scattered high-use blocks in other areas.

TABLE 2.—Summary of sighting effort in 10-minute blocks, expressed as kilometers of track line surveyed within acceptable criteria, for CETAP dedicated and POP surveys.

	Season				Total
	Winter	Spring	Summer	Fall	
Blocks sampled	1,179	1,344	1,395	1,169	1,476
Mean effort per block	40.3	108.0	80.7	58.2	252.9
Standard deviation	32.9	104.9	56.1	47.6	207.9
Maximum effort per block	372	1,137	596	546	2,389
Total effort	47,506	145,204	112,576	67,994	373,280

TABLE 3.—Mean, median, and maximum values of biomass sighted per unit of sighting effort, by season and for the entire year, for all cetacean species combined, endangered species only, and fish-, squid-, and plankton-feeding cetaceans.

Cetacean category	Season	Biomass per unit effort (kg/km)		
		Mean	Median	Maximum
All cetaceans	All	368	67	15,170
All cetaceans	Winter	234	0	23,049
All cetaceans	Spring	423	2	20,928
All cetaceans	Summer	386	0	28,447
All cetaceans	Fall	270	0	33,747
Endangered species	All	296	0	15,170
Endangered species	Winter	198	1 <sup>20</sup>	22,048
Endangered species	Spring	350	0	20,268
Endangered species	Summer	323	0	27,478
Endangered species	Fall	190	0	33,072
Piscivores	All	205	21	6,920
Piscivores	Winter	139	0	16,266
Piscivores	Spring	256	1	15,446
Piscivores	Summer	235	0	22,483
Piscivores	Fall	158	0	23,995
Teuthivores	All	83	1	4,249
Teuthivores	Winter	62	0	11,879
Teuthivores	Spring	80	0	3,582
Teuthivores	Summer	83	0	5,380
Teuthivores	Fall	79	0	5,625
Planktivores	All	80	0	12,323
Planktivores	Winter	33	1 <sup>20</sup>	8,190
Planktivores	Spring	87	0	5,874
Planktivores	Summer	68	0	12,910
Planktivores	Fall	33	0	5,805

<sup>1</sup>75th percentile value was also 0.

<sup>2</sup>90th percentile value was also 0.

Figure 2 shows the patterns of high habitat use, again as the upper 10% of BPUE values, for the entire cetacean community in each of the four seasons. The seasonal patterns do not show any major differences; however, a slight north-south shift in the pattern is evident. The number of high-use blocks is higher in the northern portion of the area and lower in the southern portion during spring and summer than during fall and winter. It should be emphasized that the plots in Figure 2 do not indicate differences in magnitude of utilization intensity between seasons, but only pattern differences. Since the blocks which are plotted are the upper 10% of the BPUE values for each seasonal distribution, the numbers of blocks plotted for each season are fairly equivalent. For example, it appears from the plots that the shelf edge may be more intensely used in the winter than during the other seasons, but actually the reverse is true. It is simply that the blocks with highest winter utilization tend to be on the shelf edge, but the intensity of use in these blocks is still lower. Seasonal differences in intensity of habitat use can be seen by referring back to Table 3. The intensity of habitat use is highest in the spring and second highest in the summer for all categories except the teuthivores, where the summer utilization is most intense and spring and fall very close behind. There

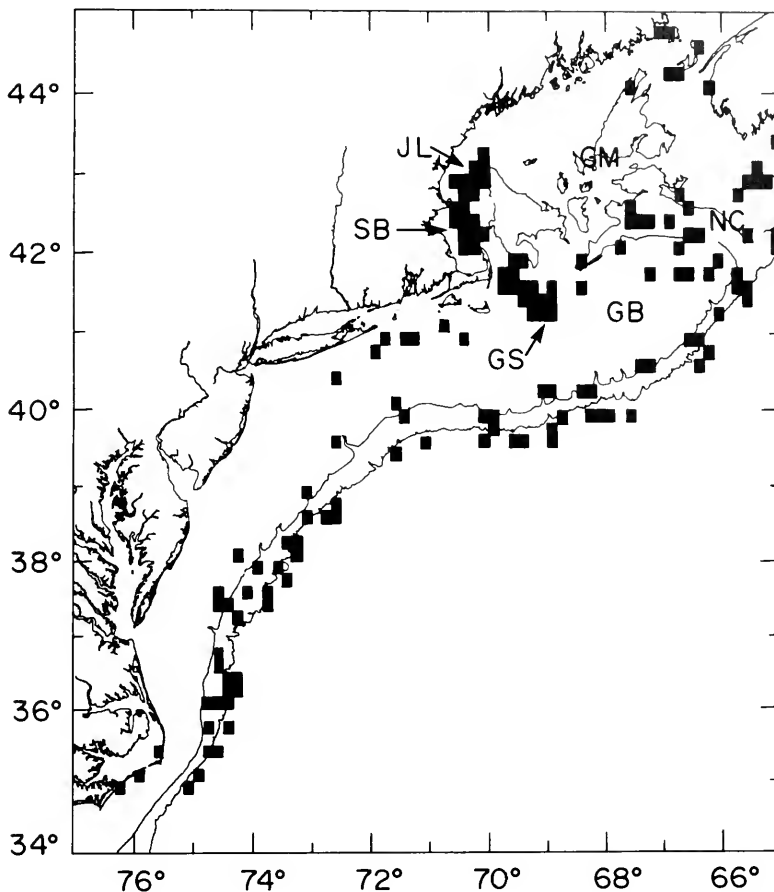

FIGURE 1.—Plot of 10-minute blocks with total cetacean biomass per unit effort values in the top 10% of all blocks. GM = Gulf of Maine; GB = Georges Bank; NC = Northeast Channel; JL = Jeffreys Ledge; SB = Stellwagen Bank; GS = Great South Channel.

is a general pattern of reduced utilization during the fall and winter.

Figure 3 shows the whole-year patterns of high habitat usage for the four subsets of the total cetacean community. The pattern for endangered species shows only slight differences from the total community pattern seen in Figure 1. Differences from the total community pattern become somewhat greater in the piscivorous component. The intensity of utilization along the shelf edge is less, but there appears an area or areas of high use at midshelf east of the Chesapeake Bay region. The planktivorous component shows a distinctive pattern. There are only scattered high-use blocks in the southern half of the area. In the northern half of the area, the pattern is similar to those for the entire community, endangered species, or piscivores, except that there are more high-use blocks in the central portion of the Gulf of Maine and on the southern part of Georges

Bank. The teuthivorous component shows the most distinct pattern, with a dense concentration of high-use blocks along the shelf edge in the southern half of the area and a less dense concentration along the more northern shelf edge and in the vicinity of the Northeast Channel.

Finally, Figure 4 presents the overall composite pattern of high-use areas, plotting those 10-minute blocks with Habitat Use Index values in the upper 5%, 10%, and 20% of all blocks sampled. Of the total of 1,476 blocks surveyed, 889 had index values of 0 and 587 were 1 or greater. The maximum index value was 49 for a block located at the northern end of Stellwagen Bank. Table 4 lists the blocks in the upper 1% of the distribution, showing their locations. Of those 16 blocks, 13 are in the western Gulf of Maine between the Great South Channel and Jeffreys Ledge. This area shows the densest concentration of high-use blocks in Figure 4. The secondary

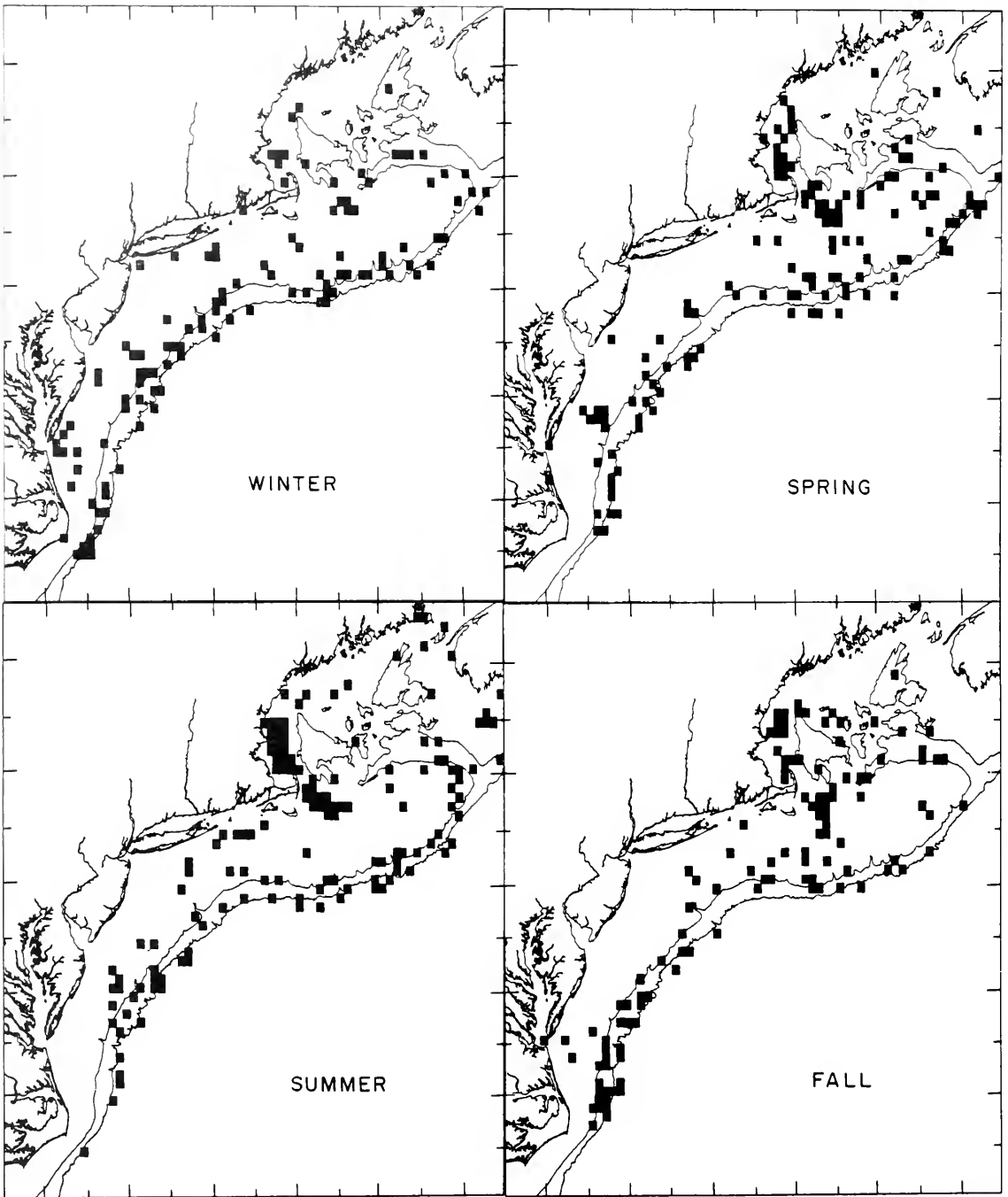

FIGURE 2.—Seasonal patterns of the top 10% of total cetacean biomass per unit effort values.



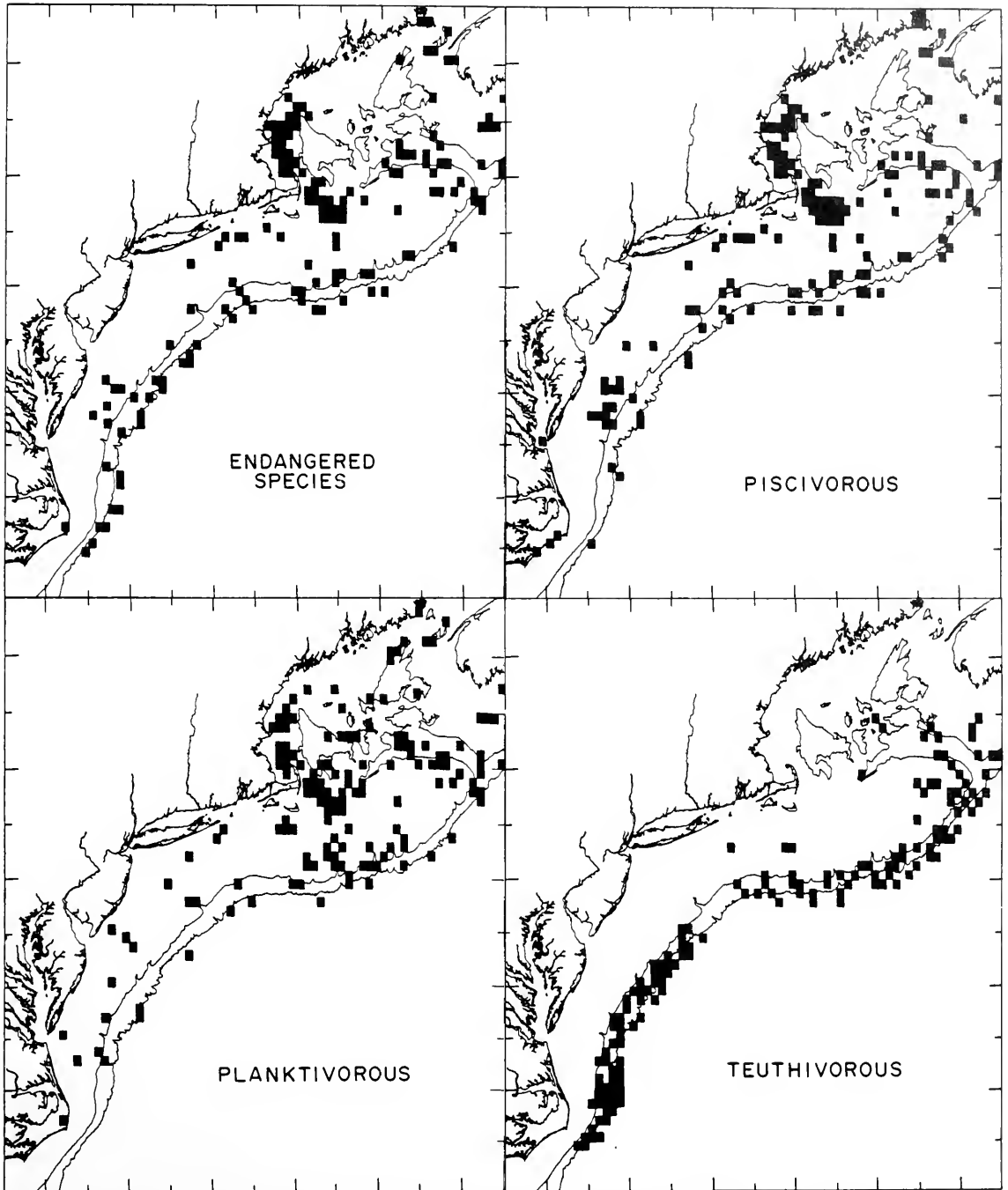

FIGURE 3.—Blocks with top 10% of cetacean biomass per unit effort values for four subsets of the total cetaceans: endangered species (right, humpback, sperm, blue, fin, and sei whales), fish-eating component, plankton-eating component, and squid-eating component.

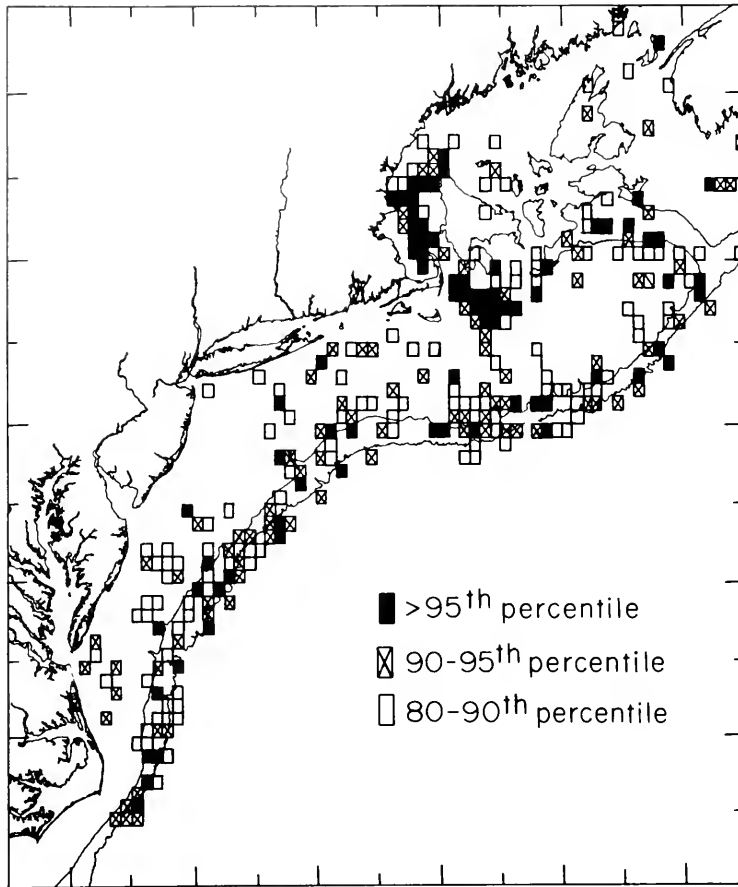

FIGURE 4.—Plot of Habitat Use Index in 10-minute blocks, showing blocks with values in the upper 5%, 10%, and 20% of the distribution.

TABLE 4.—List of the 10-minute blocks with Habitat Use Index values in the upper 1% of all blocks sampled, in descending order, with the latitude and longitude of the block center and the location of the block.

Utilization index	Central point of block	General location
49	42°25' 70°25'	Northern end—Stellwagen Bank
41	41°25' 69°15'	Great South Channel
36	41°25' 69°25'	Great South Channel
34	42°15' 66°25'	Northeast Channel
33	41°35' 69°25'	Great South Channel
32	42°15' 70°25'	Stellwagen Bank
32	42°15' 70°05'	Stellwagen Bank
32	40°35' 67°25'	Georges Banks—Powell Canyon head
29	42°15' 70°15'	Stellwagen Bank
29	42°05' 70°15'	Stellwagen Bank
28	41°25' 69°05'	Great South Channel
27	41°45' 69°45'	Great South Channel
27	41°25' 68°55'	Great South Channel
26	43°15' 69°55'	Northern end—Jeffreys Ledge
26	42°55' 65°35'	Off Browns Bank
26	41°15' 69°15'	Great South Channel

concentrations of high-use blocks tend to be around the perimeter of Georges Bank and along the continental shelf edge.

## DISCUSSION

The CETAP sighting data for some individual species showed a concentration of sightings along the western margin of the Gulf of Maine. This analysis has demonstrated quantitatively that this area is the most intensely used cetacean habitat on the northeast U.S. continental shelf. It comprises a major feeding ground for fin whales, humpback whales, right whales, minke whales, and white-sided dolphins. Humpbacks and fin whales are known to feed heavily upon the American sand lance, *Ammodytes americanus*, a small schooling fish (CETAP 1982; Hain et al. 1982; Mayo 1982; Mitchell 1973, 1975c; Overholtz and Nicolas 1979), and the minke whales

and white-sided dolphins likely do so as well (CETAP 1982; Mayo 1982; Mitchell 1975b). The sand lance populations of the western North Atlantic have increased dramatically since the mid-1970's (Sherman et al. 1981). Meyer et al. (1979) described the western Gulf of Maine, especially Stellwagen Bank and east of Cape Cod, as an area of extremely dense sand lance populations. Data from the National Marine Fisheries Service 1979-1981 groundfish surveys (T. R. Azarovitz<sup>5</sup>) also shows peak *Ammodytes* abundance in the Stellwagen Bank-Jeffreys Ledge area. A second area of high sand lance abundance shown by these data corresponds to the midshelf east of the Chesapeake, which was identified above as a region of high use by piscivorous cetaceans. It is likely that sand lance distributions are a primary controlling factor in the pattern of high-intensity habitat use shown here for the western Gulf of Maine.

*Ammodytes* is not the only cetacean prey species which can be shown to have a strong effect on patterns of cetacean habitat use within the western Gulf of Maine, although it is the major one. The right whale feeds primarily upon copepods (Nemoto 1970; Watkins and Schevill 1976). Right whales are a major component of the cetaceans in the southeasternmost portion of the high-use area in the western Gulf of Maine, in the vicinity of the Great South Channel, where they congregate in response to extremely dense spring concentrations of *Calanus finmarchicus* (CETAP 1982).

The other high-use cetacean habitat we have identified is the edge of the continental shelf. The cetacean assemblage of this region has been analyzed in detail by Hain et al. (1985). The primary species of the shelf edge are sperm whales, pilot whales, gray grampus, saddleback dolphins, bottlenose dolphins, and striped dolphins. Less common species include the various beaked whales and other dolphin species. This assemblage does not specialize on one or two prey species as we have suggested for the Gulf of Maine, but is highly diverse in prey taken, although individual species may exhibit quite narrow dietary specializations. Food items include a wide variety of squids and fishes (Kenney et al. 1985). Furthermore, the shelf edge assemblage on Georges Bank includes sei whales, which feed primarily on copepods and secondarily on euphausiids (Jonsgard and Darling 1977; Mitchell 1975a, 1975b; Nemoto 1970). Sei whales occur primarily on the southwest and eastern

portions of Georges Bank. The CETAP data also show sightings of other baleen whales—primarily fin whales, but also minke, humpback, and right whales—near the southern edge of Georges Bank during some times of the year. The shelf edge, although used less intensely than the western Gulf of Maine, supports a cetacean fauna which is much more diverse in terms of both cetacean species and variety of prey taken.

We have interpreted our results in this study as indicating control of cetacean distributions by the distributions of the most important prey species. This is almost certain to be the case on a microscale level, but may or may not be true at the general level. It is unknown how migratory cetaceans orient or navigate to their feeding grounds, but it may be that physical cues from the environment are used in this process, in effect determining or influencing the general pattern of distribution. Another alternative could be that there is a significant traditional or historical component of the return to the same general vicinity each year, with microscale distributions within that region directly related to prey density. In each of these cases the ultimate controlling factor is food, but the proximate factors are something different.

We have limited our discussion of individual species mostly to the descriptive level. One factor, however, should be noted. Because we are dealing with biomass of cetaceans, these patterns are dominated by the large whales for the most part. Because fin whales are easily the most common whale in the region, they are the dominant factor in patterns of cetacean biomass distribution (Kenney et al. 1985; Scott et al. fn. 4). The most common species numerically were white-sided and saddleback dolphins, with estimated populations of each exceeding 30,000 individuals (CETAP 1982), but their contributions to the patterns shown here are smaller because of their relatively smaller sizes. One must refer to the distribution plots in the 1982 CETAP report for the details of individual species distribution patterns.

We have purposely avoided the use of the term "critical habitat" in this analysis. Besides the legal aspects of the term under the Endangered Species Act and Marine Mammal Protection Act, Ray and Miller<sup>6</sup> have pointed out that there are many dimensions to the concept of critical habitat. These include the biological vulnerability of a species, the ecological processes which support the species, and the poten-

<sup>5</sup>T. R. Azarovitz, Northeast Fisheries Center Woods Hole Laboratory, National Marine Fisheries Service, NOAA, Woods Hole, MA 02543, pers. commun. December 1982.

<sup>6</sup>Ray, G. C., and R. V. Miller. 1982. Critical habitats of marine mammals. Paper presented at 1982 annual meeting, International Council for the Exploration of the Seas, ICES C.M. 1982/N:7.

tial impacts of human activities. We have for the most part addressed only the patterns of habitat use, which contribute to the first two dimensions listed above. By giving extra weight to the endangered species in the Habitat Use Index, however, we have also further addressed the dimensions of biological vulnerability and potential impacts. On the other hand, the concept of critical habitat as strictly defined should be limited to single species. We have approached the problem from the viewpoint of the entire cetacean fauna of the region. Our analysis has defined those localities which appear to be important cetacean habitats based on the intensity of utilization with a special emphasis on the endangered species. These results now can and should be used as additional input for resource management and decision-making purposes.

### ACKNOWLEDGMENTS

The preparation of this paper was made possible by funding from the Minerals Management Service, U.S. Department of the Interior, contract number 14-12-0001-30090. The CETAP study, which was the source of the data utilized, was funded by the Bureau of Land Management, contract number AA551-CT8-48. We would like to collectively acknowledge the many individuals who contributed to CETAP's success. G. B. Epstein developed the computer algorithm to measure track line surveyed per block, R. J. Medved provided statistical advice, and M. Nigrelli typed the manuscript. We are also grateful to K. Sherman, S. B. Saila, P. V. August, M. P. Sissenwine, G. T. Waring, and several reviewers at Minerals Management Service who provided helpful criticisms of early drafts of the paper. The work reported herein was part of a dissertation submitted by R. D. Kenney to the Graduate School of Oceanography, University of Rhode Island, in partial fulfillment of the requirements for the degree of Ph.D.

### LITERATURE CITED

- BURNHAM, K. P., D. R. ANDERSON, AND J. L. LAAKE.  
1980. Estimation of density from line transect sampling of biological populations. *Wildl. Monogr.* 72:1-202.
- CETACEAN AND TURTLE ASSESSMENT PROGRAM.  
1982. A characterization of marine mammals and turtles in the Mid- and North-Atlantic areas of the U.S. outer continental shelf. Final report, contract AA551-CT8-48. Bureau of Land Management, Washington, DC.
- FAGEN, R. M., AND D. Y. YOUNG.  
1978. Temporal patterns of behavior: Durations, intervals, latencies, and sequences. In P. W. Colgan (editor), *Quantitative ethology*, p. 79-114. John Wiley & Sons, N.Y.
- HAIN, J. H. W., G. R. CARTER, S. D. KRAUS, C. A. MAYO, AND H. E. WINN.  
1982. Feeding behavior of the humpback whale, *Megaptera novaenglia*, in the western North Atlantic. *Fish. Bull., U.S.* 80:259-268.
- HAIN, J. H. W., R. K. EDEL, H. E. HAYS, S. K. KATONA, AND J. D. ROANOWICZ.  
1981. General distribution of cetaceans in the continental shelf waters of the northeastern United States. In CETAP, A characterization of marine mammals and turtles in the Mid- and North-Atlantic areas of the U.S. outer continental shelf, p. II.1-II.345. Annual report for 1979, contract AA551-CT8-48. Bureau of Land Management, Washington, DC, (Tables II-1, II-2, II-3.)
- HAIN, J. H. W., M. A. M. HYMAN, R. D. KENNEY, AND H. E. WINN.  
1985. The role of cetaceans in the shelf-edge region of the northeastern United States. *Mar. Fish. Rev.* 47(1):13-17.
- JONSGARD, A., AND K. DARLING.  
1977. On the biology of the eastern North Atlantic sei whale, *Balaenoptera borealis* Lesson. *Rep. Int. Whaling Comm., Spec Issue* 1:124-129.
- KENNEY, R. D., M. A. M. HYMAN, AND H. E. WINN.  
1985. Calculation of standing stocks and energetic requirements of cetaceans of the northeast United States outer continental shelf. U.S. Dep. Commer., NOAA Tech. Memo. NMFS F/NEC-41, 99 p. Northeast Fish. Cent. Woods Hole Lab., Natl. Mar. Fish. Serv., NOAA, Woods Hole, MA.
- LOCKYER, C.  
1981. Growth and energy budgets of large baleen whales from the Southern Hemisphere. In FAO Advisory Committee on Marine Resource Research, Mammals in the Sea, Vol. III, General papers and large cetaceans, p. 379-487. Food and Agriculture Organization of the United Nations, Rome.
- MAYO, C. A.  
1982. Observations of cetaceans: Cape Cod Bay and southern Stellwagen Bank, Massachusetts, 1975-1979. U.S. Mar. Mammal Comm., Rep. MMC-80/07, 75 p. [Available at National Technical Information Service, 5285 Port Royal Road, Springfield, VA 22151, as PB82-186263.]
- MEYER, T. L., R. A. COOPER, AND R. W. LANGTON.  
1979. Relative abundance, behavior, and food habits of the American sand lance, *Ammodytes americanus*, from the Gulf of Maine. *Fish. Bull., U.S.* 77:243-253.
- MITCHELL, E.  
1973. Draft report on humpback whales taken under special scientific permit by eastern Canadian land stations, 1969-71. *Rep. Int. Whaling Comm.* 23:138-154.
- 1975a. Preliminary report on Nova Scotia fishery for sei whales (*Balaenoptera borealis*). *Rep. Int. Whaling Comm.* 25:218-225.
- 1975b. Report of the meeting on smaller cetaceans, Montreal, April 1-11, 1974. *J. Fish. Res. Board Can.* 32:889-983.
- 1975c. Trophic relationships and competition for food in northwest Atlantic whales. *Proc. Can. Soc. Zool. Ann. Meet.* 1974, p. 123-133.
- NEMOTO, T.  
1970. Feeding pattern of baleen whales in the ocean. In J. H. Steele (editor), *Marine food chains*, p. 241-252. Oliver and Boyd, Edinb.
- NISHIWAKI, M.  
1972. General biology. In S. H. Ridgway (editor), *Mammals of the sea, biology and medicine*, p. 3-214. C. H. Thomas, Springfield, IL.
- OVERHOLTZ, W. J., AND J. R. NICOLAS.  
1979. Apparent feeding by the fin whale, *Balaenoptera*

- physalus*, and humpback whale, *Megaptera novaeangliae*, on the American sand lance, *Ammodytes americanus*, in the northwest Atlantic. Fish. Bull., U.S. 77:285-287.
- SCOTT, G. P., AND J. R. GILBERT.  
1982. Problems and progress in the U.S. BLM-sponsored CETAP surveys. Rep. Int. Whaling Comm. 32:587-600.
- SERGEANT, D. E.  
1969. Feeding rates of Cetacea. Fiskeridir. Skr. Ser. Havunders. 15:246-258.
- SHERMAN, K., C. JONES, L. SULLIVAN, W. SMITH, P. BERRIEN, AND L. EJSYMONT.  
1981. Congruent shifts in sand eel abundance in western and eastern North Atlantic ecosystems. Nature 291:486-489.
- SMITH, G. J. D., AND D. E. GASKIN.  
1974. The diet of harbor porpoises (*Phocoena phocoena* (L.)) in coastal waters of eastern Canada, with special reference to the Bay of Fundy. Can. J. Zool. 52:777-782.
- WATKINS, W. A., AND W. E. SCHEVILL.  
1976. Right whale feeding and baleen rattle. J. Mammal. 57: 58-66.
- WATSON, L.  
1981. Sea guide to whales of the world. E. P. Dutton, N.Y., 302 p.



# SOUNDS FROM BRYDE, *BALAENOPTERA EDENI*, AND FINBACK, *B. PHYSALUS*, WHALES IN THE GULF OF CALIFORNIA

WILLIAM C. CUMMINGS,<sup>1</sup> PAUL O. THOMPSON,<sup>2</sup> AND  
SAMUEL J. HA<sup>3</sup>

## ABSTRACT

Low-frequency moaning sounds were recorded from Bryde whales, *Balaenoptera edeni*, off Loreto, Mexico, in the Gulf of California. These utterances averaged 0.4 s in duration with most of the sound energy at about 124 Hz. Elsewhere in the Gulf, we recorded about 1,300 low-frequency moans from at least 35 feeding finback whales, *B. physalus*. The finbacks' most outstanding sound was a long moan with a 1.9-s component at 68 Hz and a 1.6-s component at 34 Hz. Overall sound source levels in the effective bandwidths ranged between 152 and 174 dB re 1  $\mu$ Pa (1 m) for Bryde whales, and 159 to 183 dB for finback whales. Short "20-Hz signals" that are typically associated with finback whales were not present in these recordings, apparently because of seasonal or behavioral differences.

The main objective of this study was to describe underwater sounds from two species of mysticete whales—the Bryde whale, *Balaenoptera edeni*, and the finback whale, *B. physalus*. We also wanted to compare the presently described finback sounds with those recorded elsewhere.

Contrasted with the typical whistles, squeals, and clicks of odontocetes, we continue to find that mysticetes utter mostly low-frequency sounds. However, exceptional and rare sounds of higher frequency have been reported (Cummings and Thompson 1971; Beamish and Mitchell 1971, 1973; Beamish 1978). The combination of low frequencies (Hz), long wavelengths, and high source levels of mysticete whale sounds enables their detection at distances up to 100 km or more, even with standard signal processing.

Low-frequency sounds (40-75 Hz, 1-s long, and others) have been recorded from finbacks in the North Atlantic (Schevill and Watkins 1962; Edds 1981). Short, powerful "20-Hz signals" have also been recorded from this species (Schevill et al. 1964). Watkins (1981) categorized underwater finback sounds as 20-Hz pulses, ragged broadband low-frequency pulses, low-frequency rumbles, higher frequency sounds, and broadband impulses.

We have long been interested in "20-Hz signals", having worked with many categories from widespread areas of the world (Cummings and Thompson 1966<sup>4</sup>; Northrop et al. 1968, 1971), and the prospects of recording them from the more accessible

finbacks in the Gulf of California also was an important objective.

We are unaware of any other descriptions (except for 20-Hz pulses) of sounds from Pacific finbacks. Underwater sounds from the Bryde whale were unknown, this being the original description except for a brief abstract of the present work in 1969 (Thompson and Cummings).

## MATERIAL AND METHODS

An expedition took place in June 1969, aboard the 27 m yawl, *Saluda*. The ship left La Paz (southeast Baja peninsula, Mexico) sailed northward to Mulegé, across the Gulf of California to Guaymas on the Mexican mainland, northward past Isla San Esteban, around Isla Angel de la Guarda, and southward to Santa Rosalia—a distance of about 1,500 km (Fig. 1). Except for Contact 3, all of the sounds recorded in the presence of unidentified large whales were generally the same as those that we determined to be from finbacks. However, we were not always certain which balaenopterid was being recorded, especially at long distances. Consequently, if an identification of a balaenopterid whale was questionable, the "contact" was noted simply as "*Balaenoptera* sp".

The water's surface varied from Sea State 0 to 2, and currents usually were minimal. The ship's operating equipment was shut down during all recordings. The instrumentation included a hydrophone-

<sup>1</sup>Oceanographic Consultants, 5948 Eton Court, San Diego, CA 92122.

<sup>2</sup>4256 Sierra Vista, San Diego, CA 92103.

<sup>3</sup>Millersville University, Millersville, PA 17551.

<sup>4</sup>Cummings, W. C., and P. O. Thompson. 1966. 20-Hz signals in the northeast Pacific. Unpubl. Rep., 17 p. Navy Electronics Laboratory, San Diego, 92152.

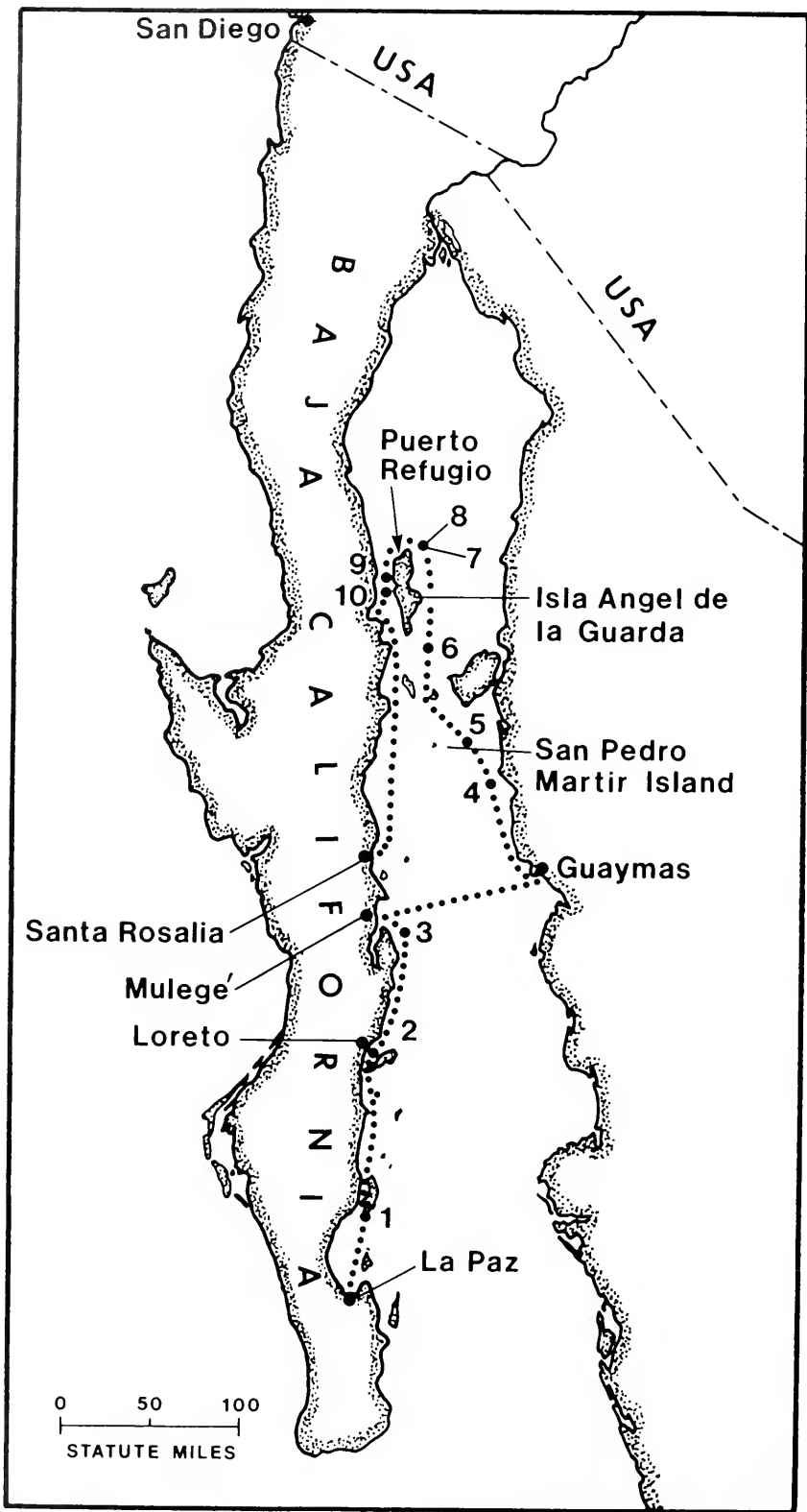

FIGURE 1.—Track of *Saluda* in the Gulf of California (June 1969) with numbered cetacean contacts.



preamplifier (Wilcoxon,<sup>5</sup> Type M-H90-A) suspended at depths of 6 to 53 m below the surface. Up to 800 m of floating cable carried the signals to the ship, allowing the hydrophone to be stationary until the ship drifted out to this distance. The hydrophone was suspended from an inflatable 8 m spar buoy which provided effective acoustic isolation from low-frequency acceleration caused by surface waves. The hydrophone's response was attenuated at low frequencies (beginning with 3 dB down at 12 Hz) to further reduce low-frequency noise and to prevent most of the preamplifier blockage from any drag motion that remained. Without these or similar measures, we have found that hydrophone and sea noise below 100 Hz, even in relatively smooth seas, usually prevents satisfactory recordings of low-frequency mysticete sounds with suspended systems.

One track of a magnetic tape recorder (Magnecord 1020), powered by a DC-AC converter, carried a running commentary and airborne whale sounds from a radio microphone (Vega Telemike). The other track recorded signals from the hydrophone. Continuous visible records were made on station with a level recorder (Brüel & Kjaer, Type 2301), also powered by the converter which was acoustically isolated. A sound analyzer (General Radio, Type 1558) was used to monitor incoming signals and their absolute levels and to provide power to the hydrophone-preamplifier. Calibration was by means of a 1,000-Hz tone and pink or white noise which were inserted through the system and recorded at frequent intervals. Overall response of the recording system was  $\pm 5$  dB from 25 Hz to 18 kHz.

Without a hydrophone array we could not precisely localize sound sources. However, correlations between whale movements and changes in received sound level provided evidence that those sounds came from the whales observed.

At sea we find it difficult to distinguish the Bryde

whale from other balaenopterids, especially the sei whale, *B. borealis*. An exception was the circumstance noted here, involving long contacts and good visibility above and below water, so that identifying features of behavior and form were revealed. Most useful of these field characteristics were 1) the presence of ridges on top of the head of Bryde whales, 2) the asymmetrical coloration of finbacks, usually a yellowish white on the lower right jaw and baleen that is contrasted with the darker appearance of the left area, and 3) the peculiar surfacing of sei whales whereby head and fin appear nearly simultaneously, without arching.

Received overall sound levels are reported in dB re 1  $\mu$ Pa, and source levels are referenced to 1 m. Analysis was accomplished using graphic level recorders, oscilloscopes, a sound spectrographic recorder, and a RTA (real time analyzer).

## RESULTS

### Sightings and Recordings

The locations of whale sightings associated with recordings of whale sounds are listed (Table 1). Unidentified balaenopterid whales were sighted off La Paz, where two low-level whale sounds were recorded during Contact 1.

We spotted two Bryde whales, about 11 m long, southeast of Loreto (Contact 2). The sea was calm and the surface water temperature was 24°C. The two animals separated as the ship approached. One swam away and remained mostly out of sight. The other began passing back and forth under the ship's keel. It dove about 10 m and surfaced every 1 to 6 min. W. C. Cummings dove on the whale and photographed it underwater for identification.

We recorded 288 low-frequency moans in 50 min from the Bryde whales during Contact 2. Some of these sounds were of very low signal-noise ratio (down into the ambient level of the sea noise) and presumably originated from the more distant of the

<sup>5</sup>Reference to trade names does not imply endorsement by the National Marine Fisheries Service, NOAA.

TABLE 1.—Contacts with sound producing whales in the Gulf of California.

Contact	Date	Time	Location	Subjects (No.)
1	6-11	1000	24°43.5'N, 110°36'W, 2 km S of Isla San Francisco	<i>Balaenoptera</i> sp. (1)
2	6-13	0700	25°57.5'N, 110°19'W, 8 km SSE of Loreto	<i>B. edeni</i> (2)
3		1930	26°50'N, 111°42'W, 14.8 km SE of Pta. Concepción	<i>B. edeni</i> (1)
4	6-17	1815	28°18'N, 111°46'W, midway, Guaymas to Isla San Esteban	Large whale (1)
5	6-18	0530	28°25'N, 112°9.5'W, 18.5 km ENE of San Pedro Martir Island	<i>Balaenoptera</i> sp. (1)
6		1330	28°58'N, 112°53.5'W, 24.1 km ESE of Isla Angel de la Guarda	<i>B. physalus</i> (3)
7	6-19	0900	29°35'N, 113°31'W, 3.7 km ENE of Puerto Refugio	<i>B. physalus</i> (about 35)
8		1430	29°41.5'N, 113°27'W, 17.6 km NE of Puerto Refugio	<i>B. physalus</i> (2)
9	6-20	1430	29°14'N, 113°33'W, N. end of Ballenas Channel	<i>Balaenoptera</i> sp. (1)
10		1530	29°15.5'N, 113°30'W, N. end of Ballenas Channel	<i>Balaenoptera</i> sp. (1)

two whales. Coincidentally, we were recording low-level, high-pitched whistles and squeals from a distant group of saddleback porpoises, *Delphinus delphis*. It was obvious that changes in the loudness of other low-frequency signals, as aurally monitored, and in the level on the graphic recorder were correlated with the nearby Bryde whale's proximity to the ship.

Later the same day, another whale was sighted off Pta. Concepción in the Mulegé area and tentatively identified as either a sei or Bryde whale of about 12 m (Contact 3). We recorded 407 sounds from this whale. The sounds were essentially the same as those recorded earlier from the Bryde whales of Contact 2. After analyzing the sounds, Contact 3 was identified as a Bryde whale. Sounds of these characteristics were not encountered again during the cruise, nor were any other Bryde whales seen.

About 100 km northwest of Guaymas, a large whale was sighted at a range of about 450 m (Contact 4). A brisk wind and choppy seas prevented iden-

tification, but one distinctly whalelike moaning sound appeared in the accompanying noisy recording.

East of San Pedro Martir Island, we recorded 42 sounds from another whale (Contact 5) identified as a finback, about 15 m in length. Three large finback whales were sighted off the southern tip of Isla Angel de la Guarda (Contact 6). All of the 376 moans recorded from these whales occurred when the animals were below the surface.

On 19 June, we sighted about 35 finback whales outside the entrance of Puerto Refugio (Contacts 7, 8). They surfaced in series of 2 to 7 times, usually in pairs or in trios. Their blows were accompanied by smooth resonant sounds similar to that expected from air rushing through a confined space. Climaxing the final appearance in a series of surfacings, the whales strongly arched their backs and appeared to dive at a steep angle. Some of the finbacks' dorsal fins were distorted. Large concentrations of whales, porpoises, and sea lions occurred over an area of at least 6 km around the ship where they

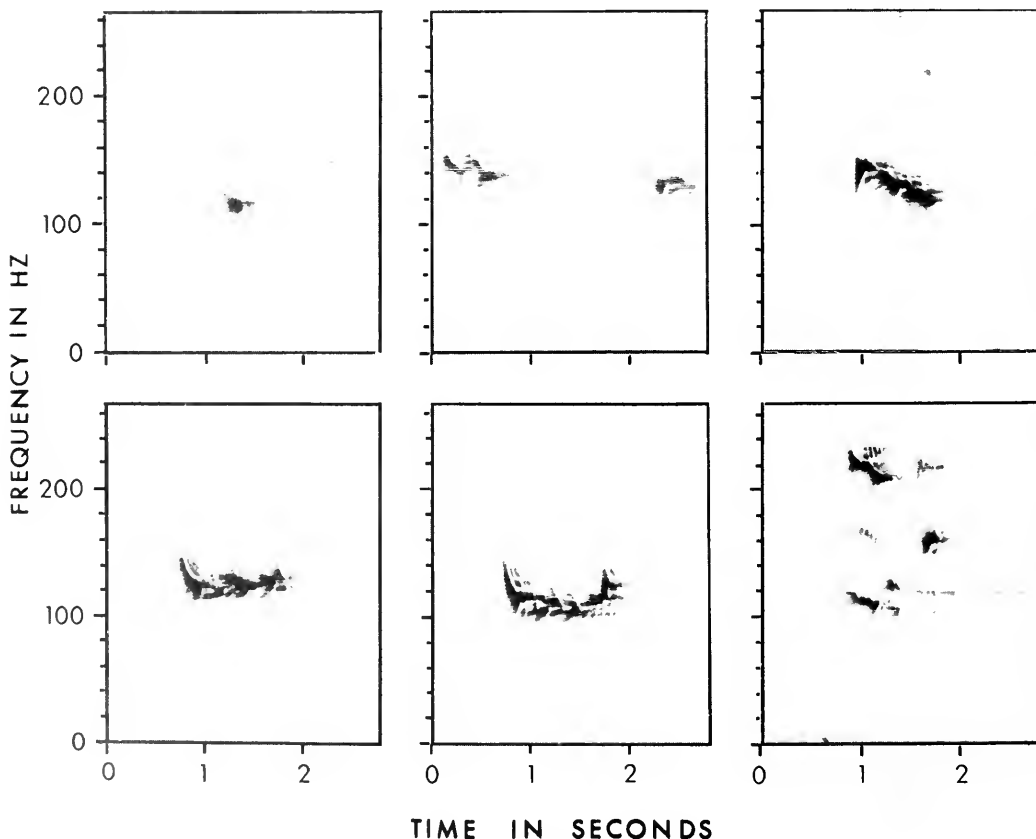

FIGURE 2.—Spectrograms of typical Bryde whale moans. The effective analyzing filter bandwidth was 3 Hz.

were feeding on red crabs, *Pleuroncodes planipes*, that swarmed at the surface during the early morning and evening. We distantly accompanied two of the whales which were swimming at 18 km/h and surfacing every 1 to 1.5 min. They rose high enough above the surface for us to clearly identify them as finbacks. Extensive sound recordings were made among the large concentration of whales near shore (Contact 7) and also much farther offshore (Contact 8), away from the main group.

Recordings of whale sounds from Contacts 9 and 10 were made in Ballenas Channel near finned whales on the west side of Isla Angel de la Guarda.

## Analysis of Whales Sounds

Most sounds attributed to Bryde and finback whales, other than those from blows, were in a class we called "moan"—emissions longer than 0.2 s and  $<250$  Hz in frequency. Many other sounds of biological origin, including clicks, knocks, etc., were recorded in the presence of the whales, but only when other possible sources were present, such as porpoises and sea lions.

### Bryde Whales

As seen in Figures 2 and 3, upper, Bryde whale

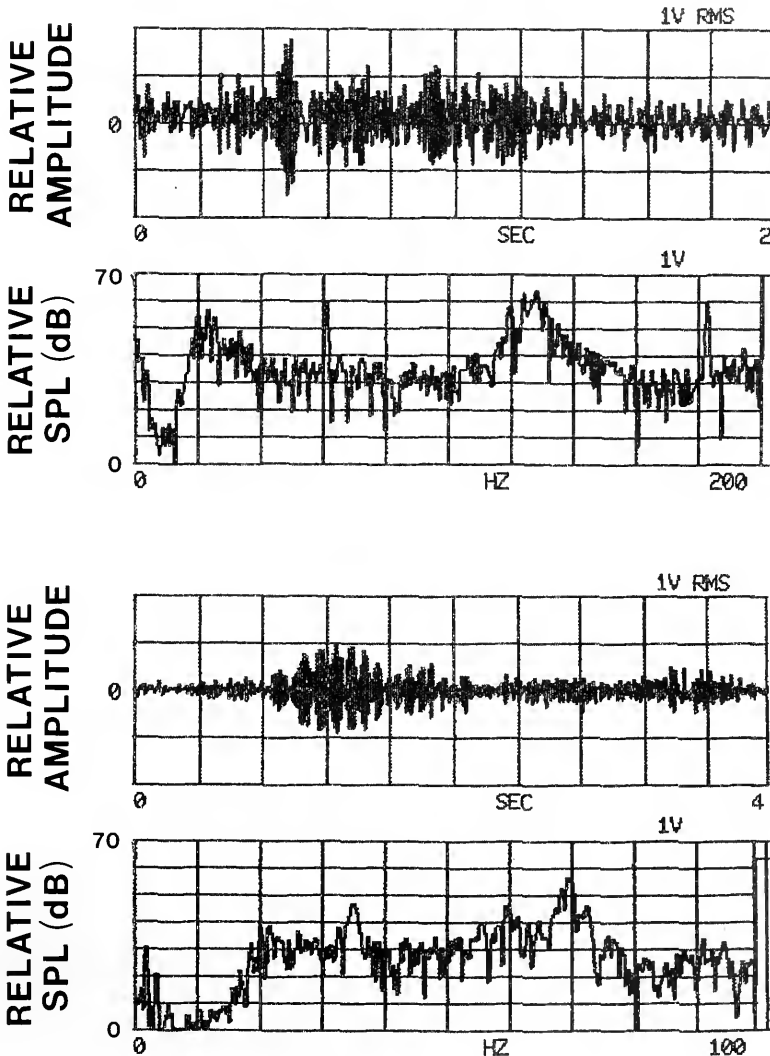

FIGURE 3.—Waveform and spectrum (/Hz) for Bryde whale (upper) and finback whale (lower). Effective analyzing filter bandwidth was 0.75 Hz (Bryde whale sound), 0.375 Hz (finback whale).

moans varied widely in duration and frequency (Hz). Of the 93 miscellaneous moans analyzed (Table 2), the principal sound energy occurred at a mean frequency of 124 Hz; that of individual moans varied from 70 to 245 Hz. Seventy-three percent of these sounds exhibited frequency shifts (mean of 15.2 Hz) that were downward or upward, or a combination thereof. The mean duration of the moans was 0.42

s (range, 0.2 to 1.5). These sounds occurred at intervals of 0.2 to 9 min.

The Bryde whale that apparently was attracted to the ship (Contact 2) did not emit moans when very closeby. The received overall sound level for a typical moan, when this whale was estimated to be 300 m away, was 102 dB. Assuming a spherical spreading loss of  $20 \log_{10} 1.094(R)$ , R being distance in

TABLE 2.—Analysis of whale sounds.

Contact	Identification	68/34-Hz moans				Miscellaneous moans					
		No. <sup>1</sup>	Range (m)	Received level (dB) <sup>2</sup>	Source level (dB) <sup>3</sup>	No. <sup>1</sup>	Mean frequency (Hz)	Duration (s)	Range (m)	Received level (dB) <sup>2</sup>	Source level (dB) <sup>3</sup>
1	<i>Balaenoptera</i> sp.	2(2)	—	83	—	0	—	—	—	—	—
2	<i>B. edeni</i>	0	—	—	—	288(93)	123.9	0.42	300	102	152
3	<i>B. edeni</i>	0	—	—	—	407(35)	132.0	0.40	600	116	168
									250	126	174
4	Large whale	0	—	—	—	1(1)	75.0	0.60	—	90	—
5	<i>Balaenoptera</i> sp.	30(10)	250	121	169	12(8)	49.6	0.55	200	121	166
	No visual contact	44(16)	—	90	—	21(21)	50.7	0.63	—	92	—
6	<i>Balaenoptera</i> sp.	203(6)	2,000	115	183	173(14)	53.7	1.23	2,000	115	183
7	<i>B. physalus</i>	164(20)	—	108	—	468(131)	59.8	0.59	100	125	165
8	<i>B. physalus</i>	201(30)	—	99	—	550(42)	65.5	0.73	—	117	—
9	<i>Balaenoptera</i> sp.	3(3)	2,000	95	—	102(17)	63.3	0.70	2,000	118	181
10	<i>Balaenoptera</i> sp.	90(5)	800	108	166	12(8)	77.5	0.68	800	101	159

<sup>1</sup>Number of sounds encountered with number analyzed in parenthesis.

<sup>2</sup>dB re 1  $\mu$ Pa.

<sup>3</sup>dB re 1  $\mu$ Pa at 1 m.

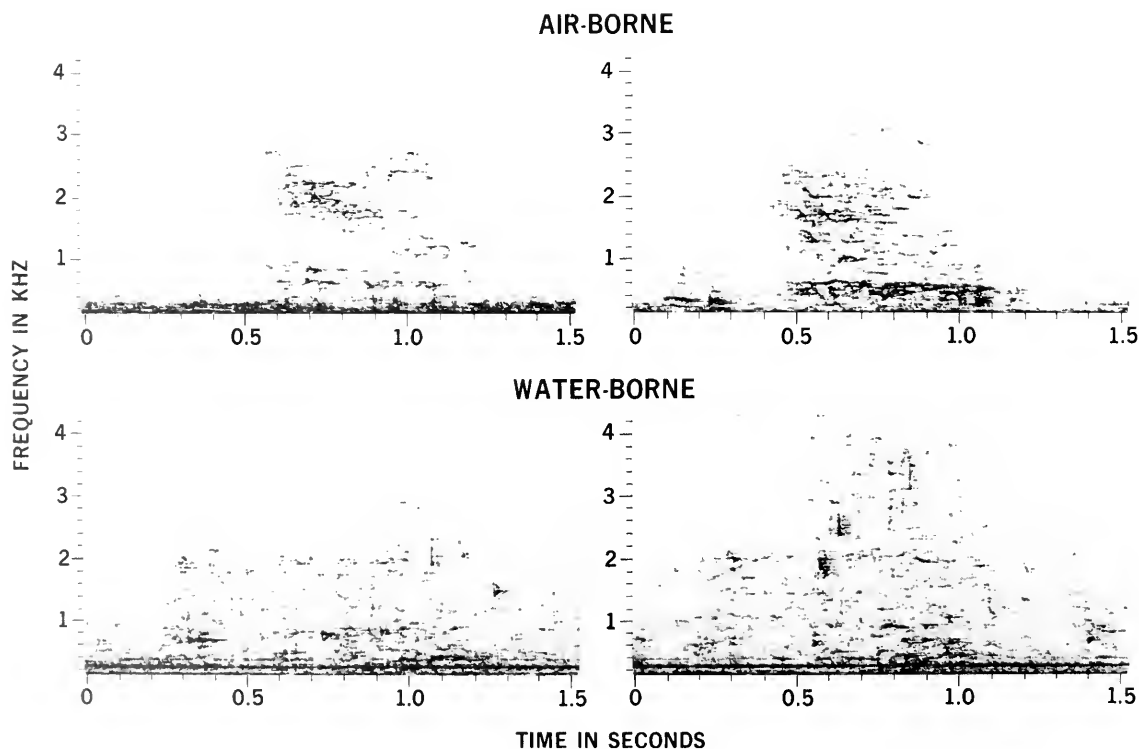

FIGURE 4.—Spectrograms of two blows from a Bryde whale recorded in air (upper) and in water (lower). The effective analyzing filter bandwidth was 20 Hz.

meters, this received level would indicate an overall source level of 152 dB in the effective bandwidth. The whales were close enough and the frequencies low enough that attenuation was probably minimal. However, these particular moans could possibly have been emitted by the other whale that was about 500 m away at the time. In this case, the estimated overall source level would have been 157 dB in the effective bandwidth.

Weak exhalation sounds were recorded simultaneously from underwater and in the air from the nearby surfaced Bryde whale. The exhalation sounds received underwater were nearly obscured by splashing sounds as the animal broke the surface (Fig. 4).

For the 35 moans analyzed from the Bryde whale of Contact 3, the mean frequency of the strongest component was 132 Hz and the mean duration was 0.40 s, both values close to those from Contact 2 (Table 2). However, the overall source level estimates of 168 and 174 dB (in the effective bandwidths) were greater.

The nearby Bryde whale (Contact 2) was totally submerged as it produced all of its moaning sounds, but no other apparent behavior was associated with the moans.

### Finback Whales

In addition to miscellaneous moans (Fig. 5) that were similar to, but lower in frequency than those recorded from Bryde whales, the sounds of identified finback whales (Contacts 7, 8) included unique moans characterized by a long 68-Hz component that was usually followed by another component at 34 Hz (Figs. 6, 3 (lower)). Of the miscellaneous moans analyzed from recordings of the finback whales of Contacts 7 and 8, the mean frequency of the strongest component was 59.8 and 65.5 Hz, and the mean duration was 0.59 and 0.73 s, respectively (Table 2). Typically, these moans showed some frequency shift with <10% of the signals changing more than 20 Hz, generally downward. Overall source level

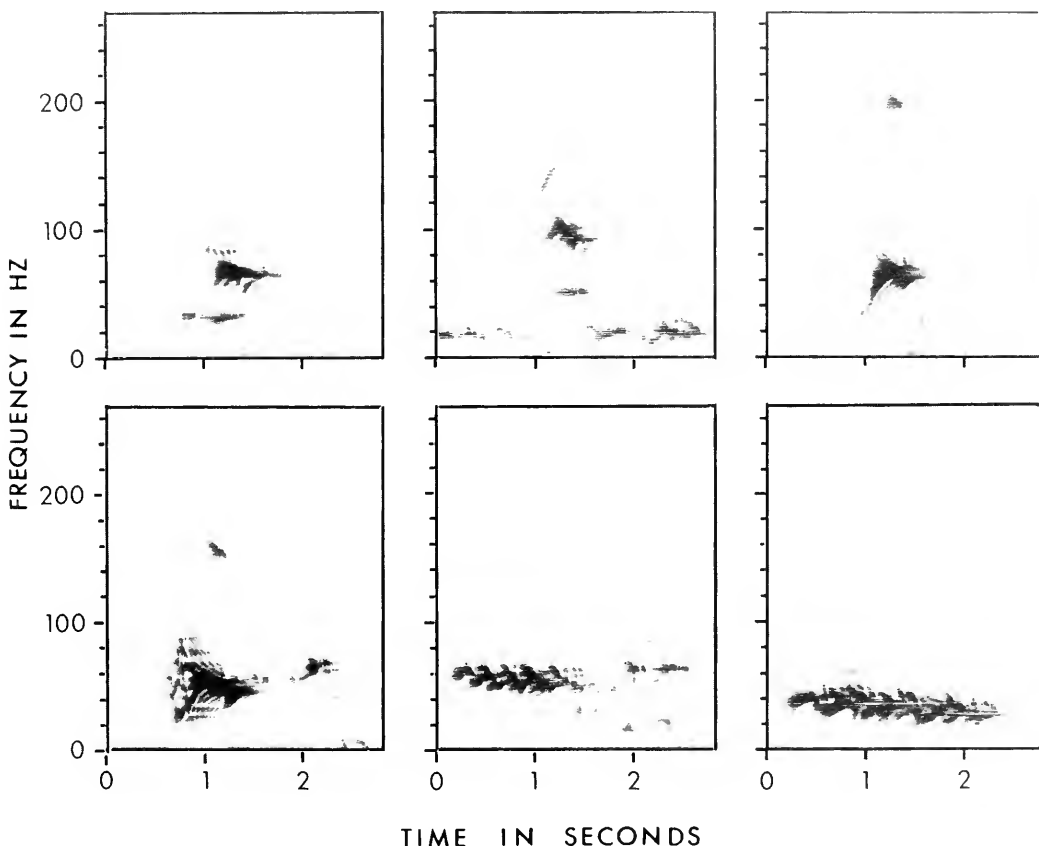

FIGURE 5.—Spectrograms of miscellaneous whale moans from finback whales off Isla Angel de la Guarda. The effective analyzing filter bandwidth was 3 Hz.

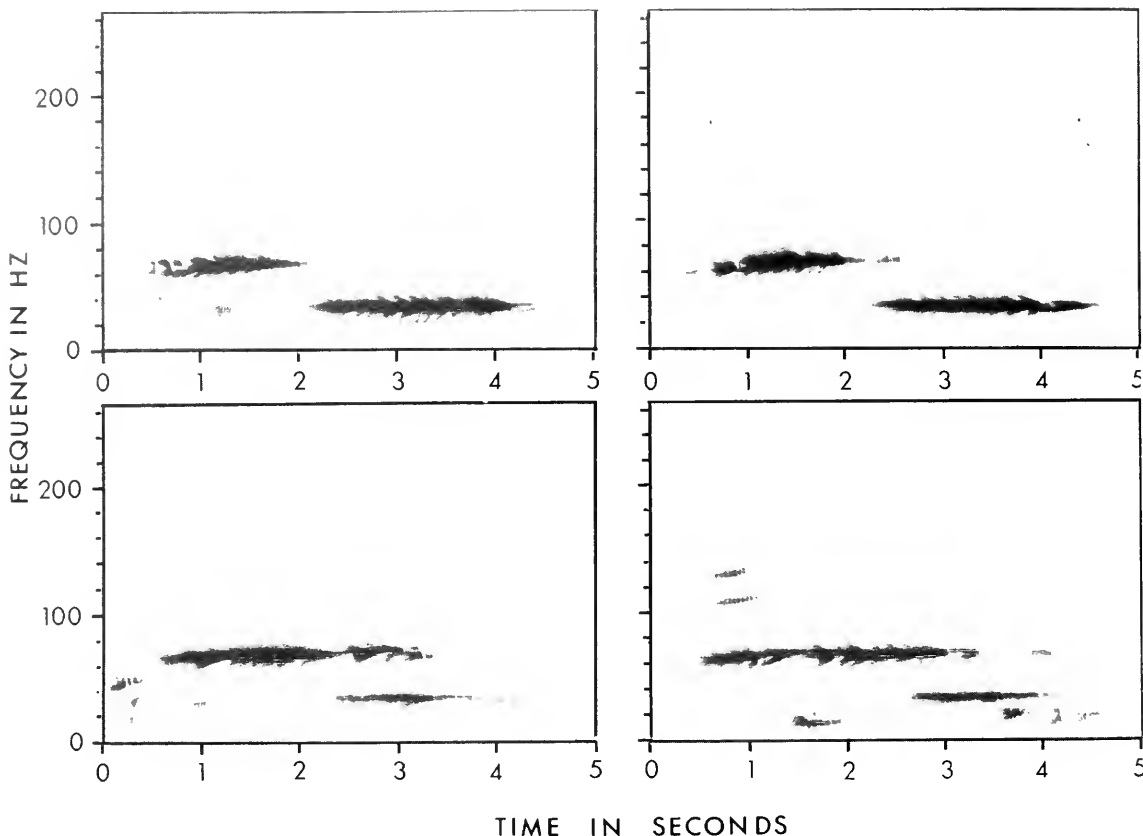

FIGURE 6.—Spectrograms of typical 68/34-Hz moans from finback whales recorded off Isla Angel de la Guarda. The first component of the moans began at 65 Hz and increased to 68 Hz in the first sec. It was accompanied by weaker modulation products at about 23-Hz intervals, mostly above the main frequency. The 34-Hz component followed and sometimes overlapped the first component (lower spectrogram). The effective analyzing filter bandwidth was 3 Hz.

of the sounds was 165 dB in the effective bandwidths.

Of the 50 long moans from finbacks that were analyzed, the mean frequency of the main, or first, component was 68.2 Hz; the mean frequency at onset being 66.1 Hz. The mean duration was 1.5 s. Thirty moans exhibited additional lower frequency components with a mean frequency of 33.5 Hz and a mean duration of 1.3 s. The overall mean duration of these two-part moans was 3.1 s. The 365 moans of this type encountered in Contacts 7 and 8 occurred on the average of 1.6 and 2.2 times/min, respectively.

In the case of unidentified balaenopterid whales, the mean frequency of the strongest component of the 68 miscellaneous moans analyzed was 58.5 Hz (range from 15 to 95 Hz), and the mean duration was 0.8 s. Of these sounds <10% had any frequency shift >10 Hz. Thirty-seven of the analyzed moans were the same as the long two-part moans recorded in the presence of finbacks. Their mean frequencies were

68.1 and 34 Hz, the mean component duration was 1.9 and 2.6 s, respectively, and the mean total duration was 3.4 s. The mean starting frequency of the 68-Hz component was 63.9 Hz. These two-part moans occurred at a rate of 1.5 to 3.2/min. Overall source levels ranged from 159 to 183 dB in the effective frequency bandwidth.

The blows of finback whales were as high as about 7 m above the water's surface, and often they were clearly audible in air at distances out to 200 m. The last blow in a series was followed by an inhalation that sometimes involved a low-frequency whistle-like sound just before a long dive (Fig. 7). The physical characteristics of blow sounds varied slightly from one whale to another, providing a certain degree of uniqueness for an individual whale (Fig. 7). Wheezing, shriek, and hornlike sounds produced by humpback whales in association with their blows have been described by Watkins (1967) and Thompson et al. (1977).

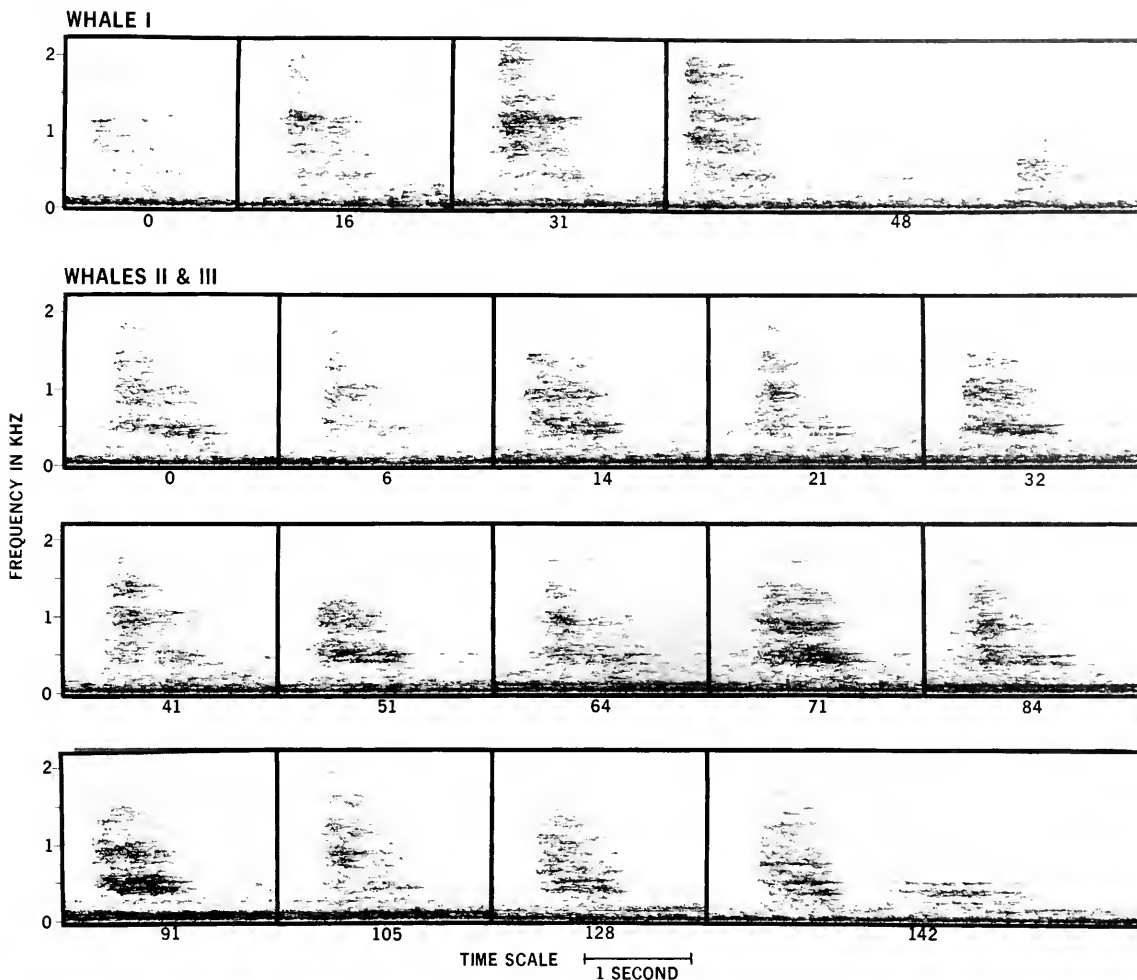

FIGURE 7.—Spectrograms of whale blow series recorded in air. Running time in seconds relative to the first blow is indicated on the abscissa. Whales II and III (second series) can be distinguished throughout the first 105 min by the unique physical characteristics of their alternating blows. Just before a long dive, the whales produced a low-frequency whistle-like sound at inhalation (last spectrogram, first row; last spectrogram, last row) which was not apparent during earlier blows of a series. In the second series, two low-level blow sounds at 110 and 132 min are not shown. The effective analyzing filter bandwidth was 20 Hz.

## DISCUSSION

The moans recorded on this cruise from visually unidentified or unseen whales were very similar to those found to be from finbacks, except for Contact 3 involving Bryde whale sounds. Thus we believe the former also were from finback whales.

Some of the moans recorded in this study only slightly resembled short “20-Hz signals” described by several investigators (Walker 1963; Patterson and Hamilton 1964; Schevill et al. 1964; Weston and Black 1965; Cummings and Thompson 1966 [fn. 4]; Northrop et al. 1968; Watkins 1981). However, none of the presently described signals could be categorized as short “20-Hz signals” noted in other

studies, because of differences in frequency (Hz) of major sound energy, signal repetition, and intervals between repetitions. Typical short “20-Hz signals” are narrowband pulses with principal sound energy near 20 Hz. They are repeated at remarkably constant intervals. Only about 3% of the sounds reported here had components as low as 20 Hz.

The miscellaneous moans that were recorded from finbacks mainly resemble the category that Watkins (1981) called “higher frequency sounds”. However, most of his recordings of these sounds were downward-sweeping pulses, e.g., 75-40 Hz, with emphasis around 40 Hz. We did not record sounds similar to Watkins’ low-frequency rumble or ragged pulse

categories, nor did we record his nonvocal, sharp impulsive category.

Our experience with finback and Bryde whales in the Gulf of California showed that underwater-generated sounds were not produced when visible animals were at or very close to the surface. Exceptions were those sounds which, although principally airborne (e.g., blow and snort sounds), established a physical coupling with the water medium allowing detection by hydrophone. The typical short "20-Hz signals" noted from finback whales in other locations (Northrop et al. 1968) appear in trains that are interrupted after 3 to 22 min of pulsing (equivalent to expected dive times, Fig. 8). We believe that these interruptions that last from 1 to 6 min represented surface time. Blue whale sounds in southeast Pacific waters had silent interruptions that were associated with surfacing and ventilation (Cum-

mings and Thompson 1971). Winn et al. (1970) correlated certain "cries" and "ratchet" sounds with surfacing behavior of humpback whales. Data from the present cruise, our recordings of typical short "20-Hz signals", our recordings from blue whales, and from work on humpback whales, apparently reveal surface and dive times as learned through monitoring underwater whale sounds.

Possible explanations for our lack of 20-Hz short pulses in the presently described recordings and for the absence of other classes of sounds that Watkins (1981) has commonly recorded from finbacks are seasonality and insufficient sampling. We now know that seasonality is involved.

Watkins (1981) recorded the pulses in the North Atlantic only from late October to early May. Cummings and Thompson (fn. 4) recorded them in the North Pacific from September to April, and Thomp-

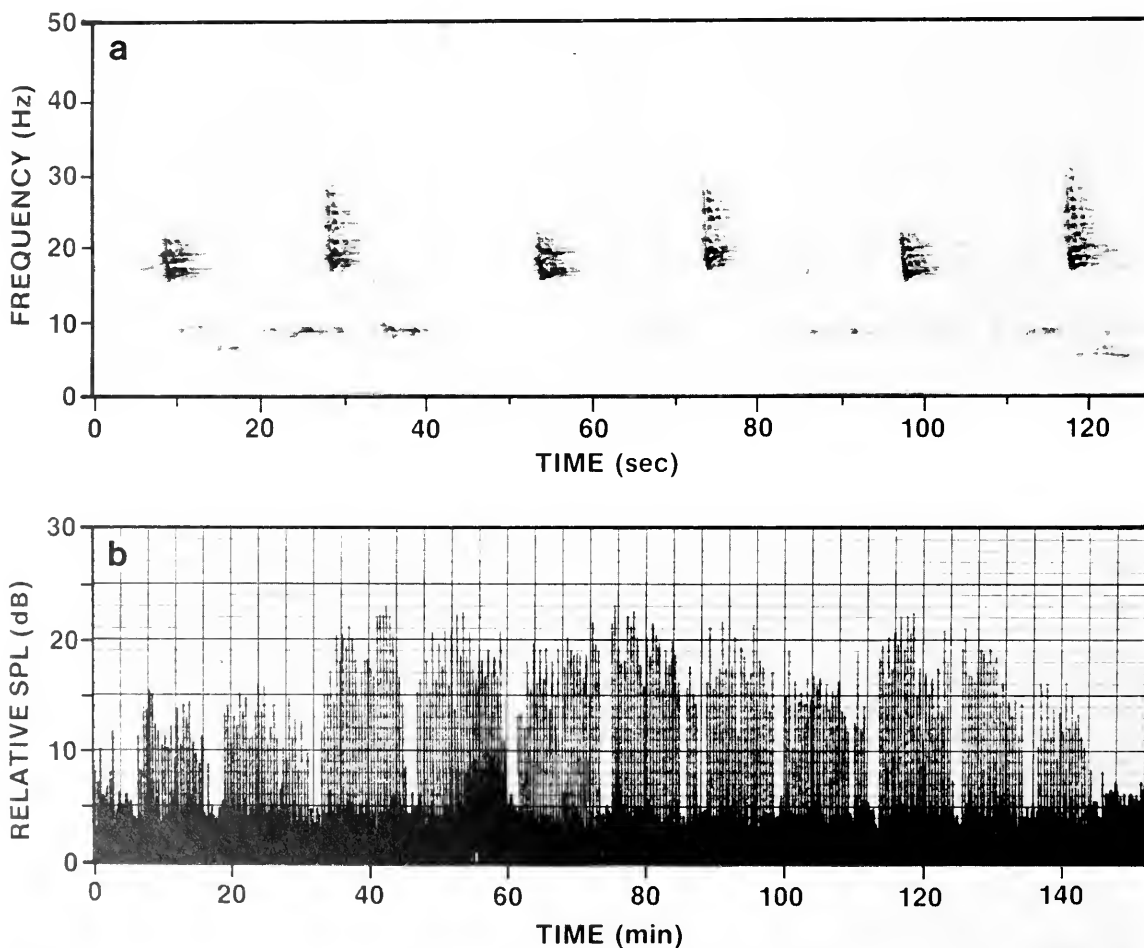

FIGURE 8.—(a) Spectrogram of short "20-Hz signals" from finback whales; the effective analyzing filter bandwidth was 0.4 Hz. (b) Strip chart showing 11 trains of short "20-Hz signals" with interruptions between; the filter passband was 12.5-25 Hz.



son and Friedl (1982), working off Hawaii, recorded them only from the end of August to late April. Northrop et al. (1968), in the North Pacific, noted them from October to March. Finally, in recordings from finbacks in March 1985 (Gulf of California) typical 20-Hz short pulses were the predominant sound (Thompson et al.<sup>6</sup>). Like the well-known songs of humpback whales, these sounds are probably a manifestation of social or other behavior which occurs seasonally. According to Watkins (1981) they "perhaps were a courtship or reproductive display". Watkins and others apparently have not noted our frequently recorded 68-34 Hz long moans.

There have been many technical advances in bioacoustic signal acquisition and processing. Long-term recordings can be used for obtaining information about certain behaviors, presence or absence of animals, or perhaps distribution of a given species, without the presence of an observer (Cummings et al. 1983). Great gains are being made in the field of signal processing wherein computer- and optically aided automatic acoustic pattern recognition is possible for a number of sounds with recognizable physical criteria. However, regardless of technical advances, the use of such tools is severely limited without first knowing the behavioral significance of the animal sound production. In reality, the two are mutually dependent. An analogous situation would be the use of the most refined instrumentation available for listening in on a conversation carried out in a foreign language that is unfamiliar to the observer. Although extremely difficult to fulfill, the need for related behavioral information on finback whales is paramount.

For these and other reasons, descriptions of sounds from identified sources should be given in detail along with adequate description of the recording instruments. Recording procedures and analyses can greatly affect the apparent variability of sounds. Moreover, one must be careful to consider the large variety of sounds that is apparent in any species of marine mammal (including the finback whale, as shown in this report) and the relatively limited number of recorded sounds of any species.

## ACKNOWLEDGMENT

The authors thank R. S. Gales for assisting in the field observations; D. R. Nelson for assisting in the

diving and other field work; R. Ludwig and crew for operating the ship; W. A. Watkins and W. E. Schevill for comments on the research; and M. Richardson, R. Hawley, and T. Rydlinski for producing the finished manuscript. This work was supported by funds for Independent Research (Naval Ocean Systems Center) and by the Office of Naval Research (R. C. Tipper and B. Zahuranec) by means of contracts with the San Diego Society of Natural History and Scripps Institution of Oceanography.

## LITERATURE CITED

- BEAMISH, P.  
1978. Evidence that a captive humpback whale (*Megaptera novaeangliae*) does not use sonar. *Deep-Sea Res.* 25:469-472.
- BEAMISH, P., AND E. MITCHELL.  
1971. Ultrasonic sounds recorded in the presence of a blue whale, *Balaenoptera musculus*. *Deep-Sea Res.* 18:803-809.  
1973. Short pulse length audio frequency sounds recorded in the presence of a minke whale (*Balaenoptera acutorostrata*). *Deep-Sea Res.* 20:375-386.
- CUMMINGS, W. C., D. V. HOLLIDAY, W. T. ELLISON, AND B. J. GRAHAM.  
1983. Technical feasibility of passive acoustic location of bowhead whales in population studies off Pt. Barrow, Alaska. *Tracor, Inc., San Diego, Doc. No. T-83-06-002*, 169 p.
- CUMMINGS, W. C., AND P. O. THOMPSON.  
1971. Underwater sounds from the blue whale, *Balaenoptera musculus*. *J. Acoust. Soc. Am.* 50:1193-1198.
- EDDS, P. L.  
1981. Variations in vocalizations of fin whales, *Balaenoptera physalus*, in the St. Lawrence River. M.S. Thesis, Univ. Maryland, College Park, 126 p.
- NORTHROP, J., W. C. CUMMINGS, AND M. F. MORRISON.  
1971. Underwater 20-Hz signals recorded near Midway Island. *J. Acoust. Soc. Am.* 49:1909-1910.
- NORTHROP, J., W. C. CUMMINGS, AND P. O. THOMPSON.  
1968. 20-Hz signals observed in the central Pacific. *J. Acoust. Soc. Am.* 43:383-384.
- PATTERSON, B., AND G. R. HAMILTON.  
1964. Repetitive 20 cycle per second biological hydroacoustic signals at Bermuda. In W. N. Tavolga (editor), *Marine bioacoustics*, p. 125-145. Pergamon Press, N.Y.
- SCHEVILL, W. E., AND W. A. WATKINS.  
1962. Whale and porpoise voices. *Woods Hole Oceanogr. Inst.* (with a phonograph record), 24 p.
- SCHEVILL, W. E., W. A. WATKINS, AND R. H. BACKUS.  
1964. The 20-cycle signals and *Balaenoptera* (fin whales). In W. N. Tavolga (editor), *Marine bio-acoustics*, p. 147-152. Pergamon Press, N.Y.
- THOMPSON, P. O., AND W. C. CUMMINGS.  
1969. Sound production of the finback whale, *Balaenoptera physalus*, and Eden's whale, *B. edeni*, in the Gulf of California (A). In *Proceedings of the Sixth Annual Conference on Biological Sonar and Diving Mammals*, p. 109. Stanford Res. Inst., Menlo Park, CA.
- THOMPSON, P. O., W. C. CUMMINGS, AND S. J. KENNISON.  
1977. Sound production of humpback whales, *Megaptera novaeangliae*, in Alaskan waters. [Abstr.] *J. Acoust. Soc. Am.* 62(Suppl. 1):S89.

<sup>6</sup>Thompson, P. O., L. T. Findley, and O. Vidal. Finback whale underwater sounds recorded near Guaymas, Mexico. *Manuscr. in prep.* Paul O. Thompson, 4256 Sierra Vista, San Diego, CA 92103.

- THOMPSON, P. O., AND W. A. FRIEDL.  
1982. A long term study of low-frequency sounds from several species of whales off Oahu, Hawaii. *Cetology* 45, 19 p.
- WALKER, R. A.  
1963. Some intense, low-frequency, underwater sounds of wide geographical distribution, apparently of biological origin. *J. Acoust. Soc. Am.* 35:1816-1824.
- WATKINS, W. A.  
1967. Air-borne sounds of the humpback whale, *Megaptera novaeangliae*. *J. Mammal.* 48:573-578.
1981. Activities and underwater sounds of fin whales. *Rep. Whales Res. Inst.* 33:83-117.
- WESTON, D. E., AND R. I. BLACK.  
1965. Some unusual low-frequency biological noises underwater. *Deep Sea Res.* 12:295-298.
- WINN, H. E., P. J. PERKINS, AND T. C. POULTER.  
1970. Sounds of the humpback whale. *In Proceedings of the Seventh Conference on Biological Sonar and Diving Mammals*, p. 39-52. Stanford Res. Inst., Menlo Park, CA.

# INCREASED FOOD AND ENERGY CONSUMPTION OF LACTATING NORTHERN FUR SEALS, *CALLORHINUS URSINUS*

MICHAEL A. PEREZ AND ELIZABETH E. MOONEY<sup>1</sup>

## ABSTRACT

Data from pelagic northern fur seals, *Callorhinus ursinus*, taken during 1958-74 by the United States and Canada in the eastern Bering Sea were analyzed to determine relative feeding rates of lactating and nonlactating females. Estimates of the quantity of food and energy consumed by these seals during July-September were evaluated. The average daily feeding rate (adjusted for percentage of time feeding at sea) for lactating seals is 1.6 times that for nonlactating seals. During July-September, the total population of lactating and nonlactating females were estimated to consume  $146.5 \times 10^3$  t ( $204.5 \times 10^9$  kcal) and  $43.1 \times 10^3$  t ( $60.2 \times 10^9$  kcal) of food respectively. Fish accounted for 66.4% of food biomass (69.4% of total energy consumption); squid, the remainder.

The energetics of reproduction, especially during lactation, are poorly documented for free-ranging animals. The various reproductive states of domestic mammals, e.g., cattle, sheep, etc., have been extensively studied; and there has also been considerable research on rodents, e.g., mice, voles, etc., under both laboratory and field conditions. As a result of these studies it is widely accepted that most nursing females require considerably more energy than do nonnursing females of the same species, age, and size. Brody (1945) also noted that the maintenance requirements of lactating animals are elevated relative to nonlactating animals.

In some mammalian species, food intake during lactation may be up to 5 times greater than that observed in nonpregnant, nonlactating adult females, and lactating animals often convert considerable body substance to support the lactation process (Baldwin 1978). Previous studies on terrestrial mammals have specifically shown increased energy consumption by lactating females relative to nonlactating females. For example, captive deer mice, *Peromyscus maniculatus*, have a 96% to a 194% increase (Stebbins 1977); and ewes have a 116% increase (Engels and Malan 1979). The bat, *Myotis thysanodes*, which undergoes thermoregulatory physiological changes during reproductive stages, also has higher energy requirements for lactating females (Studier et al. 1973). Lactating humans are recommended to increase food con-

sumption by at least 25% (Eagles and Randall 1980); however, some lactating humans in Guatemala meet their additional lactation energy costs by fat loss (Schutz et al. 1980).

There are few studies on the energetics and consumption of food during lactation by marine mammals. Lactation appears to drain the energy reserves of large baleen whales; the blubber of lactating females (e.g., blue, *Balaenoptera musculus*, and fin, *Balaenoptera physalus*, whales) is lean and emaciated compared with nonlactating females (Lockyer 1978, 1981a). Lockyer (1981b) estimated that adult female sperm whales, *Physeter macrocephalus*, need to increase their food intake by about 32-63% during lactation, meaning that they would need to feed 4 or 5 times daily to meet higher energy requirements. Lockyer (1981b) also estimated that minke, *Balaenoptera acutorostrata*, and fin whales increase their food intake by 75 and 86%, respectively. Spotte and Babus (1980) did not find a significantly increased mean feeding rate for one captive, pregnant bottlenosed dolphin, *Tursiops truncatus*, but standard deviations were consistently greater. In addition, during the first 3½ mo of lactation, a captive mother bottlenosed dolphin consumed 170% more food than she did while not lactating the following year (Mooney<sup>2</sup>). Costa and Gentry (in press) derived metabolic rates for lactating female northern fur seals from measurements of water flux and discussed the components of the

<sup>1</sup>Northwest and Alaska Fisheries Center National Marine Mammal Laboratory, National Marine Fisheries Service, NOAA, 7600 Sand Point Way, N.E., Seattle, WA 98115.

<sup>2</sup>Mooney, E. E. 1981. Unpubl. data. Northwest and Alaska Fish. Cent. Natl. Mar. Mammal Lab., Natl. Mar. Fish. Serv., NOAA, 7600 Sand Point Way NE, Seattle, WA 98115.

energy budget for females and pups during the first two months of the reproductive cycle.

Although most mammals ingest more food while they are lactating than they would in a nonlactating state, many species of phocid seals fast during the lactation period (Harrison 1969). These seals (e.g., gray seal, *Halichoerus grypus*, and northern elephant seal, *Mirounga angustirostris*) do not feed from parturition to weaning of the young, and all of their energy needs during lactation must be met by metabolism of in situ energy such as fat reserves. This behavior has been well documented for the gray seal (e.g., Amoroso and Matthews 1951, 1952; Fedak and Anderson 1982) and also for the harp seal, *Phoca groenlandica*, (Lavigne et al. 1982). However, metabolism of fat reserves does not reduce the energetic costs of producing offspring; it merely shifts the time that energy must be acquired, at some energy cost for storage (Millar 1978).

The objectives of this study were to show, using both stomach content and body mass data, that lactating female fur seals ingest more food than nonlactating females in order to meet their increased energy requirements for maintenance and milk production, and to make estimates of the magnitude of this difference in food ingestion. For this study, we utilized data from postpartum and nonpregnant adult, female northern fur seals, *Callorhinus ursinus*, taken pelagically during 1958-74.

## METHODS

Data on the contents of stomachs from the female northern fur seals taken pelagically (Fig. 1) in the eastern Bering Sea during 1958-74 by the United States and Canada were analyzed to determine the relation between lactation and food consumption during the summer breeding season. Only data from female fur seals (age  $\geq 4$  yr) which had information on both body mass and stomach content mass were included. Age was determined from longitudinal half-sections of the upper canine teeth by counting the annual growth layers in the dentine, a method widely accepted by researchers during recent decades to determine the age of many species of mammals (Klevezal' and Kleinenberg 1967). Methods used during 1958-74 to determine age, reproductive status, and the different items in the stomachs were discussed by Lander (1980).

The data used in this study represented stomach contents under different stages of digestion; however, it was not possible to make comparisons between stages because no data on stages of digestion were recorded. Rates of digestion of all prey

were assumed to be similar for all females during the same time interval. In our study, all postpartum females were considered lactating, and all nonpregnant (not postpartum) females were considered nonlactating.

## Statistical Methods

The cumulative frequency distributions of data on mass of total stomach contents for both lactating and nonlactating females were compared using the one-tail Kolmogorov-Smirnov two-sample test (Siegel 1956).

Data from seals with empty stomachs or stomachs with only a trace of contents (i.e.,  $< 10$  cc) were considered as zero mass and pooled with data from seals with food in their stomachs. Data for different ages and months were pooled to provide sufficient sample size for analysis because the normal approximation to compute confidence limits is only valid if sample sizes are adequate (Cochran 1977). In order to use parametric statistics, and yet not seriously violate basic assumptions of normality, data were transformed by the modified arcsine transformation discussed by Zar (1974):

$$X = \sqrt{M + 0.5} \arcsin \sqrt{(S + 0.375)/(M + 0.75)}$$

where  $M$  is the net body mass (excluding mass of stomach contents,  $S$ ) and  $X$  is the transformed value. This equation was used because of its utility where a large number of the data were from stomachs containing only a trace or less.

The transformed values on the mass of total stomach contents (expressed as a percentage of net body mass) obtained from the above equation were transformed back to percentages to obtain means. We calculated an index of the relative intake of food by lactating females compared with that of nonlactating females by multiplying the ratio of their respective mean mass of stomach contents by 100. The  $t$ -test for two independent samples, with the assumption of unequal variance (Snedecor and Cochran 1980), was used on the transformed data to determine if any significant difference in total food consumption and body mass existed between females of different reproductive status.

The relative importance of individual prey in the total diet was assessed using the modified volume percentage method (Bigg and Perez 1985). Only foods with fleshy remains were used as evidence of diet in this method, and the procedure combined the traditional methods of volume and frequency of occurrence. The proportion of total fish and total squid

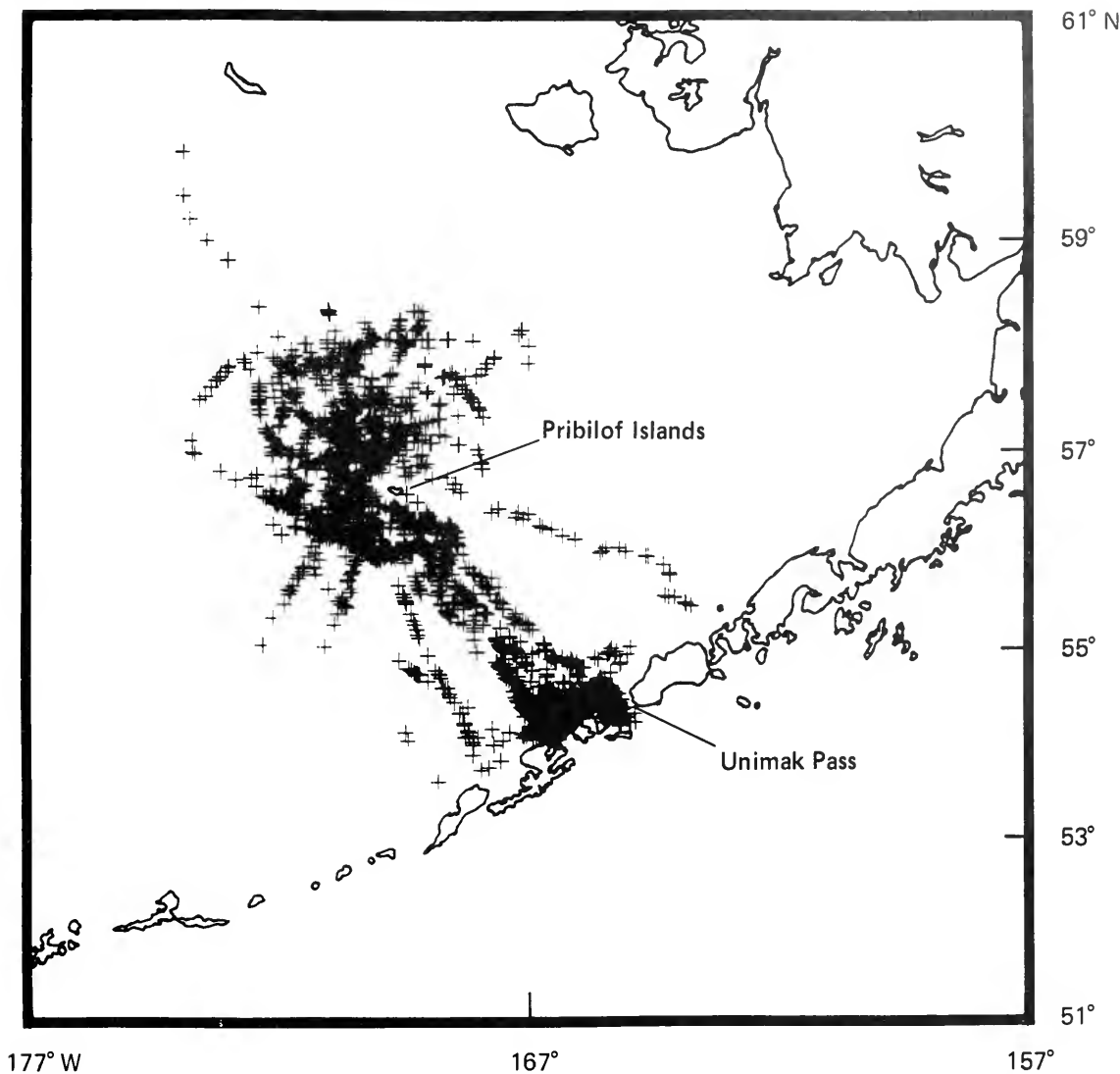

FIGURE 1.—Locations where 3,494 adult female northern fur seals (ages  $\geq 4$  yr), whose data were analyzed in this study, were taken by the United States and Canada in the eastern Bering Sea during July-September 1958-74.

in the diet was determined by frequency, while the ration of each species within only fish and squid was determined by volume. Statistical comparison of the diets of lactating and nonlactating females included 1) the Spearman rank correlation coefficient (Siegel 1956; Fritz 1974), 2) percentage similarity (Goodall 1973), and 3)  $2 \times 2$  contingency table analysis (Zar 1974) on the number of stomachs with fish or squid.

#### Feeding Time at Sea

The largest breeding population of northern fur seals (currently estimated at  $8.7 \times 10^5$  for a declin-

ing population; North Pacific Fur Seal Commission 1984) resides on the Pribilof Islands during the summer months. Pups first appear in late June (Bartholomew and Hoel 1953) and the mean date of pup birth based on recent data is 5 July (Gentry and Holt in press); a date median between values cited by Bartholomew and Hoel (1953) and Peterson (1968). After this time, adult females spend a number of days on shore in several visits to the islands during June-November, and the intervening days between these visits at sea foraging for food (Bartholomew and Hoel 1953; Peterson 1968). They do not feed daily.

Once arriving at the rookery, a parturient female gives birth to one pup, initiates lactation, comes into estrus, and copulates with a male, but does not feed. Gentry and Holt (in press) provided data showing that the average adult female is on shore about 1 d before and 7.4 d after parturition. Each subsequent shore visit lasts about 2.2 d (Peterson 1968; Gentry and Holt in press). The duration of the first sea trip is the shortest (4.8 d), with the duration of the subsequent sea trips increasing at a rate of an additional 1.2 d/30 d postpartum (Gentry and Holt in press).

Recent data collected on the Pribilof Islands by Gentry and Holt (in press) suggests that nonpregnant (= nonlactating) adult females arrive later (about 8 d) on the rookeries and that they may show a somewhat different behavioral pattern than pregnant females. Their first foraging trip at sea is longer (8.9 d), but each of their subsequent shore visits is of constant duration (2.5 d). From these data we derived values for total percent of time spent at sea during July-September (92 d) for the average adult female. Assuming birth of pups on 5 July, this was 69.3 and 75.9% for lactating and nonlactating females, respectively. However, it should be noted that individual females vary from these averages because the period during which adult females first arrive on the rookeries extends over 30 d (Bartholomew and Hoel 1953; Peterson 1968; Gentry and Holt in press).

### Feeding Rate Calculations

Bigg et al. (1978) provided data on feeding rates for three captive adult female northern fur seals. Their data for these seals were 5,977 kcal/d (3.0 kg; 6.7% of body mass), 6,118 kcal/d (3.1 kg; 7.6% of body mass), and 5,055 kcal/d (2.5 kg; 8.5% of body mass). These captive northern fur seals were maintained with a diet of Pacific herring (2.01 kcal/g dur-

ing winter), and it was necessary to consider the energetic concentration of the seal's diet in the wild with respect to the data in Bigg et al. (1978). We derived the following relationship from these data:

$$\text{Daily energy consumption (kcal/d)} = 375.47 M^{0.75}$$

by averaging the results given for the three captive seals. We calculated average daily feeding rates using this relationship and data on seal body mass.

## RESULTS

### Body Mass

Table 1 gives the mean values of body mass of adult female northern fur seals (age  $\geq 4$  yr) taken during June-September in the eastern Bering Sea and western Alaska. During July-September, the average lactating female (mean 35.3 kg, median age 10 yr) had a body mass 1.13 times that of the average adult nonlactating female (mean 31.1 kg, median age 5 yr; seals age  $\geq 4$  yr only). However, as Figure 2 shows, lactating and nonlactating females of the same age were similar in body mass. The differences shown in Table 1 are primarily due to the higher proportions of lactating females at older ages (Lander 1981).

Lactating females exhibited a significant ( $P < 0.001$ ) loss of 7.1 kg of body mass between June and July following parturition (Table 1). This is based

TABLE 1.—Body mass (minus stomach contents mass) of lactating (postpartum) and nonlactating female northern fur seals (ages  $\geq 4$  yr pooled) taken pelagically in the eastern Bering Sea and western Alaska, 1958-74.

Month	Lactating		Nonlactating	
	<i>n</i>	$\bar{x}$ and 95% C.I. (kg)	<i>n</i>	$\bar{x}$ and 95% C.I. (kg)
June	1,499	41.10 $\pm$ 0.54	128	29.77 $\pm$ 1.41
July	743	34.04 $\pm$ 0.42	376	31.49 $\pm$ 0.70
Aug.	1,481	35.62 $\pm$ 0.30	551	31.05 $\pm$ 0.57
Sept.	305	36.46 $\pm$ 0.34	118	30.19 $\pm$ 1.36
July-Sept.	2,529	35.26 $\pm$ 0.23	1,045	31.11 $\pm$ 0.42

<sup>1</sup>Pregnant (prepartum) females. Body mass does not include fetal mass.

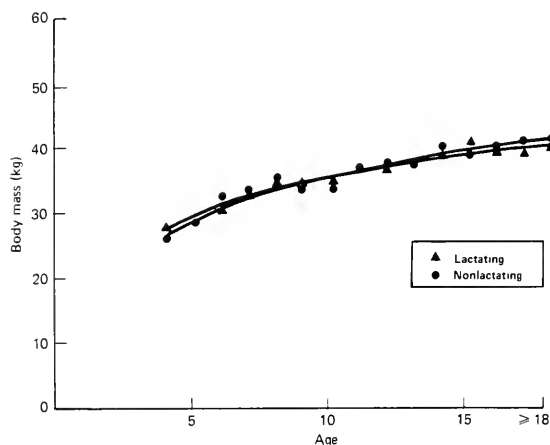

FIGURE 2.—Mean body mass (minus stomach contents mass) of lactating and nonlactating female northern fur seals by age taken pelagically in the eastern Bering Sea and western Alaska during July-September 1958-74.

on data for pregnant females, after excluding fetal mass, which we used to represent body mass of lactating females prior to parturition. Figure 3 shows that this loss in body mass occurred for all ages.

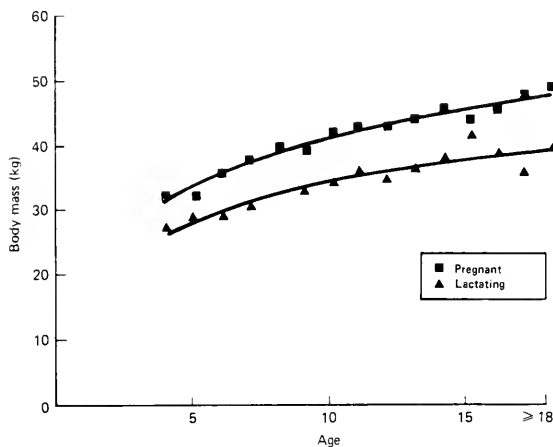

FIGURE 3.—Mean body mass (minus stomach contents and fetal mass) of pregnant (prepartum) and lactating (postpartum) female northern fur seals by age taken pelagically in the eastern Bering Sea and western Alaska during June and July respectively (1958-74).

## Relative Food Intake

We found a significant difference ( $P < 0.05$ ) in the relative magnitude of food consumption between lactating and nonlactating female northern fur seals during July-September, but not October, and Figure 4 shows the relative percentage frequency of the number of lactating and nonlactating adult females showing different masses of stomach contents during July-September (pooled data). It is apparent that a greater proportion of lactating females contained food in their stomachs. Lactating females significantly ( $P < 0.001$ ) ingested more food because they had lower cumulative percentages of empty stomachs and stomachs with smaller quantities of food than did nonlactating females.

Table 2 presents the results of analyses between lactating and nonlactating females for the July-September period by time of collection during the day. Our calculated values of the index of relative food intake after sunrise were 162% during 0-3 h, 166% during 4-7 h, 537% during 8-11 h, and 585% during 12-15 h ( $P < 0.05$ ). The calculated index values during 8-15 h after sunrise are excessive, presumably an artifact of food digestion in the stomach.

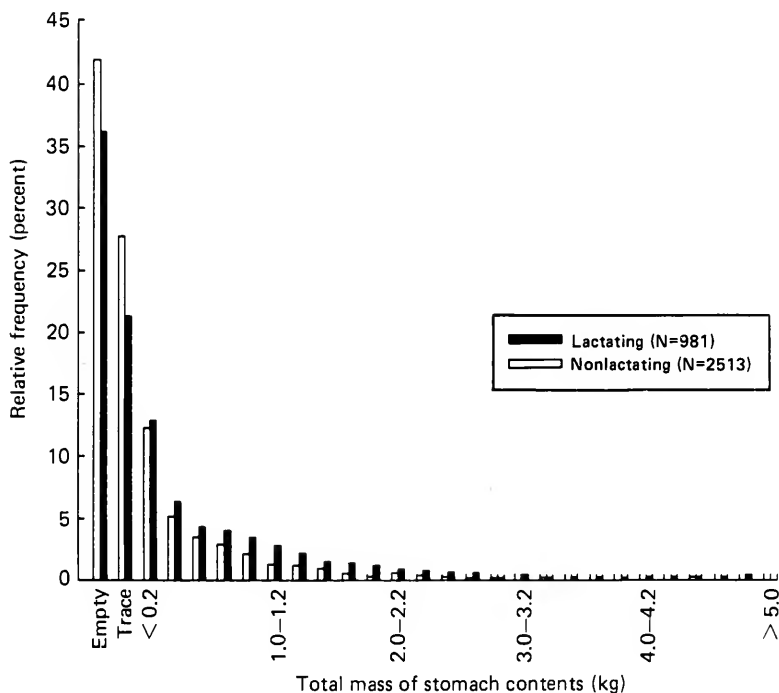

FIGURE 4.—The relative percentage frequency of lactating and nonlactating female northern fur seals (age  $\geq 4$  yr) by total mass of stomach contents during July-September.

TABLE 2.—Body mass and arcsine transformed mass of stomach contents (expressed as a percentage of body mass) for lactating (LACT) and nonlactating (NON) female northern fur seals (age  $\geq 4$  yr) by hour of collection after sunrise during July-September 1958-74. The relative consumption index (percentage expression of the ratio of the proportion of body mass which was stomach contents for lactating females relative to that for nonlactating females) is also given.

Hours after sunrise	Reproductive condition	n	Body mass (kg) $\bar{x}$ and 95% C.I.	Mass of stomach contents as percentage of body mass			Relative consumption index (%)	P <sup>1</sup>
				Arcsine units		Percentage units		
				$\bar{x}$	SE	$\bar{x}$		
0-3	LACT	312	35.7 $\pm$ 0.7	1,355.81	57.24	1.558	161.6	<0.05
	NON	108	31.4 $\pm$ 1.5	997.74	83.33	0.964		
4-7	LACT	1,070	35.5 $\pm$ 0.4	623.22	25.86	0.333	165.7	<0.05
	NON	381	31.1 $\pm$ 0.7	453.29	35.42	0.201		
8-11	LACT	906	35.0 $\pm$ 0.4	408.80	24.46	0.145	537.0	<0.05
	NON	365	31.4 $\pm$ 0.7	167.27	20.22	0.027		
12-15	LACT	225	34.6 $\pm$ 0.7	415.60	47.64	0.152	584.6	<0.05
	NON	127	30.5 $\pm$ 1.2	161.66	36.38	0.026		

<sup>1</sup>Significance levels for comparisons between the mean proportions of body mass which was stomach contents (arcsine units) for lactating and nonlactating females were determined by *t* tests.

To derive a single index value for relative food consumption between lactating and nonlactating females, we performed alternative calculations. In this case we did not simply pool data because that would not adequately account for digestion trends. Northern fur seals feed primarily at night or in the early morning hours (Fiscus et al. 1964; Gentry et al. in press); therefore, we considered the value at 0-3 h after sunrise (0.96; Table 2) as the relative daily quantity of stomach contents for nonlactating seals. Feeding more than once a day to satisfy only energy needs of maintenance and routine activity should be done by all fur seals, and would already be included in these results (Table 2) when the inherent relative rate of digestion is examined. However, lactating females require additional food intake for milk production, and we added an increment (0.12) to the value observed at 0-3 h after sunrise (1.56; Table 2) to calculate an adjusted index of 1.68% of body mass. This incremental value was derived first by calculating the rate of decrease between data values for partially digested stomach contents at the different hourly time intervals. We assumed the rate of digestion throughout the day was the same for lactating females as that observed for nonlactating females. Next, keeping the value for lactating females at 0-3 h after sunrise (1.56) as constant, we summed the absolute value of the differences between the expected values for remaining stomach contents and the observed values in Table 2 to obtain a value of 0.12. We then calculated a value of 174% as our index of relative food intake (i.e., the ratio of 1.68 for lactating females relative to 0.96 for nonlactating females) for a typical foraging day.

However, because females do not feed every day during the breeding season (Bartholomew and Hoel 1953; Peterson 1968; Gentry and Holt in press), the average daily feeding rate (adjusted for percentage of time feeding at sea) for lactating seals is 1.6 times that for nonlactating seals during July-September, i.e., the increased cost of lactation is +59.8%.

### Estimated Energy and Food Requirements

Lactating and nonlactating female northern fur seals consumed the same species of prey in relatively similar proportions within their diet, when feeding in the same general area at the same time during 1958-74. Ranks of importance of prey to the diet were significantly correlated ( $P < 0.05$ ); the percent similarity of relative prey importance by percent modified volume was 80%; and there was no significant difference in the frequency of food stomachs containing fish or squid. Being culled from the same region and for the same season, data for all adult females were pooled.

We derived a gross energy estimate of 1.40 kcal/g as the average energetic density of northern fur seal prey during July-September based on their relative dietary importance and information in the literature on their energy content (Table 3). Using the data on seal body mass (Table 1) and increased cost of lactation (+59.8%), we calculated average daily feeding rates of 18.2% (6.42 kg) and 11.4% (3.55 kg) of total body mass, respectively, for the average lactating and nonlactating adult female. This represents daily energy consumption requirements of



TABLE 3.—Relative dietary importance, energy value and average daily consumption of prey by individual lactating and nonlactating female northern fur seals (age  $\geq 4$  yr) in the eastern Bering Sea during July-September.

Prey	Relative dietary importance (%) <sup>1</sup>	Energy (kcal/g) <sup>2</sup>	Relative energy value in diet (%) <sup>3</sup>	Estimated average consumption			
				Biomass (kg/d)		Energy (kcal/d)	
				Lactating	Nonlactating	Lactating	Nonlactating
Pacific herring	7.67	42.17	11.95	0.49	0.27	1,070	590
Salmonids	1.87	52.01	2.69	0.12	0.06	240	130
Capelin	14.85	61.31	14.00	0.95	0.53	1,250	690
Deepsea smelt	3.30	70.76	1.81	0.21	0.12	160	90
Walleye pollock	36.11	61.41	36.51	2.32	1.28	3,270	1,800
Atka mackerel	1.05	81.58	1.19	0.07	0.04	110	60
Pacific sand lance	0.43	51.22	0.38	0.03	0.02	40	20
Flounders	1.10	51.20	0.94	0.07	0.04	80	50
Subtotal (fish)	66.38	91.46	69.47	4.26	2.36	6,220	3,430
Gonatid squid	33.62	101.27	30.53	2.16	1.19	2,740	1,510
Total	100.0	91.40	100.00	6.42	3.55	8,960	4,940

<sup>1</sup>Percent modified volume of stomach contents data collected during 1958-74.

<sup>2</sup>For some species, data were derived from results of proximate analyses on muscle tissue composition using energetic density factors of 9.50, 5.65 and 4.00 kcal/g (gross energy), respectively for fat, protein, and carbohydrate (Watt and Merrill 1963). Data for other species were based on bomb calorimetry analyses of whole specimens.

<sup>3</sup>Derived by multiplying columns 1 and 2, and summing to 100%.

<sup>4</sup>Based on proximate analysis data for Pacific herring, *Clupea harengus pallasi*, in Bigg et al. (1978).

<sup>5</sup>Based on proximate analysis data for salmonids (Salmonidae); Pacific sand lance, *Ammodytes hexapterus*; and flounders (Pleuronectidae) in Sidwell (1981).

<sup>6</sup>Based on data from heat of combustion in analyses of whole fish specimens of capelin, *Mallotus villosus*, and walleye pollock, *Theragra chalcogramma* [Miller, L. K. 1978. Energetics of the northern fur seal in relation to climate and food resources of the Bering Sea. U.S. Mar. Mammal Comm. Rep. MMC-75/08, 27 p.]

<sup>7</sup>Based on proximate analysis data for deepsea smelt (Bathylagidae) in Childress and Nygaard (1973).

<sup>8</sup>Based on proximate analysis data for Atka mackerel, *Pleurogrammus monopterygius*, in Kizevetter (1971).

<sup>9</sup>Average value of prey species in diet adjusted by their relative dietary importance.

<sup>10</sup>Perez, M. A. 1984. Unpubl. data. Northwest and Alaska Fish. Cent. Natl. Mar. Mammal Lab., Natl. Mar. Fish. Serv., NOAA, 7600 Sand Point Way NE., Seattle, WA 98115.

8,960 kcal and 4,940 kcal for the average, individual lactating and nonlactating adult female northern fur seal during July-September (Table 3). Average postpartum females not in a lactating state would have a daily energy consumption requirement of 5,430 kcal or feeding rate of 11.0% (3.89 kg) of total body mass.

Table 3 also provides estimates for each food item of the total energy and biomass consumed daily by the average individual adult female. Lactating females each consume about 6,220 kcal/d gross energy (4.3 kg/d) of fish and 2,740 kcal/d gross energy (2.2 kg/d) of squid, and each nonlactating individual consumes about 3,430 kcal/d gross energy (2.4 kg/d) of fish and 1,510 kcal/d gross energy (1.2 kg/d) of squid. Female northern fur seals are not able to feed every day, and thus estimated consumption for the average foraging day is 8,980 kcal/d gross energy (6.1 kg/d) of fish and 3,950 kcal/d gross energy (3.1 kg/d) of squid by lactating seals, and 4,530 kcal/d gross energy (3.1 kg/d) of fish and 1,990 kcal/d gross energy (1.6 kg/d) of squid by nonlactating females.

We also calculated estimates of the total energy in biomass consumed by all adult females during July-September in the eastern Bering Sea (Table 4).

Because the northern fur seal population has been declining in recent years (North Pacific Fur Seal Commission 1984) we used 80% of the estimated population values given by Lander (1981):  $2.61 \times 10^5$  pregnant/postpartum and  $1.19 \times 10^5$  nonpregnant adult females (age  $\geq 4$  yr). We assumed all of these seals are present in the eastern Bering Sea during this period. Because 5% of the pups born on St. Paul Island, Pribilof Islands, between 1975 and 1982 died on the rookeries during July and August (Kozloff 1985), we modified our calculations to reflect the number of postpartum females which are nonlactating. We thus estimated a total of  $2.48 \times 10^5$  lactating and  $1.32 \times 10^5$  nonlactating adult females (age  $\geq 4$  yr). Multiplying individual estimates by these population totals, lactating females consume an estimated collective total of  $204.5 \times 10^9$  kcal gross energy ( $146.5 \times 10^3$  t) and nonlactating females consume an estimated collective total of  $60.2 \times 10^9$  kcal gross energy ( $43.1 \times 10^3$  t) of food. Therefore, all adult female northern fur seals consume an estimated collective biomass of  $189.6 \times 10^3$  t with a gross energy value of  $264.7 \times 10^9$  kcal during July-September, of which 69.4% of this energy ( $183.7 \times 10^9$  kcal;  $125.9 \times 10^3$  t) are fish and 30.6% ( $81.0 \times 10^9$  kcal;  $63.7 \times 10^3$  t) are squid.

TABLE 4.—Estimated energy value and consumption of fish and squid by the total population of lactating and nonlactating female northern fur seals (age  $\geq 4$  yr) during July-September (92 days).

Prey	Energy (kcal/g) <sup>1</sup>	Lactating females			Nonlactating females		
		Individual average consumption (kg/d) <sup>1</sup>	Total seasonal consumption by population ( $2.48 \times 10^5$ )		Individual average consumption (kg/d) <sup>1</sup>	Total seasonal consumption by population ( $1.32 \times 10^5$ ) <sup>2</sup>	
			Biomass ( $\times 10^3$ t)	Energy ( $\times 10^9$ kcal)		Biomass ( $\times 10^3$ t)	Energy ( $\times 10^9$ kcal)
Fish	1.46	4.26	97.2	141.9	2.36	28.7	41.8
Squid	1.27	2.16	49.3	62.6	1.19	14.4	18.4
Total	1.40	6.42	146.5	204.5	3.55	43.1	60.2

<sup>1</sup>From Table 3.<sup>2</sup>Includes postpartum females that fail to lactate.

## DISCUSSION

The food consumption data presented in Table 2 were based on partially digested stomach contents, and thus underestimate the actual feeding rates of adult female northern fur seals. It is apparent from these data that lactating seals obtain most of their energy needs by filling their stomachs slightly more than the nonlactating seals early in the day and by eating additional food later in the day. Any female, whether lactating or not, may eat more than once during the day, as captive northern fur seals often do (Spotte 1980). Females must feed more than once during the 24-h period (on those days when they are able to feed) to meet their daily food requirements because the maximum observed stomach contents by percentage of body mass during July-September 1958-74 were 13.8 and 8.2%, respectively, for lactating and nonlactating females (Perez<sup>3</sup>), which are less than their predicted feeding rates. In addition, digestion does vary among individual seals and with the type and amount of prey eaten (Bigg and Fawcett 1985). However, the data in Table 2 should be typical of the relative relationship between lactating and nonlactating females if actual feeding rates could be measured for free-ranging seals.

Lactating northern fur seals were estimated to consume 8,960 kcal/d (gross energy), of which 3,520 kcal/d (gross energy) represent the additional intake of food related to lactation. Energy expenditures for maintenance and routine activity not directly attributable to lactation were estimated to be 5,440 kcal/d (gross energy). This estimate is about 5.4 times the amount predicted (1,010 kcal/d metabolizable energy or 49.0  $W$ ) for basal metabolism by the relationship between metabolic rate ( $MR$ ) in watts

( $W$ ) and body mass ( $M$ ) shown by Kleiber (1961) ( $MR$  ( $W$ ) =  $3.39 M^{0.75}$ ).

These estimates are not typical of energy expenditure during the first week (7.4 d average) postpartum, a period during which the parturient female does not feed. Lactating seals must metabolize their energy from fat reserves during this period (including the day before parturition when they usually do not feed, although we considered only the postparturition period). The loss in body mass (Table 1) in postpartum females following parturition accounts for some of this metabolism of energy from fat reserves. This loss includes about 0.6 kg (12% of pup mass as in harp seals, Lavigne and Stewart 1979) of placental matter and 3.3 kg (7% preparturient female mass) of amniotic and other fluids during parturition (Costa and Gentry in press). There is a calculated net mass loss of 3.2 kg. Loss of body water, as has been reported for some mammals, e.g., cattle (Degen and Young 1980) is also probably part of this loss. In addition, this loss includes the utilization of fat reserves to satisfy energy requirements for lactation (Sadleir 1969) during the first few days of the pup's life, a period when parturient females remain on shore and do not feed (Bartholomew and Hoel 1953; Peterson 1968; Gentry and Holt in press).

Our estimate of net mass loss, presumably through fat metabolism, is an underestimate because it was derived from mean body mass data from seals taken at sea, and, therefore, includes lactating animals which probably regained some body mass after their first foraging trip at sea. Costa and Gentry (in press) measured an average of 8.75 kg of mass loss, presumably by tissue metabolism and water loss, prior to the female's initial departure to sea, after which they gained additional body mass. This situation is analogous to that in gray seals. The gray seal does not feed during its entire 18-d lactation period from parturition to weaning (Amoroso and Mat-

<sup>3</sup>Perez, M. A. 1981. Unpubl. data. Northwest and Alaska Fish. Cent. Natl. Mar. Mammal Lab., Natl. Mar. Fish. Serv., NOAA, 7600 Sand Point Way NE, Seattle, WA 98115.

thews 1951, 1952) and over 80% of the female's stored energy reserves are used to feed their pup (Fedak and Anderson 1982).

We conducted similar analyses of data comparing pregnant and nonpregnant adult females (age  $\geq 4$  yr) during June-July, but we did not find any significant difference in relative feeding rates. We, therefore, conclude that the onset of the lactation process, and not pregnancy, initiates increased feeding behavior in parturient fur seals. Pregnant northern fur seals presumably consume more food than required by nonpregnant females (i.e., more than that simply required as a function of body mass). This would be necessary for growth of the fetus, especially during winter and spring months when they are in the North Pacific. This conclusion was based on a preliminary examination of the pelagic fur seal data, although the results were not statistically conclusive. Female northern fur seals probably also store energy in fat reserves for the stresses of birth and the first week of lactation. Nevertheless, any additional food intake required by pregnant females is substantially less than that of lactating seals.

We believe lactating females may reduce their need for additional food intake during the last month prior to weaning of pups because we did not find a significant difference in food consumption between lactating and nonlactating females during October; however, data were few. Weaning does not occur until late October or early November when females abandon their pups; the mean date of weaning is about 2 November (Peterson 1968). It should be noted that births occur over at least a 30-d period (Peterson 1968), and weaning of individual pups will likewise occur over a similar time frame. It is thus possible that pups born earlier will quit nursing earlier than those born later in the season. The total lactation period is about 3-5 mo. Therefore, the feeding rate relationships and energy estimates presented in this paper should typify those during the first three months of lactation only, and not necessarily during July-September.

We assumed that all postpartum females taken during 1958-74 were lactating. We believe that this assumption does not significantly affect our results because only a small percentage of the postpartum females fail to lactate or terminate lactation for one reason or another (such as still birth or death of the pup). Therefore, our estimate of the difference in consumption between lactating and nonlactating females is a conservative indicator of the magnitude of this ratio. This is because inclusion of postpartum females that did not lactate would have decreased

the mean value of stomach contents for the lactating group.

Individual northern fur seals show variations in their feeding locations. Differences may occur over location and time. For example, lactating females may travel great distances, e.g., at least 160 km from the Pribilof Islands (Perez<sup>4</sup>), during their sea trips in search of food, and they may dive up to 200 m (Gentry et al. in press) to catch prey. There are, of course, differences in availability (e.g., walleye pollock, *Theragra chalcogramma*, Smith and Bakala 1982) and energetic density (e.g., Pacific herring, *Clupea harengus pallasii*, Bigg et al. 1978; deepsea smelt, Bathylagidae, Childress and Nygaard 1973) of prey by season, region, and depth. The 95% C.I. for the importance of fish biomass in the fur seal diet in the Bering Sea is 64.0-68.6% (Perez and Bigg<sup>5</sup>). Therefore, the estimated quantity of fish and squid consumed, and their relative energy contribution, may vary  $\pm 5\%$ .

It should also be stressed that the estimates presented in this paper also depend heavily on metabolic rate information for adult females which we obtained from the literature. Individual variations among seals will cause differences in results obtained from several experiments, and future research may provide somewhat different metabolic rates. Should feeding rates be revised substantially, then the magnitude of energetic estimates from these data will be affected in a corresponding direction. However, the relative ratio of food consumption between lactating and nonlactating females during the breeding season will be unaffected, and remain about 1.6. We suggest the need for further studies on feeding behavior and energetics of lactating females and pups prior to weaning.

## ACKNOWLEDGMENTS

We thank Michael Bigg and Peter Olesiuk of the Pacific Biological Station, Nanaimo, B.C.; Daniel Costa of the University of California at Santa Cruz, and Roger Gentry and the late Mark Keyes of the National Marine Mammal Laboratory, Seattle, WA, for valuable information on the biology and behavior of fur seals. We also thank Charles Fowler and

<sup>4</sup>Perez, M. A., Northwest and Alaska Fisheries Center National Marine Mammal Laboratory, National Marine Fisheries Service, NOAA, 7600 Sand Point Way NE, Seattle WA 98115, pers. observ., 1984.

<sup>5</sup>Perez, M. A., and M. A. Bigg. 1984. Food habits of northern fur seals (*Callorhinus ursinus*) off western North America. Unpubl. rep., 67 p. Northwest and Alaska Fish. Cent. Natl. Mar. Mammal Lab., Natl. Mar. Fish. Serv., NOAA, 7600 Sand Point Way NE, Seattle, WA 98115.

Thomas Loughlin for constructive criticism of the draft manuscript. We are grateful to Teresa Clocksin, Carol Hastings, Sherry Pearson, James Kenagy, and George Antonelis, Jr., for comments, suggestions, and technical assistance.

## LITERATURE CITED

- AMOROSO, E. C., AND L. H. MATTHEWS.  
1951. The growth of the grey seal (*Halichoerus grypus*) from birth to weaning. *J. Anat.* 85:427-428.  
1952. Reproduction and lactation in the seal. *Proc. Int. Congr. Anim. Reprod. Artif. Insemin.* 1:193-203.
- BALDWIN, R. L., JR.  
1978. The initiation and maintenance of lactation. *In* A. Yokoyama, H. Mizuno, and H. Nagasawa (editors), *Physiology of mammary glands*, p. 5-19. *Jpn. Sci. Soc. Press*, Tokyo.
- BARTHOLOMEW, G. A., AND P. G. HOEL.  
1953. Reproductive behavior of the Alaska fur seal, *Callorhinus ursinus*. *J. Mammal.* 34:417-436.
- BIGG, M. A., AND I. FAWCETT.  
1985. Two biases in diet determination of northern fur seals (*Callorhinus ursinus*). *In* J. R. Beddington, R. J. H. Beverton, and D. M. Lavigne (editors), *Marine mammals and fisheries*, p. 284-291. George Allen and Unwin, Publ., Lond.
- BIGG, M. A., I. B. MACASKIE, AND G. ELLIS.  
1978. Studies on captive fur seals. *Progress rep. 2. Can. Fish. Mar. Serv. Manuscr. Rep.* 1471, 21 p.
- BIGG, M. A., AND M. A. PEREZ.  
1985. Modified volume: a frequency-volume method to assess marine mammal food habits. *In* J. R. Beddington, R. J. H. Beverton, and D. M. Lavigne (editors), *Marine mammals and fisheries*, p. 277-283. George Allen and Unwin, Publ., Lond.
- BRODY, S.  
1945. *Bioenergetics and growth*. Reinhold, N.Y., 1023 p.
- CHILDRESS, J. J., AND M. H. NYGAARD.  
1973. The chemical composition of midwater fishes as a function of depth of occurrence off Southern California. *Deep-Sea Res.* 20:1093-1109.
- COCHRAN, W. G.  
1977. *Sampling techniques*. 3d ed. John Wiley and Sons, N.Y., 428 p.
- COSTA, D. P., AND R. L. GENTRY.  
*In press*. Free-ranging energetics of the northern fur seals. *In* R. L. Gentry and G. L. Kooyman (editors), *Fur seals: Maternal strategies on land and at sea*, p. 79-101. Princeton Univ. Press, Princeton, NJ.
- DEGEN, A. A., AND B. A. YOUNG.  
1980. Live-weight, total body-water and maternal body-solid changes in pregnant and lactating beef cows. *J. Agric. Sci.* 95:1-5.
- EAGLES, J. A., AND M. N. RANDALL.  
1980. *Handbook of normal and therapeutic nutrition*. Raven Press, N.Y., 323 p.
- ENGELS, E. A. N., AND A. MALAN.  
1979. Feed intake of non-pregnant, pregnant and lactating ewes on native pasture and lucerne hay. *S. Afr. J. Anim. Sci.* 9:27-32.
- FEDAK, M. A., AND S. S. ANDERSON.  
1982. The energetics of lactation: accurate measurements from a large wild mammal, the grey seal (*Halichoerus grypus*). *J. Zool. (Lond.)* 198:473-479.
- FISCUS, C. H., G. A. BAINES, AND F. WILKE.  
1964. Pelagic fur seal investigations, Alaska waters, 1962. U.S. Fish Wildl. Serv., Spec. Sci. Rep. Fish. 475, 59 p.
- FRITZ, E. S.  
1974. Total diet comparison in fishes by Spearman rank correlation coefficients. *Copeia* 1974:210-214.
- GENTRY, R. L., AND J. R. HOLT.  
*In press*. Attendance behavior of female northern fur seals. *In* R. L. Gentry and G. L. Kooyman (editors), *Fur seals: Maternal strategies on land and at sea*, p. 41-60. Princeton Univ. Press, Princeton, NJ.
- GENTRY, R. L., G. L. KOOYMAN, AND M. E. GOEBEL.  
*In press*. Feeding and diving behavior of northern fur seals. *In* R. L. Gentry and G. L. Kooyman (editors), *Fur seals: Maternal strategies on land and at sea*, p. 61-78. Princeton Univ. Press, Princeton, NJ.
- GOODALL, D. W.  
1973. Sample similarity and species correlation. *In* R. Tuxen (editor), *Handbook of vegetation science, Part 5: Ordination and classification of communities*, p. 105-106. Dr. W. Junk B. V. Publ., The Hague.
- HARRISON, R. J.  
1969. Reproduction and reproductive organs. *In* H. T. Andersen (editor), *The biology of marine mammals*, p. 253-348. Acad. Press, N.Y.
- KIZEVETTER, I. V.  
1971. Chemistry and technology of Pacific fish. [In Russ.] Dal'izdat, Vladivostok. [Translated by Isr. Program Sci. Transl., 1973, available U.S. Dep. Commer., Natl. Tech. Inf. Serv., Springfield, VA, as TT72-50019, 304 p.]
- KLEIBER, M.  
1961. The fire of life, an introduction to animal energetics. John Wiley and Sons, N.Y., 454 p.
- KLEVEZAL', G. A., AND S. E. KLEINENBERG.  
1967. Age determination of mammals from annual layers in teeth and bones. [In Russ.] Izdatel'stvo "Nauka", Moscow. [Translated by Isr. Program Sci. Transl. 1969, available U.S. Dep. Commer., Natl. Tech. Inf. Serv., Springfield, VA, as TT69-55033, 128 p.]
- KOZLOFF, P. (editor).  
1985. Fur seal investigations, 1982. U.S. Dep. Commer., NOAA Tech. Memo. NMFS F/NWC-71, 127 p.
- LANDER, R. H. (editor).  
1980. Summary of northern fur seal data and collection procedures. Vol. 2: Eastern Pacific pelagic data of the United States and Canada (excluding fur seals sighted). U.S. Dep. Commer., NOAA Tech. Memo. NMFS F/NWC-4, 541 p.
- LANDER, R. H.  
1981. A life table and biomass estimate for Alaskan fur seals. *Fish. Res.* 1:55-70.
- LAVIGNE, D. M., AND R. E. A. STEWART.  
1979. Energy content of harp seal placentas. *J. Mammal.* 60:854-856.
- LAVIGNE, D. M., R. E. A. STEWART, AND F. FLETCHER.  
1982. Changes in composition and energy content of harp seal milk during lactation. *Physiol. Zool.* 55:1-9.
- LOCKYER, C.  
1978. A theoretical approach to the balance between growth and food consumption in fin and sei whales, with special reference to the female reproductive cycle. *Int. Whaling Comm. Rep. Comm.* 28:243-249.
- 1981a. Growth and energy budgets of large baleen whales from the Southern Hemisphere. *In* *Mammals in the seas; 3, General papers and large cetaceans*, p. 379-487. FAO

- Fish. Ser. 5, Vol. 3.
- 1981b. Estimates of growth and energy budget for the sperm whale, *Physeter catodon*. In Mammals in the seas; 3, General papers and large cetaceans, p. 489-504. FAO Fish. Ser. 5, Vol. 3.
- 1981c. Estimation of the energy costs of growth, maintenance, and reproduction in the female minke whale, (*Balaenoptera acutorostrata*), from the Southern Hemisphere. Int. Whaling Comm. Rep. Comm. 31:337-343.
- MILLAR, J. S.
1978. Energetics of reproduction in *Peromyscus leucopus*: the cost of lactation. Ecology 59:1055-1061.
- NORTH PACIFIC FUR SEAL COMMISSION.
1984. Proceedings of the 27th annual meeting. North Pac. Fur Seal Comm., Wash., D.C., 50 p.
- PETERSON, R. S.
1968. Social behavior of pinnipeds with particular reference to the northern fur seal. In R. J. Harrison, R. C. Hubbard, R. S. Peterson, C. E. Rice, and R. J. Schusterman (editors), The behavior and physiology of pinnipeds, p. 3-53. Appleton-Century-Crofts, N.Y.
- SADLEIR, R. M. F. S.
1969. The ecology of reproduction in wild and domestic mammals. Methuen and Co., Lond., 321 p.
- SCHUTZ, Y., A. LECHTIG, AND R. B. BRADFIELD.
1980. Energy expenditures and food intakes of lactating women in Guatemala. Am. J. Clin. Nutr. 33:892-902.
- SIDWELL, V. D.
1981. Chemical and nutritional composition of finfishes, whales, crustaceans, mollusks, and their products. U.S. Dep. Commer., NOAA Tech. Memo. NMFS F/SEC-11, 432 p.
- SIEGEL, S.
1956. Nonparametric statistics for the behavioral sciences. McGraw-Hill, N.Y., 312 p.
- SMITH, G. B., AND R. G. BAKKALA.
1982. Demersal fish resources of the eastern Bering Sea: spring 1976. U.S. Dep. Commer., NOAA Tech. Rep. NMFS SSRF-754, 129 p.
- SNEDECOR, G. W., AND W. G. COCHRAN.
1980. Statistical methods. 7th ed. Iowa State Univ. Press, 507 p.
- SPOTTE, S.
1980. Acclimation of adult northern fur seals (*Callorhinus ursinus*) to captivity. Cetology 36:1-8.
- SPOTTE, S., AND B. BABUS.
1980. Does a pregnant dolphin (*Tursiops truncatus*) eat more? Cetology 39:1-7.
- STEBBINS, L. L.
1977. Energy requirements during reproduction of *Peromyscus maniculatus*. Can. J. Zool. 55:1701-1704.
- STUDIER, E. H., V. L. LYSENGEN, AND M. J. O'FARRELL.
1973. Biology of *Myotis thysanodes* and *M. lucifugus* (Chiroptera: Vespertilionidae)—II: Bioenergetics of pregnancy and lactation. Comp. Biochem. Physiol. 44A:467-471.
- WATT, B. K., AND A. L. MERRILL.
1963. Composition of foods...raw, processed, prepared. U.S. Dep. Agric., Agric. Handb. 8, 190 p.
- ZAR, J. H.
1974. Biostatistical analysis. Prentice Hall, Englewood Cliffs, NJ, 620 p.



# ARRIVAL OF NORTHERN FUR SEALS, *CALLORHINUS URSINUS*, ON ST. PAUL ISLAND, ALASKA

MICHAEL A. BIGG<sup>1</sup>

## ABSTRACT

The age-specific arrival times and relative numbers of northern fur seals, *Callorhinus ursinus*, on St. Paul Island, Alaska, were determined from an analysis of kill data collected during 1956-82, and a review of the fur seal literature. Arrival times differed by sex, age, and reproductive state. Arrival took place progressively earlier with age in young males and females. Most males age  $\geq 6$  arrived by late June, while most males age 5 arrived by late June to early July, those age 4 by mid-July, those age 3 by late July, those age 2 by mid- to late August, and those age 1 by late September to early October. Females tended to arrive later than males of the same age. Nonpregnant females age  $\geq 3$  arrived by mid-August, while those age 2 arrived by mid- to late September, and females age 1 by October to early November. Pregnant females age  $\geq 4$  arrived mainly by mid-July, about 1 month before nonpregnant females of the same age. For both sexes, the number of seals returning increased between age 1 and age 3. Both sexes appeared to stop arriving earlier and in larger numbers at about the age of sexual maturity. The process of gradual maturation may play a role in inducing a cohort to undertake the return migration at earlier times with age, and to cause a greater proportion to return.

The northern fur seal, *Callorhinus ursinus*, inhabits the North Pacific Ocean mainly between lat. 32°N and 60°N (Fiscus 1978; King 1983). The species is migratory, being pelagic and widely dispersed in winter, and gathering on rookeries to give birth, mate, nurse, and rest in summer. Rookeries occur along the Asian coast on Robben, Kurile, and Commander Islands, and along the North American coast mainly on the Pribilof Islands and on San Miguel Island. The presence of large numbers of animals on Robben Island, Commander Islands, and the Pribilof Islands has allowed an annual commercial kill for pelts over many years.

The Pribilof Islands, in particular St. Paul Island and St. George Island has the largest stock of seals, numbering currently about 0.9 million (North Pacific Fur Seal Commission 1984a). The species has been harvested there almost every year since discovery in 1786 (Roppel and Davey 1965; Roppel 1984). Over the years, fishery managers learned to adjust the kill quite specifically for seals of a particular age and sex by making use of the arrival sequence of migrants and their preferences for haul-out sites. For example, Russians in the early 1800's took juvenile males on hauling grounds, and left the breeding adults and pups undisturbed on nearby rookeries. Americans in the late 1800's knew that the largest, and thus oldest, juvenile males arrived before small males (Jordan and Clark 1898). Follow-

ing the discovery in 1950 that teeth could be used for aging, the kill was refined further to focus on 3- and 4-yr-old males. Although the kill has been directed primarily at young males since the early 1900's, females were taken during a herd reduction program from 1956 to 1968.

Behavioral studies on the Pribilof Islands have documented the arrival times for broad population categories, such as adult and juvenile males, and pregnant females (Jordan and Clark 1898; Bartholomew and Hoel 1953; Peterson 1965, 1968; Gentry 1981). However, these studies could not determine the age-specific arrival times because no method was available to distinguish the age of the live animals being observed. The widely accepted arrival sequence was for bulls to arrive on land first, followed by progressively younger males, progressively younger pregnant females, and later by mostly young nonpregnant cows (Kenyon and Wilke 1953; Fiscus 1978). This arrival sequence was deduced from preliminary examinations of the age and sex composition of commercial kills and from the arrival times of tagged individuals and to some extent from differences in body size, at least for the 1- and 2-yr-olds. There are no published analyses that describe age-specific arrival times, although some unpublished reports give information on arrival times.

In this study, I determine the arrival times for seals of each age, sex, and reproductive condition on hauling grounds and rookeries of St. Paul Island, the largest of the Pribilof Islands. The study is based

<sup>1</sup>Department of Fisheries and Oceans, Pacific Biological Station, Nanaimo, British Columbia, Canada V9R 5K6.

mainly on an analysis of seasonal changes in the number of animals killed of each age during harvests. I examine the evidence for arrival times by order of decreasing age within each sex, and compare the relative numbers returning for each age of young seals. The published and unpublished literature on northern fur seals is reviewed for information on arrival times and abundance. The relationship between arrival schedules, relative number returning, and onset of sexual maturity is discussed.

## METHODS

The kill data from St. Paul Island used in this study were collected during 1956-82 by the National Marine Mammal Laboratory, National Marine Fisheries Service, Seattle. Most data up to 1979 were listed by Lander (1980), who noted the method of data collection and the number killed by age, sex, date, and location. Kozloff (1981<sup>2</sup>, 1982, 1983) listed the data collected during 1980-82. Abegglen et al. (1956, 1957, 1958, 1959) determined the age-specific pregnancy rates of females killed during 1956-59. These authors considered a female to be pregnant when parous (carrying a term fetus), or recently postpartum (lactating or uterus involuting). They did not separate females into these two categories, or determine whether postpartum females were carrying a new conceptus.

Almost all males and females were killed on hauling grounds rather than on rookeries. No commercial kills for males took place on rookeries, and only a few took place for females. Typically, the kill of both sexes on hauling grounds was made between late June and mid-August. It consisted of a series of consecutive 5-d circuits, or rounds, of all hauling ground sites. During each round, a crew undertook one killing operation at each site, and killed all seals present of a particular sex and length. The body length limits for harvesting were set in inches (in) from nose to tip of tail, or from nose to base of tail. I converted all lengths to cm and standard length, using 1 in for tail length. Lander (1980) and the North Pacific Fur Seal Commission (1984b) noted the annual changes in management practices on St. Paul Island. The changes included variations in body length limits, kill dates, quotas, kill locations, and special kills for sex and age. I used only data that were collected under comparable management restrictions.

Probit plots of age-specific cumulative length frequencies were used to determine the percentage of males and females of each age present in the kill for each set of length limits. Sufficient age-length data were not available for the plots from kills made on St. Paul Island, but were available from samples collected pelagically for research purposes by the United States and Canada under the terms of the North Pacific Fur Seal Commission. These data are on file at the Pacific Biological Station, Nanaimo, and at the National Marine Mammal Laboratory, Seattle. The age-length data used were from seals collected near St. Paul Island during June-August 1958-74. The lengths of females used were those of postpartum and nonpregnant seals, the main categories of females killed on land.

I assumed that seals were arriving on St. Paul Island when the number killed increased in successive rounds and that arrival was completed when the number killed reached an asymptote. These assumptions were valid only under certain circumstances. One was that all seals encountered of a designated sex and length were killed, which was the case. Another was that the number of seals hauled out, and thus available for killing, was a constant proportion of the number alive through the harvest season. The assumption seems reasonable in that Gentry (1981) estimated an average of about 19% of marked juvenile males were ashore at any one time on St. George Island. Finally, the proportion of a particular age and sex killed during each year must have been sufficiently small so as not to have substantially reduced cohort size, and thus altered the trend in numbers killed by round. This qualification was probably true for all ages, except perhaps for 4-yr-old males. Lander (1981) estimated the harvest utilization rate of males on St. Paul Island to be only 2.8% for age 2, 40.3% for age 3, 14.7% for age 5, but 57.3% for age 4. Escapement rates of females from the commercial harvest were not calculated, but were probably high. The females killed were mainly of ages 3 and 4 with the largest annual take for age 3 in the years studied being 9,700, and for age 4 being 6,300. These figures compared with about 55,000 and 48,000, respectively, for females present in the whole population, based on Lander's (1981) life table for the species.

The number killed of each age up to the last day of each round for each year was plotted to describe the seasonal change in numbers killed. For males, the most common last-day dates for each round were in the series of 5-d rounds ending between 1 July and 5 August. For years in which the dates for last-day rounds differed from this series, the number of

<sup>2</sup>P. Kozloff (editor). 1981. Fur seal investigations, 1980. NWAFC Processed Rep., 96 p. National Marine Mammal Laboratory, National Marine Fisheries Service, NOAA, Seattle.



males killed was interpolated from the annual plots, so as to standardize the number killed by date. The mean number of males killed, and standard error of the mean, were determined for each date of the last-day of rounds. During 1965-72, a kill of males sometimes took place twice at a haul-out site in one round, but was missed at this site in the preceding or following round. In these cases, one of the two kills was selected randomly and transposed to the other round. Occasionally, sites were visited extra times without being missed in the adjacent round. These data were omitted.

The kill data used for females on hauling grounds were from years in which the kills on rookeries and hauling grounds were recorded separately, and in which the pregnancy rates were noted. Such kills took place only during 1956-59. These kills were made during the 5-d rounds with the last-day dates between 1 July and 20 August. The only kills on rookeries for which pregnancy data could be used were in 1956 and 1957. On 1-6 July 1956, a kill was made on Polivina rookery. All kills made in the region of this rookery on 1-21 July 1957 were in fact made only on the rookery (A. Roppel<sup>3</sup>). The number of females killed on rookeries was set by quota, rather than by all available animals being taken, as on hauling grounds. No body length limits were imposed on the kill of females on rookeries in 1956 and 1957.

To determine the relative number of each age that returned to St. Paul Island, I reviewed the largely subjective comments on abundance given in the literature, and also compared the number killed when arrival was believed to have been completed. For the latter, the only data used were from years when body length limits included at least 50% of the individuals of the relevant age and when the total number of living animals of a particular age did not change substantially between years. The main change in herd size was between 1956 and 1959, when pup production on St. Paul Island decreased by about 27% due to the killing of adult females during the herd reduction program (York and Hartley 1981; Fowler 1982). Pup production changed little between 1960 and 1980, although declined slightly in 1981-82. The cumulative effect of harvesting a cohort over several years was considered when comparing the relative number of each age killed. The relative numbers of females of each age killed between 1956 and 1959 were biased slightly downward with time by the herd reduction program during the

intervening years. The bias was only slight because of the years and ages selected for analysis, the lack of time for the herd reduction program to have potentially changed age distribution, and the fact that most seals ages 1 and 2 remained at sea.

## RESULTS

### Effect of Body Length Limits

The lower length limit of 107 cm for males included essentially no individuals age 1, few age 2, but most of those  $\geq 3$  yr (Table 1). The upper length limit varied by year, with the smallest upper limit including a few  $\geq 4$  yr, and the largest, a few  $\geq 6$  yr. I used kill data collected from the years 1969-82 to describe arrival times and relative numbers of males ages 1 and 2. Data from the years 1962-82 were used to describe the arrival time and relative number of 3-yr-olds. For males  $\geq 4$  yr, the relative numbers returning by age could not be compared with one another, or with younger males, because of the cumulative reduction in the size of a cohort by the harvest, and the exclusion of seals by upper length limits. I used data from the years 1963-72 and 1980-82 to describe the arrival schedule for age 4, and 1964-71 for ages 5, 6, and  $\geq 7$ .

The lower length limit of 104 cm for females included most individuals  $\geq 4$  yr, while the upper length limit of 116-117 cm included mostly  $\leq 5$  yr. Data collected in 1956 were used to describe the arrival schedules for females  $\geq 4$  yr, and 1958-59 for those  $\leq 5$  yr. The number of females killed at age 3 during 1959 was not used due to an unusually low pup survival in 1956 (Abegglen et al. 1959; Lander 1979).

### Arrival of Males on Hauling Grounds

#### 1-Year-Olds

No yearling males were taken in the kill by 5 August, and thus none were likely to have been on hauling grounds up to this time. However, few yearling males apparently go to hauling grounds. Osgood et al. (1915) and Roppel et al. (1965a) indicated that yearlings of both sexes preferred rookery edges, near cows and pups, and only occasionally went to hauling grounds (see section on Arrival of Males on Rookeries).

#### 2-Year-Olds

Very few 2-yr-old males arrived by 1 July (Fig.

<sup>3</sup>A. Roppel, Northwest and Alaska Fisheries Center, National Marine Fisheries Service, NOAA, 7600 Sand Point Way N.E., Seattle, WA 98115, pers. commun. July 1983.

TABLE 1.—Percent of each age included in standard length restrictions for kills of male and female northern fur seals on hauling grounds. Percentages determined from Probit plots of age-length cumulative length frequencies of seals collected at sea near St. Paul Island by the United States and Canada. Sample sizes are in parentheses.

Length limit (cm)	Years	Age (yr)						
		1	2	3	4	5	6	≥7
Males								
		(24)	(166)	(251)	(117)	(48)	(20)	(43)
107-119	1956-58, 1960	1.6	27.7	71.0	44.2	5.0	3.0	0.0
107-121	1959	1.6	27.9	76.5	55.7	8.3	4.0	0.0
107-124	1961-63	1.6	28.0	79.5	71.2	15.5	6.5	0.0
107-135	1964-68	1.6	28.0	82.0	96.8	64.0	28.0	≤1.2
1 ≤135	1969-71	100.0	100.0	100.0	98.6	64.0	28.0	≤1.2
≤124	1972, 1980-82	100.0	100.0	97.5	73.0	15.5	6.5	0.0
≤117	1973-75	100.0	99.2	82.0	35.0	3.0	1.5	0.0
≤119	1976-79	100.0	99.5	86.0	40.0	4.0	2.0	0.0
Females								
		(18)	(69)	(297)	(465)	(301)	(136)	(530)
≥104	1956	0.0	16.0	48.0	89.0	97.0	99.4	≥99.9
≤116	1958	100.0	99.8	98.4	80.0	54.0	31.5	≤12.0
≤117	1959	100.0	99.9	99.0	84.0	63.0	40.0	≤16.0

<sup>1</sup>Upper body size was the presence of a mane. A. Roppel (National Marine Mammal Laboratory, National Marine Fisheries Service, NOAA, Seattle, WA 98115, pers. comm. July 1983) felt that the mane developed at a body length of about 135 cm.

1). Numbers began to increase in early July and continued to increase up to 5 August. This age group began to arrive earlier than the yearlings. Osgood et al. (1915) observed the first branded 2-yr-old individuals on 12 June, about 1½ mo before the first branded yearling males on rookeries. As found in the current study, Kenyon and Wilke (1953) noted that 2-yr-olds were quite common by the end of July, and after 1 August became increasingly abundant.

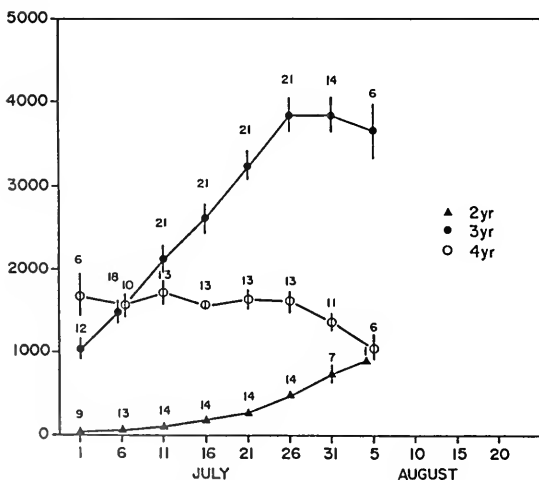

FIGURE 1.—Mean number, and standard error, of northern fur seal males killed of age 2-4 on hauling grounds of St. Paul Island, by date. Data from Lander (1980) and annual reports of the National Marine Mammal Laboratory, Seattle. Number of years of data for each date indicated above means.

The date of peak numbers, and thus the date when most arrived, was probably after early August. The date when most would have arrived may be determined by assuming that the interval between the time when seals clearly began to increase in number and the time when essentially all seals had arrived was the same for 2-yr-olds as for bulls and cows. Observations by Peterson (1968) suggested that this interval was about 1-1½ mo for bulls and pregnant females. Because the number of 2-yr-old males began to increase in early July, the arrival time for most was probably mid- to late August. A similar arrival time was also indicated by subtracting 1-1½ mo, the interval separating the first sightings of tagged yearlings and 2-yr-olds, from the arrival time of late September to early October for yearling males on rookeries.

The number of 2-yr-olds returning appeared to be greater than that for yearlings, but less than that for 3-yr-olds. Roppel (fn. 3) felt that more 2-yr-old males returned than yearling males, and Kenyon et al. (1954) noted that many 2-yr-olds remained at sea.

### 3-Year-Olds

The 3-yr-olds were already quite abundant by 1 July and reached a peak in numbers by late July (Fig. 1), suggesting that arrival was completed by late July. Kenyon and Wilke (1953) similarly noted the maximum number of 3-yr-olds on hauling grounds was after mid-July. This age group

appeared to have the largest number of males returning.

#### 4-Year-Olds

The number of males killed of age 4 remained essentially constant during July, except for a decrease in late July (Fig. 1). Although no distinctive peak in numbers was evident, several factors suggest the main arrival was probably completed by mid-July. First, the number killed in the first round (i.e., up to 1 July) was likely to have been too large relative to later rounds because of an accumulation of males that arrived before the kill began. This situation was most obvious for kills of males ages 5 and 6 (Fig. 2), but also could have existed to some extent for the kill of males ages 2 and 3. For ages 2 and 3, the accumulation would not have been as obvious because the main arrival time was after kills began. Secondly, the true peak in number killed of 4-yr-olds was probably flattened by the high harvest utilization rate of this age. Finally, an examination of the trend in numbers killed by round for individual years indicated the seasonal pattern was quite variable, ranging between that noted for males age 3, and that for males age 5. For example, the arrival time for 4-yr-olds in 1971 was similar to that seen for the typical 3-yr-olds; it was similar for the typical 5-yr-olds in 1968; and in 1980 it was intermediate, with a distinctive peak in mid-July. Such variations tended to dampen the peak. Kenyon and Wilke (1953) remarked that the maximum number of males older than 3 yr arrived before mid-July. Fewer age-4 males returned than age-3 males, probably due to the large kill at age 3.

#### 5-Year-Olds

Most 5-yr-olds appeared to have already arrived

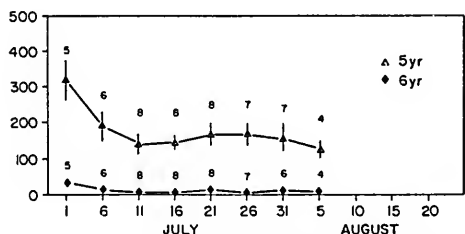

FIGURE 2.—Mean number, and standard error, of northern fur seal males killed of age 5-6 on hauling grounds of St. Paul Island, by date. Data from Lander (1980) and annual reports of the National Marine Mammal Laboratory, Seattle. Number of years of data for each date indicated above means.

by early July (Fig. 2). However, as noted for 4-yr-olds, the kill by 1 July was probably large relative to the number killed in later rounds. Most males probably arrived by late June to early July, assuming the time in peak numbers of 5-yr-olds was earlier than mid-July, but not earlier than for territorial bulls ( $\geq 7$  yr) on rookeries. Fewer 5-yr-olds returned than 4-yr-olds because of the large kill of males at age 4.

#### 6-Year-Olds

As with 4- and 5-yr-olds, the first kill was likely too large. Most 6-yr-olds probably arrived by late June. Gentry (1981) tagged juvenile males on hauling grounds of St. George Island in 1977 and counted them during late May to mid-August 1980. Although the ages were not known with certainty, the most common age in 1977 was likely 3 yr, with a range of 2-5 yr (R. Gentry<sup>4</sup>), and thus most males in 1980 were probably 6 yr of age. His counts indicated numbers began to increase in late May, reached a peak on 19-28 June 1980, and declined thereafter.

#### $\geq 7$ -Year-Olds

No males older than 6 yr of age were taken in the annual kills on hauling grounds. This was because the upper length limits excluded these ages from kills, and because many males of these ages go to rookeries for breeding rather than to hauling grounds.

### Arrival of Males on Rookeries

#### 1-Year-Olds

Behavioral studies suggest most yearling males probably arrived on rookeries by late September to early October, and the number returning was the smallest of any age group of males. Osgood et al. (1915) reported that branded male yearlings were rarely seen between late July and mid-August but became more numerous later, although they always remained small in number. Kenyon and Wilke (1953) mentioned yearlings of unspecified sex returned principally in September to November, and that only a few individuals were involved. Using counts of tagged yearlings seen on rookeries between 17 September and 17 October, Roppel et al. (1965a)

<sup>4</sup>R. Gentry, Northwest and Alaska Fisheries Center, National Marine Fisheries Service, NOAA, 7600 Sand Point Way N.E., Seattle, WA 98115, pers. commun. February 1984.

suggested that the largest number of yearlings of unspecified sex was present on 27 September to 11 October. These animals were predominantly males, as indicated by the recorded sex ratio of 84% males in a sample of 356 yearlings seen during 1961-65 (Roppel et al. 1965a, 1965b, 1966). Osgood et al. (1915) noted all yearlings examined during his study were males. Surveys by Abegglen et al. (1961) indicated very few yearlings of either sex were present on rookeries after early November.

### ≥7-Year-Olds

Essentially all males present on rookeries during the pupping season were bulls (Jordan and Clark 1898). According to Johnson (1968), the age of such bulls would have been ≥7 yr. Peterson (1965, 1968) noted that bulls began to arrive on rookeries in mid-May, reached peak numbers by late June, and declined in numbers after mid-July. No data exist on whether old bulls arrived before young bulls.

## Arrival of Females on Hauling Grounds

### Pregnant, ≥4 Years

Very few females younger than 4 yr give birth

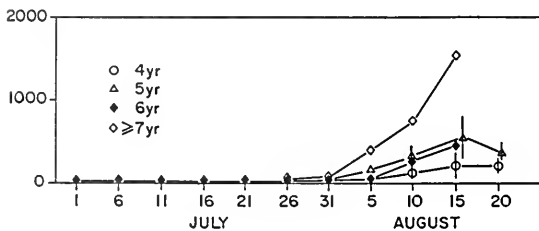

FIGURE 3.—Mean number, and range, of pregnant females of northern fur seal killed of age ≥4 on hauling grounds of St. Paul Island, by date. Data from Lander (1980) and annual reports of the National Marine Mammal Laboratory, Seattle.

(Lander 1981). Pregnant females age ≥4 were rarely taken on hauling grounds during July, but were increasingly common during 1-15 August (Fig. 3). Using the trend in the number of 4- and 5-yr-olds killed after 15 August, most pregnant females probably arrived by mid-August. Because essentially all pregnant females gave birth in July, the pregnant females killed on hauling grounds during August would have been postpartum. An examination of the median dates for collection of pregnant females suggested that arrival times on hauling grounds of age ≥4 did not differ among ages (Table 2).

### Nonpregnant

**1-YEAR-OLDS.**—As with yearling males, yearling females apparently preferred rookeries to hauling grounds (Jordan and Clark 1898; Roppel et al. 1965a). No yearling females were taken on hauling grounds during the commercial kill for females up to 20 August.

**2-YEAR-OLDS.**—Jordan and Clark (1898) and Osgood et al. (1915) suggested 2-yr-old females also preferred rookeries to hauling grounds. However, a few were taken on the hauling grounds during the harvest for females. Numbers began to increase in mid-August (Fig. 4), and thus increases began about 1 mo later than males of the same age. Assuming a 1-1½ mo interval for essentially all animals to arrive, as assumed for 2-yr-old males, then 2-yr-old females probably arrived by mid- to late September.

**≥3-YEAR-OLDS.**—Very few nonpregnant females ≥3 yr were taken on hauling grounds in July, but many were present by 15 August (Figs. 4, 5). Based on the trend in the number of females killed at 3-5 yr, the arrival of ages ≥3 yr was essentially completed by mid-August. Support for this conclusion comes from Peterson (1965, 1968), who counted

TABLE 2.—Median dates of collection of pregnant and nonpregnant females of northern fur seals taken during 1956, 1958, and 1959 on hauling grounds of St. Paul Island. All dates are in August. Data from annual reports of the National Marine Mammal Laboratory, National Marine Fisheries Service, NOAA, Seattle.

Year	State	Age (yr)							
		3	4	5	6	7	8	9	≥10
1956	Pregnant	—	11	11	9	11	10	10	9
	Nonpregnant	12	11	11	10	11	10	10	9
1958	Pregnant	—	9	9	9	8	10	15	10
	Nonpregnant	13	11	10	10	8	10	10	8
1959	Pregnant	—	13	12	12	12	12	12	13
	Nonpregnant	14	13	13	12	12	13	11	12

"nonbreeders" on hauling grounds and the inland edges of rookeries. "Nonbreeders" were thought to consist of idle females and young males. He observed a sharp increase in numbers in early August and that most arrived by mid-August. The current study indicated the female component of Peterson's "nonbreeders" were mainly nonpregnant females, plus a few postpartum females. Abegglen et al. (1956) noted an increase in the number of seals on hauling grounds and rookery edges between 15 August and 4 September. While this increase may have resulted from a continued influx of nonpregnant females at  $\geq 3$  yr, it may also have been due, at least in part, to the arrival of some 2-yr-old males and females.

The increase in number of nonpregnant females during August consisted primarily of 3- and 4-yr-olds. A comparison of the median dates for collection of nonpregnant females at  $\geq 3$  yr on hauling grounds suggests that arrival times were similar for each age (Table 2).

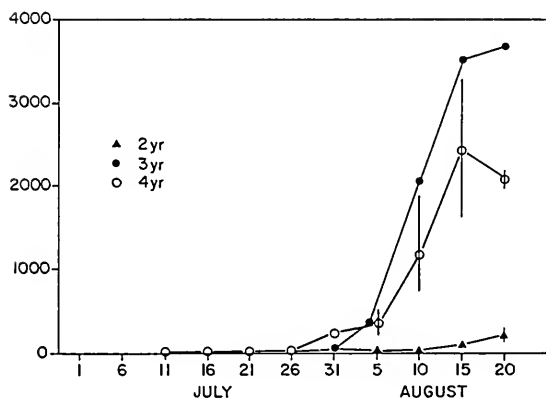

FIGURE 4.—Mean number, and range, of nonpregnant females of northern fur seal killed of ages 2-4 on hauling grounds of St. Paul Island, by date. Data from Lander (1980) and annual reports of the National Marine Mammal Laboratory, Seattle.

## Arrival of Females on Rookeries

### Pregnant, $\geq 4$ Years

Females gave birth on St. Paul Island during 15 June to 10 August, with about 90% of all births completed by 20 July (Bartholomew and Hoel 1953; Peterson 1965, 1968). The general belief that pregnant females arrived by order of decreasing age apparently originated from Wilke (1953). He collected 571 females on rookeries from 15 June to 4 September and showed the median date of collection for each age became progressively earlier with age. For example, the median collection date for females at  $\geq 10$  yr was 7 July, while that for females at 3 yr was 23 August. However, Wilke did not separate pregnant and nonpregnant females in his calculations. The large shift in median dates probably resulted mainly from an influx of young nonpregnant females on rookeries during August, as took place on hauling grounds.

An analysis of arrival times for pregnant females of each age should not include seals that are nonpregnant. Such an analysis can be made using data collected by Wilke between 15 July and 22 July 1953 (Table 3). Although Wilke did not record pregnancy

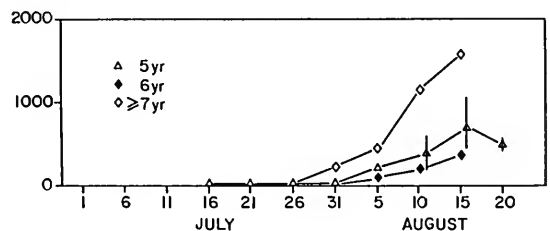

FIGURE 5.—Mean number, and range, of nonpregnant females of northern fur seal killed at age  $\geq 5$  on hauling grounds of St. Paul Island, by date. Data from Lander (1980) and annual reports of the National Marine Mammal Laboratory, Seattle.

TABLE 3.—Median dates of collection of northern fur seal females on rookeries of St. Paul Island during 17 June to 22 July 1953. Data from Wilke (1953) and the current study.

Date	Age (yrs):	Number collected by age							n
		4	5	6	7	8	9	$\geq 10$	
17 June	0	2	2	1	0	0	0	20	25
22 June	1	0	7	3	2	2	2	22	37
27 June	0	2	3	1	1	3	26	36	
2 July	0	4	5	7	5	5	23	49	
7 July	0	2	6	3	3	6	20	40	
12 July	1	3	5	1	1	0	2	13	
17 July	2	2	5	3	5	5	21	43	
22 July	3	9	8	7	6	1	16	50	
Median date		16 Jul	10 Jul	6 Jul	4 Jul	9 Jul	3 Jul	29 Jun	

rates for this sampling period, the rates were probably 90-100%, as will be shown later on rookeries for the period 1-21 July. A comparison of median collection dates suggests arrival may have taken place slightly earlier with increasing age, but no clear shift in arrival times was evident, as previously believed. Unfortunately, the true age-specific arrival times of parous females cannot be determined readily from these data. The main difficulty is that the pregnant females used in the analysis included not just parous seals, but postpartum seals as well. Postpartum seals usually remain on land for 2 d, then go to sea to forage for 8 or 9 d, and repeat this pattern about 10 times throughout the nursing period (Peterson 1958; Gentry and Holt in press). The potentially complex effect that returning postpartum females could have on the trend in the number of parous females arriving of a particular age must be considered. Other difficulties were the small sample sizes, and the fact that the sample sizes taken on each date did not reflect the increase in numbers on rookeries. At this time, while a slight shift in arrival times of parous females may exist with age, more research is needed for confirmation.

#### Nonpregnant

**1-YEAR-OLD.**—Jordan and Clark (1898) felt yearling females did not arrive on rookeries before September. As noted earlier for yearling males, Kenyon and Wilke (1953) felt yearlings returned to the Pribilof Islands mainly during September to November, and only a few individuals were involved. The date of arrival for most yearling females is unclear, although it is probably after yearling males, during October to early November. Only a small

number of yearling females had arrived by late September to early October compared to males. However, they arrived presumably no later than early November, because few yearlings were present on the rookeries after that time.

**2-YEAR-OLDS.**—The arrival of 2-yr-old females on rookeries began in August, a similar time to that seen on hauling grounds. Branding studies by Osgood et al. (1915) suggested a few individuals began to arrive about one month after males. The first branded 2-yr-old female was seen on 19 July compared to 12 June for males age 2. Thus, arrival was probably completed also a month later than males, by mid- to late September. Jordan and Clark (1898) reported that 2-yr-old females began to increase in numbers by about 1 August, while Kenyon and Wilke (1953) noted they did not begin until late August, and the current study suggested arrival on hauling grounds began in mid-August. Kenyon and Wilke (1953) believed the largest number were present in October, slightly later than suggested by the current study. Based on the comments by Kenyon and Wilke (1953) and Kenyon et al. (1954), fewer 2-yr-olds returned than 3-yr-olds, but more 2-yr-olds returned than yearlings.

**≥4-YEAR-OLDS.**—A total of 1,533 females were collected on rookeries during 1-6 July 1956 and 1-21 July 1957, a period covering the main pupping season. All females were ≥4 yr of age. Of these, only 2% were nonpregnant, a low rate compared to 31% nonpregnancy for the population as a whole, based on the life table derived by Lander (1981). The low rate likely resulted from the small number of nonpregnant females on the rookeries, as was found on

TABLE 4.—Summary of the times of arrival and relative numbers for males and females of northern fur seal rookeries and hauling grounds of St. Paul Island, based on the current study and a review of the literature.

Sex	Site <sup>1</sup>	State <sup>2</sup>	Age (yr)	Arrival time <sup>3</sup>	Abundance
Male	R		1	late Sept. to early Oct.	few
	HG		2	mid- to late Aug.	2 yr > 1 yr
	HG		3	late July	3 yr > 2 yr
	HG		4	mid-July	—
	HG		5	late June to early July	—
	HG		6	late June	—
	R		≥7	late June	—
Female	R	NP	1	Oct. to early Nov.	few
	HG,R	NP	2	mid- to late Sept.	2 yr > 1 yr
	HG	NP	≥3	mid-Aug.	3 yr > 2 yr
	HG	P	≥4	mid-Aug.	—
	R	P	≥4	mid-July	—

<sup>1</sup>R = rookery; HG = hauling grounds.

<sup>2</sup>NP = nonpregnant; P = pregnant.

<sup>3</sup> Date when essentially all seals would have arrived.

the hauling grounds at this time (Figs. 4, 5). The rate was probably biased downward by the fact that nonpregnant females stayed on land for a slightly shorter period of time than nursing females. Using data given by Gentry and Holt (in press), nonnursing females appeared to stay on shore for only about 64% as long as nursing females. Nonnursing females make about half as many visits to land as nursing females, but stay about one-third longer for each visit.

A gradual increase in the nonpregnancy rate took place on Polivina rookery during early to mid-July: 1 July = 0% ( $n = 280$ ), 6 July = 2% (734), 11 July = 1% (198), 16 July = 3% (148), and 21 July = 6% (173). When weighted for the shorter period of stay on land by nonpregnant females, the rates increased from 0% by 1 July to 10% by 21 July. Presumably, the increasing rate during July resulted from the arrival of more nonpregnant females age  $\geq 4$ . Numbers of nonpregnant females began to increase particularly by mid-July.

## DISCUSSION

Northern fur seals arriving on St. Paul Island can go first to rookeries located on beaches just above high tide, or to hauling grounds more inland. The typical arrival sequence (Jordan and Clark 1898; Kenyon and Wilke 1953; Peterson 1965, 1968) is for the bulls to establish territories for breeding on rookeries in May-June. Pregnant females arrive next on rookeries to pup, mate, and nurse in harems within the territories. Subadult males arrive mainly during the pupping season and go to hauling grounds rather than rookeries. Although young males of different sizes (i.e., ages) tend to arrive in successive waves with time, studies of marked seals (Gentry et al. 1979) indicate that arrival times of individual subadult males can be quite variable between years. In early August, harem bulls abandon their territories, and the social structure of the rookery disintegrates. Nursing cows then tend to disperse more widely on land, and nonterritorial bulls and some subadult males move on rookeries from hauling grounds. The mixing of seals between rookeries and hauling grounds after July results in less site distinction. The literature is unclear as to the arrival times of subadult and nonpregnant adult females after July, and whether these seals go first to rookeries or to hauling grounds, or go to both simultaneously. Age 2 females arrive later in the season, and go to rookeries and hauling grounds, while yearlings of both sexes arrive last, and go mainly to rookeries. Seals begin leaving St. Paul

Island for the southern migration in October to November (Roppel et al. 1965a; Kenyon and Wilke 1953). Few remain on the hauling grounds after mid-October, and few on rookeries after early November.

Table 4 summarizes the age-specific arrival times and relative numbers of seals seen on rookeries and hauling grounds, based on information given in the Results. Two arrival times existed for pregnant females, one by mid-July on rookeries and the other by mid-August on hauling grounds. The second date no doubt resulted from the movement of some postpartum females from the rookeries to the hauling grounds after the harems disintegrated. Thus, the arrival time on St. Paul Island was by mid-July, rather than mid-August.

The arrival times for nonpregnant females at  $\geq 3$  yr on St. Paul Island was less certain than for pregnant females because age-specific data on arrival times existed from hauling grounds up to mid-August, but not from rookeries after mid-July. Also it was not known whether nonpregnant females went first to rookeries or to hauling grounds. The main arrival time was probably by mid-August, as was found on hauling grounds. This was likely because nonpregnant females began to increase in numbers on rookeries in early to mid-July, and an interval of 1-1½ mo was probably needed for essentially all arrivals to be completed. Also, Abegglen et al. (1956) felt that most females on the hauling grounds during August came directly from the sea, although some came from rookeries. From the current study, some postpartum females go from rookeries to hauling grounds. Perhaps most nonpregnant females go first to the hauling grounds.

Nonpregnant females  $\geq 3$  yr arrived about 1 mo later than pregnant females. According to R. Gentry (fn. 4), marked adult females on St. George Island also arrived later when nonpregnant, although only about 10 d later. The reason for the differences in length of delay caused by nonpregnancy found in the two studies is unclear at this time. The answer may come when details of the study by Gentry are reported, or perhaps when more is known about movement patterns of adult females between rookeries and hauling grounds.

The finding that nonpregnant females arrived after pupping suggests nonpregnancy delayed the date of mating. A delay in mating has been reported previously for maturing females, but not for nonpregnant cows. Because parous females pup about 1 d after arrival, and mate 5-6 d after pupping (Peterson 1968; Gentry and Holt in press), essentially all females that pup will have mated by mid-

to late July. Assuming a similar interval between arrival and mating for nonpregnant females, most nonpregnant females would be mated by mid- to late August. Jordan and Clark (1898) stated that young females were impregnated in early August, after old females, and Abegglen et al. (1958) observed that females ages 3 and 4 bred after the harems disbanded. Also, Craig (1964) reported females ovulated for the first time in late August or September. The only evidence that I could find of late mating in a nonpregnant cow was by Osgood et al. (1915), who observed a harem bull mating a female that was "not very young" on 21 August.

A comparison of the age-specific arrival times for each sex on St. Paul Island (Table 4) largely confirms the comments by Kenyon and Wilke (1953) and Fiscus (1978) that arrival began progressively earlier with increasing age. However, the current study indicated that this phenomenon was obvious only for young ages. It was seen in nonpregnant females ages 1-3 and in males ages 1-6. Although no differences in arrival times were shown for older males and nonpregnant females, differences could exist, but would be small. The differences in arrival times became progressively less with age for males between 1 and 6 yr and apparently for females between 1 and 3 yr.

A comparison of the relative numbers returning to St. Paul Island (Table 4) suggests that progressively more males and females returned between ages 1 and 3. The cumulative effect of the kill on males of 2 and 3 yr prevented comparisons of abundance with males  $\geq 4$  yr. For females, the number of 4-yr-olds returning was probably not greater than 3-yr-olds, as suggested by the similarity in the number of 3- and 4-yr-olds killed on hauling grounds by mid-August (Figs. 3, 4). However, pregnancies complicate comparisons of abundance on hauling grounds between females 3 yr and older. Between ages 4 and 10, an increasing proportion of females become pregnant (Lander 1981) and thus go to rookeries rather than hauling grounds.

The data collected in this study suggest that, with age, young seals of both sexes arrive progressively earlier, and in progressively larger numbers. The reason for these changes in arrival schedules lies in an understanding of the mechanism that controls the migration schedule. However, little is known about this mechanism in the northern fur seal. The mechanism, if it is like that of other vertebrates (see Gauthreaux 1980; Baker 1978), is probably complex. It could involve selective factors, such as food supply and climate, and numerous environmental and physiological factors, such as photoperiod, reproduc-

tive hormones, and endogenous rhythms. For northern fur seals, learned and innate components are likely to be involved. There are several examples of where learning has been suggested to be involved in migration. When the species leaves the Pribilof Islands for the southern migration, juveniles tend to disperse widely in the North Pacific Ocean, pregnant females tend to travel to the coastal waters off California, and adult males generally remain in the northern Gulf of Alaska (Baker et al. 1970; Fiscus 1978). Baker (1978) has suggested that the juvenile northern fur seals may explore the habitat, and, with age, eventually learn the best wintering areas. Also, an increasing proportion of immature seals return to their natal sites on Pribilof Islands with age (Kenyon and Wilke 1953), although sometimes the natal site is abandoned and a new colony is established, such as at San Miguel Island, CA (Peterson et al. 1968). Baker (1978) has proposed that site recognition may be learned shortly after birth, and with time, the site is usually relocated. However, other components of migration may be innate. For example, the annual timing of arrival for pregnant females on St. Paul Island is remarkably precise. Peterson (1968) calculated the mean arrival date to be 30 June for each of 3 years. Such precision seems unlikely to be the result of only learning. Keyes et al. (1971) examined the pineal gland of this species for seasonal variations in hydroxy-indole levels for various ages of males and females, and postulated photoperiodic regulation of the reproductive cycle.

A physiological event in the lives of young males and females which coincides with the cessation of arriving earlier and returning in greater numbers is the attainment of sexual maturity. Baker (1978) pointed out that sexual maturation controls the initiation of migration in many vertebrates. While a few male northern fur seals begin to produce sperm at 3 yr, most do not do so until about 5 yr (Kenyon et al. 1954; Murphy 1969, 1970). The average female conceives for the first time on her 5th birthday, although typically ovulates for the first time on her 4th (Craig 1964; York 1983). Thus, it was during the years of immaturity that young seals gradually synchronized their arrival schedules with that of the adults. Perhaps the gradual process of gonad maturation in both sexes over several years plays a role in inducing a cohort to migrate progressively earlier in the year and in causing a greater proportion to return to breeding sites.

A relationship between sexual maturity and changes in arrival times on St. Paul Island could explain two other arrival phenomena noted in this study. In the first case, considerable annual varia-



tion was noted in the seasonal pattern of arrival for 4-yr-old males, ranging from the typical pattern seen in 3-yr-olds to that seen in 5-yr-olds. Such differences in the arrival pattern may indicate that the age at which males reach sexual maturity differs between cohorts, a possibility worth further investigation. Variations in the age at sexual maturity could result from annual variations in body growth rate caused in turn by fluctuations in food supply. In the second case, pregnant females at  $\geq 4$  yr may have arrived slightly earlier with increasing age. This would take place if the first conception resulted in a later date of parturition than in subsequent years. This is a possibility because, according to Craig (1964), the first ovulation appears to be later than subsequent ovulations. The age of primiparous females spans mainly between 4 and 10 yr (York 1983), and thus the age at first ovulations presumably also spans a similar number of years. Arrival times would tend to be slightly earlier with age from the increased proportion of mature females.

An alternate explanation for seals arriving in progressively larger numbers, may lie in the energetic costs of the return migration from the North Pacific Ocean to the Bering Sea. For yearlings, the energetic costs may be too large for all but a few individuals to return. With age, the relative costs may be more favorable and permit an increased proportion to return.

For each age, males tended to arrive before females. This situation could result if, through selection or learning, the time of the return migration was ultimately established for each sex by the adults. The mechanism controlling the timing of migration in young seals would gradually shift arrival times with age to eventually synchronize with those of the adults. However, because the arrival times of adult males was earlier than that of cows, the arrival times of immature males would also be before those of immature females. The fact that nonpregnant adult females arrived after parous females could be the result of nonpregnant females gaining some advantage in the energetic costs of migration. Since presumably competition exists for food around the Pribilof Islands during the summer, perhaps survival of nonpregnant adult females is enhanced by feeding elsewhere, thus delaying the return migration by 1 mo.

## ACKNOWLEDGMENTS

I am grateful to P. Olesiuk for preparing the Probit plots, and I. Fawcett for collating much of the data on kills and pregnancy rates. I thank P.

Olesiuk, T. Quinn, and two journal reviewers for useful comments on the manuscript.

## LITERATURE CITED

- ABEGGLEN, C. E., A. Y. ROPPEL, AND F. WILKE.  
1956. Alaska fur seal investigations, Pribilof Islands, Alaska. Report of field activities, June-September 1956. U.S. Fish Wildl. Serv., Bur. Commer. Fish., Sect. Mar. Mammal Res., 1956, 145 p.  
1957. Alaska fur seal investigations, Pribilof Islands, Alaska. Report of field activities, June-September 1957. U.S. Fish Wildl. Serv., Bur. Commer. Fish., Sect. Mar. Mammal Res., 1957, 163 p.  
1958. Alaska fur seal investigations, Pribilof Islands, Alaska. Report of field activities, June-September 1958. U.S. Fish Wildl. Serv., Bur. Commer. Fish., Sect. Mar. Mammal Res., 1958, 187 p.  
1959. Alaska fur seal investigations, Pribilof Islands, Alaska. Report of field activities, June-September 1959. U.S. Fish Wildl. Serv., Bur. Commer. Fish., Sect. Mar. Mammal Res., 1959, 132 p.
- ABEGGLEN, C. E., A. Y. ROPPEL, A. M. JOHNSON, AND F. WILKE.  
1961. Alaska fur seal investigations, Pribilof Islands, Alaska. Report of field activities, June-September 1961. U.S. Fish Wildl. Serv., Bur. Commer. Fish., Sect. Mar. Mammal Res., 1961, 148 p.
- BAKER, R. C., F. WILKE, AND C. H. BALTZO.  
1970. The northern fur seal. U.S. Fish. Wildl. Serv., Circ. 336, 19 p.
- BAKER, R. R.  
1978. The evolutionary ecology of animal migration. Holmes and Meier Publ. Inc., N.Y., 1012 p.
- BARTHOLOMEW, G. A., JR., AND P. G. HOEL.  
1953. Reproductive behavior in the Alaska fur seal, *Callorhinus ursinus*. J. Mammal. 34:417-436.
- CRAIG, A. M.  
1964. Histology of reproduction and the estrus cycle in the female fur seal, *Callorhinus ursinus*. J. Fish. Res. Board Can. 21:773-811.
- FISCUS, C. H.  
1978. Northern fur seal. In D. Haley (editor), Marine mammals of eastern North Pacific and Arctic waters, p. 152-159. Pac. Search Press, Seattle.
- FOWLER, C. W.  
1982. Interactions of northern fur seals and commercial fisheries. Trans. 47th North Am. Wildl. Natl. Resour. Conf., p. 278-292.
- GAUTHREAUX, S. A., JR., (editor).  
1980. Animal migration, orientation, and navigation. Acad. Press, N.Y., 387 p.
- GENTRY, R. L.  
1981. Land-sea movements of northern fur seals relative to commercial harvesting. In J. A. Chapman and D. Pursley (editors), Worldwide Furbearer Conference Proceedings, Vol. 2, p. 1328-1359. The Worldwide Furbearer Conference Inc., Frostburg, MD.
- GENTRY, R. L., AND J. R. HOLT.  
In press. Attendance behavior of northern fur seals. In R. Gentry and G. L. Kooyman (editors), Fur seals: maternal strategies on land and at sea. Princeton Univ. Press, Princeton, NJ.
- GENTRY, R. L., J. HOLT, AND J. FRANCIS.  
1979. Land-sea movements of juvenile males. In Marine

- Mammals Division, Fur seal investigations. 1978, p. 19-32. National Marine Mammal Laboratory, Northwest and Alaska Fisheries Center, National Marine Fisheries Service, NOAA, 7600 Sand Point Way N.E., Seattle, WA.
- JOHNSON, A. M.  
1968. Annual mortality of territorial male fur seals and its management significance. *J. Wildl. Manage.* 32:94-99.
- JORDAN, D. S., AND G. A. CLARK.  
1898. The history, condition, and needs of the herd of fur seals resorting to the Pribilof Islands. *In* D. S. Jordan, L. Stejneger, F. A. Lucas, J. F. Moser, C. H. Townsend, G. A. Clark, and J. Murrery (editors), *The fur seals and fur-seal islands of the North Pacific Ocean, Part 1*, 249 p. *Treas. Dep. Doc.* 2017, 4 parts.
- KENYON, K. W., AND F. WILKE.  
1953. Migration of the northern fur seal, *Callorhinus ursinus*. *J. Mammal.* 34:86-98.
- KENYON, K. W., V. B. SCHEFFER, AND D. G. CHAPMAN.  
1954. A population study of the Alaska fur-seal herd. *U.S. Fish Wildl. Serv., Spec. Sci. Rep. Wildl.* 12, 77 p.
- KEYES, M. C., R. J. WURTMAN, C. A. ELDEN, C. CHOU, AND R. MCGUIRE.  
1971. Seasonal fluctuations of hydroxy-indole levels in the pineal gland of the northern fur seal. [Abstr.] *J. Wildl. Dis.* 7:235.
- KING, J. E.  
1983. *Seals of the world*. British Museum (Natural History), Oxford Univ. Press, Oxford, 240 p.
- KOZLOFF, P.  
1982. Fur seal investigations, 1981. *U.S. Dep. Commer., NOAA Tech. Memo. NMFS F/NWC-37*, 88 p.  
1985. Fur seal investigations, 1982. *U.S. Dep. Commer., NOAA Tech. Memo. NMFS F/NWC-71*, 127 p.
- LANDER, R. H.  
1979. Role of land and ocean mortality in yield of male Alaskan fur seal, *Callorhinus ursinus*. *Fish. Bull., U.S.* 77:311-314.  
1980 (editor). Summary of northern fur seal data and collection procedures. Vol. 1: Land data of the United States and Soviet Union (excluding tag and recovery records). *U.S. Dep. Commer., NOAA Tech. Memo. NMFS F/NWC-3*, 315 p.  
1981. A life table and biomass estimate for the Alaska fur seals. *Fish. Res.* 1:55-70.
- MURPHY, H. D.  
1969. Microscopic studies on the testis of the northern fur seal, *Callorhinus ursinus*, (Part Two). *In* Proceedings of the Sixth Annual Conference on Biological Sonar and Diving Mammals, p. 15-18. Stanford Research Institute, Menlo Park, CA.  
1970. Microscopic studies on the testis of the northern fur seal, *Callorhinus ursinus*, (3). *In* Proceedings of the Seventh Annual Conference on Biological Sonar and Diving Mammals, p. 97-103. Stanford Research Institute, Menlo Park, CA.
- NORTH PACIFIC FUR SEAL COMMISSION.  
1984a. Proceedings of the 27th Annual Meeting April 9-13, 1984, Moscow, U.S.S.R. *North Pac. Fur Seal Comm., Wash., DC*, 50 p.  
1984b. North Pacific Fur Seal Commission report on investigations during 1977-80. *North Pac. Fur Seal Comm., Wash., DC*, 198 p.
- OSGOOD, W. H., E. A. PREBLE, AND G. H. PARKER.  
1915. The fur seals and other life of the Pribilof Islands, Alaska, in 1914. *U.S. Bur. Fish. Bull.* 34:1-172.
- PETERSON, R. S.  
1965. Behavior of the northern fur seal. Ph.D. thesis, The John Hopkins Univ., Baltimore, 233 p.  
1968. Social behavior in pinnipeds, with particular reference to the northern fur seal. *In* R. J. Harrison, R. C. Hubbard, R. S. Peterson, C. E. Rice, and R. J. Schusterman (editors), *The behavior and physiology of pinnipeds*, p. 3-53. Appleton-Century-Crofts, N.Y., 411 p.
- PETERSON, R. S., B. J. LE BOEUF, AND R. L. DELONG.  
1968. Fur seals from the Bering Sea breeding in California. *Nature* 219:899-901.
- ROPPEL, A. Y.  
1984. Management of northern fur seals on the Pribilof Islands, Alaska, 1786-1981. *U.S. Dep. Commer., NOAA Tech. Rep. NMFS* 4, 26 p.
- ROPPEL, A. Y., AND S. P. DAVEY.  
1965. Evolution of fur seal management on the Pribilof Islands. *J. Wildl. Manage.* 29:448-463.
- ROPPEL, A. Y., A. M. JOHNSON, AND D. G. CHAPMAN.  
1965a. Fur seal investigations, Pribilof Island, Alaska, 1963. *U.S. Fish Wildl. Serv., Spec. Sci. Rep. Fish.* 497, 60 p.  
ROPPEL, A. Y., A. M. JOHNSON, R. E. ANAS, AND D. G. CHAPMAN.  
1965b. Fur seal investigations, Pribilof Islands, Alaska 1964. *U.S. Fish Wildl. Serv., Spec. Sci. Rep. Fish.* 502, 46 p.  
1966. Fur seal investigations, Pribilof Islands, Alaska, 1965. *U.S. Fish Wildl. Serv., Spec. Sci. Rep. Fish.* 536, 45 p.
- WILKE, F.  
1953. Alaska fur seal investigations, Pribilof Islands, Alaska, summer of 1953. *U.S. Fish Wildl. Serv., Bur. Commer. Fish., Sect. Mar. Mammal Res.*, 34 p.
- YORK, A. E.  
1983. Average age at first reproduction of the northern fur seal (*Callorhinus ursinus*). *Can. J. Fish. Aquat. Sci.* 40: 121-127.
- YORK, A. E., AND J. R. HARTLEY.  
1981. Pup production following harvest of female northern fur seals. *Can. J. Fish. Aquat. Sci.* 38:84-90.

# MODELING LIFE-STAGE-SPECIFIC INSTANTANEOUS MORTALITY RATES, AN APPLICATION TO NORTHERN ANCHOVY, *ENGRAULIS MORDAX*, EGGS AND LARVAE

NANCY C. H. LO<sup>1</sup>

## ABSTRACT

Life-stage-specific instantaneous mortality rates (IMRs) are often estimated individually for each life stage of an organism using regression analysis. A single estimation procedure for all life stages may be preferable because it would increase the overall precision of the IMRs and also provide a more realistic mortality model. Two such procedures were developed in this paper. One is single-equation model where regression estimates of all IMRs are obtained by fitting a single survivorship function to the entire data set. The other is the maximum likelihood estimator. These models were compared using northern anchovy egg and larval data. The survivorship functions of each were, respectively, exponential and Pareto functions.

The mortality of marine fish can be described by its survival probability  $S(t) = P(T > t) = \exp[-\int_0^t \lambda(u)du]$ , where  $T$  is the age of the fish and  $\lambda(t)$  is the instantaneous mortality rate (IMR) at age  $t$ . During their early life history, pelagic marine fishes pass through a series of life stages: eggs, yolk-sac larval, feeding pelagic larval, juvenile and adult stages. The IMR  $\lambda(t)$  could be different for some life stages. Therefore, for  $I$  life stages, there may be  $G$  distinctive IMRs where  $G \leq I$ . The IMR  $\lambda(t)$  is then a piecewise function (Gross and Clark 1975, p. 20-21; Johnson and Kotz 1976, p. 272-273)

$$\lambda(t) = \begin{cases} \lambda_1(t) & 0 \leq t \leq u_1 \\ \lambda_2(t) & u_1 \leq t \leq u_2 \\ \vdots & \vdots \\ \lambda_g(t) & u_{g-1} \leq t \leq u_g \\ \vdots & \vdots \\ \lambda_G(t) & u_{G-1} \leq t \leq u_G \end{cases}$$

where  $u_g$  is the maximum age of mortality stanza  $g$ .  $\lambda_g(t) \neq \lambda_{\hat{g}}(t)$  for  $g \neq \hat{g}$ . For example,  $\lambda_1(t)$  may be the IMR for egg and yolk-sac larval stages, even though each is a different life stage, and  $\lambda_2(t)$  the IMR for feeding larvae. As a result, the conditional survival probability,  $S_g(t) = P(T > t | T \geq u_{g-1})$  corresponding to  $\lambda_g(t)$ , will also be different from  $S_g(t)$

and the survival probability  $S(t) = (P T > t)$  will be

$$S(t) = \begin{cases} S_1(t) & 0 \leq t \leq u_1 \\ S_1(u_1)S_2(t) & u_1 \leq t \leq u_2 \\ \vdots & \vdots \\ \vdots & \vdots \\ \prod_{d=1}^{G-1} S_d(u_d)S_G(t) & u_{G-1} \leq t \leq u_G \end{cases}$$

The common method for estimating  $\lambda_g(t)$ 's for marine fishes has been to fit  $S_g(t)$  to sample age data separately for each life stage or to assume one common  $\lambda(t)$  for all life stages and to fit one  $S(t)$  to sample data of all life stages (Hewitt and Brewer 1983). For northern anchovy, *Engraulis mordax*, eggs and larvae <20 d old, the IMR  $\lambda(t)$  for eggs and yolk-sac larvae is different from that of the feeding larvae (Lo 1985):

$$\lambda(t) = \begin{cases} \lambda_1(t) = \alpha & 0 < t \leq u_1 \\ \lambda_2(t) = \frac{\beta}{t} & u_1 \leq t \leq 20 \end{cases} \quad (1)$$

where  $u_1$  is either the hatching time ( $t_h \sim 3$  d) or the age of yolk-sac larvae ( $t_{ys} \sim 4.5$  d) with the first feeding as the critical period after which mortality decreased. Either  $t_h$  or  $t_{ys}$  has been used in various models under different assumptions. If morphological differences cause the changes in mortality rates,  $t_h$  is a reasonable separation point between

<sup>1</sup>Southwest Fisheries Center La Jolla Laboratory, National Marine Fisheries Service, NOAA, P.O. Box 271, La Jolla, CA 92038.

egg and larval stages. However, predation, the major cause of mortality in the embryonic period, may be similar for eggs and yolk-sac larvae (Hunter<sup>2</sup>). If this is true, then the end of the yolk-sac stage is a reasonable separation point for the mortality stanza.

The conditional survival probability corresponding to IMR in Equation (1) is

$$S_1(t) = e^{-at} \quad t \leq u_1 \quad (2a)$$

and

$$S_2(t) = \left( \frac{t}{u_1} \right)^{-\beta} \quad u_1 \leq t \leq 20 \quad (2b)$$

To assess  $S_g(t)$  for  $g = 1, 2$  in Equation (2), anchovy egg and larval data were first divided into  $K$  age groups. The mortality curves (Equation (3)) were fitted to the sample mean counts ( $\bar{y}_i$ ) and mean age ( $t_i$ )  $i = 1, \dots, K$ :

$$E(\bar{y}_i) = \begin{cases} \theta_0 S_1[t_i; \lambda_1(t)] & t_i \leq u_1 \\ \theta_{u_1} S_2[t_i; \lambda_2(t)] & u_1 \leq t_i \leq 20 \end{cases} \quad (3)$$

where  $\theta_i$  is the expected number of fish at age  $t$ . Using separate equations like Equation (3) is unsatisfactory for some applications because separate mortality curves may produce discontinuities at transitions between mortality stanzas (or life stages). The purpose of this paper is to obtain a regression estimator and a maximum likelihood estimator (MLE) of the IMRs ( $\lambda(t)$ ). The regression estimator was based upon a single mortality curve for all early life stages of anchovy, and the MLE was based upon a truncated exponential (Equation (2a)) and Pareto (Equation (2b)) likelihood function of time to death (Lo 1985).

In section on Data, I describe the method of anchovy egg and larval data collection and standardization procedures. The standardization procedures are necessary because the gear and sample sizes used to collect eggs differ from those used to collect larvae. In section on Multi-Equation Model, the current estimation procedures for constructing mortality functions for different life stages are presented. In these procedures separate mortality functions are fitted to the data set for each life stage. In the next two sections, I develop two estimation procedures for the IMRs of different life stages from a single analysis: a single mortality function is con-

structed which is based on the IMRs of different life stages, and the maximum likelihood estimators of life-stage specific IMRs are described. The MLEs of anchovy eggs and larvae (<20 d) are obtained. The results and the comparisons of various models based on anchovy egg and larval data are given in the last two sections.

## DATA

The standardized abundance of anchovy eggs and larvae taken in routine biomass surveys was used to evaluate different estimation procedures for mortality rates (Smith 1972; Parker 1980). The variables used in the standardization procedures were extrusion through the net, avoidance of the net mouth, and the variation of the water volume filtered per unit depth (Zweifel and Smith 1981).

The northern anchovy spawning area lies off central and southern California and Baja California. The sampling area was divided into 23 regions covering  $17.566 \times 10^{11} \text{ m}^2$  (Fig. 1). The central anchovy stock is enclosed by 8 regions (4, 5, 7, 8, 9, 11, 13, and 14) with a total of  $5.703 \times 10^{11} \text{ m}^2$  (Duke<sup>3</sup>). In this paper, I study the mortality of egg and larva of central anchovy stock. Anchovy eggs and larvae are sampled by net tows and each tow is a sampling unit. Every year,  $m_1$  egg tows, vertical tows of 0.333 mm mesh with 25 cm diameter mouth opening, and  $m_2$  larval tows using an oblique plankton net of 0.505 mm mesh with 60 cm diameter mouth opening are made. Ages were assigned to life stages using stage specific growth curves (Methot and Hewitt 1980<sup>4</sup>; Lo 1983). The standardized number of larvae in each group was divided by the time that larvae remained at a particular length to yield the sample mean daily larval production per unit area ( $0.05 \text{ m}^2$ ). A weighted mean per unit area for the entire survey area (8 regions) was calculated:  $\bar{y}_i = \sum_r w_r \bar{y}_{ir}$  where  $w_r$  was the weight for region  $r$  and  $\sum_r w_r = 1$  (Table 1) (Lo 1985) and  $\bar{y}_{ir}$  was the sample mean count for  $i^{\text{th}}$  age group in region  $r$ . I considered only larvae smaller than 10 mm (20 d old) because for anchovy larvae larger than 10 mm, the

<sup>3</sup>Duke, S. 1976. CalCOFI station and region specification. Southwest Fish. Cent. Admin. Rep. No. LJ-76-3, 37 p. National Marine Fisheries Service, NOAA, P.O. Box 271, La Jolla, CA 92038.

<sup>4</sup>Methot, R. D., and R. P. Hewitt. 1980. A generalized growth curve for young anchovy larvae; derivation and tubular example. Southwest Fish. Cent. Admin. Rep. No. LJ-80-17. National Marine Fisheries Service, NOAA, P.O. Box 271, La Jolla, CA 92038.

<sup>2</sup>J. R. Hunter, Fishery Biologist, Southwest Fisheries Center La Jolla Laboratory, National Marine Fisheries Service, NOAA, P.O. Box 271, La Jolla, CA 92038, pers. commun. July 1983.

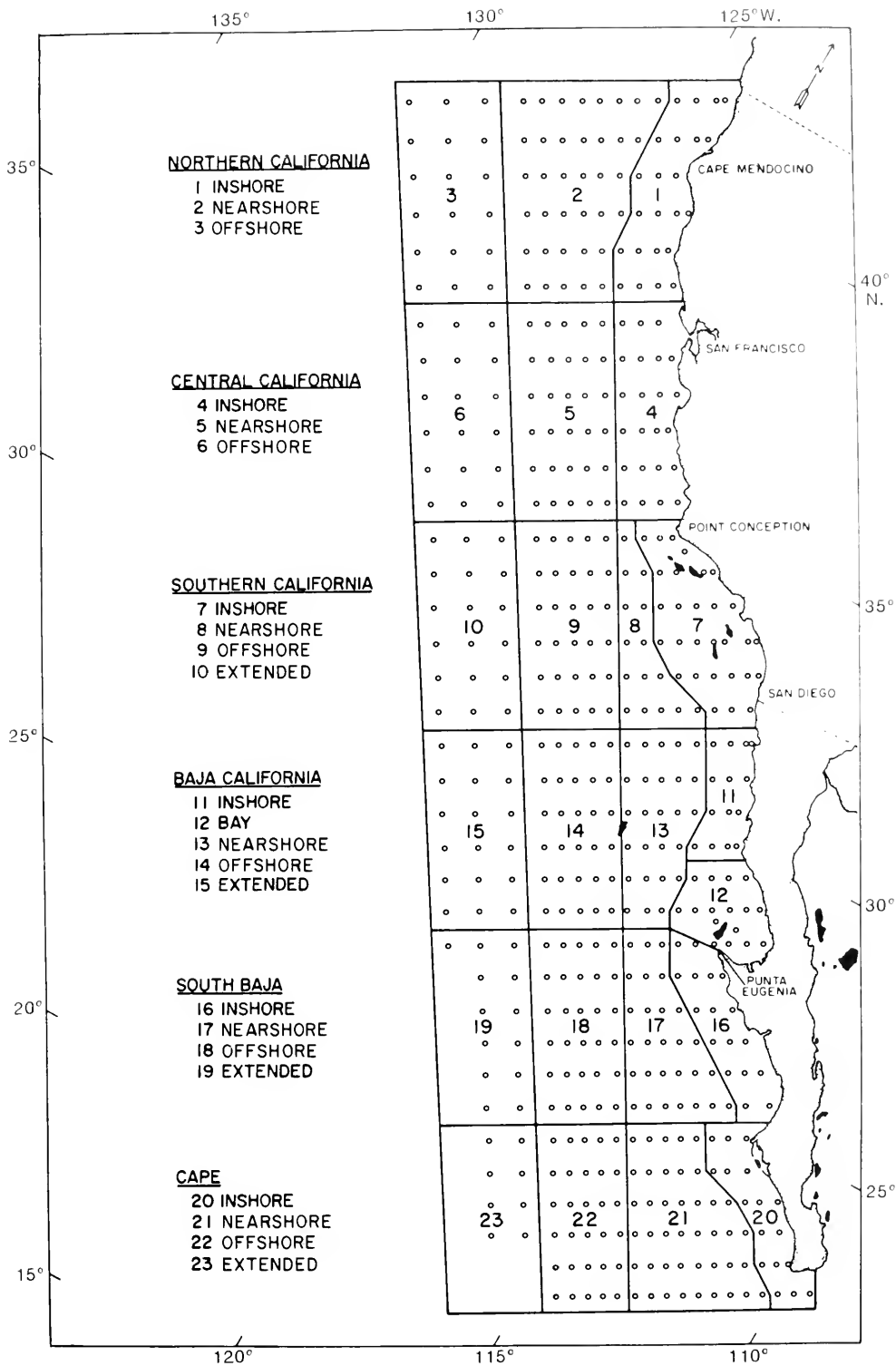

FIGURE 1.—Sampling area for estimating mortality of northern anchovy eggs and larvae (<20 d) with sampling stations denoted by the open circles, and regions denoted by numbers.

TABLE 1.—Group data of anchovy eggs and larvae: Sample mean daily production ( $\bar{y}_i$ ) at age  $t_i$ , days for regression estimators and sample mean daily death ( $n_i$ ) for maximum likelihood estimators (MLEs) of egg and larval mortality.

1980							1981						
Regression estimators			MLE				Regression estimators			MLE			
$i$	$t_i$	$\bar{y}_i$	$i$	$t_i$	$\bar{y}_i$	$n_i$	$i$	$t_i$	$\bar{y}_i$	$i$	$t_i$	$\bar{y}_i$	$n_i$
1	0.41666	1.57	1	0.41666	1.57		1	0.41666	1.33				
2	0.91666	1.21	2	0.91666	1.21	0.36	2	0.91666	2.00	1	0.6666	1.665	
3	1.41666	1.07	3	1.41666	1.07	0.14	3	1.41666	1.19	2	1.6666	1.33	0.335
4	1.91666	0.64					4	1.91666	1.47				
5	2.41666	0.88	4	2.1666	0.76	0.31	5	2.41666	1.11	3	2.41666	1.11	0.22
6	3.05	0.74	5	3.05	0.74	0.02	6	2.91666	0.60	4	3.008	0.915	0.195
7	5.6	0.37	6	5.6	0.31	0.37	7	3.10	1.23				
8	9.06	0.21	7	9.06	0.21	0.16	8	5.98	0.44	5	5.98	0.44	0.475
9	11.40	0.16	8	11.40	0.16	0.05	9	9.45	0.25	6	9.45	0.25	0.19
10	13.98	0.10	9	13.98	0.10	0.06	10	11.97	0.16	7	11.97	0.16	0.09
11	16.00	0.086	10	16.00	0.086	0.014	11	14.37	0.10	8	14.37	0.10	0.06
12	18.63	0.012	11	18.63	0.072	0.014	12	16.53	0.10	9	16.53	0.10	0
							13	18.56	0.08	10	18.56	0.08	0.02

1982							1983						
Regression estimators			MLE				Regression estimators			MLE			
$i$	$t_i$	$\bar{y}_i$	$i$	$t_i$	$\bar{y}_i$	$n_i$	$i$	$t_i$	$\bar{y}_i$	$i$	$t_i$	$\bar{y}_i$	$n_i$
1	0.41666	0.84					1	0.41666	1.78	1	0.41666	1.78	
2	0.91666	1.57	1	0.6666	1.21		2	0.91666	1.02				
3	1.41666	0.76					3	1.41666	2.31	2	1.1666	1.67	0.11
4	1.91666	1.10	2	1.6666	0.93	0.28	4	1.91666	0.99	3	1.91666	0.99	0.68
5	2.41666	0.61					5	2.41666	0.92	4	2.41666	0.92	0.07
6	4.42	0.67	3	3.42	0.64	0.29	6	3.82	0.68	5	3.82	0.68	0.24
7	8.00	0.23	4	8.00	0.23	0.41	7	7.03	0.16	6	7.03	0.16	0.52
8	11.07	0.14	5	11.07	0.14	0.09	8	9.97	0.11	7	9.97	0.11	0.05
9	13.62	0.08	6	13.62	0.08	0.06	9	12.34	0.08	8	12.34	0.08	0.03
10	15.74	0.06	7	15.74	0.06	0.02	10	14.60	0.05	9	14.60	0.05	0.03
11	18.13	0.05	8	18.13	0.05	0.01	11	16.73	0.0405	10	16.73	0.0405	0.01
							12	18.88	0.0375	11	18.88	0.0375	0.003

<sup>1</sup> $n_i = \bar{y}_{i-1} - \bar{y}_i$

<sup>2</sup>Used in MLE only.

avoidance of the net becomes a serious bias.

Region	$nm^2 \times 10^{-3}$	$n^2 \times 10^{-10}$	$w_r$
4	18	6.105	0.107
5	29	9.878	0.174
7	20	6.896	0.119
8	12	4.116	0.072
9	29	9.878	0.174
11	9	3.171	0.054
13	21	7.122	0.125
14	29	9.866	0.174
Total	167	57.031	1.00

The sample mean daily production of eggs and larvae per 0.05 m<sup>2</sup> ( $\bar{y}_i$ ) with its age ( $t_i$ ) constituted the data base for regression estimates of IMRs of eggs and larvae in MEM and SEM. Mean daily production represent eggs for 0.17 d (4 h) <  $t_i$  ≤ 3 d, and

larvae for 3 d <  $t_i$  ≤ 20 d;  $i = 1, \dots, K$ , where  $K$  is the total number of age groups. The sample age structure ( $\bar{y}_i, t_i$ ) reflects that of a single cohort under the assumption of steady production over the survey period (Seber 1980). The same data set was also used to generate the sample mean number of eggs or larvae lost per day between two adjacent age groups ( $n_i = \bar{y}_{i-1} - \bar{y}_i$ ). The statistics  $n_i$ 's were used directly in the MLE. Normally, sample totals were used instead of sample means in MLE. I used  $n_i$ 's because anchovy eggs and larvae were sampled with different nets and because the number of egg tows was different from that of larvae.

### MULTI-EQUATION MODEL (MEM)

In the current estimation procedures, separate mortality curves are constructed (Equation (3)) for

the IMRs ( $\lambda(t)$ ) of anchovy eggs and larvae. If the life-stage-specific IMR is the main objective, the MEM is an easy method for obtaining the estimates of IMRs. The mortality curves (Equation (3)) are nonlinear functions of age ( $t$ ). The IMRs can be estimated by either nonlinear regression (NR) or linear regression (LR) after the data set ( $\bar{y}_i, t_i$ ) is transformed. The NR is based upon the assumption that the errors are additive. The observed mean daily production ( $\bar{y}_i$ ) relates to the conditional survival probability as

$$\begin{aligned}\bar{y}_i &= \theta_0 S_1[t_i; \lambda_1(t)] + e_{1i} \\ &= \bar{y}_0 e^{-\alpha t_i} + e_{1i} \quad t_i \leq u_1\end{aligned}\quad (4a)$$

$$\begin{aligned}\bar{y}_i &= \theta_{u_1} S_1[t_i; \lambda_2(t)] + e_{2i} \\ &= \bar{y}_{u_1} \left( \frac{t}{u_1} \right)^{-\beta} + e_{2i} \quad u_1 \leq t_i \leq 20\end{aligned}\quad (4b)$$

where  $u_1 = t_h \sim 3$  d old. Nonlinear regression estimation procedures provided by standard statistical packages such as BMDP statistical software (Dixon et al. 1983) are then used to estimate the parameters of IMRs, i.e.,  $\alpha$  and  $\beta$ .

The LR assumes that the errors are multiplicative. The observed daily production ( $\bar{y}_i$ ) relates to the conditional survival probability in the form of

$$\bar{y}_i = \theta_{u_{g-1}} S_g(t_i; \lambda_g(t)) e_{gi} \quad \text{for } g = 1, 2.$$

The logarithm of both sides of the equation yields two linear functions

$$\ln(\bar{y}_i) = A - \alpha t_i + \epsilon_{1i} \quad t_i \leq u_1 \quad (5a)$$

$$\ln(\bar{y}_i) = B - \beta \ln\left(\frac{t_i}{u_1}\right) + \epsilon_{2i} \quad u_1 \leq t_i \leq 20. \quad (5b)$$

Equation (5a) is then fitted to data set  $(\ln(\bar{y}_i), t_i)$  for  $t_i \leq u_1$ , and Equation (5b) is fitted to data set  $(\ln(\bar{y}_i), \ln(t_i/u_1))$  for  $u_1 \leq t_i \leq 20$  d) to estimate  $\alpha$  and  $\beta$ .

## SINGLE-EQUATION MODEL (SEM)

The SEM consolidates all the conditional survival probabilities ( $S_g(t)$ ) from each mortality stanza into a single equation. It not only eliminates discontinuities at transitions between life stages, but also im-

proves the precision of overall mortality estimates because of the large sample size. Moreover, the SEM makes it possible to estimate the IMR for life stages where data are scarce.

Based upon Equation (2),  $S(t_i)$  of anchovy eggs and larvae is

$$S(t_i) = \begin{cases} S_1(t_i) & t_i \leq u_1 \\ S_1(u_1)S_2(t_i) & u_1 \leq t_i \leq 20 \end{cases}$$

or

$$S(t_i) = \begin{cases} S_1(t_i)S_2(u_1) & t_i \leq u_1 \\ S_1(u_1)S_2(t_i) & u_1 \leq t_i \leq 20 \end{cases}$$

where  $S_1(u_1) = P(T > u_1 | T \geq 0) = e^{-\alpha u_1}$ ,  $S_2(u_1) = P(T > u_1 | T \geq u_1) = 1$ , and  $u_1 = t_{ys} = 4.5$  d. Thus by creating two new independent variables  $x_{1i}$  and  $x_{2i}$  such that

$$x_{1i} = \begin{cases} t_i & t_i \leq u_1 \\ u_1 & u_1 \leq t_i \leq 20 \end{cases}$$

and

$$x_{2i} = \begin{cases} u_1 & t_i \leq u_1 \\ t_i & u_1 \leq t_i \leq 20 \end{cases}$$

it follows that  $S(t_i) = S_1(x_{1i})S_2(x_{2i})$  and the mortality curve can be written as

$$E(\bar{y}_i) = \theta_0 S_1(x_{1i})S_2(x_{2i}) = \theta_0 e^{-\alpha x_{1i}} \left( \frac{x_{2i}}{u_1} \right)^{-\beta}. \quad (6)$$

The data set for fitting Equation (6) looks like

age group	age	$\bar{y}_i$	$x_{1i}$	$x_{2i}$
(i)	( $t_i$ )	$\bar{y}_i$	$x_{1i}$	$x_{2i}$
1	$t_1$	$\bar{y}_1$	$t_1$	$u_1$
2	$t_2$	$\bar{y}_2$	$t_2$	$u_1$
.	.	.	.	.
.	.	.	.	.
.	.	.	.	.
$u_1 = 4.5$ d				
$i$	$t_i$	$\bar{y}_i$	$\bar{u}_1$	$t_i$
.	.	.	.	.
.	.	.	.	.
$k$	$t_k$	$\bar{y}_k$	$\bar{u}_1$	$t_k$

In order to use Equation (6) to estimate the IMRs of eggs and larvae in Equation (1), a combined data

set  $(\bar{y}_1, x_{1i}, x_{2i})$ , which includes all the data from each life stage and the maximum ages of mortality stanzas ( $u_g$ 's), is important to ensure the accuracy of the estimates of the IMRs. The determination of  $u_g$ 's depends primarily on the changes of the mortality rates, which may be related to the changes in morphology or behavior that affects mortality rates. In the best fit of the SEM, however, the end points of morphological patterns may not correspond to the maximum ages. Three life stages were identified for anchovy eggs and larvae, with the end point of mortality stanza 1 being the average age of yolk-sac larvae ( $u_1 = 4.5$  d). In the MEM, the hatching time ( $t_h$ ) was used, but, the best fit of the SEM occurred when  $u_1 = 4.5$  d. Two mortality stanzas were assigned to three life stages of anchovy (<20 d) because from the existing data, no evidence for a change in the IMRs within a life stage existed although the data may not have been adequate to detect such changes.

The regression estimates of the IMRs for the SEM can be obtained by either NR or LR as described in the previous section. If NR is used, Equation (6) is fitted to the data set  $(\bar{y}_i, x_{1i}, \text{ and } x_{2i})$  directly to obtain estimates of parameters of  $\lambda_1(t)$  and  $\lambda_2(t)$ . Because the variance of egg data is larger than that of larvae, a weighted NR (WNR) would be preferable. If errors are assumed to be multiplicative, taking the logarithm of both sides of the Equation (6) yields

$$\ln(\bar{y}_i) = A - \alpha x_{1i} - \beta \ln\left(\frac{x_{2i}}{u_1}\right) + \epsilon_i. \quad (7)$$

The data set  $(\ln(\bar{y}_i), x_{1i}, \text{ and } \ln(x_{2i}/u_1))$  is then used to estimate  $\alpha$  and  $\beta$  through linear least squares regression.

### MAXIMUM LIKELIHOOD ESTIMATOR (MLE)

The MLE is presented here as an alternative method of estimating IMRs. Because the data used for mortality estimators are grouped by age, I followed the procedures described by Kulldorff (1961) and McDonald and Ransom (1979) for grouped data. Here,  $N_i = Y_{i-1} - Y_i$  (number of deaths between ages  $t_{i-1}$  and  $t_i$ ) of a single cohort are multinomial variables, each with probability

$$P_i = S(t_{i-1}) - S(t_i).$$

The likelihood function of  $N_i$ 's for the whole life cycle ( $i = 1, \dots, I$ , and  $Y_I = 0$ ) is

$$L(N_i, P_i(z'); i = 1, \dots, I) \propto \prod_{i=1}^I P_i(z')^{N_i} \\ = \prod_{i=1}^I [S(t_{i-1}) - S(t_i)]^{N_i} \quad (8)$$

where  $z$  is the parameter vector in  $\lambda(t)$ . The derivatives of the logarithm of likelihood function with respect to the parameters  $z$ 's are set equal to zero. Solutions to the simultaneous equations

$$\frac{\partial \ln L}{\partial z_i} = 0$$

are MLEs of  $z$ , if certain conditions are satisfied (Kulldorff 1961). In marine fish only the IMRs of a few life stages are considered because of the lack of data. It is then necessary to compute the conditional probability

$$P_i = P(t_{i-1} \leq T < t_i \mid T \in D) \\ = [S(t_{i-1}) - S(t_i)]/P(T \in D)$$

where  $D$  is the domain of ages of life stages considered.

Because I considered only the IMRs of anchovy eggs and larvae of ages >4 h (0.17 d) and <20 d, the conditional probabilities are computed from a truncated exponential and Pareto survival probability (Equation (2)) (Gross and Clark 1975, p. 128-132):

$$P_i = P(t_{i-1} < T \leq t_i \mid t_1 < T \leq 20) \\ = (S(t_{i-1}) - S(t_i))/(S(t_1) - S(20))$$

$$P_i = \begin{cases} \frac{e^{-at_{i-1}} - e^{-at_i}}{e^{-at_1} - e^{-a u_1} \left(\frac{20}{u_1}\right)^{-\beta}} & t_i \leq u_1 \\ \frac{e^{-a u_1} \left[\left(\frac{t_{i-1}}{u_1}\right)^{-\beta} - \left(\frac{t_i}{u_1}\right)^{-\beta}\right]}{e^{-at_1} - e^{-a u_1} \left(\frac{20}{u_1}\right)^{-\beta}} & u_1 \leq t_i \leq 20. \end{cases} \quad (9)$$

Then the likelihood function of  $N_i$ 's for anchovy eggs and larvae of ages <20 d is



$$L \propto \prod_{i=2}^k P_i^{N_i} = \left[ \prod_{i=2}^k (S(t_{i-1}) - S(t_i))^{N_i} \right] / \left[ S(t_1) - S(t_0) \right]^{\sum_{i=2}^k N_i}$$

and

$$\ln(L) = \sum_{i=2}^k [N_i \ln(P_i)] = \sum_{i=2}^c [N_i \ln(P_i)] + \sum_{i=c+1}^k [N_i \ln(P_i)] \quad (10)$$

where  $N_i = m(\bar{y}_{i-1} - \bar{y}_i) = m \cdot n_i$  and  $c$  is  $\max(i)$  for  $t_i \leq 3 \text{ d } (u_1)$ . Substituting Equation (9) for  $P_i$  in Equation (10) yields

$$\begin{aligned} \ln(L) = & \sum_{i=2}^c N_i \ln(e^{-\alpha t_{i-1}} - e^{-\alpha t_i}) + \sum_{i=c+1}^k \left[ N_i(-\alpha u_1 + \beta \ln u_1) + N_i \ln(t_{i-1}^{-\beta} - t_i^{-\beta}) \right] \\ & - \sum_{i=2}^k N_i \ln \left[ e^{-\alpha t_i} - e^{-\alpha u_1} \left( \frac{20}{u_1} \right)^{-\beta} \right]. \end{aligned} \quad (11)$$

Solving simultaneous equations  $\frac{\partial \ln L}{\partial \alpha} = 0$  and  $\frac{\partial \ln L}{\partial \beta} = 0$  for  $\alpha$  and  $\beta$  gives their MLEs.

The asymptotic variance-covariance (ASVAR-COV) of MLEs of  $\alpha$  and  $\beta$  was computed according to Kulldorff (1961, p. 86-87):

$$\begin{aligned} \left[ \begin{array}{cc} \text{As var}(\alpha) & \\ \text{As cov}(\alpha, \beta) & \text{As var}(\beta) \end{array} \right]_{\hat{\alpha}, \hat{\beta}} &= (1/N) \left[ \begin{array}{cc} \mathbf{a}_{11} & \\ \mathbf{a}_{21} & \mathbf{a}_{22} \end{array} \right]_{\hat{\alpha}, \hat{\beta}} = (1/N) A_{\hat{\alpha}, \hat{\beta}} \\ &= - \frac{1}{N} \left[ \begin{array}{cc} \sum_{i=2}^k P_i \frac{\partial^2 \ln P_i}{\partial \alpha^2} & \\ \sum_{i=2}^k P_i \frac{\partial^2 \ln P_i}{\partial \alpha \partial \beta} & \sum_{i=2}^k P_i \frac{\partial^2 \ln P_i}{\partial \beta^2} \end{array} \right]_{\hat{\alpha}, \hat{\beta}}^{-1} \end{aligned} \quad (12)$$

For detailed derivation of the MLEs, see the Appendix.

Conceptually, abundance declines monotonically with increasing age, but this may not occur in the sample. Although its absence does not complicate regression analysis, corrections are required when the MLEs are used. The MLEs are functions of sample totals  $N_i = (\bar{y}_{i-1} - \bar{y}_i)m$ ,  $N_i \geq 0$ , and can also be expressed as function of sample proportions  $N_i/N$  (Equations (A1) and (A2)), which are equal to the ratios of differences of sample mean daily productions  $(\bar{y}_{i-1} - \bar{y}_i)/(\bar{y}_1 - \bar{y}_k) = n_i/n$  (see Appendix). The quantity  $n_i = N_i/m$  is the sample mean daily death between two adjacent groups. The MLEs require  $N_i \geq 0$ . Due to sampling error, it is possible to observe more individuals in the older group than the adjacent younger group, i.e.,  $\bar{y}_{i-1} < \bar{y}_i$ . If so, some adjacent groups

$(\bar{y}_i, t_i)$  have to be combined so that  $\bar{y}_i > \bar{y}_i$  for  $t_i < t_i$ . The ratio  $n_i/n$  can be used in place of  $N_i/N$  to compute the MLEs. This correction is inappropriate if the reason for  $\bar{y}_i > \bar{y}_i$ , for  $t_i < t_i$  is that individuals were evicted from the sampling area or immigrated into it, as such movements violate the assumption of a stationary population.

Although  $n_i$ 's are sufficient for computing point estimates of the MLE, the total number of deaths between ages  $t_1$  and  $t_k$  ( $N = m(\bar{y}_1 - \bar{y}_k)$ ) is required for computation of the ASVAR-COV of the MLEs.  $N$  can then be used to determine minimum number of tows ( $m_1$ ) for the youngest stage through  $m_1 \bar{y}_1 \pm N$  for a given precision of the MLE. Although the sample size for eggs may differ from that of larvae, an equal number of sample sizes is assumed to compute the ASVAR-COV. The minimum number of egg tows can be determined by  $m_1 = N/\bar{y}_1$ .

## RESULTS

Both the MEM and the SEM were fitted to the basic data ( $\bar{y}_i, t_i$ ;  $0.17 \text{ d} < t_i \leq 20 \text{ d}$ ) collected from 1980 to 1983, using NR and LR (Table 1, Fig. 2). The point estimates and their asymptotic standard

errors are listed in Table 2 and Figure 3. NR and LR produced similar estimates of the IMRs for the MEM. When the SEM was applied to the combined egg and larval data, the WNR was also used to compute the IMRs in addition to NR and LR because of the inequality of the variances among life stages. The variance of egg counts was higher than that of larvae because eggs were more patchily distributed than larvae. Because of this, the inverse of the variances of sample means of eggs and larvae was used as the weights for the WNR. The estimates from the WNR were similar to those from LR and the standard errors from both methods were lower than those from NR.

The WNR estimates of egg IMRs from the SEM were more precise than estimates from the MEM, whereas the most precise estimates of larval IMRs were provided by the MEM using NR. The SEM was more precise than the MEM for eggs but not for the larvae, because the variance of eggs was larger than that of larvae. Thus, when eggs and larvae were combined in an SEM, the variance around the single equation was smaller for the eggs and larger for the larvae. Nevertheless, the SEM produced larval IMRs with reasonable precision when the WNR was used. Therefore, the SEM WNR is suitable for ap-

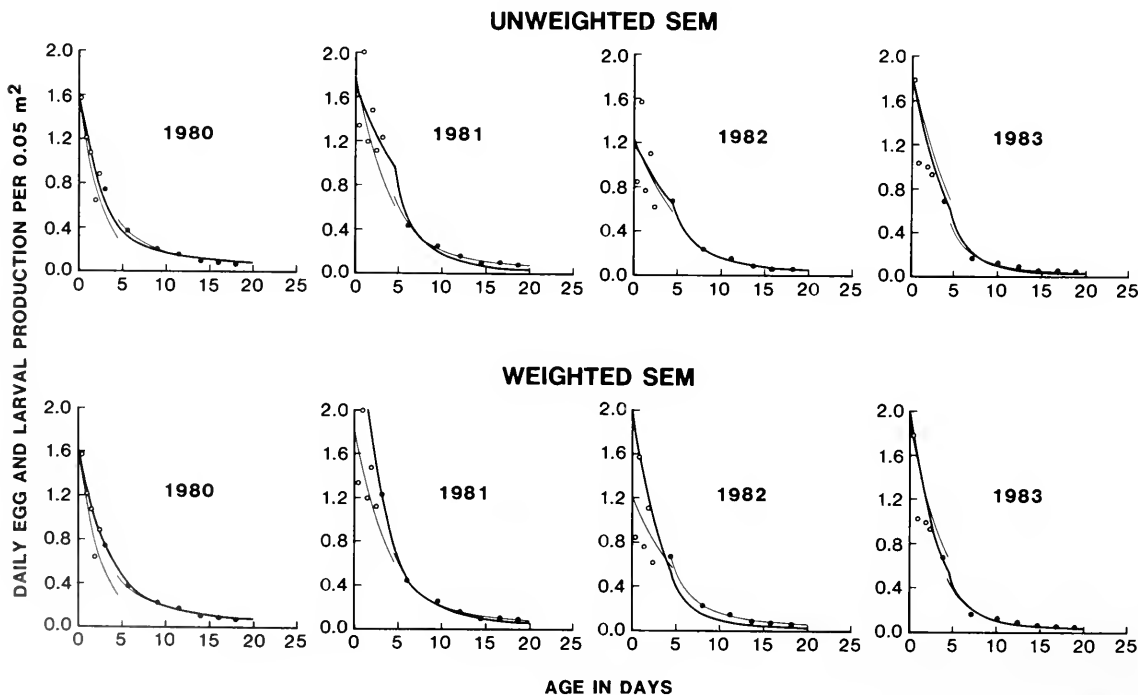

FIGURE 2.—Observed daily anchovy egg and larval production/0.05 m<sup>2</sup> (○ = eggs, ● = larvae), and the mortality curves from the MEM (two short curves) and the SEM (one single curve) using unweighted and weighted nonlinear regression for 1980-83 field collected data.

TABLE 2.—Estimates from multi-equation model (MEM), single-equation model (SEM), and maximum likelihood estimator (MLE) for anchovy egg and larval mortality ( $\hat{\alpha}$  and  $\hat{\beta}$ ), and their standard error (SE) based upon 1980-83 field data where  $K$  is number of age groups and  $m$  is number of tows used in each model. For both MEM and SEM, nonlinear regression (NR), linear regression (LR) and weighted nonlinear regression (WNR) estimates are given.

	Egg mortality			Larval mortality		
	$\hat{\alpha}$	SE	$K(m)$	$\hat{\beta}$	SE	$K(m)$
1980						
MEM						
NR	0.39	0.103	5(961)	1.22	0.0314	7(199)
LR	0.35	0.13		1.32	0.06	
SEM						
NR	0.32	0.05	12(1,160)	1.06	0.41	12(1,160)
WNR	0.25	0.02		1.33	0.06	
LR	0.24	0.05		1.36	0.13	
MLE	0.36	0.012	11(961)	1.28	0.09	11(961)
		0.016	(500)		0.12	(500)
		0.02	(300)		0.16	(300)
		0.03	(199)		0.27	(199)
1981						
MEM						
NR	0.13	0.16	5(1,134)	1.53	0.032	7(403)
LR	0.13	0.15		1.54	0.06	
SEM						
NR	0.13	0.07	12(1,537)	2.19	0.96	12(1,537)
WNR	0.33	0.06		1.70	0.18	
LR	0.20	0.05		1.64	0.15	
MLE	0.24	0.008	10(1,134)	0.96	0.06	10(961)
		0.01	(500)		0.08	(500)
		0.02	(300)		0.11	(300)
		0.01	(403)		0.10	(403)
1982						
MEM						
NR	0.17	0.26	5(992)	1.81	0.036	6(96)
LR	0.19	0.24		1.87	0.065	
SEM						
NR	0.14	0.10	11(1,088)	1.77	1.46	11(1,088)
WNR	0.13	0.04		1.83	0.36	
LR	0.12	0.07		1.85	0.20	
MLE	0.24	0.008	8(992)	1.20	0.08	8(992)
		0.01	(500)		0.11	(500)
		0.015	(300)		0.14	(300)
		0.03	(100)		0.25	(100)
1983						
MEM						
NR	0.23	0.29	5(850)	2.05	0.11	7(78)
LR	0.27	0.25		1.80	0.10	
SEM						
NR	0.26	0.19	12(928)	2.45	2.71	12(928)
WNR	0.30	0.05		2.23	0.28	
LR	0.33	0.08		1.84	0.22	
MLE	0.32	0.007	11(850)	2.48	0.10	11(850)
		0.01	(500)		0.14	(500)
		0.013	(300)		0.18	(300)
		0.02	(80)		0.35	(80)

plications where it is preferable to estimate IMRs for egg and larvae simultaneously (e.g., simulation studies of mortality at all life stages). The SEM is preferable for modeling the mortality curves through all life stages because it eliminates the multiple estimates that occur at the endpoint of each life stage (Fig. 2). In addition, the SEM allows

estimation of the IMRs for all life stages even when data for some life stages are inadequate for independent estimation of a life-stage-specific IMR. In comparing NR and LR, the estimates of IMRs from these two procedures were similar, despite the different assumptions about the error term. One complication of using LR is that the abundance for any

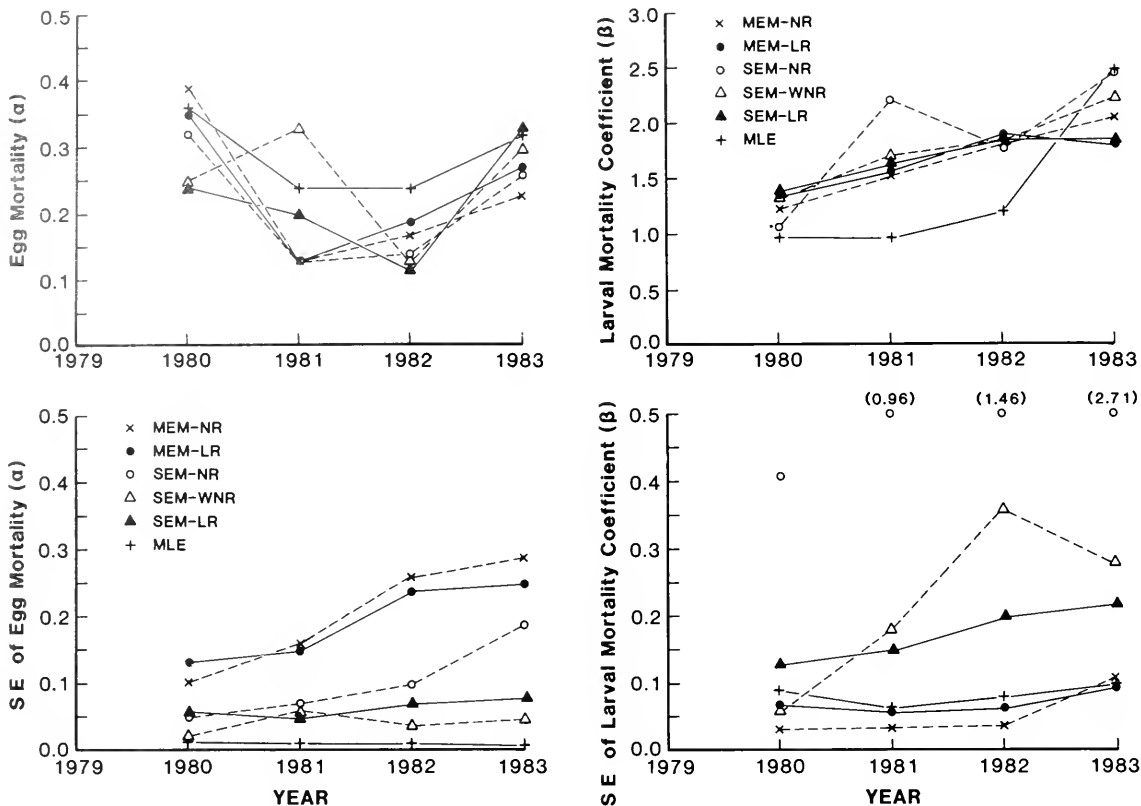

FIGURE 3.—Estimated anchovy egg mortality ( $\hat{\alpha}$ ), larval mortality coefficient ( $\hat{\beta}$ ), and their standard error (SE) using multi-equation model (MEM), single-equation model (SEM), and maximum likelihood estimator (MLE) for 1980-83.

specific age needs to be transformed back to the original unit. Direct inverse transformation may bias the estimates. Thus, the LR may not be appropriate for biomass estimation or other applications where a transformation back to original units is required.

In addition to the above regression models, the MLEs of egg and larval IMRs were also computed based on the data set  $n_i = \bar{y}_{i-1} - \bar{y}_i$ ,  $i = 1, \dots, k$  (Equations (A1) and (A2), Table 1). The ASCOVAR for anchovy egg and larval mortality rates requires the total number of eggs and larvae that died between ages 4 h and 20 d from the sample ( $N$ ). It is not possible to obtain  $N$  directly from  $m\bar{y}_1$  (i.e.  $N \neq m\bar{y}_1$ ) because eggs and larvae are sampled with different nets and in different regions. Anchovy eggs have a more concentrated and patchy distribution than larvae which are less numerous and distributed more uniformly throughout the entire survey area because of the diffusion of larvae after hatching (Hewitt 1982). Zero density of eggs was assumed for the offshore regions where eggs were

not sampled to compute the weighted average egg production  $\bar{y}_i = \sum_r w_r \bar{y}_{ir}$ . I then divided  $m_1 \bar{y}_1$  by the proportion of area sampled ( $q = \sum_r w_r$  where

$w_r$ 's are summed over the regions where egg tows were taken) to obtain sample daily death  $N$  in  $[t_1, t_k]$ . Thus,  $N = m_1 \bar{y}_1 / q$ ;  $q$  ranges from 0.53 to 0.82 for 1980-83. Four sets of sample sizes were considered:  $m = m_1, 500, 300, m_2$  where  $m_1$  is the actual number of egg tows and  $m_2$ , actual number of larval tows (Table 2). For any given  $N$ , one obtains the ASVAR-COV of  $\alpha$  and  $\beta$  by dividing  $a_{ij}$  by  $N$  where  $a_{ij}$ 's are the elements in matrix  $A$  of Equation (12).

The MLE point estimates  $\hat{\alpha}$  and  $\hat{\beta}$ , were between the estimates yielded by the SEM and the MEM in most cases. The precision of the MLE for egg IMR was higher than that of the regression estimates. The standard error of the MLE of the larval IMR was between those of the MEM and SEM regression estimates (Table 2, Fig. 3).

## DISCUSSION

All the estimates of instantaneous mortality rates (IMR) discussed in this paper were computed from age (stage) frequency data. To ensure the unbiasedness of the estimates, three assumptions have to be met: a stationary population, reliable growth curves, and accurate samplers. Any violation of these assumptions will cause biases in the mortality estimates. Nets usually do not retain fish of all sizes because some small fish extrude through the net and some large fish avoid the net. Thus the estimates of size-specific retention rates are essential correction factors for the catch. If fish migrate at a significant rate, either the migration rate should be estimated or the sampling area should be expanded to eliminate migration problems, for migration violates the assumption of a stationary population and thus biases the mortality. Because growth curves are normally used to assign age to stage of eggs and larvae, biased growth curves would lead to inaccurate age assignments which definitely would bias the mortality estimates.

Although modeling the mortality rates of the early life stages of anchovy is the focus of this paper, I have shown that the SEM (Fig. 2) can be applied to any continuous process whose parameters are life-stage specific and generally estimated separately. For example, many allometric relations such as the growth curves may have different instantaneous growth rates for different life stages. A single continuous growth curve for the whole life cycle is possible using the SEM which allows greater latitude of modeling life-stage-specific growth rates than modeling the instantaneous growth rate for the whole life cycle as proposed by Schnute (1981). However, the SEM does require knowledge of the forms of instantaneous rates and the endpoint of each mortality stanza (or life stage).

In this study, the determination of a cutoff point between life stages was based upon examination of the empirical data and biological implications. It is conceivable to include the cutoff point ( $u_1$ ) as one of the parameters in both SEM and MLE (Matthews and Farewell 1982). The cutoff point can then be estimated directly through the models. Matthews and Farewell considered the exponential mortality curve with one cutoff point and obtained MLE of the cutoff point (change point). For anchovy egg and larvae, the cutoff point for the eggs and larvae up to 20 d old was easily determined from the IMR and age data (Lo 1985). Estimation of the cutoff point through SEM or MLE would be laborious and any improvement may be minimal. However, the

estimates through the models would eliminate the problem of whether  $u_1$  should be hatching time or the age of yolk-sac larvae.

Comparison of these two regression models with the MLEs based on anchovy egg and larval data indicated that the point estimates of the IMRs were similar. The SEM using WNR provided the most precise egg IMR which was nearly the same as the MLE. The MEM, using NR, provided the most precise estimates of larval IMR's. The regression estimators of the IMR's are easier to compute than the MLEs, yet they require larger sample sizes than the MLEs. If money is not a constraint, the SEM is preferred to the MLE. Otherwise, the MLE should be used. Based upon 1980 anchovy egg and larval data, 300 tows for eggs and larvae each (a total of 600 tows) could guarantee MLEs of  $\alpha$  and  $\beta$  with  $cv = 0.10$ . The current sampling design (egg tows  $\sim 1,000$ ) seems to use an excessive number of egg tows for the MLEs of egg and larval IMRs. If the larval IMR is the only parameter to be estimated, the MEM is recommended.

## ACKNOWLEDGMENTS

I thank J. Hunter of Southwest Fisheries Center, National Marine Fisheries Service, and C. J. Park of San Diego State University for valuable discussions through the writing of the manuscript, the referee for constructive comments, and Mary Ragan and Lorraine Prescott for typing the manuscript.

## LITERATURE CITED

- DIXON, W. J., M. B. BROWN, L. ENGLEMAN, J. W. FRANE, M. A. HILL, R. J. JENNRICH, AND J. D. TOPOREK.  
1983. BMDP statistical software. Univ. Calif. Press, Berkeley.
- GROSS, A. J., AND V. A. CLARK.  
1975. Survival distributions: reliability applications in the biomedical sciences. John Wiley and Sons, N.Y., 331 p.
- HEWITT, R. P.  
1982. Spatial pattern and survival of anchovy larvae: implications of adult reproductive strategy. Ph.D. Thesis, Univ. California, San Diego, 207 p.
- HEWITT, R. P., AND G. D. BREWER.  
1983. Nearshore production of young anchovy. CalCOFI (Calif. Coop. Oceanic Fish. Invest.), Rep. 24, 235-244.
- JOHNSON, N. L., AND S. KOTZ.  
1976. Distributions in statistics: continuous univariate distributions - 2. John Wiley and Sons, N.Y., 306 p.
- KULLDORFF, G.  
1961. Contributions to the theory of estimation from grouped and partially grouped samples. John Wiley & Sons, Inc., N.Y., 144 p.
- LO, N. C. H.  
1983. Re-estimation of three parameters associated with an-

chovy egg and larval abundance: Temperature dependent hatching time, yolk-sac growth rate and egg and larval retention in mesh nets. U.S. Dep. Commer., NOAA NMFS SWFC-31, 33 p.

1985. Egg production of the central stock of northern anchovy 1951-83. Fish. Bull., U.S. 83:137-150.

MATTHEWS, D. E., AND V. T. FAREWELL.  
1982. On testing for a constant hazard against a change-point alternative. Biometrics 38:463-468.

MCDONALD, J. B., AND M. R. RANSOM.  
1979. Alternative parameter estimators based upon grouped data. Commun. Stat.-Theory, Method A8(9)899-917.

PARKER, K.  
1980. A direct method for estimating northern anchovy, *Engraulis mordax*, spawning biomass. Fish. Bull., U.S.

78:541-544.

SCHNUTE, J.  
1981. A versatile growth model with statistically stable parameters. Can. J. Fish. Aquat. Sci. 38:1128-1140.

SEBER, G. A. F.  
1980. Some recent advances in the estimation of animal abundance. Tech. Rep. WSG 80-1, 101 p.

SMITH, P. E.  
1972. The increase in spawning biomass of northern anchovy, *Engraulis mordax*. Fish. Bull., U.S. 80:849-974.

ZWEIFEL, J. R., AND P. E. SMITH.  
1981. Estimates of abundance and mortality of larval anchovies (1951-75). Rapp. P.-v. Réun. Cons. int. Explor. Mer. 178:248-259.

### APPENDIX

The two partial deviations of  $\ln L$  (Equation (11)) are

$$\frac{\partial \ln L}{\partial \alpha} = N \sum_{i=2}^c \frac{N_i}{N} \left[ \frac{-t_{i-1} - t_i e^{-\alpha \Delta_i}}{1 - e^{-\alpha \Delta_i}} \right] - u_1 \sum_{i=c+1}^k \frac{N_i}{N} + t_1 - (u_1 - t_1) \left[ e^{\alpha(u_1 - t_1)} \left( \frac{20}{u_1} \right)^\beta - 1 \right]^{-1} = 0 \quad (A1)$$

$$\frac{\partial \ln L}{\partial \beta} = N \sum_{i=c+1}^k \frac{N_i}{N} \left[ \ln u_1 + \frac{-\ln t_{i-1} + \left( \frac{t_i}{t_{i-1}} \right)^{-\beta} \ln t_i}{1 - \left( \frac{t_i}{t_{i-1}} \right)^{-\beta}} \right] - \ln \left( \frac{20}{u_1} \right) \left[ e^{\alpha(u_1 - t_1)} \left( \frac{20}{u_1} \right)^\beta - 1 \right]^{-1} = 0 \quad (A2)$$

where  $\Delta_i = t_i - t_{i-1}$  and  $u_1 \sim 3$ .

Both Equations (A1) and (A2) depend on the proportion  $N_i/N$  rather than the absolute counts ( $N_i$ 's). In order to have a unique solution of  $\alpha$  and  $\beta$ , it is necessary to have

$$\frac{\partial^2 \ln L}{\partial \alpha^2} < 0 \quad \text{and} \quad \frac{\partial^2 \ln L}{\partial \beta^2} < 0. \quad (A3)$$

Moreover, the conditions

$$\lim_{\alpha \rightarrow 0} \frac{\partial \ln L}{\partial \alpha} > 0, \quad \lim_{\alpha \rightarrow \infty} \frac{\partial \ln L}{\partial \alpha} < 0$$

and

$$\lim_{\beta \rightarrow 0} \frac{\partial \ln L}{\partial \beta} > 0, \quad \lim_{\beta \rightarrow \infty} \frac{\partial \ln L}{\partial \beta} < 0 \quad (A4)$$

guarantee a positive solution of  $\alpha$  and  $\beta$ . Equation (A3) leads to the following constraints

$$1 < \frac{\left[ e^{\alpha(u_1-t_1)} \left( \frac{20}{u_1} \right)^\beta - 1 \right]^2}{(u_1 - t_1)^2 \left( \frac{20}{u_1} \right)^\beta e^{\alpha(u_1-t_1)\alpha}} \sum_{i=2}^c \frac{N_i}{N} \left( \frac{t_i - t_{i-1}}{1 - e^{-\alpha(t_i-t_{i-1})}} \right)^2 e^{-\alpha(t_i-t_{i-1})} \quad (\text{A5})$$

and

$$1 < \frac{\left[ e^{\alpha(u_1-t_1)} \left( \frac{20}{u_1} \right)^\beta - 1 \right]^2}{\left[ \ln \left( \frac{20}{u_1} \right) \right]^2 \left( \frac{20}{u_1} \right)^\beta e^{\alpha(u_1-t_1)}} \sum_{i=c+1}^k \frac{N_i}{N} \frac{\left( \frac{t_i}{t_{i-1}} \right)^{-\beta} \left[ \ln \frac{t_i}{t_{i-1}} \right]^2}{\left[ 1 - \left( \frac{t_i}{t_{i-1}} \right)^{-\beta} \right]^2}. \quad (\text{A6})$$

After algebraic manipulation, it was easy to see that Equation (A4) was true for this truncated exponential and the Pareto MLE. We used an iterative procedure to select the MLE of  $\alpha$  and  $\beta$ , which satisfies not only Equation (A3) but also the constraints of Equations (A5) and (A6).

The partial derivations in each entry of matrix A (Equation (12)) are

$$\frac{\partial^2 \ln P_i}{\partial \alpha^2} = - \left( \frac{\Delta_i}{e^{\alpha \Delta_i} - 1} \right)^2 e^{\alpha \Delta_i} + (u_1 - t_1)^2 \frac{\left( \frac{20}{u_1} \right)^\beta e^{\alpha(u_1-t_1)}}{\left[ e^{\alpha(u_1-t_1)} \left( \frac{20}{u_1} \right)^\beta - 1 \right]^2}$$

$$\frac{\partial^2 \ln P_i}{\partial \beta^2} = \frac{\left[ \ln \left( \frac{20}{u_1} \right) \right]^2 \left( \frac{20}{u_1} \right)^\beta e^{\alpha(u_1-t_1)}}{\left[ e^{\alpha(u_1-t_1)} \left( \frac{20}{u_1} \right)^\beta - 1 \right]^2}$$

and

$$\frac{\partial^2 \ln P_i}{\partial \alpha \partial \beta} = \frac{(u_1 - t_1) \left( \frac{20}{u_1} \right)^\beta e^{\alpha(u_1-t_1)} \ln \left( \frac{20}{u_1} \right)}{\left[ e^{\alpha(u_1-t_1)} \left( \frac{20}{u_1} \right)^\beta - 1 \right]^2}.$$





# METHODOLOGICAL PROBLEMS IN SAMPLING COMMERCIAL ROCKFISH LANDINGS

A. R. SEN<sup>1</sup>

## ABSTRACT

The present sample survey plan, for the estimation of age and species composition of California rockfish landings, which is stratified two-stage with port-month group as a stratum, poses serious operational problems in data collection. A revised plan is suggested which is workable. Formulas have been developed for estimating total catch and its error by species-sex-age groups; optimum sampling and subsampling fractions have been obtained for a given cost function and the precision of the estimator is compared with two other estimators. The method developed has been extended to cover situations other than rockfish.

The paper also deals with double-sampling for specified cost for the estimation of age composition of a species, which is important to predict the status of a stock in future years, the inherent problems in data collection in commercial fisheries, and the measurement errors involved in the survey.

Estimates of the total catch (in terms of number) by species-sex-age and by area of landing and during a given time for commercial rockfish caught in California north of point Arguello are currently based on a probability sample of landings. The commercially important species of rockfish taken by California's fishery with mixed species are widow rockfish, *Sebastes entomelas*; bocaccio, *Sebastes paucispinis*; and chilipepper, *Sebastes goodei*.

A study was undertaken during 1983 under agreement between the present author, the Humboldt State University Foundation, and the Tiburon Laboratory of the National Marine Fisheries Service, NOAA, to determine if the present sampling plan for the estimation of species and age-composition of California rockfish landings is workable. The study revealed that the current plan is not operationally feasible. A revised plan is proposed which is workable and would provide efficient estimates of the parameters based on existing catch data within the usual limitations of budget and personnel and under the assumptions made in the plan. Formulas have been developed for the ratio estimators of mean and total catch and their errors. Optimum sampling and subsampling fractions have been obtained for a given cost function and the precision of the estimator is compared with two other estimators.

For most theoretical population work and for management purposes, the knowledge of the age

composition is important to predict the status of the stock in future years. Fridricksson (1934) developed the age-length key method for determining age composition from a large number of length measurements. Fridricksson's approach was improved by Ketchen (1950) who provided more accurate results for age groups at the extremities of the distribution. Kutkuhn (1963) mentioned the limitations of the age-length key approach except in situations where price differentials may demand sorting of landings by size criterion. Westrheim and Ricker (1978) pointed out that the age-length key approach will almost always give biased estimates. Clark (1981) and more recently Bartoo and Parker (1983) dealt with methods for control or elimination of bias. Following the method of Tanaka (1953) in which stratification occurs after subsampling for age, Kutkuhn (1963) estimated absolute age composition of California salmon landings by port-month groups. He showed that the sampling procedure is not effective unless the age sample is at least five times costlier than the length sample.

Mackett (1963) found double sampling more efficient than simple random sampling with fixed sampling costs for estimating relative age composition of Pacific albacore landings.

Southward (1976) found that a sample of otoliths proportional to the length frequency of sampled fish from each port was preferable to fixed sample size procedure for estimating age composition of Pacific halibut. Kimura (1977) arrived at the same conclusion as Southward by following a somewhat different approach.

We will present some of the important considera-

<sup>1</sup>Department of Mathematics and Statistics, Queen's University, Kingston, Ontario, Canada K7L 3N6; present address: 67 Ranch-Ridge Way N.W., Calgary, Alberta, Canada T3G 1Z8.

tions in sampling for estimating age composition of rockfish landings based on recent widow rockfish data from the California coast. Finally, we will describe some of the measurement errors, which would normally occur in simple random sample of individual fish and which are taken care of in cluster sampling adopted in our approach.

The sampling plan arrived at may produce usable results under the assumptions stated, though some of the assumptions have been under attack during recent years.

## DESIGN OF THE SURVEY

Rockfish are being landed at 14 points on the California coast. Of these, three cater only to commercial fishing, four to sport fishing, and seven to both sport and commercial fishing. The 10 commercial ports are grouped into 6 port groups with a sampler (six in all) assigned to each of the 6 ports—Eureka, Fort Bragg, Bodega Bay, San Francisco, Monterey, and Morro Bay.

The commercial trawlers make trips varying in length from 1 to 8 d. These vessels maintain log books to keep records of area fished and appropriate catch for each tow. Sampling by tow is generally not feasible because it is not possible for the sampler to be on board during haul time. For the same reasons no estimates of fish being rejected and returned to the sea are obtained because this would involve collection of discarded fish from randomly selected tows within sampled trips.

### Selection Procedure

A two-stage stratified random sampling plan was adopted with port-month group as a stratum and boat trips within a stratum as first-stage sampling units. Fish are sorted at sea into market categories. The first stage sampling units are poststratified into categories and at least one cluster of a given weight is subsampled within each sort-type from a first-stage sampling unit. Categories are based upon species composition, size, and quality, but in other contexts they could be strictly size or species categories. Cluster (box) of 25 lb is taken when sampling small fish, or any time small rockfish are landed such that there would be more than 20 fish in the 50-lb cluster. In all other cases 50-lb standard cluster size is selected. A cluster is next separated by number of each species and its weight, which are recorded along with sex, total length, and otolith of each member of a species in the cluster.

The instructions are to "sample all market

categories (sorts) from a boat, and from as many boats as possible and select:

- "(i) 1 cluster per 20,000 lb of widow rockfish landed by each boat, up to 4 clusters,
- "(ii) 1 cluster for all other species, if less than 5,000 lb landed, and
- "(iii) 2 clusters for all species if more than 5,000 lb are landed.

"The second cluster should not be taken if this precludes sampling another boat."

### Estimation with Poststratification of Sample Trips by Categories

Consider the problem of estimation of total catch of a given species for a port-month stratum. Equations for estimation of other characteristics for fisheries with mixed species are straightforward and can be obtained by substituting the value of the characteristic for the catch of the species. Totals across strata are formed by simple addition.

#### Notation

For a given species, let

- $N$  = total number of trips,
- $n$  = number of randomly sampled trips,
- $W$  = total weight of fish caught from all trips,
- $W_i$  = weight of fish caught on trip  $i$ ,
- $W_{ij}$  = weight of fish for sort  $j$  caught in trip  $i$ ,
- $m_{ij}$  = number of clusters sampled from sort  $j$  on trip  $i$ ,
- $m_i$  = number of clusters sampled on trip  $i$ ,
- $m$  = number of clusters sampled over  $n$  trips,
- $W_i = \sum_j^{L_i} W_{ij}$  where  $L_i$  is the number of sorts in trip  $i$ ,
- $y_{ijk}$  = number of fish of the species in cluster  $k$  from sort  $j$  of trip  $i$ ,
- $Y_{ij}$  = total number of the species caught from sort  $j$  of trip  $i$ ,
- $Y$  = total number of species caught from all trips,
- $\bar{Y}$  = mean catch per cluster for the species,
- $\bar{y}_{ij} = \sum_k y_{ijk}/m_{ij}$  = unbiased estimate of  $\bar{Y}_{ij}$ ,
- $w_{ijk}$  = weight of the  $k$ th cluster from the  $j$ th sort of the  $i$ th trip,
- $\hat{M}_i = \frac{W_i}{\bar{w}_i}$  where  $\bar{w}_i = \sum_j \sum_k w_{ijk} / \sum_j m_{ij} =$

average weight of sampled clusters in the  $i$ th trip.

If  $\bar{W}_i$  is a constant, its estimate  $\bar{w}$  will be given by  $\bar{w} = \sum_i \sum_j \sum_k w_{ijk} / \sum_i \sum_j m_{ij}$ . In practice,  $N$  and  $M_i$  will not be known and will be estimated by  $\hat{N} = \frac{nW}{\sum_i \hat{W}_i}$ ;  $\hat{M}_i = \frac{W_i}{\hat{w}}$  respectively, if  $\bar{W}_i$  is a constant =  $\bar{w}$  (say).

### Ratio Estimates of Mean and Total

The ratio estimate of mean catch ( $\bar{Y}$ ) per cluster is

$$\hat{\bar{Y}}_R = \frac{\sum_i M_i \bar{y}_i}{\sum_i M_i} \doteq \frac{\sum_i W_i \bar{y}_i}{\sum_i W_i} \quad (1)$$

where  $\bar{y}_i = \sum_j M_{ij} \bar{y}_{ij} / \sum_j M_{ij} \doteq \sum_j W_{ij} \bar{y}_{ij} / \sum_j W_{ij}$ .

The ratio estimate of total catch  $Y$  is

$$\hat{Y}_R = \frac{W}{\bar{w}} \hat{\bar{Y}}_R \quad (2)$$

The above estimators recommended for use are not workable in rockfish sampling because the sampler failed in almost all cases to subsample from more than one category in a sampled trip as would be seen from a sample of basic data for 1982 (Table 1) available for Eureka from the Department of

TABLE 1.—Distribution of landing weights (lb) from all categories and from the sampled category for Eureka for 1982.

Sample no. (boat trip)	Number of clusters sampled ( $m_i$ )	Market category sampled <sup>1</sup>	Weight of all fish ( $W_i$ ) in a given trip	Weight of all fish for the category in a given trip
1528	1	269	26,550	24,176
1529	1	250	4,133	445
1530	2	269	59,218	58,239
1531	1	269	20,511	15,987
1533	1	269	35,022	14,661
1534	1	269	20,757	20,705
1535	1	269	15,812	8,436
1536	1	250	1,975	1,010
1537	1	250	16,055	1,075
1541	3	269	65,837	65,837

<sup>1</sup>Shows the code number of categories which are based on species, size, and quality.

Note: In all cases, only one of the categories could be sampled from a given trip. In boat 1541 there was only one category (269) of fish.

California Fish and Game. The reasons for failure to collect the data are discussed in the section on Collection of Representative Data-Measurement Errors. The above estimators are, however, recommended for use in situations where the problem does not exist and, in particular, for single species where the categories are based on size. The estimates of error are given in Equations (4) and (5).

### Estimation Ignoring Category Variation Within Sampled Trips

Assume that a cluster is selected at random from all possible clusters in a sampled trip. In other words, we ignore categories altogether both in sample selection as well as in estimation. Valid ratio estimates  $\hat{\bar{Y}}_{1R}$  of  $\bar{Y}$  and  $\hat{Y}_{1R}$  of  $Y$  are respectively given by

$$\hat{\bar{Y}}_{1R} = \frac{\sum_i W_i \bar{y}_i}{\sum_i W_i}; \hat{Y}_{1R} = \frac{W}{\bar{w}} \hat{\bar{Y}}_{1R} \quad (3)$$

Note these equations are essentially the same as Equations (1) and (2) except that we now assume that a cluster is randomly selected from all possible clusters in a sampled trip where  $W_i$  is the total landing weight from all categories for the  $i$ th boat trip in the sample ( $W = \sum_i W_i$ ). In practice, the sampler would tend to subsample from a category which is accessible and is preponderant. This may lead to some bias in the estimate though its contribution to the total error will be negligible, since this would occur at the second stage of sampling.

The estimates of variance of estimated total and mean are approximately given by

$$v(\hat{Y}_{1R}) \doteq \left[ \frac{1}{n} (1 - f_1) s_b^2 + \frac{f_1(1 - \bar{f}_2) s_w^2}{n\bar{m}} \right] \left( \frac{W}{\bar{w}} \right)^2 \quad (4)$$

$$v(\hat{\bar{Y}}_{1R}) \doteq \left( \frac{\bar{w}}{W} \right)^2 v(\hat{Y}_{1R}) \quad (5)$$

$$\text{where } s_b^2 = \sum_i \left( \frac{W_i}{\hat{W}} \right)^2 \frac{(\bar{y}_i - \hat{\bar{Y}}_{1R})^2}{n - 1};$$

$$s_w^2 = \sum_i \frac{\bar{m}}{n} \left( \frac{W_i}{\hat{W}} \right)^2 \frac{s_{2i}^2}{m_i} \quad (6)$$

and  $s_{2i}^2 = \sum_k^{m_i} (y_{ik} - \bar{y}_i)^2 / (m_i - 1)$ ;  $\hat{W} = \sum^n W_i / n$ ;

$$f_1 = \sum^n W_i / W; \bar{f}_2 = \frac{\bar{w} \sum_i^n \frac{m_i}{W_i}}{n} \quad (7)$$

We will consider an operationally feasible plan in which sample trips at a port during a month are poststratified into categories and clusters are subsampled from each category; where one or more categories are missed due to inadequate field staff and/or management problems, clusters should be selected from other boat trips containing the missed categories.

Assuming that the cluster weight of the unequal cluster size varies over trips, i.e.,  $\bar{w}_i = \sum_j \sum_k w_{ijk} / \sum_j m_{ij}$  estimates of mean and total are

$$\hat{Y}_{2R} = \frac{\sum_i^n W_i \hat{R}_i}{\sum_i^n W_i / \bar{w}_i}; \hat{Y}_{2R} = W \frac{\sum_i^n W_i \hat{R}_i}{\sum_i^n W_i} \quad (8)$$

where  $\hat{R}_i = \frac{\bar{y}_i}{\bar{w}_i}$ ;  $v(\hat{Y}_{2R})$  and  $v(\hat{Y}_{2R})$  can be obtained similar to Equations (4) and (5).

### Estimation Based on Categories as Domains of Study

This method is almost as precise as proportional stratified sampling if within each port-month stratum (a) a minimum of four landings or boat trips ( $n_j \geq 4$ ) is selected for each category and (b) the landing weights are available by categories after the season to serve as weights at the estimation stage. The minimum number in (a) is mainly based on limitations of field staff and budget restrictions. The ratio estimates of mean catch per cluster, total catch, and their errors, assuming clusters of equal size and using categories as domains of study are given by

$$\hat{Y}_{3R} \doteq \sum_j W_j \bar{y}_j / \sum_j W_j; \hat{Y}_{3R} \doteq \sum_j \hat{Y}_j \quad (9)$$

where  $\bar{y}_j = \sum_i^{n_j} W_{ij} \bar{y}_{ij} / \sum_i W_{ij}$  (10)

$$\hat{Y}_j = \bar{y}_j \frac{W_j}{\bar{w}} \quad (11)$$

$$v(\hat{Y}_{3R}) \doteq \sum_j \frac{W_j^2}{W^2} v(\bar{y}_j) + 2 \sum_j \sum_{<k} \frac{W_j W_k}{W^2} \text{cov}(\bar{y}_j, \bar{y}_k) \quad (12)$$

and

$$v(\hat{Y}_{3R}) \doteq v(\hat{Y}_j) + 2 \sum_j \sum_{<k} \text{cov}(\hat{Y}_j, \hat{Y}_k). \quad (13)$$

Both  $v(\bar{y}_j)$  and  $v(\hat{Y}_{3R})$  are of standard forms and can be obtained as in Equation (4). Similarly,  $v(\hat{Y}_j)$  and  $v(\hat{Y}_{3R})$  can be obtained. The covariance terms in Equations (12) and (13) are ignored when the subsamples from different categories are from different boat trips and are, therefore, independent. In rockfish sampling this was found true, because the sampler failed in almost all cases to subsample from more than one category. In general, for all fish where sampling from more than one category per boat trip is feasible, e.g., with few species-size-qualities, Equation (13) should be used.

Assume that the clusters vary in size over trips. For any sort (say  $j$ )

$$\hat{Y}_j = \left[ \sum_i W_{ij} \hat{R}_{ij} / \sum_i W_{ij} \right] W_j = \hat{R}_j W_j \quad (14)$$

and

$$\hat{y}_j = \sum_i W_{ij} \hat{R}_{ij} / \sum_i W_{ij} / \bar{w}_{ij} \quad (15)$$

where  $\hat{R}_{ij} = \frac{\bar{y}_{ij}}{\bar{w}_{ij}}$ ;  $\hat{R}_j = \sum_i \hat{R}_{ij} W_{ij} / \sum_i W_{ij}$ . (16)

If  $n_j$  is small compared to  $N_j$  and if the same subsampling strategy is applied to each of the sample landings, we have, ignoring contribution due to second-stage sampling units,

$$v_1(\hat{R}_j) = \frac{1}{n_j(n_j - 1)} \sum_i \left[ \frac{W_{ij}}{\hat{W}_{ij}} \right]^2 (\hat{R}_{ij} - \hat{R}_j)^2. \quad (17)$$

Another estimator  $v_2(\hat{R}_j)$  is the jackknife

$$v_2(\hat{R}_j) \doteq \frac{(n_j - 1)}{n_j} \sum_i (\hat{R}'_{ij} - \hat{R}_j')^2 \quad (18)$$

$$\text{where } \hat{R}'_{ij} = \frac{\hat{R}_{1j}W_{1j} + \dots + \hat{R}_{(i-1)j}W_{(i-1)j} + \hat{R}_{(i+1)j}W_{(i+1)j} + \dots + \hat{R}_{n_j}W_{n_j}}{W_{1j} + \dots + W_{(i-1)j} + W_{(i+1)j} + \dots + W_{n_j}} \quad (19)$$

$$\text{and } \hat{R}'_j = \frac{1}{n_j} \sum_i R'_{ij}.$$

Thus  $\hat{R}'_{ij}$  is obtained by omitting trip  $i$  from the sample for sort  $j$  and calculating  $\hat{R}'_{ij}$  instead of  $\hat{R}_{ij}$  as in Equation (16).

Hence, for category  $j$  of a species

$$\begin{aligned} v(\hat{Y}_j) &= W_j^2 v_1(\hat{R}_j) \\ \text{or} &= W_j^2 v_2(\hat{R}_j) \end{aligned} \quad (20)$$

where  $v_1(\hat{R}_j)$  and  $v_2(\hat{R}_j)$  are given by Equations (17) and (18).

For estimate of total over all sort groups for a species

$$\hat{Y}_{4R} = \sum_j \hat{Y}_j \quad (21)$$

$$v(\hat{Y}_{4R}) = \sum_j v(\hat{Y}_j) + 2 \sum_j \sum_{k < j} \text{cov}(\hat{Y}_j, \hat{Y}_k) \quad (22)$$

A simpler formula  $v(\hat{Y}_{4R}) = \sum_j v(\hat{Y}_j)$  can be used where subsamples from different categories are from different boat trips and are, therefore, independent.

It is, however, more reasonable to assume that the frequency distribution of fish caught is more uniform within a category so that cluster weight would be approximately a constant within a category. If so, the estimates of mean and total are given by

$$\bar{\bar{Y}}_{5R} = \sum_j W_j \bar{\bar{y}}_j / \sum_j W_j; \hat{Y}_{5R} = \sum_j \hat{Y}_j \quad (23)$$

$$\text{where } \bar{\bar{y}}_j = \sum_i W_{ij} \bar{y}_{ij} / \sum_i W_{ij};$$

$$\hat{Y}_j = \frac{\sum_i W_{ij} \bar{y}_{ij}}{\sum_i W_{ij}} \frac{W_j}{\bar{w}_j} \quad (24)$$

and  $\bar{w}_j$  is the simple mean weight of clusters in the  $j$ th group. Where the assumption of constant cluster weight within a category is not valid, the more general results given in Equations (14) and (15) should be used.

### Comparison of Methods: Ignoring Category Variation Versus Poststratification by Categories

We will compare the efficiency of the estimators (3), ignoring variation due to categories, with the estimators (9), based on poststratification of landings by categories at a port during a month. The analyses were based on Eureka and Monterey data for 1982. The coefficients of variation (c.v.) of mean catch per cluster for a species based on categories as domains of study (method 2) were in almost all cases lower (Table 2) than ignoring category variation (method 1). Since method 1 results in underestimation of c.v.'s because sampling is actually based on a stratified random sample instead of a simple random sample, the increased precision of method 2 is all the more striking.

The c.v. of the estimated mean catch by sex-age groups for a species for which the number of sample landings were  $\geq 10$  (Table 3) were in all cases less for method 2 than for method 1. It may, however, be pointed out the c.v.'s are likely to be affected by factors such as growth, maximum age, and maximum size of fish. These have not been considered in this study. Thus, estimates based on categories as domains of study proved more efficient than ignoring categories altogether. Besides, method 2 has the added advantage of providing estimates by

TABLE 2.—Coefficient of variation (c.v., in percent) of mean catch by species at Eureka and Monterey based on the two methods during 1982.

Location and species	Sample size (number of boat trips sampled)	c.v. (%)	
		Method 1 <sup>1</sup>	Method 2 <sup>2</sup>
<b>Eureka</b>			
Widow rockfish	88	11.48	7.33
Chilipepper	88	30.83	32.12
Bocaccio	88	26.01	24.40
<b>Monterey</b>			
Widow rockfish	54	18.31	6.62
Chilipepper	54	15.68	13.92
Bocaccio	54	12.57	10.32

<sup>1</sup>Method 1, based on random categories (i.e., ignoring stratification by categories).

<sup>2</sup>Method 2, based on categories as domains of study.

TABLE 3.—Coefficient of variation (c.v., in percent) of mean catch by species-sex-age<sup>1</sup> group at Eureka and Monterey based on the two methods during 1982.

Eureka					Monterey				
Number of boat trips sampled	Sex	Age (yr)	c.v. (%)		Number of boat trips sampled	Sex	Age (yr)	c.v. (%)	
			Method 1	Method 2				Method 1	Method 2
Widow rockfish									
17	M	7	19.71	18.83	10	F	13	39.98	24.29
18	F	7	13.50	10.94	10	F	12	35.16	20.49
Chilipepper									
11	F	13	39.98	24.89	24	F	9	18.48	7.63
11	F	12	34.77	31.21	21	F	7	22.09	9.81
Bocaccio									
15	M	6	30.10	19.82	14	M	7	27.46	12.45
19	F	6	35.87	32.45	20	F	7	24.34	10.06

<sup>1</sup>Age-sex groups for which primary sampling units (landings) are ≥10.

market categories which is of considerable economic importance.

### COST FUNCTION

Consider the cost function

$$C = c_1n + c_2n\bar{m} \tag{25}$$

where  $c_1$  is the average cost (in minutes) per boat trip due to transport, contact, and delay in making a contact,  $c_2$  the average cost in data collection (identification of species, sex, length, otoliths, etc.) per cluster within clusters per boat trip and  $C$  is the total cost involved in visiting the primary sampling units (boat trips) and collecting data from the  $n$  boats with an average of  $\bar{m}$  clusters per boat sampled. Data collected at Tiburon by the California Department of Fish and Game and the National Marine Fisheries Service show that  $c = 111.80$  min,  $c_2 =$

58.3 min so that  $\frac{c_1}{c_2} = 2$  apply. However, from more

recent studies conducted  $\frac{c_1}{c_2} = 3$ .

The components  $c_1$  and  $c_2$  were estimated at

Activity	Percent	Mean (in minutes)
Transport	50.0	81.7
Contact	5.0	8.7
Delay (off loading, etc.)	13.0	21.4
	68.0	111.8
Data collection	Percent	Mean (in minutes)
Species <sup>1</sup>	7.7	14.0
Sex, length	5.8	10.6
Otolith	10.8	19.7
Preparation time	7.7	14.0
	32.0	58.3

<sup>1</sup>Excluding samples dominated by single species.

Minimizing Equation (4) subject to Equation (25) for the optimum allocation we have

$$\bar{m}_{opt} = \frac{s_w}{\sqrt{s_b^2 - \frac{s_w^2}{\bar{m}}}} \sqrt{\frac{c_1}{c_2}} \tag{26}$$

TABLE 4.—Optimum values of  $m$  for estimating species catch per cluster by categories for different variance and cost ratios, 1978.

Species	Category <sup>1</sup>	$n$	$s_b^2$	$s_w^2$	$\bar{m}$	$c_1/c_2 = \frac{m_{opt}}{2}$	$c_1/c_2 = 3$
Eureka							
Bocaccio	250	25	1.80	3.01	2.16	3.86	4.73
Chilipepper	250	13	24.45	3.13	1.92	0.52	0.64
Widow rockfish	250	11	59.49	8.71	2.46	0.56	0.68
Monterey							
Bocaccio	253	31	95.15	4.20	1.97	0.63	0.77
Chilipepper	253	33	43.71	4.16	1.94	0.45	0.55
Widow rockfish	253	12	22.38	4.66	2.00	0.68	0.84

<sup>1</sup>Code numbers of categories which are based on size, species and quality.

The variation among clusters ( $s_b^2$ ) in different landings at Eureka and Monterey for 1978 was in almost all cases greater than between clusters within the same landings (Table 4); also the optimum number of clusters per boat for estimating species number was mostly unity. Data from other ports follow the same pattern. Since a minimum of two clusters is needed to provide an estimate of between cluster within trip variation, a subsample of two clusters per category per trip is recommended. In practice, it is preferable to select a systematic sample of clusters separated in time.

### VARIANCE COMPONENTS: SPECIES-AGE AND LENGTH GROUPS

A two-level nested analysis of variance for length and age with unequal sample size for species based on sample landings at ports during 1979 (Table 5) shows that both the variation, because of length and age, was generally high among sample landings compared with clusters within landings. Also, variation between clusters was generally of the same order as within clusters, and the optimum number of clusters was  $\leq 2$ . Data for other ports and years (not shown in the table) mostly supported the findings.

On the whole, both the variation in species number (Table 4) as well as in length and age (Table 5) was consistently high among sample landings relative to between clusters within landings; also, variation among clusters was not significant compared with variation within clusters. Hence, for precise estima-

tion of species number, length, and age composition for a category at a port during a season, data should be collected from a large number of landings and from few clusters (two) from a category within a sample landing.

### RELATIVE EFFICIENCY OF ESTIMATORS USING POSTSTRATIFICATION

Consider the three estimators of total catch for a sort of a species at a port during a year. We will use the same selection procedure with poststratification by sorts but different estimation procedures.

$$\hat{Y}'_j = \frac{N_j}{n_j} \sum_{i=1}^{n_j} \bar{y}_{ij} \quad (27)$$

$$\hat{Y}_j = \frac{\sum_i^{n_j} W_{ij} \bar{y}_{ij}}{\sum_i^{n_j} W_{ij}} \frac{W_j}{\bar{w}_j} \quad (28)$$

$$\hat{Y}_{j_1} = \hat{R}_j W_j \quad (29)$$

where  $\hat{R}_j$  is given by Equation (16),  $\bar{y}_{ij}$  is the simple mean of species number per cluster for sort  $j$  from the  $i$ th sample,  $\hat{Y}_j$  is the same as Equation (24) with a constant cluster weight within a sort group, and  $\hat{Y}_{j_1}$  is a more general estimator based on the assumption that cluster weight varies among trips. For  $v(\hat{Y}_{j_1})$  use  $W_j^2 v_2(\hat{R}_j)$  where  $v_2(\hat{R}_j)$  is the jack-

TABLE 5.—Two-level nested ANOVA of length and age of species with unequal sample sizes by ports during 1979. MS = mean square; F = F-RATIO, Statistic; P = observed probability level.

Source	Age				Length			
	df	MS	F	P	df	MS	F	P
Widow rockfish at Eureka								
Samples	15	34.45	4.75	<0.005		37.86	3.09	<0.025
Clusters (within samples)	13	7.25	1.19	0.35		12.27	1.43	~0.18
Within clusters	320	6.09				8.58		
Chilipepper at Monterey								
Samples	43	31.74	4.05	<0.001	48	145.20	4.02	<0.001
Clusters	39	7.84	1.80	~0.001	44	36.10	1.43	~0.035
Within clusters	320	4.35			971	25.25		
Bocaccio at San Francisco								
Samples	10	84.97	6.95	<0.001	10	317.88	6.98	<0.001
Clusters	15	12.23	1.20	~0.30	16	45.55	0.80	~0.75
Within clusters	225	10.20			227	57.11		

knife estimator of Equation (18) and for  $v(\hat{Y}'_j)$  see Sukhatme (1954).  $\hat{Y}'_j$  is generally subject to considerable bias.

The c.v. of total catch of bocaccio, chilipepper, and widow rockfish for different categories by port-year groups (Table 6) show that the estimators  $\hat{Y}_j$  and  $\hat{Y}'_j$  are highly efficient compared with  $\hat{Y}'_j$ ; also,  $\hat{Y}_j$  turns out to be slightly superior to  $\hat{Y}'_j$ , since the jackknife estimator  $v_2(\hat{Y}'_j)$  is an underestimate and does not take into account the contribution of the within component of variance. Thus, the empirical evidence supports strongly the use of the estimator  $\hat{Y}_j$ .

TABLE 6.—Coefficient of variation (in percent) of estimates of total catch of bocaccio, chilipepper, and widow rockfish per cluster by ports during 1978 and for different categories for the three estimators  $\hat{Y}'_j$ ,  $\hat{Y}_j$ , and  $\hat{Y}_j$ .

Port	Category	Number of boat trips sampled	$\hat{Y}'_j$	$\hat{Y}_j$	$\hat{Y}_j$
Bocaccio					
San Francisco	253	20	13.51	10.24	11.64
Fort Bragg	250	86	16.21	7.36	8.14
Monterey	253	31	12.07	17.93	19.51
Eureka	250	25	40.11	26.00	29.84
Chilipepper					
Eureka	250	13	37.66	34.52	42.33
Widow rockfish					
Monterey	250	12	111.20	43.47	68.29
Eureka	250	11	72.69	27.81	33.90

## AGE-COMPOSITION: DOUBLE SAMPLING

Studies mentioned in the Introduction section have shown that since aging from otoliths of each individual fish in a sample is more expensive than an easily measured quantity such as length, it may pay 1) to choose a random subsample from the whole sample of length measurements for age determination or 2) stratify the sample according to length classes and choose a subsample from each class for age determination. The technique is profitable only if the correlation between length and age is fairly high.

It may be recalled that considerable bias is introduced by applying age-length keys developed during a year to subsequent years. Both Kimura (1977) and Westrheim and Ricker (1978) showed that age-length keys can yield most inefficient estimates of numbers-at-age with substantial overlap of lengths between ages. In the latter case the correlation between length and age will be low for the larger and

the very small sizes. Consequently, we will need a higher sampling intensity at the tails to provide reliable estimates of age for such sizes.

In the construction of length strata for selection of the subsample, additional questions arise on 1) number of strata to choose, 2) strata boundaries to decide, and 3) the number of sampling units to be allocated to each stratum for deriving maximum gain from double sampling. These are discussed as follows.

### Number of Strata

The values of  $V(\bar{y}_{st})/V(\bar{y})$  (Cochran 1977) are given below as a function of  $L$ , the number of strata using the linear model

$$y = \alpha + \beta x + \epsilon \quad (30)$$

where  $y$  is the length,  $x$  the age of female widow rockfish and

$$\frac{V(\bar{y}_{st})}{V(\bar{y})} = \frac{\rho^2}{L^2} + (1 - \rho^2) \quad (31)$$

where  $\rho$  is the correlation between length and age in the unstratified sample and  $L$  the number of strata. It can be shown for this model that when  $L \geq 6$  and  $\rho > 0.95$ , there is hardly any gain due to stratification (Table 7). The improvement in stratification is highest for data set 1 for which  $\rho^2 = 0.7004$  and lowest for set 3 for which  $\rho^2 = 0.5278$ . The results for the regression model indicate that unless  $\rho$  exceeds 0.95, little reduction in variance is to be expected beyond  $L = 6$ . Data sets 1, 2, and 3 support this conclusion. In fact, there does not seem to be any profit resulting from increase in strata beyond  $L = 5$ .

### Strata Boundaries

For the length-age strata on 239 females (widow rockfish) landed during 1982 at San Francisco and the rule based on the cumulative of  $\sqrt{f(y)}$  (Cochran 1977) where  $y$  denotes the length in centimeters, the nearest available points for the two strata are

	Stratum	
	1	2
Boundaries	36-47 cm	48-55 cm
Intervals on cum $\sqrt{f}$	18.70	23.72



TABLE 7.— $V(\bar{y}_s)/V(\bar{y})$  as a function of  $L$  for the linear regression and for some actual data.

L	Linear regression model $\rho =$				Data set		
	0.99	0.95	0.90	0.85	1	2	3
2	0.265	0.323	0.392	0.458	0.4747	0.5114	0.6041
3	0.129	0.198	0.280	0.358	0.3774	0.4209	0.5308
4	0.081	0.154	0.241	0.323	0.3434	0.3892	0.5052
5	0.059	0.134	0.222	0.306	0.3276	0.3746	0.4933
6	0.047	0.123	0.212	0.298	0.3154	0.3740	0.4890
$\infty$	0.020	0.098	0.190	0.277			

Type of data				
Set	Data	x Age (yr)	y Length (cm)	Source
1	Female widow rockfish (532) Monterey, San Francisco and Bodega Bay	1982 (Jan.-Mar.)	1982 (Jan.-Mar.)	Department of California Fish and Game and Tiburon Laboratory
2	Female widow rockfish (444) Eureka	1981 (Jan.-Sept.)	1981 (Jan.-Sept.)	
3	Female widow rockfish (328) Eureka	1980 (Apr.-Dec.)	1980 (Apr.-Dec.)	

It turns out that the division point is approximately the same for young as well as old widow rockfish.

For length-age data (1981) based on 444 females (widow rockfish) landed at Eureka, the boundaries using 2 and 3 strata are

	Stratum		
	1	2	
Boundaries	31.5-47 cm	46.5-55 cm	
Intervals on cum $\sqrt{f}$	17.70	29.01	

	Stratum		
	1	2	3
Boundaries	31.5-46 cm	46.5-49 cm	49.5-55 cm
Intervals on cum $\sqrt{f}$	17.70	13.12	15.89

### Optimum Allocation Plan

Double sampling with regression is more efficient than single sampling (when the first sample is measured for age alone) for the same cost if

$$\rho^2 > \frac{4 \frac{c}{c'}}{\left[1 + \frac{c}{c'}\right]^2} \quad (32)$$

where  $\rho$  is the correlation between length and age of fish,  $c$  and  $c'$  are respectively the costs of aging and measuring a fish. Assuming that the average cost of aging a rockfish (including small and large fish) is 6 min and of measuring it is 1.2 min (estimates based on measurements by W. Lenarz of Tiburon Laboratory), we have from Equation (32)

$$\rho^2 > 0.5555$$

or

$$\rho > 0.7453.$$

For the three data sets (Table 7) the values of  $\rho^2$  are respectively 0.7004, 0.6515, and 0.5278 so that Equation (32) is approximately satisfied. However,

neither  $\rho$  nor  $\frac{c}{c'}$  are large enough to suggest that

double sampling will be much more efficient than single sampling.

We will illustrate the use of double sampling for stratification by analyzing 1981 length-age data at Eureka to estimate the proportion of female in age group 11, based on a sample of 444 fish. For the three length strata,  $h = 1, 2, 3$  with stratum boundaries based quadratic fit of length on age are 31.5-43, 43.5-49, 49.5-55. (Note this is different than boundaries based on length only.) Also

$$\begin{aligned}
 c_0 &= 1.2 \text{ min}, c_1 = 3.8 \text{ min}, c_2 = 3.8 \text{ min}, \text{ and } c_3 = 8 \text{ min} \\
 w_1 &= 0.0653, w_2 = 0.5451, \text{ and } w_3 = 0.3896 \\
 s_1 &= 0.1825, s_2 = 0.4966, s_3 = 0.1503, \\
 &\text{and } s = 0.4343
 \end{aligned}$$

where  $w_1, w_2,$  and  $w_3$  are the proportions of fish in the sample,  $c_0$  is the cost of measuring a fish and  $c_1, c_2, c_3$  are respectively the costs of aging them in the three length groups. From Cochran (1977, p. 331) we have

$$\begin{aligned}
 v_{\min}(p_{st}) &= \frac{1}{C^*} \left[ \sum w_h s_h \sqrt{c_h} + (S^2 - \sum w_h s_h^2)^{1/2} \sqrt{c'} \right]^2 \\
 &= 0.8915/C^*
 \end{aligned} \tag{33}$$

where  $p_{st}$  is the estimated proportion and  $C^* = E(c) = E(c_0 n + \sum_n c_h n_h)$  with  $n_1 = 14, n_2 = 120, n_3 = 48$  and  $n' = 444$ . The efficiency of double sampling with respect to single sampling is given by

$$v_{srs}(p)/v_{\min}(p_{st}) = 1.27$$

where  $v_{srs}(p) = 0.1885 \frac{C^*}{6}$ , i.e., double sampling is 27% more efficient than single sampling. However, as noted by Ricker (1975) the increase in accuracy achieved by combining a length sample with a smaller age sample may not be great unless fish used for age determination is taken from the same stock, during the same season and using gear having the same selective properties as the length-frequency samples. This point will generally be met if fish are subsampled systematically for age from fish arranged in increasing (or decreasing) order of length from a port-month stratum. Our studies have shown that the best length-age fit does not change significantly if age determination is made on every other fish arranged in ascending order of length.

It is difficult to obtain reliable estimates of the numbers at age for the extremely small or larger sizes because lengths cannot be used for estimating age. There is need for search for other auxiliary variables (other than length) associated with age and for increase in sampling rate at the tails. In double sampling where lengths are obtained in the first phase, a number of small clusters may be used separated in space and time to provide a large number of fish at the tails for estimating numbers at age. The extent of bias in estimation of numbers

at age through length-age key approach may be tested by Monte Carlo simulation.

## COLLECTION OF REPRESENTATIVE DATA-MEASUREMENT ERRORS

Owing to uncertainty of arrival times and varying unloading procedures, no objective method is available to ensure random sampling of the trips. When the vessels return to port, they are usually available for sampling except when they are transhipped immediately due to inclement weather, lack of processing facilities, uncooperative buyers, or unscheduled deliveries at short notice. It is, however, not unreasonable to regard a set of sample landings during a week at a port as random and representative of the totality of all landings at the port for the month.

Although rockfish are landed by categories, which are mostly determined by market agreement based on size, composition, and condition of the catch, the number of categories per delivery cannot be predetermined. This number would vary from delivery to delivery and from dealer to dealer. Also, there are no guarantees that a complete boat sample, covering clusters from each category, can be taken on any sampling day and some of the categories are actually missed in sampling. Some of the possible reasons for missing the categories are 1) when landing weight would not occur during regular hours, one of the sorts may have already been shipped before the sample could arrive at the spot; 2) often one of the sorts may be quite small and there may be a buyer at the dock waiting for the fish to be taken away; 3) while the sampler is working on a sort, the other sort(s) will have either been processed or shipped away; and 4) the sampler may

be prevented from taking a sample from another sort by the skipper who may not like some of his fish being cut and otoliths removed for biological studies. This may happen at ports where either processing facilities are inadequate or fish are bought by local merchants immediately after landing. The question arises if failure to sample from all categories of a sample landing as originally planned would cause appreciable bias and loss in efficiency in the estimates of species catch and its distribution and whether a more efficient method could be developed that is operationally feasible. This point has been examined in the present paper.

The present technique of selecting a cluster (box) of fish as second stage sampling unit is preferred to random selection of a specified number of individual fish because in practice the potential of personal bias of the sampler could be considerable. Often fish chosen by the latter technique are ones closest to the sampler or those that fell in a certain position. Tomlinson (1971) felt that in this approach the sampler may tend to choose a fish with certain qualities and thus may introduce procedural bias.

The selection of a representative cluster would depend whether samples after sorting on the vessel come from bins, strap boxes, or off conveyor belts. Buyers from small markets occasionally select fish from the top of bins. Hence, to avoid this bias, it is preferable to select the cluster from the conveyor belt which exposes unsorted fish from the lower portion of the bin. However, where small market buyers do not buy fish, a cluster may be selected from a bin. Where many bins are present a systematic sample of two clusters, preferably from the beginning and end of the trip may be selected. Where fish are graded on a conveyor belt before they enter the plant (e.g., Fieldslanding at Eureka) the sampler should try to intercept the landings prior to secondary sorting or obtain separate weights for each subsort category. In general, selection of a cluster for a market category should be done before any presorting is done at the port.

It has been pointed out earlier that bias may result from personal selection of fish within a cluster. If the sampler were to select a number of clusters with few fish per cluster, a cluster will on the average contain more big fish. This would lead to high non-sampling bias. Sometimes, the top few fish in a bin are selected and put there to impress small buyers. The resulting bias in selection can be avoided by taking all the fish in a cluster (e.g., 50 lb) from one side of the box.

For obtaining reliable and comprehensive information on population characteristics, it is essential

for the sampler to maintain good relationships with both the skipper and the buyer; this will depend to a large extent on the expertise of the sampler gained in the course of the field work.

## SUMMARY

1. The sampling scheme at a port during a month with poststratification of sampled trips into categories and subsampling of clusters from each category (see sections on Estimation with poststratification and Estimation ignoring category variation) is not workable for estimating rockfish catch since some of the categories may be missed in sampling due to inadequate field staff and/or management problems.
2. For other commercial fish where the above problem does not exist and landing weights by categories are not available at the end of the season, the methods (see sections on Estimation with poststratification and Estimation ignoring category variation) are recommended, e.g., for single species where the categories are based on size.
3. For estimating the catch of rockfish, a two-stage sampling plan is recommended with boat trips as first stage units poststratified into categories and clusters subsampled from a category; estimates are based on categories as domains of study with landing weights available for each category. A minimum of four landings or boat trips should be used for each category, to provide efficient estimates. With few categories, this number is likely to be large.

Where only one category is subsampled for each boat in the sample,  $v(\hat{Y}_{3R}) = \sum_j v(\hat{Y}_j)$ . In all other cases Equation (13) should be used.

4. The design described in the above paragraph is recommended for use in other fisheries where landing weights are available for each category. Equations (9) and (21) are recommended for the estimation of catch according as the clusters are of equal or unequal size. Equations have been provided for the more practical case when cluster weight can be treated as constant within a category but different among categories.
5. Estimates of species catch by sex and age based on method 1 are less efficient than those based on method 2 which is based on categories as domains of study (Tables 2, 3).
6. Method 2 is preferred to method 1 when there

- is variation among categories. This is true for all fish.
7. With few categories (species-size-qualities) the chance of missing a category is reduced. Equations (9) and (13) should be used for clusters of equal size and Equations (21) and (22) for unequal size clusters. This result is, of course, applicable to all commercial fish.
  8. As far as practicable, selection of a cluster for a market category should be done before any presorting is done at the port either from bins, strap boxes, or off conveyor belts.
  9. Variation (within categories) in length and age for a species was considerably higher among boat trips than among clusters within boat trips. Also, variation among clusters was not significant, compared with variation within clusters (Table 5). Hence, for precise estimation of species number, length, and age composition for a category at a port during a season data should be collected from a large number of landings and from few clusters from a category within a sample landing. This result should hold for all commercial fish.
  10. For the cost function  $C = c_1n + c_2n\bar{m}$  where  $c_1$  is the average cost (in minutes) per boat trip due to transport, contact, and delay in making a contact,  $c_2$  the average cost of data collection (identification of species, sex, length, otoliths, etc.) per cluster per boat trip and  $C$  is the total cost involved in visiting the primary sampling units (boat trips) and collecting data, the optimum number of clusters per sampled trip for a fixed cost for a category is two (Table 4). This should provide valid estimates of error as required in Equations (13) and (22).
  11. The principal contribution of the paper is that a minimum of four sample landings be subsampled for each category from a port-month stratum, i.e., about 1 per week and two clusters of 50 lb (25 lb for small fish) each should be sampled to provide port-year estimates with a reasonable degree of accuracy.  
If a category is infrequently landed, sampling should be directed towards the infrequent category, as long as the number of landings for the category is less than four per month.
  12. The efficiency of the ratio estimator (Equation (28)) based on poststratification by categories at port-year level and using constant cluster weight within a category was compared with two other estimators, including the ratio estimator based on jackknife. Empirical evidence indicated that the ratio estimator using constant

- cluster weight within a category proved most efficient for estimation of species catch.
13. Age-length keys can yield most inefficient estimates of the numbers at age for extremely small and large fish. It is suggested that cluster sampling for length be based on a number of clusters separated in space and time; also, sampling for age should be intensified for small and large fish. This approach is applicable to all fish.
14. Double-sampling was adopted for estimating proportion of widow rockfish in 11-yr age group. A sample of fish was divided into 3 strata and optimum allocation for age was adopted within strata. The estimated proportion was 27% more efficient than if single sampling were adopted.

The best length-age did not change significantly if age determination is made on every other fish selected in ascending order of length.

The method is general and is applicable to all fish.

## ACKNOWLEDGMENTS

Thanks are due to William Lenarz of Tiburon Laboratory for providing information on problems related to widow rockfish landings on the Californian coast, to Candis Cooperider and Mark Allen for the computations done on data collected, to the field staff of the California Department of Fish and Game responsible for collection of relevant data, and to Norman Abramson, Director, Tiburon Laboratory for all the assistance rendered to me during my work in the Laboratory. My thanks are also due to Pat Dalgetty, Department of Mathematics and Statistics, University of Calgary, for assistance in typing the paper and finally to the referees for helpful comments.

## LITERATURE CITED

- BARTOO, N. W., AND K. R. PARKER.  
1983. Stochastic age-frequency estimation using the von Bertalanffy growth equation. *Fish. Bull.*, U.S. 81:91-96.
- CLARK, W. G.  
1981. Restricted least-squares estimates of age composition from length composition. *Can. J. Fish. Aquat. Sci.* 38: 297-307.
- COCHRAN, W. G.  
1977. *Sampling techniques*. 3d ed. Wiley and Sons, N.Y., 428 p.
- FRIDRIKSSON, A.  
1934. On the calculation of age-distribution within a stock of cod by means of relatively few age-determinations as a key to measurements on a large scale. *Rapp. P.-v. Réun. Cons. Perm. int. Explor. Mer* 86:1-14.

KETCHEN, K. S.

1950. Stratified subsampling for determining age determinations. Trans. Am. Fish. Soc. 79:205-212.

KIMURA, D. K.

1977. Statistical assessment of the age-length key. J. Fish. Res. Board Can. 34:317-324.

KUTKUHN, J. H.

1963. Estimating absolute age composition of California salmon landings. Calif. Dep. Fish Game, Fish. Bull. 120, 47 p.

MACKETT, D. J.

1963. A method of sampling the Pacific albacore (*Thunnus germa*) catch for relative age composition. F.A.O. Fish. Rep. 3:1355-1366.

RICKER, W. E.

1975. Computation and interpretation of biological statistics of fish populations. Fish. Res. Board Can., Bull. 191, 382 p.

SOUTHWARD, G. M.

1976. Sampling landings of halibut for age composition. Int. Pac. Halibut Comm. Sci. Rep. 58:1-31.

SUKHATME, P. V.

1954. Sampling theory of surveys with applications. Iowa State College Press, Ames, 491 p.

TANAKA, S.

1953. Precision of age-determination of fish estimated by double sampling method using the length for stratification. Bull. Jpn. Soc. Sci. Fish. 19:657-670.

TOMLINSON, P. K.

1971. Some sampling problems in fishery work. Biometrics 27:631-641.

WESTRHEIM, S. J., AND W. E. RICKER.

1978. Bias in using an age-length key to estimate age-frequency distributions. J. Fish. Res. Board Can. 35:184-189.



# A VARIABLE CATCHABILITY VERSION OF THE LESLIE MODEL WITH APPLICATION TO AN INTENSIVE FISHING EXPERIMENT ON A MULTISPECIES STOCK

JEFFREY J. POLOVINA<sup>1</sup>

## ABSTRACT

A variable catchability version of the Leslie model is developed which permits the catchability of one species to vary inversely with the abundance of competing species. This model is used to fit data from an intensive fishing experiment conducted on a multispecies bottom fish stock in the Marianas where catchability of a subordinate species is inversely related to the abundance of a more dominant species. Analysis of this multispecies intensive fishing experiment produced estimates of exploitable bottom fish density in the 150-275 m depth range of 10,156 fish per nmi<sup>2</sup> or 1,354 fish per nmi of 183 m (100-fathom) contour.

Intensive fishing of a closed population can produce data to estimate the initial population size and the catchability coefficient of fish stocks. Two frequently used models applied to intensive fishing data are the Leslie model and the Delury model (Ricker 1975). The Leslie model expresses catch per unit effort (CPUE) at any point during the period of intensive fishing as a linear function of the cumulative catch to that point, whereas the Delury model expresses the logarithm of CPUE at any point during the intensive fishing experiment as a linear function of the cumulative effort. From a statistical viewpoint the Leslie model is often preferable to the Delury model, since a predictive linear regression is used to estimate the parameters of both models and since typically catch is measured more accurately than effort.

Both the Leslie and Delury models assume that catchability is constant during the period of intensive fishing. However, experience indicates that this assumption may not always be satisfied (Pope and Garrod 1975; Schaaf 1975; MacCall 1976; Ulltang 1976; Garrod 1977; Peterman and Steer 1981; Fox<sup>2</sup>). Several authors have found that competition for baits between fish of different size or species can alter catchability (Allen 1963; Rothschild 1967). In this paper a variable catchability Leslie model will be developed for multispecies application where, due

to species interactions, the catchability of one species is altered by the presence of other species. This variable catchability Leslie model will be applied to multispecies intensive fishing data from snapper (family Lutjanidae) populations where the application of the constant catchability Leslie model leads to biologically untenable results.

## VARIABLE CATCHABILITY LESLIE MODEL

The CPUE during a time interval  $t$  (CPUE( $t$ )) is defined as the product of catchability ( $q$ ) and the mean population size (number of individuals) present during the period  $t$  ( $N(t)$ ), thus

$$\text{CPUE}(t) = qN(t). \quad (1)$$

Suppose that up to the beginning of period  $t$ ,  $K(t)$  fish have been caught and removed. If the period  $t$  is relatively short, the population of fish closed or isolated, and the fishing pressure heavy enough so that it can be assumed that mortality from other factors is negligible, then  $N(t)$  can be expressed as

$$N(t) = N(0) - K(t),$$

where  $N(0)$  is the initial population size at the beginning of the experiment ( $t = 0$ ). Inserting this expression for  $N(t)$  in Equation (1) produces the Leslie model:

$$\text{CPUE}(t) = q(N(0) - K(t)). \quad (2)$$

<sup>1</sup>Southwest Fisheries Center Honolulu Laboratory, National Marine Fisheries Service, NOAA, P.O. Box 3830, Honolulu, HI 96812.

<sup>2</sup>Fox, W. W. 1974. An overview of production modelling. U.S. National Marine Fisheries Service, Southwest Fisheries Center, Administrative Report LJ-74-10, La Jolla, CA.

Henceforth, this model will be referred to as the constant catchability Leslie model.

In a multispecies situation, competition between species for baited hooks may produce a dominance hierarchy where some species are more aggressive feeders than others and effectively out compete the less aggressive feeders for baited hooks. The catchability of the species at the top of the dominance hierarchy, is independent of the presence of more subordinate species, while the catchability of those species not at the very top of the hierarchy will vary inversely with the abundance of the more dominant species. A simple model which describes the catchability of a subordinate species ( $q(s,t)$ ) as a function of the cumulative catch and initial population size of the more dominant species,  $K(d,t)$  and  $N(d,0)$  respectively is

$$q(s,t) = q(s)(K(d,t)/N(d,0)) \quad (3)$$

where  $q(s)$  is the catchability of the subordinate species in the absence of the dominant species. Combining Equations (2) and (3) produces

$$\begin{aligned} \text{CPUE}(s,t) &= q(s)(K(d,t)/N(d,0)) \\ &\times (N(s,0) - K(s,t)) \quad (4) \end{aligned}$$

and by defining  $K(ds,t) = K(d,t)K(s,t)$ ,  $B1 = q(s)(N(s,0)/N(d,0))$ , and  $B2 = q(s)/N(d,0)$  Equation (3) becomes

$$\text{CPUE}(s,t) = B1K(d,t) - B2K(ds,t).$$

Estimates of  $B1$  and  $B2$  are obtained from multiple linear regression and the estimates of  $N(s,0)$  and  $q(s)$  are computed as

$$\hat{N}(s,0) = \hat{B}1/\hat{B}2, \text{ and } \hat{q}(s) = \hat{N}(d,0)\hat{B}2.$$

The estimate of  $N(d,0)$  is determined from the constant catchability model. As is evident from Equation (4), the estimate of  $N(s,0)$  is independent of the estimate of  $N(d,0)$ . Estimates of the variance of the estimate of  $N(s,0)$  are obtained from estimates of the means and variances of the estimates of  $B1$ , and  $B2$  and an exact expression for the variance of a ratio (Frishman 1975). Thus,

$$\begin{aligned} V(\hat{N}(s,0)) &= V(\hat{B}1/\hat{B}2) \\ &= \frac{V(\hat{B}1)[E(\hat{B}2)]^2 - V(\hat{B}2)[E(\hat{B}1)]^2}{(E(\hat{B}2))^2 [V(\hat{B}2) + [E(\hat{B}2)]^2]} \quad (5) \end{aligned}$$

where  $V(\ )$  and  $E(\ )$  represent the variances and means, respectively.

## APPLICATION OF MULTISPECIES LESLIE MODEL TO SNAPPER INTENSIVE FISHING

A 13-d intensive fishing experiment covering the period 10-19 April and 5-7 May 1984 was conducted at Pathfinder Reef (lat. 16°30'N, long. 143°05'E) in the Mariana Archipelago. Pathfinder Reef is a circular pinnacle rising steeply from a depth of about 1,600 to 16 m beneath the surface. At the 200 m contour, the diameter is about 0.8 nmi (Fig. 1). The snapper population at Pathfinder Reef is a closed population for purposes of the intensive fishing since the closest bank is a small pinnacle 40 nmi to the north.

Intensive fishing was conducted from the NOAA ship *Townsend Cromwell* using four bottom handlines on hydraulic gurdies targeting species in the 150-275 m depth range. Each day during the 13-d experiment, fishing was conducted around the entire perimeter of the bank. During the experiment 1,467 bottom fish were caught. Three lutjanids, *Pristipomoides zonatus*, *P. auricilla*, and *Etelis carbunculus*, accounted for 1,317 fish or about 90% of the catch (Table 1). Fishing effort was measured in

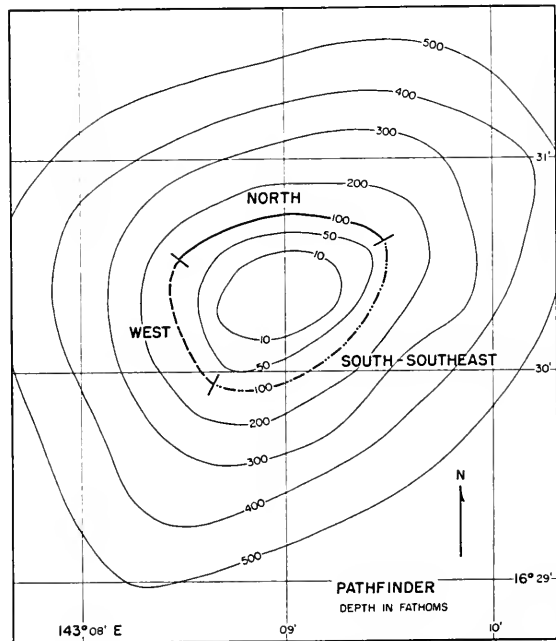

FIGURE 1.—Bathymetric chart of Pathfinder Reef showing the segments of the 100-fathom (183 m) contour used to partition daily fishing effort.



TABLE 1.—Species composition of bottom fish catch at Pathfinder Reef.

Species	Number caught	Percent of catch
<b>Lutjanidae</b>		
<i>Aphareus rutilans</i>	4	0.27
<i>Aprion virescens</i>	1	0.07
<i>Etelis carbunculus</i>	314	21.40
<i>Pristipomoides auricilla</i>	262	17.86
<i>P. filamentosus</i>	16	1.09
<i>P. flavipinnis</i>	7	0.48
<i>P. zonatus</i>	741	50.51
<b>Carangidae</b>		
<i>Caranx lugubris</i>	83	5.66
<i>Seriola</i> sp.	32	2.18
<b>Serranidae</b>		
<i>Cephalopholis igarasiensis</i>	2	0.14
<i>Epinephelus cometae</i>	2	0.14
<i>Saloptia powelli</i>	3	0.20
<b>Total</b>	<b>1,467</b>	<b>100.00</b>

line-hours. As is indicated in Figure 1, the circumference of the reef can be divided into three segments—north, west, and south-southeast, each having similar species composition (Table 2). Further, an attempt was made daily to allocate a consistent proportion of the day's fishing effort to each segment. The proportion allocated to each segment was influenced by the length of each segment and wind

TABLE 2.—Species composition for the three segments of the circumference of Pathfinder Reef (see Figure 1).

Species	South-Southeast		North		West	
	No.	%	No.	%	No.	%
<b><i>Pristipomoides zonatus</i></b>						
<i>P. auricilla</i>	170	24	37	16	55	14
<i>Etelis carbunculus</i>	171	25	39	17	104	27

and current conditions. On the average, the proportion of the total daily effort allocated to each segment was 0.45 on the south-southeast, 0.21 on the north, and 0.34 on the west. A chi-squared test applied to the daily allocation of fishing effort indicates that there was no significant departure ( $P = 0.89$ ) from this allocation during the course of the fishing experiment. Since the effort was reasonably constant over the duration of the experiment and the entire reef was fished each day, catch, effort, and CPUE computed on a daily basis were used in the analysis. An adjustment to cumulative catch suggested by Chapman (1961) was subsequently shown to improve the model fit in the Delury model (Braaten 1969). This adjustment computes cumulative catch for interval  $i$  as the cumulative catch to interval  $i$  plus one half the catch during interval  $i$ . This adjustment compensates for the decline in CPUE within each time interval. The adjusted cumulative catch is used as the independent variable in all subsequent analyses (Table 3).

Plots of CPUE against adjusted cumulative catch for each of the three species of snappers show a decline in CPUE for *P. zonatus*, a slight decline for *E. carbunculus*, and an increase for *P. auricilla* (Fig. 2). A regression line fitted to these data results in negative slopes for *P. zonatus* ( $P = 0.0007$ ) and *E. carbunculus* ( $P = 0.05$ ) and a positive slope for *P. auricilla* ( $P = 0.008$ ). The constant catchability Leslie model fitted the *P. zonatus* data well and resulted in an  $R^2$  of 0.71 and a pattern of residuals which supports the linear model. The estimates of  $N(0)$  and  $q$  for *P. zonatus* from this fit are 1,066 fish and 0.0038 per line-hour. Due to the selectivity of the fishing gear,  $N(0)$  estimated from this intensive fishing data does not represent total population size

TABLE 3.—Daily catch, effort, catch per unit of effort (CPUE), and adjusted cumulative catch for *Pristipomoides zonatus*, *P. auricilla*, and *Etelis carbunculus*

Date 1984	Effort (line-hours)	Total			<i>Pristipomoides zonatus</i>			<i>P. auricilla</i>			<i>Etelis carbunculus</i>		
		Catch (no.)	CPUE	Adjusted cumulative catch	Catch (no.)	CPUE	Adjusted cumulative catch	Catch (no.)	CPUE	Adjusted cumulative catch	Catch (no.)	CPUE	Adjusted cumulative catch
Apr. 10	27.5	152	5.53	76	98	3.56	49	12	0.44	6	42	1.53	21
Apr. 11	23.7	150	6.33	227	111	4.68	153.5	17	0.72	20.5	22	0.93	53
Apr. 12	21.3	100	4.67	352	47	2.21	232.5	12	0.56	35	41	1.93	84.5
Apr. 13	29.7	139	4.68	471.5	91	3.06	301.5	29	0.98	55.5	19	0.64	114.5
Apr. 14	29.3	112	3.82	597.0	66	2.25	380	17	0.58	78.5	29	0.99	138.5
Apr. 15	17.5	84	4.80	695.0	50	2.86	438	13	0.74	93.5	21	1.20	163.5
Apr. 16	30.7	129	4.20	801.5	67	2.18	496.5	26	0.85	113	36	1.17	192.0
Apr. 17	21.4	65	3.04	897.5	38	1.78	548	12	0.56	132	15	0.70	217.5
Apr. 18	22.4	81	3.62	970.5	41	1.83	587.5	15	0.67	145.5	25	1.12	237.5
Apr. 19	21.6	60	2.78	1,041	28	1.30	622.0	17	0.78	161.5	15	0.69	257.5
May 5	20.3	82	4.04	1,112.5	40	1.97	656	29	1.43	184.5	13	0.64	271.5
May 6	22.8	91	3.99	1,199.0	35	1.54	693.5	35	1.54	216.5	21	0.92	288.5
May 7	24.1	72	2.99	1,281	30	1.25	726.0	27	1.12	248.5	15	0.62	306.5

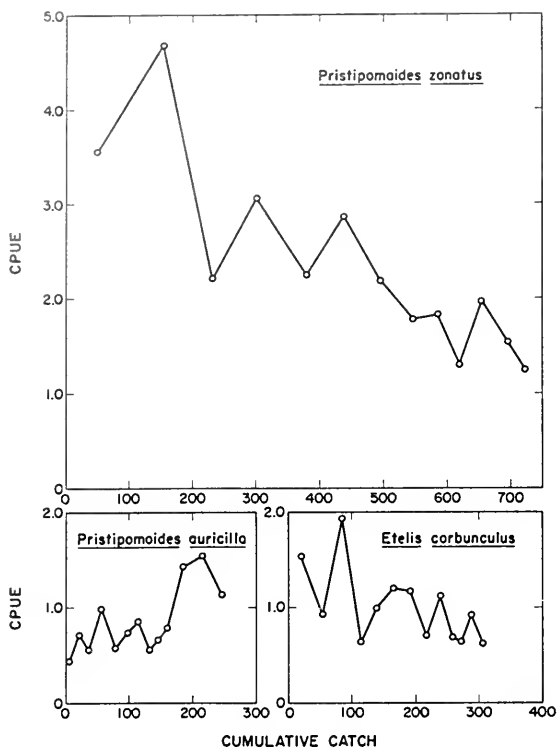

FIGURE 2.—Daily catch per unit effort (CPUE) and adjusted cumulative catch for *Pristipomoides zonatus*, *P. auricilla*, and *Etelis carbunculus*.

but rather the population size of those fish that can be caught by the fishing gear which will be termed the exploitable population. Although the constant catchability Leslie model does not explain as much of the variation for *E. carbunculus* ( $R^2 = 0.35$ ) as it does for *P. zonatus*, the regression is significant and the pattern of residuals supports the linear fit. The estimates for catchability and initial exploitable population size for *E. carbunculus* from the fit of this model are 0.0025 per line-hour and 583 fish. The positive slope for the regression of CPUE on cumulative catch for *P. auricilla* does not make sense biologically under the constant catchability Leslie model.

The depth of capture data show that *P. zonatus* and *P. auricilla* were caught in the same depth range, whereas *E. carbunculus* was typically caught at somewhat greater depths (Table 4). Thus, species interactions would most likely occur between *P. zonatus* and *P. auricilla*. If *P. zonatus* is more aggressive than *P. auricilla* in pursuing fishing baits or in some other way affects the behavior of the latter, then the initial catchability for *P. auricilla* will

TABLE 4.—Percent of catch by depth (in fathoms, 1 fathom = 1.83 m).

Species	Depth		
	<100	100-120	>120
<i>Pristipomoides zonatus</i>	15.1	71.7	13.2
<i>P. auricilla</i>	12.6	79.0	8.4
<i>Etelis carbunculus</i>	1.9	46.5	51.6

be low but will rise as the population of *P. zonatus* is reduced. Applying the variable catchability Leslie model to the *P. auricilla* data, with the assumption that *P. zonatus* is the dominant species and that *P. auricilla* is the subordinate species so that the catchability of *P. auricilla* depends on the population size of *P. zonatus*, results in the following relationship:

$$\begin{aligned} \text{CPUE}(a,t) &= q(a)(K(z,t)/N(z,0)) \\ &\quad \times (N(a,0) - K(a,t)), \end{aligned} \quad (6)$$

where  $q(a)$  is the catchability of *P. auricilla* in the absence of *P. zonatus* and  $N(z,0)$  and  $N(a,0)$  are the initial exploitable population sizes of *P. zonatus* and *P. auricilla*, respectively, and  $K(z,t)$  and  $K(a,t)$  are the cumulative catch of *P. zonatus* and *P. auricilla* to time  $t$ , respectively.

Using the estimate of  $N(z,0)$ , 1,066 fish, from the fit of the constant catchability model to *P. zonatus* data, Equation (6) has two unknowns to be estimated— $q(a)$  and  $N(a,0)$ . A multiple linear regression model estimates the initial exploitable population size of *P. auricilla*,  $N(a,0)$ , at 2,007 fish and  $q(a)$  at 0.00087. The variable catchability Leslie model fits the *P. auricilla* CPUE data well and produces an  $R^2$  of 0.89 (Fig. 3). The estimates of initial population sizes for the three species are summarized in Table 5 together with their 95% confidence intervals. For the constant catchability model, the population size confidence interval is computed from a relationship derived by Delury (1958), whereas the confidence interval for the variable catchability model is computed from the variance expression given in Equation (5).

## DISCUSSION

The constant catchability Leslie model fit the *P. zonatus* and *E. carbunculus* data well but was not appropriate for the *P. auricilla* data. The variable catchability Leslie model fit the *P. auricilla* data well and provided a plausible explanation for the observed increase in CPUE. Given that there was a time delay between the first 10 d of the intensive

fishing (10-19 April) and the last 3 d (5-7 May), and that the greatest increase in the catchability of *P. auricilla* occurred after the time delay, it is possible that the increase in catchability might have a time lag component associated with it. However, given the short time series of data, it would be difficult to test the appropriateness of a more complicated time lag model.

Based on the fit of these two models the initial exploitable population of the three species in the 150-275 m depth range at Pathfinder Reef is estimated at 3,656 fish (Table 5). If we assume, based on the species composition data (Table 1), that these three species represent 90% of the exploitable population then the total exploitable population at the beginning of the intensive fishing is 4,062 fish.

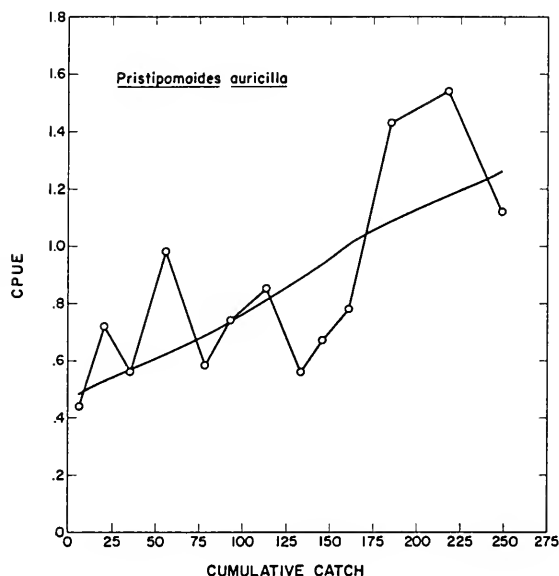

FIGURE 3.—Daily catch per unit effort (CPUE) and predicted CPUE based on the variable Leslie model as a function of adjusted cumulative catch for *Pristipomoides auricilla*.

From Figure 1 the length of the 183 m (100-fathom) contour is estimated at 3.0 nmi, and the area in the 180-300 m depth range is estimated to be 0.4 nmi<sup>2</sup>. With these area measures, density estimates of 1,354 fish per nmi of (183 m) 100-fathom contour and 10,156 fish/nmi<sup>2</sup>, are obtained for Pathfinder Reef.

Estimates of bottom fish densities based on visual observation from a submersible at Johnston Atoll were 57,281 fish/nmi<sup>2</sup> for the 92-183 m (50-100 fathom) depth range and 66,199 fish/nmi<sup>2</sup> for the 1983-274 m (100-150 fathom) depth range (Ralston et al. 1986). These figures are considerably larger than both the point and interval estimates presented here. Significantly, the study of Ralston et al. (1986) also employed the *Townsend Cromwell*, and the catch rates were comparable at Pathfinder and Johnston (e.g., 3.18 bottom fish/line-hour for the latter). Thus the difference between estimates of standing stock is likely not due to differences in absolute abundance but rather to differences between exploitable population size and total population size. For example, at Johnston Atoll at least 69 species of fish were observed from the submersible, whereas only 10 species were taken by fishing gear in the same depth (Ralston et al. 1986).

If the constant catchability Leslie model is applied to the pooled data for the three species, an estimate of exploitable population size of 2,689 is obtained, about 71% of the estimate of the exploitable population size for the three species when they are estimated separately (Table 5).

Size-specific behavior has been raised as a factor which might affect catchability (Allen 1963). For all three species, there is no evidence of intraspecies size-specific behavior affecting catchability since for two of the species the constant catchability model fits well and for the third species, catchability depends only on the population size of an interacting species. Further, under the hypothesis that within a stock catchability is size-specific across the

TABLE 5.—Estimates of population size and catchability for three species.

Species	Model	R <sup>2</sup>	Catch-ability	SE	Initial population size	Confidence interval (95%)
<i>Pristipomoides zonatus</i>	Constant catchability	0.71	0.0038	0.0075	1,066	(803-1,691)
<i>Etelis carbunculus</i>	Constant catchability	0.35	0.0025	0.0010	583	(361-3,011)
<i>P. auricilla</i>	Variable catchability	0.89	0.00087	0.00031	2,007	(261-5,727)
Three species pooled	Constant catchability	0.66	0.0022	0.0047	2,689	(1,955-4,535)

range of exploitable size, intensive fishing would produce a substantial change in the population size structure. A plot of the mean fork length by day of fishing for the three species (Fig. 4) shows very little change in fork length even for *P. zonatus* where 68% of the exploitable stock is estimated to have been removed. Thus, the mean size of the fish in a catch may be a much less sensitive indicator of changes in the population size than catch rates, at least over the short term.

## ACKNOWLEDGMENTS

I wish to thank Alec D. MacCall and William E. Schaaf whose reviews resulted in an improvement in the formulation of the variable catch Leslie model. This paper is a result of the Resource Assessment Investigation of the Mariana Archipelago at the Southwest Fisheries Center Honolulu Laboratory, National Marine Fisheries Service, NOAA.

## LITERATURE CITED

- ALLEN, K. R.  
1963. The influence of behavior on the capture of fish with baits. In *The selectivity of fishing gear*, Vol. 5, p. 5-7. Proceedings of Joint ICNAF/ICES/FAO, Special Scientific Meeting, Lisbon, 1957, Special Publications No. 5.
- BRAATEN, D. O.  
1969. Robustness of the Delury population estimator. *J. Fish. Res. Board Can.* 26:339-355.
- CHAPMAN, D. G.  
1961. Statistical problems in dynamics of exploited fisheries populations. *Proc. Berkeley Symp. Math. Stat. Probab.* 4:153-168.
- DELURY, D. B.  
1958. The estimation of population size by a marking and recapture procedure. *J. Fish. Res. Board Can.* 15:19-25.
- FRISHMAN, F.  
1975. On the arithmetic means and variances of products and ratios of random variables. In G. P. Patil et al. (editors), *Statistical distributions in scientific work*, Vol. I, p. 401-406.
- GARROD, D. J.  
1977. The North Atlantic cod. In J. A. Gulland (editor), *Fish population dynamics*, p. 216-242. John Wiley & Sons, N.Y.
- MACCALL, A. D.  
1976. Density dependence of catchability coefficient in the California Pacific sardine, *Sardinops sagax caerulea*, purse seine fishery. *Calif. Coop. Oceanic Fish. Invest. Rep.* 18:

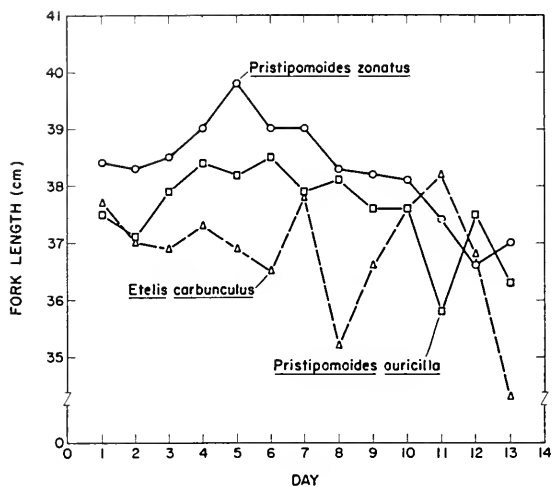

FIGURE 4.—Mean fork length for each day of fishing for *Pristipomoides zonatus*, *P. auricilla*, and *Etelis carbunculus*.

136-148.

- PETERMAN, R. M., AND G. J. STEER.  
1981. Relation between sport-fishing catchability coefficients and salmon abundance. *Trans. Am. Fish. Soc.* 110:585-593.
- POPE, J. G., AND D. J. GARROD.  
1975. Sources of error in catch and effort quota regulations with particular reference to variation in the catchability coefficient. *Int. Comm. Northwest Atl. Fish. Res. Bull.* 11: 17-30.
- RALSTON, S., R. M. GOODING, AND G. M. LUDWIG.  
1986. An ecological survey and comparison of bottom fish resource assessments (submersible versus handline fishing) at Johnston Atoll. *Fish. Bull.*, U.S. 84:141-155.
- RICKER, W. E.  
1975. Computation and interpretation of biological statistics of fish populations. *Fish. Res. Board Can.*, Bull. 191, 382 p.
- ROTHSCHILD, B. J.  
1967. Competition for gear in a multiple-species fishery. *J. Cons.* 31:102-110.
- SCHAAF, W. E.  
1975. Fish population models: potential and actual links to ecological models. In C. S. Russell (editor), *Ecological modeling in a resource management framework*, p. 211-239. Johns Hopkins Univ. Press, Balt.
- ULLTANG, Ø.  
1976. Catch per unit of effort in the Norwegian purse seine fishery for Atlanto-Scandian (Norwegian spring spawning) herring. *FAO Fish. Tech. Pap.* 155:91-101.

# EARLY DEVELOPMENT OF THE LOPHIID ANGLERFISH, *LOPHIUS GASTROPHYSUS*

YASUNOBU MATSUURA AND NELSON TAKUMI YONEDA<sup>1</sup>

## ABSTRACT

Using larval specimens collected in bongo nets in southern Brazilian waters (between lat. 23° and 29°S), early development of the lophiid anglerfish, *Lophius gastrophysus*, is described and compared with other lophiid species. Larval morphology of *L. gastrophysus* is very similar to that of *L. americanus*, having three conspicuous melanophores on the trunk and caudal region, but the former can be easily distinguished from the latter by the presence of two melanophores on the preopercular and suborbital regions and positions of the melanophores on the elongate ventral fin.

The peculiar larvae of *Lophius* have been known since the description of the early developmental stage of *L. americanus* by Agassiz (1882). Their characteristic form with elongate dorsal and ventral fin rays makes them easily identifiable. Of the 25 species of the Lophiidae (Caruso 1981), larvae have been repeatedly described and discussed for *L. piscatorius* (Prince 1891; Williamson 1911; Stiasny 1911; Allen 1917; Lebour 1919, 1925; Bowman 1920; Tåning 1923; Arbault and Boutin 1968; Russel 1976) and for *L. americanus* (Agassiz 1882; Connolly 1920, 1922; Tåning 1923; Berrill 1929; Dahlgren 1928; Procter et al. 1928; Bigelow and Schroeder 1953; Martin and Drewry 1978; Fahay 1983; Pietsch 1984). The larvae of two other species also have been described: *L. budegassa* (Stiasny 1911; Padoa 1956) and *L. litulon* (Tanaka 1916; Mito 1966). There is no literature on larval morphology of *L. gastrophysus*.

During ichthyoplankton surveys along the southern Brazilian coast, many *Lophius* larvae were collected and identified as *L. gastrophysus*. This report gives a detailed comparative description of larval development based on 136 specimens collected during the past 13 years.

## MATERIALS AND METHODS

Larval specimens used in this report were obtained from the collections of ichthyoplankton at the Instituto Oceanográfico da Universidade de São Paulo. These samples were collected from the southern Brazilian coast using a 61 cm bongo net following the sampling method of Matsuura (1979) and

preserved in 10% Formalin<sup>2</sup> solution. Notochord length (NL) was taken from the tip of the upper jaw to the tip of the notochord. A total of 136 larvae (3.3-15.7 mm NL) of *L. gastrophysus* was used in this study. Specimens were measured with a micrometer in a stereoscopic dissecting microscope and illustrations were made with the aid of a camera lucida.

## MORPHOLOGY OF LARVAE

The smallest identified specimens which were collected with plankton nets as free-living forms were about 3.3 mm NL, but they still had a large yolk sac. Fahay (1983) showed that the newly hatched larvae of *L. americanus* was as small as 2.5 mm long, and they were still encased in the egg veils (Fahay<sup>3</sup>). The reported size of newly hatched larvae of *L. piscatorius* was 4.5 mm TL (Lebour 1925).

Since the 3.3 mm larvae were not in perfect condition, we used larger specimens for the morphological description. Preflexion larvae of *L. gastrophysus* have a slender body (Fig. 1A, B, C, D), but they later become robust form (Fig. 1E, F). This change of body shape is partly a result of increase in body depth and partly due to enlargement of subepidermal space (Fig. 1C, D, E, F), which appears, firstly, on the head region and later becomes larger and extends posteriorly, giving the larvae a balloonlike appearance. This subepidermal space consists of transparent, gelatinous connective tissue and is considered an adaptation to planktonic life

<sup>2</sup>Reference to trade names does not imply endorsement by the National Marine Fisheries Service, NOAA.

<sup>3</sup>M. P. Fahay, Northeast Fisheries Center Sandy Hook Laboratory, National Marine Fisheries Service, NOAA, Highlands, NJ 07732, pers. commun. July 1985.

<sup>1</sup>Instituto Oceanográfico da Universidade de São Paulo, Butantã, São Paulo 05508, Brasil.

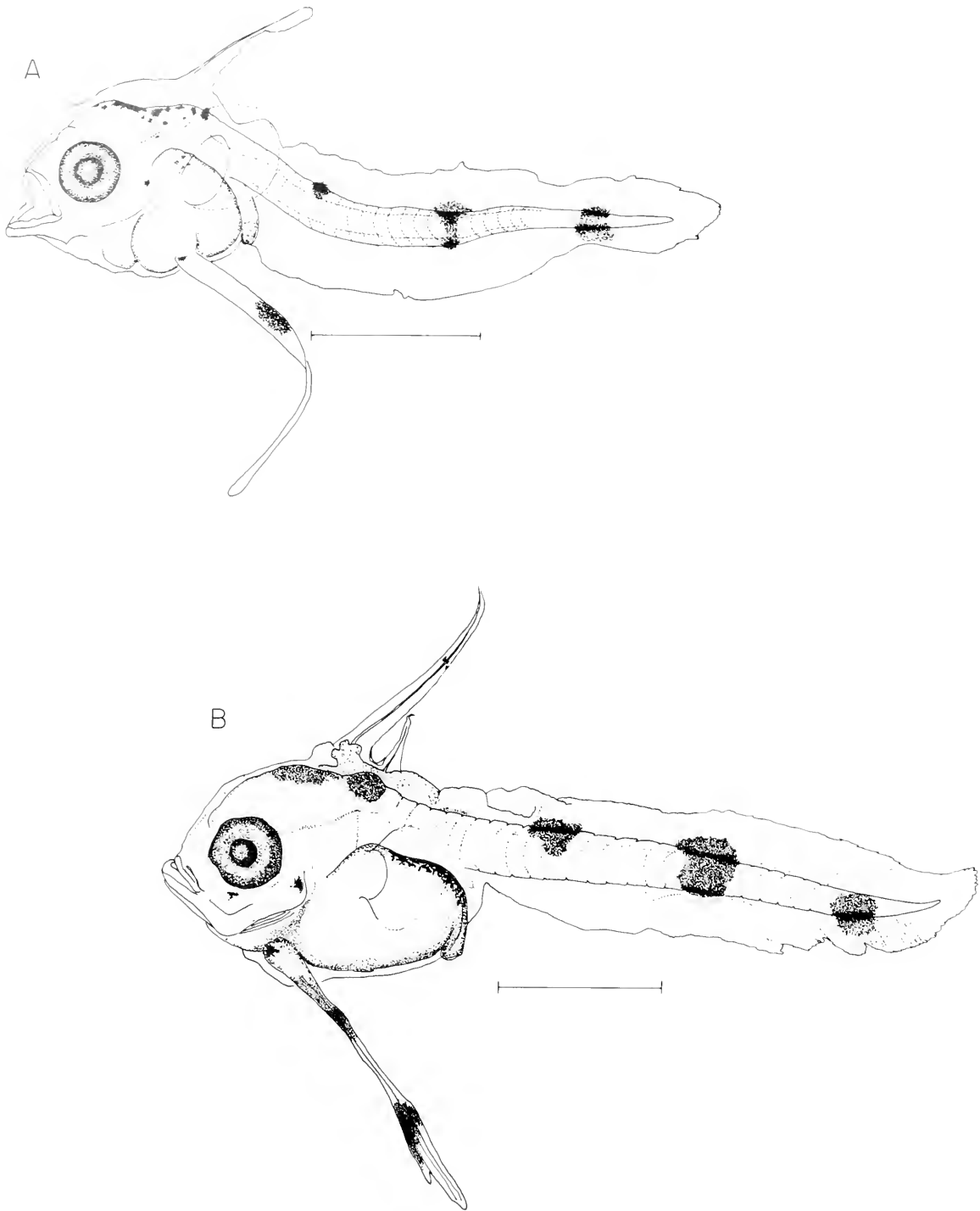

FIGURE 1.—*Lophius gastrophysus* larvae from southern Brazil: A. 3.8 mm NL, B. 4.5 mm NL. Scale bar is 1.0 mm.

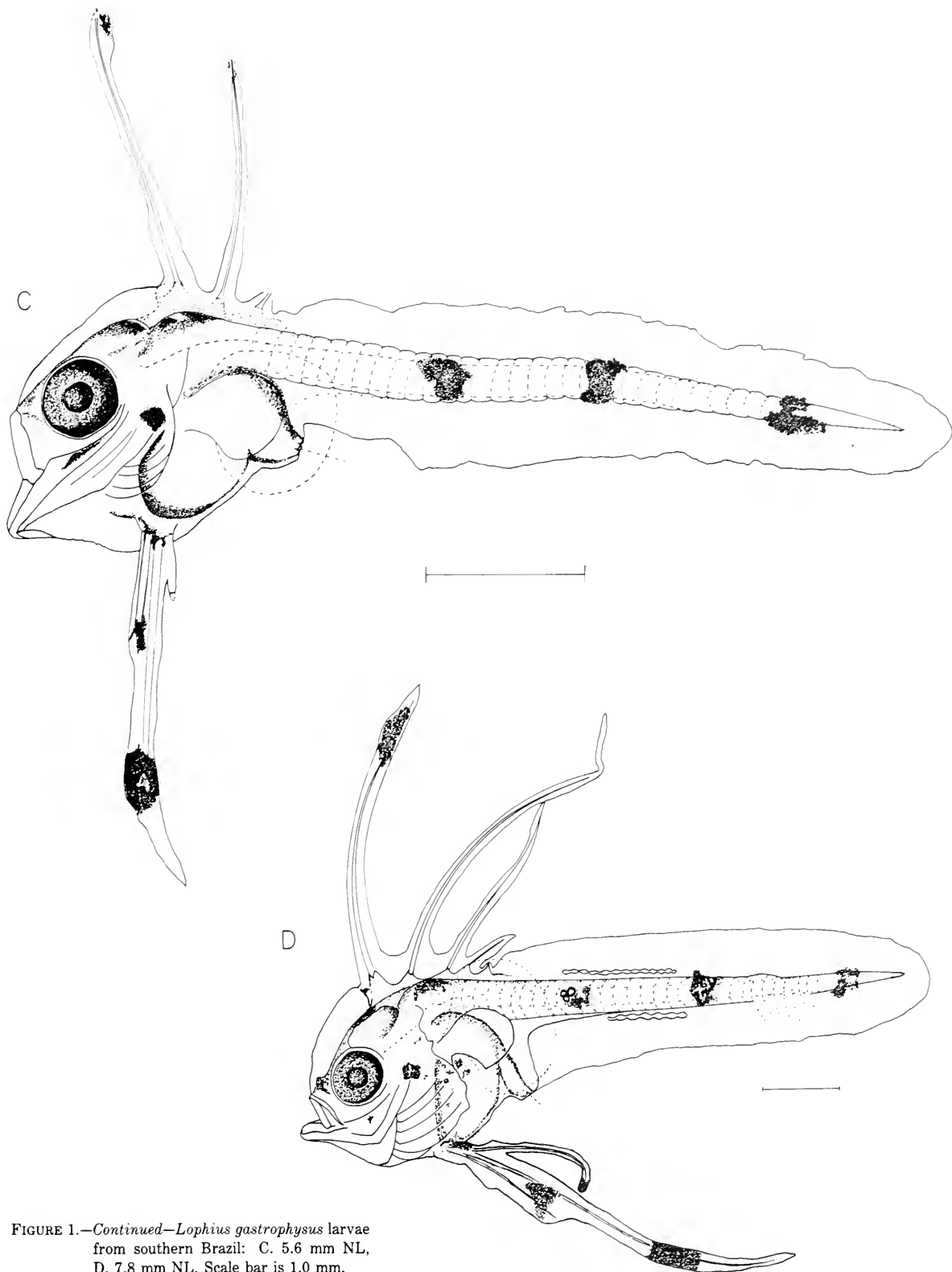

FIGURE 1.—Continued—*Lophius gastrophysus* larvae from southern Brazil: C. 5.6 mm NL, D. 7.8 mm NL. Scale bar is 1.0 mm.

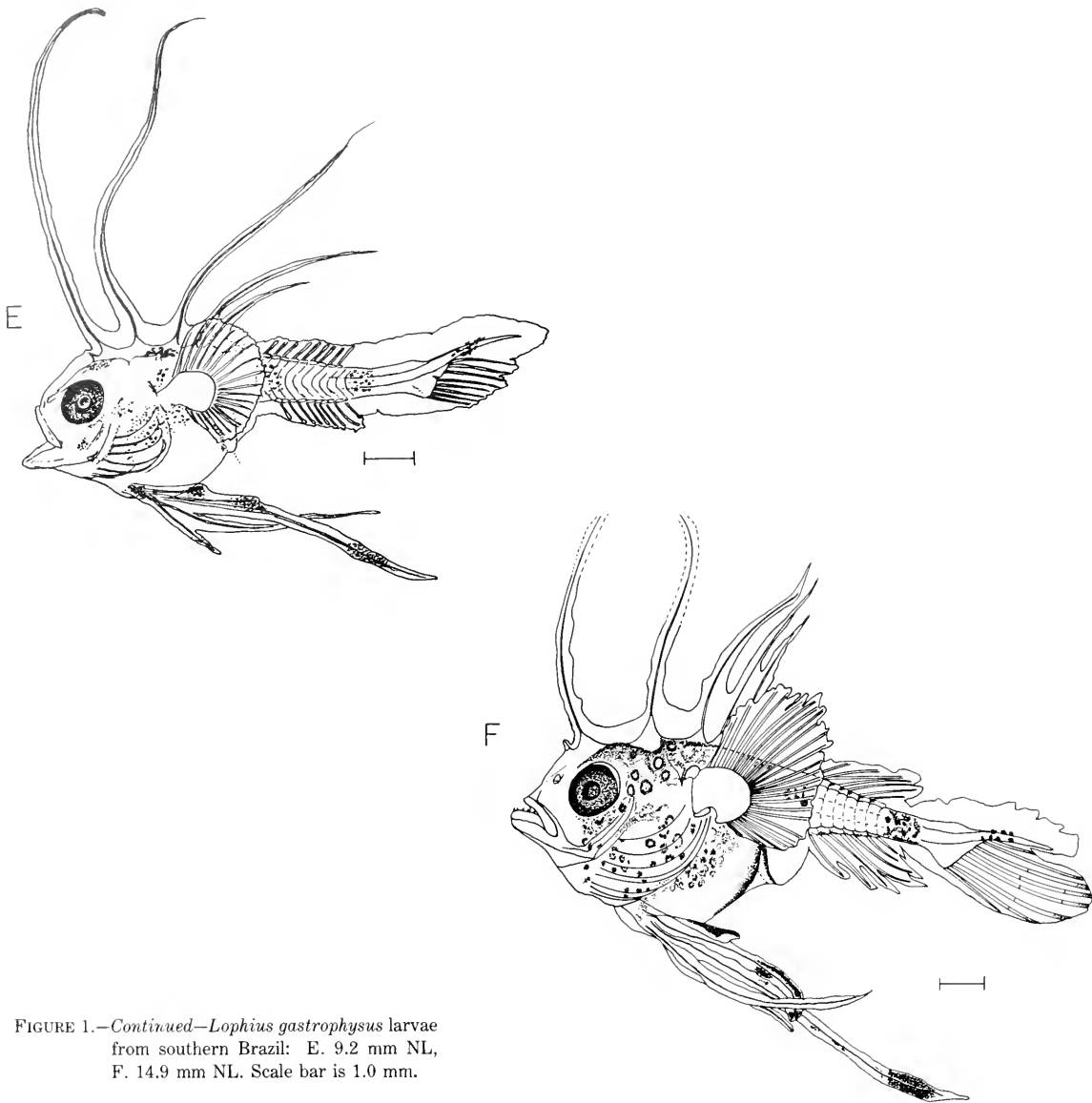

FIGURE 1.—Continued—*Lophius gastrophysus* larvae from southern Brazil: E. 9.2 mm NL, F. 14.9 mm NL. Scale bar is 1.0 mm.

(Tåning 1923). Notochord flexion starts at about 9 mm NL (Fig. 1E).

As shown in *L. piscatorius* larvae (Tåning 1923), the laterally compressed larval form changes gradually during their planktonic stage toward the dorsoventrally depressed shape of juvenile and adults. The largest larvae examined, 15.7 mm NL, had not yet achieved the juvenile stage, but a similar tendency was observed. For example, the maximal breadth of the head in 3.5 mm larva is only 22%, but that in 15.7 mm larva is about 40% of body length. The

proportion of body depth also shows a similar tendency, i.e., it starts at 30% at 4 mm and attains 45% of body length at 15.7 mm. The proportion of head length starts at about 23% at 4.5 mm and attains almost 45% at 15.7 mm NL.

Statistics describing regressions of different body parts in relation to body length are shown in Table 1. The regressions lines of head length and body depth showed an inflexion at the size of 7.6 mm NL, while those of other body parts were linear for the size range 3.2-15.7 mm NL. Thus, the regressions



TABLE 1.—Statistics describing regressions relating notochord length with length of different body parts of *Lophius gastrophysus* larvae.  $a$  and  $b$  = constant ( $y = a + bx$ ),  $r$  = correlation coefficient,  $n$  = number of specimens.

Characters (x)	Size range of notochord length (y) (mm)	a	b	r	n
Head length	3.2- 7.5	-0.18334	0.27117	0.68827	97
	7.7-15.7	-2.11501	0.56058	0.94483	27
Body depth	3.2- 7.5	0.10498	0.28333	0.74299	99
	7.7-15.7	-2.49286	0.65397	0.92825	27
Preanal distance	3.2-15.7	-1.54475	0.77254	0.96482	27
Predorsal distance	3.2-15.7	-1.65336	0.74641	0.96717	27
Eye diameter	3.2-15.7	-0.00095	0.10383	0.94353	124
Length of the second dorsal spine	3.2-15.7	-3.19397	0.99987	0.90707	96
Length of the third ventral fin ray	3.2-15.7	-3.47484	1.14083	0.90497	102

lines of the former were calculated in two size ranges.

## PIGMENTATION

*Lophius gastrophysus* larvae develop a distinct pattern of melanophores. Since early stage (Fig. 1A), there are three large pigment bars on the trunk and caudal region and they remain at the same position during larval stage. The larva of 14.9 mm NL (Fig. 1F) has a heavily pigmented body, but the three large pigment bars on the trunk and caudal region are still visible. There are dense melanophores over the occipital region of the head and shoulder (Fig. 1A). Pigments on the elongate ventral fin ray is also visible in the smallest specimen, but the positions and number of them change gradually. In the earliest stage (3.8 mm NL) there are two melanophores on the ventral fin: one at the fin ray base and another at the middle of the ventral fin. At the size of 4.5 mm NL (Fig. 1B), there appears another small melanophore at one-third the length of the fin ray. The melanophore at the fin ray base remains at the same position, but the distal large one moves to the position three-fourths the length of the fin ray. After this size, positions and number of melanophores on the elongate third ventral fin ray remain the same up to 15.7 mm NL. When distal part of other ventral fin rays start to separate from the third one, there appears some melanophores on the distal edge of each fin ray.

There appears a patch of melanophores on the preopercular region at 3.8 mm NL and another small one appears on the suborbital region at 4.5 mm NL. The small melanophore, which appears on the tip of the elongate second dorsal spine at 4.5 mm NL, will later become a large pigment bar (Fig. 1C, D).

## FIN DEVELOPMENT

The most remarkable change can be seen in lengths of the dorsal and ventral fins. Since the earliest stage (Fig. 1A), the larvae have elongate dorsal spine and ventral fin ray, which later become the second dorsal spine and the third ventral fin ray, respectively. The length of the second dorsal spine relative to body length changed from 28% at 3.3 mm NL to 90% at 8.3 mm NL (Fig. 2A). In larger larvae the proportion of the second dorsal spine length relative to body length decreased gradually to 70% at 15.7 mm NL. A similar tendency was observed for the length of the third ventral fin ray: it varied from 45% of body length at 3.3 mm NL to 121% at 11.6 mm NL (Fig. 2B). Unfortunately, these fin rays are in many cases lost or damaged at the distal tip, making it difficult to say whether we measured the total length of fin rays or the partial length of a damaged ray. In any case, the figure shows a clear tendency of rapid increase of fin rays during larval stage.

The number of fin rays increases during larval stage. For example, the origin of the first dorsal spine firstly appears anterior to the elongate second dorsal spine in 9.2 mm NL larva (Fig. 1E). The tip of the first dorsal spine which will transform into the illicium in the adult fish, emerges from the epidermal skin at about 10 mm NL. At this size, all fin rays are well developed and number of fin rays on the second dorsal, anal, and caudal fins attains the adult number.

Another remarkable change in fin development is a forward advancement of the dorsal spines. At 3.3 mm NL larva, the elongate second dorsal spine lies behind the head (Fig. 1A) and it moves gradually forward during larval stage; at 14.9 mm NL,

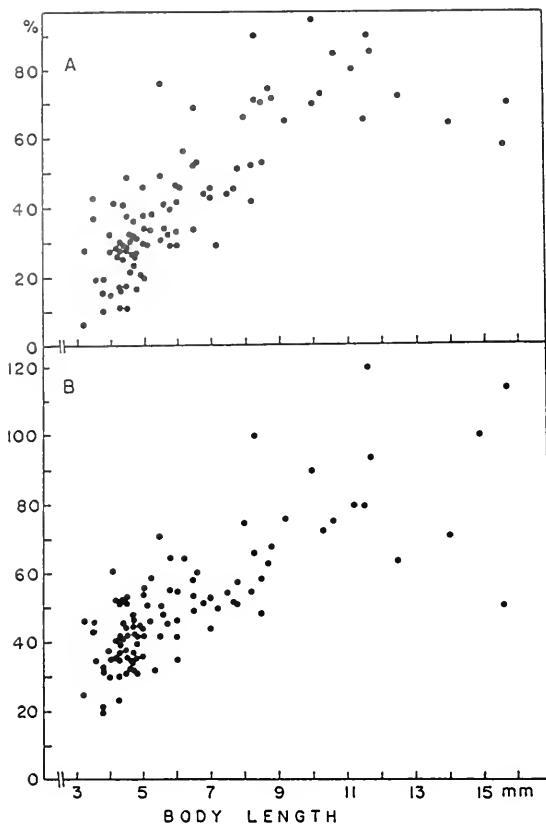

FIGURE 2.—Relationships between changes of proportion of second dorsal spine (A) and third ventral fin ray (B) and body length (NL) of *Lophius gastrophysus*.

it becomes the position anterior to the eyes (Fig. 1F).

## DISCUSSION

Based on a study of world-wide collections, Caruso (1981, 1983) recently concluded that the Lophiidae is represented by 4 genera and 25 species, of which only 2 species inhabit the western Atlantic: *Lophius americanus* in the western North Atlantic and *L. gastrophysus* in the western Central and South Atlantic. The geographic ranges of the two species overlap between Cape Hatteras, NC, and Florida. The two western Atlantic species are very similar, but they can be easily distinguished by differences in dorsal and anal fin ray counts, size of the third and fourth dorsal spines, and differences in pigment pattern (Caruso 1983).

It is well known that lophiid anglerfishes spawn over deep water producing large gelatinous ribbons of spawn which often contain more than a million

eggs (Berrill 1929). Spawning behavior is not known, but some authors have suggested that it may occur at or near the bottom (Tåning 1923; Dahlgren 1928). After hatching, the larvae emerge from the gelatinous capsules and pass a long planktonic stage. Upon attaining a length of about 60 mm TL, young fish probably take to the bottom (Connolly 1922; Tåning 1923; Bigelow and Schroeder 1953).

As shown previously, *Lophius* larvae can be easily distinguished from those of other species. Because there is only one species in the western South Atlantic, there is no doubt about the identification of our larvae as *L. gastrophysus*. Therefore, we have documented morphological differences in early developmental stages of our specimens and compared them with those of other well-known species (Table 2).

Meristic characters and adult forms of *L. americanus* and *L. piscatorius* are very similar, but their larval forms are quite different (Tåning 1923). The most remarkable difference is the presence of three large pigment bars on the trunk and caudal region in *L. americanus* from the yolk-sac stage. He also pointed out that the larval development of *L. americanus* was more rapid than that of *L. piscatorius*.

The larvae of *L. gastrophysus* are very similar to that of *L. americanus*. Both species have three large pigment bars on the trunk and caudal region from the very earliest stages. Larval development of *L. gastrophysus* is more rapid than that of *L. americanus*, e.g., formation of the bases of the second dorsal and anal fins and the five dorsal spines occurs at sizes 8.1 mm, 8.5 mm, and 11.5 mm, respectively, for *L. gastrophysus*, *L. americanus*, and *L. piscatorius*. In the same way, the first appearance of canine teeth on both jaws occurs at sizes of 4.2 mm, 6.5 mm, and 9.8 mm, respectively, in the same order for the three species.

Another difference is in the position of the melanophore of the ventral fin, present on the distal part of this fin in larvae of *L. americanus* and *L. piscatorius*, but at three-fourths the length of the fin in *L. gastrophysus* larvae. The presence of pigmentation in the preopercular and suborbital regions is also peculiar to *L. gastrophysus* larvae.

## ACKNOWLEDGMENTS

The authors wish to thank Edward D. Houde of the University of Maryland for revision and critical reading of the manuscript.

They are also grateful to June Ferraz Dias and Kazuko Suzuki for sorting and drawing the larvae.

The financial support of this work came from the

TABLE 2.—Comparison of development stages of three Atlantic species of lophiid anglerfishes.

Characters	<i>L. gastrophysus</i>	<i>L. americanus</i>	<i>L. piscatorius</i>
General development			
Formation of bases of second dorsal and anal fins, the five dorsal spines, and the elongate ventral fin	8.1	8.5 mm <sup>1</sup>	11.5 mm <sup>2</sup>
First dorsal spine	about 10-11 mm	about 12-14 mm <sup>1, 2</sup>	about 15-16 mm <sup>2, 3</sup>
Completion of anal fin rays	9.3 mm	10.5 mm <sup>2</sup>	16 mm <sup>3</sup>
Completion of soft dorsal fin rays	9.3 mm	10.5 mm <sup>2</sup>	16 mm <sup>3</sup>
Size at first appearance of canine teeth in both jaws	4.2 mm	6.5 mm <sup>2</sup>	9.8 mm <sup>2</sup>
Size of newly hatched larva	about 3.5 mm	about 2.5 mm <sup>4</sup>	about 4.5 mm <sup>3</sup>
Pigment on distal edge of the second dorsal spine	since 5.2 mm	no pigment <sup>1, 2</sup>	since 6 mm <sup>3, 5</sup>
Position of pigment on distal part of the ventral fin	3/4 of ventral fin	far distal edge <sup>2, 6</sup>	far distal edge <sup>5</sup>
Pigment bars on the trunk and caudal region	three bars since early stage	three bars since <sup>2</sup> early stage	anterior two bars <sup>5</sup> since 11 mm
Meristic characters <sup>7</sup>			
Dorsal fin rays	9-11	11-12	11-12
Anal fin rays	8-9	9-10	9-10
Pectoral fin rays	22-26 (24.6)	25-28 (26.1)	23-27 (25.2)
Vertebrae	26-27 (26.2)	28-30 (29.1)	30-31 (30.4)

<sup>1</sup>Martin and Drewry 1978; <sup>2</sup>Tåning 1923; <sup>3</sup>Russel 1976; <sup>4</sup>Fahay 1983; <sup>5</sup>Lebour 1925; <sup>6</sup>Agassiz 1882; <sup>7</sup>Caruso 1983.

Note: For comparative purpose, the body length was given in total length for all species. Notochord length of *L. gastrophysus* larvae was converted to total length with an equation: TL = 1.024 mm NL + 0.1168 ( $r = 0.999$ ), for larvae smaller than 10.0 mm NL.

Financiadora de Estudos e Projetos (FINEP). The senior author received the research fellowship of the Conselho Nacional de Desenvolvimento Científico e Tecnológico (CNPq) and the junior author received the scholarship of the Fundação de Amparo à Pesquisa do Estado de São Paulo (FAPESP). This is contribution nº 620 of the Instituto Oceanográfico da Universidade de São Paulo.

## LITERATURE CITED

- AGASSIZ, A.  
1882. On the young stages of some osseous fishes. Part III. Proc. Am. Acad. Arts Sci. 17:271-303.
- ALLEN, E. J.  
1917. Post-larval teleosts collected near Plymouth during the summer of 1914. J. Mar. Biol. Assoc., U.K. 11:207-250.
- ARBAULT, S., AND N. L. BOUTIN.  
1968. Ichthyoplankton. Oeufs et larves de poissons téléostéens dans le Golfe de Gascogne en 1964. Rev. Trav. Inst. Pêches Marit. 32:413-476.
- BERRILL, N. J.  
1929. The validity of *Lophius americanus* Val. as a species distinct from *L. piscatorius* Linn., with notes on the rate of development. Contrib. Can. Biol. (N.S.) 4:145-151.
- BIGELOW, H. B., AND W. C. SCHROEDER.  
1953. Fishes of the Gulf of Maine. U.S. Fish Wildl. Serv., Fish. Bull. 53, 577 p.
- BOWMAN, A.  
1920. The eggs and larvae of the angler (*Lophius piscatorius*) in Scottish waters. A review of our present knowledge of the life history of the angler. Sci. Invest. Fish. Board Scotl. 1919, No. 1, p. 1-42.
- CARUSO, J. H.  
1981. The systematics and distribution of the lophiid anglerfishes: I. A revision of the genus *Lophiodes* with the description of two new species. Copeia 1981:522-549.
1983. The systematics and distribution of the lophiid anglerfishes: II. Revisions of the Genera *Lophiomus* and *Lophius*. Copeia 1983:11-30.
- CONNOLLY, C. J.  
1920. Histories of new food fishes. III. The angler. Bull. Biol. Board Can., Ottawa, No. 3, 17 p.
1922. On the development of the angler (*Lophius piscatorius* L.). Contrib. Can. Biol. 1921(7):113-124.
- DAHLGREN, U.  
1928. The habits and life history of *Lophius*, the angler fish. Nat. Hist. 28:18-32.
- FAHAY, M. P.  
1983. Guide to the early stages of marine fishes occurring in the western North Atlantic Ocean, Cape Hatteras to the southern Scotian shelf. J. Northwest Atl. Fish. Sci. 4:1-423.
- LEBOUR, M. V.  
1919. Feeding habits of some young fish. J. Mar. Biol. Assoc., U.K. 12:9-21.
1925. Young anglers in captivity and some of their enemies. A study in a plunger jar. J. Mar. Biol. Assoc., U.K. 13: 721-734.
- MARTIN, F. D., AND G. E. DREWRY.  
1978. Development of fishes of the Mid-Atlantic Bight: an atlas of eggs, larval and juvenile stages. Vol VI, Stromateidae through Ogocephalidae. U.S. Fish Wildl. Serv. Off. Biol. Serv., 78/12, 416 p.
- MATSUURA, Y.  
1979. Distribution and abundance of eggs and larvae of the Brazilian sardine, *Sardinella brasiliensis*, during 1974-75 and 1975-76 seasons. Bull. Jpn. Soc. Fish. Oceanogr. 34: 1-12.
- MITO, S.  
1966. Fish eggs and larvae. [In Jpn.] In S. Motoda (editor), Illustrations of the marine plankton of Japan, Vol. 7, 74 p. Soyo-Sha, Tokyo.

- PADOA, E.  
 1956. Triglidae, Peristediidae, Dactylopteridae, Gobiidae, Echnidae, Jugulares, Gobiesocidae, Heterosomata, Pediculi. [In Ital.] *In* Uova, larve, e studi giovanili di Teleostei, p. 627-880. Fauna Flora Golfo Napoli 38.
- PIETSCH, T. W.  
 1984. Lophiiformes: development and relationships. *In* H. G. Moser et al. (editors), *Ontogeny and systematics of fishes*, p. 320-322. Am. Soc. Ichthyol. Herpetol., Spec. Publ. No. 1.
- PRINCE, E. E.  
 1891. Notes on the development of the angler-fish (*Lophius piscatorius*). 9th Ann. Rep. Fish. Board Scotl., (1890), p. 343-348.
- PROCTER, W., H. C. TRACY, E. HELWIG, C. H. BLAKE, J. E. MORRISON, AND S. COHEN.  
 1928. Fishes—a contribution to the life history of the angler (*Lophius piscatorius*). *In* Biological survey of the Mount Desert region, Part 2, p. 1-29. Philadelphia.
- RUSSEL, F. S.  
 1976. The eggs and planktonic stages of British marine fishes. Acad. Press, Lond., 524 p.
- STIASNY, G.  
 1911. Über einige postlarvale Entwicklungsstadien von *Lophius piscatorius* L. Arb. Zool. Inst. Univ. Wien 19:57-74.
- TANAKA, S.  
 1915-1919. Figures and descriptions of the fishes of Japan. J. Coll. Sci., Imp. Univ. Tokyo 24:419-440.
- TANING, A. V.  
 1923. *Lophius*. Rep. Dan. Oceanogr. Exped. 1908-1910 Mediterr. Adjacent Seas 2, Biol. A. 10, 30 p.
- WILLIAMSON, H. C.  
 1911. Notes on the eggs of the angler (*Lophius piscatorius*), halibut (*Hippoglossus vulgaris*), *Conger vulgaris* and tusk (*Brosmius brosme*), a young *Arnoglossus* sp.; abnormalities in *Lophius*, *Gadus*, Raia; diseases in *Gadus*, *Pleuronectes*, *Onos*, *Zoarces*; occurrence of *Himantolophus rheinhardi*, and *Clupea pilchardus*; the effectiveness of a seine-trawl in a small pond. 28th Ann. Rep. Fish. Board Scotl., (1909), Part III, p. 46-66.

# EX-VESSEL PRICE LINKAGES IN THE NEW ENGLAND FISHING INDUSTRY

DALE SQUIRES<sup>1</sup>

## ABSTRACT

This study examines the direction of ex-vessel price linkages between the three New England ports of Boston, New Bedford, and Gloucester. Within-sample, bivariate tests of Granger causality are applied for monthly data from 1965 through 1981. It is found that cod and haddock prices are formed in New Bedford, that pollock prices are simultaneously formed between Boston and Gloucester, and that a spurious relationship exists for flounder prices between the three ports. The hypothesis is advanced that this spurious relationship may be due to flounder price leadership from outside the region, most probably the New York Fulton Fish Market.

The direction of price linkages between various market and production centers in an industry is important to studies of marketing and prices. Although these spatial and hierarchical relationships are generally well understood in domestic agriculture, they have received little or no attention in natural resource utilization and in the domestic commercial fishing industry in particular. This study therefore examines the spatial characteristics of round ex-vessel price linkages of the most important species in the New England fishing industry from 1965 through 1981.

Three ports—New Bedford, Boston, and Gloucester—dominate the New England fishing industry, as both home ports or production centers and as marketing centers. By both volume and value of landings, New Bedford is the most important port, followed by Gloucester and then Boston. The most important species of groundfish in New England are cod; haddock; yellowtail, winter, and other flounders; ocean perch or red fish; and pollock. Sea scallops and lobsters also provide a significant contribution to the industry in both value and volume of landings. This study accordingly focuses upon the ports of Boston, New Bedford, and Gloucester, and the species of cod, haddock, yellowtail and winter flounders, and pollock. Additional attention is given to ocean perch and sea scallops, though rigorous conclusions are not possible.

In New Bedford and Boston, fishermen sell their catches to the highest bidder in an open auction. The New Bedford auction begins at 8:00 a.m. and ends at 8:22 a.m. The Boston market begins at 7:00 a.m.,

and invariably overlaps with the New Bedford market. There is significant communication between the two markets during the auctions. The volume and total value of fish harvested is substantially greater in New Bedford than in Boston. Bidders purchase an entire vessel's landings in New Bedford, while in contrast, purchasers offer individual bids for each species in Boston. In most of the ports other than Point Judith in Rhode Island (where an important fishermen's cooperative exists), the catch is sold directly to fish processors or by prior arrangements between individual vessels and purchasers. Further, it is generally believed that Gloucester prices for most fresh groundfish species are set in Boston, and differ only by a transportation cost.

Fishermen of all ports are free to land their harvests at any port offering the highest prices, which, however, must be balanced against steaming time. Few vessels land exclusively at a single port, since the distances between the three are not great. A definite limit exists to port switching due to the prevalence of market transactions costs. Wilson (1980) indicated that personal and financial relationships tend to bind particular fishermen and fish buyers. In contrast to many other natural resource and primary production industries, a futures market does not exist for fresh fish.<sup>2</sup>

Different ports and markets have developed singular reputations. These specializations are based in large part upon proximity to resource stocks. New Bedford has developed a reputation as a flounder and sea scallop port, while Boston has become known as a cod, haddock, and, to a lesser extent,

<sup>1</sup>Southwest Fisheries Center La Jolla Laboratory, National Marine Fisheries Service, NOAA, P.O. Box 271, La Jolla, CA 92038.

<sup>2</sup>Trading on futures markets involves buying and selling standardized contracts for the future delivery of a specific grade of a commodity at a specific location(s).

pollock port. Although Gloucester fishermen direct much of their effort towards cod, haddock, and flounders (generally joint products), Gloucester has developed a reputation as a port for both pollock and ocean perch.

Conventional wisdom in the New England ground-fishery market holds that New England round (fish as harvested) ex-vessel prices of fresh flounders are formed in the New Bedford auction market, while fresh cod, haddock, and pollock round ex-vessel prices are set in the Boston auction. These widely held beliefs serve as the null hypotheses to be tested in this study of the ex-vessel groundfish price linkages in New Bedford, Gloucester, and Boston.

Knowledge of ex-vessel price linkages has a number of applications. Efforts at improving market efficiency would find this information useful. The broadcasting of daily ex-vessel fish prices by the National Marine Fisheries Service can properly focus upon the most crucial markets. Infrastructural or institutional improvements can be more judiciously targeted, an important consideration in a time of tight public and private budgets. Price forecasts to improve industry functioning can concentrate upon those prices formed in markets which demonstrate price leadership. Fishermen may want to land their harvests in the market in which ex-vessel prices are first formed, should fishermen want to affect the pricing process, be less dependent upon the landings of others, or capture advantageous prices. Similar considerations apply to buyers. Knowledge of the price formation process allows government price policies to target the appropriate markets. Finally, price linkage information is crucial to studies of marketing margins, length of price transmission, and asymmetric pricing.

## THE DATA

The data are taken from the vessel weighout files of the National Marine Fisheries Service. After every trip of a commercial fishing vessel of any gear type, port agents in each port obtain the value and volume of landings for each species harvested. The entire collection of this information constitutes the weighout file. The output vector from the weighout file is then linearly aggregated over vessels and trips to form monthly round ex-vessel prices for each port. The resulting nominal prices are subsequently deflated by the consumer price index for food. As Sims (1974) and Feige and Pierce (1980) noted, the use of seasonally adjusted data may confound lag distributions and causality relationships. Consequently, the data are left in their unseasonalized

state. However, to account for seasonal differences, quarterly dummy variables are employed. The time domain of the data set extends from 1965 through 1981.

## METHOD OF ANALYSIS

Granger (1977) provided a definition of causality among a set of variables that is based upon predictability as well as the fact that the effect of a change in an exogenous variable upon an endogenous variable requires time. A variable  $X$  causes another variable  $Y$ , with respect to a given universe or information set that includes  $X$  and  $Y$ , if present  $Y$  can be better predicted by using past values of  $X$  than not doing so, all other information in the past of the universe being used in either case. Causality from  $Y$  and  $X$  is defined in the same manner. Feedback occurs if  $X$  causes  $Y$  and  $Y$  causes  $X$ . A causal relationship between  $X$  and  $Y$  does not exist if causality does not run from  $X$  to  $Y$  or from  $Y$  to  $X$ , and feedback does not occur.

Causality tests may be classified into two fundamental types at their most basic level, within-sample and out-of-sample tests. The within-sample test is widely applied and is the first one developed. This test is developed over the full-time domain of the data set, and essentially relies upon a measure of fit. The definition of causality in the out-of-sample test requires evidence of improved forecasts. This approach is implemented by identifying and estimating different models using the first part of the sample and then comparing their respective forecasting abilities on the latter part of the sample. This study utilizes the within-sample test, the one most commonly applied, since the properties of the out-of-sample test have yet to be systematically examined.

Two basic approaches have been advanced by which to apply empirically the within-sample bivariate Granger criterion to time series. The first approach is represented by the test proposed by Pierce (1977) based upon Haugh (1976). The procedure first estimates whitening filters for each time series, then subsequently estimates the cross-correlation function for the first step's residuals.<sup>3</sup> However, Sims (1977) and Geweke (1981) indicated that this approach may be limited.<sup>4</sup> A second basic

<sup>3</sup>Whitening filters remove serial correlation from a time series. Each time series used in a test of causality will be a white noise process, and any relationships will be based on actual, systematic relationships between the two time series, instead of a spurious relationship caused by the common serial correlation.

<sup>4</sup>Prefiltering each time series with separate autoregressive integrated moving average (ARIMA) filters biases the test toward

approach relying directly upon distributed lag relationships between dependent and independent variables has led to three widely used tests: those suggested by Sims (1977), the direct Granger test forwarded by Sargent (1976), and the Modified Sims test advanced by Geweke et al. (1983).

The small-sample properties of the Sims (1972), direct Granger, and Modified Sims tests have recently been examined within Monte-Carlo frameworks by Guilkey and Salemi (1982) and Geweke et al. (1983). Although the two studies differ somewhat in their specifications, both found that the Sims test was outperformed by the other two. Since the Sims test is more time-consuming and expensive to employ and requires more decisions about parameterizations, both studies unequivocally recommend against its use.

The two studies reach slightly different conclusions on the efficacy of the direct Granger and Modified Sims test. These contradictory results can be attributed to differences in research design. Geweke et al. (1983) concluded that the two tests essentially perform equally well. In contrast, Guilkey and Salemi (1982) determined that the direct Granger test consistently outperforms the Modified Sims procedures by small amounts. Since the direct Granger test is computationally the least expensive of the three and results in the fewest degrees of freedom lost from formation of leads and lags, Guilkey and Salemi recommend its use over the Modified Sims and Sims procedures. Nonetheless, they do note that the Granger procedure's advantage over the other two diminishes with increases in sample size.

Several additional findings of Guilkey and Salemi (1982) are also worth reporting. They observed that for sample size <200, the shorter versions of all three tests are superior to the longer versions.<sup>5</sup> They further noted that in their Monte-Carlo study the direct Granger and Modified Sims procedures accurately recover the coefficients of the relevant population projections of the statistical model used to generate experimental time series in small samples. Consequently, it may be unlikely to observe "large" coefficient estimates arising spuriously. Finally, test performance is extremely sensitive to sample size, strength of causation, and length of test parameterization employed.

The direct Granger test as applied in this study

failing to reject the null hypothesis of independence of the two series more often than the specified level of significance suggests. Because of this limitation, the second basic approach is applied.

<sup>5</sup>Longer versions of these tests include additional lead and lag variables.

is based upon ordinary least squares regression of the current observation of the time series of round ex-vessel prices from one port upon its own past observations and the past observations of the other port's round ex-vessel prices for species  $k$ :

$$P2_k(t) = a_k + \sum_{i=2}^4 b_{ki} D_i + cLT + \sum_{j=1}^J d_{kj} P2_k \times (t - j) + \sum_{j=1}^J f_{kj} P1_k(t - j) + e_{kt}. \quad (1)$$

Here,  $LT$  refers to a linear time trend,  $D_i$  is the zero-one variable for quarter  $i$ ,  $P1_k(t)$  is the round ex-vessel price of species  $k$  in month  $t$  in port 1,  $J$  is the number of periods lagged, and  $e_{kt}$  is a vector of stochastic, white noise residuals. The presence of lagged dependent variables in Equation (1) is counted on to remove serial correlation from the estimated residuals.<sup>6</sup>

The test of the null hypothesis that  $P1_k$  does not cause  $P2_k$  is a test that  $f_{kj} = 0$ ,  $j = 1, 2, \dots, J$ . Guilkey and Salemi (1982) indicated that the  $F$ -test statistic is calculated by estimating Equation (1) in both constrained ( $f_{kj} = 0$ ,  $j = 1, 2, \dots, J$ ) and unconstrained forms, and may be written as<sup>7</sup>

$$F = \frac{(SSE_c - SSE_u)/J}{SSE_u/(T - (2J + 2))}, \quad (2)$$

where  $SSE_u$  and  $SSE_c$  are the residual sum of squares from the unconstrained and constrained regressions, respectively, and  $T$  represents the number of monthly observations on round ex-vessel prices. Under the null hypothesis,  $F$  is an  $F$ -test statistic with  $J$  and  $T - (2J + 2)$  degrees of freedom. This procedure is then repeated reversing the roles of  $P1_k$  and  $P2_k$  to test the null hypothesis that  $P1_k$  does not cause  $P2_k$ .

The direct Granger test requires selection of a lag length,  $J$ , large enough to purge serial correlation from estimated residuals. Several factors require consideration before specifying the lag length. Chilled fresh fish is a commodity that rapidly deteriorates in quality. Consequently, definite limits exist to the length of time which inventories of

<sup>6</sup>Serial correlation exists when the error terms from different observations in a time series are correlated. Serial correlation tends to give unbiased but inefficient estimators, and a biased sampling variance, which then affects the results from significant tests such as the  $F$ - or  $t$ -tests.

<sup>7</sup>A constrained  $F$ -test includes one or more restrictions, such as one or more coefficients constrained to zero. An unconstrained  $F$ -test does not include these restrictions.

chilled fresh fish can be held. Since most groundfish harvested in New England waters are not processed into frozen fish products, long-term storage of New England groundfish is unlikely, and fresh fish prices are likely to adjust more quickly than those of most other food commodities. In addition, previous exploratory analysis with adaptive filtering methods on the weighout file suggests that two sets of round ex-vessel prices for any species  $k$  are particularly important, the previous month's price and the price within one month on either side of the previous year. In order to account for these characteristics and to provide both short and long versions of the test, lags of 8 and 14 mo were specified. These lag lengths are sufficiently long to encompass price lags with monthly data. The diagnostic  $Q$  test of Box and Pierce (1970) is used to detect serious serial correlation.

## EMPIRICAL RESULTS

The empirical results from the direct Granger causality tests lead to somewhat unexpected conclusions for most species. The null hypothesis that monthly round ex-vessel prices of cod and haddock in all three ports are first formed in the Boston auction market is rejected in almost all instances. The findings in Table 1 instead suggest that the cod and haddock prices established in the New Bedford auction lead the prices formed in the Boston market. Several factors may account for this. The New Bedford auction's volume of landings is substantially higher than that of Boston. In addition, the two market times ordinarily overlap, and frequent com-

munication occurs between economic agents during the auctions. Further, the proximity of New Bedford to Boston allows fresh fish to be easily trucked to Boston from New Bedford. The markets are thus physically linked, before the auctions by fishermen and after the auctions by fish buyers. One element of conventional wisdom may perhaps be substantiated, however. Although the  $Q$ -test statistic indicates severe serial correlation (and thereby possibly refuting the  $F$ -test statistic), the empirical results indicate that Boston cod prices do lead Gloucester cod prices at the ex-vessel level for the shorter lag length parameterization.

Rejection of the null hypothesis that Boston prices lead New Bedford and probably Gloucester cod and haddock round ex-vessel prices and the finding that New Bedford prices lead Boston prices suggest a second null hypothesis for consideration. This second hypothesis states that Gloucester cod and haddock prices are directly led by New Bedford prices. In addition, the possibilities that Boston prices lead Gloucester prices and that New Bedford prices lead Boston prices suggest an additional, indirect price linkage between Gloucester and New Bedford via Boston.

The results for this second null hypothesis are also given in Table 1. Since this is an unplanned comparison, a Scheffe interval is used.<sup>8</sup> Strictly followed,

<sup>8</sup>An unplanned comparison occurs when in the course of examining results a hypothesis is tested which was not specified prior to the experiment. The initial region is altered by the additional information, so that the level of significance has changed. A Scheffe interval allows for a more cautious test by providing a larger critical value than that given by a  $t$  or  $F$  table. This pre-test bias is accounted for by a conservative test. The  $F$ -test statistic now

TABLE 1.—Direct Granger causality tests for monthly fresh round ex-vessel cod and haddock prices.

Cod				Haddock			
Direction <sup>1</sup>	Lags <sup>2</sup>	$F$ -test <sup>3</sup>	$Q$ -test <sup>4</sup>	Direction <sup>1</sup>	Lags <sup>2</sup>	$F$ -test <sup>3</sup>	$Q$ -test <sup>4</sup>
B ----->G	8	2.37*	35.67*	B ----->G	8	1.69	9.60
B ----->G	14	1.17	2.61	B ----->G	14	1.09	4.49
G ----->B	8	1.59	10.98	G ----->B	8	1.07	10.98
G ----->B	14	1.02	12.35	G ----->B	14	1.29	15.07
B ----->NB	8	1.67	13.52	B ----->NB	8	0.08	12.54
B ----->NB	14	0.74	21.85*	B ----->NB	14	0.09	7.06
NB ----->B	8	2.52*	8.82	NB ----->B	8	3.15*	8.62
NB ----->B	14	1.89*	16.27	NB ----->B	14	1.76*	8.74
G ----->NB	8	1.78	16.46	G ----->NB	8	0.56	11.71
G ----->NB	14	0.91	28.42	G ----->NB	14	1.36	15.09
NB ----->G	8	52.96	7.84	NB ----->G	8	52.90	11.76
NB ----->G	14	1.40	6.86	NB ----->G	14	1.65	8.37

<sup>1</sup>Variable abbreviations are B (Boston), G (Gloucester), NB (New Bedford).

<sup>2</sup> $J$  indicates  $J$  months lagged.

<sup>3</sup>Null hypothesis that past values of the causal variable do not significantly affect current values of the dependent variable. An asterisk indicates rejection of the null hypothesis at the 5% level.

<sup>4</sup>Null hypothesis that regression residuals are white noise. An asterisk indicates rejection of the null hypothesis at the 5% level.

<sup>5</sup> $F$ -test statistic is significant at the 5% level, but not significant at the 5% level when a Scheffe interval is used.



the results indicate that the cod and haddock price linkage does not run from New Bedford to Gloucester. If a Scheffe interval is not used, then the New Bedford cod and haddock prices do lead those of Gloucester. Therefore, with this caveat, New Bedford auction market monthly round ex-vessel cod and haddock prices lead the prices of Gloucester and Boston, and Boston prices may lead those of Gloucester. In any case, it appears that the New Bedford auction market dominates the formation of round ex-vessel prices for cod and haddock.

The empirical results for yellowtail and winter flounder of Table 2 also contradict the null hypothesis that monthly fresh round ex-vessel prices for both species are formed first in New Bedford. Instead, the findings indicate that pricing feedback exists between both New Bedford and Gloucester and between New Bedford and Boston. These conclusions must be tempered by the significant *Q*-test statistics for several relationships.

These conclusions lead to a second null hypothesis

between the prices of New Bedford and Gloucester, New Bedford and Boston, and possibly between Gloucester and Boston rests with a spurious relationship. Although New Bedford is the most important flounder port by landings in New England, New York City is even more important on the eastern seaboard by volume of consumption. New York City's Fulton Fish Market is primarily a wholesale market without substantial landings. Much of the New England flounder harvested is sent to Fulton on consignment without an ex-vessel price being established in New England. The Fulton Fish Market also begins much earlier in the morning than New Bedford's auction market. Thus the apparent feedback among the ex-vessel yellowtail and winter flounder prices in the New England ports is probably due to their following of the wholesale prices set in the Fulton Fish Market.

Table 3 presents the results for pollock. As with the other species, consistent results are obtained for different lag lengths. Again, the null hypothesis dic-

TABLE 2.—Direct Granger causality tests for monthly fresh round ex-vessel yellowtail and winter flounder prices.

Yellowtail flounder				Winter flounder			
Direction <sup>1</sup>	Lags <sup>2</sup>	<i>F</i> -test <sup>3</sup>	<i>Q</i> -test <sup>4</sup>	Direction <sup>1</sup>	Lags <sup>2</sup>	<i>F</i> -test <sup>3</sup>	<i>Q</i> -test <sup>4</sup>
NB ----->G	8	2.05*	20.19	NB ----->G	8	7.52*	5.68
NB ----->G	14	2.27*	19.42	NB ----->G	14	8.71*	1.78
G ----->NB	8	1.96*	23.56*	G ----->NB	8	2.88*	16.98
G ----->NB	14	2.48*	26.78*	G ----->NB	14	2.97*	22.19*
NB ----->B	8	2.02*	10.56	NB ----->B	8	11.87*	18.45
NB ----->B	14	1.76*	9.89	NB ----->B	14	7.66*	7.92
B ----->NB	8	0.75	17.63	B ----->NB	8	23.57*	9.94
B ----->NB	14	2.83	21.83*	B ----->NB	14	5.25*	3.99
G ----->B	8	2.27 <sup>5</sup>	9.41	G ----->B	8	3.87 <sup>5</sup>	12.43
G ----->B	14	2.50 <sup>5</sup>	12.74	G ----->B	14	4.37 <sup>5</sup>	4.70
B ----->G	8	1.48	16.86	B ----->G	8	4.15 <sup>5</sup>	18.16
B ----->G	14	1.27	18.82	B ----->G	14	3.56 <sup>5</sup>	17.34

<sup>1</sup>Variable abbreviations are B (Boston), G (Gloucester), NB (New Bedford).

<sup>2</sup>*J* indicates *J* months lagged.

<sup>3</sup>Null hypothesis that past values of the causal variable do not significantly affect current values of the dependent variable. An asterisk indicates rejection of the null hypothesis at the 5% level.

<sup>4</sup>Null hypothesis that regression residuals are white noise. An asterisk indicates rejection of the null hypothesis at the 5% level.

<sup>5</sup>*F*-test statistic is significant at the 5% level, but not significant at the 5% level when a Scheffe interval is used.

to be tested on the yellowtail and winter flounder price linkages between Gloucester and Boston. Since this test is also an unplanned comparison, a Scheffe interval is required. Again, the strict test results indicate that neither port's prices lead the other, nor that feedback exists.

The most probable explanation for the feedback

becomes significant only if it exceeds in magnitude  $((a-1)F_b)^{1/2}$ , where *F* is the *b*·100% critical value for *F* (*a*-1, *N*-*a*) and *N* is the number of observations. See Snedecor and Cochran (1976, p. 271) for more details.

TABLE 3.—Direct Granger causality tests for monthly fresh round ex-vessel pollock prices.

Direction <sup>1</sup>	Lags <sup>2</sup>	<i>F</i> -test <sup>3</sup>	<i>Q</i> -test <sup>4</sup>
B ----->G	8	4.34*	12.54
B ----->G	14	4.99*	10.15
G ----->B	8	5.28*	18.27
G ----->B	14	4.77*	22.96*

<sup>1</sup>Variable abbreviations are B (Boston), G (Gloucester), NB (New Bedford).

<sup>2</sup>*J* indicates *J* months lagged.

<sup>3</sup>Null hypothesis is that past values of the causal variable do not significantly affect current values of the dependent variable. An asterisk indicates rejection of the null hypothesis at the 5% level.

<sup>4</sup>Null hypothesis that regression residuals are white noise. An asterisk indicates rejection of the null hypothesis at the 5% level.

tated by widely held industrial perceptions is rejected. The results indicate that feedback exists between the monthly fresh round ex-vessel prices of pollock in both Gloucester and Boston. Both ports dominate pollock landings and are close to one another.

A complete time series of prices for sea scallops exists only for New Bedford. Since New Bedford greatly dominates this fishery by both volume and value of landings, it may be safely concluded that monthly round ex-vessel sea scallop prices are formed in New Bedford. Finally, Gloucester is the only one of these ports to possess a complete time series of prices and landings of ocean perch or red fish. Since Gloucester dominates this fishery, monthly fresh round ex-vessel ocean perch prices appear to be formed in this port, at least among these three.

### CONCLUDING COMMENTS

The within-sample bivariate direct Granger causality tests of monthly round ex-vessel price linkages for the three most important New England ports (Boston, New Bedford, and Gloucester) and the most important groundfish species lead to unexpected results. Conventional wisdom considers the round ex-vessel cod and haddock prices formed in the Boston auction market to lead the comparable prices of the other New England ports. However, the empirical results indicate that New Bedford's prices lead those of the other ports, although in certain cases Boston's cod prices may lead those of Gloucester as well.

The common industry perception also holds that the yellowtail and winter flounder round ex-vessel prices are first formed in New Bedford and lead those of Boston and Gloucester. Instead, the empirical findings suggest that feedback and simultaneous price formation occur among all three ports for both species. Since flounder landings in Boston and Gloucester are negligible in comparison to those of New Bedford, a spurious relationship due to the leading wholesale prices formed in the even earlier and more flounder-important Fulton Fish Market of New York City is suggested. Feedback is likely for fresh round pollock ex-vessel price formation in Boston and Gloucester. Finally, it is suggested that the New Bedford auction market dominates fresh ex-vessel sea scallop price formation and that Gloucester dominates among these three ports for ocean perch. New Bedford thus generally dominates ex-vessel price formation among the major New

England ports for the most important species harvested.

### ACKNOWLEDGMENTS

Helpful comments from David Bessler, Joseph Mueller, Robert Reidman, Patricia Kurkul, and Daniel Huppert and an anonymous reviewer are gratefully acknowledged.

### LITERATURE CITED

- BOX, G. E. P., AND D. PIERCE.  
1970. Distribution of residual autocorrelations in autoregressive-integrated moving average time series models. *J. Am. Stat. Assoc.* 65:1509-1526.
- FEIGE, E. L., AND D. K. PEARCE.  
1980. The casual causal relationship between money and income: some caveats for time series analysis. SSRI Pap. No. 7809, 39 p. Social Syst. Res. Inst., Univ. Wisconsin, Madison.
- GEWEKE, J.  
1981. The approximate slopes of econometric tests. *Econometrica* 49:1427-1442.
- GEWEKE, J., R. MEESE, AND W. DENT.  
1983. Comparing alternative tests of causality in temporal systems: analytic results and experimental evidence. *J. Econ.* 21:161-194.
- GRANGER, C. W. J.  
1977. Investigating causal relations by econometric models and cross-spectral methods. *Econometrica* 37:424-438.
- GUILKEY, D. K., AND M. K. SALEMI.  
1982. Small sample properties of three tests for granger-causal ordering in a bivariate stochastic system. *Rev. Econ. Stat.* 64:668-680.
- HAUGH, L. D.  
1976. Checking the independence of two covariance-stationary time series: a univariate cross correlation approach. *J. Am. Stat. Assoc.* 71:378-385.
- PIERCE, D. A.  
1977. Relationships - and the lack of thereof - between economic time series, with special reference to money and interest rates. *J. Am. Stat. Assoc.* 72:11-21.
- SARGENT, R. J.  
1976. A classical macroeconomic model for the United States. *J. Polit. Econ.* 84:207-238.
- SIMS, C.  
1972. Money, income, and causality. *Am. Econ. Rev.* 62: 540-552.  
1974. Distribution lags. In M. D. Intriligator and D. A. Kendrick (editors), *Frontiers of quantitative economics, Vol. II*, p. 289-336. Amsterdam: North-Holland Publ. Co.  
1977. Comment to Pierce. *J. Am. Stat. Soc.* 72:23-24.
- SNEDECOR, G., AND W. COCHRAN.  
1976. *Statistical methods*. 6th ed. State Univ. Press, Ames, 593 p.
- WILSON, J. A.  
1980. Adaption to uncertainty in small numbers exchange: the New England fresh fish market. *Bell J. Econ.* 11, p. 491-504.

# COMMUNITY STUDIES IN SEAGRASS MEADOWS: A COMPARISON OF TWO METHODS FOR SAMPLING MACROINVERTEBRATES AND FISHES<sup>1</sup>

KENNETH M. LEBER<sup>2</sup> AND HOLLY S. GREENING<sup>3</sup>

## ABSTRACT

The effectiveness of using an otter trawl for estimating macrofaunal species ranks and abundances in seagrass meadows is unknown. In this study, we compare the catch effectiveness of the commonly used 5 m otter trawl with that of a 0.9 m wide epibenthic crab scrape for fishes, decapod crustaceans, molluscs, and echinoderms, using data from both day and night collections from a northeast Gulf of Mexico seagrass meadow. The crab scrape collected significantly more individuals and species of all taxa except (water-column) fishes. Clear discrepancies existed between trawl and scrape estimates of species ranks and relative abundances, with trawl collections estimating a higher degree of dominance within groups of shrimps and demersal fishes, and lower dominance among crabs. Whereas the crab scrape was clearly superior to the trawl for sampling macroinvertebrates and demersal fishes, the trawl was the better device for collecting water-column fishes. Explanations for observed differences in the sampling effectiveness of these gears are discussed. Sampling was considerably more productive at night than during the day. The combined approach of day-night sampling with both a crab scrape (for demersal fishes and epibenthic invertebrates) and an otter trawl (for water-column fishes) is recommended for community-wide studies in seagrass meadows.

Hypotheses concerning ecological community dynamics should be based upon accurate descriptions of the habitats and species involved. It is thus essential that collection methods maximize sampling efficiency in "community" (sensu Pielou 1977) studies. Because estimates of species composition, relative abundances, and biomass in aquatic environments may vary with different sampling devices (eg., Lewis and Stoner 1981; Stoner et al. 1983), knowledge of sample gear effectiveness allows a more rigorous approach to sampling design and interpretation of results from studies of aquatic communities.

Seagrass community studies often employ a small, semiballoon otter trawl (try net) for sampling fishes and epibenthic invertebrates (Kikuchi 1966; Livingston 1975, 1976, 1982; Heck 1976, 1977, 1979; Hooks et al. 1976; Heck and Wetstone 1977; Weinstein and Heck 1979; Heck and Orth 1980; Orth and Heck 1980; Ryan 1981; Dugan and Livingston 1982; Dugan 1983). Although a small otter trawl may be one of the most effective samplers for estimating relative abundances of juvenile and small pelagic

fishes in shallow nonvegetated waters (Kjelson and Johnson 1978; Orth and Heck 1980), there are few published accounts of its effectiveness in sampling benthic fishes or epibenthic invertebrates in vegetated habitats. Greening and Livingston (1982) noted that a Chesapeake Bay crab scrape appeared to collect more invertebrate species per sample effort in vegetated habitats than did an otter trawl. Miller et al. (1980) found a crab scrape to be more effective than either an otter trawl or a push net for collecting juvenile blue crabs, *Callinectes sapidus*, in the Chesapeake Bay area. Blue crab fishermen routinely use crab scrapes, rather than trawls, in grassbeds in Chesapeake Bay (Warner 1976).

In this study, the catch effectiveness of a 5 m otter trawl is compared with that of a 0.9 m epibenthic scrape in the shallow grassbeds of Apalachee Bay, FL. Species richness and abundance are examined within four taxonomic groups (decapod crustaceans, molluscs, echinoderms, and fishes). Because many grassbed organisms are more susceptible at night to certain sampling methods (Ryan 1981; Greening and Livingston 1982), both day and night samples are considered.

## METHODS

Day and night samples were taken in about 1.7 m of water from seagrass beds in Apalachee Bay, FL.

<sup>1</sup>Contribution No. 439 of the Harbor Branch Foundation, Ft. Pierce, FL 33450.

<sup>2</sup>Department of Biological Science, Florida State University, Tallahassee, FL 32306; present address: The Oceanic Institute, Makapuu Point, Waimanalo, HI 96795.

<sup>3</sup>Department of Biological Science, Florida State University, Tallahassee, FL 32306; present address: Martin Marietta Environmental Systems, 9200 Rumsey Road, Columbia, MD 21045.

The sample site was located 5 km southwest of the Econfina River mouth (permanent station E-12 (Livingston 1975)). This site is characterized by relatively uniform, dense stands of the seagrasses, *Thalassia testudinum* and *Syringodium filiforme*, with seasonal occurrence of red drift algae (mean annual macrophyte biomass = 320 g dry wt/m<sup>2</sup>; see Zimmerman and Livingston 1979 for a description of macrophytes). Station E-12 was polyhaline, with salinities during collections ranging from 22 to 30 ppt ( $\bar{x}$  = 27.0 ppt). Water temperatures ranged from 12.0° to 31.0°C ( $\bar{x}$  = 19.9°). Depth varied from 1.6 to 2.1 m. Physical characteristics are summarized in Table 1.

TABLE 1.—Physical characteristics of the sampling station for collection dates, Apalachee Bay, FL.

	Temp. (°C)	Salinity (ppt)	Depth (m)
Jan. 1979			
Day	12	31	2.0
Night	10	30	1.8
Apr. 1979			
Day	22	23	2.1
Night	21	22	1.6
July 1979			
Day	31	25	1.7
Night	30	25	2.1
Oct. 1979			
Day	17	30	2.1
Night	16	30	1.7

A 90 cm wide commercial Chesapeake Bay crab scrape (Miller et al. 1980) was fished with the cod end of a 5 m otter trawl (6 mm mesh liner). The crab scrape was towed at about 1.4 knots for 1 min (after Greening and Livingston 1982; Leber 1983), yielding a standardized tow of 42 m (mean of 10 preliminary measured 1-min tows). A 42 m weighted line was then used to standardize scrape tows during collections. A 5 m otter trawl (19 mm mesh wings, 6 mm mesh liner in the cod end) was towed at the same speed for 2 min (as in Livingston 1975, 1982; Hooks et al. 1976; Heck 1977, 1979; Orth and Heck 1980; Stoner 1980; Stoner and Livingston 1980; Dugan and Livingston 1982; Dugan 1983), covering an average measured distance of 84 m. Under tow, the trawl mouth tickler chain fished a 2.1 m wide path over the substratum (Leber, pers. obs.). Hence, each individual trawl tow fished over 4.6 times the substratum surface area sampled by each tow of the crab scrape (176 m<sup>2</sup> vs. 38 m<sup>2</sup>). Because the scrape collected larger amounts of dead vegetation, it was logistically difficult to sample as much surface area with it as was sampled by the trawl.

Collections were made quarterly (January, April, July, and October). On each sampling date eight scrape and four trawl tows were taken (in the sequence two trawls, eight scrapes, two trawls) during the day, and again beginning 1 h after dark. Greening and Livingston (1982) determined that eight 1-min scrapes were sufficient for sampling >95% of the species of macroinvertebrates at our sample site in Apalachee Bay. Because each scrape was towed for only half the 2-min towing time used for each trawl (scrape tows lasting longer than 1 min often resulted in clogging the net with red drift algae), only four trawls were taken during each sampling period. Thus, the combined length of the eight scrape tows (8 × 42 m = 336 m) matched that of the four trawl tows. All samples were collected from a 0.25 km<sup>2</sup> area immediately south of the station marker. Replicate tows were taken along transects spaced at least 30 m apart to prevent overlapping samples.

Organisms were preserved in 10% Formalin<sup>4</sup> (buffered with seawater) in the field, then identified, counted, and measured in the laboratory. A two-way, Model II, factorial ANOVA design for unequal but proportional cell sizes (Sokal and Rohlf 1969) was used to compare mean numbers of species and individuals of each taxon group in scrape vs. trawl (Factor 1) and day vs. night (Factor 2) samples. Log<sub>10</sub> transformations were used where *F*-max tests indicated heterogeneity of variance. Rather than extrapolating our data to numbers per unit area, we compared the collections made with these two gears using absolute numbers per tow in our calculations (which are biased in favor of the trawl by a factor of 4.6). We used these absolute abundances because 1) we wanted a strongly conservative test of our premise that the scrape is the more effective of these two sample gears in vegetated aquatic habitats, and 2) we believe that extrapolations of semiquantitative data to abundances per unit area yield highly unrealistic results, which may be misinterpreted by readers as accurate densities (cf. Howard 1984, who determined that a towed beam trawl was only 4.7% efficient in estimating densities of shrimp in an Australian seagrass meadow).

## RESULTS

### Factor 1: Trawl vs. Scrape

Although the surface area sampled by the otter

<sup>4</sup>Reference to trade names does not imply endorsement by the National Marine Fisheries Service, NOAA.

trawl during each tow exceeded that sampled with the crab scrape by a factor of 4.6, mean numbers of individuals collected in scrape samples were significantly greater than those in trawl samples in 44% of the 16 scrape-trawl comparisons (Table 2). The trawl was a significantly more effective collecting device for number of individuals of fishes (Table 2; April, July, and October fishes), but interaction terms were significant for April and October analyses (see Interactions, below). Mean numbers of individuals were greater in trawl, than in scrape, samples in two other cases (Fig. 1, January and July decapods in night samples); however, scrape-trawl differences on those dates were nonsignificant (Table 2). The crab scrape was clearly the better gear for sampling epibenthic individuals.

Species numbers were never significantly greater in trawl, than in scrape, samples (Fig. 1). In contrast, the crab scrape collected significantly more species than the trawl in 75% of the scrape-trawl comparisons (Table 2). Because the scrape often sampled greater numbers of individuals than the trawl, the presence of more species in scrape, than in trawl, samples may be simply a sampling phenomenon. By chance alone, one would expect to encounter more rare species in larger samples. Using rarefaction analysis (Simberloff 1978), we have factored out the influence of sample size on species number for a better comparison of scrape vs. trawl sampling effectiveness (Fig. 2). Eight of the 12 cases in which the scrape sampled significantly more species than the trawl (Table 2) can be attributed to a sampling phenomenon; there were generally more species in scrape samples because so many more individuals were collected in each scrape tow. However, it is clear in Figure 2 that the greater numbers of decapod

species in January and July scrape samples, and fish species in April and October scrapes, represent real differences in the catch effectiveness of these gears for species within these two taxa.

## Factor 2: Day vs. Night

Day-night differences were clear. None of the combined (scrape-trawl) daytime collections contained significantly more species or individuals than night collections. But nocturnal samples contained significantly more individuals than daytime samples in 69%, and more species in 62%, of the 16 day-night comparisons (Table 2).

## Interactions

Significance of an interaction term indicates dependence of one factor upon the other; in this case, when sampling differences between scrape and trawl exist but are dependent upon time of day. Scrape-trawl vs. day-night interactions were significant in 8 of the 32 ANOVAs in Table 2. For these eight cases, either the trawl sampled better only at night for a certain taxon/month combination (one of the eight interactions), or the scrape sampled better only during the day (five of the eight cases), or both of these events occurred (two of the eight cases, scrape was better during the day but the trawl was better at night).

Although fish were taken in greater abundances by the trawl on three of the four sampling dates, interactions were significant on two of those dates (April and October, Table 2). With the exception of July collections, fish were equally as abundant in daytime scrape samples as in trawls (see Figure 1).

TABLE 2.—Two-way ANOVA, *F*-values. Underlined values indicate trawl samples significantly larger, all other significant values are scrape samples. All significant day-night values indicate night significantly larger than day samples.

Date	Sample	Decapods		Molluscs		Echinoderms		Fishes	
		No. indiv.	No. species	No. indiv.	No. species	No. indiv.	No. species	No. indiv.	No. species
Jan. 1979	Day Night	0.48	35.81***	0.02	0.31	0.73	1.22	57.98***	42.14***
	Scrape Trawl	0.02	27.77***	56.71***	58.48***	1.92	4.29	0.44	0.08
	Interaction	0.00	5.07*	0.01	0.15	1.73	0.03	0.35	0.33
Apr. 1979	Day Night	37.72***	31.16***	63.17***	21.41***	0.00	1.01	103.02***	29.93***
	Scrape Trawl	106.26***	68.13***	206.89***	55.30***	111.27***	29.71***	61.55***	27.47***
	Interaction	5.24*	0.62	22.51***	2.21	0.51	0.50	68.10***	0.03
July 1979	Day Night	97.55*	139.64***	16.93***	24.75***	6.64*	2.79	14.06**	4.00
	Scrape Trawl	4.16	66.94***	70.39***	30.56***	3.06	1.72	6.93*	0.35
	Interaction	55.35***	3.67	4.32	0.29	2.57	2.48	0.03	0.09
Oct. 1979	Day Night	7.29*	45.12***	8.03*	20.32***	1.87	3.27	20.36***	5.04*
	Scrape Trawl	0.42	32.14***	34.46***	99.21***	10.12**	7.91*	5.04*	9.62**
	Interaction	10.63**	0.02	5.01*	1.43	8.28**	3.20	23.85***	0.13

\* =  $P \leq 0.05$ .

\*\* =  $P \leq 0.01$ .

\*\*\* =  $P \leq 0.001$ .

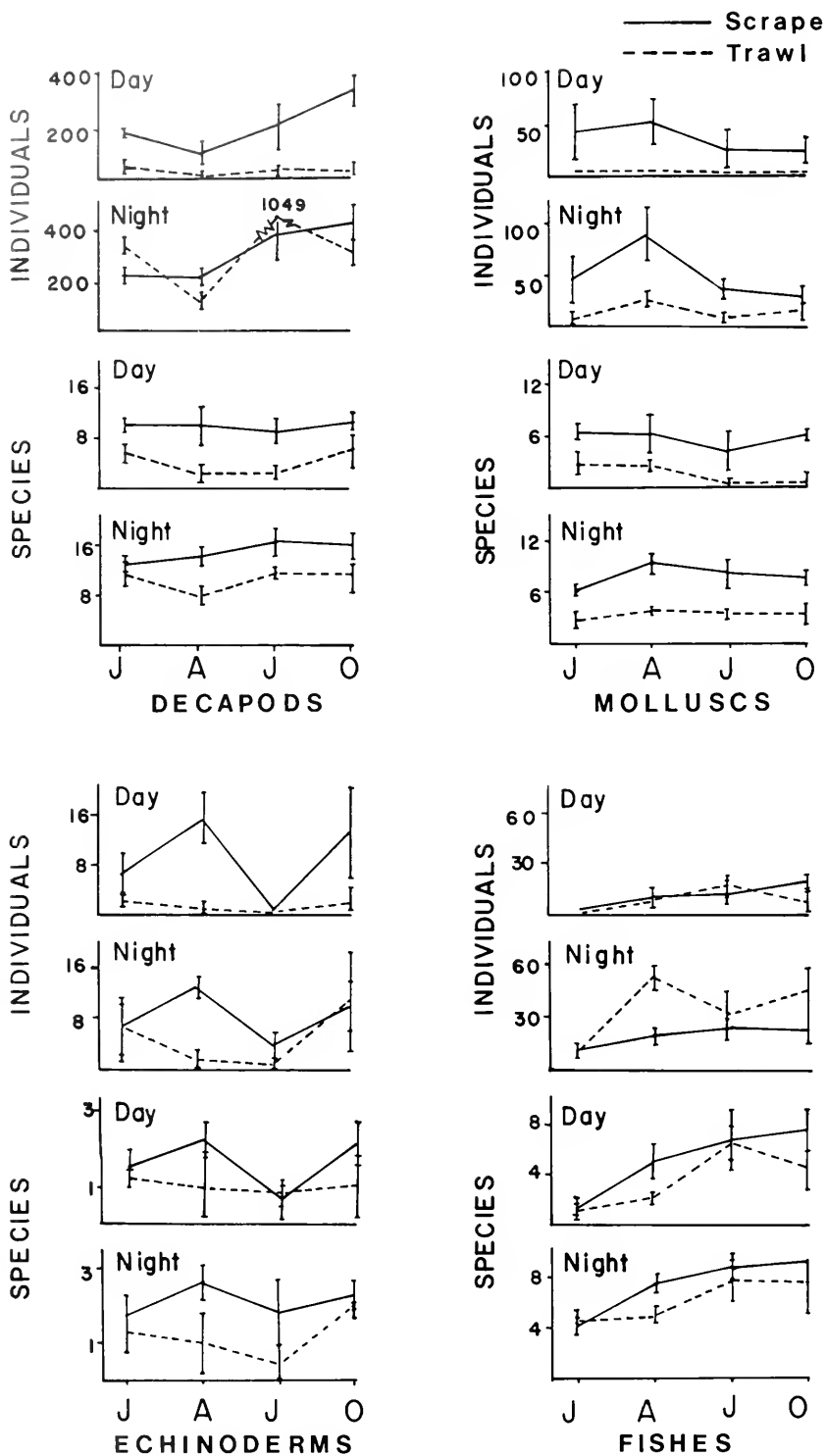

FIGURE 1.—Mean numbers of individuals and species ( $\pm 1$  SD) collected by the crab scrape (solid line) and trawl (dashed line) during day and night sampling in January, April, July, and October 1979.

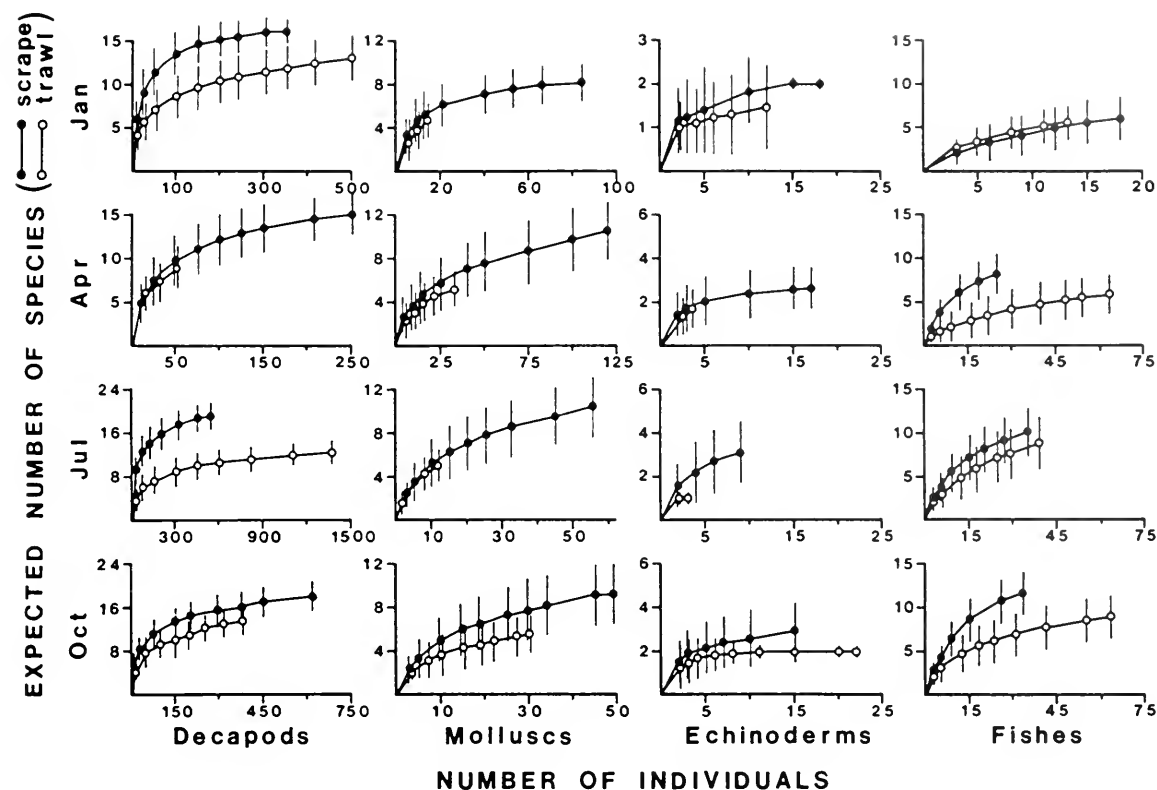

FIGURE 2.—Rarefaction curves for crab scrape (closed circles) and trawl data (open circles) from 1979 night samples. Expected numbers of species ( $\pm 2$  SD) are plotted against numbers of individuals. Length of curves indicates maximum number of individuals taken in any single tow.

Hence, with only one exception (July fish abundance), the otter trawl never outperformed the scrape during daylight collections.

The trawl was more effective in sampling a taxonomic group other than fish in only one case. Significantly more decapod individuals were taken in July trawl samples at night, reflecting high densities of two caridean shrimps, *Tozeuma carolinense* and *Periclimenes longicaudatus*, which appear to be more susceptible to night trawl, rather than scrape, sampling. However, decapod abundances were notably higher in July daytime collections made with the crab scrape (see Figure 1), thus the highly significant interaction term for the July analysis (decapod individuals, Table 2).

### Relative Abundance

Numerical rankings of the most abundant organisms in each taxonomic group (combined over all sample dates) taken in night scrape samples are compared with those from night trawl samples in Table

3. Clear discrepancies exist between scrape and trawl estimates of species ranks and relative abundances. Relative to scrape samples, trawl collections overestimated the degree of dominance (DI = combined proportions of the two most abundant species,  $(n_1 + n_2)/N$ , McNaughton 1967) contributed by the most abundant shrimp *Tozeuma carolinense* and demersal fish *Gobiosoma robustum*, and underestimated dominance of the most important crab *Pagurus maclaughlinae* and mollusc *Argopectin irradians* in our samples (Table 3). Relative to trawl collections, the scrape underestimated dominance for the most abundant water-column fishes, *Lagodon rhomboides* and *Bairdiella chrysura*. Species ranks of subdominants in trawl samples also differed from rankings based on data from scrape samples.

### DISCUSSION

Scrape-trawl and day-night differences in sampling effectiveness were conspicuous and generally constant throughout the year. Although more (by a fac-

TABLE 3.—Species ranks, relative abundances, and dominance for each taxonomic group. Combined night samples.  $\bar{x}$  = mean number of individuals per sample (per group), DI = dominance (McNaughton 1967).

Scrape			Trawl		Scrape			Trawl	
Rank	Relative abundance		Rank	Relative abundance	Rank	Relative abundance	Rank	Relative abundance	
Shrimp									
1	0.324	<i>Tozeuma carolinense</i>	1	0.667	1	0.413	<i>Argopectin irradians</i>	1	0.383
2	0.157	<i>Penaeus duorarum</i>	4	0.027	2	0.145	<i>Modulus modulus</i>	4	0.118
3	0.143	<i>Periclimenes longicaudatus</i>	2	0.191	3	0.130	<i>Cerithium muscarum</i>	6	0.077
4	0.127	<i>Hippolyte zostericola</i>	3	0.066	4	0.096	<i>Anachis avara</i>	2	0.169
5	0.099	<i>Thor dobkini</i>	6	0.016	5	0.086	<i>Columbella rusticoidea</i>	3	0.131
6	0.049	<i>Latreutes fucorum</i>	5	0.018	6	0.064	<i>Turbo castanea</i>	5	0.101
7	0.049	<i>Ambidexter symmetricus</i>	8	0.003	7	0.025	<i>Urosalpinx perrugata</i>	7	0.009
8	0.038	<i>Alpheus normanni</i>	10	0.0002	8	0.013	<i>Nassarius vibex</i>	8	0.006
9	0.009	<i>Palaemon floridanus</i>	7	0.010	9	0.008	<i>Hyalina veliei</i>	—	0
10	0.006	<i>Periclimenes americanus</i>	9	0.001	10	0.007	<i>Fasciolaria hunteri</i>	—	0
$\bar{x}$	= 219.98		$\bar{x}$	= 423.38	$\bar{x}$	= 48.92		$\bar{x}$	= 13.32
DI	= 0.481		DI	= 0.858	DI	= 0.558		DI	= 0.501
Crabs									
1	0.735	<i>Pagurus maclaughlinae</i>	1	0.578	1	0.360	<i>Gobiosoma robustum</i>	1	0.544
2	0.117	<i>Neopanope packardii</i>	3	0.101	2	0.291	<i>Opsanus beta</i>	4	0.097
3	0.039	<i>Epialtus dilatatus</i>	4	0.055	3	0.246	<i>Paraclinus fasciatus</i>	2	0.194
4	0.032	<i>Libinia dubia</i>	5	0.048	4	0.086	<i>Centropristis melana</i>	3	0.106
5	0.027	<i>Podochela riisei</i>	6	0.041	5	0.017	<i>Ophidion beani</i>	5	0.058
6	0.026	<i>Metaporaphis calcerata</i>	2	0.133	$\bar{x}$	= 7.2		$\bar{x}$	= 2.6
7	0.016	<i>Neopanope texana</i>	9.5	0.007	DI	= 0.651		DI	= 0.738
8	0.004	<i>Pitho anisodon</i>	9.5	0.007					
9	0.003	<i>Pilumnus sayi</i>	7	0.018					
10	0.002	<i>Pilumnus dasypodus</i>	8	0.011					
$\bar{x}$	= 75.1		$\bar{x}$	= 10.9					
DI	= 0.852		DI	= 0.711					
Echinoderms									
1	0.659	<i>Echinaster</i> sp.	1	0.824	1	0.345	<i>Lagodon rhomboides</i>	1	0.621
2	0.255	<i>Ophiothrix angulata</i>	2	0.176	2	0.158	<i>Monacanthus ciliatus</i>	4	0.044
3	0.056	<i>Lytechinus variegatus</i>	—	0	3	0.154	<i>Syngnathus floridae</i>	5	0.042
4	0.027	<i>Ophioderma brevispinum</i>	—	0	4	0.151	<i>Orthopristis chrysoptera</i>	3	0.099
$\bar{x}$	= 8.42		$\bar{x}$	= 5.12	5	0.067	<i>Hippocampus zosterae</i>	7	0.007
DI	= 0.914		DI	= 1.00	6.5	0.052	<i>Micrognathus crinigerus</i>	8.5	0.002
					6.5	0.052	<i>Haemulon plumieri</i>	6	0.013
					8	0.015	<i>Bairdiella chrysura</i>	2	0.168
					9	0.004	<i>Monacanthus hispidus</i>	8.5	0.002
					$\bar{x}$	= 11.5		$\bar{x}$	= 31.7
					DI	= 0.503		DI	= 0.789

tor of 4.6) substratum surface area was sampled per tow by the otter trawl, the crab scrape collected more species and individuals per tow, across taxa, with few exceptions. The trawl was the better faunal collecting gear in this seagrass habitat only for numbers of individuals of certain water-column fishes and for two species of caridean shrimps. The scrape was notably more effective than the trawl (day and night) for collecting penaeid, alpheid, and processid shrimps, brachyuran and pagurid crabs, molluscs, echinoderms, syngnathid fishes, and demersal fishes (*Opsanus*, *Paraclinus*, *Gobiosoma*, and *Centropristis*).

The otter trawl appears to collect fewer species and individuals of demersal animals in grassbeds than does the scrape because the weighted (tickler) chain on the trawl is not in contact with the substratum. Under tow, the cylindrical bottom crossbar of a crab scrape bends grassblades flat against the substratum, sweeping demersal and epifaunal organisms over the bar and into the net, whereas

the otter trawl tickler chain is generally supported 8-10 cm above the substratum by the buoyant vegetation (Leber, pers. obs.). Grassblades do not yield as much to the relatively light weight of a tickler chain (as they do to a scrape crossbar), and any organisms remaining close to the substratum as the chain passes over them evade capture. Most epibenthic inhabitants of grassbeds, including several fishes, are more closely associated with seagrasses and red drift algae than with the water column above the vegetation or bare patches within beds (Hooks et al. 1976; Heck and Wetstone 1977; Stoner 1980; Stoner and Livingston 1980; Gore et al. 1981). The crab scrape is more effective because it samples more grassblade surface area, including an additional microhabitat, the region <10 cm above the substratum (Leber, pers. obs.).

The greater effectiveness of both devices at night is probably accounted for, in part, by nocturnal increases in faunal activity on the substratum, on blade tips, and in the water column above vegetation.



Several crustaceans emerge from the substratum and forage at night in grassbeds, including pink shrimp, *Penaeus duorarum*, some majid crabs (notably *Pitho* and adult *Libinia* at our site), and alpheid and processid shrimps (Fuss 1964; Fuss and Ogren 1966; Hughes 1968; Kikuchi and Peres 1977; Saloman 1979; Greening and Livingston 1982; Leber 1983). Emergence of nocturnal organisms from the substratum after dark would explain some of the variability between day and night collections of invertebrates. Higher densities of diurnally active animals in night samples may be due to nocturnal vertical migrations up grass-blades. Animals located near the tips of blades are clearly more vulnerable to capture by either device; even the scrape misses individuals trapped between grass-blades and substratum by the crossbar, an event less likely to occur to an individual near a blade tip. Fishes were probably less abundant in daytime trawl collections because of avoidance reactions to the clearly visible net.

Emergence and vertical migration do not account for all of the increases in invertebrate abundance in night samples. The case of the arrow shrimp, *Tozeuma carolinense*, is interesting in this regard. We expected no day-night sampling differences for *Tozeuma* with either device, based on evidence that *Tozeuma* inhabit the region near tips of grass-blades, both during the day and at night (Main in press). As expected, *Tozeuma* were collected in roughly equal numbers in both day and night scrape samples. However, almost an order of magnitude more *Tozeuma* were taken in night trawl samples than during daytime collections (Leber and Greening, unpubl. data). It appears that *Tozeuma* may be capable of avoiding the trawl, which is highly visible during the day. These shrimp have keen vision in daylight and are capable of rapid movement (up to 30 cm) via a caridoid escape response (Main in press). They need only move down blades, closer to the substratum, to avoid the trawl net.

This study suggests that many demersal fishes and epibenthic invertebrates may be more important numerically in seagrass communities than indicated by collections made with an otter trawl. Species ranks and relative abundances of these organisms determined from trawl collections in seagrass beds should be interpreted with care. Whereas trawl collections may be satisfactory for monthly or year-to-year comparisons of single species abundances within a seagrass habitat, application of such data to examination of predatory-prey relationships (e.g., energy flow and optimal-diet models) or other biotic interactions in grassbeds may lead to erroneous

interpretations. The combined approach of day-night sampling with both an otter trawl (for water-column fishes) and a crab scrape (for demersal organisms) is recommended for seagrass studies.

## ACKNOWLEDGMENTS

We thank B. J. Freeman, J. Gerritsen, R. Howard, C. Koenig, F. G. Lewis, K. Main, G. Morrison, and J. Ryan for comments and reviews of earlier drafts of this manuscript. R. J. Livingston provided technical support and M. Babineau provided help with the graphics.

## LITERATURE CITED

- DUGAN, P. J.  
1983. Seasonal and geographic distribution of seven decapod crustaceans in Apalachee Bay, Florida. *Contrib. Mar. Sci.* 26:65-79.
- DUGAN, P. J., AND R. J. LIVINGSTON.  
1982. Long-term variation of macroinvertebrate assemblages in Apalachee Bay, Florida. *Estuarine Coast. Shelf Sci.* 14: 391-403.
- FUSS, C. M., JR.  
1964. Observations on burrowing behavior of the pink shrimp, *Penaeus duorarum* Burkenroad. *Bull. Mar. Sci. Gulf Caribb.* 14(1):62-73.
- FUSS, C. M., AND L. H. OGREN.  
1966. Factors affecting activity and burrowing habits of the pink shrimp, *Penaeus duorarum* Burkenroad. *Biol. Bull. (Woods Hole)* 130:170-191.
- GORE, R. H., E. E. GALLAHER, L. E. SCOTTO, AND K. A. WILSON.  
1981. Studies on decapod crustacea for the Indian River region of Florida. XI. Community composition of structure, biomass and species areal relationships of seagrass and drift algae-associated macrocrustaceans. *Estuarine Coastal Shelf Sci.* 12:485-508.
- GREENING, H. S., AND R. J. LIVINGSTON.  
1982. Diel variation in the structure of seagrass-associated epibenthic macroinvertebrate communities. *Mar. Ecol. Prog. Ser.* 7:147-156.
- HECK, K. L., JR.  
1976. Community structure and the effects of pollution in seagrass meadows and adjacent habitats. *Mar. Biol.* 35:345-357.  
1977. Comparative species richness, composition, and abundance of invertebrates in Caribbean seagrass (*Thalassia testudinum*) meadows (Panama). *Mar. Biol.* 41:335-348.  
1979. Some determinants of composition and abundance of motile macroinvertebrate species in tropical and temperate turtlegrass (*Thalassia testudinum*) meadows. *J. Biogeogr.* 6:183-200.
- HECK, K. L., JR., AND R. J. ORTH.  
1980. Structural components of eelgrass (*Zostera marina*) meadows in the lower Chesapeake Bay-decapod crustacea. *Estuaries* 3:289-295.
- HECK, K. L., JR., AND G. S. WETSTONE.  
1977. Habitat complexity and invertebrate species richness and abundance in tropical seagrass meadows. *J. Biogeogr.* 4:135-142.
- HOOKE, T. A., K. L. HECK, AND R. J. LIVINGSTON.  
1976. An inshore marine invertebrate community: structure

- and habitat association in the northeastern Gulf of Mexico. *Bull. Mar. Sci.* 26:99-109.
- HOWARD, R. K., AND K. W. LOWE.  
1984. Predation by birds as a factor influencing the demography of an intertidal shrimp. *J. Exp. Mar. Biol. Ecol.* 74:35-52.
- HUGHES, D. A.  
1968. Factors controlling the emergence of pink shrimp (*Penaeus duorarum*) from the substrate. *Biol. Bull. (Woods Hole)* 134:48-59.
- KIKUCHI, T.  
1966. An ecological study on animal communities of the *Zostera marina* belt in Tomioka Bay, Amakusa, Kyushu. *Amakusa Mar. Biol. Lab., Kyushu Univ., Vol. 1, No. 1.*
- KIKUCHI, T., AND J. M. PERES.  
1977. Consumer ecology of seagrass beds. In C. P. McRoy and C. Helfferich (editors), *Seagrass ecosystems; a scientific perspective*, p. 147-193. Marcel Dekker, Inc.
- KJELSON, M. A., AND G. N. JOHNSON.  
1978. Catch efficiencies of a 6.1-meter otter trawl for estuarine fish populations. *Trans. Am. Fish. Soc.* 107:246-254.
- LEBER, K. M.  
1983. Feeding ecology of decapod crustaceans and the influence of vegetation on foraging success in a subtropical seagrass meadow. Ph.D. Thesis, Florida State Univ., Tallahassee, 166 p.
- LEWIS, F. G., III, AND A. W. STONER.  
1981. An examination of methods for sampling macrobenthos in seagrass meadows. *Bull. Mar. Sci.* 31:116-124.
- LIVINGSTON, R. J.  
1975. Impact of kraft pulp-mill effluent on estuarine coastal fishes in Apalachee Bay, Florida, USA. *Mar. Biol.* 32:19-48.  
1976. Diurnal and seasonal fluctuation of organisms in a north Florida estuary. *Estuarine Coast. Mar. Sci.* 4:373-400.  
1982. Trophic organization of fishes in a coastal seagrass system. *Mar. Ecol. Prog. Ser.* 7:1-12.
- MAIN, K. L.  
In press. Predator avoidance in seagrass meadows: An examination of prey behavior, microhabitat selection, and cryptic coloration. *Ecology*.
- MCNAUGHTON, S. J.  
1967. Relationships among functional properties of California grasslands. *Nature (Lond.)* 216:168-169.
- MILLER, R. E., D. W. CAMPBELL, AND P. J. LUNSFORD.  
1980. Comparison of sampling devices for the juvenile blue crab, *Callinectes sapidus*. *Fish. Bull., U.S.* 78:196-198.
- ORTH, R. J., AND K. L. HECK, JR.  
1980. Structural components of eelgrass (*Zostera marina*) meadows in the lower Chesapeake Bay - fishes. *Estuaries* 3:278-288.
- PIELOU, E. C.  
1977. *Mathematical ecology*. 2d ed. Wiley, N.Y. 385 p.
- RYAN, J. D.  
1981. Diel predator-prey relationships in a subtropical seagrass meadow: Apalachee Bay, Florida. MS Thesis, Florida State Univ., Tallahassee.
- SALOMAN, C. H.  
1979. New records of Caridean shrimps (Decapoda, Caridea) from the nearshore area of Panama City Beach, Florida, USA. *Crustaceana (Suppl.)* 5:147-152.
- SIMBERLOFF, D.  
1978. Use of rarefaction and related methods in ecology. *Am. Soc. Testing Materials, Spec. Tech. Publ.* 652, p. 150-164.
- SOKAL, R. R., AND F. J. ROHLF.  
1969. *Biometry*. W. H. Freeman and Co., San Franc., 776 p.
- STONER, A. W.  
1980. Feeding ecology of *Lagodon rhomboides* (Pisces: Sparidae): Variation and functional responses. *Fish. Bull., U.S.* 78:337-352.
- STONER, A. W., H. S. GREENING, J. D. RYAN, AND R. J. LIVINGSTON.  
1983. Comparison of macrobenthos collected with cores and suction sampler in vegetated and unvegetated marine habitats. *Estuaries* 6:76-82.
- STONER, A. W., AND R. J. LIVINGSTON.  
1980. Distributional ecology and food habits of the banded blenny *Paraclinus fasciatus* (Clinidae): a resident in a mobile habitat. *Mar. Biol.* 56:239-246.
- WARNER, W. W.  
1976. *Beautiful swimmers; watermen, crabs and the Chesapeake Bay*. Penguin Books, N.Y.
- WEINSTEIN, M. D., AND K. L. HECK, JR.  
1979. Ichthyofauna of seagrass meadows along the Caribbean Coast of Panama and in the Gulf of Mexico: composition, structure and community ecology. *Mar. Biol.* 50:97-107.
- ZIMMERMAN, M. S., AND R. J. LIVINGSTON.  
1979. Dominance and distribution of benthic macrophyte assemblages in a north Florida estuary (Apalachee Bay, Florida). *Bull. Mar. Sci.* 29:27-40.

## NOTES

### A PRELIMINARY INVESTIGATION OF THE STOCK STRUCTURE OF THE DOLPHIN, *CORYPHAENA HIPPURUS*, IN THE WESTERN CENTRAL ATLANTIC

Dolphin, *Coryphaena hippurus*, are fast swimming, migratory, pelagic fish, which support commercial and sport fisheries throughout the western central Atlantic (Erdman 1956; Zaneveld 1961; Beardsley 1967; Rose and Hassler 1969; Sacchi et al. 1981; Olsen and Wood 1982). In terms of weight and revenue, they are the most important large pelagic fish landed by the commercial fisheries in the south-eastern Caribbean (Mahon et al. 1981). In the north-west, they are the most important sport fish, being taken on more trips and in greater numbers by charter boats in Florida (Ellis 1957; Iversen 1962) and in North Carolina (Hassler and Hogarth 1977; Rose and Hassler 1969) than any other species. Rapid expansion of the dolphin fishery fleets is currently underway in the eastern Caribbean, but the biological data necessary for management have not been gathered. For example, we remain ignorant of the number and distribution of stocks of *C. hippurus* in the western central Atlantic.

Regional dolphin fisheries are markedly seasonal and this presumably results from migration; but migration patterns remain largely unknown (Palko et al. 1982). However, Beardsley (1967) believed that dolphin migrate northwards during spring and summer, and Gibbs and Collette (1959) suggested that the spring abundance of *C. hippurus* in the Caribbean may be a prespawning migration, mostly by females. A preliminary survey of regional catch records indicates a staggering of the peak fishing seasons, which supports the assumption that migration is large-scale (Hunte and Mahon 1982).

In the present paper, we take three approaches to our investigation of *C. hippurus* in the western central Atlantic: 1) We use commercial and sport fishing data from several countries to examine seasonality and size structure of catch throughout the region; 2) we compare growth, age/size at sexual maturity, fecundity, and egg size of dolphin from different parts of the region; 3) we use electrophoretic techniques to compare dolphin sampled from Miami and Barbados, two widely spaced fisheries in the region. Electrophoretic techniques, combined with histo-

chemical staining for isozymes, are now widely recognized as a useful tool for examining genetic affinities between fish stocks (Iwata 1975; Allendorf 1979; McGlade 1981; Ihssen et al. 1981; Ferris et al. 1982). By these means, we address the question of whether the dolphin fisheries in the western central Atlantic exploit a single stock migrating through the region or distinct units located in geographically contiguous areas. Resolution of this question will affect the extent to which individual territories should expand their dolphin fisheries, will determine whether management programs need be regional or territory-specific, and will identify which territories need to collaborate for joint management of stocks.

#### Methods

Dolphin monthly catch data, recorded by commercial or sport fisheries, were obtained either by letter, personal visit to fisheries departments, and/or published literature (Table 1). The catch data, recorded as numbers, weights, catch per day or per boat, and over time periods of 1 to 12 years, were standardized and plotted as percentages of total annual catch landed each month. Where more than 1 year's data were available, the average catch each month was calculated.

Tissue samples for the electrophoretic survey were collected off Barbados between December 1982 and March 1983, and off Miami in May and June 1983. Samples of eye, heart, liver, gonad, and white muscle were taken from a total of 1,669 freshly landed dolphin and were deep frozen for later analysis. A survey of 22 enzymes encoded by 55 presumptive loci was conducted to identify polymorphic enzyme systems. The allelic frequencies of the highly polymorphic isocitrate dehydrogenase, *Idh-2*, locus were compared in Miami and Barbados dolphin. The horizontal starch gel electrophoresis methodology follows that of May et al. (1979) and McGlade et al. (1983). Allelic nomenclature follows that of Allendorf and Utter (1979).

Life history data were obtained from the literature, from records of length and weight of specimens caught in the Bahamas, Bermuda, and North Carolina, and from our own studies of 624 dolphin landed during the peak of the sport fishery in Miami and 3,126 dolphin landed by the commercial fishery in Barbados.

TABLE 1.—Countries from which catch data on the dolphin, *Coryphaena hippurus*, were obtained, with the data source for each country.

Territory	Data source	Time period	Territory	Data source	Time period
Curacao	Zaneveld (1961)	1957-58	Puerto Rico	Erdman (1956)	1951-56
Grenada	J. Finlay, Fisheries Officer, Ministry of Agriculture, National Resources and Industrial Development, St. George's, Grenada.	1981-83		O. Munoz-Roure, Executive Director, Caribbean Fisheries Management Council, Hato Rey, Puerto Rico.	
St. Vincent	K. Morris, Fisheries Officer, Ministry of Agriculture and Fisheries, Kingstown, St. Vincent.	1975-81	Bahamas	P. Major, Fisheries Biologist, Ministry of Agriculture, Fisheries, and Local Government, Nassau, Bahamas.	1976, 1978
Barbados	R. Hastings and P. McConney, Fisheries Officers, Fisheries Division, Bay Street, Bridgetown, Barbados.	1973-82	Florida	A. Jones, Fisheries Scientist, Southeast Fisheries Center, NMFS, NOAA, Miami, Florida.	1970-80
St. Lucia	P. Murray, Fisheries Biologist, Ministry of Agriculture, Lands, Fisheries, and Cooperatives, Fisheries Division, Castries, St. Lucia.	1978, 1980-82	Georgia	A. Jones, see Florida	1978-79
			South Carolina	A. Jones, see Florida	1976-80
			North Carolina	A. Jones, see Florida	1978-80
				Manooch and Laws (1979)	1977
Martinique and Guadeloupe	Sacchi et al. (1981)	1980		Rose and Hassler (1969)	1961
Virgin Isles	R. Wood, Fisheries Biologist, Department of Conservation and Cultural Affairs, Division of Fish and Wildlife, St. Thomas, Virgin Islands.	1967-78	Bermuda	B. Luckhurst, Fisheries Officer, Ministry of Fisheries and Agriculture, Naval Base, Southampton, Bermuda.	1973-80
	Olsen and Wood (1982)				

## RESULTS AND DISCUSSION

### Seasonality and Size Structure of Catch

The seasonality of dolphin catch in 14 territories is shown in Figure 1. Martinique and Guadeloupe supplied no data, but information was given on the duration and peak of the dolphin season. It should be noted that the U.S. Virgin Islands is the only territory with a distinctly bimodal catch pattern.

The peak months of catch in each territory are superimposed on a map of the western central Atlantic in Figure 2. Grenada peak catch is in February/March; Barbados, St. Vincent, and St. Lucia in March/April; Martinique and Guadeloupe in April; and the Virgin Islands in April/May, giving the Virgin Islands their first and largest annual peak. This pattern of catch seasonality is suggestive of a stock (subsequently called the southern stock) moving northwest through the island arc. If the stock then turned west and moved past Puerto Rico, we would expect peak catch there to be between June, July, and August; but this is when Puerto Rico catches the least dolphin (see Figure 1). We therefore suggest that, on leaving the Virgin Islands, the stock moves northeasterly into the Atlantic, completing a circuit and returning to Grenada by February/March of the following year. This implies that there is a sec-

ond stock (subsequently called the northern stock) located in the northwest region of the western central Atlantic. It occurs near Puerto Rico between December and February. It next moves northwesterly past the Bahamas in April/May, Florida and Georgia in May/June, South and North Carolina in June/July, and Bermuda in July/August. It then completes its circuit by passing through the Virgin Islands, giving that territory its second and smaller peak in November and returning to Puerto Rico by December/February.

The mean size of fish caught in five territories during peak fishing season is shown in Figure 3, and the size structure of the catch throughout the fishing season in Barbados is shown in Figure 4. The data are consistent with the migration circuits proposed. In the northern stock, small presumably young-of-the-year fish are predominant during the summer when the stock is near Florida, North Carolina, and Bermuda. The mean size taken by the sport fishery in Florida is 1.69 kg; in North Carolina, where they occur 1 mo later, it is 2.92 kg; and in Bermuda, where they occur 2 mo later, it is 3.85 kg. These differences presumably reflect growth within the cohort. The largest fish are taken by Puerto Rico, where Erdman (1956) reported that dolphin up to 23 kg in weight occur during the peak winter fishing season, and by the Bahamas where the mean weight during the peak fishing months is 6.45 kg. This suggests

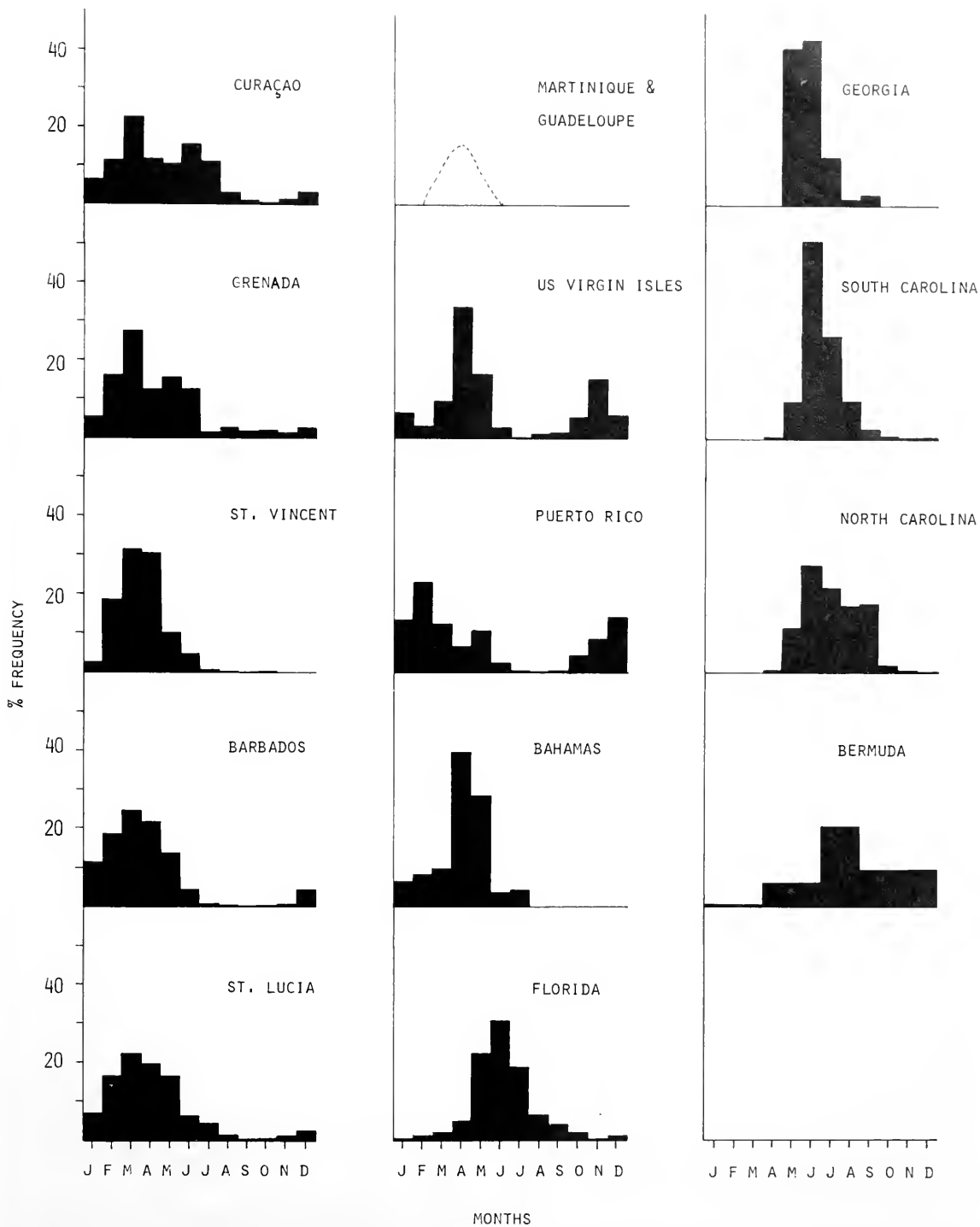

FIGURE 1.—Seasonality of the dolphin, *Coryphaena hippurus* fisheries in the western central Atlantic, shown in geographical order from south to north. Note that raw catch data were not available from Martinique and Guadeloupe, but the duration of season and peak month were known.

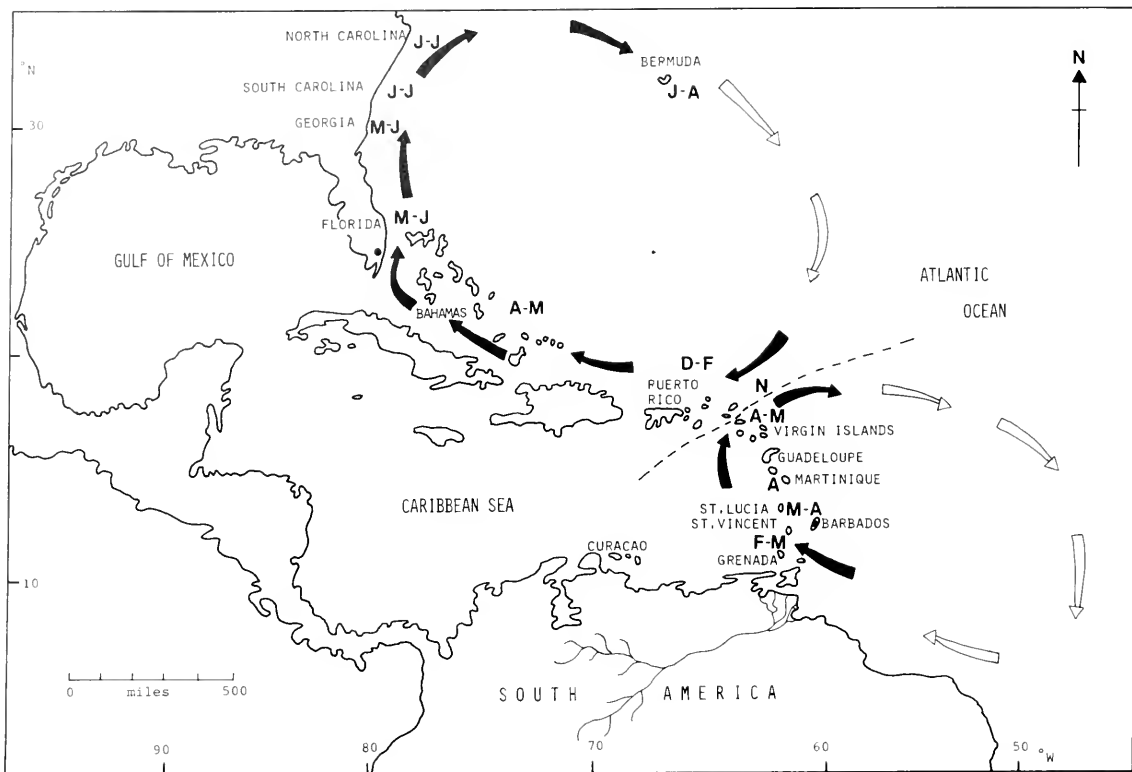

FIGURE 2.—Months of peak catch of the dolphin, *Coryphaena hippurus*, and proposed migration circuits for northern and southern dolphin stocks in the western central Atlantic. Letter symbols (e.g., A-M) indicate months of peak catch. **➔** indicate proposed migration. **➞** indicate proposed migration where catch data were not available. • indicate locations from which samples for electrophoresis were collected.

continued growth of the cohort as it leaves Bermuda and returns southwards into the northern Caribbean for the winter. Note that since dolphins are serial spawners and since fecundity is proportional to size (Beardsley 1967; Oxenford and Hunte in press), most spawning by a cohort will occur when the dolphin comprising it are large. For the northern dolphin, this would be when the stock is near Puerto Rico, i.e., at the southeastern or up-current limit of their range. Peak spawning near Puerto Rico is reported to occur in early spring (Erdman 1976) and presumably produces the small young-of-the-year fish caught near Florida during the summer.

The size structure of dolphin caught at Barbados (Fig. 4) is consistent with the proposed migration for the southern stock. In February, the main cohort is composed of fish about 5½ mo old with a mean standard length of 812.24 mm. Growth within this cohort occurs throughout the fishing season to June, when the average fish size is 1,007.83 mm SL (Oxenford and Hunte 1983). After this, abundance drops sharply (Fig. 1) as the cohort leaves Barbados

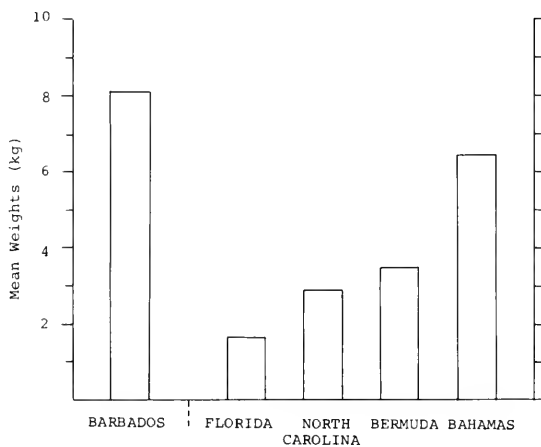

FIGURE 3.—Mean weights of individuals of the dolphin, *Coryphaena hippurus*, landed during peak fishing seasons at five locations in the western central Atlantic.

migrating northwards. During early summer (June/July) and early autumn (October), the presence of

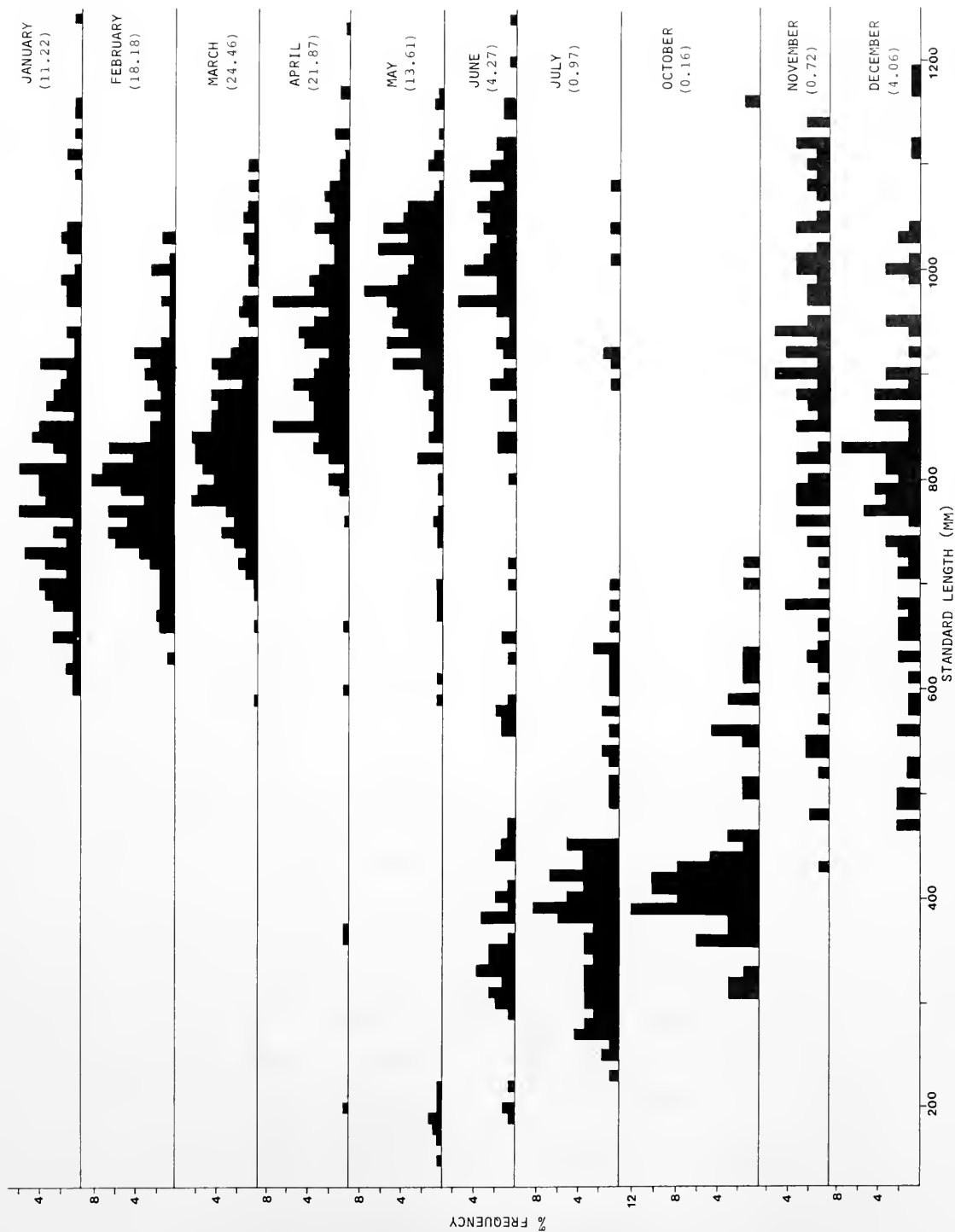

FIGURE 4.—The size-structure of the dolphin, *Coryphaena hippurus*, landed by the Barbados commercial fishery over 10 mo. The values in parentheses are the percentage of total annual catch by weight landed each month.

a few very small dolphin (<2% of the annual catch by weight), landed as bycatch of the flying fish fishery (see Figure 4), indicates the arrival of the first of the young-of-the-year group, with a few very large mature adults from the previous year. Note that many of these young-of-the-year are already mature on reaching Barbados in November, and all are ripe by the time the cohort leaves Barbados in June. Note too, that aging of the cohort (Oxenford

and Hunte 1983) suggests that the cohort was spawned between September and January, when the parent stock would be towards the southeastern, up-current extreme of the proposed migration circuit.

### Life History Comparisons

Data on life history parameters of dolphin from northern and southern circuits are summarized in

TABLE 2.—Life history characteristics of the dolphin *Coryphaena hippurus* in the western central Atlantic.

Life history characteristics		Location	Data Source
<b>Northern area:</b>			
Average 1st year growth rate (mm SL/d)	≈ 1.64 ≈ 1.82	N. Carolina Florida	Rose and Hassler (1968) Beardsley (1967)
Length-weight relationship in the form $y = ax^p$ (y is weight (kg) x is SL (mm))	Males: $y = 0.05 \times 10^{-8} x^{2.75}$ $y \approx 1.45 \times 10^{-7} x^{2.58}$ Females: $y = 1.27 \times 10^{-7} x^{2.59}$ $y \approx 5.75 \times 10^{-8} x^{2.71}$	N. Carolina Florida	Rose and Hassler (1968) Beardsley (1967, fig. 7)
Fecundity-length relationship in the form $y = ax^p$ (y is mature egg numbers x is FL (mm))	$y \approx 2.52 \times 10^{-4} x^{3.12}$	N. Carolina Florida	Rose and Hassler (1968) Beardsley (1967, fig. 7)
Size at first maturity (mm SL)	Males: 393 Females: 324	Florida	Beardsley (1967)
Age at first maturity (months)	≈ 6-7	Florida	Beardsley (1967)
Mature egg size range (mm diameter)	1-1.7	Florida	Beardsley (1967, fig. 9)
Mean mature egg size (mm diameter)	1.3	N. Carolina	Hassler and Rainville (1975)
Spawning season	Extended	Atlantic  Florida Current	Shcherbachev (1973) Fahay (1975) Johnson (1978) Gibbs and Collette (1959) Beardsley (1967)
Age structure (% which are <2 yr)	96 98	N. Carolina Florida	Rose and Hassler (1968) Beardsley (1967)
<b>Southern area:</b>			
Average 1st year growth rate (mm SL/d)	≈ 4.17	Barbados	Oxenford and Hunte (1983)
Length-weight relationship in the form $y = ax^p$ (y is weight (kg) x is SL (mm))	Males: $y = 1.24 \times 10^{-8} x^{2.94}$ Females: $y = 2.22 \times 10^{-8} x^{2.84}$	Barbados	Oxenford and Hunte (in press)
Fecundity-length relationship in the form $y = ax^p$ (y is mature egg numbers x is FL (mm))	$y = 2.7 \times 10^{-6} x^{3.67}$	Barbados	this study
Size at first maturity (mm SL)	Males: 735 Females: 610	Barbados	this study
Age at first maturity (months)	≈ 4	Barbados	this study
Mature egg size range (mm diameter)	0.86-1.00	Barbados	this study
Mean mature egg size (mm diameter)	0.97	Barbados	this study
Spawning season	Extended	Barbados	this study
Age structure (% which are <2 yr)	100	Barbados	Oxenford and Hunte (1983)



Table 2 and are not supportive of a single stock hypothesis. Dolphin in Barbados waters appear to grow faster (Oxenford and Hunte 1983) than those in North Carolina (Rose and Hassler 1968) and Florida (Beardsley 1967). Note that scale annuli are found in northern dolphin but not in southern dolphin; a difference supportive of the assertion that the two groups are distinct. Beardsley (1967) suggested that the formation of the dolphin scale annuli at Florida was correlated with the temperature reduction occurring in the Florida Current during winter.

Dolphin from Barbados are larger but younger at first sexual maturity than those from Florida. Fecundity increases with fish size in both groups, but Florida dolphin have higher fecundity at size than Barbados dolphin (Oxenford and Hunte in press). Mature eggs taken from Florida and North Carolina dolphin are apparently larger than those from Barbados dolphin. Intraspecific variation in egg size is seldom environmental and is typically a function of fish age (Bagenal 1971; Kazakov 1981). Mature egg size does not increase with fish size/age for Barbados dolphin (linear regression,  $r = 0.353$   $b = 0.0001$ ). Therefore, assuming that the differences observed in egg size of southern and northern dolphin do not result merely from differences in investigators' methodologies, they are suggestive of separate stocks as shown for different spawning groups of herring (Blaxter and Hempel 1963; Cushing 1967) and sockeye salmon (Foerster 1968; Bagenal 1971).

### Electrophoretic Comparisons

In the electrophoretic survey, 55 presumptive loci could be consistently scored. Of these, 39 were fixed

for the same alleles in both samples, and a further 12 were close to fixation. Two isocitrate dehydrogenase loci (Idh-2,3) and two esterase loci (Est-1,2) had alternate alleles at a frequency  $>0.05$ , i.e. were significantly polymorphic.

Seven phenotypes were observed at the Idh-2 locus expressed in heart tissue (Fig. 5). The pattern of activity at this locus is typical of an active dimeric enzyme with disomic inheritance (Darnall and Klotz 1972; Kirpichnikov 1981) and four alleles with relative mobilities to 100, 123, 86, and 68. Thus, putative genotypes could be assigned to the observed phenotypes as indicated in Figure 5, and allelic frequencies calculated (Table 3). Unequivocal assignment of genotypes to the phenotypes, observed at the remaining polymorphic loci, was not possible in the absence of inheritance data, since the loci have alleles with overlapping mobilities. Idh-3 and Idh-2, expressed together in liver tissue, both have alleles with relative mobilities to 100, 123, and 86, and although the asymmetrically banded phenotypes could be easily read, the presence of a null allele at Idh-3 meant that certain phenotypes could have been produced by a number of different genotypes. Est-1 and Est-2 share all or some of four alleles, but the banding intensity ratios of individual phenotypes could not be determined. Hence, assignment of genotypes to phenotypes at these loci was not possible. In summary, only the Idh-2 locus, expressed independently from Idh-3 in heart tissue, was considered suitable for a comparison of Miami and Barbados dolphin.

The frequencies of alleles at Idh-2 differed significantly in the two populations (chi-square  $2 \times 4$  contingency test:  $\chi^2 = 12.725$ ,  $df = (r - 1)(C - 1) = 3$ ,  $0.01 > P > 0.0005$ ; Table 3). Note that the varia-

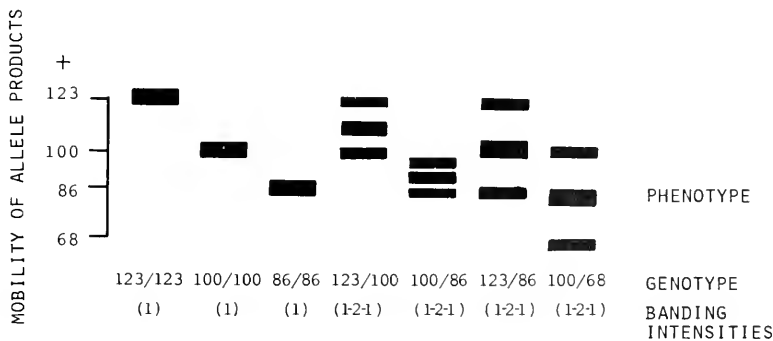

FIGURE 5.—A starch-gel zymogram of the dimeric enzyme isocitric dehydrogenase, showing the phenotypes observed and putative genotypes at the Idh-2 locus in heart extracts of the dolphin, *Coryphaena hippurus*, from the western central Atlantic. Values in parentheses are ratios of allele products.

TABLE 3.—Observed allelic frequencies (obs. freq.) and number (obs. no.) of alleles at the *Idh-2* locus in heart tissue of the dolphin, *Coryphaena hippurus*, from Miami and Barbados. Expected values (exp. no.) refer to the number expected if the samples do not differ.

Sample location	No. of fish	Alleles				
		68	86	100	123	
Miami	539	obs. freq.	0.0009	0.3154	0.6660	0.0176
		obs. no.	1	340	718	19
		exp. no.	(0.47)	(304.14)	(751.56)	(21.83)
Barbados	597	obs. freq.	0.0000	0.2521	0.7253	0.0226
		obs. no.	0	301	866	27
		exp. no.	(0.53)	(336.86)	(832.44)	(24.17)

tion observed at *Idh-2* did not differ from that predicted under Hardy-Weinberg equilibrium for either population (chi-square goodness of fit: for Barbados,  $\chi^2 = 6.337$ ,  $df = 3$ ,  $0.25 > P > 0.1$ ; for Miami,  $\chi^2 = 9.9145$ ,  $df = 6$ ,  $0.25 > P > 0.1$ ; Table 4).

The differences in life history traits of Miami and Barbados dolphin could in principle be environmental. The genetic differences observed at the *Idh-2* locus suggest that there may be little gene flow between the northern and southern groups; but could in theory result from a regional cline. The primary evidence supporting our suggestion of more than one dolphin stock in the western central Atlantic is there-

fore the seasonality of catch data and the mean size of dolphin landed in each territory. Taken together, the three data sets certainly suggest that the assumption of a single stock may be unjustified. Efforts should now be made to test the two stock hypothesis proposed and to investigate the possible presence of additional dolphin stocks, particularly in the western Caribbean Sea and in the Gulf of Mexico.

#### Acknowledgments

This project was supported by an Inter-University Council (British Council) grant to Hazel Oxenford, a University of the West Indies research grant to Wayne Hunte and a Manuel Noreiga Morales Science Prize from the Organization of American States to Wayne Hunte. The electrophoresis was carried out at the Bedford Institute of Oceanography, Dartmouth, Nova Scotia, with technical supervision by J. McGlade, and C. Annand, and with technical assistance from D. Beanlands. We thank C. Limouzy for collecting specimens in Miami, R. Mahon for assistance in compiling regional catch records, and J. Horrocks and J. Marsden for comments on the manuscript. Cooperation of fisheries officers and fisheries biologists in the region is gratefully acknowledged.

#### Literature Cited

- ALLENDORF, F. W.  
1979. Rapid loss of duplicate gene expression by natural selection. *Heredity* 43:247-258.
- ALLENDORF, F. W., AND F. M. UTTER.  
1979. Population genetics. *Fish. Physiol.* 8:407-454.
- BAGENAL, T. B.  
1971. The interrelation of the size of fish eggs, the date of spawning and the production cycle. *J. Fish. Biol.* 3:207-219.
- BEARDSLEY, G. L., JR.  
1967. Age, growth, and reproduction of the dolphin, *Coryphaena hippurus*, in the Straits of Florida. *Copeia* 1967:

TABLE 4.—The number of each phenotype observed (obs.) at the *Idh-2* locus in heart tissue of the dolphin, *Coryphaena hippurus*, from Barbados and Miami. Expected values (exp.) refer to the numbers expected if the populations are in Hardy-Weinberg equilibrium.

Putative genotype for <i>Idh-2</i>		Sample location	
		Barbados ( <i>n</i> = 597)	Miami ( <i>n</i> = 539)
86/86	obs.	47	64
	exp.	(37.94)	(53.62)
100/86	obs.	199	205
	exp.	(218.31)	(226.46)
100/100	obs.	325	251
	exp.	(314.05)	(239.11)
100/123	obs.	17	10
	exp.	(19.58)	(12.65)
123/123	obs.	1	1
	exp.	(0.31)	(0.17)
123/86	obs.	8	7
	exp.	(6.81)	(5.99)
68/68	obs.	—	0
	exp.	—	(0.00)
100/68	obs.	—	1
	exp.	—	(0.67)
123/68	obs.	—	0
	exp.	—	(0.02)
86/68	obs.	—	0
	exp.	—	(0.32)

- 441-451.
- BLAXTER, J. H. S., AND G. HEMPEL.  
1963. The influence of egg size on herring larvae (*Clupea harengus* L.). J. Cons. Perm. Int. Explor. Mer 28:211-240.
- CUSHING, D. H.  
1967. The grouping of herring populations. J. Mar. Biol. Assoc. U.K. 47:193-208.
- DARNALL, D. W., AND I. M. KLOTZ.  
1972. Protein subunits: a table (revised edition). Arch. Biochem. Biophys. 149:1-14.
- ELLIS, R. W.  
1957. Catches of fish by charter boats on Florida's east coast. Univ. Miami, Mar. Fish. Res. Spec. Ser. Bull. 14, 6 p.
- ERDMAN, D. S.  
1956. Recent fish records from Puerto Rico. Bull. Mar. Sci. Gulf Caribb. 6:315-348.  
1976. Spawning patterns of fishes from the northeastern Caribbean. Agric. Fish. Contrib. Off. Pub. Spec. Serv. 7(2): 10-11.
- FABLE, W. A., JR., H. A. BRUSHER, L. TRENT, AND J. FINNEGAN, JR.  
1981. Possible temperature effects on charter boat catches of king mackerel and other coastal pelagic species in northwest Florida. Mar. Fish. Rev. 43(8):21-26.
- FAHAY, M. P.  
1975. An annotated (sic) list of larval and juvenile fishes captured with surface-towed meter net in the South Atlantic Bight during four RV *Dolphin* cruises between May 1967 and February 1968. U.S. Dep. Commer., NOAA Tech. Rep. NMFS, SSRF-685, 312 p.
- FERRIS, S. D., D. G. BUTH, AND G. S. WHITT.  
1982. Substantial genetic differentiation among populations of *Catostomus plebeius*. Copeia 1982:444-449.
- FOERSTER, R. E.  
1968. The sockeye salmon *Oncorhynchus nerka*. Bull. Fish. Res. Board Can. 162:1-422.
- GIBBS, R. H., JR., AND B. B. COLLETTE.  
1959. On the identification, distribution, and biology of the dolphins, *Coryphaena hippurus* and *C. equiselis*. Bull. Mar. Sci. Gulf of Caribb. 9:117-152.
- HASSLER, W. W., AND W. T. HOGARTH.  
1977. The growth and culture of dolphin, *Coryphaena hippurus*, in North Carolina. Aquaculture 12:115-122.
- HASSLER, W. W., AND R. P. RAINVILLE.  
1975. Techniques for hatching and rearing dolphin, *Coryphaena hippurus*, through larvae and juvenile stages. Univ. N.C., Sea Grant Program Publ. UNC-SG-75-31, 16 p.
- HUNTE, W., AND R. MAHON.  
1982. How important are migratory patterns of pelagic fishes in the Caribbean? FAO Fish. Rep. 278, p. 165-175.
- IHSSEN, P. E., H. E. BOOKE, J. M. CASSELMAN, J. M. MCGLADE, N. R. PAYNE, AND F. M. UTTER.  
1981. Stock identification: materials and methods. Can. J. Fish. Aquat. Sci. 38:1838-1855.
- IVERSEN, E. S.  
1962. The dolphin fish. Sea Front. 8:167-172.
- IWATA, M.  
1975. Genetic identification of walleye pollock *Theragra chalcogramma* populations on the basis of tetrazolium oxidase polymorphism. Comp. Biochem. Physiol. 50(B):197-201.
- JOHNSON, G. D.  
1978. Development of fishes of the Mid-Atlantic Bight. An atlas of egg, larval, and juvenile stages. Vol. IV, Carangidae through Ephippidae. U.S. Dep. Inter., Fish Wildl. Ser., Biol. Serv. Program, FWS/OBS-78/12, Jan. 1978:123-128.
- KAZAKOV, R. V.  
1981. The effect of the size of Atlantic salmon, *Salmo salar* L., eggs on embryos and alevins. J. Fish. Biol. 19:353-360.
- KIRPICHNIKOV, V. S.  
1981. Genetic bases of fish selection. Springer-Verlag, Berlin, 410 p. (Translated from Russian by G. G. Gause.)
- MANOOCH, C. S., III, AND S. T. LAWS.  
1979. Survey of the charter boat troll fishery in North Carolina, 1977. Mar. Fish. Rev. 41(4):15-27.
- MAHON, R., W. HUNTE, H. OXENFORD, K. STOREY, AND F. E. HASTINGS.  
1981. Seasonality in the commercial marine fisheries of Barbados. Proc. Gulf Caribb. Fish. Inst. 34:28-37.
- MAY, B., J. E. WRIGHT, AND M. STONEKING.  
1979. Joint segregation of biochemical loci in Salmonidae: Results from experiments with *Salvelinus*, and review of the literature on other species. Can. J. Fish. Aquat. Sci. 36: 1114-1128.
- MCGLADE, J. M.  
1981. Genotypic and phenotypic variation in the brook trout, *Salvelinus fontinalis* (Mitchell). Ph.D. Thesis, Univ. Guelph, Guelph, Ontario, 280 p.
- MCGLADE, J. M., M. C. ANNAND, AND T. J. KENCHINGTON.  
1983. Electrophoretic identification of *Sebastes* and *Helicolenus* in the northwestern Atlantic. Can. J. Fish. Aquat. Sci. 40:1861-1870.
- OLSEN, D. A., AND R. S. WOOD.  
1982. The marine resource base for marine recreation fisheries development in the Caribbean. Proc. Gulf Caribb. Fish. Inst. 35:152-160.
- OXENFORD, H. A., AND W. HUNTE.  
1983. Age and growth of dolphin, *Coryphaena hippurus*, as determined by growth rings in otoliths. Fish. Bull., U.S. 81: 906-909.  
In press. Migration of the dolphin (*Coryphaena hippurus*) and its implications for fisheries management in the Western Central Atlantic. Proc. Gulf Caribb. Fish. Inst. 37.
- PALKO, B. J., G. L. BEARDSLEY, AND W. J. RICHARDS.  
1982. Synopsis of the biological data on dolphin-fishes, *Coryphaena hippurus* Linnaeus and *Coryphaena equiselis* Linnaeus. U.S. Dep. Commer., NOAA Tech. Rep. NMFS Cir. 443, 28 p.
- ROSE, C. D., AND W. W. HASSLER.  
1968. Age and growth of the dolphin *Coryphaena hippurus* (Linnaeus), in North Carolina waters. Trans. Am. Fish. Soc. 97:271-276.  
1969. Application of survey techniques to the dolphin, *Coryphaena hippurus*, fishery of North Carolina. Trans. Am. Fish. Soc. 98:94-103.
- SACCHI, J., A. LAGIN, AND C. LANGLAIS.  
1981. La peche des especes pelagiques aux Antilles Francais. Etat actuel et perspective de developpement. Bull. Inst. Pêches Marit. 312:1-15.
- SHCHERBACHEV, Y. N.  
1973. The biology and distribution of the dolphins (Pisces, Coryphaenidae). J. Ichthyol. 13:182-191.
- ZANEVELD, J. S.  
1961. The fishery resources and the fishery industries of the Netherlands Antilles. Proc. Gulf Caribb. Fish. Inst. 14:137-171.

HAZEL A. OXENFORD

Department of Biology

## EFFECTS OF TEMPERATURE ON SWIMMING SPEED OF THE DINOFLAGELLATE *GYMNODINIUM SPLENDENS*

Dinoflagellate blooms or red tides frequently occur in a stratified water column having low nutrients near the surface (Huntsman et al. 1981). Under these conditions dinoflagellates have a competitive advantage over other phytoplankton due to their motility and diel vertical migration pattern. In the absence of turbulence, active swimming allows them to overcome sinking and thereby, remain close to the surface. The normal diel vertical migration consists of an ascent to some minimum depth during the day and descent to a maximum depth at the night (reviewed by Forward 1976). Through this pattern they have access to nutrients over the area covered by migration and they can migrate to the surface during the day to obtain more light for photosynthesis (Ryther 1955; Margalef 1978; Huntsman et al. 1981).

The success of dinoflagellates depends to a great extent upon their swimming capability. There have been few measurements of actual swimming speeds of individual dinoflagellates (e.g., Hand et al. 1965) or estimates of speeds from population movements during migration (Eppley et al. 1968; Kamykowski and Zentara 1977). This is unfortunate because such measurements are necessary to estimate the depth of the water column available to dinoflagellates for nutrients during migration.

The most pronounced and widespread dinoflagellate blooms off the coast of Peru are caused by *Gymnodinium splendens* Lebour. Blooms occur most frequently during the summer and are usually associated with the phenomenon of El Niño (Rojas de Mendiola 1979). At the beginning of the 1976 El Niño, there was a major bloom of *G. splendens*. Blasco's (1979) surface measurements during this bloom indicated the dinoflagellate vertically migrated with the suggested pattern involving an

ascent in the early morning and maintenance of a deeper distribution at night. This pattern was similar to that observed by Kiefer and Lasker (1975) for this species in the Gulf of California. Vertical chlorophyll a profiles indicated the cells rose in the morning and descended in the evening. The present study was undertaken to measure swimming speeds of *G. splendens* under different temperature conditions. The observed speeds vary with temperature and are similar to those calculated from field studies.

### Materials and Methods

The dinoflagellate *Gymnodinium splendens* Lebour was cultured as described previously (Forward 1974) in a Sherer<sup>1</sup> environmental chamber (Model CEL-44) on a 14:10 LD cycle at a salinity of about 34 ppt. All experiments were performed in the middle 4 h of the light phase with cultures having densities of about 2,000 cells/mL. This cell density was used because it was similar to that used in past studies (Forward 1974, 1977) and thus past results can be applied to the present study. Swimming speed during phototaxis was only measured during a specific time interval because there is a circadian rhythm in phototaxis (Forward 1974). *Gymnodinium splendens* shows about average levels of phototaxis during the middle 4 h of the light phase. It is not known whether there is a similar rhythm in swimming.

Subcultures were exposed to two sets of temperature conditions to test for the effects of 1) temperature acclimation and 2) acute temperature changes upon swimming speed. In the first tests cells were acclimated to selected temperatures from 13° to 25°C for at least 5 d prior to swimming speed measurements. These temperatures were used because they encompass the range in which the cells grow at reasonable rates (Thomas et al. 1973). For the second tests, cultures were acclimated to 19°C for at least 5 d. At the time of testing cultures were exposed to an acute temperature change by placing the flasks in a water bath set at selected temperatures for 0.5 h, after which time swimming speed was measured. Room lights were on during this 0.5-h period. The temperature of the room in which swimming was measured was regulated to approximately each test temperature. Each test was performed on four separate subcultures.

To measure swimming speeds, a sample of cells was removed from a subculture and placed in a clear

<sup>1</sup>Reference to trade names does not imply endorsement by the National Marine Fisheries Service, NOAA.

cuvette. The cells were viewed by the closed circuit video system described by Forward (1974). During random swimming the cells can move in any direction and are not necessarily moving in the plane of view of the video camera. Thus measurements of swimming speeds during random swimming tend to underestimate true speed. To prevent this problem, cells were stimulated horizontally with light and speed measured during oriented swimming toward the light (positive phototaxis). Room lights were off during light stimulation.

The light stimulus was a tungsten light source filtered with a 4-96 Corning filter. The spectral composition of the light was similar to the spectral sensitivity of phototaxis of *G. splendens* (Forward 1974). A constant light intensity of  $4.79 \times 10^2 \text{ Wm}^{-2}$ , as measured with an EG and G radiometer (Model 550) and calculated at 465 nm, was used for all tests because maximum positive phototaxis occurs in this intensity range, and it was necessary to measure swimming speed during phototaxis. Swimming was recorded on video tape and speed analyzed using previous techniques (Forward 1974).

### Results

Swimming speed varied greatly with temperature (Fig. 1) as mean speeds approximately double upon acclimation to temperatures between 13° and 25°C ( $0.56 \text{ h}^{-1}$  to  $1.16 \text{ mh}^{-1}$ ). The dinoflagellate seems

capable of limited temperature acclimation. If the cells were acclimated to 19°C and suddenly exposed to other temperatures, there was always a significant difference (Student's *t* test;  $P < 0.001$ ) between these mean speeds and those upon acclimation. At a lower temperature of 13°C the acclimation speed was higher; while at temperatures above 19°C, the acclimation speeds were lower. This trend is expected with acclimation.

The effects of temperature can be further assessed by calculating the temperature coefficients upon acclimation and exposure to acute temperature changes (Table 1). The  $Q_{10}$  values for acute changes are always higher than those upon acclimation, which is expected if swimming rates are adjusted through acclimation. When acclimated to temperatures between 13° and 19°C, the cells showed total compensation ( $Q_{10} = 0.98$ ). In contrast, they were less able to adjust their rates upon acclimation to higher temperatures between 19° and 25°C ( $Q_{10} = 3.42$ ). Partial acclimation occurred over this temperature

TABLE 1.—Temperature coefficient values for the dinoflagellate *Gymnodinium splendens* upon temperature acclimation and exposure to acute changes in temperature.

Temperature range	Acute $Q_{10}$	Acclimation $Q_{10}$
13°-19°C	1.47	0.98
19°-25°C	4.68	3.42

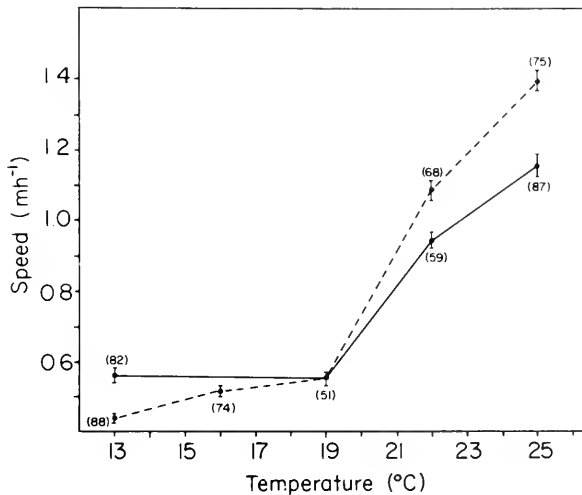

FIGURE 1.—Swimming speeds of the dinoflagellate *Gymnodinium splendens* upon acclimation to various temperatures (solid line). The effect of acute temperature change was measured by acclimating the animals to 19°C and measuring speeds upon exposure to other temperatures (dashed line). The number beside the points are the sample sizes and the vertical bars are standard errors.

range since the acclimation  $Q_{10}$  is lower than the acute  $Q_{10}$  (Table 1).

## Discussion

Blooms of *G. splendens* occur off the coast of Peru in temperatures ranging from 17° to 23°C with optimum being 18°-21°C (Rojas de Mendiola 1979). The lower temperature agrees with laboratory measurements of vertical migration, as Kamykowski (1981) found migration in the laboratory occurred at temperatures above 16°C. In the laboratory, this dinoflagellate can survive and divide at temperatures from 12° to 29°C. The most rapid growth rates (0.4 divisions/d), however, occur at 20°-27°C (Thomas et al. 1973). Within the optimum temperature range suggested from these studies (18°-26°C), swimming speed of *G. splendens* approximately doubles (Fig. 1). These speeds and their change with temperature are similar to those reported for other dinoflagellate species (Hand et al. 1965).

The speeds of movement calculated from field studies of vertical migration of *G. splendens* agree with the speeds found in the present study. Blasco (1979) calculated that a speed of 1 m/h was sufficient to account for the migration off Peru during the 1976 El Niño. In the Gulf of California, *G. splendens* migrated over a depth of about 9 m and had a calculated descent velocity at sunset of 1.7 m/h (Kiefer and Lasker 1975). The present study predicted this speed would occur at temperatures above 25°C. Unfortunately Kiefer and Lasker (1975) did not state the water temperature at the time of migration.

An objective of the present study was to use the measured swimming speeds to determine the distance over which *G. splendens* should be capable of migrating. A conservative estimate of distance can be calculated from the speeds upon acclimation to optimum temperatures (19°-25°C) and assuming the dinoflagellate 1) swims continuously in either the upward or downward direction for half of the migration cycle (12 h) and 2) does not have a diel rhythm in swimming speed. At 19°, 22°, and 25°C the calculated distances are 6.6, 11.3, and 13.9 m respectively. These distances would increase slightly if a temperature gradient existed because speed is approximately constant at 19°C and lower temperatures, and acute exposure to higher temperatures, which would occur high in the water column, would elevate speeds above those upon acclimation (Fig. 1). In addition, these values would probably vary if *G. splendens* is exposed to different environmental conditions, since salinity, light intensity, and nutrient

levels can affect migration patterns (Kamykowski 1981).

## Acknowledgments

This work was supported by an International Oceanographic Commission travel grant to BRM and a National Science Foundation Grant No. OCE-8110702.

## Literature Cited

- BARBER, R. T., AND F. P. CHAVEZ.  
1983. Biological consequences of El Niño. *Science* 222:1203-1210.
- BLASCO, D.  
1979. Changes in surface distribution of a dinoflagellate bloom of the Peru coast related to time of day. *In* D. L. Taylor and H. H. Seliger (editors), *Toxic dinoflagellate blooms*, p. 209-214. Elsevier, N.Y.
- EPPLEY, R. W., O. HOLM-HANSEN, AND J. D. H. STRICKLAND.  
1968. Some observations on the vertical migration of dinoflagellates. *J. Phycol.* 4:333-340.
- FORWARD, R. B., JR.  
1974. Phototaxis by the dinoflagellate *Gymnodinium splendens* Lebour. *J. Protozool.* 21:312-315.  
1976. Light and diurnal vertical migration: photobehavior and photophysiology of plankton. *In* K. Smith (editor), *Photochemical and photobiological reviews*, Vol. 1, p. 157-209. Plenum Press, N.Y.  
1977. Effect of neurochemicals upon a dinoflagellate photoresponse. *J. Protozool.* 24:401-405.
- HAND, W. G., P. A. COLLARD, AND D. DAVENPORT.  
1965. The effects of temperature and salinity change on swimming rate in the dinoflagellates, *Gonyaulax* and *Gyrodinium*. *Biol. Bull.* 128:90-101.
- HUNTSMAN, S. A., K. H. BRINK, R. T. BARBER, AND D. BLASCO.  
1981. The role of circulation and stability in controlling the relative abundance of dinoflagellates and diatoms over the Peru shelf. *Coastal Upwelling Coast Estuarine Sci.* 1:357-365.
- KAMYKOWSKI, D.  
1981. Laboratory experiments on the diurnal vertical migration of marine dinoflagellates through temperature gradients. *Mar. Biol. (Berl.)* 62:57-64.
- KAMYKOWSKI, D., AND S. J. ZENTARA.  
1977. The diurnal vertical migration of motile phytoplankton through temperature gradients. *Limnol. Oceanogr.* 22:148-151.
- KIEFER, D. A., AND R. LASKER.  
1975. Two blooms of *Gymnodinium splendens*, an unarmored dinoflagellate. *Fish. Bull., U.S.* 73:675-678.
- MARGALEF, R.  
1978. Life-forms of phytoplankton as survival alternatives in an unstable environment. *Oceanol. Acta* 1:493-509.
- RHYTHER, J. H.  
1955. Ecology of autotrophic marine dinoflagellates with reference to red water conditions. *In* F. H. Johnson (editor), *The luminescence of biological systems*, p. 387-414. *Am. Assoc. Adv. Sci., Wash., D.C.*
- ROJAS DE MENDIOLA, B.  
1979. Red tide along the Peruvian coast. *In* D. L. Taylor and H. H. Seliger (editors), *Toxic dinoflagellate blooms*, p. 183-190.

Elsevier, N.Y.

THOMAS, W. H., A. N. DODSON, AND C. A. LINDEN.

1973. Optimum light and temperature requirements for *Gymnodinium splendens*, a larval fish food organism. Fish. Bull., U.S. 71:599-601.

RICHARD B. FORWARD, JR.

Duke University Marine Laboratory  
Beaufort, NC 28516-9721  
and  
Zoology Department, Duke University  
Durham, NC 27706

BLANCA ROJAS DE MENDIOLA

Instituto del Mar del Peru  
P.O. Box 22, Callao, Peru

RICHARD T. BARBER

Duke University Marine Laboratory  
Beaufort, NC 28516-9721

## MORPHOLOGY AND POSSIBLE SWIMMING MODE OF A YELLOWFIN TUNA, *THUNNUS ALBACARES*, LACKING ONE PECTORAL FIN

In September of 1982, the Mexican bait boat, *Paesa*, fishing off Baja California, captured a 36.5 cm fork length (861.2 g wet weight) yellowfin tuna, *Thunnus albacares*, that lacked a left pectoral fin (Fig. 1). The fish was frozen and was brought to the Inter-American Tropical Tuna Commission, La Jolla, CA, for study by W. H. Bayliff.

Pectoral fins provide virtually all hydrodynamic lift in scombrids and are essential for stable and efficient swimming at sustained speeds (Magnuson 1973, 1978). A specimen with only one pectoral fin raises questions on what ways the fish might have compensated for an asymmetrical decrease in hydrodynamic lift and how the presence of only one pectoral fin might have affected its locomotion. We examined the fish to determine what may have caused fin loss and whether morphology was noticeably altered in a manner suggesting some compensation.

Skin in the area where the left pectoral fin should have been was thin, smooth, and silvery in appearance (Fig. 1). There was neither a trace of pectoral fin remnants nor a skin groove for it, suggesting the fin had never formed. On the other hand, the appearance of the skin and the presence of variably sized scales in the area around the normal fin position is compatible with a healed wound, and we thus

could not rule out the possibility that the fin had been bitten off cleanly.

## Methods

The specimen was X-rayed and maximum body height and width measured. We measured and traced its median fins, caudal keel, pectoral fin, and both pelvic fins, and estimated their surface areas with a planimeter. The same body and fin measurements were made on similarly sized, preserved yellowfin tuna in the Scripps Institution of Oceanography Fish Collection (SIO). Morphometric data were compared with values derived from the literature (Gibbs and Collette 1967; Fierstine and Walters 1968; Magnuson 1973, 1978; Magnuson and Weininger 1978, app. II). Although some of the specimen's caudal rays were bent (Fig. 1), all rays were present, and the fin was extended to a more natural position before its span was measured and area (which was well defined) traced. Also, to avoid measurement errors noted by Fierstine and Walters (1968) and Magnuson (1978), care was taken not to overextend caudal fins during span measurement.

Density of the thawed fish was determined by water displacement (density = wet weight/displacement volume). The right and left pectoral girdles were then removed and the gas bladder was inspected. Transverse sections were cut (see Graham et al. 1983), concentric myotomal rings on the right and left sides were counted, and red and white muscle were weighed for each section.

## Results

The abundance of comparative morphometric and anatomical data for the yellowfin tuna permits a nearly complete assessment of the morphologic and hydrodynamic status of the one-finned specimen. The length (L; 36.5 cm)/weight (861.2 g) relationship and the density ( $1.080 \text{ g} \cdot \text{mL}^{-1}$ ) agree with values published for yellowfin tuna by Magnuson (1973, tables 1, 4). Also, the maximum thickness value (i.e., max. height + max. width/2 = 21.6% L) is within the range (20.5-23.0% L) measured for four SIO specimens (L from 28.5 to 42.5 cm) and near the value given by Magnuson (1973, table 7, 22.3% L). Finally, the point of maximum body thickness in the study fish (39.7% L) and that of SIO fish (36-40% L) are near Magnuson's value of 41.2% L (for fish from 28 to 45 cm L).

The dorsal fin of this fish is normal in shape, with 13 spinous rays, a maximum height of 3.5 cm and a surface area of  $9.5 \text{ cm}^2$ . The second dorsal fin is

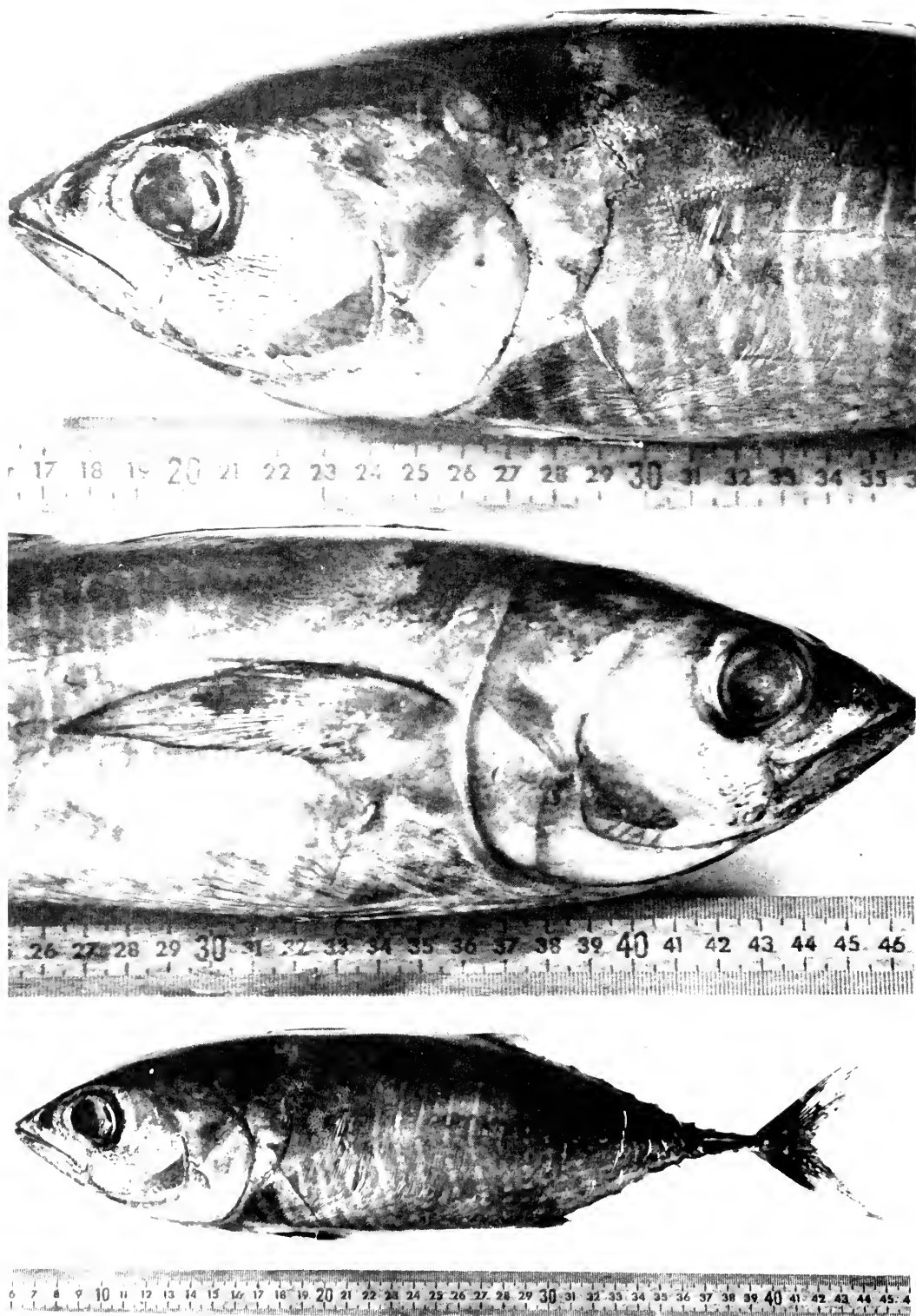

FIGURE 1.—Left- and right-side close-ups and a full-length, left-side photo of the *Thunnus albacares* with only one pectoral fin.



1 cm high and has an area of 2.0 cm<sup>2</sup>. The anal fin is also 1 cm high and has an area of 2.2 cm<sup>2</sup>. The combined total surface area of both sides of the second dorsal and anal fins is 8.4 cm<sup>2</sup>, which is larger than predicted (7.2 cm<sup>2</sup>) by the Magnuson and Weininger equation (1978, app. II). The total number of second dorsal and anal fin rays and dorsal and ventral finlets agrees with that for other yellowfin tuna (Gibbs and Collette 1967, table 1).

Table 1 compares caudal keel area and caudal and right pectoral fin dimensions of the study specimen and seven SIO fish of differing L. Also shown are values calculated for several of the same parameters using allometric equations for *T. albacares* (Magnuson 1978, table X; Magnuson and Weininger 1978, app. II). The caudal keel area of the one-finned fish (6.2 cm<sup>2</sup>) is smaller than the value expected from the equation (6.7 cm<sup>2</sup>) but is well within (i.e., 93%) the range of variation (77-102%) seen in the SIO specimens (Table 1). Comparison of the measured and the equation-derived caudal data for the one-finned fish with the same set of values for the next smallest (32.5 cm) and largest (37.0 cm) SIO fish indicates that the caudal fin of the one-finned fish has a slightly smaller span but larger area than would be expected for its L. This is further reflected

in its aspect ratio (AR; 4.63), which is lower than that of any of the SIO specimens. This lower value probably does not represent an artifact of preservation because in the other material caudal span and area increased directly with L. There is also general agreement between the measured and calculated values for each, showing that neither preservation nor measurement protocols affected caudal fin data. As would be expected from the underlying formulae, caudal AR calculated from the equations increases with L. However, among the measured data, there is no correlation between AR and L. It is also noteworthy that both the mean and predicted AR values of all of these small yellowfin (5.64, 5.34, Table 1) are in good agreement but well below the summary range (6.8-7.2) given for larger *T. albacares* by Magnuson (1978, table IX). This serves to emphasize that while AR may differ between species of scombrids (Magnuson 1978), it also varies within each species as a function of body size.

Both the length and area of the right pectoral fin of the one-finned fish are much less than those of the 37 cm SIO specimen (Table 1). When measured and computed pectoral fin areas are compared, there is good agreement between both values for the 37 and 42.5 cm L fishes but not for the 36.5 cm L one-

TABLE 1.—Comparative caudal and right pectoral fin measurements for the one-finned yellowfin tuna (36.5 cm L) and seven specimens of different lengths (L) from the SIO collection. Data for each fish includes the actual measured values (m) and values calculated (c) from equations in the footnotes (Magnuson and Weininger 1978, app. II).

Fork length (cm)	Caudal keel		Caudal fin		Right pectoral fin		
	Area <sup>1</sup> (cm <sup>2</sup> )	Span <sup>2</sup> (cm)	Area <sup>3</sup> (cm <sup>2</sup> )	Aspect ratio <sup>4</sup>	Length (cm)	(%L)	Area <sup>5</sup> (cm <sup>2</sup> )
25.8 m	2.7	9.5	12.7	7.11	5.63	(21.8)	6.7
c	3.1	6.8	9.9	4.67			9.4
28.5 m	3.8	8.0	12.3	5.20	6.00	(21.0)	5.3
c	3.8	7.7	12.1	4.90			11.3
31.5 m	3.7	9.0	15.8	5.13	7.71	(24.5)	11.1
c	4.8	8.8	14.8	5.23			13.5
32.5 m	4.8	10.0	15.7	6.37	7.25	(22.3)	10.6
c	5.2	9.1	15.8	5.24			14.2
<sup>6</sup> 36.5 m	6.2	10.0	21.6	4.63	7.50	(20.5)	12.8
c	6.7	10.5	20.0	5.51			17.5
37.0 m	5.3	11.0	21.6	5.60	9.67	(26.1)	17.8
c	6.9	10.7	20.6	5.56			17.9
40.0 m	8.5	12.5	25.4	6.15	10.40	(26.0)	<sup>7</sup> 14.3
c	8.3	11.7	24.1	5.68			20.6
45.0 m	8.8	12.2	30.3	4.91	11.00	(25.9)	25.3
c	10.8	13.5	30.7	5.92			25.4
m				$\bar{x}$ , SE 5.64, 0.30			
c				$\bar{x}$ , SE 5.34, 0.15			

<sup>1</sup>Caudal keel area =  $0.00198 L^{2.26}$ .

<sup>2</sup>Caudal span =  $-2.27 + 0.35 L$ .

<sup>3</sup>Caudal area =  $0.013 L^{2.64}$ .

<sup>4</sup>Aspect ratio =  $\text{Span}^2/\text{area}$ .

<sup>5</sup>Pectoral fin area =  $0.116 L^{1.79}/4$ .

<sup>6</sup>One-finned fish.

<sup>7</sup>Fin was torn.

finned fish. In general, application of the pectoral area equation to the smaller SIO fish (Table 1) does not result in close correspondence between estimated and observed areas, suggesting that the relationship derived from larger individuals does not fit smaller yellowfin tuna. The relative length of the pectoral fin in yellowfin tuna changes abruptly with size. In fish between about 35 and 42 cm L, pectoral fin length should normally be about 25% L (Gibbs and Collette 1967, fig. 26). This contrasts with the value for the one-finned fish of 20.5% L.

The left pectoral girdle is present, but clearly abnormal in gross examination. The posttemporal is reduced in overall size; the upper (pterotic) fork is somewhat reduced and lower (epiotic) fork weakly developed and without a flattened articular surface. The rear margin of the supracleithrum is eroded, and the lateral surface rough. The cleithrum is almost as large as that of the right side, but the lateral groove for muscle attachment is reduced, and the upper process that normally curves out over the scapula is absent. The scapula is a block of bone without an articular facet for the first pectoral ray, and the scapular foramen is represented by a slit in the lateral surface. The coracoid is much reduced posteriorly, and its reduced lower process is tightly applied to the cleithrum so that the interosseus space is almost absent. The pectoral actinosts may be represented by a small lump of bone that is tightly attached to the scapula. A number of bone chips

were embedded in the tissue overlying the pectoral girdle. The postcleithra appear to be essentially normal.

Elements in the left side of the pelvic girdle are larger and have a different orientation from those of the right. Also, the left pelvic fin is both smaller in area and shorter than the right (Fig. 2). Pelvic fin lengths and areas in the one-finned fish are left 2.9 cm, 3.2 cm<sup>2</sup>; right 3.5 cm, 4.7 cm<sup>2</sup>. Comparable values for the 37.0 L SIO fish are left 3.5 cm, 4.5 cm<sup>2</sup>; right 3.7 cm, 4.9 cm<sup>2</sup>. X-rays showed that the centra of vertebrae 19 and 20 are abnormal (Fig. 3). They lie parallel to one another and overlap by about 80% in the horizontal axis. There is considerable erosion of the adjoining surfaces of the two centra and their neural and haemal spines are displaced. This deformity, together with the reduced left pelvic fin, the absence of a left pectoral fin, and a deformed left pectoral girdle, suggests the presence of a congenital malformation.

As would be expected from our density findings, the gas bladder of the one-finned fish was small (17 × 5 mm, length × diameter), but about the same size as that of other yellowfin tuna (Magnuson 1973, 1978). Finally, we found no differences in the left and right body myotomes. The total red muscle was estimated to be 6.7% of wet weight, which is within the 95% confidence limits of the value reported for yellowfin tuna (5.2-7.8%) by Graham et al. (1983).



FIGURE 2.—Anterior ventral view showing the reduced size of the left pelvic fin.

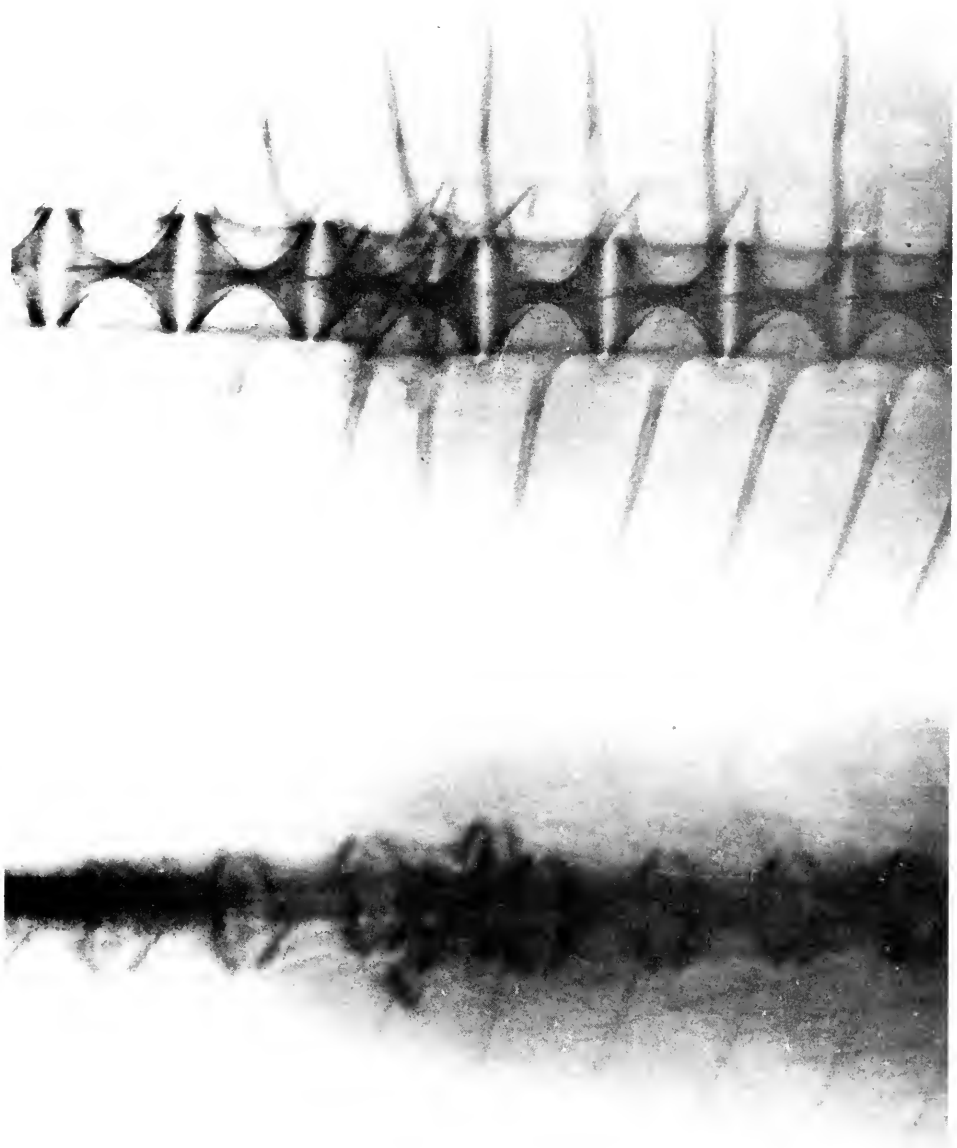

FIGURE 3.—Top: Right-side X-ray of the vertebral column showing the impacted vertebrae and the neural and haemal spine displacement. Bottom: Dorsal X-ray of the same vertebrae. Arrow indicates anterior. Scale is 2.5 cm.

Our study suggests that congenital defects led to the absence of a left pectoral fin, the formation of a small right pectoral and left pelvic fins, and to the impaction of two vertebrae. A smaller caudal span may also be a result of such defects. On the basis of age studies (Uchiyama and Struhsaker 1981) we estimate that this fish (36.5 L) was about 9 mo old when captured. (But, because of the vertebral damage, the fish is shorter than it should be and 9 mo is a conservative age estimate.) Thus in spite of significant locomotory handicaps, this fish had been swimming and feeding effectively at the time it was taken by hook and line.

Morphological comparisons with SIO specimens and with equation-derived values for similarly sized yellowfin tuna did not indicate any major structural differences in the one-finned fish that can be interpreted as having facilitated its swimming. However, since the absence of one pectoral fin doubtlessly affects the minimum speed required for hydrostatic equilibrium, the horizontal stability, and the maneuverability of a tuna, it is instructive to consider how the loss might have been compensated. Magnuson (1973, 1978) has amply demonstrated the role of the paired fins in providing lift and reducing minimum equilibrium speed. Total lift ( $L_t$ ) is calculated as

$$L_t \text{ (dynes)} = M \left[ 1 - \frac{\rho_e}{\rho_f} (g) \right], \quad (1)$$

where  $M$  is fish wet weight,  $\rho_e$  is seawater density,  $\rho_f$  is fish density, and  $g$  is the acceleration of gravity ( $980 \text{ cm} \cdot \text{sec}^{-2}$ ). The amount of lift needed by the one-finned fish ( $M = 861 \text{ g}$ ,  $\rho_f = 1.08$ ,  $\rho_e = 1.02$  at  $25^\circ\text{C}$ ) is  $47,203$  dynes.

The minimum speed for hydrostatic equilibrium  $U_{100}$  is determined by

$$U_{100} = \left[ \frac{L_t}{\rho_e / 2 (C_{L_p} A_p + C_{L_k} A_k)} \right]^{1/2}, \quad (2)$$

where  $C_L$  is the coefficient of lift for the pectoral fins ( $p$ ) and caudal keel ( $k$ ) and  $A_p$  and  $A_k$  are their respective areas (Magnuson 1973). Pectoral fin lift area includes both fins and the flat section of body between them (Magnuson 1978, fig. 4). This can be calculated from an allometric relationship (Magnuson 1973, table 4).

$$A_p = 0.0609 L^{1.87}, \quad (3)$$

and, for a 36.5 cm L yellowfin,  $A_p = 50.8 \text{ cm}^2$ . With this value, a measured keel area (Table 1) of  $6.2 \text{ cm}^2$ , and assuming a lift coefficient of 1.0 for both surfaces (Magnuson 1973, table 4) the calculated (Equation (2)) minimum speed for a 36.5 cm yellowfin tuna is  $40.3 \text{ cm} \cdot \text{s}^{-1}$ . The same calculation for the one-finned fish ( $A_p = 25.4 \text{ cm}^2$ ) yields a minimum speed of  $54.1 \text{ cm} \cdot \text{s}^{-1}$ , a 34.3% increase. The one-finned fish would need to swim faster, and thus expend more energy. Its higher speed would also probably have required it to make continuous velocity and position changes in order to keep pace with a school of, on average, similarly sized and thus slower swimming yellowfin tuna.

Alternatively the fish might have assumed a pitched (i.e., head up) swimming mode in an attitude such that its body surface would have contributed to hydrodynamic lift by having a positive angle of attack relative to the direction of motion, and the  $C_L$  of the caudal keel would be increased (Magnuson 1978). Of course this would result in increased pressure drag and require more swimming power, but it might have enabled the fish to swim more slowly.

Under any conditions, it seems likely that this fish was not highly maneuverable and would have difficulty remaining upright (i.e., not rolling to the left). It, of course, could not use its left pectoral for braking and left turns, and its left pelvic fin, which would also contribute to these actions, was less effective than normal because of its small size. Tunas normally accelerate with their first dorsal, pectoral, and pelvic fins appressed (Magnuson 1978), but as this fish slowed and needed lift it would have likely began to roll to its left as soon as its right pectoral fin was extended. This could be countered somewhat by its dorsal fin, but the necessity for unilateral use of the right pectoral fin should have always resulted in some amount of leftward roll and a tendency to turn to the right. Both the sharpness of the turn and the net upward or downward spiral movement of the fish would depend upon the degree of fin extension and swimming velocity.

Finally, to compensate for the tendency to roll it is possible that the fish habitually swam with its body tilted as much as  $80^\circ$  to the right. In this position it would retain the largest possible pectoral lift area and might gain sufficient additional lift from the dorsal, second dorsal, anal fins and the body surface to more than compensate for loss of keel lift. It is noteworthy that the second dorsal and anal fin areas of this fish are larger than predicted (see above). The fish would be able to roll from its side to an upright position merely by extending its pectoral fin a bit

farther. Also, side swimming would place both pelvic fins in a position where they could facilitate rapid left (now ventral) turns while possibly adding lift.

### Acknowledgments

This study benefited from funds provided by the Foundation for Ocean Research at SIO, and by University of California, San Diego, Biomedical and Academic Senate research grants. We thank Captain Jesus Yamamoto for saving the specimen for study and W. Bayliff for providing it to us. We also thank W. Klawe, W. Bayliff, and A. Dizon for commenting on the manuscript.

### Literature Cited

- FIERSTINE, H. L., AND V. WALTERS.  
1968. Studies in locomotion and anatomy of scombroid fishes. Mem. South. Calif. Acad. Sci. 6:1-29.
- GIBBS, R. H., AND B. B. COLLETTE.  
1967. Comparative anatomy and systematics of the tunas, genus *Thunnus*. Fish. Bull., U.S. 66:65-130.
- GRAHAM, J. B., F. J. KOEHRN, AND K. A. DICKSON.  
1983. Distribution and relative proportions of red muscle in scombrid fishes: consequences of body size and relationships to locomotion and endothermy. Can. J. Zool. 61:2087-2096.
- MAGNUSON, J. J.  
1973. Comparative study of adaptations for continuous swimming and hydrostatic equilibrium of scombroid and xiphoid fishes. Fish. Bull., U.S. 71:337-356.  
1978. Locomotion by scombrid fishes. In W. S. Hoar and D. J. Randall (editors), Fish physiology, Vol. 7, p. 239-313. Acad. Press, N.Y.
- MAGNUSON, J. J., AND D. WEININGER.  
1978. Estimation of minimum sustained speed and associated body drag of scombrids. In G. D. Sharp and A. E. Dizon (editors), The physiological ecology of tunas, p. 293-311. Acad. Press, N.Y.
- UCHIYAMA, J. H., AND P. STRUHSAKER.  
1981. Age and growth of skipjack tuna, *Katsuwonus pelamis*, and yellowfin tuna, *Thunnus albacares*, as indicated by daily growth increments of sagittae. Fish. Bull., U.S. 79:151-162.
- JEFFREY B. GRAHAM  
RICHARD H. ROSENBLATT  
DARC Y L. GIBSON

Physiological Research Laboratory and  
Marine Biology Research Division  
Scripps Institution of Oceanography  
La Jolla, CA 92093

## CHROMOSOMAL ANALYSIS OF ALBACORE, *THUNNUS ALALUNGA*, AND YELLOWFIN, *THUNNUS ALBACARES*, AND SKIPJACK, *KATSUWONUS PELAMIS*, TUNA

Chromosomal analysis is being used as part of an investigation of the population stock structure of the North Pacific albacore, *Thunnus alalunga*. There is a growing body of evidence (Brock 1943; Laurs and Lynn 1977; Laurs and Wetherall 1981; Laurs 1983) that North Pacific albacore are not as homogeneous as usually assumed (Clemens 1961; Otsu and Uchida 1963). Results from recent tagging studies suggest that northern and southern substocks constitute the North Pacific albacore population and that these proposed substocks have different migratory patterns (Laurs and Nishimoto 1979<sup>1</sup>; Laurs 1983). Laurs and Wetherall (1981) also found that the growth rates were significantly different in the two proposed substocks. In addition, the differences in growth rate are consistent with differences in length frequencies of albacore caught in commercial fisheries off North America (Brock 1943; Laurs and Lynn 1977).

In this paper we report results from chromosomal analysis using C-banding for albacore (from the proposed North Pacific southern substock) and compare them with similar results obtained for yellowfin, *Thunnus albacares*, and skipjack, *Katsuwonus pelamis*, tuna. We demonstrate that there is a chromosomal basis for placing the albacore and the yellowfin tuna in the genus *Thunnus* and that recognizable chromosomal differences exist between the genera *Thunnus* and *Katsuwonus*. These findings corroborate the taxonomy of the albacore and the yellowfin and skipjack tuna based on comparative anatomy (Gibbs and Collette 1967; Collette 1978).

The results reported here are from part of a larger study, which is helping us to evaluate if genetic heterogeneity exists in the North Pacific albacore population. Information on chromosome characteristics is scarce for fishes, and to our knowledge this is the first time chromosome analyses have been reported for scombrid fishes.

### Materials and Methods

All blood samples were collected from freshly caught fish either aboard the NOAA RV *David Starr Jordan* (August 1983) or aboard fishing boats

<sup>1</sup>Laurs, R. M., and R. N. Nishimoto. 1979. Results from North Pacific albacore tagging studies. U.S. Dep. Commer., Natl. Mar. Fish. Serv., SWFC Admin. Rep. LJ-79-17, 9 p.

(October-November 1983). Because albacore have a high titer of red blood cells (Alexander et al. 1980), it was expedient to separate the lymphocytes from the erythrocytes. The lymphocytes were isolated from the blood on a density gradient of ficoll-sodium diatrizoate solution using a modification of the technique developed by Boyum (1968), which is specific for the concentration of lymphocytes. We found that it was necessary to isolate the lymphocytes and place them in culture within a couple of hours after blood samples were collected. The ficoll gradient procedure was not successful using undiluted heparinized blood that was retained for more than a few hours.

Two albacore, three skipjack tuna, and four yellowfin tuna were sampled. All fish were juveniles which have virtually no sexual dimorphic characteristics, and no sex determinations were made. The estimated fork lengths of the fish ranged from 65 to 85 cm for albacore, 80 to 120 cm for yellowfin, and 45 to 55 cm for skipjack.

From each fish, an 8-10 mL sample of blood was withdrawn via sterile intracardial puncture into a syringe coated with 1,000 units/mL of heparin. Two mL aliquots of blood were pipetted into each of the four 15 mL centrifuge tubes, and 4 mL of cell culture medium<sup>2</sup> was added. The mixture was centrifuged at 20 *g* for 5 min, and the white cells and plasma were transferred to another centrifuge tube. This procedure for the separation of the plasma and white cell mixture was repeated three times following the suggestions given by Blaxhall (1981).

Five mL of the white cell-plasma mixture were layered over 3 mL of ficoll-sodium diatrizoate solution and centrifuged at 572 *g* for 30 min. The overlying plasma was removed carefully with Pasteur pipets, and the lymphocytes below were transferred to a culture tube containing 5 mL of marine teleost cell culture medium (Michael and Beasley 1973). This procedure resulted in an erythrocyte free culture of lymphocytes having a higher mitotic index. The cultures were incubated at 25°C for 3-5 d, at which time they were terminated and the cells harvested. The techniques for chromosomal analysis were patterned after those of Nowell (1960) for mammals because tuna are also endothermic (Graham and Dickson 1981). This work is an extension of the procedures developed by Kelly and Laurs (1983<sup>3</sup>).

Prior to harvesting the cells, 0.5 µg colcemid was added to 5 mL of culture medium and incubated for 2 h at 25°C. The culture was then centrifuged for 5 min at 180 *g* and the supernatant was replaced with 5 mL 0.075 M KCl for 10 min. The culture tubes were centrifuged again for 5 min at 180 *g*, and the supernatant was replaced with 3 mL of freshly prepared cold fixative which consists of 3 parts methyl alcohol to 1 part glacial acetic acid and mixed for 1 h. The tubes were again centrifuged at 180 *g* for 5 min, decanted, and fixed. The cell pellet plus 0.5 mL of fixative was retained for slide preparation.

Precleaned slides dipped in methanol and then in deionized water were used for slide preparations. Two drops of cell suspension were placed on the slide and 4 drops of fixative were immediately added. The slide was dried on a slide warmer at 37°C and stored at room temperature for 24-72 h prior to C-banding. The C-banding procedures were patterned after the work of Pardue and Gall (1970) and Arrighi and Hsu (1971).

In preparation for C-banding, the slides were placed in 0.2 N HCl for 15 min at 37°C, rinsed in deionized water, treated with saturated Ba(OH)<sub>2</sub> at room temperature for 7 min, and rinsed in deionized water. They were then immediately dipped again in 0.2 N HCl for 10 s and rinsed in deionized water. After the final rinsing the slides were incubated in 2× sodium chloride-sodium citrate solution at 60°C for 90 min and then stained for 90 min in Giemsa diluted with 1:10 Sorenson's buffer pH 6.8. Suitable metaphase figures were photographed at 1,008× magnification using a Zeiss<sup>4</sup> microscope equipped with a phase planapochromat 63/1.4 oil immersion lens.

## Results

### Chromosome Numbers

Kelly and Laurs (fn. 3) found that the diploid number of chromosomes for albacore was 48. We have confirmed this observation and have found that the diploid numbers for yellowfin and skipjack tuna are also 48. The modal frequencies of about 90 cells containing 48 chromosomes were 82.2% for albacore, 92.6% for yellowfin, and 80.5% for skipjack. Kelly and Laurs also observed that 85% of albacore cells had 48 chromosomes. Two polyploid cells with

<sup>2</sup>RPMI-1640 Sigma Cat. No. R6504.

<sup>3</sup>Kelly, Raymond M., and R. Michael Laurs. 1983. Summary of methods developed for investigations of albacore chromosomes and of findings made on number of chromosomes. Unpubl. field and laboratory notes and results (April 1983). [Raymond M. Kelly, School of Medicine, University of California, La Jolla, CA; R.

Michael Laurs, National Marine Fisheries Service, NOAA, La Jolla, CA.]

<sup>4</sup>Reference to trade names does not imply endorsement by the National Marine Fisheries Service, NOAA.

96 chromosomes were observed in skipjack, and one polyploid cell with 96 chromosomes was observed in albacore. No polyploid cells were observed in yellowfin.

### Chromosome Morphology

The albacore and the yellowfin and skipjack tuna were observed to have the same diploid chromosome number; however, their karyotype differed with respect to chromosome morphology. In this study, the chromosome pairs were arranged according to the morphology index (M), developed by Giannelli and Howlett (1967), which is obtained by dividing the length of the total haploid chromosome set  $p + q$  by the arm ratio ( $q/p$ ). Based on our evaluation of 256 metaphase cells (Table 1), we found that the chromosome morphology of the yellowfin (Fig. 1) is more similar to that of the albacore (Fig. 2) than the skipjack (Fig. 3). The differences in chromosome morphology were most apparent in the three largest pairs of chromosomes (Table 1). The morphology index (M) places the metacentric and submetacentric chromosomes of the albacore and yellowfin in the number 1 and 2 positions respectively. Chromosome 3 of the albacore is also submetacentric while chromosome 3 of the yellowfin is referred to as subtelocentric. The subtelocentric category is used to describe chromosomes in which the centromeres are displaced more towards the telomere when compared with submetacentrics. The metacentric

chromosome of the albacore was consistently larger than the metacentric of the yellowfin. The remaining 42 chromosomes were telocentric in the albacore and yellowfin. All of the chromosomes of the skipjack were telocentric.

### C-Banding Patterns

C-banding determinations were done to differentiate individual chromosome characteristics among the three species of tunas (Table 2). The centromeric regions of most of the chromosomes of all three species contained C-band constitutive heterochromatin. However, there were differences in the intensities of staining on comparable chromosomes among the three species. Intercalary C-banding was observed only in the skipjack tuna and there was variability in terminal banding among the three species.

In the albacore all chromosomes, except pair 10, showed C-banding in the centromeric regions with intense, prominent bands notably apparent in chromosome pairs 2 and 3 (Fig. 2). Terminal banding was restricted to chromosome pair 1 which had obscure C-bands on one arm of each homologue. No intercalary C-banding was observed in the albacore. There were some minor differences in the C-banding patterns between albacore and yellowfin tuna. In the yellowfin, the centromeric regions of all chromosomes were banded, the intensity of the banding in the centromeric region was uniform

TABLE 1.—Classification of chromosome morphology for albacore and yellowfin and skipjack tuna.

Chromosome number	Albacore	Yellowfin	Skipjack
1	metacentric	metacentric	telocentric
2	submetacentric	submetacentric	telocentric
3	submetacentric	subtelocentric	telocentric
4-48	telocentric	telocentric	telocentric

TABLE 2.—Summary of C-banding characteristics for albacore and yellowfin and skipjack tuna.

Location of bands	Albacore	Yellowfin	Skipjack
Centromeric region	Present on all chromosomes except pair 10; intensely prominent on pairs 2 and 3	Present on all chromosomes with uniform prominent intensity	Present on all chromosomes except pairs 10 and 19, great variability in intensity most prominent on pairs 1, 3, 4, 7, and 18
Terminal bands	Present on one arm of each homologue on pair 1; weakly developed	Weakly developed on chromosome pairs 1, 3, 7, 8, 14, 15, 21, & 24	Notably prominent in pair 4
Intercalary	None present	None present	Present on all chromosome pairs except 17 and 24

1



FIGURE 1.—Giemsa stained karyotype (upper row) and C-banding karyotype (lower row) of the same yellowfin tuna.

among all chromosomes, and terminal banding was weakly developed on eight pairs of chromosomes (Fig. 1). As in the albacore, no intercalary banding was observed in the yellowfin. The following significant differences were observed in the C-banding patterns between the skipjack and the other two species: 1) all chromosomes except 10 and 19 had C-banding in the centromeric region, 2) there was great variability in the intensity of staining in the

centromeric region, 3) terminal banding was notably prominent in chromosome pair 4, and 4) there were intercalary bands on all chromosomes except pairs 17 and 24.

**Discussion**

Our results assist in understanding speciation processes that have occurred in the evolution of the



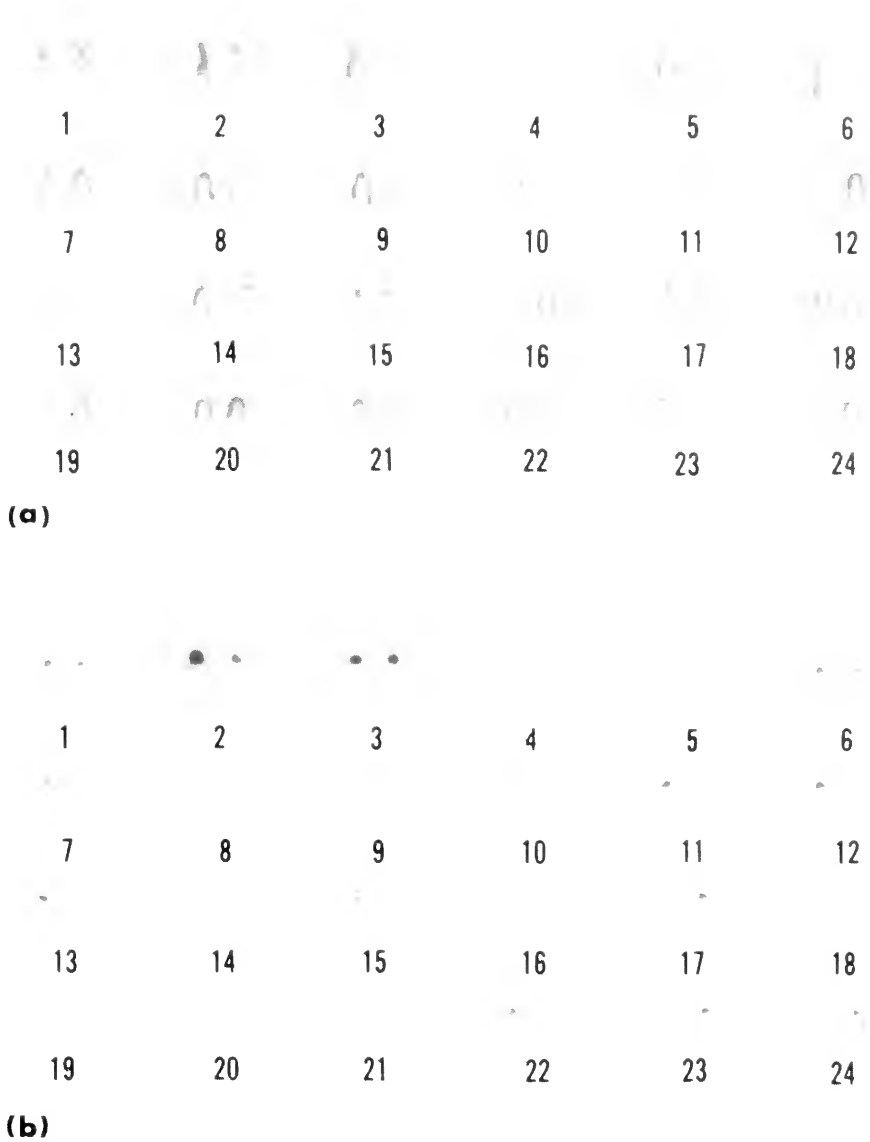

FIGURE 2.—Giemsa stained karyotype (a) and C-banding karyotype (b) from two different fish of the North Pacific albacore.

tuna. Gibbs and Collette (1967) proposed that seven species of tuna be included in the genus *Thunnus* on the basis of external morphological and internal anatomical characters. Our results demonstrate that there is a genetic basis for placing the albacore, *T. alalunga*, and the yellowfin tuna, *T. albacares*, in one genus *Thunnus* and the skipjack tuna, *Katsuwonus pelamis*, in a separate genus. These relationships are based on the assumption that

closely related species will share certain karyotypic characteristics.

The determination that the albacore, yellowfin tuna, and skipjack tuna have the same number of chromosomes suggests that speciation of the genera of Thunnini might have occurred by intrachromosomal rearrangement as opposed to Robertsonian changes as hypothesized for the rainbow trout, *Salmo gairdneri* (Thorgaard 1976). If speciation had

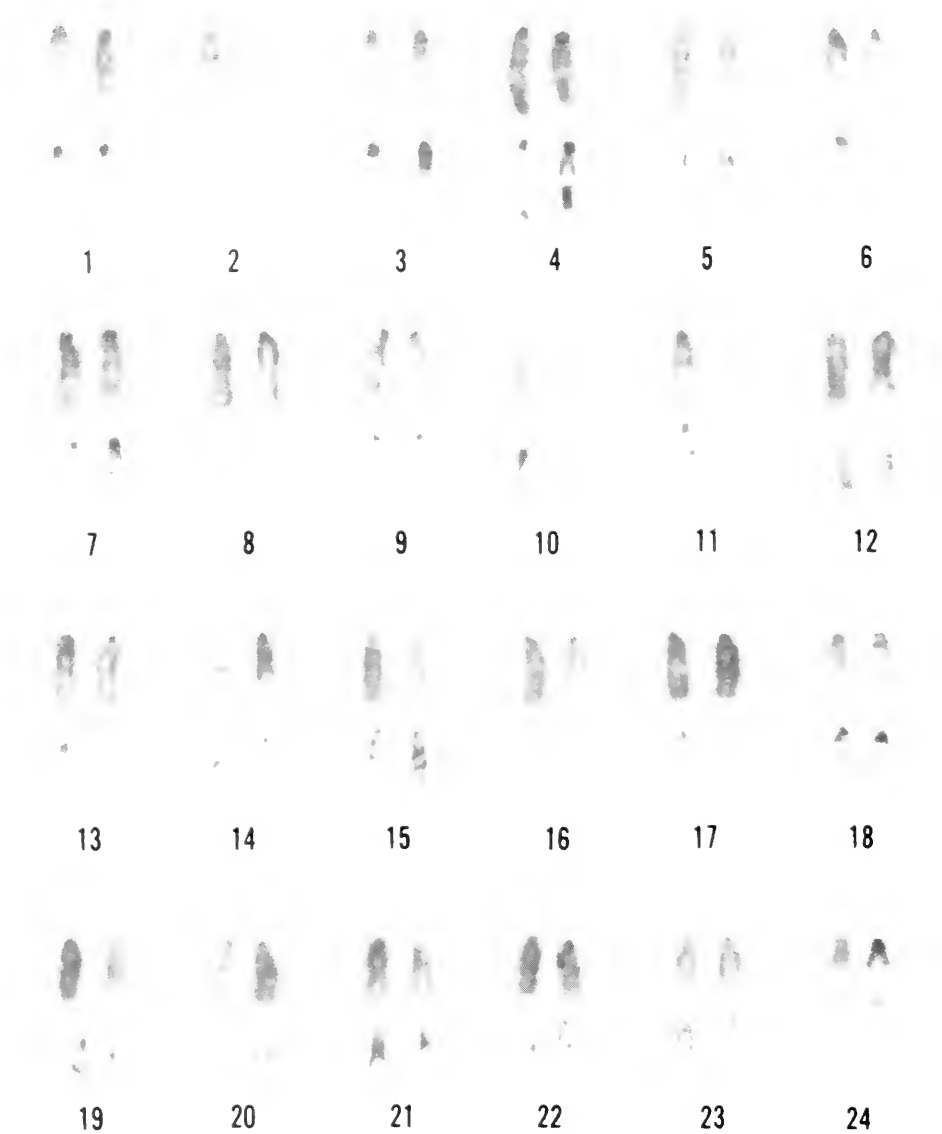

FIGURE 3.—Giemsa stained karyotype (upper row) and C-banding karyotype (lower row) of the same skipjack tuna.

involved a reduction in uniarmed chromosomes to form biarmed chromosomes, we would have expected to find a difference in the chromosome number between *Katsuwonus* and *Thunnus*.

It is probable that speciation within the genus *Thunnus* might also be related to chromosome rearrangement because the number of chromosomes is the same. Pericentric inversion is a type of intra-

chromosomal rearrangement that could result in the displacement of the centromere to convert a telocentric chromosome into a metacentric one. Zenzes and Voiculescu (1975) suggested that pericentric inversion was involved in the chromosomal organization of the brown trout, *Salmo trutta*. The extent to which this mechanism has been related to the speciation of genera *Thunnus* and *Katsuwonus* is

uncertain. However, the occurrence of terminal C-bands on chromosome 1 of the albacore and chromosomes 1 and 3 of the yellowfin tuna is consistent with the hypothesis that these banded chromosomes were derived from a unbanded condition. Indeed, White (1951) believed that, in grasshoppers, telocentric chromosomes are more primitive than the metacentric condition. Absence of terminal bands on chromosomes 2 and 3 of the albacore and chromosome 2 of the yellowfin tuna does not preclude the suggested derivation of metacentric chromosomes. It is possible that in the metacentric chromosomes lacking terminal bands, centromeric heterochromatin either was not moved or was lost. It is also possible that chromosome rearrangement in the speciation of the albacore and yellowfin occurred through changes in the euchromatic portions of chromosomes. To test this hypothesis it will be necessary to use G-banding techniques (Rishi 1978) to conduct analysis of these portions of the chromosomes.

In contrast to the albacore and yellowfin tuna, the telocentric chromosomes of the skipjack tuna showed a variety of intercalary and terminal C-banding in addition to those of the centromeric regions. An interesting condition was the polymorphic terminal heterochromatic block that occurred in chromosome pair number 4 of the skipjack, but not in the albacore or yellowfin. While the four specimens of skipjack analyzed had this polymorphism, it is not possible to comment on the frequency with which it might occur in the population. This type of differential banding also occurs in other fishes as demonstrated by Zenzes and Voiculescu (1975) who observed a difference in the size of C-bands in *Salmo trutta*. The C-band polymorphism we observed in skipjack could be related to the sex determining mechanism of the fish. However, we do not have any information on the sex of the skipjack used in this study and most fish do not have heteromorphic sex chromosomes (Zenzes and Voiculescu 1975; Thorgaard 1976; Kligerman and Bloom 1977). An exception occurs in the eels which have highly heteromorphic sex chromosomes (Park and Grimm 1981).

Analysis of C-banding patterns associated with the morphological differences in chromosomes has permitted us to identify all of the chromosome pairs of the albacore, yellowfin tuna, and skipjack tuna. We have demonstrated that karyotype analysis may provide a chromosomal basis for placing albacore and yellowfin in *Thunnus* and skipjack in *Katsuwonus*. Although C-banding techniques did not allow a detailed evaluation of the *Thunnus* chromosomes, we believe that the use of multiple banding procedures could provide important information on the

speciation and cytotaxonomy of the species of this commercially important genus. In addition, use of G-banding procedures will be an important next step in determining if genetic heterogeneity exists in the North Pacific albacore population.

#### Acknowledgments

We wish to thank A. Dean Stock (City of Hope Hospital, Duarte, CA) and James Mascarello (Children's Hospital, San Diego, CA) for many helpful suggestions, Raymond Kelly (University of California Medical School, San Diego, CA) for help in procurement of materials, and the personnel of the San Diego Sportsfishing Association, Captains Ed McEwen and Buzz Brizendine for space aboard their boats to make this work possible.

#### Literature Cited

- ALEXANDER, N., R. M. LAURS, A. MCINTOSH, AND S. N. RUSSELL.  
1980. Haematological characteristics of albacore, *Thunnus alalunga* (Bonnaterre), and skipjack *Katsuwonus pelamis* (Linnaeus). *J. Fish. Biol.* 16:383-395.
- ARRIGHI, F. E., AND T. C. HSU.  
1971. Localization of heterochromatin in human chromosomes. *Cytogenetics* 10:81-86.
- BROCK, V. E.  
1943. Contribution to the biology of the albacore (*Germo alalunga*) of the Oregon coast and other parts of the North Pacific. *Stanford Ichthyol. Bull.* 2:199-248.
- BLAXHALL, P. C.  
1981. A comparison of methods used for the separation of fish lymphocytes. *J. Fish. Biol.* 18:177-181.
- BOYUM, A.  
1968. Separation of leukocytes from blood and bone marrow. *Scand. J. Clin. Lab. Invest.*, 21, Suppl. 97:77.
- CLEMENS, H. B.  
1961. The migration, age, and growth of Pacific albacore (*Thunnus germo*), 1951-1958. *Calif. Dep. Fish Game, Fish Bull.* 115, 128 p.
- COLLETTE, B. B.  
1978. Adaptations and systematics of the mackerels and tunas. In G. D. Sharp and A. E. Dizon (editors), *The physiological ecology of tunas*, p. 7-88. *Acad. Press, N.Y.*
- GIANNELLI, F., AND R. M. HOWLETT.  
1967. The identification of the chromosomes of the E group (16-18 Denver): an autoradiographic and measurement study. *Cytogenetics* (Basel) 6:420-435.
- GIBBS, R. H., JR., AND B. B. COLLETTE.  
1967. Comparative anatomy and systematics of the tunas Genus *Thunnus*. *U.S. Fish Wildl. Serv., Fish. Bull.* 66: 65-130.
- GRAHAM, J. B., AND K. A. DICKSON.  
1981. Physiological thermoregulation in the albacore tuna *Thunnus alalunga*. *Physiol. Zool.* 54:470-486.
- KLIGERMAN, A. D., AND S. E. BLOOM.  
1977. Distribution of F-bodies, heterochromatin, and nucleolar organizers in the genome of the central mudminnow, *Umbra limi*. *Cytogenet. Cell Genet.* 18:182-196.

ABUNDANCE, SIZE, AND SEX RATIO OF  
ADULT SEA-RUN SEA LAMPREYS,  
*PETROMYZON MARINUS*,  
IN THE CONNECTICUT RIVER<sup>1</sup>

- LAURS, R. M.  
1983. The North Pacific albacore - an important visitor to California Current water. Calif. Coop. Oceanic Fish. Invest. Rep. 24:99-106.
- LAURS, R. M., AND R. J. LYNN.  
1977. Seasonal migration of North Pacific albacore, *Thunnus alabunga*, into North American coastal waters: distribution, relative abundance, and association with Transition Zone waters. Fish. Bull., U.S. 75:795-822.
- LAURS, R. M., AND J. A. WETHERALL.  
1981. Growth rates of North Pacific albacore, *Thunnus alabunga*, based on tag returns. Fish. Bull., U.S. 79:293-302.
- MICHAEL, S. M., AND A. R. BEASLEY.  
1973. Marine teleost fish tissues. In P. F. Kruse, Jr. and M. K. Patterson, Jr. (editors), Tissue culture methods and application, p. 134. Acad. Press, N.Y.
- NOWELL, P. C.  
1960. Phytohaemagglutinin: an initiator of mitosis in culture of normal human leukocytes. Cancer Res. 20:462-466.
- OTSU, T., AND R. N. UCHIDA.  
1963. Model of the migration of albacore in the North Pacific Ocean. U.S. Dep. Inter., Fish. Wildl. Serv., Fish. Bull. 63:33-44.
- PARDUE, M. L., AND J. G. GALL.  
1970. Chromosome localization of mouse satellite DNA. Science 168:1356-1358.
- PARK, E. H., AND H. GRIMM.  
1981. Distribution of C-band heterochromatin in the ZW sex chromosomes of European and American eels (Anguillidae, Teleostomi). Cytogenet. Cell Genet. 31:167-174.
- RISHI, K. K.  
1978. Giesma-banding in fish chromosomes. Current Science 47:393-394.
- THORGAARD, G. H.  
1976. Robertsonian polymorphism and constitutive heterochromatin distribution in chromosomes of the rainbow trout (*Salmo gairdneri*). Cytogenet. Cell Genet. 17:174-184.
- WHITE, M. J. D.  
1951. A cytological survey of wild populations of *Trimerotropis* and *Circotettix* (Orthoptera, Acrididae). II. Racial differentiation in *T. sparsa*. Genetics 36:31-53.
- ZENZES, M. T., AND I. VOICULESCU.  
1975. C-banding patterns in *Salmo trutta*, a species of tetraploid origin. Genetica 45:531-536.

F. J. RATTY

San Diego State University  
San Diego, CA 92182

Y. C. SONG

San Diego State University  
San Diego, CA 92182  
Present address:  
Wuhan University  
Wuhan, Peoples Republic of China

R. M. LAURS

Southwest Fisheries Center  
National Marine Fisheries Service, NOAA  
P.O. Box 271,  
La Jolla, CA 92038

Populations of sea-run sea lampreys, *Petromyzon marinus*, occur in many rivers on the east coast of North America from Labrador to Florida (Bigelow and Schroeder 1953). The Connecticut River in the northeastern United States is believed to have the largest population (Beamish 1980). Although the historical, upstream range of the sea lamprey in the Connecticut River is not known, it probably was similar to American shad, *Alosa sapidissima*, which migrated 280 km upstream to Bellows Falls, VT (Moffitt et al. 1982).

Upstream migration of anadromous fish species in the Connecticut River main stem was first restricted in 1798 by the construction of Turners Falls Dam at km 197, and further in 1849 by the construction of Holyoke Dam at km 140. The first upstream fish passage facility for anadromous fish was a fish lift at Holyoke Dam that began operating in 1955. Until 1969 the sea lampreys using the fish lift were counted and either killed or thrown back. From 1969 to 1984, they have been passed upstream each year. Sea lampreys have also used the fish ladders that were completed in 1980 and 1981 at Turners Falls and Vernon Dams, respectively. With the completion of the fish ladder at Bellows Falls Dam in 1984, migrants now have access to 350 km of main-stem river and many additional tributaries (Fig. 1).

The present report summarizes the annual counts of sea lampreys from 1958 to 1984 at the two Holyoke fish lifts (a second fish lift was added in 1976). We also examined the sex ratio, total length, and weight of adults in 1981-82 and compared these characteristics with those of the population in the St. John River, New Brunswick. Beamish et al. (1979) sampled the St. John River population at km 140, at a fish lift located at Mactaquac Dam.

## Methods

Sea lampreys that were lifted above the dam were counted each year from 1958 to 1984, except for the period from 1969 to 1974. From 1958 to 1968, sea lampreys were counted by personnel of the Holyoke Water Power Company (the owner of the dam), and

<sup>1</sup>Contribution No. 95 of the Massachusetts Cooperative Fishery Research Unit, which is supported by the U.S. Fish and Wildlife Service, Massachusetts Division of Fisheries and Wildlife, Massachusetts Division of Marine Fisheries, and the University of Massachusetts.

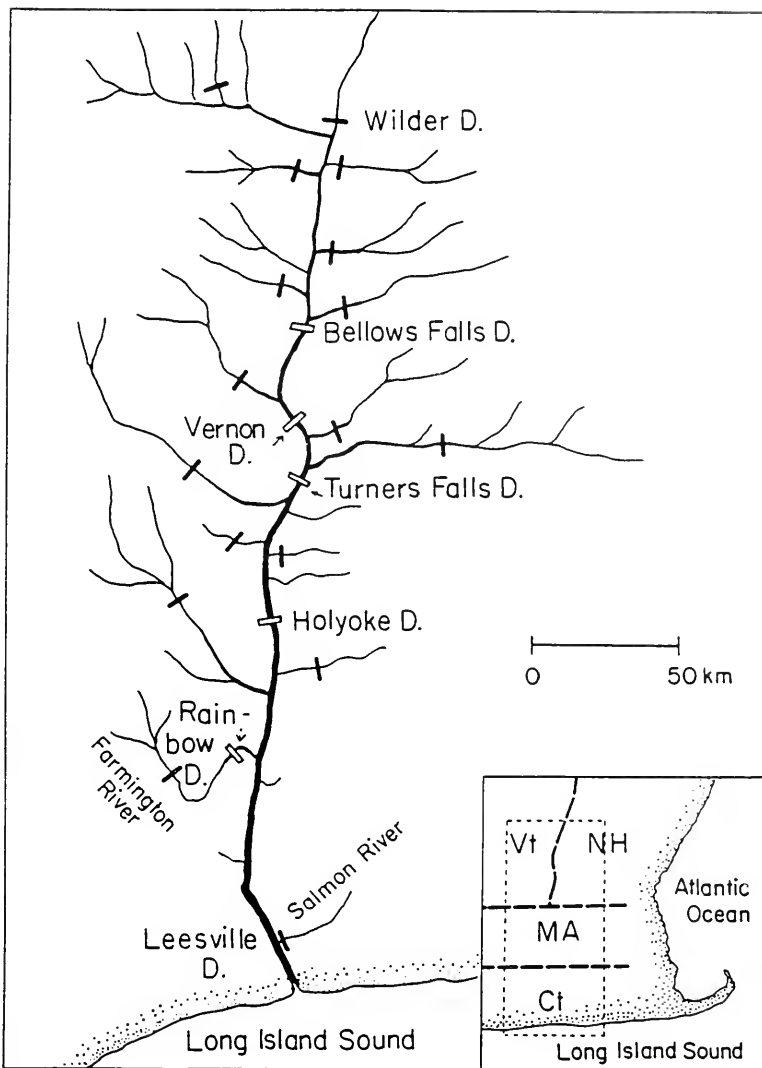

FIGURE 1.—Map of the Connecticut River showing the location of Holyoke Dam and the other dams with fishways on the lower 350 km of the main stem and major tributaries. Dams that sea lampreys can pass are designated by an open bar; dams they cannot pass are designated by a solid bar.

from 1975 to 1984, they were counted by personnel from either the Massachusetts Division of Fisheries and Wildlife or the Massachusetts Cooperative Fishery Research Unit. Until 1975, fish of all species were lifted, deposited into small carts, carried across the dam, and counted as they were released. Beginning in 1975, all fish were sluiced directly from the fish lift bucket into a large flume and were counted through a glass window in the side of the flume as they swam upstream. The accuracy of these counts has not been experimentally determined. However, the counts are probably very accurate because the

sea lampreys are large and swim slowly through the flume.

We collected sea lampreys daily at the fish lift trap from 1 May to 10 June 1981, and from 10 May to 30 June 1982 for determination of total length (TL) and sex. The number of sea lampreys sampled each day was proportional to the number lifted the previous day. The number of sea lampreys lifted and (in parenthesis) the number collected follow: 0-50 (2); 51-100 (4); 101-200 (6); 201-400 (8); 401-800 (10); 801-1,000 (15); 1,001-2,000 (25); 2,001-3,000 (30); 3,001-5,000 (40); >5,000 (50). in both years, total

length was measured to the nearest millimeter and sex was determined by dissection. We determined the sex ratio for each day of the run to observe changes during the migration. In 1982 each sea lamprey was also weighed to the nearest gram. Chi-square tests were used to compare the sex ratios for differences from a 1:1 frequency. Student's *t*-test was used to compare the males and females for mean length and weight. We compared males and females for the length-weight relationship by calculating a separate regression for each sex using the logarithmic equation:  $\log w = \log a + (b) (\log l)$  (Ricker 1975).

## Results and Discussion

### Abundance

The numbers of sea lampreys lifted from 1958 to 1967 were relatively few, and probably reflected the inefficiency of the fish lift rather than a small population (Fig. 2). After the flume and second lift were added in 1975 and 1976, respectively, 22,000-53,000 adults have been passed upstream each year. The 53,000 counted in 1981 was the largest number ever passed at Holyoke and the largest run documented in any river. In 1981, 59% of the total run was lifted

during the week of 24-30 May; and in 1982, 68% were lifted during the week of 28 May-3 June. Beamish (1980) reported that about 8,600 sea lampreys are lifted annually in the fish lift at Mactaquac Dam. He estimated the spawning populations in other northern streams at <8,000.

The sea lampreys that reach Holyoke Dam are only a portion of the total run, because several tributaries below the dam support populations (Whitworth et al. 1976). The sea lamprey population may increase as adults gain access to additional spawning and rearing habitat in headwater streams by using fish passage facilities constructed for Atlantic salmon, *Salmo salar*, and American shad (Moffitt et al. 1982). Thus, the restoration program designed primarily for Atlantic salmon and American shad is also restoring the sea lamprey to additional habitat. Since 1975, over 20,000 sea lampreys have been passed each year at Holyoke Dam and given access to new spawning and rearing habitat. The estimated life span of sea lampreys in the St. John River is estimated at 9-12 yr (Beamish and Potter 1975). Therefore, if the Connecticut River population returns to their natal stream and has a similar life cycle, and if the strength of the year classes after 1975 was enhanced by the additional rearing habitat above Holyoke, then beginning in

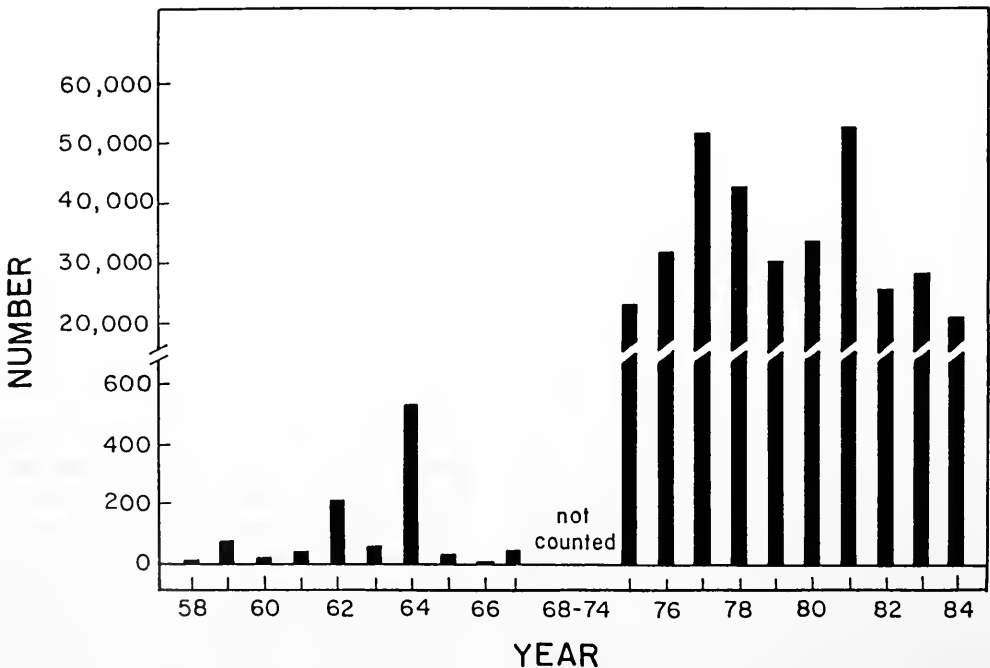

FIGURE 2.—Number of adult sea lampreys lifted in the Holyoke fish lifts each year, 1958-84.

1984 there should be increased returns of adults at Holyoke. The return of sea lampreys at Holyoke in 1984 was not a record return, but this could be due to the high discharge caused by the 50-yr flood that occurred in early June 1984, when most sea lampreys are lifted. If the sea lamprey population increases, the wound frequencies should increase on host species of marine and anadromous fish.

### Sex Ratio

Sex ratios for both years were skewed from 1:1 in favor of males, but the ratio was only significant in 1982: in 1981, 56% were males (ratio: 1.3:1;  $\chi^2 = 3.4$ ,  $P > 0.05$ ; in 1982, 62% were males (ratio: 1.6:1;  $\chi^2 = 11.6$ ,  $P < 0.005$ , Table 1). Sex ratios also changed during the spawning migration with the proportion of males increasing late in the run. The percent of males in the early and late periods were 55 and 59% in 1981 and 59 and 67% in 1982. The increase in the proportion of males was not significantly different from a 1:1 ratio in 1981, but the increase was significant in 1982 ( $\chi^2 = 7.6$ ;  $P < 0.01$ ). Applegate (1950) found that males in landlocked sea lamprey populations increased to about 75% in the late part of the run. The reason for this phenomenon is unknown.

Males are the most abundant sex in stable populations of sea-run and landlocked sea lampreys. Beamish et al. (1979) reported 55% males (ratio: 1.36:1) in nearly mature adults in the St. John River in 1974-77 (Table 1). Davis (1967), who collected anadromous sea lampreys for 5 yr from Barrows Stream, ME, reported a male:female ratio of 1.9:1; however, the sample size was very small ( $N = 66$ ). Potter et al. (1974) found an excess of males in land-

locked sea lamprey (ratio: 1.26:1). The sex ratio in stable populations (where males are more abundant than females) is different from the ratio in populations from the upper Great Lakes, where an excess of females is typical of populations being eradicated or controlled (Smith 1971). Sex ratios in sea lampreys also vary with cycles of abundance (Wigley 1959; Smith 1971), and temperature and nutrition may differentially affect growth and survival of male and female ammocoetes (Hardisty 1954).

### Total Length and Weight

In 1981, 464 sea lampreys (0.9% of the number lifted) were measured for total length; in 1982 the number examined was 404 (1.5% of the number lifted). There was no significant difference between the mean length of males and females during either year or for both years (Student's *t*-test:  $P > 0.05$ , Table 1). Length of females and males ranged from 60 to 85 cm in both years.

The similarity in mean total length of adults in the consecutive spawning runs of 1981-82 suggests relative stability of the sea lamprey population. This differs greatly from the unstable sea lamprey populations in the Great Lakes where body length decreased from 1950's to 1960's—changes related to decreases in food supply and changes in the environment (Smith 1971).

The mean weight of females was not significantly different from the mean weight of males (Student's *t*-test:  $P > 0.05$ , Table 1). We determined the length-weight relationship by using the regression equations:  $\log w = -3.42 \pm (2.21) (\log l)$ , ( $r^2 = 0.75$ ,  $P < 0.01$ ) for females and  $\log w = -3.11 \pm (2.10) (\log l)$ , ( $r^2 = 0.76$ ,  $P < 0.01$ ) for males. There was no significant difference between the slopes of the regression lines, consequently we combined males and females ( $N = 404$ ). Using the equation  $y = b + mx$  or  $\text{weight} = b + (\text{slope}) (\text{length})$ , a highly significant correlation ( $r^2 = 0.76$ ,  $P < 0.01$ ) was found for the regression equation:  $\text{weight} = 521.9 + (0.23890) (\text{length})$ . The length-weight relationship is linear, rather than sigmoid, as it is in most fishes. Because the body is attenuate, the weight of sea lampreys does not increase as rapidly with length as it does in most other fishes. This relationship is less evident in females, possibly because of the additional weight of their eggs.

Generally, in landlocked populations, females are slightly heavier than males because of their high fecundity (Applegate 1950). We also found this was true. Although the sea lampreys at Holyoke Dam were similar in length to those in the St. John River,

TABLE 1.—Mean total length and weight (SE in parenthesis), and percent males in sea lampreys sampled at Holyoke Dam, Connecticut River, compared with samples collected from the Mactaquac Dam, St. John River.

Dam & year	N	Mean length (cm)		Mean length (cm)		Percent male
		Male	Female	Male	Female	
Holyoke						
1981	464	71.3 (2.8)	71.5 (2.9)	—	—	56
1982	404	71.4 (2.7)	71.1 (3.6)	79.4 (8.2)	80.6 (12.01)	62
Mactaquac <sup>3</sup>						
1974-77	341	72.4 (4.7)	72.9 (5.1)	86.8 (18.1)	88.5 (18.3)	55

<sup>1</sup>249 males were weighed.

<sup>2</sup>155 females were weighed.

<sup>3</sup>Data from Beamish et al. (1979);  $\pm$  95% confidence limits in parenthesis.

the average weight of Connecticut River fish was considerably less (Table 1). The difference in average weight between sea lampreys in the two populations is not due to the difference in location of upstream sampling sites, but possibly to differences in energetic requirements, food supplies, or some aspect of the environment during the oceanic parasitic phase. A difference in weight between populations has previously been found in landlocked sea lampreys in the Great Lakes (Smith 1971).

### Acknowledgments

This project was supported by Federal Aid Project AFS-4-R-21 and D-J Project 5-29328 to the Massachusetts Division of Fisheries and Wildlife and the Massachusetts Cooperative Fishery Research Unit. We thank P. Eschmeyer for a valuable review of the manuscript.

### Literature Cited

- APPLEGATE, V. C.  
1950. Natural history of the sea lamprey, *Petromyzon marinus*, in Michigan. U.S. Fish Wildl. Serv., Spec. Sci. Rep.—Fish. 55, 237 p.
- BEAMISH, F. W. H.  
1980. Biology of the North American anadromous sea lamprey, *Petromyzon marinus*. Can. J. Fish. Aquat. Sci. 37: 1924-1943.
- BEAMISH, F. W. H., AND I. C. POTTER.  
1975. The biology of the anadromous sea lamprey (*Petromyzon marinus*) in New Brunswick. J. Zool. (Lond.) 177: 57-72.
- BEAMISH, F. W. H., I. C. POTTER, AND E. THOMAS.  
1979. Proximate composition of the adult anadromous sea lamprey, *Petromyzon marinus*, in relation to feeding, migration and reproduction. J. Anim. Ecol. 48:1-19.
- BIGELOW, H. B., AND W. C. SCHROEDER.  
1953. Fishes of the Gulf of Maine. U.S. Fish Wildl. Serv., Fish. Bull. 53:1-577.
- DAVIS, R. M.  
1967. Parasitism by newly-transformed anadromous sea lampreys on landlocked salmon and other fishes in a coastal Maine lake. Trans. Am. Fish. Soc. 96:11-16.
- HARDISTY, M. W.  
1954. Sex ratio in spawning populations of *Lampetra planeri*. Nature (Lond.) 173:874-875.
- MOFFITT, C. M., B. KYNARD, AND S. G. RIDEOUT.  
1982. Fish passage facilities and anadromous fish restoration in the Connecticut River basin. Fisheries (Bethesda) 7(6): 2-11.
- POTTER, I. C., F. W. H. BEAMISH, AND B. G. H. JOHNSON.  
1974. Sex ratios and lengths of adult sea lampreys (*Petromyzon marinus*) from a Lake Ontario tributary. J. Fish. Res. Board Can. 31:122-124.
- RICKER, W. E.  
1975. Computation and interpretation of biological statistics of fish populations. Fish. Res. Board Can., Bull. 191:1-382.
- SMITH, B. R.  
1971. Sea lampreys in the Great Lakes of North America.

- In M. W. Hardisty and I. C. Potter (editors), The biology of lampreys, Vol. 1, p. 207-247. Acad. Press, Lond.
- WHITWORTH, W. R., P. L. BERRIEN, AND W. T. KELLER.  
1976. Freshwater fishes of Connecticut. State Geol. Nat. Hist. Serv. Conn., Dep. Environ. Prot., Bull. 101, 134 p.
- WIGLEY, R. L.  
1959. Life history of the sea lamprey of Cayuga Lake, New York. U.S. Fish Wildl. Serv., Fish. Bull. 59:560-617.

KATHLEEN STIER  
BOYD KYNARD

Massachusetts Cooperative Fishery Research Unit  
204 Holdsworth Hall  
University of Massachusetts  
Amherst, MA 01003

### AN IMPROVED OTTER SURFACE SAMPLER

Field trials using a neuston sampler described by Sameoto and Jaroszynski (1969) revealed serious sampling problems associated with coastal waters of British Columbia. Due to extensive freshwater runoff in the vicinity of large rivers, sampling conditions including choppy surface waters of lowered salinity and vertically depressed distributions of near-surface larval and juvenile fishes. Under such conditions, the S-J sampler behaved erratically, throwing considerable spray, and, when adjusted to increase depth of tow, the body and control surfaces deformed at speeds in excess of 5 knots. The modifications described here reflect our objectives of improving performance, increasing durability, and ease of handling, without increasing costs other than those incurred by adding a flowmeter to provide quantitative catches. The complete unit is depicted in Figure 1.

### Detailed Description

#### Sampler Box

Constructed of 1/8" marine aluminum, this aluminum is folded into a body with one welded seam (Fig. 2). The leading edges are reinforced with 1/4" aluminum for attaching the bridles and depressor. The square mouth opening was sized to accommodate 0.25 m<sup>2</sup> bongo nets having a circumference of 185 cm. Body dimensions are 46 × 46 × 60 cm.



## PERSPECTIVE - NEUSTON SAMPLER

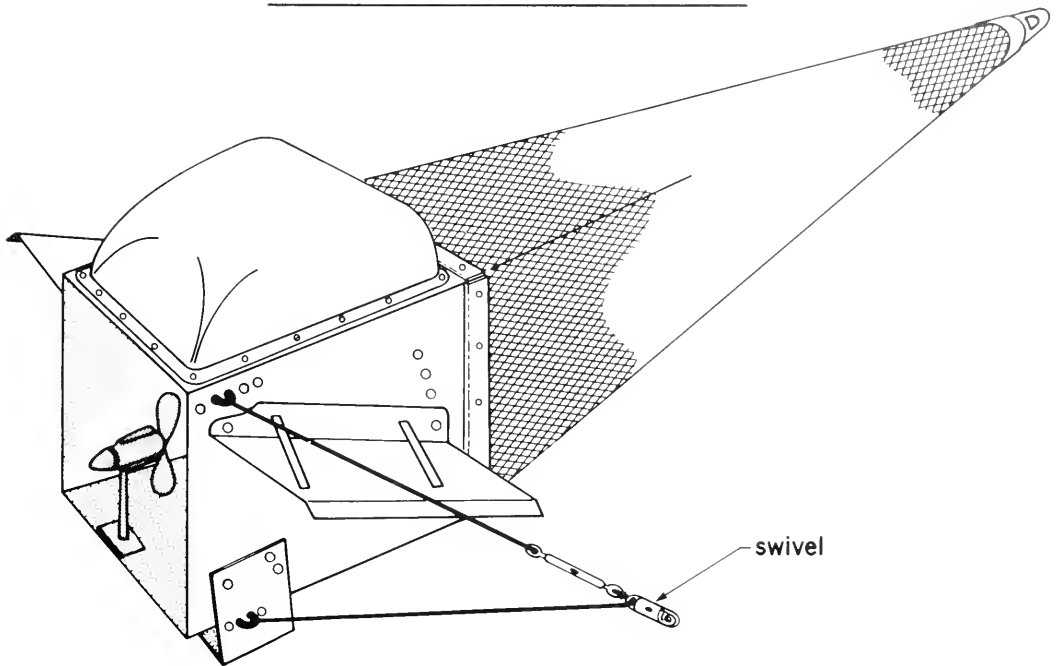

FIGURE 1.—Neuston sampler with net cod-end attached.

### **Net Attachment**

We replaced the grommet and bolt-through net fastening system of the S-J sampler with an aluminum channel clamp (Fig. 2). Net slippage is prevented by sewing a 1/4" rope into the net collar. Stainless steel bolts remain permanently attached to the sampler body so that, to mount or replace the net, it is merely slid over the box and the channel placed over the bolts and secured. One man can replace the net in 5 min.

### **Lateral Wings**

Individual fins bolt directly to the sides of the body and are made of 1/8" aluminum with the inside edge bent at 90° for an attachment face (Fig. 3). The outer edge is bent downward 15° to stiffen it and to reduce side slippage under tow. The wings pivot on a bolt anteriorly and are adjusted through a series of holes in the sampler body (Figs. 1, 2).

### **Depressor**

Bolted directly to the body and adjusted as for the wings (Figs. 1, 2), the depressor is made from 1/4"

marine aluminum bent at right angles on either end for attachment (Fig. 3). It serves also as the lower towing point and stiffens the body.

### **Tow Points**

The sampler is adjusted in relation to the towing vessel by a stainless steel turnbuckle on the upper bridle (roll aspect), and by selecting the lower tow point (depressor) and upper tow point (leading top corner of the body) from a series of holes (Figs. 1, 2, 3). The tow point fastening is a threaded U-bolt, fastened on both sides of the sampler frame (Fig. 3).

### **Flotation**

A streamlined float constructed of fibreglassed, polyurethane foam which bolts to the upper face of the body (Figs. 1, 2). At neutral buoyancy the sampler floats with the mouth opening just below the water surface. As with the S-J sampler, vertical positioning under tow is the balanced outcome of downward depressor force and lift from the lateral fins. These adjustments are made to maintain an 8-10 cm headspace of air in the sampler while under tow.

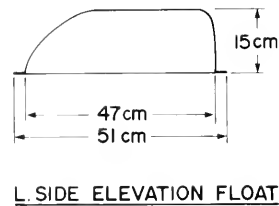
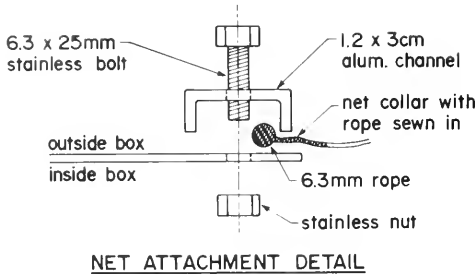
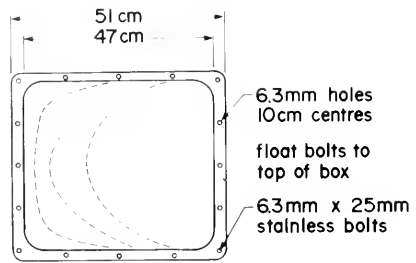
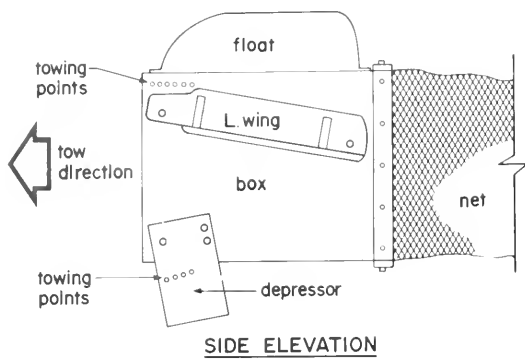

to accept standard 1/4m<sup>2</sup>  
(184 cm circum) plankton net

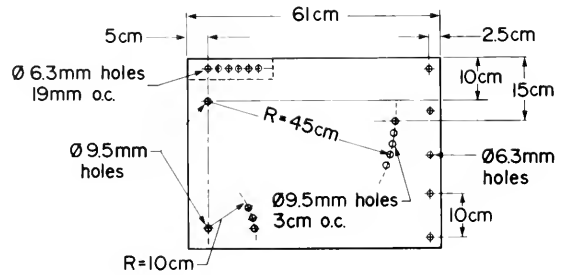
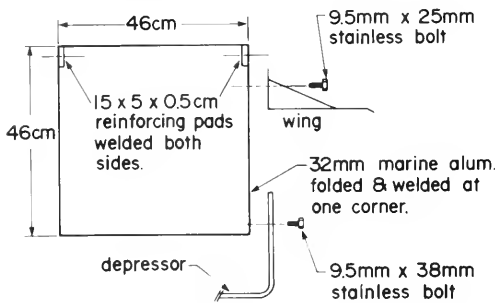

FIGURE 2.—Scale drawings of the sampler body and float, and net attachment detail.

### Flowmeter

A General Oceanics meter is attached inside the body by means of a hinged strut which folds forward to facilitate reading the meter (Figs. 1, 3). The meter is free-pivoting in the horizontal plane and offset 17 cm from the center of the mouth opening.

### Evaluation

This modified version of the otter neuston sampler

has been used extensively since 1981, offshore to Station Papa (Mason et al. 1983) and in inside waters under all weather conditions, including a full gale. It performs best when towed into or across the wave direction at 4-6 knots. At higher speeds, disturbance due to backsplash from the fins and bridal may cancel out potential advantage of further increase in tow speed. Sampling efficiency is deemed to be relatively high when using a 500  $\mu$ m mesh net at night. Catches of juvenile fishes in the Strait of Georgia are quantitatively comparable with those

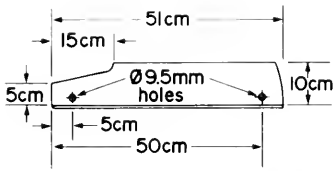

L. WING - SIDE ELEVATION

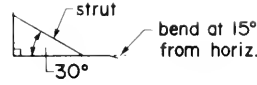

WING-FRONT ELEVATION

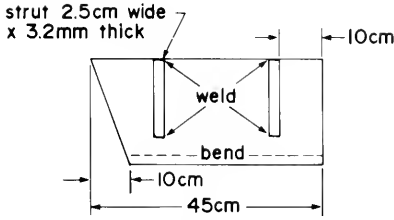

L. WING PLAN VIEW

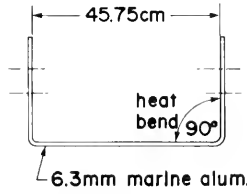

DEPRESSOR-FRONT ELEVATION

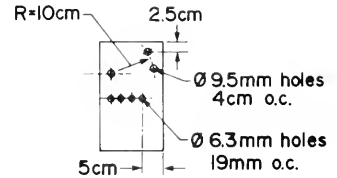

SIDE ELEVATION

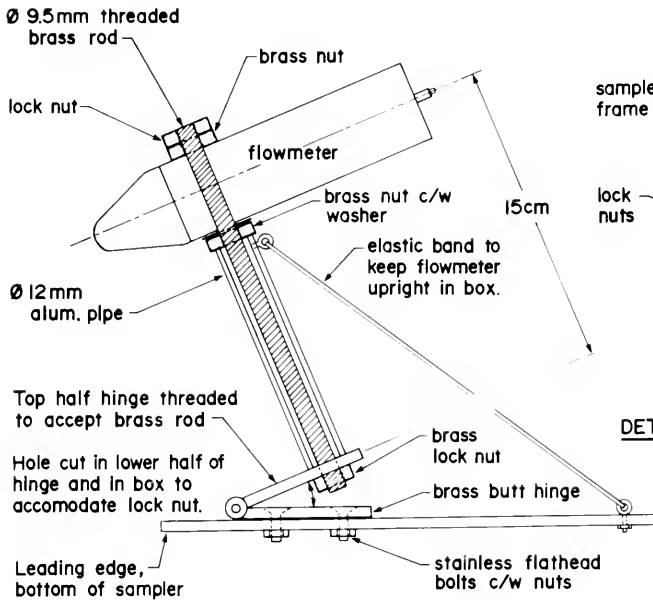

FLOWMETER ATTACHMENT DETAIL

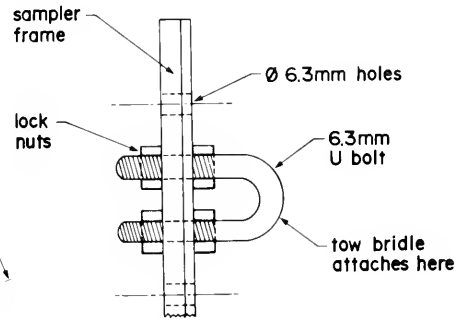

DETAIL OF TOW POINTS

FIGURE 3.—Scale drawings of the depressor and wings, and tow point and flowmeter details.

made with a large volume, two-boat surface trawl as employed by Barraclough et al. (1966). We found no significant difference (student's *t*-test) between mean total catch (12.9 and 12.1 fish/100 m<sup>3</sup>) for nine taxa common to both gears in eight pairs of tows made locally in the Strait of Georgia, British

Columbia, during March-April. Among the fish sampled by this gear in offshore and shelf waters are juvenile Pacific salmon to 14 cm, Pacific saury to 25 cm, juvenile sablefish, rockfish, greenlings, and squid, in addition to the routine catches of ichthyoplankton and general zooplankton.

## Literature Cited

BARACLOUGH, W. E.

1967. Number, size and food of larval and juvenile fish caught with a two-boat surface trawl in the Strait of Georgia, April 25-29, 1966. Fish. Res. Board Can., Biol. Stn. Nanaimo, B.C., Manusc. Rep. Ser. 922, 54 p.

MASON, J. C., R. J. BEAMISH, AND G. A. MCFARLANE.

1983. Sexual maturity, fecundity, spawning, and early life history of sablefish (*Anoplopoma fimbria*) off the Pacific coast of Canada. Can. J. Fish. Aquat. Sci. 40:2126-2134.

SAMEOTO, D. D., AND L. O. JAROSZYNSKI.

1969. Otter surface sampler: a new neuston net. J. Fish. Res. Board Can. 26:2240-2244.

J. C. MASON  
A. C. PHILLIPS

*Pacific Biological Station  
Fisheries Research Branch  
Department of Fisheries and Oceans  
Nanaimo, British Columbia V9R 5K6, Canada*

### MORPHOLOGICAL EVIDENCE FOR STARVATION AND PREY SIZE SELECTION OF SEA-CAUGHT LARVAL SABLEFISH, *ANOPOLOPOMA FIMBRIA*

One of the major causes of larval mortality is starvation, this being related to the patchiness of food resources (Hunter 1981). While starvation has been induced under laboratory conditions [e.g., herring, *Clupea harengus*, and plaice, *Pleuronectes platessa* (Ehrlich et al. 1976); northern anchovy, *Engraulis mordax* (O'Connell 1976); jack mackerel, *Trachurus symmetricus* (Theilacker 1978, 1981)], starved larvae have rarely been observed in nature (northern anchovy, O'Connell 1980; jack mackerel, Theilacker 1986). Various methods have been used to characterize starvation in fish larvae, including condition factor (Blaxter 1971), chemical analyses (Ehrlich 1974), histological analyses (Umeda and Ochiai 1975; O'Connell 1976, 1980; Theilacker 1978, 1986), and morphological analyses (Shelbourne 1957; Nakai et al. 1969; Ehrlich et al. 1976; Theilacker 1978, 1981, 1986). While histological and chemical analyses are based on qualitative changes in tissues that result from starvation, their methodologies require special preservation techniques, negating their application to samples preserved without these techniques in mind. To characterize starvation in samples that have not been specially preserved, measures of morphology and/or condition factor are more appropri-

ately applied. In the present study, in the absence of special preservation techniques, the occurrence of starvation in sea-caught larval sablefish, *Anoplopoma fimbria*, was examined using morphological measures.

The sablefish inhabits the continental shelf of the North Pacific Ocean and is the subject of an intensifying fishery off the west coast of North America, yet little is known about the early life history of the species. Recent evidence obtained off Canada suggests that sablefish spawn in water deeper than 300 m, with spawning activity peaking in February. Eggs (1.8-2.2 mm in diameter) descend while developing, and hatching probably occurs at depths in excess of 400 m (Mason et al. 1983). Although size at hatching and the size at first feeding have not been clearly defined, Mason et al. (1983) reported collecting recently hatched larvae of 5-6 mm. After hatching, larvae ascend to surface waters and become neustonic (Kendall and Clark 1982<sup>1</sup>). Juveniles apparently remain in shallow water until they mature. Beyond reports of distribution (Kendall and Clark fn. 1; Clark 1984<sup>2</sup>) and descriptive work (e.g., Kobayashi 1957; Ahlstrom and Stevens 1976), studies of larval and early juvenile sablefish have concentrated on aging and growth (Boehlert and Yoklavich 1985; Shenker and Olla in press).

Our aim in the present study was to detect the possible occurrence of starvation in larval sablefish collected off Washington and Oregon during April and May 1980 (Kendall and Clark fn. 1), using selected morphological measurements to determine variability in larval condition. Further, to elucidate the possible relationship between larval condition and feeding requirements, prey size-selection and diet were analyzed.

### Methods

Sablefish larvae were collected by using a 0.5 m neuston net (Sameoto and Jaroszynski 1969) with 0.505 mm mesh, towed for 10 min from the RV *Tikhookaenskiy*, during the first cooperative U.S.-U.S.S.R. ichthyoplankton survey off the Washington and Oregon coast in 1980 (Kendall and Clark fn. 1). Larvae from stations 20, 24, 25, 34, 38, 50,

<sup>1</sup>Kendall, A. W., and J. Clark. 1982. Ichthyoplankton off Washington, Oregon and Northern California, April-May 1980. Processed Rep. 82-11, 44 p. Northwest and Alaska Fisheries Center, National Marine Fisheries Service, NOAA, Seattle, WA 98112.

<sup>2</sup>Clark, J. B. 1984. Ichthyoplankton off Washington, Oregon and Northern California, May-June 1981. Processed Rep. 84-11, 46 p. Northwest and Alaska Fisheries Center, National Marine Fisheries Service, NOAA, Seattle, WA 98112.

54, 70, and 71 (Fig. 1), collected between 22 April and 4 May 1980, formed the basis for this study. All larvae were preserved in 10% Formalin<sup>3</sup> at sea. After sorting, larvae were switched into 5% Formalin, where they remained until their examination in 1983.

The following body measurements were recorded: standard length (SL), head length (HL), eye diameter (ED), body depth at pectoral (BD.P), and body depth at anus (BD.A) (after Theilacker 1981). Standard length was measured to the nearest 0.1 mm. All other measurements were made to the nearest 0.05 mm using an ocular micrometer. Because body proportions change dramatically with size of larvae, it was necessary to restrict any comparisons to samples which were not statistically different in terms of the distribution of SL values. Also, to minimize ambiguities attributable to slight differences in size, comparisons of body measurements were made using a ratio of the body measurement to SL (e.g., HL/SL) as well as the absolute measurement (mm). Because a number of larvae were damaged prior to the time measurements were made (e.g., eyes were missing, the gut was separated from

the body) the sample size (*n*) varied within a station. To classify larval condition, statistical comparisons of the body measurements were made using the Mann-Whitney test (Zar 1974), a nonparametric rank procedure.

Food particle-size selection was examined by measuring the widths of prey items ingested by 84 larvae from stations 24, 34, 50, 70, and 71. Soft-bodied prey items were not measured due to the difficulty in accurately assessing their effective width. All measurements were made using an ocular micrometer at 40 $\times$ . Prey widths were originally plotted for five size classes of larvae: 8.2-12.5, 12.6-16.5, 16.6-20.5, 20.6-24.5, and 24.6-28.5 mm SL. The prey-size selection curve of larvae 12.6-16.5 mm closely approximated the curve of larvae 16.6-20.5 mm, and so these size classes were combined. Similarly, the curves of larvae 20.6-24.5 mm and 24.6-28.5 mm were essentially superimposed one upon the other, and as a result these size classes were also combined. This yielded three functional sablefish size classes for particle-size analysis: 8.2-12.5, 12.6-20.5, and 20.6-28.5 mm SL.

The incidence of empty guts was recorded, and diet was analyzed in terms of numerical percent composition and frequency of occurrence of copepod nauplii.

<sup>3</sup>Reference to trade names does not imply endorsement by the National Marine Fisheries Service, NOAA.

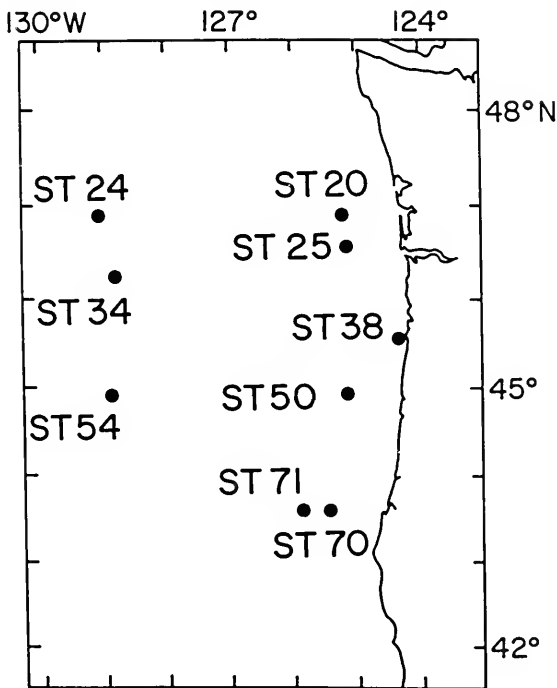

FIGURE 1.—Map of the Washington and Oregon coast where larval sablefish were collected in 1980.

## Results

### Morphological Measurements

Out of a total of 56 larvae collected at station 25, 48% (27 larvae) appeared emaciated, in marked contrast to larvae collected at all other stations. This emaciated condition, which we interpreted as evidence of starvation, was present in 82% of the larvae <12.5 mm SL (27 out of 32) collected at this station but was absent in fish larger than 12.5 mm SL. To test whether this interpretation, which was based on a gross visual examination of these larvae, was statistically verifiable, the morphology of the emaciated larvae from station 25 was compared with larvae of the same size from stations 20, 24, 34, 38, 50, 54, 70, and 71. The size range, 8.2-12.5 mm SL, was selected as the broadest range over which the distributions of SL values of these two groups were equivalent, and excluded the two smallest larvae collected at station 25 from the comparisons. Significant differences were observed in seven of eight body measurements, indicating that distinct differences were present in the larvae from station 25 when compared with larvae of similar size from all other stations (Table 1).

TABLE 1.—A comparison of median values of body measurements of *Anoplopoma fimbria* larvae from station 25 with larvae from stations 20, 24, 34, 38, 50, 54, 70, and 71. The size range was 8.2-12.5 mm SL.

	Station 25	Stations 20, 24, 34, 38, 50, 54, 70, and 71	P <sup>1</sup>
Standard length, SL (mm)	10.0	10.25	>0.20
95% Confidence Interval, C.I.	(9.2-10.4)	(10.0-10.5)	
n <sup>2</sup> =	25	118	
Head length, HL (mm)	1.5	2.1	<0.001
95% C.I.	(1.4-1.8)	(2.0-2.1)	
HL/SL	0.165	0.200	<0.001
95% C.I.	(0.147-0.177)	(0.194-0.206)	
n =	25	114	
Eye diameter, ED (mm)	0.7	0.85	<0.001
95% C.I.	(0.6-0.7)	(0.8-0.9)	
ED/SL	0.069	0.082	<0.001
95% C.I.	(0.066-0.073)	(0.081-0.084)	
n =	23	113	
Body depth at pectoral, BD.P (mm)	1.0	1.3	<0.001
95% C.I.	(0.9-1.15)	(1.3-1.3)	
BD.P/SL	0.109	0.128	<0.001
95% C.I.	(0.098-0.118)	(0.125-0.131)	
n =	13	100	
Body depth at anus, BD.A (mm)	1.0	1.2	<0.005
95% C.I.	(0.7-1.2)	(1.15-1.25)	
BD.A/SL	0.104	0.116	>0.10
95% C.I.	(0.082-0.139)	(0.112-0.118)	
n =	11	84	

<sup>1</sup>P = probability that body measurements of station 25 larvae were equivalent with larvae from stations 20, 24, 34, 38, 50, 54, 70, and 71, as determined by the Mann-Whitney test.

<sup>2</sup>The sample size was not constant within each group because some larvae were damaged prior to the time measurements were made (e.g., some had lost eyes, the gut was separated from the body).

## Analysis of Gut Contents

Examination of the gut contents of larvae <12.5 mm SL provided further evidence as to the starved condition of the larvae at station 25. At this station 75% of the larvae (24 out of 32) had no food in their guts, and 9% (3 larvae) had ingested 2 or fewer prey items. In addition to being empty, the guts of larvae collected at station 25 were shrunken, which is reflective of poor feeding conditions (Nakai et al. 1969). At all other stations the incidence of empty guts for larvae <12.5 mm SL was <1%, as was the incidence of larvae ingesting 2 or fewer prey items.

Circumstantial evidence as to the cause of starvation comes from food analyses. It was apparent that while sablefish larvae selected increasingly larger prey as they grew larger, the minimum size of prey eaten did not increase appreciably. By examining the widths of all prey items ingested by larvae of different lengths (Fig. 2), three general patterns emerged: 1) Larvae 8.2-12.5 mm SL principally ingested the narrowest prey (0.01-0.10 mm in width), 2) larvae 12.6-20.5 mm SL ingested slightly larger prey (0.11-0.20 mm in width), and 3) sablefish 20.6-28.5 mm SL primarily ingested the

largest prey (0.21-0.30 mm in width), although they also ingested a broad range of prey sizes.

Copepod nauplii were the dominant small prey, and were all <0.20 mm wide. They accounted for 88.3% of the diet (by number) of small larvae (≤12.5 mm). Based on prey-size selection alone (Fig. 2), it appears that copepod nauplii may have also contributed substantially to the diet of larvae 12.6-20.5 mm SL, but not to the diet of fish 20.6-28.5 mm SL. Dietary analysis confirmed this, with nauplii comprising 26.9% of the diet of larvae 12.6-20.5 mm, but merely 1.4% of the diet of fish 20.6-28.5 mm SL.

Considering the relative importance of copepod nauplii in the diet of larvae 12.6-20.5 mm SL and the fact that this size class continued to ingest nauplii although capable of ingesting larger prey, the frequency of occurrence of copepod nauplii in the guts of these larvae was examined at each station as inferential evidence of the abundance or availability of copepod nauplii (Table 2). At station 25 only 27% of larvae 12.6-20.5 mm SL ingested nauplii compared with 60-100% at all other stations; the low frequency of occurrence of nauplii in guts of these larvae at station 25 was obtained even though no guts were empty. These data indicate that copepod nauplii may not have been abundant or

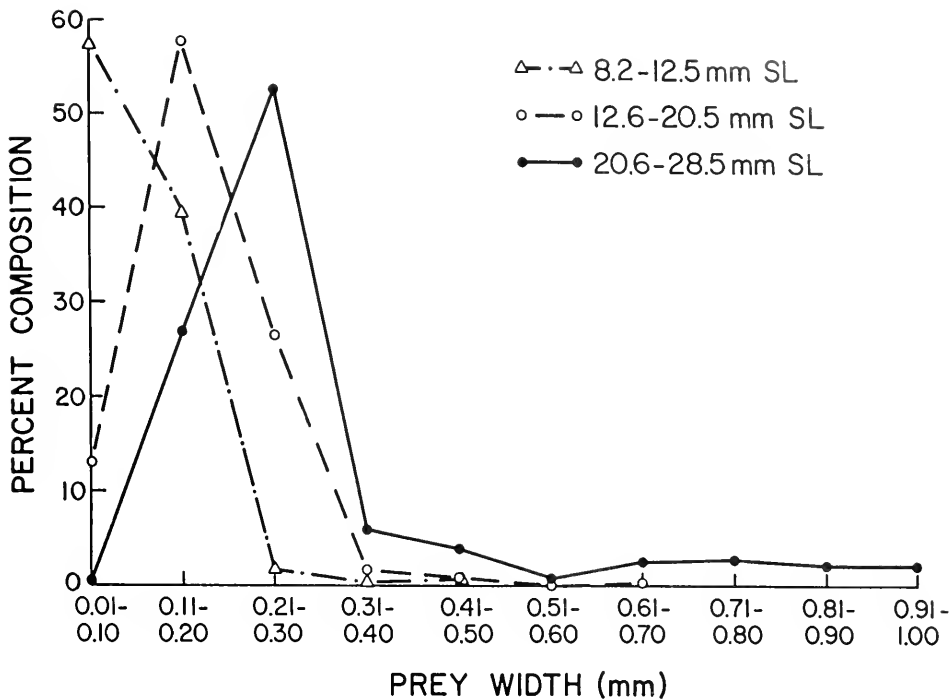

FIGURE 2.—The size of prey selected by larval sablefish, plotted for three size classes of larvae: 8.2-12.5 mm SL ( $n = 43$ ), 12.6-20.5 mm SL ( $n = 25$ ), and 20.6-28.5 mm SL ( $n = 16$ ).

TABLE 2.—Frequency of occurrence of copepod nauplii found in the guts of larval sablefish, by size class and station.

Size class	Station number									
	20	24	25	34	38	50	54	70	71	
≤12.5 mm	38/38 100%	6/6 100%	17/32 22%	9/9 100%	32/32 100%	6/6 100%	15/16 94%	10/10 100%	11/12 92%	
12.6-20.5 mm	6/10 60%	2/2 100%	4/15 27%	8/8 100%	11/11 100%	1/1 100%	3/3 100%	10/11 91%	2/3 67%	

<sup>1</sup>This includes 24 larvae ≤12.5 mm SL with empty guts.

readily available at station 25, with the high incidence of starvation at this station suggesting a cause-and-effect relationship between these two factors.

### Discussion

There is no definitive way of discerning whether the sablefish larvae that we categorized as starving had starved to the "point of no return". To ascertain whether sea-caught larvae have starved beyond recovery requires rearing larvae from eggs in the laboratory under different feeding regimes, and using these as standards of comparison for sea-caught specimens. Unfortunately, this has been done

in only a few cases. For example, O'Connell (1976) established histological criteria for starvation under laboratory conditions for the northern anchovy. These criteria were then employed to identify starving larvae collected in the Southern California Bight (O'Connell 1980). The proportion of starving larvae was estimated to be 8%, for larvae <7.5 mm SL, with this representing 40% of the daily rate of mortality. In a more recent and comprehensive study, Theilacker (1986) utilized both histological and morphological criteria (Theilacker 1978, 1981) to examine starvation of sea-caught first-feeding jack mackerel in the Southern California Bight. She determined that starvation varied with habitat. In the open ocean, the number of larvae <3.5 mm dying

of starvation per day was 57-70%, whereas only 6-12% of the first-feeding larvae collected near islands and banks were starving.

Until techniques are developed for rearing sablefish from eggs, we are limited to utilizing comparisons of sea-caught larvae to infer the importance of starvation in the early life history of this species. While starving larvae were observed at only one station, our finding confirms that sablefish larvae do encounter suboptimal environmental conditions in the sea. However, neither the transience nor geographic extent of this phenomenon can be assessed in the absence of an intensive sampling scheme designed specifically to answer these questions.

Although definitive plankton composition data are lacking, the occurrence of starving larvae at station 25 appears to reflect a paucity of copepod nauplii. While appropriate prey concentrations (Laurence 1974; Lasker 1975; Houde 1978), particle size (Lasker 1975; Hunter 1981), and prey species composition (Lasker 1975; Scura and Jerde 1977) all relate to the survival and growth of marine fish larvae, not all larvae are able to maintain associations with suitable prey patches. Lasker (1975) emphasized the transient nature of optimal feeding conditions in the sea, noting that northern anchovy larvae which had been associated with a good feeding patch (a bloom of *Gymnodinium splendens* that persisted for 18 d) would probably die of starvation after a wind storm broke up the bloom. Patchiness of food resources has also been suggested by the station-to-station variability in growth rates of northern anchovy (as determined from daily increments of otoliths) (Methot and Kramer 1979). Similarly, after monitoring larval development in both good and bad plankton patches, Shelbourne (1957) reported that a scarcity of appropriate food resulted in a deterioration of the physical condition of plaice larvae.

Where morphological measurements of larvae are concerned, changes in body measurements which result from handling and preservation techniques must be considered. Net abrasion results in mechanical damage to the larvae (Blaxter 1971) as well as shrinkage (Blaxter 1971; Theilacker 1980), with the amount of shrinkage depending on whether death preceded fixation (Blaxter 1971), and the extent of handling (Theilacker 1980). The type of fixative used (Theilacker 1980), its concentration, salinity, and temperature (Hay 1982) also affect the degree of shrinkage. In the present case, shrinkage most likely occurred during the 3 yr these larvae were held in Formalin. However, absolute lengths may not be critical to evaluating the significance of

our findings, and the differences that were seen between stations could not have resulted simply from differences in shrinkage. This was clear from the qualitative differences in gut appearance seen between stations (i.e., shrunken and empty guts versus guts filled to distention). Further, since the sablefish larvae we examined were all caught and preserved during the same cruise, we assumed that whatever shrinkage that may have resulted from handling and preservation techniques is constant throughout the samples.

Larval fishes are limited in the prey that they consume by their ability to capture and process it. As they grow, larvae become very successful predators, caused in part by an increase in mouth size. As a result, the size of prey selected increases as development proceeds. Prey width was used to examine prey-size selection because prey width appears to be the critical dimension for the successful ingestion of oblong prey by larval fishes (Blaxter 1965; Arthur 1976; Hunter 1981). For sablefish, definitive shifts in the size of prey consumed occurred at about 12.5 and 20.5 mm SL. The diet of the larger larvae was more diverse than the diet of small larvae. This expansion of the range of prey selected is not uncommon (e.g., Hunter 1981) and is adaptive inasmuch as it enables larvae to ingest suboptimal prey items at times when optimal or preferred prey are not available. Smaller fish appear limited in the size of prey they can exploit. This limitation, combined with larvae  $\leq 12.5$  mm SL being associated with an unsuitable prey patch at station 25, may have been responsible for the high incidence of empty guts and starvation.

### Acknowledgments

We wish to thank Kevin Bailey, George Boehlert, and two anonymous reviewers for their comments on drafts of this manuscript. Thanks also to Michael Davis and Steve Ferraro for their advice on statistical analyses, and Art Kendall for valuable discussions and continual encouragement.

This work was supported by the Northwest and Alaska Fisheries Center, National Marine Fisheries Service, NOAA Contract No. 83-ABC-00045.

### Literature Cited

- AHLSTROM, E. H., AND E. STEVENS.  
1976. Report of neuston (surface) collections made on an extended CalCOFI cruise during May 1972. Calif. Coop. Oceanic Fish. Invest. Rep. 18:167-180.
- ARTHUR, D. K.  
1976. Food and feeding of larvae of three fishes occurring



- in the California Current, *Sardinops sagax*, *Engraulis mordax*, and *Trachurus symmetricus*. Fish. Bull., U.S. 74: 517-530.
- BLAXTER, J. H. S.  
1965. The feeding of herring larvae and their ecology in relation to feeding. Calif. Coop. Oceanic Fish. Invest. Rep. 10: 79-88.  
1971. Feeding and condition of clyde herring larvae. Rapp. P.-v. Réun. Cons. int. Explor. Mer 160:128-136.
- BOEHLERT, G. W., AND M. M. YOKLAVICH.  
1985. Larval and juvenile growth of sablefish, *Anoplopoma fimbria*, as determined from otolith increments. Fish. Bull., U.S. 83:475-481.
- EHRlich, K. F.  
1974. Chemical changes during growth and starvation of herring larvae. In J. H. S. Blaxter (editor), The early life history of fish, p. 301-323. Springer-Verlag, Berlin.  
EHRlich, K. F., J. H. S. BLAXTER, AND R. PEMBERTON.  
1976. Morphological and histological changes during the growth and starvation of herring and plaice larvae. Mar. Biol. (Berl.) 35:105-118.
- HAY, D. E.  
1982. Fixation shrinkage of herring larvae: effects of salinity, formalin concentration, and other factors. Can. J. Fish. Aquat. Sci. 39:1138-1143.
- HOUDE, E. D.  
1978. Critical food concentrations for larvae of three species of subtropical marine fishes. Bull. Mar. Sci. 28:395-411.
- HUNTER, J. R.  
1981. Feeding ecology and predation of marine fish larvae. In R. Lasker (editor), Marine fish larvae: morphology, ecology, and relation to fisheries, p. 33-77. Sea Grant Program, Univ. Wash. Press, Seattle.
- KOBAYASHI, K.  
1957. Larvae and young of the sablefish, *Anoplopoma fimbria* (Pallas), from the sea near the Aleutian Islands. [In Jpn., Engl. abstr.] Bull. Jpn. Soc. Sci. Fish. 23:376-382.
- LASKER, R.  
1975. Field criteria for survival of anchovy larvae: The relation between inshore chlorophyll maximum layers and successful first feeding. Fish. Bull., U.S. 73:453-462.
- LAURENCE, G. C.  
1974. Growth and survival of haddock *Melanogrammus aeglefinus* larvae in relation to planktonic prey concentration. J. Fish. Res. Board Can. 31:1415-1419.
- MASON, J. C., R. J. BEAMISH, AND G. A. MCFARLANE.  
1983. Sexual maturity, fecundity, spawning, and early life history of sablefish (*Anoplopoma fimbria*) off the Pacific coast of Canada. Can. J. Fish. Aquat. Sci. 40:2126-2134.
- METHOT, R. D., JR., AND D. KRAMER.  
1979. Growth of northern anchovy, *Engraulis mordax*, larvae in the sea. Fish. Bull., U.S. 77:413-423.
- NAKAI, Z., M. KOSAKA, M. OGURA, G. HAYASHIDA, AND H. SHIMONONO.  
1969. Feeding habit, and depth of body and diameter of digestive tract of *shirasu*, in relation with nutritious condition. [In Jpn., Engl. abstr.] J. Coll. Mar. Sci. Technol., Tokai Univ. 3:23-34.
- O'CONNELL, C. P.  
1976. Histological criteria for diagnosing the starving condition in early post yolk sac larvae of the northern anchovy, *Engraulis mordax* Girard. J. Exp. Mar. Biol. Ecol. 25: 285-312.
1980. Percentage of starving northern anchovy, *Engraulis mordax*, larvae in the sea as estimated by histological methods. Fish. Bull., U.S. 78:475-489.
- SAMEOTO, D. D., AND L. O. JAROSZYNSKI.  
1969. Otter surface sampler: a new neuston net. J. Fish. Res. Board Can. 26:2240-2244.
- SCURA, E. D., AND C. W. JERDE.  
1977. Various species of phytoplankton as food for larval northern anchovy, *Engraulis mordax*, and relative nutritional value of the dinoflagellates *Gymnodinium splendens* and *Gonyaulax polyedra*. Fish. Bull., U.S. 75:577-583.
- SHELBOURNE, J. E.  
1957. The feeding and condition of plaice larvae in good and bad plankton patches. J. Mar. Biol. Assoc. U.K. 36:539-552.
- SHENKER, J. M., AND B. L. OLLA.  
In press. Laboratory feeding and growth of early juvenile sablefish, *Anoplopoma fimbria*. Can. J. Fish. Aquat. Sci.
- THEILACKER, G. H.  
1978. Effect of starvation on the histological and morphological characteristics of jack mackerel, *Trachurus symmetricus*, larvae. Fish. Bull., U.S. 76:403-414.  
1980. Changes in body measurements of larval northern anchovy, *Engraulis mordax*, and other fishes due to handling and preservation. Fish. Bull., U.S. 78:685-692.  
1981. Effect of feeding history and egg size on the morphology of jack mackerel, *Trachurus symmetricus*, larvae. Rapp. P.-v. Réun. Cons. int. Explor. Mer 178:432-440.  
1986. Starvation-induced mortality of young sea-caught jack mackerel, *Trachurus symmetricus*, determined with histological and morphological methods. Fish. Bull., U.S. 84:1-17.
- UMEDA, S., AND A. OCHIAI.  
1975. On the histological structure and function of digestive organs of the fed and starved larvae of the yellowtail, *Seriola quinqueradiata*. [In Jpn., Engl. abstr.] Jpn. J. Ichthyol. 21:213-219.
- ZAR, J. H.  
1974. Biostatistical analysis. Prentice-Hall, Englewood Cliffs, NJ, 620 p.

JILL J. GROVER

College of Oceanography  
Oregon State University  
Hatfield Marine Science Center  
Newport, OR 97365

BORI L. OLLA

Cooperative Institute for Marine Resources Studies  
Northwest and Alaska Fisheries Center  
National Marine Fisheries Service, NOAA  
Hatfield Marine Science Center  
Newport, OR 97365

## NOTICES

NOAA Technical Reports NMFS published during last 6 months of 1985

### Technical Report NMFS

31. Shark catches from selected fisheries off the U.S. east coast. July 1985, iii + 22 p.  
Analysis of various sources of pelagic shark catches in the Northwest and Western Central Atlantic Ocean and Gulf of Mexico with comments of other large pelagics. By Emory D. Anderson, p. 1-14, 3 figs., 17 tables.  
Estimated catches of large sharks by U.S. recreational fishermen in the Atlantic and Gulf of Mexico. By John G. Casey and John J. Hoey p. 15-19, 5 tables.  
The incidental capture of sharks in the Atlantic United States Fishery Conservation Zone reported by the Japanese tuna longline fleet. By W. N. Witzell, p. 21-22, 3 tables.
32. Nutrient distributions for Georges Bank and adjacent waters in 1979. By A. F. J. Draxler, A. Matte, R. Waldhauer, and J. E. O'Reilly. July 1985, iii + 34 p., 32 figs., 2 tables.
33. Marine flora and fauna of the Northeastern United States. Echinodermata: Echinoidea. By D. Keith Serafy and F. Julian Fell. September 1985, iii + 25 p., 42 figs.
34. Additions to a revision of the shark genus *Carcharhinus*: synonymy of *Aprionodon* and *Hypoprion*, and description of a new species of *Carcharhinus* (Carcharhinidae). By J. A. F. Garrick. November 1985, iii + 26 p., 14 figs., 4 tables.
35. Synoptic review of the literature on the Southern Oyster Drill *Thais haemastoma floridana*. By Philip A. Butler. November 1985, iii + 9 p.
36. An egg production method for estimating spawning biomass of pelagic fish: application to the northern anchovy, *Engraulis mordax*. Reuben Lasker (editor). December 1985, iii + 99 p.  
Introduction: an egg production method for anchovy biomass assessment. By Reuben Lasker, p. 1-3, 1 fig.  
Biomass model for the egg production method. By Keith Parker, p. 5-6.  
Parameter estimation for an egg production method of northern anchovy biomass assessment. By Susan Picquelle and Gary Stauffer, p. 7-15, 8 figs., 6 tables.  
Sea survey design and analysis for an egg production method of anchovy biomass assessment. By Paul E. Smith and Roger P. Hewitt, p. 17-26, 4 figs., 8 tables.  
The CalCOFI vertical egg tow (CalVET) net. By Paul E. Smith, William Flerx, and Roger P. Hewitt, p. 27-32, 5 figs., 1 table.  
Procedures for sorting, staging, and ageing eggs. By Gary Stauffer and Susan Picquelle, p. 33-35.  
Staging anchovy eggs. By H. Geoffrey Moser and Elbert H. Ahlstrom, p. 37-41, 2 figs.  
A model for temperature-dependent northern anchovy egg development and an automated procedure for the assignment of age to staged eggs. By Nancy C. H. Lo, p. 43-50, 2 figs., 6 tables.  
A protocol for designing a sea survey for anchovy biomass assessment. By Robert P. Hewitt, p. 51-53.  
Sampling requirements for the adult fish survey. By Susan Picquelle, p. 55-57, 1 fig.  
Spawning frequency of Peruvian anchovies taken with a purse seine. By Jurgen Alheit, p. 59-61, 1 table.  
Preservation of northern anchovy in formaldehyde solution. By J. Roe Hunter, p. 63-65, 1 fig., 1 table.

Batch fecundity in multiple spawning fishes. By J. Roe Hunter, Nancy C. H. Lo, and Roderick J. H. Leong, p. 67-77, 6 figs., 5 tables.  
Measurement of spawning frequency in multiple spawning fishes. By J. Roe Hunter and Beverly J. Macewicz, p. 79-94, 7 figs., 1 table.  
Comparison between egg production method and larval census method for fish biomass assessment. By Roger P. Hewitt, p. 95-99, 2 figs., 1 table.

Some NOAA publications are available by purchase from the Superintendent of Documents, U.S. Government Printing Office, Washington, DC 20402.

6083-031

# INFORMATION FOR CONTRIBUTORS TO THE *FISHERY BULLETIN*

Manuscripts submitted to the *Fishery Bulletin* will reach print faster if they conform to the following instructions. These are not absolute requirements, of course, but desiderata.

## CONTENT OF MANUSCRIPT

The **title page** should give only the title of the paper, the author's name, his affiliation, and mailing address, including ZIP code.

The **abstract** should not exceed one double-spaced page.

In the **text**, *Fishery Bulletin* style, for the most part, follows that of the *U.S. Government Printing Office Style Manual*. Fish names follow the style of the American Fisheries Society Special Publication No. 12, *A List of Common and Scientific Names of Fishes from the United States and Canada*, Fourth Edition, 1980.

**Text footnotes** should be typed separately from the text.

**Figures and tables**, with their legends and headings, should be self-explanatory, not requiring reference to the text. Their placement should be indicated in the right hand margin of the manuscript.

Preferably **figures** should be reduced by photography to 5 1/4 inches (for single column figures), allowing for 50% reduction in printing), or to 12 inches (for double column figures). The maximum height, for either width, is 14 inches. Photographs should be printed on high quality or glossy paper.

Do not send original drawings to the Scientific Editor, if they, rather than the photographic reductions, are needed by the printer; the Scientific Publications Office will request them.

Each **table** should start on a separate page. Consistency in headings and format is desirable. Vertical rules should be avoided, as they make the tables more expensive to print. Footnotes in tables should be numbered sequentially in arabic numerals. To avoid confusion with powers, they should be placed to the *left* of numerals.

**Acknowledgments**, if included, are placed at the end of the text.

Literature is cited in the text as: Lynn and Reid (1968) or (Lynn and Reid 1968). All papers referred to in the text should be listed alphabetically by the senior author's surname under the heading "Literature Cited." Only the author's surname and initials are required in the **literature cited**. The accuracy of the **literature cited** is the respon-

sibility of the author. Abbreviations of names of periodical and serials should conform to *Serials sources for the BIOSIS Data Base (Botanical Abstracts)* or the *Library Term*, which was developed by the American Standard Association.

Common **abbreviations and symbols**, such as mm, mg, g, L, ml, mg, °C (for Celsius), °F, and so forth, should be used. Abbreviate only measure only when used with numerals. Periods are only rarely used with abbreviations.

We prefer that **measurements** be given in metric units; other equivalent units may be given in parentheses.

## FORM OF THE MANUSCRIPT

The original of the manuscript should be typed, double-spaced, on white bond paper. Please triple space above headings. We would rather receive good duplicated copies of manuscripts than carbon copies. The sequence of the material should be:

- TITLE PAGE
- ABSTRACT
- TEXT
- LITERATURE CITED
- TEXT FOOTNOTES
- APPENDIX
- TABLES (Each table should be numbered with an arabic numeral and heading provided)
- LIST OF FIGURES (Entire figure legends)
- FIGURES (Each figure should be numbered with an arabic numeral, legends are desired)

## ADDITIONAL INFORMATION

Send the ribbon copy and two duplicated or carbon copies of the manuscript to:

Dr. William J. Richards, Scientific Editor  
*Fishery Bulletin*  
Southeast Fisheries Center Miami Laboratory  
National Marine Fisheries Service, NOAA  
75 Virginia Beach Drive  
Miami, FL 33149-1099

Fifty **separates** will be supplied to an author free of charge and 50 supplied to his organization. No covers will be supplied.

LO, NANCY C. H. Modeling life stage specific instantaneous mortality rates, an application to northern anchovy, *Engraulis mordax*, eggs and larvae . . . . . 395

SEN, A. R. Methodological problems in analyzing commercial rockfish landings . . . 409

POLOVINA, JEFFREY J. A variable catchability version of the Leslie model with application to an intensive fishing experiment on a multispecies stock . . . . . 423

MATSUURA, YASUNORI, and NELSON TAKUMI YONEDA. Early development of the lophid anglerfish, *Lophius gulosus* . . . . . 429

SQUIRES, DALE. Ex-vessel price linkages in the New England fishing industry . . 437

LEBER, KENNETH M., and HOLLY S. GREENING. Community studies in seagrass meadows: A comparison of two methods for sampling macroinvertebrates and fishes . . . . . 443

**Notes**

OXENFORD, HAZEL A., and WAYNE HUNTE. A preliminary investigation of the stock structure of the dolphin, *Coryphaena hippurus*, in the western central Atlantic . . . . . 451

FORWARD, RICHARD B., JR., BLANCA ROJAS de MENDIOLA, and RICHARD T. BARBER. Effects of temperature on swimming speed of the dinoflagellate *Gymnodinium splendens* . . . . . 460

GRAHAM, JEFFREY B., RICHARD H. ROSENBLATT, and DARCY L. GIBSON. Morphology and possible swimming mode of a yellowfin tuna, *Thunnus albacares*, lacking one pectoral fin . . . . . 463

RATTY, F. J., Y. C. SONG, and R. M. LAURS. Chromosomal analysis of albacore, *Thunnus alalunga*, and yellowfin, *Thunnus albacares*, and skipjack, *Katsuwonus pelamis*, tuna . . . . . 469

STIER, KATHLEEN, and BOYD KYNARD. Abundance, size, and sex ratio of adult sea run sea lamprey, *Petromyzon marinus*, in the Connecticut River . . . . . 476

MASON, J. C., and A. C. PHILLIPS. An improved otter surface sampler . . . . . 480

GROVER, JILL J., and BORI L. OLLA. Morphological evidence for starvation and prey size selection of sea caught larval sablefish, *Anoplopoma fimbria* . . . . . 484

Notices . . . . . 490







MBL WHOI LIBRARY



WH 19WB 6













# Fishery Bulletin

Vol. 84, No. 3

July 1986

PRINCE, ERIC D., DENNIS W. LEE, CHARLES A. WILSON, and JOHN M. DEAN. Longevity and age validation of a tag-recaptured Atlantic sailfin, <i>Istophorus platypterus</i> , using dorsal spines and otoliths . . . . .	193
PARRISH, RICHARD H., DONNA L. MALLICOATE, and RICHARD A. KLINGBEIL. Age dependent fecundity, number of spawnings per year, sex ratio, and maturation stages in northern anchovy, <i>Engraulis mordax</i> . . . . .	503
PENNINGTON, MICHAEL. Some statistical techniques for estimating abundance indices from trawl surveys . . . . .	519
REILLY, STEPHEN B., and JAY BARLOW. Rates of increase in dolphin population size . . . . .	527
ATKINSON, C. ALLEN. Discrete time difference model for simulating interacting fish population dynamics . . . . .	535
PARSONS, D. G., and G. E. TUCKER. Fecundity of northern shrimp, <i>Pandalus borealis</i> , (Crustacea, Decapoda) in areas of the Northwest Atlantic . . . . .	549
WAHLEN, BRUCE E. Incidental dolphin mortality in the eastern tropical Pacific tuna fishery, 1973 through 1978 . . . . .	559
SOMERSON, DAVID A., and ROBERT S. OTTO. Distribution and reproductive biology of the golden king crab, <i>Lithodes aquispina</i> , in the eastern Bering Sea . . . . .	571
POWER, JAMES H. A model of the drift of northern anchovy, <i>Engraulis mordax</i> , larvae in the California Current . . . . .	585
JOHNSON, PHYLLIS T. Parasites of benthic amphipods: dinoflagellates (Duboscquodiniida: Syndinidae) . . . . .	605
YANG, M. S., and P. A. LIVINGSTON. Food habits and diet overlap of two congeneric species, <i>Atheresthes stomus</i> and <i>Atheresthes evermanni</i> , in the eastern Bering Sea . . . . .	615
SHEPARD, ANDREW N., ROGER B. THEROUX, RICHARD A. COOPER, and JOSEPH R. UZMANN. Ecology of Ceriantharia (Coelenterata, Anthozoa) of the northwest Atlantic from Cape Hatteras to Nova Scotia . . . . .	625
POTTHOFF, THOMAS, SHARON KELLEY, and JOAQUIN C. JAVECH. Cartilage and bone development in scombroid fishes . . . . .	647
REIS, ENIR GIRONDI. Age and growth of the marine catfish, <i>Netuma barba</i> (Siluriformes, Ariidae), in the estuary of the Patos Lagoon (Brasil) . . . . .	679
DANDONNEAU, YVES. Monitoring the sea surface chlorophyll concentration in the tropical Pacific: consequences of the 1982-83 El Niño . . . . .	687

(Continued on back cover)

# U.S. DEPARTMENT OF COMMERCE

Malcolm Baldrige, *Secretary*

## NATIONAL OCEANIC AND ATMOSPHERIC ADMINISTRATION

Anthony J. Calio, *Administrator*

### NATIONAL MARINE FISHERIES SERVICE

William G. Gordon, *Assistant Administrator*

## Fishery Bulletin

The *Fishery Bulletin* carries original research reports and technical notes on investigations in fishery science, engineering, and economics. The Bulletin of the United States Fish Commission was begun in 1881; it became the Bulletin of the Bureau of Fisheries in 1904 and the Fishery Bulletin of the Fish and Wildlife Service in 1941. Separates were issued as documents through volume 46, the last document was No. 1103. Beginning with volume 47 in 1931 and continuing through volume 62 in 1963, each separate appeared as a numbered bulletin. A new system began in 1963 with volume 63 in which papers are bound together in a single issue of the bulletin instead of being issued individually. Beginning with volume 70, number 1, January, 1972, the *Fishery Bulletin* became a periodical, issued quarterly. In this form, it is available by subscription from the Superintendent of Documents, U.S. Government Printing Office, Washington, DC 20402. It is also available free, in limited numbers, to libraries, research institutions, State and Federal agencies, and in exchange for other scientific publications.

### SCIENTIFIC EDITOR, *Fishery Bulletin*

Dr. William J. Richards  
Southeast Fisheries Center Miami Laboratory  
National Marine Fisheries Service, NOAA  
Miami, FL 33149-1099

### Editorial Committee

Dr. Bruce B. Collette  
National Marine Fisheries Service

Dr. Jay C. Quast  
National Marine Fisheries Service

Dr. Reuben Lasker  
National Marine Fisheries Service

Dr. Carl J. Sindermann  
National Marine Fisheries Service

Mary S. Fukuyama, *Managing Editor*

The *Fishery Bulletin* (ISSN 0090-0650) is published quarterly by the Scientific Publications Office, National Marine Fisheries Service, NOAA, 7600 Sand Point Way NE, BIN C15700, Seattle, WA 98115. Second class postage is paid in Seattle, Wash., and additional offices. POSTMASTER send address changes for subscriptions to Superintendent of Documents, U.S. Government Printing Office, Washington, DC 20402.

Although the contents have not been copyrighted and may be reprinted entirely, reference to source is appreciated.



# Fishery Bulletin

## CONTENTS

Vol. 84, No. 3

July 1986

PRINCE, ERIC D., DENNIS W. LEE, CHARLES A. WILSON, and JOHN M. DEAN. Longevity and age validation of a tag-recaptured Atlantic sailfish, <i>Istiophorus platypterus</i> , using dorsal spines and otoliths . . . . .	493
PARRISH, RICHARD H., DONNA L. MALLICOATE, and RICHARD A. KLINGBEIL. Age dependent fecundity, number of spawnings per year, sex ratio, and maturation stages in northern anchovy, <i>Engraulis mordax</i> . . . . .	503
PENNINGTON, MICHAEL. Some statistical techniques for estimating abundance indices from trawl surveys . . . . .	519
REILLY, STEPHEN B., and JAY BARLOW. Rates of increase in dolphin population size . . . . .	527
ATKINSON, C. ALLEN. Discrete-time difference model for simulating interacting fish population dynamics . . . . .	535
PARSONS, D. G., and G. E. TUCKER. Fecundity of northern shrimp, <i>Pandalus borealis</i> , (Crustacea, Decapoda) in areas of the Northwest Atlantic . . . . .	549
WAHLEN, BRUCE E. Incidental dolphin mortality in the eastern tropical Pacific tuna fishery, 1973 through 1978 . . . . .	559
SOMERTON, DAVID A., and ROBERT S. OTTO. Distribution and reproductive biology of the golden king crab, <i>Lithodes aequispina</i> , in the eastern Bering Sea . . . . .	571
POWER, JAMES H. A model of the drift of northern anchovy, <i>Engraulis mordax</i> , larvae in the California Current . . . . .	585
JOHNSON, PHYLLIS T. Parasites of benthic amphipods: dinoflagellates (Duboscquodina: Syndinidae) . . . . .	605
YANG, M. S., and P. A. LIVINGSTON. Food habits and diet overlap of two congeneric species, <i>Antheresthes stomias</i> and <i>Atheresthes evermanni</i> , in the eastern Bering Sea . . . . .	615
SHEPARD, ANDREW N., ROGER B. THEROUX, RICHARD A. COOPER, and JOSEPH R. UZMANN. Ecology of Ceriantaria (Coelenterata, Anthozoa) of the northwest Atlantic from Cape Hatteras to Nova Scotia . . . . .	625
POTTHOFF, THOMAS, SHARON KELLEY, and JOAQUIN C. JAVECH. Cartilage and bone development in scombroid fishes . . . . .	647
REIS, ENIR GIRONDI. Age and growth of the marine catfish, <i>Netuma barba</i> (Siluriformes, Ariidae), in the estuary of the Patos Lagoon (Brasil) . . . . .	679
DANDONNEAU, YVES. Monitoring the sea surface chlorophyll concentration in the tropical Pacific: consequences of the 1982-83 El Niño . . . . .	687

(Continued on next page)

Seattle, Washington

1986

ROGERS, S. GORDON, HIRAM T. LANGSTON, and TIMOTHY E. TARGETT. Anatomical trauma to sponge-coral reef fishes captured by trawling and angling . . . . 697

QUAST, JAY C. Annual production of eviscerated body weight, fat, and gonads by Pacific herring, *Clupea harengus pallasi*, near Auke Bay, southeastern Alaska . . . 705

WENNER, CHARLES A., WILLIAM A. ROUMILLAT, and C. WAYNE WALTZ. Contributions to the life history of Black sea bass, *Centropristis striata*, off the southeastern United States . . . . . 723

Notes

LENARZ, WILLIAM H., and TINA WYLLIE ECHEVERRIA. Comparison of visceral fat and gonadal fat volumes of yellowtail rockfish, *Sebastes flavidus*, during a normal year and a year of El Niño conditions . . . . . 743

SORENSEN, PETER W., MARCO L. BIANCHINI, and HOWARD E. WINN. Diel foraging activity of American eels, *Anguilla rostrata* (Lesueur), in a Rhode Island estuary . . . . . 746

KILLAM, KRISTIE, and GLENN PARSONS. First record of the longfin mako, *Isurus paucus*, in the Gulf of Mexico . . . . . 748

STIER, KATHLEEN, and BOYD KYNARD. Movement of sea-run sea lampreys, *Petromyzon marinus*, during the spawning migration in the Connecticut River . . . . . 749

HOGANS, W. E., and P. C. F. HURLEY. Variations in the morphology of *Fistulicola plicatus* Rudolphi (1802) (Cestoda:Pseudophyllidea) from the swordfish, *Xiphias gladius* L., in the Northwest Atlantic Ocean . . . . . 754

The National Marine Fisheries Service (NMFS) does not approve, recommend or endorse any proprietary product or proprietary material mentioned in this publication. No reference shall be made to NMFS, or to this publication furnished by NMFS, in any advertising or sales promotion which would indicate or imply that NMFS approves, recommends or endorses any proprietary product or proprietary material mentioned herein, or which has as its purpose an intent to cause directly or indirectly the advertised product to be used or purchased because of this NMFS publication.

# LONGEVITY AND AGE VALIDATION OF A TAG-RECAPTURED ATLANTIC SAILFISH, *ISTIOPHORUS PLATYPTERUS*, USING DORSAL SPINES AND OTOLITHS

ERIC D. PRINCE,<sup>1</sup> DENNIS W. LEE,<sup>1</sup> CHARLES A. WILSON,<sup>2</sup>  
AND JOHN M. DEAN<sup>3</sup>

## ABSTRACT

A tagged female Atlantic sailfish, *Istiophorus platypterus*, of 24.6 kg (54 lb) was recaptured on 14 January 1984, after being at large for 10 yr and 10 mo (4,025 d). Approximate age based on tagging records ranged from at least 13 to 15+ yr. Maximum estimated longevity of this species was therefore revised upwards from previously reported  $\geq 7$  yr to at least 13-15+ yr. Estimates of age based on sections of dorsal spine numbers 3-6 ranged from 2 to 8 yr and substantially underestimated the range in age known from tagging records (13-15+ yr). This discrepancy was due to enlargement of the porous, vascularized core of spine sections which obscured zonations associated with early growth history. Thus, dorsal spines do not appear to be useful in ageing older sailfish (i.e.,  $\geq 5$  yr). Age estimates from sagittae (otoliths) were 13 yr based on scanning electron microscope counts of external ridges and analysis of internal otolith microstructure. Otolith age, therefore, agreed with age known from tagging records. The relatively large size of the sagitta (7.84 mg) also provides additional evidence that the otolith could be from a very old sailfish. These data strongly suggest that in older, larger sailfish ( $\geq 5$  yr, 22.7 kg), sagittae, rather than dorsal spines, should be used as the source of age and growth information.

The Atlantic sailfish, *Istiophorus platypterus*, is one of the most popular recreational fishes along the U.S. Atlantic coast, Gulf of Mexico, and Caribbean Sea. In fact, this species has been described as the most sought after fish by southeast marine charter boat anglers, particularly in south Florida (Ellis 1957). Although most landings of Atlantic sailfish in the southeastern United States are made by recreational anglers, many are also taken incidentally by domestic and foreign commercial longline vessels (Lopez et al. 1979). The biological information presently used in stock assessments of Atlantic sailfish (Conser 1984) consists of age and growth data derived exclusively from analysis of dorsal spines (Jolley 1974, 1977; Hedgpeth and Jolley 1983). However, uncertainties remain concerning Atlantic sailfish age structure, longevity, choice of skeletal structure for ageing, and rate of growth because of inconsistencies reported in the literature. In addition, the accuracy of age and growth esti-

mates from skeletal structures and length-frequency analyses have not been validated for all age classes (de Sylva 1957; Jolley 1974, 1977; Radtke and Dean 1981; Hedgpeth and Jolley 1983).

One problem in using spines as a source of age and growth information is the tendency of the vascularized core to obscure zonations associated with early growth history. The enlargement of the vascularized core and subsequent reabsorption of tissues are most severe in the largest and oldest specimens (causing underestimates of true age) and have contributed to the lack of detailed information for older age classes. Several studies have also reported difficulty in interpreting the double and triple bands often observed in Atlantic sailfish spines (Jolley 1977; Hedgpeth and Jolley 1983). These problems are not unique to sailfish (Casselman 1983; Compean-Jimenez and Bard 1983) and have resulted in an unusually large proportion of spine samples (as much as 76%) being rejected for age and growth analysis (Jolley 1977). Radtke and Dean (1981) reviewed this problem and suggested that otoliths (sagittae) may be a better skeletal structure for age and growth assessment in sailfish because these structures do not have the disadvantages associated with the spinal core. For example, 98% of the otolith samples examined by Radtke and Dean (1981) were reportedly suitable for age and growth estimation. Even though these preliminary findings were

<sup>1</sup>Southeast Fisheries Center Miami Laboratory, National Marine Fisheries Service, NOAA, 75 Virginia Beach Drive, Miami, FL 33149-1099.

<sup>2</sup>Belle W. Baruch Institute for Marine Biology and Coastal Research, Department of Biology and Marine Science Program, University of South Carolina, Columbia, SC 29208; present address: Coastal Ecology and Fisheries Institute, Louisiana State University, Baton Rouge, LA 70803-7503.

<sup>3</sup>Belle W. Baruch Institute for Marine Biology and Coastal Research, Department of Biology and Marine Science Program, University of South Carolina, Columbia, SC 29208.

encouraging, use of otoliths to resolve age and growth discrepancies for Atlantic sailfish has not been reported, and no conclusive evidence is available to validate the accuracy of age estimates for this species using any method. We present an analysis of dorsal spines and otoliths obtained from one tag-recaptured Atlantic sailfish, where age was very closely approximated from tagging records, to help resolve the problems associated with ageing this species.

## METHODS

The Cooperative Gamefish Tagging Program of the Southeast Fisheries Center Miami Laboratory recovered a tag from a female Atlantic sailfish, which had been recaptured on 14 January 1984, off Boynton Beach, FL (Prince and Lee 1984). This fish was originally tagged and released off the Florida Keys (Islamorada) on 5 March 1973, at an estimated weight of 18.2 kg (about 40 lb). When recaptured it weighed 24.6 kg (54 lb) and had a lower jaw fork length (LJFL) of 176.5 cm. The sailfish appeared to have a healthy external appearance when caught and body proportions and overall morphology were within the normal range for a specimen of this size. The entire fish was made available to us by J. T. Reese Taxidermist, Inc. (Ft. Lauderdale, FL), and both sagittae and the first six dorsal spines were sampled for age determination.

### Dorsal Spine Analysis

Dorsal spines were collected from the tagged Atlantic sailfish following the procedures of Prince and Lee (1982). Past efforts to age sailfish using dorsal spines have relied on spine number 4 as the source of age and growth information (Jolley 1974, 1977; Hedgepeth and Jolley 1983). We collected the first six anterior dorsal spines to insure that the number assigned to each spine was accurate for identification and analysis and to gain information about possible differences between spines. The first two anterior dorsal spines of sailfish are greatly reduced in size compared with spines 3-6 and were not used to estimate age. In addition, spines posterior to spine number 6 have a smaller diameter and were not used for age determination. This decision was based, in part, on a report by Robins<sup>4</sup> and Robins and de Sylva (1963) who believed that the

posterior dorsal spines of billfish do not grow throughout their entire lifetime and recommended that only anterior spines be used for age and growth studies.

Dorsal spines 3-6 were cleansed of tissue, labeled with a collection number, and preserved in isopropyl alcohol (98%). The methods of sectioning dorsal spines given by Hedgepeth and Jolley (1983) and Prince et al. (1984) were used in this study. Dorsal spine number 4 was sectioned by M. Y. Hedgepeth at the laboratory of the Florida Department of Natural Resources (FDNR), West Palm Beach, FL, to ensure that processing of this spine was identical with methods previously reported. We sectioned spines 3, 5, and 6 using a Buehler ISOMET<sup>5</sup> saw and a 10.16 cm diameter diamond wafer blade. At least 2 or 3 sections (0.44-0.46 mm thick) were taken from each spine. Additional sections were taken from spine number 4 after it had been processed by FDNR personnel. All spine sections were placed into labeled vials with isopropyl alcohol (98%) for storage and extraction of oil. A single section was selected and allowed to air dry before microscopic examination.

Dorsal spine sections were examined initially using a compound stereoscope (6.0×) with transmitted light in order to assess that portion of the section not affected by the vascularized core. Measurements (in millimeters, mm) of the solid bone area in the distal portion of the right lobe of each section were taken along a straight-line counting path from the focus to the outside margin of the structure.

We assigned an age to each spine by counting only concentric translucent bands that were continuous around the circumference of the entire section. In transmitted light, the zonations consisted of a dark opaque zone followed by a light translucent zone. D. W. Lee made three repeated counts of translucent zones using a compound stereoscope at 12.0 to 25.0× magnification.

### Otolith Analysis

The general methods of Radtke and Dean (1981) and Wilson and Dean (1983) were used to extract and prepare the sagittae for examination by scanning electron microscopy (SEM) and light microscopy. The sagittae were removed from the tagged Atlantic sailfish, cleaned with sodium hypochloride solution, and rinsed in xylene and then 95% ethanol.

<sup>4</sup>Robins, C. R., Professor, Rosenstiel School of Marine and Atmospheric Sciences, University of Miami, 4600 Rickenbacker Causeway, Miami, FL 33149, pers. commun. 1982.

<sup>5</sup>Reference to trade names and products does not imply endorsement by the National Marine Fisheries Service.

The weight of one air-dried otolith was measured to 0.001 mg ( $\pm 5\%$ ) using a Perkin Elmer AD2Z ultra-microbalance. The sagitta was attached to an aluminum stub, coated with gold, and examined by SEM at 15.0-1500 $\times$  to observe the surface morphology. External ridges on the rostral lobe of sailfish sagittae, first described by Radtke and Dean (1981), was one of the features used in this study for age estimation.

Following the methods of Haake et al. (1982) and Wilson and Dean (1983), the other member of the pair of sagittae was embedded in epoxy resin, and a section was made in the transverse plane by polishing both sides to 0.5 mm thickness with 600 grit sandpaper and 0.3  $\mu$ m alumina polish. The internal structure of the sectioned sagitta was examined with an Olympus BH<sub>2</sub> compound microscope at 4.0 to 1200 $\times$  to aid overall orientation and understanding of the growth of the structure and to interpret the external ridges used for age estimation.

## RESULTS AND DISCUSSION

Our tagging records indicate that the tagged Atlantic sailfish recaptured on 14 January 1984, was at-large for 10 yr and 10 mo or 4,025 d. An experienced charter boat captain estimated its size when tagged to be 18.2 kg (40 lb). Bias in overestimating the size of billfish during tagging has been a common problem since the inception of the Cooperative Gamefish Tagging Program in 1954 (Prince 1984). However, we feel that such an error would probably not exceed  $\pm 4.6$  kg (10 lb) in a fish of this size, particularly when the experience of the captain making the estimate is considered. The estimated age of a sailfish of about 18.2 kg (40 lb) would be 2-4 yr based on dorsal spine analysis (Jolley 1974, 1977; Hedgepeth and Jolley 1983) and 3-5 yr based on otolith analysis (Radtke and Dean 1981). Therefore, the approximate range in age of this sailfish based on tagging information is 13-15+ yr. We feel these are conservative figures based on the available information and it is highly unlikely that this fish could be younger than 13 yr.

Maximum longevity of Atlantic sailfish was first inferred by de Sylva (1957) to be at least 3 or 4 yr based on length-frequency analysis (Fig. 1). A modal group beyond 4 yr was indicated in his analysis but year class designation was not discussed. Since 1957, estimated longevity of Atlantic sailfish has been revised upwards (Fig. 1) to  $\geq 7$  yr. Our tagging records indicate, however, that the oldest Atlantic sailfish aged by dorsal spine analysis (Jolley 1977; estimated age 8) probably underestimates the max-

imum longevity of this species by a considerable margin. Although Jolley (1977) speculated that sailfish may live as long as 9 or 10 yr because the one age 8 individual was not the largest specimen in his sample, his estimated ages did not exceed 8 yr. In addition, the maximum estimated age reported in other recent studies was  $\geq 7$  yr (Radtke and Dean 1981; Hedgepeth and Jolley 1983). An Atlantic sailfish of estimated age 7 or 8 from the above sources corresponds to an average size of about 25 kg (55 lb). Since our records indicate the age of the tag-recaptured 24.6 kg (54 lb) sailfish was 13-15+ yr, it appears that maximum longevity of Atlantic sailfish could be considerably older, perhaps over 20 yr, because numerous specimens exceeding 45.5 kg (100 lb) have been caught during the last decade (Beardsley 1980). This reasoning assumes that sailfish have indeterminate growth throughout their entire lifetime and that their size is proportional to age. It also appears from tagging data that Atlantic sailfish may

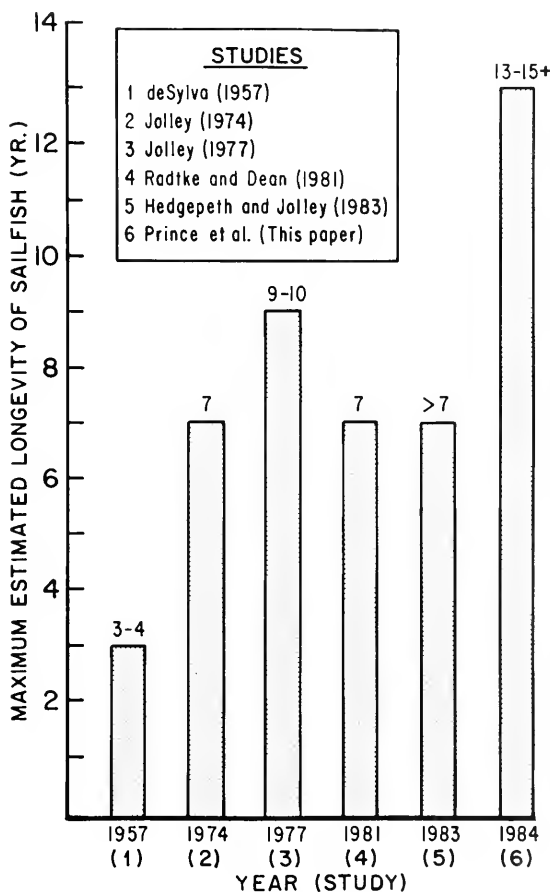

FIGURE 1.—Estimates of maximum longevity (yr) for Atlantic sailfish from six different studies, 1957-84.

grow very slowly after sexual maturity (sexual maturity for female Atlantic sailfish reported at 13-18 kg, Jolley 1977). For example, tagging records indicate that this fish, which was tagged at 18.2 kg, gained only about 6.4 (14 lb) while being at-large almost 11 yr. Our analysis of spines and otoliths support these findings.

### Dorsal Spines

Examination of sections from dorsal spines 3-6 (Fig. 2) indicated that the vascularized core comprised an extensive area in all sections. The solid bone area where zonations were not disrupted varied in size and comprised 14, 19, 30, and 37% of the right lobe of spine sections 3, 4, 5, and 6, respectively (Table 1). The vascularized core severely restricted the zonation counts because increments associated with early growth history were totally disrupted and could not be enumerated. Counts of zonations on the four spine sections ranged from 2 to 8 (Table 1). This suggests that spine number 4, which had been used in past studies to assign ages, may not necessarily be the best choice for ageing sailfish, particularly for the larger, older specimens. For example, spines 5 and 6 both had a higher percentage of solid bone, and counts of zonations in these spines were proportionately higher than in spines 3 and 4 (Fig. 2, Table 1). However, all spines substantially underestimated the age of this sailfish, where approximate age (13-15+ yr) was known from tagging records. Hedgepeth<sup>6</sup> reports that spine number 4 would not have been included in the data sets of previous published studies because of the extensive size of the vascularized core area. We conclude from these data that dorsal spine sections are probably only useful for ageing sailfish from >1 to

5 yr. Although there may be some bias associated with ageing these young sailfish because of the vascularized core, this bias is probably minimal. However, for sailfish older than estimated age 5 and about  $\geq 22.7$  kg (50 lb), the bias substantially underestimates age and this bias increases with an increase in size and age of the fish. In addition, spines have not been shown to be useful in ageing sailfish <1-yr-old (Jolley 1974, 1977).

### Otoliths

Sagittae from the tagged Atlantic sailfish had external and internal morphologies that were characteristic of sailfish reported by Radtke and Dean (1981), as well as other istiophorids (Radtke et al. 1982; Wilson and Dean 1983; Radtke 1983). For example, major features of these sagittae include a rostrum and antirostrum separated by a deep sulcus (Fig. 3). The external ventral and lateral surfaces of the rostrum consist of a series of ridges that are perpendicular to the axis of growth (Fig. 4). Radtke and Dean (1981) suggested that the number of rostral ridges can be used to estimate age of Atlantic sailfish. To make an accurate count of external ridges for age estimation, it is necessary to understand the internal and external otolith growth pattern so that the location and number of the first few rostral ridges can be firmly established. These initial ridges are often covered by excess calcium carbonate (Wilson 1984), particularly in older specimens, and are not always visible on the external features of the lateral surface (Fig. 4).

The growth of the rostrum occurs in two directions (Figs. 3, 4). During early stages, incremental growth of the rostral lobe occurs in the ventral direction out to a bend where growth shifts to a more medioventral and then to a medial direction (Fig. 3). This same pattern of otolith growth has been reported for blue marlin, *Makaira nigricans*, and white marlin, *Tetrapturus albidus* (Wilson 1984). However, it is difficult to illustrate a complex three-dimensional otolith on a two-dimensional photograph. Therefore, Figures 3 and 4 should be examined consecutively to obtain a proper orientation of the structure.

Although rostral ridges on the external lateral surface (Fig. 4) are not distinct because of the excess calcium carbonate, after the change in the axis of growth, the ridges on the ventral surface (ridges 3-10) can be counted easily (Fig. 4). Several lines of evidence points towards the first two growth zones occurring within the boundaries of the lateral surface. For example, a distinct internal translucent

<sup>6</sup>Hedgepeth, M. Y., Fisheries Biologist, Florida Department of Natural Resources, 727 Belvedere Rd., West Palm Beach, FL 33405, pers. commun. 1984.

TABLE 1.—Mean count of zonations (3 repetitions) and percentage solid bone in the distal portion of the right lobe of sections taken from dorsal spines 3-6 of Atlantic sailfish (see text and Fig. 2). Measurements and counts were taken along a straight line counting path bisecting the spine laterally from the focus to the edge of each section.

Dorsal spine number	Mean count (range)	Solid bone (%)	Solid bone measurement (mm)	Total measurement (mm)
3	2.0	14	1.89	13.52
4	3.7(3-4)	19	3.55	18.76
5	5.0	30	4.90	16.56
6	7.3(7-8)	37	6.08	16.39

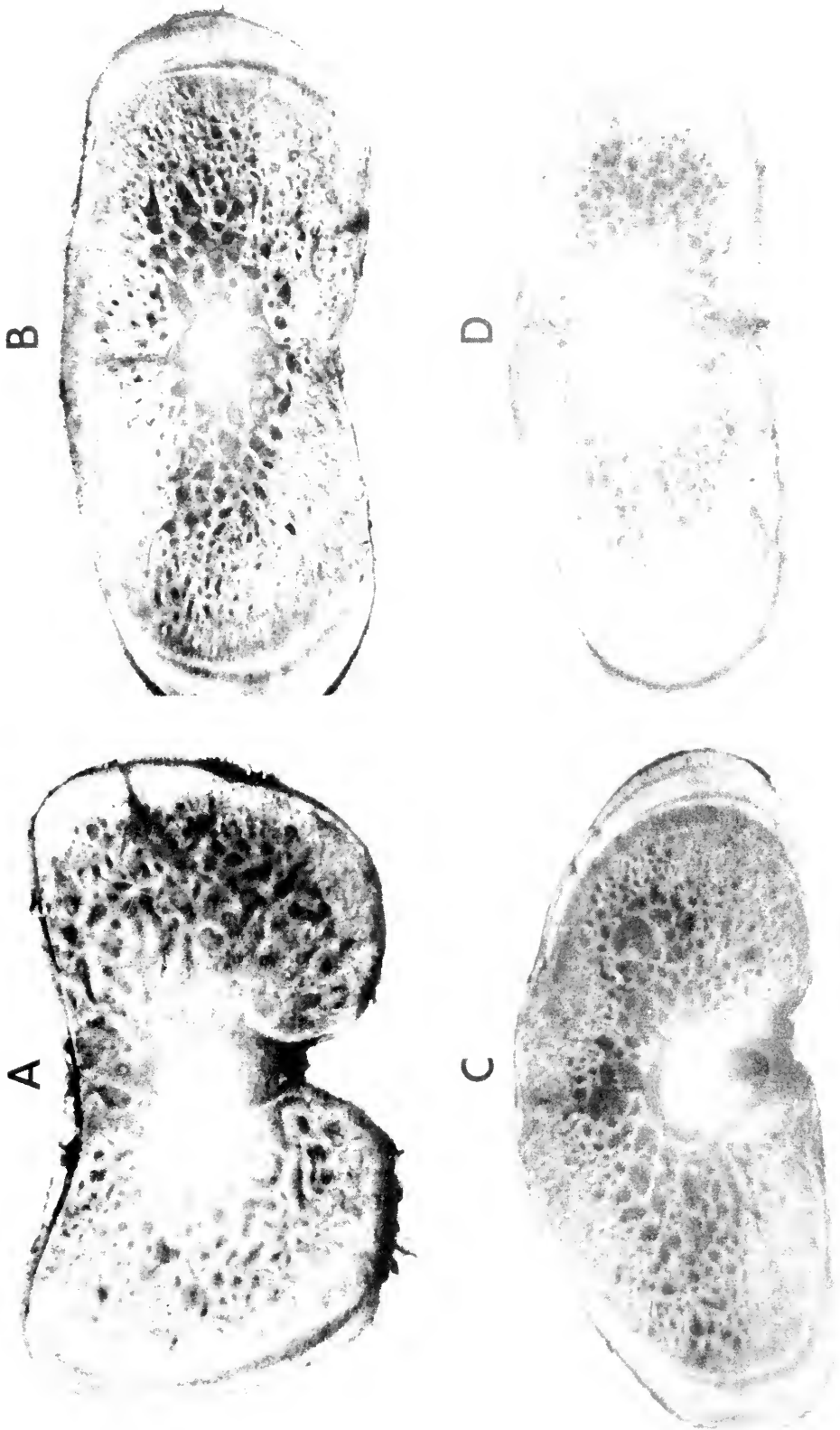

FIGURE 2.—Sections of dorsal spines 3(A), 4(B), 5(C), and 6(D) from a tag-recaptured Atlantic sailfish at-large for 10 yr, 10 mo. Age based on tagging records was 13-15+ yr.

## ANTIROSTRUM

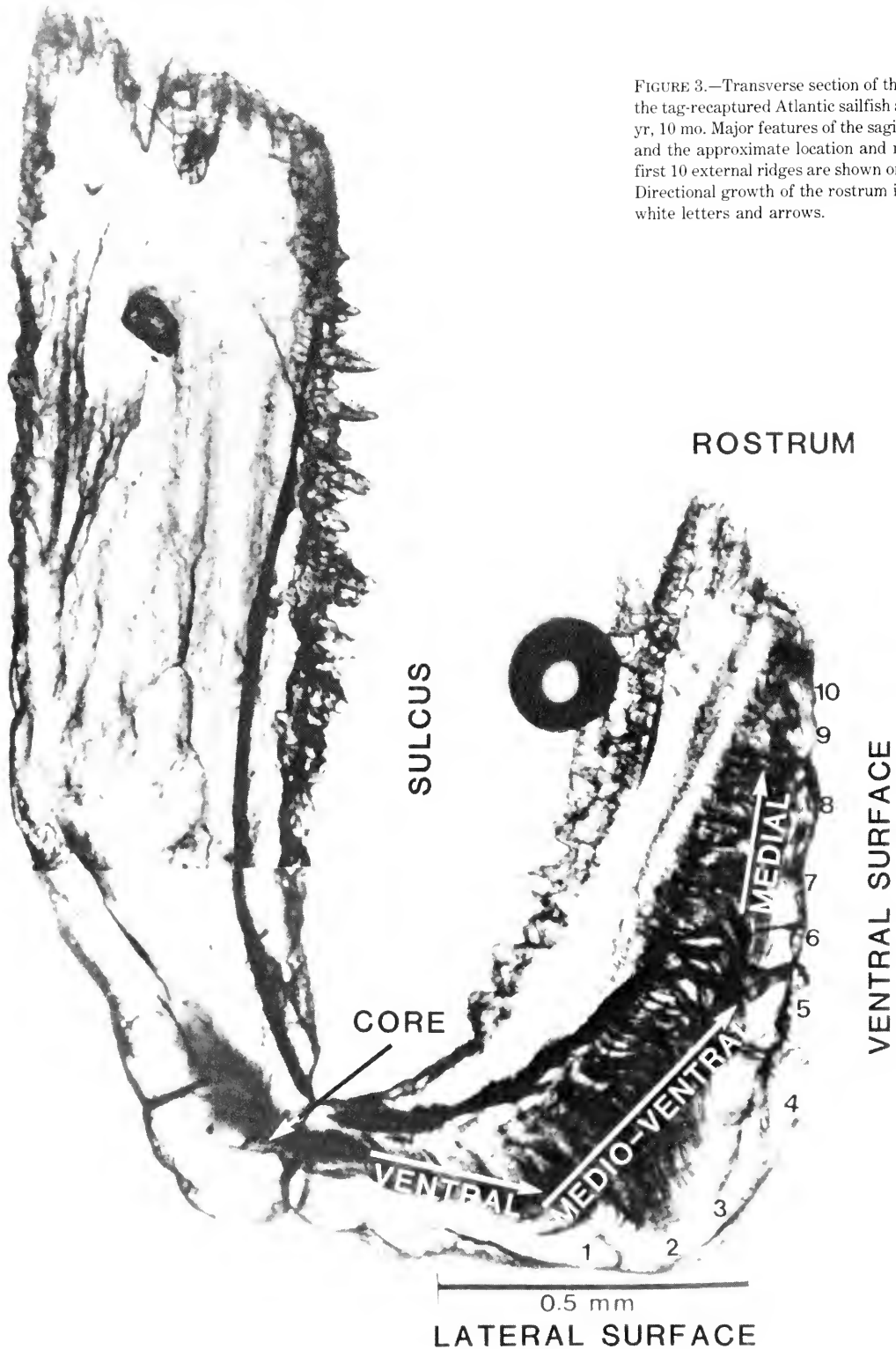

FIGURE 3.—Transverse section of the sagitta from the tag-recaptured Atlantic sailfish at-large for 10 yr, 10 mo. Major features of the sagitta are labeled and the approximate location and number of the first 10 external ridges are shown on the rostrum. Directional growth of the rostrum is indicated by white letters and arrows.



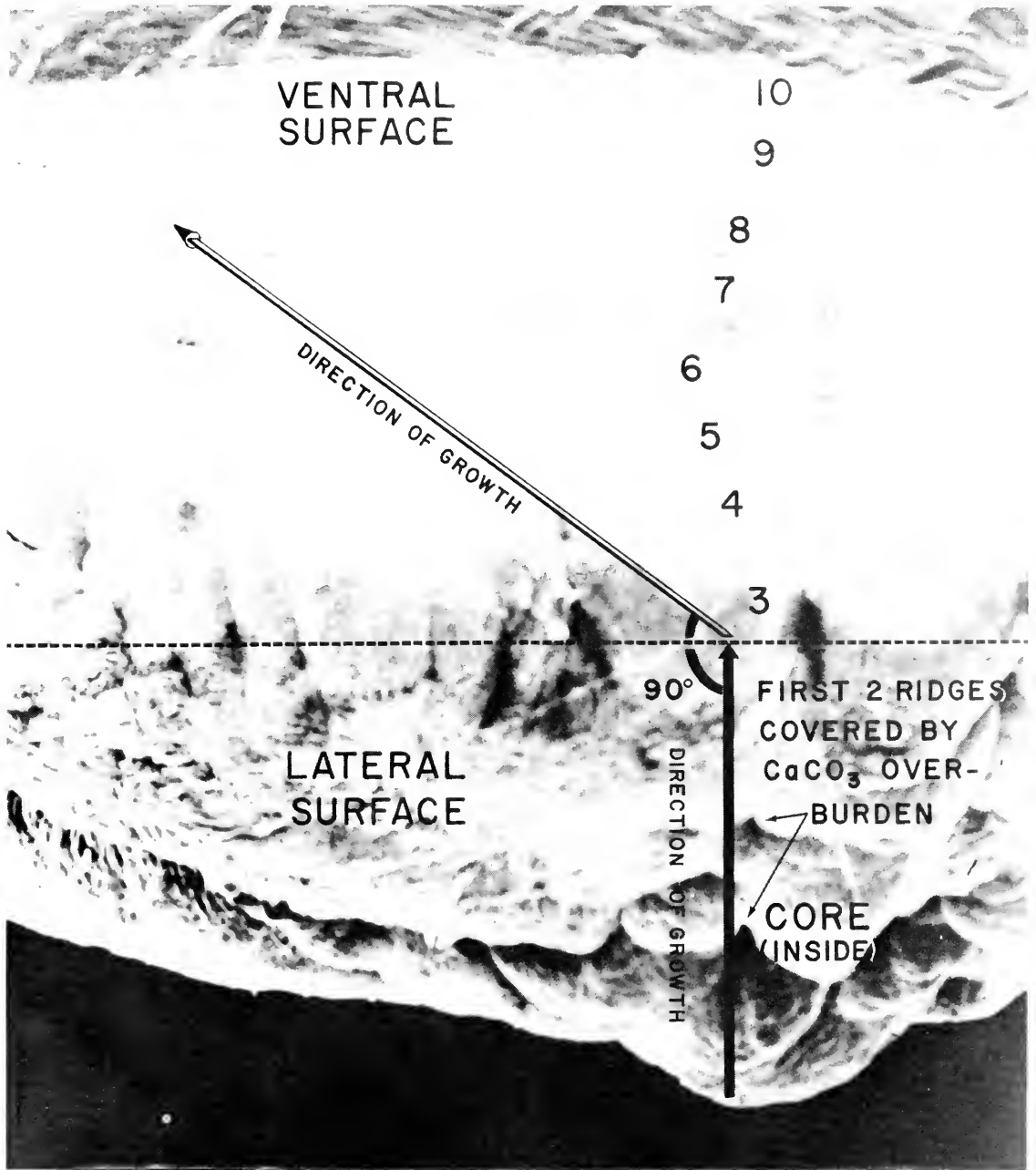

FIGURE 4.—Lateral and ventral view of the sagitta rostrum from the tag-recaptured Atlantic sailfish showing the overall pattern of otolith growth and the approximate location and number of the first 10 external ridges.

zone exists between the boundary of many of the external ridges shown in Figure 3. This zone extends from the surface to deep within the internal structure of the rostrum (Fig. 3). The distinct change in optical density of the first of these prominent zones marks what we believe is the boundary between the 1st and 2d ridges and suggests that the first major growth zone is located between the core and the bend (Fig. 3). Further, using the SEM we counted 150-200 finely spaced increments between the core and the first prominent translucent zone. This count also supports our interpretation of the location of the first annual zone if these increments are assumed to form daily, the fish was born sometime in late spring or early summer (as reported by Beardsley et al. 1975), and the annual zonations are being formed in the winter. Jolley (1977) reported that annual zones in Atlantic sailfish spines tend to be formed in late fall or winter and he also speculated that sailfish may form the first annuli on spines prior to a full year's growth. The location of the second translucent zone, based on similar evidence, appears to be at the beginning of the bend (Fig. 3). The width of the first two major growth zones ( $\geq 0.5$  mm) are considerably larger than the zones beyond the end. Wide spacing of year marks during early growth have been observed in many fishes when growth rates are most rapid (Dean et al. 1983). Therefore, these data support our contention that at least two ridges should be accounted for as occurring within the boundaries of the lateral surface.

Rostral ridges 3 through 10 were easily distinguished and counted on the sagitta's ventral surface within the same plane of focus (Fig. 5, bottom). After the 10th ridge, however, the rostrum changes direction slightly (Fig. 3), and it was necessary to refocus to observe ridges 11 through 13 (Fig. 5, top). We feel that potential sources of error in our counts of rostral ridges would have most likely occurred at the beginning and end of the counting path. In addition, we feel that if errors were made at these locations, they would have increased the count. Therefore, otolith age of the tagged Atlantic sailfish was estimated to be 13 yr. However, it should be recognized that potential errors in this estimate could have resulted if one or two ridges were unaccounted for on the lateral surface or on the tip of the rostrum on the ventral surface. Otolith age under these circumstances should be presented conservatively as ranging from 13 to 15+ yr.

The weight of one sagitta from the tagged Atlantic sailfish (7.84 mg) was extremely heavy for an istiophorid of comparable size. For example, it was

1.24 mg heavier than the sagitta from a 29.6 kg (65 lb) sailfish caught in 1985 off Miami and was 1.18 mg heavier than the largest sagitta from Pacific blue marlin reported by Radtke (1983). In addition, the tagged sailfish sagitta was in the upper range in weight (0.51-8.16 mg) of more than 500 blue and white marlin sagittae examined by Wilson (1984). Since the relationship between the size of otoliths and the age of fishes has been shown to be positively correlated for some teleosts (Somerton 1985), we feel that the relatively large size of this sagitta provides additional indirect evidence that this structure could be from a very old sailfish.

## CONCLUSIONS

Our tagging records indicate that estimates of maximum longevity for Atlantic sailfish should be revised upwards to at least 13-15+ yr, and that sailfish of this age can grow at a very slow rate (about 0.59 kg/yr during its time at large). Dorsal spines do not appear to be an accurate source of age and growth information for older, larger sailfish ( $\geq 5$  yr,  $\geq 22.7$  kg or 50 lb), while sagittae do provide more accurate estimates of age for these older age groups. Since current stock assessments of Atlantic sailfish (Conser 1984) rely exclusively on dorsal spine ageing data as input, these assessments offer little insight into the more mature segments of the population. If skeletal structures from the larger, older fish are systematically rejected for ageing analyses, an underestimate of age and longevity and an overestimate of growth rate can occur (Nammack et al. 1985). Therefore, future assessments should be revised using otolith ageing methods to clarify that portion of the age structure that can not be reliably appraised using dorsal spines.

## ACKNOWLEDGMENTS

We thank J. T. Reese Taxidermist, Inc., Ron Harrison (angler), and Captain Bud Carr for providing us with biological samples and other information from the tagged Atlantic sailfish. Personnel from the Florida Department of Natural Resources in West Palm Beach, FL, sectioned and analyzed dorsal spine number 4. Dana Dunkleberger (University of South Carolina) assisted in preparing scanning electron micrographs.

## LITERATURE CITED

BEARDSLEY, G. L.

1980. Size and possible origin of sailfish, *Istiophorus*

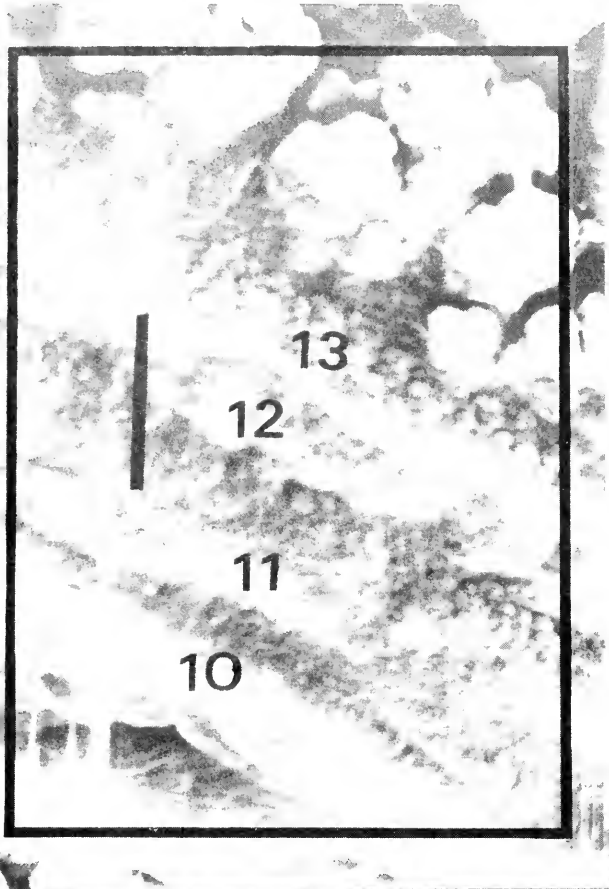
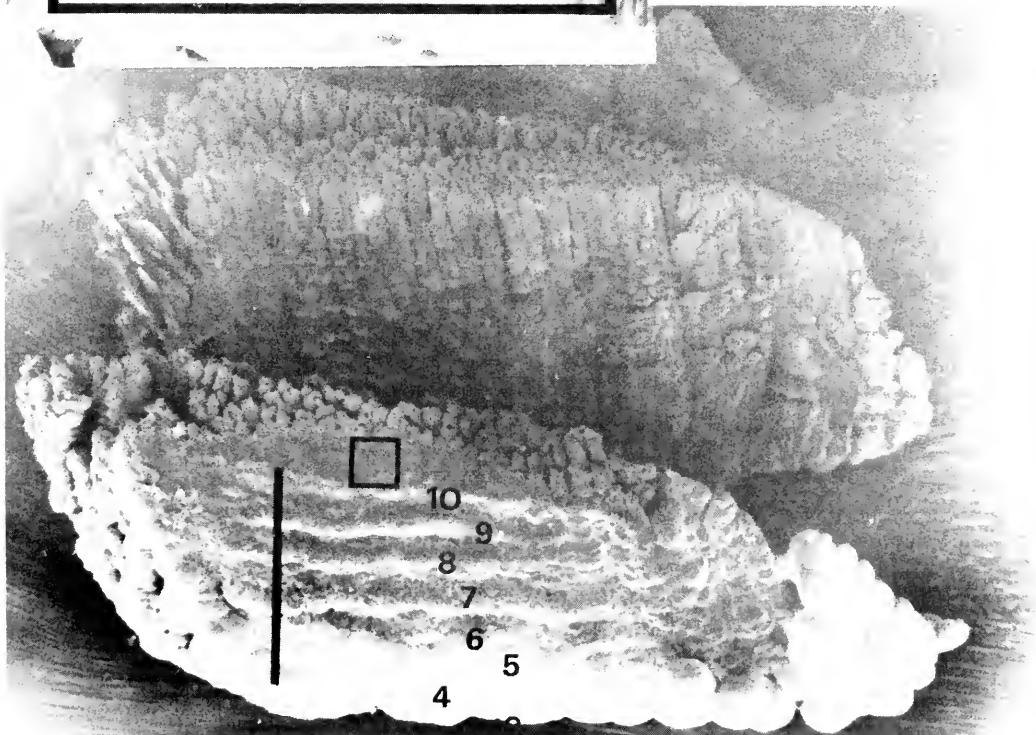

FIGURE 5.—Scanning electron micrograph of the ventral view of the sagitta rostrum from the tag-recaptured Atlantic sailfish. A count of external ridges 3-10 (bottom) and 10-13 (top) were used to assign a numeric otolith age of 13 yr. Bar on bottom = 1.0 mm, bar on top = 0.1 mm.



- platypterus*, from the eastern Atlantic Ocean. Fish. Bull., U.S. 78:805-808.
- BEARDSLEY, G. L., JR., N. R. MERRETT, AND W. J. RICHARDS. 1975. Synopsis of the biology of the sailfish, *Istiophorus platypterus* (Shaw and Neddor, 1791). In R. S. Shomura and F. Williams (editors), Proceedings of the international billfish symposium, Kailua-Kona, Hawaii, 9-12 August 1972, part 3, p. 95-120. U.S. Dep. Commer., NOAA Tech. Rep. NMFS SSRF-675.
- CASSELMAN, J. M. 1983. Age and growth assessment of fish from their calcified structures—techniques and tools. In E. D. Prince and L. M. Pulos (editors), Proceedings of the international workshop on age determination of ocean pelagic fishes: tunas, billfishes, and sharks, p. 1-18. U.S. Dep. Commer., NOAA Tech. Rep. NMFS-8.
- COMPEAN-JIMENEZ, G., AND F. X. BARD. 1983. Growth increments on dorsal spines of eastern Atlantic bluefin tuna, *Thunnus thynnus*, and their possible relation to migration patterns. In E. D. Prince and L. M. Pulos (editors), Proceedings of the international workshop on age determination of oceanic pelagic fishes: tunas, billfishes, and sharks, p. 77-86. U.S. Dep. Commer., NOAA Tech. Rep. NMFS-8.
- CONSER, R. J. 1984. Yield per recruit analysis of sailfish, *Istiophorus platypterus*, in the western Atlantic Ocean. Int. Comm. Conserv. Atl. Tunas, Collect. Vol. Sci. Pap., Madrid 20:448-464.
- DEAN, J. M., C. A. WILSON, P. W. HAAKE, AND D. W. BECKMAN. 1983. Microstructural features of teleost otoliths. In P. Westbroek and E. W. deJong (editors), Biomineralization and biological metal accumulation, biological and geological perspectives. p. 353-359. D. Reidel Publ. Co., Holland.
- DE SYLVA, D. P. 1957. Studies on the age and growth of the Atlantic sailfish, *Istiophorus americanus* (Cuvier), using length-frequency curves. Bull. Mar. Sci. Gulf Caribb. 7:1-20.
- ELLIS, R. W. 1957. Catches of fish by charter boats on Florida's east coast. Univ. Miami Mar. Lab. Spec. Serv. Bull. 14, 6 p.
- HAAKE, W., C. A. WILSON, AND J. M. DEAN. 1982. A technique for the examination of otoliths with applications to larval fishes. In C. F. Bryan, S. V. Conner, and F. M. Truesdale (editors), Proceedings of the 5th annual larval fish conference, p. 12-15. Baton Rouge, LA.
- HEDGEFETH, M. Y., AND J. W. JOLLEY, JR. 1983. Age and growth of sailfish, *Istiophorus platypterus*, using cross sections from the fourth dorsal fin spine. In E. D. Prince and L. M. Pulos (editors), Proceedings of the international workshop on age determination of oceanic pelagic fishes: tunas, billfishes, and sharks, p. 131-136. U.S. Dep. Commer., NOAA Tech. Rep. NMFS-8.
- JOLLEY, J. W., JR. 1974. On the biology of Florida east coast Atlantic sailfish (*Istiophorus platypterus*). In R. S. Shomura and F. Williams (editors), Proceedings of the international billfish symposium, Kailua-Kona, Hawaii, 9-12 August 1972, part 2, Review and contributed papers, p. 81-88. U.S. Dep. Commer., NOAA Tech. Rep. NMFS SSRF-675.
1977. The biology and fishery of Atlantic sailfish, *Istiophorus platypterus*, from southeast Florida. Fla. Mar. Res. Publ. 28, 31 p.
- LOPEZ, A. M., D. B. MCCLELLAN, A. R. BERTOLINO, AND M. D. LANGE. 1979. The Japanese longline fishery in the Gulf of Mexico, 1978. Mar. Fish. Rev. 41(10):23-28.
- NAMMACK, M. F., J. A. MUSICK, AND J. A. COLVOCORESSES. 1985. Life history of spiny dogfish off the northeastern United States. Tran. Am. Fish. Soc. 114:367-376.
- PRINCE, E. D. 1984. Angler participation in oceanic pelagics programs, Southeast Fisheries Center, Miami Laboratory. (Abstr.) In 114th annual meeting of the American Fisheries Society, Ithaca, NY, August 12-16, 1984, p. 74-75.
- PRINCE, E. D., AND D. W. LEE. 1982. Bioprofiles sampling manual for oceanic pelagic fishes, 1982-83. U.S. Dep. Commer., NOAA Tech. Memo. NMFS SEFC-103, 26 p.
1984. Research on age and growth. In Oceanic pelagic program summary 1983, p. 45-62. NOAA, NMFS, Miami Lab. Ann. Rep.
- PRINCE, E. D., D. W. LEE, C. A. WILSON, AND J. M. DEAN. 1984. Progress in estimating age of blue marlin, *Makaira nigricans*, and white marlin, *Tetrapturus albidus*, from the western Atlantic Ocean, Caribbean Sea, and Gulf of Mexico. Int. Comm. Conserv. Atl. Tunas, Collect. Vol. Sci. Pap., Madrid 20:435-447.
- RADTKE, R. L. 1983. Istiophorid otoliths: extraction, morphology, and possible use as ageing structures. In E. D. Prince and L. M. Pulos (editors), Proceedings of the international workshop on age determination of oceanic pelagic fishes: tunas, billfishes, and sharks, p. 123-129. U.S. Dep. Commer., NOAA Tech. Rep. NMFS-8.
- RADTKE, R. L., AND J. M. DEAN. 1981. Morphological features of the otoliths of the sailfish, *Istiophorus platypterus*, useful in age determination. Fish. Bull., U.S. 79:360-367.
- RADTKE, R. L., L. M. COLLINS, AND J. M. DEAN. 1982. Morphology of the otoliths of the Atlantic blue marlin (*Makaira nigricans*) and their possible use in age estimation. Bull. Mar. Sci. 32:498-503.
- ROBINS, C. R., AND D. P. DE SYLVA. 1963. A new western Atlantic spearfish, *Tetrapturus pfluegeri*, with a redescription of the Mediterranean spearfish *Tetrapturus belone*. Bull. Mar. Sci. Gulf Caribb. 13:84-122.
- SOMERTON, D. 1985. Indirect aging of fish using otolith weights and cross-section areas. (Abstr.) In International symposium on age and growth of fish, Des Moines, Iowa, June 9-12, 1985, p. 93-94.
- WILSON, C. A. 1984. Age and growth aspects of the life history of billfish. Ph.D. Thesis, Univ. South Carolina, Columbia, SC, 180 p.
- WILSON, C. A., AND J. M. DEAN. 1983. The potential use of sagittae for estimating age of Atlantic swordfish, *Xiphias gladius*. In E. D. Prince and L. M. Pulos (editors), Proceedings of the international workshop on age determination of oceanic pelagic fishes: tunas, billfishes and sharks, p. 151-156. U.S. Dep. Commer., NOAA Tech. Rep. NMFS-8.

# AGE DEPENDENT FECUNDITY, NUMBER OF SPAWNINGS PER YEAR, SEX RATIO, AND MATURATION STAGES IN NORTHERN ANCHOVY, *ENGRAULIS MORDAX*

RICHARD H. PARRISH,<sup>1</sup> DONNA L. MALLICOATE,<sup>1</sup> AND  
RICHARD A. KLINGBEIL<sup>2</sup>

## ABSTRACT

Maturity stage data from fishery sampling programs and ovarian histological data from research cruises were used to develop a method for determining the age-specific number of spawnings per year and annual fecundity of the central stock of northern anchovy, *Engraulis mordax*.

The sex ratio was found to be size and age dependent in both the fishery and trawl surveys with females increasingly dominant in the larger and older size and age classes. The overall sex ratio in trawl surveys was nearly 1:1; the fishery data favored females 1.48:1. The magnitude and duration of maturity stages were size and age dependent with peak spawning occurring earlier in the season in younger fish. Maturity stages and histological classes with hydrated eggs showed essentially the same diurnal pattern for nightly spawning activity indicating that the presence of hydrated eggs could be used as an index of daily spawning. The daily spawning incidence and total annual fecundity were found to be heavily age dependent. Females in their first spawning season had an average of 5.3 spawnings, while those in their fourth had an average of 23.5 spawnings. When combined with the higher batch fecundity of larger fish this results in 4+ year-old females producing nearly 5 times as many eggs per unit of weight as 1-year-olds. When the age-specific fecundity and sex ratio in the fishery are combined it is apparent that the catch of a ton of 4+ year-old northern anchovy reduces the reproductive potential of the stock 7.3 times as much as the catch of a ton of 1-year-olds.

It was concluded that age-specific fecundity in multiple spawning fishes is of greater significance for management than previously thought. It is also significant that much of the observed variance in stock-recruitment relationships for multiple-spawning fishes may be due to the fact that spawning biomass is a poor index of the egg production and reproductive potential of the stock.

Age-specific variation in life history rates is a major factor in population and management models of exploited fishes, and variation in reproductive effort is of great significance in such models. Size and age-specific batch fecundity estimates have been available for many species for decades, and for species which spawn only once per spawning season these are readily incorporated into models. However it has been impossible to determine the age-specific reproductive effort of species which spawn many times during a spawning season because there has been no way to determine the number of spawnings per year.

Recent research on the histology of the ovaries of northern anchovy, *Engraulis mordax*, and anchoveta, *Engraulis ringens*, suggest that they spawn approximately once a week during peak spawning months (Hunter and Goldberg 1980;

Hunter and Macewicz 1980; Alheit et al. 1983; Alheit et al. 1984). Hunter and Leong (1981), in their study of the spawning energetics of the northern anchovy, found that northern anchovy spawn about 20 times per year. Hunter and Leong (1981) and Alheit et al. (1983) suggested that annual fecundity per unit of parental biomass may be highly variable and dependent upon the nutritional state and size structure of the stock.

Potentially the recently developed histological techniques could be utilized to determine age-specific annual fecundity; however, this would be very expensive as it would require a very large data set which would necessarily be stratified by age and time of year. The objectives of this report are 1) to demonstrate a method for combining the high resolution reproductive information from the histology of the ovaries with inexpensive, lower resolution reproductive information derived from resource surveys and fishery sampling programs to determine the age-specific reproductive potential of a multiple spawning species, and 2) to evaluate the gross anatomical maturity stages which have been

<sup>1</sup>Southwest Fisheries Center, Pacific Fisheries Environmental Group, National Marine Fisheries Service, NOAA, P.O. Box 831, Monterey, CA 93942.

<sup>2</sup>California Department of Fish and Game, 245 W. Broadway Street, Long Beach, CA 90802.

utilized in field sampling programs for northern anchovy and to use the historical data from these programs in conjunction with ovarian histological data to describe age-dependent annual fecundity in the central stock of northern anchovy.

## DATA SOURCES

There are three major sources of biological data for adult northern anchovy in California: samples taken from the commercial fishery (Collins and Spratt 1969), samples taken from midwater trawl hauls carried out by the Sea Survey Program (Mais 1974), and samples taken primarily by midwater trawl during egg production cruises (Picquelle and Hewitt 1983). The first two sources are the result of long-term research and monitoring programs carried out by the California Department of Fish and Game, and the third is the result of research cruises carried out by the National Marine Fisheries Service. The fishery data used in this analysis consist of biological information for 60,661 northern anchovy sampled from the San Pedro purse seine fleet during the period of 1966-80 and 4,904 northern anchovy sampled from the Monterey fleet during 1966-78. All northern anchovy in the fishery samples were aged and nearly all were assigned maturity stages. We used a geographically restricted subset of the 1966-83 sea survey data (lat. 29.5°-34.5°N; 54,457 northern anchovy). Maturity stages were not recorded for males in the sea survey data and age determinations were made on only a portion (19,031) of the fish sampled. In both data sets age determinations were made from otoliths with methods described by Collins and Spratt (1969). The third source of data, provided to us by B. Macewicz<sup>3</sup>, consists of histological information for the gonads of 8,672 females sampled during the months of February to April from 1977 to 1984. Age determinations were not made and maturity stages were not taken on these fish.

The gross anatomical maturity stage description used for northern anchovy is a slightly modified version of the system developed by Bowers and Holliday (1961) for herring. The system has seven maturity stages which are primarily based on the portion of the body cavity occupied by the gonads and, in the later stages, by the appearance of translucent eggs or milt (Table 1). Herring are considerably larger than anchovy, and they are generally not

considered to be multiple spawners; therefore, there are some difficulties in applying the maturity stages to anchovy. The most obvious problem is that a considerable proportion of the anchovy sampled had gonads so small that sex determinations were not made as they would have required magnification. There was also a small proportion of fish in which physical deterioration made sex determination impossible. The California anchovy fishery is primarily for reduction to fish meal, and the quality of the fish was occasionally very poor when the fish were sampled. Another major difficulty is that it is not possible to distinguish between anchovy gonads that are resting (i.e., stage 2) between multiple spawnings in the same season and those resting between spawning seasons. A comparable problem exists with spent fish (stage 7).

TABLE 1.—The international (Hjort) scale of maturity stages of the gonad. From Bowers and Holliday (1961).

Stage 1:	Virgin individuals: very small sexual organs close under vertebral column; ovaries wine-colored, torpedo-shaped, about 2-3 cm long and 2-3 cm thick, eggs invisible to naked eye; testes whitish or greyish-brown, knife-shaped, 2-3 cm long and 2-3 cm broad.
Stage 2:	Maturing virgins or recovering spents: ovaries somewhat longer than half the length of ventral cavity, about 1 cm diameter, eggs small but visible to naked eye; milt whitish, somewhat bloodshot, of same size as ovaries, but still thin and knife-shaped.
Stage 3:	Sexual organs more swollen, occupying about half of ventral cavity.
Stage 4:	Ovaries and testes occupying almost two thirds of ventral cavity; eggs not transparent, milt whitish, swollen.
Stage 5:	Sexual organs filling ventral cavity; ovaries with some large transparent eggs; milt white, not yet running.
Stage 6:	Roe and milt running (spawning).
Stage 7:	Spents: ovaries slack with residual eggs; testes baggy, bloodshot.

## SEX RATIO

Description of the sex ratio in northern anchovy was confounded by the presence of fish for which the sex could not be determined. The relationship between size and the percentage of these unsexed fish is similar for both the commercial purse seine and midwater trawl data. In both data sets, a large percentage of the fish smaller than 100 mm standard length (SL) are of unknown sex, about 10% of the 101-110 mm fish are of unknown sex, and only a small percentage of the fish larger than 110 mm are of unknown sex (Table 2). The percentages of fish with unknown sex at sizes larger than 110 mm in the purse seine data are somewhat higher than those in the midwater trawl data. This is probably due to the occasional occurrences of fish in which

<sup>3</sup>B. Macewicz, Southwest Fisheries Center La Jolla Laboratory, National Marine Fisheries Service, NOAA, 8604 La Jolla Shores Drive, La Jolla, CA 92038, pers. commun. August 1984.

the condition was too poor to allow sex identification. The relationship between age and the percentage of unsexed fish is similar to that described for size (Table 2). It should be noted that both data sets are biased towards larger and older fish. The age composition of anchovy in the midwater trawl data is biased because of the fact that otoliths were often not taken when trawl hauls were dominated by young-of-the-year fish (Parrish et al. 1985). The purse seine data contain a much smaller percentage of small or young fish than the midwater trawl data. This is primarily caused by the fact that a 5-in (about 108 mm SL) minimum size limit was in effect for most of the 1966-80 period.

To evaluate the seasonal cycle of the occurrence of northern anchovy for which the sex could not be identified, the monthly percentages of females, males, and anchovy with unknown sex were determined by age group for the San Pedro fishery (Fig.

1). In all age groups the minimum percentages of fish which could not be sexed occurred from about January to May in association with the spawning season. Higher percentages occurred both before and after the spawning season, particularly in the first potential spawning season. This implies that a significant percentage of anchovy mature, or at least partially mature, and then reabsorb their gonadal tissue to the point that their gonads are so small that they cannot be sexed without magnification. It also implies that a bias due to the unsexed fish exists. This bias is at a minimum from January to May and it primarily affects the analyses of fish in their first potential spawning season.

Klingbeil (1978) found the female:male ratios of northern anchovy sampled in the Sea Survey Program and in the commercial fishery to be 1.03:1 and 1.60:1 respectively. The additional years of information from these two sources, in our data sets, pro-

TABLE 2.—Proportion of northern anchovies with unknown sex and sex ratio by size (A) and by age (B).

Length (mm)	San Pedro anchovy fishery				Sea survey (lat 29.5°-34.5°N)			
	Unknown sex	Females male	Mean SL	Number	Unknown sex	Females male	Mean SL	Number
A								
61- 70	1.000	—	—	1	0.996	0.00	—	273
71- 80	0.676	0.71	—	37	0.941	0.94	—	597
81- 90	0.437	0.67	—	252	0.810	0.78	—	1,396
91-100	0.283	0.77	—	2,261	0.500	0.84	—	2,208
101-110	0.114	1.06	—	8,684	0.100	0.82	—	2,882
111-120	0.057	1.30	—	17,186	0.016	0.78	—	4,141
121-130	0.029	1.53	—	19,396	0.007	1.07	—	4,016
131-140	0.014	2.10	—	10,010	0.003	1.43	—	2,439
141-150	0.007	2.90	—	2,354	0.003	2.56	—	772
151-160	0.009	4.43	—	438	0.005	3.09	—	185
161+	0.024	7.20	—	42	0.000	9.67	—	32
Total	0.057	1.48	—	60,661	0.187	1.02	—	19,031
B								
Age	Annual							
0	0.202	0.83	104.2	1,862	0.779	0.81	88.7	3,616
1	0.090	1.15	112.8	16,167	0.122	0.88	107.2	4,812
2	0.046	1.49	121.1	20,885	0.022	0.86	119.4	4,733
3	0.036	1.76	126.3	14,174	0.010	1.15	126.4	3,543
4+	0.022	2.01	134.0	7,573	0.003	1.66	135.0	2,327
Total	0.057	1.48	121.2	60,661	0.187	1.02	113.7	19,031
Age	February-April							
0	—	—	—	0	—	—	—	0
1	0.093	0.95	106.5	4,646	0.153	0.79	101.0	2,271
2	0.027	1.33	116.2	4,279	0.004	0.78	117.3	2,035
3	0.018	1.45	123.3	3,410	0.002	1.04	125.3	1,928
4+	0.014	1.69	134.4	3,620	0.001	1.55	134.6	1,382
Total	0.041	1.30	119.0	15,955	0.048	0.96	117.6	7,616
Age	August-December							
0	0.259	0.77	104.2	1,204	0.831	0.78	88.6	3,216
1	0.083	1.19	117.6	6,411	0.104	0.97	112.2	2,198
2	0.060	1.59	123.1	12,082	0.035	0.91	120.5	2,311
3	0.051	1.92	127.7	7,648	0.021	1.28	128.1	1,255
4+	0.039	2.33	132.9	2,532	0.007	1.57	135.4	560
Total	0.069	1.58	123.2	29,877	0.316	1.02	109.7	9,540

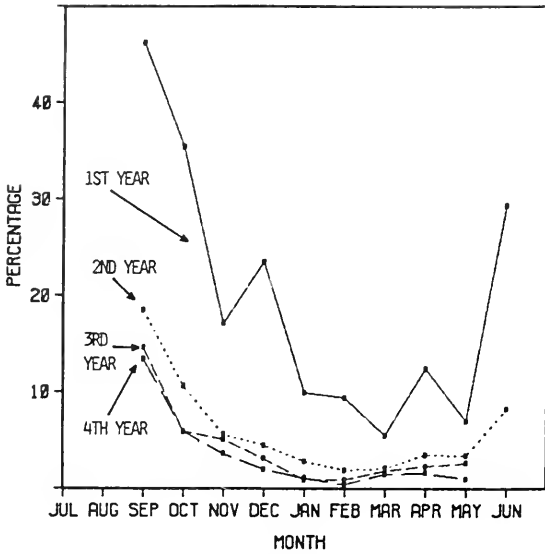

FIGURE 1.—The monthly percentages of northern anchovies with unknown sex, by age group, in samples from the San Pedro fishery.

duced essentially no change in the sex ratio in the sea survey data (1.02:1). However, there was a reduction in the proportion of females in the fishery data (1.48:1) which was associated with a reduction in the average age of anchovy in the catch after 1977 (Mais 1981). Sunada and Silva (1980) also found a female:male sex ratio greater than unity in the northern Baja California purse seine fishery, 2.15:1 in 1976 and 1.44:1 in 1977. Alheit et al. (1984) reported a sex ratio of 1.30:1 in purse seine caught Peruvian anchoveta sampled during their spawning season. Klingbeil (1978) and Alheit et al. (1984) reported that during the spawning season there were unexpectedly large numbers of samples in which sex ratios were heavily dominated by either males or females. Alheit et al. (1984) suggested that "hydrated females segregate, either by depth or area, from the 'normal' school, taking a high percentage of males with them forming 'spawning schools' dominated by males."

Analysis of the sex ratio by size and age groups shows that there are increasingly larger proportions of females in the larger and older groups (Table 2). This trend is evident in both the fishery and sea survey data. In the fishery data there are more males than females identified in the fish smaller than 100 mm SL and in age group 0. The proportion of females increases until there are more than twice as many females as males among fish larger than 130 mm and in age group 4+. There is a similar trend in the sea survey data; however, females do

not outnumber males until the fish are larger than 120 mm and 3 yr of age. The sex ratio in age group 4+ is 1.66:1. The apparent dominance of females in the larger size classes may be partially caused by sex related differences in growth rates; however, their dominance in the older age classes of both the purse seine and midwater trawl samples cannot be explained by differences in growth. We grouped our data sets into the spawning months (February-April) and nonspawning months (August-December) in order to evaluate features which might be caused by behavioral differences that may occur during the spawning season. This analysis shows that the overall sex ratio in northern anchovy taken by midwater trawl is close to 1:1 in both nonspawning and spawning seasons (Table 2B). It also shows that the sex ratios in younger fish are dominated by males and those in older fish are dominated by females. The overall sex ratio in northern anchovy sampled in the purse seine fishery is heavily dominated by females; however, the sex ratio is higher in the nonspawning season (1.58:1) than in the spawning season (1.30:1). The crossover from male to female dominance of the sex ratio occurs between age group 2 and 3 in the sea survey data and at age 1 in the fishery data.

## MATURITY STAGES IN NORTHERN ANCHOVY

### Seasonal Variation in Maturity Stages

To determine which of the various data sets available for northern anchovy were best suited for evaluating maturity stages in the central stock, we examined the seasonality of three grouped maturity stages of four data subsets. The grouped stages included immature or resting females (stages 1 and 2); females just beginning to mature (stage 3); and the highly mature, spawning, and spent females (stages 4-7). The data consisted of two sets of samples from the commercial fishery (Monterey and San Pedro) and the sea survey samples from southern California (lat. 32.5°-34.5°N) and northern Baja California (29.5°-32.5°N).

The seasonal patterns of the grouped maturity stages of females sampled in the San Pedro fishery (Fig. 2A), the sea survey in southern California (Fig. 2B), and the sea survey in northern Baja California (Fig. 2C) are quite similar. The pattern in the Monterey fishery differs from that in the other data sets in that spawning is at the highest levels in April and September (Fig. 2D). It cannot presently be determined if there are one or two peaks of spawning in



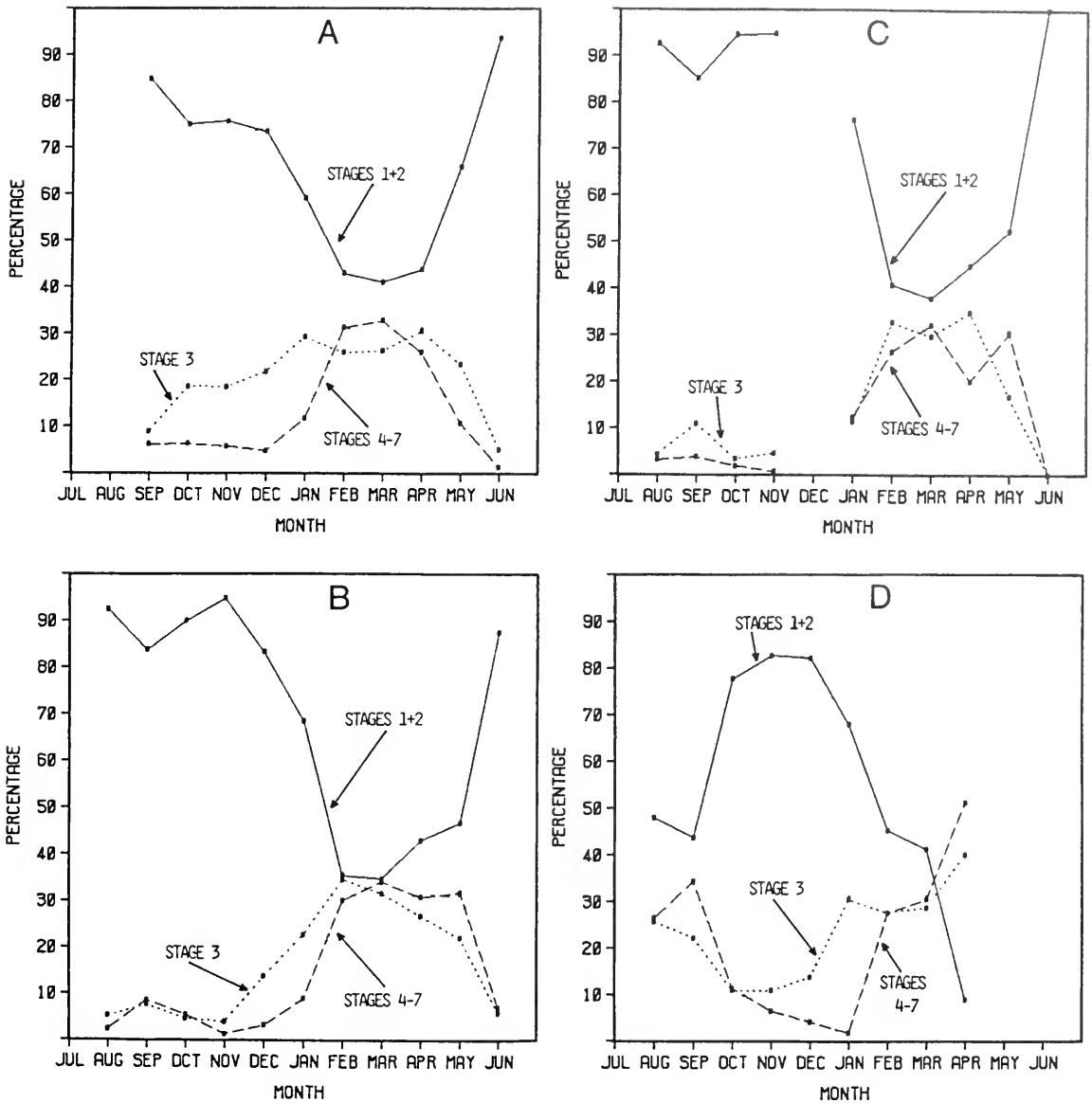

FIGURE 2.—The monthly percentages of grouped maturity stages for female northern anchovies sampled in A, San Pedro fishery; B, Sea survey (lat. 32.5°-34.5°N); C, Sea survey (29.5°-32.5°N); D, Monterey fishery.

the Monterey area due to the lack of data from May to July. Because of the different seasonal pattern of the grouped maturity stages in the Monterey fishery data and because there is more than one stock in this region (Vrooman et al. 1981), it was decided to exclude this area from further analysis. The analyses that follow are based on the combined San Pedro fishery and southern California-northern Baja California sea survey data sets (52,352 females of which 41,930 were aged).

To obtain a first approximation of the magnitude and duration of maturity stages in the central stock of northern anchovy, the monthly percentages of fish with each maturity stage were calculated for females and for males. The seasonal patterns were found to be essentially the same for males and females; however, the males tended to have somewhat larger percentages of fish in the higher maturity stages. Our presentation is limited to information on females.

The proportion of females classified as stage 1, virgin individuals, is at a minimum during the spawning season, comprising <10% of the females sampled during February, March, and April. However, during the summer more than half of the females were classified as stage 1 (Fig. 3A). Stage 2 females, maturing virgins and recovering spents, are at a minimum in August (when most females are classified as stage 1). From September until January between 40 and 60% of the females are classified as stage 2. During the spawning season, and just after, the percentage of stage 2 females dropped between 30 and 40%. The August to September decline in the percentage of stage 1 females is primarily caused by the sharp increase in the proportion of stage 2 females. Thus, the combined percentage of stages 1 and 2 females is probably a reasonable inverse indicator of the seasonality of spawning. However, during the spawning season an unknown proportion of those classified as stages 1 and 2 are females that have recently spawned and are between multiple spawnings.

Stage 3 females (ovary enlarged, occupying about half of the length of the ventral cavity) have a considerably different pattern. There is a gradual increase from about 5% in August to about 30% in January. This percentage is maintained until April, i.e., through the spawning season; it then drops to about 5% in June. The monthly percentages of the higher maturity stages (4, 5, and 6) clearly delineate the spawning season as primarily a January-May

event (Fig. 3B). The relatively constant low level of stage 7 females is unexpected as the maximum proportion of spent fish would be expected to occur just after the peak of spawning.

### Maturity Stage Relationships with Size and Age

To examine potential relationships between the size and age of northern anchovy and the duration and magnitude of maturity stages we calculated the monthly percentages of grouped maturity stages for four size classes (81-100, 101-120, 121-140, and 141-160 mm SL) and four age groups (1, 2, 3, and 4+). Age group 1 includes fish prior to and after their first potential spawning season (i.e., young-of-the-year fish in July through the following June). Age group 4+ includes fish in their fourth and subsequent spawning seasons. The grouped maturity stages (1, 2, 3, and 4-7) are the same as those presented earlier.

Size has a large effect on both the duration and magnitude of maturity stages in northern anchovy. With the exception of those sampled from February to April nearly all of the 81-100 mm SL females were classified as immature or resting (Fig. 4A). In addition, the majority of this size anchovy have gonads too small to determine their sex without magnification (Table 2). As the size class increases the percentage of stages 1 and 2 decreases; this occurs in all months; however, the minimum percentage of

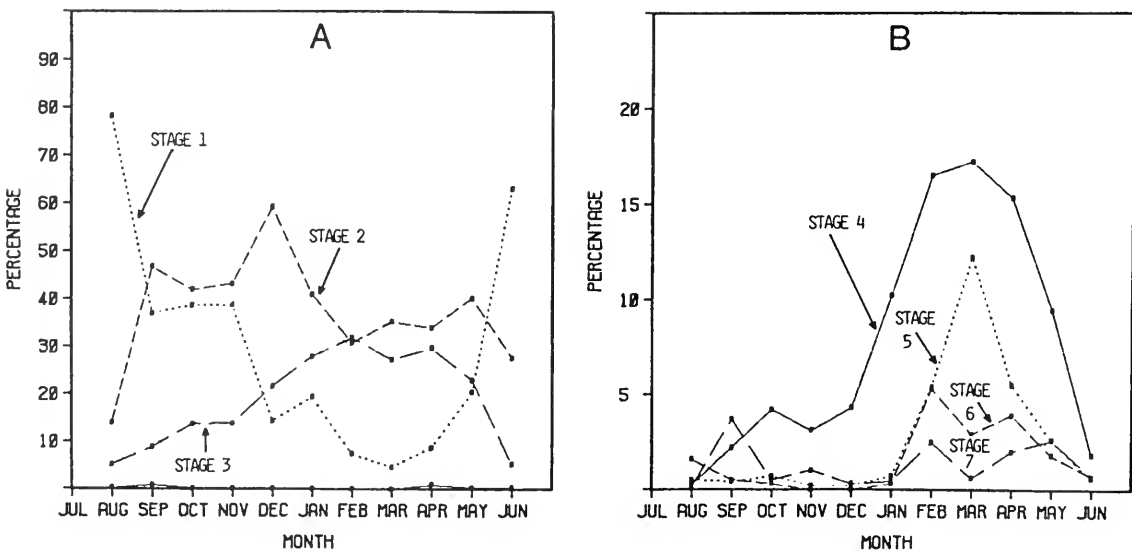

FIGURE 3.—The monthly percentages of individual maturity stages for female northern anchovies. A. Stages 1-3. B. Stages 4-7.

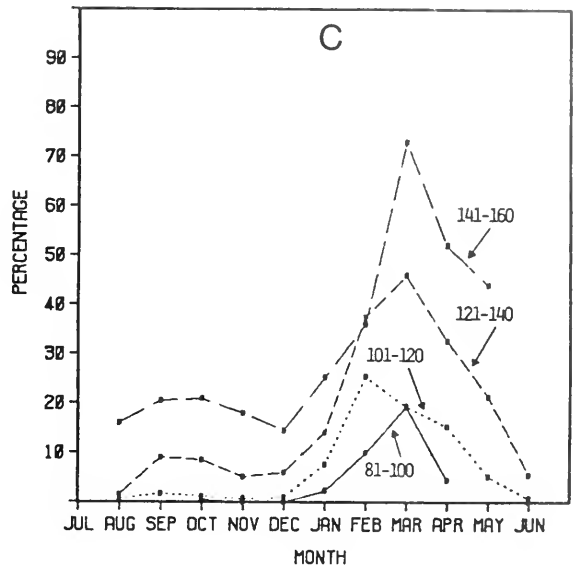
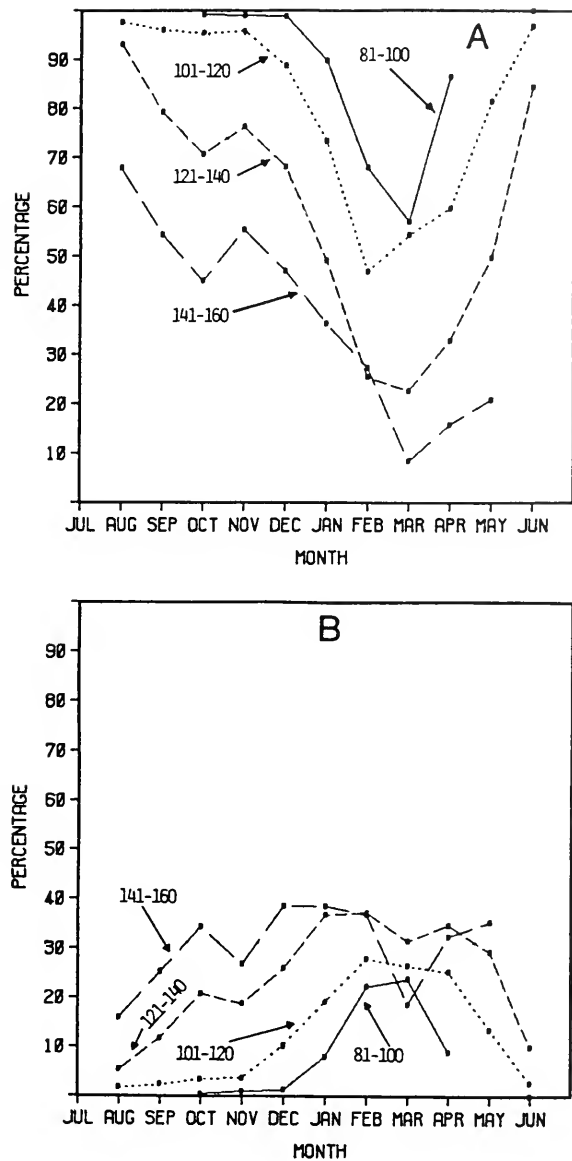

FIGURE 4.—The monthly percentages of grouped maturity stages for female northern anchovies, by size group. A. Stages 1+2 B. Stage 3. C. Stages 4-7.

stages 1 + 2 occurs in February to April. The percentage of females just beginning to mature (i.e., stage 3) has an abrupt peak in February-March in the smallest size class (Fig. 4B). This peak becomes increasingly spread out in the larger size classes. The higher maturity stages (4-7) are most abundant from February to April in all size classes (Fig. 4C). The larger size classes have much larger percentages of females in the higher maturity stages than the smaller size classes, and there is a minor peak in the percentage of the higher maturity stages during the fall in the two largest size classes. Analysis of the data by age group showed, as would be ex-

pected, that increased age has essentially the same effect as increased size on the magnitude and duration of maturation stages.

### SPAWNING INCIDENCE AND FECUNDITY

Studies by Hunter and Goldberg (1980) in California and Alheit et al. (1983) in Peru examined post-ovulatory follicles to determine the spawning frequency of female anchovies (i.e., the time interval between spawnings). A second method would be to determine the percentage of females with

hydrated eggs. Hunter and Macewicz (1980) showed that northern anchovy begin hydrating eggs at about 0600 in the morning and by sunset about 14% of the females have hydrated eggs. They felt that the best indicator of the time of spawning was the occurrence of both hydrated eggs and new postovulatory follicles. This occurred in a low percentage of their samples indicating that spawning was completed rapidly; the time of maximum spawning occurred between 2100 and 0200 with a peak between 2200 and 2300. Hunter and Macewicz (1980) divided the nightly pattern of spawning in anchovy into three periods: "early spawning period (1800 to 2100 hours), some spawning occurs but the ovaries of most reproductively active females are in the hydrated stage; maximum spawning (2100-0200 hours), most females spawn (females with hydrated eggs decline to 0 and females with new postovulatory follicles reach the maximum number for the night); and post-spawning (0200-0600 hours), little or no spawning occurs and females destined to spawn the next night begin hydration." A considerable amount of new histological data is now available as a result of a series of egg production biomass surveys for northern anchovy. B. Macewicz (fn. 3) has analyzed the histology of the ovaries of 8,672 anchovy sampled in these surveys, and our analysis of this new information verifies the temporal patterns which Hunter and Macewicz (1980) described from a much smaller sample (Fig. 5).

### Comparison of Maturity Stages and Histology Classes

The histological data show that during the early evening the percentage of females with hydrated eggs could be an indicator of the percentage of females spawning per day (i.e., the spawning incidence). To use the extensive maturity stage data available for northern anchovy it is necessary to determine the relationships between the histology of the gonads and the maturity stages used in the California Department of Fish and Game's sampling programs. To date histological and field maturity stage data have not been taken on the same individuals; therefore, analysis is limited to comparisons of the two data sets. In the following comparisons the sea survey and histology data sets were limited to samples taken during the period 1977-84 and during the principal spawning season (i.e., February-April). Since nearly all of the trawls were taken at night, the data were limited to those taken from 1800 to 0500 h. The midwater trawl hauls were normally 15 min in duration, and about 30% of the fish in the

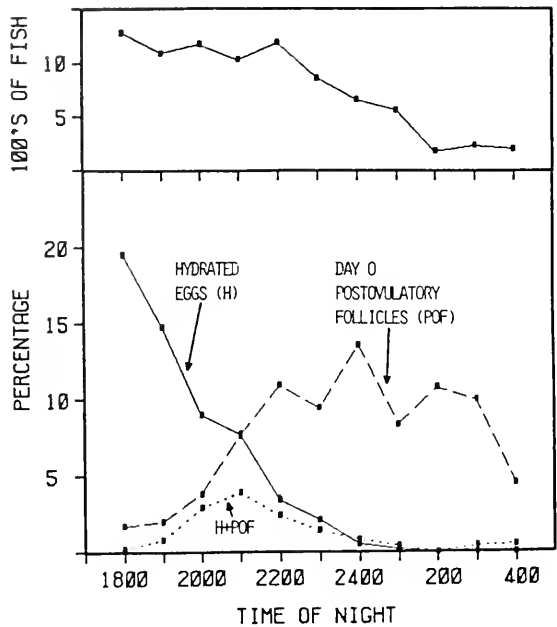

FIGURE 5.—The percentages of female northern anchovies with ovaries in three histological classes, by time of night.

histological data set and 30% in the maturity stage data sets were taken in the same trawl hauls during cooperative cruises.

The histological data are divided into six classes (B. Macewicz fn. 3):

1. Ovaries with hydrated eggs and no day-0 postovulatory follicles.
2. Ovaries with hydrated eggs and day-0 postovulatory follicles.
3. Ovaries with day-0 postovulatory follicles and no hydrated eggs.
4. Ovaries with day-1 postovulatory follicles.
5. Mature ovaries with no hydrated eggs, no day-0 nor day-1 postovulatory follicles.
6. Immature ovaries, few or no yolked oocytes, no atresia present in the ovary other than late-stage corpora atretica.

Northern anchovy, spawning on the night they were sampled (day 0), include the first three classes; those that spawned on the night before they were sampled (day 1) are class four.

A comparison of the percentages of hydrated females in the sea survey data (i.e., stages 5 + 6) with that in the histological data (i.e., classes 1 + 2) shows that they have essentially the same pattern from the onset of spawning in the early evening until spawn-

ing is completed in the early morning (Fig. 6). This implies that in the early evening maturity stages 5 + 6 can be used to estimate the spawning incidence; however, within a few hours after sunset the percentage of females with hydrated eggs (i.e., stages 5 + 6) rapidly becomes an underestimate of the incidence of spawning due to the completion of spawning. If only the females ( $n = 2,161$ ) sampled between the hours of 1800 and 2000 are considered, then the percentage in maturity stages 5 + 6 (15.3%) is quite close to the percentage of day-0 females calculated for the total histology data set (15.9%).

The variation throughout the night of the percentages of the other maturity stages is also of interest as it offers some insight into the meaning of maturity stages in anchovy. Hunter and Macewicz (1980) showed that spawning primarily occurs between the hours of 1800 and 0200. In the sea survey data the percentage of stages 5 + 6 falls from 15.3 to 1.6% over this time period (Fig. 7). The expected maturity stage that should increase over this time period is stage 7 (i.e., spent: ovaries slack with residual eggs). This, however, is not the case. The percentage of stage-7 females has very little variation over the 1900-0200 period; going from 2% at 1900 to 3.6% at 0200. This suggests that residual eggs occur in only a small percentage of anchovy and that stage 7 cannot be used to determine if an anchovy has

spawned within 24 h. This is consistent with Stauffer and Picquelle's (1980) observation that field-spawned northern anchovy were found to release nearly 100% of their hydrated eggs. The percentages of the other maturity stages show considerable variation from 1900 to 0200 h. Stages in which the ovary is small (i.e., 1 + 2) occur in about 37% of the females in the early evening. This increases rapidly after 2300 and by 0200 these stages comprise about 46% of the females. Stages 3 + 4, in which the ovaries occupy from one half to two thirds of the ventral cavity, occur in about 46% of females in the early evening. This rises to a peak of about 54% at 2300-2400 and then declines to about 49% at 0200.

Our interpretation of the patterns exhibited by the sea survey data is that the percentage of females at stages 5 + 6 in the early evening (i.e., 15.3%) is a valid estimate of the percentage of sampled females with hydrated eggs. However, as the night progresses the percentage of stages 5 + 6 declines. At the peak of spawning, just before midnight, many females appear to be misidentified as stages 3 + 4. This could occur if they had spawned part of their eggs before they were captured and if the person making the maturity stage determinations used the size of the ovary, rather than the presence of hydrated eggs, to determine the maturity stage. After midnight an increasing percentage of spawning females have

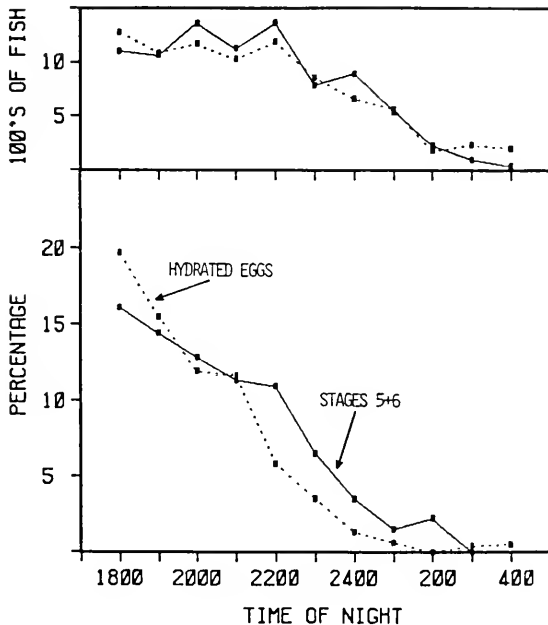

FIGURE 6.—The percentages of female northern anchovies with hydrated eggs and with maturity stages 5+6, by time of night.

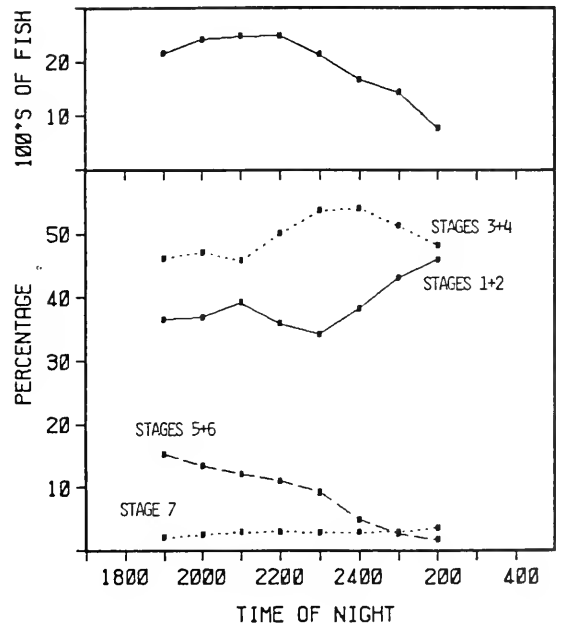

FIGURE 7.—The percentages of grouped maturity stages for female northern anchovies by time of night. (Two hour moving average.)

apparently spawned all of their hydrated eggs and they are then classified as stage 1 or 2. The meaning of stage 7 in female anchovy remains a mystery.

The seasonal and diurnal patterns described above indicate that, with the exception of stages defined by the presence of hydrated eggs, gross anatomical maturity stages have little utility other than describing the seasonality of spawning. However, field identifications of the presence of hydrated eggs, if they are calibrated with histological data and if the diurnal pattern of hydration is known, can potentially be used to determine spawning incidence.

Several authors have pointed out that females with hydrated eggs and actively spawning females were more numerous than females with day-1 postovulatory follicles, and have suggested that hydrated and actively spawning females may be more susceptible to capture due to behavioral or physiological factors (Hunter and Goldberg 1980; Stauffer and Picquelle 1980; Alheit et al. 1984). Previous workers have therefore used the percentage of day-1 females as the index of the daily spawning incidence. The overall percentages of day-0 and day-1 females in the histology data set (8,672 females) used in our analyses are 15.9 and 11.5%. Alheit et al. (1983) found the overall percentages of day-1 and day-2 Peruvian anchoveta females to be 17.26 and 14.81%. Hunter and Goldberg (1980), and subsequent workers on the northern anchovy, took their samples at night whereas Alheit et al. (1983) took their Peruvian anchoveta samples primarily during the day. Therefore the definition of day-1 is somewhat different in studies of the two species. In our analysis both day-0 and day-1 females appear to be more susceptible to capture by midwater trawl in the early evening than later at night. The percentages of both decline as the night progresses; however, the decline is more extreme in the day-0 females (Fig. 8).

The use of maturity stages 5 + 6 could result in several sources of bias that would tend to produce overestimates of the spawning incidence of northern anchovy. If females with hydrated eggs are more susceptible to capture, there will be a tendency to produce biased estimates. However, this bias would not be expected to be size or age dependent, nor would it be expected to vary during the spawning season. The same bias would be expected to occur in 1- and 4-yr-old hydrated females and the same bias would be expected in February and April. Therefore the use of the percentages of hydrated females or maturity stages 5 + 6 females may result in overestimates of the total spawning incidence or annual fecundity, but the relative spawning incidence or relative annual fecundity of the different age groups

would not be biased. A second source of bias is that an unknown number of females have ovaries so small that visual determination of sex is impossible without magnification. Therefore, the incidence of spawning is overestimated because it is calculated by dividing the number of stages 5 + 6 females by less than the total number of females. This bias is size and age dependent, being much more common in smaller and younger anchovy, but not month dependent. Note that the various studies of the spawning incidence in northern anchovy and Peruvian anchoveta have defined the spawning incidence to be the number of females spawning per day divided by the number of *mature* females, i.e., these studies exclude immature females, which are primarily the smaller and younger fish, from the calculation.

There are also several sources of bias that would tend to produce underestimates of the spawning incidence. The anchovy fishery in southern California primarily occurs at night during the fall months and during the daylight hours in the spring. A period of low availability to the commercial fishery is associated with the spawning season. Mais (1974) associated this phenomenon with variation in schooling behavior and showed that acoustic surveys detect relatively few "commercial-sized" anchovy schools during the spawning season. If low availability to the commercial fishery is associated with spawning ac-

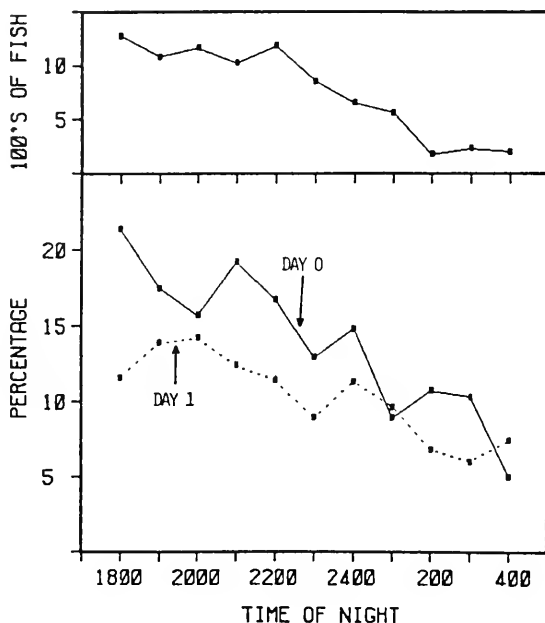

FIGURE 8.—The percentages of day-0 and day-1 female northern anchovies by time of night.

tivity, it is probable that the fishery undersamples the active spawners. In addition, a proportion of the commercial catches occur during the time of day when the females do not have hydrated eggs. The fishery data will therefore tend to underestimate the spawning incidence. The total sea survey data will also produce an underestimate as it includes samples taken throughout the night.

The combined fishery-sea survey data used in our analyses will therefore provide only an index of the daily spawning incidence. To evaluate the potential net bias of this index we calculated the percentage of females with maturity stages 5 + 6, in the combined fishery-sea survey data, and the percentage of females with day-1 postovulatory follicles, in the histological data. To make the data comparable we used the period 1977-84 and the months February-April. The percentage of females with maturity stages 5 + 6 and the percentage of females with day-1 postovulatory follicles was 10.9 and 11.5%. Use of the maturity stage data will therefore slightly underestimate the daily spawning incidence (i.e.,  $10.9/11.5 = 0.948$ ).

### Size Dependent Batch Fecundity

Annual fecundity in the northern anchovy is dependent upon the batch fecundity and the number of spawnings per year. Batch fecundity is size dependent and the best average estimate over six seasons (Hunter et al. 1985) is given below. Note that Hunter et al. found significant variation (ANOVA) among years.

$$\text{batch fecundity} = -1,104 + 614 (\text{WT})$$

where WT = female wet weight, minus ovaries, in grams. During the spawning season ovary free weight of northern anchovy is equal to 95% of the total wet weight (Hunter and Leong 1981). Batch fecundity, with the above relationships, for a typical 1-yr-old (12 g) and a typical 4-yr-old (24 g) are 5,896 eggs and 12,895 eggs. On a per unit weight basis the 24 g fish would produce only 9.4% more eggs than the 12 g fish. Age-dependent variations in batch fecundity are therefore of only minor significance in the relationship between spawning biomass and annual fecundity. There is the possibility that batch fecundity could vary over the spawning season, and since we have shown an age-dependent seasonality in the spawning incidence of northern anchovy, this could potentially contribute to age-dependent differences in annual fecundity. Hunter and Leong (1981), however, found average batch

fecundity to be essentially the same in samples taken in January-February and in March-April.

### Size-Dependent Histology Classes

Hunter and Macewicz (1980) found no relationship between size and the percentage of mature female northern anchovy with day-1 postovulatory follicles. Later work by Picquelle and Hewitt (1984) showed that weight and spawning incidence were highly correlated in the northern portion of the central stocks range. They stated that this implied that the larger females spawned more frequently or that the smaller females had a much shorter spawning season. We analyzed the larger histology data set now available and found that the percentages of females with hydrated oocytes or with day-1 postovulatory follicles, as well as the percentage of females with maturity stages 5 + 6, were dependent upon the size of the females (Fig. 9).

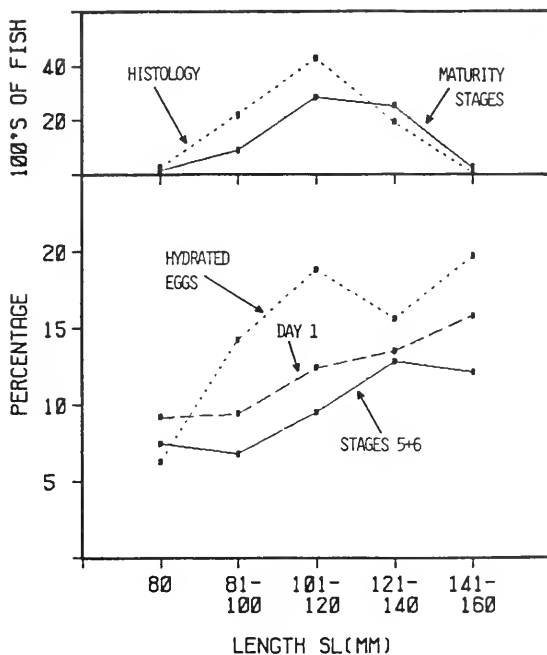

FIGURE 9.—The percentages of female northern anchovies with hydrated eggs, with maturity stages 5 + 6, and day-1 histological classes by size group.

### Age-Dependent Spawning Incidence and Annual Fecundity

To assess age-dependent, annual fecundity in the central stock of northern anchovy we calculated the

number of spawnings and the fecundity on a monthly basis for age groups 1, 2, 3, and 4+. Average monthly wet weight by age was taken from Mallicoate and Parrish (1981). The number of spawnings per month was calculated from the number of days per month and the index of daily spawning (i.e., the proportion of stages 5 + 6). Note that the bias due to the unknown sex problem discussed earlier would tend to cause an overestimation of the daily spawning incidence: particularly in females in their first spawning season. Also note that the index of daily spawning underestimates the spawning incidence by about 5%.

Our analysis shows that there are large, age-dependent variations in the proportions of female northern anchovy spawning as the spawning season progresses (Fig. 10). From July until January all age groups have a very low daily spawning index. Intensive spawning commences in February and all age groups have roughly the same spawning index (9-12%). In March the spawning index of age group 1 declines to about 2%; it increases slightly in April and declines to about 1% in May. In age group 2 the spawning index increases to 13% in March and then declines to about 2% by May. Age groups 3 and 4+ have peak spawning indices in March (25 and 27%), considerable spawning in April (10 and 17%) and lesser amounts in May (3 and 6%).

Older females have a much larger number of spawnings per spawning season than younger

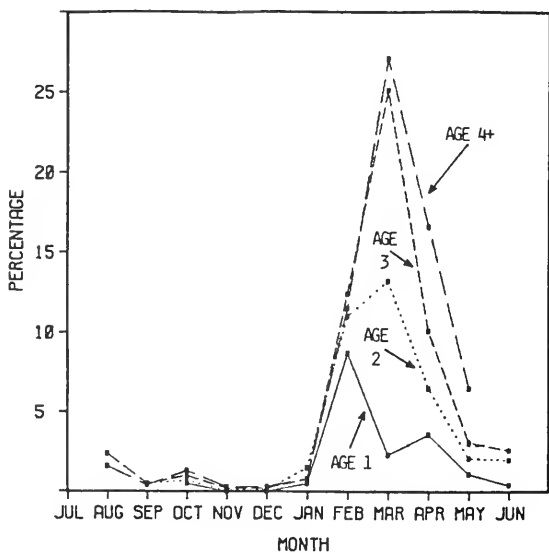

FIGURE 10.—The monthly percentages of female northern anchovies with maturity stages 5+6, by age group.

females (Table 3). In their first spawning season females have an average of 5.3 spawnings. In their second spawning season this rises to 11.9 and in their third and fourth plus seasons the number of spawnings rises to 19.2 and 23.5. The increase in the number of spawnings associated with increasing age appears to be primarily due to the increase in the length of the spawning season that occurs in older fish. The average number of spawnings per season for all females sampled was 15.1. This is less than the estimate that Hunter and Leong (1981) developed from the energetics of female northern anchovy (i.e., 20 spawnings per year). Their calculations indicated that mature female northern anchovy spawned on the average 15 times between February and September; their calculation of the number of spawnings from October to January (5) was estimated indirectly from the relative monthly larval abundance in 1953-60. Our estimate of the number of spawnings from February to September (14.3) is very close to the Hunter and Leong (1981) estimate which was based on a smaller histology data set. However, our estimate of the number of spawnings from October to January is only 0.8 and is much less than their indirect estimate based on the relative seasonal larval abundance for the 1953-60 period. The central stock of northern anchovy was at a much smaller population size in 1953-60 than it was in 1966-84 (MacCall 1980) and northern fish, with a seasonal spawning pattern similar to that occurring in the Monterey data, may have comprised a larger proportion of the anchovy population off California during the 1953-60 period than at present thus inflating Hunter and Leong's estimate for the October-January period.

Our analysis indicates that annual fecundity in the central stock of northern anchovy is heavily age dependent; the average 4+ yr-old female produces nearly 10 times as many eggs as a 1-yr-old female (Table 3). Our calculations show that central stock, female anchovy produce 2,803, 6,550, 11,434, and 13,861 eggs/g of body weight per spawning season in their 1st, 2d, 3d, and 4th plus spawning seasons. Females 4 yr of age and older produce nearly 5 times as many eggs per unit of weight as 1-yr-olds.

## DISCUSSION

Over the last decade it has become apparent that recruitment failure is the major threat to many of the world's largest fisheries. In addition, variation in recruitment is a significant causal factor in the interyear variation of the annual catches of many fisheries. Stocks of small pelagic fishes appear to



TABLE 3.—Proportion of maturity stages 5 + 6, number of spawnings and fecundity of female northern anchovies sampled in the Sea Survey Program (lat. 29.5°-34.5°N) and San Pedro fishery.

	July <sup>1</sup>	Aug. <sup>1</sup>	Sept.	Oct.	Nov.	Dec.	Jan.	Feb.	Mar.	Apr.	May	June	Total <sup>2</sup>	Eggs/g <sup>3</sup>
First spawning season														
Prop. 5 + 6	0.000	0.000	0.000	0.005	0.000	0.000	0.005	0.087	0.023	0.036	0.011	0.004		
Spawnings	0.000	0.000	0.000	0.155	0.000	0.000	0.155	2.436	0.713	1.080	0.341	0.120	5.3	
Wt. (g)	—	—	11.2	11.1	12.0	11.0	11.4	11.6	12.8	13.7	15.4	13.6		
No. eggs	0	0	0	832	0	0	860	13,793	4,536	7,438	2,687	819	32,514	2,803
Second spawning season														
Prop. 5 + 6	0.002	0.000	0.005	0.007	0.001	0.001	0.015	0.110	0.132	0.065	0.021	0.020		
Spawnings	0.062	0.000	0.150	0.217	0.030	0.031	0.465	3.080	4.092	1.950	0.651	0.600	11.9	
Wt. (g)	15.5	15.5	17.4	16.8	17.2	16.3	16.2	15.6	16.5	17.7	18.3	17.5		
No. eggs	492	0	1,357	1,887	268	261	8,881	24,626	34,866	17,980	6,230	5,462	102,174	6,550
Third spawning season														
Prop. 5 + 6	0.022	0.024	0.005	0.010	0.002	0.002	0.008	0.124	0.251	0.101	0.031	0.026		
Spawnings	0.682	0.744	0.150	0.310	0.060	0.062	0.248	3.472	7.781	3.030	0.961	0.780	19.2	
Wt. (g)	18.3	18.3	19.1	19.3	19.2	19.3	19.1	18.0	20.7	22.2	20.9	22.7		
No. eggs	6,527	7,120	1,506	3,148	606	630	2,489	33,836	85,360	35,891	10,655	9,467	205,819	11,434
Fourth-plus spawning seasons														
Prop. 5 + 6	0.021	0.016	0.004	0.013	0.003	0.003	0.008	0.115	0.271	0.166	0.065	0.056		
Spawnings	0.651	0.496	0.120	0.403	0.090	0.093	0.248	3.220	8.401	4.980	2.015	1.680	23.5	
Wt. (g)	20.1	20.1	20.9	21.8	22.3	22.2	23.6	23.3	26.6	26.5	25.7	25.7		
No. eggs	6,914	5,268	1,330	4,680	1,071	1,102	2,952	37,390	110,293	67,123	26,454	18,136	322,957	13,861
All spawning seasons combined														
Prop. 5 + 6	0.017	0.021	0.008	0.011	0.002	0.002	0.010	0.107	0.151	0.094	0.044	0.012		
Spawnings	0.527	0.651	0.240	0.341	0.060	0.062	0.310	2.996	4.681	2.820	1.364	0.360	15.1	

<sup>1</sup>Missing data estimated from adjacent months.<sup>2</sup>Includes 5% correction for spawning incidence bias.<sup>3</sup>Total eggs/February weight.

be particularly susceptible to collapse; however, perturbations of recruitment is a potential threat to any fishery in which one or two year classes comprise the bulk of the landings. The stock-recruitment approach to understanding or predicting recruitment has fallen into disfavor, at least in the small pelagic fishes, because stock size has not proven to be a good predictor of recruitment. In its pure form (Beverton and Holt 1957; Cushing 1971; Ricker 1975) the stock-recruitment concept is based on two factors: 1) Parent stock size is a measure of the reproductive potential of the stock, and 2) there are compensatory mechanisms which reduce the number of recruits per spawner as the size of the parent stock increases. This compensation occurs through some mix of reduced fecundity of the parent stock, reduced growth of the recruiting cohort and increased mortality of the recruiting cohort. Recruitment variations are usually attributed to changes in environmental conditions, usually unknown, and the causal mechanisms, also usually unknown, are thought to occur during the early life history stages. The present emphasis of recruitment research is on the growth and mortality of the early life history stages. Potential variations of stock fecundity as a factor in recruitment variations has largely been ignored.

There are now 6 years of egg production estimates

available for the central stock of northern anchovy (Bindman 1985). The mean spawning incidence for these years is 0.124 and the spawning incidence varied from 0.094 in the El Niño year of 1983 to 0.160 in 1984. This implies that the central stock produced 70% more eggs, per unit of spawning biomass, in 1984 than in 1983. Santander (1980) showed that the Peruvian anchoveta had both reduced spawning and an alteration of the seasonality of spawning during the 1972 El Niño. The results presented here, which show that fecundity is strongly age dependent, suggest that the reduction in age composition caused by heavy exploitation will greatly reduce the average fecundity per unit of biomass and also result in a reduction in the length of the spawning season. It appears that interyear variations in the age composition of a stock or in environmental factors associated with energy reserves or egg production are likely to alter greatly a stock's reproductive potential. If this is the case in other species which have multiple spawning, much of the variance in the stock-recruitment relationships of these fishes may be due to the fact that spawning biomass is a poor index of the reproductive potential of the stock.

To date information concerning age-specific reproductive potential has not been available for multiple spawning fishes because of the difficulty

of determining the number of spawnings per year. The pioneering work by Hunter and Goldberg (1980) and later studies based on this work clearly demonstrate that, at least for many clupeids, the spawning incidence or spawning frequency can be determined with properly designed histological studies. Unfortunately a research program designed to determine age-specific reproductive potential would be very expensive as it would require a field sampling program extending over the whole spawning season, in many cases the entire year; and it would require histological analysis and aging of a large number of females, both quite labor intensive.

It appears that the only way it may be possible to determine age-specific reproductive potential for many fishes is to use the approach developed here which combines two methodologies: histological assessment of ovaries because it unambiguously and accurately measure spawning rate and a traditional fishery sampling program which utilizes an inexpensive rapid index of reproductive condition, such as the maturity stage system or a gonado-somatic index, in which thousands of specimens can be processed. Whichever anatomical grading system is used, its principal purpose would be to determine the percentage of hydrated females. Most of the maturity stages (i.e., 1-4, 7) in the system used for northern anchovy are only of value in describing the seasonality of spawning. The only stages (i.e., 5 and 6) which can be used to determine the number of spawnings are those in which the eggs are hydrated, and they can be directly used as an index in northern anchovy because it is known that the duration of hydrated eggs in the ovary is <24 h. The traditional fishery sampling program may, as in the case for northern anchovy, already be available. If this is the case the principal work will be to calibrate properly the maturity stage or gonado-somatic index with the histological analysis. For this approach to work the fishery must, of course, take hydrated females.

## CONCLUSIONS

It is important for those managing fisheries which are susceptible to recruitment overfishing to realize that the alteration in the age structure of a stock that occurs under heavy exploitation may have greater effects on the total fecundity and seasonality of spawning than previously recognized. Management strategies which decrease the exploitation of older, more fecund females could increase yields and also provide increased protection against recruitment overfishing. In northern anchovy there is the

additional factor that the sex ratio in the fishery is age dependent (i.e., the female:male ratio for 1-yr-old anchovy in the San Pedro fishery is 0.83:1, whereas that for 4+ yr-olds is 2.01:1). When this factor is multiplied by the difference in the fecundity of the two age groups, it is apparent that the catch of a ton of 4+ yr-old northern anchovy reduces the reproductive potential of the stock 7.3 times as much as the catch of a ton of 1-yr-old fish.

## ACKNOWLEDGMENTS

We gratefully acknowledge John Hunter and Beverly Macewicz for allowing us to use their extensive data on the histology of the ovaries of northern anchovy and Carol Kimbrell for providing us with the computer files. John Hunter also provided considerable input to the development of the work and edited the manuscript. We would also like to thank Eric Knaggs, Eugene Fleming, and John Sunada for providing us with the anchovy fishery data and Kenneth Mais for providing the sea survey anchovy data.

## LITERATURE CITED

- ALHEIT, J., B. ALEGRE, V. H. ALARCÓN, AND B. J. MACEWICZ.  
1983. Batch fecundity and spawning frequency of various anchovy (Genus: *Engraulis*) populations from upwelling areas and their use for spawning biomass estimates. FAO Fish. Rep. 291, 3:977-985.
- ALHEIT, J., V. H. ALARCON, AND B. J. MACEWICZ.  
1984. Spawning frequency and sex ratio in the Peruvian anchovy, *Engraulis ringens*. CalCOFI Rep. 25:43-52.
- BEVERTON, R. J. H., AND S. J. HOLT.  
1957. On the dynamics of exploited fish populations. Fish. Invest. Lond. Ser. 2, 19:1-533.
- BINDMAN, A. G.  
1985. The 1985 spawning biomass of the northern anchovy. U.S. Dep. Commer., NOAA, NMFS, SWFC, Admin. Rep. LJ-85-21, 21 p.
- BOWERS, A. B., AND F. G. T. HOLLIDAY.  
1961. Histological changes in the gonad associated with the reproductive cycle of the herring (*Clupea harengus* L.). Mar. Res. Scot. 5, 16 p.
- COLLINS, R. A., AND J. D. SPRATT.  
1969. Age determination of northern anchovies, *Engraulis mordax*, from otoliths. Calif. Dep. Fish Game, Fish Bull. 147, p. 39-55.
- CUSHING, D. H.  
1971. The dependence of recruitment on parent stock in different groups of fishes. J. Cons. Perm. Int. Explor. Mer 33:340-362.
- HUNTER, J. R., AND S. R. GOLDBERG.  
1979. Spawning incidence and batch fecundity in northern anchovy, *Engraulis mordax*. Fish. Bull., U.S. 77:641-652.
- HUNTER, J. R., AND R. LEONG.  
1981. The spawning energetics of female northern anchovy, *Engraulis mordax*. Fish. Bull., U.S. 79:215-230.
- HUNTER, J. R., N. C. H. LO, AND R. J. H. LEONG.  
1985. Batch fecundity in multiple spawning fishes. In R.

- Lasker (editor), An egg production method for estimating spawning biomass of pelagic fish: application to the northern anchovy, *Engraulis mordax*, p. 67-77. U.S. Dep. Commer., NOAA Tech. Rep. NMFS 36.
- HUNTER, J. R., AND B. J. MACEWICZ.  
1980. Sexual maturity, batch fecundity, spawning frequency, and temporal pattern of spawning for the northern anchovy, *Engraulis mordax*, during the 1979 spawning season. CalCOFI Rep. 21:139-149.
- KLINGBEIL, R. A.  
1978. Sex ratios of the northern anchovy, *Engraulis mordax*, off southern California. Calif. Fish Game 64:200-209.
- MACCALL, A. D.  
1980. Population models for the northern anchovy (*Engraulis mordax*). Rapp. P.-v. Réun. Cons. Perm. int. Explor. Mer 177:292-306.
- MAIS, K. F.  
1974. Pelagic fish surveys in the California Current. Calif. Dep. Fish Game, Fish Bull. 162. 79 p.  
1981. Age-composition changes in the anchovy, *Engraulis mordax*, central population. CalCOFI Rep. 22:82-87.
- MALLICOATE, D. L., AND R. H. PARRISH.  
1981. Seasonal growth patterns of California stocks of northern anchovy, *Engraulis mordax*, Pacific mackerel, *Scomber japonicus*, and jack mackerel, *Trachurus symmetricus*. CalCOFI Rep. 22:69-81.
- PARRISH, R. H., D. L. MALLICOATE, AND K. F. MAIS.  
1985. Regional variations in the growth and age composition of northern anchovy, *Engraulis mordax*. Fish. Bull., U.S. 83:483-496.
- PICQUELLE, S. J., AND R. P. HEWITT.  
1983. The northern anchovy spawning biomass for the 1982-83 California fishing season. CalCOFI Rep. 24:16-28.  
1984. The 1983 spawning biomass of the northern anchovy. CalCOFI Rep. 25:16-27.
- RICKER, W. E.  
1975. Computation and interpretation of biological statistics of fish populations. Fish. Res. Board Can. Bull. 191, 382 p.
- SANTANDER, H.  
1980. Fluctuaciones del desove de anchoveta y algunos factores relacionados. In IOC Workshop Rep. 28, UNESCO, Paris, p. 255-274. [Workshop on the effects of environmental variation on the survival of larval pelagic fishes, Lima, Peru. 20 April-5 May 1980.]
- STAUFFER, G. D., AND S. J. PICQUELLE.  
1980. Estimates of the 1980 spawning biomass of the central subpopulation of northern anchovy. U.S. Dep. Commer., NOAA, NMFS, SWFC, Admin. Rep. LJ-80-09, 24 p.
- SUNADA, J. S., AND S. SILVA.  
1980. The fishery for northern anchovy, *Engraulis mordax*, off California and Baja California in 1976 and 1977. CalCOFI Rep. 21:132-138.
- VROOMAN, A. M., P. A. PALOMA, AND J. R. ZWEIFEL.  
1981. Electrophoretic, morphometric, and meristic studies of subpopulations of northern anchovy, *Engraulis mordax*. Calif. Dep. Fish Game 67:39-51.



# SOME STATISTICAL TECHNIQUES FOR ESTIMATING ABUNDANCE INDICES FROM TRAWL SURVEYS

MICHAEL PENNINGTON<sup>1</sup>

## ABSTRACT

Methods are presented for estimating an index of relative abundance from trawl survey catch per tow data. The estimated variance of the index takes into account the within survey variability in catch and possible yearly changes in catchability. Applying the techniques to a series of surveys for yellowtail flounder, *Limanda ferruginea*, off the northeast coast of the United States yields an abundance index with a variance which is 40% lower than the variance of the original survey index for the current value and 57% lower for values not near the ends of the survey series.

The average number of fish caught per tow during a trawl survey is often used as an index of a species's relative abundance (Grosslein 1969; Clark 1979). Catch per tow data are usually quite variable because of the heterogeneous distribution of many fish stocks (Byrne et al. 1981). A further source of variability for survey indices of abundance is that the catchability of a particular species with respect to the survey trawl may change from year to year (Byrne et al. 1981; Collie and Sissenwine 1983). As a result, the observed time series of abundance indices reflects changes in the population, within survey sampling variability, and varying catchability over time.

This paper uses various statistical methods to construct from the catch per tow data an index of abundance which more closely tracks the population than does the original (average catch per tow) series. Specifically, since the distribution of catch per tow data is often highly skewed and contains a proportion of zeros, estimates of the mean catch per tow for each survey are made based on the  $\Delta$ -distribution (Aitchison and Brown 1957). Next, time series techniques are used to estimate the component of the series generated by the actual changes in the population.

The methods are applied to data for yellowtail flounder, *Limanda ferruginea*, from a series of groundfish trawl surveys conducted off the northeast coast of the United States as part of the National Marine Fisheries Service's MARMAP program. The resulting index of abundance is substantially more precise than the original index.

## STATISTICAL METHODS

### Sources of Variability

Let  $y_t$  denote the observed average catch per tow for the survey conducted in year  $t$  and  $z'_t = E[y_t]$ , the expected value of  $y_t$ . Since a species catchability may change from year to year with respect to the survey trawl, let  $z = E[z'|p]$  denote the expected value of  $z'$  given a population level  $p$ . Then

$$y_t = z_t + e_t.$$

The error term,  $e_t$ , can be expressed as

$$e_t = (y_t - z'_t) + (z'_t - z_t),$$

where the first error component is due to the within survey variability and the second is due to changes in catchability.

In order to construct an index of abundance, it is necessary to assume a functional relationship between  $z_t$  and  $p_t$ . A reasonable assumption made in practice (and in this paper) is that

$$z_t = ap_t.$$

If the relationship is not linear, then the unadjusted catch per tow index will be a biased measure of relative abundance.

### Estimating the Mean Catch per Tow

The distribution of marine survey data often can be described by what is called a  $\Delta$ -distribution (Aitchison and Brown 1957). That is, the data contain

<sup>1</sup>Northeast Fisheries Center Woods Hole Laboratory, National Marine Fisheries Service, NOAA, Woods Hole, MA 02543.

a proportion of zeros and the nonzero values are distributed lognormally. The minimum variance unbiased estimates of the mean,  $c$ , and its variance,  $\text{var}(c)$ , for the  $\Delta$ -distribution are given by (Pennington 1983),

$$c = \begin{cases} \frac{m}{n} \exp(\bar{y}) G_m(s^2/2), & m > 1, \\ \frac{x_1}{n}, & m = 1, \\ 0, & m = 0, \end{cases} \quad (1)$$

and

$$\text{var}(c) = \begin{cases} \frac{m}{n} \exp(2\bar{y}) \left[ \frac{m}{n} G_m^2(s^2/2) - \left( \frac{m-1}{n-1} \right) \times G_m \left( \frac{m-2}{m-1} s^2 \right) \right], & m > 1, \\ \left( \frac{x_1}{n} \right)^2, & m = 1, \\ 0, & m = 0, \end{cases} \quad (2)$$

where  $n$  is the number of tows,  $m$  is the number of nonzero values,  $\bar{y}$  and  $s^2$  are the sample mean and variance respectively of the nonzero  $\log_e$  values,  $x_1$  is the single (untransformed) nonzero value when  $m = 1$ , and

$$G_m(x) = 1 + \frac{m-1}{m} x + \sum_{j=2}^{\infty} \frac{(m-1)^{2j-1} x^j}{m^j (m+1)(m+3)\dots(m+2j-3)j!}$$

The series defining  $G_m(x)$  is a function of  $x$  [e.g.,  $x = s^2/2$  in Equation (1)] and  $m$  which is easily evaluated for particular values of  $x$  and  $m$  using a computer.

Figure 1, which is an extension of a graph in Aitchison and Brown (1957, p. 98), shows the large sample efficiency of the ordinary sample statistics as compared with their most efficient estimates for the  $\Delta$ -distribution with 50% zeros. Estimates of  $\sigma^2$ , the variance of the nonzero  $\log_e$  values, are often between 1 and 2 for trawl surveys. Thus (Fig. 1) the

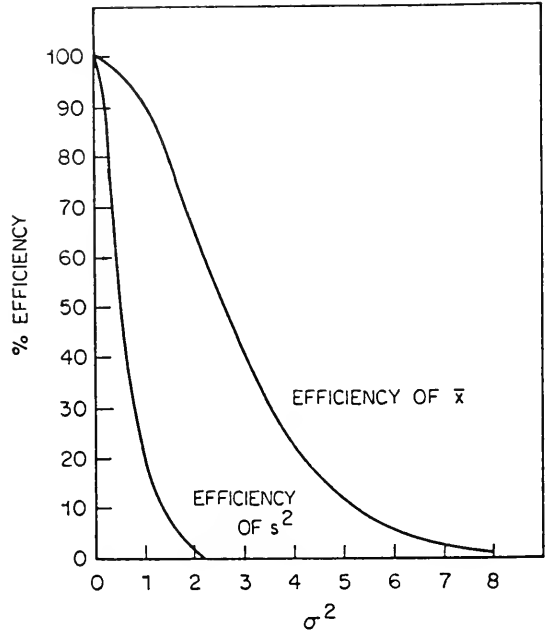

FIGURE 1.—The efficiency of  $\bar{x}$  and  $s^2$  (the sample mean and variance, respectively) for the  $\Delta$ -distribution with 50% zeros.

sample mean is a fairly efficient estimator of the mean for trawl surveys, but the sample variance is highly inefficient. Though for larger values of  $\sigma^2$ , which, for example, are common for egg surveys (Pennington and Berrien 1984), the sample mean is also very inefficient. It does not follow that the variance of  $c$  is necessarily small, but it is smaller, and as  $\sigma^2$  increases, much smaller than the variance of the sample mean. However, it should be noted that if the sample variance is used to estimate the variance of the sample mean for moderate sample sizes because of the inefficiency of the sample variance, the estimated variance of  $c$  will often be greater than the estimated variance of the sample mean.

### Estimating the Index of Abundance

As an index of abundance, the series of yearly catch per tow estimates,  $y_t$ , (based, e.g., on the  $\Delta$ -distribution theory if appropriate) has two drawbacks. First, its estimated variance when derived from the within survey variance can be an underestimate since catchability may vary from year to year. The second and more serious deficiency is that the index for a particular year is based only on that year's survey which disregards relevant information contained in the surveys for other years.

One method to construct an abundance index based on the entire survey series is briefly as follows (more details can be found in Pennington (1985)).

Suppose the population (or  $z_t$ ) can be represented by the autoregressive integrated moving average process (Box and Jenkins 1976, Chap. 4)

$$\Phi(B) z_t = \theta(B) a_t.$$

where the  $a_t$ 's are independently identically distributed (*iid*) and normally distributed ( $N$ ) with mean zero and variance  $\sigma_a^2$  [*iid*  $N(0, \sigma_a^2)$ ]. If  $y_t = z_t + e_t$ , and the  $e_t$ 's are assumed *iid*  $N(0, \sigma_e^2)$ , then  $y_t$  will follow the model

$$\Phi(B) y_t = \eta(B) c_t, \tag{3}$$

where the  $c_t$ 's are *iid*  $N(0, \sigma_c^2)$ . Now if model (3) and the ratio  $\sigma_e^2/\sigma_c^2$  are known, then the maximum likelihood estimate of  $z_t$  is given by

$$\hat{z}_t = y_t - \frac{\sigma_e^2}{\sigma_c^2} (\hat{c}_t - \pi_1 \hat{c}_{t+1} - \pi_2 \hat{c}_{t+2} - \dots - \pi_{T-t} \hat{c}_T), \tag{4}$$

where  $T$  denotes the last year of the series, the  $\hat{c}_t$ 's are the estimated residuals generated by model (3), and the  $\pi$  values are calculated using the identity

$$\Phi(B) = (1 - \pi_1 B - \pi_2 B^2 - \dots) \eta(B). \tag{5}$$

The variance of  $\hat{z}_t$  is given approximately by

$$\text{var}(\hat{z}_t) \doteq \sigma_e^2 \left[ 1 - (\pi_0^2 + \pi_1^2 + \dots + \pi_{T-t}^2) \frac{\sigma_e^2}{\sigma_c^2} \right], \tag{6}$$

where  $\pi_0 = 1$ .

The model for  $y_t$  [Equation (3)] is usually obtained in practice by fitting a model to the observed series using procedures described in Box and Jenkins (1976). If catchability is constant over time, the within survey sampling variance provides an estimate of  $\sigma_e^2$ . But if catchability varies, another approach is necessary.

Toward this end, consider the expression

$$z_t = z_{t-1} e^{a_t}$$

or

$$(1 - B) \ln z_t = a_t. \tag{7}$$

Suppose the factors causing the change in population from year  $t - 1$  to year  $t$  (such as recruitment, fishing mortality, natural mortality, and migrations) produce  $a_t$ 's which are approximately *iid*  $N(0, \sigma_a^2)$ . If the measurement errors are multiplicative, then

$$\ln y_t = \ln z_t + e_t. \tag{8}$$

Assuming the  $e_t$ 's are *iid*  $N(0, \sigma_e^2)$  and independent of the  $a_t$ 's, then it follows as above that  $y_t$  can be represented by the model

$$(1 - B) \ln y_t = (1 - \theta B) c_t. \tag{9}$$

where the  $c_t$ 's are *iid*  $N(0, \sigma_c^2)$

For model (9) [generated by Equations (7) and (8)]

$$\theta = \sigma_e^2/\sigma_c^2 \tag{10}$$

and

$$(1 - \theta)^2 = \sigma_a^2/\sigma_c^2.$$

Therefore, assuming the above approximations to the population dynamics, fitting model (9) to the observed survey series provides an estimate,  $\hat{\theta}$ , of  $\sigma_e^2/\sigma_c^2$  and an estimate of  $\sigma_c^2$ . The  $\pi$ -weights for the model are from Equation (5) given by

$$\pi_i = (1 - \hat{\theta}) \hat{\theta}^{i-1}, \quad i \geq 1. \tag{11}$$

It may be noted that if model (9) is valid and catchability is constant over time then the estimate of  $\sigma_e^2$  given by  $\hat{\theta} \sigma_c^2$  [from Equation (10)] would approximately equal the estimate of  $\sigma_e^2$  based on the within survey sampling variance.

## AN APPLICATION

The Northeast Fisheries Center conducts an extensive groundfish trawl survey as part of its MARMAP program two times a year: in the fall since 1963 and in the spring since 1968 (Grosslein 1969). The survey region is divided into sampling strata based on geographic boundaries and depth contours (Fig. 2). For each survey, trawl stations are chosen randomly within each stratum. One of the objectives of the surveys is to provide indices of abundance for the many species of commercial value in the region.

Yellowtail flounder is an important New England fishery resource whose population has fluctuated considerably over the survey period (Clark et al. 1984). Commercial catch statistics exist for yellowtail flounder, but age data suitable for a VPA (Virtual Population Analysis) are unavailable. Major

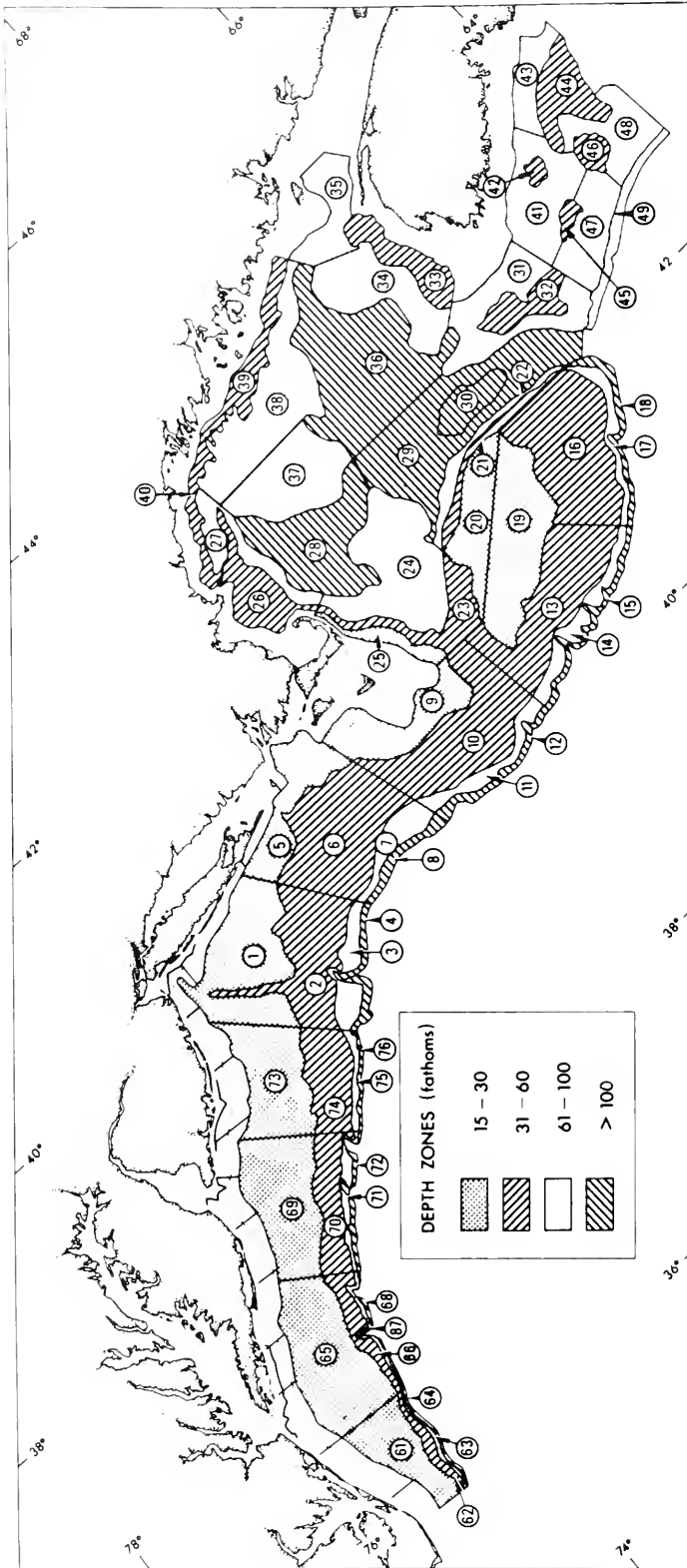

FIGURE 2.—The National Marine Fisheries Service's MARMAP survey strata.



yellowtail flounder fisheries are off southern New England (strata 5, 6, 8, 9) and on Georges Bank (strata 13-21). The two stocks are fairly distinct but with some intermixing (Clark et al. 1984).

The nonzero catch per tow survey data for yellowtail flounder are approximately lognormally distributed within a stratum. Therefore, the estimators based on the  $\Delta$ -distribution [Equations (1) and (2)] were used to estimate the mean catch per tow and its variance in each stratum. The regional estimates for southern New England and Georges Bank were then calculated in the usual manner for each survey (see, e.g., Pennington and Brown 1981).

Model (9) was fit to each series (spring 1968-84 and fall 1963-84 in both regions) and the model's adequacy checked (Box and Jenkins 1976, Chap. 8). Table 1 contains summary statistics and parameter

estimates for the four series. Since the series are relatively short, the averages of the areal and seasonal estimates are used as the final estimates of  $\theta$  and  $\sigma_c^2$  (last line in Table 1).

Abundance indices for the two regions and seasons were calculated by applying to each series Equation (4) with  $\theta = 0.4$ , the  $\pi$ -weights given by Equation (11), and the  $\hat{c}_t$ 's (for each series) generated by model (9). An estimate of  $\sigma_c^2$  equal to 0.20 and of  $\sigma_a^2$  equal to 0.18 were obtained from Equation (10). The estimated variance of the index equals, from Equation (6), 0.12 for the current value and declines to 0.09 for values not near the series' end points. This compares with a variance of 0.20 ( $= \hat{\sigma}_c^2$ ) for the original index. Figures 3 (log scale) and 4 (linear scale) show plots of the estimated index and the observed catch per tow series for the fall surveys off southern New England.

## DISCUSSION

The major advantage of estimating an index of abundance from the entire survey series is that it can produce an index with a variance considerably smaller than the variance of the observed series. But the application also demonstrates that estimates of the accuracy of an index based only on the within survey sampling variance can be misleading. For example, the 1972 survey value for yellowtail flounder off southern New England is considered an anom-

TABLE 1.—Summary statistics and parameter estimates for the yellowtail flounder survey series. The first three sample autocorrelations ( $r_1$ ,  $r_2$ , and  $r_3$ ) are for the first differenced logged series.

Survey	No. of years	$r_1$	$r_2$	$r_3$	$\hat{\theta}$	SE( $\hat{\theta}$ )	$\hat{\sigma}_c^2$
Southern New England							
Spring	17	-0.23	0.12	-0.18	0.21	0.28	0.57
Fall	22	-0.26	0.07	-0.31	0.40	0.22	0.71
Georges Bank							
Spring	17	-0.32	0.00	-0.09	0.61	0.23	0.36
Fall	22	-0.30	-0.06	0.18	0.36	0.23	0.33
Average		-0.28	0.03	-0.10	0.40	0.12	0.50

<sup>1</sup>Assuming the estimates of  $\theta$  are independent.



FIGURE 3.—Logged average catch per tow and the estimated index of abundance for southern New England yellowtail flounder.

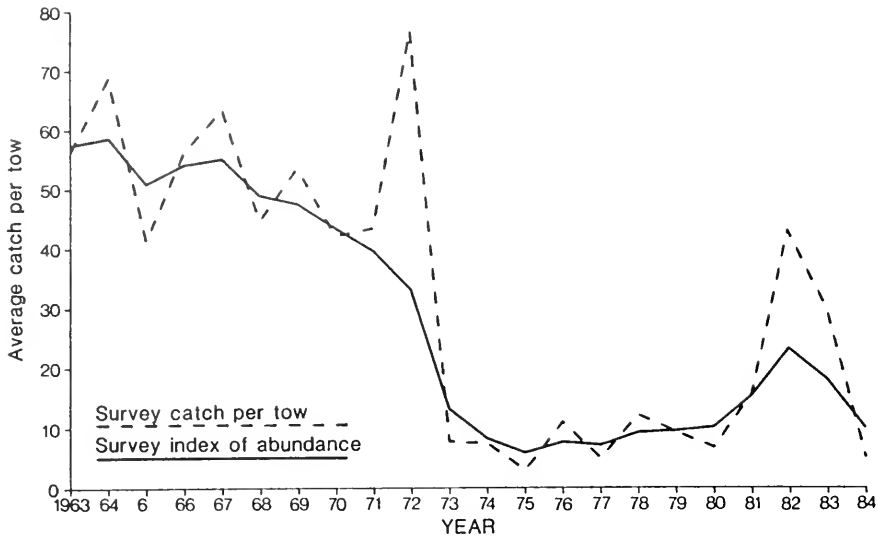

FIGURE 4.—Average catch per tow and the estimated index of abundance for southern New England yellowtail flounder.

ally (Collie and Sissenwine 1983). It does appear anomalous if comparisons are made using 0.11, the estimated variance based on the within survey variance, but not if the estimate of 0.20 ( $= \hat{\sigma}_e^2$ ) is considered (Fig. 3).

Assessing the accuracy of an index of abundance for marine stocks is difficult since the true levels are never known with certainty. But they can be compared with other indicators of abundance. The methods were applied to the haddock stock on Georges Bank (Pennington 1985) for which a VPA exists. It was found that model (7) adequately describes the dynamics of the VPA series, and the survey series follows model (9). The resulting index of abundance is quite similar to the VPA estimates.

Collie and Sissenwine (1983) give a method for estimating the relative abundance of a fish stock using survey data and commercial catch statistics. They observe that their method produces estimates which compare favorably with VPA estimates. Figure 5 shows plots of Collie and Sissenwine's estimate of the relative abundance of southern New England yellowtail flounder and the index based only on the survey data.

Finally, it should be noted that the purpose of the modeling stage in the estimation procedure is not necessarily to develop a realistic model for the population, but to describe the important stochastic properties of the series. As the observed series becomes longer, more precise estimates can be made. For shorter series, given the large variability

inherent in marine trawl surveys, a preliminary estimate of between 0.3 and 0.4 for the smoothing parameter  $\theta$  appears to be an appropriate initial value to use for estimating an abundance index until more information becomes available.

## LITERATURE CITED

- AITCHISON, J., AND J. A. C. BROWN.  
1957. The lognormal distribution. Cambridge Univ. Press, Lond., 176 p.
- BOX, G. E. P., AND G. M. JENKINS.  
1976. Time series analysis: forecasting and control. Rev. ed. Holden-Day, San Franc., 575 p.
- BYRNE, C. J., T. R. AZAROVITZ, AND M. P. SISENWINNE.  
1981. Factors affecting variability of research trawl surveys. Can. Spec. Publ. Aquat. Sci. 58:238-273.
- CLARK, S. H.  
1979. Application of bottom trawl survey data to fish stock assessment. Fisheries 4:9-15.
- CLARK, S. H., M. M. MCBRIDE, AND B. WELLS.  
1984. Yellowtail flounder assessment update. U.S. Dep. Commer., NOAA, Natl. Mar. Fish. Serv., Woods Hole Lab. Ref. Doc. No. 84-39, 29 p.
- COLLIE, J. S., AND M. P. SISENWINNE.  
1983. Estimating population size from relative abundance data measured with error. Can. J. Fish. Aquat. Sci. 40: 1871-1879.
- GROSSLEIN, M. D.  
1969. Groundfish survey program of BCF Woods Hole. Comm. Fish. Rev. 31(8-9):22-30.
- PENNINGTON, M.  
1983. Efficient estimators of abundance, for fish and plankton surveys. Biometrics 39:281-286.  
1985. Estimating the relative abundance of fish from a series

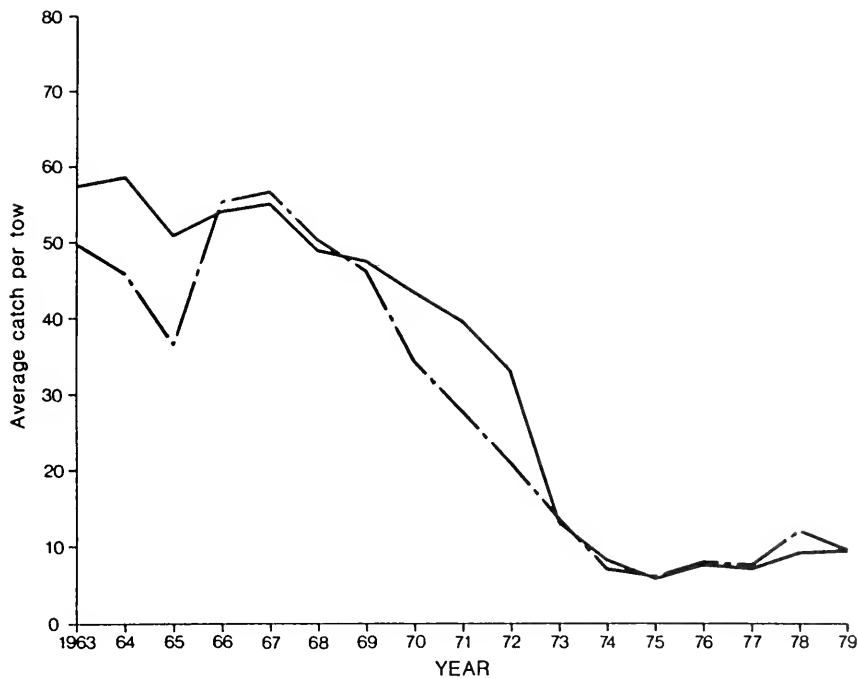

FIGURE 5.—Survey index of abundance (solid line) and Collie and Sissenwine's index (broken line) for southern New England yellowtail flounder.

of trawl surveys. *Biometrics* 41:197-202.

PENNINGTON, M., AND P. BERRIEN.

1984. Measuring the precision of estimates of total egg production based on plankton surveys. *J. Plankton. Res.* 6:

869-879.

PENNINGTON, M., AND B. E. BROWN.

1981. Abundance estimators based on stratified random trawl surveys. *Can. Spec. Publ. Aquat. Sci.* 58:149-153.



# RATES OF INCREASE IN DOLPHIN POPULATION SIZE

STEPHEN B. REILLY AND JAY BARLOW<sup>1</sup>

## ABSTRACT

Annual finite rates of increase in dolphin population size were estimated to vary up to a maximum of 1.09, using simulation, based on ranges in vital rates. Vital rate ranges were defined from values reported in the literature where possible, otherwise by making assumptions about biological or logical limits. Given information on current values, or limits, of one or more vital rate, one can use the figures presented to determine ranges of possible rates of increase in population size. The highest rates estimated here (up to 1.09) are probably unrealistic, because of the unlikely combinations of high fecundity and low mortality needed to achieve them.

Rates of increase in population size are important in determining management strategies for fish and wildlife subject to exploitation. A common management approach for setting incidental mortality or harvest quotas is to use a stock-production model (Schaeffer 1957; Allen 1976) with an assumed maximum rate of increase. For dolphins and other cetaceans, rates of increase have proven extremely difficult to measure directly. Nonetheless, estimates of this parameter are sometimes necessary, e.g., in setting incidental mortality quotas for dolphin populations involved in the eastern tropical Pacific purse seine fishery for yellowfin tuna (Smith 1983). In such situations, even a range, when rigorously defined, can contribute substantially to delineating the management options.

In this paper we define a range of reasonable values of rate of increase (hereafter also referred to as ROI) in dolphin population size, given what is known or can be inferred about their age-specific survival and fecundity distributions, or "vital rates". We estimate rates of increase using population projection matrices for various parameter combinations. We also suggest how the resulting ranges in ROI can be further narrowed, given specific information for an individual population.

There are many slightly different definitions for rate of increase, but all share the commonsense notion of change in population size over time. Caughley (1977) reiterated the distinction between exponential and finite rates: finite rates, here symbolized  $\lambda$ , are related to exponential rates, here symbolized  $r$ , by the simple conversion  $\lambda = e^r$ . (We use the term

"finite rates of increase" for  $\lambda$  following Birch 1948.) Further, within exponential rates Caughley distinguished among "intrinsic" ( $r_m$ ), "survival-fecundity" ( $r_s$ ) and "observed" ( $\bar{r}$ ), rates.

In this paper we compute a series of  $r_s$  values, resulting from ranges of survival-fecundity distributions. The highest value of  $r_s$  resulting from the range of vital rates considered is our best estimate of dolphin  $r_m$ , or "r-max".

We define the ranges in vital rates based on the literature for dolphins where possible. Otherwise, we rely on information for other large mammals and what appear to be logical or biological limits.

There are two previous studies of a similar nature for delphinids. As part of a general review of life history analysis of large mammals, Goodman (1981) examined the relationships among rate of increase, juvenile and adult survival rates. He looked at single values for calving interval and age at first reproduction across ranges of survival rates. We take a broader look at these relationships, examining ranges for all four parameters.

Polacheck (1984) examined interparameter relationships for eastern tropical Pacific (ETP) dolphins, *Stenella* spp., given specific vital rate estimates available as of 1981, showing the values were not consistent with a positive population growth rate. Since then, revised estimates have become available for some relevant parameters, and this specific case has been reanalyzed, with similar general conclusions.

The only reported dolphin rates of increase are for *Stenella coeruleoalba*. For the year 1974, Kasuya (1976) estimated a rate of 0.024 for the population off Japan. This value was computed in a complex manner, based on an observed fishing mortality, assumed natural mortality, and estimated popula-

<sup>1</sup>Southwest Fisheries Center La Jolla Laboratory, National Marine Fisheries Service, NOAA, P.O. Box 271, La Jolla, CA 92038.

tion size, calving interval and sex ratio. Assuming that calving interval was density dependent, Kasuya (1976) estimated a maximum annual rate of increase of 0.044 for this population of *S. coeruleoalba*.

## METHODS

### The Model

Population growth rates are estimated here using the familiar Leslie matrix model (Leslie 1945). A simplified parameterization is used for which survival rates and fecundities remain constant over many age classes. Four parameters are required: 1) calving interval for reproductively mature females, 2) average age at first birth for females, 3) annual adult (noncalf) survival rate, and 4) annual calf survival rate. This degree of detail corresponds to the practical limitations in collecting data on wild dolphin stocks.

The model is constructed with the assumption that age class 1 corresponds to newly born calves (i.e., censuses occur immediately after the calving season). In fact, the model is not dependent on discrete calving seasons, but this assumption helps in conceptualizing some elements of the model. The fecundities (elements of the first row of the Leslie matrix) represent the number of female calves born in one year per female of a given age class in the previous year. Fecundities for mature age classes are estimated as the annual pregnancy rate (the inverse of calving interval) multiplied by the adult survival rate (the probability that a [pregnant] female will survive to the calving season) multiplied by 0.5 (the fraction of female offspring). The annual pregnancy rate is estimated as the percent of sexually mature females which are pregnant, divided by the gestation period (in years).

The choice of only two different survival rates for all life stages was made because of data limitations for dolphins. Perhaps a more biologically reasonable assumption would be that dolphins have a U-shaped mortality curve which is characteristic of mammals in general (Spinage 1972; Caughley 1977; Siler 1979; Smith and Polacheck 1981). Barlow<sup>2</sup> incorporated this typical mammalian survivorship curve in models of growth for spotted dolphins, *Stenella attenuata*. Our choice of a separate survival rate for calves was based on the common observation of higher mortal-

ity in juvenile mammals (Caughley 1977; Siler 1979). For convenience, juvenile mortality factors are compressed into the first year's survival rates. This simplification is justified because population growth rates do not depend on the age at which juvenile mortality actually occurs. We recognize that juvenile mortality factors probably extend past the first year of life, but insufficient data exist to justify including this in our model. Higher mortality in old age was not incorporated in our model, but maximum age was limited to 50 yr. The survival rate at age 50 was thus zero.

We calculate population growth rates for a range of the four vital rate parameters mentioned above. Finite population growth rates,  $\lambda$ , that are associated with these parameter values were calculated by solving Lotka's characteristic equation, using Newton's method. The explicit form of Lotka's equation used is

$$1 = \sum_{x=1}^{50} \lambda^{-x} l_x m_x$$

where  $l_x$  is the survivorship from birth to age class  $x$  and  $m_x$  is the fecundity of age class  $x$ .

Below, we define the ranges used for the four population parameters and describe how they were selected.

## Survival Rates

### Ranges in Noncalf Survival Rates

Few estimates of adult survival rates for dolphins are available in the literature, primarily because adequate data are difficult to collect. Kasuya (1976) presented annual survival rate estimates of 0.925 and 0.882 for exploited populations of *Stenella attenuata* and *S. coeruleoalba*, respectively; however, his method (log-linear regression) is biased (Barlow 1982), and he did not adjust for the effect of population growth on age structure. A range of 0.85 to 0.97 was chosen for survival rates in this study. Values <0.85 do not allow population growth for the ranges of other parameters appropriate here, hence these values were not considered. Values higher than 0.97 result in more than 22% of the population being over 50 yr old. This is inconsistent with estimates of longevity for delphinids based on tooth layer counts [58 yr in *S. coeruleoalba* (Sacher 1980), 38 yr in *S. attenuata* (Hohn and Myrick<sup>3</sup>)], hence values

<sup>2</sup>Barlow, Jay. 1986. Biological limits on current growth rate of a spotted dolphin population (*Stenella attenuata*). Unpubl. manuscr. Southwest Fisheries Center La Jolla Laboratory, National Marine Fisheries Service, NOAA, 8604 La Jolla Shores Drive, La Jolla, CA 92038.

<sup>3</sup>Hohn, A. A., and A. C. Myrick, Jr. 1986. Age distribution of the kill of spotted dolphins in the eastern tropical Pacific.

>0.97 are untenable as mean per-capita survival rates.

### Ranges in Calf Survival Rate

Again little information is available on calf survival for dolphins. Kasuya (1976) estimated a juvenile survival rate that was higher than that of adults, based on a balance equation. His methods assume that populations are neither growing nor declining, and he did not show that this assumption was met. Also his juvenile period included all sexually immature age classes. The overwhelming body of evidence from terrestrial mammals is that very early juvenile mortality is higher than adult mortality (Spinage 1972; Caughley 1977; Siler 1979). Even human populations had a first year survival rate of <0.88 prior to modern antibiotics (Fruehling 1982, data for U.S. circa 1900). An upper limit on calf survival rates was generated by assuming a calf is absolutely dependent on its mother for 1 yr. A calf has the same risk of dying as an adult, plus the additional risk of dying of starvation if its mother dies before completing 1 yr of lactation. The upper limit on calf survival would thus equal the square of the adult survival rate. The lower limit on calf survival rates was chosen as 0.50, a value that seems typical of pinnipeds (Smith and Polacheck 1981) and long-lived terrestrial mammals (Spinage 1972).

## Fecundity-Related Rates

### Ranges in Calving Interval

Observed calving intervals for dolphins generally range from 2 to 4 yr (Perrin and Reilly 1984); consequently, we have used this range in our computations. Intervals reported for killer whales (which are also delphinids, but not "dolphins") are considerably longer, up to 8 yr (e.g., Jonsgård and Lyshoel 1970).

The literature includes reports of calving intervals <2 yr for dolphins. These reports do not appear to be valid. Reevaluation of data for three of these reports<sup>4</sup> indicates that sampling was biased toward pregnant females (Perrin and Reilly 1984), a result of what may be a general tendency for

dolphins to segregate by age/sex groupings<sup>5</sup>.

The remaining reports of calving intervals <2 yr are from very small sample sizes.<sup>6</sup> Gestation periods for dolphins are at minimum 10 mo, and intraspecific variation is small. Reported lactation periods range from 1 yr to over 2 yr (Perrin and Reilly 1984). Summing these two periods gives another indication that dolphin calving intervals are not likely to be <2 yr.

An exception to the 2-yr minimum calving interval would possibly be in a population experiencing very high calf mortality, causing premature cessation of lactation, and allowing females the opportunity to begin a new calving cycle (assuming there was no seasonality to breeding which could require a resting period before the next breeding season). To include consideration of this case we would need to devise an arbitrary function relating low calf survival to short calving intervals. The net result would again be low rates of increase. To avoid such complications we have simply used 2 yr as the minimum average calving interval.

### Ranges in Age at First Birth

The available data suggest a range in age at attainment of sexual maturity of 6 to 12 yr for dolphins (Perrin and Reilly 1984). Early reports of Black Sea common dolphins, *Delphinus delphis*, attaining sexual maturity at an average of 3 yr (Kleinenberg 1956) are almost certainly due to faulty age determination<sup>7</sup>. Because of the recent findings for *S. attenuata* from the ETP (Myrick et al. 1986), we considered the ages at first birth up to 15 yr. In our formulation of the Leslie model, if females mature and first conceive at an average age of 10 yr, the first nonzero fecundity would be in age class 11 (Table 1).

<sup>5</sup>Hohn, A. A., and M. D. Scott. 1983. Segregation by age in schools of spotted dolphins in the eastern tropical Pacific. Fifth Biennial Conf. Biol. Mar. Mammals, Abstr., p. 47.

<sup>6</sup>Henderson, J. R., W. F. Perrin, and R. B. Miller. 1980. Rate of gross annual reproduction in dolphin populations (*Stenella* spp. and *Delphinus delphis*) in the eastern tropical Pacific, 1973-78. Southwest Fisheries Center, La Jolla, California, Admin. Rep. LJ-80-02, 51 p.

<sup>7</sup>Myrick, A. C. Jr., Southwest Fisheries Center La Jolla Laboratory, National Marine Fisheries Service, NOAA, 8604 La Jolla Shores Drive, La Jolla, CA 92038, pers. commun. June 1984.

TABLE 1.—Parameters used and values included in the computation of rates of increase in dolphin population size.

Parameter	Values
Calving interval	2 yr 3 yr 4 yr
Age at first birth	7 yr 9 yr 11 yr 13 yr 15 yr
Calf survival rate	0.50 0.52 0.54 . . . (Sa) <sup>2</sup>
Noncalf survival rate (Sa)	0.850 0.855 0.860 0.865 . . . 0.970

Unpubl. manuscr. Southwest Fisheries Center La Jolla Laboratory, National Marine Fisheries Service, NOAA, 8604 La Jolla Shores Drive, La Jolla, CA 92038.

<sup>4</sup>Three reported cases of dolphin calving intervals <2 yr, later found to be biased due to age and sex segregation, are Black Sea *Delphinus delphis* and *Tursiops truncatus* (Kleinenberg 1956) and Western Pacific *Stenella coeruleoalba* (Miyazaki and Nishiwaki 1978).

## RESULTS

Figures 1 through 5 give finite rates of increase (displayed as  $(\lambda - 1) \cdot 100$ ) for the above ranges of age at first birth, calving interval, and calf and noncalf survival. The lower left corner of each panel is blank because we did not consider cases where calf survival exceeded the square of noncalf survival, for the reason discussed in Methods.

The maximum finite rates of increase which would result from the parameter ranges included here are 1.08 to 1.09. Rates as low as 0.89, i.e., decrease of 11%/yr. also resulted from the parameter ranges used.

Within the ranges of parameters examined here, rate of increase is most sensitive to calving inter-

val and noncalf survival rate, followed by age at first birth, and is relatively insensitive to changes in calf survival rate. This is an expected result following the reports by Eberhardt and Siniff (1977) and Goodman (1981). An increase in calving interval of 1 yr results in a decrease in ROI of about 0.02, holding other parameters constant. For example, the maximum ROI for a 9 yr age at first birth is about 1.07 with a 2 yr calving interval. This ROI drops to 1.05 with a 3 yr calving interval. A decrease of 0.01 in noncalf survival rate results in a 0.01 decrease in ROI, while a 0.10 decrease in calf survival rate decreases ROI by  $<0.01$ . Age at first birth appears to be nonlinearly related to ROI over the ranges examined here. An increase in this age from 7 to 9 yr results in a 0.02 decrease in ROI, while an increase

FIGURES 1-5.—Contours of percent rate of increase in dolphin population size  $(\lambda - 1) \cdot 100$ , as a function

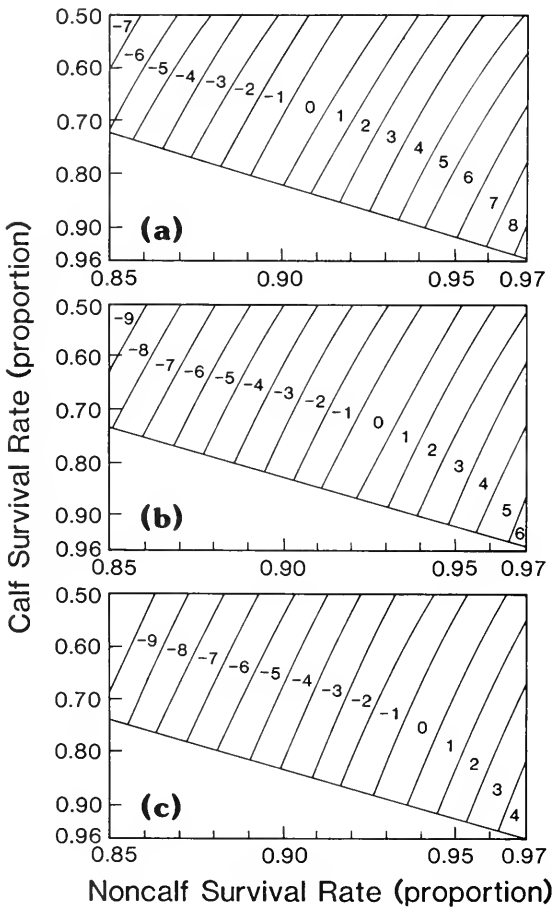

FIGURE 1.—First reproduction of dolphin age class 7 yr: a) 2-yr calving interval (upper panel); b) 3-yr calving interval (middle panel); c) 4-yr calving interval (lower panel).

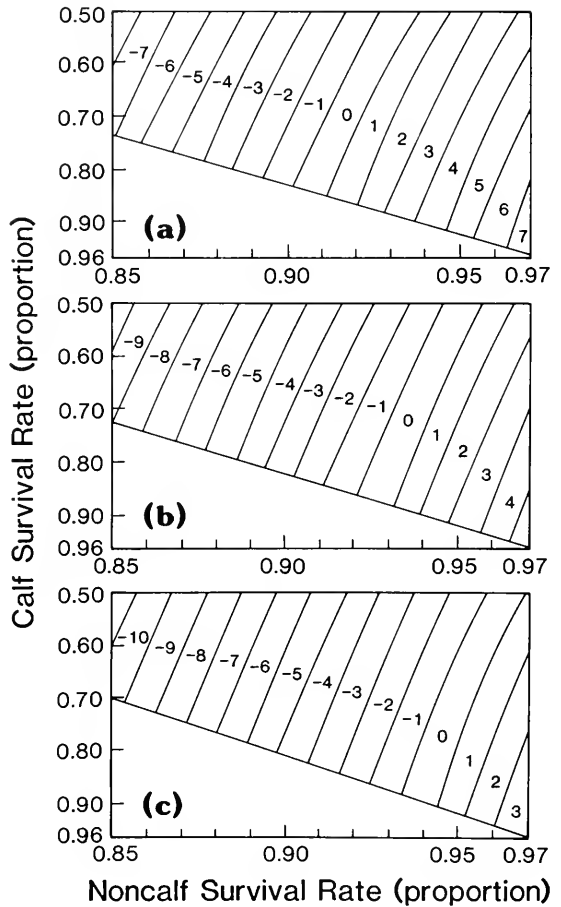

FIGURE 2.—First reproduction of dolphin age class 9 yr: a) 2-yr calving interval (upper panel); b) 3-yr calving interval (middle panel); c) 4-yr calving interval (lower panel).



from 11 to 13 yr causes only a 0.01 decrease in ROI.

### DISCUSSION

The ranges of rate of increase estimated here are potentially useful in bracketing possible ROIs for delphinids in general. For any particular population it should be possible to further narrow the range of likely values of ROI, given available estimates for vital rates. For example, *Tursiops truncatus* from the northeast coast of Florida reportedly attain sexual maturity at 12 yr on the average (Sergeant et al. 1973) and have a 12-mo gestation period (Essaïan 1963), giving an estimated age at first birth of 13 yr. Knowledge of this single parameter can nar-

row consideration to Figure 4. Here the estimated range in ROI is up to a maximum of 1.05, for the extreme case of an average calving interval of 2 yr, and noncalf survival  $>0.96$ . Additional knowledge of, say, minimal calving interval for *Tursiops* could further narrow consideration to one of the three panels of Figure 4, and establish minimal survival rates for positive growth rates, or the maximum rate of increase possible, given the above constraints on age at first birth and calving interval.

We assume that the ranges defined here also encompass the limits within which vital rates for any one dolphin species might change in response to changes in population density. This obviously entails making simplistic assumptions about density dependence in vital rates, and therefore in rate of increase.

of calf and noncalf survival rates, for the following combinations of calving interval and age at first reproduction:

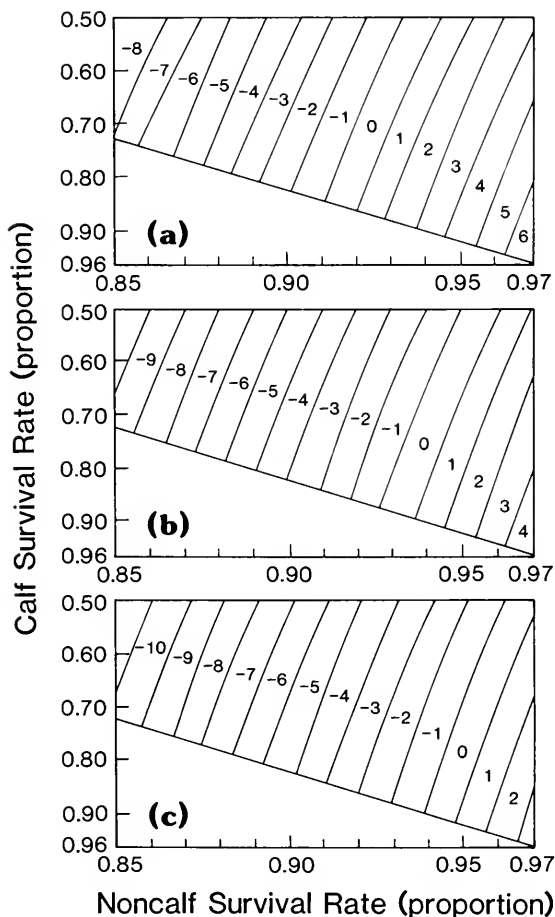

FIGURE 3.—First reproduction of dolphin age class 11 yr: a) 2-yr calving interval (upper panel); b) 3-yr calving interval (middle panel); c) 4-yr calving interval (lower panel).

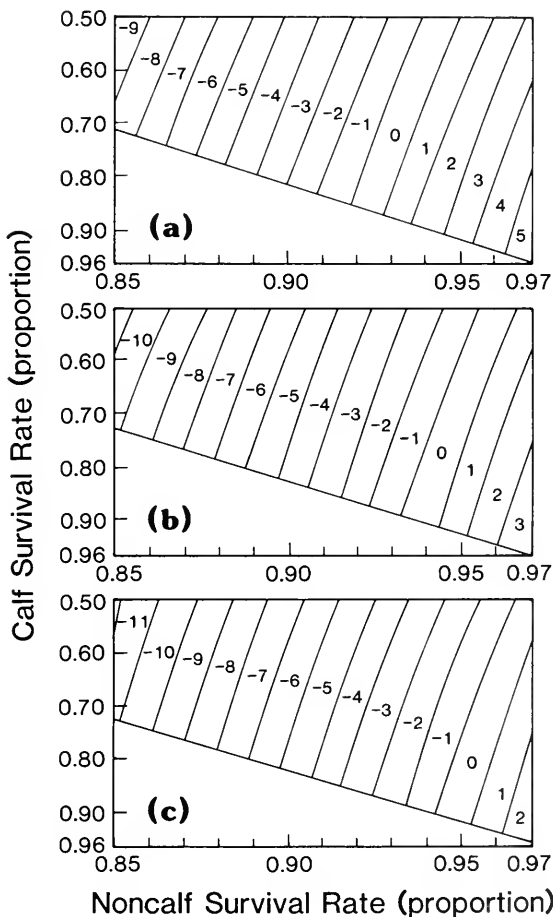

FIGURE 4.—First reproduction of dolphin age class 13 yr: a) 2-yr calving interval (upper panel); b) 3-yr calving interval (middle panel); c) 4-yr calving interval (lower panel).

These assumptions are implicit in the concept of  $r$ -max.

There is no evidence that the highest rates of increase calculated here can be achieved by any real dolphin population. Trade offs may exist between survival and reproduction. Because of this, some of the parameter combinations examined here are probably unlikely, especially combinations of the extreme values, i.e., those producing the highest rates of increase.

Although our figures also present minimum values based on parameter combinations we used, we do not believe that these will be useful in setting lower bounds on finite rates of increase. Catastrophic events can always lead to rapid extirpation of a population. In fact, it is clear that dolphins (and other animals with similar life histories) can

decrease in number much faster than they can increase.

## ACKNOWLEDGMENTS

This study benefited greatly from reviews by J. Breiwick, D. Chapman, D. DeMaster, D. Goodman, J. Hedgepeth, F. Hester, G. Sakagawa, D. Siniff, T. Smith, and an anonymous reviewer. We sincerely thank these people for their contributions.

## LITERATURE CITED

- ALLEN, K. R.  
1976. A more flexible model for baleen whale populations. Rep. Int. Whaling Comm. 26: App. Report and Papers of the Scientific Committee, p. 247-263.
- BARLOW, J.  
1982. Methods and applications in estimating mortality and other vital rates. Ph.D. Thesis, Univ. California, San Diego, 177 p.
- BIRCH, L. C.  
1948. The intrinsic rate of natural increase of an insect population. J. Anim. Ecol. 17:15-26.
- CAUGHLEY, G.  
1977. Analysis of vertebrate populations. Wiley-Interscience, N.Y., 234 p.
- EBERHARDT, L. L., AND D. B. SINIFF.  
1977. Population dynamics and marine mammal management policies. J. Fish. Res. Board Can. 34:183-190.
- ESSAPIAN, F. S.  
1963. Observations on abnormalities of parturition in captive bottlenosed dolphins, *Tursiops truncatus*, and concurrent behavior of other porpoises. J. Mammal. 44:405-414.
- FREUEHLING, J. A. (editor).  
1982. Sourcebook on death and dying. Marquis Prof. Publ., Chicago, 788 p.
- GOODMAN, D.  
1981. Life history analysis of large mammals. In C. W. Fowler and T. D. Smith (editors), Dynamics of large mammal populations, p. 415-436. Wiley, N.Y.
- JONSGÅRD, A., AND P. B. LYSHOEL.  
1970. A contribution to the knowledge of the biology of the killer whale *Orcinus orca* (L.). Nytt. Mag. Zool. (Oslo) 18:41-48.
- KASUYA, T.  
1976. Reconsideration of life history parameters of the spotted and striped dolphins based on cemental layers. Sci. Rep. Whales Res. Inst. Tokyo 28:73-106.
- KLEINENBERG, S. E.  
1956. Miekopitauishchenie Chernogo i Azovskogo Morei (Mammals of the Black Sea and Sea of Azov). Akad. Nauk., Moscow, 288 p. (Fish. Mar. Serv., Quebec, 1978, Transl. ser. 4319, 428 p.)
- LESLIE, P. H.  
1945. On the use of matrices in certain population mathematics. Biometrika 33:183-212.
- MIYAZAKI, N., AND M. NISHIWAKI.  
1978. School structure of the striped dolphin off the Pacific coast of Japan. Sci. Rep. Whales Res. Inst., Tokyo 30: 65-115.

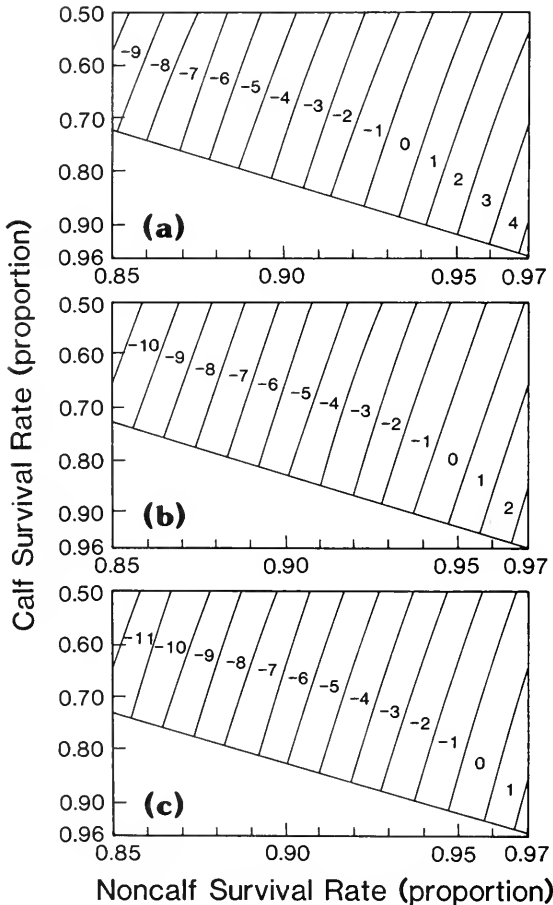

FIGURE 5.—First reproduction of dolphin age class 15 yr: a) 2-yr calving interval (upper panel); b) 3-yr calving interval (middle panel); c) 4-yr calving interval (lower panel).

- MYRICK, A. C. JR., A. A. HOHN, J. BARLOW, AND P. A. SLOAN.  
1986. Reproductive biology of female spotted dolphins, *Stenella attenuata*, from the eastern tropical Pacific. Fish. Bull., U.S. 84:247-259.
- PERRIN, W. F., AND S. B. REILLY.  
1984. Reproductive parameters of dolphins and small whales of the family delphinidae. In W. F. Perrin, D. P. DeMaster, and R. L. Brownell, Jr. (editors), Cetacean reproduction, p. 181-185. Rep. Int. Whaling Comm. Spec. Issue 6.
- SACHER, G. A.  
1980. The constitutional basis for longevity in the Cetacea: Do the whales and the terrestrial mammals obey the same laws? In W. F. Perrin and A. C. Myrick, Jr. (editors), Age determination of toothed whales and sirenians, 229 p. Rep. Int. Whaling Comm., Spec. Issue 3.
- SCHAEFER, M. B.  
1957. Some aspects of the dynamics of populations important to the management of commercial marine fisheries. Inter-Am. Trop. Tuna Comm. Bull. 1:27-56.
- SERGEANT, D. E., D. K. CALDWELL, AND M. C. CALDWELL.  
1973. Age, growth and maturity of bottlenosed dolphins (*Tursiops truncatus*) from northeast Florida. J. Fish. Res. Board Can. 30:1009-1011.
- SILER, W.  
1979. A competing-risk model for animal mortality. Ecology 60:750-757.
- SMITH, T. D.  
1983. Changes in size of three dolphin (*Stenella* spp.) populations in the eastern tropical Pacific. Fish Bull., U.S. 81: 1-13.
- SMITH, T., AND T. POLACHECK.  
1981. Reexamination of the life table for northern fur seals with implications about population regulatory mechanisms. In C. W. Fowler and T. D. Smith (editors), Dynamics of large mammal populations. Wiley, N.Y.
- SPINAGE, C. A.  
1972. African ungulate life tables. Ecology 53:645-652.



# DISCRETE-TIME DIFFERENCE MODEL FOR SIMULATING INTERACTING FISH POPULATION DYNAMICS

C. ALLEN ATKINSON<sup>1</sup>

## ABSTRACT

The dynamics of interacting fish populations are modeled using a coupled set of discrete-time difference equations. The basic equations describe predator-prey and competitive relationships analogous to the first-order expressions used in standard differential equation models. Population births and aging are represented using a modified Leslie matrix. A spatial representation is also incorporated and consists of a number of separate compartments, each containing interacting population groups which can be interchanged between compartments during a given time period. The potential applicability of the discrete-time formulation is demonstrated via a simulation of the multispecies fish populations within the California Current during the sardine population collapse of 1930-60.

Numerous mathematical models of interacting multispecies fish populations are found in the literature (Riffenburgh 1969; Saila and Parrish 1972; May et al. 1979; Steele 1979). Depending on the nature of a particular ecosystem and the desired resolution level for its components and processes, these models can become extremely complex (Parrish 1975; Anderson and Ursin 1977; Laevastu and Favorite 1978). The major limitation in practical fisheries applications is the lack of sufficient field data to adequately estimate many of the model parameters, particularly the population interaction terms in complex multispecies models (Goodall 1972).

The two objectives in the present multispecies model development are 1) to establish a general mathematical form applicable to a variety of practical fisheries problems and 2) to provide an efficient computational tool for simulating complex multispecies systems. The latter feature has implications for dealing with the problem of model parameter uncertainty via specialized Monte Carlo and nonlinear programming procedures as discussed by Atkinson (1985).

The proposed formulation consists of a unique set of discrete-time difference equations that describe first-order dynamic processes affecting some arbitrary number of interacting fish populations at one or more trophic levels. The discrete equations are particularly well suited for computer implementation. There are no requirements for sophisticated integration routines (e.g., Runge-Kutta, Adams-Moulton), and the equations have inherent numerical

stability. Difference equations are also compatible with fisheries data sets (e.g., eggs and larvae surveys) which are usually sampled seasonally.

The essential biological processes represented in the model are spawning, growth, mortalities, age class structure, nonuniform spatial distributions, and migrations. Certain of these features, such as spawning, sexual maturation, and migrations, are often most conveniently described in a discrete form as assumed in the model. Seasonal time steps are natural increments for consideration as the values of appropriate model parameters can then be easily changed to relate seasonal fish behavior.

The mathematical details of the discrete-time difference model are developed below. The special problem of estimating model parameters in practical applications is also briefly discussed. The dynamics of the California Current fish populations are then modeled and simulation runs performed corresponding to the period of the sardine collapse in 1930-60. Comparisons are made between the simulation results and the actual (estimated) population responses.

## DEVELOPMENT OF THE DISCRETE-TIME DIFFERENCE EQUATIONS

The dominant first-order ecological processes affecting fish populations are modeled by discrete-time difference equations. For convenience in the mathematical development, these processes are assumed to occur in the following sequence during a given time period: 1) individual growth and mortalities; 2) spatial redistributions of the surviving members; and 3) births and age class changes of the surviving,

<sup>1</sup>System Science Applications, Inc., 121 Via Pasqual, Redondo Beach, CA 90277.

535-548

redistributed populations. Consistent with the first-order nature of the formulas, certain simplifications are expected to be incorporated in the ecological representation including implicit modeling of lower trophic levels (e.g., phytoplankton and zooplankton) and functional groupings of less important species as competitors, predators, and prey.

### Growth and Mortalities

First-order differential equations of the following general form are typically used to describe the growth and mortalities of a population  $P_i$  under competitive and predator-prey influences with itself and other populations:

$$\frac{d P_i}{d t} = (r_i - u_i P - v_i P + w_i P) P_i \quad (1)$$

- where  $r_i$  = survival/growth parameter
- $P$  = population vector  
=  $(P_1, P_2, \dots, P_i, \dots, P_n)$
- $u_i$  = competition coefficient vector  
=  $(u_{i1}, u_{i2}, \dots, u_{ii}, \dots, u_{in})$
- $v_i$  = predation coefficient vector
- $w_i$  = prey coefficient vector.

The coefficient vectors  $u_i$ ,  $v_i$ , and  $w_i$  contain appropriate zeros such that only the active interactions between populations are defined. (Note that vector multiplication is implied by the forms such as  $u_i P$ .) The competition terms correspond to the standard Gause model, while the predator-prey terms correspond to the simple Lotka-Volterra model (Pielou 1977). The population variables  $P_i$  can be expressed in units of either numbers of individuals or total biomass, with the coefficients defined accordingly.

Assuming a small time step ( $\Delta t$ ) relative to the characteristic time of the system ( $1/r$ ), a discrete-time approximation is found directly by integrating Equation (1) to give

$$P_i(\Delta t) = e^{r_i \Delta t} \cdot e^{-u_i P \Delta t} \cdot e^{-v_i P \Delta t} \cdot e^{w_i P \Delta t} \cdot P_i(0) \quad (2)$$

These exponential terms form the basis of the difference model. However, some modification and interpretation of terms is required in order to describe a general form appropriate over a range of population levels.

The most obvious inadequacy of Equation (2) is the positive exponential prey term,  $e^{w_i P \Delta t}$ , which gets increasingly larger as prey increases without ever reaching a saturation condition. A more ap-

propriate form is the predator feeding model given by Ivlev (1961):

$$F = F_{\max} (1 - e^{-\xi P}) \quad (3)$$

where  $F$  is the predator feeding ration and  $\xi$  is an associated prey coefficient, assuming that this form can also be used to describe the predator's growth/survival as a function of prey density.

The proposed difference equation for expressing population growth and mortalities during a  $\Delta t$  time step is

$$P_i(t + 1) = S_i e^{-\alpha_i P} e^{-\beta_i P} (1 - R_i e^{-\gamma_i P}) P_i(t) \quad (4)$$

- where  $S_i$  = maximum survival/growth rate per time period
- $\alpha_i$  = discrete form of competition coefficient vector
- $\beta_i$  = discrete form of predation coefficient vector
- $R_i$  = starvation mortality factor
- $\gamma_i$  = discrete form of prey coefficient vector.

The terms in this generalized form need further discussion and interpretation.

The maximum survival/growth rate factor,  $S$ , accounts for population births (if single age class), growth (if biomass units), and certain mortalities such as fishing, disease, and old age. It also accounts for predatory deaths caused by populations not explicitly included in the ecosystem model. It does not account for predation, competition, and prey availability effects associated with the modeled populations, which are explicitly stated by the other terms of Equation (4). Maximum survival/growth is defined under ideal conditions when competition and predation influences are negligible and there is an abundant supply of prey.

The  $\alpha$  competition coefficient is the exponential equivalent to the Gause term in Equation (1) and represents a basic damping factor inhibiting population expansion. Self-competition generally relates to the essential environmental resources such as food supply and habitat space. Additional intra-population effects can come into play at the extreme ranges of population densities to complicate this interpretation, such as decreased fecundity caused by crowding (Parrish 1975) and decreased birth rates at very low densities (May 1973). Competition between population groups involves considerations of niche overlap relative to the common resources for which they compete (May 1973). Active competition

interference effects may also be involved (Levine 1976; Vance 1978). Since my model deals only with first-order effects, the components of the coefficient vector  $\alpha$  are defined as constants and assumed to be related to the dominant competitive mechanisms acting over the range of population densities expected in the simulation.

The  $\beta$  predation coefficient in Equation (4) corresponds to the Lotka-Volterra term in the differential equation and implies unlimited attack capacity per predator (May 1973). Relative values of these vector components reflect the comparative attack rates of the different predators in the model. The effective  $\beta$  coefficients perhaps should be reduced when there are relatively few predators compared with the size of population  $P_i$  because of saturated feeding. However, predation is probably a secondary factor under these conditions as competitive limitations will tend to dominate. Based on first-order arguments, constant  $\beta$  components are assumed to apply over a reasonable range of predator densities. Leslie and Grower (1960) make a similar assumption in the prey equation of their two-component predator-prey model. Their predator response equation, on the other hand, saturates at high relative prey levels as in the present model.

The prey form, represented in Equation (4), reflects Ivlev's form (Equation (3)) and implies some upper bound survival/growth rate under abundant prey conditions. The present form also incorporates a starvation mortality parameter,  $R$ , that describes a worst case condition without prey. This parameter would typically equal one unless the  $\Delta t$  time step is short or an alternative food source not explicitly included in the modeling is available to sustain the population.

Component magnitudes of the prey coefficient vector,  $\gamma$ , relate differences in the relative efficiency with which alternative prey are captured and utilized for predator growth and/or survival. At similar prey densities, a predator may utilize different capture methods and feed at higher or lower rates depending on the size and behavioral characteristics of a particular prey (Parsons and Takahashi 1973). Note, however, from the form of the exponential prey term in Equation (4), that any one sufficiently abundant prey population can satisfy the predator feeding requirement.

Finally, in comparing the present development with traditional fishery models, note that Equation (4) can be directly related to the single species recruitment models of Ricker (1958) and Beverton and Holt (1957) if the time step is defined as the maturation time between spawning and recruit-

ment. Also, a comparable fishing term can be broken out of the survival/growth parameter as follows:

$$S = S_f S_0 \tag{5}$$

where  $S_f$  is the fishing survival rate and  $S_0$  incorporates the remaining survival/growth effects. A corresponding fishing mortality rate,  $f$ , can be defined and related to fishing effort,  $E_f$ , as in the Beverton and Holt (1957) model:

$$f = \frac{-\ln S_f}{\Delta t} = \frac{E_f E_j}{A_f} \tag{6}$$

where  $E_j$  is the fishing efficiency and  $A_f$  is the fishing area. The general compatibility with traditional fishery models is stressed.

### Spatial Redistributions

A simplified picture of fish stock migratory patterns during a typical life cycle is illustrated in Figure 1. Adult fish move from the feeding grounds to the spawning grounds and return; larval fish drift from the spawning to the nursery ground; and recruits join the adult stock on the feeding grounds.

The seasonal timing of these events is quite regular as are the spatial regions to which the stock return during the cycle (Cushing 1975).



FIGURE 1.—Typical fish migratory pattern (from Cushing 1975).

ing segments of the various ecosystem populations. Population variables will now be uniquely assigned for each box and expressed in density units, such as numbers or kilograms per hectare. Spatial redistributions are assumed to occur during a given time period via migration, net drift, or turbulent dispersion. The resultant redistribution process is expressed by defining population transfers between boxes.

Spatial redistribution is applied to the surviving populations determined from Equation (4) and is described by

$$P_i^k(t + 1, 2) = \sum_{m=1}^M g_i^{mk} P_i^m(t + 1, 1) \quad (7)$$

where

- $P_i^k(t + 1, 2)$  = density of surviving population  $i$  in compartment  $k$  after spatial redistributions
- $P_i^m(t + 1, 1)$  = density of surviving population  $i$  in compartment  $m$  before spatial redistributions
- $M$  = total number of spatial compartments
- $g_i^{mk}$  = population  $i$  transport coefficient for the exchange from compartment  $m$  to compartment  $k$ .

The  $g$  coefficient defines the population fraction involved in the exchange with an adjustment to account for the difference in area or volume between compartments. If no transit occurs between compartments, the value of the respective coefficient is zero.

### Birth and Aging Processes

The larvae and juvenile age classes of fish populations have markedly different survival rates and behavioral characteristics than do adult populations. These differences have potentially important first-order ecological consequences and are, therefore, of concern in the present model development.

A modified version of the Leslie matrix as presented by Lefkovich (1965) is adopted here. Populations are grouped by stages which can be of unequal duration with no restriction to single year classes. The birth and aging matrix transform for  $N$  such stages is given by

$$\begin{bmatrix} P_{i1}^k(t+1,3) \\ P_{i2}^k(t+1,3) \\ P_{i3}^k(t+1,3) \\ \cdot \\ \cdot \\ \cdot \\ P_{iN}^k(t+1,3) \end{bmatrix} = \begin{bmatrix} b_{i1} & f_{i2}^k & f_{i3}^k & \cdot & f_{iN}^k \\ a_{i1} & b_{i1} & 0 & \cdot & 0 \\ 0 & a_{i2} & b_{i3} & \cdot & 0 \\ \cdot & \cdot & \cdot & \cdot & \cdot \\ \cdot & \cdot & \cdot & \cdot & \cdot \\ \cdot & \cdot & \cdot & \cdot & \cdot \\ 0 & 0 & 0 & \cdot & 1 \end{bmatrix} \begin{bmatrix} P_{i1}^k(t+1,2) \\ P_{i2}^k(t+1,2) \\ P_{i3}^k(t+1,2) \\ \cdot \\ \cdot \\ \cdot \\ P_{iN}^k(t+1,2) \end{bmatrix} \quad (8)$$

where

- $P_{ij}^k(t + 1, 3)$  = density of population  $i$ , age class  $j$  after accounting for births and aging in compartment  $k$
- $P_{ij}^k(t + 1, 2)$  = density of population  $i$ , age class  $j$  before accounting for births and aging, but after accounting for spatial redistributions to compartment  $k$
- $a_{ij}$  = fraction of population  $i$ , age class  $j$  advancing to age class  $j + 1$
- $b_{ij}$  = fraction of population  $i$ , age class  $j$  remaining in age class  $j$
- $f_{ij}^k$  = fecundity function for population  $i$ , age class  $j$  in compartment  $k$ .

The coefficients  $a$  and  $b$  are functions of the size of the time step and the division of ages within the population. Equation (8) also implies a fixed age distribution within an age class, such as a uniform distribution.

The fecundity term,  $f$ , is a function of the population age class, as well as being time and space dependent. Explicit population crowding effects are neglected here because they would be comingled with the other density-dependent terms in Equation (4).

### Composite Ecosystem Dynamics Equations

The above equations are combined and expressed by the general ecosystem dynamics model given below. The final surviving, redistributed, and aged population vector at the end of the time period has been redefined as  $P(t + 1) = P(t + 1, 3)$ .



$$\begin{aligned}
 P_{ij}^k(t+1) &= \sum_{n=1}^{N_i} \sum_{m=1}^M F_{ijn}^k(t) g_{in}^{mk}(t) S_{in}^m(t) e^{-\alpha_n P^m(t)} \\
 &\times e^{-\beta_n P^m(t)} [1 - R_{in}^m(t) e^{-\gamma_n P^m(t)}] \\
 &\times P_{in}^m(t) \tag{9}
 \end{aligned}$$

where  $m$  is summed over all spatial compartments  $M$ ;  $n$  is summed over all population subgroups  $N_i$ ; and  $F_{ijn}^k(t)$  is defined by

$$F_{ijn}^k(t) = \begin{cases} f_{in}^k(t); & j = 1, n \geq 2 \\ b_{in}(t); & j \geq 1, n = j \\ a_{in}(t); & j \geq 2, n = j - 1 \\ 0 & ; \text{ otherwise.} \end{cases} \tag{10}$$

The model parameters in Equations (9) and (10) consist of maximum survival/growth rates ( $S$ ), starvation mortality rates ( $R$ ), transport terms ( $g$ ), fecundity factors ( $f$ ), age class changes ( $a$  and  $b$ ), and population interaction coefficients ( $\alpha$ ,  $\beta$ , and  $\gamma$ ). Time dependency is indicated for all parameters except the interaction terms. Space dependency is assumed to apply to all but age class changes and interaction terms. If the parameters are described by probabilistic functions, the model becomes a stochastic representation.

The above difference model represents a comprehensive description of coupled fish population dynamics and is proposed for general application. The form of Equation (9) is particularly well suited for computer implementation; it provides an efficient time-step simulation capability without requiring a numerical integration scheme. The model can be conveniently programmed on a mini-computer system and used to simulate complex multispecies population dynamics.

### MODEL PARAMETER ESTIMATION IN PRACTICAL APPLICATIONS

The predictive power of the difference model in practical applications is obviously dependent on the knowledge of the ecosystem processes and the ability to estimate the associated parameters used in the modeling. This situation is true for any ecosystem model whether it consists of difference equations, differential equations, or any other formulation. In fact, I (1980) showed that difference equations representing multispecies populations can

be used to approximate the complex response modes of differential equations by relating parameters and choosing suitably small differencing time steps. I also showed that the difference model suffers from a similar sensitivity to the parameter estimates; the problem becomes more severe with increasing ecosystem complexity.

Certain parameters in either difference or differential equation models can be roughly estimated from field and/or laboratory studies. Examples include fecundity and growth rates of individual fish which can be observed directly. Population-level parameters, such as interaction and transport terms, are more difficult to estimate given the dynamic, wide-ranging nature of fish behavior. Even with extensive field sampling and the use of multivariate statistical techniques to sort out stochastic environmental features (Reid and Mackay 1968; Mobley 1973; Poole 1976), these parameter estimates will typically have a large degree of uncertainty.

The potential advantage of difference models in dealing with parameter uncertainty is related to their computational efficiency. When parameter uncertainty is represented in a probabilistic framework, Monte Carlo procedures can be applied to statistically describe population response characteristics based on large numbers of simulation runs. Probabilistic descriptions of parameter uncertainty can express both the inherent stochastic nature of the ecosystem and the parameter estimation error. One problem is that the stochastic ecosystem features, which are of primary interest, will typically be masked in the statistics by the large parameter estimation errors if realistic values for the latter are included.

I (1980, in press) used nonlinear programming (NLP) techniques to treat parameter uncertainty in dynamics models for a general class of ecosystem problem. My approach is summarized below; it has been used for resolving parameter estimates in the difference model application discussed in the section that follows.

An NLP problem can be stated in the following general form:

$$\begin{aligned}
 &\text{minimize} && f(x) \\
 &\text{subject to} && g(x) = 0 \\
 &&& x_0 \leq x \leq x_m
 \end{aligned}$$

where  $x$  is the variable vector with upper and lower bounds of  $x_0$  and  $x_m$ , respectively;  $f(x)$  is the so-called objective function; and  $g(x)$  is a vector function of implicit constraints.

The problem scenario for my NLP formulation is that of predicting the dynamic response of ecosystem populations to a given perturbation. The response is characterized over some period of interest by the objective function which, depending on the particular problem, can be equated to average population numbers, final population levels, worst-year fishery catch, or some other dynamic feature. The ecological parameters in the dynamics model become the variables with bounds corresponding to the estimated parameter uncertainty range.

Implicit parameter constraints are added to the formulation based on available population history data, ecosystem stability observations, or any known or postulated relationships between parameters. The historical population data are substituted directly into the difference equations, or other assumed dynamics equations. In effect, such constraints force the response modes of the dynamics model to include past population observations, albeit ones that occurred under different (known) conditions than those of interest in the future. Stability observations also infer conditions on the dynamics equations and, hence, model parameters. However, there are practical issues in formulating such conditions. Lyapunov stability analysis techniques (Brogan 1974), while applicable to nonlinear system analysis, are not readily defined for the complex difference equations.

Efficient NLP computational procedures have been applied by me (1980) to solve the special ecosystem formulation described above. A search takes place through bounded parameter space for extreme (minimum and maximum) objective function values while maintaining the equality of the implicit constraints, i.e., the search proceeds on the "constraint surface" in parameter space. The key to an effective problem solution is the computational requirements of the dynamics model which is used in both constraint formulation and for evaluating the objective function at each search step. While the NLP approach does not give definitive estimates of individual model parameters, it strongly delimits their range of values via the interrelationships established by the implicit constraints (Atkinson 1980).

## ECOSYSTEM SIMULATIONS USING THE DIFFERENTIAL EQUATION MODEL

The discrete-time multispecies dynamics model given by Equation (9) has been implemented as a FORTRAN computer program and used to perform a variety of simulations of theoretical and applied fisheries scenarios (Atkinson 1980). A case of some practical interest, the collapse of the sardine popula-

tion within the California Current region, will be described and used to demonstrate the potential model utility.

### General Description of the Sardine Population Collapse off California

The waters of the California Current flow southward along the west coast of North America covering the general region are illustrated in Figure 2. While the California Current supports a diverse group of fish, the sardine fishery was by far the most important in the early years of this century until the dramatic collapse of the sardine population in 1930-60. A large increase in fishing effort took place during this time and apparently caused, or at least was associated with the sardine population collapse. The estimated history of the sardine population from 1930 to 1960 as derived by Murphy (1966) is shown in Figure 3.

Two sets of anchovy population estimates for the 1930-60 time frame are also presented in Figure 3. Although these data are confused by significant gaps and strong fluctuations from year to year, there does appear to be a significant population increase from levels in the 1940's and early 1950's to that near the end of the 1950's. Since the anchovy is the chief competitor of the sardine with similar food requirements and overlapping habitat boundaries, the general indication is that the anchovy replaced the sardine within the trophic structure (Murphy 1966; Gulland 1971). Murphy's (1966) 3-yr averaged data provides the clearest evidence of this increasing trend. Smith's (1972) yearly estimates show that the anchovy population actually declined from 1940-41 to 1950 (the next year in which data was available), before a sharp rise occurred. The significant variations evident in both anchovy and sardine data are probably caused by random environmental influences on recruitment success (Lasker 1978; Parrish et al. 1981; Methot 1983).

Soutar and Isaacs (1974) presented some interesting longer term data on the sardine and anchovy (plus other pelagic fish) as derived from sedimentary scale depositions in anaerobic basins off Southern California and Baja California. The deposition rate, which is averaged by 5-yr periods, provides a relative picture of the population variations over the last 150 yr (up to 1970). The data for the 1930-60 time frame indicate similar trends to that above, i.e., decreasing sardine levels and increasing anchovy levels. However, significant sardine and anchovy

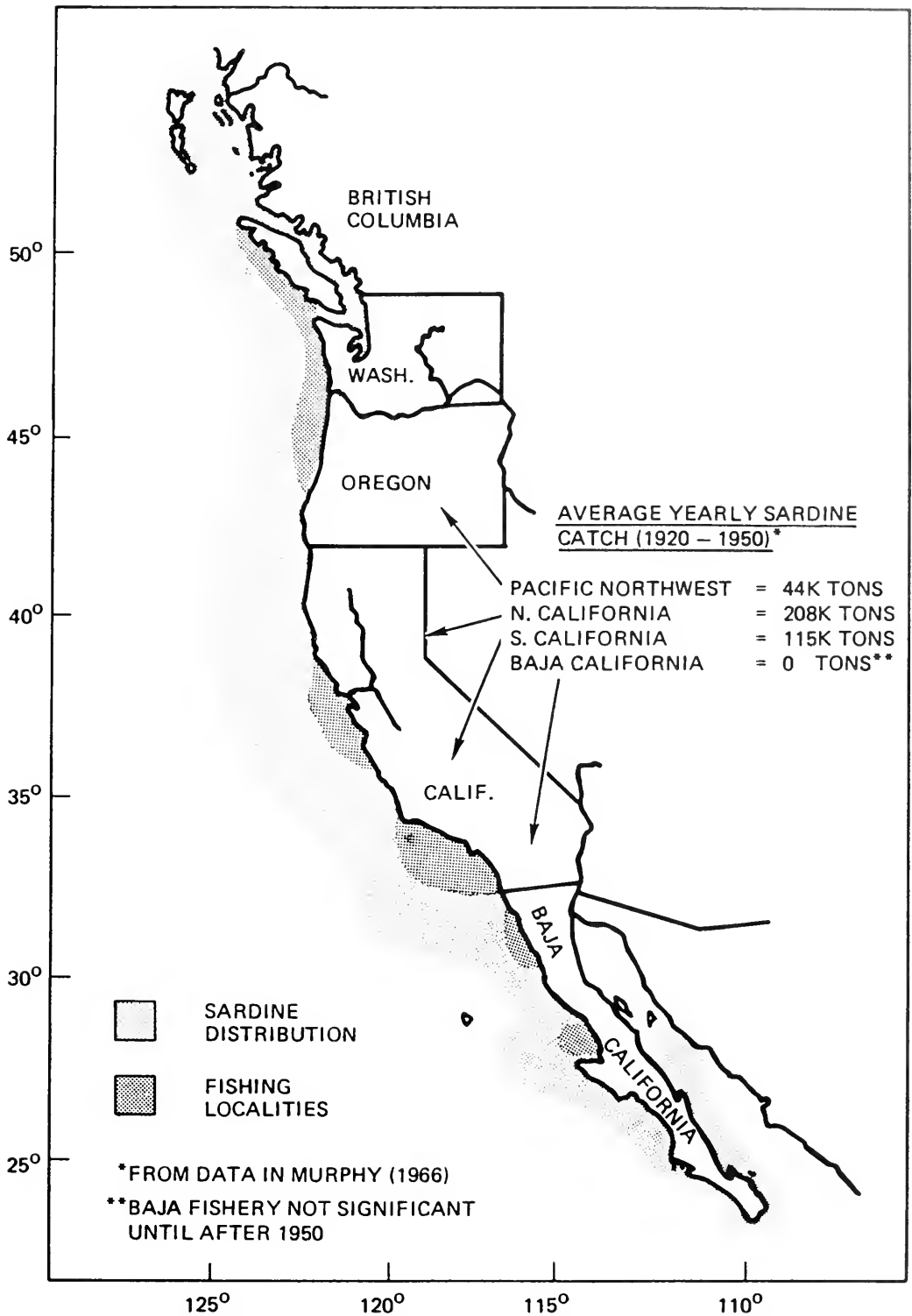

FIGURE 2.—Map of the California Current region showing sardine distribution and major fishing localities in the period before 1950 (from Murphy 1966).

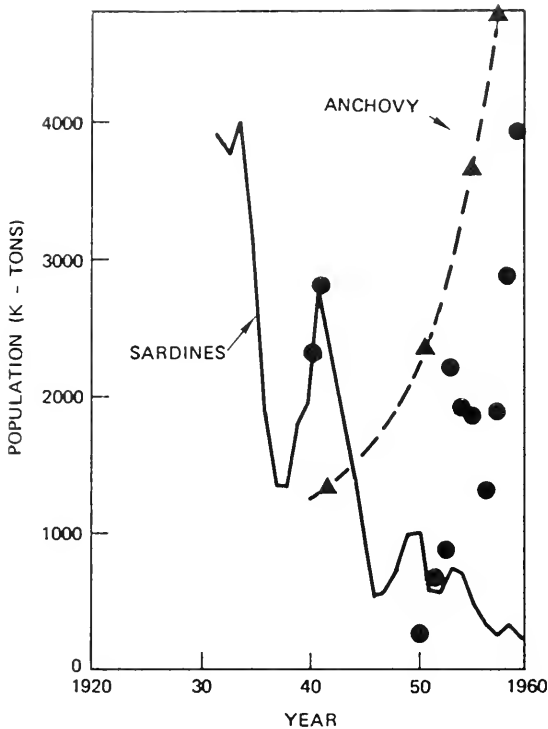

FIGURE 3.—Estimated adult populations of sardine and anchovy during the 1930-60 sardine collapse period. The solid line corresponds to yearly sardine estimates by Murphy (1966). The dashed line with triangles corresponds to 3-yr average anchovy estimates also by Murphy; the initial point is a 2-yr estimate with a data gap until 1951. The circles correspond to yearly anchovy estimates by Smith (1972); a data gap exists between 1941 and 1950.

variations are also evident in earlier times before fishing pressure became a significant factor in the ecosystem. For example, the sardine history showed extremely low levels in 1865-80 comparable to the levels after 1940. The earlier anchovy record, while also having periods of relatively high and low sedimentation rate, appears to have been at consistently higher levels before 1930-60, even higher than the recent increase of the late 1950's. Soutar and Isaacs (1974) stated that relatively unproductive conditions have apparently existed for the past 30 yr or so and have generally affected fish populations of the California Current.

### Model Formulation

The waters of the California Current region, with their chemical and biological constituents, can be viewed as an ecological system (Sette 1969). The present model focuses on the sardine and anchovy

subsystem defined by Riffenburgh (1969) and shown in Figure 4. While not a comprehensive description of this ecosystem, I use this representation to demonstrate the application of the difference model in a reasonably complex fishery situation. The sardine ecosystem will be simulated during the period from 1932 to 1952 spanning the years of the major sardine collapse.

The sardine population is divided into three age groups: larval-year stages, yearlings, and adults. The larval year is the most vulnerable period of the sardines' development during which it goes through many fundamental changes. The yearlings are the in-between stage to the sexually mature adult members of the population, which are defined to be 2-yr-olds and above. Early stages of the sardine feed on phytoplankton while the adults feed primarily on zooplankton (Huppert et al. 1980). The adults are also predators of their own larval stages and those of the anchovy as indicated in Figure 4.

The anchovy population is divided into two groups, larvae and adult, which have similar intergroup relationships and feeding habits to the corresponding sardine groups. Competitor and predator groups to the sardine and anchovy are defined as lumped assemblages, both encompassing a broad range of diverse fish species; the competitor group also contains many invertebrates. The pelagic fish competitors (e.g., jack mackerel) are assumed to behave similarly to the sardine and anchovy except that some of the larger members feed on the sardine yearling stage (Riffenburgh 1969). The predators (e.g., hake and baracuda) feed on the adults of the sardine-anchovy-competitor trophic level and also have other prey that have been decoupled from the modeled subsystem. Phytoplankton and zooplankton groups are modeled implicitly as carrying capacity terms.

Additional model assumptions are that 1) spatial features are not critical (i.e., one spatial compartment is used), and 2) seasonal effects can be ignored (i.e., a yearly time step is defined). These two assumptions are probably not justifiable in the time period after 1950 or so, because of the shift of dominance from the northern sardine subpopulation to the southern one. Important differences in such factors as natural survival rates, maturation characteristics, and fishing effort exist for these subpopulations (Murphy 1966).

### Discrete-Time Difference Equations

The difference model representing the seven interacting populations of the sardine ecosystem is pre-

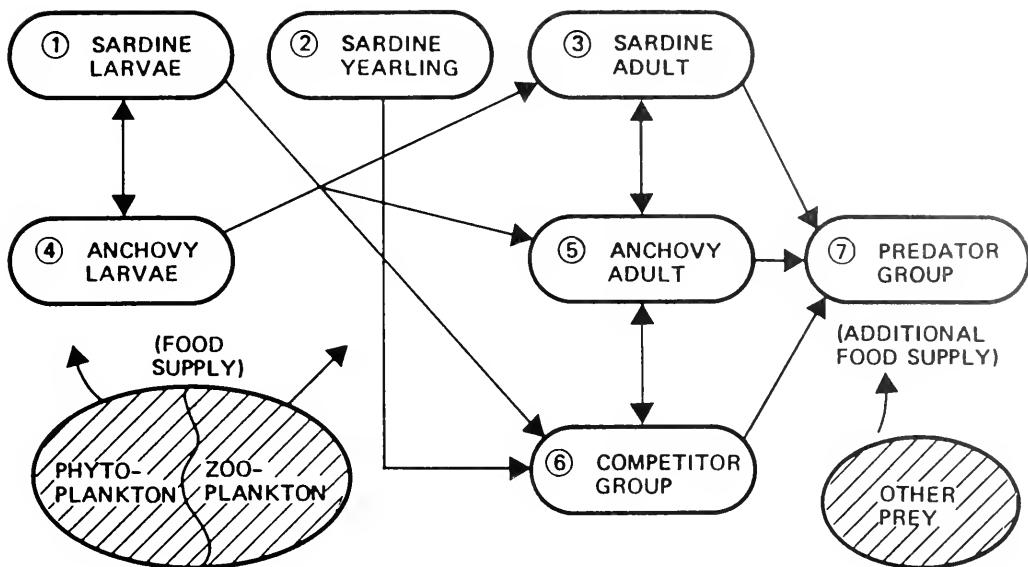

FIGURE 4.—Schematic showing interactions between sardine ecosystem groups as modeled by Riffenburg (1969). Competitive relationships are indicated by the connecting lines with dual arrowheads, while predator-prey relationships are defined by arrows pointing to the predator.

sented in Table 1. These equations reflect the general form of Equation (9) for a single spatial compartment. Parameters are defined for all processes other than transport, including competition, predator-prey, survival/growth, births, and fecundity. These parameters are assumed to be independent of the year during the 1932-52 simulation period, except for 1) the sardine fishing rate,  $\delta_3(t)$ , and 2) a sardine larvae survival factor,  $E_1(t)$ . The latter are related to the parameters presented earlier by

$$\delta_3(t) = 1 - S_{f3}(t)$$

$$E_1(t) = S_1(t)/\bar{S}_1$$

where  $S_{f3}$  is defined in Equation (5) and  $\bar{S}_1$  is the average (reference) sardine larvae survival rate during 1932-52. The time-varying fishing rate and larvae survival factor represent the “drivers” perturbing the ecosystem during the sardine collapse period.

Time-varying representations may also be ap-

TABLE 1—Difference equations describing biomass dynamics of the sardine ecosystem populations. Note that age sub-groups are indexed as separate populations to simplify the nomenclature. Also, all populations in exponentials are assumed to be at time  $t$ .

Population 1 - sardine larvae	$P_1(t + 1) = f_3 S_{3,0} [1 - \delta_3(t)] \exp(-\alpha_{33} P_3 - \alpha_{35} P_5 - \alpha_{36} P_6) \exp(-\beta_{37} P_7) P_3(t)$
Population 2 - sardine yearling	$P_2(t + 1) = E_1(t) S_1 \exp(-\alpha_{11} P_1 - \alpha_{14} P_4) \exp(-\beta_{13} P_3 - \beta_{15} P_5 - \beta_{16} P_6) P_1(t)$
Population 3 - sardine adult	$P_3(t + 1) = S_2 \exp(-\alpha_{22} P_2 - \alpha_{25} P_5) \exp(-\beta_{26} P_6) P_2(t) + S_{3,0} [1 - \delta_3(t)] \exp(-\alpha_{33} P_3 - \alpha_{35} P_5 - \alpha_{36} P_6) \exp(-\beta_{37} P_7) P_3(t)$
Population 4 - anchovy larvae	$P_4(t + 1) = f_5 S_5 \exp(-\alpha_{53} P_3 - \alpha_{55} P_5 - \alpha_{56} P_6) \exp(-\beta_{57} P_7) P_5(t)$
Population 5 - anchovy adult	$P_5(t + 1) = S_4 \exp(-\alpha_{41} P_1 - \alpha_{44} P_4) \exp(-\beta_{43} P_3 - \beta_{45} P_5 - \beta_{46} P_6) P_4(t) + S_5 \exp(-\alpha_{53} P_3 - \alpha_{55} P_5 - \alpha_{56} P_6) \exp(-\beta_{57} P_7) P_5(t)$
Population 6 - competitor group	$P_6(t + 1) = S_6 \exp(-\alpha_{63} P_3 - \alpha_{65} P_5 - \alpha_{66} P_6) \exp(-\beta_{67} P_7) P_6(t)$
Population 7 - predator group	$P_7(t + 1) = S_7 \exp(-\alpha_{77} P_7) [1 - R_7 \exp(-\gamma_{73} P_3 - \gamma_{75} P_5 - \gamma_{76} P_6)] P_7(t)$

appropriate for other population parameters such as anchovy larvae survival but are ignored here. The modeling emphasizes those features directly impacting the adult sardine population because it is the only population for which detailed data are available for making comparisons.

### Initial Conditions: State of the Ecosystem

The sardine ecosystem will assumed to be in an approximate equilibrium state prior to 1932, ignoring random population fluctuations. The sardine population appears to be consistently near virgin levels for the few years that data are available before 1932 (Fig. 3), and I speculate that the other populations are at reasonably consistent levels as well. There is some justification for overall stability at the sardine-anchovy-competitor trophic level and the predator trophic level, if not for individual fish species or population groups (Sette 1969; Steele 1979).

Estimates of population biomasses prior to the 1932-52 collapse period were summarized by Atkinson (1980) from data given by Murphy (1966) and Riffenburgh (1969). The biomasses presented below correspond to the assumed equilibrium state at the start of a fishing year. A fishing year is defined to begin in the summer after the main spring spawning season of the sardine and anchovy.

• sardine larvae	$\bar{P}_1 = 1,600$ kilotons
• sardine yearling	$\bar{P}_2 = 300$ kilotons
• sardine adult	$\bar{P}_3 = 4,000$ kilotons
• anchovy larvae	$\bar{P}_4 = 400$ kilotons
• anchovy adult	$\bar{P}_5 = 1,000$ kilotons
• competitors	$\bar{P}_6 = 3,000$ kilotons
• predators	$\bar{P}_7 = 2,000$ kilotons

The initial state in 1932 is also defined by this biomass vector,  $\bar{P}$ .

### Parameter Estimation for the Sardine Ecosystem Model

First, I point out that the above model representation is not intended to be a comprehensive description of the sardine ecosystem or to have general application for predicting future population dynamics, at least not as developed here. However, it is proposed as a reasonable representation to demonstrate the similarity between simulated results and observed system dynamics during the 1932-52 time frame provided appropriate parameter estimates

can be determined. The value of the difference formation in dealing with the parameter uncertainty issue will be illustrated in the discussion below of parameter estimation procedures.

Two model parameters in the equations of Table 1 were estimated directly from available data in the literature (Murphy 1967; MacCall 1979; Clark and Phillips 1932; Huppert et al. 1980): adult sardine survival,  $S_{3,0} = 1.40$  (excludes fishing mortality effects), and adult anchovy survival,  $S_5 = 1.20$ . The driver terms in the model,  $\delta_3(t)$  and  $E_1(t)$ , were also estimated from available data during the simulation period. These terms could not, of course, be definitized without the benefit of present hindsight. In a predictive situation, such terms would generally have a large degree of uncertainty, because projected fishing pressure is highly speculative while larvae survival has a strong stochastic component. Here, however, the available data will be used to the extent possible to resolve model terms.

Estimates of sardine fishing parameter,  $\delta_3(t)$ , were derived from Murphy's (1966) data and are shown plotted in Figure 5. The simplified model used in the simulations ignores detailed yearly variations and focuses on the major trends. A linear increase is assumed during the period from a rate of about 0.1 in 1932 to a rate  $>0.4$  in 1936. The fishing rate is assumed to remain constant for the remainder of the simulation period.

The assumed model for the sardine larvae survival term,  $E_1(t)$ , is presented in Figure 6 along with Sette's (1969) data from which it was derived. These data represent numbers of fish at age class two versus the year spawned. The survival rate model assumes that these observed fluctuations in the data primarily reflect random survival effects during the first year of life.  $E_1(t)$  was obtained by normalizing Sette's data with respect to the spawning population biomass and defining a relative scale such that the integrated value over the 20-yr period from 1932 to 1952 was equal to one.

The remaining model parameters, which represent the great majority of those in the equations of Table 1, could not be directly estimated to any degree of accuracy from available literature data. Instead, these estimates were derived from the special nonlinear programming analysis of mine (1980, in press) mentioned previously. I treated these ecosystem model parameters as variables with upper and lower bounds reflecting their uncertainty ranges. The bounds established by me for the sardine ecosystem parameters were typically an order of magnitude. Implicit parameter constraints were

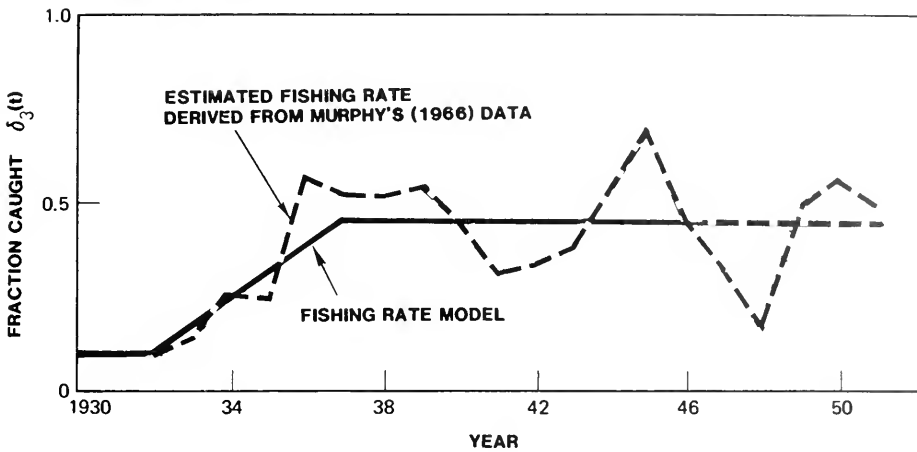

FIGURE 5.—Model of sardine fishing rate,  $\delta_3(t)$ , used in the sardine ecosystem simulations.

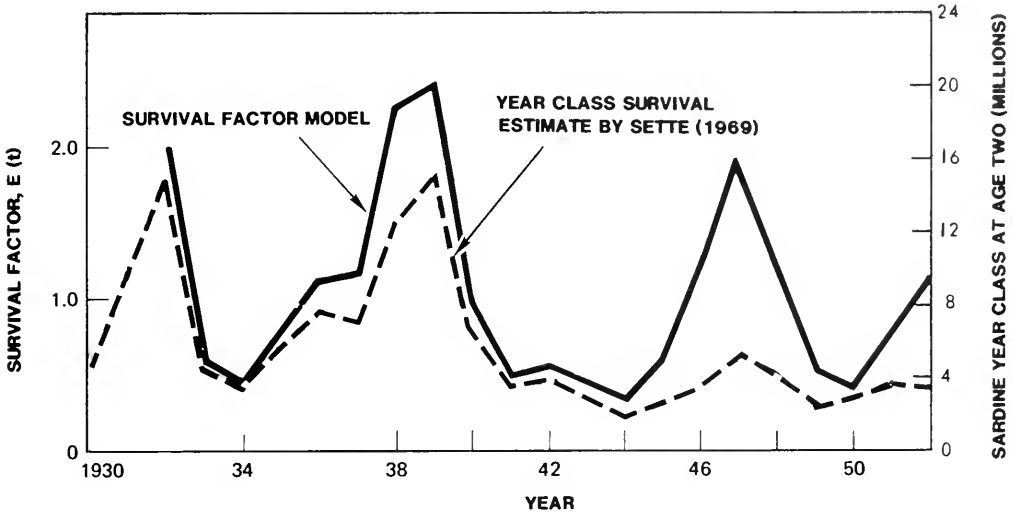

FIGURE 6.—Model of sardine larvae survival,  $E_1(t)$ , used in the sardine ecosystem simulations.

defined by the assumed equilibrium condition prior to 1932-52. Setting the time-varying fishing rate at its pre-1932 value ( $\delta_3 = 0.10$ ) and fixing the time-varying larval survival factor at its reference value ( $E_1 = 1.0$ ), a set of seven equality constraints were specified corresponding to the seven population equations in Table 1 with  $P(t + 1) = P(t) = \bar{P}$ . While there is still significant degrees-of-freedom in the model (i.e., more parameters than equality constraints), I was able to greatly resolve their values based on my nonlinear programming procedures.

The parameters in Table 2 represent the “nominal” estimates presented by me (1980) based on my

NLP analyses. In searching for minimum and maximum population response levels throughout bounded parameter space, a series of intermediate search steps were taken that produced suites of interdependent parameter values satisfying the pre-1932 equilibrium condition. Population response levels were equated to the average sardine population during the 1932-52 simulation period in this analysis. The selected nominal parameter suite in Table 2 gives response levels approximately midway between the determination of minimum and maximum levels.

Note that the parameter values in Table 2 were not derived from statistical procedures using the

TABLE 2.—Estimated values of the sardine ecosystem model parameters (from Atkinson 1980).

Population	Parameter type	Symbol	Nominal value	Population	Parameter type	Symbol	Nominal value
1 Sardine larvae	Survival/growth	$S_1$	7.26	5 Anchovy adult	Survival/growth	$S_5$	1.30
	Competition	$a_{11}$	$5 \times 10^{-6}$		Competition	$a_{53}$	$2.0 \times 10^{-5}$
	Competition	$a_{14}$	$2.5 \times 10^{-6}$		Competition	$a_{55}$	$3.0 \times 10^{-5}$
	Predation	$\beta_{13}$	$7.6 \times 10^{-4}$		Competition	$a_{56}$	$1.0 \times 10^{-5}$
	Predation	$\beta_{15}$	$3.8 \times 10^{-4}$		Predation	$\beta_{57}$	$1.0 \times 10^{-4}$
	Predation	$\beta_{16}$	$7.6 \times 10^{-5}$		Fecundity	$f_5$	0.432
2 Sardine yearling	Survival/growth	$S_2$	2.10	6 Competitor group	Survival/growth	$S_6$	1.65
	Competition	$a_{22}$	$3.7 \times 10^{-5}$		Competition	$a_{63}$	$5.0 \times 10^{-5}$
	Competition	$a_{25}$	$1.8 \times 10^{-5}$		Competition	$a_{65}$	$5.0 \times 10^{-5}$
	Predation	$\beta_{26}$	$1.8 \times 10^{-5}$		Competition	$a_{66}$	$5.0 \times 10^{-5}$
3 Sardine adult	Survival/growth	$S_{3,0}$	1.40	7 Predator group	Survival/growth	$S_7$	1.23
	Competition	$a_{33}$	$1.5 \times 10^{-5}$		Mortality	$R_7$	0.5
	Competition	$a_{35}$	$1.0 \times 10^{-5}$		Competition	$a_{77}$	$5.2 \times 10^{-5}$
	Competition	$a_{36}$	$5.0 \times 10^{-6}$		Prey	$\gamma_{73}$	$2.5 \times 10^{-4}$
	Predation	$\beta_{37}$	$1.0 \times 10^{-4}$		Prey	$\gamma_{75}$	$2.5 \times 10^{-4}$
	Fecundity	$f_3$	0.468		Prey	$\gamma_{76}$	$1.25 \times 10^{-4}$
4 Anchovy larvae	Survival/growth	$S_4$	0.50				
	Competition	$a_{41}$	$2.5 \times 10^{-6}$				
	Competition	$a_{44}$	$5.0 \times 10^{-6}$				
	Predation	$\beta_{43}$	$1.5 \times 10^{-4}$				
	Predation	$\beta_{45}$	$3.0 \times 10^{-4}$				
	Predation	$\beta_{46}$	$3.0 \times 10^{-5}$				

population data during the simulation period (Fig. 3). The estimates are uncoupled from these data and, hence, reflect strictly a priori knowledge as would exist in applications where predictions are required. Furthermore, the parameter values are not proposed as best estimates of these parameters, but simply provide a consistent set of values for use in the simulation demonstration. The nonlinear programming approach of mine is structured in general to bound future ecosystem response characteristics given only a priori population data.

### Ecosystem Simulations

The simulated sardine ecosystem histories are presented and compared with estimated sardine and anchovy population data in Figure 7. The adult sardine population simulation is in reasonably good agreement with the data of Murphy (1966) giving the many approximations and simplifying assumptions used in the modeling. The major dynamic features of the adult sardines decline are consistent, including the sharp rebounds associated with the favorable conditions for sardine larvae survival in 1938 and 1939 and again in 1947 (Fig. 6).

The simulated anchovy response in Figure 7, which ignores any fluctuating larvae survival component, appears to track the 3-yr averaged estimates of Murphy (1966). The anchovy population increases along with the competitor group to fill the ecological void in this trophic level. The predator biomass decreased slightly because the decline of the sardine

results in a less desirable food supply, at least according to estimated input parameters. Unfortunately, there are no available data for comparing with the predicted competitor and predator group responses.

Another simulation run was made to investigate the speculation that fluctuating larval survival rates, by themselves, might have caused the sardine collapse. The sardine fishing rate was held at the relatively low levels that existed before 1932 ( $\delta_3 = 0.10$ ), and the fluctuating larvae survival model in Figure 6 was applied. The resulting simulation run is presented in Figure 8 and shows the predicted history of the adult sardine population, along with that of the anchovy, competitor, and predator groups. The adult sardine population again fluctuates markedly but now remains at relatively high levels, in no apparent danger of collapsing. It would appear from these runs that the added fishing pressure is necessary to explain the actual event during this period.

### CONCLUSIONS

A general set of discrete-time difference equations have been developed for use in simulating the important dynamic processes effecting fish populations, including

- interactions between competitors, predators, and prey
- birth, growth, and aging processes within a



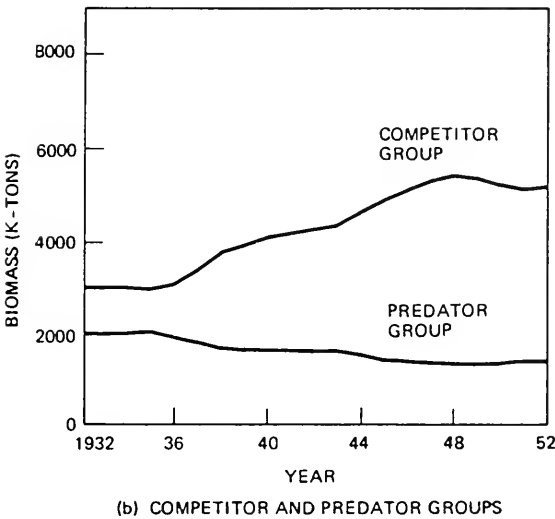
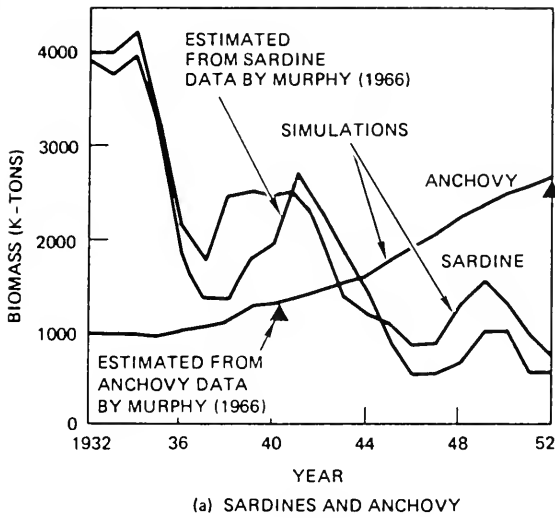

FIGURE 7.—Simulation run for assumed models of increased sardine fishing rate and fluctuating sardine larvae survival rate.

- single population group
- spatial and temporal variations.

The sardine subsystem within the California Current region was modeled using the multispecies difference model and simulations computed for the sardine's collapse period of 1932-52. Input drivers perturbing the system included representations of the increased sardine fishing pressure and the fluctuating sardine larvae survival rates during this period. Simulation results were shown to compare favorably with the available population history data. The increased fishing pressure was indicated to be

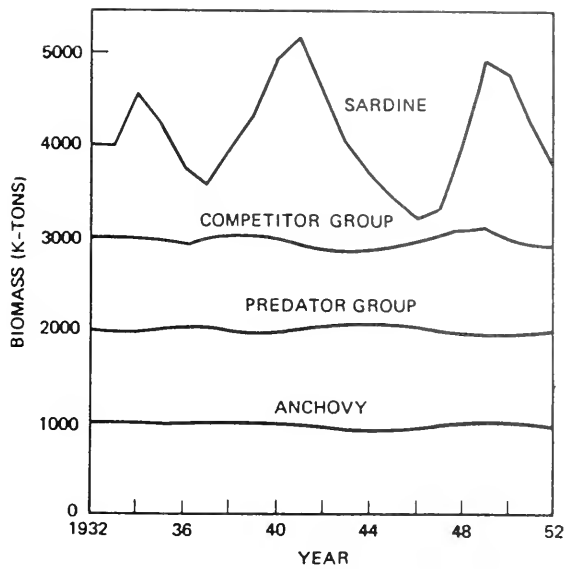

FIGURE 8.—Simulation run for assumed constant pre-1932 fishing rate but with fluctuating sardine larvae survival rate.

the fundamental cause for the sardine collapse; the estimated yearly fluctuations in sardine larvae survival could not by themselves have caused this sudden event.

These simulation results demonstrate the use of the discrete-time difference model as an efficient simulation tool. There appear to be many applications for the model in theoretical and applied multi-species fisheries studies.

### ACKNOWLEDGMENTS

This work was based on a part of a dissertation submitted in partial satisfaction of the requirements for the Ph.D. degree at the University of California, Los Angeles. S. E. Jacobsen, chairman of the dissertation committee, provided guidance and encouragement throughout these studies. D. A. Kiefer of the Department of Biological Sciences, University of Southern California, reviewed early versions of this paper and made helpful comments.

### LITERATURE CITED

ANDERSON, K. P., AND E. URSIN.  
 1977. A multispecies extension to the Beverton and Holt theory of fishing, with accounts of phosphorus circulation and primary production. *Medd. Dan. Fisk. Havunders.* 7:319-435.  
 ATKINSON, C. A.  
 1980. Analysis of perturbed dynamic systems under param-

- eter uncertainty - a nonlinear programming approach with applications to marine ecosystems. Ph.D. Thesis, Univ. California, Los Angeles, 198 p.
- In press. A nonlinear programming approach to the analysis of perturbed marine ecosystems under model parameter uncertainty. *Ecological Modeling*.
- BEVERTON, R. J. H., AND S. H. HOLT.  
1957. On the dynamics of exploited fish populations. *Fish. Invest. Minist. Agric. Fish. Food (G.B.)*. Ser. II, 19, 533 p. (See p. 21-135.)
- BROGAN, W. L.  
1974. *Modern control theory*. Quantum Publishers, Inc., N.Y., 393 p. (See p. 262-283.)
- CLARK, F. N., AND J. B. PHILLIPS.  
1952. The northern anchovy in the California fishery. *Calif. Fish and Game* 38:189-207.
- CUSHING, D. H.  
1975. *Marine ecology and fisheries*. Cambridge Univ. Press, Cambridge, 278 p. (See p. 85-247.)
- GOODALL, D. W.  
1972. Building and testing ecosystem models. In J. N. R. Jeffers (editor), *Math models in ecology*. The 12th symposium of the British Ecological Society, Grange-Over-Sands, Lancashire, 23-26, March 1971. p. 173-183. Blackwell Sci. Publ. Lond.
- GULLAND, J. A.  
1971. Ecological aspects of fishing research. *Adv. Ecol. Res.* 7:115-176.
- HUPPERT, D. D., A. D. MACCALL, G. F. STAUFFER, J. A. McMILLAN, AND H. W. FREY.  
1980. California's northern anchovy fishery: biological and economic basis for fishery management. U.S. Dep. Commer., NOAA Tech. Memo. NMFS-SWFC-1.
- IVLEV, V. S.  
1961. *Experimental ecology of the feeding of fishes*. Yale Univ. Press, New Haven, Conn., 302 p.
- LAEVASTU, T., AND F. FAVORITE.  
1978. Fluctuations in Pacific herring stock in the Eastern Bering Sea as revealed by ecosystem model (DYNUMES III). *Rapp. P.-v. Réun. Cons. Perm. int. Explor. Mer* 177:445-459.
- LASKER, R.  
1978. The relation between oceanographic conditions and larval anchovy food in the California Current: identification of factors contributing to recruitment failure. *Rapp. P.-v. Réun. Cons. int. Explor. Mer* 173:212-230.
- LEFKOVITCH, L. P.  
1965. The study of population growth in organisms grouped by stages. *Biometrics*. 12:1-18.
- LESLIE, P. H., AND J. C. GROWER.  
1960. The properties of a stochastic model for the predator-prey type of interactions between two species. *Biometrika* 47:219-234.
- LEVINE, S. H.  
1976. Competitive interactions in ecosystems. *Am. Nat.* 110:903-910.
- MACCALL, A. D.  
1979. Population estimates for the waning years of the Pacific sardine fishery. *Calif. Coop. Oceanic Fish. Invest. Rep.* 20, p. 72-82.
- MAY, R. M.  
1973. *Stability and complexity in model ecosystems*. Princeton Univ. Press, Princeton, NJ, 265 p. (See p. 13-171.)
- MAY, R. M., J. R. BEDDINGTON, C. W. CLARK, S. J. HOLT, AND R. M. LAWS.  
1979. Management of multispecies fisheries. *Science* 205: 267-277.
- METHOT, R. D., JR.  
1983. Seasonal variation in survival of larval northern anchovy, *Engraulis mordax*, estimated from the age distribution of juveniles. *Fish. Bull., U.S.* 81:741-750.
- MOBLEY, C. D.  
1973. A systematic approach to ecosystems analysis. *J. Theor. Biol.* 42:119-136.
- MURPHY, G. I.  
1966. Population biology of the Pacific sardine (*Sardinops caerulea*). *Proc. Calif. Acad. Sci.* 34:1-84.
- PARRISH, J. D.  
1975. Marine trophic interactions by dynamic simulation of fish species. *Fish. Bull., U.S.* 73:695-716.
- PARRISH, R. H., C. S. NELSON, AND A. BAKUN.  
1981. Transport mechanisms and reproductive success of fishes in the California Current. *Biol. Oceano.* 1:175-203.
- PARSONS, T. R., AND M. TAKAHASHI.  
1973. *Biological oceanographic processes*. Pergamon Press, Oxford, 186 p. (See p. 149-155.)
- PIELOU, E. C.  
1977. *Mathematical ecology*. John Wiley and Son, N.Y., 385 p. (See p. 8-110.)
- POOLE, R. W.  
1976. Empirical multivariate autoregressive equation predictors of the fluctuations of interacting species. *Math. Biosci.* 28:81-97.
- REID, M. H., AND R. S. MACKAY.  
1968. A review and discussion of some methods for system identification and modeling. *Med. Biol. Eng.* 6:231-268.
- RICKER, W. E.  
1958. *Handbook of computations for biological statistics of fish populations*. *Fish. Res. Board Can. Bull.* 119, 300 p.
- RIFFENBURGH, R. H.  
1969. A stochastic model of interpopulation dynamics in marine ecology. *J. Fish. Res. Board Can.* 26:2843-2880.
- SAILA, S. B., AND J. D. PARRISH.  
1972. Exploitation effects upon interspecific relationships in marine ecosystems. *Fish. Bull., U.S.* 70:383-393.
- SETTE, O. E.  
1969. A perspective of a multi-species fishery. *Calif. Coop. Oceanic Fish. Invest. Rep.* 13, p. 81-87.
- SMITH, P. E.  
1972. The increase in spawning biomass of northern anchovy, *Engraulis mordax*. *Fish. Bull., U.S.* 70:849-874.
- SOUTAR, A., AND J. D. ISAACS.  
1974. Abundance of pelagic fish during the 19th and 20th centuries as recorded in anaerobic sediment off the Californias. *Fish. Bull., U.S.* 72:257-273.
- STEELE, J. H.  
1979. Some problems in the management of marine resources. *Appl. Biol.* 4:103-140.
- VANCE, R. R.  
1978. Predation and resource partitioning in one predator-two prey model communities. *Am. Nat.* 112:797-813.

# FECUNDITY OF NORTHERN SHRIMP, *PANDALUS BOREALIS*, (CRUSTACEA, DECAPODA) IN AREAS OF THE NORTHWEST ATLANTIC

D. G. PARSONS AND G. E. TUCKER<sup>1</sup>

## ABSTRACT

Fecundity of the northern shrimp, *Pandalus borealis*, and relationships between number of eggs and carapace length were determined from 15 samples taken in 9 areas of the Northwest Atlantic. The sampling area extended from Davis Strait to the south coast of Newfoundland. Comparisons of samples suggested that fecundity levels can vary between seasons, years, and areas. A relationship between egg production and environmental temperature was not evident from available samples.

The northern or pink shrimp, *Pandalus borealis*, is a protandric hermaphrodite with a circumboreal distribution. In the Northwest Atlantic, it occurs from about lat. 75°N at West Greenland to about lat. 42°N at Georges Bank (Squires 1970). Fecundity of this species in the North Atlantic has been studied in southern Norway (Rasmussen 1953), northern Norway (Thomassen 1977), the North Sea (Allen 1959), Iceland (Skúladóttir et al. 1978), West Greenland (Horsted and Smidt 1956), Barents Sea (Teigsmark 1983), and Gulf of Maine (Haynes and Wigley 1969). Bottom water temperatures recorded at depths where shrimp samples were collected during these studies varied considerably between areas but were within the range of tolerance for survival of adults as reported by Allen in 1959 (-1.68° to 11.13°C).

This paper provides information on the fecundity of *P. borealis* in the Northwest Atlantic. Samples were collected in areas of known shrimp concentration off Baffin Island, in the eastern Hudson Strait and Labrador Sea, and off the south coast of Newfoundland. Bottom temperatures at sampling sites also varied between these areas but were confined to the lower half of the tolerance range (<7°C). Comparisons are made between selected combinations of the data sets presented. The possible effects of ambient temperature on fecundity levels also are considered.

## MATERIALS AND METHODS

Samples of ovigerous female shrimp were col-

lected opportunistically during various research cruises conducted by or for the Department of Fisheries and Oceans, St. John's, Newfoundland, Canada, between 1971 and 1982. A total of 15 samples was selected for analysis. These were taken from the Baffin Island area (east of Cumberland Sound); Hudson Strait; North Labrador Sea; Hope-dale, Cartwright, and Hawke Channels (on the Labrador Shelf); St. Mary's Bay; Fortune Bay; and the Southwest Newfoundland coast (Fig. 1). For some areas, only one sample was available while for others, samples were obtained in different months and/or different years (Table 1).

Only animals in good condition were selected from the trawl catches for the study (i.e., no noticeable damage and egg mass undisturbed). Individuals were selected over the complete size range of females, preserved in 10% Formalin<sup>2</sup> and returned to the laboratory. It was assumed that within any length group the selection (in terms of number of eggs) was random.

Oblique carapace lengths were measured to the nearest 0.1 mm using Vernier calipers. This measurement is the distance between the posterior margin of the orbit of the eye and the posterodorsal margin of the carapace (Rasmussen 1953).

All eggs were removed from the pleopods, spread in a Petrie dish, and oven dried overnight at 60°C. After drying, eggs were further separated and counted.

Accuracy of the counts was determined by re-counting the eggs from 49 animals. Differences from the initial counts in 48 cases varied between -5.75%

<sup>1</sup>Fisheries Research Branch, Department of Fisheries and Oceans, P.O. Box 5667, St. John's, Newfoundland A1C 5X1, Canada.

<sup>2</sup>Reference to trade names does not imply endorsement by the National Marine Fisheries Service, NOAA.

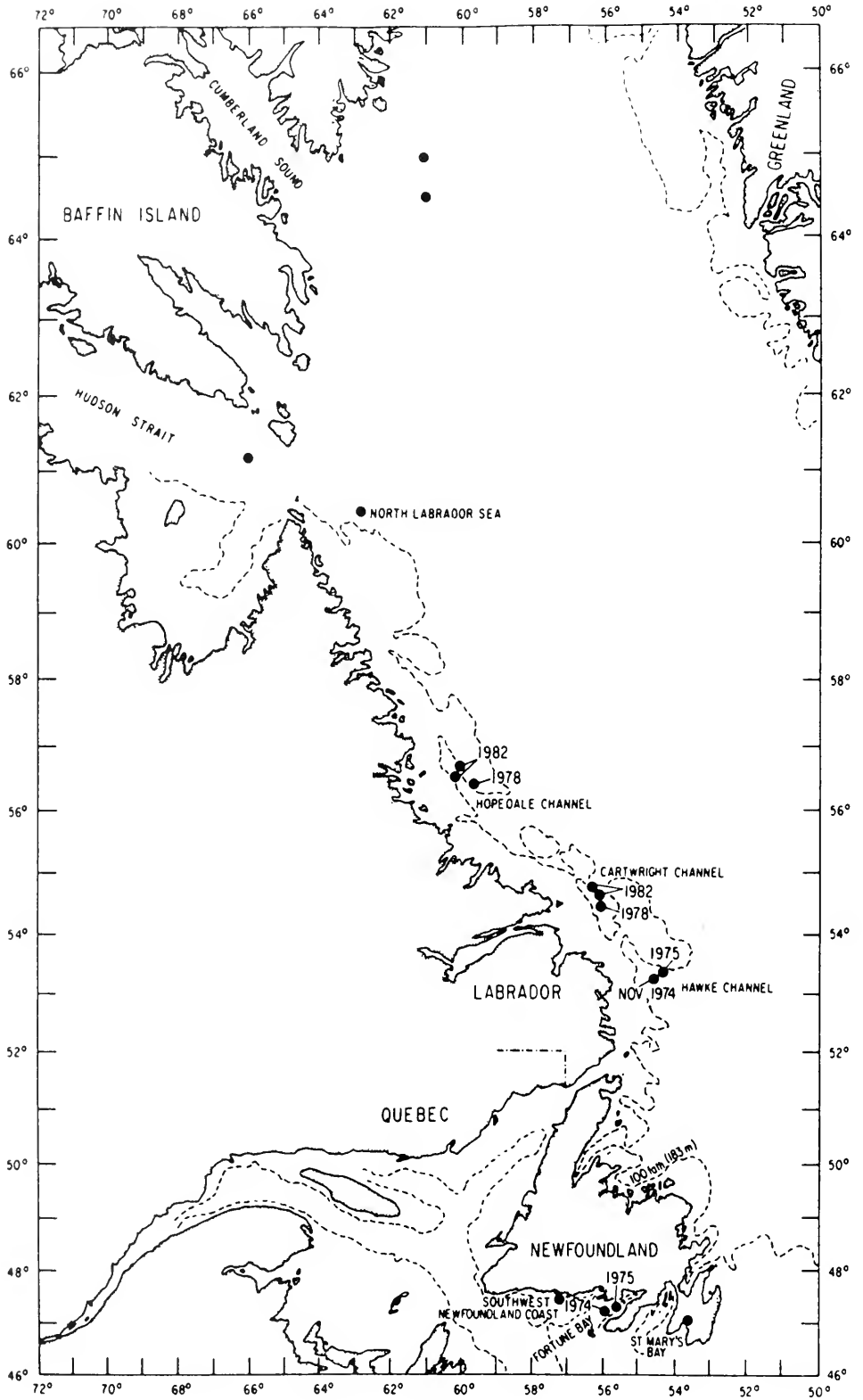

TABLE 1.—Regression equations for fecundity (F) vs. length (L) for *Pandalus borealis* in the Northwest Atlantic.

Sample	Date	N	Regression equation	r <sup>2</sup>	Temp. °C
Baffin Island	14 Aug. 1978	48	log <sub>10</sub> F = 3.0955 log <sub>10</sub> L - 1.1417	0.75	0.7-1.8
Hudson Strait	13 Sept. 1982	24	log <sub>10</sub> F = 3.8880 log <sub>10</sub> L - 2.3967	0.33	0.6
North Labrador Sea	22 Sept. 1982	43	log <sub>10</sub> F = 3.2715 log <sub>10</sub> L - 1.4550	0.45	0.5
Hopedale Channel	28 Sept. 1978	46	log <sub>10</sub> F = 2.8045 log <sub>10</sub> L - 0.7202	0.70	3.0
Hopedale Channel	11, 25 Sept. 1982	96	log <sub>10</sub> F = 2.8884 log <sub>10</sub> L - 0.8893	0.74	3.2
Cartwright Channel	20 Sept. 1978	45	log <sub>10</sub> F = 3.1824 log <sub>10</sub> L - 1.3059	0.74	3.0
Cartwright Channel	11, 26 Sept. 1982	87	log <sub>10</sub> F = 2.5240 log <sub>10</sub> L - 0.3750	0.68	2.0-2.4
Hawke Channel	24 Aug. 1974	20	log <sub>10</sub> F = 3.4614 log <sub>10</sub> L - 1.6670	0.70	—
Hawke Channel	30 Nov. 1974	24	log <sub>10</sub> F = 1.4613 log <sub>10</sub> L + 1.1015	0.31	2.9
Hawke Channel	23 Sept. 1975	27	log <sub>10</sub> F = 3.0106 log <sub>10</sub> L - 1.0147	0.68	2.7
St. Mary's Bay	18 Mar. 1971	48	log <sub>10</sub> F = 2.3954 log <sub>10</sub> L - 0.3691	0.53	—
St. Mary's Bay	28 Feb. 1974	44	log <sub>10</sub> F = 2.5290 log <sub>10</sub> L - 0.5476	0.47	—
Fortune Bay	17 Mar. 1978	48	log <sub>10</sub> F = 3.0413 log <sub>10</sub> L - 1.1187	0.57	1.0
Fortune Bay	30 Mar. 1979	47	log <sub>10</sub> F = 2.6870 log <sub>10</sub> L - 0.6428	0.70	—
SW Newfoundland Coast	27 Feb. 1978	48	log <sub>10</sub> F = 2.8557 log <sub>10</sub> L - 0.7396	0.78	6.2

and +5.65%. The difference between the total number of eggs counted and recounted was only -0.22% of the initial count. A recount of eggs from one female indicated a difference of -9.38%. It is possible that, in this case, some of the eggs were inadvertently lost between counts.

Parameters for the relationship between number of eggs and carapace length for each sample were determined by linear regression using log-log (base 10) transformation. Some data sets were compared by analysis of covariance, assuming homoscedasticity. All statistical analyses were performed using the REG (regression) and GLM (general linear models) procedures of SAS (Statistical Analysis System).

It must be stressed that samples were obtained opportunistically and not according to a predetermined sampling design. Consequently, the statistical analyses were performed based on a practical approach rather than attempting methods for which strict sampling procedures are required. It was anticipated that differences in fecundity-length relationships could be due to seasonal, annual, and areal effects. Our data only permitted simple comparisons, investigating each factor separately.

Bottom temperatures at most sample locations were recorded to the nearest 0.1°C using either manual or expendable bathythermographs.

## RESULTS

The parameters of the fecundity-carapace length relationships for all 15 samples are given in Table

1. Data and the fitted line for each sample are displayed in Figure 2. Coefficients of determination ranged from 0.31 to 0.78 and all relationships were significant (differences from zero slope were highly significant). Intercepts for the log transformed data were less than zero in all but one case. Slopes ranged from 2.4 to 3.9 except for the sample with positive intercept (1.5).

Only two samples were available (Hawke Channel, August and November 1974) for comparison of fecundity between seasons. Analysis of covariance on the log of both variables indicated a highly significant difference in slopes (Table 2). The data showed that larger females (>24 mm), on average, carried more eggs in August whereas smaller females showed higher fecundity in November (Fig. 3).

Samples from specific areas and seasons were compared to determine similarities or differences between years. Five simple comparisons were possible: St. Mary's Bay - March 1971 vs. February 1974, Hawke Channel - August 1974 vs. September 1975, Fortune Bay - March 1978 vs. March 1979, Cartwright Channel - September 1978 vs. September 1982, and Hopedale Channel - September 1978 vs. September 1982.

No significant differences in either the rate of increase in fecundity with increasing size (slope) or mean number of eggs produced (intercept) were detected between years in three of the five areas compared (Table 2). These were St. Mary's Bay, 1971 and 1974; Hawke Channel, 1974 and 1975; and Fortune Bay, 1978 and 1979 (Fig. 4a, b, and c, respectively). Samples from Cartwright Channel from September 1978 and 1982 showed a significant difference in slopes at  $\alpha = 0.05$  (Fig. 4d) whereas samples from the Hopedale Channel for the same

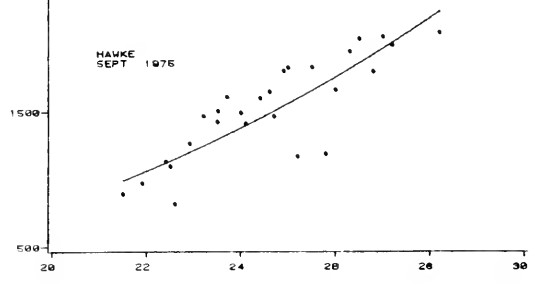
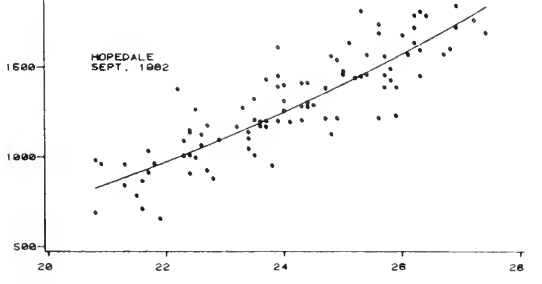
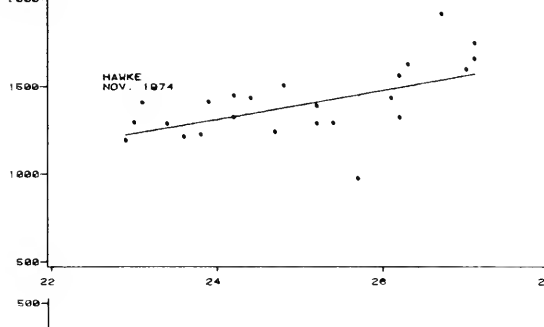
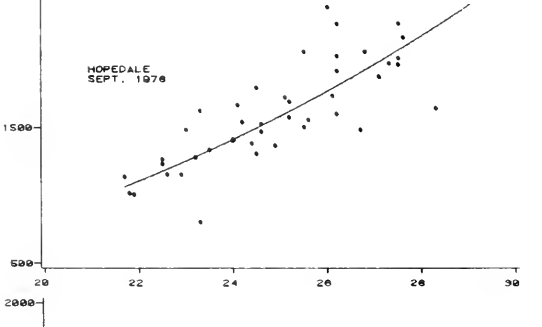
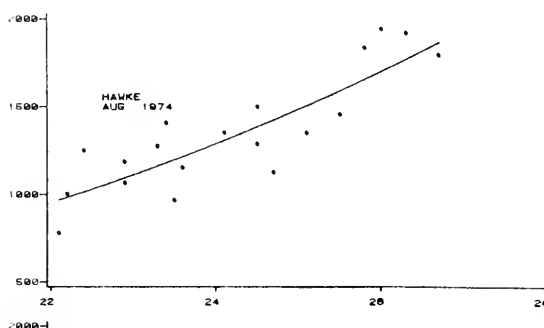
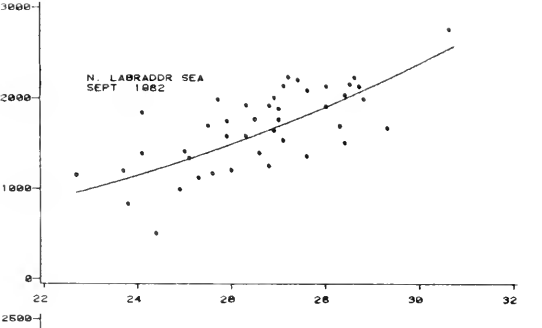
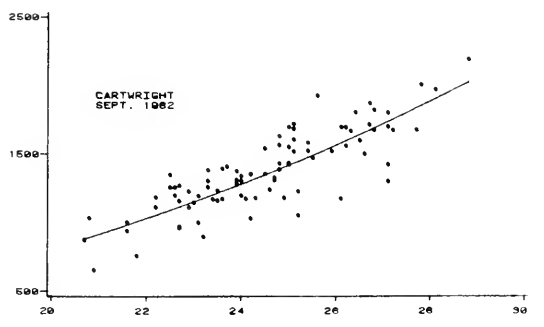
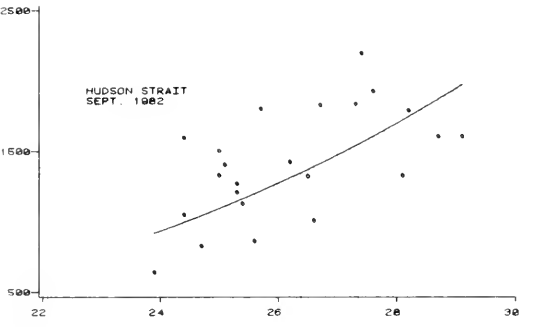
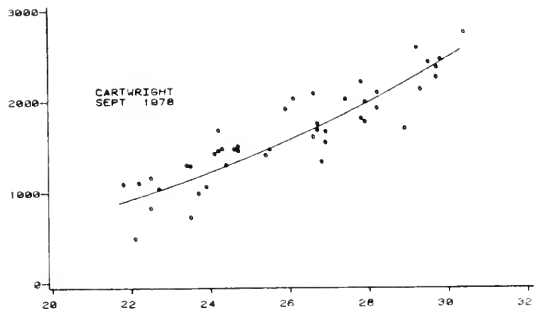
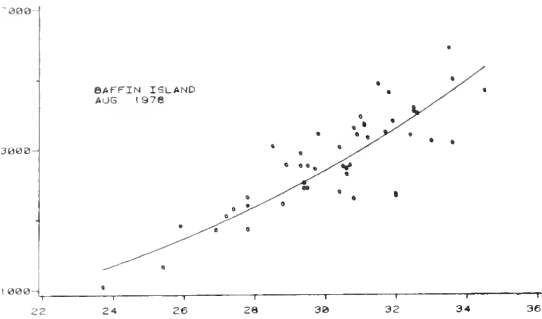

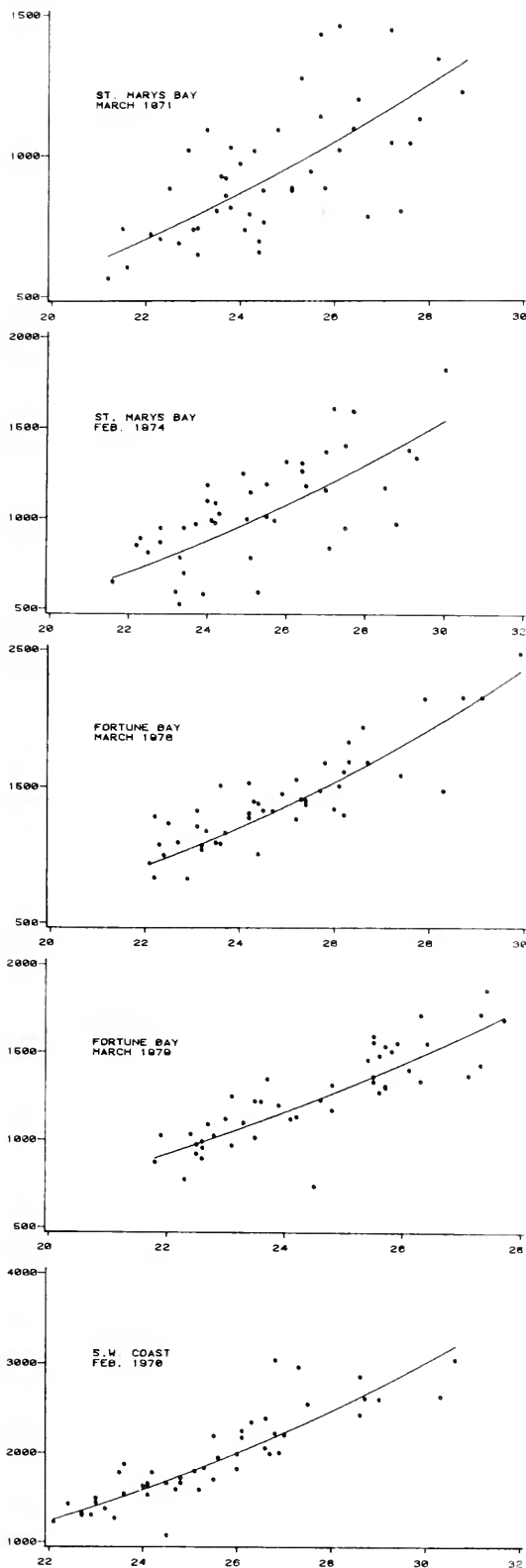

years were similar in slope but different in elevation (Fig. 4e). Average fecundity at length was higher in 1978 than in 1982 in the latter area.

Three comparisons were possible to detect differences between areas. In 1982, four areas were sampled during September: Hudson Strait, North Labrador Sea, Hopedale Channel, and Cartwright Channel. Analysis of the data indicated no difference in the rate of increase in fecundity with increasing size but a highly significant difference in the mean number of eggs produced (Table 2, Fig. 5a). *T*-Tests for sample means showed that the sample from Hudson Strait was different from those taken off the Labrador coast (Table 3). Fecundity in the former was less at comparable sizes.

Three areas were sampled in August and September 1978: east of Baffin Island (August), Hopedale and Cartwright Channels (September). The data from these samples also were similar in slope but different in elevations (Table 2, Fig. 5b). *T*-tests showed that the lower fecundity observed in the Cartwright Channel was significantly different ( $\alpha = 0.05$ ) from that observed in the other two areas (Table 3).

Two samples were taken off the south coast of Newfoundland early in 1978: one from the southwest coast in February and the other from Fortune Bay in March. Eggs in both samples were "eyed", indicating late stage development. The data showed that average egg production was higher off the southwest coast over the range of sizes compared (Fig. 5c). The statistical analysis indicated similarity in slopes but a highly significant difference in elevations (Table 2).

## DISCUSSION

Loss of eggs over the ovigerous period has been reported in previous studies on fecundity of *P. borealis* (Elliot 1970<sup>3</sup>; Ito 1976; Skúladóttir et al. 1978; Stickney and Perkins 1979; Stickney 1981). This loss could be incidental or due to incomplete fertilization and/or disease. Egg diameter also increases between spawning and hatching (Haynes and Wigley 1969; Ito 1976), and some eggs that are

<sup>3</sup>Elliot, D. L. 1970. Fecundity of the northern shrimp, *Pandalus borealis*. Unpubl. manusc., 32 p. Bowdoin University, Brunswick, ME 04011.

FIGURE 2.—Number of eggs (vertical axis) vs. carapace length in mm (horizontal axis) for 15 samples of female northern shrimp taken from areas of the northwest Atlantic.

TABLE 2.—Analyses of covariance for fecundity-length relationships.

Effect	Comparison		Slopes		Intercepts	
			F-value	Prob.	F-value	Prob.
Season	Hawke Channel	08/74 vs.	8.19	0.0067		
	Hawke Channel	11/74				
Year	St. Mary's Bay	03/71 vs.	0.06	0.8024	0.18	0.6748
	St. Mary's Bay	02/74				
	Hawke Channel	08/74 vs.	0.42	0.5215	2.30	0.1367
	Hawke Channel	09/75				
	Fortune Bay	03/78 vs.	0.52	0.4707	1.23	0.2709
	Fortune Bay	03/79				
	Cartwright Channel	09/78 vs.	4.27	0.0408	0.43	0.5141
	Cartwright Channel	09/82				
Hopedale Channel	09/78 vs.	0.07	0.7861	26.31	0.0001	
Hopedale Channel	09/82					
Area	Hudson Strait	09/82 vs.	1.78	0.1490	10.69	0.0001
	North Labrador Sea	09/82 vs.				
	Hopedale Channel	09/82 vs.				
	Cartwright Channel	09/82				
	Baffin Island	08/78 vs.	0.49	0.6140	8.51	0.0003
	Hopedale Channel	09/78 vs.				
	Cartwright Channel	09/78				
SW Newfoundland Coast	02/78 vs.	0.17	0.6792	61.32	0.0001	
Fortune Bay	03/78					

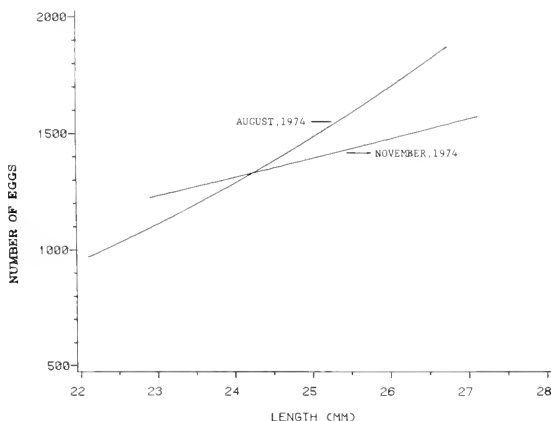

FIGURE 3.—Comparisons of northern shrimp fecundity between seasons for the Hawke Channel, based on predicted values from equations in Table 1.

close to the periphery and loosely attached may be simply "crowded out".

The evidence of egg loss described in previous studies is sufficient to suggest that combining data from different times of year is not appropriate. The two samples compared in this study produced inconclusive results in that average fecundity was not consistently lower over the complete size range in November compared with the August sample.

Annual variation in fecundity-length relationships occurred in two of five areas sampled in different years. The rate of increase in number of eggs with

TABLE 3.—Paired comparisons for area differences when  $k$  (no. of samples)  $> 2$ .

Date/sample	No.	P values for $H_0: \text{Mean}_i = \text{mean}_j$			
		1	2	3	4
September 1982					
Hudson Strait	1	.	.	.	.
North Labrador Sea	2	0.0002	.	.	.
Hopedale Channel	3	0.0001	0.2141	.	.
Cartwright Channel	4	0.0001	0.0695	0.4525	.
August 1978					
Baffin Island	1	.	.	.	.
Hopedale Channel	2	0.5709	.	.	.
Cartwright Channel	3	0.0121	0.0002	.	.

increasing size only differed significantly in one case, however. The reasons why fecundity differs between years are not known but could be related to changes in environmental conditions and/or egg disease (Stickney 1981). In support of the latter, it is noted that the proportion of nonviable eggs in the 1982 Hopedale Channel sample was higher than in the 1978 sample by an order of magnitude (D. G. Parsons unpubl. data). Fecundity was significantly higher in the 1978 data.

Teigsmark (1983) found that variation within a population during successive years is as great as the variation between populations in a single year and was unable to make a conclusive statement about fecundity of different populations of *P. borealis* in the Barents Sea. He speculated that such differences could be related to availability of food and population density.



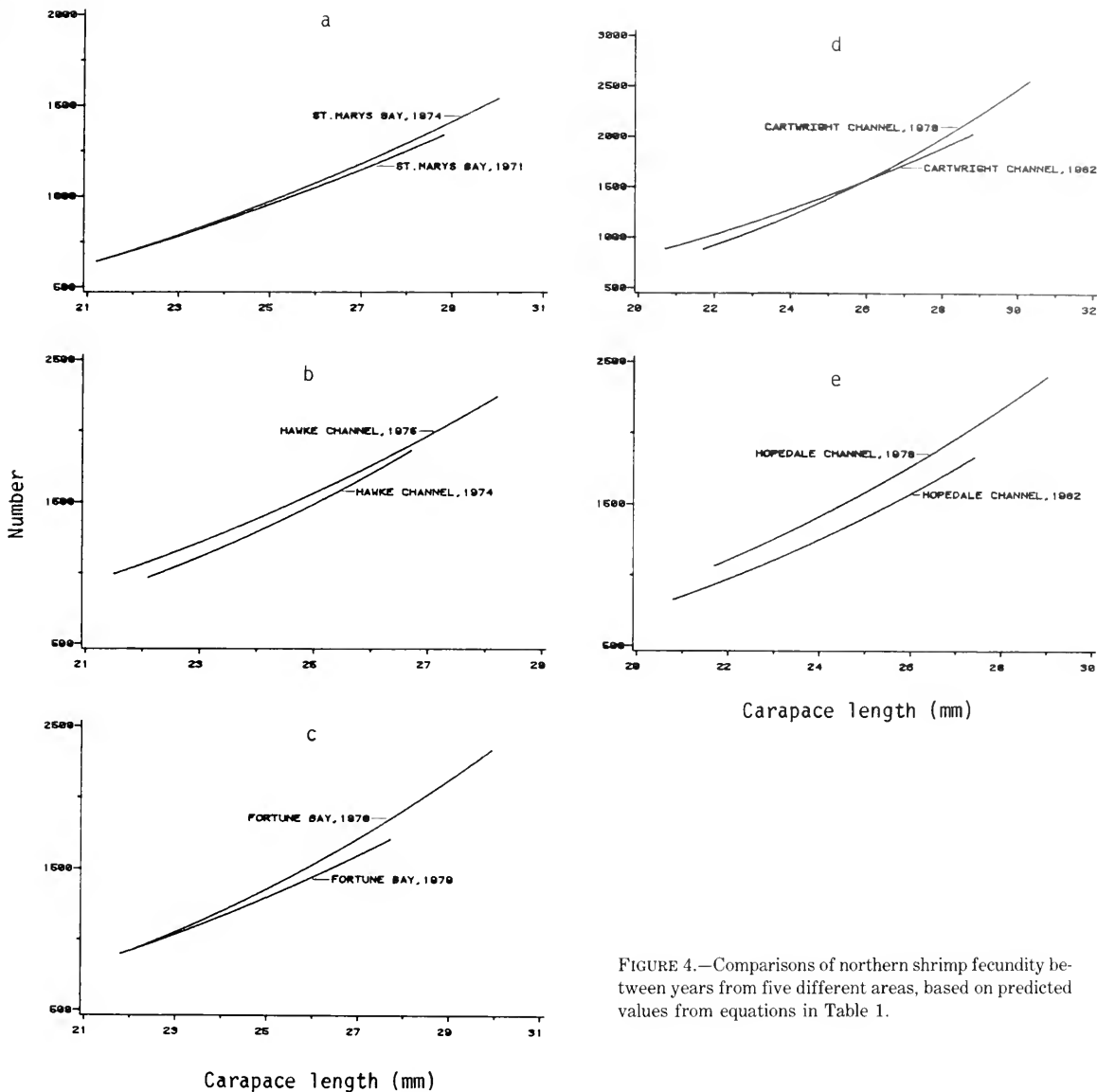

FIGURE 4.—Comparisons of northern shrimp fecundity between years from five different areas, based on predicted values from equations in Table 1.

Based on the comparison of samples taken in 1982, it was shown that the fecundity-length relationships in three areas off Labrador were similar. Similarity was not apparent in 1978 samples which showed that fecundity in the Cartwright Channel was lower than in the Hopedale Channel. This discrepancy in results from Labrador is due to annual differences demonstrated for both channels in 1978 and 1982 samples.

The comparison by area for the 1978 data also implied similarity between the Baffin Island and Hopedale Channel samples. However, the size ranges compared were not the same. Female shrimp

ranged in size from 23.7 to 34.5 for the Baffin Island sample in contrast to 21.7 to 29.0 for the Hopedale Channel sample. These differences in size likely reflect separate rates of growth and maturity in the two areas. Therefore, from a biological viewpoint, all three areas sampled in 1978 exhibited different fecundity-length relationships.

The differences between areas, described above, can be considered in relation to the temperatures present in these areas. The bottom temperature at the sampling station off the southwest coast of Newfoundland was 6.2°C, the warmest of all areas sampled (Table 1). The temperature recorded in

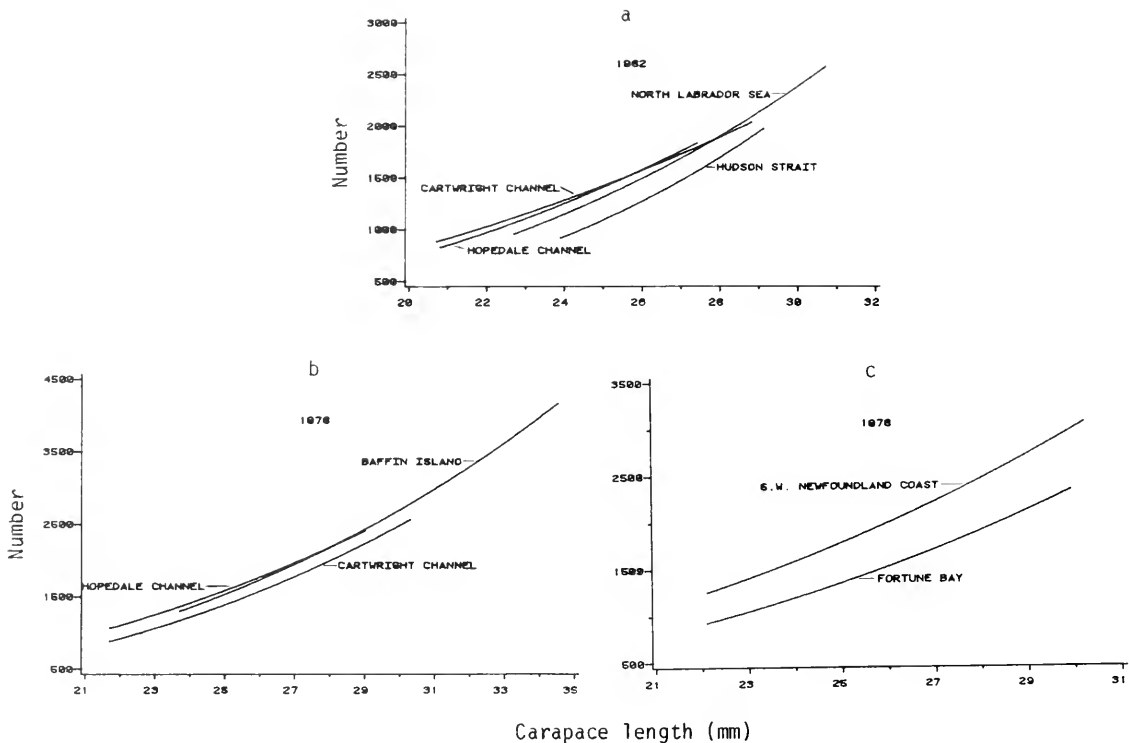

FIGURE 5.—Comparisons of northern shrimp fecundity between areas in 1982 and 1978, based on predicted values from equations in Table 1.

March 1978 in Fortune Bay was  $1.0^{\circ}\text{C}$ , one of the coldest areas. According to Squires (1968), the penetration of Atlantic water into the former area accounts for these warmer temperatures which persist throughout the year. In Fortune Bay, however, the deep bottom water is of mixed Atlantic and Arctic origin resulting in much colder temperatures. Thus, the lower fecundity in the Fortune Bay sample is likely linked with an overall reduction in productivity in a cold water environment. Reduced productivity has been observed previously in the cold water habitats of le Fjord du Saguenay, Quebec (Couture 1971) and the Barents Sea (Berenboim 1982).

The sample taken east of Baffin Island showed relatively high fecundity in cold water ( $0.7^{\circ}$ - $1.8^{\circ}\text{C}$ ) compared with other cold water areas. Also, average size of females was larger than encountered elsewhere with largest females carrying clutches in excess of 4,300 eggs. This is similar to a situation in the Sea of Japan where female shrimp carried similar numbers of eggs as those (at comparable lengths) off Labrador. Again, greater sizes were attained and egg counts as high as 4,900 were en-

countered (Ito 1976). Growth and maturation are delayed in colder water (Allen 1959; Rasmussen 1969; Butler 1971) and shrimp in these two cold water environments likely live longer than conspecifics on the Labrador Shelf.

Dupouy et al. (1981) concluded that shrimp off Baffin Island spawned intermittently based on the high proportion of nonspawning females observed during a survey in 1979. If all females do not spawn annually, more time is available for growth. (Ovigerous females do not molt.) This can account for the larger sizes attained in the colder area. Failure to spawn annually reduces reproductive potential but is compensated to some degree by the large sizes females attain (larger females carry more eggs) and the apparently increased longevity.

Samples taken in 1982 in the Hudson Strait and North Labrador Sea came from waters of  $0.6^{\circ}$  and  $0.5^{\circ}\text{C}$ , respectively, but only data from the former were significantly different ( $\alpha = 0.05$ ) from samples taken in the warmer Hopedale and Cartwright Channels. Data from Haynes and Wigley (1969) showed higher fecundity in warmer water ( $\sim 5^{\circ}\text{C}$ ) of the Gulf of Maine where a 28 mm female can pro-

duce around 2,800 eggs compared with 1,900-2,000 in the Cartwright Channel (2°-3°C). In the Gulf of St. Lawrence, temperatures were similar to those in the Gulf of Maine but fecundity in 1970 (E. J. Sandeman<sup>4</sup> unpubl. data) was comparable with levels observed in the colder Labrador channels. Allen (1959) reported smaller shrimp and fewer eggs for *P. borealis* in the North Sea (~9°C) compared with the colder area off Southern Norway (7°C).

## CONCLUSIONS

Fecundity of *Pandalus borealis* in the areas of the Northwest Atlantic considered in this study was generally lower than observed previously in the Gulf of Maine (Haynes and Wigley 1969) and off Southern Norway (Rasmussen 1953). Fecundity can vary seasonally, annually, and between areas, making conclusions based on such data difficult. Skúladóttir et al. (1978) concluded that fecundity does not seem to be a useful characteristic for distinguishing between populations unless it is certain that no egg loss or hatching has taken place. The results of the present study concur with these findings and those of Teigsmark (1983) which also showed that annual variation within areas also must be considered.

In some comparisons between areas, there appears to be reduced egg production in areas with low environmental temperature. In others, this is not at all apparent, especially at extremely cold and warm temperatures. Thus, there is no clear relationship between fecundity and environmental temperature, especially at the extremes of the range of temperature tolerance.

Squires (1968) described warm water areas as areas of high reproductive potential for shrimp and colder regions as areas of low reproductive potential. The cold water bays of Newfoundland and the eastern Hudson Strait fit into the latter category in terms of shrimp fecundity. Other cold water concentrations of shrimp appear to be better adapted such as those off Baffin Island, in the North Labrador Sea and Sea of Japan. In these cases, environmental conditions other than temperature (e.g., availability of nutrients) may be more important.

## ACKNOWLEDGMENTS

We are grateful to the many technicians and

casual employees who assisted in collecting the data over the years and performed the laborious task of counting the eggs. In this regard, the services of W. Edison are particularly appreciated. Assistance in the statistical analyses was provided by D. Stansbury.

## LITERATURE CITED

- ALLEN, J. A.  
1959. On the biology of *Pandalus borealis* Krøyer, with reference to a population off the Northumberland coast. J. Mar. Biol. Assoc. U.K. 38:189-220.
- BERENBOIM, B. I.  
1982. Reproduction of the shrimp *Pandalus borealis* populations in the Barents Sea. Okeanologiya 22(1):118-124.
- BUTLER, T. H.  
1971. A review of the biology of the pink shrimp, *Pandalus borealis* Krøyer 1838. Can. Fish. Rep. 17:17-24.
- COUTURE, R.  
1970. Reproduction de *Pandalus borealis* Krøyer (Crustacea, Decapoda) dans le fjord du Saguenay. Nat. Can. 97:825-826.
- DUPOUY, H., C. LEROY, AND J. FRÉCHETTE.  
1981. Etude des Stocks de Crevette *Pandalus borealis* du Détroit de Davis. Sci. Pêche, Bull. Inst. Pêches Marit. 311, mars 1981, 21 p.
- HAYNES, E. B., AND A. L. WIGLEY.  
1969. Biology of the northern shrimp *Pandalus borealis* in the Gulf of Maine. Trans. Am. Fish. Soc. 98:60-76.
- HORSTED, SV. AA., AND E. SMIDT.  
1956. The deep sea prawn (*Pandalus borealis* Kr.) in Greenland waters. Meddelelser fra Danmarks Fiskeri-og Havundersøgelse. Ny Serie, Bind I, Nr. 11, 118 p.
- ITO, H.  
1976. Some findings concerning *Pandalus borealis* Krøyer originating in the Sea of Japan. Bull. Jpn. Sea Reg. Fish. Res. Lab. 27, p. 75-89.
- RASMUSSEN, B.  
1953. On the geographical variation in growth and sexual development of the deep sea prawn (*Pandalus borealis* Kr.). Norweg. Fish. Mar. Invest. Rep. 10(3):1-160.  
1969. Variations in protandric hermaphroditism of *Pandalus borealis*. FAO Fish. Rep. 57:1101-1106.
- SKÚLADÓTTIR, U., E. JÓNSSON, AND I. HALLGRÍMSSON.  
1978. Testing for heterogeneity of *Pandalus borealis* populations at Iceland. ICES C.M. Doc. 1978/K:27, 41 p.
- SQUIRES, H. J.  
1968. Relation of temperature to growth and self-propagation of *Pandalus borealis* in Newfoundland. FAO Fish. Rep. 57:243-250.  
1970. Decapod crustaceans of Newfoundland, Labrador and the Eastern Canadian Arctic. Fish. Res. Board Can., Manusc. Rep. Ser. No. 810, 212 p.
- STICKNEY, A. P.  
1981. Laboratory studies on the development and survival of *Pandalus borealis* eggs in the Gulf of Maine. In T. Frady (editor), Proceedings of the International Pandalid Shrimp Symposium, Kodiak, Alaska, 1979, p. 395-406. Sea Grant Rep. 81-3.
- STICKNEY, A. P., AND H. C. PERKINS.  
1979. Environmental physiology of northern shrimp, *Pandalus borealis*. Completion Report. Maine Dep. Mar. Res., Proj. 3-277-R, 66 p.

<sup>4</sup>E. J. Sandeman, Fisheries Research Branch, Department of Fisheries and Oceans, P.O. Box 5667, St. John's, Newfoundland A1C 5X1, Canada.

TEIGSMARK, G.

1983. Populations of the deep-sea shrimp (*Pandalus borealis* Krøyer) in the Barents Sea. Fiskeridir. Skr. Serv. Havunders. 17:377-430.

THOMASSEN, T.

1977. Comparisons of growth, fecundity and mortality between two populations of *Pandalus borealis* in Northern Norway. ICES C.M. Doc. 1977/K:38, 16 p.

# INCIDENTAL DOLPHIN MORTALITY IN THE EASTERN TROPICAL PACIFIC TUNA FISHERY, 1973 THROUGH 1978

BRUCE E. WAHLEN<sup>1</sup>

## ABSTRACT

Since the late 1950's, large numbers of dolphins have been killed incidentally in the yellowfin tuna purse seine fishery in the eastern tropical Pacific. Estimates of numbers of dolphins killed incidentally in this fishery from 1973 through 1978 were made previously using a stratified ratio estimator. Previous estimates were revised by reducing the number of strata and incorporating revisions in the data. Revised estimates of total mortality, which are consistently more precise than previous estimates, declined from about 100,000 dolphins per year from 1973 through 1976 to about 25,000 and 15,000 during 1977 and 1978. The decline in estimated mortality between 1976 and 1977 was primarily the result of a decline in the kill rate which coincided with a significant management action in late 1976. Other examples during the 1964 through 1982 period of such a temporal correspondence between a change in the number or distribution of dolphins killed and legal or management actions are discussed.

Since the late 1950's, tuna purse seine fishermen operating in the eastern tropical Pacific Ocean (ETP) have exploited several dolphin species—primarily spotted dolphins, *Stenella attenuata*, and spinner dolphins, *S. longirostris*, and also striped dolphins, *S. coeruleoalba*, and common dolphins, *Delphinus delphis*—to locate and catch yellowfin tuna, *Thunnus albacares*. Perrin (1969) described the process of deploying, or setting, the net around the tuna and dolphins, and then releasing the dolphins while retaining the tuna. During this process, however, large numbers of dolphins have been killed incidentally by becoming entangled in the purse seines (Smith 1983).

The U.S. Marine Mammal Protection Act of 1972 mandated the Secretary of Commerce to make periodic assessments of the condition of dolphin populations involved in this ETP fishery. As a result of a 1976 ruling by a U.S. District Court regarding regulations promulgated under the Act, the Federal Government established annual dolphin mortality limits for the U.S. registered fleet (Fox 1978). Estimates of annual dolphin mortality have been an integral component of periodic assessments (Smith 1983).

Estimates of cumulative dolphin mortality made throughout the year are used to monitor mortalities relative to the annual limits (Lo et al. 1982). When a particular limit is reached, regulations prohibit U.S. registered vessels from fishing on the affected populations for the remainder of the year. In Octo-

ber 1976, the National Marine Fisheries Service (NMFS) issued a prohibition notice for the first time (Federal Register 1976), but because of litigation the notice did not become effective until November 1976.

In recent years, researchers have published several estimates and revisions of estimates of dolphin mortality incidental to this fishery. For the period 1959-78, estimates have been made by Smith (1979<sup>2</sup>), Lo et al. (1982), Smith (1983), and Lo and Smith (1986); for the years 1979-83, see Allen and Goldsmith (1981, 1982), Lo et al. (1982), Hammond and Tsai (1983), Hammond (1984), and Hammond and Hall (1985).

Lo et al. (1982) suggested that previous estimates of dolphin mortality incidental to this fishery were based on a stratification scheme with an unnecessarily large number of strata. In this paper, I revise the 1973-78 estimates for U.S. registered purse seiners by reducing the number of strata and by incorporating revisions in the data.

## DATA

Sample data were obtained from recorded observations of scientific observers who had been placed by the NMFS aboard selected U.S. registered tuna purse seine vessels fishing in the ETP. Data recorded by these observers included the type, date,

<sup>2</sup>Smith, T. D. (editor). 1979. Report of the status of porpoise stocks workshop, La Jolla, Calif., 27-31 August 1979. Southwest Fish. Cent. La Jolla Lab., Natl. Mar. Fish. Serv., NOAA, Admin. Rep. LJ-79-41, 120 p.

<sup>1</sup>Southwest Fisheries Center La Jolla Laboratory, National Marine Fisheries Service, P.O. Box 271, La Jolla, CA 92038.

location, and estimated tuna catch of each set, and other information describing the fishing operation. For sets involving dolphins (dolphin sets), the observers collected additional data, including the number of dolphins killed by species.

In 1973, all sampled trips were arranged with vessel captains under a voluntary sampling program. Beginning in 1974, trips to be sampled were determined from a randomly ordered list of vessels. Which trips were actually sampled during 1974 and 1975 depended on several factors, including the cooperation of the captains. Because of uncertainties about the cooperation of the captains and the number of fishing trips that would be made in a year, observers were placed on vessels as soon as possible. Thus, before 1976, the planned number of sampled trips was frequently obtained in the first half of the year. The sampling process became more random starting in 1976, when participation in the sampling program became mandatory for captains making sets on dolphins.

I extracted independent information for the population of all fishing trips by U.S. registered tuna purse seiners in the ETP from the Inter-American Tropical Tuna Commission (IATTC) logbook data base. This data base contains abstracts of vessels' logbooks obtained by IATTC personnel. An individual entry in the logbook data base provides information about one or more sets, including number of sets, set type, date and location, estimated tuna catch by species, but not numbers of dolphins killed.

The logbook data are incomplete in that number of sets may be missing, set type may not be recorded, and information for some sets of a trip and for all sets of some trips may be omitted (Punsly 1983). To compensate for these omissions from the logbook data, Punsly (1983) estimated the total number of dolphin sets made by all U.S. and non-U.S. seiners in the ETP. He then modified this procedure to estimate the total number of dolphin sets made by U.S. seiners only (Table 1).

## METHODS

I stratified the data to allow for potential differences in dolphin kills. If kills do indeed differ among strata, then a stratified estimator may be superior to an unstratified estimator in two respects. First, a stratified estimator will have a smaller standard error and thus be more precise. Second, if the sample data are unrepresentative of the population with respect to these strata, a stratified estimator will be less biased.

Therefore, estimates of incidental dolphin mortality by species or species grouping were computed using a stratified kill-per-set ratio estimator, following the general approach described by Lo et al. (1982). I excluded trips which made no dolphin sets and experimental-gear trips from the sample and the population. However, I added dolphin kills incidental to the experimental-gear trips as constants to the mortality estimates.

I stratified the dolphin set data by four factors used in previously published estimates: 1) year of the set, 2) fish-carrying capacity of the vessel, or simply vessel capacity, 3) period within year of the set, and 4) geographic location of the set. Vessel capacity was divided into two categories—small and large. The breakpoint between categories was determined by examining the cumulative distribution of sampled trips by capacity. Periods were defined to be quarters of the year, considering the results of Wahlen and Smith (1985). The ETP was divided into three geographic areas—North Inside, North Outside, and South (Fig. 1)—because mean kill (per set) after 1978 has been shown to differ among these areas.<sup>3</sup>

In previous estimates, the amount of tuna caught in the set was included as a stratification factor. However, Hammond and Tsai (1983) found that stratification by this factor made very little difference in their estimates. For that reason and to avoid possible overstratification, I omitted amount of tuna caught as a stratification factor.

I pooled dolphin set data over strata when it was determined that between-strata differences in mean kill were not statistically significant or that sample sizes were otherwise too small. I prorated the estimated numbers of dolphin sets made by U.S. seiners (Table 1) among the pooled strata according to pro-

<sup>3</sup>K.-T. Tsai, Inter-American Tropical Tuna Commission, c/o Scripps Institute of Oceanography, La Jolla, CA 92093, pers. commun. December 1983.

TABLE 1.—Estimated number of dolphin sets made by U.S. purse seiners fishing in the eastern tropical Pacific, by year.<sup>1</sup>

Year	Number of dolphin sets
1973	8,341
1974	7,475
1975	7,902
1976	7,126
1977	7,239
1978	4,214

<sup>1</sup>Peterson, C. L. (editor). 1984. The quarterly report October-December 1983 of the Inter-American Tropical Tuna Commission. Inter-Am. Trop. Tuna Comm., c/o Scripps Inst. Oceanogr., La Jolla, CA 92093.

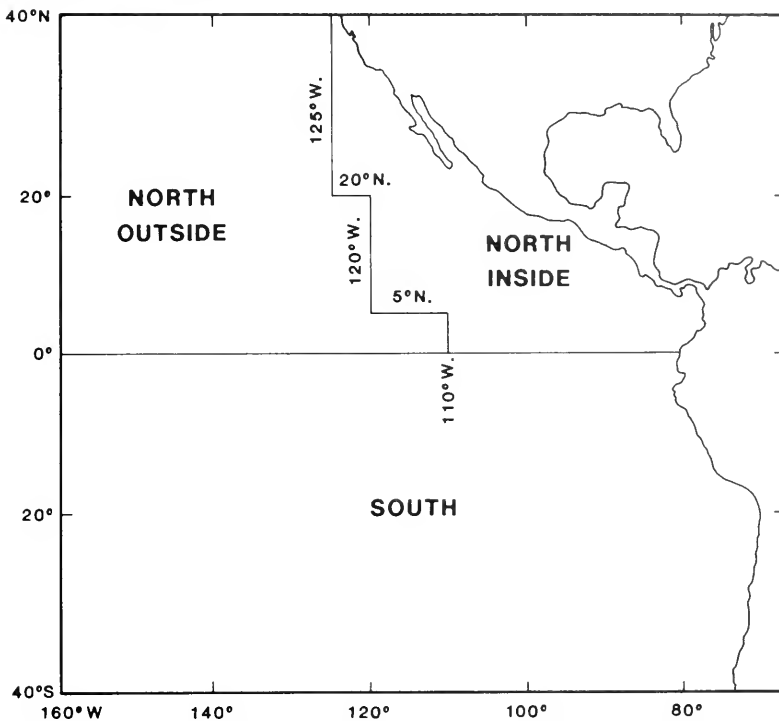

FIGURE 1.—The three areas of the eastern tropical Pacific used to stratify the data, bounded by lat. 40°N, long. 160°W, lat. 40°S, and the western coastline of the North and South American continents.

portions of known dolphin sets which were calculated from logbook data.

I tested for significant between-strata differences in mean total kill using analysis of variance (ANOVA) methods of BMDP programs P7D and P2V (Dixon 1983). Violation of the ANOVA assumption of equal cell variances may seriously distort significance probabilities in unbalanced models such as in this study (Glass et al. 1972). Because such distortion could be great, test results were considered to be inconclusive when significance probabilities were close to 0.05.

I was unable to test for the combined effect of all four stratification factors using the whole data set because data were sparse or unavailable in many of the 144 cells of the proposed four-factor stratification. Thus, ANOVA results for restricted subsets of the data containing adequate sample sizes were assumed to hold for subsets with inadequate sample sizes. To eliminate significant between-factor interactions, I tried logarithmic and power transformations of the dependent variable, total number of dolphins killed. When these transformations failed to eliminate the interactions, I partitioned the

analysis into individual levels of the interacting variables.

When it was necessary to determine where the within-factor differences occurred, *t*-tests for differences between all pairs of cell means were made. Since I tested for differences between all pairs rather than between a few preselected pairs, a difference was considered significant if its significance probability was less than the quotient of 0.05 and the number of pairs. This Bonferroni adjustment to the significance level of each test assured a level of 0.05 simultaneously across all tests (Snedecor and Cochran 1980).

I computed *t*-values for pairwise differences using separate rather than pooled variance estimates because the cell variances were unequal according to Levene's test; this test was selected because it is more robust under nonnormality than either the common *F*-ratio or Bartlett's test (Brown and Forsythe 1974). Degrees of freedom were calculated with Satterthwaite's approximation, so that significance probabilities could be obtained from an ordinary *t*-distribution (Snedecor and Cochran 1980).

## RESULTS

TABLE 2.—Cumulative distributions of number of sampled U.S. purse seine trips, by vessel capacity (tons) for the years 1973-78, with relative frequencies (percents) in parentheses.

Vessel capacity (tons)	Year					
	1973	1974	1975	1976	1977	1978
<200	0 (0)	0 (0)	0 (0)	0 (0)	0 (0)	0 (0)
<300	0 (0)	1 (3)	1 (3)	0 (0)	0 (0)	0 (0)
<400	1 (4)	3 (8)	2 (7)	3 (7)	0 (0)	0 (0)
<600	5 (22)	9 (24)	5 (17)	11 (24)	15 (15)	8 (8)
<800	15 (65)	15 (41)	8 (28)	20 (43)	34 (35)	27 (26)
<1,000	16 (70)	20 (54)	16 (55)	24 (52)	39 (40)	33 (32)
<1,200	20 (87)	30 (81)	26 (90)	34 (74)	70 (71)	67 (66)
Total	23 (100)	37 (100)	29 (100)	46 (100)	98 (100)	102 (100)

Setting the breakpoint between small and large vessel capacities at 600 tons (or lower) or at 1,200 tons would, in each case, create small and large vessel categories with severely unbalanced sample sizes (Table 2). The percent of sampled vessels with capacity <1,000 tons was more stable over years than the percent of sampled vessels <800 tons, especially from 1973 through 1976. Therefore, the breakpoint between vessel categories was set at 1,000 tons.

Because of data sparseness, particularly in the North Outside and South areas (Table 3), I made three multiway ANOVA tests restricted to subsets of the whole data set: 1) two-way test of year and vessel capacity, restricted to the North Inside area and the second quarter, 2) three-way test of year, quarter, and vessel capacity, restricted to the North Inside area and the first two quarters during 1973 through 1976, and 3) four-way test, restricted to the North Inside and North Outside areas, and the

TABLE 3.—Number of dolphin sets made during sampled trips, by year, vessel capacity (tons), quarter of the year, and area.

Year	Vessel capacity (tons)	Quarter	Area			Total	Year	Vessel capacity (tons)	Quarter	Area			Total	
			North Inside	North Outside	South					North Inside	North Outside	South		
1973	<1,000	1	325	0	9	334	1976	<1,000	1	155	0	0	155	
		2	167	47	0	214			2	41	27	0	68	
		3	0	0	0	0			3	18	71	0	89	
		4	0	0	0	0			4	20	13	4	37	
		Total	492	47	9	548			Total	234	111	4	349	
	≥1,000	1	116	0	5	121	≥1,000	1	129	0	118	247		
		2	43	2	0	45		2	42	0	0	42		
		3	0	0	0	0		3	17	80	1	98		
		4	0	0	0	0		4	16	6	0	22		
		Total	159	2	5	166		Total	204	86	119	409		
1974	<1,000	1	459	0	0	459	1977	<1,000	1	3	0	1	4	
		2	88	0	0	88			2	239	67	0	306	
		3	0	6	0	6			3	433	134	0	567	
		4	0	0	0	0			4	53	0	0	53	
		Total	547	6	0	553			Total	728	201	1	930	
	≥1,000	1	362	0	0	362	≥1,000	1	0	0	2	2		
		2	57	0	0	57		2	563	86	16	665		
		3	31	12	0	43		3	1,034	218	23	1,275		
		4	0	0	0	0		4	356	30	31	417		
		Total	450	12	0	462		Total	1,953	334	72	2,359		
1975	<1,000	1	404	0	3	407	1978	<1,000	1	170	0	13	183	
		2	106	0	4	110			2	75	50	0	125	
		3	0	0	0	0			3	86	138	0	224	
		4	0	0	0	0			4	59	6	0	65	
		Total	510	0	7	517			Total	390	194	13	597	
	≥1,000	1	268	0	0	268	≥1,000	1	320	0	52	372		
		2	111	0	5	116		2	117	77	1	195		
		3	47	0	0	47		3	104	255	2	361		
		4	0	0	0	0		4	165	8	15	188		
		Total	426	0	5	431		Total	706	340	70	1,116		
Total						6,799						1,333	305	8,437



second and third quarters during 1977 and 1978. Additionally, pairwise *t*-tests were made to isolate annual and quarter differences detected by the above tests.

### Tests for Year Differences

Sample statistics of mean kill by year and vessel capacity (Test 1) revealed an unbalanced design and suggested that cell variances were related to cell means (Table 4). For each of several transformations of total kill, neither the interaction between vessel capacity and year nor the difference between vessel capacities was significant, but the difference among years was significant.

To determine where the yearly differences occurred, the data were pooled over vessel capacity so that *t*-tests for differences between each pair of yearly means could be made. The resulting one-way classification by year was unbalanced and characterized by significantly different cell variances ( $P < 0.001$ ), and suggested that the means from 1973

TABLE 4.—Mean of total number of dolphins killed ( $\bar{k}$ ), standard deviation (*s*), and number of dolphin sets (*d*) for sampled trips, by year and vessel capacity (tons) for all sets made in the North Inside area during quarter two. Significance probabilities (*P*) obtained for 2-way ANOVA's on transformed values of total kill: interaction ( $P \geq 0.1180$ ), year ( $P < 0.001$ ), and vessel capacity ( $P \geq 0.7851$ ).

Vessel capacity (tons)	Statistic	Year					
		1973	1974	1975	1976	1977	1978
<1,000	$\bar{k}$	8.62	6.20	16.33	8.58	3.08	2.35
	<i>s</i>	18.84	10.94	40.73	20.08	11.64	7.34
	<i>d</i>	167	88	106	41	239	75
$\geq 1,000$	$\bar{k}$	11.49	5.25	8.79	14.57	2.53	1.18
	<i>s</i>	25.96	14.08	17.43	32.44	7.84	3.31
	<i>d</i>	43	57	111	42	563	117
Pooled	$\bar{k}$	9.21	5.83	12.47	11.61	2.69	1.64
	<i>s</i>	20.46	12.23	31.23	27.05	9.13	5.28
	<i>d</i>	210	145	217	83	802	192

TABLE 5.—Matrix of significance probabilities associated with *t*-tests for differences between pairs of annual means of total number of dolphins killed. Significant values, required by the Bonferroni adjustment to be  $< 0.0033$ , are indicated by "\*\*\*\*", and nearly significant values are indicated by "+ +". Data are from sampled dolphin sets made during quarter two in the North Inside area.

Year	Year				
	1974	1975	1976	1977	1978
1973	0.0526	0.2007	0.4659	0.0000*	0.0000*
1974		0.0050	0.0681	0.0037*	0.0002*
1975			0.8139	0.0000*	0.0000*
1976				0.0037*	0.0013*
1977					0.0344

through 1976 were larger than the means from 1977 and 1978 (Table 4).

Results from pairwise *t*-tests indicated that means were not significantly different within each of the two periods from 1973 through 1976 and from 1977 through 1978 (Table 5). However, each of the means from 1973 through 1976 was significantly different (or nearly so) from each of the means from 1977 and 1978 (Table 5). Based on these results, I divided the data into two periods, 1973 through 1976 and 1977 through 1978, for further tests within each period.

### Tests for Differences Within the 1973-76 Period

The three-way ANOVA table by year, quarter, and vessel capacity (Test 2) was unbalanced and suggested that cell variances were unequal (Table 6). Furthermore, no between-factor interactions were significant. The test for year differences was inconclusive; however, there is evidence for a year effect within only one cell (1976, quarter 1, small vessels), and there is no consistent yearly pattern of means within rows of the table. Therefore, I concluded that annual means during 1973-76 were not significantly different and, hence, I pooled over years within this period. I also pooled over vessel capacity since it was not a significant effect during these years.

Before 1976, sample data were unrepresentative of quarter and area, since nearly all data were obtained from trips made during the first half of the year and, thus, within the North Inside area. Data sparseness in the North Outside and South areas,

TABLE 6.—Mean of total number of dolphins killed ( $\bar{k}$ ), standard deviation (*s*), and number of dolphin sets (*d*) for sampled trips, by year, quarter, and vessel capacity (tons) for all sets made in the North Inside area during the first two quarters of 1973-76. Significance probabilities (*P*) obtained for a 3-way ANOVA on total kill: interactions ( $P \geq 0.1374$ ), year ( $P = 0.0534$ ), quarter ( $P = 0.0501$ ), and vessel capacity ( $P = 0.8219$ ).

Vessel capacity (tons)	Quarter	Statistic	Year			
			1973	1974	1975	1976
<1,000	1	$\bar{k}$	23.15	14.10	16.45	3.47
		<i>s</i>	69.70	40.39	47.31	8.12
		<i>d</i>	325	459	404	155
	2	$\bar{k}$	8.62	6.20	16.33	8.59
		<i>s</i>	18.84	10.94	40.73	20.08
		<i>d</i>	167	88	106	41
$\geq 1,000$	1	$\bar{k}$	15.75	11.23	15.45	10.86
		<i>s</i>	27.64	24.85	34.37	24.35
		<i>d</i>	116	362	268	129
	2	$\bar{k}$	11.49	5.25	8.79	14.57
		<i>s</i>	25.95	14.08	17.43	32.44
		<i>d</i>	43	57	111	42

resulting from the unrepresentative areal sample, precluded testing for an area effect during the 1973-76 period (Table 3); however, after 1978 mean kills were shown to differ among the three areas, as noted earlier. Therefore, to minimize the amount of bias which might be introduced into the estimates from a sample which was unrepresentative of area, I retained the three-area stratification.

Small sample sizes during 1973-76 dictated pooling over all quarters within both the North Outside and South areas and over quarters 3 and 4 within the North Inside area (Table 3). The test result for quarter 1 and 2 differences in the North Inside area was inconclusive (Table 6). Based on bias considerations similar to those above, I did not pool data from quarters 1 and 2 in the North Inside area in case their means did indeed differ.

After pooling over year, vessel capacity, and quarter as indicated above, five strata remained for the 1973-76 data: 1) North Inside, quarter 1, 2) North Inside, quarter 2, 3) North Inside, quarters 3 and 4 pooled, 4) North Outside, all quarters pooled, and 5) South, all quarters pooled.

### Tests for Differences Within the 1977-78 Period

Interpretation of the four-way ANOVA (Test 3), restricted by data sparseness to the North Inside and North Outside areas during the second and third quarters of 1977-78 (Table 3), was complicated by significant interaction between quarters and each of the other three factors ( $P \leq 0.0159$ , for total kill and all transformations of total kill). Therefore, the four-way table was partitioned into two, three-way tables, one for each level of quarter (Tables 7, 8), and decisions about between-strata differences during these years were based on results obtained separately for each quarter.

For second quarter data, interactions were not significant (Table 7). However, for third quarter data, interaction between year and vessel capacity was significant ( $P < 0.001$ ) primarily because of the two large means recorded in the North Inside and North Outside areas by small vessels during 1978 (Table 8). Omitting the data from one extraordinarily large kill set in each of these two cells reduces their means from 11.27 to 4.68 for the North Inside and from 9.77 to 5.46 for the North Outside.

Results from the second and third quarter data were inconsistent for both year and vessel capacity. Neither effect was significant during the second quarter (Table 7), but during the third quarter (Table 8) the large means in the two cells noted above pro-

vided some evidence of both a year and vessel capacity effect. Since the evidence for both a year and vessel capacity effect was confined to two, third quarter cells whose means were each strongly influenced by only one set, I concluded that year and vessel capacity were not significant effects during 1977-78. Hence, I pooled over year and vessel capacity within this period. The evidence regarding an area effect during 1977-78 was also inconsistent between quarters (Tables 7, 8); however, I retained area as a stratification factor since it was shown to be significant after 1978.

Beginning in 1976 when the sampling program became mandatory the sample data became more representative of quarter. Thus, for the 1977-78 data, bias considerations were of lesser importance

TABLE 7.—Mean of total number of dolphins killed ( $\bar{k}$ ), standard deviation ( $s$ ), and number of dolphin sets ( $d$ ) for sampled trips, by area, vessel capacity (tons), and year for all sets made in the North Inside and North Outside areas during quarter two of 1977-78. Significance probabilities ( $P$ ) obtained for a 3-way ANOVA on total kill: interactions ( $P \geq 0.2095$ ), area ( $P = 0.0060$ ), vessel capacity ( $P = 0.8857$ ), and year ( $P = 0.6050$ ).

Year	Vessel capacity (tons)	Statistic	Area	
			North Inside	North Outside
1977	<1,000	$\bar{k}$	3.08	2.94
		$s$	11.64	8.68
		$d$	239	67
	$\geq 1,000$	$\bar{k}$	2.53	5.66
		$s$	7.84	13.82
		$d$	563	86
1978	<1,000	$\bar{k}$	2.35	4.82
		$s$	7.34	16.00
		$d$	75	50
	$\geq 1,000$	$\bar{k}$	1.18	4.26
		$s$	3.31	21.19
		$d$	117	77

TABLE 8.—Mean of total number of dolphins killed ( $\bar{k}$ ), standard deviation ( $s$ ), and number of dolphin sets ( $d$ ) for sampled trips, by area, vessel capacity (tons), and year for all sets made in the North Inside and North Outside areas during quarter three of 1977-78.

Year	Vessel capacity (tons)	Statistic	Area	
			North Inside	North Outside
1977	<1,000	$\bar{k}$	2.08	2.33
		$s$	5.72	7.92
		$d$	433	134
	$\geq 1,000$	$\bar{k}$	2.85	2.89
		$s$	9.81	6.45
		$d$	1034	218
1978	<1,000	$\bar{k}$	11.27	9.77
		$s$	61.74	52.52
		$d$	86	138
	$\geq 1,000$	$\bar{k}$	2.00	2.81
		$s$	4.34	10.97
		$d$	104	255

in stratification decisions than for the 1973-76 data. The four-way test on 1977-78 data (Test 3) was not helpful in resolving the question of quarter differences because of the interactions between quarter and each of the other three factors. However, pairwise *t*-tests for differences between quarterly means in the North Inside area during 1977-78, pooled over

year and vessel capacity, detected no significant quarter differences (Table 9). Based on that result, I pooled over all quarters in the North Inside and North Outside areas. Finally, I pooled over all quarters in the South area because of the small sample sizes (Table 3).

Thus, after pooling over year, vessel capacity, and quarter as indicated above, only three strata remained for the 1977-78 data: 1) North Inside, 2) North Outside, and 3) South.

## Estimates

I obtained annual estimates of the total number of dolphins killed by summing estimates for each of three or five strata, depending on the year. Estimates for a stratum were computed as the product of (a) total number of dolphin sets (Table 10) and (b) the corresponding total kill-per-set ratio (Table 11), increased by (c) the observed total number of dolphins killed during experimental-gear trips (Table

TABLE 9.—Matrix of significance probabilities associated with *t*-tests for differences between pairs of quarterly means of total number of dolphins killed. No significant values, required by the Bonferroni adjustment to be <0.0083, were attained. Data are from sampled dolphin sets made in the North Inside area from 1977 through 1978.

Quarter	Quarter		
	2	3	4
1	0.7062	0.2417	0.0684
2		0.2623	0.0730
3			0.2831

TABLE 10.—Estimated number of dolphin sets (D) and number of trips (N) for the population of trips, by year within strata.

Year	Statistic	North Inside			Total	North Outside	South	Total
		Quarter 1	Quarter 2	Quarters 3 & 4				
1973	D	3,203	1,670	501		2,591	330	8,295
	N	172	104	69		117	34	
1974	D	3,486	1,176	242		2,453	12	7,369
	N	126	92	38		93	4	
1975	D	3,069	1,749	434		2,495	53	7,800
	N	119	96	40		96	23	
1976	D	1,618	1,520	716		2,001	729	6,584
	N	127	98	92		90	76	
1977	D				5,722	1,128	252	7,102
	N				186	76	37	
1978	D				2,811	1,153	162	4,126
	N				206	58	27	

TABLE 11.—By-trip means of total number of dolphins killed ( $\bar{k}$ ) and of number of dolphin sets ( $\bar{d}$ ), total kill-per-set ratio ( $\bar{R}$ ), estimated standard error of the total kill-per-set ratio (*s*), and number of sampled trips (*n*), by strata.

Years	Statistic	North Inside			Total	North Outside	South
		Quarter 1	Quarter 2	Quarters 3 & 4			
1973-76	$\bar{k}$	354.51	157.32	155.50		265.06	239.85
	$\bar{d}$	24.11	15.98	9.31		16.50	7.45
	$\bar{R}$	14.70	9.85	16.70		16.06	32.19
	<i>s</i>	1.19	1.15	4.38		4.21	4.17
	<i>n</i>	92	41	16		16	20
1977-78	$\bar{k}$				58.66	57.55	22.12
	$\bar{d}$				19.88	13.71	4.73
	$\bar{R}$				2.95	4.20	4.68
	<i>s</i>				0.23	0.51	1.03
	<i>n</i>				190	78	33

12). For example, the total estimated kill for 1977 (Table 13) was obtained as a sum of estimates of the total for three strata as  $[(5,722)(2.95) + 175] + [(1,128)(4.20) + 15] + [(252)(4.68) + 0]$ . Estimates for each species or species grouping were obtained in the same manner as estimates of the total, ex-

cept that values for the species or species grouping were substituted for the totals in (b) and (c) above.

Similarly, I estimated the variance of the number of dolphins killed during any year by summing variance estimates for each stratum. The estimated variance of total kill for a stratum was computed

TABLE 12.—Total number of dolphins killed (*k*), number of dolphin sets (*d*), and number of experimental-gear trips (*n*), by year within strata. These data were excluded from all sample and population statistics.

Year	Statistic	North Inside			Total	North Outside	South	Total
		Quarter 1	Quarter 2	Quarters 3 & 4				
1973	<i>k</i>	0	0	513	0	0	513	
	<i>d</i>	0	0	46	0	0	46	
	<i>n</i>	0	0	2	0	0		
1974	<i>k</i>	0	0	497	192	0	689	
	<i>d</i>	0	0	70	36	0	106	
	<i>n</i>	0	0	2	1	0		
1975	<i>k</i>	0	0	512	271	0	783	
	<i>d</i>	0	0	76	26	0	102	
	<i>n</i>	0	0	2	1	0		
1976	<i>k</i>	139	1,400	111	1,886	547	4,083	
	<i>d</i>	35	256	92	153	6	542	
	<i>n</i>	2	16	7	5	2		
1977	<i>k</i>				175	15	190	
	<i>d</i>				129	8	137	
	<i>n</i>				4	2		
1978	<i>k</i>				226	27	253	
	<i>d</i>				77	11	88	
	<i>n</i>				6	2		

TABLE 13.—Estimates of dolphin mortality incidental to U.S. purse seiners, by species grouping and year, with coefficients of variation in parentheses.

Species grouping	Year					
	1973	1974	1975	1976	1977	1978
Spotted	70,000 (0.12)	61,000 (0.13)	63,000 (0.13)	61,000 (0.11)	14,000 (0.08)	9,000 (0.08)
Spinner						
Eastern <sup>1</sup>	12,000 (0.16)	11,000 (0.11)	11,600 (0.11)	9,500 (0.12)	1,300 (0.12)	700 (0.11)
Whitebelly	20,000 (0.17)	16,000 (0.19)	17,000 (0.19)	19,000 (0.15)	3,600 (0.11)	2,300 (0.10)
Unidentified	8,700 (0.24)	7,600 (0.26)	7,700 (0.25)	7,500 (0.25)	60 (0.18)	40 (0.17)
Total	41,000	35,000	36,000	36,000	5,000	3,000
Common	8,500 (0.22)	7,000 (0.25)	8,300 (0.22)	6,600 (0.20)	3,000 (0.23)	1,500 (0.24)
Striped	640 (0.30)	380 (0.34)	500 (0.35)	800 (0.33)	200 (0.26)	130 (0.24)
Unidentified	5,000 (0.19)	3,700 (0.20)	4,000 (0.19)	5,400 (0.26)	450 (0.12)	300 (0.12)
Other	180 (0.45)	90 (0.26)	100 (0.26)	280 (0.64)	180 (0.22)	100 (0.26)
Total <sup>2</sup>	125,000 (0.10)	107,000 (0.10)	112,000 (0.10)	110,000 (0.09)	23,000 (0.06)	14,000 (0.06)

<sup>1</sup>May include small number of Costa Rican spinner dolphins.

<sup>2</sup>Sum of estimated kills over species grouping not exactly equal to total estimated kill because of rounding error.

as the square of the product of (a) the number of dolphin sets<sup>4</sup> (Table 10) and (b) the corresponding estimated standard error of the total kill-per-set ratio (Table 11). I computed the estimated stratum variance for each species or species grouping, substituting values for the species or species grouping for the total in (b) above. I estimated the standard errors (Table 11) using mean number of dolphin sets per trip calculated from the sample rather than from the population (Lo et al. 1982).

My annual estimates of the total number of dolphins killed incidentally in the U.S. purse seine fishery of the ETP ranged from a maximum of 125,000 dolphins in 1973 to a minimum of 14,000 dolphins in 1978, with coefficients of variation (CV) no greater than 10% (Table 13). The estimated mortalities of the two species most often exploited, spotted and spinner dolphins, together accounted for about 80-90% of each annual total.

## DISCUSSION AND CONCLUSIONS

The kill-per-set ratio, or mean kill, declined from 15 dolphins/set during the 1973-76 period to 3 dolphins/set during the 1977-78 period (Table 11, pooled over quarter and area). Many changes affecting dolphin kill were made during these periods, including improvements in fishing gear and dolphin-release procedures and introduction of federal regulations. The change in mean kill between 1973-76 and 1977-78 coincided with the first NMFS notice in late 1976 prohibiting fishing on dolphins for the remainder of the year. This one example of a correspondence between a change in the number or distribution of dolphins killed during purse seine sets and an identifiable legal or management action is not necessarily indicative of a cause and effect relationship. There are, however, two other examples of such a temporal correspondence present in the data from 1964 through 1982.

In the second example, the data prior to 1973, while sparse, suggest that the mean kill was substantially higher than during the 1973-76 period. Lo and Smith (1986) reported a mean kill of 46 dolphins/set based on 1964 through 1972 data, pooled over vessel capacity and catch of tuna. They found no consistent differences in annual mean kill during that period. The decline in the mean from 46 dolphins/set during the 1964-72 period to 15 dolphins/set dur-

ing the 1973-76 period coincided with the passage of the Marine Mammal Protection Act in late 1972.

In the third example, Wahlen and Smith (1985) demonstrated a difference between the two periods from 1979 through March 1981 and from April 1981 through 1982 in the frequency distributions of number of dolphins killed during purse seine sets. While the difference in mean kill during these two periods was not significant, the percent of dolphin sets in which no dolphins were killed (zero-kill sets) decreased significantly. This decrease coincided with a court order in March 1981 which prohibited using data collected by NMFS observers to monitor compliance of vessel captains with dolphin-release procedures.

These three examples suggest that significant legal or management actions can affect kill rates, measured by the kill-per-set ratio or by the percent of zero-kill sets. Furthermore, such effects on the kill-per-set rate are reflected in the series of estimates of total numbers of dolphins killed presented here. For example, between 1976 and 1977 the number of dolphin sets increased slightly (Table 10), yet total estimated mortality decreased by nearly 80% (Table 13), due primarily to the significantly lower kill rate after 1976. The further decline in estimated mortality to 14,000 dolphins in 1978 reflects both the lower kill rate and a decline in the number of dolphin sets. Thus, the decrease in the kill rate following the first enforcement of dolphin kill limits in 1976 is reflected in the decrease in the estimates of total mortality after 1976.

My estimates of total annual dolphin mortality in U.S. purse seine fishing from 1973 through 1978 (Table 13) are lower, except for 1976, and more precise than those in the Status of Porpoise Stocks Workshop Report (SOPS) (Table 14). However, for each year except 1973, my estimated total is contained inside an approximate 95% confidence interval around the estimated total ( $\hat{T}$ ) in SOPS, where the confidence interval is computed as  $\hat{T} \pm 2 \cdot CV \cdot \hat{T}$ . Thus, the differences between my point estimates and those in SOPS are small when the imprecision (large CV) of the SOPS estimates is considered.

The lower precision of the SOPS estimates may be due to overstratification because of a concern that the sample might not be representative of the population, particularly during the 1973-75 period. Thus, in order to minimize bias, a large number of strata (32 per year) were defined. Tests for between-strata differences in mean kill were not made, but strata were pooled to the degree that each pooled stratum contained some sample data. However, even after pooling, some strata during the years 1973-76

<sup>4</sup>Numbers of dolphin sets were treated as constants since no variances were provided for these estimated quantities. Therefore, my variances of estimated mortality are underestimated to an unknown, though likely small, degree.

TABLE 14.—Estimates of dolphin mortality incidental to U.S. purse seiners, by species and year, from Status of Porpoise Stocks Workshop Report (Smith text footnote 2). Coefficients of variation of totals in parentheses.

Species	Year					
	1973	1974	1975	1976	1977	1978
Spotted	114,000	75,000	84,000	57,000	12,000	13,000
Spinner	65,000	62,000	70,000	39,000	5,000	4,400
Common	18,000	3,000	2,300	5,400	6,600	1,000
Striped	40	140	900	2,000	100	250
Unidentified <sup>1</sup>	0	0	0	0	0	0
Other	0	80	160	690	80	50
Total <sup>2</sup>	197,000 (0.17)	140,000 (0.41)	157,000 (0.17)	104,000 (0.13)	24,000 (0.15)	19,000 (0.20)

<sup>1</sup>Kills of unidentified dolphins prorated among known species.

<sup>2</sup>Sum of estimated kills over species not exactly equal to total estimated kill because of rounding error.

contained only one dolphin set. Such small sample sizes within some strata account for the lower precision of the SOPS estimates relative to my estimates.

While the differences between my point estimates and those in SOPS are small in a statistical sense, my estimates are consistently lower except for 1976. However, these new estimates are to be preferred on methodological grounds. I tested for statistically significant between-strata differences in mean kill and pooled over strata when significant differences were not detected or when sample sizes were otherwise too small. Pooling of the data produced estimates which were more precise than the SOPS estimates because it resulted in fewer strata with larger sample sizes. However, to minimize the possibility of introducing bias into the estimates during the 1973-76 period, when the sample was unrepresentative of area and quarter, I did not pool over area and I pooled over quarter only in the event of small sample sizes.

## ACKNOWLEDGMENTS

I am grateful to K. E. Wallace, C. J. Orange, and G. Ver Steeg for providing data, and to R. G. Punsly for modifying his procedure to estimate numbers of sets for U.S. seiners only. I also appreciate the helpful reviews by two anonymous individuals as well as those by F. G. Alverson, I. Barrett, D. G. Chapman, P. S. Hammond, R. S. Holt, N. C. H. Lo, J. M. Michalski, G. T. Sakagawa, and K.-T. Tsai. Finally, I am especially indebted to T. D. Smith for his suggestions and encouragement.

## LITERATURE CITED

- ALLEN, R. L., AND M. D. GOLDSMITH.  
1981. Dolphin mortality in the eastern tropical Pacific incidental to purse seining for yellowfin tunas, 1979. Rep. Int. Whaling Comm. 31:539-540.
1982. Dolphin mortality in the eastern tropical Pacific incidental to purse seining for yellowfin tuna, 1980. Rep. Int. Whaling Comm. 32:419-421.
- BROWN, M. B., AND A. B. FORSYTHE.  
1974. Robust tests for the equality of variances. J. Am. Stat. Assoc. 69:364-367.
- DIXON, W. J. (editor).  
1983. BMDP statistical software. Univ. Calif. Press, Berkeley, CA, 733 p.
- FEDERAL REGISTER.  
1976. Dep. Commer., NOAA, Regulations governing the taking and importing of marine mammals. Prohibition on encircling marine mammals in the course of fishing operations for yellowfin tuna. Fed. Regist. 41(201):45569.
- FOX, W. W., JR.  
1978. Tuna-dolphin program: five years of progress. Oceans 11(3):57-59.
- GLASS, G. V., P. D. PECKHAM, AND J. R. SANDERS.  
1972. Consequences of failure to meet assumptions underlying the fixed effects analyses of variance and covariance. Rev. Educ. Res. 42(3):237-288.
- HAMMOND, P. S.  
1984. Dolphin mortality incidental to purse-seining for tunas in the eastern tropical Pacific, 1982. Rep. Int. Whaling Comm. 34:539-541.
- HAMMOND, P. S., AND M. A. HALL.  
1985. Dolphin mortality incidental to purse-seining for tunas in the eastern tropical Pacific inflicted by the US fleet in 1983 and non-US fleet in 1979-1983. Rep. Int. Whaling Comm. 35:431-433.
- HAMMOND, P. S., AND K.-T. TSAI.  
1983. Dolphin mortality incidental to purse-seining for tunas in the eastern Pacific Ocean, 1979-81. Rep. Int. Whaling Comm. 33:589-597.
- LO, N. C. H., J. E. POWERS, AND B. E. WAHLEN.  
1982. Estimating and monitoring incidental dolphin mortality in the eastern tropical Pacific tuna purse seine fishery. Fish. Bull., U.S. 80:396-401.
- LO, N. C. H., AND T. D. SMITH.  
1986. Incidental mortality of dolphins in the eastern tropical Pacific 1959-1972. Fish. Bull., U.S. 84:27-34.
- PERRIN, W. F.  
1969. Using porpoise to catch tuna. World Fish. 18(6):42-45.
- PUNSLY, R. G.  
1983. Estimation of the number of purse-seiner sets on tuna

associated with dolphins in the eastern Pacific Ocean during 1959-1980. [In Engl. and Span.] Inter-Am. Trop. Tuna Comm. Bull. 18:229-299.

SMITH, T. D.

1983. Changes in size of three dolphin (*Stenella* spp.) populations in the eastern tropical Pacific. Fish. Bull., U.S. 81: 1-13.

SNEDECOR, G. W., AND W. G. COCHRAN.

1980. Statistical methods. 7th ed. Iowa State Univ. Press, Ames, 507 p.

WAHLEN, B. E., AND T. D. SMITH.

1985. Observer effect on incidental dolphin mortality in the eastern tropical Pacific tuna fishery. Fish. Bull., U.S. 83: 521-530.





# DISTRIBUTION AND REPRODUCTIVE BIOLOGY OF THE GOLDEN KING CRAB, *LITHODES AEQUISPINA*, IN THE EASTERN BERING SEA

DAVID A. SOMERTON<sup>1</sup> AND ROBERT S. OTTO<sup>2</sup>

## ABSTRACT

The golden king crab is a large anomuran that supports a new, rapidly expanding fishery in the eastern Bering Sea and Aleutian Islands. Based on size, sex, and abundance data collected by U.S. observers aboard foreign trawlers and by National Marine Fisheries Service personnel aboard research vessels, we examined latitudinal and depth variation in mean size (carapace length), size at maturity, weight at size, and relative abundance. Mean size decreases by 6.2 mm for males and 4.6 mm for females with each 1 degree increase in latitude. Size at maturity decreases with increasing latitude from 130 mm for males and 111 mm for females in the southern area to 92 mm and 98 mm in the northern area. These decreases may be due to a temperature induced decrease in growth rate. Weight at size increases by 10% from the southern to the northern area owing to a latitudinal change in body shape. Mean size and relative abundance of both sexes increase with a decrease in depth, suggesting that an onshore ontogenetic migration occurs and that adult males migrate into somewhat shallower water than adult females. Fecundity (number of uneyed embryos) of northern females increases with size according to  $-24815 + 323 \text{ CL}$ , where CL is carapace length. This relationship changes with latitude and southern females carry about 1,330 fewer eggs than equal-sized northern females. Mean length of uneyed eggs is 2.2 mm. Based on the lack of a clear seasonal change in the occurrence of eyed and uneyed clutches, golden king crab appear to have protracted, or perhaps year-round, breeding.

The golden king crab, *Lithodes aequispina*, is a large anomuran that inhabits the upper continental slope from southern British Columbia, Canada, northward to the Bering Sea and westward to Suruga Bay, Japan (Butler and Hart 1962; Suzuki and Sawada 1978). Although similar in size to red king crab, *Paralithodes camtschatica*, and blue king crab, *P. platypus*, the traditional species harvested by Alaskan crab fisheries, golden king crab have not been intensively harvested because they live in deeper water than red and blue king crabs and are therefore more difficult and expensive to capture (McNair 1983). Since 1980, however, precipitous declines in abundance of red and blue king crabs have stimulated growth of directed fisheries for golden king crab. These fisheries expanded rapidly in the eastern Bering Sea and Aleutian Islands, and between 1981 and 1983 the catch of golden king crab increased from 50 t to 4900 t or 44% of the total king crab catch from these areas.

The fisheries for golden king crab have been managed according to regulations designed for red and blue king crabs (Alaska Department of Fish and Game 1983; Miller 1976) because little biological information was available to establish more specific regulations. Although golden king crab have been studied before, published reports either concern Asian stocks (Hiramoto and Sato 1970; Suzuki and Sawada 1978; Rodin 1970) or are restricted to taxonomy (Benedict 1895; Makarov 1938), distribution (Butler and Hart 1962; Slizkin 1974), or early life history (Haynes 1981).

In 1981, the National Marine Fisheries Service (NMFS) began collecting biological data on golden king crab necessary for establishing minimum size limits and fishing seasons. We summarize these data here, focusing our attention on latitudinal and depth gradients in mean size, size at maturity, weight at size, and sex ratio as well as various aspects of the reproductive biology. We then examine the management implications of our findings.

## MATERIALS AND METHODS

### Data Sources

Golden king crab were sampled by NMFS re-

<sup>1</sup>Northwest and Alaska Fisheries Center Seattle Laboratory, National Marine Fisheries Service, NOAA, 7600 Sand Point Way N.E., Seattle, WA; present address: Southwest Fisheries Center Hawaii Laboratory, National Marine Fisheries Service, NOAA, 2570 Dole Street, Honolulu, HI 96822-2396.

<sup>2</sup>Northwest and Alaska Fisheries Center Kodiak Laboratory, National Marine Fisheries Service, NOAA, P.O. Box 1638, Kodiak, AK 99615.

search personnel on stock assessment and tagging cruises and by NMFS observers aboard foreign fishing vessels. In the following we distinguish between survey data and observer data because the sampling designs differed considerably. In both cases, however, crabs were measured with calipers to the nearest millimeter according to the descriptions in Wallace et al. (1949).

### Survey Data

From 1981 to 1983, NMFS conducted 10 survey cruises sampling the eastern Bering Sea population of golden king crab with either bottom trawls or commercial king crab pots (Table 1). All crabs were measured for carapace length, and females were classified into one of four categories of reproductive condition:

- 1) Non-ovigerous - no embryos or empty egg cases attached to the pleopod setae.
- 2) uneyed embryos - embryos without conspicuous dark eyes.
- 3) eyed embryos - embryos with dark eyes.
- 4) empty egg cases - empty egg cases and funiculi attached to the pleopod setae.

When opportunity occurred, one or more of the following were also collected:

- 1) height of the right chela of males (excluding males with partially regenerated right chela).
- 2) Total wet body weight of males, measured to the nearest gram on a triple beam balance or to the nearest 5 g on a handheld spring scale (excluding males with damaged exoskeletons or missing appendages).
- 3) egg masses from females (stored in Formalin<sup>3</sup> diluted to 10% with seawater).

### Observer Data

Golden king crab, like most of the other large Alaskan crabs, is classified as a prohibited species and, as such, may not be retained if captured by foreign fisheries. Because of this status, NMFS fishery observers routinely record the carapace length, sex, and number of golden king crab that are incidentally caught by foreign vessels during their normal fishing operations for other species (Nelson et al. 1981). To delineate the distribution

TABLE 1.—Inclusive dates, latitude and depth ranges, number of crabs sampled and type of sampling gear are shown for each of the 10 golden king crab research cruises conducted by the National Marine Fisheries Service.

Year	Dates	Latitude (degrees N)	Depth (m)	Number		Gear
				males	females	
1981	2/12-2/23	54.4-55.1	346-472	4	6	trawl
1982	7/12-8/4	58.3-60.9	168-849	292	341	trawl
1983	1/31-2/8	52.3-52.5	183-366	188	123	pot
	2/22-2/24	54.4-55.7	362-461	24	17	trawl
	5/9-5/10	56.0-56.1	365-421	288	1,114	pot
	5/12-5/15	57.8-58.5	329-365	489	1,753	pot
	7/8-7/10	57.7-57.7	347-365	1,073	741	pot
	7/14-7/18	55.9-56.3	311-384	1,285	1,012	pot
	10/2-10/4	56.2-56.2	347-365	596	1,035	pot
	11/15-11/21	52.4-52.6	110-283	376	404	pot

of golden king crab in the eastern Bering Sea, we chose to examine the 1981 and 1982 observer data obtained from Japanese small stern trawlers that fish for turbot (*Reinhardtius hippoglossoides*) because 1) these vessels use trawls designed to remain in direct contact with the bottom and are therefore likely to catch crabs, 2) these vessels operate year-round along nearly the entire length of the continental slope of the eastern Bering Sea, and 3) turbot have a depth distribution similar to that of golden king crab. Although these data are not necessarily a random sample of the golden king crab population, they are the most extensive data available and include samples from the entire depth range of golden king crab during all four seasons. The number of crabs measured and the number of trawl hauls sampled are summarized by year, month, latitude, and depth (Table 2). Due to a lack of Japanese fishing effort for turbot, observer data were unavailable for areas south of lat. 54°15'N.

Both survey and observer data, in some instances, were partitioned into three latitudinal strata or subareas (Fig. 1): northern (north of lat. 58°30'N), central (between lat. 58°30'N and 54°15'N), southern (south of lat. 54°15'N and east of long. 173°00'W), which correspond approximately to the crab management districts used by the Alaska Department of Fish and Game. In addition, the observer data were partitioned into two depth strata separated at the approximate median depth (500 m) of the samples (nearly the entire depth range of golden king crab is bounded by the 200 m and 1,000 m isobaths).

### Methods of Analysis

Size-frequency distributions by sex were constructed from the combined 1981 and 1982 observer

<sup>3</sup>Reference to trade names does not imply endorsement by the National Marine Fisheries Service, NOAA.

TABLE 2.—Number of trawl hauls sampled (excluding hauls without crabs) and number of crabs sexed and measured by U.S. observers aboard Japanese small trawlers within the study area during 1981 and 1982. Data are summarized by depth, latitude and month.

	1981		1982	
	Hauls	Crabs	Hauls	Crabs
Depth (m)				
100	0	0	3	3
200	7	81	23	86
300	30	323	33	848
400	217	2,475	339	3,551
500	456	6,885	548	4,380
600	201	2,065	192	1,112
700	16	97	27	81
800	6	24	1	2
900	2	13	0	0
1,000	1	6	0	0
Latitude (degrees N)				
53	12	18	0	0
54	7	135	132	678
55	34	455	43	184
56	165	1,582	163	879
57	59	376	75	552
58	284	3,936	151	899
59	175	2,995	166	2,019
60	200	2,472	436	4,852
Month				
1	18	55	19	125
2	65	443	19	79
3	75	977	66	528
4	114	1,688	41	73
5	104	1,398	102	332
6	112	2,027	136	1,681
7	72	1,528	75	306
8	89	1,121	124	1,215
9	106	927	192	992
10	99	814	194	2,436
11	68	931	150	1,654
12	14	60	48	654
Total	936	11,969	1,166	10,063

data for each of the two depth strata within the northern and central subareas to help illustrate depth and latitude trends in the size distributions (see Figure 2). Potential bias because of the variation of fishing effort with depth was minimized by first partitioning the data into 100 m depth intervals. Within each depth interval, a size-frequency distribution and an average catch per hour (CPH) were calculated. Size-frequency distributions, weighted by the appropriate mean CPH, were then summed over all 100 m depth intervals within each of the two depth strata.

Variations in mean size, CPH, and proportion male with latitude and depth were also examined using multiple regression. Two normalizing transformations were used: 1) CPH was transformed to the natural log scale and 2) proportion male was transformed to the arcsine-square root scale after replacing 0 with  $0.25/N$  and 1 with  $(N - 0.25)/N$ ,

where  $N$  is the number of crabs within each trawl haul (Bartlett 1947).

Egg size was estimated by randomly selecting 10 eggs from each preserved egg mass and measuring their maximum lengths (eggs are oval) to the nearest 0.1 mm with an ocular micrometer. The remainder of each egg mass was air dried and, after separating the eggs from the pleopods and setae, weighed to the nearest 0.1 mg. Two subsamples of about 200 eggs each were randomly selected from each dried egg mass and then weighed and counted. Fecundity was then estimated by dividing the total weight of an egg mass by the average of the two estimates of individual egg weight that were obtained from that egg mass.

Male size at maturity was estimated from the allometric growth of the right chela. When king crab chela measurements are plotted against carapace measurements on log-log axes, the data conform to two straight lines that intersect at the average carapace length at maturity (see Figure 3) (Somerton 1980; Somerton and MacIntosh 1983). To estimate this size, we used the computer method described in Somerton and MacIntosh (1983) which fits a pair of intersecting straight lines by iteratively varying the carapace length at the intersection point until the residual sum of squares about the lines is minimized. Variance of the male size at maturity was estimated using a computer technique known as bootstrapping (Efron and Gong 1983). In our application, the method consisted of randomly choosing, with replacement, 50 subsamples equal in size to the original data set. For each subsample, the size at maturity was estimated by fitting the two line model. Variance of the estimated size at maturity was then computed as the variance among the 50 independent estimates.

Although we attempted to detect and exclude partially regenerated chelae in the field, we were not always successful. Measurements from partially regenerated chelae can increase the variance of estimates of male size at maturity; therefore, these measurements were removed from the data set before analysis using a sequential outlier elimination technique described in Somerton and MacIntosh (1983).

Golden king crab females were considered to be mature, if they had eggs or empty egg cases attached to the pleopod setae. Although we are not certain that this is always true, for red and blue king crabs, adult females extrude eggs soon after every molt and the empty egg cases remain attached to the pleopod setae until the next molt (Somerton and MacIntosh 1985).

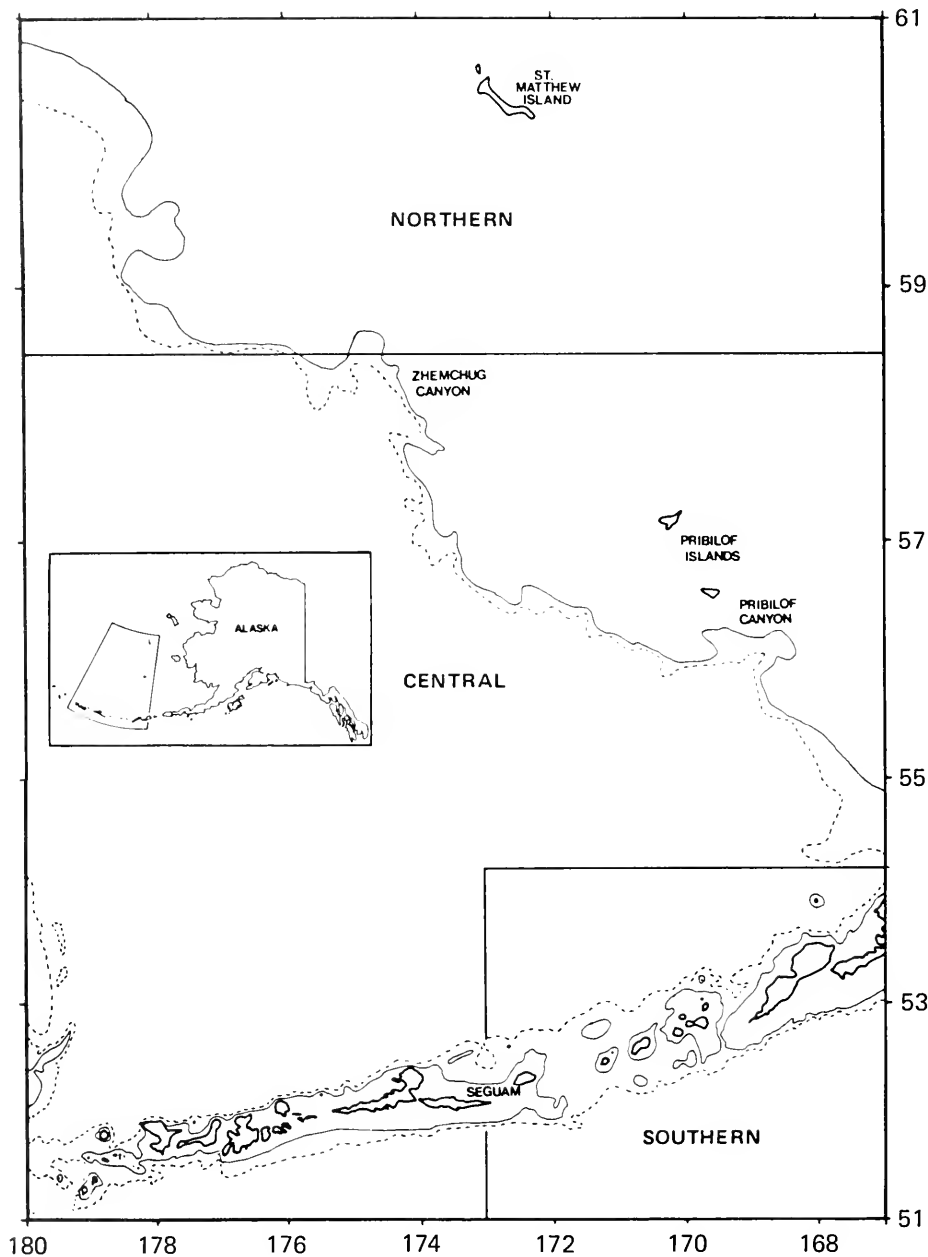

FIGURE 1.—Areas of the Bering Sea and eastern Aleutian Islands where golden king crab were sampled by U.S. fishery observers and National Marine Fisheries Service research cruises. Golden king crab occur primarily in a region bounded by the 200 m (solid line) and 1,000 m (dashed line) isobaths. The dark lines indicate the separation of this region into the three latitudinal strata discussed in the text.

Female size at maturity was estimated as the size at which 50% of the crabs were mature. Weighted nonlinear regression (weights equal to the inverse of the binomial variance at each size) was used to fit a logistic equation to the percentage mature

within 5 mm size intervals. The fitted logistic equation was then evaluated to determine the carapace length corresponding to 50% maturity. Variance of this size was estimated using the formula provided in Somerton (1980).

## BIOLOGICAL VARIATION WITH DEPTH AND LATITUDE

### Mean Size

Size-frequency distributions of golden king crab, based on the combined 1981 and 1982 observer data, are shown by sex, area, and depth strata in Figure 2. Linear trends in mean size with depth and latitude were examined statistically using multiple regression. For each sex in each year, when carapace length was regressed against latitude and depth simultaneously, ignoring interaction, both the latitude coefficient and the depth coefficient were negative and highly significant ( $P < 0.001$ ). Aver-

aged over both years, mean size decreased by 6.2 mm for males and by 4.6 mm for females for each 1 degree increase in latitude, and mean size decreased by 7.9 mm for males and by 6.2 mm for females with each 100 m increase in depth.

The latitudinal decrease in size probably reflects a latitudinal decrease in growth rate. Two shallow-water Bering Sea crabs, *Chionoecetes bairdi* and *C. opilio*, also show a latitudinal decrease in size, and this decrease was correlated with a latitudinal decrease in maximum summer water temperature (Somerton 1981a). Although we lack sufficient temperature data from the depths inhabited by golden king crab to allow a statistical test, it is likely that mean annual bottom temperature also decreases

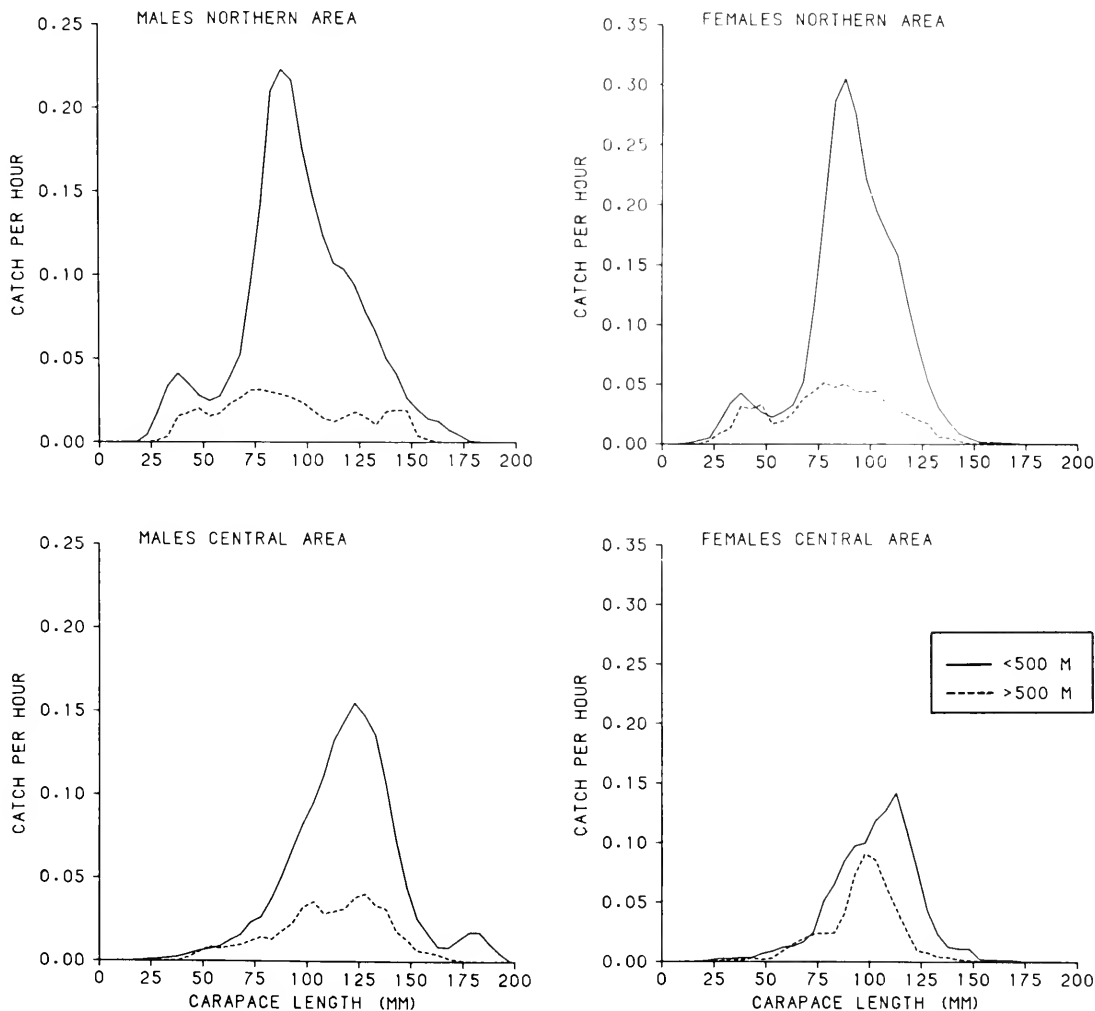

FIGURE 2.—Size-frequency histograms for males and females of golden king crab, by depth strata and subarea. Due to differences in the sampling intensity with depth (Table 2), frequencies have been standardized to catch per hour of trawling.

with increasing latitude along the slope. If this is true, then it is reasonable to assume that growth rates are lower in higher latitudes. Part of the latitudinal decrease in mean size, however, is due to the greater relative abundance of small (25-50 mm) crabs in the northern area (Fig. 2). Since we have only two years of data, we do not know if the greater abundance of small crabs in the northern area is a persistent feature of the distribution. But if it is, it may indicate that greater larval settlement occurs in the northern area because of the advection of larvae by the northwesterly currents over the continental slope (Kinder and Schumacher 1981).

The decrease in size with depth may reflect an ontogenetic upslope migration. Another slope dwelling crab, *Chionoecetes tanneri*, also displays a decrease in size with depth, and this was attributed to an offshore advection of pelagic larvae followed by an onshore migration of juveniles (Pereyra 1968). Although an onshore migration might explain the size variation with depth of golden king crab in the eastern Bering Sea, offshore advection depends on local oceanographic conditions and may not occur everywhere ovigerous golden king crab occur. For example, studies of golden king crab in other areas indicated that adults could be found in shallower water than juveniles (Hiromoto and Sato 1970), or at similar depths as juveniles but in different areas (Rodin 1970) or in deeper water than juveniles (N. Sloan<sup>4</sup>).

### Size at Maturity

The change in the relative growth of a male's chela which occurs at maturity is more pronounced for golden king crab than it is for either blue king crab (Somerton and MacIntosh 1983) or red king crab (Somerton 1980), and this allows greater precision in the estimates of size at maturity (Fig. 3). Nevertheless, the estimates of male size at maturity are less precise than those for females (Fig. 4). For both sexes, however, the estimated sizes at maturity differ significantly between areas and progressively decrease with increasing latitude (Fig. 4).

The decrease in the size at maturity is consistent with a latitudinal decrease in growth rate; however, the decrease is greater for males than it is for females (Fig. 4). If golden king crab are similar to red king crab (Weber 1967) in that males and females grow identically while they are immature,

then the greater latitudinal decrease in male size at maturity implies that female age at maturity increases, relative to that of males, with latitude. This could occur if females and males have different life history strategies to maximize their reproductive values (Bell 1980). The reproductive value of a female is largely determined by her lifetime fecundity. Since fecundity increases markedly with size and somatic growth decreases abruptly at maturity, under conditions of reduced growth, female reproductive value might be increased by delaying maturity until some optimum size is reached. The reproductive value of a male, however, is largely determined by the number of females he is able to mate with over his lifetime. Unless access to females is strictly limited to the largest males, male reproductive value is unlikely to be increased by delaying maturity. Along a gradient of decreasing growth rate, such strategies would lead to a divergence between male and female sizes and ages at maturity.

### Weight at Size

Weight-size relationships of males were determined for each of the three subareas by regressing body weight on carapace length after transforming both variables to natural logarithms. Analysis of covariance showed that the slopes of the regression lines were not significantly different ( $F = 0.49$ ,  $df = 2, 1,079$ ,  $P = 0.613$ ), but that the intercepts were significantly different between areas ( $F = 19.03$ ,  $df = 2, 1,081$ ,  $P < 0.001$ ). Pairwise  $t$ -tests further showed that the intercept for each area differed significantly from the other two (Bonferroni critical values; maximum  $P < 0.05$ ) and that the intercepts progressively increased with increasing latitude. Males in higher latitudes are therefore proportionately heavier than equal-sized males from lower latitudes.

This proportionate change in weight with latitude might be due to changes in body shape, such as the relative size of the chelae, that are coincident with the onset of maturity. Since the rate of chela growth increases, relative to carapace growth, at maturity, and since the size at maturity decreases with latitude, mature males in northern areas should have larger chelae than equal-sized males in southern

FIGURE 3.—For the golden king crab males, chela heights, carapace lengths, and the best fitting two line model are shown for each subarea. For the females, percentage mature, within 5 mm size intervals, and the fitted logistic equation are shown for each subarea. Estimated sizes (carapace length) at maturity are indicated by dotted lines.

<sup>4</sup>N. Sloan, Department of Fisheries and Oceans, Pacific Biological Station, Nanaimo, British Columbia, V9R 5K6, Canada, pers. commun. 1984.

MALE

FEMALE

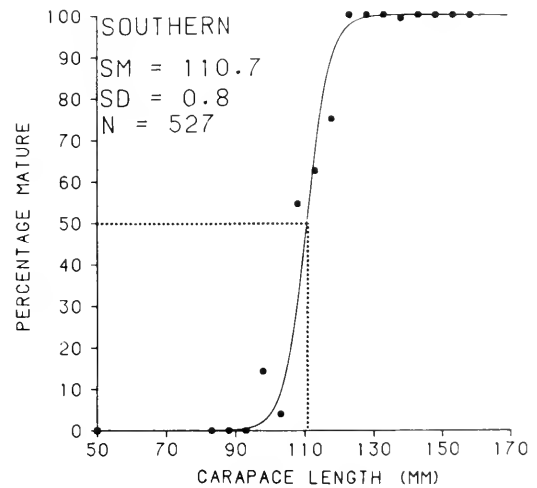
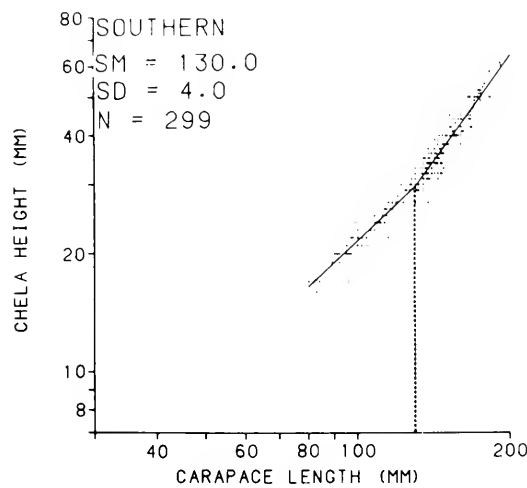
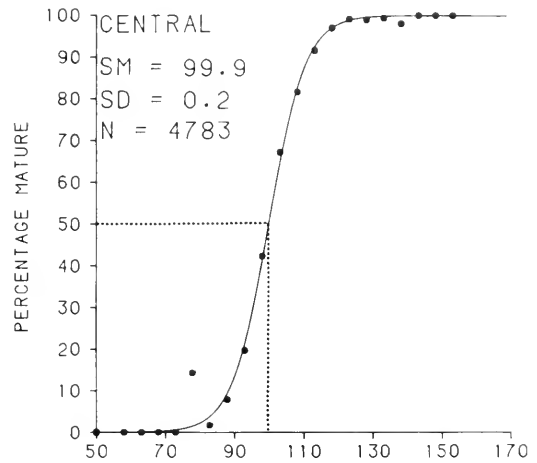
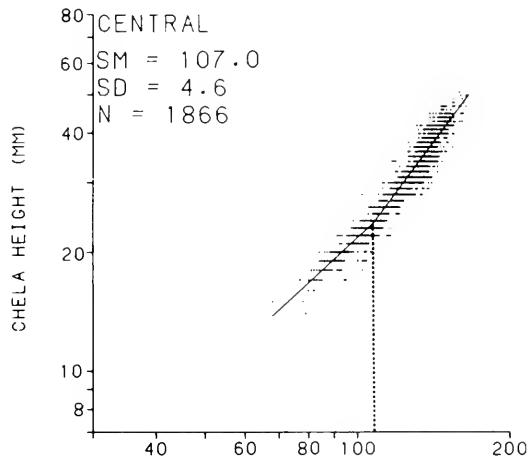
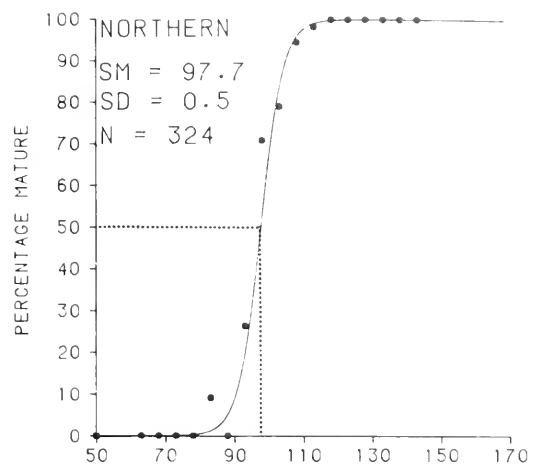
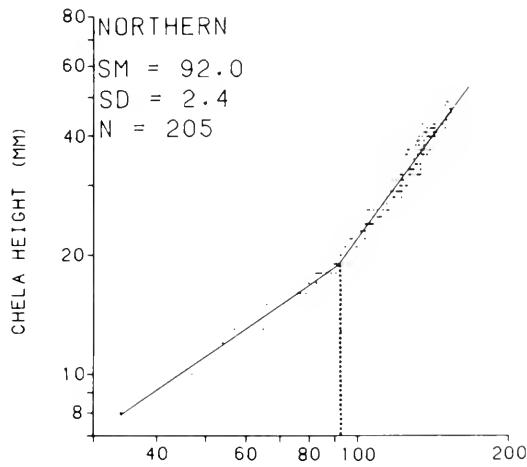

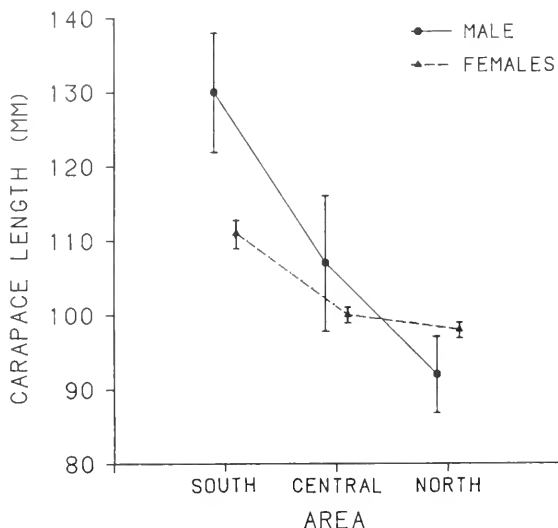

FIGURE 4.—For both sexes of golden king crab, estimated sizes at maturity, and their 95% confidence intervals, are plotted against area.

areas. To test whether this is true, chela height and carapace length relationships for adult males were compared between areas. Analysis of covariance showed that the slopes did not differ ( $F = 0.14$ ,  $df = 2$ ,  $1,998$ ,  $P = 0.87$ ), but the intercepts differed significantly ( $F = 146.7$ ,  $df = 2$ ,  $2,000$ ,  $P < 0.001$ ). Pairwise  $t$ -tests further showed that each intercept differed significantly (Bonferroni critical values; maximum  $P < 0.05$ ) from the other two and, similar to the weight-size relationships, that the intercepts progressively increased with latitude. Thus northern males, which are the heaviest, have the largest chelae.

By itself, chela size is unlikely to be responsible for latitudinal differences in weight because chela weight is only a small proportion of total body weight. However, chela size may be correlated with other body dimensions (for example, length of walking legs) that also increase relative to carapace length at maturity. We therefore used chela height as a proxy for these dimensions and examined whether the difference in chela height could account for the difference in weight-size relationships. This was done by comparing the weight-size relationships between areas including the logarithm of chela height as a covariate. Two additional modifications of the previous weight-size comparison were made. First, since weights and chela measurements were not obtained from the same crabs in the southern area, the comparison was restricted to the northern and central areas. Second, since chela height and

carapace length are linearly related only over the adult (or juvenile) size range, the comparison was restricted to males greater than the size at maturity in each area. When the northern ( $N = 129$ ) and central ( $N = 614$ ) areas were compared considering only carapace length as a covariate, the slopes were not significantly different ( $F = 0.06$ ,  $df = 2$ ,  $739$ ,  $P = 0.81$ ), but the intercepts were significantly different ( $F = 7.36$ ,  $df = 1$ ,  $740$ ,  $P = 0.007$ ). When chela height was included as a covariate, however, neither the slopes ( $P = 0.316$ ) nor the intercepts ( $P = 0.430$ ) differed significantly between areas. This indicates that latitudinal changes in chela size, and perhaps other body measurements that also increase at maturity, account for the observed latitudinal increase in body weight.

Juvenile weight-size relationships were also compared between the northern ( $N = 10$ ) and central ( $N = 207$ ) areas and neither the slopes ( $F = 0.06$ ,  $df = 1$ ,  $213$ ,  $P = 0.938$ ) nor the intercepts ( $F = 0.19$ ,  $df = 1$ ,  $214$ ,  $P = 0.664$ ) were significantly different. The weight-size relationship for male golden king crabs is therefore described by one equation for juveniles and three equations for adults. Transformed back to a linear scale, these relationships are

Juveniles	$W = 0.000365 \text{ CL}^{3.099}$	( $N = 217$ , $R^2 = 0.88$ )
Adults		
Northern	$W = 0.000225 \text{ CL}^{3.206}$	( $N = 139$ , $R^2 = 0.93$ )
Central	$W = 0.000219 \text{ CL}^{3.206}$	( $N = 632$ , $R^2 = 0.91$ )
Southern	$W = 0.000204 \text{ CL}^{3.206}$	( $N = 100$ , $R^2 = 0.91$ )

where  $W$  is body weight in grams and  $CL$  is carapace length in millimeters. Within the adult size range, males from the northern area are 10.3% heavier and males from the central area are 9.8% heavier than equal-sized males from the southern area.

### Relative Abundance and Proportion Male

Relative abundance, or catch per hour (CPH), based on combined 1981 and 1982 observer data, is shown by sex, latitude, and depth in Figure 5. Linear trends in CPH with depth and latitude were examined statistically using multiple regression (depth and latitude were considered simultaneously; interaction was ignored). The latitude coefficient for males was not significant ( $P > 0.05$ ) in either year, but the latitude coefficient for females was positive and highly significant ( $P < 0.01$ ) in both years. The depth coefficient for males was negative



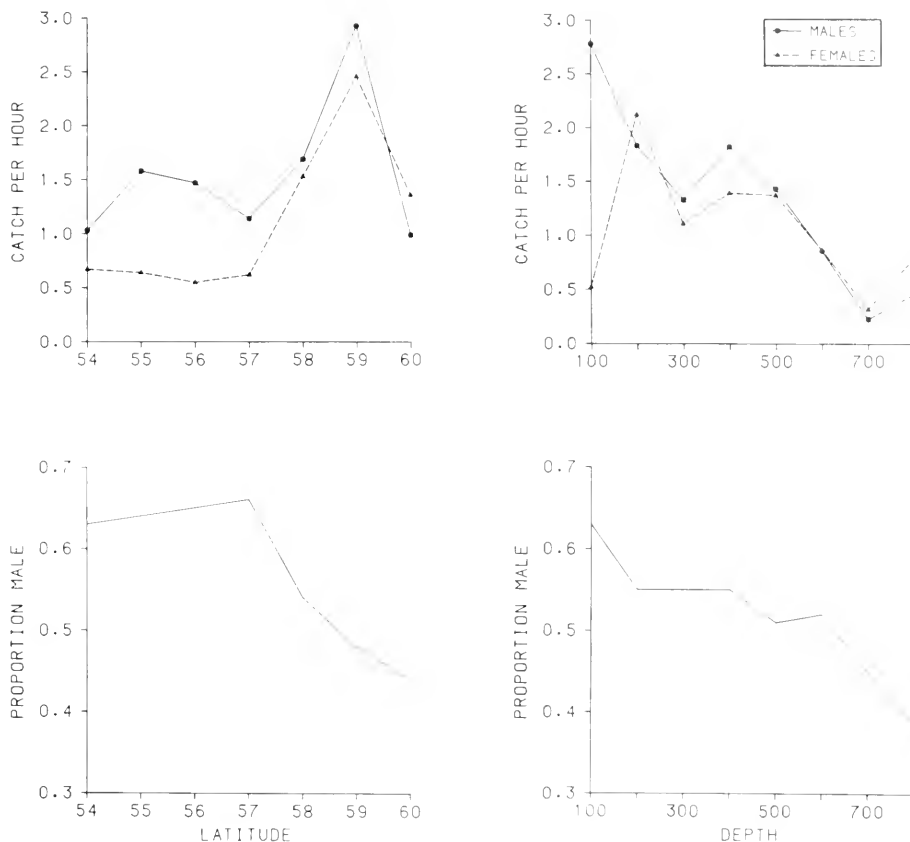

FIGURE 5.—Catch per hour, by sex, and the proportion of males of golden king crab are shown as a function of latitude (left panels) and depth (right panels).

and highly significant in both years ( $P < 0.01$ ), but the depth coefficient for females, although negative in both years, was significant ( $P < 0.05$ ) in only one. Although male CPH decreases significantly with depth whereas female CPH decreases significantly with latitude, CPH is not a strict linear function of depth and latitude; therefore, linear approximations mask aspects of the variability. The important point is that both male and female CPH generally increase with an increase in latitude or a decrease in depth, but at more southerly latitudes or at the shallowest depth, male CPH is considerably higher than female CPH (Fig. 5).

Different trends in CPH between sexes suggested that the sex ratio of golden king crab varied spatially. To investigate this further we examined the variation in proportion of males within trawl hauls having at least five crabs. The proportion of males, based on combined 1981 and 1982 observer data, is shown by latitude and depth in Figure 5. When the proportion of males was regressed against

latitude and depth (using weights equal to the number of crabs within each trawl haul), the latitude coefficient was negative and highly significant ( $P < 0.01$ ) in both years; and the depth coefficient, although negative in both years, was significant ( $P < 0.05$ ) in only one.

From a biological perspective, the latitudinal decrease in the proportion of males is difficult to explain; therefore, we considered possible sampling bias that could lead to an apparent change in the proportion of males. Since males are considerably larger than females in the central area but nearly the same size as females in the northern area, the proportion of males might vary with latitude due to size selectivity of the trawls. This hypothesis was tested by comparing the proportion of males between the northern and central areas considering only crabs within an equal size range. To eliminate a possible confounding effect due to a sexual difference in growth rate that begins at maturity, we restricted the comparison to crabs  $< 90$  mm. Based

on the combined 1981 and 1982 observer data, the proportion of males was 0.51 ( $N = 1,375$ ) in the central area and 0.43 ( $N = 8,271$ ) in the northern area. Since the proportion of males still differed significantly between areas ( $2 \times 2$  contingency table,  $\chi^2 = 30.7$ ,  $df = 1$ ,  $P < 0.001$ ), it is unlikely that the change in the proportion of males was due to size selectivity. Furthermore, since the difference in the proportion of males appears to be established before maturity, biological explanations such as sexual differences in migratory behavior or natural mortality are also unlikely.

Although we cannot explain the latitudinal variation in the proportion of males, we believe that the depth variation, especially the abrupt increase in the proportion of males in the shallowest depth zone, is due to sexual segregation. Sexual segregation by depth has been observed for another slope-dwelling crab, *C. tanneri* (Pereyra 1966). Adult female *C. tanneri* occur within a rather narrow depth zone throughout the year while adult males undergo a seasonal migration from relatively shallow water in summer to the deeper water occupied by females during the winter mating period. To determine if golden king crab have a similar seasonal migration, we examined the proportion of males from the northern area at depths  $< 400$  m (the northern area had nearly equal sampling in all four seasons). Using pooled 1981 and 1982 data, analysis of variance showed that the proportion of males did not vary significantly between seasons ( $F = 0.13$ ,  $df = 3, 179$ ,  $P > 0.05$ ). Although adult males of golden king crab probably congregate in somewhat shallower water than adult females, unlike *C. tanneri* this segregation appears to be maintained throughout the year.

## REPRODUCTIVE BIOLOGY

### Fecundity

Fecundity-size relationships for golden king crab were estimated stagewise by examining 1) the form of the relationship, 2) whether the relationships varied with stage of embryo development, and 3) whether the relationships varied between areas.

The fecundity of king crabs has been reported to increase as either a linear (Haynes 1968) or a curvilinear (Somerton 1981b) function of carapace length. To determine which form was more appropriate for golden king crab, a second degree polynomial was fitted to the fecundity and size data from the northern area (all clutches contained uneyed embryos) and the coefficient of the quadratic term was tested for

significance. Since the coefficient was not significantly different from zero ( $F = 3.85$ ,  $df = 1, 57$ ,  $P = 0.06$ ), we chose a linear relationship to describe the data.

Fecundity-size relationships for females with uneyed embryos ( $N = 46$ ) and eyed embryos ( $N = 19$ ) from the central area were compared to determine whether the relationships changed with stage of embryo development. Analysis of covariance showed that the slopes did not differ ( $F = 0.77$ ,  $df = 1, 61$ ,  $P = 0.38$ ) but that the intercept for eyed embryos was significantly less ( $F = 4.89$ ,  $df = 1, 62$ ,  $P = 0.03$ ) than that for uneyed embryos. At 114 mm, the median size of adult females in all areas combined, uneyed clutches were 18% greater than eyed clutches. Similar to other crab species (Wear 1974), golden king crab lose a significant number of embryos between egg extrusion and the appearance of embryonic eyes.

Fecundity-size relationships were then compared between the northern ( $N = 59$ ), central ( $N = 46$ ), and southern ( $N = 24$ ) areas considering only those clutches with uneyed eggs. Analysis of covariance showed that the slopes did not differ ( $F = 0.74$ ,  $df = 2, 123$ ,  $P = 0.48$ ), but the intercepts differed significantly between areas ( $F = 4.38$ ,  $df = 2, 125$ ,  $P = 0.01$ ). Pairwise  $t$ -tests indicated that southern and central intercepts did not differ ( $P = 0.99$ ) from each other, but that both differed significantly ( $P = 0.01$ ,  $P = 0.04$ ) from the northern intercept. Data from the southern and central areas were therefore pooled and compared with those from the northern area. Again, the slopes did not differ ( $F = 1.25$ ,  $df = 1, 125$ ,  $P = 0.27$ ), but the northern intercept was significantly greater ( $F = 8.83$ ,  $df = 1, 126$ ,  $P = 0.004$ ) than the pooled central and southern intercept. Assuming equal slopes, the resulting fecundity-size relationships are

Northern	$E = -24815 + 323 \text{ CL}$ ( $N = 59, R^2 = 0.79$ )
Central-southern	$E = -26145 + 323 \text{ CL}$ ( $N = 68, R^2 = 0.74$ )

where  $E$  is number of uneyed eggs and CL is carapace length in millimeters. Females from the northern area carry, on average, 1,330 more eggs than equal-sized females from the central and southern areas. For 114 mm females, this represents a 12.6% difference in fecundity.

Northern females may be more fecund than equal-sized central and southern females because they are older and size-specific fecundity often increases with age (Pianka and Parker 1975). But, it is also likely

that the observed difference in fecundity is an artifact due to a difference in mean embryo age. We attempted to eliminate the effect of embryo age by considering only clutches with uneyed embryos, but this may not have been a sufficiently sensitive criterion of age and northern females could have had more embryos simply because they had younger embryos. Considering that for equal-sized females the percent difference in clutch size between eyed and uneyed stages was greater than the percent difference in clutch size between areas, it is possible that the loss of embryos within the uneyed stage is sufficient to account for between-area differences. More precise embryo aging techniques are needed to clarify this.

### Egg Size

To estimate the size of golden king crab eggs, we considered 1) whether egg size varied with stage of embryo development and 2) whether egg size varied between areas. When mean lengths of uneyed eggs ( $N = 42$ ) and eyed eggs ( $N = 26$ ) from the central area were compared, eyed eggs were found to be significantly larger than uneyed eggs (two sample  $t$ -test,  $P < 0.001$ ). Golden king crab eggs therefore appear to increase in size, as has been reported for other crab species (Wear 1974), during embryonic development. When mean length of uneyed eggs from the southern ( $N = 25$ ) and central ( $N = 42$ ) areas (no egg length data was collected from the northern area) were compared, no significant difference was found (two sample  $t$ -test,  $P = 0.25$ ). Mean length of uneyed eggs, based on the pooled central and southern data, is 2.2 mm (SD = 0.1).

Our estimate of egg length is similar to those reported for Asian populations of golden king crab (2.38 mm, Hiramoto and Sato 1970; 2.30 mm, Suzuki and Sawada 1978), and it is also similar to egg lengths reported for other *Lithodes* species (*L. antarctica*, 2.2 mm, Guzman and Campodonico 1972; *L. couesi*, 2.3 mm, Somerton 1981b). However, this size is more than twice as large as the egg lengths reported for *Paralithodes* species (*P. camtschatica*, 1.0 mm, Haynes 1968; *P. platypus*, 1.2 mm, Sasaki and Sawada 1975). The larger eggs of golden king crab are, in turn, reflected in the relatively large size of their first stage zoea (*L. aequispina*, 7.3 mm TL, Haynes 1981; *P. camtschatica*, 4.6 mm TL, Sato and Tanaka 1949; *P. platypus*, 4.9 mm TL, Hoffman 1968). The larger size of *L. aequispina* larvae may allow them to withstand starvation for a longer period or may allow them to capture a wider size range of prey

than *Paralithodes* larvae. If this is true, golden king crab larvae may not need to ascend to the photic zone but instead stay at greater depths. Evidence supporting this hypothesis is provided by a study on crab larvae that sampled the upper 50 m near the edge of the eastern Bering sea continental shelf (Fig. 1). Although both *P. platypus* and *P. camtschatica* larvae were found, *L. aequispina* larvae were not (D. Armstrong<sup>5</sup>).

### Seasonality of Reproduction

King crabs either can be synchronous and seasonal in their egg extrusion and embryo hatching, as reported for *P. camtschatica* (Powell et al. 1973), or they can be asynchronous and lack seasonal periodicity, as reported for *L. couesi* (Somerton 1981b). To determine which pattern better characterizes golden king crab, we tabulated the percentage of mature females in each of the three reproductive conditions by area and by quarter (Table 3). If the reproductive cycle were synchronous and seasonal, then each of the three categories of reproductive condition should predominate sequentially over the course of a year, but such a pattern is not evident. Regardless of the area or the season in which a sample was collected, all three reproductive categories were always obtained. This suggests that golden king crab have an asynchronous reproductive cycle lacking distinct seasonal variation.

TABLE 3.—Percentage of adult females in each of three categories of reproductive condition: 1) uneyed embryos, 2) eyed embryos, and 3) empty egg cases, and total sample size ( $N$ ) by subarea and quarter.

Quarter	South				Central				North			
	1	2	3	$N$	1	2	3	$N$	1	2	3	$N$
1	55	33	12	67	50	8	42	12				
2					28	63	9	1,307				
3					14	36	50	1,399	78	3	19	224
4	28	67	5	384	61	16	23	859				

The apparent lack of seasonality conflicts with previous studies of golden king crab reproduction. Hiramoto and Sato (1970) reported that egg extrusion occurs from July to October and embryo hatching occurs from February to July along central Japan. However, Hiramoto and Sato found embryos in late stages of development throughout the year,

<sup>5</sup>D. Armstrong, College of Fisheries, University of Washington, Seattle, WA 98195, pers. commun. 1984.

indicating that embryo hatching was probably occurring at times other than the peak season. Rodin (1970) reported that egg extrusion occurs from August to September based on the relatively high incidence of recently molted females with new embryos. However, Rodin based this on only one summer sample and some of our samples, especially those from the northern area, if examined alone would have also incorrectly led to the same conclusion. Our findings, however, are consistent with those for other deep water crabs (*L. couesi*, Somerton 1981b; *Geryon quinquedens*, Haefner 1978) which have asynchronous or protracted spawning.

Asynchronous spawning is also consistent with two of our other observations. First, the larvae of golden king crab, due to their large size and presumably deep habitat, should be relatively insensitive to seasonal changes in primary production. Second, adult males and females of golden king crab appear to segregate by depth and this segregation appears to be maintained throughout the year. Such year-round sexual segregation is unlikely for a seasonally reproducing species; however, it is consistent with an asynchronous reproducing species if only the reproductively active individuals migrate between depth zones.

## IMPLICATIONS FOR FISHERY MANAGEMENT

Two of our findings, the latitudinal decrease in the size at maturity and the asynchronous reproductive cycle, pertain to regulations used to manage the golden king crab fisheries in Alaska.

Commercial harvest of king crabs is restricted to males larger than a minimum legal size (maximum carapace width including spines) which is specified for each species in each management area. These minimum sizes are set at the average size of a male three years after reaching maturity based on the rationale that such a size would preserve sufficient males for breeding even when the exploitation rate is high (North Pacific Fishery Management Council 1981). Thus, to establish a minimum size limit that conforms to this rule, both an estimate of the size at maturity and an estimate of male growth rate are needed. Unfortunately, we lack sufficient data to estimate the growth rates of golden king crab in any of the three management areas considered here and therefore cannot determine appropriate minimum size limits. However, our estimates of male size at maturity can be used to judge, in a qualitative sense, the adequacy of the current minimum size limits. These size limits and the estimated sizes at matur-

ity, expressed in terms of carapace length, are as follows:

	<i>Minimum size limit</i> (mm CL)	<i>Size at maturity</i> (mm CL)
Northern area	123	92
Central area	123	107
Southern area	134	130

The current minimum size limits decrease with increasing latitude, but not in proportion to the estimated sizes at maturity. Based solely on the relative magnitude of our estimates, we believe that the current minimum size limit in the southern area, and perhaps in the central area as well, is too low. However, we believe that the prolonged or year-round breeding of golden king crab would allow males more opportunities for mating than would be possible with a short breeding season; therefore, relative to seasonally breeding king crabs, fewer males would be sufficient for the breeding needs of the population. If this is true, then minimum size limits based on the criteria established for red and blue king crabs may be unnecessarily conservative for golden king crab.

Commercial harvest of king crabs is also restricted to a legal fishing season specified for each species in each area. Although economic or logistic factors are considered when fishing seasons are established, of primary importance is the timing of the breeding and molting seasons. During the breeding season, females molt while aggregated together with the males (Powell et al. 1973); and if fishing were permitted at this time, not only would females be caught in greater numbers, they would also be injured by the fishing gear. During and soon after the male molting season, the recovery rate (ratio of recoverable meat to total body weight) is low; and if fishing were permitted at this time, the value of the crabs would also be low. Since the breeding seasons tend to occur in the late winter and early spring and the male molting seasons occur in late spring, the fishing seasons usually begin in the fall. For golden king crab, however, there is no clear seasonality in breeding; and adult males and females appear to be spatially segregated throughout the year. Although we lack sufficient data to determine if there is any seasonality in male molting, it appears that there is no compelling biological reason to restrict the golden king crab fisheries to any particular time of the year. Therefore, we believe that, at present, fishing seasons should be determined primarily by what is most convenient or beneficial to fishermen and processors.

## ACKNOWLEDGMENTS

We thank Peter Cummiskey, Steven Meyers, and Kenneth Cronk (NMFS, Kodiak) for providing invaluable assistance in both field and laboratory data collection; David Stanchfield (FV *Morning Star*), Joe Wabey (FV *American Eagle*), Scott Bowlden (FV *Valiant*), Edward Compton (FV *Valiant*), John Atwell (RV *Miller Freeman*), and Edward Gelb (RV *Miller Freeman*) for their cooperation and expertise in the operation of the research vessels; Kevin Bailey, James Balsiger, Nicholas Bax, Robert Francis, and Nancy Pola for providing helpful reviews of the manuscript. In addition, we express our gratitude to Dennis Peterson, Barry Collier and the North Pacific Fishing Vessel Owner's Association for arranging and supporting the charter of the FV *American Eagle*.

## LITERATURE CITED

- ALASKA DEPARTMENT OF FISH AND GAME (ADFG).  
1983. Commercial shellfish regulations. Alas. Dep. Fish Game, Juneau, AK, 111 p.
- BARTLETT, M. S.  
1947. The use of transformations. *Biometrics* 3:39-52.
- BELL, G.  
1980. The costs of reproduction and their consequences. *Am. Nat.* 116:45-76.
- BENEDICT, J. E.  
1895. Scientific results of explorations by the U.S. Fish Commission Steamship Albatross No. XXXI: Descriptions of new genera and species of crabs of the family Lithodidae with notes on the young of *Lithodes camtschatica* and *Lithodes brevipes*. *Proc. U.S. Natl. Mus.* 17:479-488.
- BUTLER, T. H., AND J. F. L. HART.  
1962. The occurrence of the king crab *Paralithodes camtschatica* (Tilesius), and of *Lithodes aequispina* Benedict in British Columbia. *J. Fish. Res. Board Can.* 19:401-408.
- EFRON, B., AND G. GONG.  
1983. A leisurely look at the bootstrap, the jackknife and cross validation. *Am. Stat.* 37:36-48.
- GUZMAN, L. M., AND I. G. CAMPODONICO.  
1972. Fecundidad de la centolla *Lithodes antarctica* Jacquinot (Crustacea, Decapoda, Anomura: Lithodidae). *Ans. Inst. Pat. (Punta Arenas, Chile)* 3:249-258.
- HAEFNER, P. A., JR.  
1978. Seasonal aspects of the biology, distribution and relative abundance of the deep-sea red crab, *Geryon quinquedens* Smith, in the vicinity of the Norfolk Canyon, western North Atlantic. *Proc. Natl. Shellfish. Assoc.* 68: 49-62.
- HAYNES, E. B.  
1968. Relation of fecundity and egg length to carapace length in the king crab, *Paralithodes camtschatica*. *Proc. Natl. Shellfish. Assoc.* 58:60-62.  
1981. Description of larvae of the golden king crab, *Lithodes aequispina*, reared in the laboratory. *Fish. Bull., U.S.* 80: 305-313.
- HIRAMOTO, K., AND S. SATO.  
1970. Biological and fisheries survey on an anomuran crab, *Lithodes aequispina*, off Boso Peninsula and Sagami Bay, central Japan. *Jpn. J. Ecol.* 20:165-170.
- HOFFMAN, E. G.  
1968. Description of laboratory-reared larvae of *Paralithodes platypus* (Decapoda, Anomura, Lithodidae). *J. Fish. Res. Board Can.* 25:439-455.
- KINDER, T. H., AND J. D. SCHUMACHER.  
1981. Circulation over the continental shelf of the South-eastern Bering Sea. In D. W. Hood and J. A. Calder (editors), *The eastern Bering Sea shelf: Oceanography and resources*, Vol. 1. p. 53-75. U.S. Gov. Print. Off., Wash., DC.
- MAKAROV, V. V.  
1938. Rakoobraznye, Anomura (Crustacea, Anomura). [In Russ.] *Akad. Nauk SSSR, Zool. Inst. Fauna SSSR* 10(3), N.S. 16, 325 p. Izd. Akad. Nauk SSSR, Moscow-Leningrad. [Transl. by Israel Program Sci. Transl., 1962, 283 p., available from U.S. Dep. Commer., Natl. Tech. Inf. Serv., Springfield, VA, as OTS 60-21822.]
- McNAIR, D.  
1983. The new king crabbing: How much harder can this fishery get? *Pac. Fish.* 4:50-53.
- MILLER, R. J.  
1976. North American crab fisheries: regulations and their rationales. *Fish. Bull., U.S.* 74:623-633.
- NELSON, R., JR., R. FRENCH, AND J. WALL.  
1981. Sampling by U.S. observers on foreign fishing vessels in the eastern Bering Sea and Aleutian Island region, 1977-1978. *Mar. Fish. Rev.* 43(5):1-19.
- NORTH PACIFIC FISHERY MANAGEMENT COUNCIL.  
1981. Bering Sea/Aleutian Islands king crab fishery management plan. North Pacific Fishery Management Council, Anchorage, AK, 35 p.
- PEREYRA, W. T.  
1966. The bathymetric and seasonal distribution, and reproduction of adult tanner crabs, *Chionoecetes tanneri* Rathbun (Brachyura: Majidae), off the northern Oregon coast. *Deep-Sea Res.* 13:1185-1205.  
1968. Distribution of juvenile tanner crabs, *Chionoecetes tanneri* Rathbun, life history model and fisheries management. *Proc. Natl. Shellfish. Assoc.* 58:66-70.
- PIANKA, E. R., AND W. S. PARKER.  
1975. Age-specific reproductive tactics. *Am. Nat.* 109: 453-464.
- POWELL, G. C., B. SHAFFORD, AND M. JONES.  
1973. Reproductive biology of young adult king crabs *Paralithodes camtschatica* (Tilesius) at Kodiak, Alaska. *Proc. Natl. Shellfish. Assoc.* 63:77-87.
- RODIN, V. E.  
1970. Novye dannye o ravnoshpim krabe (New data on the golden king crab). [In Russ.] *Rybn. Khoz.* 46:11-13. [Transl. by S. Pearson, 1982, 7 p.; available from Northwest and Alaska Fisheries Center, National Marine Fisheries Service, NOAA, 2725 Montlake Blvd. E., Seattle, WA 98112.]
- SASAKAWA, Y.  
1975. Studies on blue king crab resources in the western Bering Sea III ovarian weights, egg numbers carried and diameters. *Bull. Jpn. Soc. Sci. Fish.* 41:941-944.
- SATO, S., AND S. TANAKA.  
1949. Study on the larval stage of *Paralithodes camtschatica* (Tilesius) I. Morphological research. [In Jpn.] *Hokkaido Fish. Exp. Stn. Res. Rep.* 1:7-24. [Transl. by I. M. Nakatsu, U.S. Fish Wildl. Serv., Seattle Biol. Lab., 1968, 24 p.; available from Northwest and Alaska Fisheries Center, National Marine Fisheries Service, NOAA, 2725 Montlake Blvd. E., Seattle, WA 98115.]

- SLIZKIN, A. G.  
 1974. Osobennosti raspredeleniya krabov (Crustacea, Decapoda, Lithodidae et Majidae) v beringovom more (Specifics of the distribution of crabs (Crustacea, Decapoda, Lithodidae and Majidae) in the Bering Sea). Bonitet mirovogo okeana (Estimated productivity of the world ocean), part 5. [In Russ.] Tr. Vses. Nauchno-Issled. Inst. Morsk. Rybn. Khoz. Okeanogr. 99:28-37. [Transl. by A. L. Peabody, 11 p., available from Northwest and Alaska Fisheries Center, National Marine Fisheries Service, NOAA, 2725 Montlake Blvd. E., Seattle, WA 98112.]
- SOMERTON, D. A.  
 1980. A computer technique for estimating the size of sexual maturity in crabs. Can. J. Fish. Aquat. Sci. 37:1488-1494.  
 1981a. Regional variation in the size of maturity of two species of tanner crab (*Chionoecetes bairdi* and *C. opilio*) in the eastern Bering Sea, and its use in defining management subareas. Can. J. Fish. Aquat. Sci. 38:163-174.  
 1981b. Contribution to the life history of the deep-sea king crab, *Lithodes couesi*, in the Gulf of Alaska. Fish. Bull., U.S. 79:259-269.
- SOMERTON, D. A., AND R. A. MACINTOSH.  
 1983. The size at sexual maturity of blue king crab, *Paralithodes platypus*, in Alaska. Fish. Bull., U.S. 81:621-628.  
 1985. Reproductive biology of the female blue king crab, *Paralithodes platypus* near the Pribilof Islands, Alaska. J. Crustacean Biol. 5:365-376.
- SUZUKI, Y., AND T. SAWADA.  
 1978. Notes on an anomuran crab, *Lithodes aequispina* Benedict, in Suruga Bay. Bull. Shizuoka Prefect. Fish. Exp. Stn. 12:1-10.
- WALLACE, M., C. J. PERTUIT, AND A. R. HVATUM.  
 1949. Contribution to the biology of the king crab, *Paralithodes camtschatica*. U.S. Fish Wildl. Serv., Fish. Leaflet. 340, 50. p.
- WEAR, R. G.  
 1974. Incubation in British decapod crustacea, and the effects of temperature on the rate and success of embryonic development. J. Mar. Biol. Assoc. U.K. 54:745-762.
- WEBER, D. G.  
 1967. Growth of the immature king crab, *Paralithodes camtschatica* (Tilesius). Int. North. Pac. Fish. Comm., Bull. 21:21-53.

# A MODEL OF THE DRIFT OF NORTHERN ANCHOVY, *ENGRAULIS MORDAX*, LARVAE IN THE CALIFORNIA CURRENT

JAMES H. POWER<sup>1</sup>

## ABSTRACT

The drift of northern anchovy, *Engraulis mordax*, larvae in the California Current to unfavorable offshore areas may be an important factor contributing to larval mortality, and hence it may affect recruitment and subsequent adult population size. A simulation model based on a finite-difference approximation to the advection-diffusion equation was developed to aid in the study of larval anchovy drift. Model components included the long-term mean geostrophic and wind-driven current velocities to 50 m depth, and turbulent diffusion. The model predicted larval distributions in the Southern California Bight and offshore regions after 30 days of drift, and these distributions were used to assess the extent of cross-shore and alongshore larval transport that occurs when spawning takes place at different locations, seasons, and during times of increased offshore-directed Ekman transport.

Offshore transport was minimal in most simulations. Simulations of drift starting from the location of peak spawning showed strongest seasonal effects, with currents during the season of peak northern anchovy spawning (March) resulting in reduced offshore dispersal when compared with currents at other times of the year. March currents also produced the greatest downshore (southeasterly) transport of larvae, and strong seasonal currents, such as the nearshore, northwesterly flowing California Counter-current, can greatly affect the alongshore 30-day larval distributions. Offshore directed Ekman transport, associated with upwelling, does not strongly affect the drift of larvae in the nearshore region, but large increases in overall Ekman transport, or extension of spawning into offshore regions, can result in significant seaward transport of larvae out of the Southern California Bight.

The total population of northern anchovy, *Engraulis mordax*, a common pelagic fish off the west coast of North America, is comprised of three subpopulations (Vrooman et al. 1981): northern (found north of lat. 36°30'N); central (between lat. 29° and 38°N); and southern (south of lat. 29°N). The central subpopulation inhabits the Southern California Bight region, and in recent times has exhibited substantial changes in population biomass (e.g., Smith 1972). Analysis of northern anchovy scales deposited in sediments indicates that large northern anchovy population fluctuations have also occurred in the past few centuries (Soutar and Isaacs 1974). Historically the central subpopulation of northern anchovy has supported a significant fishery (Messersmith and Associates 1969; Sunada 1975; Stauffer and Charter 1982), and although the U.S. fishery has recently declined, there is still a significant Mexican fishery. The northern anchovy fishery, the recent and historical changes in anchovy population size, and the fish's important role in the marine ecosystem all provide the motivation for studying the mechanisms

that may cause interannual variations in northern anchovy stock size.

Such changes in stock size may be a consequence of variations in the previous spawning stock size, or they can also arise as a result of interannual differences in mortality during prerecruit life history stages (Rothschild et al. 1982). Because the egg and larval stages have the highest mortalities, it seems possible that processes affecting the relative mortality during these stages can have a significant effect on subsequent recruitment. Two major causes of larval mortality are starvation and predation (Smith and Lasker 1978; Hunter 1981). A factor that may contribute to these is larval drift. The northern anchovy eggs and larvae, lacking adequate motility, can be involuntarily transported away from nearshore spawning areas. It is the nearshore regions in the Southern California Bight that most frequently contain adequate food concentrations for growth and survival of first feeding northern anchovy larvae (Lasker 1978, 1981).

Although eddies and other short-term mesoscale features are important in the Southern California Bight (Mooers and Robinson 1984; Simpson et al. 1984), the broad and relatively slow equatorward flow termed the California Current is the dominant feature in the region that persists on evolutionary

<sup>1</sup>Southwest Fisheries Center La Jolla Laboratory, National Marine Fisheries Service, NOAA, P.O. Box 271, La Jolla, CA 92038; present address: Coastal Fisheries Institute, Center for Wetland Resources, Louisiana State University, Baton Rouge, LA 70803-7503.

time scales. Hence, it seems plausible that northern anchovy spawning strategies have developed in response to the relatively predictable seasonal and spatial trends in the California Current. Possible relationships between time and location of fish spawning and the currents off the west coast of North America have been discussed by Parrish et al. (1981). They noted that in the Southern California Bight the Ekman (wind-driven) currents are generally diminished relative to other areas along the coast. This reduced offshore transport is favorable for the retention of fish eggs and larvae. However, some weak offshore directed Ekman transport is consistently present in the Southern California Bight year round (Nelson 1977; Parrish et al. 1981; Bakun and Parrish 1982).

Smith (1972) analyzed historical records of northern anchovy larval distribution in the Southern California Bight and found that samples taken farther offshore had a higher proportion of older larvae than that of samples taken nearshore. Assuming a uniform spatial and temporal distribution of spawning, this result implied that a significant fraction of northern anchovy eggs and larvae were transported offshore after nearshore spawning. Bailey (1981) found that the average distance offshore of Pacific hake, *Merluccius productus*, larvae north of Point Conception was positively correlated with offshore Ekman transport and that the magnitude of subsequent Pacific hake recruitment was negatively correlated with offshore transport. Hewitt and Methot (1982) compared the distributions of northern anchovy larvae sampled in 1978 and 1979 and found that the bulk of the larvae in 1979 were farther offshore than those in 1978 and that mortality of 0-group northern anchovy was greater in 1979 when compared with those spawned in 1978. The year 1979 was one of enhanced upwelling and colder temperatures (both concomitants of offshore Ekman transport) relative to 1978.

The studies cited above suggest drift may play an important role in larval ecology, but the conclusions drawn from plankton sampling must be viewed with caution. Inferences drawn from field collections about the drift of larvae usually carry the assumption that both northern anchovy spawning and larval mortality were uniform in space and time, because the time and distance scales involved largely preclude synoptic sampling of eggs and larvae throughout the region. Hence, only correlative explanations for the observed distribution can be made, and other causal factors affecting the larval distribution may be hidden. For example, an observation of greater proportions of older larvae in off-

shore waters could also result from earlier spawning or greater early mortality (possibly coupled with increased spawning activity) in those waters, and not drift. Additionally, the mesoscale variability present in the Southern California Bight and the considerable patchiness of early and late larvae (due to northern anchovy schooling behavior; Hewitt 1980, 1981a) further confound the conclusions drawn from plankton samples and diminish the value of interannual comparisons. Therefore, as an alternative to field studies, a simulation model of northern anchovy drift in the California Current was developed to help evaluate the role of drift in larval ecology. The objective was to use the model to determine the effect of differences in northern anchovy spawning location and time on the subsequent larval distribution and to evaluate the effects on larval distribution when offshore Ekman transport is increased above its normal mean value.

## METHODS

The drift simulation was based on the two-dimensional ( $x, y$ ) form of the advection-diffusion equation:

$$\frac{\partial F}{\partial t} + \frac{\partial}{\partial x} \left( uF - K_x \frac{\partial F}{\partial x} \right) + \frac{\partial}{\partial y} \left( vF - K_y \frac{\partial F}{\partial y} \right) = 0$$

where  $F$  = the concentration of eggs and larvae;  
 $u$  and  $v$  = current velocities in the respective  $x$  and  $y$  directions; and  
 $K_x$  and  $K_y$  = eddy diffusivity coefficients for the  $x$  and  $y$  directions.

An analytical solution to this equation cannot be evaluated relative to northern anchovy larval drift in the California Current, although a numerical approximation that specifies larval concentration as a function of location and time can be determined. This was accomplished by approximating each of the derivatives in the equation by weighted finite-differences, so that the model was algebraically formulated as the current and diffusivity-mediated fluxes of larvae among geographic points in the Southern California Bight. Apart from the assumption that larvae continually maintained themselves in surface waters, the northern anchovy were assumed to be conservative and completely passive drifters, i.e., no mortality or movement due to larval swimming was incorporated into the model. Details of the numerical methods used are presented in Power (1984).

The geographic grid for the model was defined



using the California Cooperative Oceanic Fisheries Investigation (CalCOFI) coordinate system. The CalCOFI grid is a regular coordinate system of cross-shore "lines" and alongshore "stations". The model and CalCOFI grids are oriented with respect to the coast so that increasing station number corresponds to increasing offshore distance and increasing line number implies the downshore (southeasterly) direction. Each line unit increment is spaced 12 nm apart, and each station unit represents 4 nm. The grid for the model was defined to form cells that were 37 km (20 nm) on a side, and the fluxes of larvae were among grid cell centers. Model coverage was from CalCOFI lines 70 to 120, and extended offshore to CalCOFI station 120 (Fig. 1).

Unless northern anchovy utilize a strategy whereby spawning is initiated in response to the presence of an eddy or other short-term mesoscale features, it can reasonably be expected that spawning time

and location have evolved partially in response to predictable current features. For this reason, seasonal currents based on interannual means were used in the model. Northern anchovy spawning behavior relative to eddies, etc., is presently unknown, and there are persistent seasonal trends in spawning, e.g., northern anchovy spawn throughout the year, but March is typically the peak time of spawning (Smith 1972; Methot 1981).

Geostrophic currents for the model were calculated using the geopotential anomalies computed by Lynn et al. (1982). Lynn et al. used CalCOFI data collected between 1950 and 1978 to compute the average geopotential anomaly relative to 500 m for four seasonal periods (nominally January, April, July, and October) at 175 locations in the California Current. Average geopotential anomalies were computed for an additional 23 locations for this study to augment the Lynn et al. (1982) coverage

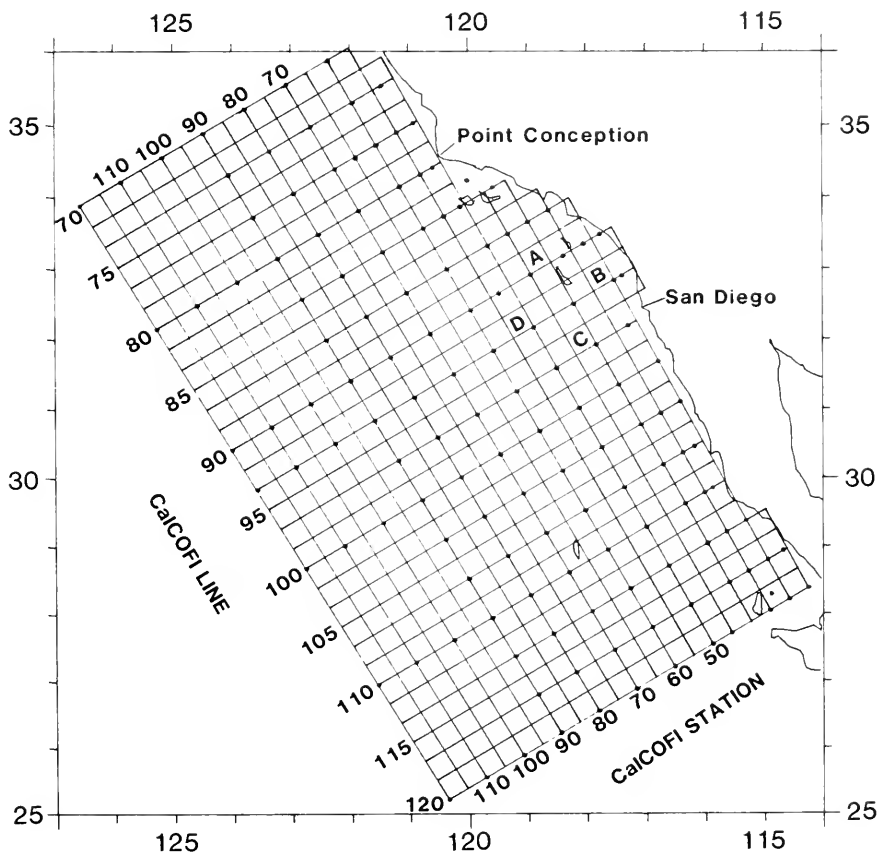

FIGURE 1.—Geographic grid used in the northern anchovy drift simulations, and the corresponding CalCOFI line and station coordinate system. Lettered locations are starting points for simulation presented in this paper. Mean geopotential anomalies (used for computing geostrophic currents) were calculated for the locations indicated by dots (Lynn et al. 1982; this study).

(Fig. 1). The top 50 m of the water column is the predominant depth range of anchovy larvae (Ahlstrom 1959), therefore mean anomaly values for the surface and for 10, 20, 30, and 50 m of depth were used in this study. The anomalies at each standard depth were interpolated to model grid nodes using the bivariate interpolation algorithm of Akima (1978). Geostrophic current velocities normal to each grid cell interface were computed for each of the standard depths, and average geostrophic current velocities were then calculated for a layer extending from the surface to 50 m.

Wind speed and direction data used in this study were from the data base summarized and discussed by Nelson (1977). The raw wind observations were converted to surface wind stress ( $\tau$ ) values using the relation

$$\tau = \rho C_d W^2$$

where  $\rho$  = air density ( $1.22 \text{ kg m}^{-3}$ );

$C_d$  = drag coefficient; and

$W$  = wind speed.

The drag coefficient was computed as a function of wind speed using the empirical relation of Amorocho and DeVries (1980, 1981). The computed wind stress vectors were partitioned by month of observation and resolved into alongshore and cross-shore components. A monthly mean wind stress component for each model grid cell interface was then computed by averaging the appropriate component of the stress vectors in the 37 km by 37 km area bisected by the grid cell interface. Total Ekman or wind-driven transport in the direction  $90^\circ$  to the right of the wind can be approximated by dividing the wind stress by the Coriolis parameter (Neumann and Pierson 1965), and this calculation was performed for the mean wind stress components. The mixed layer depth in the California Current is seldom  $>50$  m, and is often  $<20$  m in the Southern California Bight during the summer (Husby and Nelson 1982). It was assumed that Ekman transport occurring deeper than 50 m was negligible, and the Ekman transport values were converted to a mean wind-driven velocity for the surface to 50 m layer by dividing the transport by the 50 m layer thickness.

The final current velocities were calculated as the vector sum of the seasonal geostrophic and appropriate monthly Ekman components. Vector addition of the two components appears to be a reasonable assumption (Parrish et al. 1981), and no compensation for redistribution of mass owing to sustained winds was performed. The final seasonal current

fields for the simulations were January, March (April geostrophic velocities plus March Ekman velocities), July, and October currents.

Figure 2 illustrates the general trends in the California Current for the January and March seasons. This figure should be interpreted with caution. Apart from the large potential differences between actual synoptic conditions and the average pattern used in the simulations, the resultant vector for a cell was necessarily computed for Figure 2 by averaging the current components of opposing cell faces and then calculating the resultant. A distortion is introduced wherever components on opposite faces of a cell differ in magnitude or sign, so that Figure 2 best represents features of the California Current that are consistent over several model grid cells. The California Current is evident as two regions of intensified southeasterly flow at the left margins and midlines of the plots. During all parts of the year except spring, the current turns toward shore at the southern end of the Southern California Bight. A northwesterly flow near the coast subsequently forms the inshore portion of a large cyclonic eddy (the Southern California Eddy; Owen 1980) that occupies most of the Southern California Bight. During most of the year part of this eddy's northeasterly flow continues past Point Conception, to form the California Countercurrent (Hickey 1979; Fig. 2, January plot). In the spring the southeasterly flow of the California Current moves closer to shore to obliterate the surface portion of the Countercurrent (Fig. 2, March). Tsuchiya (1980, fig. 2) gives a clear picture of the seasonal inshore-offshore movements of the California Current at CalCOFI lines 90 and 93. Close to shore in the southern half of the modeled region there is another region of intensified southeasterly flow, most evident in the March current plot. Lynn et al. (1981) provided detailed illustrations of the geostrophic flow regimes used in the simulations, and Nelson (1977) presented graphical representations of the wind stress fields along the west coast of North America. Hickey (1979) presented a comprehensive review of seasonal and spatial variations of the California Current and the possible driving mechanisms involved, and Owen (1980) reviewed the incidence and ecological consequences of eddies in the California Current system.

Two additional current fields were calculated in order to assess the effects of increased offshore directed Ekman transport on larval northern anchovy distribution. As mentioned earlier, the mean wind stress is consistently directed downshore during March in the modeled region, a condition

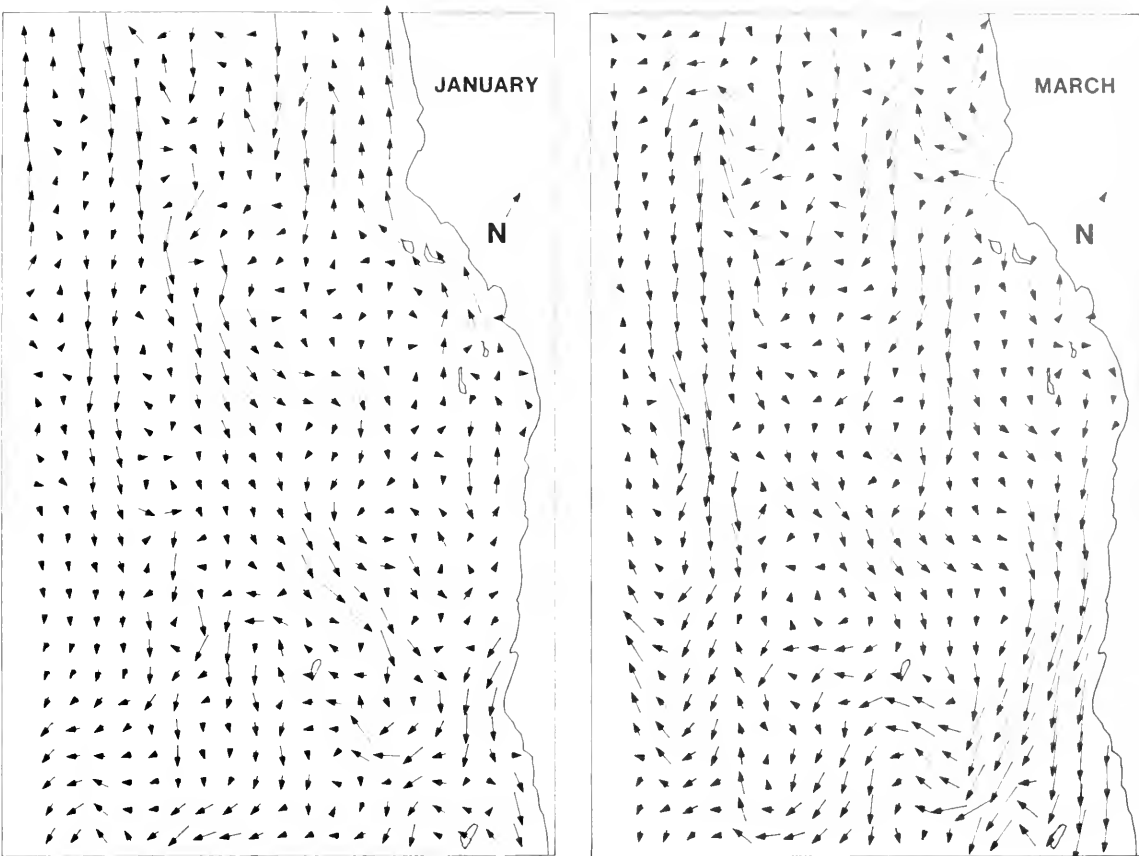

FIGURE 2.—Resultant mean current vectors for the normal January and the March seasonal current data used in this study. See text for cautions concerning figure interpretation. Length of arrow indicating north direction corresponds to a current velocity of 10 cm/s.

producing offshore directed Ekman transport. Two current fields were obtained by increasing the cross-shore component of the mean March Ekman velocities by the factors 1.5 and 3.0, and then combining the April seasonal geostrophic and augmented March Ekman velocities. Wind stress, and hence transport, is proportional to the square of wind speed. This means that roughly a 22% increase in a downshore wind speed increases the corresponding offshore directed Ekman transport by the factor 1.5. A threefold increase in offshore Ekman transport results from about a 77% increase in the downshore wind speed. Bakun and Nelson (1976) presented extensive statistical analyses of an “upwelling index” (defined as the offshore directed component of Ekman transport) for the location lat. 33°N, long. 119°W (this point is very close to location A used in the simulations; see below). Over an annual cycle the mean upwelling index for this location changes by at least a factor of two, with a rapid increase in both mean and standard deviation dur-

ing the spring. The March mean index at this point was about 50 t/s per 100 m of coastline with a standard deviation of roughly 80, hence upwelling at this particular time and location can be highly variable. Further, Bakun and Nelson (1976) found that enhanced or diminished upwelling persists on a seasonal time scale, so incorporation in the model of prolonged increased Ekman transport was not unrealistic.

Diffusion was incorporated into the model solely to parameterize subgrid scale mixing; including larger scale and more ephemeral mixing processes would obscure the broad seasonal trends the model was intended to illustrate. The eddy diffusivity parameter was computed using scale-dependent diffusion formulae of Okubo (1976) and a regression analysis of diffusion data presented by Okubo (1971). The finite-difference representation of diffusion required the use of a pseudo-Fickian diffusivity coefficient, so the mean scale-dependent diffusivity for the 37 km grid spacing ( $K_x = K_y = 101 \text{ m}^2/\text{s}$ ) was

used for all locations and all times in the model. The numerical method incorporated diffusion as the weighting factor  $\coth[(uh)/(2K)]$  for the flux at each grid cell interface, where  $u$  is the current velocity at the interface and  $h$  is the 37 m grid spacing (see Power 1984 for further details). Hence, diffusion becomes important in regions of low current velocity, and at higher velocities diffusion is less important and advection dominates the flux. For the current velocities in most of the modeled region, the above hyperbolic cotangent function is usually evaluated to a magnitude near unity, making the contribution of turbulent transport to larval drift minimal relative to advective (current velocity) transport.

Simulations were carried out by starting an initial point source of northern anchovy eggs or larvae at various locations historically known to be larval anchovy habitat (Hewitt 1980). Examples of simulations for four starting locations (Table 1; Fig. 1), which are representative of the overall patterns produced by the simulations, are presented here. The four locations will be referred to in the text by their letter designations indicated in Figure 1 and Table 1. Northern anchovy larvae begin to school at about 27 d (Hunter and Coyne 1982); therefore larval distributions after 30 d of drift are presented. Thirty-d-old larvae are also rapidly increasing their "patchiness" (Hewitt 1981a), indicating that they could then exert significant control over their position. The time step in the simulations was 1 d. Results from a simulation using the actual northern anchovy egg distribution found in 1982 as the initial condition can be found in MacCall (1983).

TABLE 1.—Geographic and CalCOFI coordinates of starting locations for simulations presented in this paper. Letter designation corresponds to the same locations in Figure 1.

Starting location	Coordinates		CalCOFI	
	Lat. N	Long. W	Line	Station
A	33°08.4'	118°51.4'	89.17	42.5
B	32°54.1'	117°47.3'	92.5	32.5
C	31°59.3'	118°05.4'	95.83	42.5
D	32°14.1'	119°09.2'	92.5	52.5

Northern anchovy larval concentrations in the contour plots are relative to starting concentration; the unitless contour value of  $10^{-2}$  represents a larval concentration two orders of magnitude below the starting concentration, and only concentrations down to  $10^{-7}$  are illustrated. Larvae were permitted to be advected out the borders of the modeled area, except for the border along the coast. Grid cells bordering the Santa Barbara Channel (at about lat.

34°N, long. 120°W; Fig. 1) between the Channel Islands and Point Conception were open, and larvae advected into this region were considered to be lost from the system. Larvae were not permitted to be transported across any of the islands in the modeled region. Because March is the peak spawning time of northern anchovy, the effects of different starting locations on the 30-d larval distributions during March conditions will be presented first. The effects of spawning in different seasons and enhanced offshore Ekman transport during March will then be presented for comparison. The simulation results nominally represent larval northern anchovy distributions, but the results also apply to any planktonic species that begin drift at the same locations and maintain themselves in the top 50 m of the California Current.

The overall extent of onshore-offshore and along-shore transport was of major interest in this study. A convenient way of summarizing the simulated larval distributions relative to their cross-shore distribution was to sum all larval concentrations in the cells having the same CalCOFI station coordinates. These sums were converted to percentages of the total number of larvae at 30 d, and the cumulative percentage of larvae present as one progressed offshore was plotted versus CalCOFI station coordinates. A similar procedure using CalCOFI line coordinates was done to summarize alongshore transport.

## RESULTS

### Effects of Starting Location, Normal March Currents

Northern anchovy larvae that began drift at location B, near the coast, were transported downshore by March currents (Fig. 3B). This was an effect of the nearshore southeasterly current (Fig. 2), and because of this flow only 15% of the larvae were at or upshore of the starting location after 30 d of drift

FIGURE 3.—Distribution of northern anchovy larvae after 30 d of drift in March currents. Letter designation corresponds to a simulation with northern anchovy begun at the corresponding lettered location in Figure 1 and Table 1; starting location is marked in this and subsequent contour plots with asterisks. Locations A and C share the same CalCOFI station coordinate; points B and D have the same CalCOFI line coordinate. Concentration contour intervals are proportions of the starting concentration, decreasing in order of magnitude steps. Tic marks around perimeter are at whole degrees of latitude and longitude; dots are at intervals of 3.33 CalCOFI line units from lines 70 to 120 and intervals of 10 station units offshore to station 120 (i.e., every 74 km).

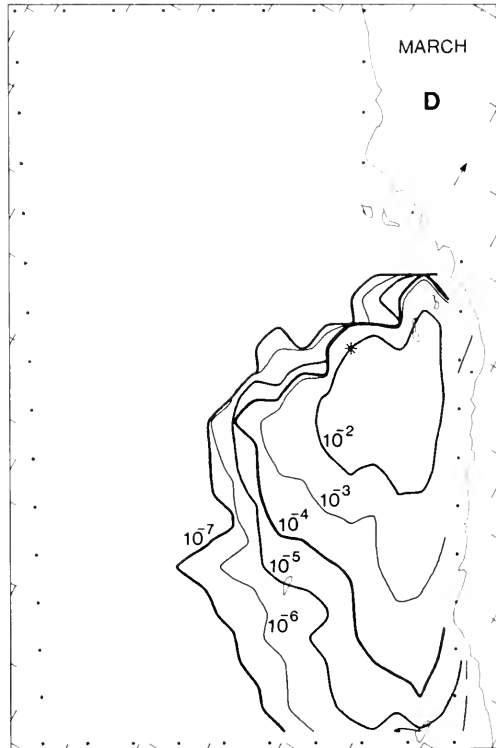
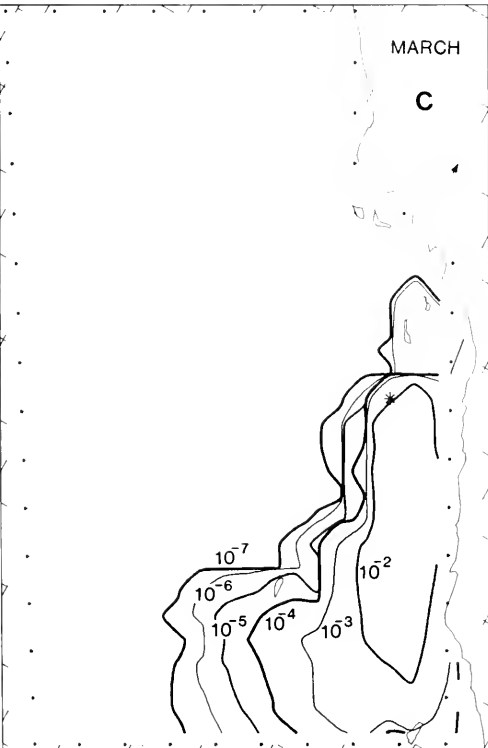
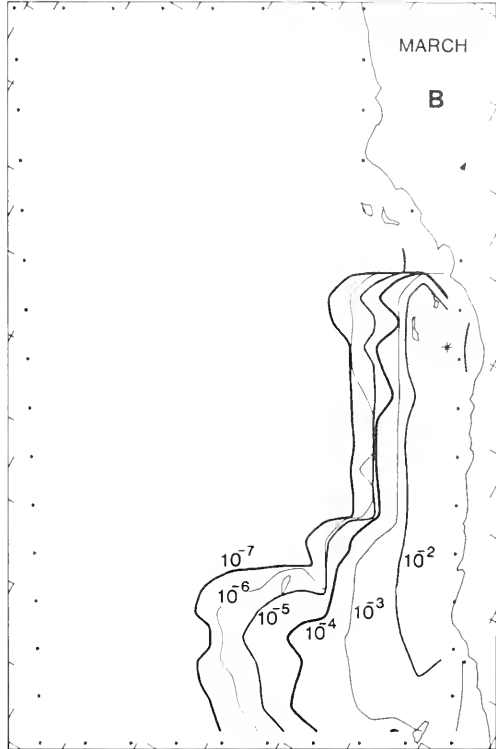
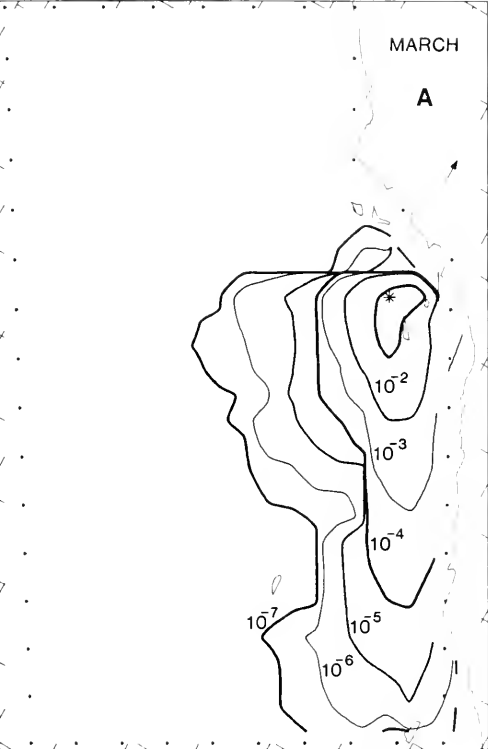

(Fig. 4). The alongshore distribution of larvae below the starting point was quite uniform, and the lower larval concentrations had reached the southern border of the modeled region (CalCOFI line 120). Dispersal offshore was minimal, and a majority of the larvae lay in a band near the coast with about equal proportions inshore and offshore of the starting point; 92% of the larvae were on or inshore of CalCOFI station 37.5. After initial southeasterly transport, some larvae were transported in an offshore, southwesterly direction.

Extensive downshore transport also occurred to northern anchovy larvae begun at location C, and in fact only 3% of the larvae remained at or upshore of the starting location after 30 d of drift (Figs. 3C, 4). The larvae begun at point C were also concentrated in a narrow band along the coast, but unlike those started at point B most of the larvae begun at C moved inshore of the starting location after 30 d of drift.

Northern anchovy larvae begun at the offshore location D showed much less extensive downshore transport than those begun at B or C (Figs. 3D, 4). Only 10% of the larvae remained at or upshore of the starting point, but 86% of the total remained at or between CalCOFI line 92.5 (location C's line coordinate) and line 102.5, a span of 222 km. Most larvae were inshore of location D, and the cross-shore distribution was slightly more uniform than those begun farther inshore. Starting point D's distance from the coastline permitted the slightly broader cross-shore distribution.

Larvae begun at location A showed an alongshore cumulative percentage distribution after 30 d of drift which was similar to that of larvae that begin drift at point D, although it was displaced farther upshore (Fig. 4). Location A produced the greatest percentage of larvae remaining at or upshore of the starting location, and there is a small patch of high ( $10^{-1}$ ) larval concentrations present at the starting location (Fig. 3A). This reduced dispersal of larvae begun at A also produced the strongest cross-shore gradient of larvae. A majority of the larvae were again on or inshore of the starting location after 30 d of drift.

In summary, the distributions of northern anchovy larvae that began drift at locations A through D and that were produced by March currents were formed as relatively strong cross-shore gradients, so that the 30-d distributions were bands (ca. 100 km wide) parallel to the coast. The results of starting larvae at locations A, C, and D were that more than 85% of the larvae were inshore of the starting location after 30 d of drift. Larvae that began drift at loca-

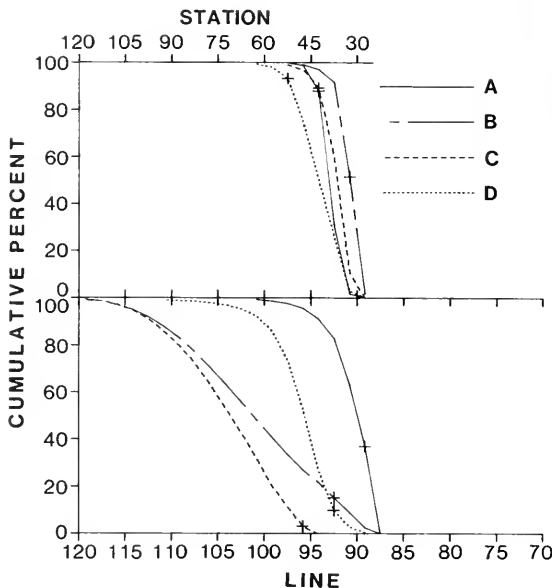

FIGURE 4.—Cumulative percentages of northern anchovy larvae after 30 d of drift, progressing offshore (increasing CalCOFI station number) and downshore (increasing CalCOFI line number), for the four starting locations under March current conditions. Cross symbols are at the starting location's corresponding CalCOFI line or station coordinate. Distance between tic marks on the abscissae is equivalent to a distance of 111 km. Note that a steep curve implies a compact distribution of larvae, while more gradual slopes imply more widely dispersed larvae.

tions B and C were extensively carried downshore of the starting location. Most of the larvae that started at points A and D also moved downshore from those locations, but the bulk of the larvae were not as widely dispersed from the starting location as those begun at points B and C.

### Effects of Seasonal Current Fields on Larval Distribution

The distributions of northern anchovy larvae started at the same location but using different seasonal current regimes appear very different to the eye (Figs. 3, 5-7). Part of this effect is real, but part is also due to displacement of the contours for the lower larval concentrations (e.g.,  $10^{-7}$ ), which represent few larvae. The cumulative percentage plots (Fig. 8) indicate that, when summarized on a model-wide basis, the overall cross-shore distributions of larvae begun at locations B, C, and D were not greatly different when currents from the four seasonal periods were used in the simulations. A fixed distance offshore there were some large differences in the cumulative percentages among seasons

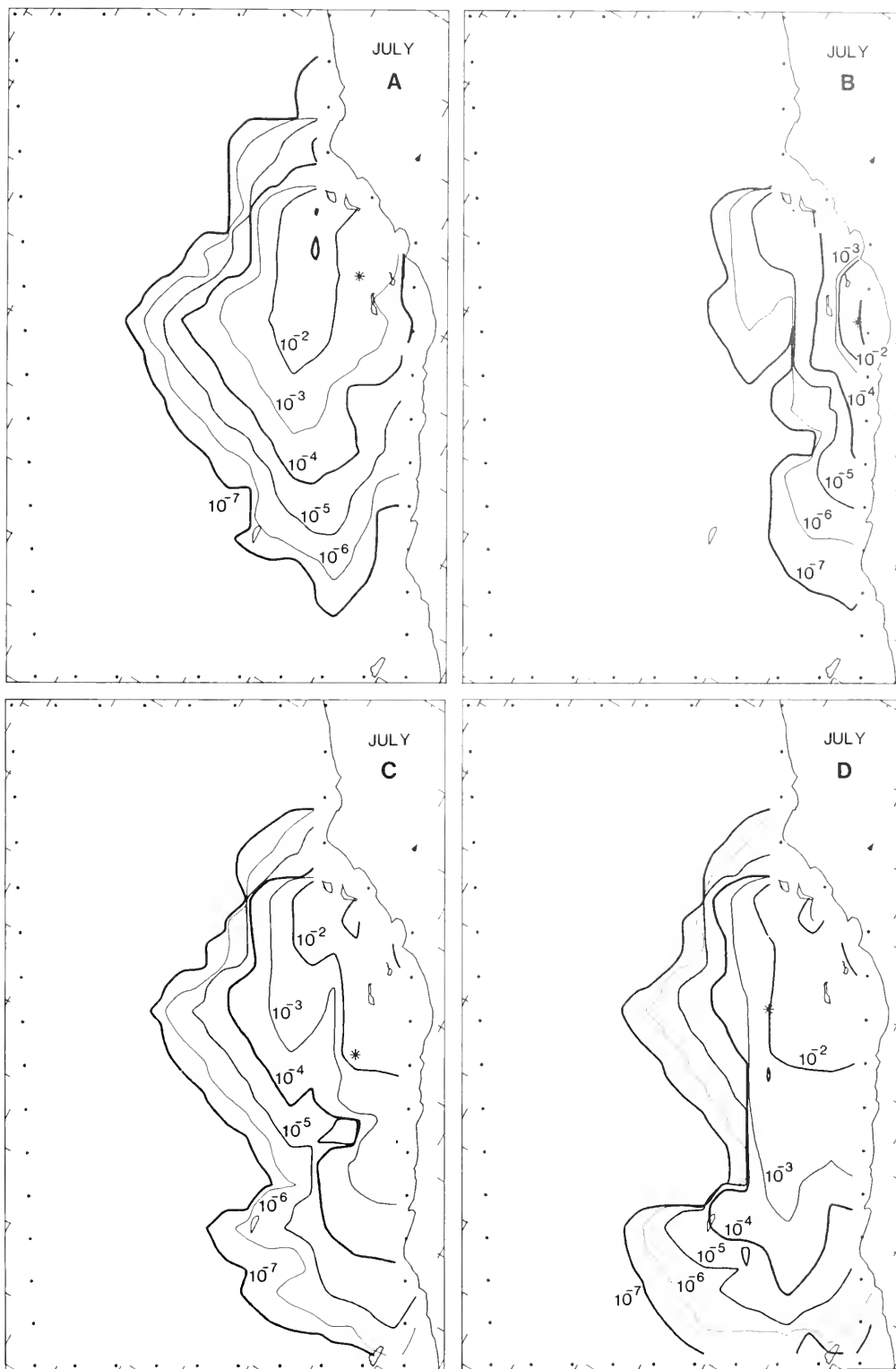

FIGURE 5.—Distribution of northern anchovy larvae after 30 d of drift in normal July currents.

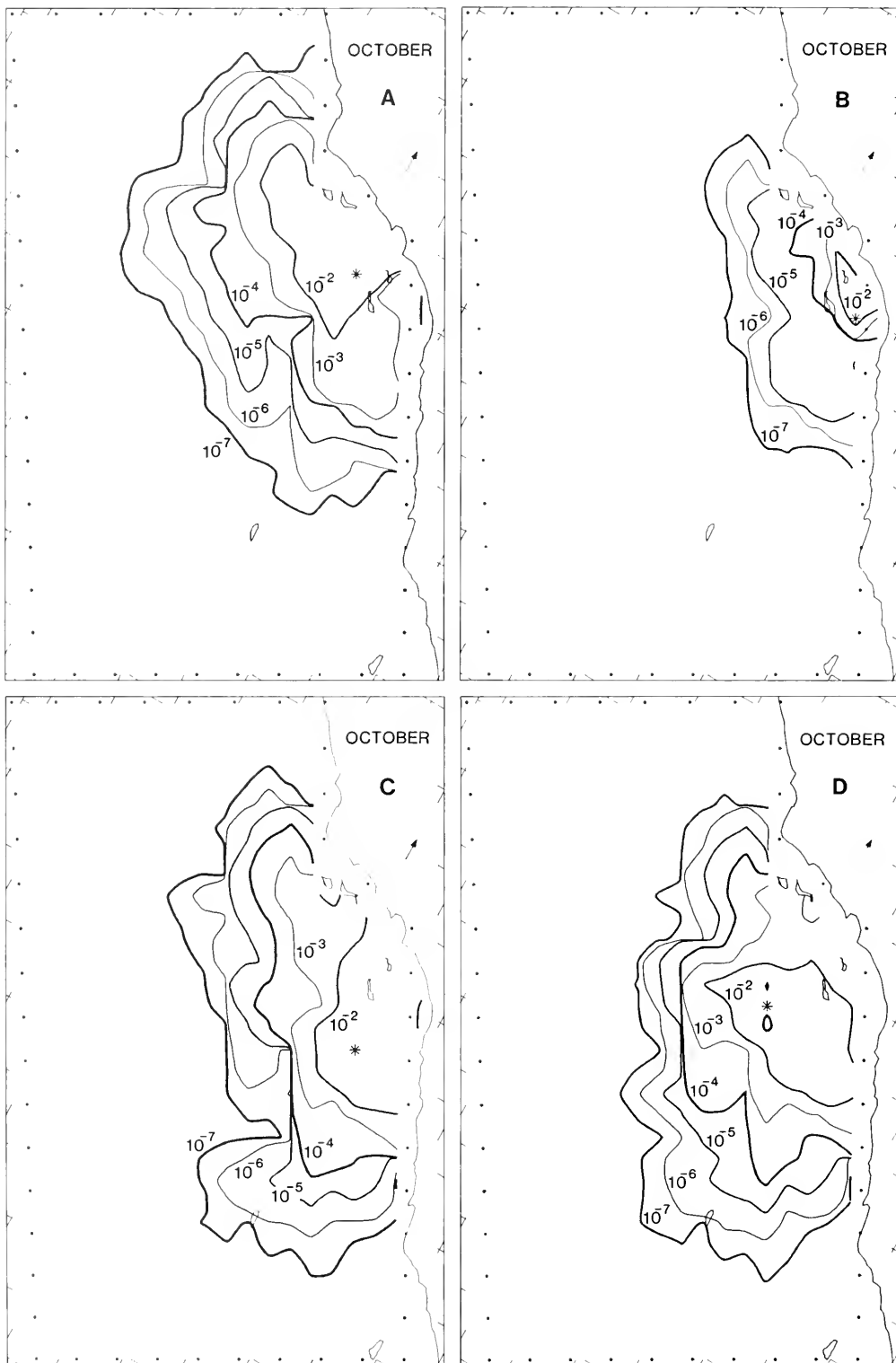

FIGURE 6.—Distribution of northern anchovy larvae after 30 d of drift in normal October currents.



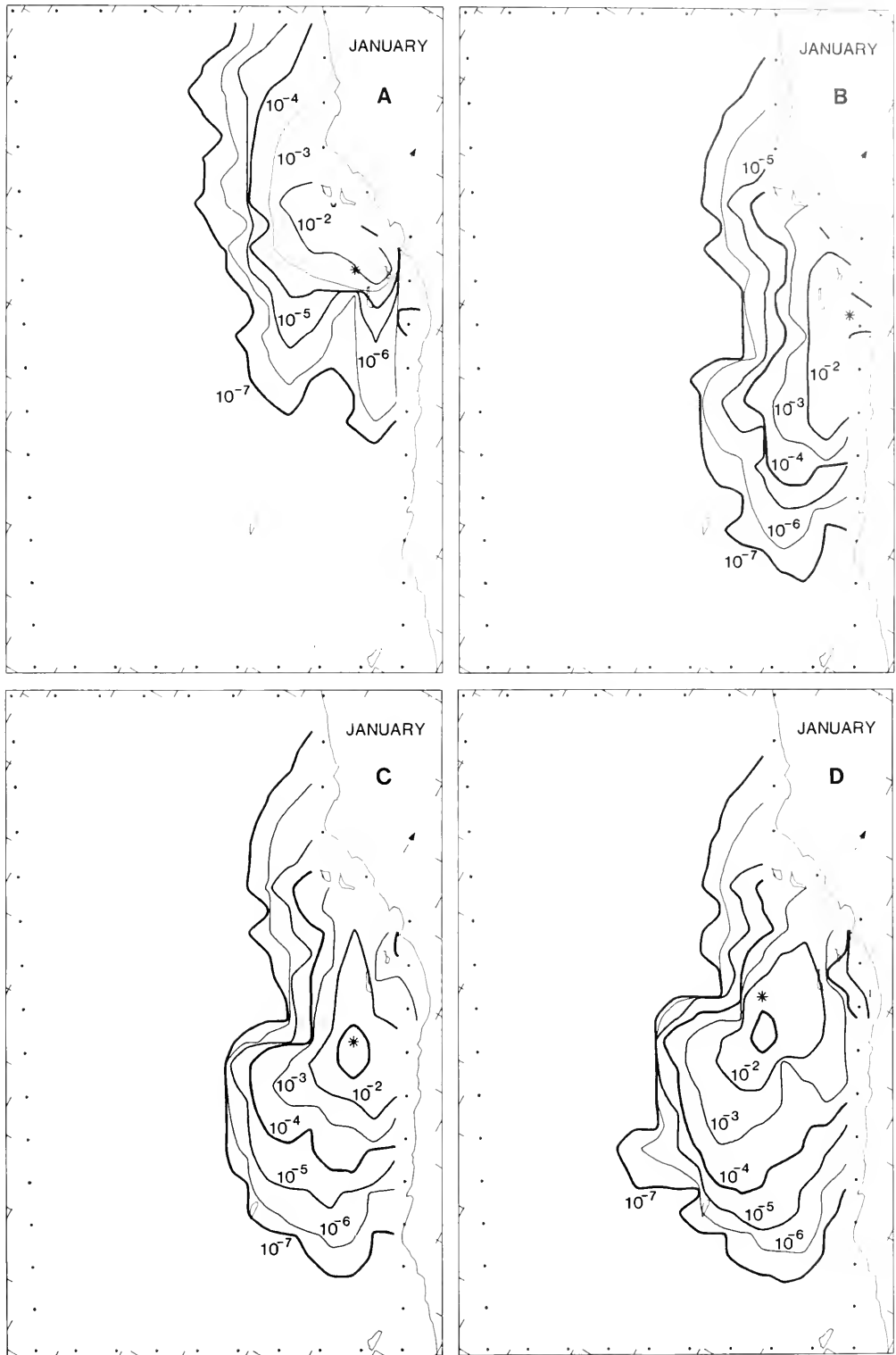

FIGURE 7.—Distribution of northern anchovy larvae after 30 d of drift in normal January currents.

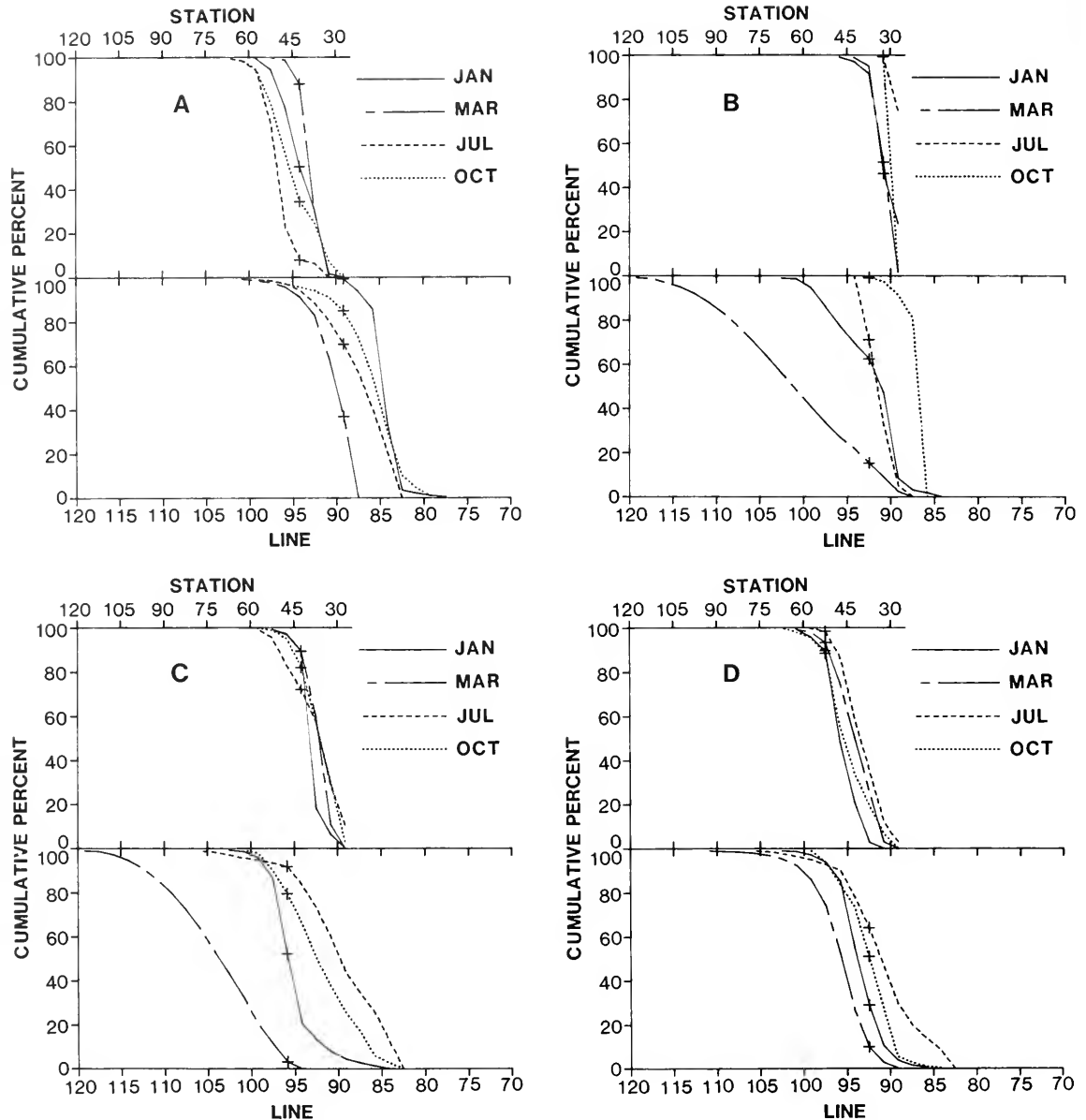

FIGURE 8.—Cumulative percentage plots of northern anchovy larval concentrations after drift in the four seasonal current regimes. Letter designation corresponds to starting locations indicated in Figure 1 and Table 1.

for larvae begun at the same location, but a comparable percentage was usually present a short distance away, i.e., most curves in Figure 8 are closely spaced on the CalCOFI station abscissae. Most larvae begun at the offshore location D moved inshore regardless of season, and the seasonal differences were in the relative extent of inshore movement, the maximum occurring during July. In all simulations the cross-shore distributions of larvae

formed strong gradients, regardless of season.

Starting location A is within the Southern California Bight proper, the region that most consistently has high larval concentrations of northern anchovy (cf. Hewitt 1980). Larval distributions started at location A did exhibit notable seasonal differences in their 30-d cross-shore distributions, with the greatest offshore dispersal occurring during July (Figs. 5A, 8A), and the largest inshore movement

occurring during March current conditions (Figs. 3A, 8A). January and October were intermediate between these two extremes. In all cases the cross-shore gradients of larvae were strong.

In contrast, the alongshore distributions of larvae differed markedly when the simulations were done with currents from the four seasonal periods. Virtually all larvae were carried upshore of starting location A by the California Countercurrent in the January simulation (Figs. 7A, 8A), but when the model was run using March currents, a majority of the larvae were downshore of point A after 30 d of drift (Fig. 3A). The July and October simulation results for point A seemed to indicate an annual progression between the March and January extremes (Fig. 8A).

The seasonal differences in the overall alongshore distributions were even more dramatic for northern anchovy larvae begun at locations B and C. The uniform downshore distribution produced by March currents differed from the distributions formed in all other seasons. Larvae begun at location B were all transported upshore of the starting location during October current conditions (Fig. 6B). When January currents were used (Fig. 7B), the upshore movement had lessened, so that only 62% of the larvae were at or upshore of location B, and the larvae were more evenly distributed along the coast (Fig. 8B). March currents yielded the greatest downshore movement, and the July distribution (Fig. 5B) was intermediate between that produced by March and October conditions, with the alongshore gradient of larvae again steepening. The changes on an annual basis between upshore, then downshore transport were similar for larvae begun at location C, except that the July current conditions produced the greatest upshore transport (Figs. 5C, 8C); March again produced the maximum downshore transport for larvae begun at point C (Fig. 3C). Larvae begun at location C formed a relatively compact distribution after 30 d of drift in the January currents (Fig. 7C).

The overall alongshore distributions of northern anchovy larvae that started drift at point D appeared to be least influenced by seasonal changes in the currents, although March conditions again produced the greatest transport downshore of the starting point (Fig. 3D), with July currents again yielding the greatest upshore transport (Fig. 5D). January currents also produced a very compact distribution of larvae started at location D, similar to that of larvae begun at point C.

In summary, only northern anchovy larvae begun at location A appeared to have notable differences

in their model-wide, cross-shore distributions after 30 d of drift. Larvae begun at all four locations did have substantial seasonal differences in their along-shore distributions, with March currents consistently producing the greatest downshore dispersal. The least downshore dispersal occurred during January, October, July, and July current conditions for larvae started at locations A, B, C, and D respectively. January currents generally seemed to produce the most compact 30-d distributions of larvae (least dispersal).

### Effects of Increased Offshore Ekman Transport, March Currents

Increasing the March cross-shore Ekman transport by a factor of 1.5 had little effect on the 30-d distributions of northern anchovy larvae begun at locations B and C (Fig. 9); these curves are also closely spaced on the CalCOFI station abscissae. Increasing the average or "normal" offshore Ekman component by a factor of three produced more noticeable changes in the cross-shore distributions of larvae begun at points B and C, but this effect was not substantial; the contours representing the lower concentrations extended far offshore (Fig. 10B, C), but the higher concentration contours, which delimit the majority of the larvae, were not greatly displaced from those of normal March currents (Fig. 3B, C). This is also evident in the cumulative percentage curves.

In comparison, northern anchovy larvae begun at locations A and D underwent about the same increase in offshore dispersal with a  $1.5\times$  offshore directed Ekman component increase as those begun at points B and C did with the  $3\times$  offshore Ekman increase (Fig. 9). When the offshore directed Ekman transport was increased to three times its normal mean value, the effects on larvae begun at points A and D were substantial. A majority of the larvae were carried offshore of starting locations A and D, and a large fraction were transported a significant distance (Fig. 10A, D), well seaward of the Southern California Bight. The increase in offshore Ekman transport also noticeably affected the along-shore distributions of larvae begun at locations A and D (Fig. 9). The overall pattern of alongshore distribution is similar to that produced by the normal mean conditions, but the larvae were generally farther downshore.

## DISCUSSION

Models have inherent assumptions and simplifica-

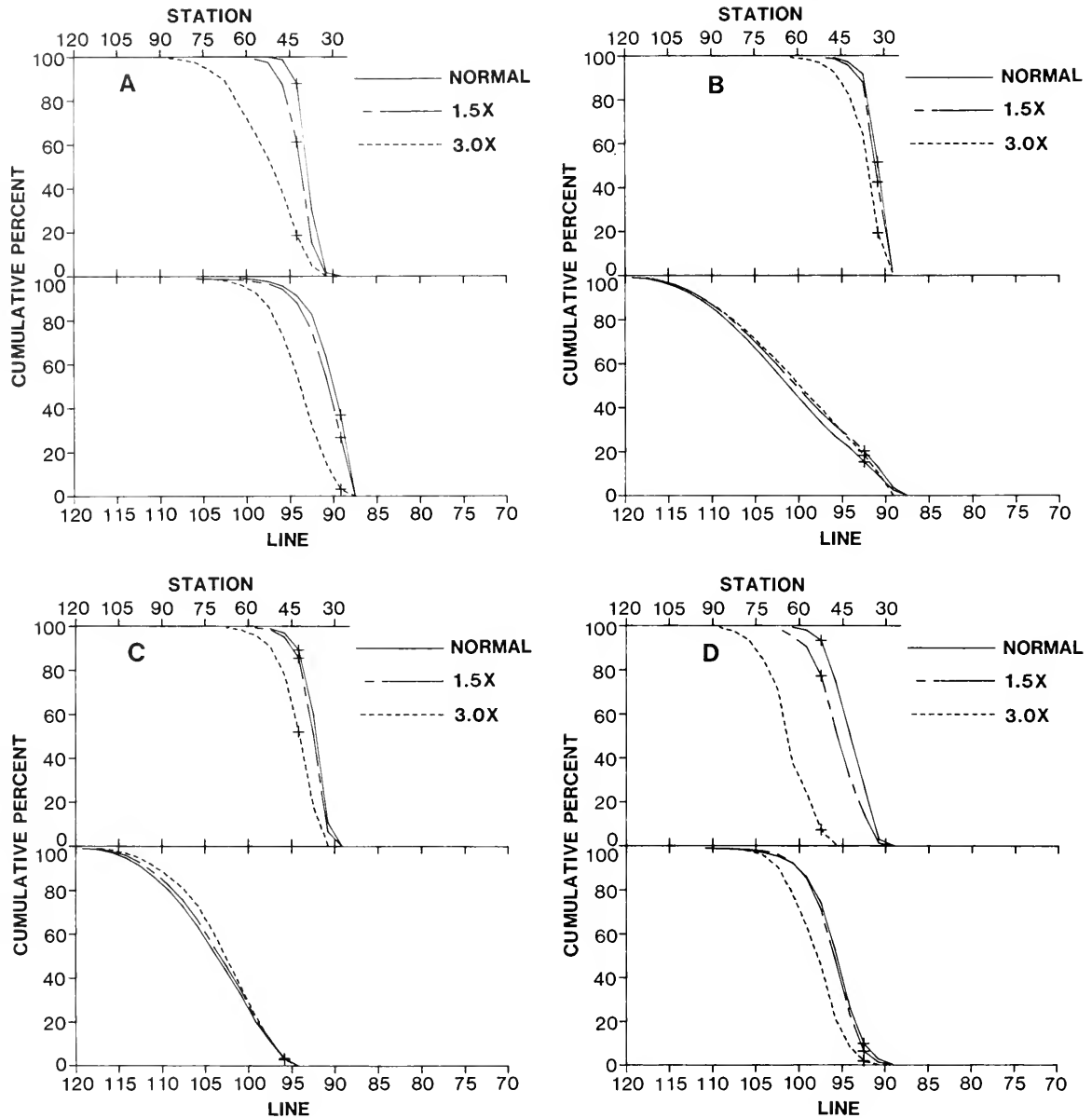
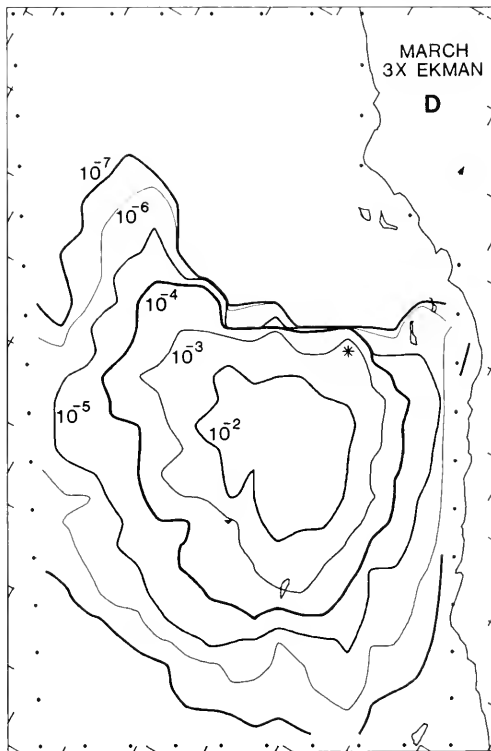
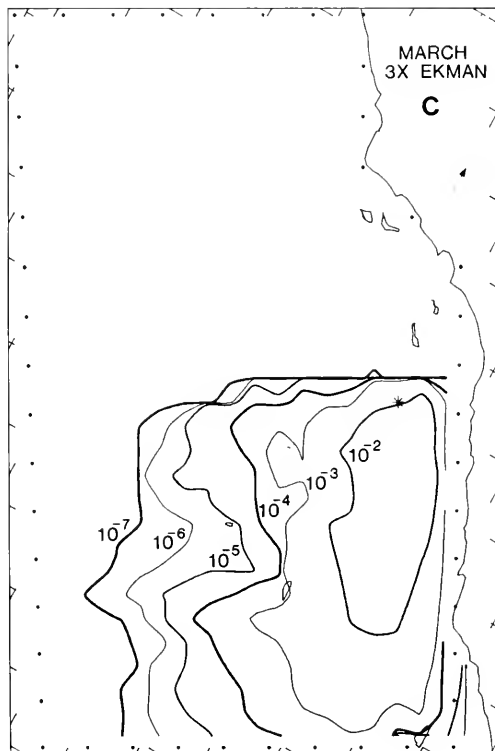
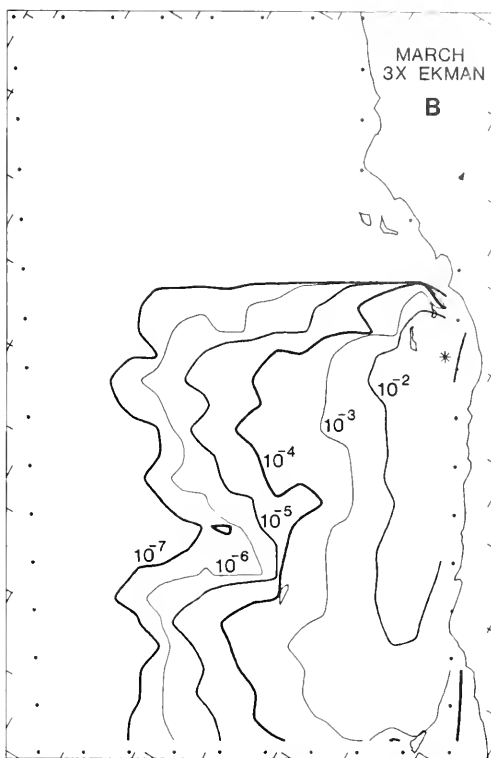
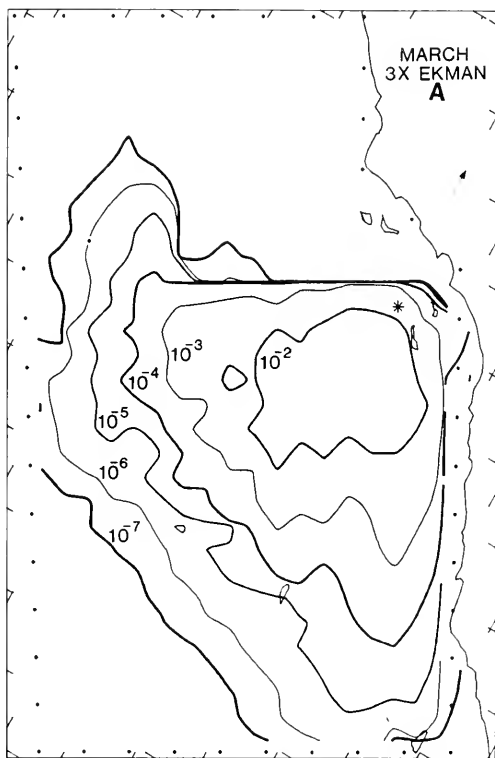

FIGURE 9.—Cumulative percentage plots of northern anchovy larval concentrations after 30 d drift in the three March Ekman current regimes ("normal" or long-term mean, 1.5× offshore directed Ekman transport, 3× offshore directed Ekman).

tions, and thus approximate what occurs in nature. The geostrophic current information, while some of the best available, nonetheless constrained the spatiotemporal resolution of this model, and incorporating Ekman transport required several assumptions. Further, there can be considerable interannual variability in the modeled region (Mooers and Robinson 1984; Simpson et al. 1984), and presumably the model is of "average" conditions and cannot be

representative of any specific year; I felt that including such variability (assuming adequate data were available) would complicate the results without significantly contributing to biological insight. An

FIGURE 10.—Distribution of northern anchovy larvae after 30 d of drift in March currents with three times the normal offshore directed Ekman transport.



additional confounding factor is the lack of biological information in the model; consistent larval behavior patterns (e.g., diurnal vertical migrations) and spatially heterogeneous mortality could produce distributional patterns differing from those presented here. In spite of these caveats, the simulations do demonstrate that variations in northern anchovy spawning location and time, and changes in the magnitude of offshore directed Ekman transport, can have significant consequences for the subsequent larval distribution. By inference, these changes in distribution can result in increased or reduced larval mortality, and ultimately affect adult northern anchovy population size.

Offshore transport was not significant in the simulations done with the unaugmented or "normal" March (seasonal April geostrophic + March Ekman) currents. A majority of the northern anchovy larvae that began drift at the four starting locations were inshore of their starting points after 30 d of drift, and the cross-shore distributions indicated that most larvae occupied a relatively narrow range of distances close to shore. Mais (1974) and Methot (1981) reported that most juvenile northern anchovy occupy inshore areas in the fall, and the model indicates that this inshore movement could be facilitated by passive drift. As mentioned earlier, the consensus is that nearshore regions provide more hospitable food conditions for the northern anchovy larvae. Lasker (1978, 1981) summarized the results of surveys of larval food distributions in the Southern California Bight. His figures indicate that suitable larval food concentrations decline rapidly as one progresses offshore. O'Connell (1980) reported the results of a survey for starving northern anchovy larvae in the Southern California Bight, the degree of starvation being defined by histological criteria. He found apparently healthy larvae at locations as far as about 250 km offshore (at lat. 32°30'N, long. 120°W), where model concentrations were  $<10^{-7}$  after 30 d in all March simulations except for larvae begun at A, where they were  $<10^{-4}$ . Despite the good condition of these offshore larvae, the simulation results indicate a low likelihood of their being recruited to the nearshore juvenile population. The low offshore larval concentrations will also hinder the development of schooling (Hewitt 1981a).

The minimal offshore transport situation found in the March current simulations was also generally true when simulations were done using currents from other seasons, except for northern anchovy larvae begun at location A. This point is the most interior starting location within the Southern California Bight proper and is primary northern anchovy

spawning habitat (Hewitt 1980) and where seasonal changes in the currents are especially important (Tsuchiya 1980). Spring is a time when currents in the Southern California Bight are not as well organized as other times of the year, and the Southern California Eddy is often absent (Hickey 1979; Owen 1980). It is interesting that currents during March, the peak spawning period, produced the least offshore transport of larvae begun at location A when compared with other seasons, even though March is the time of greatest overall Ekman transport (Bakun and Nelson 1976). There is significant spawning in January (Methot 1981), and the January simulations also had reduced dispersal of larvae. The model results support the hypothesis of Parrish et al. (1981) that northern anchovy spawning in the Southern California Bight do so at a time and place that minimizes offshore transport of eggs and larvae.

It is clear that the overall 30-d alongshore distributions of northern anchovy larvae produced by normal March currents depended largely on the spawning location's proximity to the well-defined southeasterly current present near the coast in the southern half of the modeled region. Larvae that started drift near this current underwent extensive downshore transport. Larvae begun farther into the Southern California Bight (location A), and farther offshore (location D), were also transported downshore, but to a much lesser extent. This again confirms the role of the Southern California Bight as an area where minimal transport of spawning products takes place. The southwesterly, offshore transport that occurred in many of the simulations at the southern margin of the modeled region (between CalCOFI lines 110 and 120) is consistent with the evidence that this region forms a faunal boundary between species of the Southern California Bight and those of Baja California to the south, and that this faunal boundary is created by current patterns (Hewitt 1981b). This is also a region of increased surface convergence (Parrish et al. 1981).

The extent of alongshore transport was markedly different for northern anchovy larvae begun at the same starting location when currents from the different seasons were used. Depending on starting location, seasonal changes in currents could produce almost complete reversals between predominantly upshore or downshore transport. March currents consistently produced the greatest downshore transport. These effects were due to the presence or absence of the Southern California Eddy and the Southern California Countercurrent. Because the Southern California Countercurrent is present

year-round, except during peak spawning in the spring, it is clear that the relationship between the time of northern anchovy spawning and the time that this countercurrent diminishes is critical. The simulations indicated that eggs and larvae from early spawning (i.e., January) are carried upshore into the Santa Barbara Channel and north of Point Conception, while those from later spawning (March) move in the opposite, southeasterly direction. The sizes and birth dates of juveniles collected in the fall of 1978 and 1979 were in accordance with this pattern. Methot (1981) reported that juvenile northern anchovy collected during both fall seasons in the northern portion of the Southern California Bight had birth dates (as determined from daily growth increments in otoliths) in the preceding months of December and January, and these fish were generally larger than those collected farther to the south. The northern anchovy collected in the south had predominantly February and March birth dates. It may be that the northern group, containing fish from early spawning, were advected to the north by the Southern California Countercurrent and that the southern group of fish from late spawning were produced when the surface countercurrent had diminished. Future studies of the transport and distribution of northern anchovy larvae or other planktonic species in the Southern California Bight should incorporate as much information as is available on the presence and magnitude of the Southern California Countercurrent and the Southern California Eddy.

Nearshore winds in the Southern California Bight are relatively weak, and downshore wind speeds generally increase farther offshore (Bakun and Nelson 1976; Nelson 1977; Dorman 1982). The implication, in terms of offshore transport, is that larvae closest to shore are affected least by offshore transport, while those farther offshore experience a much greater impact. Thus the areal extent of northern anchovy spawning interacts with offshore Ekman transport; in years when most northern anchovy spawn close to shore there will be decreased offshore transport, because of weak inshore winds, than in years when northern anchovy spawn farther offshore. The impact on the products of offshore spawning will depend on the magnitude of the winds in the offshore areas in each particular year. Northern anchovy larvae that began drift farthest north in the Southern California Bight (location A) and at the more offshore location (D) were most affected by increases in offshore directed Ekman transport, indicating southerly and inshore spawning are best for reduced dispersal in March. Hewitt and Methot

(1982) stated that the area of northern anchovy spawning was more compact and more northerly in 1978 than in 1979. Survival of young larvae was about the same in both years, indicating that early mortality from starvation and predation was not substantially different in the two years. Survival through the juvenile stage was greater in 1978 than in 1979, however, and Hewitt and Methot (1982) cited increased offshore transport in 1979 as a possible reason.

Superimposed on the effects of spawning location is the interaction between the increase in downshore wind speeds (offshore directed Ekman transport) as one progresses offshore and the magnitude of inter-annual variations in the wind speeds. In the simulations the effects of the  $3\times$  increase in Ekman transport were substantially greater than those of the  $1.5\times$  increase. The  $1.5\times$  change was not a great enough increase to carry many northern anchovy larvae into offshore regions of higher, offshore directed Ekman transport. The inshore  $3\times$  increase carried a greater fraction of larvae farther offshore, and the  $3\times$  increase in the offshore region subsequently operated on a greater proportion of the larval population. Thus there was an interaction between enhanced offshore directed Ekman transport in the nearshore area and increased Ekman transport farther offshore, the two of these acting together to produce the extensive drift evident in the simulation results. Years in which downshore winds increase in only the inshore or the offshore regions would not produce as much overall offshore dispersal. Bakun and Nelson's (1976) statistical analyses of the "upwelling index" indicates that prolonged increased Ekman transport is feasible, although the  $3\times$  condition would probably be a particularly bad year. It should also be noted that Ekman transport was incorporated into the model as acting uniformly on the 50 m surface layer, and presumably the model depicts the drift of "average" larvae. Larvae that remain near the surface or at 50 m would undergo greater or lesser transport, respectively. Alternatively, it is known that winds in the Southern California Bight have a strong diurnal periodicity (Bakun and Nelson 1976; Dorman 1982), and a diurnal vertical migration coupled with diurnal changes in the winds could significantly alter larval drift.

In summary, the simulation results indicated that seaward dispersal of northern anchovy larvae is generally small, but that seasonal effects are strongest in the area of peak spawning (location A) and that March spawning at this point minimizes offshore dispersal. Spawning at locations or times near

well-defined currents, such as the California Countercurrent, can produce major changes in larval distribution, and consequently may affect larval survival. The effect of offshore directed Ekman transport on the larval population depends on the areal extent of northern anchovy spawning, and the spatial distribution of any changes in wind stress and subsequent Ekman transport; an increase in Ekman transport in both the inshore and offshore regions will act together to produce maximum offshore dispersal.

## ACKNOWLEDGMENTS

This work was done while the author held a National Research Council Research Associateship. I thank Reuben Lasker and John Hunter for their hospitality and advice, as well as for the opportunity to conduct this research. Larry Eber and Craig Nelson were instrumental in providing dynamic height and wind speed data, without which this work could not have been done. I also thank Andy Bakun, Roger Hewitt, Ron Lynn, Alec MacCall, Rick Methot, Bob Owen, Dick Parrish, and Paul Smith for their stimulating discussions, advice, and review of this work. This manuscript was revised while the author held a CIMAS (Cooperative Institute for Marine and Atmospheric Sciences) postdoctoral fellowship at the University of Miami, and this support is gratefully acknowledged.

## LITERATURE CITED

- AHLSTROM, E. H.  
1959. Vertical distribution of pelagic fish eggs and larvae off California and Baja California. *Fish. Bull.*, U.S. 60:107-146.
- AKIMA, H.  
1978. A method of bivariate interpolation and smooth surface fitting for irregularly distributed data points. *ACM Trans. Math. Software* 4:148-159.
- AMOROCHO, J., AND J. J. DEVRIES.  
1980. A new evaluation of the wind stress coefficient over water surfaces. *J. Geophys. Res.* 85C:433-442.  
1981. Reply to comment on 'A new evaluation of the wind stress coefficient over water surfaces'. *J. Geophys. Res.* 86C:4308.
- BAILEY, K. M.  
1981. Larval transport and recruitment of Pacific hake *Merluccius productus*. *Mar. Ecol. Prog. Ser.* 6:1-9.
- BAKUN, A., AND C. S. NELSON.  
1976. Climatology of upwelling related processes off Baja California. *Calif. Coop. Oceanic Fish. Invest. Rep.* 19:107-127.
- BAKUN, A., AND R. H. PARRISH.  
1982. Turbulence, transport, and pelagic fish in the California and Peru Current systems. *Calif. Coop. Oceanic Fish. Invest. Rep.* 23:99-112.
- DORMAN, C. E.  
1982. Winds between San Diego and San Clemente Islands. *J. Geophys. Res.* 87C:9636-9646.
- HEWITT, R.  
1980. Distributional atlas of fish larvae in the California Current region: northern anchovy, *Engraulis mordax* Girard, 1966 through 1979. *Calif. Coop. Oceanic Fish. Invest. Atlas* 28, 101 p.  
1981a. The value of pattern in the distribution of young fish. *Rapp. P.-v. Réun. Cons. int. Explor. Mer* 178:229-236.  
1981b. Eddies and speciation in the California Current. *Calif. Coop. Oceanic Fish. Invest. Rep.* 22:96-98.
- HEWITT, R. P., AND R. D. METHOT, JR.  
1982. Distribution and mortality of northern anchovy larvae in 1978 and 1979. *Calif. Coop. Oceanic Fish. Invest. Rep.* 23:226-245.
- HICKEY, B. M.  
1979. The California Current system - hypotheses and facts. *Prog. Oceanogr.* 8:191-279.
- HUNTER, J. R.  
1981. Feeding ecology and predation of marine fish larvae. In R. Lasker (editor), *Marine fish larvae*, p. 33-77. Univ. Wash. Press., Seattle-Lond.
- HUNTER, J. R., AND K. M. COYNE.  
1982. The onset of schooling in northern anchovy larvae, *Engraulis mordax*. *Calif. Coop. Oceanic Fish. Invest. Rep.* 23:246-251.
- HUSBY, D. M., AND C. S. NELSON.  
1982. Turbulence and vertical stability in the California Current. *Calif. Coop. Oceanic Fish. Invest. Rep.* 23:113-129.
- LASKER, R.  
1978. The relation between oceanographic conditions and larval anchovy food in the California Current: identification of factors contributing to recruitment failure. *Rapp. P.-v. Réun. Cons. int. Explor. Mer* 173:212-230.  
1981. Factors contributing to variable recruitment of the northern anchovy (*Engraulis mordax*) in the California Current: Contrasting years, 1975 through 1978. *Rapp. P.-v. Réun. Cons. int. Explor. Mer* 178:375-388.
- LYNN, R. J., K. A. BLISS, AND L. E. EBER.  
1982. Vertical and horizontal distributions of seasonal mean temperature, salinity, sigma-t, stability, dynamic height, oxygen, and oxygen saturation in the California Current, 1950-1978. *Calif. Coop. Oceanic Fish. Invest. Atlas* 30, 513 p.
- MACCALL, A. D.  
1983. Population models of habitat selection, with application to the northern anchovy. Ph.D. Thesis, Univ. California at San Diego, San Diego, 170 p.
- MAIS, K. F.  
1974. Pelagic fish surveys in the California Current. *Calif. Dep. Fish Game Fish Bull.* 162, 79 p.
- MESSERSMITH, J. D., AND ASSOCIATES.  
1969. The northern anchovy (*Engraulis mordax*) and its fishery, 1965-1968. *Calif. Dep. Fish Game Fish Bull.* 147, 102 p.
- METHOT, R. JR.  
1981. Growth rates and age distributions of larval and juvenile northern anchovy, *Engraulis mordax*, with inferences on larval survival. Ph.D. Thesis, Univ. California at San Diego, San Diego, 203 p.
- MOOERS, C. N. K., AND A. R. ROBINSON.  
1984. Turbulent jets and eddies in the California Current and inferred cross-shore transports. *Science* 223:51-53.
- NELSON, C. S.  
1977. Wind stress and wind stress curl over the California Current. U.S. Dep. Commer., NOAA Tech. Rep. NMFS



- SSRF-714, 87 p.
- NEUMANN, G., AND W. J. PIERSON, JR.  
1966. Principles of physical oceanography. Prentice-Hall, Englewood Cliffs, NJ, 545 p.
- O'CONNELL, C. P.  
1980. Percentage of starving northern anchovy, *Engraulis mordax*, larvae in the sea as estimated by histological methods. Fish. Bull., U.S. 78:475-489.
- OKUBO, A.  
1971. Oceanic diffusion diagrams. Deep-Sea Res. 18:789-802.  
1976. Remarks on the use of 'diffusion diagrams' in modeling scale-dependent diffusion. Deep-Sea Res. 23:1213-1214.
- OWEN, R. W.  
1980. Eddies of the California Current system: physical and ecological characteristics. In D. M. Power (editor), The California Islands: Proceedings of a Multidisciplinary Symposium, p. 237-263. Santa Barbara Mus. Nat. History.
- PARRISH, R. H., C. S. NELSON, AND A. BAKUN.  
1981. Transport mechanisms and reproductive success of fishes in the California Current. Biol. Oceanogr. 1:175-203.
- POWER, J. H.  
1984. A numerical method for simulating plankton transport. Ecol. Model. 23:53-66.
- ROTHSCHILD, B. J., E. D. HOUDE, AND R. LASKER.  
1982. Causes of fish stock fluctuations: Problem setting and perspectives. In B. J. Rothschild and C. Rooth (editors), Fish ecology III, p. 39-86. Univ. Miami Tech. Rep.
- SIMPSON, J. J., C. J. KOBLINSKY, L. R. HAURY, AND T. D. DICKEY.  
1984. An offshore eddy in the California Current system: preface. Prog. Oceanogr. 13:1-4.
- SMITH, P. E.  
1972. The increase in spawning biomass of northern anchovy, *Engraulis mordax*. Fish. Bull., U.S. 70:849-874.
- SMITH, P. E., AND R. LASKER.  
1978. Position of larval fish in an ecosystem. Rapp. P.-v. Réun. Cons. int. Explor. Mer 173:77-84.
- SOUTAR, A., AND J. D. ISAACS.  
1974. Abundance of pelagic fish during the 19th and 20th centuries as recorded in anaerobic sediments off the California. Fish. Bull., U.S. 72:257-273.
- STAUFFER, G. D., AND R. L. CHARTER.  
1982. The northern anchovy spawning biomass for the 1981-82 California fishing season. Calif. Coop. Oceanic Fish. Invest. Rep. 23:15-19.
- SUNADA, J. S.  
1975. Age and length composition of northern anchovies, *Engraulis mordax*, in the 1972-73 season California anchovy reduction fishery. Calif. Fish Game 61:133-143.
- TSUCHIYA, M.  
1980. Inshore circulation in the Southern California Bight, 1974-1977. Deep-Sea Res. 27A:99-118.
- VROOMAN, A. M., P. A. PALOMA, AND J. R. ZWEIFEL.  
1981. Electrophoretic, morphometric, and meristic studies of subpopulations of northern anchovy (*Engraulis mordax*). Calif. Fish Game 67:39-51.



# PARASITES OF BENTHIC AMPHIPODS: DINOFLAGELLATES (DUBOSQUODINIDA: SYNDINIDAE)

PHYLLIS T. JOHNSON<sup>1</sup>

## ABSTRACT

During a 2½-yr survey, 13 species of benthic amphipods collected from the continental shelf of the north-eastern United States were found infected by dinoflagellates. Prevalences ranged from <1% to 67%, depending on amphipod species, time, and place of collection. The parasites are assigned to the order Duboscquodina, family Syndinidae, based on similar life histories and a similar kind of mitosis ("mitose syndinienne"). Two types of organisms were involved, both apparently more closely related to *Hematodinium* Chatton and Poisson than to other described syndinids. Morphology and development of the parasites and host-parasite interactions are discussed. A cytochemical method used to determine presence or absence of basic nuclear proteins was strongly positive for basic proteins in spores and prespores but negative in most other stages. A few spores in four infections possessed a distinct flagellum, but in the absence of living material, shape of spores and whether they were biflagellate could not be determined. With three possible exceptions in the group of 303 infections studied, the syndinids were not recognized as foreign by their hosts, and in joint infections of syndinids and fungi, only the fungi were being attacked by host hemocytes. High prevalences in certain of the amphipod species suggest that the syndinids might be population regulators in these species.

This paper is one of three that describe and discuss the more common parasites found in populations of benthic amphipods of the continental shelf of the northeastern United States. The other papers concern microsporidians and ciliates (Johnson 1985, 1986).

Because my observations on the parasites discussed in this paper were based on examination of histological sections, I could not determine whether spores were typical "dinospores". However, agreement with other developmental stages of well-studied species of syndinids from copepods and an amphipod, and the nuclear type, indicates that the parasites of benthic amphipods are related to species currently placed in the Syndinidae, order Duboscquodina (sensu Chatton 1952 and Cachon 1964). Previously described syndinids occur intracellularly in radiolarians and in copepod and shrimp eggs (Chatton 1952; Stickney 1978) and extracellularly in the hemocoel of copepods, an amphipod, and portunid and cancrid crabs (Chatton and Poisson 1931; Chatton 1952; Manier et al. 1971; Newman and Johnson 1975; MacLean and Ruddell 1978).

The relationship of the Duboscquodina to free-living dinoflagellates is in doubt (Cachon 1964; Ris and Kubai 1974; Siebert and West 1974; Hollande 1975; Loeblich 1976; Herzog et al. 1984). Lacking

a definitive consensus, the parasitic protists discussed here are provisionally referred to the Dinoflagellata.

The data presented and discussed in this paper show that species of syndinids are probably ubiquitous hemocoelic parasites of benthic and epibenthic amphipods, and may be population regulators in some species.

## METHODS

The data are based on material collected during monitoring surveys carried out over a 2½-yr period by the Northeast Fisheries Center, National Marine Fisheries Service. The 35 stations where benthic amphipods were collected during the surveys are shown in Figure 1. Amphipods were sampled during 11 cruises, but not all stations were visited on each cruise, so that stations were sampled from 1 to 10 times each during the survey. A Smith-McIntyre<sup>2</sup> grab and occasionally an epibenthic sled or scallop dredge were used to obtain the samples. The 11 stations indicated by solid circles on Figure 1 had the most consistent and numerous populations of amphipods, and were sampled at least five times each. They yielded the majority of data presented here.

Amphipods were preserved in 10% seawater Formalin. Up to 30 individuals of each species pres-

<sup>1</sup>Northeast Fisheries Center, National Marine Fisheries Service, NOAA, Oxford, MD 21654.

<sup>2</sup>Reference to trade names does not imply endorsement by the National Marine Fisheries Service, NOAA.

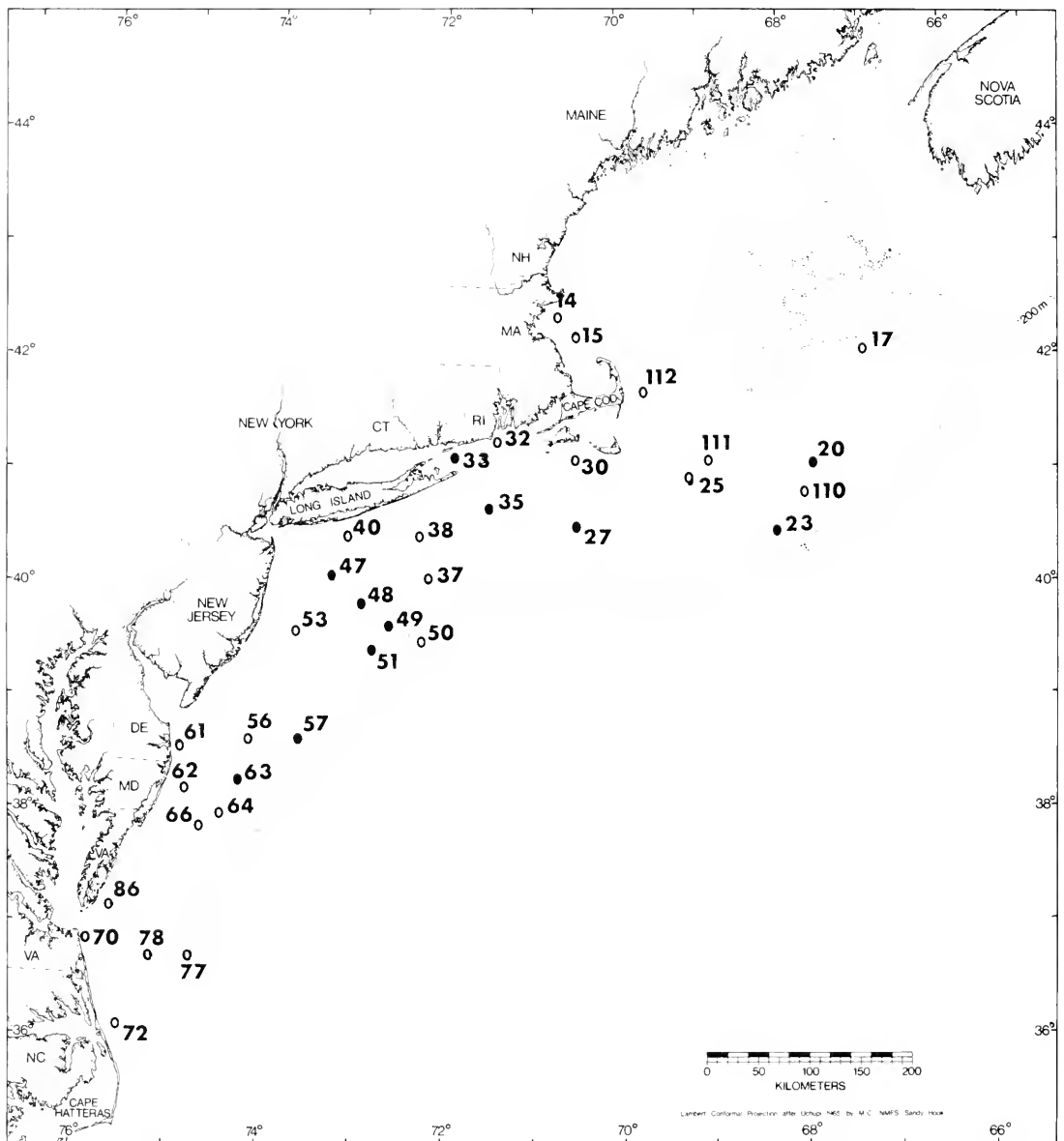

FIGURE 1.—Benthic stations where gammaridean amphipods were sampled during the survey.

ent in a sample, and sometimes more, depending on numbers present, were prepared for histological study. Details of collecting procedures and histological preparation of the amphipods are given by Johnson (1985). Sections were cut at  $6\ \mu\text{m}$ . Staining methods included Harris' hematoxylin and eosin (H&E), the Feulgen reaction, and Alfert and Geschwind's (1953) fast-green method for demonstration of basic nuclear proteins. Harris' hematoxylin and eosin is specified because this combination stains

nuclei of the parasites purple during certain stages. Other hematoxylin solutions, used with eosin, will not necessarily impart the same distinct purple color. Unless otherwise indicated, references to staining properties of the organisms are to H&E-stained specimens.

## OBSERVATIONS

Thirteen amphipod species were infected with syn-

dinids (Table 1). The organisms occupied the hemocoel and morphologically were most like *Hematodinium perezi* Chatton and Poisson, which was described from European portunid crabs. There were two distinct types, based on morphology and development. There is not enough information about the life history stages of *Hematodinium* to warrant assigning either or both types to that genus, and they are identified casually in this paper as "Type AA" and "Type AV" (Table 2). The Type AA forms

were similar in all the amphipod species they infected, but there was variation in forms assigned to Type AV, and probably more than one species was involved.

### Host and Geographic Distribution

Juvenile and mature amphipods of both sexes were attacked. Only Type AA was found in *Ampelisca agassizi* (Judd), *Byblis serrata* Smith, and

TABLE 1.—Amphipod species infected with Type AA and Type AV parasites.

Species of amphipod	Type of parasite	Prevalence positive stations (%)	Prevalence all stations (%)
<i>Ampelisca agassizi</i> (Judd)	AA	7 (101/1468)	4 (101/2403)
<i>Byblis serrata</i> Smith	AA	14 (24/170)	8 (24/316)
<i>Harpinia propinqua</i> Sars	AA <sup>1</sup>	18 (3/17)	3 (3/116)
<i>Ampelisca vadorum</i> Mills	AV	41 (74/181)	17 (74/448)
<i>Ampelisca verrilli</i> Mills	AV	18 (7/38)	15 (7/48)
<i>Casco bigelowi</i> (Blake)	AV	67 (6/9)	10 (6/60)
<i>Leptocheirus pinguis</i> (Stimpson)	AV	4 (7/163)	0.8 (7/913)
<i>Melita dentata</i> (Krøyer) s. lat.	AV	8 (1/12)	2 (1/44)
<i>Monoculodes edwardsi</i> Holmes	AV	27 (25/93)	23 (25/110)
<i>Protohaustorius wigleyi</i> Bousfield	AV	20 (1/5)	0.9 (1/110)
<i>Phoxocephalus holbolli</i> Krøyer	AV	27 (10/37)	14 (10/73)
<i>Rhepoxynius epistomus</i> (Shoemaker)	AA and AV	20 (7/35)	3 (7/249)
<i>Unciola</i> species (probably all <i>U. irrorata</i> Say and <i>U. inermis</i> Shoemaker)	AA and AV	9 (37/404)	3 (37/1365)

<sup>1</sup>Parasites in two of the infections may not be either Type AA or Type AV.

TABLE 2.—Main characteristics of Type AA and Type AV.

Stage	Characteristic	Type AA	Type AV
I	Nuclear diameter	<3 to >5 $\mu$ m	2.5 to 3 $\mu$ m
	Nuclear color	Blue or purple	Purple
	Chromosomes	Usually condensed	Not condensed
	Plasmodia	Present, small	Present, small
	Single cells	Common	Absent or uncommon
	Cytoplasm	Scanty	Abundant, faintly fibrous
	IA	Dense bodies	Not present
Nuclear diameter		—	2.5 to 4 $\mu$ m
Nuclear color		—	Purple
Plasmodia		—	Present, small
Single cells		—	Present
II	Nuclear diameter	4 to 5.5 $\mu$ m	3 to 4 $\mu$ m
	Nuclear color	Purple	Purple
	Chromosomes	Indistinct, partly condensed	Distinct, partly condensed
	Plasmodia	Uncommon, small	Very rare
	Cytoplasm	Vacuolate	Homogeneous
III	Nuclear diameter (spore)	2.5 to 3 $\mu$ m	<2 $\mu$ m
	Nuclear color (spore)	Deep blue	Deep blue
	Chromosomes (spore)	Always condensed	Always condensed
	Cytoplasm (spore)	Scanty	Scanty
	Plasmodia	Absent	Present
	Nuclear diameter (plasmodia)	—	3.5 $\mu$ m
	Nuclear color (plasmodia)	—	Purple

*Harpinia propinqua* Sars. Both Types AA and AV occurred in *Rhepoxynius epistomus* (Shoemaker) and *Unciola* species (*U. irrorata* Say and *U. inermis* Shoemaker), and only Type AV occurred in the remaining species (Table 1). Both types of syndinidians were present in *Unciola* species taken in a single sample at station 35, but individual specimens were parasitized by only one type. There are not enough data to indicate whether or not incidence varies by time of year in any of the amphipod species infected with these parasites. Infected amphipods were not found at the most northern and southern of the stations, but these stations were sampled fewer times than most of the "positive" stations (i.e., stations where amphipods with syndinid infections occurred). There were 18 positive stations. Only Type AA was found at stations 23, 37, and 50. Only Type AV occurred at stations 33, 40, 56, and 62. Both types were represented at stations 20, 27, 35, 38, 47, 48, 49, 51, 57, 63, and 64.

Whether one or both types occurred at a single station depended variously on which amphipod species were present, and on unknown factors. Two species of *Ampelisca*, *A. vadorum* Mills and *A. agassizi*, were common at inshore station 33. Prevalence of Type AV in *A. vadorum* was 35% (56/158). However, Type AA did not occur at station 33 although a favored host, *A. agassizi*, was abundant there. In contrast, only Type AA was found at station 23, no doubt because of 2,811 amphipods collected there, only 23 were not *A. agassizi*.

### Development and Morphology

All forms were similar in that extensive plasmodia were never present and chromosomes were condensed in the interphase nuclei of the spores. There were four, possibly five, chromosomes. There was no metaphase plate. At telophase the apices of the two sets of chromosomes were touching (see Figure 3), and at all stages of mitosis the chromosomes of each group were juxtaposed basally (where they presumably were attached to the nuclear membrane) and spread out apically to varying degrees, like the spokes of a parasol (Figs. 2-4). These events are typical of "mitose syndinienne" (Chatton 1921). Syndinid chromosomes are V-shaped, so that each has two arms. In tissue sections the V shape was best seen in cells that had lysed, leaving only the chromosomes (Fig. 5). During telophase there were often only four (sometimes five?) visible arms of chromosomes in each daughter nucleus. If sectioning artifact was not responsible for the small number

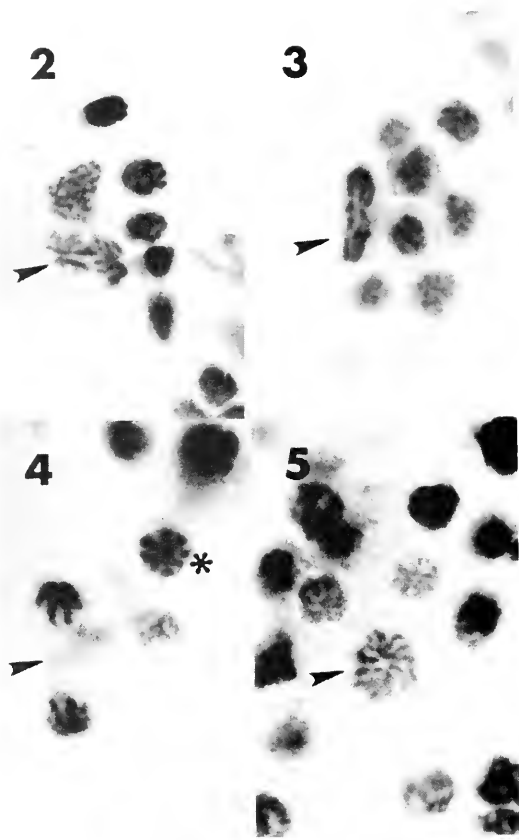

FIGURES 2-3.—Mitosis in Type AV parasites in *Ampelisca vadorum* (arrowheads). Interphase parasites of Figure 3 are stage II.

FIGURE 4.—Mitosis in a Type AA parasite in *Ampelisca agassizi* (arrowhead). Chromosomes form a rosette in the interphase nucleus to the right (asterisk).

FIGURE 5.—Chromosomes in a lysed Type AA parasite from *Byblis serrata* (arrowhead). The V shape of the chromosomes is evident. Figures 2-5,  $\times 1500$ .

of visible arms, the cells might have been haploid.

Before spore formation, chromatin disposition in nuclei was variable, depending on the type of parasite and the stage of development. Resting nuclei with unfolded chromosomes were granular or vesicular, and sometimes rimmed with chromatin (see Figures 8, 17). In nuclei with partially unfolded chromosomes, clumps of chromatin often were arranged so that they created a dashed or dotted line in the position that would be occupied by a completely condensed chromosome (see Figure 9). When seen in a polar view, chromosomes or chromatin clumps formed rosettes (Figs. 4, 5). Morphology of the persistent chromosomes of spores was variable and will be described later.

Staining characteristics of nuclei differed depending on the stage. Except for spores, prespores, and some cells in early Type AA infections, nuclei tended to be purple, not blue, with both chromatin and the matrix staining similarly in some cases. When nuclei at these stages were in mitosis, the chromosomes were little, if at all, bluer than chromatin in resting cells, although sometimes chromatin was more deeply staining in the dividing cells. Types of chromosomes that stained with fast green by the Alfert and Geschwind method (indicating presence of basic proteins on the chromosomes) would stain blue in H&E preparations. Chromatin and chromosomes that did not stain with fast green in the Alfert and Geschwind method would stain purple with H&E.

A comparison of Types AA and AV, by developmental stage, is given in Table 2. Infections consisting of few parasites were considered to be the earliest ones and are here designated stage I infections. Stage II infections consisted of more numerous and generally larger organisms, and stage III infections consisted of prespores and spores that usually filled the hemocoel.

### Type AA

Most Type AA infections were in *Ampelisca agassizi* (Table 1). Type AA chromosomes of all developmental stages were usually thicker than those of Type AV (compare Figures 2 and 4), and the organisms and their nuclei were larger (Table 2). Stage I organisms were scattered through the hemocoel, never numerous, and variable in morphology and staining characteristics. The one common attribute was scanty and poorly staining cytoplasm. Chromosomes were usually distinct. The most usual stage I infection consisted of scattered single cells and small plasmodia with nuclei that measured 3 to 4  $\mu\text{m}$  and had rather distinct chromosomes or chromatin clumps that stained a clear blue. Mitotic figures were not frequent, but were more common than in the other stages. A few cells in a late stage I (or very early stage II) infection probably were polyploid. They had many rather long, tangled chromosomes that sometimes formed partially separated groups within the nuclear area. The nuclei of these cells measured more than 7  $\mu\text{m}$  in the greater dimension.

Stage II organisms were more numerous and distinguished by having voluminous vacuolate or foamy cytoplasm (Fig. 6). Chromosomes and chromatin clumps were often obscured because the nuclear matrix stained almost as strong a purple as the chromatin. The nuclear matrix did not stain in the

Feulgen reaction. Plasmodia were uncommon, always small, and sometimes consisted of short chains of joined cells. Mitosis was rarely seen in stage II and stage III, and probably was closely synchronized, which would reduce the probability of finding mitotic figures in fixed material. As the spore stage was approached, nuclei became smaller and bluer, and chromatin clumps and chromosomes gained clear outlines, because the matrix no longer stained.

By the time of spore formation (stage III), organisms filled the hemocoel, and infected amphipods in H&E-stained sections could be distinguished with the naked eye because of their overall dark-blue color. Spore nuclei were spherical, and chromosomes were condensed but tightly packed and impossible to count (Fig. 7). In one infection, synchronized nuclear division had apparently just taken place, and daughter cells had not yet separated, so that bi- and

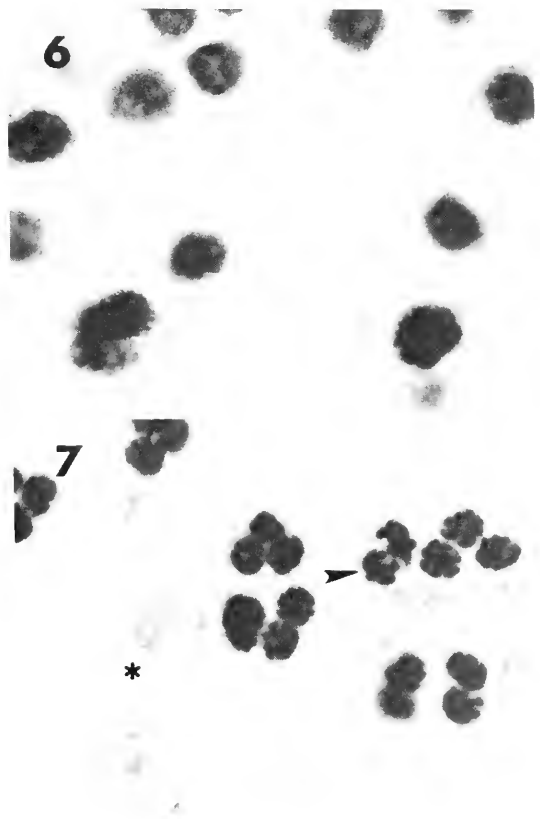

FIGURES 6-7.—Type AA parasites in *Ampelisca agassizi*. 6: Stage II. Nuclei do not have distinct clumps of chromatin and the cytoplasm is vacuolate. 7: Stage III (spores) (arrowhead). An unidentified fungus was also infecting the amphipod (asterisk). Figures 6-7,  $\times 1500$ .

quadrinucleate plasmodia were common. Cytoplasm of spores was scant. Sometimes spores were shaped like teardrops but generally they had amorphous outlines. A flagellum was visible on a few spores in an individual of *Unciola* species.

### Type AV

This description is based on the organisms that infected *Ampelisca vadorum*. Stage I consisted of scarce and scattered small plasmodia, typically each with 2 to 10 nuclei. Their cytoplasm was faintly fibrous. Chromatin and the nuclear matrix were always purplish and nuclei were often rimmed with chromatin (Fig. 8). The nuclear matrix was not Feulgen positive, and chromatin did not stain strongly by this method. Slightly more advanced infections, with more parasites, had irregularly shaped single cells as well as plasmodia. The single organisms were often elongate, their nuclei were as above, and their cytoplasm was faintly stained.

Stage IA, which I presume follows stage I, and which did not occur in Type AA, had moderate numbers of small plasmodia and single cells. Chromatin patterns were rather distinct in most nuclei, particularly in the larger ones. Chromatin stained purple. Stage IA was distinguished by the presence of small, densely staining bodies. They were usually spherical but sometimes oval, and were usually surrounded by thin rims of cytoplasm. The bodies were associated with the plasmodia (Fig. 9) and also scattered through the hemocoel. They were intensely Feulgen positive and stained bright green by the Alfert and Geschwind method. The dense bodies were never extremely abundant and were present only in the company of many stage IA cells.

Chromosomes of stage II cells were partially condensed, and chromosomes and chromatin clumps were distinct because there was minimal staining in the nuclear matrix, unlike Type AA parasites in stage II. The cytoplasm was usually densely and homogeneously stained (Fig. 3). Cells were often very numerous and closely packed, but were not plasmodial. Occasionally there were a few dense bodies like those associated with stage IA.

Occasional stage III infections were not as heavy as some stage II infections. There was apparently an abrupt transition from stage II cells to stage III prespores and spores. In one infection, a mass of spores with distinct deep-blue chromosomes occupied a circumscribed area in the hemocoel, and larger single cells with condensed chromosomes that stained purple, and were probably very late stage II, occupied the remainder of the hemocoel (Fig. 10).

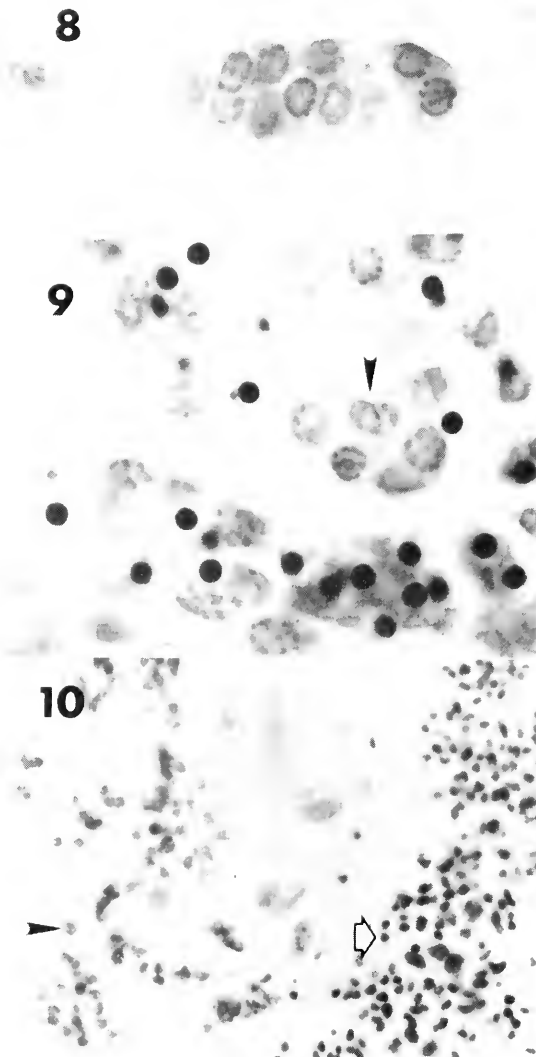

FIGURES 8-10.—Type AV parasites in *Ampelisca vadorum*. 8: Stage I. Several nuclei in the plasmodia are rimmed with chromatin. 9: Stage IA. Plasmodia with associated spherical dense bodies. Nuclei are pale and chromosomes are partially unfolded in some nuclei (arrowhead). 10: Late Stage II (larger, pale nuclei to the left—arrowhead) and Stage III (smaller, deeply staining nuclei to the right—open arrow). A demonstration of synchronized division of the parasite. Larger host nuclei are also present. Figures 8-9,  $\times 1500$ ; Figure 10,  $\times 600$ .

Presumably, the mass of spores resulted from synchronized but circumscribed division of a part of the population of the larger cell type. The roughly spherical nuclei of the spores in this infection were  $<2 \mu\text{m}$  in diameter; nuclei of the larger cells were slightly  $>3 \mu\text{m}$  in diameter.



Cells presumed to represent spores had either elongate or spherical nuclei (Figs. 11, 12). The two types did not occur together. Mitosis took place in very small cells, and possibly cells with spherical nuclei were prespores. They might also have been spores that had not yet acquired their final form, because cells of an intermediate shape also occurred. Chromosomes of the spherical nuclei were short; those of elongate nuclei were longer, somewhat more slender, and beaded. Because the cytoplasm was usually indistinct or invisible, outlines of spores were also indistinct. It is probable that spores often ruptured during fixation, resulting in loss of all cell components except the chromosomes, as shown in Figure 11.

A probable polyploid cell was present in one early stage III infection, and there were small plasmodia in all stage III infections (as in Figure 17). Nuclei in plasmodia had purple-staining chromatin and did not stain by the Alfert and Geschwind method, unlike chromosomes of the spores. The relationship of the small plasmodia to spore formation was not obvious.

Numbers of Type AV-infected individuals of species other than *A. vadorum* and *M. edwardsi* were small, and all stages of development were not usually represented. Stage IA infections, as well as

some or all the other stages, were seen in *Ampelisca verrilli* Mills, *Leptocheirus pinguis* (Stimpson), *Casco bigelowi* (Blake), and *Unciola* species. Stage IA infections of *A. verrilli* and *C. bigelowi* differed from those of *A. vadorum* because the small dense bodies were often irregularly shaped or composed of two or three contiguous particles rather than being single and spherical or oval. In one of two stage III infections in *L. pinguis*, spores had almost spherical chromosomes (Fig. 13). In the other, chromosomes were indistinct because they were closely packed, but were longer than in the first infection and apparently beaded. All stages of infection were represented in *Unciola* species. Spore nuclei were round or oval and a flagellum was visible on a few spores in two infections. The final divisions were just taking place in one of these infections, and many cells were still binucleate. Most of the single spores had rounded outlines, but spores with a visible flagellum were oval.

*Monoculodes edwardsi* had the highest overall prevalence of Type AV (Table 1). The 25 infections encompassed all stages except Stage IA. There were polyploid cells in stage II infections. Their nuclei were sometimes over 6  $\mu\text{m}$  in diameter, often had chromatin separated into several areas (Fig. 14), and their chromosomes were seldom completely condensed, except in mitotic cells. Polyploid cells in mitosis had at least three sets of chromosomes. Outlines of both the interphase nucleus and the entire cell were often highly irregular. Plasmodia that presumably resulted from nuclear division of the polyploid cells often had nuclei of two or more sizes (Fig. 15), suggesting that all chromosome sets did not divide at the same time, or that the genetic material was not distributed equally at the time of division, so that a single plasmodium might have contained haploid, diploid, and polyploid nuclei. Nuclei of Type AV spores in *M. edwardsi* were about 1  $\mu\text{m}$  in diameter (Fig. 16). A single flagellum (not pictured) was visible on some spores in the infection presented in Figure 16. As typical of Type AV, plasmodia were present in all stage III infections (Fig. 17).

### Host Response

Reactions against the syndinid parasites were extremely rare. One Type AV-infected specimen each of *Melita dentata* (Krøyer) s. lat. and *Unciola* species had scattered, melanized, amorphous nodules in the hemocoel, but the nodules could not be definitely associated with the syndinid infections. In one specimen of *L. pinguis*, hemocytes were associated

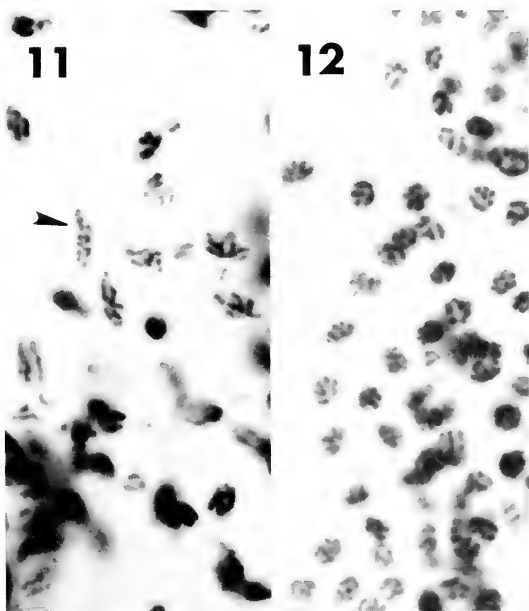

FIGURES 11-12.—Type AV, Stage III (spores), in *Ampelisca vadorum*. 11: Elongate spores. Note the beaded appearance of the chromosomes in one spore (arrowhead). 12: Spherical spores. Figures 11-12,  $\times 1500$ .

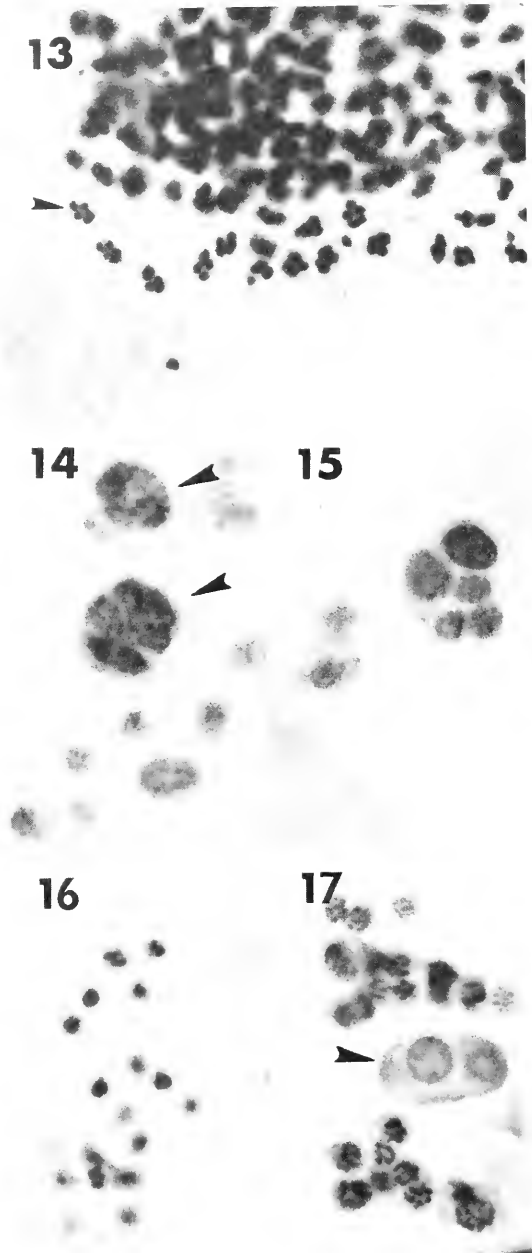

FIGURES 13-17.—Type AV parasites. 13: Stage III (spores) in *Leptocheirus pinguis*. The chromosomes are spherical (arrowhead). 14: Stage II in *Monoculodes edwardsi*. Two of the parasites are polyploid (arrowheads). Note separate groups of chromosomes or chromatin clumps in both these parasites. 15: Plasmodium resulting from nuclear division of a polyploid parasite in *M. edwardsi*. Note differently sized nuclei. 16: Stage III (spores) in *M. edwardsi*. There were flagellated spores in this infection. 17: Prespores, some dividing, in *M. edwardsi*. A plasmodium, with rimmed nuclei, is also present (arrowhead). Figures 13-17,  $\times 1500$ .

with Type AV organisms, and karyorrhexis had occurred in unidentified cells in the area. With the possible exception of the Type AV infection in *L. pinguis*, the syndinids were not being attacked by hemocytes at the time of fixation.

There was another sign that the syndinid parasites successfully evaded detection by their hosts. Two specimens of *A. agassizi*, both collected at station 47 but at different times, were infected jointly and heavily with Type AA and an unidentified fungus (Fig. 7). Of the more than 7,000 examined microscopically, these were the only two amphipods that had systemic fungal infections. Fungi were being phagocytized by hemocytes and fixed phagocytes, and other groups of fungi were being transformed into melanized nodules. (Probably the latter fungi had originally been phagocytized and killed by hemocytes that did not survive the process themselves.) Although hemocytes and fixed phagocytes were actively destroying fungi, there was no indication that the accompanying syndinids were recognized as foreign.

Numbers of hemocytes apparently decreased during syndinid infection, but even in heavy infections some hemocytes remained and were still functional as shown by their ability to phagocytize the fungi discussed above. It is probable that the two successful fungal infections in syndinid-infected amphipods resulted in part from the fungi multiplying more rapidly than they could be phagocytized and degraded by the few remaining hemocytes and the fixed phagocytes associated with the heart.

The syndinid parasites did not castrate their hosts.

Whether death ensues from every infection with these parasites is not known. However, the general lack of discernible host response makes it unlikely that amphipods could successfully combat the parasites.

## DISCUSSION

Like species of *Syndinium* described from copepods, Types AA and AV have a small number of chromosomes which are permanently condensed in spores and partially condensed in certain other stages; plasmodia (small and multiple in the case of Types AA and AV) are present during some developmental stages; and spore formation takes place in the hemocoel of the host. However, species of *Syndinium* in copepods differ from Types AA and AV in that they develop from a plasmodium that is first applied to the wall of the gut and then expands to fill the entire hemocoel. The massive plasmodium then fragments to form individual dinospores. By

the time of sporulation, the host is castrated (Chatton 1910, 1920). Types AA and AV resemble *Hematodinium*, not *Syndinium*, in that apparently none of these organisms develop from a primary plasmodium associated with the gut, but instead they multiply from a few single cells and small plasmodia in the general hemocoel and never form a single massive plasmodium. Further, these parasites do not castrate their hosts (Newman and Johnson 1975; MacLean and Ruddell 1978; P. T. Johnson, unpubl. data).

*Syndinium gammari*, like Types AA and AV, is perhaps more closely related to *Hematodinium* than to *Syndinium*. *Syndinium gammari* was assigned to *Syndinium* by Manier et al. (1971) on the assumption that a massive plasmodium was present during development. However, none of the infections studied by these authors had either a primary plasmodium associated with the gut or a later and massive plasmodium throughout the hemocoel. The first stage of *S. gammari* observed consisted of small irregular plasmodia up to 15  $\mu\text{m}$  in diameter, which Manier and coworkers assumed resulted from the splitting-up of a large plasmodium. The small plasmodia then divided to form "diplococcal" forms, and these divided to give round, single organisms which transformed into spores measuring 7-8  $\mu\text{m}$  by 3-3.5  $\mu\text{m}$ . In the later stages of division, typical "dinomitosis" and "dinokaryons" were present. Considering the course of development in the apparently related parasites of benthic amphipods, Types AA and AV, it is possible that *S. gammari* does not have a primary plasmodium associated with the gut wall and does not develop an extensive plasmodium in the hemocoel. If early stages of *S. gammari* consist of a few single cells or small plasmodia, these could have escaped notice because the parasites were observed after their removal from the host amphipod, either alive or in fixed and stained smears (Manier et al. 1971). Scattered organisms could more easily be missed by this technique than by inspection of paraffin-embedded and sectioned whole amphipods.

Chromosomes of *Solenodinium globiforme* and three species of *Syndinium*, all parasites of radiolarians, stain with fast green in the Alfert and Geschwind method for demonstration of basic nuclear proteins (Ris and Kubai 1974; Hollande 1975). Ris and Kubai remarked that chromosomes of the *Syndinium* species they studied also stained brightly in the Feulgen reaction. Although not definitely stated by the above authors, apparently chromosomes of all developmental stages of the above parasites stained equally with fast green.

Chromosomes of these species tend to remain condensed through the entire developmental cycle. On the other hand, Hollande (1975) found that trophont nuclei of the duboscquodiniids *Amoebophrya ceratii* and *Duboscquella melo* do not stain by the Alfert and Geschwind method. He pointed out that chromosomes are not condensed in the trophont nuclei of these forms and that he did not investigate staining properties of the condensed chromosomes of spores. Hollande did find that a portion of the nucleolus of *A. ceratii* stains with fast green in the Alfert and Geschwind method. Like the syndinid parasites of radiolarians, chromosomes of Type AA and AV spores stain brightly in both Alfert and Geschwind's technique and the Feulgen reaction. However, Feulgen staining is less intense in stages I and II nuclei and these nuclei do not stain at all with fast green.

Eukaryotes have a greater quantity of histone in rapidly dividing cells than in quiescent ones (DuPraw 1968; Wu et al. 1982), and nonhistone basic nuclear proteins—although scarce at all times—are much more abundant in log-phase than in stationary-phase cultures of the free-living dinoflagellates *Gyrodinium cohnii* and *Peridinium trochoideum* (Rizzo and Noodén 1974). It would be interesting to determine the relative amounts of basic nuclear proteins through the developmental cycle of syndinids and other duboscquodiniids, and to determine whether basic proteins of the amphipod parasites increase when cells are dividing rapidly; and whether these proteins are masked by other substances (acidic proteins?) in stages where both chromatin and nuclear matrix stain purple with H&E and do not stain in the Alfert and Geschwind method.

Probably fixation and paraffin embedment not only damaged flagella and were responsible for apparent lack of flagella on most spores of Types AA and AV, but also distorted spores of these parasites. Cachon (1964) cautioned that because spores of parasitic dinoflagellates become distorted or ruptured both on fixation and when physical conditions are not proper, their shapes must be determined in living material.

Origin and function of the small dense bodies present in Type AV, stage IA infections were not evident. These bodies might represent necrotic nuclei like those seen in *Syndinium* infections (Jepps 1936-37), discarded chromatin resulting from reduction divisions, or, perhaps, nuclei of microspores (Cachon 1964).

Numbers of *Gammarus locusta* (Linn.) infected with *Syndinium gammari* in the Étang de Thau, France, varied from few to all members of a popula-

tion (Manier et al. 1971). The infected amphipods these authors examined were apparently unaffected by the parasite. However, before one could determine the mortality rate due to syndinid infection, it would be necessary to examine moribund and dead amphipods found in the field for presence of syndinids, as well as to follow progress of infection in the laboratory. Syndinids appear to be unaffected by host defense mechanisms. Spores of syndinids that parasitize the hemocoel must exit through breaks in the exoskeleton or gut. Because hemocytes are in short supply by time of sporulation and other host resources can be expected to be depleted, host defense mechanisms probably would not be sufficient to prevent death by infection with other microorganisms that would enter through the breaks or death by leakage of body fluids. Assuming, on the basis of evidence presented in this paper, that amphipods are unable to contain syndinid infections and that most infections would therefore progress to the spore stage, syndinid infection could serve as a population regulator in heavily parasitized species. *Monoculodes edwardsi* and *Ampelisca vadorum*, which had overall prevalences of syndinid infection of 23% and 17% respectively, are examples of species that might be affected in this manner.

## ACKNOWLEDGMENTS

Sara V. Otto, Maryland Department of Natural Resources, Oxford, MD, aided in translation of articles from the French, and the following personnel from the Oxford and Sandy Hook Laboratories of the Northeast Fisheries Center helped as follows: Frank Steimle, David Radosh, Linda Dorigatti, Gretchen Roe, and Sharon MacLean collected the amphipods; Ann Frame and Linda Dorigatti aided in their identification; and Gretchen Roe, Dorothy Howard, Cecelia Smith, and Linda Dorigatti prepared the specimens for histological examination. My thanks to all of the above.

## LITERATURE CITED

- ALFERT, M., AND I. I. GESCHWIND.  
1953. A selective staining method for the basic proteins of cell nuclei. *Proc. Nat. Acad. Sci. USA* 39:991-999.
- CACHON, J.  
1964. Contribution à l'étude des Péridiniens parasites. *Ann. Sci. Nat. Zool. Fr., Sér. 12*, 6:1-158.
- CHATTON, E.  
1910. Sur l'existence de Dinoflagellés parasites coelomiques. Les *Syndinium* chez les Copépodes pélagiques. *C. R. Acad. Sci. Paris*, 151:654-656.
- CHATTON, E.  
1920. Les Péridiniens parasites. Morphologie, reproduction, éthologie. *Arch. Zool. Exp. Gén.* 59:1-475.
- CHATTON, E.  
1921. Sur un mécanisme cinétique nouveau: la mitose syndinienne chez les Péridiniens parasites plasmodiaux. *C. R. Acad. Sci. Paris, Sér. D*, 173:859-862.
- CHATTON, E.  
1952. Classe des Dinoflagellés ou Péridiniens. *In* P. P. Grasse (editor), *Traité de Zoologie*, Vol. 1, p. 309-390. Masson et Cie, Paris.
- CHATTON, E., AND R. POISSON.  
1931. Sur l'existence, dans le sang des Crabes de Péridiniens parasites: *Hematodinium perezi* n.g., n. sp. (Syndinidae). *C. R. Soc. Biol.* 105:553-557.
- DU PRAW, E. J.  
1968. Cell and molecular biology. Academic Press, N.Y.
- HERZOG, M., S. VON BOLETZKY, AND M.-O. SOYER.  
1984. Ultrastructural and biochemical nuclear aspects of eukaryote classification: independent evolution of the dinoflagellates as a sister group of the actual eukaryotes? *Origins Life* 13:205-215.
- HOLLANDE, A.  
1975. Étude comparée de la mitose syndinienne et de celle des Péridiniens libres et des Hypermastigines infrastructure et cycle évolutif des Syndinides parasites de Radiolaires. *Protistologica* 10:413-451.
- JEPPE, M. W.  
1936-37. On the protozoan parasites of *Calanus finmarchicus* in the Clyde Sea area. *Q. J. Microsc. Sci.* 79:589-662.
- JOHNSON, P. T.  
1985. Parasites of benthic amphipods: microsporidians of *Ampelisca agassizi* (Judd) and some other gammarideans. *Fish. Bull.*, U.S. 83:497-505.  
1986. Parasites of benthic amphipods: ciliates. *Fish. Bull.*, U.S. 84:204-209.
- LOEBLICH, A. R., III.  
1976. Dinoflagellate evolution: speculation and evidence. *J. Protozool.* 23:13-28.
- MACLEAN, S. A., AND C. L. RUDELL.  
1978. Three new crustacean hosts for the parasitic dinoflagellate *Hematodinium perezi* (Dinoflagellata: Syndinidae). *J. Parasitol.* 64:158-160.
- MANIER, J.-F., A. FIZE, AND H. GRIZEL.  
1971. *Syndinium gammari* n. sp. péridinien Dubosquodimida Syndinidae, parasite de *Gammarus locusta* (Lin.) Crustacé Amphipode. *Protistologica* 7:213-219.
- NEWMAN, M. W., AND C. A. JOHNSON.  
1975. A disease of blue crabs (*Callinectes sapidus*) caused by a parasitic dinoflagellate, *Hematodinium* sp. *J. Parasitol.* 61:554-557.
- RIS, H., AND D. F. KUBAL.  
1974. An unusual mitotic mechanism in the parasitic protozoan *Syndinium* sp. *J. Cell Biol.* 60:702-720.
- RIZZO, P. J., AND L. D. NOODEN.  
1974. Isolation and partial characterization of dinoflagellate chromatin. *Biochim. Biophys. Acta* 349:402-414.
- SIEBERT, A. E., AND J. A. WEST.  
1974. The fine structure of the parasitic dinoflagellate *Haplozoon axiothellae*. *Protoplasma* 81:17-35.
- STICKNEY, A. P.  
1978. A previously unreported peridinin parasite in the eggs of the northern shrimp, *Pandalus borealis*. *J. Invertebr. Pathol.* 32:212-215.
- WU, R. S., S. TSAI, AND W. M. BONNER.  
1982. Patterns of histone variant synthesis can distinguish G<sub>0</sub> from G<sub>1</sub> cells. *Cell* 31:367-374.

# FOOD HABITS AND DIET OVERLAP OF TWO CONGENERIC SPECIES, *ATHERESTHES STOMIAS* and *ATHERESTHES EVERMANNI*, IN THE EASTERN BERING SEA

M. S. YANG<sup>1</sup> AND P. A. LIVINGSTON<sup>2</sup>

## ABSTRACT

Stomachs of 196 arrowtooth flounder, *Atheresthes stomias*, and 152 Kamchatka flounder, *A. evermanni*, collected from the same area of the eastern Bering Sea in summer 1983 were examined. Each species was divided into four fork-length groups: less than 201 mm, 201-300 mm, 301-400 mm, and greater than 400 mm. The principle diet of both species was comprised of walleye pollock, *Theragra chalcogramma*, shrimp (mostly Crangonidae), and euphausiids. Pollock was the most important prey item for both species in all four size groups, ranging from 56 to 86% and 66 to 88% of the total stomach content weight of Kamchatka flounder and arrowtooth flounder, respectively. Schoener's indices of diet overlap were calculated between the two species for each size group. The high value of the indices (ranging from 0.67 to 0.90) indicate that these two congeneric species basically consume the same resources.

The genus *Atheresthes* of the family Pleuronectidae has two species: Kamchatka flounder, *A. evermanni* (Jordan and Starks), and arrowtooth flounder (Norman, 1934), *A. stomias* (Jordan and Gilbert). *Atheresthes evermanni* is distributed from northern Japan (Hokkaido) through the Sea of Okhotsk to the western Bering Sea north to Anadyr Gulf (Willimovsky et al. 1967). *Atheresthes stomias* is distributed from Central California to the eastern Bering Sea. In the Bering Sea, it meets about on a line with Saint Matthew Island, overlaps with, and is replaced by *A. evermanni* (Hart 1973).

Because the morphological differences between *A. evermanni* and *A. stomias* are subtle, they have been recorded as one species, *A. stomias*, in the eastern Bering Sea resource assessment surveys of the Northwest and Alaska Fisheries Center (NWAFRC) (Smith and Bakkala 1982). Food habits of *A. stomias* have been studied by some researchers (Gotshall 1969; Kabata and Forrester 1974; Smith et al. 1978), but none of those studies covered the food habits of *A. evermanni*. Shuntov (1970) studied the feeding intensity of the two *Atheresthes* species, but he did not compare the diets of these species.

Using electrophoretic examination, Ranck et al. (1986) have confirmed that these two types of *Atheresthes* are separate species. The purpose of this study is to analyze stomach samples of these two con-

generic species collected in the area of their distributional overlap in the eastern Bering Sea and compare the diets of both fish species to calculate the degree of diet similarity to determine whether the two species can be considered trophically equivalent.

## COLLECTION AND PROCESSING OF SAMPLES

Specimens were collected from 6 July to 16 July 1983 in the eastern Bering Sea aboard the *Alaska*, a research vessel participating in the annual summer resource assessment survey conducted by the Resource Assessment and Conservation Engineering (RACE) division of the NWAFRC in Seattle, WA. Stomachs of arrowtooth flounder and Kamchatka flounder were taken at standard resource assessment stations where half-hour tows were made using an 83-112 Eastern bottom trawl net with an estimated 2.3 m vertical and 16.4 m horizontal mouth opening.

The samples were collected in an area around and to the northwest of the Pribilof Islands at bottom depths ranging from 71 to 137 m (Fig. 1, Table 1). A random subsample of individuals of both arrowtooth flounder and Kamchatka flounder was obtained at each station with a total collection of 348 stomachs from 19 stations.

Individual fish were first checked for signs of regurgitation, i.e., food items in mouth or gill plates or flaccid stomach, and were discarded if any such signs were noted. Stomachs from the remaining fish

<sup>1</sup>Fisheries Research Institute, University of Washington, WH-10, Seattle, WA 98195.

<sup>2</sup>Northwest and Alaska Fisheries Center, National Marine Fisheries Service, NOAA, 7600 Sand Point Way N.E., Seattle, WA 98115.

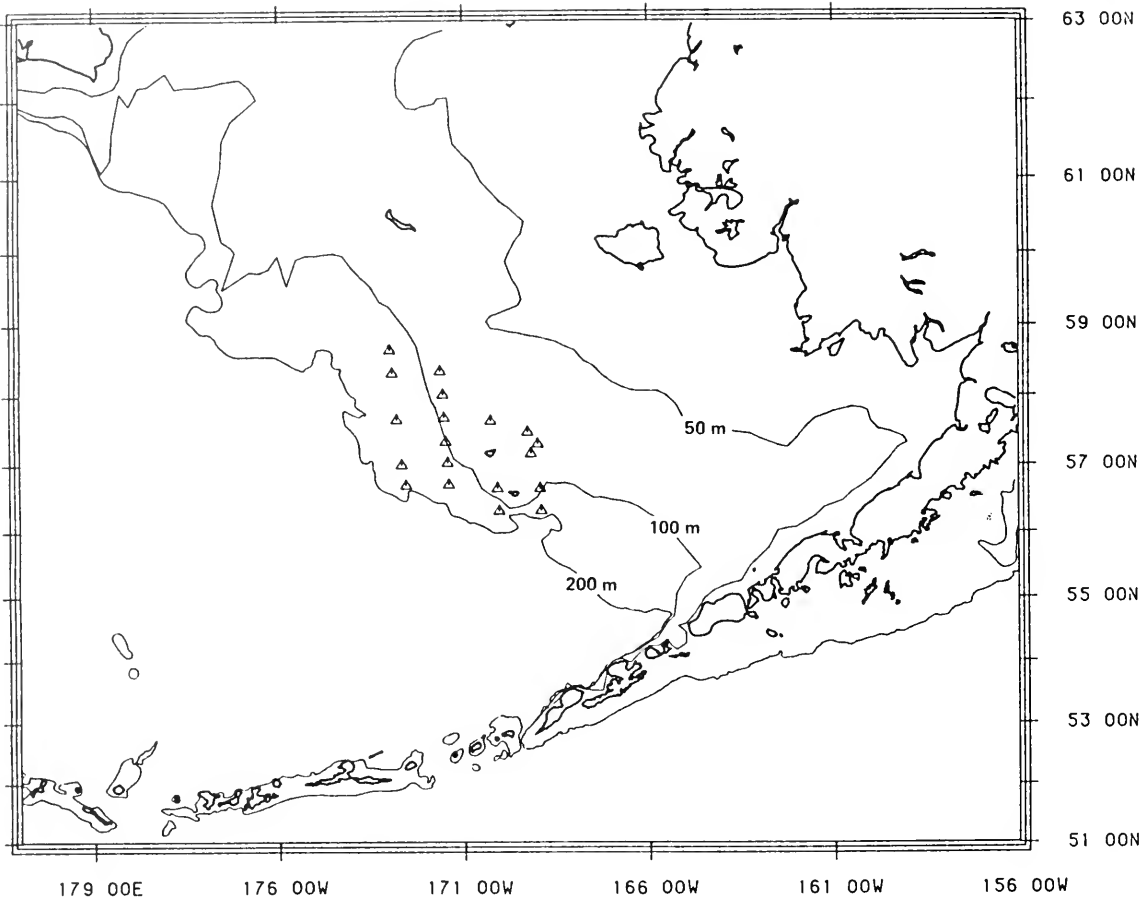

FIGURE 1.—Sampling locations for arrowtooth flounder, *Atheresthes stomias*, and Kamchatka flounder, *A. evermanni*, in summer 1983 in the eastern Bering Sea.

were excised along with the anterior portion of the body (including head, stomach, and intestines), and these samples were sent to the laboratory for species identification. Each specimen was placed in a muslin bag with a specimen label bearing fork length, sex, and station information. All samples were preserved in 10% Formalin<sup>3</sup>.

In the laboratory, two characters were used for species identification: the position of the left eye relative to the dorsal profile and gill rakers. Kamchatka flounder has the upper eye completely on the right side of the head and 13 or fewer gill rakers on the first arch. Arrowtooth flounder has an upper eye which interrupts the dorsal profile of the head and 15 or more gill rakers on the first arch (Norman 1934; Willimovsky et al. 1967).

Stomachs were analyzed individually. Prey items were identified to the lowest taxonomic level practical, counted, and weighed damp to the nearest milligram. The standard length of fish prey were also measured.

#### DATA ANALYSIS

Specimens of *A. stomias* and *A. evermanni* were divided into 100 mm fork-length groups for data analysis: <201 mm, 201-300 mm, 301-400 mm, and >400 mm. Percent of frequency of occurrence (% FO), percentage of total stomach content weight (% W), percentage of total prey number (% N) and the Index of Relative Importance [IRI = % FO (% N + % W)] (Pinkas et al. 1971) were calculated for major categories of prey items in the 100 mm size groupings of *A. stomias* and *A. evermanni*.

Based on a review of dietary overlap measures

<sup>3</sup>Reference to trade names does not imply endorsement by the National Marine Fisheries Service, NOAA.

TABLE 1.—Station information and number of stomachs collected at each station of arrowtooth flounder (ATF) and Kamchatka flounder (KF) in the eastern Bering Sea for the summer 1983.

Haul	Date	Alaska daylight time	Haul depth (m)	Bottom temp. (°C)	Latitude N	Longitude W	No. ATF <sup>1</sup> stomachs collected	No. KF <sup>1</sup> stomachs collected
100	7/6	1000	71.3	3.1	56°29.46'	169°15.61'	14 (6)	19 (17)
101	7/6	1200	71.3	3.1	57°19.25'	168°59.13'	4 (5)	2 (1)
102	7/6	1400	76.8	2.6	57°10.87'	169°10.22'	14 (6)	7 (6)
105	7/7	0800	102.4	2.7	56°39.96'	168°55.22'	18 (9)	7 (4)
106	7/7	1100	133.5	3.8	56°20.18'	168°53.24'	11 (2)	10 (3)
107	7/7	1600	111.6	3.5	58°20.01'	170°02.15'	12 (0)	12 (1)
108	7/8	0800	96.9	3.8	56°40.00'	170°04.47'	5 (1)	3 (1)
114	7/9	1400	75.0	2.7	57°39.23'	170°16.12'	13 (1)	2 (0)
135	7/13	1900	96.9	1.5	58°22.09'	171°37.39'	6 (1)	0 (0)
136	7/14	0700	100.6	2.8	58°01.90'	171°33.37'	5 (0)	1 (0)
137	7/14	1000	100.6	3.0	57°41.94'	171°31.16'	7 (0)	0 (1)
138	7/14	1300	102.4	3.7	57°21.05'	171°28.26'	8 (3)	6 (1)
139	7/14	1500	109.7	3.9	57°02.54'	171°25.63'	11 (0)	6 (1)
140	7/14	1800	120.7	3.7	56°43.42'	171°23.38'	6 (0)	9 (0)
141	7/15	0700	137.2	4.0	56°42.72'	172°32.33'	2 (6)	7 (2)
142	7/15	0900	124.4	3.6	57°00.84'	172°39.37'	5 (6)	7 (2)
144	7/15	1500	122.5	3.7	57°40.10'	172°47.92'	3 (1)	2 (0)
146	7/16	0600	111.6	2.6	58°20.10'	172°55.00'	2 (2)	9 (0)
147	7/16	0900	115.2	2.6	58°40.07'	172°59.18'	3 (0)	3 (0)
Total							149 (47)	112 (40)

<sup>1</sup>Stomachs containing food, number of empties in parentheses.

(Cailliet and Barry 1979; Linton et al. 1981), Schoener's (1970) index was chosen because it was found to measure overlap accurately over most of the range of potential overlap (Linton et al. 1981). Schoener's index,  $C_{xy}$ , is calculated as

$$C_{xy} = 1.0 - 0.5 \left( \sum |p_{x,i} - p_{y,i}| \right)$$

where  $p_{x,i}$  and  $p_{y,i}$  are the estimated proportions by weight of prey  $i$  in the diets of species  $x$  and  $y$ , respectively (the percentage by weight of prey items in Table 2). The index ranges from 0 which indicates no dietary overlap to a maximum overlap of 1 when all prey items are found in equal proportions.

## RESULTS

### General Feeding Trends

A total of 348 stomachs were analyzed; 87 stomachs (25%) were empty. Table 2 shows the percentages by weight of all prey items found in the stomachs of both flounder species by size group. In general, both species consumed the same prey species or groups: euphausiids, pandalid and crangonid shrimps, and walleye pollock (Fig. 2). *Thysanoessa inermis* and *T. raschii* were the dominant euphausiids consumed. Some pandalid shrimps were eaten by smaller (<301 mm) flounders of both species, but crangonid shrimps, mainly *Crangon*

*communis*, were the dominant shrimp consumed. Walleye pollock constituted the highest proportion of the diet for all size groups of flounder, ranging from 56% by weight of the diet for Kamchatka flounders 301-400 mm long to about 88% by weight for arrowtooth flounders >400 mm long. Miscellaneous food items consumed included polychaetes, copepods, cumaceans, hippolytid shrimps, ophiuroids, and various fish species.

Mean stomach content weight of those stomachs with food was similar between arrowtooth flounder and Kamchatka flounder for all but the largest size group. The mean stomach content weight ranged from about 1.4 g for the small flounders to over 20 g for the largest size group.

### Diet Comparisons Within Size Groups

The principle diet of both *Atheresthes* species in the ≤200 mm size group was comprised of walleye pollock, euphausiids, and shrimps (Fig. 3). Walleye pollock comprised 58% and 65.5% by weight of the diet of Kamchatka flounder and arrowtooth flounder, respectively. Euphausiids comprised the highest percentage by numbers of the diet of both species, 53% for Kamchatka flounder and 69.4% for arrowtooth flounder. Shrimps, including *Crangon communis*, *Pandalus goniurus*, *Pandalus tridens*, and *Eualus avinus*, constituted 17.1% and 7.2% by weight of the diet of Kamchatka flounder and arrowtooth flounder, respectively. Other less important

TABLE 2.—Percentage by weight of prey items in the stomachs of arrowtooth flounder (ATF) and Kamchatka flounder (KF) by 100 mm FL categories; and Schoener's indices (Cxy) of diet overlap between the two species.

Prey item	Predator size group (mm)							
	≤200		201-300		301-400		>400	
	KF	ATF	KF	ATF	KF	ATF	KF	ATF
Invertebrates								
Polychaeta	—	—	—	0.28	—	—	—	—
Copepoda	—	0.01	—	—	—	—	—	—
Mysidacea	0.45	0.34	0.12	—	—	—	—	—
Cumacea	—	—	0.01	—	—	—	—	—
Amphipoda	0.22	—	0.52	—	0.07	—	—	—
Euphausiacea								
Unidentified	5.64	8.99	0.23	9.10	0.54	3.86	—	0.22
<i>Thysanoessa rachii</i>	—	2.76	—	1.35	—	2.32	—	—
<i>T. inermis</i>	4.28	10.67	3.55	9.33	7.40	10.03	4.09	6.55
Caridea								
Unidentified	1.05	1.31	—	—	—	0.08	—	—
Hippolytidae								
<i>Eualus avinus</i>	0.88	—	—	0.05	—	—	—	—
Pandalidae								
Unidentified	—	1.08	—	—	—	—	—	—
<i>Pandalus goniurus</i>	3.89	—	—	—	—	—	—	—
<i>Pandalus tridens</i>	4.77	—	—	—	—	—	—	—
<i>Pandalus</i> sp.	0.54	0.37	0.24	—	—	—	—	—
Crangonidae								
Unidentified	0.34	2.98	2.15	0.10	—	—	0.07	—
<i>Crangon dalli</i>	—	—	0.85	0.61	—	—	—	—
<i>C. communis</i>	5.67	1.43	5.53	0.70	0.31	0.15	—	0.22
Paguridae	—	0.01	—	—	0.58	—	—	—
Ophiuroidea	—	0.19	—	—	0.03	—	—	—
Chaetognatha								
<i>Sagitta</i> sp.	—	0.03	—	0.01	—	—	—	—
Pisces								
Gadidae								
Unidentified	—	—	5.40	4.62	2.70	5.65	8.20	—
<i>Theragra chalcogramma</i>	58.03	65.51	81.55	71.69	55.78	76.99	85.87	87.96
Zoarcidae								
Unidentified	—	—	—	—	5.55	—	—	5.06
<i>Lycodes brevipes</i>	—	—	—	—	8.20	—	—	—
Cottidae	—	1.15	—	—	—	—	—	—
Stichaeidae								
Unidentified	3.00	—	—	—	—	—	—	—
<i>Lumpenus maculatus</i>	—	3.16	—	1.97	9.47	—	—	—
Pleuronectidae								
Unidentified	7.50	—	—	—	9.36	—	1.77	—
<i>Atheresthes</i> sp.	3.73	—	—	—	—	—	—	—
Unidentified organic material	—	—	0.05	0.19	—	0.92	—	—
No. of stomachs with food	32	40	43	53	20	40	19	14
Total weight of stomach content (g)	46.96	57.24	93.29	167.66	181.89	291.43	383.32	467.91
Mean stomach content weight (g)	1.47	1.43	2.17	3.16	9.09	7.29	20.17	33.42
Mean fish length (mm)	187.80	184.60	250.10	260.70	350.50	341.30	441.10	450.00
Cxy		0.72		0.82		0.67		0.90

food items were stichaeids, pleuronectids, cottids, mysids, and amphipods.

Walleye pollock, the dominant food of both *Atheresthes* species in the 201-300 mm size group (Fig. 3), constituted 81.6% and 71.7% by weight of the diet of Kamchatka flounder and arrowtooth flounder, respectively. Euphausiids comprised 20% by weight of the diet of arrowtooth flounder. However, euphausiids only comprised 3.8% by weight

(39.9% by number) of the diet of Kamchatka flounder. Shrimps (Crangonidae, Pandalidae) were more important food for Kamchatka flounder (8.8% by weight) than for arrowtooth (1.4% by weight). Unidentified gadoids comprised 5.4% and 4.6% by weight of the diet of Kamchatka flounder and arrowtooth flounder, respectively. Other less important food items were polychaetes, mysids, amphipods, and the stichaeid *Lumpenus maculatus*; they were



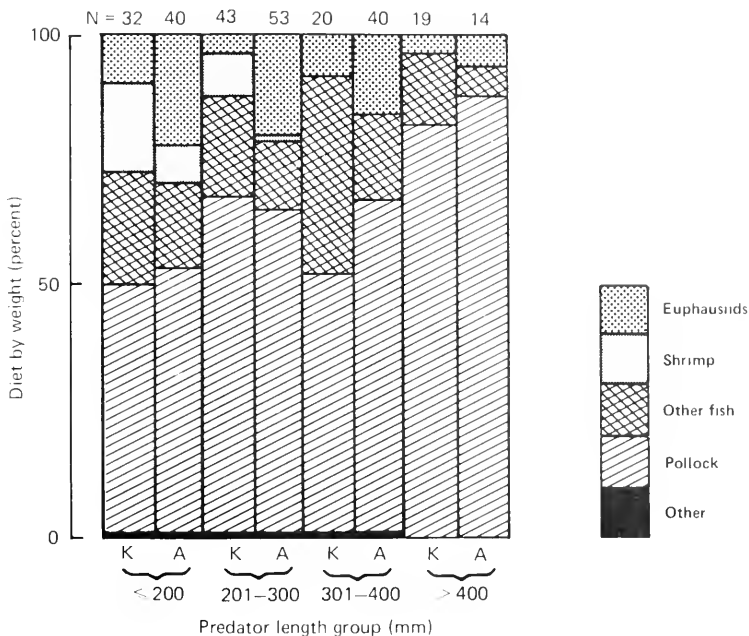

FIGURE 2.—Percentage by weight of major prey categories in the diet of arrowtooth flounder (A), *Atheresthes stomias*, and Kamchatka flounder (K), *A. evermanni*, for different length groups of fish collected from the eastern Bering Sea in summer 1983.

all <5% by weight of the diet of both *Atheresthes* species.

The principle diet by weight of Kamchatka flounder in the 301-400 mm size group was comprised of 55.8% walleye pollock, 13.8% zoarcids, 9.4% pleuronectids, 9.5% stichaeids, and 7.9% euphausiids (Table 2, Fig. 3). Walleye pollock also dominated the diet of arrowtooth flounder (77% by weight). The other two main items of arrowtooth flounder were euphausiids (16.2% by weight) and unidentified gadoids (5.7% by weight). Shrimps were not important food for either *Atheresthes* species of this size; they contributed <1% by weight of the diet. Other less important prey items were ophiuroids and pagurids. Numerically, euphausiids dominated the food for both species (90.7% for Kamchatka flounder, 96.0% for arrowtooth flounder).

Walleye pollock dominated the food of the two *Atheresthes* species in the >400 mm size group (Fig. 3). It constituted 85.9% and 88.0% by weight of the diet of Kamchatka flounder and arrowtooth flounder, respectively (Table 2). Though euphausiids dominated the food by number (91.5% for Kamchatka flounder, 97.0% for arrowtooth flounder), they only contributed 4.1% and 6.8% by weight of the diet of Kamchatka flounder and arrowtooth flounder, respectively. In addition to walleye pollock,

unidentified gadoids comprised 8.2% and pleuronectids comprised 1.8% by weight of the diet of Kamchatka flounder. Zoarcids comprised 5.1% by weight of the diet of arrowtooth flounder. Shrimps played a less important role in the food of both *Atheresthes* species (<1% by weight).

### Diet Comparison Among Size Groups

There was not much difference in diets among size groups in the proportion by weight of the prey categories such as euphausiids and fish (Fig. 2). However, shrimps disappeared from the diets of flounders in the two larger size groups. The number of different species in the diet also changes with size. The ≤200 mm size group of flounders consumed about 11 or 12 different prey categories while the >400 mm size groups consumed only 3 or 4 different prey types (see Table 2).

Even though the proportion by weight of fish in the diet remained fairly constant over flounder size groups, the size of individual fish consumed did change with flounder length. Figure 4 shows the frequency distribution of fish prey lengths found in the stomachs of different size *A. evermanni*. Most of the prey fish were age-0 juvenile pollock (<100 mm) for the two smaller size groups and age-1 juvenile

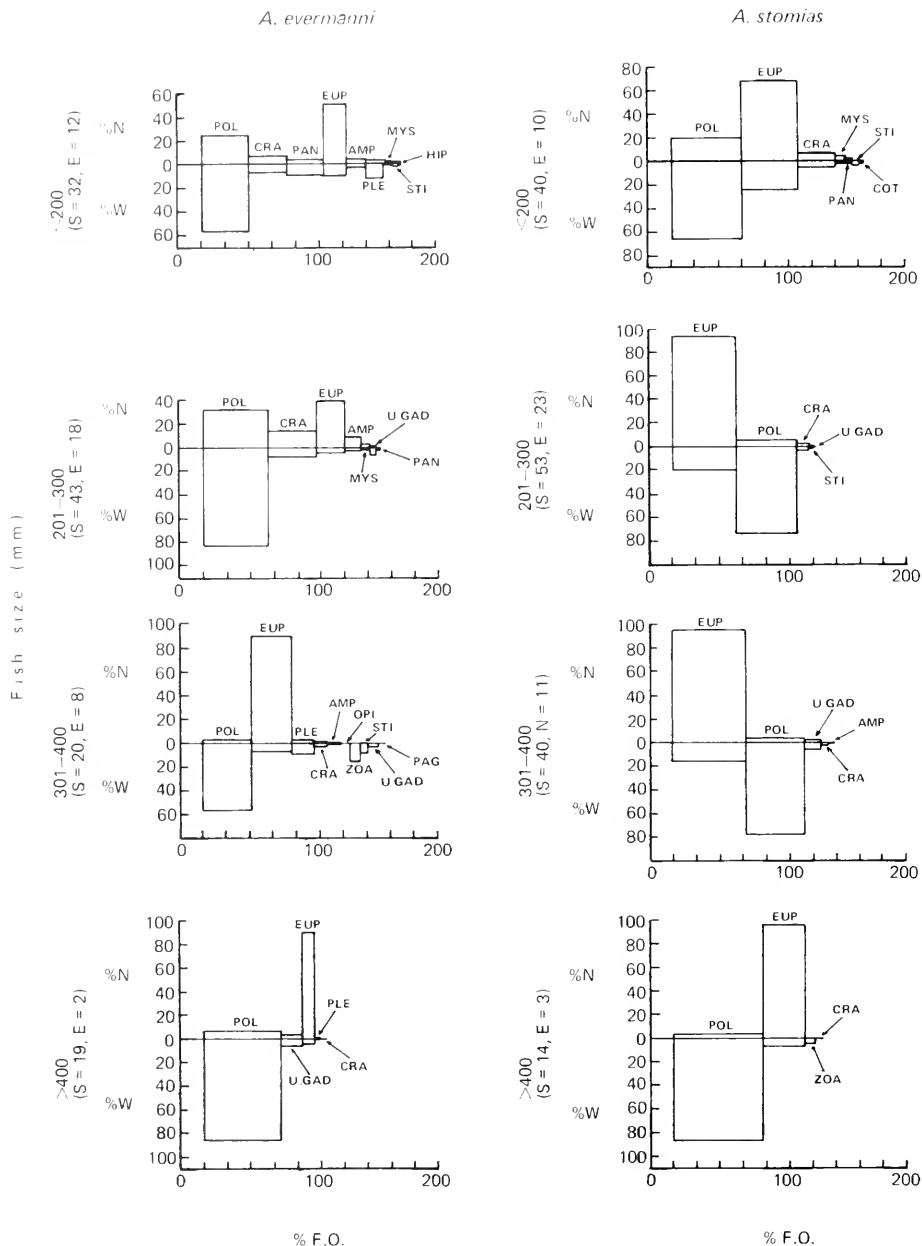

FIGURE 3.—Indices of Relative Importance of major prey items in the diets of *Atheresthes evermanni* and *A. stomias* of different size groups. % F.O., percent frequency of occurrence; % N, percentage of prey number; % W, percentage of total stomach content weight; POL, pollock; EUP, Euphausiacea; CRA, Crangonidae; PAN, Pandalidae; AMP, Amphipoda; PLE, Pleuronectidae; MYS, Mysidacea; STI, Stichaeidae; HIP, Hippolytidae; ZOA, Zoarcidae; U. GAD, Unidentified Gadidae; COT, Cottidae; S, number of stomachs containing food; E, number of empty stomachs.

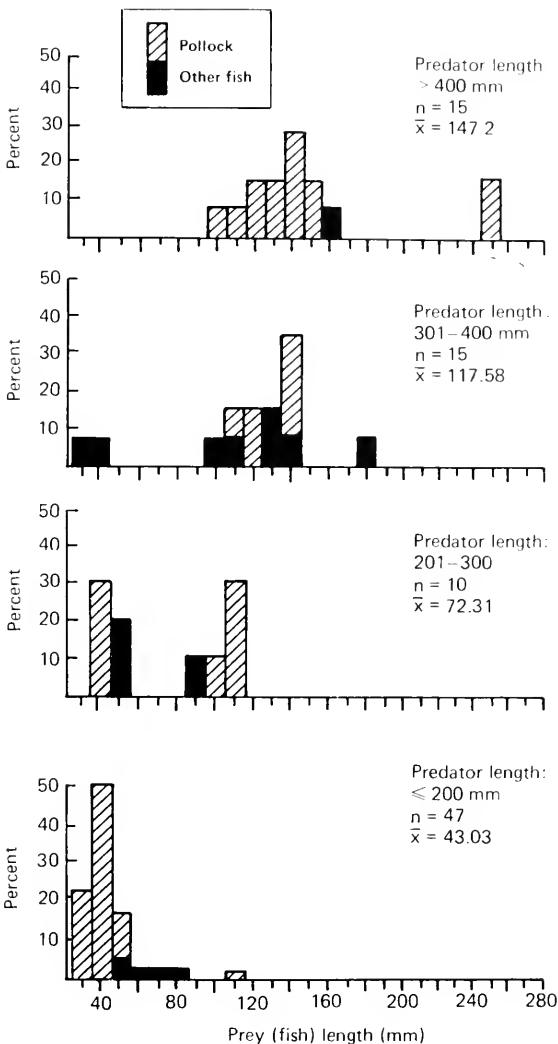

FIGURE 4.—Frequency distribution of standard lengths of prey fish found in the stomachs of *Atheresthes* species from the eastern Bering Sea in summer 1983.

pollock (100-200 mm) for the two larger size groups. The fish prey length was plotted against the predator length (Fig. 5). Fish prey size appears to increase linearly with increasing predator size.

### Diet Overlap

Values for Schoener's (1970) index of dietary overlap were obtained from a comparison (by weight) between the diets of Kamchatka and arrowtooth flounder of the same size groups (Table 2). All the values obtained were >0.60, an indicator of high dietary overlap (Langton 1982). The ≤200 mm size group had an overlap value of 0.72 and the 201-300

mm size group had an overlap value 0.82. Within each of these two size groups, fairly similar proportions by weight of walleye pollock, euphausiids, and shrimps were consumed. The 301-400 mm size group had the lowest overlap value of 0.67. This is probably because Kamchatka flounder ate less walleye pollock by weight (56%) than did the arrowtooth flounder (77%). Most of the remainder of the diet for Kamchatka flounder in this size group was composed of different fish groups, such as zoarcids, stichaeids, and pleuronectids, which were almost totally absent from the arrowtooth's diet at this size. The largest size group of flounders (>400 mm) had the highest overlap value of 0.90. This size group ate very similar proportions by weight of walleye pollock and euphausiids.

### DISCUSSION

From this study, it appears that both Kamchatka flounder and arrowtooth flounder are largely fish feeders. Walleye pollock was the most frequently observed prey and contributed the largest percentage by weight to the diets, followed by euphausiids and shrimps (Table 2, Fig. 3). Gotshall (1969) found that ocean shrimp, *Pandalus jordani*, was the most common food item of arrowtooth flounder (because the stomachs were collected on commercial shrimp grounds), followed by fishes and euphausiids. Pacific sanddabs, *Citharichthys sordidus*, were the most numerous prey fish found in his study. Kabata and Forrester (1974) examined 753 arrowtooth flounder collected off the west coast of Vancouver Island. Their study showed that euphausiids, followed by fish were the predominant foods taken by arrowtooth flounder. The most commonly found species of fish were eulachon, *Thaleichthys pacificus*, and Pacific herring, *Clupea pallasii*. Smith et al. (1978) found that fish constituted 41.09% and euphausiids 37.22% by volume of the food of 236 arrowtooth flounder collected from the northeast Gulf of Alaska. Walleye pollock were most commonly consumed fish prey. Moiseev (1953) found that Kamchatka flounder fed almost exclusively on pollock and only occasionally on herring and other fishes.

The type of prey eaten by a fish is strongly correlated with the morphology of the alimentary tract of the fish (De Groot 1971; Ebeling and Cailliet 1974; Allen 1982). Structure of the digestive tract of arrowtooth flounder and Kamchatka flounder are very similar. Both have a very large terminal mouth that is nearly symmetrical with a wide gape; teeth are arrow-shaped and well developed on both sides of the jaws; gill rakers are long and strongly dentate;

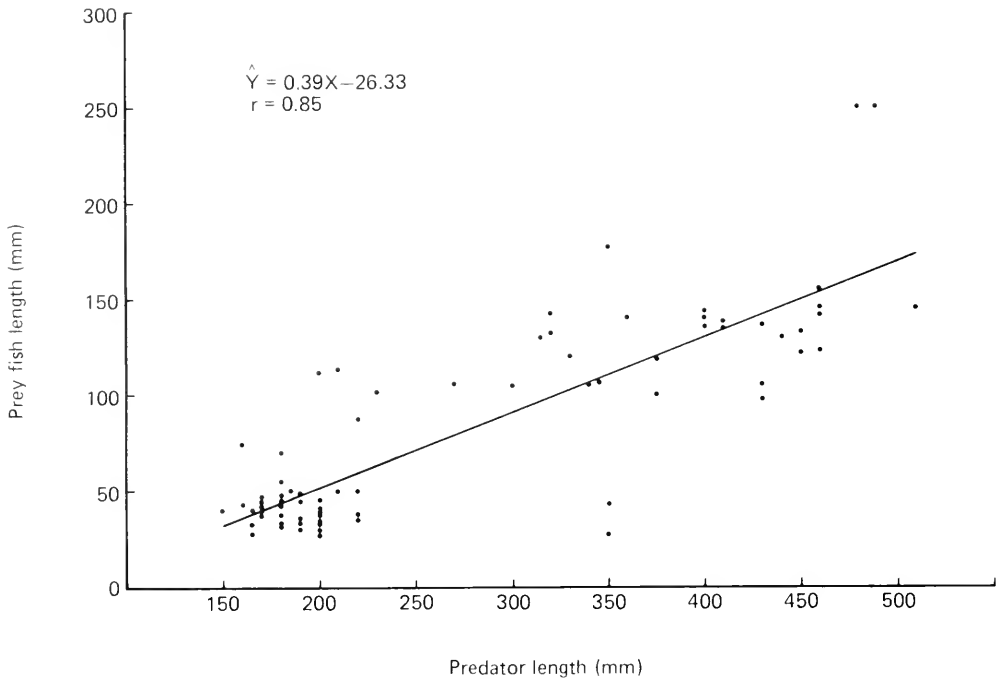

FIGURE 5.—Scatter plot of prey fish length consumed by *Atheresthes* species from the eastern Bering Sea in summer 1983.

and the esophagus and stomach are large with four large pyloric caeca and the intestine is a simple loop. All of these characteristics indicate that *Atheresthes* species are fish feeders as predicted by using De Groot's (1971) morphological criteria. He stated that large gill rakers with teeth are indispensable to fish feeders, since they prevent the prey, grasped alive, from struggling out of the mouth. The high percentages of fish in the diet of the two *Atheresthes* species obtained in this study would be expected on the basis of the similarities in the digestive tracts of the two species.

The results also indicate that *Atheresthes* species feed up in the water column. According to Allen (1982), flatfishes with large symmetrical mouths (*Atheresthes* species) probably use sight to locate prey. They are oriented up in the water column when foraging. The presence of pelagic fish (*T. chalcogramma*) and euphausiids or nektonic benthopelagic crustaceans such as shrimps in the diets of *Atheresthes* species supports Allen's generalizations concerning correlations between morphology and feeding behavior in flatfishes.

The trend of the feeding habits of *Atheresthes* species with regard to predator length is toward piscivory; that is, when the predators are bigger, they take more fish (by weight) as food. Specimens

from the  $\leq 200$  mm size group were found to ingest the greatest variety of prey items in comparison to other size groups. Specimens  $> 400$  mm long preyed mainly on other fishes, primarily on pollock. However, euphausiids were of importance in the diet of all size groups. One 460 mm arrowtooth flounder was found to have 838 *Thysanoessa inermis* in its stomach. Smith et al. (1978) also noted a change in food habits with increasing length in the arrowtooth flounder. In their study, specimens over 450 mm long preyed exclusively on pollock and other gadoids. Euphausiids were important food of the arrowtooth flounder up to 350 mm long; however, none were found among the stomach contents of specimens larger than 350 mm.

Based on the results of this study and those of Smith et al. (1978) and Gotshall (1969), it appears that *Atheresthes* species are opportunistic feeders; they feed on those prey items that are most abundant—pollock and euphausiids in the Gulf of Alaska and eastern Bering Sea and ocean shrimp in northern California. In the eastern Bering Sea, the estimated abundance of age-0 pollock in 1982 is between 100 billion and 1,300 billion and, based on the results of the 1983 bottom trawl survey by NWAFC, this 1982 year class is the largest observed since the large 1978 year class (Traynor in press).

In spite of the high diet overlap between Kamchatka flounder and arrowtooth flounder, there is probably no competition for food between these two species because they are exploiting abundant food sources.

Finally, although Kamchatka flounder and arrowtooth flounder are genetically distinct, they can be considered trophically equivalent on the basis of their similar diets and high diet overlap.

## LITERATURE CITED

- ALLEN, M. J.  
1982. Functional structure of soft-bottom fish communities of the southern California shelf. Ph.D. Thesis, Univ. California, San Diego, 577 p.
- CAILLIET, G. M., AND J. P. BARRY.  
1979. Comparison of food array overlap measures useful in fish feeding habits analysis. In S. J. Lipovsky and C. A. Simenstad (editors), Gutshop '78, fish food habits studies; Proceedings of the 2d Pacific Northwest Technical Workshop, p. 67-79. Univ. Wash., Div. Mar. Resour., Wash. Sea Grant, WSG-WO-79-1.
- DE GROOT, S. J.  
1971. On the interrelationships between morphology of the alimentary tract, food and feeding behavior in flatfishes (Pisces: Pleuronectiformes). Neth. J. Sea Res. 5:121-196.
- EBELING, A. W., AND G. M. CAILLIET.  
1974. Mouth size and predator strategy of midwater fishes. Deep-Sea Res. 21:959-968.
- GOTSHALL, D. W.  
1969. Stomach contents of Pacific hake and arrowtooth flounder from northern California. Calif. Fish Game 55:75-82.
- HART, J. L.  
1973. Pacific fishes of Canada. Bull. Fish. Res. Board Can. 180, 740 p.
- KABATA, Z., AND C. R. FORRESTER.  
1974. *Atheresthes stomias* (Jordan and Gilbert 1880) (Pisces: Pleuronectiformes) and its eye parasite *Phrixocephalus cinnatus* Wilson 1908 (Copepoda: Lernaeoceridae) in Canadian Pacific waters. J. Fish. Res. Board Can. 31:1589-1595.
- LANGTON, R. W.  
1982. Diet overlap between Atlantic cod, *Gadus morhua*, silver hake, *Merluccius bilinearis*, and fifteen other Northwest Atlantic finfish. Fish. Bull., U.S. 80:745-759.
- LINTON, L. R., R. W. DAVIES, AND F. J. WRONA.  
1981. Resource utilization indices: an assessment. J. Anim. Ecol. 50:283-292.
- MOISEEV, P. A.  
1953. Treska i Kambaly dalnevestochnykh morei (Cod and flounders of Far-Eastern seas). [In Russ.] Izv. Tikhookean. Nauchno-Issled. Inst. Rybn. Khoz. Okeanogr. 40:1-287. (Transl. by Transl. Bur. Can. Dep. Secr. State, 576 p., available as Fish. Res. Board Can. Transl. Ser. 119.)
- NORMAN, J. R.  
1934. A systematic monograph of the flatfishes (Heterosomata). Vol. 1.: Psettodidae, Bothidae, Pleuronectidae. Trustees Br. Mus., Lond., 459 p. (Available from Johnson Reprint, N.Y., 1966.)
- PINKAS, L., M. S. OLIPHANT, AND I. L. K. IVERSON.  
1971. Food habits of albacore, bluefin tuna, and bonito in California waters. Calif. Dep. Fish Game, Fish Bull. 152, 105 p.
- RANCK, C., F. UTTER, G. MILNER, AND G. B. SMITH.  
1986. Genetic confirmation of specific distinction of arrowtooth flounder, *Atheresthes stomias*, and Kamchatka flounder, *A. evermanni*. Fish. Bull., U.S. 84:222-226.
- SCHOENER, T. W.  
1970. Non-synchronous spatial overlap of lizards in patchy habitats. Ecology 51:408-418.
- SHUNTOV, V. P.  
1970. Sezonnoe respredelenie chernogo i strelozubykh paltusov v Beringovum more (Seasonal distribution of black and arrow-tooth halibuts in the Bering Sea). [In Russ.] Tr. Vses. Nauchno-Issled. Inst. Morsk. Rybn. Khoz. Okeanogr. 70 (Izv. Tikhookean. Nauchno-Issled. Inst. Rybn. Khoz. Okeanogr. 72):391-401. [Transl. by Isr. Program Sci. Transl., 1972, In P. A. Moiseev (editor), Soviet fisheries investigations in the northeastern Pacific, Part 5, p. 397-408. Available from U.S. Dep. Commer., Natl. Tech. Inf. Serv., Springfield, VA, as TT 71-50127.]
- SMITH, G. B., AND R. BAKKALA.  
1982. Demersal fish resources of the eastern Bering Sea: spring 1976. U.S. Dep. Commer., NOAA Tech. Rep. NMFS SSRF-754, 129 p.
- SMITH, R. L., A. C. PAULSON, AND J. R. ROSE.  
1978. Food and feeding relationships in the benthic and demersal fishes of the Gulf of Alaska and Bering Sea. In Environmental assessment of the Alaskan Continental Shelf, Final Rep., Biol. Stud. 1:33-107. U.S. Dep. Commer., NOAA, Environ. Res. Lab., Boulder, CO.
- TRAYNOR, J. J.  
In press. Midwater abundance of walleye pollock in the eastern Bering Sea, 1979 and 1982. Bull., Int. North. Pac. Fish. Comm.
- WILLIMOVSKY, N. J., A. PEDEN, AND J. PEPPAR.  
1967. Systematics of six demersal fishes of the North Pacific Ocean. Fish. Res. Board Can., Tech. Rep. 34, 95 p.



# ECOLOGY OF CERIANTHARIA (COELENTERATA, ANTHOZOA) OF THE NORTHWEST ATLANTIC FROM CAPE HATTERAS TO NOVA SCOTIA

ANDREW N. SHEPARD,<sup>1</sup> ROGER B. THEROUX,<sup>2</sup> RICHARD A. COOPER,<sup>1</sup>  
AND JOSEPH R. UZMANN<sup>2</sup>

## ABSTRACT

Ceriantharia, tube dwelling anthozoans, were collected in grab samples and documented by direct observations and photographs from research submersibles on the continental shelf and slope off the northeast United States coast (Cape Hatteras to Nova Scotia). Two species [(*Cerianthus borealis* Verrill and *Ceriantheopsis americanus* (Agassiz)] were identified from grab samples and four species, probably including *C. borealis*, were observed from submersibles.

Ceriantharia distribution in relation to latitude, depth, temperature, and sediments was examined. They occurred throughout the study area, abundantly at depths of 0 to 500 m and less abundantly from 900 to 2,400 m. Ceriantharia habitats displayed an extreme range in bottom water temperature (summer maximum minus winter minimum) of from 8° to 16°C, and had every sediment type, except 100% gravel and coarse shifting sand. Geographic and bathymetric zonation is attributed primarily to temperature and secondarily to food supply and substrate type.

Ceriantharia distribution patterns, in submarine canyon heads at depths of <400 m, were determined from photographic transects run with submersibles; observed patchiness may be related to local differences in food supply, sediments, and microtopography.

The motile megafauna associated with Ceriantharia "forest" areas and the infauna and epifauna inhabiting ceriantharian tubes were evidence to show that tubes may enhance local species diversity and abundance in featureless soft-bottom areas by 1) attracting motile species seeking cover and 2), acting as a stable, elevated substrate for tubicolous and suspension feeding macrofauna.

The possibility of exploitation of energy reserves beneath the northwest Atlantic outer continental shelf and slope has prompted many new studies and the reexamination of past investigations for baseline information on the region's seafloor communities. Research submersible studies of potential oil lease tracts identified "indicator species" for assessing environmental changes owing to drilling activities. We considered Ceriantharia suitable for this purpose because they were abundant, passive suspension feeders, and nonmobile. Literature searches revealed that very little has been published on the Ceriantharia species occurring from Cape Hatteras to Nova Scotia. This is surprising in light of the group's significant contribution to the benthic biomass of the region (Wigley and Theroux 1981) and the important functional role [the effect a species has on the distribution and abundance of other residents (Sutherland 1978)] Ceriantharia may have in structuring communities inhabiting featureless soft-bottom substrate (O'Connor et al. 1977).

Woods Hole Laboratory, Northeast Fisheries Center (NEFC), National Marine Fisheries Service (NMFS), personnel have reported on the general composition and distribution of invertebrate fauna of the New England and Mid-Atlantic Bight continental shelf and slope (e.g., Wigley and Theroux 1981; Theroux and Wigley 1984<sup>3</sup>; Cooper et al., in press). Data on Ceriantharia were collected during ecological studies pertaining to various kinds of demersal fishes and benthic invertebrates: 1) a grab sample survey (Fig. 1) done from 1955 to 1969 (Shepard and Theroux 1983<sup>4</sup>), and 2) observations, photographs, and limited sample collections from research submersible studies. Dredge and trawl data were available (Shepard and Theroux fn. 4), but not analyzed since deep burrowing Ceriantharia (some-

<sup>3</sup>Theroux, R. B., and R. L. Wigley. 1984. Quantitative composition and distribution of macrobenthic invertebrate fauna of the New England Region. Unpubl. Manusc. Northeast Fisheries Center Woods Hole Laboratory, National Marine Fisheries Service, NOAA, Woods Hole, MA 02543.

<sup>4</sup>Shepard, A. N., and R. B. Theroux. 1983. Distribution of Cerianthids (Coelenterata, Anthozoa, Ceriantharia) on the U.S. East Coast Continental Margin, 1955-1969: Collection data and environmental measurements. Lab Ref. Doc. 83-12, 24 p. Northeast Fisheries Center Woods Hole Laboratory, National Marine Fisheries Service, NOAA, Woods Hole, MA 02543.

<sup>1</sup>NOAA National Undersea Research Program, University of Connecticut, Avery Point, Groton, CT 06340.

<sup>2</sup>Northeast Fisheries Center Woods Hole Laboratory, National Marine Fisheries Service, NOAA, Woods Hole, MA 02543.

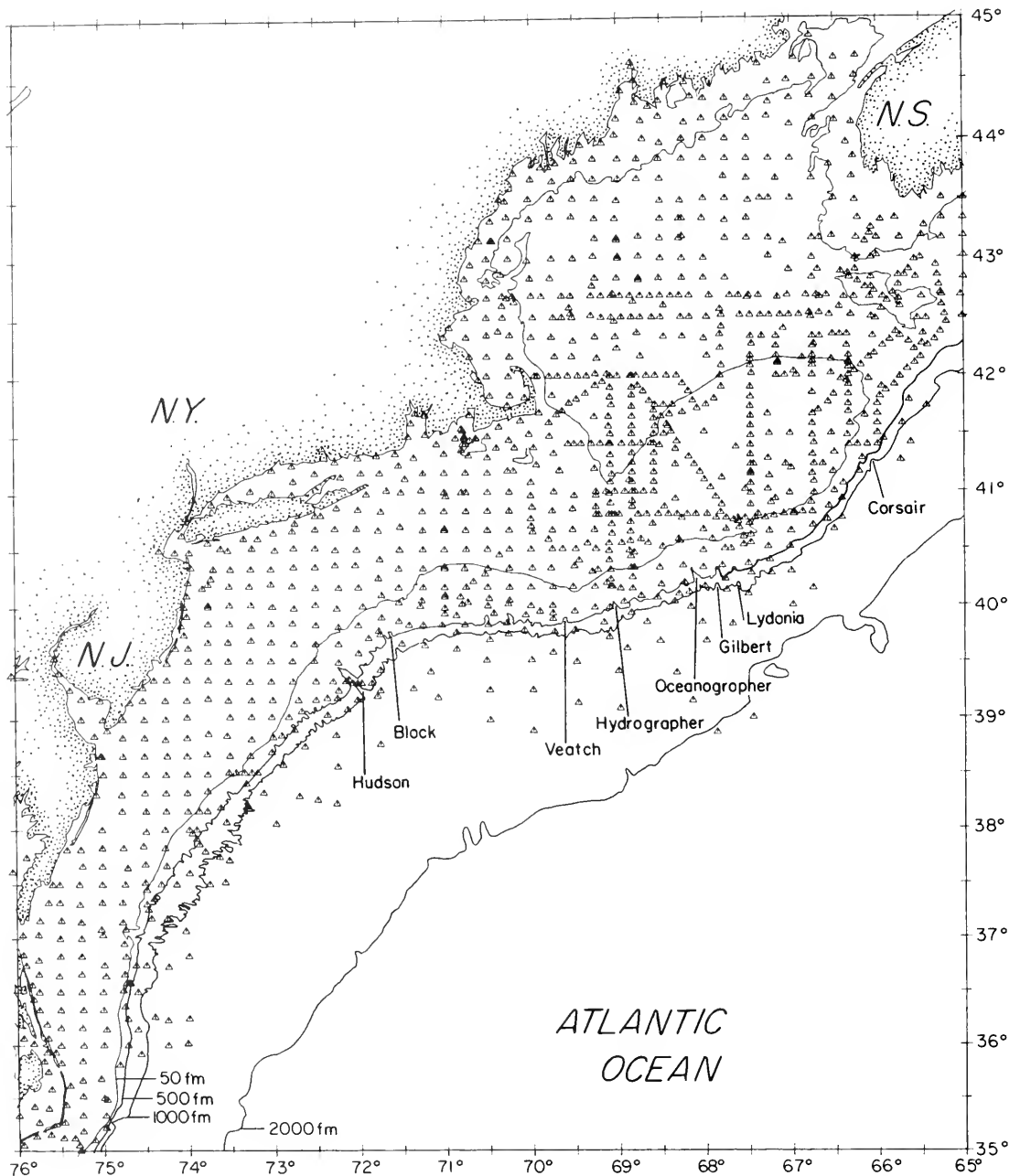

FIGURE 1.—Chart of the northwest Atlantic from lat. 35° to 45°N (Cape Hatteras to Nova Scotia) showing stations where grab samples of macrobenthic invertebrates were obtained, and the location of submarine canyons visited with research submersibles (1 fm = 1.83 m).

times more than 1 m; Sebens<sup>5</sup>) may be poorly sampled by dragged collection gear.

<sup>5</sup>K. P. Sebens, Maritime Studies Center, Northeastern University, Nahant, MA 01908, pers. commun. February 1985.

The objectives of this study are to describe 1) the *Ceriantharia* species encountered, 2) their general distribution in relation to latitude, depth, temperature, and sediments, 3) their local distribution pat-



terns, and 4) how they interact with other benthic species.

## CERIANTHARIA

Ceriantharians represent a small, incompletely described order of Anthozoa. Species identification is difficult, and many species probably remain undescribed since twice as many larval forms as adults are known (Hartog 1977; Hartog<sup>6</sup>). Two northwest Atlantic species have been identified; *Cerianthus borealis* Verrill (1873) (see also Parker 1900; Kingsley 1904; Widersten 1976) and *Ceriantheopsis americanus* (Agassiz 1859) (see also Verrill 1864; McMurrich 1890; Parker 1900; Carlgren 1912; Field 1949; Widersten 1976). Two other unidentified species have been found on the continental slope (Grassle et al. 1975; Hecker et al. 1980; Valentine et al. 1980; Sebens in press). Table 1 summarizes the geographic and bathymetric ranges of the above four species.

Ceriantharia live in permanent semirigid tubes composed of a type of cnidae peculiar to the Order (called ptychocysts by Mariscal et al. 1977), mucus, and adhering substrate debris (Emig et al. 1972). The feltlike tube is usually deep purple in coloration and distinct enough to be used alone as evidence of Ceriantharia presence. New England bottom trawl fishermen are familiar with nets fouled with ceriantharian tubes (Rogers 1979). In contrast to other burrowing anemones which have a single whorl of tentacles, Ceriantharia have two distinct whorls (marginal and oral tentacles) which remain outside

the tube during feeding and rapidly retract into the tube when disturbed.

Ceriantharia are protandric hermaphrodites; gametes are produced in the mesenteries and fertilization is external. The larvae are pelagic and duration of the planktonic stage is variable (Carlgren 1912; Hyman 1940; Robson 1966; TRIGOM-PARC 1974). Adults are capable of oral disc regeneration by budding (Hyman 1940; Frey 1970). Asexual reproduction has been described for at least one species, *Aracanthus oligopodus* (Cerfontaine 1909).

Ceriantharia are carnivorous passive suspension or impingement feeders (Emig et al. 1972; Caracciola and Steimle 1983). Digestion may begin in the tentacles, and larger particles are primarily taken up in the endoderm of sterile septa (Tiffon and Daireaux 1974). Fish species inhabiting the region, including cod, haddock, flounder, scup, and skate are known predators of whole juvenile Ceriantharia (Bowman and Michaels<sup>7</sup>) and may graze the tentacles of adults (TRIGOM-PARC 1974). Off the U.S. west coast, a nudibranch, *Dendronotus iris* Cooper, preys on adult Ceriantharia (Wobber 1970).

Previous documentation of Ceriantharia in the northwest Atlantic has come from grab samples (Sanders 1956; Wigley 1968; Pearce 1972; Pearce et al. 1976; Pearce et al. 1981; Reid et al. 1981; Wigley and Theroux 1981; Caracciola and Steimle 1983) and submersibles (Grassle et al. 1975; Rowe et al. 1975; Hecker et al. 1980; Valentine et al. 1980). However, no studies in the region report exclusively on ceriantharian ecology.

<sup>6</sup>J. C. den Hartog, Curator of Coelenterata, Rijksmuseum van Natuurlijke Historie, Postbus 9517, 2300 RA Leiden, Netherlands, pers. commun. March 1983.

<sup>7</sup>Bowman, R., and W. Michaels. 1983. Unpubl. data. Food Habits Program, Northeast Fisheries Center Woods Hole Laboratory, National Marine Fisheries Service, NOAA, Woods Hole, MA 02543.

TABLE 1.—Morphologic descriptions and geographic and bathymetric ranges of previously described Ceriantharia species inhabiting the study area.

Species	General morphologic description	Geographic range	Bathymetric range (m)
<i>Ceriantheopsis americanus</i>	see Verrill 1864	Cape Cod to Florida <sup>1</sup>	<sup>2</sup> 0- <sup>3</sup> 70
<i>Cerianthus borealis</i>	see Verrill 1873	Arctic to Cape Hatteras <sup>1</sup>	10- <sup>4</sup> 500
Unidentified species I <sup>5</sup>	small (<5 cm contracted), dark brown tentacles, tube flush to seafloor. <sup>5</sup>	Continental slope off New England	<sup>5,6,7</sup> >1,000
Cerianthid A <sup>8</sup>	larger than unidentified species I, uniformly dark tentacles, tube flush to seafloor <sup>5</sup>	Continental slope off New England	<sup>5,6,7,8</sup> >1,500

<sup>1</sup>Parker 1900.

<sup>2</sup>Field 1949.

<sup>3</sup>Pearce et al. 1981.

<sup>4</sup>Miner 1950, p. 196.

<sup>5</sup>Sebens in press.

<sup>6</sup>Grassle et al. 1975.

<sup>7</sup>Hecker et al. 1980.

<sup>8</sup>Valentine et al. 1980.

## METHODS

Grab sample methodology (gear description, sample processing, data reduction, bathymetry, temperature, and sediments) is reported in Wigley and Theroux (1981). A chi-square ( $\chi^2$ ) test, employing contingency tables (Richmond 1964), was used to assess ceriantharian occurrence at grab sample stations (relation to latitude, depth, bottom water temperature, and sediment type).

Table 2 lists the submersibles used and sampling gear employed by each. Quantitative data were obtained with externally mounted 35 mm camera-strobe systems. Qualitative ecological and behavioral information was acquired with 35 mm hand-held cameras, audio tapes, and video tapes made with a hand-held or externally mounted video camera. In situ faunal and sediment collections were made with the submersibles' manipulator arms. Only those dives performed to assess the distribution of megabenthos and associated habitat types were analyzed.

The externally mounted 35 mm camera systems used on *Nekton Gamma*, *Johnson-Sea-Link*, and *Alvin* were quantitatively calibrated, assessing 3.6 m<sup>2</sup>, 7.0 m<sup>2</sup>, and 15.0 m<sup>2</sup> of ocean floor per photographic frame, respectively (Bland et al. 1976; Cooper and Uzmann 1981<sup>8</sup>).

Photographs were read on either a light table with a hand-held magnifying glass or motorized microfilm reader with a 36 × 36 cm screen and 15× magnification lens. Each photograph was time-annotated, thus allowing correlation with depth,

<sup>8</sup>Cooper, R. A., and J. R. Uzmann. 1981. Georges Bank and Submarine Canyon living resources and habitat baselines in oil and gas drilling areas. Northeast Monitoring Program Annual Report for FY 80. Unpubl. manuscr., 34 p. Northeast Fisheries Center Woods Hole Laboratory, National Marine Fisheries Service, NOAA, Woods Hole, MA 02543.

TABLE 2.—Submersible, cruise year, and gear used for data collection. PC8 = *Perry Model C8*, NG = *Nekton Gamma*, AL = *Alvin*, and JSL = *Johnson-Sea-Link*.

Submersible/ year	Audio tapes	Video tapes	35 mm photographs		In situ collections of fauna/ substrate
			Hand-held	External	
PC8/1971	X	X			
NG/1973	X	X	X		
NG/1974	X	X	X		
NG/1979	X	X		X	
AL/1975	X	X		X	X
AL/1976	X	X			X
AL/1978	X	X			X
AL/1980	X	X		X	X
JSL/1980	X	X		X	X
JSL/1981	X	X		X	X

temperature, slope angle, substrate-habitat type, and current speed and direction documented on hand-held audio recorders during the dives.

## RESULTS

### Species Identification

Ceriantharia occurred at 229 of the 1,295 grab sample stations; 990 anemones were caught at 139 stations, whole tubes only at 29 stations, and tube fragments at 61 stations (Fig. 2). Two species, *Ceriantheopsis americanus* and *Cerianthus borealis*, were identified from grab samples (at four stations), the remaining anemones were identified only as Ceriantharia. The mean blotted wet weight of the 990 anemones was 5.0 g (95% C.L. = ±3.6); however, more than 90% weighed less than the mean.

Ceriantharia occurred at 82% of the submersible dive sites (Appendix Tables 1, 2) and at every major geographic feature visited (Fig. 2, Table 3). Submersible samples have not yet yielded anemones suitable for identification to the species level. Figure 3 shows three of the four species (Cerianthids A, B, C, and D) photographed from submersibles, and Table 3 classifies the species by morphological features apparent in photographs.

The minimum gross Ceriantharia size (height above seafloor or width of exposed tentacle crown and/or tube) visible in photographs was about 5 cm. It was not unusual to see large Cerianthid B or C tubes 20 cm above the seafloor. Based on laboratory examination of 61 anemones and a few specimens which were photographed in situ and then collected with the manipulator arm, a gross size of 5 cm corresponds to an anemone wet weight of about 16 g (3 times the mean weight of anemones captured with grab samplers).

### Relation to Latitude

Ceriantharia occurrence at grab sample stations was not independent of latitude ( $\chi^2$ ,  $P < 0.05$ ). Occurrence was highest in three areas: off Chesapeake Bay (lat. 37° to 38°N); south of Cape Cod in the zone also including the southern half of Georges Bank (lat. 40° to 41°N); and on the shelf off Nova Scotia (lat. 44° to 45°N) (Fig. 4).

From submersibles, Cerianthid B was the only species seen on Georges Bank, or north of 41°N [Wilkinson Basin (Gulf of Maine) and Corsair Canyon]; Cerianthids A, C, and D were all seen in canyons or on the slope south of Georges Bank (Table 3).

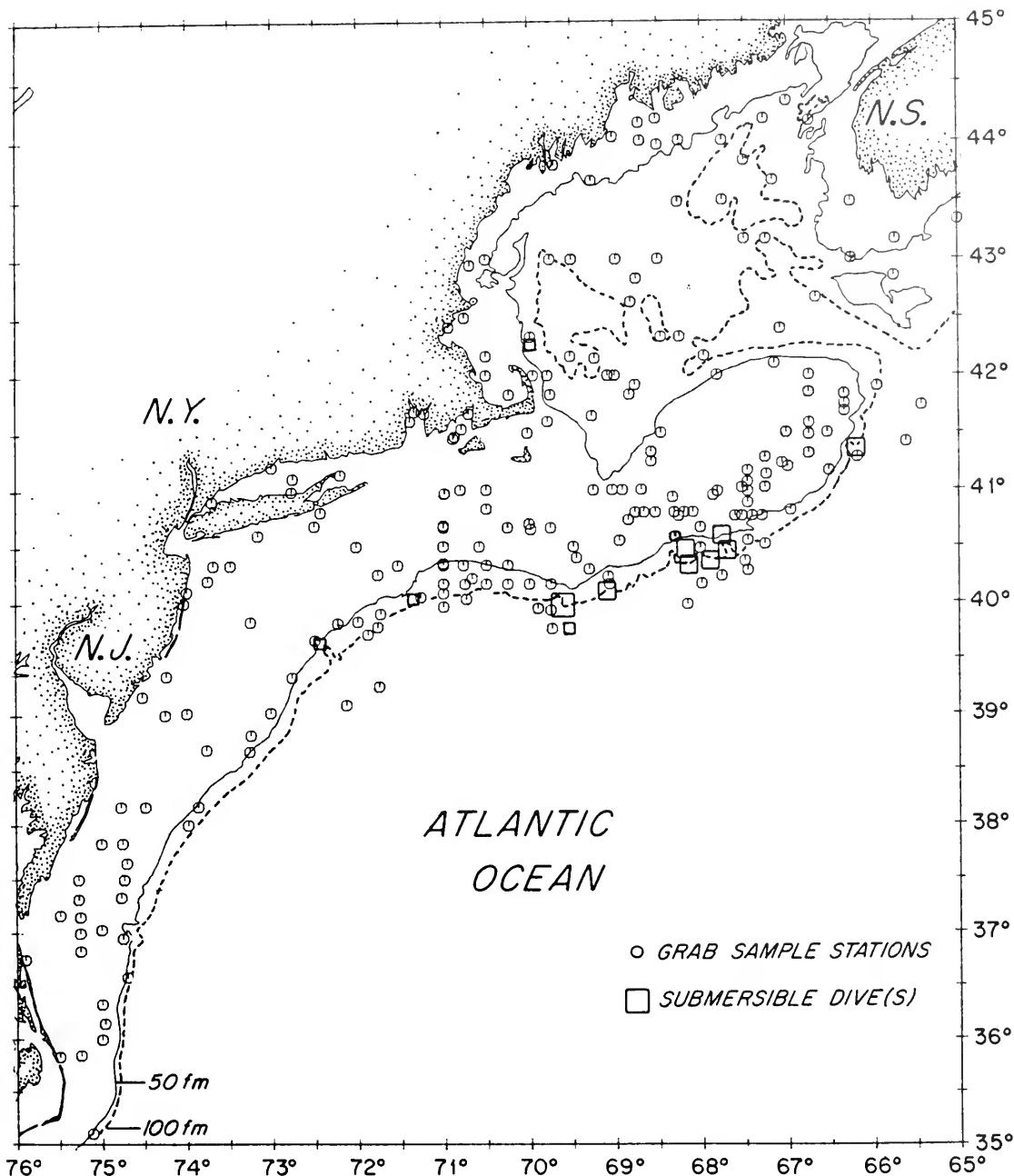

FIGURE 2.—Chart showing the submersible dive(s) sites and grab sample stations containing Ceriantharia. Symbols for submersible dive(s) sites often circumscribe more than one dive, since at this scale some dives were too close together to distinguish with separate symbols (1 fm = 1.83 m).

### Relation to Bathymetry

In grab samples, Ceriantharia were found at depths from 6 to 2,329 m, but occurrence was not independent of depth ( $\chi^2$ ,  $P < 0.05$ ). Occurrence

was highest from 0 to 100 m, and no Ceriantharia were caught from 501 to 900 m (Fig. 4).

Submersible dive depth range was 80 to 1,930 m (Appendix Tables 1, 2). Cerianthids B, C, and D were seen within the 80-400 m range, no species were

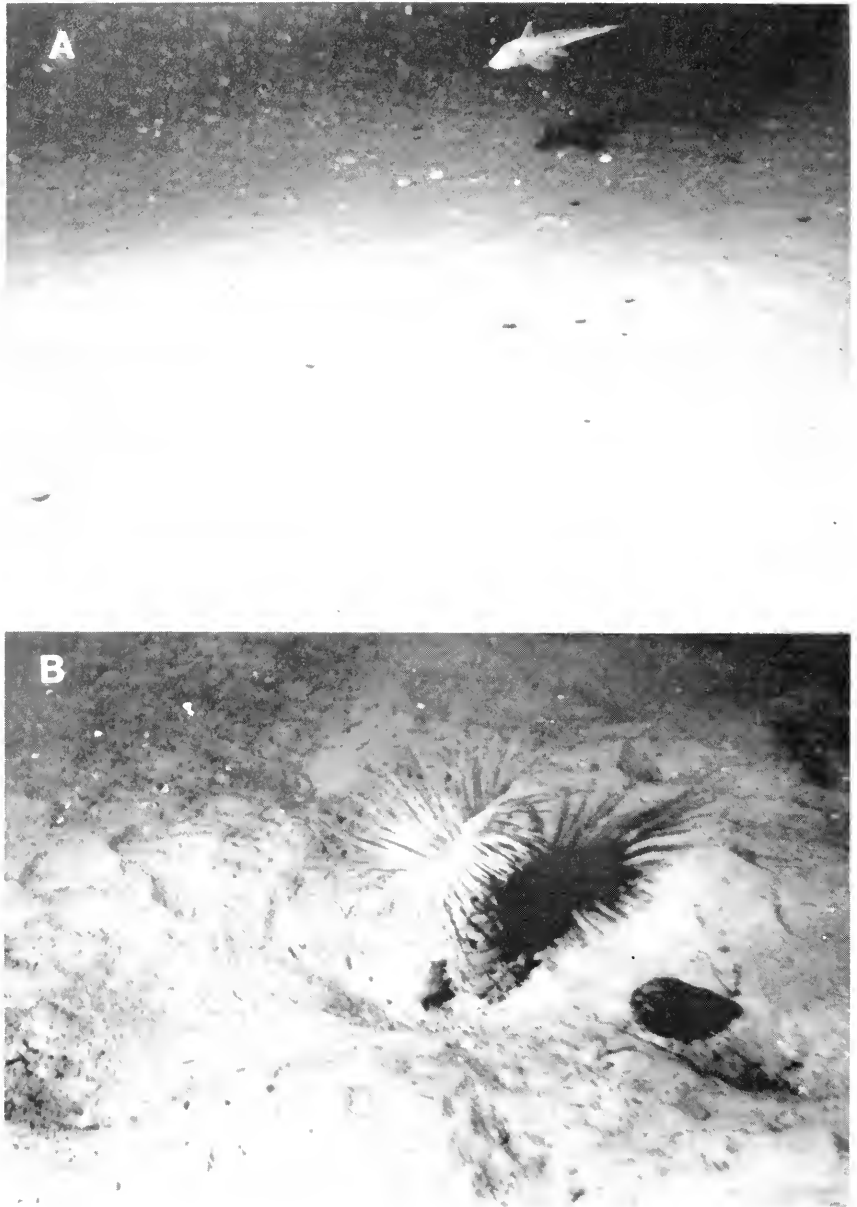

FIGURE 3.—A, B, C, - black and white prints of 35 mm Ektachrome transparencies from a hand-held camera; D - from externally mounted 35 mm brow camera. A. *Alvin* dive 838, axis of Oceanographer Canyon, 1,740 m: Cerianthid A (dark anemones); white brittle stars, *Ophiomusium* sp.; sea urchins, *Echinus affinis*; and a grenadier (Macrouridae) on a calcareous silt-sand substrate. B. *Nekton Gamma* 1974 dive 30, head of Lydonia Canyon, 300 m: Cerianthid B with a blackbelly rosefish, *Helicolenus dac-*



*tylopterus*, at its tube base, on silt-clay substrate. C. *Nekton Gamma* 1974 dive 30, 300 m: Cerianthid B with a portunid crab, *Bathynectes* sp., at its tube base on silt-clay substrate. D. *Nekton Gamma* 1979 dive 3, head of Block Canyon, 150 m: Cerianthid C with tube epifauna (sponges and colonial white anemones), and redfish, *Sebastes* sp., just visible near center of the photograph on a silt-clay substrate, current direction was from left to right.

TABLE 3.—Morphological features, apparent in photographs taken from submersibles, used to distinguish between four *Ceriantharia* species seen, and the geographic areas and bathymetric ranges in which they were found (cf. Fig. 3, Appendix Tables 1 and 2).

Species	Tube height in relation to seafloor		Characteristics of marginal tentacles			Geo-graphic areas <sup>1</sup>	Depth range (m x 100)
	Above	Flush	Length	Arrangement	Coloration		
A		X	unequal	multiplanar <sup>2</sup>	dark red, black	6,8	16-19
B	X		unequal	multiplanar	pale purple, pink, tan, or brown	1-8, 10	1-4
C	X		equal	parabolic <sup>2</sup>	white with purple marks	4,9	2-4
D		X	unequal	multiplanar	greenish yellow	10	2-3

<sup>1</sup> 1 - Wilkinson Basin, Gulf of Maine; 2 - Georges Bank; 3 - Corsair Canyon; 4 - Lydonia Canyon; 5 - Gilbert Canyon; 6 - Oceanographer Canyon; 7 - Hydrographer Canyon; 8 - Veatch Canyon; 9 - Block Canyon; 10 - Hudson Canyon.

<sup>2</sup> Used by Meyer (1980) to characterize feeding nets of other passive suspension feeders.

observed at depths from 400 to 1,600 m, and *Cerianthid* A was seen at depths from 1,600 to 1,930 m (Table 3).

### Relation to Bottom Water Temperature

Temperature observations were sparse for grab sample stations, so, the extreme range of temperature ( $\Delta T$ ), a commonly used measure of climatic variability (MacArthur 1975), was used to compare temperature with *Ceriantharia* distribution;  $\Delta T$  equals the difference between extreme annual recorded temperatures (summer high minus winter low), obtained from various published sources, and measurements, made by the NEFC. Site ranges were grouped for plotting: 0° to 3.9°C, 4° to 7.9°C, 8° to 11.9°C, 12° to 15.9°C, 16° to 19.9°C, and >19.9°C. Temperature range changed significantly with latitude and depth. Largest  $\Delta T$ 's generally dominated shelf waters south of lat. 41°N, and in-shore waters (Fig. 5).

*Ceriantharia* occurrence at grab sample stations was not independent of temperature range ( $\chi^2$ ,  $P < 0.05$ ); occurrence was highest on the continental shelf where  $\Delta T$  was from 8° to 15.9°C (Fig. 4).

All submersible dives were performed in July or August. Bottom water temperatures (external

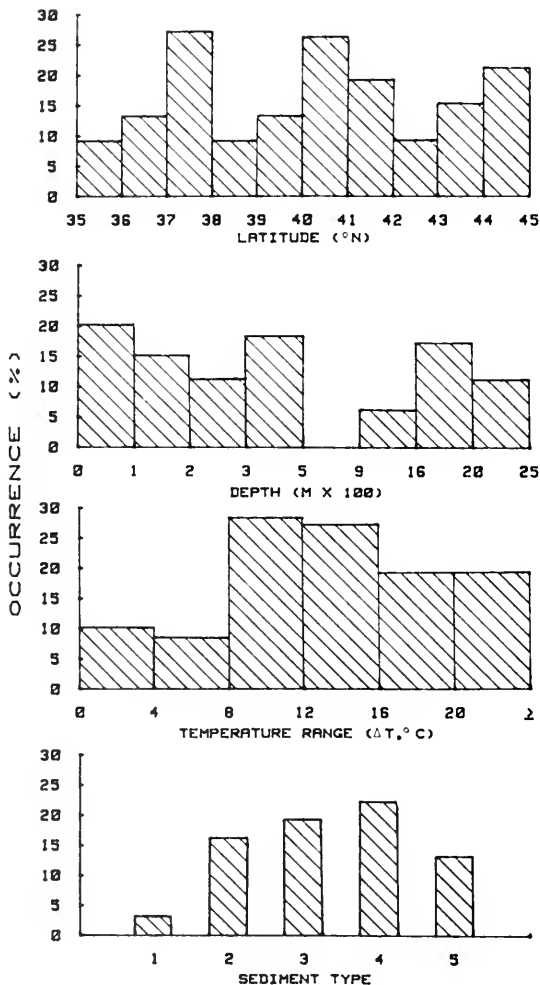

FIGURE 4.—*Ceriantharia* occurrence (% of grab sample stations) in relation to latitude, depth, temperature range ( $\Delta T$  = summer high minus winter low), and sediment type. Depth stratum size was determined by pooling, from shallow to deep, adjacent 100 m depth intervals until enough observations were available for a chi-square test. Sediment type codes are 1 - gravel; 2 - gravel/sand, silt, mud or clay; 3 - sand; 4 - silt/sand; 5 - silt/clay.

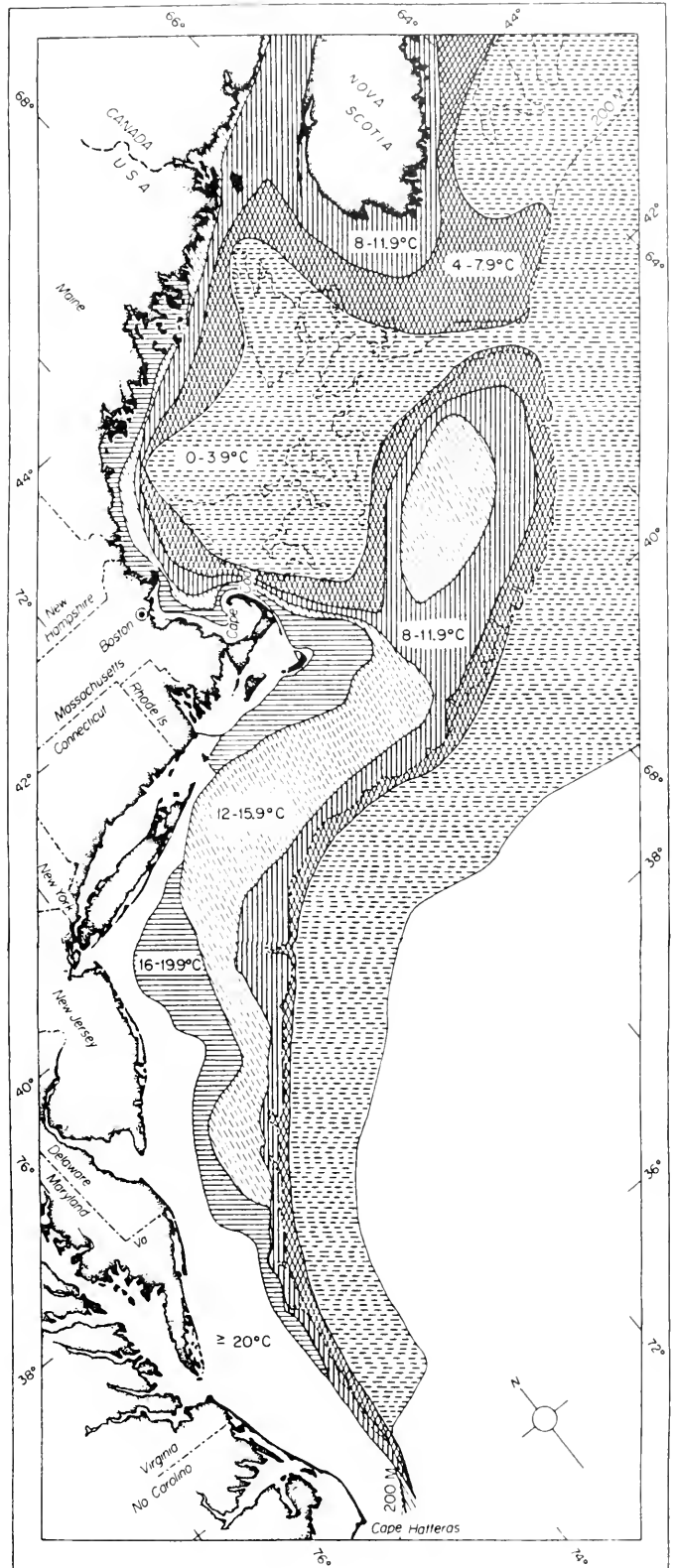

FIGURE 5.—Distribution of extreme range in bottom water temperature (summer maximum minus winter minimum) in the Middle Atlantic Bight (from Wigley and Theroux 1981) and New England region (Theroux and Wigley, text footnote 3).

thermometer observations) decreased with depth; temperatures ranged from 5° to 13°C at depths <500 m and declined gradually from 5°C at 500 m to 3.5°C at 1,900 m (Appendix Tables 1, 2). Depth-temperature profiles of three *Alvin* dives (Fig. 6) indicate depths of 500 to 600 m were a transition zone; deeper bottom water temperatures decreased little with depth, in comparison to shallower temperatures. Cerianthids B, C, and D were seen at temperatures of 5.3° to 13.0°C, and Cerianthid A was observed only in colder, deeper water, in the narrow range of 3.5° to 3.9°C (Appendix Tables 1, 2).

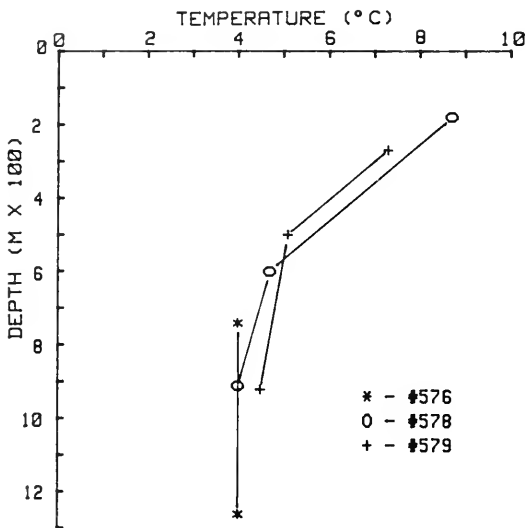

FIGURE 6.—Depth-temperature profiles constructed from observations (of external thermometers) made on the bottom during three *Alvin* dives in Veatch Canyon. Temperature stabilized at about 500-600 m.

### Relation to Sediments

Ceriantharia occurrence at grab sample stations was not independent of sediment type ( $\chi^2$ ,  $P < 0.05$ ); they rarely inhabited 100% gravel sediments (Fig. 4). However, when stations with 100% gravel sediments were not included, occurrence was independent of sediment type ( $\chi^2$ ,  $P > 0.05$ ). Although occurrence in silt-clay sediments was lower than in other unconsolidated sediments (Fig. 4), this may be a result of the large proportion of silt-clay sediment stations at depths >500 m, where Ceriantharia were scarcer; if only silt-clay sediments from shallower than 500 m are analyzed, occurrence is more than 20%.

Photographic transect profiles of submersible

dives (Appendix Table 2, depths <400 m) provided information on Ceriantharia abundance with respect to substrate, depth, temperature, transect direction, and distance (Figure 7 shows one profile). Based on the number of sightings in various substrata (Appendix Tables 1, 2) and the transect profiles, about 70% of the Ceriantharia inhabited silt-sand and silt-clay sediments. However, they also commonly occurred in rarer gravelly substrates (less than about 50% gravel cover on sand or clay; only about 20% of the total seafloor viewed). They were not seen in coarse sand sediments (usually rippled and/or in dune formations).

The clay substrate observed from submersibles was actually a semiconsolidated mud (Cooper et al. in press); the term clay was used to differentiate it from sand substrates, but clay may only be a minor constituent.

### Spatial Pattern

Ceriantharia density and biomass estimates from grab sample data were determined for comparison to other studies (e.g., Sanders 1956; Pearce et al. 1981; Reid et al. 1981; Caracciola and Steimle 1983). However, because no replicate sampling was done at over 90% of the stations, density and biomass were not analyzed further. For stations with anemones or whole tubes, mean density was 35.7  $m^{-2}$  ( $N = 168$ , 95% C.L. =  $\pm 12.1$ , range = 1.7 to 1,370  $m^{-2}$ ). Mean station biomass (anemone blotted wet weight) was 48.6  $g m^{-2}$  ( $N = 139$ , 95% C.L. =  $\pm 35.4$ ).

On the quantitative submersible dives, Ceriantharia density ranged from 0 to 0.414  $m^{-2} dive^{-1}$  (Appendix Table 2). The maximum density in one photographic frame was 6.6  $m^{-2}$ . The photographic transect profiles (Fig. 7) showed Ceriantharia populations shallower than 400 m were spatially aggregated. No quantitative information was available for the Cerianthid A populations seen in the axes of Oceanographer and Veatch Canyons.

The largest aggregation encountered (head of Lydonia Canyon, Fig. 7) was over 0.5 km wide and composed mostly of Cerianthid B, with some Cerianthid C individuals. The dives were run over a permanent station marker (37 khz pinger) positioned on a 14-15 m high knoll. Substrate atop the knoll was gravel-sand, near the base and surrounding the knoll was silt-sand. Approximately half of the Ceriantharia aggregation occupied the gravel-sand sediments. Ceriantharia were the dominant megafauna in the area, other common megafauna were galatheid crabs, *Munida iris* Milne-Edwards, and



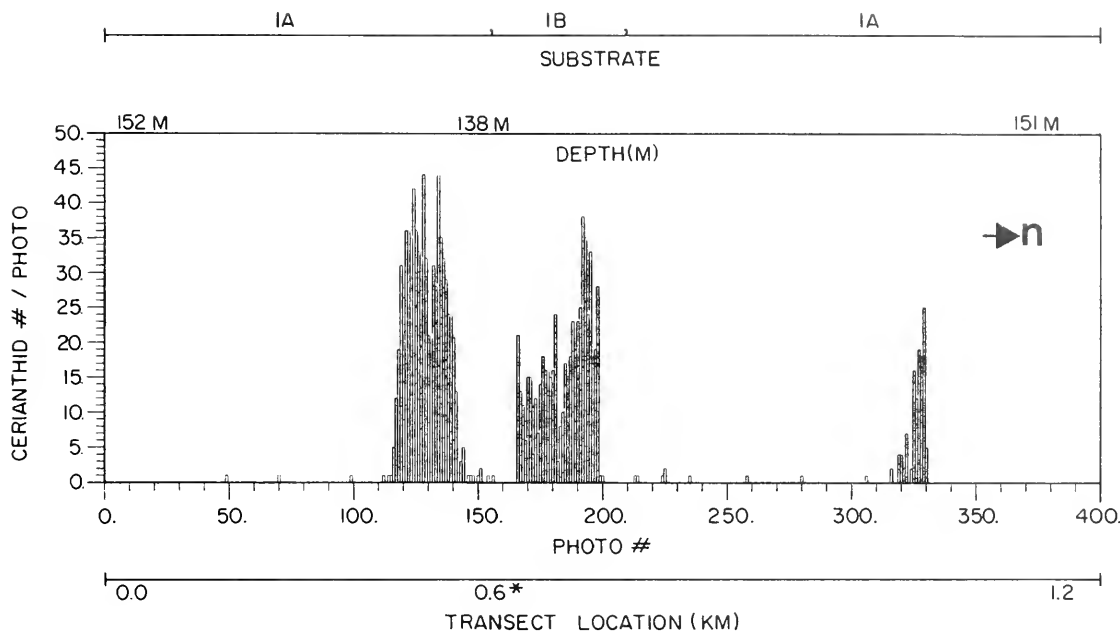

FIGURE 7.—One example, from 1980 *Johnson-Sea-Link* dives 15 and 16 in Lydonia Canyon, of the photograph-by-photograph transect profiles of *Ceriantthia* abundance constructed for quantitative submersible dives during which *Ceriantthia* density exceeded  $0.1 \text{ m}^{-2} \text{ dive}^{-1}$ , at depths of less than 400 m. Substrate codes: 1 - sand base, 1A - silt veneer, 1B - greater than 5% gravel cover. A permanent station marker (37 khz pinger) was located at 0.6 km into the transect, as denoted by the asterisk.

asteroids on gravel-sand, and shell-less hermit crabs, *Catapagurus* sp., on silt-sand. Galatheids were also observed on silt-sand sediments, often near cerianttharian tubes. A qualitative observation made on several submersible dives was that *Cerianttharia* "forests" (aggregations) were often associated with rises in seafloor topography.

## Functional Role

Figure 8 (data from 1979 *Nekton Gamma* dive #3 in Block Canyon) shows *Ceriantthid C* frequency of occurrence and number of associated species (diversity) plotted by photographic frame. The substrate throughout the dive was a low-relief silt-clay, and

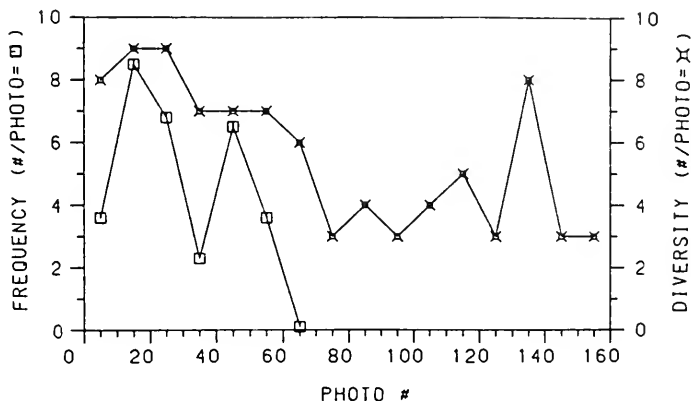

FIGURE 8.—*Ceriantthid C* abundance and diversity (number of species) of associated fauna along a 1.0 km photographic transect from 1979 *Nekton Gamma* dive #3. Each data point represents the sum of 5 adjacent photographic frames: species diversity increased significantly in areas with *Cerianttharia* (Mann-Whitney test,  $P < 0.01$ ).

the depth and temperature ranges were 137 to 183 m, and 13.0° to 10.7°C. Mean number of species was significantly higher in photographs with Ceriantharia (Mann-Whitney test,  $P < 0.01$ ): Three groups of epifauna (hydroids, sponges, and small white anemones; Fig. 3D) were attached to Ceriantharia tubes only and not found on the surrounding substrate. Also, blackbelly rosefish, *Helicolenus dactylopterus* (De La Roche) (Fig. 3B), and redfish, *Sebastes* sp. (Fig. 3D), abundances were higher in the Cerianthid C patch (0.40/frame and 0.18/frame, respectively) than in the adjacent area (0.03/frame and 0.00/frame); about half of the fish were nestled at tube bases.

At other dive locations, motile megafaunal species often seen nestled near tubes included portunid crabs (*Bathynectes* sp.) (Fig. 3C); jonah crabs, *Cancer* sp.; pandalid shrimps, *Pandalus* sp.; American lobsters, *Homarus americanus* Milne-Edwards; hakes, *Urophycis* spp.; and greeneyes *Chlorophthalmus agassizii* Bonaparte.

Two Cerianthid B tubes (50 m apart) and adjacent sediments were collected with the grab sampler of the submersible *Johnson-Sea-Link*, in the head of Oceanographer Canyon at a depth of 293 m. The tubes were separated from the adjacent sediments immediately after the submersible surfaced. The volume of each tube was less than the volume of adjacent sediments (80% fine sand, <0.5 mm; 10% coarse sand; 10% silt) (Appendix Table 3). After preservation and staining, the macrofauna (>0.5 mm) were identified for each sample (Appendix Table 3): Polychaetes were dominant and the three most abundant polychaete species inhabiting the Ceriantharia tubes were absent or scarce in the adjacent sediments; *Polycirrus eximius* (Leily) (a tentacle feeder which sweeps the water and substratum for food), *Marphysa* sp. (a jawed omnivore), and a filter-feeder, *Potamilla neglecta* (Sars) (Fauchald 1977; Fauchald and Jumars 1979).

## DISCUSSION

### Collection Gear

Gear differences largely account for the differences in Ceriantharia size and density estimates from grab samples versus photographs. Due to limitations in resolution, photographs provide valid data only on larger epifauna (Emery et al. 1965; Barham et al. 1967; Wigley and Emery 1967). However, since the estimated depth of penetration of a 0.1 m<sup>2</sup> Smith-McIntyre grab sampler, the gear used most frequently in this study, is only 3 to 5 cm in

unconsolidated substrates (Smith and McIntyre 1954), and large ceriantharian tubes often extend much deeper than 5 cm below the seafloor (Sebens fn. 5), making them difficult to dislodge, if the primary objective is to sample large individuals and document the associations between tubes and other fauna, then photographs and direct observations are more useful than grab samples.

### Species Identification

*Ceriantheopsis americanus* and *Cerianthus borealis*, identified from grab samples, occurred within the geographic and bathymetric ranges noted previously for these species (Table 1). Unfortunately, many Ceriantharia samples were discarded, and none of the available samples from depths greater than 500 m contained anemones for taxonomic identification.

The morphological features used to distinguish between the four species seen from submersibles (Table 3) may not individually be reliable; tentacle coloration may vary noticeably within a species (Arai 1971; Uchida 1979). However, taken together, we feel the features were consistent enough to indicate we saw four species of adult Ceriantharia: *C. borealis* (probably Cerianthid B), two unidentified species (Cerianthids C and D) from depths shallower than about 500 m, and another unidentified species (Cerianthid A) living deeper down the continental slope.

The conclusion that Cerianthid B is *C. borealis* is based on the similarities between our descriptions of Cerianthid B morphology and distribution (Table 3), and information from other studies on *C. borealis* (Table 1; Gosner 1979). The only other previously identified inhabitant of the study area, *C. americanus*, was probably not encountered on our submersible dives; the deepest record found for *C. americanus* was about 70 m (Pearce et al. 1981), whereas our shallowest submersible dive was to a depth of 80 m.

Sebens (in press) described two unidentified Ceriantharia species which occur at depths >1,000 m in the Northwest Atlantic: Unidentified Species II (seen at depths >1,500 m) resembles Cerianthid A (Table 3, Fig. 3A), Cerianthid A in Valentine et al. (1980), and a photograph of unidentified Ceriantharia taken by Grassle et al. (1975) at depths of 1,550 to 1,830 m just south of New England. The distinction Sebens (in press) makes between Unidentified Species I (seen at depths of >1,000 m) and Unidentified Species II (Cerianthid A) is that Species II is smaller (Table 1). Grassle et al. (1975) and

Hecker et al. (1980) also reported seeing small unidentified Ceriantharia at about 1,300 and 1,000 m, respectively. We saw (from submersibles) no Ceriantharia from 1,000 to 1,600 m for comparison.

In addition to the six documented species above, other Ceriantharia sighted in or near the region include two possible species photographed by Hecker<sup>9</sup>: one at depths of 1,800 to 2,800 m (from Lydonia Canyon to Cape Lookout, NC), which resembles a stout black Cerianthid B, and another resembling Cerianthid A (except its tube extends above the seafloor) at depths of 500 to 1,000 m off Cape Hatteras. Rowe and Menzies (1969) photographed Ceriantharia on the continental slope (at depths of 400 to 3,000 m) south of Cape Hatteras (about lat. 34°N) which they guessed to be *Ceriantheomorpha brasiliensis* Carlgren. However, they presented no photographs for comparison and collected no voucher specimens. The *C. brasiliensis* specimens identified by Carlgren (1931) were from Brazil, South America, and its resemblance to other slope species is uncertain. Submersible dive time devoted to in situ documentation and collection of specimens is obviously needed in order to identify the deep-water species<sup>10</sup>.

### Relation to Latitude

North of Cape Cod and Georges Bank (lat. 42° to 44°N) the continental shelf is dominated by the Gulf of Maine, a feature unlike the rest of the shelf in the region because of its topographic irregularity and because it reaches depths of more than 100 m closer to shore. The lack of tidal mixing below 100 m over much of the gulf, and the fact that the principal source of its bottom water is thermally stable continental slope water introduced through the Northeast Channel, results in water temperature stratification which keeps the gulf bottom water temperatures virtually constant throughout the year (TRIGOM-PARC 1974; Rowe et al. 1975; Ingham et al. 1982, p. 43). The narrow extreme range of bottom water temperature ( $\Delta T$ ) dominant from lat. 42° to 43°N (Fig. 5) may account for low Ceriantharia occurrence at grab sample stations there (Fig. 4), while peaks in occurrence are evident at lat. 40° to 41°N (shelf just south of Cape Cod, including southern Georges Bank), and from 44° to 45°N (shelf off

Nova Scotia) may be associated with more favorable intermediate temperature ranges which prevail there (8° to 15.9°C). High Ceriantharia occurrence at grab sample stations between 37° to 38°N is in part due to high occurrence at stations in the lower half of Chesapeake Bay; occurrence was 56% at nine Bay Stations and 23% at 52 shelf/slope stations. However, our data is too sparse and inconclusive to make a bay versus non-bay comparison, or explain the high occurrence at shelf stations in this area.

According to Gosner (1971), the continental margin from Cape Hatteras to Nova Scotia is divided into two faunal provinces with respect to benthic invertebrates: a Boreal (cold-temperate) province north of Cape Cod, and a Virginian (warm-temperate) province of Cape Cod, MA. Theroux (in press) considers the situation to be more complex and to depend on the species considered, but agrees that Cape Cod and Georges Bank are the beginning of a rapid transition from cold to warm temperate fauna, and suggests that the transition is associated with Georges Bank and Nantucket Shoals thermal fronts (Fig. 5; Ingham et al. 1982, p. 40-41).

Using Gosner's (1971) faunal province descriptions, our submersible data indicate that, in addition to *C. americanus*, at least two other warm-temperate species inhabit the northwest Atlantic continental shelf (Cerianthids C and D). The only cold-temperate shelf species, Cerianthid B (probably *C. borealis*) ranges south to Cape Hatteras (Tables 1, 3). The last species we saw (Cerianthid A) is bathyal.

### Relation to Bathymetry

Bathymetric zonation of benthic fauna has been previously described for the continental shelf-slope region of the northwest Atlantic (Wigley and Emery 1967; Rowe and Menzies 1969; Sanders and Hessler 1969; Rowe 1972; Grassle et al. 1975; Haedrich et al. 1975, 1980; Hecker et al. 1980; Valentine et al. 1980; Wigley and Theroux 1981). Rowe et al. (1982) cautioned, "'zones' that previous investigations have described apparently are a function both of the animal groups studied and distribution of samples with depth". Thus, our discussion of Ceriantharia zonation is limited to depths <2,000 m, since below that depth there were no submersible data to support the grab sample data.

Ceriantharia distribution, as determined from the grab sample data (Fig. 4), our submersible observations (Table 3), and data from other investigations (Table 1) imply boundaries (defined here as depths characterized by distinct changes in the benthic com-

<sup>9</sup>B. Hecker, Lamont-Doherty Geological Observatory, Columbia University, Palisades, NY 10964, pers. commun. October 1984.

<sup>10</sup>For all photographed, but unidentified slope species, we know of only one voucher specimen (of Unidentified Species I), presently located at the Harvard Museum of Comparative Zoology, Cambridge, MA.

munity's species composition) to *Ceriantharia* distribution exist at about 500, 900, and 1,600 m.

Our submersible data indicate that shelf species were confined to depths of less than about 400 m, and the bathyal species (*Cerianthid* A) was seen between 1,600 and 2,000 m. Published reports indicate another unidentified species lives deeper than about 1,000 m (Grassle et al. 1975; Hecker et al. 1980; Sebens in press). Similar depth zonation of slope fauna inhabiting the study area have been reported for isopods (Menzies et al. 1973), demersal fishes (Musick<sup>11</sup>), and megafauna captured in trawls (Haedrich et al. 1980). Some environmental factors, suggested as causes for observed distributions, are temperature, sedimentation rates, and substrate types (summarized by Haedrich et al. 1975, 1980).

The depth interval between about 400 and 600 m on the continental slope south of New England is a temperature transition zone; shallower bottom waters experience larger seasonal temperature variations than stable deeper waters (Sanders and Hessler 1969; Haedrich et al. 1975). Depth-temperature profiles (Fig. 6) made on *Alvin* dives in Veatch Canyon showed larger depth related temperature variations also occurred shallower than 500 to 600 m. The shelf species (*Cerianthids* B, C, and D) may not be able to tolerate and/or thrive in the cold stable conditions below 500 m.

The *Cerianthid* A population, we saw deeper than 1,600 m in the axis of Oceanographer Canyon, inhabited sediments high in biogenic carbonates; canyon axes may act as settling basins for suspended matter being funneled down canyon (Valentine et al. 1980). Rowe and Menzies (1969) attributed increases in suspension-feeder concentration, in photographs from the upper slope (200-800 m) and at the slope base (3,000 m) off North Carolina, to increased detritus accumulation resulting from downslope movement and concentration by the prevailing bottom currents. Haedrich et al. (1980) stated, in reference to the depth zonation of megabenthic fauna on the slope off southern New England, that "zonation must result to some degree from varying strategies that promote success along a food resource gradient".

Haedrich et al. (1975) suggested boundaries to zones of larger epifauna, at about 400 and 1,000 m

on the continental slope south of New England, result from physical changes in the slope environment. MacIlvaine (1973, p. 30-70) reported on the physical environment in the same area (sediment type, suspended sediments, and slope gradient). The zone between 400 and 1,000 m consists largely of homogeneous silt-sand substrate, near-bottom suspended sediments at 520 m were 50 to 60  $\mu\text{g/L}$  (about 25% organics), and the slope gradient is about  $1.4^\circ$ . Deeper than about 1,000 m there are more variable sediment features (stiff clayey silt sediments which are smooth or hummocky, talus slopes, and rock outcrops), suspended sediments were 20  $\mu\text{g/L}$  (about 45% organics) at 1,000 m and 80  $\mu\text{g/L}$  (about 80% organics) at 1,670 m, and the slope gradient is steeper ( $7.6^\circ$ ).

Suspension feeders rely on current velocity and nutrient load for their food supply. Substrate variability deeper than 1,000 m may enhance *Ceriantharia* occurrence down to 2,000 m: Features such as hummocks may act as perches for suspension feeders, placing them up higher where current is swifter and their food supply is replenished more rapidly (Hughes 1975; Dyer 1980; Sebens 1984). Higher suspended sediments and percentage of organics may further enhance *Ceriantharia* occurrence below 1,600 m, as compared with 1,000 or 520 m. The lesser slope gradient between 400 and 1,000 m probably results in lower near bottom current velocities; near the shelf-slope break in Oceanographer Canyon, bottom currents are swifter at 105 to 300 m than at 650 m, due primarily to a difference in slope gradient (Valentine in press). Thus, increased slope gradient may enhance *Ceriantharia* occurrence below 1,000 m.

Other mechanisms may affect ceriantharian depth zonation such as the direct effects of pressure (Siebenallar and Somero 1978), or predators (Paine 1966; Rex 1976); however, data were not available to evaluate these factors.

Submarine canyons received particular attention during submersible dive activities because of the potential entrainment of discharges from oil exploration activities into productive canyon environments (Cooper and Uzman fn. 8). Bathymetric zonation of slope fauna may be altered and/or species abundance enhanced by submarine canyons (Rowe 1971; Haedrich et al. 1975). The conduitlike nature and substrate heterogeneity of canyons have both been implied as explanations for observed faunal enrichment in canyons as opposed to adjacent noncanyon slope areas (Rowe and Menzies 1969; Rowe 1971, 1972; Haedrich et al. 1975; Hecker et al. 1980; Valentine et al. 1980; Rowe et al. 1982). Although

<sup>11</sup>Musick, J. A. 1976. Community structure of fishes on the continental slope and rise off the Middle Atlantic Coast of the U.S. Manuscript presented at Joint Oceanographic Assembly, Edinburgh, September. (Copies available from: J. A. Musick, Virginia Institute of Marine Science, Gloucester Point, VA 23062, USA).

we had no adjacent slope dives to compare with the canyon dives, *Ceriantharia* were common in canyons and have been suggested to be canyon "indicator" species (Rowe 1972). In the future, we hope a canyon-slope comparison of *Ceriantharia* species' diversity and abundance will be made.

### Relation to Bottom Water Temperature

Wigley and Theroux (1981) found that total macrofaunal density in the Middle Atlantic Bight generally increased directly with increasing temperature range ( $\Delta T$ ). *Ceriantharia* occurrence at grab sample stations followed this trend until  $\Delta T$  reached 15.9°C, after which it decreased (Fig. 4). Why an intermediate temperature range may be favorable to *Ceriantharia* is unknown. Wide ranges might entail harmful extremes of temperature, while narrower ones may be too constant at an unfavorable level, or larval stages may benefit from some degree of fluctuation for maximal development (Andrewartha and Birch 1954, p. 129-205). Information on how temperature affects ceriantharian metabolism, activity patterns, and development is lacking.

Marine organism distributions are largely controlled by temperature (Hutchins 1947; Crisp 1965; Gosner 1971). The most obvious effect of temperature on invertebrate distributions is exclusion of species from areas with unsuitable thermal regimes (Kinne 1970). Submersible data on ceriantharian geographic and bathymetric distribution demonstrate allopatric speciation which we believe is primarily a response to temperature.

### Relation to Sediments

The presence of silt is characteristic of depositional areas which may be favorable to suspension feeders (Rowe and Menzies 1969). Wigley (1968) described *Ceriantharia* as common inhabitants of silty-sand sediments on Georges Bank. Through resuspension, surficial deposits are potential food for *Ceriantharia* (Rhoads 1974). In addition to low deposition, substrate instability may account for the scarcity of *Ceriantharia* in 100% gravel and rippled coarse sand substrate. Shifting substrates, such as the 100% gravel sediments at grab sample stations or the rippled sand dunes observed from submersibles, may harm suspension feeders through clogging of feeding apparatus, or the burial of larvae (Sanders 1956; Ross 1968; Rhoads and Young 1970; Rhoads 1974).

However, *Ceriantharia* were generally cosmopolitan with respect to substrate (Fig. 4; Appendix

Tables 1, 2). They are well adapted to withstand strong currents, sediment movement, and extreme deposition of fine material because their tubes provide firm anchorage (Frey 1970) and protection against clogging or burial (Pearce 1972). Pearce et al. (1976) found *Ceriantharia* were dominant macrofauna in fine carbon-rich sediments stressful to other benthic species, near New York Bight sewage sludge disposal sites.

Just as 100% gravel substrate is unfavorable for burrowing, a gravel veneer might also be expected to limit space available for burrowing. However, on submersible dives, *Ceriantharia* were frequently seen in gravel-covered areas (less than about 50% gravel cover). These deposits, probably Pleistocene ice-rafted glacial debris, are exposed in areas which usually experience higher currents than adjacent areas (Valentine et al. 1980; Valentine in press), a favorable consideration for suspension feeders.

### Spatial Pattern

Local conditions of food supply, substrate, or microtopography, may enhance *Ceriantharia* aggregation (Fig. 7). Local differences in food supply may allow *Ceriantharia* to survive in aggregations. Grassle et al. (1975) observed that strongly clumped suspension-feeders were able to maintain aggregations because their food supply was continually renewed. Unusually high *Ceriantharia* abundances near a sewage sludge/dredge spoil disposal area may have occurred owing to the increased amounts of organic matter (Pearce et al. 1976).

Grassle et al. (1975) found *Ceriantharia*, similar to *Cerianthid* A, more randomly distributed on the continental slope, south of Cape Cod (depth of 1,465 to 1,830 m, homogeneous sandy silt-clay substrate). In comparison, substrata in canyon heads where aggregations were observed from submersibles are heterogeneous (Hecker et al. 1980; Valentine et al. 1980). Our grab samples showed the same contrast between heterogeneous substrata shallower than 500 m and homogeneous silt-sands and clays down-slope (Shepard and Theroux fn. 4). Since invertebrates are capable of substrate selectivity (Thorson 1966; Gray 1974), a variable substrate may be characterized by patchy inhabitant distributions (Hecker et al. 1980).

The *Cerianthid* B aggregation in Lydonia Canyon (Fig. 7), located on a knoll, may benefit from elevated positioning and swifter currents (Hughes 1975; Sebens 1984), thus aggregations may also form in response to local changes in surface elevation.

## Functional Role

An increase in structural complexity of the substrate vertically and/or horizontally increases the number of microhabitats, and if the appropriate colonizers and mortality sources are present, within-habitat diversity will likely be increased (Steimle and Stone 1973; Abele 1974; Hughes 1975; Woodin 1976, 1978; Connell 1978; Suchanek 1979; Hulbert et al. 1982). Ceriantharia tubes may increase species diversity and abundance on featureless soft bottom areas by 1) attracting motile megafauna seeking refuge near tubes and 2) serving as a favorable substrate for epifauna and infauna, particularly suspension-feeders and tubicolous species.

By acting as a three-dimensional refuge, the tubes may ease predation pressure on smaller motile species (Ware 1972; Whoriskey 1983). Demersal fish and crustaceans similar to those we observed have been noted by others in association with Ceriantharia (Uzmann et al. 1977; Hecker et al. 1980; Valentine et al. 1980). The species most commonly observed near tubes, *Helicolenus dactylopterus*, *Sebastes* sp., and *Bathyneustes* sp., characteristically exhibit thigmotactic behavior.

Associations similar to the ones we found between suspension feeders and Ceriantharia tubes in Block Canyon (Figs. 3D, 8), and polychaetes and tubes from Oceanographer Canyon (Appendix Table 3), have been recorded for Ceriantharia and polychaetes (Kingsley 1904; O'Connor et al. 1977), phoronids (Ponder 1971; Emig et al. 1972; Hartog 1977), and bivalves (Ponder 1971). These associations have been alternately referred to as commensalism or inquilinism; we prefer the latter definition as it highlights the role of the ceriantharian tube. Emig et al. (1972) speculated that *Cerianthus maua* Carlgren tentacles may act as baffles, causing waterborne food particles to settle out, and become available to suspension feeders (*Phoronis australis* Haswell) inhabiting the *C. maua* tubes, in which case the term commensalism may be more appropriate. However, Emig et al. also stated that increased food supply is probably a secondary benefit to the phoronids and that the suitability of the tube as a settlement surface for larvae motivates the association. O'Connor et al. (1977) studied a *Pachycerianthus multiplicatus* Carlgren population inhabiting deposit substrates (85% silt-clay, 15% sand) off Ireland and suggested tubes were prime settlement surface for the larvae of inquiline filter-feeding polychaetes, *Myxicola infundibulum* (Renier). The associates (sponges, hydroids, and colonial anemones) of Ceriantharia tubes in Block Canyon are generally nonmotile so

they probably had to arrive on the tubes as larvae. More unstable substrate surrounding the tubes may be less suitable as a settlement surface for larvae of suspension feeders (Rhoads and Young 1970, 1971; Rhoads 1974).

The vertical aspect of Ceriantharia tubes may enhance diversity and abundance by 1) allowing vertical stratification of trophic types (MacArthur and Levins 1964; Hughes 1975; Schoener 1975; Ausich and Bottjer 1982), and 2) affording inhabitants, such as the filter feeder *Potamilla neglecta*, elevated feeding stations where clogging by resuspended sediments is less likely, and current velocities tend to be greater (Dyer 1980), thus the food supply is more rapidly renewed (Hughes 1975; Sebens 1984).

The stable nature of the tubes may serve species behaviorally inclined to attach themselves to firm substrate. The three species of polychaetes, *Polycirrus eximius*, *Marphysa* sp., and *Potamilla neglecta*, most abundant on ceriantharian tubes caught in Oceanographer Canyon, but rarely found in the adjacent sediments (Appendix Table 3), usually attach their tubes to solid surfaces such as stones, algae, or hydroids (Gosner 1971; Fauchald and Jumars 1979).

Infaunal species may also gain relief from predation pressure by inhabiting ceriantharian tubes. The feltlike tubes are generally more consolidated than the sediments surrounding them, thus more difficult to graze. Ponder (1971) viewed protection as the principal benefit to a leptonid bivalve, *Montacutona ceriantha* Ponder, inquiline with *Cerianthus* sp. in Japanese waters. Protection may be enhanced for tubicolous infauna since their retraction may be stimulated by a similar response to disturbance by the host ceriantharian (Emig et al. 1972).

Ceriantharia tubes may serve as a preferential food source for some infauna. O'Connor et al. (1977) noted sipunculids, *Golfingia elongata* (Keferstein), inquiline with *Pachycerianthus multiplicatus* had tube remains in their guts. Scavengers, such as *Marphysa sanguinea* may benefit from the inquilinism for this reason.

Ceriantharia may also negatively affect the infauna in sediments adjacent to the tubes; large motile species, attracted to the tubes for shelter, might selectively graze near tubes. We hope to investigate Ceriantharia "forest" communities more thoroughly on future submersible cruises: Substrate collections taken away from tubes will further define their functional role. We believe Ceriantharia influence the ecology of the northwest Atlantic continental shelf and slope more than has been revealed from data collected by conventional surface tech-

niques alone; methods inadequate for collecting deep-burrowing adults, and providing information on behavioral and spatial relationships between Ceriantharia and other community residents.

## ACKNOWLEDGMENTS

Funding for submersible time was provided by NOAA's Office of Undersea Research, Washington, D.C. Ann Frame, NMFS Sandy Hook Laboratory, NJ, identified invertebrate specimens. We thank Kenneth Sebens and J. C. den Hartog for critically reviewing the manuscript. Alan Hulbert and Michael Pennington provided advice on data analysis. Hannah Goodale, Jean Klemm, and Connie Fontaine typed the various drafts of the manuscript. Special thanks to the submersible and ship crews who made the data collection possible: R/V *Johnson* (JSL), R/V *Atlantic Twin* (Nekton), and R/V *Lulu* (Alvin).

We dedicate this effort to the memory of John Lamont, whose talents, patience, and humor made our daily burdens easier to bear.

## LITERATURE CITED

- ABELE, L. G.  
1974. Species diversity of decapod crustaceans in marine habitats. *Ecology* 55:156-161.
- AGASSIZ, A.  
1859. On some new Actinoid polyps of the coast of the United States. *Proc. Boston Soc. Nat. Hist.* 7:23-24.
- ANDREWARTHA, H. G., AND L. C. BIRCH.  
1954. The distribution and abundance of animals. Univ. Chicago Press, Chicago, IL, 782 p.
- ARAI, M. N.  
1971. *Pachycerianthus* (Ceriantharia) from British Columbia and Washington. *J. Fish. Res. Board Can.* 28:1677-1680.
- AUSICH, W. I., AND D. J. BOTTJER.  
1982. Tiering in suspension-feeding communities on soft substrata throughout the Phanerozoic. *Science* 216:173-174.
- BARHAM, E. G., N. J. AYER, JR., AND R. E. BOYCE.  
1967. Macrobenthos of the San Diego Trough: photographic census and observations from bathyscaphe *Trieste*. *Deep-Sea Res.* 14:773-784.
- BLAND, E. L., J. D. DONNELLY, AND L. A. SHUMAKER.  
1976. *Alvin* user's manual. Woods Hole Oceanogr. Inst., Tech. Memo. No. 3-76, 36 p.
- CARACCILO, J. V. AND F. W. STEIMLE.  
1983. An atlas of the distribution and abundance of dominant benthic invertebrates in the New York Bight Apex with reviews of their life histories. U.S. Dep. Commer., NOAA Tech. Rep. NMFS SSRF-766, 58 p.
- CARLGRÉN, O.  
1912. Ceriantharia. Danish-Ingolf Exped. 5a(3):1-78.  
1931. On some Ceriantharia. *Ark. Zool.* 23A(2):1-10.
- CERFONTAINE, P.  
1909. Contribution a l'étude des Cerianthides, nouvelles recherches sur le *Cerianthus oligopodus*. *Arch. Biol.* 24: 653-707.
- CONNELL, J. H.  
1978. Diversity in tropical rain forests and coral reefs. *Science* 199:1302-1310.
- COOPER, R. A., P. C. VALENTINE, J. R. UZMANN, AND B. BUTMAN.  
In press. Georges Bank Submarine Canyons. In R. Backus (editor), *Georges Bank*, Chap. 10. MIT Press, Cambridge, MA.
- CRISP, D. J.  
1965. Observations on the effects of climate and weather on marine communities. In C. G. Johnson and L. P. Smith (editors), *The biological significance of climatic changes in Britain*, p. 63-77. Acad. Press, N.Y.
- DYER, K. R.  
1980. Velocity profiles over a rippled bed and the threshold of movement of sand. *Estuarine Coast. Mar. Sci.* 10:181-199.
- EMERY, K. O., A. S. MERRILL, AND J. V. A. TRUMBULL.  
1965. Geology and biology of the sea floor as deduced from simultaneous photographs and samples. *Limnol. Oceanogr.* 10:1-21.
- EMIG, C. C., C. HERBERTS, AND B. A. THOMASSIN.  
1972. Sur l'association de *Phoronis australis* (Phoronida) avec *Cerianthus mava* (Ceriantharia) dans les zones récifales de Madagascar. *Mar. Biol. (Berl.)* 15:304-315.
- FAUCHALD, K.  
1977. The polychaete worms: definitions and keys to the Orders, Families, and Genera. *Nat. Hist. Mus. Los Ang. Cty., Sci. Ser. No. 28*, 188 p.
- FAUCHALD, K., AND P. A. JUMARS.  
1979. The diet of worms: A study of polychaete feeding guilds. *Oceanogr. Mar. Biol. Annu. Rev.* 17:193-284.
- FIELD, L. R.  
1949. Sea anemones and corals of Beaufort, North Carolina. *Duke Univ. Mar. Stn. Bull.* 5, 39 p.
- FREY, R. W.  
1970. The lebensspuren of some common marine invertebrates near Beaufort, N.C. II. Anemone burrows. *J. Paleontol.* 44:308-311.
- GOSNER, K. L.  
1971. Guide to identification of marine and estuarine invertebrates. Wiley-Interscience, N.Y., 693 p.  
1979. A field guide to the Atlantic seashore, from Bay of Fundy to Cape Hatteras. Houghton-Mifflin Co., Boston, MA, 329 p.
- GRASSLE, J. F., H. L. SANDERS, R. R. HESSLER, G. T. ROWE, AND T. MCLELLAN.  
1975. Pattern and zonation: a study of the bathyal megafauna using the research submersible *Alvin*. *Deep-Sea Res.* 22: 457-481.
- GRAY, J. S.  
1974. Animal-sediment relationships. *Oceanogr. Mar. Biol. Annu. Rev.* 12:223-262.
- HAEDRICH, R. L., G. T. ROWE, AND P. T. POLLONI.  
1975. Zonation and faunal composition of epibenthic populations on the continental slope south of New England. *J. Mar. Res.* 33:191-211.  
1980. The megabenthic fauna in the deep sea south of New England, USA. *Mar. Biol. (Berl.)* 57:165-179.
- HARTOG, J. C. DEN.  
1977. Description of two new Ceriantharia from the Caribbean region, *Pachycerianthus curacaoensis* N. SP. and *Arachnanthus nocturnus* N. SP., with a discussion of the cnidom and of the classification of the Ceriantharia. *Zool. Meded. (Leiden)* 51(14):211-248.

- HECKER, B., G. BLECHSCHMIDT, AND P. GIBSON.  
1980. Canyon assessment study in the Mid and North Atlantic areas of the U.S. Outer Continental Shelf: epifaunal zonation and community structure in three mid and north Atlantic canyons. Final Rep., U.S. Dep. Inter., Bur. Land Manage., Wash., DC. 139 p.
- HUGHES, R. G.  
1975. The distribution of epizoids on the hydroid *Nemertesia antennina* (L.). *J. Mar. Biol. Assoc. U.K.* 55:275-294.
- HULBERT, A. W., K. J. PECCI, J. D. WITMAN, L. G. HARRIS, J. R. SEARS, AND R. A. COOPER.  
1982. Ecosystem definition and community structure of the macrobenthos of the NEMP monitoring station at Pigeon Hill in the Gulf of Maine. U.S. Dep. Commer., NOAA Tech. Memo. NMFS F/NEC-14, 143 p.
- HUTCHINS, L. M.  
1947. The bases for temperature zonation in geographical distribution. *Ecol. Monogr.* 17:325-335.
- HYMAN, L. H.  
1940. The invertebrates, Protozoa through Ctenophora. McGraw-Hill, N.Y., 726 p.
- INGHAM, M. C. (editor).  
1982. Summary of the physical oceanographic processes and features pertinent to pollution distribution in the coastal and offshore waters of the northeastern United States, Virginia to Maine. U.S. Dep. Commer., NOAA Tech. Memo. NMFS F/NEC-17, 166 p.
- KINGSLEY, J. S.  
1904. A description of *Cerianthus borealis*. *Tufts Coll. Stud.* 8:345-361.
- KINNE, O.  
1970. Temperature. In O. Kinne (editor), *Marine ecology*, Vol. 1., p. 321-616. John Wiley and Sons, N.Y.
- MACARTHUR, J. W.  
1975. Environmental fluctuations and species diversity. In M. L. Cody and J. M. Diamond (editors), *Ecology and evolution of communities*, p. 74-80. Belknap Press of Harvard Univ. Press, Cambridge, MA.
- MACARTHUR, R., AND R. LEVINS.  
1964. Competition, habitat selection, and character displacement in a patchy environment. *Proc. Natl. Acad. Sci. USA* 51:1207-1210.
- MACILVAINE, J. C.  
1973. Sedimentary processes on the continental slope off New England. *Woods Hole Oceanogr. Inst. Tech. Rep.* 73-58, 211 p.
- MARISCAL, R. N., E. J. CONKLIN, AND C. H. BIGGER.  
1977. The ptychocyst: a major new category of cnida used in tube construction by a cerianthid anemone. *Biol. Bull.* 152:392-405.
- McMURRICH, J. P.  
1890. Contributions on the morphology of the Actinozoa. I. The structure of *Cerianthus americanus*. *J. Morphol.* 4(2): 131-152.
- MENZIES, R. J., R. Y. GEORGE, AND G. T. ROWE.  
1973. Abyssal environment and ecology of the world oceans. John Wiley and Sons, Inc., N.Y., 488 p.
- MEYER, D. L.  
1980. Ecology and biogeography of living classes. In T. W. Broadhead and J. A. Waters (editors), *Echinoderms: notes for a short course*, p. 1-14. *Stud. Geol.* 3, Dep. Geol. Sci., Univ. Tenn.
- MINER, R. W.  
1950. Field book of seashore life. G. P. Putnam's Sons, N.Y., 888 p.
- O'CONNOR, B., G. KÖNNECKER, D. McGRATH, AND B. F. KEEGAN.  
1977. *Pachycerianthus multiplicatus* Carlgren - biotope or biocoenosis? In B. F. Keegan, P.O. Ceidigh, and P. J. S. Boaden (editors), *Biology of benthic organisms*, p. 475-482. Pergamon Press, Lond.
- PAINE, R. T.  
1966. Food web complexity and species diversity. *Am. Nat.* 100:65-75.
- PARKER, G. H.  
1900. Synopses of N. American invertebrates. *Am. Nat.* 34: 747-758.
- PEARCE, J. B.  
1972. The effects of solid waste disposal on benthic communities in the New York Bight. In M. Ruivo (editor), *Marine pollution and sea life*, p. 404-411. Fishing News (Books) Ltd., Lond.
- PEARCE, J. B., J. V. CARACCILO, M. B. HALSEY, AND L. H. ROGERS.  
1976. Temporal and spatial distributions of benthic macroinvertebrates in the New York Bight. *Am. Soc. Limnol. Oceanogr. Spec. Symp.* 2:394-403.
- PEARCE, J. B., D. J. RADOSH, J. V. CARACCILO, AND F. W. STEIMLE.  
1981. Benthic fauna. MESA N.Y. Bight Atlas Monogr. 14, 79 p.
- PONDER, W. F.  
1971. *Montacutona ceriantha* n. sp., a commensal leptonid bivalve living with *Cerianthus*. *J. Conchylol.* 109:15-25.
- REID, R., D. RADOSH, A. FRAME, F. STEIMLE, J. WARD, AND C. MACKENZIE.  
1981. Coastal ecosystems investigations, 1980. U.S. Dep. Commer., NOAA Northeast Monit. Program Rep. No. NEMP-111-80-G-001, 50 p.
- REX, M. A.  
1976. Biological accommodation in the deep-sea benthos: comparative evidence on the importance of predation and productivity. *Deep-Sea Res.* 23:975-987.
- RHOADS, D. C.  
1974. Organism-sediment relations on the muddy sea floor. *Oceanogr. Mar. Biol. Annu. Rev.* 12:263-300.
- RHOADS, D. C., AND D. K. YOUNG.  
1970. The influence of deposit-feeding organisms on sediment stability and community trophic structure. *J. Mar. Res.* 28:150-178.  
1971. Animal-sediment relations in Cape Cod Bay, Massachusetts. II. Reworking by *Molpadia oolitica* (Holothuroidea). *Mar. Biol. (Berl.)* 11:255-261.
- RICHMOND, S. B.  
1964. Statistical analysis. Ronald Press Co., N.Y., 633 p.
- ROBSON, E. A.  
1966. Swimming in Actiniaria. In W. J. Rees (editor), *The Cnidaria and their evolution*. *Symp. of the Zool. Soc. Lond.* 16:334-359.
- ROGERS, C. A.  
1979. Siphonophore ("Lipo") swarming in New England coastal waters—update 1976. In J. R. Goulet, Jr. and E. D. Haynes (editors), *Ocean variability in the U.S. Fishery Conservation Zone, 1976*, p. 349-352. U.S. Dep. Commer., NOAA Tech. Rep. NMFS Circ. 472.
- ROSS, D. A.  
1968. Current action in a submarine canyon. *Nature* 218: 1242-1245.
- ROWE, G. T.  
1971. Observations on bottom currents and epibenthic populations in Hatteras Submarine Canyon. *Deep-Sea Res.* 18:569-581.



1972. The exploration of submarine canyons and their benthic faunal assemblages. *Proc. R. Soc. Edinb. (B)* 73(17): 159-169.
- ROWE, G. T., AND R. J. MENZIES.  
1969. Zonation of large benthic invertebrates in the deep-sea off the Carolinas. *Deep-Sea Res.* 16:531-537.
- ROWE, G. T., P. T. POLLONI, AND R. L. HAEDRICH.  
1975. Quantitative biological assessment of the benthic fauna in deep basins of the Gulf of Maine. *J. Fish. Res. Board Can.* 32:1805-1812.  
1982. The deep-sea macrobenthos on the continental margin of the Northwest Atlantic Ocean. *Deep-Sea Res.* 29:257-278.
- SANDERS, H. L.  
1956. The biology of marine bottom communities. *In* G. A. Riley et al. (editors), *Oceanography of Long Island Sound, 1952-1954*. *Bull. Bingham Oceanogr. Collect.*, 15:345-414.
- SANDERS, H. L., AND R. R. HESSLER.  
1969. Ecology of the deep-sea benthos. *Science* 163:1419-1424.
- SCHOENER, T. W.  
1975. Resource partitioning in ecological communities. *In* W. E. Hazen (editor), *Readings in population and community ecology*, p. 370-390. W. B. Saunders Co., Phila., PA.
- SEBENS, K. P.  
1984. Water flow and coral colony size: interhabitat comparisons of the octocoral *Alcyonium siderium*. *Proc. Natl. Acad. Sci.* 81:5473-5477.  
*In press.* Marine flora and fauna of the northeastern United States, Anthozoa: Actiniaria, Zoanthidea, Corallimorpharia, and Ceriantharia. U.S. Dep. Commer. NOAA Tech. Rep. NMFS.
- SIEBENALLER, J., AND G. N. SOMERO.  
1978. Pressure-adaptive differences in lactate dehydrogenases of congeneric fishes living at different depths. *Science* 201:255-257.
- SMITH, W., AND A. D. MCINTYRE.  
1954. A spring-loaded bottom sampler. *J. Mar. Biol. Assoc. U.K.* 33:257-264.
- STEIMLE, F. W., JR., AND R. B. STONE.  
1973. Abundance and distribution of inshore benthic fauna off southwestern Long Island, N.Y. U.S. Dep. Commer., NOAA Tech. Rep. NMFS SSRF-673, 50 p.
- SUCHANEK, T. H.  
1979. The *Mytilus californianus* community: studies on the composition, structure, organization, and dynamics of a mussel bed. Ph.D. Thesis, Univ. Washington, Seattle, 300 p.
- SUTHERLAND, J. P.  
1978. Functional roles of *Schizoporella* and *Styela* in the fouling community of Beaufort, North Carolina. *Ecology* 59: 257-264.
- THEROUX, R. B.  
*In press.* Bottom animals. *In* R. Backus (editor), *Georges Bank*, Chap. 6.2. MIT Press, Cambridge, MA.
- THORSON, G.  
1966. Some factors influencing the recruitment and establishment of marine benthic communities. *Neth. J. Sea Res.* 3:267-293.
- TIFFON, Y., AND M. DAIREAUX.  
1974. Phagocytose et pinocytose par ectoderme et l'endoderme de *Cerianthus lloydii* Gosse. *J. Exp. Mar. Biol. Ecol.* 16:155-165.
- TRIGOM-PARC (The Research Institute of the Gulf of Maine-Public Affairs Research Center).  
1974. A Socio-economic and environmental inventory of the North Atlantic region, Vol. I., Book Three. BLM Contract 08550-CT3-8. Res. Inst. Gulf of Maine, South Portland, ME, USA.
- UCHIDA, H.  
1979. Cerianthid (Anthozoa, Coelenterata) from Kii Region, Middle Japan. *Mem. Nat. Sci. Mus., Tokyo* 12:185-199.
- UZMANN, J. R., R. A. COOPER, R. B. THEROUX, AND R. L. WIGLEY.  
1977. Synoptic comparison of three sampling techniques for estimating abundance and distribution of selected megafauna: submersible vs. camera sled vs. otter trawl. *Mar. Fish. Rev.* 39(2):11-19.
- VALENTINE, P. C.  
*In press.* Sediment texture and dynamics at outer shelf and upper slope depths on the southern flank of Georges Banks. *In* Undersea research and technology - scientific applications and future needs, Vol. 2. Symposia Series for Undersea Research, NOAA, Undersea Research Program, Univ. Connecticut, Groton, CT 06340.
- VALENTINE, P. C., J. R. UZMANN, AND R. A. COOPER.  
1980. Geology and biology of Oceanographer Canyon. *Mar. Geol.* 38:283-312.
- VERRILL, A. E.  
1864. List of polyps and corals sent by the Museum of Comparative Zoology to other institutions in exchange, with annotations. *Mus. Comp. Zool* 13:29-60.  
1873. Dredging on the coast of New England. *Am. J. Sci.* 5:1-15.
- WARE, D. M.  
1972. Predation by rainbow trout, *Salmo gairdneri*: the influence of hunger, prey density, and prey size. *J. Fish. Res. Board Can.* 29:1193-1201.
- WHORISKEY, F. G., JR.  
1983. Intertidal feeding and refuging by cunners, *Tautoglabrus adspersus* (Labridae). *Fish. Bull., U.S.* 81:426-428.
- WIDERSTEN, B.  
1976. Ceriantharia, zoanthidea, corallimorpharia, and actiniaria from the continental shelf and slope off the eastern coast of the United States. *Fish. Bull., U.S.* 74:857-878.
- WIGLEY, R. L.  
1968. Benthic invertebrates of the New England fishing banks. *Underwater Nat.* 5(1):8-13.
- WIGLEY, R. L., AND K. O. EMERY.  
1967. Benthic animals, particularly *Hyalinoccia* (Annelida) and *Ophiomusium* (Echinodermata), in sea-bottom photographs from the continental slope. *In* J. B. Hersey (editor), *Deep-sea photography*, p. 235-249. John Hopkins Oceanogr. Stud. 3.
- WIGLEY, R. L., AND R. B. THEROUX.  
1981. Atlantic Continental Shelf and Slope of the United States - macrobenthic invertebrate fauna of the Middle Atlantic Bight Region - faunal composition and quantitative distribution. U.S. Dep. Inter., Geol. Survey Prof. Pap. 529-N, 198 p.
- WOBBER, D. R.  
1970. A report on the feeding of *Dendronotus iris* on the anthozoan *Cerianthus* sp. from Monterey Bay, California. *Veliger* 12:383-387.
- WOODIN, S. A.  
1976. The importance of structural heterogeneity in a marine infaunal system. *In* J. D. Costlow (editor), *The ecology of fouling communities*, p. 207-208. Duke Univ., Beaufort, NC.  
1978. Refuges, disturbance, and community structure: a marine soft-bottom example. *Ecology* 59:274-284.

APPENDIX TABLE 1.—Summary of statistics for submersible dives during which only qualitative data were collected. Substrate definitions: 1 = sand base; 1a = silt-sand; 1b = gravel sand; 1c = shell-sand; 2 = rocky cover; 2a = cobbles; 2b = boulders; 2/1 or 3 = rocks on sand or clay base; 3 = clay base; 3a = silt-clay; 3b = gravel-clay. Substrates and temperatures listed are those in which Ceriantharia were seen, for dives without Ceriantharia all substrates and temperatures recorded on the dive are listed. Ceriantharia species: 0 = absent; A, B, C, or D = species recorded on video tapes; + = Ceriantharia seen but species not identified.

Year/submersible dive(s) <sup>1</sup>	Geographic name	Lat. N	Long. W	Horizontal distance travelled (km)	Dive depth range (m x 100)	Ceriantharia depth range (m x 100)	Temp (°C)	Substrate	Cerian- thid species
1971 PC8 9/26 (1,2) 1973 NG 4	Wilkinson Basin	42°17'	69°58'	1.8	1.2-2.2	1.2-1.6	6.1	1a,1b,3a	B
	Veatch Canyon	40°00'	69°38'	1.8	1.5	1.5	11.1	1a,3a	+
	Veatch Canyon	39°59'	69°37'	2.0	1.9-3.0	2.4-3.0	7.2-9.2	3a	+
	Veatch Canyon	39°57'	69°33'	2.0	1.6	1.6	9.4-10.0	1a	+
	Veatch Canyon	39°56'	69°33'	2.0	1.7	1.7	10.6	1a	+
	Veatch Canyon	39°55'	69°33'	2.0	2.5	2.5	7.2-7.8	1a,1c	+
	Veatch Canyon	40°00'	69°37'	2.0	1.8	—	8.3-9.2	1a,3a	0
	Veatch Canyon	40°00'	69°37'	1.0 km <sup>2</sup>	1.7-2.6	2.1	8.3-11.1	1a	+
	Hydrographer Canyon	40°12'	69°05'	1.3	1.5-2.5	1.6-2.4	8.9-10.8	1a	+
	Hydrographer Canyon	40°08'	69°02'	1.2	2.0-3.0	2.8-3.0	9.2-11.1	1a	+
	Hydrographer Canyon	40°09'	69°06'	0.7	1.5-2.7	1.6-1.7	10.8-11.1	1a,2/1	+
	Hydrographer Canyon	40°04'	69°05'	1.3	1.9-2.1	1.9-2.1	10.8-11.1	1a	+
	Oceanographer Canyon	40°30'	68°10'	3.0	1.7-2.4	?	?	1a,2a/1,3a	+
	Oceanographer Canyon	40°28'	68°10'	3.0	1.3-2.7	1.3-2.7	9.4-11.0	1a,1c,3a	B
Oceanographer Canyon	40°29'	68°15'	1.7	1.6-2.2	1.6	9.7-11.9	1a,2a/1	+	
Oceanographer Canyon	40°29'	68°09'	2.2	1.7	1.7	11.1	3a,3b	B	
Oceanographer Canyon	40°27'	68°07'	1.5	1.9-3.0	2.7	8.2-9.7	1a	B	
Oceanographer Canyon	40°23'	68°08'	2.0	1.9-3.0	2.4	9.7-10.4	3a	B	
Oceanographer Canyon	40°20'	68°05'	2.6	1.9-3.0	2.1-2.9	8.1-12.8	1a	B	
Oceanographer Canyon	41°21'	66°11'	3.0	1.5-3.0	1.8-3.0	6.4-9.7	1a,2a/3,3a,3b	B	
Corsair Canyon	41°24'	66°14'	4.0	1.1-2.4	1.5	9.4	1b,2a/1	B	
Corsair Canyon	41°23'	66°10'	1.0	2.2-3.0	2.4-2.7	5.8-9.2	1b	B	
Corsair Canyon	41°20'	66°06'	3.2	1.5-3.0	2.6-2.9	6.9-7.2	1a,1b	B	
Lydonia Canyon	40°32'	67°42'	1.5	1.5-3.0	1.6-3.0	7.2-11.4	1a,1c	B	
Lydonia Canyon	40°31'	67°44'	2.2	1.4-3.0	1.4-2.7	8.3-10.8	1a,1c	B	
Lydonia Canyon	40°31'	67°40'	1.7	1.4-2.9	2.4-2.7	8.9	1a	B	
Lydonia Canyon	40°28'	67°41'	1.4	1.7-3.0	2.6-2.9	8.6-10.8	3a,3b	+	
Lydonia Canyon	40°23'	67°41'	2.1	1.5-2.9	1.5-2.7	7.5-12.8	1a,1b,1c	0	
Lydonia Canyon	40°24'	67°38'	1.3	1.8-2.2	—	9.2-9.7	1a	B	
Gilbert Canyon	40°22'	67°49'	2.0	2.0-3.0	2.1-2.7	9.2-10.8	1a	B	
Gilbert Canyon	40°22'	67°55'	2.4	1.5-3.0	2.4-2.6	9.4-12.2	1a	B	
Oceanographer Canyon	40°20'	68°12'	2.1	1.8-3.0	1.8	7.2-12.2	1a	B	
Veatch Canyon	39°59'	69°39'	1.8	1.6-2.3	—	10.0-14.1	1a,2/3,3a	0	
Veatch Canyon	39°38'	69°38'	1.8	1.8	—	11.4	1a	0	
Veatch Canyon	39°59'	69°37'	1.8	1.7-2.5	2.5	7.8-10.6	3a	+	
Veatch Canyon	39°35'	69°35'	3.3	1.3-6.7	1.4-4.0	?	3a	+	
Veatch Canyon	39°51'	69°33'	?	9.1-14.4	—	4.0	3a	0	
Veatch Canyon	39°47'	69°32'	?	14.0-19.3	18.4-19.3	3.5	3a	A	
Veatch Canyon	39°52'	69°34'	?	8.0-15.1	—	4.0	3a	0	
Veatch Canyon	39°58'	69°37'	3.2	1.9-6.8	2.9	10.5	3a	+	
Veatch Canyon	40°01'	69°37'	7.4	1.4-2.2	1.6-2.2	9.0	3a	B	
1976 AL 667	Veatch Canyon	39°59'	69°37'	1.8	1.7-2.5	2.5	7.8-10.6	3a	+
668	Veatch Canyon	39°59'	69°35'	3.3	1.3-6.7	1.4-4.0	?	3a	+
669	Veatch Canyon	39°51'	69°33'	?	9.1-14.4	—	4.0	3a	0
670	Veatch Canyon	39°47'	69°32'	?	14.0-19.3	18.4-19.3	3.5	3a	A
671	Veatch Canyon	39°52'	69°34'	?	8.0-15.1	—	4.0	3a	0
672	Veatch Canyon	39°58'	69°37'	3.2	1.9-6.8	2.9	10.5	3a	+
	Veatch Canyon	40°01'	69°37'	7.4	1.4-2.2	1.6-2.2	9.0	3a	B

APPENDIX TABLE 1.—Continued.

Year/submersible dive(s) <sup>1</sup>	Geographic name	Lat. N	Long. W	Horizontal distance travelled (km)	Dive depth range (m x 100)	Ceriantharia depth range (m x 100)	Temp (°C)	Substrate	Cerianthid species
1978 AL 835	Oceanographer Canyon	40°24'	68°10'	3.3	1.5-7.0	1.5-3.0	7.1-10.8	1a,1b,3a	+
836	Oceanographer Canyon	40°17'	68°07'	0.7	10.0-12.9	—	?	3a	+
837	Oceanographer Canyon	40°28'	68°10'	3.1	1.3-3.5	1.3-2.9	?	3a	0
838	Oceanographer Canyon	40°12'	68°05'	6.1	14.5-18.7	16-18.7	3.7-3.9	1a	A
839	Oceanographer Canyon	40°26'	68°07'	3.1	1.4-5.2	1.4-3.0	7.8-10.7	1a,1b,2a/3,3b	+
840	Oceanographer Canyon	40°21'	68°09'	0.4	9.0-9.5	—	?	3a	0

<sup>1</sup>Submersible abbreviations: PCB = Perry Model C8, NG = Nekton Gamma, AL = Alvin.

APPENDIX TABLE 2.—Summary of statistics for submersible dives during which quantitative data were collected. Vessel information: AL = Alvin (15 m<sup>2</sup> photo<sup>-1</sup>); NG = Nekton Gamma (3.6 m<sup>2</sup> photo<sup>-1</sup>); JSL = Johnson-Sea-Link (7 m<sup>2</sup> photo<sup>-1</sup>). Substrate definitions: 1 = sand base; 1a = silt-sand; 1b = gravel-sand; 1c = shell-sand; 2 = rocky cover; 2a = cobbles; 2b = boulders; 2/1 or 3 = rocks on sand or clay base; 3 = clay base; 3a = silt-clay; 3b = gravel-clay. Substrates and temperatures listed are those in which Ceriantharia were seen, for dives without Ceriantharia all substrates and temperatures recorded on the dive are listed. Cerianthid species: 0 = absent, A, B, C, or D = species (cf. Table 3). Densities are mean # m<sup>-2</sup>, \* = Ceriantharia present but less than 0.01 m<sup>-2</sup>.

Year/submersible dive(s)	Geographic name	Lat. N	Long. W	Areal coverage (m <sup>2</sup> )	Dive depth range (m x 100)	Ceriantharia depth range (m x 100)	Temp (°C)	Ceriantharia		
								Substrate	Species	Density (# m <sup>-2</sup> ± 95% C.L.)
1975 AL 576	Veatch Canyon	39°54'	69°36'	4,170	7.4-12.6	—	4.0	3a	—	—
577	Veatch Canyon	39°59'	69°35'	6,840	2.1-4.6	2.7-4.0	5.3-7.6	3a	B	—
578	Veatch Canyon	39°56'	69°35'	5,355	1.8-9.1	2.0-3.6	5.5-9.2	3a	B	0.012
579	Veatch Canyon	39°55'	69°37'	5,010	2.7-9.2	2.7-3.8	5.5-7.3	3a	B	0.013
1979 NG 1	Oceanographer Canyon	40°29'	68°11'	572	1.6-2.3	1.6-2.0	11.0	1a,1b,2b/1	B	0.086 ± 0.039
2	Oceanographer Canyon	40°28'	68°08'	418	1.7-1.8	1.7-1.8	—	3b	B	—
3,4	Block Canyon	40°02'	71°20'	756	1.4-2.4	1.4-1.8	9.1-13.0	3a	C	0.124
12	Hudson Canyon	39°30'	71°22'	868	1.5-3.0	1.5-2.9	—	3a	—	—
14	Hudson Canyon	39°38'	71°25'	378	1.6-3.0	3.0	—	3a	B,D	—
1980 AL 1034	Oceanographer Canyon	40°29'	68°10'	11,070	2.1-3.9	2.7-3.4	9.4	1a,3a,2a/3	B	0.016 ± 0.008
1035	Oceanographer Canyon	40°18'	68°07'	8,580	7.3-13.2	—	5.8	3a	—	—
1036	Oceanographer Canyon	40°25'	68°09'	10,005	2.1-6.2	3.1	9.8-11.2	3a	B	—
1980 JSL 3,4	Georges Bank	40°43'	67°28'	5,992	0.9	0.9	9.6	1a	B	—
7,8	Georges Bank	40°37'	67°45'	6,230	0.8	0.8	9.2-9.5	1a	B	—
12,14	Lydonia Canyon	40°28'	67°42'	3,759	1.5-3.0	1.7-2.9	10.3-11.9	3a,1a	B,C	0.034
15,16	Lydonia Canyon	40°32'	67°43'	5,138	1.2-1.9	1.2-1.9	11.6-11.9	1a,1b	B,C	0.077
1981 JSL 2	Georges Bank	40°43'	67°28'	2,765	0.9	0.9	8.3	1a	B	—
3,4,5	Georges Bank	40°37'	67°45'	5,110	0.8	0.8	8.1	1a	B	—
8,9	Lydonia Canyon	40°32'	67°43'	5,551	1.2-1.7	1.3-1.6	9.9-10.8	1a,1b	B,C	0.377 ± 0.062
12,13	Lydonia Canyon	40°28'	67°42'	4,655	1.4-2.6	1.7-2.5	9.6-9.9	3a,1a	B,C	0.030 ± 0.012
16	Oceanographer Canyon	40°30'	68°09'	3,150	1.4-1.5	1.4-1.5	9.9-10.3	3a,1a,1c	B	0.029 ± 0.008
19,20	Oceanographer Canyon	40°26'	68°09'	5,593	2.0-4.6	2.1-3.4	9.4-10.4	3a,3b,1a	B	—

APPENDIX TABLE 3.—Macrofauna (>0.5 mm) inhabiting two Cerianthid B tubes, and adjacent sediments (silt-sand), collected by a grab sampler (290 cm<sup>2</sup>, 5-10 cm penetration depth) from the Johnson-Sea-Lmk's manipulator arm, at a depth of 293 m in Oceanographer Canyon. A tube and the adjacent sediments were collected together, put in the same sample container, and separated as soon as the submersible was aboard ship.

Tube (200 cc)	No.	Sediments (800 cc)	No.	Tube (1200 cc)	No.	Sediments (1,600 cc)	No.
		Sample #1				Sample #2	
Annélida		Annélida		Annélida		Annélida	
Oligochaeta	2	Oligochaeta	7	Polychaeta		Oligochaeta	15
Polychaeta		Polychaeta		<i>Polycirrus eximius</i>	25	Polychaeta	
<i>Polycirrus eximius</i>	14	<i>Prionospio cirrifera</i>	11	<i>Marphysa</i> sp.	16	<i>Aricidea catherinae</i>	49
<i>Marphysa</i> sp.	8	<i>Aricidea catherinae</i>	7	<i>Potamilla neglecta</i>	11	<i>Prionospio cirrifera</i>	28
<i>Potamilla neglecta</i>	6	<i>Goniada maculata</i>	3	<i>Podarke obscura</i>	9	<i>P. juv.</i>	14
<i>Prionospio cirrifera</i>	5	<i>Exogone hebes</i>	2	<i>Exogone verugera</i>	5	<i>Tharyx annulosus</i>	13
<i>Ninoe gayheadi</i>	2	<i>E. verugera</i>	2	<i>E. hebes</i>	3	<i>Goniada maculata</i>	10
<i>Aricidea catherinae</i>	1	<i>Ninoe gayheadi</i>	2	<i>Aricidea catherinae</i>	1	<i>Ophalina accuminata</i>	7
<i>A. cerruti</i>	1	<i>Ophalina accuminata</i>	2	Terebellidae	1	<i>Prionospio</i>	
<i>Exogone hebes</i>	1	<i>Aglaophamus igalis</i>	1	<i>Tharyx acutus</i>	1	<i>steenstrupi</i>	5
<i>E. verugera</i>	1	<i>Ampharete arctica</i>	1	<i>Typosyllis alternata</i>	1	<i>Dodecaceria</i> sp.	3
<i>Glycera capitata</i>	1	<i>Cirratulus cirratus</i>	1	Arthropoda		<i>Exogone hebes</i>	3
<i>Lumbrineris</i> sp.	1	<i>Micronephthys minuta</i>	1	Crustacea		<i>E. verugera</i>	3
<i>Schistomerengos</i>		<i>Neopodarke</i>	1	<i>Photis dentata</i>	4	<i>Nephtyidae</i> juv.	3
caeca	1	<i>woodsholea</i>	1	Copepoda	1	<i>Paraonis gracilis</i>	3
<i>Tharyx annulosus</i>	1	<i>Nereis zonata</i>	1	Crab zoea	1	<i>Anobothorus gracilis</i>	2
Arthropoda		<i>Polycirrus eximius</i>	1	Total	79	<i>Schistomerengos</i>	
Crustacea		<i>Prionospio cirrifera</i>	1			sp.	2
Tanaidacea	38	<i>Protodorvillea</i>	1			<i>Tharyx acutus</i>	2
<i>Photis dentata</i>	2	<i>gaspeensis</i>	1			<i>T. sp.</i>	2
<i>Caprella linearis</i>	1	<i>Typosyllis</i> sp.	1			<i>Aglaophamus</i>	
<i>Janira alta</i>	1	Arthropoda				<i>circinata</i>	1
Total	87	Crustacea	56			<i>Drilonereis longa</i>	1
		Copepoda	6			<i>Eunice pennata</i>	1
		Tanaidacea	3			<i>Haploscoloplos</i> sp.	1
		Hyperidea	1			<i>Lumbrineris fragilis</i>	1
		Total	56			<i>Neopodarke</i>	
						<i>woodsholea</i>	1
						<i>Nereis zonata</i>	1
						<i>Protodorvillea</i>	1
						<i>gaspeensis</i>	1
						<i>Spio</i> sp.	1
						Anthropoda	
						Crustacea	
						<i>Diastyliis</i> sp.	1
						<i>Janira alta</i>	1
						<i>Pagurus annulipes</i>	1
						Total	176

# CARTILAGE AND BONE DEVELOPMENT IN SCOMBROID FISHES

THOMAS POTTHOFF, SHARON KELLEY, AND JOAQUIN C. JAVECH<sup>1</sup>

## ABSTRACT

Early development of cartilage and bone was examined in representative species of the scombroid fish families Scombrobracidae, Gempylidae, Trichiuridae, Scombridae, Istiophoridae, and Xiphiidae from cleared and stained larval size series. Development of the dorsal and anal fins and their pterygiophore supports, development of the neural and haemal spines and hypural complex, and ossification of the vertebrae were studied. The first appearance and location of these skeletal elements in cartilage were noted, and then the direction of new additions was observed. Direction of ossification of these elements was also noted. There were three major kinds of vertebral column development: The first was shared by Scombrobracidae, Scombridae in part - Scombrini, Scomberomorini, and Thunnini; the second was shared by Gempylidae, *Sarda* (Scombridae in part - Sardini), Istiophoridae, and Xiphiidae; the third kind was found in *Trichiurus* (Trichiuridae). Saddle-shaped ossifications of the vertebrae were found only in the Scombrobracidae, and Gempylidae, and Scombridae. Four major kinds of fin and pterygiophore development were observed in the scombroid families: Scombrobracidae and Scombridae in part - Scombrini shared one kind; Gempylidae, Trichiuridae, and Scombridae in part - Scomberomorini, Sardini, and Thunnini shared another kind, which had some variations for different taxa; Istiophoridae had the third kind; and Xiphiidae had the fourth kind. Initial ossification of the vertebral column started in one place in *Scombrobrax*, Gempylidae, *Trichiurus*, and *Xiphias*, in two places in *Scomberomorus*, *Sarda*, *Thunnus*, and *Istiophorus*, and in four places in *Scomber* and *Acanthocybium*. From our investigation, we are just beginning to learn about developmental characters and we cannot interpret their full meaning until more developmental work has been accomplished; we can only state that billfish (Istiophoridae, Xiphiidae) are very different from all other scombroids studied and that *Scombrobrax* shows affinity with the scombroids.

In this paper we describe development of selected osteological features of families in the suborder Scombroidei. We believe that this ontogenetic data will be useful in future taxonomic studies to aid in establishing familial relationships. Under current classification the scombroids comprise various numbers of families. Greenwood et al. (1966) recognized six families in the suborder Scombroidei: Scombridae, Gempylidae, Trichiuridae, Istiophoridae, Xiphiidae, and Luvaridae. Gosline (1968), Potthoff et al. (1980), and Collette et al. (1984) included the family Scombrobracidae in the Scombroidei, but Johnson (in press) removed it recently. Collette et al. (1984), Leis and Richards (1984), and Tyler et al.<sup>2</sup> removed the Luvaridae from the Scombroidei. For this study we examined ontogenetic series of representative genera of the families Scombrobracidae, Gempylidae, Trichiuridae, Scombridae (four tribes), Istiophoridae, and Xiphiidae.

Research on the larvae and young stages of scombroids, particularly tunas (Richards and Klawe 1972) has been extensive. In general, most papers deal with the external description of the larvae and juveniles (Okiyama and Ueyanagi 1978); few exist that address the internal morphology and development of scombroids and those are mostly on scombrids. Kramer (1960) described bone development in the mackerel (*Pneumatophorus diego* = *Scomber japonicus*). Potthoff and Richards (1970), Matsuoto et al. (1972), and Richards and Potthoff (1974) published osteological characters for juvenile scombrids. Cartilage and bone development were described in *Thunnus atlanticus* (Potthoff 1975), *Scombrobrax heterolepis* (Potthoff et al. 1980), and *Xiphias gladius* (Potthoff and Kelley 1982). Kohno et al. (1984) described fin and cartilaginous fin support development in *Scomber japonicus*. To our knowledge no developmental studies of cartilage and bone have been made for the scombroid families Istiophoridae and Gempylidae, although a part of the research presented here was published in Collette et al. (1984). Since Collette et al. (1984), we have conducted additional research and have discovered several errors in our published observations. We have added developmental series of *Scomber*

<sup>1</sup>Southeast Fisheries Center Miami Laboratory, National Marine Fisheries Service, NOAA, 75 Virginia Beach Drive, Miami, FL 33149.

<sup>2</sup>Tyler, J. C., G. D. Johnson, I. Nakamura, and B. B. Collette. Osteology and relationships of the oceanic fish *Luvarus imperialis* (Luvaridae): an acanthuroid not a scombroid. Unpubl. manuscr. National Museum of Natural History, Wash., DC 20560.

spp., *Scomberomorus* spp., *Acanthocybium solanderi* and *Sarda sarda* (Scombridae), *Trichiurus lepturus* (Trichiuridae), and *Makaira nigricans* (Istiophoridae). We examined numerous juvenile and adult Trichiuridae; our findings are incorporated here. In

table 161 of Collette et al. (1984), observations from the gempylid *Diplospinus multistriatus* were erroneously listed under Trichiuridae. In this paper we have revised and corrected that table and incorporated all our new findings (Tables 1, 2).

TABLE 1.—Developmental and osteological features and counts

			Trichiridae		Scombridae
	Scombrobracidae ( <i>Scombrobrax</i> )	Gempylidae	without tail and pelvic fin, <i>Trichiurus</i>	with tail and pelvic fin, <i>Benthodesmus</i> <i>Evoxymetapon</i> <i>Lepidopus</i>	Scombrini ( <i>Scomber</i> )
Predorsal bones: present or absent	absent	present or or absent <sup>2</sup>	absent	absent	absent
number	0	0 or 1	0	0	0
First anteriormost dorsal pterygiophore: supports number of fin spines	2	2	2	2	2
inserts in interneural space number	3	2	2	2	3
First anteriormost anal pterygiophore: supports number of spines or rays	3	<sup>3</sup> 2 or 3	2	<sup>4</sup> 3	2
Middle radials: present or absent	present	present <sup>5</sup>	present	present	present
Dorsal and anal stay: present or absent ossifies to one or two parts	present one part	present one or two parts <sup>6</sup>	not determined —	present one part	present one part
posteriorly bifurcated or nonbifurcated	nonbifurcated	bifurcated	—	nonbifurcated	bifurcated
Pelvic fin: spine, ray count	1,5	1,5;1,4;1,2; 1,1;1	—	1,1;1,2	1,5
Preural centrum 3: neural spine with or without cartilage tip haemal spine autogenous or nonautogenous	with autogenous	with autogenous	— —	with ontogenetically fused	with autogenous
Vertebrae inclusive of urostyle supporting caudal rays: number	3	3	—	3	3
Number of vertebrae: precaudal + caudal = total	13 + 17 = 30	usually more precaudal, fewer caudal, total 31-67	40 + 126 = 166	fewer precaudal, more caudal, total 99-192	13,14 + 17,18 = 31
Epurals: number	3	<sup>7</sup> 3	—	1 (ontogenetic fusion from 2)	2
Anterior epural fused with neural arch of Pu <sub>2</sub>	No	No	—	No	No

<sup>1</sup>Data from Fritzsche and Johnson (1980) and G. D. Johnson (text footnote).

<sup>2</sup>*Ruvettus*, *Thyrstitops* and *Tongaichthys* have one predorsal bone.

<sup>3</sup>*Rexea* and *Thyrstites* (*Leionura*) have two spines, *Nealotus* ontogenetically has three spines but second spine fuses to basipterygium during development.

<sup>4</sup>Two of these spines are extreme vestiges.

## METHODS

Scombroid larvae were cleared and stained for cartilage and bone (Potthoff 1984) and subsequently measured in millimeters with a calibrated ocular

micrometer under a binocular microscope. Notochord length (NL) was measured on preflexion and flexion stage larvae from the anterior tip of the upper jaw to the posterior tip of the notochord. Standard length (SL) was measured from the anterior

for the scombroid families and *Morone*, a primitive perciform fish.

## Scombridae—Continued

Scomberomorini ( <i>Scomberomorus</i> )	Scomberomorini ( <i>Acanthocybium</i> )	Sardini ( <i>Sarda</i> )	Thunnini ( <i>Thunnus</i> )	Istiophoridae ( <i>Istiophorus</i> )	Xiphiidae ( <i>Xiphias</i> )	Percichthyidae ( <i>Morone</i> ) <sup>1</sup>
absent 0	absent 0	absent 0	absent 0	absent 0	absent 0	present 3
2	2	2	2	3	1 to 3, mostly 2	3
3	3	2	3	1	2	3
3	not known	3	3	2	1 to 3, mostly 2	3
present	present	present	present	present	absent	present
present one part	present one part	present one part	present one part	present one part	present one part	present one part
nonbifurcated	slightly bifurcated	bifurcated	bifurcated	bifurcated, sometimes non- bifurcated	non- bifurcated	nonbifurcated
1,5	1,5	1,5	1,5	1,2	0	1,5
with autogenous	with autogenous	with autogenous	with autogenous	with autogenous	without non- autogenous	with autogenous
4,5	5	5	4	3	2	3
(16-22) + (24-32) = (41-53)	(30-32) + (31-33) = (62-64)	26 + 25 = 51	fewer precaudal, more caudal, total 39-41	12 + 12 = 24 11 + 13 = 24	15 + 11 = 26 16 + 10 = 26	12 + 13 = 25 11 + 14 = 25
2	2	2	2	3	3	3
No	No	No	Yes	No	No	No

<sup>5</sup>*Neoepinnula* lacks middle radials.

<sup>6</sup>*Lepidocybium*, *Rexea*, *Diplospinus*, *Paradiplospinus*, *Tongaichthys*, and *Gempylus* have a one-part stay, all other gempylids have a two-part stay.

<sup>7</sup>*Diplospinus* ontogenetically usually has three epurals, posterior two epurals are fused to one in adults, but some *Diplospinus* develop only two epurals.

TABLE 1.—Continued.

	Trichiuridae				Scombridae
	Scombrobracidae ( <i>Scombrobrax</i> )	Gempylidae	without tail and pelvic fin, <i>Trichiurus</i>	with tail and pelvic fin, <i>Benthodesmus</i> <i>Evoxymetapon</i> <i>Lepidopus</i>	Scombrini ( <i>Scomber</i> )
Uroneural: number	2	2	—	1	1
Hypural 5: present or absent fused or separate	present separate	present separate	— —	absent not known	present fused to uroneural proximally
Ontogenetic hypural fusion: fusion of hypurals 1 & 2 to ventral plate is in cartilaginous or ossified state	no fusion	if present, ossified	—	not known	cartilaginous
fusion of hypurals 3 & 4 to dorsal plate is in cartilaginous or ossified state	no fusion	If present, ossified	—	not known	cartilaginous or ossified
Procurrent spur (Johnson 1975): present or absent	present	present, reduced or absent	—	absent	absent
Stay on 4th pharyngo- branchial (G. D. Johnson, text footnote): present or absent	absent	absent	absent	absent	present

TABLE 2.—Developmental features for the scombroid

	Neural and haemal arches and spines, parapophyses and hypural parts initially develop in the following places on the notochord by the following sequence. Addition is in a given direction.	Developing pterygiophores and fin spines and rays are added in a direction.
Scombrobracidae ( <i>Scombrobrax</i> )	1. Anterodorsad, posteriorly. 2. Posteroventrad, posteriorly and anteriorly. 3. Ventrad at center, posteriorly and anteriorly. 4. Dorsad at center, posteriorly and anteriorly.	First dorsal: anteriorly and posteriorly. Second dorsal: anteriorly and posteriorly. Anal: anteriorly and posteriorly.
Gempylidae ( <i>Gempylus</i> , <i>Nesiarchus</i> , <i>Diplospinus</i> )	1. Anterodorsad, posteriorly. 2. Posteroventrad, posteriorly and anteriorly. 3. Ventrad at center, posteriorly and anteriorly.	First dorsal: posteriorly. Second dorsal: anteriorly and posteriorly. Anal: anteriorly and posteriorly.
Trichiuridae ( <i>Trichiurus</i> )	1. Anterodorsad, posteriorly. 2. Ventrad at center, posteriorly and anteriorly.	Entire dorsal and anal: posteriorly.



Scombridae—Continued

Scomberomorini ( <i>Scomberomorus</i> )	Scomberomorini ( <i>Acanthocybium</i> )	Sardini ( <i>Sarda</i> )	Thunnini ( <i>Thunnus</i> )	Istiophoridae ( <i>Istiophorus</i> )	Xiphiidae ( <i>Xiphias</i> )	Percichthyidae ( <i>Morone</i> ) <sup>1</sup>
1	1	1	1	1	1	2
present separate	present fused to uroneural proximally	present separate	present separate	absent —	present separate	present separate
cartilaginous	cartilaginous	cartilaginous	cartilaginous	cartilaginous or ossified	ossified	no fusion
cartilaginous	cartilaginous or ossified	cartilaginous or ossified	cartilaginous	cartilaginous or ossified	ossified	no fusion
absent	absent	absent	absent	absent	absent	present
present	present	present	present	present	present	absent

families and *Morone*, a primitive perciform fish.

Sequence of fin and associated pterygiophore development.	First anteriormost dorsal and anal pterygiophore develop from one or two pieces of cartilage.	Number of initial places of ossification along vertebral column; centra develop from saddle-shaped ossifications at bases of neural and haemal arches.
1. Second dorsal and anal concurrently. 2. First dorsal. First dorsal separated from second dorsal during part of development.	Dorsal from one piece, anal from two pieces.	1;Yes
1. First dorsal. 2. Second dorsal and anal concurrently. First dorsal separated from second dorsal during part of development.	Dorsal from one piece, anal from two pieces.	1;Yes
1. All dorsal rays and pterygiophores dorsoanterior to anal fin. 2. All dorsal rays and pterygiophores opposite future anterior portion of anal fin. 3. All anal rays and pterygiophores.	Dorsal and anal from one piece.	1;No

TABLE 2.—Continued.

	Neural and haemal arches and spines, parapophyses and hypural parts initially develop in the following places on the notochord by the following sequence. Addition is in a given direction.	Developing pterygiophores and fin spines and rays are added in a direction.
Scombridae, Scombrini ( <i>Scomber</i> )	<ol style="list-style-type: none"> <li>1. Posteroventrad, posteriorly and anteriorly.</li> <li>2. Ventrad at center, posteriorly and anteriorly.</li> <li>3. Dorsad at center, posteriorly and anteriorly.</li> <li>4. Anterodorsad, posteriorly.</li> </ol>	First dorsal: pterygiophores anteriorly and posteriorly. Spines: one anteriorly, rest posteriorly. Second dorsal: anteriorly and posteriorly. Anal: anteriorly and posteriorly.
Scombridae, Scomberomorini ( <i>Scomberomorus</i> )	<ol style="list-style-type: none"> <li>1. Anterodorsad, posteriorly.</li> <li>2. Posteroventrad, posteriorly and anteriorly.</li> <li>3. Ventrad at center, posteriorly and anteriorly.</li> <li>4. Dorsad at center, posteriorly and anteriorly.</li> </ol>	First dorsal: posteriorly. Second dorsal: anteriorly and posteriorly. Anal: anteriorly and posteriorly.
Scombridae, Scomberomorini ( <i>Acanthocybium</i> )	Not entirely known. Smallest specimen available had already two centers of initial development: anterodorsad and posteroventrad.	First dorsal: probably posteriorly. Second dorsal: anteriorly and posteriorly. Anal: anteriorly and posteriorly.
Scombridae, Sardini ( <i>Sarda</i> )	<ol style="list-style-type: none"> <li>1. Anterodorsad, posteriorly and anteriorly.</li> <li>2. Posteroventrad, posteriorly and anteriorly.</li> <li>3. Ventrad at center, posteriorly and anteriorly.</li> </ol>	First dorsal: pterygiophores posteriorly. Spines: first one anteriorly, rest posteriorly. Second dorsal: probably anteriorly and posteriorly. Anal: anteriorly and posteriorly.
Scombridae, Thunnini ( <i>Thunnus</i> )	<ol style="list-style-type: none"> <li>1. Anterodorsad, posteriorly and anteriorly.</li> <li>2. Posteroventrad, posteriorly and anteriorly.</li> <li>3. Ventrad at center, posteriorly and anteriorly.</li> <li>4. Dorsad at center, posteriorly and anteriorly.</li> </ol>	First dorsal: pterygiophores posteriorly. Spines: first one anteriorly, rest posteriorly. Second dorsal: anteriorly and posteriorly. Anal: some anteriorly, most posteriorly.
Istiophoridae ( <i>Istiophorus</i> )	<ol style="list-style-type: none"> <li>1. Anterodorsad, posteriorly and anteriorly.</li> <li>2. Posteroventrad, posteriorly and anteriorly.</li> <li>3. Ventrad at center, haemal spines posteriorly, parapophyses anteriorly.</li> </ol>	Entire dorsal: very few anteriorly, most posteriorly. Anal: very few anteriorly, most posteriorly.
Xiphiidae ( <i>Xiphias</i> )	<ol style="list-style-type: none"> <li>1. Anterodorsad, posteriorly and anteriorly.</li> <li>2. Posteroventrad, posteriorly and anteriorly.</li> <li>3. Ventrad at center, posteriorly and anteriorly.</li> </ol>	Entire dorsal: anteriorly and posteriorly. Anal: very few anteriorly, most posteriorly.
Percichthyidae ( <i>Morone</i> ) <sup>1</sup>	Anterodorsad, posteriorly. Ventrad at center, posteriorly and anteriorly. Posteroventrad, posteriorly and anteriorly. Initial sequence not known, not known if neural arches and spines develop initially at center.	First dorsal: anteriorly and posteriorly. Second dorsal: anteriorly and posteriorly. Anal: anteriorly and posteriorly.

<sup>1</sup>Data from Fritzsche and Johnson (1980) and G. D. Johnson (text footnote 3).

Sequence of fin and associated pterygiophore development.	First anteriormost dorsal and anal pterygiophore develop from one or two pieces of cartilage.	Number of initial places of ossification along vertebral column; centra develop from saddle-shaped ossifications at bases of neural and haemal arches.
1. Second dorsal and anal concurrently. 2. First dorsal.	Dorsal and anal from one piece.	4;Yes
1. First dorsal. 2. Second dorsal and anal concurrently. First dorsal separated from second dorsal during part of development.	Dorsal from one piece, anal from two pieces.	2;Yes
1. First dorsal. 2. Second dorsal and anal concurrently. First dorsal separated from second dorsal during part of development.	Dorsal probably from one piece, anal not known.	4;Not known
1. First dorsal. 2. Second dorsal and anal concurrently. Not known if first dorsal is separated from second dorsal during part of development.	Dorsal from one piece, anal probably from two pieces.	2?;Yes
1. First dorsal. 2. Second dorsal and anal almost concurrently. First dorsal separated from second dorsal during part of development.	Dorsal from one piece, anal from two pieces.	2;Yes
1. First dorsal. 2. Second dorsal and anal concurrently. First dorsal <i>not</i> separated from second dorsal during development.	Dorsal from one piece, anal from two pieces.	2;No
1. Second dorsal and anal concurrently. 2. First dorsal. First dorsal and first anal <i>not</i> separated from second dorsal and second anal during development.	Variable, dorsal and anal may develop from one or two pieces.	1;No
1. Second dorsal and anal concurrently. 2. First dorsal. Separation or continuity of first and second dorsals not known.	Dorsal and anal from two pieces.	?;No

tip of the upper jaw to the posterior margin of the hypural bones. *Xiphias* larvae were measured from the anterior margin of the eye to the posterior tip of the notochord for eye notochord length (ENL) or from the anterior margin of the eye to the posterior margin of the hypural bones for eye standard length (ESL).

## FAMILY SCOMBROLABRACIDAE

Figure 1

Thirty *Scombrolabrax heterolepis* larvae (2.9-10.4 mm NL or SL) were available.

Development of the vertebral column initially started in four places on the notochord: 1) anterodorsad (neural arches and spines of future centra 1-3), 2) posteroventrad (parhypural, hypurals), 3) ventrad at the center (haemal arches and spines on future centra 16-21), and 4) dorsad at the center (neural arches and spines on future centra 12-28). The anterior neural spines were added in a posterior direction whereas the neural and haemal spines at the center of the body were added anteriorly and posteriorly. The two areas of neural spine development coalesced around the eighth neural spine anteriorly and just anterior to the hypural complex posteriorly. The hypurals were added in a posterior direction, but the parhypural and the two autogenous haemal spines were added anteriorly (Table 2). Ossification of the vertebral column in *Scombrolabrax* initially started in one place with the anteriormost neural arches and spines and proceeded in a posterior direction. The hypural complex was the last along the vertebral column to start ossifying. Vertebrae first ossified by forming saddles of bone dorsad and ventrad around the notochord. As ossification proceeded the saddles merged laterally forming an hourglass-shaped vertebra in the lateral view.

Cartilaginous second dorsal and anal fin pterygiophores developed first simultaneously above interneural spaces 15-17 and below interhaemal spaces 16-19 before the anterior neural arches and spines had coalesced. The addition of cartilaginous second dorsal and anal fin pterygiophores was in an anterior and posterior direction. First dorsal fin pterygiophores appeared second above interneural spaces 4-7, to which pterygiophores were added anteriorly and posteriorly, terminating anteriorly in the third interneural space and joining with the second dorsal fin pterygiophores posteriorly. Dorsal and anal fin rays and spines developed in the same sequence as their corresponding pterygiophores, but a little later (Table 2).

*Scombrolabrax heterolepis* does not develop predorsal bones. The first dorsal pterygiophore originated from one piece of cartilage and inserted in the third interneural space supporting two fin spines (one supernumerary spine). The first anal pterygiophore developed from two pieces of cartilage and supported three spines (two supernumerary spines). The posteriormost five or six dorsal and anal pterygiophores had middle radials. The last dorsal and anal pterygiophore supported a double ray and had a nonbifurcated stay (Table 1).

In *S. heterolepis*, first caudal development of the cartilaginous parhypural and hypurals 1 and 2 was concurrent with the anterior development of the neural spines and the central appearance of haemal spines. The hypural complex development was described by Potthoff et al. (1980). *Scombrolabrax heterolepis* had the basic perciform caudal skeleton (Gosline 1968), with no hypural fusion observed in adults. The neural and haemal elements of preural centra 2 and 3 supported the procurrent caudal rays. A procurrent spur was present on the posteriormost ventral secondary caudal ray with a basally shortened ray anterior to it (Johnson 1975) (Table 1).

## FAMILY GEMPYLIDAE

Figures 2-4

One hundred and ten gempylids in 11 genera were available: 33 *Gempylus serpens* (3.7-9.9, 160 mm NL or SL), 23 *Nesiarchus nasutus*, (2.6-10.2, 55, 242 mm NL or SL), 7 *Neoepinnula orientalis* (3.3-7.1, 112 mm NL or SL), 11 *Nealotus tripes* (3.4-11.9, 24-140 mm NL or SL), 5 *Lepidocybium flavobrunneum* (5.5-35.3 mm NL or SL), 5 *Promethichthys prometheus* (26.4-161 mm SL), 2 *Rexea* sp. (132, 155 mm SL), 2 *Ruvettus pretiosus* (209, 212 mm SL), 1 *Thyrsitops lepidopoides* (160 mm SL), 16 *Diplospinus multistriatus* (3.4-13.5 mm NL or SL), 5 *Thyrsites atun* (= *Leionura*, 83-254 mm SL). Of these, *G. serpens*, *D. multistriatus*, and *N. nasutus* yielded complete developmental series.

Development of the vertebral column initially started in three places on the notochord: 1) anterodorsad (neural arches and spines on future centra 1-6); 2) posteroventrad (hypurals); and 3) ventrad at the center (anterior haemal arches and posterior parapophyses). The neural arches and spines were

FIGURE 1.—Schematic representation of vertebral column, dorsal and anal fin, pterygiophore, and hypural development in *Scombrolabrax heterolepis*, Scombrabrachidae. Cartilage, white; ossifying, stippled. Scale represents interneural and interhaemal space number and vertebra number.

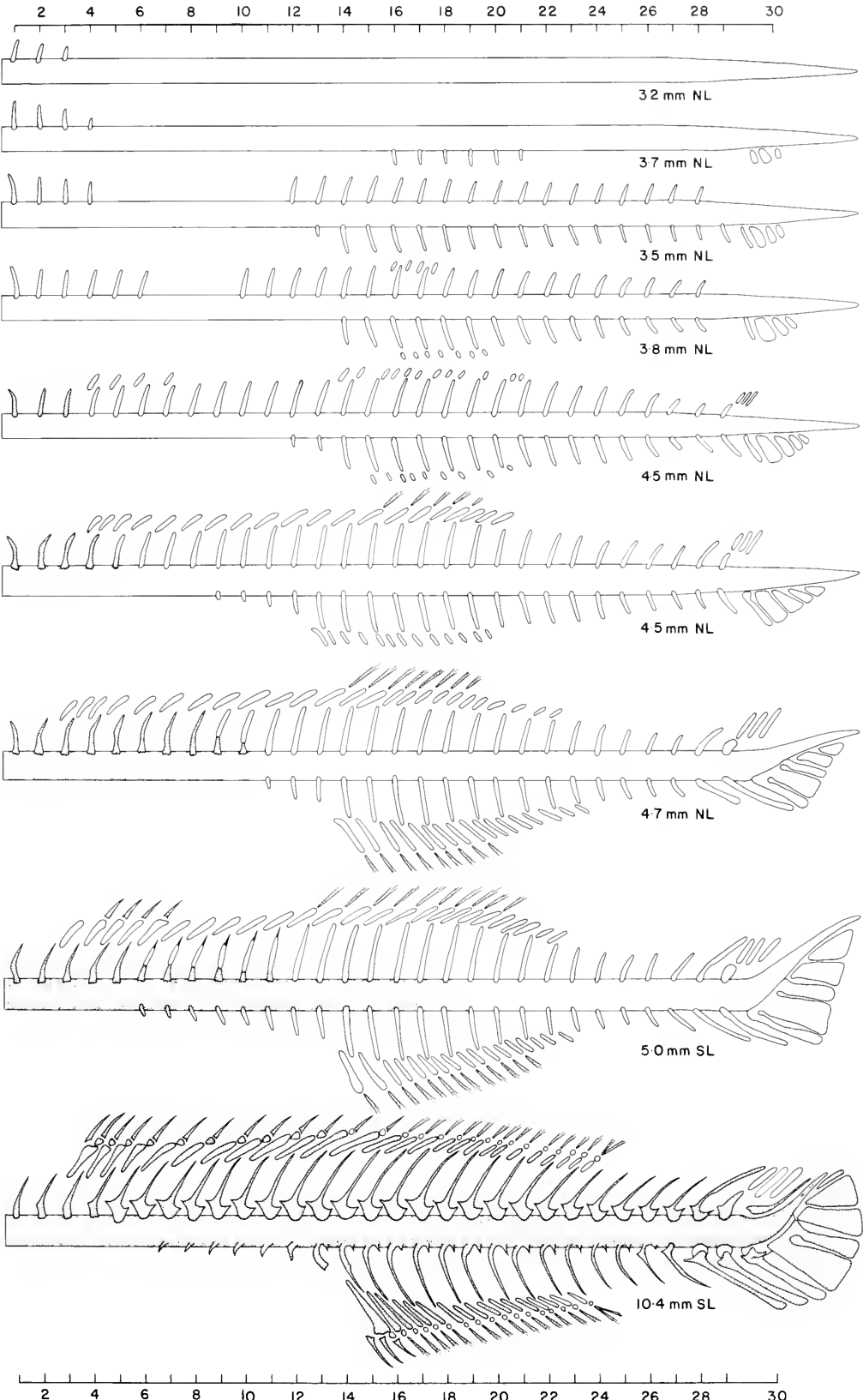

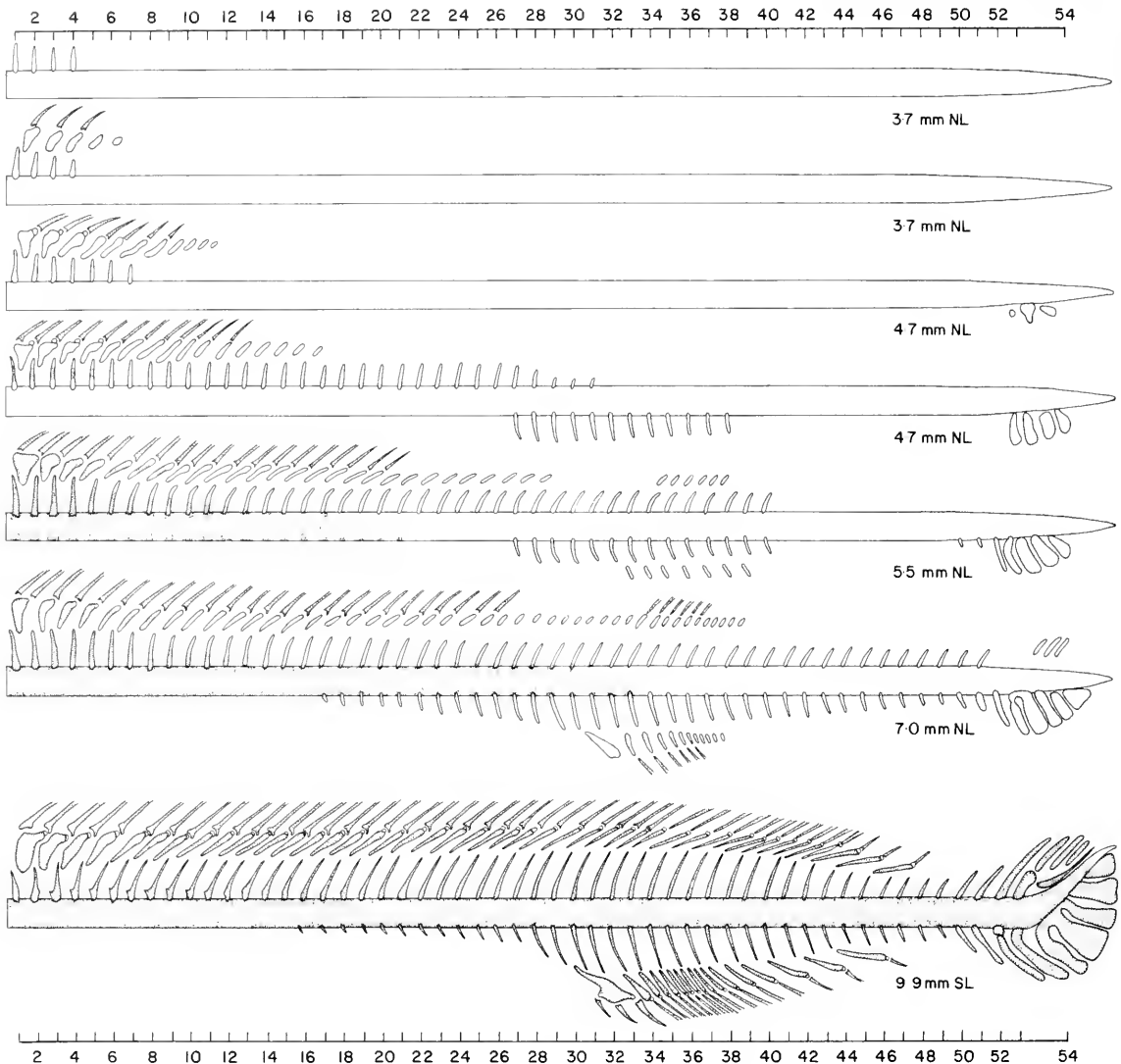

FIGURE 2.—Schematic representation of vertebral column, dorsal and anal fin, pterygiophore, and hypural development in *Gempylus serpens*, Gempylidae. Cartilage, white; ossifying, stippled. Scale represents interneural and interhaemal space number and vertebra number.

added in a posterior direction. Haemal arches and spines developed only when the neural spines reached the caudal area, and they were added in a posterior direction. Parapophyses were added anteriorly. The hypurals were added posteriorly, the parhypural and the autogenous haemal spines were added anteriorly (Table 2). Ossification of the vertebral column in the gempylid genera examined by us initially started in one place and was similar to the ossification in *Scombrobrax*, except in *Diplospinus* the vertebral column was ossified to preural centrum 6 when the urostyle and the hypurals initially started to ossify. Saddle-shaped vertebral ossifications were

observed in all gempylids examined, similar to those described for *Scombrobrax*.

Gempylids developed first dorsal fin pterygiophores and fin spines first, after only a few cartilaginous neural spines had developed. Development of first dorsal fin pterygiophores and spines was in a posterior direction. During early development the neural spines were anterior to the first dorsal fin pterygiophores and fin spines, but later they developed faster and were posterior to the pterygiophores. Pterygiophores of the second dorsal and anal fins developed before the developing first dorsal fin pterygiophores and had joined with the second dor-

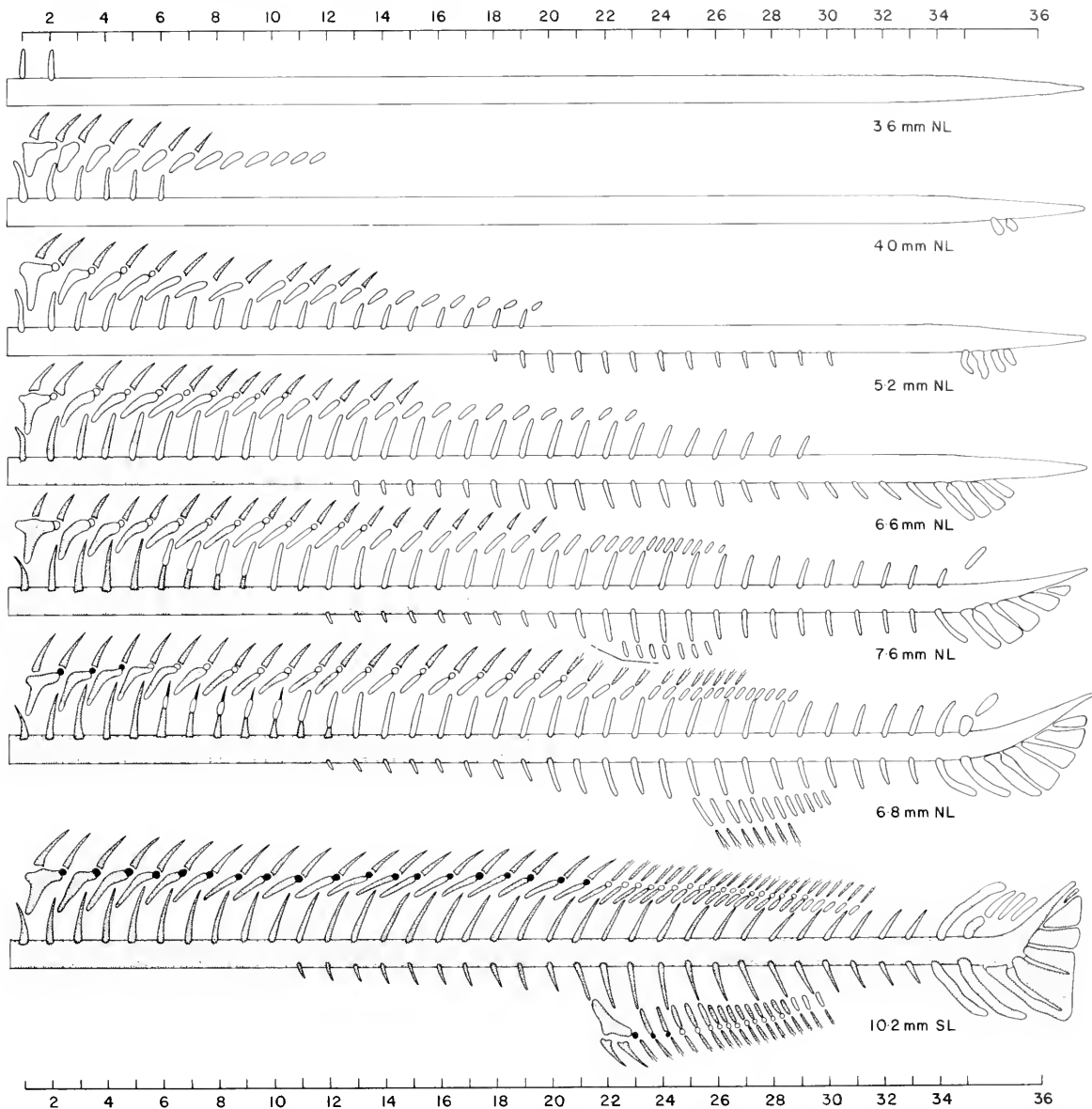
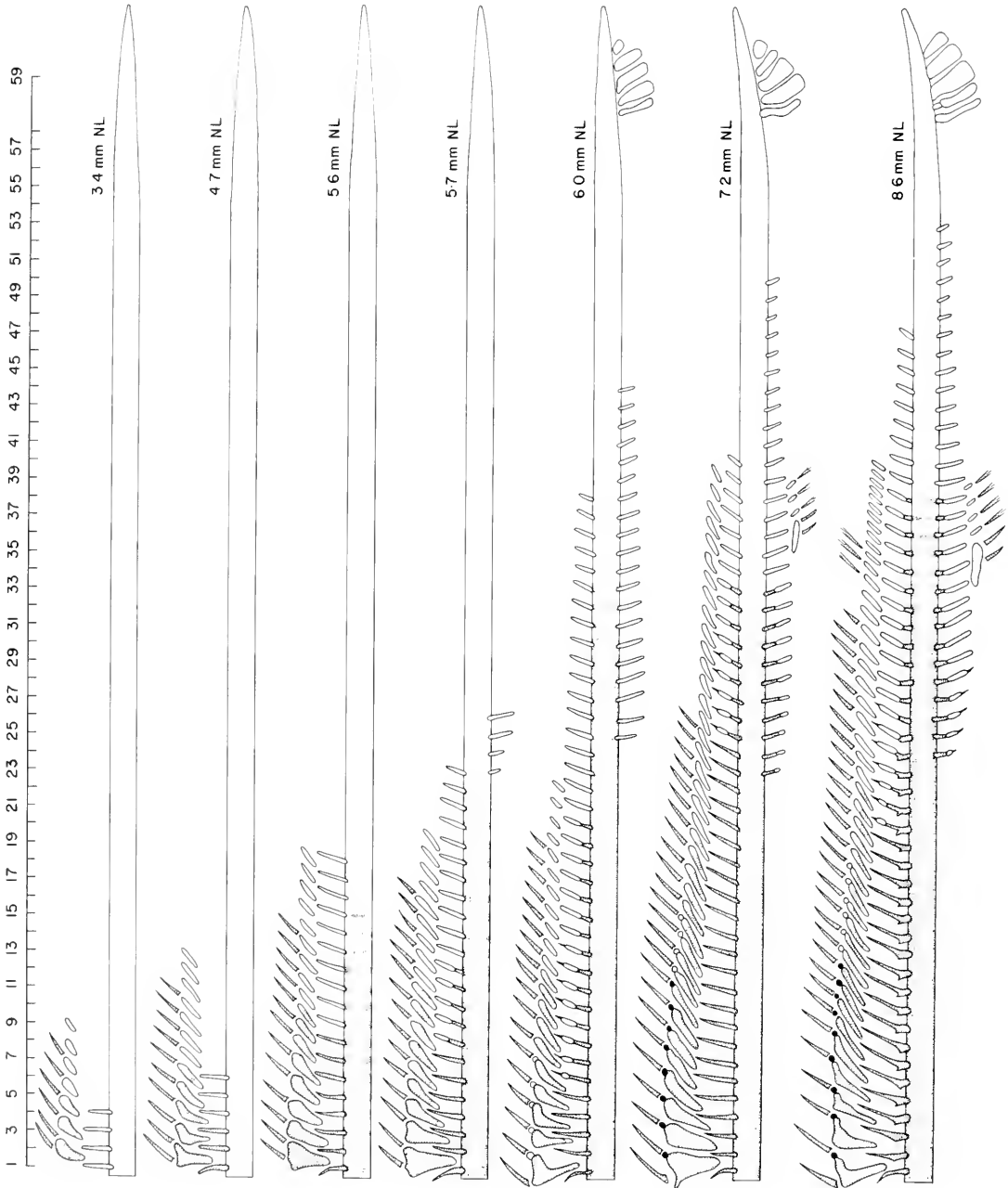

FIGURE 3.—Schematic representation of vertebral column, dorsal and anal fin, pterygiophore, and hypural development in *Nesiarichthys nasutus*, Gempylidae. Cartilage, white; ossifying, stippled. Scale represents interneural and interhaemal space number and vertebra number.

sal fin pterygiophores. Addition of second dorsal and anal pterygiophores was then in an anterior and posterior direction. The same development was observed for the second dorsal and anal fin rays and anal spines at slightly greater size (Table 2).

Most gempylid genera lack predorsal bones, except *Tongaichthys* (Nakamura and Fujii 1983), *Ruvettus* (Potthoff's pers. obs.), and *Thyrsitops* (Sato 1983) which have one predorsal bone. The first dorsal pterygiophore originated from one piece of

cartilage and inserted in the second interneural space supporting two fin spines (one supernumerary spine). In three Atlantic *Lepidocybium*, the first dorsal pterygiophore inserted in the second interneural space, but in two Pacific specimens it was found in the third space. The first anal pterygiophore was considerably larger than the following pterygiophores and presumably developed from two pieces of cartilage. It supported three anal spines (two supernumerary spines) except in adults of *Rexea*,





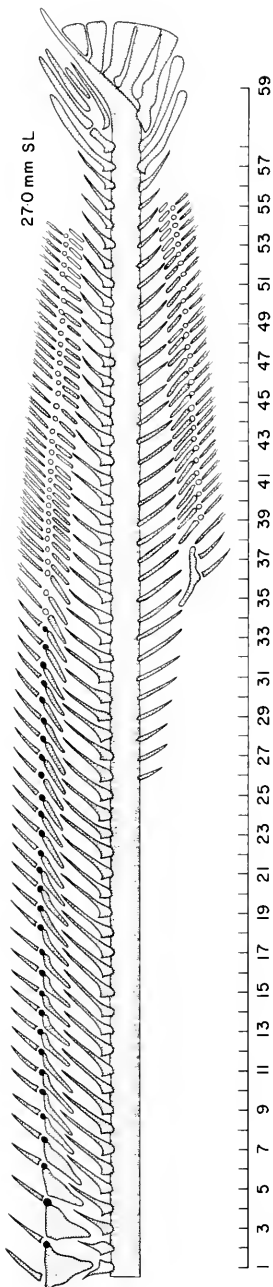

FIGURE 4.—Schematic representation of vertebral column, dorsal and anal fin, pterygiophore, and hypural development in *Diplospinus multi-striatus*, Gempylidae. Cartilage, white; ossifying, stippled. Scale represents interneural and interhaemal space number and vertebra number.

*Thyrsites* (*Leionura*), and *Nealotus* where only two spines were supported (one supernumerary). Larvae of *Nealotus* have three spines associated with the first anal pterygiophore, but in juveniles the second anal spine was fusing to the posterior process of the pterygiophore. No evidence of a similar fusion was observed in *Rexea* or *Thyrsites* (*Leionura*). Gempylids had middle radials in one to six posteriormost dorsal and anal pterygiophores (except *Neopinnula* lacked middle radials). A double ray, and a two-part posteriorly bifurcated stay was associated with the last dorsal and anal pterygiophore in approximately one half of the genera. *Lepidocybium*, *Gempylus*, *Diplospinus*, *Paradiplospinus*, *Tongaichthys*, and *Rexea* had a one-part posteriorly bifurcated stay (Table 1).

First caudal development of the cartilaginous parhypural and hypurals 1 and 2 was concurrent with anterior development of a few neural spines and some first dorsal fin pterygiophores and fin spines. The gempylid genera studied by us developed all parts found in basic perciform caudal skeletons (Gosline 1968), even the smaller second unoneural. Caudal parts then fuse differently in the various genera of adults (Matsubara and Iwai 1958). The neural and haemal elements of preural centra 2 and 3 supported the procurrent caudal rays. In the gempylids the procurrent spur on the posteriormost ventral secondary caudal ray may be present, reduced, or absent. Johnson (1975) examined two species in which it was absent (Table 1).

## FAMILY TRICHIURIDAE

### Figures 5-8

Seventy-three trichiurids in four genera were available: 61 *Trichiurus* (4.5-26, 300, 303, 510 mm TL), 8 *Benthodesmus* (4.5, 12 mm NL, 65-120, 541, 545 mm SL), 3 *Evoxymetapon* (210-550 mm SL), 1 *Lepidopus* (280 mm SL). Only *Trichiurus* yielded a complete developmental series.

Development of the vertebral column in *Trichiurus* initially started in two places on the notochord: 1) anterodorsad (neural arch and spine on future centrum 1), and 2) ventrad at the center (anterior haemal arches and posterior parapophyses). Cartilaginous neural arches and spines were added in a posterior direction. Haemal arches and spines developed when the neural spines reached the anterior future caudal vertebrae. Addition of haemal arches and spines was also in a posterior direction (Table 2). *Trichiurus* lacked a caudal complex. Ossification of the vertebral column started initially in one place, with the anteriormost neural spines and

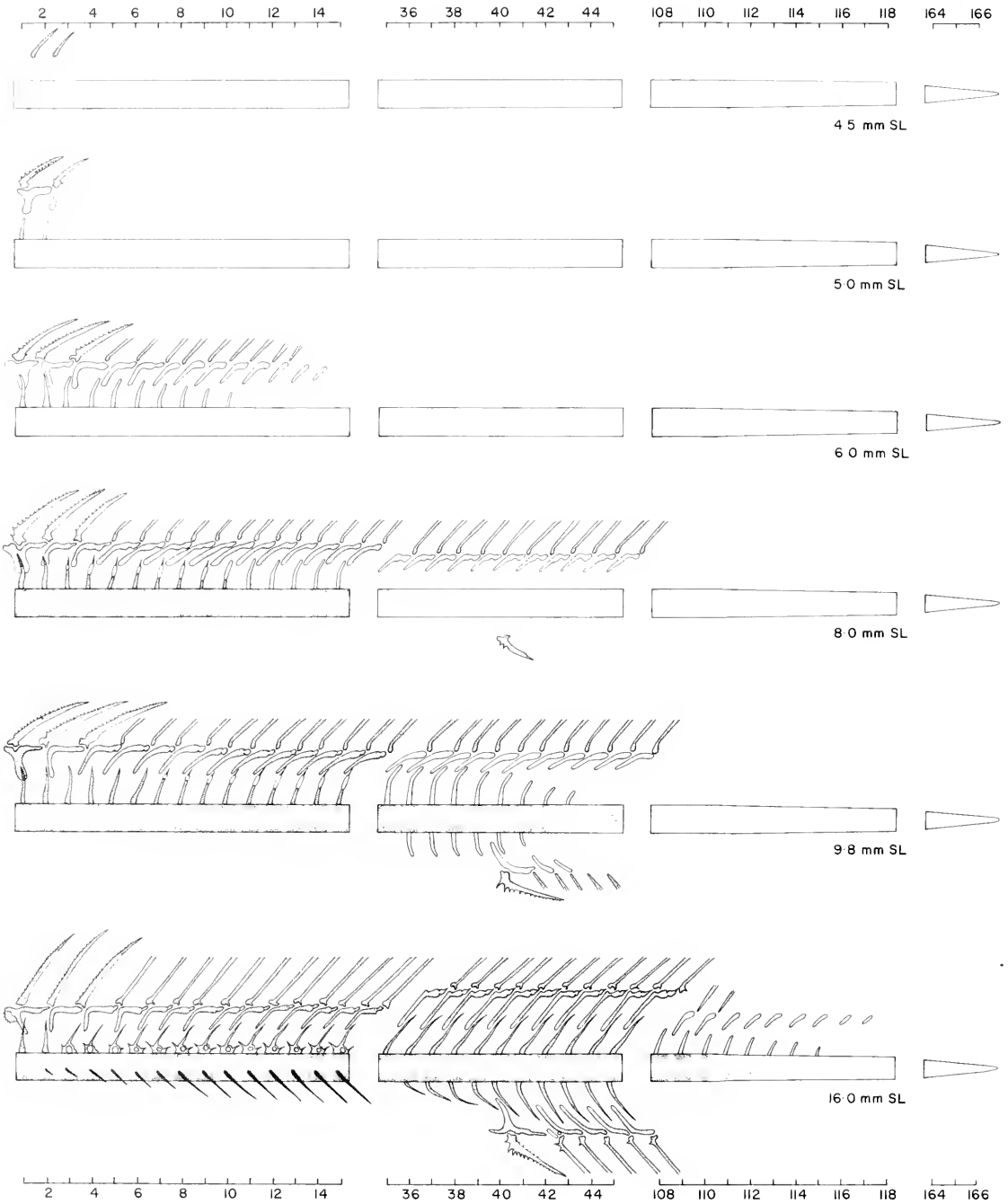

FIGURE 5.—Schematic representation of vertebral column, dorsal and anal fin, pterygiophore, and hypural development in *Trichiurus lepturus*, Trichiuridae. Cartilage, white; ossifying, stippled. Scale represents interneural and interhaemal space number and vertebra number.

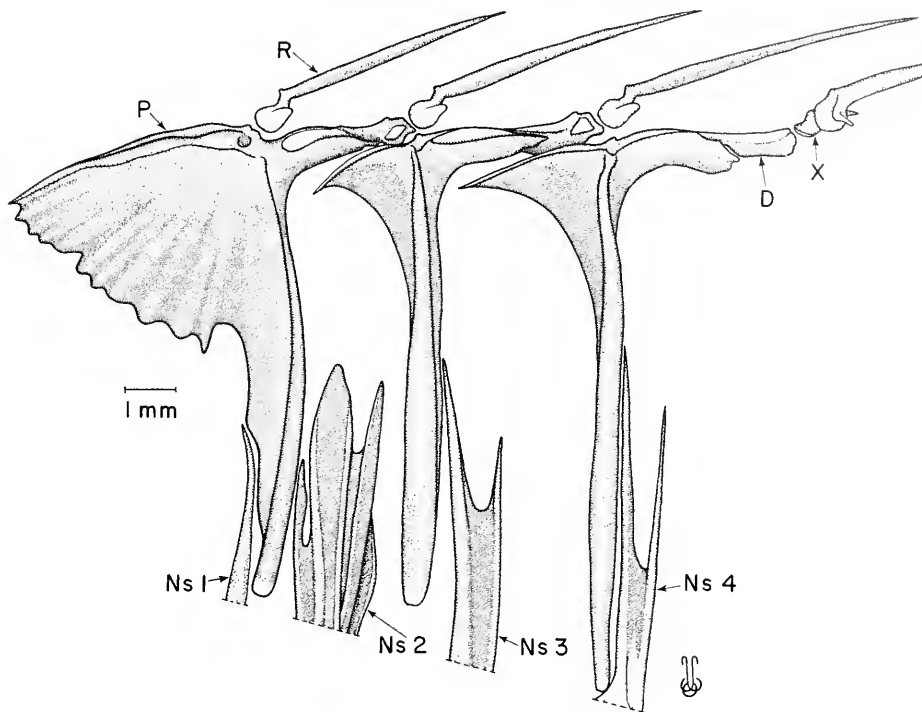

FIGURE 6.—Left lateral view of the anteriormost three dorsal pterygiophores inserting in the interneural spaces 2-4 from a juvenile *Trichiurus lepturus* 510 mm TL. D, distal radial; Ns, neural spine; P, proximal radial; R, ray or spine; X, a new pterygiophore element of unknown homology. Cartilage, white; bone, stippled.

arches and proceeded in a posterior direction. Saddle-shaped ossifications of the vertebrae as seen in Scombrolabrocoidae, Gempylidae, and Scombridae were not observed in *Trichiurus*, instead vertebral ossification started laterally on both sides of the notochord as a thin strip of bone. During further development the lateral strip elongated dorsad and ventrad joining the strip from the opposite side and forming a ring of bone around the notochord.

*Trichiurus* first developed two of the three anterior dorsal fin spines. Next the first dorsal pterygiophore developed. Then dorsal pterygiophores, the third dorsal fin spine, and the dorsal fin rays were added in a posterior direction, with the pterygiophore development being slightly posterior to the ray development and considerably posterior to the neural arch and spine development. The single large anal spine developed first after dorsal fin ray and pterygiophore development had dorsally passed the anterior portion of the anal fin fold. Next, the large first anal fin pterygiophore and some haemal arches and spines developed. Further development consisted of the addition of anal fin rays, pterygiophores,

and haemal arches and spines in a posterior direction. The haemal arches and spines and the anal fin rays developed slightly anterior to the anal pterygiophores. The anal pterygiophores were slightly anterior to the dorsal fin ray and pterygiophore development (Table 2).

*Trichiurus* lacked predorsal bones. The first dorsal pterygiophore supported two fin spines (one supernumerary) and originated from one piece of cartilage. In larvae the first dorsal pterygiophore inserted between the split neural arch and spine of the first centrum, thus inserting into the first and second interneural spaces. However, in adults the first dorsal pterygiophore inserted into the second interneural space. All following interneural and interhaemal spaces accommodated one pterygiophore per space. The first anal pterygiophore was larger than the following pterygiophores, but it developed from one piece of cartilage and supported one supernumerary spine and one ray (Table 1).

The pterygiophores in *Trichiurus* and probably in most if not all species of the Trichiuridae are anatomically different from those of other scom-

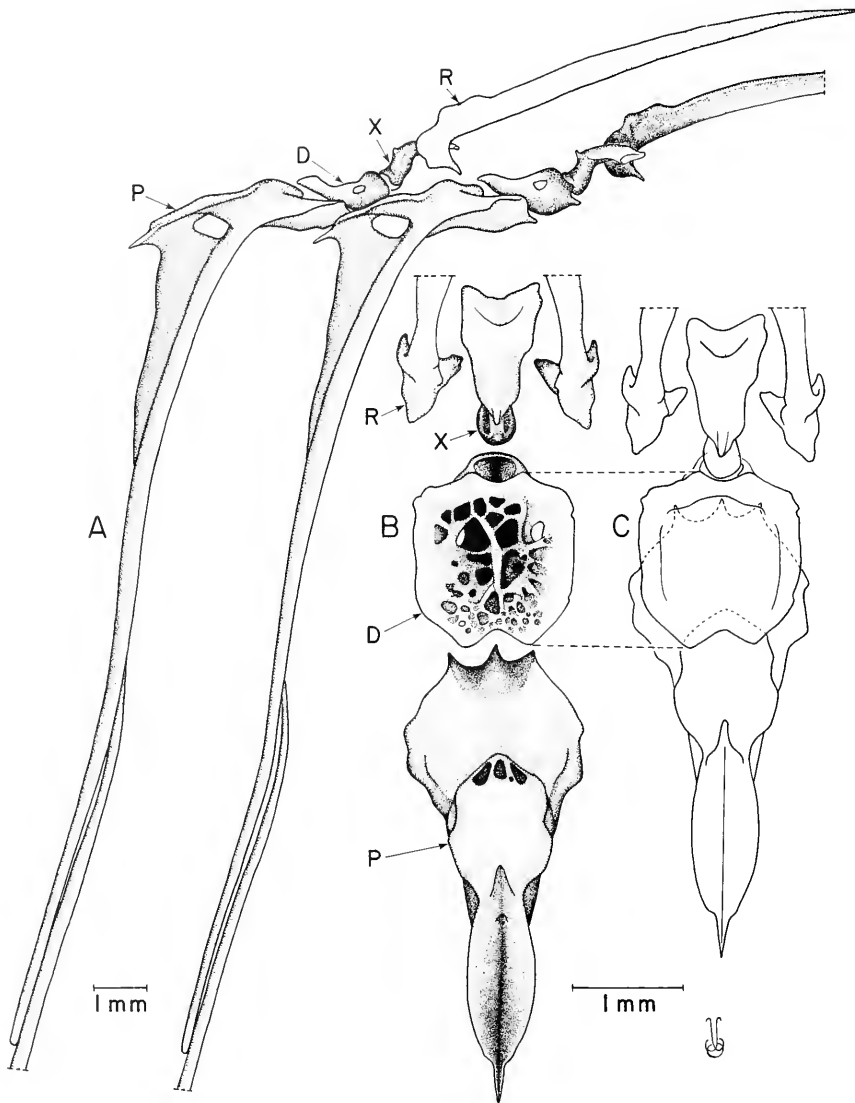

FIGURE 7.—Two dorsal fin pterygiophores from *Trichiurus lepturus* 510 mm TL, taken directly from opposite the anterior portion of the anal fin. A, left lateral view of the pterygiophores and rays; the left side of the posterior ray has been removed. Cartilage, white; ossifying, stippled. B, dorsal view of one of the two pterygiophores; unfused parts have been disarticulated. C, dorsal view of pterygiophore in B, unfused parts have been left articulated. For abbreviations see Figure 6.

broids (G. D. Johnson<sup>3</sup>). The anteriormost two dorsal pterygiophores supported three spines, which were the only dorsal fin spines and which had serrations in larvae and juveniles, but were smooth in adults. The anterior two pterygiophores had two parts each and supported fin spines. The 3d-127th pterygiophores had three parts and supported fin

rays, the distal parts being located between the bifurcate bases of the rays. These distal parts were not homologous with distal radials and are labeled "X" in Figures 6-8. The 128th-130th pterygiophores had four parts, and the last three pterygiophores (131st-133d) had become vestigial having a variable number of parts, usually from two to four. Anal fin pterygiophores were anatomically similar to the dorsal fin pterygiophores. The first anal fin spine was large and serrated in larvae and juveniles but became small and smooth in adults. *Trichiurus* lar-

<sup>3</sup>G. David Johnson, Curator (Fishes), Smithsonian Institution, National Museum of Natural History, Wash., DC 20560, pers. commun. 1985.

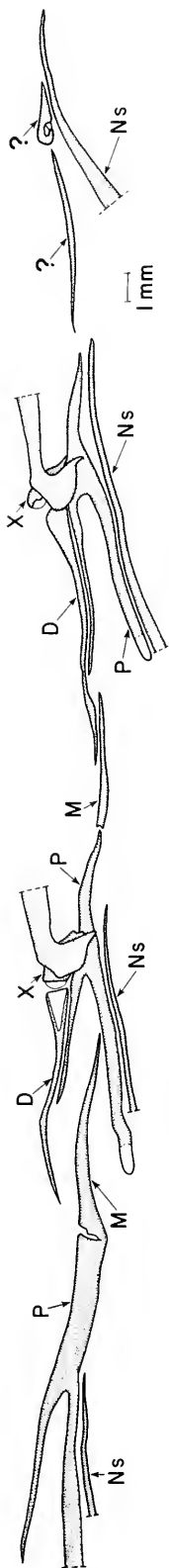

FIGURE 8.—Left lateral view of the three posteriormost dorsal fin pterygiophores from *Trichiurus lepturus* 303 mm TL. M, middle radial; P, pterygiophore parts where

homology cannot be determined; for other abbreviations see Figure 6. Cartilage, white; bone, stippled.

vae and juveniles developed an anal fin in which the rays were of the same length as those in the dorsal fin, but the anal rays became very short and vestigial in adults. In adult *Trichiurus* the posterior end of the dorsal fin was anterior to the posterior end of the anal fin. Other trichiurids (*Benthodesmus*, *Evoxymetapon*, *Lepidopus*) examined by us had pterygiophore arrangements similar to *Trichiurus*.

## FAMILY SCOMBRIDAE

The family is a very speciose group which is divided into two subfamilies (Collette et al. 1984). For the monotypic Gasterochismatinae, larvae were not obtainable, but one or more species for each of the four tribes of the Scombrinae was studied.

### Tribe Scombrini

Figure 9

Twenty-two *Scomber japonicus* (4.4 mm NL - 9.6 mm SL, 100, 103 mm SL) and 12 *S. scombrus* (5.7 mm NL - 8.2 mm SL) were used in this study. Many more *Scomber* smaller than 5.5 mm NL were available but showed no cartilage development along the notochord. In addition, developmental studies on *Scomber* by Kramer (1960) and Kohno et al. (1984) were consulted.

Development of the vertebral column in *Scomber* initially started in four places on the notochord: 1) posteroventrad (parhypural, hypurals 1 and 2), 2) ventrad at the center (anterior haemal arches and spines), 3) dorsad at the center (neural arches and spines above developing haemal arches and spines), and 4) anterodorsad (neural arches and spines of future centra 1-3). The anterior neural spines were added posteriorly, the neural spines at the center of the notochord were added anteriorly and posteriorly, the haemal spines were added posteriorly, but the parapophyses were added anteriorly. The hypurals were added in a posterior direction, but the two autogenous haemal spines were added anteriorly. The dorsal and ventral areas of development coalesced completing the cartilaginous ontogeny of the vertebral column. Ossification of the vertebral column (neural and haemal spines, vertebrae, and hypural complex) initially started in four places: 1) dorsoanteriorly (anteriormost neural arches and spines), 2) ventrad at the center (anterior haemal arches and spines and posterior parapophyses), 3) posteriorly (hypural complex), and 4) dorsad at the center (neural arches and spines). The four initial areas of ossification coalesced as ossification progressed. Vertebrae in *Scomber* initially had saddle-

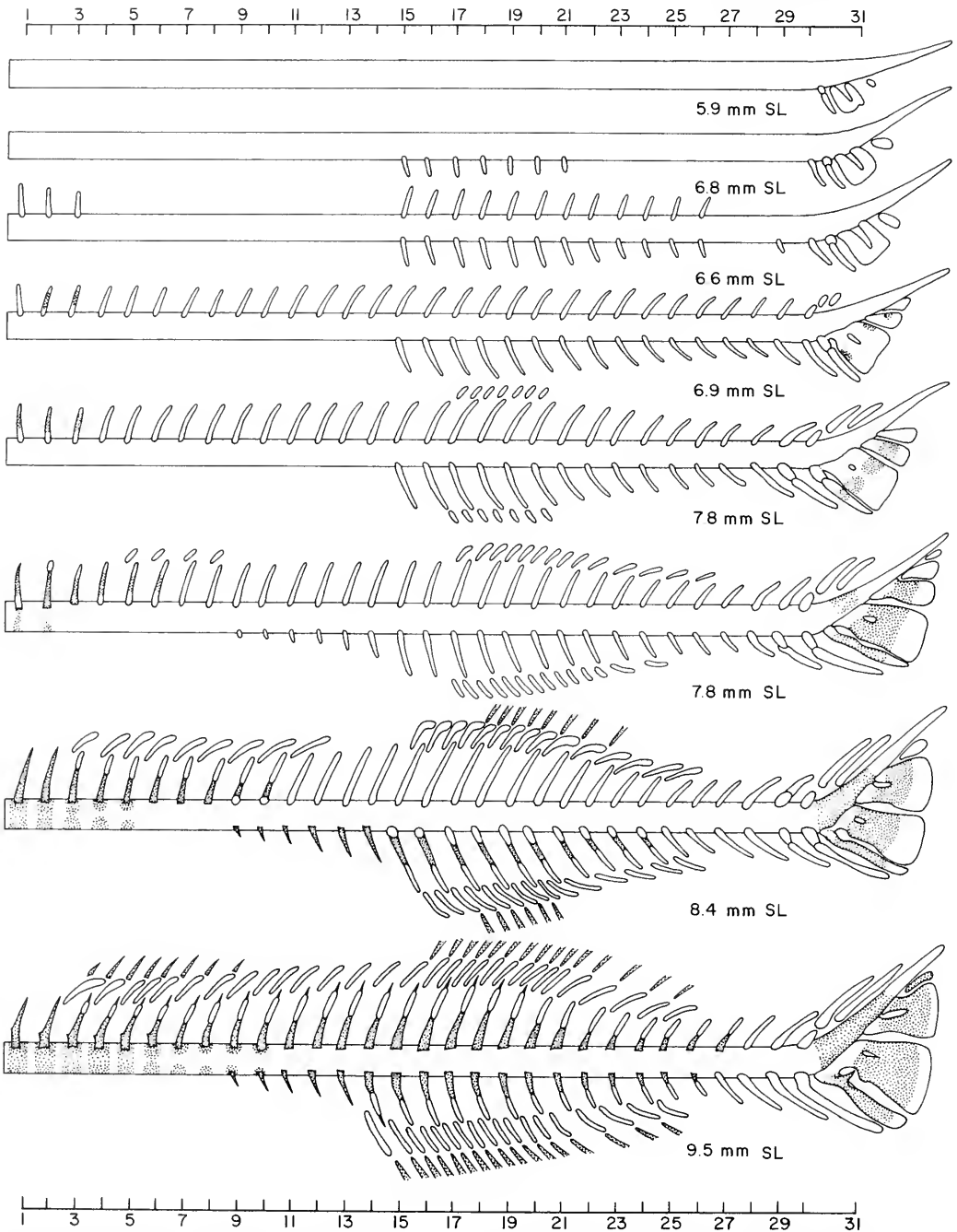

FIGURE 9.—Schematic representation of vertebral column, dorsal and anal fin, pterygiophore, and hypural development in *Scomber japonicus*, Scombrini, Scombridae. Cartilage, white; ossifying, stippled. Scale represents interneurial and interhaemal space number and vertebra number.

shaped ossifications similar to those described for *Scombrolabrax* (Table 2).

Cartilaginous second dorsal and anal fin pterygiophores developed first simultaneously above interneural spaces and below interhaemal spaces 17-19. The addition of cartilaginous second dorsal and anal fin pterygiophores was in an anterior and posterior direction. Cartilaginous first dorsal fin pterygiophores appeared second above interneural spaces 5-8 and were added anteriorly and posteriorly, terminating anteriorly in the third interneural space and joining with the second dorsal fin pterygiophores posteriorly. Second dorsal and anal fin rays developed in the same sequence as their corresponding pterygiophore, but a little later. The first dorsal fin spines developed from anterior in a posterior direction, but the anteriormost (supernumerary) spine first developed when seven first dorsal fin spines were already present (Table 2).

*Scomber* lacked predorsal bones. The first dorsal pterygiophore originated from one piece of cartilage and inserted in the third interneural space supporting two fin spines (one supernumerary spine). The first anal pterygiophore was considerably larger than all other pterygiophores, but it originated from only one piece of cartilage supporting two anal spines (one supernumerary spine). The posterior-most six dorsal and anal pterygiophores had middle radials. The last dorsal and anal pterygiophore supported a double finlet and had a posteriorly bifurcated stay (Table 1).

In *Scomber*, caudal development of the cartilaginous parhypural and hypurals 1 and 2 was first before any other development of cartilaginous haemal or neural arches and spines along the notochord. The development of the hypural complex from the first appearance of cartilaginous hypurals to ossification onset was described by Kohno et al. (1984) and our findings are in agreement with theirs. Kramer (1960) described the ossification sequence in the hypural complex of *Scomber*. In our specimens, hypurals 1 and 2 were fusing to a ventral hypural plate before ossification onset. Hypurals 3 and 4 were fusing in some larvae before and in others after ossification onset. The neural and haemal elements of preural centra 2 and 3 supported the procurvent caudal rays. A procurvent spur and a basally foreshortened ray were absent in *Scomber* (Johnson 1975) (Table 1).

### Tribe Scomberomorini

Figures 10, 11

Thirty-nine specimens were available: 9 *Scomber-*

*omorus cavalla* (4.1-6.2 mm NL), 17 *S. maculatus* (6.1 mm NL - 10.2 mm SL, 40.5-67.5 mm SL), 3 *S. regalis* (5.3, 6.5 mm NL, 85.0 mm SL), 4 *S. tritor* (6.0 mm NL - 8.0 mm SL), 6 *Acanthocybium solanderi* (6.2 mm NL - 10.8 mm SL). None of the above five species yielded complete developmental series. However, *S. cavalla* specimens showed the cartilaginous ontogeny of the vertebral column, of the dorsal and anal fin pterygiophores and of the hypural complex. The *S. maculatus* specimens showed the latter phases of pterygiophore and hypural complex development, dorsal and anal fin development, and the ossification of the vertebral column and the hypural complex. Specimens of *S. regalis* and *S. tritor* provided evidence that development for the Atlantic species of *Scomberomorus* is very similar. Specimens of *A. solanderi* gave incomplete information on cartilaginous vertebral column development, but adequate information on dorsal and anal pterygiophore, on dorsal and anal fin, on hypural complex development, and on the ossification sequence of the vertebral column.

Development of the vertebral column in *Scomberomorus* initially started in four places on the notochord: 1) anterodorsad (neural arches and spines on future centra 1-3), 2) posteroventrad (parhypural, hypurals 1 and 2), 3) ventrad at the center (four haemal arches and spines), and 4) dorsad at the center (six neural arches and spines above initial haemal spine development). The anterior neural spines were added posteriad, the neural spines at the center of the notochord were added anteriorly and posteriorly, the haemal spines were added mostly posteriorly but a few were added in an anterior direction. All parapophyses were added in an anterior direction. The hypurals were added in a posterior direction, but the two autogenous haemal spines were added in an anterior direction. The dorsal and ventral areas of development coalesced and thus cartilaginous ontogeny of the vertebral column was complete. Ossification of the vertebral column initially started in two places: 1) anteriorly (neural arches and spines, and centra) and 2) posteriorly (hypural complex). Ossification of the neural arches and spines and centra was in a posterior direction. In the hypural complex ossification started with the urostyle and proceeded anteriorly to preural centrum 3. Then the ventral hypural plate started to ossify followed by the dorsal plate, the parhypural, and the two autogenous haemal spines. Last to start ossification were the epurals, the uroneural, and the neural spines. Vertebrae in *Scomberomorus* had saddle-shaped ossifications similar to those described for *Scombrolabrax* (Table 2).

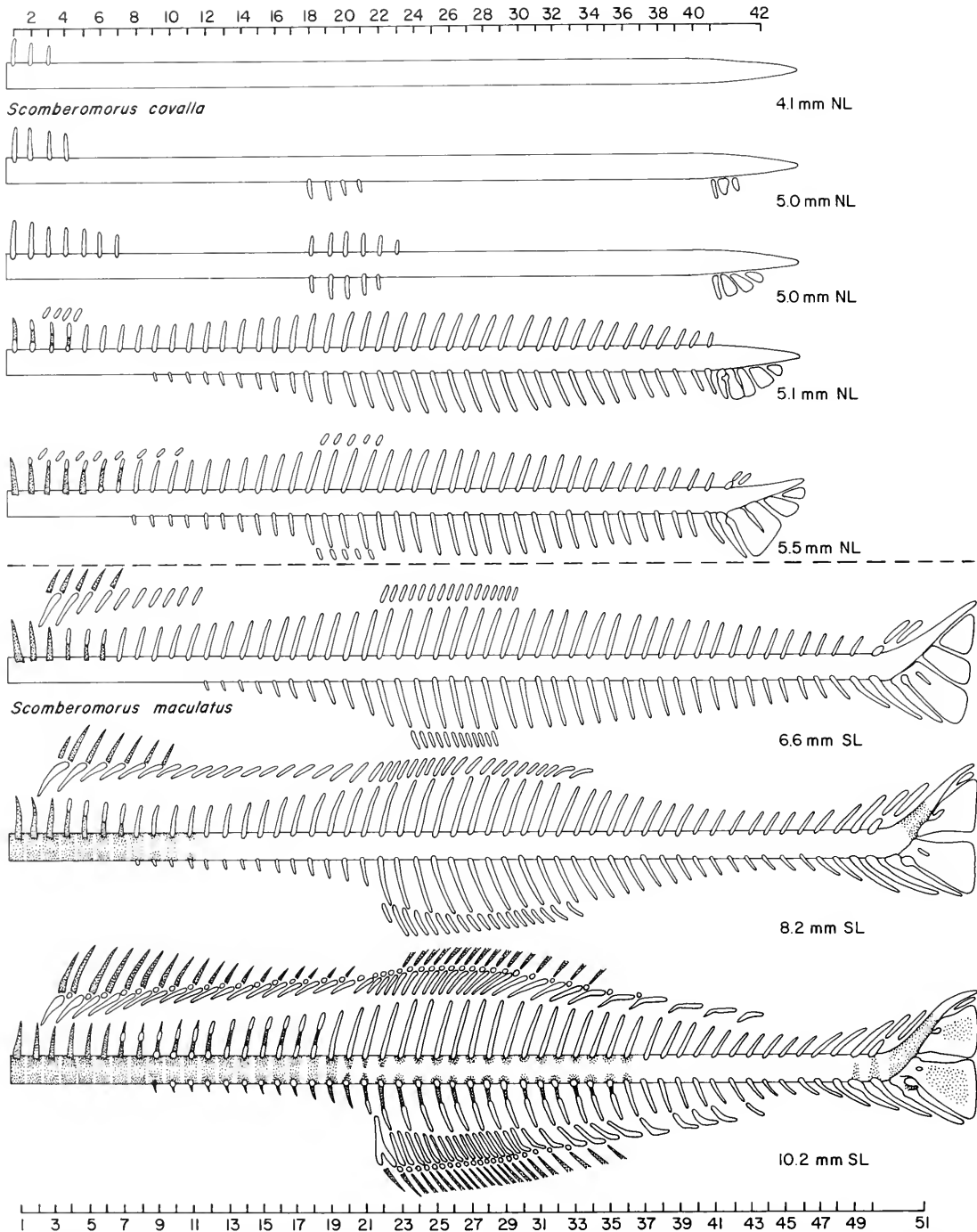

FIGURE 10.—Schematic representation of vertebral column, dorsal and anal fin, pterygiophore, and hypural development in *Scomberomorus cavalla* and *S. maculatus*, Scomberomorini, Scombridae. Cartilage, white; ossifying, stippled. Scale represents inter-neural and interhaemal space number and vertebra number.



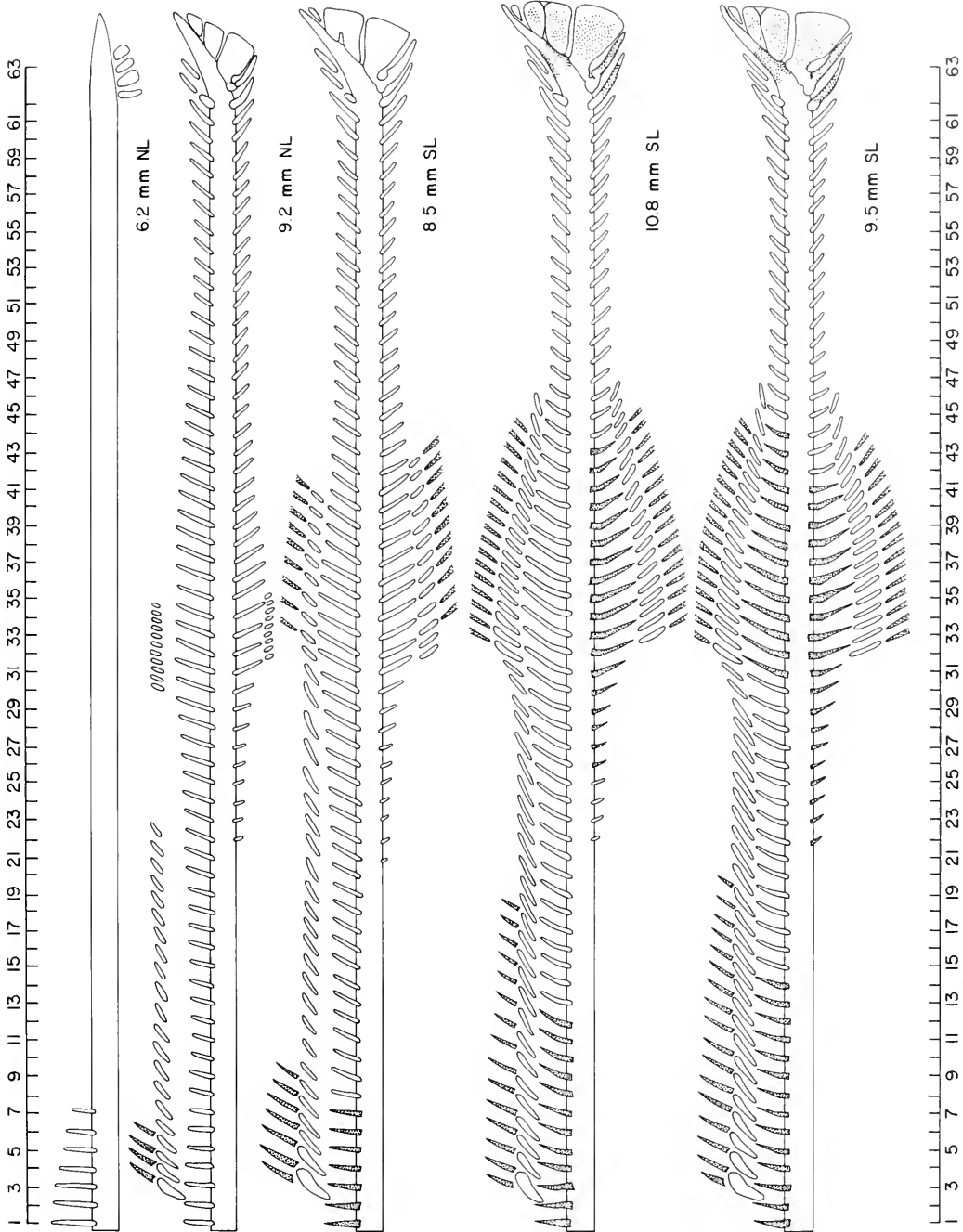

FIGURE 11.—Schematic representation of vertebral column, dorsal and anal fin, pterygophore, and hypural development in *Acanthocybium solanderi*, Scomberomorini, Scombridae. Cartilage, white; ossifying, stippled. Scale represents interneutral and interhaemal space number and vertebra number.

Two to five cartilaginous first dorsal fin pterygiophores developed first above interneural spaces 3-5 at the time of ossification onset of the anterior-most neural arches and spines. The addition of cartilaginous first dorsal fin pterygiophores was in a posterior direction. Five cartilaginous second dorsal and anal fin pterygiophores developed second simultaneously in the anterior portions of the future second dorsal and anal fins. Some addition of cartilaginous second dorsal and anal fin pterygiophores occurred in an anterior direction, but most of the addition was posteriorly. Dorsal and anal fin rays and spines developed in the same sequence as their corresponding pterygiophores, but a little later (Table 2).

*Scomberomorus* does not develop predorsal bones. The first dorsal pterygiophore originated from one piece of cartilage and inserted in the third interneural space supporting two fin spines (one supernumerary spine). The first anal pterygiophore developed from two pieces of cartilage and supported three spines (two supernumerary spines). The posteriormost nine dorsal and anal pterygiophores had middle radials. The last dorsal and anal pterygiophore supported a double finlet and had a non-bifurcated stay (Table 1).

In *Scomberomorus*, first caudal development of the cartilaginous parhypural and hypurals 1 and 2 was concurrent with the anterior development of the neural spines and the central appearance of haemal spines. Hypurals 3-5 were added posteriorly, the two autogenous haemal spines anteriorly. Hypurals 1 and 2 and hypurals 3 and 4 fused before ossification onset to a cartilaginous ventral and dorsal hypural plate. The dorsal and ventral plates fused after ossification to a single hypural plate with a central notch (Collette and Russo 1984). Hypural 5 gradually fused with the paired uroneural forming an autogenous bone resembling a third epural and mistaken as such by Leccia (1958). Two epurals developed anterior to the uroneural-hypural 5. These epurals remained autogenous. The neural and haemal elements of preural centra 2, 3, 4, and 5 supported the procurrent caudal rays. A procurrent spur and basally foreshortened ray were absent in *Scomberomorus* (Johnson 1975) (Table 1).

Only six *Acanthocybium solanderi* were available. We were therefore unable to ascertain a complete developmental sequence. Our smallest 6.2 mm NL specimen had two cartilaginous development centers along the notochord: some neural spines and arches anteriorly and the parhypural, hypural 1-3 posteriorly. The next larger specimen 9.2 mm SL had all neural and haemal arches and spines developed, thus

we were unable to tell if in *Acanthocybium* four initial centers (as in *Scomberomorus*) or only three centers (as in *Xiphias* and *Sarda*) of cartilaginous development along the notochord were present. In all our *Acanthocybium* specimens, hypurals 1 and 2 gradually fused before ossification onset to a ventral cartilaginous hypural plate. In the 8.5 mm SL *Acanthocybium*, hypurals 3 and 4 were fusing before ossification onset; in the larger 9.5 and 10.4 mm SL specimens hypurals 3 and 4 were ossifying while still separate. The dorsal and ventral hypural plates were fused in adults to one plate with a notch (Conrad 1938; Collette and Russo 1984) (Table 1). Ossification of the vertebral column initially started in four places and was similar to the ossification in *Scomber*.

The development of the dorsal and anal fins and their supporting pterygiophores in *Acanthocybium* was similar to that described in *Scomberomorus*.

### Tribe Sardini

#### Figure 12

Ninety-nine *Sarda sarda* (2.4-9.0 mm NL or SL, 59-102 mm SL) were available. Of the larval specimens (2.4-9.0 mm NL or SL) only 32 were larger than 5 mm NL, and of these 10 were between 6.0 and 6.9 mm NL or SL, 6 were between 7.0 and 7.9 mm NL or SL, and 3 were larger than 8 mm SL. Thus, since development of the vertebral column in *Sarda* begins around 5 mm NL, only 32 specimens were useful to our study and they were too few to yield a complete developmental series. Our conclusions on Sardini development are not as well supported as for most other scombroids.

Development of the vertebral column in *Sarda* initially started in three places on the notochord: 1) anterodorsad (neural arch and spine of future centrum 1), 2) posteroventrad (parhypural, hypurals 1 and 2), and 3) ventrad at center (haemal arches and spines, parapophyses). The anterior neural spines were added in a posterior direction and the haemal spines probably first appeared when the corresponding neural spines developed above them at the center of the notochord. Our evidence, however, is only indirect, because one 7.5 mm NL specimen had 21 neural spines and no haemal spines, but our 8.1 mm SL specimen had all neural and haemal spines developed. The cartilaginous hypurals were added posteriorly, but we could not observe the anterior addition of the autogenous haemal spines, although we assume that it happens in *Sarda* as in other scombroids with tails. Ossification of the vertebral column in *Sarda* initially started in two places: anteriorly (neural arches and spines) and posteriorly

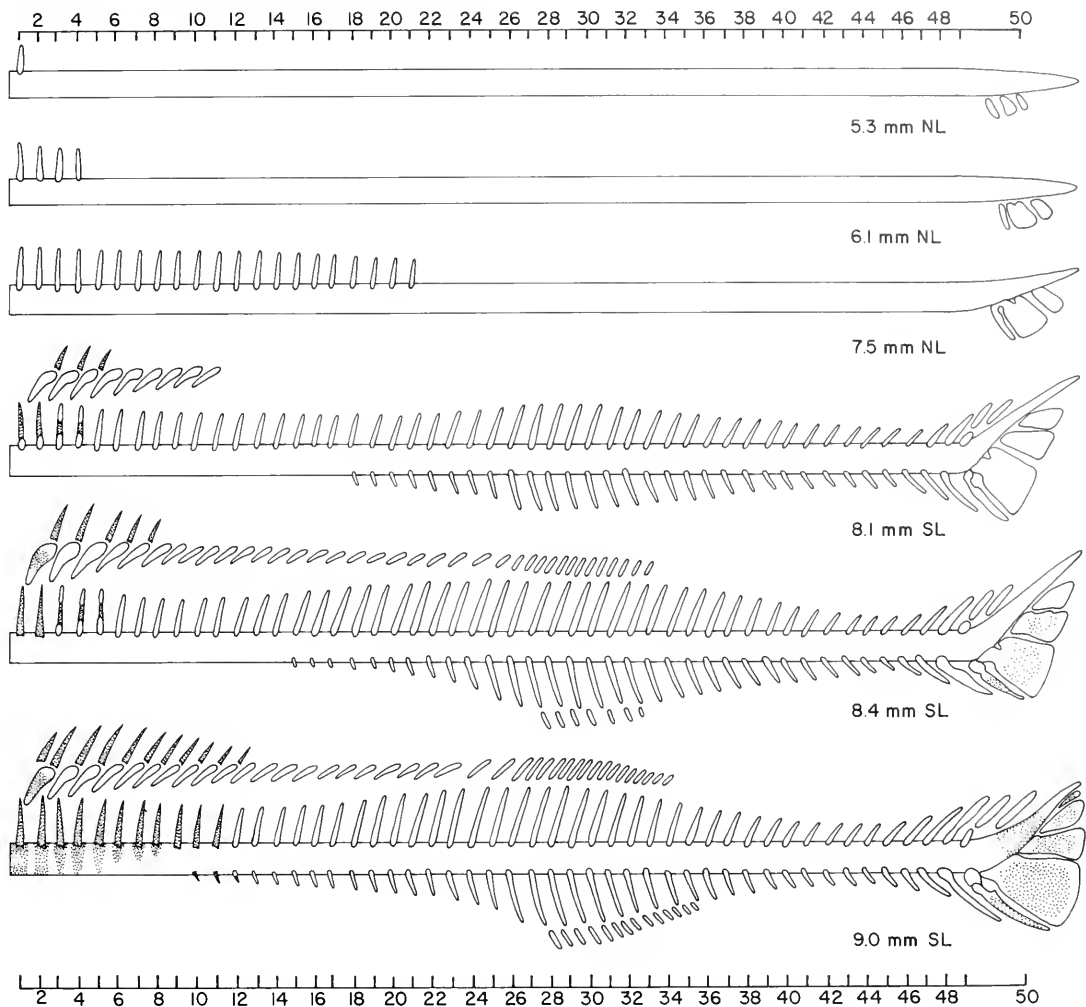

FIGURE 12.—Schematic representation of vertebral column, dorsal and anal fin, pterygiophore, and hypural development in *Sarda sarda*, Sardini, Scombridae. Cartilage, white; ossifying, stippled. Scale represents interneural and interhaemal space number and vertebra number.

(hypural complex). Our largest 9.0 mm SL specimen showed ossification to the 11th neural spine. We do not know if ossification in *Sarda* proceeds entirely posteriorly or if in *Sarda*, as in *Scomber* and *Acanthocybium*, there is some central ossification of neural and haemal spines before the anterior ossification has reached the center of the column. The hypural complex started to ossify early at the time ossification on the neural spines began anteriorly. Vertebrae in *Sarda* had saddle-shaped ossifications similar to those described for *Scombrobrax* (Table 2).

Cartilaginous first dorsal fin pterygiophores developed first anteriorly above interneural spaces 2-10 in the 8.1 mm SL specimen. Addition of cartilaginous first dorsal fin pterygiophores was in a posterior direction. The 8.4 mm specimen had all first dor-

sal fin pterygiophores and some second dorsal and anal fin pterygiophores and they were continuous with each other. Therefore, we are unable to determine if second dorsal and anal fin pterygiophores in *Sarda* developed before first dorsal fin pterygiophores were joined with the second dorsal fin pterygiophores. Three first dorsal fin spines were present in the 8.1 mm SL specimen, serially associated with the first three pterygiophores. Addition of first dorsal fin spines was in a posterior direction, except for the anteriormost first spine (supernumerary), which developed later in the 9.0 mm SL *Sarda*. Second dorsal and anal fin rays were not developed in our 9.0 mm SL specimen. Our 59 mm SL specimen had the full adult complement of fin rays (Table 2).

*Sarda* did not develop predorsal bones. The first dorsal pterygiophore originated from one piece of cartilage and inserted in the second interneural space supporting two spines (one supernumerary spine). We do not know if the first anal pterygiophore originated from one or two pieces of cartilage, but it is most likely that it originated from two pieces because it supported three fin elements (two supernumerary spines). The posteriormost seven to nine dorsal and anal pterygiophores had middle radials. The last dorsal and anal pterygiophore supported a double finlet and had a posteriorly bifurcated stay (Table 1).

In *Sarda* first caudal development of the cartilaginous parhypural and hypurals 1 and 2 was concurrent with the beginning development of the anteriormost neural arches and spines. Hypurals 1 and 2 fused in the cartilaginous state to form the ventral hypural plate. In three specimens, hypurals 3 and 4 were separate after ossification onset. These hypurals were fused to the dorsal hypural plate in juveniles. Hypural 5, the uroneural and two epurals were separate in our juveniles. Collette and Chao (1975) found that in adults the dorsal and ventral plates fused to one hypural plate without a notch and that the uroneural fused with hypural 5, but the two epurals remained autogenous. The neural and haemal elements of preural centra 2, 3, 4, and 5 supported the procurrent caudal rays. A procurrent spur and a basally foreshortened ray were absent in *Sarda* (Johnson 1975) (Table 1).

## Tribe Thunnini

### Figure 13

More than 86 specimens were available: 86 *Thunnus* (mostly *T. atlanticus* and a few *Thunnus* spp., 3.7-9.7 mm NL or SL), and a small number of *Auxis*, *Euthynnus*, and *Katsuwonus*. We were unable to observe early cartilaginous development in all genera except *Thunnus*.

Development of the vertebral column in *Thunnus* initially started in four places on the notochord: 1) anterodorsad (neural arches and spines of future vertebrae 1-3), 2) posteroventrad (hypurals 1 and 2), 3) ventrad at the center (anteriormost five haemal arches and spines and posteriormost two parapophyses), and 4) dorsad at the center (five neural arches and spines above initial haemal arch and spine development). The anterior neural arches and spines were added in a posterior direction, the central neural arches and spines were added anteriorly (coalescing around the future 14th centrum) and posteriorly toward the epurals. The parapophy-

ses were added in an anterior direction, whereas the haemal arches and spines were developing in a posterior direction. In the hypural complex hypurals were added posteriorly, but the parhypural and the two autogenous haemal spines were added in an anterior direction, coalescing with the central haemal arches and spines. Ossification of the vertebral column in Thunnini initially started in two places similar to the ossification described for *Scomberomorus*. Saddle-shaped vertebral ossification development was observed in all Thunnini examined, similar to the development described for *Scombrolabrax* (Table 2).

In Thunnini, cartilaginous first dorsal fin pterygiophores developed anteriorly in interneural spaces 3-6 when only few cartilaginous neural spines were present. Additional pterygiophores were added in a posterior direction. Later, small cartilaginous second dorsal fin pterygiophores appeared in the middle of the vertebral column above interneural spaces 15-22. As the first dorsal fin pterygiophores developed in a posterior direction, the second dorsal fin pterygiophores developed in an anterior and posterior direction until all the dorsal pterygiophores were continuous. Anal pterygiophores appeared below interhaemal spaces 20-25 and developed in an anterior and posterior direction. Addition of the first dorsal fin spines was in a posterior direction, except for the anteriormost spine (supernumerary), which developed when the second and third spine were already present. The second dorsal and anal fin rays developed in the same sequence as their corresponding pterygiophores but a little later (Table 2).

All Thunnini species examined lacked predorsal bones. The first dorsal pterygiophore originated from one piece of cartilage and inserted in the third interneural space supporting two fin spines (one supernumerary spine). The first anal pterygiophore developed from two pieces of cartilage and supported three fin spines (two supernumerary spines) (Potthoff 1975). Middle radials were present on the posterior eight or nine finlet supporting dorsal and anal pterygiophores. A one-part posteriorly bifurcated stay developed with the posteriormost dorsal and anal fin pterygiophores (Table 1).

In *Thunnus*, the caudal complex began to develop very early concurrently with the first anteriormost neural spines. Hypurals 1 and 2 and hypurals 3 and 4 developed separate cartilages and fused to a cartilaginous dorsal and ventral hypural plate. Potthoff (1975) stated that hypurals 1 and 2 developed as one piece of cartilage from the start, but he examined only specimens larger than 5.0 mm NL not stained for cartilage. The dorsal and ventral hypural plates

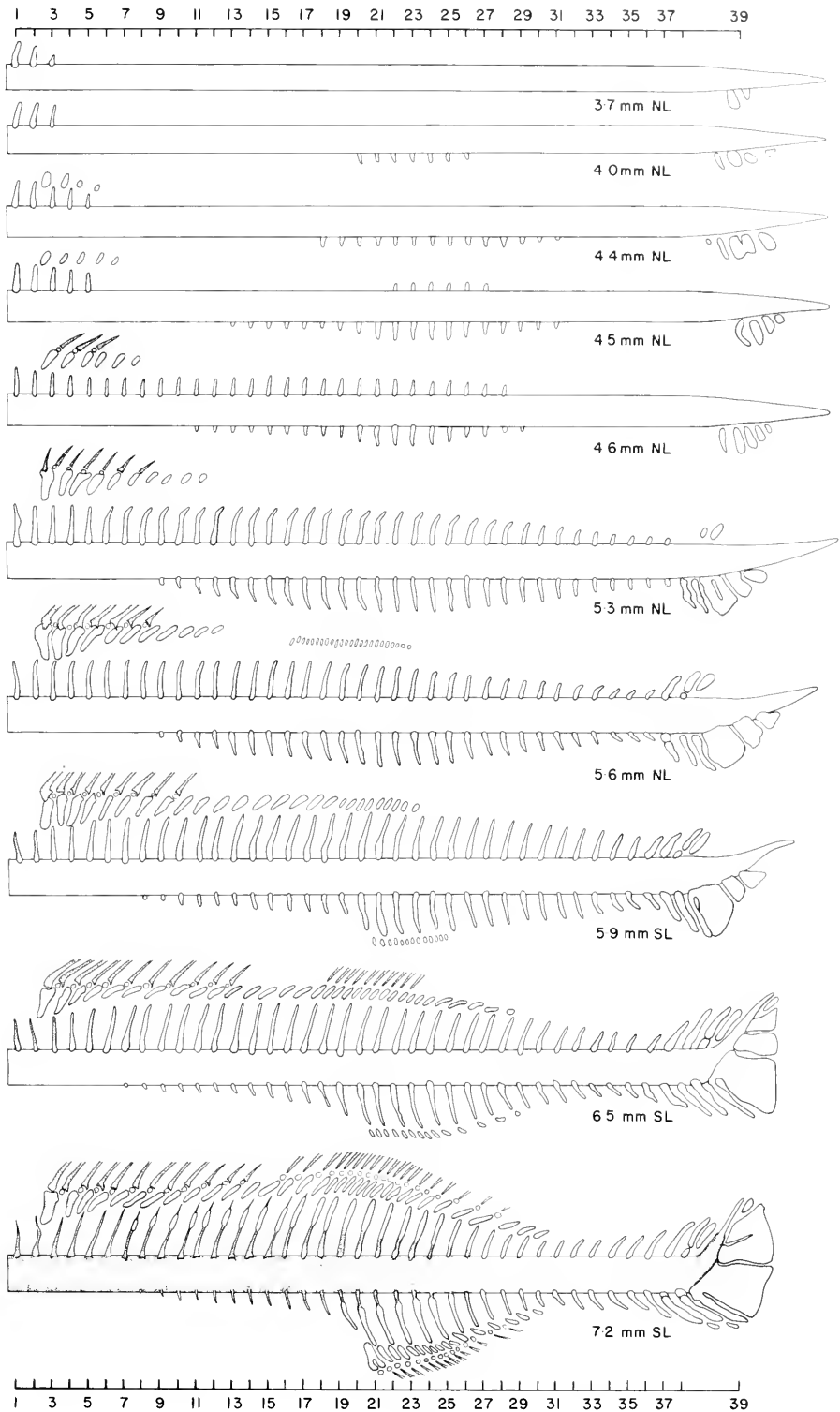

FIGURE 13.—Schematic representation of vertebral column, dorsal and anal fin, pterygiophore, and hypural development in *Thunnus atlanticus*, Thunnini, Scombridae. Cartilage, white; ossifying, stippled. Scale represents interneuronal and interhaemal space number and vertebra number.

fused after ossification, but the small hypural 5 remained separate. Preural centra 2 and 3 each had an autogenous haemal spine. Two epurals and one uroneural developed dorsad. The anterior epural fused with the neural arch of  $Pu_2$  and the uroneural fused to the urostyle (Potthoff 1975). The neural and haemal elements of preural centra 2, 3, and 4 supported the procurrent caudal rays. A procurrent spur and basally foreshortened ray were absent in the Thunnini (Johnson 1975) (Table 1).

## FAMILY ISTIOPHORIDAE

### Figure 14

One hundred and sixteen istiophorids (3.0-227 mm NL or SL) were available. Most specimens were caught in the Gulf Stream off Miami, FL. In 67 of the specimens we were able to count vertebrae; all had a count of 12+12. This identified them as *Istiophorus platypterus* or *Tetrapturus* spp. (Merrett 1971; Richards 1974). The 67 specimens with the 12+12 vertebral count, and the remainder, which were too small for vertebral counts, probably were *I. platypterus* because most adult istiophorids captured in the Gulf Stream off Miami are that species. In addition, 12 *Makaira nigricans* (3.3-5.9 mm NL, 13.3 and 220 mm SL) identified by W. J. Richards<sup>4</sup> were examined. The 13.3 and 220 mm SL specimens had a count of 11+13 vertebrae.

Development of the vertebral column initially started in three places on the notochord: 1) anterodorsad (neural arches and spines on future centra 1 and 2), 2) posteroventrad (hypurals), and 3) ventrad at the center (anterior haemal arches and posterior parapophyses). The neural arches and spines were added in a posterior direction. The haemal arches and spines also were added in a posterior direction at the time when neural arches and spines appeared above on the notochord. Parapophyses were added anteriorly. Hypural bones were added in a posterior direction, but the parhypural and the two autogenous haemal spines were added anteriorly. Ossification of the vertebral column in istiophorids initially started in two places: ossification of the anteriormost neural spines and arches proceeded in a posterior direction. The hypural complex started ossification before all neural and haemal spines were ossifying. Saddle-shaped ossifications of the vertebrae as observed in the Scombrabrachidae, Gempillidae, and Scombridae were not observed in the

Istiophoridae during ontogeny. First ossification of vertebrae in Istiophoridae was evidenced by the formation of rings of bone around the notochord (Table 2).

Cartilaginous dorsal pterygiophores appeared first above interneural spaces 3-5. Dorsal pterygiophore addition was mostly in a posterior direction, except that those pterygiophores over interneural spaces 2 and 1 were added in an anterior direction. When dorsal pterygiophore development extended to above the anterior portion of the anal fin fold, cartilaginous anterior anal pterygiophores were seen below interhaemal spaces 13 and 14, and their addition was posteriorly abreast of the dorsal pterygiophores. At larger sizes dorsal and anal finrays developed in the same sequence as their supporting pterygiophores (Table 2).

Istiophorids did not have predorsal bones, instead the first three interneural spaces were filled with fin spine supporting pterygiophores. The first dorsal pterygiophore originated from one piece of cartilage and inserted in the first interneural space supporting three spines (two supernumerary spines). The anteriormost spine was either small, reduced, or vestigial. The first anal pterygiophore developed from two pieces of cartilage supporting two fin spines (one supernumerary spine). Istiophorids had one middle radial and one posteriorly bifurcated (sometimes nonbifurcated) stay with the posteriormost dorsal and anal pterygiophore. The posteriormost dorsal and anal ray were double (Table 1).

In istiophorids, the caudal complex started to develop after the precaudal neural spines had developed. The parhypural and hypurals 1-4 developed as separate cartilages. In most istiophorid specimens the cartilages of hypurals 1 and 2 and hypurals 3 and 4 fused to a lower and upper hypural plate before ossification; in some specimens fusion did not take place until after ossification onset for the upper and lower hypurals. Also, there were specimens in which none of the cartilaginous hypurals fused. The 5th hypural did not develop in istiophorids. Dorsad 3 epurals and 1 uroneural developed. Preural centra 2 and 3 each had one autogenous haemal spine. In adult istiophorids, the fusion of the bones in the caudal complex was extensive (Gregory and Conrad 1937); we examined adult specimens of *Istiophorus*, *Tetrapturus*, and *Makaira* and found identical hypural fusions in the three genera. The three epurals remained autogenous, but the uroneural, hypurals 1-4, and the parhypural were fused with each other and with the urostyle to form a notched hypural plate. The neural and haemal

<sup>4</sup>W. J. Richards, Senior Scientist, Southeast Fisheries Center Miami Laboratory, National Marine Fisheries Service, NOAA, 75 Virginia Beach Drive, Miami, FL 33149, pers. commun. 1983.

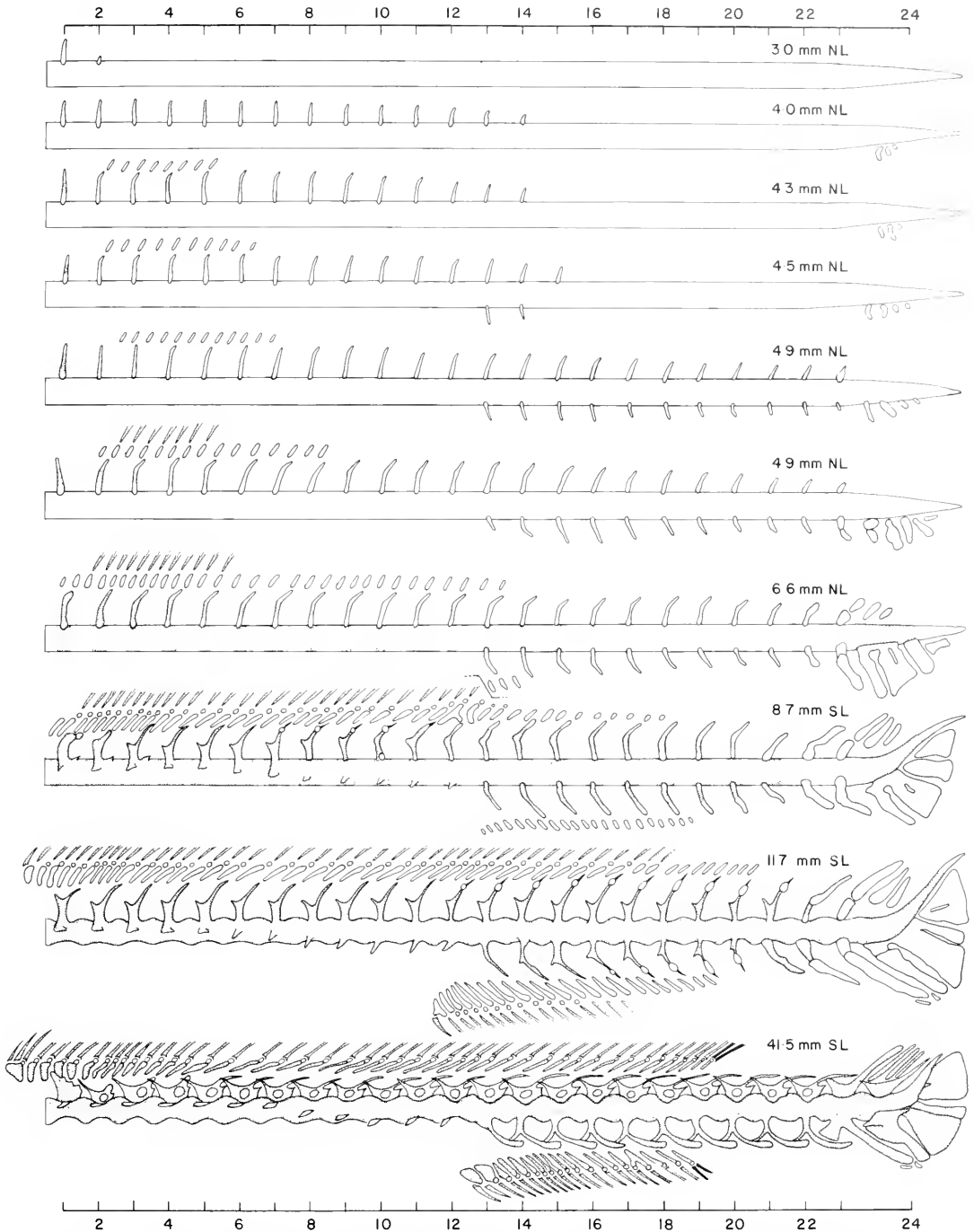

FIGURE 14.—Schematic representation of vertebral column, dorsal and anal fin, pterygiophore, and hypural development in *Istiophorus platypterus*, Istiophoridae. Cartilage, white; ossifying, stippled. Scale represents interneural and interhaemal space number and vertebra number.

elements of preural centra 2 and 3 supported procurrent caudal rays. A procurrent spur and basally foreshortened ray were absent in the Istiophoridae (Johnson 1975) (Table 1).

## FAMILY XIPHIIDAE

Figure 15

Ninety-five *Xiphias gladius* specimens (3.7-19.5 ENL or ESL) of this monotypic genus and species studied by Potthoff and Kelley (1982) were reexamined by us.

Development of the vertebral column initially started in three places on the notochord: 1) anterodorsad (neural arches and spines on future centra 1-3), 2) posteroventrad on the notochord (hypurals), and 3) ventrad at the center (anterior haemal arches and posterior parapophyses). The neural arches and spines were added in a posterior direction. When the developing neural spines had passed the pre-caudal area, some of the anterior haemal spines started to develop (except the anteriormost two of

the future caudal vertebrae). Addition of cartilaginous neural and haemal spines was in a posterior direction, except the first two haemal spines which developed anteriorly. Hypural complex bones were added in an anterior and posterior direction. Ossification of the vertebral column in *Xiphias* initially started in one place with the anteriormost neural arches and spines. Ossification then proceeded in a posterior direction with the hypural complex ossifying last. Saddle-shaped ossifications of the vertebrae as observed in the Scombralabracidae, Gempylidae, and Scombridae was not observed in *Xiphias* during ontogeny. Instead, vertebral ossification was first noted in *Xiphias* by the appearance of dorsoventral fractures on the notochord followed by the appearance of ossified vertebrae between the fractures (Table 2).

Cartilaginous dorsal and anal pterygiophores developed simultaneously before the neural and haemal spines had reached the area. The dorsal pterygiophores first developed in a group below the future middle of the dorsal fin above the future inter-

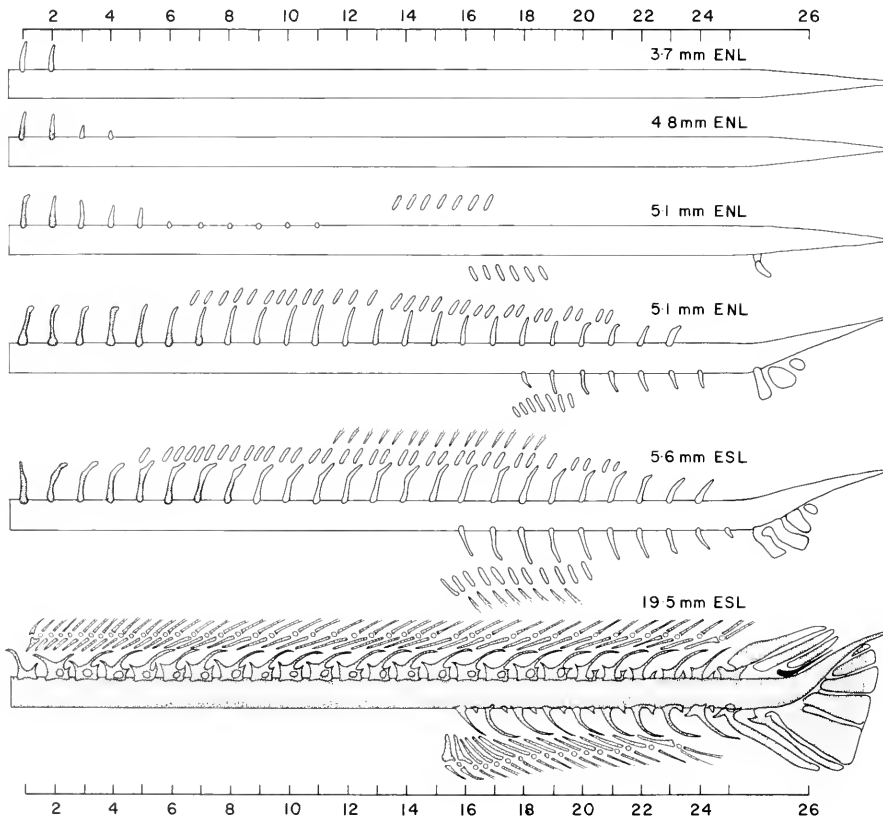

FIGURE 15.—Schematic representation of vertebral column, dorsal and anal fin, pterygiophore, and hypural development in *Xiphias gladius*, Xiphiidae. Cartilage, white; ossifying, stippled. Scale represents interneutral and interhaemal space number and vertebra number.



neural spaces 13-16. The anal pterygiophores first developed in a group above the future anterior part of the anal fin below interhaemal spaces 16-18. Further addition of cartilaginous dorsal and anal pterygiophores was in an anterior and posterior direction. The posterior pterygiophore additions dorsad and ventrad were completed before the anterior additions ceased. The full complement of anal pterygiophores was reached before the full dorsal complement. Dorsal and anal fin rays first originated in the same areas as the pterygiophores, but at larger sizes with addition of rays in the same directions (Table 2).

*Xiphias* did not have predorsal bones. The first dorsal pterygiophore originated from one or two pieces of cartilage and inserted in the second interneural space, supporting from one to three fin spines. The first anal pterygiophore developed from one or two pieces of cartilage, supporting from one to three fin spines. *Xiphias* had no middle radials in the dorsal or anal pterygiophores, but a double ray and a nonbifurcated stay were associated with the posteriormost dorsal and anal pterygiophores (Potthoff and Kelley 1982) (Table 1).

In *Xiphias*, cartilaginous hypurals were first seen before precaudal neural spine development was complete, but after dorsal and anal pterygiophore development had started. The hypural complex development was described by Potthoff and Kelley (1982). Hypurals 1-5 and the parhypural developed from separate cartilages, and there was no cartilage fusion. There were three epurals and one uroneural. Only one autogenous haemal spine was present on preural centrum 2. In adults the three epurals, the uroneural, hypural 5, and the parhypural remained autogenous, but hypurals 1-4 fused with each other and the urostyle forming a notched hypural plate (Gregory and Conrad 1937). The neural and haemal elements of only preural centrum 2 supported the procurrent caudal rays. A procurrent spur and basally foreshortened ray were absent in *Xiphias* (Johnson 1975) (Table 1).

## DISCUSSION AND CONCLUSION

Developmental features observed in our study are illustrated in Figures 4-5 and 9-15. These features along with meristic and osteological characters are compared among the six scombroid families and the primitive percoid *Morone* in Tables 1 and 2. Although our conclusions are still preliminary because of lack of adequate developmental series for many genera, some comparisons, based largely on development, are worth noticing.

There are three major kinds of early development and addition of the cartilaginous neural and haemal arches and spines along the notochord. Each kind may differ slightly between taxa. *Scombrolabrax*, *Scomber* (Scombrini), *Scomberomorus* (Scomberomorini), and Thunnini have one kind in which there are four initial developments on the notochord, but not necessarily in the given order, e.g., anteriorly dorsad, centrally dorsad, centrally ventrad, and posteriorly ventrad with a subsequent merger of the initial areas. Gempylidae, *Sarda* (Sardini), Istiophoridae, and Xiphiidae have a second kind in which there are three initial developments, e.g., anteriorly dorsad, centrally ventrad, and posteriorly ventrad; then the addition is from anterior in a posterior direction with a merger in the posterior, near the hypural complex. *Trichiurus*, which lacks hypurals, has the third kind in which there are two initial developments, e.g., anteriorly dorsad and centrally ventrad with addition in a posterior direction. We could not fully determine the cartilaginous development for *Acanthocybium*, because of an incomplete series, and for trichiurids with tails, because a series was lacking.

In the Scombrobracidae, Gempylidae, and Scombridae, the vertebrae first develop by coalescence of saddle-shaped ossifications positioned dorsad and ventrad. We were not able to observe saddle-shaped ossification in *Acanthocybium* because we lacked specimens. The other scombroid families, Trichiuridae (*Trichiurus*), Istiophoridae, and Xiphiidae, and the primitive percoid *Morone* did not have these saddle-shaped ossifications. Saddle-shaped ossifications have been observed during ontogeny in other perciform fish such as *Enchelyurus brunneolus* (Blenniidae) by Watson<sup>5</sup> and *Lutjanus campechanus* (Lutjanidae) by Potthoff and Kelley<sup>6</sup>. We are unable to comment at this time on the significance of these saddle-shaped ossifications until the ontogeny of many more taxa is studied.

In the Scombrinae two species belonging to two different tribes share a peculiar ossification sequence not observed by us in any other scombroids. Both in *Scomber* (Scombrini) and *Acanthocybium* (Sardini), initial ossification of the neural and haemal arches and spines and the hypural complex started at four locations on the vertebral column (Kramer

<sup>5</sup>Watson, W. Larval development of *Enchelyurus brunneolus* from Hawaiian waters (Pisces: Blenniidae: Omobranchini). Unpubl. manuscr. Marine Ecological Consultants of Southern California, 533 Stevens Avenue, Soloma Beach, CA 92075.

<sup>6</sup>Research on the development of *Lutjanus campechanus* is in progress at the Southeast Fisheries Center Miami Laboratory, National Marine Fisheries Service, NOAA, 75 Virginia Beach Drive, Miami, FL 33149.

1960). In other scombroids initial ossification was only anterior and posterior (*Scomberomorus*, *Sarda*?, *Thunnus*, Istiophoridae) or only anterior (*Scombrolabrax*, Gempylidae, *Trichiurus*, *Xiphias*). We believe that the relationship of *Acanthocybium* to the Sardini should be re-examined in the future.

The Scobrini and *Scombrolabrax* (Figs. 1, 9) share a primitive development in which the second dorsal fin, anal fin, and pterygiophores develop first from a center anteriorly and posteriorly, and the first dorsal fin and pterygiophores develop second, from a center anteriorly and posteriorly in *Scombrolabrax*, but posteriorly only in *Scomber* except for the first dorsal fin spine, which was added later. The Gempylidae, Thunnini, and *Scomberomorus* (Figs. 2, 3, 4, 10, 13) share an advanced development in which the first dorsal fin and pterygiophores develop first from the anteriormost element in a posterior direction, and the second dorsal fin, anal fin, and pterygiophores develop second from a center anteriorly and posteriorly, the first dorsal fin being separate from the second dorsal fin during part of the ontogeny. In *Acanthocybium*, *Sarda*, and Thunnini, the development is similar to the advanced development of the Gempylidae and *Scomberomorus* except in *Acanthocybium*, *Sarda*, and Thunnini, the second dorsal fin spine developed first, the first dorsal fin spine was added later. The first dorsal fin was separate for part of the ontogeny from the second dorsal in *Acanthocybium*, but we were unable to observe this in *Sarda* because of the lack of an adequate size series. In *Trichiurus* (Fig. 5), the dorsal fin and pterygiophores develop from the anteriormost element posteriorly. When dorsal fin development reaches above the anal fin, the anal fin develops from its anteriormost element in a posterior direction. Dorsal and anal fin development then proceed posteriorly at about the same pace. *Trichiurus* has a peculiar developmental feature, which was not observed in any other scombroid. It was that the anteriormost dorsal fin spines and anal spine and rays develop before their corresponding pterygiophores. Pterygiophore development soon overtook fin ray development and during further development more pterygiophores are present than fin rays. In the Istiophoridae and Xiphiidae, dorsal and anal fin development differ from the previously described groups. In the Istiophoridae (Fig. 14) the first dorsal fin and pterygiophores develop first from a center anteriorly and posteriorly. When the posterior portion of the first dorsal fin development reaches above the anterior portion of the anal fin, anal rays and pterygiophores are added mostly pos-

teriorly, although a few elements develop in an anterior direction. The second dorsal fin develops only in a posterior direction consecutive to the first dorsal fin. In *Xiphias* (Fig. 15), the second dorsal and anal fins and pterygiophores develop first from a center anteriorly and posteriorly. Development of the first dorsal fin and pterygiophores then is continuous with the second dorsal fin in an anterior direction only.

The hypurals in all scombroids develop as separate cartilages. Only in *Scombrolabrax* is there no fusion of the hypurals in the adults. In the Gempylidae the extent of the hypural fusion varies for different genera and we did not observe fusion in the cartilaginous state. For the trichiurids with tails, not enough specimens were available to make observations on hypural fusion. In the remaining scombroids (Scombridae, Istiophoridae, Xiphiidae) hypurals 1-4 are fused to one hypural plate in adults. Fusion to one hypural plate came about during ontogeny by fusion of hypurals 1 and 2 to a ventral and hypurals 3 and 4 to a dorsal hypural plate, with subsequent fusion of these into one plate. For the ventral plate, cartilaginous fusion occurs in all tribes of the Scombridae, but in the Istiophoridae fusion is either from cartilaginous or ossifying hypurals 1 and 2 and in *Xiphias* it is always from ossifying hypurals (Table 1). In *Scomber*, *Acanthocybium*, and Istiophoridae, the fusion of hypurals 3 and 4 to the dorsal hypural plate is variable and occurs either during the cartilaginous or ossifying state. In *Sarda* three specimens have fusion of hypurals 3 and 4 in the ossifying state. In *Scomberomorus* and *Thunnus* the fusion to the dorsal hypural plate occurs always in the cartilaginous state, whereas in *Xiphias* it is always in the ossifying state (Table 1).

The number of centra supporting the caudal rays varies in the scombroids. In *Scombrolabrax*, Gempylidae, Trichiuridae with tails, *Scomber*, and Istiophoridae, three vertebrae (including the urostyle) support the caudal rays. In *Xiphias* only two vertebrae support the rays. In the Scombridae more vertebrae are involved with the support of the caudal rays, except in *Scomber*. In the *Scomberomorus* species examined by us, five centra support the rays, but in some species of *Scomberomorus* only four centra are involved (Collette and Russo 1984). In *Acanthocybium* (Collette and Russo 1984) and *Sarda*, five centra are involved with the support of the rays, whereas in *Thunnus* only four centra support the caudal rays (Table 1).

Johnson (fn. 3; in press) is of the opinion that *Scombrolabrax* does not belong in the Scombroidei because it lacks most defining specializations of this

group. Bond and Uyeno (1981) removed *Scombrobrax* from the Scombroidei on the basis of one specialized character. We are of the opinion that *Scombrobrax* should be retained in the Scombroidei until we fully understand the significance of developmental characters. *Scombrobrax* shares many characters with other scombroids, in particular the absence of predorsal bones coupled with the anterior pterygiophore interneural insertion sequence, the saddle-shaped ossifications of the vertebrae, the sequence of neural and haemal arch and spine development and the striking resemblance of *Scombrobrax* to Thunnini larvae.

Gempylid and trichiurid relationships await further study when complete series of larvae of more species become available. We believe that *Gempylus* and *Diplospinus* are similar and very closely related. We also believe that the gempylids and trichiurids are very closely related, the trichiurids representing an advanced gempylid group.

Johnson (in press) has discovered a specialization (a stay on the 4th pharyngobranchial) unique to the Scombridae, Istiophoridae, and Xiphiidae but absent in other Perciformes. From our study we believe that the billfish (*Xiphias* and Istiophoridae) do not belong in the Scombroidei because they differ in many developmental and meristic characters from other scombroid members (Tables 1, 2). However, until more developmental studies are done to determine the meaning and significance of developmental characters, it would be premature to suggest rearranging the Scombroidei.

The full value of early developmental studies for systematic purposes will be realized when similar studies have been completed on a greater variety of fishes. Only then will we be able to interpret the meaning and significance of some developmental characters presented here.

## ACKNOWLEDGMENTS

We thank G. L. Beardsley, B. B. Collette, A. C. Jones, G. D. Johnson, and W. J. Richards for critically reading the manuscript and P. Fisher for typing many drafts of the manuscript. We thank B. B. Collette, R. H. Gibbs, M. F. Gomon, G. D. Johnson, W. J. Richards, and J. L. Russo for providing gempylid and trichiurid fishes for clearing and staining. The *Scomberomorus* and *Acanthocybium* material was loaned to us by M. Leiby and J. Gartner from the SEAMAP collections. M. P. Fahay, G. H. Moser, and B. Sumida MacCall generously provided *Scomber* and *Sarda* specimens.

## LITERATURE CITED

- BOND, C. E., AND T. UYENO.  
1981. Remarkable changes in the vertebrae of perciform fish *Scombrobrax* with notes on its anatomy and systematics. *Jpn. J. Ichthyol.* 28:259-269.
- COLLETTE, B. B., AND L. N. CHAO.  
1975. Systematics and morphology of the bonitos (*Sarda*) and their relatives (Scombridae, Sardini). *Fish. Bull., U.S.* 73: 516-625.
- COLLETTE, B. B., AND J. L. RUSSO.  
1984. Morphology, systematics and biology of the spanish mackerels (*Scomberomorus*, Scombridae). *Fish. Bull., U.S.* 82:545-692.
- COLLETTE, B. B., T. POTTHOFF, W. J. RICHARDS, S. UYEYANAGI, J. L. RUSSO, AND Y. NISHIKAWA.  
1984. Scombroidei: development and relationships. *In* H. G. Moser, W. J. Richards, D. M. Cohen, M. P. Fahay, A. W. Kendall, Jr., and S. L. Richardson (editors), *Ontogeny and systematics of fishes*, p. 591-620. *Am. Soc. Ichthyol. Herpetol., Spec. Publ.* 1.
- CONRAD, G. M.  
1938. The osteology and relationships of the wahoo (*Acanthocybium solandri*), a scombroid fish. *Am. Mus. Nov.* 1000, p. 1-32.
- FRITZSCHE, R. A., AND G. D. JOHNSON.  
1980. Early osteological development of white perch and striped bass with emphasis on identification of their larvae. *Trans. Am. Fish. Soc.* 109:387-406.
- GOSLINE, W. A.  
1968. The suborders of perciform fishes. *Proc. U.S. Natl. Mus.* 124(3647):1-78.
- GREENWOOD, P. H., D. E. ROSEN, S. H. WEITZMAN, AND G. S. MYERS.  
1966. Phyletic studies of teleostean fishes, with a provisional classification of living forms. *Bull. Am. Mus. Nat. Hist.* 131:341-355.
- GREGORY, W. K., AND G. M. CONRAD.  
1937. The comparative osteology of the swordfish (*Xiphias*) and the sailfish (*Istiophorus*). *Am. Mus. Novit.* 952, p. 1-25.
- JOHNSON, G. D.  
1975. The procurrent spur: an undescribed perciform caudal character and its phylogenetic implications. *Occas. Pap. Calif. Acad. Sci.* 121, p. 1-23.  
*In press.* Scombroid phylogeny: an alternative hypothesis. *Bull. Mar. Sci.* 39.
- KOHNO, H., M. SHIMIZU, AND Y. NOSE.  
1984. Morphological aspects of the development of swimming and feeding functions in larval *Scomber japonicus*. *Bull. Jpn. Soc. Sci. Fish.* 50:1125-1137.
- KRAMER, D.  
1960. Development of eggs and larvae of Pacific mackerel and distribution and abundance of larvae 1952-56. *U.S. Fish Wildl. Serv., Fish. Bull.* 60:393-438.
- LECCIA, F. M.  
1958. The comparative osteology of the scombroid fishes of the genus *Scomberomorus* from Florida. *Bull. Mar. Sci. Gulf. Caribb.* 8:299-341.
- LEIS, J. M., AND W. J. RICHARDS.  
1984. Acanthuroidei: development and relationships. *In* H. G. Moser, W. J. Richards, D. M. Cohen, M. P. Fahay, A. W. Kendall, Jr., and S. L. Richardson (editors), *Ontogeny and systematics of fishes*, p. 547-551. *Am. Soc. Ichthyol. Herpetol. Spec. Publ.* 1.

- MATSUBARA, K., AND T. IWAL.  
1958. Anatomy and relationships of the Japanese fishes of the family Gempylidae. Mem. Coll. Agric. Kyoto Univ., Fish. Ser. Spec. No., p. 23-54.
- MATSUMOTO, W. M., E. H. AHLSTROM, S. JONES, W. L. KLAWE, W. J. RICHARDS, AND S. UEYANAGI.  
1972. On the clarification of larval tuna identification, particularly in the genus *Thunnus*. Fish. Bull., U.S. 70:1-12.
- MERRETT, N. R.  
1971. Aspects of the biology of billfish (Istiophoridae) from the equatorial western Indian Ocean. J. Zool. 163:351-395.
- NAKAMURA, I., AND E. FUJII.  
1983. A new genus and species of Gempylidae (Pisces: Perciformes) from the Tonga Ridge. Publ. Seto Mar. Biol. Lab. 27(4/6, Art. 10):173-191.
- OKIYAMA, M., AND S. UEYANAGI.  
1978. Interrelationships of scombroid fishes: an aspect from larval morphology. Bull. Far Seas Res. Lab. 16, p. 103-113.
- POTTHOFF, T.  
1975. Development and structure of the caudal complex, the vertebral column, and the pterygiophores in the blackfin tuna (*Thunnus atlanticus*, Pisces Scombridae). Bull. Mar. Sci. 25:205-231.  
1984. Clearing and staining techniques. In H. G. Moser, W. J. Richards, D. M. Cohen, M. P. Fabay, A. W. Kendall, Jr., and S. L. Richardson (editors), Ontogeny and systematics of fishes, p. 35-37. Am. Soc. Ichthyol. Herpetol., Spec. Publ. 1.
- POTTHOFF, T., AND S. KELLEY.  
1982. Development of the vertebral column, fins and fin supports, branchiostegal rays, and squamation in the swordfish, *Xiphias gladius*. Fish. Bull., U.S. 80:161-186.
- POTTHOFF, T., AND W. J. RICHARDS.  
1970. Juvenile bluefin tuna, *Thunnus thynnus* (Linnaeus), and other scombrids taken by terns in the Dry Tortugas, Florida. Bull. Mar. Sci. 20:389-413.
- POTTHOFF, T., W. J. RICHARDS, AND S. UEYANAGI.  
1980. Development of *Scombrobrax heterolepis* (Pisces, Scombrobracidae) and comments on familial relationships. Bull. Mar. Sci. 30:329-357.
- RICHARDS, W. J.  
1974. Evaluation of identification methods for young billfishes. In R. S. Shomura and F. Williams (editors), Proceedings of the International Billfish Symposium, Kailua-Kona, Hawaii, 9-12 August 1972, Part 2. Review and contributed papers, p. 62-72. U.S. Dep. Commer., NOAA Tech. Rep. NMFS SSRF-675.
- RICHARDS, W. J., AND W. L. KLAWE.  
1972. Indexed bibliography of the eggs and young of tunas and other scombrids (Pisces, Scombridae), 1880-1970. NOAA Tech. Rep. NMFS SSRF-652, 107 p.
- RICHARDS, W. J., AND T. POTTHOFF.  
1974. Analysis of the taxonomic characters of young scombrid fishes, genus *Thunnus*. In J. H. S. Blaxter (editor), The early life history of fish, p. 623-648. Springer-Verlag, Berlin, Heidelberg, New York.
- SATO, S.  
1983. Identificação, Distribuição e desenvolvimento larval de "Lanceta" *Thyrstlops lepidopoides* (Cuvier, 1931) (Pisces: Gempylidae) da região compreendida entre cabo frio (23°S) e cabo de sta. Marta Grande (29°S). M.S. Thesis, Univ. São Paulo, Brasil, 64 p.

# AGE AND GROWTH OF THE MARINE CATFISH, *NETUMA BARBA* (SILURIFORMES, ARIIDAE), IN THE ESTUARY OF THE PATOS LAGOON (BRASIL)<sup>1</sup>

ENIR GIRONDI REIS<sup>2</sup>

## ABSTRACT

Otolith cross sections from *Netuma barba* were used for age and growth determinations. There is close agreement between average back-calculated lengths and average observed lengths determined from otoliths at capture for each year class. One opaque and one hyaline zone is formed annually. The hyaline zone appears to be formed during the breeding season when the estuarine mature population is scarcely feeding. Von Bertalanffy growth parameters were estimated through Beverton's method which showed the smallest residual variance between observed and calculated lengths for year class. The growth equation (mm) is  $L_t = 638 [1 - \exp(-0.1287(t + 0.195))]$ . The largest specimen observed was a 980 mm female, 36 years old. The life span of *N. barba* was estimated to be 23.1 years and the natural mortality rate 0.13.

The sea catfish, *Netuma barba* (Lacepède 1803), ranges in the western Atlantic from Bahia (lat. 17°00'S) in Brasil (Günther 1864) to San Blas (lat. 40°32'S) Argentina (López and Bellisio 1965). It is the second most important estuarine fishery resource in the Patos Lagoon and is caught with gill nets (Reis 1982a). The species accounts for about 29% of the total fish landings in the estuary from October to December, a period when it migrates from the sea to spawn. During the remaining months the species is dispersed in low abundance in the ocean (Reis in press). Observations on *Netuma barba* in Brasil have been restricted to taxonomy (Higuchi et al. 1982) and to feeding and reproduction (Ihering 1888, 1896; Nomura and Menezes 1964; Reis in press).

Age determinations in catfishes are usually based on reading vertebrae and pectoral or dorsal spines (Pantulu 1962; Tweddle 1975). Pectoral spines of *Netuma barba* were not used in the present study because they showed inconsistencies in age determination. However, a preliminary investigation revealed the presence of clear and readable zones in otoliths. This paper deals with the interpretation of these zones, the possible causes of zone formation, and the determination of growth of *Netuma barba* in the estuary of the Patos Lagoon.

## MATERIALS AND METHODS

### Study Area

The Patos Lagoon, the largest lagoon system in southern Brasil (10,360 km<sup>2</sup>), is connected to the Atlantic Ocean by a narrow access canal (Fig. 1). The estuary of the lagoon serves as a breeding, nursery, and feeding ground for most of the coastal fish which migrate through the canal and represent a significant percentage of the national fishery resource.

Collections of adult *Netuma barba* were made from fish-processing plants located in the estuarine zone of the lagoon, off the coast of Rio Grande to São Lourenço do Sul, a town located 94 km inland (Fig. 1). Juveniles were collected by special research surveys carried out in the estuary. Data were collected from September 1977 to December 1980 on 4,120 specimens. No samples were available from January to March because of a closed fishing season of Ariidae in the area, and few samples were collected from April to July due to the absence of the species in the estuary.

### Sampling Procedure

Specimens were measured (total length, mm), weighed (g), and sexed. Lapillus otoliths were removed, sectioned transversally next to the nucleus, polished, and were examined under a 10× binocular microscope. The dorsal, polished half of the otoliths was observed with transmitted light. The

<sup>1</sup>Based on a thesis in partial fulfillment of the requirements for the MS degree, Fundação Universidade do Rio Grande - Rio Grande (Brasil).

<sup>2</sup>Departamento de Oceanografia, Fundação Universidade do Rio Grande, Caixa Postal 474, 96200 - Rio Grande - RS, Brasil.

## ESTUARY OF THE PATOS LAGOON

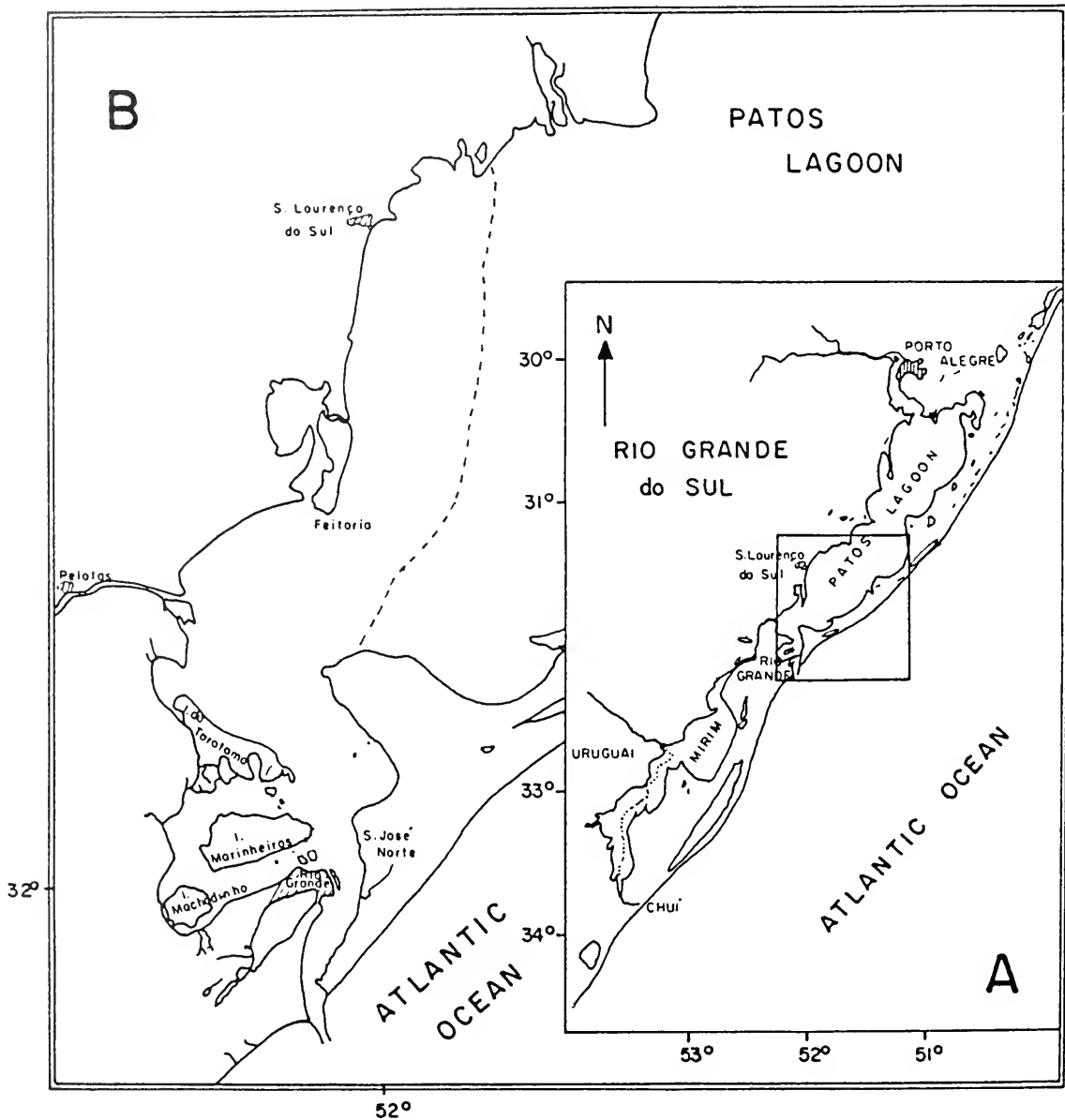

FIGURE 1.—Coastal lagoon system of southern Brasil (A) and the study area (B).

type of deposit (opaque or hyaline) on the otolith margin and the number of hyaline zones were recorded for each otolith. Back-calculation was done over the surface, the total length of the otolith ( $C_0$ ) and the length between the nucleus and each hyaline zone ( $c_i$ ) (Fig. 2) were measured with an ocular micrometer. The term nucleus used here refers to the central area of the otolith limited by the first zone (Jearld 1983).

Growth curves for males and females were calculated using the mean lengths for year class. The parameters of the von Bertalanffy growth equation were determined:

$$Lt = L_{\infty} [1 - e^{-K(t-t_0)}] \quad (1)$$

where  $Lt$  is the total length at time  $t$ ,  $L_{\infty}$  is the maximum attainable size,  $K$  is the growth coefficient,

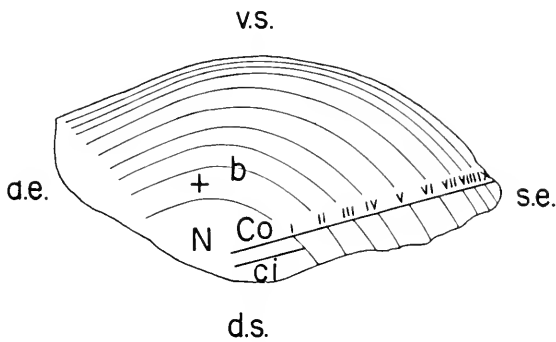

FIGURE 2.—A lapillus otolith of *Netuma barba* showing opaque (+) and hyaline (b) zones, the nucleus (N), the axes where back-calculation was made (Co = distance between the nucleus and the otolith's edge; ci = distance from the nucleus to "i" hyaline zone) and the position of otolith on fish head (a.e. = antisulcal end; s.e. = sulcal end; d.s. = dorsal surface; v.s. = ventral surface; and hyaline zones = I-IX).

cient, and  $t_0$  a correction on the time axis. The parameters of Equation (1) were estimated by determining the predictive regression of  $\ln(L_\infty - Lt)$  against  $t$  (Beverton 1954):

$$\ln(L_\infty - Lt) = \ln L_\infty + K(t_0 - t) \quad (2)$$

where  $K$  is the slope of the regression line and the  $y$ -intercept of Equation (2) can be equated to  $\ln L_\infty + Kt_0$  providing the value of  $t_0$  (Ricker 1975). Trial plots, including values of  $L_\infty$  first derived by the methods of Walford (1946) and Gulland (1964), yielded the  $L_\infty$  which gives the straightest line. The agreement between observed and calculated lengths for year class was determined by residual variance ( $S^2y$ ) expressed by

$$S^2y = \frac{\sum (\text{observed } Lt - \text{calculated } Lt)^2}{N - 1} \quad (3)$$

where  $N$  is the number of age classes.

Length-weight relationship was determined for males and females

$$Wt = \mu Lt^v \quad (4)$$

where  $Wt$  is the weight at time  $t$ , and  $\mu$  and  $v$  the coefficients of the functional regression between  $Wt$  and  $Lt$  (Ricker 1973). The condition factor was calculated for each sex as follows:

$$K = \frac{Wt}{Lt^v} \quad (5)$$

and

$$Wt = W_\infty [1 - e^{-K(t-t_0)^v}] \quad (6)$$

expressed growth in weight, where  $W_\infty$  is the maximum attainable weight obtained by solving for  $L_\infty$  in Equation (4).

The life span was estimated:

$$A_{0.95} = t_0 - \frac{\ln(1 - P)}{K} \quad (\text{Taylor 1960}) \quad (7)$$

where  $A_{0.95}$  is the time required to attain 95% of  $L_\infty$ ,  $P = 0.95$  and  $t_0$  and  $K$  are derived from the growth equation. The natural mortality coefficient ( $M$ ) was estimated according to Taylor (1960)

$$M = \frac{\ln(1 - P)}{A_{0.95}} \quad (8)$$

Statistical analyses were done when necessary (Snedecor and Cochran 1970; Sokal and Rohlf 1981).

## RESULTS AND DISCUSSION

### Age Determination

The lapillus otolith used for the determination of age of *Netuma barba* is the most developed ear bone in the Ariidae (Stinton 1975), its length attaining 3% of fish fork length (Reis 1982b). Growth zones can be observed on a sectioned otolith from the sulcal to the antisulcal end and from the nucleus on the dorsal face to the ventral one (Fig. 2). The hyaline and opaque zones are clearly evident even in otoliths of old specimens. Under transmitted light the opaque zones, or fast-growth zones, are white (broad) and hyaline zones, or slow-growth zones, are dark (narrow) (Fig. 2). Warburton (1978) counted growth checks on whole otoliths of *Galeichthys caeruleus* (Günther), and Dmitrenko (1975) studied *Arius thalassinus* (Rüppel) by viewing the otoliths the same way as in the present paper. The number of hyaline zones on sectioned otoliths and of growth checks observed on whole otoliths (Warburton 1978) were compared. A smaller number of growth checks was encountered in all cases when using whole otoliths.

In the present study only 2.4% of the otoliths were considered illegible. About 60% agreement was obtained when otoliths were read on two different occasions separated by a month. Disagreement was due to the inability to distinguish the first hyaline zone and those near the otolith's edge. When the same otoliths were analyzed for the third time, the

agreement between observations increased to 79.9%.

### Time of Zone Formation

The percentage of hyaline and opaque edged otoliths was plotted for each month (Fig. 3). Otoliths showing hyaline edge are more abundant in December when they comprise 63.7% of the total; opaque edged otoliths are fewer in this month (33.9%). Student's *t*-test (Snedecor and Cochran 1970) showed that proportions between hyaline and opaque edged otoliths differ significantly ( $P < 0.05$ ) for most months (Fig. 3). Also, the mean width of the opaque

zone on the otolith edge decreased towards the end of the year (Fig. 4), indicating a recent hyaline zone formation. The period of zone formation is not the same for all individuals, the result of individual growth differences. It is evident, however, that only one hyaline and one opaque zone is formed each year. Formation of slow-growth zones during warm months in *Netuma barba* coincides with the spawning period and the cessation of feeding activity (Reis in press). Both events suggest a decrease or a pause in growth when hyaline zones are formed. Menon (1953) observed that decreased feeding and gonad maturation may cause a periodic formation of the growth marks in skeletal parts of fish. During the

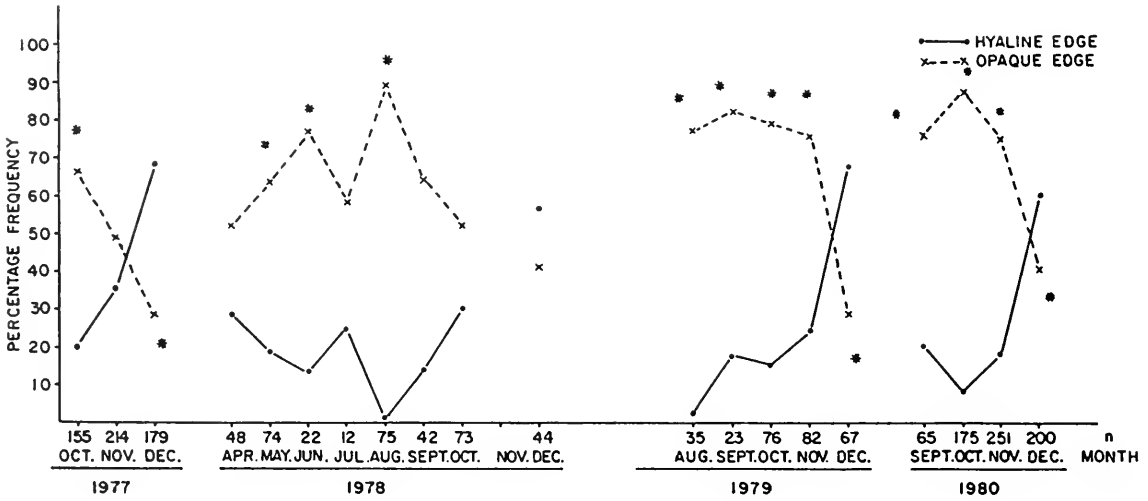

FIGURE 3.—Percentage of hyaline and opaque edge on otoliths of *Netuma barba* related to the months of four years (\*  $P < 0.05$ ;  $n$  = number of specimens).

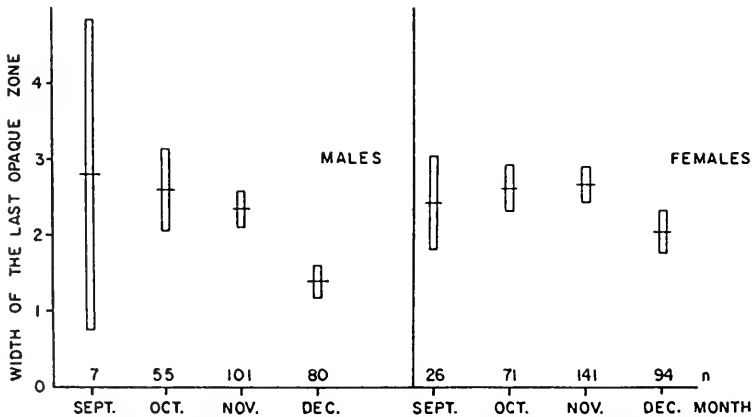

FIGURE 4.—Mean width and confidence limits at  $P < 0.05$  level of the last opaque zone on otolith's edge for males and females of *Netuma barba* ( $n$  = number of specimens).



remaining months, when *Netuma barba* is at sea actively feeding and the gonads are resting (Reis in press), the opaque zones appear to be laid down due to fast somatic growth. According to Pannella (1974), fishes of temperate environments tend to form opaque zones or fast-growth zones during warm months but the synonymy of the terms summer and opaque, winter and hyaline has to be demonstrated in each instance rather than accepted as a general fact. For *Netuma barba* slow-growth zones are formed during warm months and may be related to the maturation of the gonads and a pause in feeding activity. Gonad maturation may be one of the causative factors of hyaline formation in adults; however, a plausible cause still needs to be established for immature specimens.

## GROWTH

### Growth in Length

Sectioned otolith lengths (measured as shown in Figure 2), and fish lengths were best fitted to the power curve:

$$Lt = 1.89 Co^{1.047} \quad r = 0.960; \quad n = 689,$$

and the equation for back-calculation was

$$Lt i = Lt \left( \frac{ci}{Co} \right)^{1.047}$$

where  $Lt i$  is the length of fish when zone "i" was formed. Observed and back-calculated mean lengths for year class for each sex increase as one opaque and one hyaline zones are formed in the otolith each year (Table 1). Up to age 11, the mean lengths are similar; older females had mean lengths greater than males. The same was true for mean weight although a small number of specimens were analyzed from age 11 onward. Observed lengths are usually higher than back-calculated lengths except in ages that few specimens were analyzed.

Lengths corresponding to ages 8 to 12 are most frequent in the samples since they are most affected by the mesh size of the fishing gear used in the estuary. Mean observed lengths at these ages agree closely with mean back-calculated lengths (Fig. 5) for both sexes. Gill nets are highly size selective and retain fish at lengths of 370-520 mm (Reis 1982a). The analysis of variance (Sokal and Rohlf 1981) showed that observed lengths at ages 5, 6, and 7 are significantly higher than back-calculated lengths ( $P < 0.05$ ) which could be due to the capture of the

largest specimens of these ages since the minimum size of fish held by gill nets depends on the maximum body girth (opercle). Mean back-calculated lengths showed no definitive tendencies for any age class (Fig. 6) indicating no growth changes. Fur-

TABLE 1.—Mean observed and back-calculated lengths of males and females of *Netuma barba* for each age class (sample size in parentheses).

Estimated age	Mean observed length		Mean back-calculated length	
	Male	Female	Male	Female
1	84 ( 10)	96 ( 4)	65 (310)	63 (370)
2	145 ( 31)	152 ( 21)	140 (303)	137 (371)
3	203 ( 40)	197 ( 50)	193 (295)	192 (362)
4	228 ( 7)	261 ( 2)	244 (291)	245 (359)
5	348 ( 16)	146 ( 1)	300 (286)	299 (357)
6	378 ( 28)	365 ( 11)	347 (281)	347 (349)
7	403 ( 59)	394 ( 56)	386 (263)	385 (336)
8	415 (144)	416 (111)	413 (241)	412 (313)
9	433 (291)	431 (281)	430 (140)	433 (193)
10	452 ( 94)	463 (120)	444 ( 79)	446 (129)
11	476 ( 73)	493 (138)	455 ( 31)	462 ( 54)
12	490 ( 57)	526 ( 51)	460 ( 8)	507 ( 8)
13	464 ( 15)	602 ( 23)	508 ( 4)	612 ( 3)
14	551 ( 10)	667 ( 21)	480 ( 3)	637 ( 2)
15	522 ( 13)	622 ( 5)	520 ( 2)	578 ( 1)
16	533 ( 10)	620 ( 3)	528 ( 1)	608 ( 1)
17	494 ( 2)	647 ( 2)	546 ( 1)	637 ( 1)
18	620 ( 1)	714 ( 1)	564 ( 1)	657 ( 1)
19	588 ( 4)	554 ( 3)	—	666 ( 1)
20	550 ( 1)	860 ( 1)	—	696 ( 1)
21	520 ( 2)	520 ( 2)	—	706 ( 1)
22	490 ( 1)	649 ( 1)	—	—
23	—	736 ( 1)	—	—
24	680 ( 1)	—	—	—
36	930 ( 1)	980 ( 1)	—	—

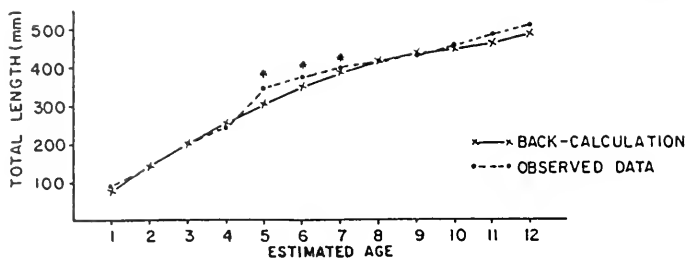

FIGURE 5.—Mean observed and back-calculated lengths for year class of *Netuma barba* (\*  $P < 0.05$ ).

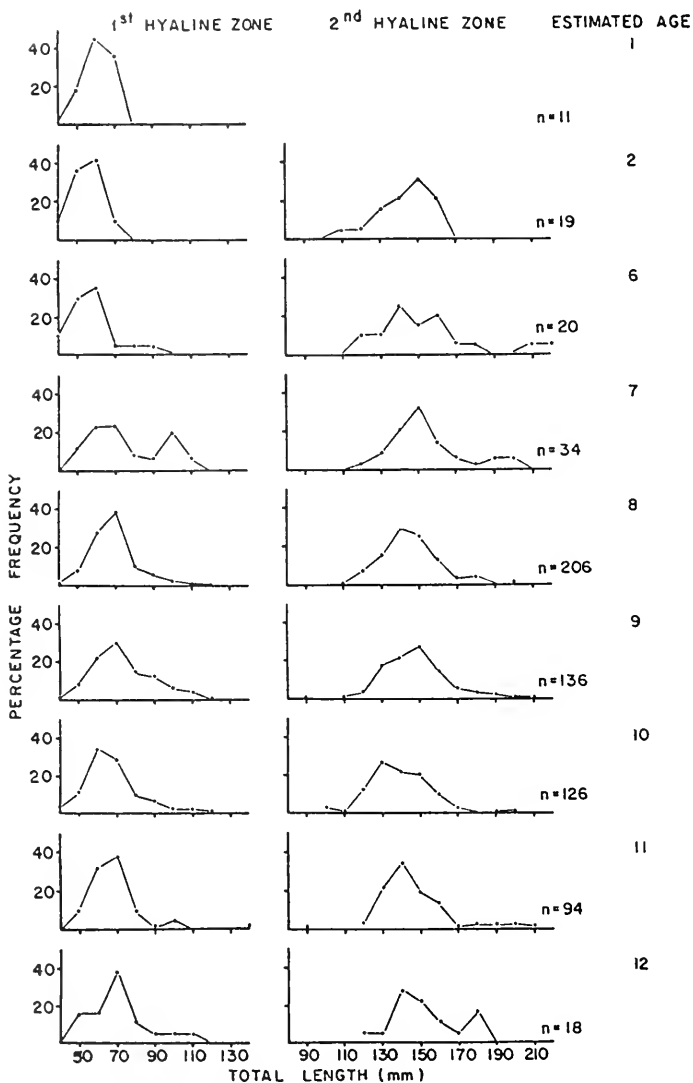

FIGURE 6.—Back-calculated lengths frequencies at first and second hyaline zones for year class of *Netuma barba* (n = number of specimens).

thermore, as the modes for each year class are similar, age determination can be considered consistent.

### Validation of Age

Validation of the otolith method for aging *Netuma*

barba is supported by the following: 1) one opaque and one hyaline zone is formed annually (Figs. 3, 4); 2) a gradual decrease of length increments with age (Table 1); 3) observed lengths generally agree with back-calculated lengths (Fig. 5); and 4) distribution of back-calculated lengths for previous ages shows similar modes for each year class (Fig. 6).

### Length-weight Relationship and Condition Factor

A total of 685 specimens captured during 1980 was used to compute the length-weight relationship for each sex:

Male	$Wt = 4.70 \times 10^{-6} Lt^{3.14}$	$r = 0.992$	$n = 332$
Female	$Wt = 2.19 \times 10^{-6} Lt^{3.26}$	$r = 0.952$	$n = 363$
Total	$Wt = 4.41 \times 10^{-6} Lt^{3.15}$	$r = 0.987$	$n = 685$

The analysis of covariance (Snedecor and Cochran 1970) at  $P < 0.05$  level showed significant difference only for the  $\mu$  value, and for that reason condition factor ( $K$ ) was determined for each sex. There is a decrease of mean  $K$  values towards the end of the year (Fig. 7). The condition factor for males is always higher probably due to a more intense feeding and fat reserves are being diverted to gonad maturation (Reis in press), thereby causing a cessation of growth. I proposed that  $K$  values for males will sharply decrease after spawning due to an oral incubation period that lasts 1 to 2 mo and prevents males from feeding (Reis in press).

### Calculation of Growth Parameters

Von Bertalanffy growth parameters were estimated by Beverton's (1954) method which presented the smallest residual variance between observed and calculated lengths for year class on the ages that are most affected by gear selectivity (8-12 yr old). For fish populations captured from a certain age onward, the smallest residual variance should be sought for all year classes from age at first capture. For *Netuma barba* the smallest residual variance could not be ascertained by this method because the true length distribution is unknown due to the use of gillnets as fishing gear. Growth equation for age 1 to 12 for both sexes is represented by

$$Lt = 638 [1 - e^{-0.1287(t+0.195)}].$$

Figure 8 shows both calculated and observed lengths for each year class.

Growth in weight for each sex resulted in

Male	$Wt = 2981.89 [1 - e^{-0.1287(t+0.195)}]^{3.14}$
Female	$Wt = 3035.70 [1 - e^{-0.1287(t+0.195)}]^{3.26}$

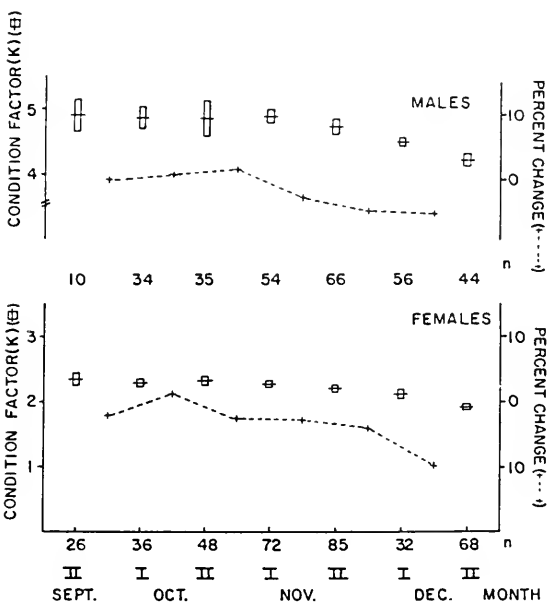

FIGURE 7.— $K$  condition factor and percent change for males and females of *Netuma barba* related to time ( $n$  = number of specimens; I = first half of the month; II = second half of the month)

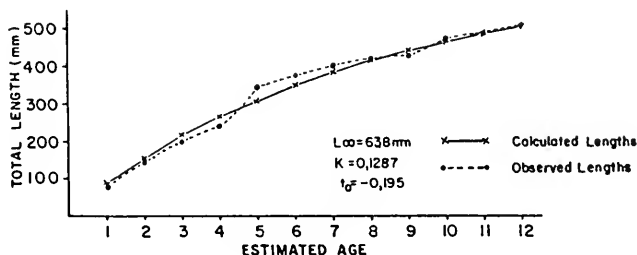

FIGURE 8.—Growth curve of *Netuma barba*.

## Maximum Size and Age, Life Span, and Mortality Rate

*Netuma barba* is a long lived, slow growing species with a low mortality rate. Specimens as long as the theoretical mean length (638 mm) are frequently captured. The largest catfish observed was a 980 mm female 36 yr old. *Netuma barba* life span was estimated to be 23.1 yr and its mortality rate was 0.13. I assumed that the estimate of M (natural mortality) is accurate, since *Netuma barba* reveals a long life span, a capacity to avoid predation through the defense represented by its hard dorsal and pectoral spines and a parent-juvenile care behavior (Reis in press). Pauly (1980) suggested that species with low mortality rates are related to high  $L_{\infty}$  values and to low growth coefficients. These characteristics combined with the fact that *Netuma barba* has a low fecundity (Reis in press) define the species as K-strategistic (Gunderson 1980).

### ACKNOWLEDGMENTS

I am greatly indebted to J. P. Castello for his assistance and valuable suggestions and to the staff of Fisheries Biology Laboratory, Department of Oceanography, Fundação Universidade do Rio Grande.

### LITERATURE CITED

- BEVERTON, R. J. H.  
1954. Notes on the use of theoretical models in the study of the dynamics of exploited fish populations. U.S. Fish. Lab., Beaufort, N.C., Misc. Contrib. 2, 159 p.
- DMITRENKO, E. M.  
1975. Size-age composition of the giant catfish, *Arius thalassinus* in the vicinity of Kathiawar Peninsula (India). Vopr. Ikhtiol. 15:695-702.
- GULLAND, J. A.  
1964. Manual of methods for fish population analysis. FAO Fish. Tech. Pap. 40, 61 p.
- GUNDERSON, D. R.  
1980. Using r-K selection theory to predict natural mortality. Can. J. Fish. Aquat. Sci. 37:2266-2271.
- GUNTHER, A.  
1864. Catalogue of the fishes in the British Museum. 5. Catalogue of the Physostomi; Ariina. Br. Mus., p. 138-182.
- HIGUCHI, H., E. G. REIS, AND F. G. ARAUJO.  
1982. A new species of marine catfish from the coast of Rio Grande do Sul, with comments on the nominal genus *Netuma* Bleeker, 1858 of the Southwest Atlantic (Siluriformes, Ariidae). Atlantica 5(1):1-15.
- HERING, H., VON.  
1888. Ueber Brutplage und Entwicklung des bagre (*Arius commersoni*). Biol. Cent. 8:268-271.  
1896. Os peixes da costa do mar do Estado do Rio Grande do Sul. Rev. Mus. Paul. 2:25-63.
- JEARLD, A., JR.  
1983. Age determination. In L. A. Nielsen and D. L. Johnson (editors), Fisheries techniques, p. 301-324. Am. Fish. Soc., Southern Print. Co., VA.
- LÓPEZ, R. B., AND N. B. BELLISIO.  
1965. Contribucion al conocimiento del *Tachysurus barbuis* (Lacepede), bagre del mar argentino (Pisces, Ariidae). In Anais II Congreso Latino-Americano Zoologia, p. 145-153.
- MENON, M. D.  
1953. The determination of age and growth of fishes of tropical and subtropical waters. J. Bombay Elist. Sec. 51: 623-635.
- NOMURA, H., AND N. A. MENEZES.  
1964. Peixes marinhos. In P. E. Vanzolini (editor), História natural dos organismos aquáticos do Brasil, p. 343-386. São Paulo.
- PANNELLA, G.  
1974. Otolith growth patterns: An aid in age determination in temperate and tropical fishes. In T. B. Bagenal (editor), The ageing of fish, p. 13-27. Proc. Int. Symp. Ageing Fish, Univ. Reading, Engl.; Unwin Brothers, Ltd., Engl.
- PANTULU, V. R.  
1962. On the use of pectoral spines for the determination of age and growth of *Pangasius pangasius* (Hamilton Buch). J. Cons. Int. Explor. Mer 27:192-216.
- PAULY, D.  
1980. On the interrelationship between natural mortality, growth parameters, and mean environmental temperature in 175 fish stocks. J. Cons. Int. Explor. Mer 39:175-192.
- REIS, E. G.  
1982a. Idade, crescimento e reprodução de *Netuma barba* (Siluriformes, Ariidae) no estuário da Lagoa dos Patos (RS). M.S. Thesis, Fundação Universidade do Rio Grande, Brasil, 114 p.  
1982b. Anatomy of the inner ear of *Netuma barba* (Lacepede, 1803), Siluriformes, Ariidae. Atlantica 5(1):16-22.  
In press. Reproduction and feeding habits of the marine catfish *Netuma barba* (Siluriformes, Ariidae) in the estuary of the Lagoa dos Patos, Brasil. Atlantica.
- RICKER, W. E.  
1973. Linear regressions in fishery research. J. Fish. Res. Board Can. 30:409-434.  
1975. Computation and interpretation of biological statistics of fish populations. Fish. Res. Board Can. Bull. 191:1-382.
- SNEDECOR, G. W., AND W. G. COCHRAN.  
1970. Metodos estadísticos aplicados a la investigacion agricola y biologica. 3d ed. Ed. Cont., Mex., 626 p.
- SOKAL, R. R., AND F. J. ROHLF.  
1981. Biometry. 2d ed. W. H. Freeman & Co., N.Y., 859 p.
- STINTON, F. C.  
1975. Fish otoliths from the English Eocene. Palaentogr. Soc. Monog. (Lond.), p. 1-56.
- TAYLOR, C. C.  
1960. Temperature, growth and mortality - the Pacific cockle. J. Cons. Int. Explor. Mer 26:117-124.
- TWEDDLE, D.  
1975. Age and growth of the catfish *Bagrus meridionalis* Günther in southern Lake Malawi. J. Fish. Biol. 7:677-685.
- WALFORD, L.  
1946. A new graphic method of describing the growth of animals. Biol. Bull. (Woods Hole) 90:141-147.
- WARBURTON, K.  
1978. Age and growth determination in a marine catfish using an otolith check technique. J. Fish. Biol. 13:429-434.

# MONITORING THE SEA SURFACE CHLOROPHYLL CONCENTRATION IN THE TROPICAL PACIFIC: CONSEQUENCES OF THE 1982-83 EL NIÑO

YVES DANDONNEAU<sup>1</sup>

## ABSTRACT

The sea surface chlorophyll concentration (SSCC) is routinely measured in the tropical Pacific using filtrations made aboard merchant ships that sail from New Caledonia to Japan, North America, Panama, New Zealand, and Australia. About 4,000 measurements are collected every year, allowing a tentative monitoring of SSCC in the Pacific. Heavy smoothing made it possible to map quarterly charts of SSCC which cover the 1982-83 El Niño episode. The usually enriched belt which corresponds to the equatorial upwelling vanished after September 1982, except for a reduced zone east of long. 120°W, where a moderate enrichment persisted throughout the warm event. It recovered after July 1983, spreading westwards to long. 170°E. During the mature phase of El Niño (October 1982-June 1983), an enriched zone appeared in the western Pacific, centered at about lat. 7°N, consistent with a rise of the thermocline in this region. An examination of oceanographic data collected in this region since 1970 shows that nutrients from below the thermocline are consumed by the phytoplankton during each El Niño. This western Pacific enrichment was weakened with time, and the period from April to June 1983 was characterized by low SSCC values over most of the tropical Pacific. Unusually high SSCC values are reported in subtropical zones, during the austral winters of 1982 and 1983 in the southwestern Pacific and during the 1982 autumn in the northeastern Pacific, which may be due to advection of rich water from higher latitudes and to intensified vertical mixing by strong westerly winds, respectively.

El Niño was first observed and experienced in Peru, where it was given its name and became a familiar part of Peruvian life. Although the southern oscillation was identified more than 60 yr ago (Walker 1924), the relation between the El Niño phenomenon and ocean-scale features was only established after the 1957-58 event by Bjerknes (1966). It is now well established that El Niño is simply the most obvious consequence of important oceanographic and meteorological changes in the Pacific Ocean (Donguy and Henin 1976; Quinn et al. 1978; Cane 1983). One would expect biological changes at the same scale. These, however, have only been studied in the eastern Pacific (Walsh 1981; Chelton et al. 1982; Barber and Chavez 1983) where a pronounced decrease in phytoplankton biomass and primary production is observed. Farther west in the equatorial zone, the decrease in primary productivity has been shown only by indirect observations on marine birds (Schreiber and Schreiber 1984) and on abnormal distributions of some fishing grounds in relation to changes of water mass (Donguy et al. 1978; Yamana 1984). The difficult problem of monitoring the intensity of primary production on a large scale is

usually reserved for satellite-borne sensors. A modest attempt, however, is in progress, as a part of the SURTROPAC program (ORSTOM, Nouméa) based upon chlorophyll samples taken by voluntary observers on ships of opportunity. Each year about 4,000 sea surface chlorophyll concentrations (SSCC) are collected in this way, distributed along maritime lanes from the Tasman Sea to Panama, North America, or Japan. These data cover the tropical Pacific from lat. 30°S to 30°N, and from long. 140°E to 80°W. There are large gaps both in space, between the main lanes, and in time, between consecutive crossings. But, on a quarterly basis, the SSCC data are numerous enough to allow a crude view of the whole tropical Pacific Ocean, with the advantage of using a single methodology. The consequences of the 1982-83 El Niño can thus be examined, and most of the attention will be directed towards the central and western Pacific, where present knowledge is very incomplete.

## METHODS

### Chlorophyll Measurements

SSCC measurements are made according to a non-extractive method (Dandonneau 1982). Twenty milli-

<sup>1</sup>Groupe SURTROPAC, Centre ORSTOM, B.P. A5, Nouméa, New Caledonia.

687-695

liters of seawater are filtered on 13 mm HAWP Millipore filters, using a syringe and Swinnex type filtering cartridges. The filters are then stored in a dark place at ambient temperature. When the observing ship reaches Nouméa, the filters are taken to the laboratory for fluorescence measurements. A 3-wk minimum time lag is needed between filtration and measurement, after which degradation processes lead to stable fluorescent chlorophyll by-products on the filters. The fluorescence ( $Ff$ ) of the filters is then measured without extraction, using a specially adapted sample holder.

The measurement error  $e$  is proportional to the chlorophyll concentration  $C$  and can be expressed as  $e = |\text{SSCC}-C|/C$  where SSCC is measured by the non-extractive method while  $C$  is obtained by a more conventional technique (Holm-Hansen et al. 1965). Ninety-five percent of  $e$  values are  $<0.6$  (Dandonneau 1982, and confirmed by later tests). This value is probably an overestimate of  $e$  since it results both from the error on SSCC and from the unknown error on  $C$ . Different phytoplankton populations can also result in different fluorescence to chlorophyll ratios for the dry filters. This ratio has shown no significant change between winter and summer conditions around New Caledonia where a mixed regime alternates with a stratified one (Dandonneau and Gohin 1984). The risk of a variation of the ratio in other environments has not been examined, and must be kept in mind. The few SSCC data points at latitudes higher than  $30^\circ$  were not taken into account for this reason.

### Calibrations

SSCC is estimated using  $\text{SSCC} = k Ff$  where  $k$  is a calibration coefficient that must be corrected from time to time. Twenty milliliters from a seawater sample are filtered giving a fluorescence  $Ff_0$  after 21 d of storage. A larger volume  $V$  from the same sample is filtered on a glass fiber filter, ground, and extracted by a volume  $v$  of 90% acetone. The fluorescence of the extract is  $Ff_e$ . Knowing the fluorescence to chlorophyll ratio of the fluorometer,  $R_0$ , determined from a known solution of pure chlorophyll a, we can estimate the following chlorophyll concentration of the seawater sample:

$$C_0 = (Ff_e \times v)/(R_0 \times V);$$

we obtain then  $k_0 = Ff_0/C_0$ .

$k_0$  is sensitive to detrital material in turbid coastal waters, so these main calibrations are made during offshore oceanographic cruises. As such op-

portunities are infrequent, secondary calibrations are made more frequently with known solutions of pure chlorophyll a, giving  $R_i$  instead of  $R_0$ . We then assume that  $k_i = k_0 \times R_i/R_0$ . This procedure does not consider correction for chlorophylls b and c, nor does it consider correction for phaeopigments, which has recently proven to be uncertain when the fluorometer is fitted with a commonly supplied blue excitation lamp (Baker et al. 1983). Although the SSCC data presented in this work are expressed in milligrams of chlorophyll a, they should be considered only as indices of phytoplankton abundance.

### Data Rejection

The crew members who take the seawater samples and make the filtrations are voluntary observers. Errors may occur which are difficult to detect because, unlike temperature or salinity, 1) any SSCC value in the interval  $0-1 \text{ mg} \cdot \text{m}^{-3}$ , which covers almost the whole data set, is a possible one anywhere in the tropical Pacific, and 2) the autocorrelation of SSCC decreases very quickly with time or space, so that surrounding data cannot help in error detection. Therefore, all the data are accepted, unless the filter exhibits an obvious fault (i.e., breaking, stain, extraneous material). Occasionally, all the data from a ship's voyage were evidently too high, by a factor 3 or 5. Contamination by a polluted sampling bucket was the cause, and the data from the entire voyage were rejected.

Other possible errors are more insidious, such as insufficient care in keeping the filters out of light, or using an oxidized sampling bucket. These errors result in slightly lowered values, but there is no way to correct them and, in most cases, no way to even detect these biases. Such data are entered in the data bank. As a resulting constraint, any estimate from this SSCC data set must be developed from many data, in order to minimize the effect of a few possibly biased values.

### Mapping Techniques

In a previous work (Dandonneau and Gohin 1984) the principles of objective analysis were applied to compute best estimates of SSCC at a given place and time in the southwestern tropical Pacific. The studied area in the current study is much larger and more complex, and the density of data is not high enough to allow good estimates of the statistics of the field. Hence, the use of an objective analysis of the SSCC data has been excluded. The SSCC mapped here on Figure 1 have been estimated using

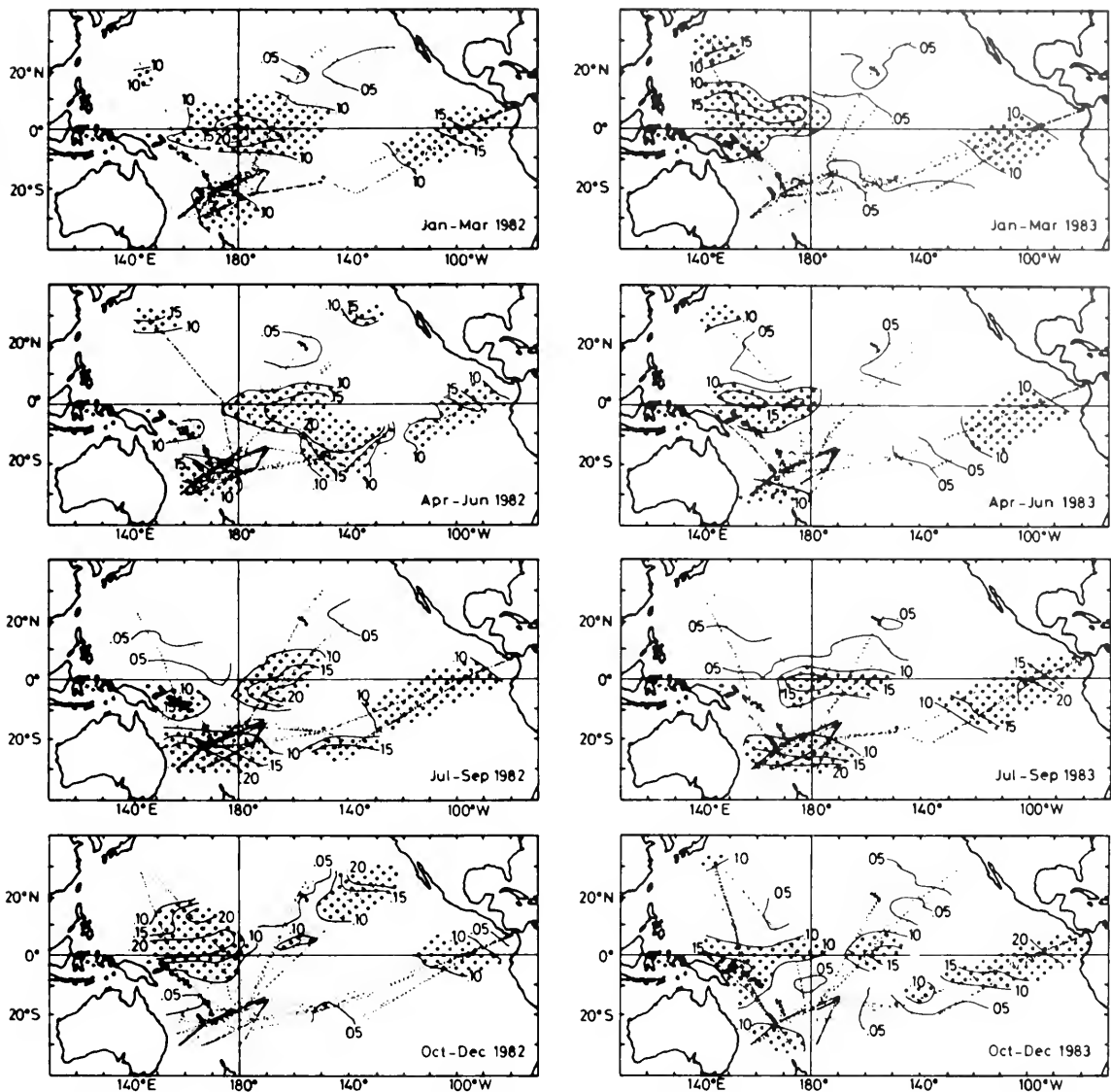

FIGURE 1.—Quarterly charts of SSCC (sea surface chlorophyll concentrations) in the tropical Pacific from January 1, 1982 to December 31, 1983. Areas where SSCC is  $>0.10 \text{ mg} \cdot \text{m}^{-3}$  are shaded with large dots. Smaller dots represent the data points.

$$\tilde{t}_j = \sum_{i=1}^{n_j} p_{ij} t_i / \sum_{i=1}^{n_j} p_{ij}$$

where  $\tilde{t}_j$  is the SSCC estimate at longitude  $x_j$  and latitude  $y_j$ , and  $p_{ij}$  is the weight given to observation  $t_i$  for the estimation  $\tilde{t}_j$ .  $p_{ij}$  is given by

$$p_{ij} = [R^2 + (x_i - x_j)^2 + a^2 (y_i - y_j)^2]^{-1}$$

where  $a$  accounts for anisotropy of the SSCC variations in space. We used  $a = 2$ , so that observations

at a distance  $\Delta y$  in latitude are given the same weight as observations at a distance  $\Delta x = 2\Delta y$  in longitude.  $p_{ij}$  was set to zero when  $(x_i - x_j)^2 + a^2 (y_i - y_j)^2$  was  $>160$ , so that the observations were considered as “non useful” when outside an ellipse centered at  $(x_j, y_j)$  with a principal axis equal to about  $25^\circ$  longitude, and a small axis equal to about  $13^\circ$  latitude. In order to avoid hazardous estimates at the margin of the contoured area,  $t_j$  has not been estimated when  $n_j$  (the number of useful observations) was  $<12$ .

$R = 0$  would give an infinite weight to an observation  $k$  available at  $x_k = x_j$  and  $y_k = y_j$ . We would then obtain  $t_j = t_k$  regardless of the other observations. This is acceptable only if the instrumental and sampling errors on  $t_k$  were null, which is not the case. Thus,  $R$  accounts for the errors on the observations. We choose  $R^2 = 25$ , which, together with  $a = 2$  and  $p_{ij} > (25 + 160)^{-1}$ , performed an efficient smoothing and preserved the large-scale information.

## RESULTS

The sequence of quarterly mean SSCC for 1982 and 1983 is presented in Figure 1, together with the positions of the data. The western part, north of lat.  $20^\circ\text{N}$ , is poorly sampled. The data range between 0.05 and  $0.20 \text{ mg} \cdot \text{m}^{-3}$ . The highest values are found during the northern spring of 1982, and the northern winter of 1983. The 1982 winter, and the spring and fall of 1983 exhibit a few values  $>0.10 \text{ mg} \cdot \text{m}^{-3}$ . The 1982 winter and fall show low SSCC, like the summer of both years, below  $0.10 \text{ mg} \cdot \text{m}^{-3}$ .

The eastern part, north of lat.  $10^\circ\text{N}$ , has generally low SSCC values, often below  $0.05 \text{ mg} \cdot \text{m}^{-3}$ . Exceptions are the spring of 1982 at the extreme north, and, mainly, the fall of 1982 during which the mean values exceeded  $0.20 \text{ mg} \cdot \text{m}^{-3}$  off California.

Low SSCC values are observed in the western part between the Equator and lat.  $20^\circ\text{N}$  until the summer of 1982. They are abruptly replaced at the end of 1982 by high values which persist until March 1983. Later, low values, generally below  $0.05 \text{ mg} \cdot \text{m}^{-3}$ , dominate again between lat.  $5^\circ\text{N}$  and  $20^\circ\text{N}$ , while SSCC  $>0.10 \text{ mg} \cdot \text{m}^{-3}$  shift back southward to the Equator.

The equatorial zone shows high SSCC in January-March 1982, between America and long.  $160^\circ\text{E}$ . Values higher than  $0.10 \text{ mg} \cdot \text{m}^{-3}$  spread from lat.  $10^\circ\text{N}$  and  $10^\circ\text{S}$  in the central Pacific, and to  $15^\circ\text{S}$  at  $120^\circ\text{W}$ . From April to June 1982, the enriched zone shifts eastwards and southwards. The eastwards shift continues between July and September and is accompanied by a decrease of SSCC in the eastern Pacific, with mean values  $<0.15 \text{ mg} \cdot \text{m}^{-3}$ . From October 1982 to June 1983, a narrow band with SSCC between 0.10 and  $0.15 \text{ mg} \cdot \text{m}^{-3}$  in the eastern Pacific is the only remnant of the equatorial enrichment. A normal situation returned after the El Niño, in July-September 1983, with SSCC values  $>0.15 \text{ mg} \cdot \text{m}^{-3}$  spreading westwards to long.  $170^\circ\text{E}$ . In October-December 1983, SSCC  $>0.10 \text{ mg} \cdot \text{m}^{-3}$  are seen all along the Equator.

South of lat.  $20^\circ\text{S}$ , an SSCC increase is observed

during the austral winter. The increase started in April-June in 1982, the maximum was reached in July-September, with SSCC  $>0.20 \text{ mg} \cdot \text{m}^{-3}$  spreading northward to  $22^\circ\text{S}$ , and low values were seen again in October-December. The increase during the austral winter of 1983 was of a lesser extent, being well developed only during July-September, with SSCC  $>0.20 \text{ mg} \cdot \text{m}^{-3}$  limited to the south of  $28^\circ\text{S}$ .

The intermediate zone, from lat.  $10^\circ\text{S}$  to  $20^\circ\text{S}$ , between the equatorial upwelling and higher latitudes where a winter increase is observed, generally has low chlorophyll concentrations, below  $0.10 \text{ mg} \cdot \text{m}^{-3}$ . The lowest concentrations are seen in austral summer, from October 1982 to June 1983, and in October-December 1983. The highest concentrations are associated with a strengthening of the equatorial upwelling (around long.  $140^\circ\text{W}$  in April-June 1982; westwards spreading of richer waters from the eastern Pacific in July-September 1982 and 1983).

When looking at the whole series of maps, the most striking feature is the reduction of the equatorial upwelling enriched area after the onset of El Niño. The most pronounced stage was in April-June 1983, with poor waters over most of the tropical Pacific. On the contrary, a zone centered at lat.  $10^\circ\text{N}$ , west of the dateline, which is usually occupied by chlorophyll-poor waters, had higher SSCC during the 1982-83 El Niño.

## DISCUSSION

### Equatorial Upwelling

The collapse of the equatorial upwelling after the onset of El Niño, when westerlies have replaced the trade winds at the Equator, consistently results in a decrease in SSCC. This decrease has already been documented for the eastern Pacific in the Galapagos Islands region by Feldman et al. (1984) using sea color satellite images. It corresponds to a decrease in primary production of the whole photic layer (Barber and Chavez 1983). The data presented here show that the equatorial zone was impoverished westwards to nearly  $180^\circ$ . This is in agreement with the reproductive failure and disappearance of seabird communities at Christmas Atoll (lat.  $2^\circ\text{N}$ , long.  $157^\circ\text{W}$ ) in November 1982; Schreiber and Schreiber (1984) attributed these events to the establishment of an oligotrophic oceanic ecosystem instead of a productive one. Successful reproduction started again for some birds species in June 1983, and hatching occurred in July-September 1983, when SSCC



higher than  $0.15 \text{ mg} \cdot \text{m}^{-3}$  reappeared at the Equator (Fig. 1).

### Western Pacific Around Lat. $7^{\circ}\text{N}$ .

Under normal conditions (see Figure 1: January to March 1982, July to December 1983) the equatorial upwelling also drives a chlorophyll-rich zone west of  $180^{\circ}$ . This does not appear on the map of Koblenz-Mishke et al. (1970) on the primary production in the world ocean, but is described as an episodic feature by Oudot and Wauthy (1976). The area with  $\text{SSCC} > 0.15 \text{ mg} \cdot \text{m}^{-3}$  which appears north of the Equator, centered at about  $7^{\circ}\text{N}$  from October 1982 to March 1983 (Fig. 1) has nothing to do with the equatorial upwelling. Based on approximately 100 SSCC data points obtained by three different merchant ships, this chlorophyll-rich area can hardly be thought to result from measurement errors. It rather may be related to the eastward draining of warm water from the western tropical Pacific and consequent thinning of the surface mixed layer and drop of the sea level (Wyrski 1985). A

simultaneous cooling of the sea surface by  $1^{\circ}\text{C}$  occurred in this region during El Niño, which can be explained by advection of cooler water, and also by other potentially important processes which are more difficult to quantify (Meyers and Donguy 1984). The observed SSCC increase supports the hypothesis that vertical mixing of cooler nutrient-rich deep water might be one of these processes. Even if vertical mixing is unlikely, the 50 m rise of the thermocline which has been observed at lat.  $7^{\circ}\text{N}$  between January 1982 and January 1983 (Meyers and Donguy 1984) allows more light to penetrate to the deep chlorophyll maximum. This hypothesis is supported by the shift which occurred between January 1982 and January 1983 in the nitrate-temperature relationship (Fig. 2; data collected by the Japan Meteorological Agency along long.  $137^{\circ}\text{E}$  aboard RV *Ryofu Maru*; Anonymous 1972-84). The nitrate concentration at a given temperature (which we assume to represent a given water mass) dropped by about  $2 \mu\text{moles} \cdot \text{L}^{-1}$ . Shifts in the nitrate-temperature relationship provide information on the consumption of nitrate by the phyto-

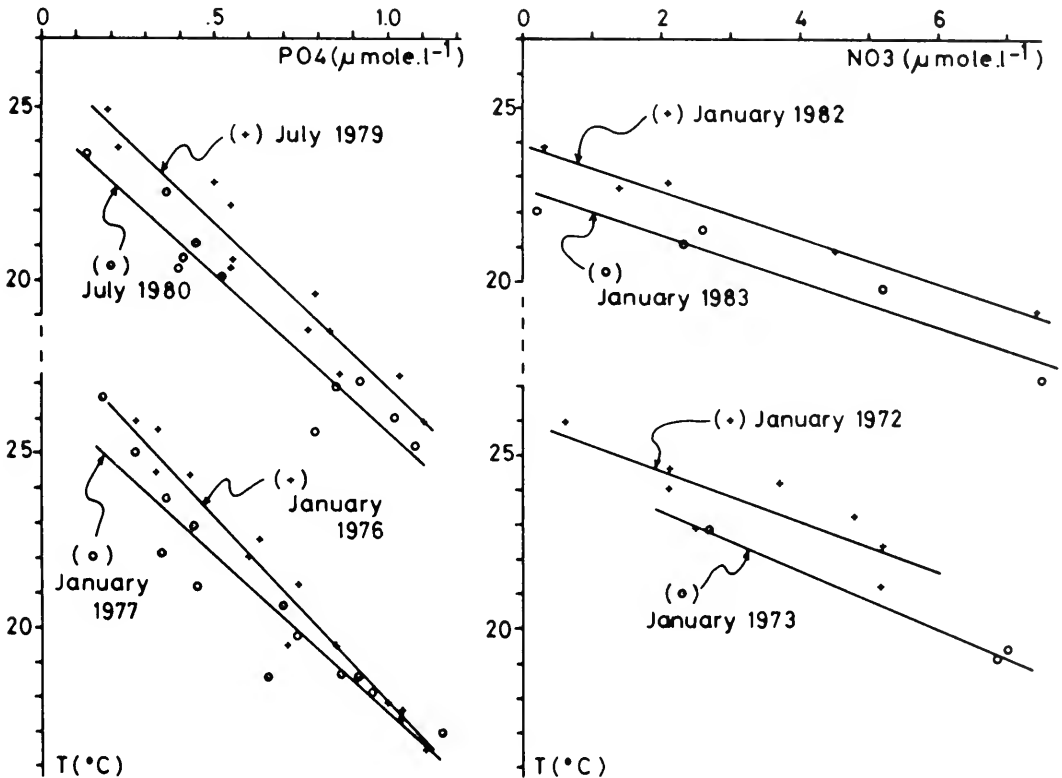

FIGURE 2.—Nutrient-temperature relationships between lat.  $6^{\circ}\text{N}$  and  $9^{\circ}\text{N}$ . Crosses: observations before an El Niño; open circles: observations after an El Niño. (Data from the RV *Ryofu Maru* cruises at long.  $137^{\circ}\text{E}$ , Anonymous 1972 to 1984).

plankton (Voituriez and Herbland 1984). We can then suggest that new nitrates have been assimilated during El Niño in the western Pacific at lat. 6-9°N. The  $2 \mu\text{moles} \cdot \text{L}^{-1}$  drop in nitrate concentration is observed in the interval 17°-22°C, corresponding to a 35 m thick water layer (Anonymous 1972-84), so that the amount of new nitrates used by photosynthesis is  $70 \mu\text{moles} \cdot \text{m}^{-2}$ , or  $980 \text{mg} \cdot \text{m}^{-2}$ . If  $C/N = 9.01$  and  $C/\text{Chl} = 114$  in surface waters of the oligotrophic central North Pacific (Sharp et al. 1980), this amount of nitrogen corresponds to  $77 \text{mg Chl a} \cdot \text{m}^{-2}$ . It represents an important supply in an ecosystem where the chlorophyll concentration is usually low.

Figure 3 shows the variations of integrated chlorophyll (0-200 m) between lat. 6°N and 9°N at long. 137°E, obtained from the *Ryofu Maru* data (Anonymous 1972-84). Values during the 1982-83 El Niño are similar to those since July 1981, i.e., below  $50 \text{mg} \cdot \text{m}^{-2}$ . SSCC from the same data set also shows low values during the 1982-83 El Niño, conflicting with the results mapped on Figure 1. Recent El Niño events in 1972 and 1976 resulted in a drop of the sea level in the western Pacific (Meyers 1982). Low sea level was also recorded during an El Niño like event in the western Pacific in 1979-80 (Donguy and Dessier 1983). These low sea level episodes during which the thermocline is shallow (Wyrтки 1978), yet do not correspond to high SSCC

or high integrated chlorophyll values in the *Ryofu Maru* results (Fig. 3). It seems however that the nutricline depth is shallower during these four episodes (Fig. 3). All of them are moreover characterized by a shift in the nutrient-temperature relationship (Fig. 2) indicating a consumption of new nutrients. We are dealing with an SSCC enrichment in the northwestern tropical Pacific which persists for several months (October 1982-March 1983) and is consistent with an input of new nutrients from below, but which does not appear in the chlorophyll concentrations measured every 6 mo on the *Ryofu Maru*. Both data sources have weaknesses. The SSCC monitoring does not measure what occurs below the surface. A significant correlation exists between SSCC and integrated chlorophyll on broad data sets (Lorenzen 1970; Platt and Herman 1983), but oligotrophic ecosystems often show no relationship or, sometimes, inverse relationships (Hayward and Venrick 1982). The *Ryofu Maru* data at 137°E between 6°N and 9°N allow a look at this problem (Fig. 4): the correlation between SSCC and integrated chlorophyll is significant at the 1% level. The value  $r = 0.52$  obtained with individual stations increases to  $r = 0.70$  when enlarging the spatial scale (i.e., taking mean values between 6°N and 9°N instead of individual stations); a further improvement would probably be obtained by enlarging the time scale, but appropriate time series do not exist

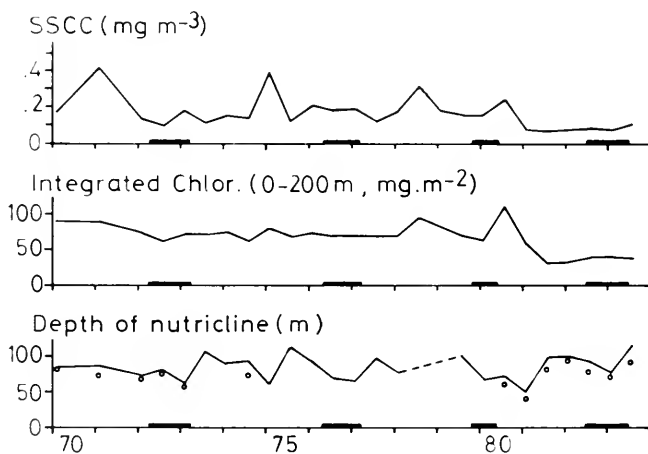

FIGURE 3.—Long-term evolution of lat. 6°N-9°N averaged parameters related to the primary production (data from the RV *Ryofu Maru* cruises at long. 137°E, Anonymous 1972 to 1984). Upper and middle panels: the chlorophyll concentrations primarily expressed in active chlorophyll a and pheophytin have been converted into chlorophyll a equivalents (Dandonneau 1979). Lower panel: the continuous line joins the depth of  $\text{PO}_4 = 0.35 \mu\text{mole} \cdot \text{L}^{-1}$ ; open circles represent the depths of  $\text{NO}_3 = 1 \mu\text{mole} \cdot \text{L}^{-1}$ . Thickened marks on the horizontal axis indicate the low sea level episodes in the western tropical Pacific.

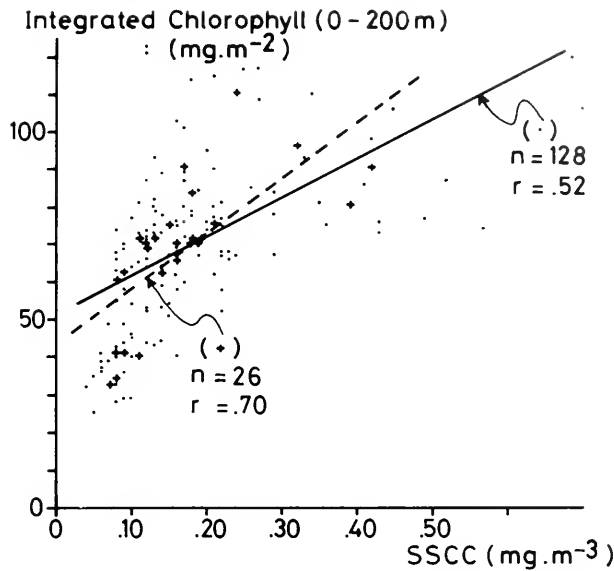

FIGURE 4.—Integrated chlorophyll (0-200 m)/SSCC relationship between lat. 6°N and 9°N (data from the RV *Ryofu Maru* cruises at long. 137°E, Anonymous 1972 to 1984). Points and continuous line: individual stations. Crosses and dashed line: averaged values for each cruise.

in this region. We can thus conclude that SSCC is a reasonable index of the chlorophyll content in the photic layer. The weakness of the *Ryofu Maru* data series is that only 4-6 stations within 3 d are available for each El Niño episode. This sampling pattern can describe the vertical structure of the ocean, but it is not helpful in large-scale studies based on chlorophyll, in which the signal to noise ratio is very low (Dandonneau and Gohin 1984).

### Subtropical Zones

At the start of the 1982-83 El Niño (and a possible cause of it?) strong southerly winds were recorded east of Australia in June and July 1982 (Harrison and Cane 1984). In the Coral and Tasman Seas, a chlorophyll enrichment occurs in austral winter between 22°S and higher latitudes (Dandonneau and Gohin 1984). This chlorophyll enrichment can be seen in austral autumn and winter of 1982 (Fig. 1), while it only appears in winter in 1983. Moreover, SSCC higher than  $0.15 \text{ mg} \cdot \text{m}^{-3}$  spread northward to lat. 20°S in July-September 1982 around long. 160°E, but only to 24°S in July-September 1983 at the same longitude. The long and intense SSCC winter increase in this area in 1982 may be the result of advection of richer water from the south after the strong wind anomaly. In the Northern Hemisphere, a zone with high SSCC

values is observed off North America during the fall of 1982 (Fig. 1); this feature is especially noteworthy since most regions of the Pacific (even those from the same merchant ship voyage) show low SSCC values. Like other El Niños, the 1982-83 one resulted in temperatures and sea levels higher than normal along the California coast, and strong westerly winds at about 30°N. One would not expect increased chlorophyll concentrations with higher temperatures, and according to Chelton et al. (1982), El Niño episodes are likely to diminish advection of water from the north which generates a higher biomass. However, our data points corresponding to the enriched zone were far offshore (Fig. 1) and the thermal anomaly there did not greatly differ from zero. The high SSCC values off North America during the fall of 1982 might then be related to the severe wind conditions which prevailed during this time, and probably induced vertical mixing of deep nutrients.

A few more features which appear on Figure 1 would be worthy of discussion, but conclusion is hindered by the lack of accordance with a poorly known field of oceanic properties and by the risk of sampling or instrumental errors in SSCC measurements. For instance the shape of the area with  $\text{SSCC} > 0.15 \text{ mg} \cdot \text{m}^{-3}$  centered slightly south of the Equator at 165°W in July-September 1982 (Fig. 1), while the upwelling was collapsing, is sur-

prisingly similar to the shape of the maximum of cloudiness in September 1982, derived from satellite measurements of outgoing long wave radiation (Gill and Rasmusson 1983). Similarity might be causal, i.e., high SSCC values might result from a response of the phytoplankton to attenuation of light by the clouds, or from enhanced phytoplankton growth caused by precipitation of dust and aerosols by the rain (Menzel and Spaeth 1962). It may also result, at least partly, from sampling artifacts.

The major features shown by this SSCC monitoring experiment are in agreement with the large-scale processes that affect the tropical Pacific during El Niño episodes. The collapse of the equatorial upwelling in October 1982 resulted in a nearly complete disappearance of the chlorophyll-rich area which is usually located across the Equator. A moderate enrichment persisted, however, east of long. 120°W. In the northwestern tropical Pacific, the eastward drift of the warmwater pool was followed by conditions which stimulated photosynthesis: a shallower thermocline, and more light penetrating to the nutrients gave rise to unusually high chlorophyll concentrations west of 180° from October 1982 to March 1983. In April-June 1983, the equatorial upwelling in the eastern Pacific was still reduced by the El Niño conditions, and the enrichment in the northwestern tropical Pacific was less intense; during this period, low chlorophyll concentrations prevailed over most of the tropical Pacific.

## ACKNOWLEDGMENTS

I would like to thank Henri Walico for the thousands of chlorophyll measurements which are the basis of the present work. I am indebted to the captains and crews of the merchant ships who call at Nouméa for kindly and carefully sampling and filtering at sea.

## LITERATURE CITED

- ANONYMOUS.  
1972-84 The results of marine meteorological and oceanographical observations. Jpn. Meteorol. Agency, Tokyo, Nos. 47-72.
- BAKER, K. S., R. C. SMITH, AND J. R. NELSON.  
1983. Chlorophyll determinations with filter fluorometer: lamp-filter combination can minimize error. *Limnol. Oceanogr.* 28:1037-1040.
- BARBER, R. T., AND F. P. CHAVEZ.  
1983. Biological consequences of El-Niño. *Science* 222:1203-1210.
- BJERKNES, J.  
1966. Survey of El-Niño 1957-58 in its relation to tropical Pacific meteorology. *Inter-Am. Trop. Tuna Comm. Bull.* 12:25-86.
- CANE, M. A.  
1983. Oceanographic events during El-Niño. *Science* 222: 1189-1195.
- CHELTON, D. B., P. A. BERNAL, AND J. A. MCGOWAN.  
1982. Large scale interannual physical and biological interaction in the California Current. *J. Mar. Res.* 40:1095-1125.
- DANDONNEAU, Y.  
1979. Concentrations en chlorophylle dans le Pacifique tropical sud-ouest: comparaison avec d'autres aires océaniques tropicales. *Oceanol. Acta* 2:133-142.  
1982. A method for the rapid determination of chlorophyll plus phaeopigments in samples collected by merchant ships. *Deep-Sea Res.* 29:647-654.
- DANDONNEAU, Y., AND F. GOHIN.  
1984. Meridional and seasonal variations of the sea surface chlorophyll concentration in the southwestern tropical Pacific (14 to 32°S, 160 to 175°E). *Deep-Sea Res.* 31:1377-1393.
- DONGUY, J. R., W. BOUR, P. GALENON, AND J. A. GUEREDRAT.  
1978. Les conditions océanographiques et la pêche de la bonite (*Katsuwonus pelamis*) dans le Pacifique occidental. *Cah. ORSTOM, Ser. Oceanogr.* 16:309-317.
- DONGUY, J. R., AND A. DESSIER.  
1983. El-Niño like events observed in the tropical Pacific. *Mon. Weather Rev.* 111:2136-2139.
- DONGUY, J. R., AND C. HENIN.  
1976. Anomalous navigational salinities in the tropical Pacific Ocean. *J. Mar. Res.* 34:355-364.
- FELDMAN, G., D. CLARK, AND D. HALPERN.  
1984. Satellite color observations of the phytoplankton distribution in the eastern equatorial Pacific during the 1982-83 El-Niño. *Science* 226:1069-1070.
- GILL, A. E., AND E. M. RASMUSSON.  
1983. The 1982-83 climate anomaly in the equatorial Pacific. *Nature* 306:229-234.
- HARRISON, D. E., AND M. A. CANE.  
1984. Changes in the Pacific during the 1982-83 event. *Oceanus* 27(2):21-28.
- HAYWARD, T. L., AND E. L. VERNICK.  
1982. Relation between surface chlorophyll, integrated chlorophyll and integrated primary production. *Mar. Biol. (Berl.)* 69:247-252.
- HOLM-HANSEN, O., C. J. LORENZEN, R. W. HOLMES, AND J. D. STRICKLAND.  
1965. Fluorometric determination of chlorophyll. *J. Cons.* 30:3-15.
- KOBLENTZ-MISHKE, O. J., V. V. VOLKOVINSKY, AND J. G. KABANOVA.  
1970. Plankton primary production of the world ocean. *In* W. S. Wooster (editor), *Scientific exploration of the southern Pacific*. Nat. Acad. Sci., Wash., D.C., p. 183-193.
- LORENZEN, C. J.  
1970. Surface chlorophyll as an index of the depth, chlorophyll content, and primary productivity of the euphotic layer. *Limnol. Oceanogr.* 15:479-480.
- MENZEL, D. W., AND J. P. SPAETH.  
1962. Occurrence of ammonia in Sargasso sea water and in rain water at Bermuda. *Limnol. Oceanogr.* 7:159-162.
- MEYERS, G.  
1982. Interannual variation in sea level near Truk Island - A bimodal seasonal cycle. *J. Phys. Oceanogr.* 12:1161-1168.
- MEYERS, G., AND J. R. DONGUY.  
1984. The north equatorial countercurrent and heat storage

- in the western Pacific Ocean during 1982-83. *Nature* 312: 258-260.
- LOUDOT, C., AND B. WAUTHY.  
1976. Upwelling et dôme dans le Pacifique tropical occidental distributions physico-chimiques et biomasse végétale. *Cah. ORSTOM, Sér. Oceanogr.* 14:27-48.
- PLATT, T., AND A. W. HERMAN.  
1983. Remote sensing of phytoplankton in the sea: surface layer chlorophyll as an estimate of water column chlorophyll and primary production. *Int. J. Remote Sensing* 4:343-351.
- QUINN, W. H., D. O. ZOPF, K. S. SHORT, AND R. T. W. KUO YANG.  
1978. Historical trends and statistics of the Southern Oscillation, El-Niño, and Indonesian droughts. *Fish. Bull., U.S.* 76:663-678.
- SCHREIBER, R. W., AND E. A. SCHREIBER.  
1984. Central Pacific seabirds and the El-Niño southern oscillation: 1982 to 1983 perspectives. *Science* 225:713-716.
- SHARP, J. H., M. J. PERRY, E. H. RINGER, AND R. W. EPPLEY.  
1980. Phytoplankton rate processes in the oligotrophic waters of the central north Pacific Ocean. *J. Plankton Res.* 2:335-353.
- VOITURIEZ, B., AND A. HERBLAND.  
1984. Signification de la relation nitrate/température dans l'upwelling équatorial du Golfe de Guinée. *Oceanol. Acta* 7:169-174.
- WALKER, G. T.  
1924. World weather II. *Mem. India Meteorol. Dep.* 24: 275-332.
- WALSH, J. J.  
1981. A carbon budget for overfishing of Peru. *Nature* 290: 300-304.
- WYRTKI, K.  
1978. Monitoring the strength of equatorial currents from XBT sections and sea level. *J. Geophys. Res.* 83C:1935-1940.  
1985. Sea level fluctuations in the Pacific during the 1982-83 El-Niño. *Geophys. Res. Lett.* 12:125-128.
- YAMANAKA, H.  
1984. The relationship between El-Niño episodes and fish migration and yields in the western Pacific. *Trop. Ocean-Atmos. Newsl.* 25:2-4.



# ANATOMICAL TRAUMA TO SPONGE-CORAL REEF FISHES CAPTURED BY TRAWLING AND ANGLING

S. GORDON ROGERS,<sup>1</sup> HIRAM T. LANGSTON,<sup>2</sup> AND  
TIMOTHY E. TARGETT<sup>3</sup>

## ABSTRACT

External signs of trauma were examined in 15 sponge-coral reef fish species captured while trawling and angling at 37 m depth. Internal evidence of trauma was noted for all species and quantified for a sample of angling-caught black sea bass, *Centropristis striata*. Distinct differences were noted in the types and frequencies of trauma experienced among species, and between gear types within species. Black sea bass; red snappers, *Lutjanus campechanus*; short bigeyes, *Pristigenys alta*; and *Mycteroperca* groupers exhibited high frequencies of oral protrusions. Planehead filefish, *Monacanthus hispidus*; orange filefish, *Aleuterus schoepfi*; and blue angelfish, *Holacanthus bermudensis*, were particularly prone to cloacal protrusions. External signs of trauma were few in vermilion snappers, *Rhomboplites aurorubens*; porgies (*Stemotomus chrysops*, *Calamus leucosteus*, and *Pagrus pagrus*); tomtates, *Haemulon aurolineatum*; and two trawl-caught serranids (*Centropristis ocyurus* and *Diplectrum formosum*). Angling produced oral protrusions in black sea bass more frequently than trawling. Trawl-caught red snappers had a higher stomach eversion frequency when brought to the surface more quickly. Angling-caught black sea bass experienced high frequencies of tissue emphysema and swim-bladder rupture. These results should be considered in studies of feeding biology, released-fish survivorship, and fishery management.

Anatomical trauma experienced by fishes during capture is interesting from several standpoints. Mortality of individuals caused by stress, tissue damage, organ displacement, and resulting aberrant behavior has been recognized primarily for its effects on the survival of released fish in mark-and-recapture studies (Ricker 1949; Parker et al. 1959, 1963; Gotshall 1964; Beamish 1966; Moe 1966; Laird and Stott 1978; Pawson and Lockwood 1980; Fable 1980; Grimes et al. 1983). Mortality of fishes released by fishermen is an important consideration for stock assessment and management (Black 1958; Pawson and Lockwood 1980; Matheson and Huntsman 1984). Recent management plans for the U.S. Gulf and South Atlantic snapper-grouper fisheries (GOMFMC 1981; SAFMC 1983a, b) recommended implementation of minimum sizes for several species. The sizes in the South Atlantic were determined from yield-per-recruit (YPR) models incorporating assumed survival rates for undersized,

released fishes (SAFMC 1983a). Size regulations were predicted on survivorship of  $\geq 60\%$ . Gulf YPR models did not incorporate survival rates, effectively assuming 100% survival.

Other workers have indicated difficulty in obtaining specimens of snapper-grouper species for quantitative analyses of feeding biology from depths which caused stomach eversion and loss of gut contents (Stearns 1884; Adams and Kendall 1891; Camber 1955; Mosely 1966; Moe 1969; Bradley and Bryan 1975; Link 1980; Ross 1982). This is of particular concern for studies comparing food habits across depth zones (Moseley 1966). Differences between fish species captured by identical gear at similar depths and differences within species between gear types introduce additional variation. This study addresses the types and frequencies of anatomical trauma experienced by sponge-coral reef fishes captured by angling and trawling at a single depth. These data are discussed in relation to trophic studies, future studies of trauma during capture, survival following release, and management of snapper-grouper fisheries.

## METHODS

Fishes were caught by angling and trawling at a low-relief (<1 m) sponge-coral reef 37 m deep on the continental shelf 84 km east of Sapelo Island, GA

<sup>1</sup>Skidaway Institute of Oceanography, University System of Georgia, POB 13687, Savannah, GA 31416; present address: Coastal Resources Division, Georgia Department of Natural Resources, 1200 Glynn Avenue, Brunswick, GA 31523.

<sup>2</sup>Skidaway Institute of Oceanography, University System of Georgia, POB 13687, Savannah, GA 31416.

<sup>3</sup>Skidaway Institute of Oceanography, University System of Georgia, POB 13687, Savannah, GA 31416; present address: University of Delaware, College of Marine Studies, Lewes, DE 19958.

(lat. 31°26'N, long. 80°20'W; central South Atlantic Bight). Angling gear was standard hand-operated boat rods rigged with double-hooked terminal tackle and baited with squid. Hook sizes were 3/0 to 5/0. Fishes were brought to the surface as quickly as possible (about 1 m/s; somewhat slower for large snappers and groupers). Trawling was conducted from two vessels, each rigged for stern trawling but with some differences in gear and handling.

The trawl gear on the RV *Georgia Bulldog* was a 25 m, 4-seam high-rise roller trawl with tongue. Meshes were (stretched) 20 cm in the wings and tongue, 10 cm in the belly and bag (2 cm liner), and 7.5 cm in an extension. Cables connecting the trawl and doors produced a sweep of 31.1 m; the rise on the tongue was 6.1 m (J. B. Rivers<sup>4</sup>). The rig had a vertical haulback rate of 0.12-0.15 m/s.

The trawl gear on the RV *Blue Fin* was a modified No. 36 Yankee flat roller trawl. Meshes were (stretched) 5 cm in the wings and belly and 3.5 cm in the bag (2 cm liner). The total sweep was 22.1 m and the rise at the center of the headrope was 3.7 m (Rivers fn. 4). The rig had a vertical haulback rate of 0.1 m/s. Gear handling was otherwise identical.

Tows were 20 min long. The fish catch was sorted to species and the alimentary tracts samples removed; or samples were placed in 20 L buckets with ice-seawater mixture, frozen on board, and processed in the laboratory. Data on anatomical trauma were recorded during dissections. An angling catch of 34 black sea bass, *Centropristis striata*, was put on ice and dissected 2 days later for examination of internal trauma. No samples were subjected to the bin-type icing procedures common on commercial snapper-grouper vessels. Fishes were collected from July through December in 1983 and in September 1984.

External evidence of trauma consisted of several types of protrusion of the gastrointestinal tract. These were classified as

- 1) Oral eversion - stomach everted into the pharynx and often present in the mouth, pulling the pyloric area and the intestine with it.
- 2) Cloacal protrusion - intestine protruded from the cloacal area. Initially such protrusions were not classified further; however, detailed dissections showed that they were either

- a) Herniations - disruptions of the body wall in the pericloacal area through which the gut protruded or
  - b) Intussusceptions - actual eversion of the terminal portion of the intestine through its own lumen.
- 3) Branchial protrusions - portions of the gut protruded through the branchial opening.

Results are expressed as occurrences and percentage frequencies. Frequencies of herniations and intussusceptions were calculated by dividing the observed number in a class by the total number of classified cloacal protrusions, then multiplying the result by the total proportion of cloacal protrusions. Example (from Table 1): planehead filefish herniations,  $(99/(99+22)) (160/440) = 0.30$ .

Internal evidence of trauma included 1) the presence of gas in the tissues (tissue emphysema) and 2) rupture of the swim bladder. Although notes on both phenomena were kept for all fish species, their frequencies were enumerated only for the 34 carefully examined, angling-caught black sea bass.

Among-species and between-gear comparisons of trauma were performed by using Pearson's test for goodness of fit (yielding a  $\chi^2$  value). The null hypotheses were specified as homogenous (equal) proportions of specimens exhibiting a particular symptom, based on the overall proportion of fish with the symptom across species or gears (significant departures were  $P < 0.05$ ).

## RESULTS

Dissection records of 1928 trawl-caught and 235 angling-caught fishes of 15 species were collated for external evidence of trauma (Table 1). Seven species were not caught with angling gear. Scamp, *Mycteroperca phenax*, and gag, *M. microlepis*, were combined to form a *Mycteroperca* grouper category due to low numbers collected.

Trawl-caught red snappers, *Lutjanus campechanus*; *Mycteroperca* groupers; short bigeyes, *Pristigenys alta*; planehead filefish, *Monacathus hispidus*; orange filefish, *Aleuterus schoepfi*; and blue angelfish, *Holacanthus bermudensis*, experienced frequent gut displacements (Table 1). These were oral eversions in red snappers, short bigeyes, and *Mycteroperca* groupers; cloacal protrusions in orange filefish and blue angelfish; and all three categories (including branchial protrusion) in planehead filefish. Alimentary tract displacements were minimal in trawl-caught black sea bass; bank sea bass, *Centropristis ocyurus*; sand perch, *Diplctrum formosum*;

<sup>4</sup>J. B. Rivers, Marine Fisheries Specialist, University of Georgia Fisheries Extension Station, POB Z, Brunswick, GA 31523, pers. commun. October 1984.



TABLE 1.—Numbers and percentage frequencies (in parentheses;  $a = 1\%$ ) of alimentary tract displacements in sponge-coral reef fishes collected by trawling (T) and angling (A) in 37 m depth. Dashes (—) indicate no data. Within cloacal protrusions, H = herniations, I = intussusceptions, U = unclassified, and TC = total cloacal.  $N$  = number of specimens examined.

Species		Oral eversions	Cloacal protrusions				Branchial protrusions	Total displacements	$N$
			H	I	U	TC			
black sea bass	T	4(2)	0	0	0	0	0	4(2)	200
<i>Centropristis striata</i>	A	45(27)	0	0	0	0	0	45(27)	169
red snapper	T	26(55)	0	0	0	0	0	26(55)	47
<i>Lutjanus campechanus</i>	A	1(50)	0	0	0	0	0	1(50)	2
bank sea bass	T	0	0	0	0	0	0	0	39
<i>Centropristis ocyurus</i>	A	1(33)	0	0	0	0	0	1(33)	3
short bigeye	T	8(22)	0	0	0	0	0	8(22)	37
<i>Pristigenys alta</i>	A	—	—	—	—	—	—	—	0
sand perch	T	0	0	0	0	0	0	0	19
<i>Diplectrum formosum</i>	A	2(18)	0	0	0	0	0	0	11
<i>Mycteroperca</i> groupers	T	5(29)	0	0	0	0	0	5(29)	17
	A	0	0	0	0	0	0	0	1
planehead filefish	T	3(1)	99(30)	22(7)	39	160(36)	14(3)	177(40)	440
<i>Monacanthus hispidus</i>	A	—	—	—	—	—	—	—	0
orange filefish	T	0	1(4)	4(17)	7	12(21)	0	12(21)	58
<i>Aleuterus schoepfi</i>	A	—	—	—	—	—	—	—	0
blue angelfish	T	0	4(30)	1(8)	4	9(38)	0	9(38)	24
<i>Holacanthus bermudensis</i>	A	—	—	—	—	—	—	—	0
vermilion snapper	T	0	0	0	0	0	0	0	339
<i>Rhomboplites aurorubens</i>	A	0	0	0	1	1(4)	0	1(4)	28
whitebone porgy	T	0	1(3)	1(3)	0	2(6)	0	2(6)	33
<i>Calamus leucosteus</i>	A	—	—	—	—	—	—	—	0
scup	T	0	1(1)	0	2	3(1)	0	3(1)	286
<i>Stenotomus chrysops</i>	A	—	—	—	—	—	—	—	0
tomtate	T	0	0	0	2	2(a)	0	2(a)	372
<i>Haemulon aurolineatum</i>	A	—	—	—	—	—	—	—	0
red porgy	T	0	0	1(6)	0	1(6)	1(6)	2(12)	17
<i>Pagrus pagrus</i>	A	0	0	0	0	0	0	0	21

tomtate, *Haemulon aurolineatum*; scup<sup>5</sup>, *Stenotomus chrysops*; whitebone porgies, *Calamus leucosteus*; red porgies, *Pagrus pagrus*; and vermilion snappers, *Rhomboplites aurorubens*.

Angling-caught black sea bass had high frequencies of oral eversion. Angling-caught red porgies and vermilion snappers exhibited few or no protrusions. Angling data for all other species are too sparse to estimate protrusion frequencies.

There was a significant lack of homogeneity in the frequencies of oral eversions between species within trawl ( $\chi^2 = 695$ ,  $df = 13$ ,  $P \ll 0.01$ ) and angling-caught ( $\chi^2 = 14.2$ ,  $df = 6$ ,  $P < 0.05$ ) samples. The trawling value resulted from high frequencies for red snapper, *Mycteroperca* groupers, and short bigeye; these three categories accounted for 95%

of the  $\chi^2$  statistic. Among angling-caught fishes, a high value for black sea bass and low values for red porgy and vermilion snapper accounted for 91% of the  $\chi^2$  statistic.

The high frequencies of cloacal protrusions in trawl-caught planehead filefish, orange filefish, and blue angelfish (21-38%) and low values in all other species (<7%) produced a highly significant departure from homogeneity ( $\chi^2 = 470$ ,  $df = 13$ ,  $P \ll 0.001$ ). Seven of the 15 fish species did not display the symptom (Table 1). Only one of the angling-caught specimens (a vermilion snapper) experienced cloacal protrusion. Of those cloacal protrusions classified for blue angelfish and the two filefish species, all herniations (Table 1) had fecal material in the protruded gut portion.

Only planehead filefish experienced branchial protrusions. Tomtate, vermilion snapper, scup, red porgy, and whitebone porgy were notably free of all forms of alimentary tract displacement.

Swim-bladder rupture was noted for all fish species. Tissue emphysema was detected only in black sea bass. Of the 34 black sea bass examined in detail for internal trauma, 33 (97%)

<sup>5</sup>The taxonomic status of this species is unclear (B. Roumillat, South Carolina Marine Resources Research Institute, POB 12559, Charleston, SC, 29412 pers. commun.) and is properly listed as scup (*Stenotomus chrysops* (Robins et al. 1980; SAFMC 1983a, b)) although several authors have recently used the nomen southern porgy (*S. aculeatus* (Miller and Richards 1980; Wenner 1983; Sedberry and Van Dolah 1984)). Still others have classified South Atlantic-caught *Stenotomus* as longspine porgy (*S. caprinus* (Chester et al. 1984)).

exhibited swim-bladder rupture (1 specimen had 2 points of rupture), and 27 (79%) had tissue emphysema.

Significantly more angling-caught black sea bass had oral protrusions than those caught by trawling ( $\chi^2 = 138$ ,  $df = 1$ ,  $P < 0.001$ ). For trawl-caught red snappers, significantly more fish caught aboard the *Georgia Bulldog* (26 of 39) had oral eversions than those caught aboard the *Blue Fin* (0 of 8) ( $\chi^2 = 5.34$ ,  $df = 1$ ,  $P < 0.025$ ). No other comparisons for combinations of symptoms, species, and gear types yielded significant results. However, all oral eversions noted for *Mycteroperca* groupers were produced by *Georgia Bulldog* trawling gear, and those noted for sand perch were produced by angling gear.

## DISCUSSION

### Differences Due to Species and Gear

Differences between fish species (captured by identical gear) in the type and frequency of gut displacement are likely due to differences in bone structure and relative swim-bladder volume. Except for planehead filefish, which exhibited all forms of external evidence, those species which experienced frequent oral eversions did not present cloacal eversions and vice versa (Table 1; refer also to the analyses of categorized data). In this study the leatherjackets (Balistidae) and angelfishes (Holacanthidae) experienced high frequencies of gut displacements toward the cloacal area. These taxa have a relatively restricted pharyngeal area and the leatherjackets have a bony sternum which further defines a "path of least resistance" toward the cloaca. Other fishes which may be similarly susceptible to cloacal protrusions include other balistids, acanthurids, chaetodontids, and scarids.

Larger mouthed species such as lutjanids (Stearns 1884; Adams and Kendall 1891; Camber 1955; Moseley 1966; Bradley and Bryan 1975; this study), serranids (Moe 1969; Link 1980; Matheson and Huntsman 1984; this study), priacanthids (this study), and scorpaenids (Gotshall 1964) experience oral eversion more frequently than cloacal protrusion. Fishes with medium-sized mouths and "non-directing" body morphologies (e.g., vermilion snapper, tomate, and sparids in this study) exhibit neither type of gut protrusion, instead having a general swelling of the body cavity.

The relative volume of the swim bladder varies from 0 to 6% of total body volume in marine fishes (Jones 1957). Although measurements were not

made, the patterns of protrusion in this and other studies (above) suggest that species-specific differences in swim-bladder volume result in varying degrees of internal pressure on ascent. This may contribute to differences in gut protrusion and the extent of body cavity swelling.

It is not clear why varying rates of ascent would induce varying frequencies of gut protrusion within a fish species. Differences between fish species in the rates at which gases can be resorbed from the swim bladder likely had little effect on patterns of protrusion. Achievement of equilibrium through resorption requires time on the order of hours (Brown 1939; Jones 1951). This is a longer time-scale than the normal vertical movements of most fishes (Steen 1970) and vertical displacements while trawling and angling. Also, the absolute magnitude of swim-bladder expansion is independent of the rate of ascent and should not be considered a factor. Yet, a pattern is apparent in the higher values for angling versus trawl-caught black sea bass and also for red snappers caught with *Georgia Bulldog* versus *Blue Fin* trawling gear. Moseley (1966) reported higher oral eversion frequencies for red snappers taken by angling versus those taken while trawling at intermediate shelf depths (42-60 m). Bradley and Bryan (1975) also noted for red snappers that angling produced more stomach eversions than trawling, but stated that their data were confounded by differences in the average depths of fishing efforts. Additionally, stomach eversion frequencies for our trawl-caught red snappers (83% taken with "rapid ascent" *Georgia Bulldog* gear) were 7.5-9.5 times higher than those reported in the literature from similar depths (Fig. 1A; Moseley 1966; Bradley and Bryan 1975). It is tempting to attribute these results to differences in vertical haulback rates. The rate of swim-bladder expansion, linked directly to changes in hydrostatics (Steen 1970) and therefore qualitatively more or less "violent", may govern the nature and extent of injuries.

An additional factor contributing potentially to the types and frequencies of gut protrusion is the consistency, amount, and position of prey material in the alimentary tract. Firm material may function as a bonelike directing structure or be what an expanding swim bladder acts upon. It is interesting that all of the herniated intestines in planehead filefish, blue angel fish, and orange filefish contain fecal material. If hydrostatic forces within a fish's body cavity are influenced by gut contents, unequal and variable allocation of sampling effort and catch over a diel feeding cycle could alter estimates of protrusion frequency for a given fish species. The major-

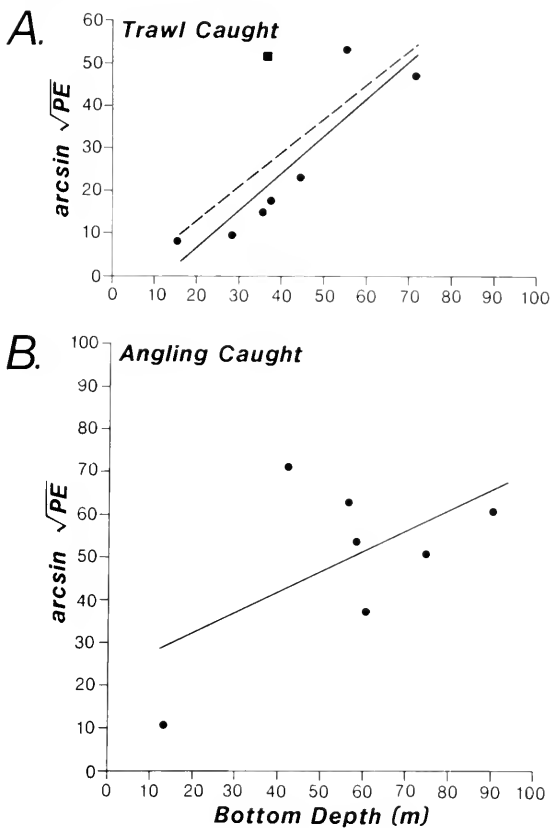

FIGURE 1.—Plots of the proportions of red snappers with everted stomachs (PE) captured by (A) trawling and (B) angling as a function of bottom depth (data from Camber 1955; Moseley 1966; Bradley and Bryan 1975; except this study). Ordinates were arcsine transformed (Snedecor and Cochran 1980). Abscissas are plotted as actual depths or midpoints of ranges. The dashed line (plot A) is the least-squares line including data from this study. The only significant relationship was for trawl-caught fishes from the literature ( $r = 0.90$ ,  $df = 5$ ,  $P < 0.01$ ).

ity of orange filefish were collected during periods of the day when there was very little material in the alimentary tract, which is likely responsible for herniation/intussusception rates at variance with planehead filefish and blue angelfish values. Sampling of other species was more equitably distributed over the 24-h period.

### Considerations for Feeding Studies

Negligible biases in stomach and intestinal contents are expected among trawl-caught black sea bass, bank sea bass, tomtate, the three porgy species, sand perch, and vermilion snapper at depths of 37 m. Angling-caught red porgies and vermilion snappers should be equally free of bias-producing

gut displacements at these depths. However, caution is necessary in analyses of stomach contents for trawl-caught red snappers, *Mycteroperca* groupers, short bigeyes, and angling-caught black sea bass from 37 m. Stomach content data for angling-caught red snappers, groupers, bank sea bass, and sand perch should also be interpreted with attention to the likelihood of bias. These considerations have been previously acknowledged for angling-caught black sea bass and bank sea bass (Link 1980), trawl and angling-caught red snappers (Stearns 1884; Adams and Kendall 1891; Camber 1955; Moseley 1966; Bradley and Bryan 1975), angling-caught red groupers, *Epinephelus morio* (Moe 1969), and angling and longline-caught blueline tilefish, *Caulolatilus microps* (Ross 1982), from southeastern U.S. shelf and slope waters. Moseley (1966) and Link (1980) both stated that partial or full stomach eversion renders quantification of consumed prey suspect, particularly with respect to across-depth comparisons (e.g., Godfriaux 1974). Studies of food habits of fishes in the South Atlantic and Gulf of Mexico shelf snapper-grouper complex have either not discussed depth as a diet-determining variable (Camber 1955; Moseley 1966; Moe 1969; Bradley and Bryan 1975; Dixon 1975; Henwood et al. 1978; Ross 1982; Steimle and Ogren 1982) or if depth was considered, dealt with fishes not prone to stomach-eversion bias (Manooch 1977; Grimes 1979; Sedberry 1985).

Species and gear-specific considerations should also be made for analyses of daily feeding chronologies and rations based on stomach content weights. Fishes with partially or completely everted stomachs should be eliminated from the data set. It is clear that trawl-caught specimens of most species are more suited to such analyses than those caught with angling gear. However, some species cannot be efficiently collected with trawling gear at certain times of day, over certain types of bottom, or indeed at all. Extra angling effort (offsetting eversion rates) and well-designed multigear approaches (including traps and longlines) can be used to complete data sets for such fishes.

Displacements of the posterior portion of the alimentary tract can also have significant effects on studies of feeding biology. Trawl-caught planehead filefish, blue angelfish, and orange filefish are subject to such bias. Prey position data used to examine the rate of movement and evacuation of material through the gut (e.g., Klumpp and Nichols 1983) will be affected by both herniations and intussusceptions. During herniation, fecal material is either shifted into the protruded portion of the intestine or the

material already present in that segment is isolated from what might otherwise be a continuous column of material. Both potentially produce gaps or "clumping" of intestinal contents. Collection of data affected by intestinal displacements should also incorporate increased sampling so that specimens with herniations or intussusceptions can be eliminated from the data set without a significant loss of information.

### Survivorship: Experimental Design and Fishery Management

Our data show that experimental studies of survivorship and the physiological responses of sponge-coral reef fishes following capture and release should stratify their designs by gear. Traps and longlines should be considered in future studies because of the gear-specific vertical haulback rates and other stress factors. Additional considerations are capture depth (Gotshall 1964; Moe 1966, 1969; Moseley 1966; Bradley and Bryan 1975; Grimes et al. 1983), predation on injured and disoriented fishes (Parker et al. 1959, 1963; Randall 1960; Topp 1963; Gotshall 1964; Fable 1980), crowding and abrasion in the gear (Pawson and Lockwood 1980), degree of gut fullness (related to stress from diverted blood supply; Beamish 1966), physiological state related to long-term feeding/activity cycles (Parker et al. 1959), water column temperature structure, currents, and turbidity. Many of the factors covary with depth and fluctuate seasonally.

The anatomical derangements investigated in the present study are severe trauma. Oral and cloacal protrusions would very likely cause high rates of mortality in subsequently released fishes. Obstruction of the gastrointestinal tract would normally be serious and interference with the blood supply to the gastric and intestinal walls would lead to severe circulatory impairment. Gotshall (1964) has shown that returns from tagged blue rockfish, *Sebastes mystinus* requiring stomach replacement and swim-bladder deflation were less than half those from fish requiring only swim-bladder deflation. These fish endured everted stomachs for only a few minutes. Topp (1963) has noted that the everted stomachs of *Lutjanus* snappers are frequently perforated by the fish's teeth. The effects of such injuries on survival require further study.

Expansion of the swim bladder in specimens which do not experience gut protrusions likely induces internal damage undetected by external examination. Aquarists commonly use swim-bladder deflation techniques to increase survivorship of specimens suf-

fering from decompression symptoms (D. Miller<sup>6</sup>). Gotshall (1964) increased tag returns of blue rockfish by deflating expanded swim bladders of specimens collected as deep as 90 m. The technique also reduces the effects of exophthalmia (protruding eyes produced by expansion of gas into the cranial region) on blue rockfish (Gotshall 1964), vermilion snapper, big eye (*Priacanthus arenatus*), and short bigeye (D. Miller fn. 6).

Although tissue emphysema per se may not be lethal, swim-bladder rupture probably is for some species. Jones (1949) reported 90% mortality of 600 perch, *Perca fluviatilis*, with swim bladders ruptured while being raised rapidly from 13.7 m. Topp (1963) speculated that survivorship of sponge-coral reef fishes with ruptured swim bladders is very low. However, R. O. Parker<sup>7</sup> has observed healing of ruptured swim bladders in black sea bass. Further experimentation is needed to determine the effects of swim-bladder rupture on a species-specific basis.

It is likely that survivorship following release varies with depth due to hydrostatic factors alone. Regression of trawl-caught red snapper stomach eversion proportions on capture depth (values from the literature) explains 80% of the variance in the observed data (Fig. 1A;  $r = 0.90$ ,  $df = 5$ ,  $P < 0.01$ ). Inclusion of our trawl-caught red snapper data rendered the relationship nonsignificant (Fig. 1A;  $r = 0.70$ ,  $df = 6$ ,  $P < 0.05$ ). A similar plot of angling-caught red snapper data from the literature was not significant (Fig. 1B;  $r = 0.58$ ;  $df = 5$ ;  $0.10 < P < 0.05$ ), possibly because of the differences in the sizes of red snappers hooked with respect to depth (see Figure 1 citations) and resultant differences in the rates of ascent, or ontogenetic differences in relative swim-bladder volume. Note that increased depth eventually outweighs any real effect of the size of the fish and tenacity of its struggle against the angling gear, or anatomical variation, rendering the overall relationship positive albeit nonlinear. The above data (Fig. 1A, B) also indicate that red snappers caught with any gear over bottoms <30 m deep do not suffer significant trauma. Similarly, depths  $\leq 20$  m introduced no difficulties to a food habits study of this species (Moseley 1966).

Clearly, regulations which diminish removal of fishes (e.g., gear/method restrictions, area/time closures) will be more effective over a larger depth

<sup>6</sup>D. M. Miller, Curator, University of Georgia Marine Education Center, POB 13687, Savannah, GA 31416, pers. commun. November 1984.

<sup>7</sup>R. O. Parker, National Marine Fisheries Service, Southeast Fisheries Center, Beaufort Laboratory, POB 500, Beaufort, NC 28516, pers. commun. October 1984.

range than release measures. Current management of the southeastern U.S. snapper-grouper fisheries guarantees subjection of protected size classes to stress and trauma. However, it is conceivable that swim-bladder deflation techniques could improve the effectiveness of current regulations.

The data we have presented show that the effects of capture on sponge-coral reef fishes vary between species and gears. These are important considerations for studies of feeding biology. Additional data on fish species survivorship following releases, stratified by gear and depth, will allow fine-tuning of present snapper-grouper management policies.

## ACKNOWLEDGMENTS

Special thanks go to the captains and crews of the RV *Blue Fin*, RV *Georgia Bulldog*, and FV *Sanctuary*. Trawl doors for the RV *Blue Fin* were loaned by S. Drummond, Southeast Fisheries Center Pascagoula Laboratory, National Marine Fisheries Service. D. Wyanski, B. Wells, C. Haney, T. Chestnut, D. Miller, P. Schlein, B. Goggins, J. Rivers, M. Harris, J. Hightower, and a host of volunteers assisted in the field. D. Wyanski, B. Wells, A. Acevedo, and L. Creasman assisted in the laboratory. The figure was drafted by A. Boyette. The manuscript was improved with comments from G. Helfman, S. Larson, and two anonymous reviewers; it was typed by L. Wainright and W. Roberts. The research benefited from discussions with R. Parker, C. Haney, D. Miller, P. Van Veld, and L. Wall. This work was supported by NOAA Sea Grants to T. E. Targett and M. V. Rawson (NA80AA-D-00091 collectively) and by operating funds at Skidaway Institute of Oceanography.

## LITERATURE CITED

- ADAMS, A. C., AND W. C. KENDALL.  
1891. Report upon an investigation of the fishing grounds off the west coast of Florida. *Bull. U.S. Fish. Comm.* 9:289-312.
- BEAMISH, F. W. H.  
1966. Muscular fatigue and mortality in haddock, *Melanogrammus aeglefinus*, caught by otter trawl. *J. Fish. Res. Board Can.* 23:1507-1521.
- BLACK, E. C.  
1958. Hyperactivity as a lethal factor in fish. *J. Fish. Res. Board Can.* 15:573-586.
- BRADLEY, E., AND C. E. BRYAN.  
1975. Life history and fishery of the red snapper (*Lutjanus campechanus*) in the northwestern Gulf of Mexico: 1970-1974. *Proc. Gulf Caribb. Fish. Inst.* 27:77-106.
- BROWN, F. A., JR.  
1939. Responses of the swimbladder of the guppy, *Lebistes reticulatus*, to sudden pressure decreases. *Biol. Bull.* 76:48-58.
- CAMBER, C. I.  
1955. A survey of the red snapper fishery of the Gulf of Mexico, with special reference to the Campeche Banks. *Fla. Board Conserv. Mar. Res. Lab. Tech. Ser.* 12, 64 p.
- CHESTER, A. J., G. R. HUNTSMAN, P. A. TESTER, AND C. S. MANOOCH, III.  
1974. South Atlantic Bight reef fish communities as represented in hook-and-line catches. *Bull. Mar. Sci.* 34:267-279.
- DIXON, R. L.  
1975. Evidence for mesopelagic feeding by the vermilion snapper, *Rhomboplites aurorubens*. *J. Elisha Mitchell Sci. Soc.* 91:240-242.
- FABLE, W. A. JR.  
1980. Tagging studies of the red snapper (*Lutjanus campechanus*) and vermilion snapper (*Rhomboplites aurorubens*) off the south Texas coast. *Contrib. Mar. Sci.* 23:115-121.
- GODFRIAUX, B. L.  
1974. Food of snapper in western Bay of Plenty, New Zealand. *N. Z. J. Mar. Freshw. Res.* 8:473-504.
- GOMFMC (GULF OF MEXICO FISHERY MANAGEMENT COUNCIL).  
1981. Environmental impact statement and fishery management plan for the reef fish resources of the Gulf of Mexico. GOMFMC, St. Petersburg, FL.
- GOTSHALL, D. W.  
1964. Increasing tagged rockfish (genus *Sebastes*) survival by deflating the swim bladder. *Calif. Fish Game* 50:253-260.
- GRIMES, C. B.  
1979. Diet and feeding ecology of the vermilion snapper, *Rhomboplites aurorubens* (Cuvier) from North Carolina and South Carolina waters. *Bull. Mar. Sci.* 29:53-61.
- GRIMES, C. B., S. C. TURNER, AND K. W. ABLE.  
1983. A technique for tagging deepwater fish. *Fish. Bull.*, U.S. 81:663-666.
- HENWOOD, T., P. JOHNSON, AND R. HEARD.  
1978. Feeding habits and food of the longspined porgy, *Stenotomus caprinus* Bean. *Northeast Gulf Sci.* 2:133-137.
- JONES, F. R. H.  
1949. The teleostean swimbladder and vertical migration. *Nature* 164:847.
1951. The swimbladder and the vertical movements of teleostean fishes. I. Physical factors. *J. Exp. Biol.* 28:553-566.
1957. The swimbladder. In M. E. Brown (editor), *The physiology of fishes*. II. Behavior, p. 305-322. Acad. Press, N.Y.
- KLUMPP, D. W., AND P. D. NICHOLS.  
1983. Nutrition of the southern sea garfish *Hyporhamphus melanochir*: gut passage rate and daily consumption of two food types and assimilation of seagrass components. *Mar. Ecol. Prog. Ser.* 12:207-216.
- LAIRD, L. M., AND B. STOTT.  
1978. Marking and tagging. In T. Bagenal (editor), *Methods for assessment of fish production in fresh waters*, p. 84-100. Blackwell Sci. Publ., Oxf.
- LINK, G. W., JR.  
1980. Age, growth, reproduction, feeding, and ecological observations on the three species of *Centropristis* (Pisces: Serranidae) in North Carolina waters. Ph.D. Thesis, Univ. North Carolina, Chapel Hill, NC.
- MANOOCH, C. S., III.  
1977. Foods of the red porgy, *Pagrus pagrus*, Linnaeus (Pisces: Sparidae), from North Carolina and South Carolina. *Bull. Mar. Sci.* 27:776-787.
- MATHESON, R. H., III, AND G. R. HUNTSMAN.  
1984. Growth, mortality, and yield-per-recruit models for

- speckled hind and snowy grouper from the United States South Atlantic Bight. *Trans. Am. Fish. Soc.* 113:607-616.
- MILLER, G. C., AND W. J. RICHARDS.  
1980. Reef fish habitat, faunal assemblages, and factors determining distributions in the South Atlantic Bight. *Proc. Ann. Gulf Caribb. Fish. Inst.* 32:114-130.
- MOE, M. A., JR.  
1966. Tagging fishes in Florida offshore waters. *Fla. Board Conserv., Div. Southwest Fish. Tech. Ser.* 49, 40 p.  
1969. Biology of the red grouper *Epinephelus morio* (Valenciennes) from the eastern Gulf of Mexico. *Fla. State Board Conserv., Dep. Nat. Resour. Mar. Lab., Prof. Pap. Ser.* 10, 95 p.
- MOSELEY, F. N.  
1966. Biology of the red snapper, *Lutjanus aya* Bloch, of the northwestern Gulf of Mexico. *Publ. Inst. Mar. Sci., Univ. Tex.* 11:90-101.
- PARKER, R. R., E. C. BLACK, AND P. A. LARKIN.  
1959. Fatigue and mortality in troll-caught Pacific salmon (*Oncorhynchus*). *J. Fish. Res. Board Can.* 16:429-448.  
1963. Some aspects of fish-marking mortality. *In* Northwest Atlantic Fish Marking Symposium, 1961, p. 117-122. *Int. Comm. Northwest Atl. Fish. Spec. Publ.* 4.
- PAWSON, M. G., AND S. J. LOCKWOOD.  
1980. Mortality of mackerel following physical stress, and its probable cause. *Rapp. P.-v. Réun. Cons. int. Explor. Mer* 177:439-443.
- RANDALL, J. E.  
1960. The case of the free-loading barracuda. *Sea Front.* 6:174-179.
- RICKER, W. E.  
1949. Effects of removal of fins upon the growth and survival of spiny-rayed fishes. *J. Wildl. Manage.* 13:29-40.
- ROBINS, C. R., R. M. BAILEY, C. E. BOND, J. R. BROOKER, E. A. LACHNER, R. N. LEA, AND W. B. SCOTT.  
1980. A list of common and scientific names of fishes from the United States and Canada. *Am. Fish. Soc. Spec. Pub.* 12, 174 p.
- ROSS, J. L.  
1982. Feeding habits of the gray tilefish, *Caulolatilus microps* (Goode and Bean, 1878), from North Carolina and South Carolina waters. *Bull. Mar. Sci.* 32:448-454.
- SAFMC (SOUTH ATLANTIC FISHERY MANAGEMENT COUNCIL).  
1983a. Source document for the snapper-grouper fishery of the South Atlantic region. SAFMC, Charleston, SC.  
1983b. Fishery management plan, regulatory impact review, and final environmental impact statement for the snapper-grouper fishery of the South Atlantic region. SAFMC, Charleston, SC.
- SEDBERRY, G. R.  
1985. Food and feeding of the tomate, *Haemulon aurolineatum* (Pisces, Haemulidae), in the South Atlantic Bight. *Fish. Bull., U.S.* 73:461-466.
- SEDBERRY, G. R., AND R. F. VAN DOLAH.  
1984. Demersal fish assemblages associated with hard bottom habitat in the South Atlantic Bight of the USA. *Environ. Biol. Fishes* 11:241-258.
- STEARNS, S.  
1984. On the position and character of the fishing grounds of the Gulf of Mexico. *Bull. U.S. Fish. Comm.* 4:289-290.
- STEEN, J. B.  
1970. The swim bladder as a hydrostatic organ. *In* W. S. Hoar and D. J. Randall (editors), *Fish physiology*. Vol. IV. The nervous system, circulation, and respiration, p. 413-443. *Acad. Press*, N.Y.
- STEIMLE, F. W., JR., AND L. OGDEN.  
1982. Food of fish collected on artificial reefs in the New York Bight and off Charleston, South Carolina. *Mar. Fish. Rev.* 44(6-7):49-52.
- TOPP, R.  
1963. The tagging of fishes in Florida 1962 program. *Fla. Board Conserv., Mar. Lab. Prof. Pap. Ser.* 5, 76 p.
- WENNER, C. A.  
1983. Species associations and day-night variability of trawl-caught fishes from the inshore sponge-coral habitat, South Atlantic Bight. *Fish. Bull., U.S.* 81:537-552.

# ANNUAL PRODUCTION OF EVISCERATED BODY WEIGHT, FAT, AND GONADS BY PACIFIC HERRING, *CLUPEA HARENGUS PALLASI*, NEAR AUKE BAY, SOUTHEASTERN ALASKA

JAY C. QUAST<sup>1</sup>

## ABSTRACT

Pacific herring, *Clupea harengus pallasii*, grow according to the constant-proportion growth model, which requires that yearly growth in body length be a constant proportion of growth during the previous year. Herring have one or two growth stanzas (periods of constant-proportional growth) in the eastern Pacific Ocean and eastern Bering Sea, and grow faster in the eastern Bering Sea than in the northeastern Pacific Ocean.

With growth, total and eviscerated body weights of fresh Auke Bay herring bear an exponential relationship to body length (BL) that is slightly greater than cubic, and evisceration does not lower variability in length-weight relationships. With growth, an increasing part of the annual product (growth plus gonads) is partitioned into gonads so that in the largest fish most of the annual product is gonads. The annual product is constantly proportional to BL through ages 2-6 and also through ages 9-12, but the proportion is considerably smaller in the 9- to 12-yr-old fish. The two differing proportions may indicate that young and old Auke Bay herring occupy slightly different feeding niches and that the trophic environment in the Auke Bay vicinity may not support the older fish as well as the younger.

Pacific herring spawn in April or May in the Auke Bay vicinity, as zooplankton density rapidly increases to its peak in June. The time of spawning seems optimal for rapid building of fat reserves and feeding of newly hatched larvae.

Pacific herring, *Clupea harengus pallasii*, range off western North America, from the Chukchi Sea to San Diego, CA, and have been commercially exploited over the entire range (Rounsefell 1930; McLean and Delaney 1978; Spratt 1981). Pacific herring usually occupy extensive reaches of coast, from tens to hundreds of miles, and populations are particularly dense around the Alexander Archipelago of southeastern Alaska and the archipelago off British Columbia (from charts or fisheries maps in Rounsefell 1930, McLean and Delaney 1978, and Spratt 1981). Yet, even where dense, populations can be locally distinctive in vertebral number and spawning time (Rounsefell and Dahlgren 1935; Hourston 1980).

Pacific herring have been commercially harvested in Alaska since the late 1800's (Rounsefell 1930), principally for reduction to meal and oil. Herring were also pickled, starting in 1900, but the industry never became large and declined in the 1920's. A fishery for Pacific halibut, *Hippoglossus stenolepis*, bait had a similar rise and decline. The reduction

fishery ended in the 1960's, and the principal fishery for Pacific herring in Alaska now is sac roe, which is exported to Japan.

The biology of Pacific herring in Alaska has not been thoroughly described. The study by Rounsefell (1930) is the most comprehensive work, and Rounsefell and Dahlgren (1935) separated stocks in southeastern Alaska on the basis of vertebral counts. Skud (1963) analyzed tag returns, and Carlson (1980) described the ecology of Auke Bay herring. Reid (1971) summarized some biological characteristics of herring taken for the reduction fishery from 1929 to 1966.

Because Pacific herring are economically and ecologically important in southeastern Alaska and there is little information on the growth, productivity, and life history of this species in this region, I undertook a 1-yr study of a population in the Auke Bay vicinity (Auke Bay is about 16 km northwest of Juneau). Goals of the study were to compare growth of Pacific herring in the Auke Bay vicinity with growth of Pacific herring from other locales in the eastern Pacific Ocean and relate annual production of fat, gonads, and eviscerated weight in the Auke Bay herring to the annual cycle of food supply.

Pacific herring of the Auke Bay vicinity are one of the innermost and northernmost populations in

<sup>1</sup>Northwest and Alaska Fisheries Center Auke Bay Laboratory, National Marine Fisheries Service, NOAA, P.O. Box 210155, Auke Bay, AK 99821; present address: 1565 Jamestown Street S.E., Salem, OR 97302.

the Alexander Archipelago (Auke Bay is about 80 nmi [148 km] by water from the open coast). Although this population may contain more than one spawning stock, it will be identified with Auke Bay in the present study (local populations spawn within weeks of each other and within a few nautical miles).

## METHODS

Auke Bay herring were sampled several times monthly from April 1973 to March 1974; however, no fish were taken in February 1974. The fish were captured principally by jigging with bright hooks or hooks wrapped with colored yarn. Samples were also taken during spring 1973 from nearby locales in southeastern Alaska, including Hood Bay (off Chatham Strait, southwest of Juneau), Carroll Inlet (near Ketchikan), and Katlian Bay (near Sitka), and also from the eastern Bering Sea west of Nunivak Island.

Auke Bay herring were usually examined fresh but sometimes were frozen and examined within 1 wk. Lengths were originally measured as standard lengths (SL, tip of upper jaw to end of hypural bones) but were later converted to body length (BL, tip of lower jaw to end of hypural bones) by multiplying SL by 1.0132, the average ratio in 126 specimens from Auke Bay.

Body lengths were back-calculated from scales taken from above the pectoral fins and posterior to the opercular flap. The calculations followed the proportional method of Whitney and Carlander (1956), which should reduce the variation in BL-scale size relationships because the method adjusts for possible differences in scale length in the same-sized fish. This method requires that the regression between BL and scale length be linear, which was satisfied (Fig. 1). The intercept of the regression (55 mm) was somewhat higher than the median BL (36.5 mm) for first squamation of 16 preserved specimens; however, the differences between estimates for BL at first squamation are probably important only for fish younger than 1 yr. The regression fit the data well for herring  $\geq 1$  yr old (Fig. 1). I also attempted to reduce variability in the back-calculations for the Auke Bay fish by averaging focus-to-annulus distances from left and right sides of the scales (annuli were as well defined at the sides as in the centerline of the scale), but only a centerline measurement was used in samples from other geographic regions.

After the growth data were analyzed by Walford graphs (Walford 1946), linear regressions (Walford

regressions) were fit by least squares to adult sections of constant parameters (stanzas) that were indicated on the graphs. Both the Walford regression and von Bertalanffy formulation are variants of the constant-proportion growth model, which requires that growth in one year be a constant proportion of growth the preceding year (Ricker 1975). (The slope of a Walford regression equals the von Bertalanffy  $e^{-K}$ , and the intercept equals  $L_{\infty}(1 - e^{-K})$ .)

Annual changes in development of fat and gonads were evaluated by indices that were derived from total body weights, eviscerated body weights, and gonad weights. I estimated unbound water in the eviscerated body tissues and gonads as the percentage weight lost by drying 1 cm wide transverse body sections and entire gonads in a drying oven for more than 4 d at 27°C, a period that yielded weight stability. Visual estimates of visceral fat used a four-point scale (from none to heavy), and visual estimates of maturity used a seven-point scale, as follows (Roman numerals in brackets refer to a similar scale developed by Hay and Outram (1981) for Pacific herring): 1) Newly regenerating [VIII], 2) regenerating [III], 3) nearly mature [IV], 4) ripe [V], 5) ripe and running [VI], 6) partially spawned [VII], and 7) spawned out [VII]. Fresh body, eviscerated, and gonad weights were regressed on body lengths by least squares after logarithmic transformation of variates. Statistical tests were significant when  $P < 0.05$ .

Scales of Pacific herring from southeastern Alaska and the eastern Bering Sea probably have two annuli in the first growth year. When the annulus nearest to the scale focus of Auke Bay herring was used for back-calculations, the BL's were much smaller (average of 65 mm) for the first winter than the BL's of juvenile herring (at least 80 mm) captured at the end of their first year in Auke Bay by Jones (1978). Pacific herring in British Columbia attain a length of at least 80 mm by their first September (Hourston 1958). Furthermore, when the first annulus was used as the first year mark, Walford graphs of the growth data were erratic and differed markedly from graphs of the same type of data in the literature. When the second annulus was used as the first year mark, the graphs were simple and corresponded to graphs of similar data from the literature.

There was no indication of Lee's phenomenon (slower growth in longer lived individuals) in the back-calculated BL's, but there was evidence of a changing relation between growth back-calculated for ages 1 and 2 and the span of years that was used



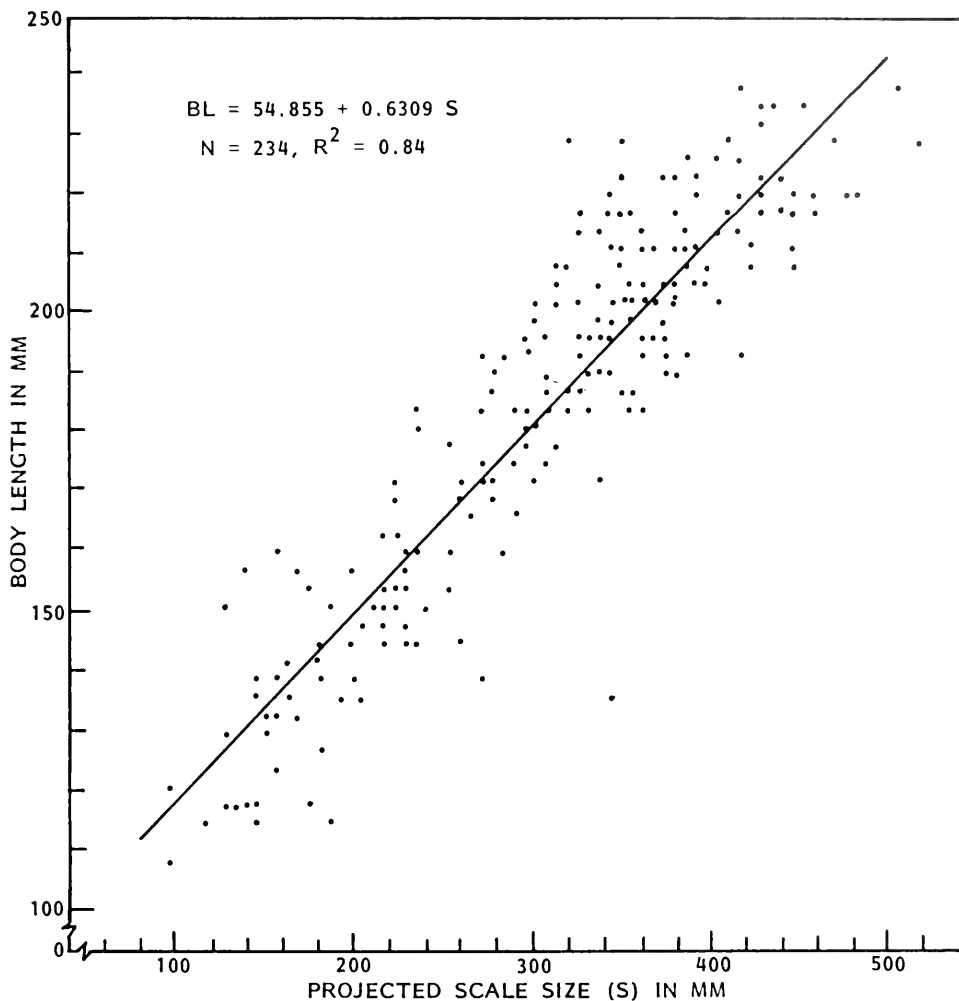

FIGURE 1.—Relationship between body length (BL) and projected scale size (S) of Pacific herring from Auke Bay, AK.

in the back-calculations. When the estimates of growth to ages 1 and 2 were compared for all specimens, those from herring aged 2-4 at time of capture (back-calculated over a span of 0-2 yr) had slower-than-average growth, and those herring aged 4-7 (back-calculated over a span of 3-5 yr) had faster-than-average growth (Fig. 2). Estimates for the oldest herring (back-calculated over a span of  $\geq 6$  yr), however, gave mixed results. The trends in fish of 5 yr and younger may have been caused by environmental influences because the trends occur in sets of years (fish aged 2-4, when captured, spent their first or second growth years in 1970-72, and those aged 4-7 spent their first or second growth years principally in 1966-69).

## GROWTH

The average size-at-age data in my samples of Pacific herring from the eastern Pacific and eastern Bering Sea and data from the literature for those regions usually formed two stanzas on Walford graphs and inflected at ages 2 or 3 (see Figure 3 for examples). The data for Norwegian and Murman stocks of Atlantic herring, *Clupea harengus harengus*, (Svetovidov 1952) also formed two stanzas and intersected at age 2. Although the stanzas for all of my back-calculated data from the eastern Pacific Ocean intersected at age 2, stanzas for two populations from California (data from Spratt 1981) intersected at age 3, and a plot of Naumenko's

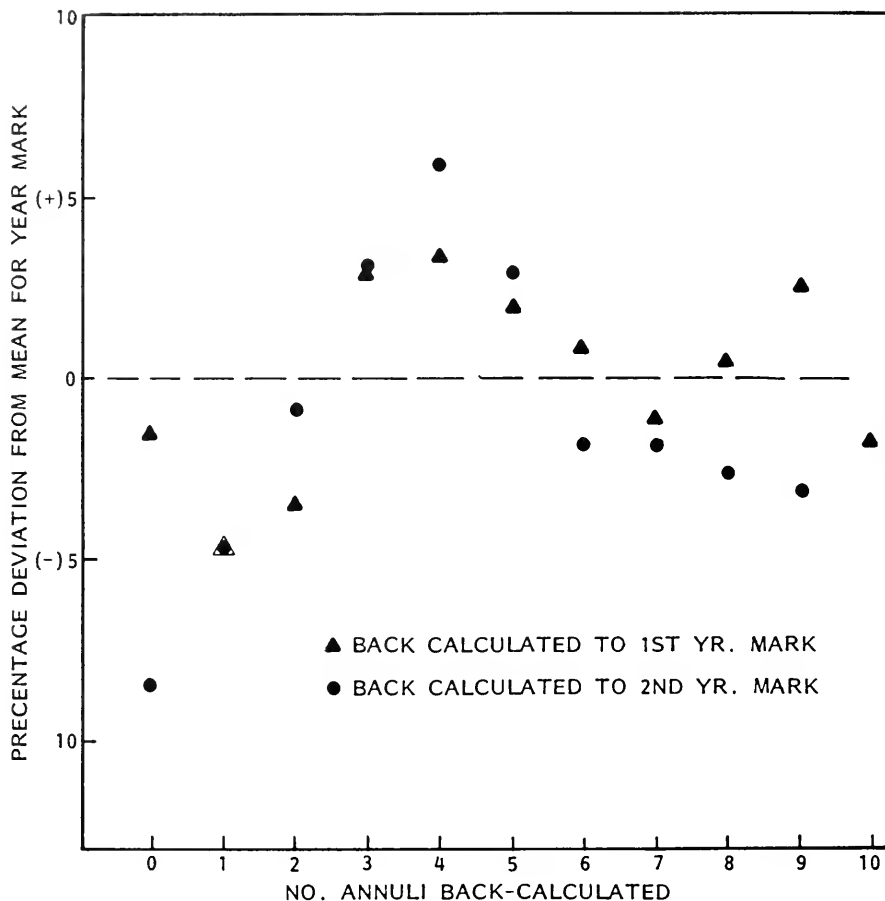

FIGURE 2.—Relationship between extent of back-calculation from scales and the body length estimated at 1 and 2 yr in Pacific herring from Auke Bay, AK. Points indicate the deviation of size estimates for age-1 and age-2 Pacific herring from the average for all annuli (the second annulus was taken as the first year's mark).

(1979) data from the eastern Bering Sea had only one stanza. Regardless of the data source, linear regressions (Walford regressions) closely fit the data in the growth stanzas (Tables 1, 2).

The method of aging Pacific herring can influence estimates of growth. In the data that I examined for this study, adult stanzas based on back-calculated lengths usually had lower slopes than adult stanzas based on terminal-lengths-at age (Table 1). Furthermore, the plots of back-calculated data inflected either at 2 yr or not at all, in contrast to plots of lengths-at-terminal-age, which inflected at 3 yr in three of six examples (Table 1). Important factors, however, remain uncontrolled in this comparison. For instance, the lengths-at-terminal-age from the literature were based on summer sampling; hence, they include additional growth after annulus formation. The lengths-at-terminal-age were from

populations near or on the open coast, which may grow faster than populations from protected and possibly less productive waters within the Alexander Archipelago. Furthermore, it is not clear that the Alaskan data for lengths-at-terminal-age used the second scale annulus as the first year's mark.

Walford graphs for Pacific herring from Tomales Bay, CA (data from Spratt 1981), and the eastern Bering Sea (this study) indicated that juvenile growth success and age at inflection (intersection of juvenile and adult stanzas) are more important determinants of adult size at age than either length at year 1 or the slope of the adult stanza, the adult growth proportion (Table 1; Fig. 3). The data indicate that herring from the Bering Sea quickly outgrow those from Tomales Bay although the BL's of the two groups were almost identical at ages 1

TABLE 1.—Growth characteristics and growth parameters of Pacific herring from the northeastern Pacific Ocean and eastern Bering Sea, based on data from the present study and from the literature. Growth is portrayed by the Walford version of the constant-proportion growth model (see text). Because Reid's (1971) data were gathered from a summer fishery, body lengths are longer than they were at the time of annulus formation and may not be comparable to back-calculated data or to lengths-at-terminal-age collected on or near the time of annulus formation. The inflections column refers to the junction of juvenile stanzas with stanzas for adults. Juvenile stanzas on the Walford graphs were fit by eye to sizes at ages 1 and 2, or ages 1-3; adult stanzas were fit by least squares.

Capture location	Size at age 1 (mm)	Inflection at year	Adult stanza			Aging method	Source
			Intercept	Slope	R <sup>2</sup>		
Back-calculated lengths:							
Auke Bay vicinity	93.3	2	64.89	0.709	0.998	scales	this study
Hood Bay, Chatham Strait	90.8	2	66.31	0.664	0.995	scales	this study
Katlai Bay	101.5	2	81.50	0.659	0.991	scales	this study
Carroll Inlet	102.7	2	83.61	0.632	0.999	scales	this study
Eastern Bering Sea	112.8	2	79.26	0.727	0.993	scales	this study
Eastern Bering Sea	90.3	? <sup>1</sup>	88.79	0.722	0.999	scales	Naumenko 1979
Lengths-at-terminal-age:							
Auke Bay vicinity	—	2	64.94	0.716	0.983	scales	Blankenbeckler 1979 <sup>2</sup>
Prince William Sound, AK	131.4	3	40.60	0.859	0.985	scales	Reid 1971
Kodiak vicinity, AK	132.1	2+	55.99	0.792	0.990	scales	Reid 1971
Southeastern Alaska	145.1	2+	52.14	0.788	0.967	scales	Reid 1971
San Francisco, CA	113	3	44.87	0.816	0.989	otoliths	Spratt 1981
Tomales Bay, CA	113	3	36.95	0.871	0.996	otoliths	Spratt 1981

<sup>1</sup>No inflection apparent.

<sup>2</sup>Blankenbeckler, D. 1978. Age, growth, maturation, and parasite occurrence of Pacific herring (*Clupea pallasii*) from southeastern Alaska, 1974 through 1976. Alaska Dep. Fish Game, Tech. Data Rep. 39, 88 p.

and 2, and the adult stanza was steeper for herring from Tomales Bay. The Bering Sea herring, however, inflected to a steeper slope at age 2 rather than age 3. Environment may not determine the time of inflection in Pacific herring because juveniles both from the Bering Sea and Tomales Bay had similar BL's during the first 2 yr (Fig. 3) although the environments of the locales probably differ greatly.

## Weight-Length Relationships

Total weight ( $W$ , grams) relates to BL (millimeters) in fresh Pacific herring from the Auke Bay vicinity as  $W = (4.4467 \times 10^{-6})BL^{3.2232}$  ( $N = 491$ ;  $R^2 = 0.97$ ). The lower confidence limit for the exponent exceeds 3.0, and the exponent exceeds 3.0 in reports for herring in most locales; e.g., Pacific herring from Tomales Bay, 2.93 (Spratt 1981); San Francisco Bay, 3.23 (Spratt 1981); the east coast of Vancouver Island, 3.26 (Hart et al. 1940), and Barkley Sound, British Columbia, 3.46 (Hart et al. 1940); and in Atlantic herring, 3.15 and 3.5 (Hart et al. 1940). Many differences between exponents, as cited, may not be biologically significant because weight-length relationships vary seasonally and between sexes, even in eviscerated fish. The exponent for the relationship between BL and total weight probably exceeds 3.0 in healthy herring populations because, as noted in later paragraphs, both eviscer-

ated and gonad fresh weights also have exponents  $>3.0$  when related to BL.

Eviscerated weight of Auke Bay herring also had an exponential relationship to BL that significantly exceeded 3.0 [ $(W = 5.0894 \times 10^{-6})BL^{3.16640}$ ; Fig. 4]. In theory, evisceration avoids large potential weight variations caused by seasonal changes in gonads and fat deposits about the viscera, and variable food content; yet, eviscerated weight ( $Sy \cdot x = 0.1030$ ) was at least as variable a function of BL as total weight ( $Sy \cdot x = 0.0953$ ) in the same specimens, and both total weight and eviscerated weight had the same coefficient of determination (0.97). The lack of decreased variability in the weight of eviscerated herring, as a function of BL, compared with whole fish is evidence that building of visceral fat and gonads does not simply add weight, but rather that some compensatory mechanism may act between these apparent weight sources and the eviscerated body.

In contrast to the results of Hart et al. (1940), Hickling (1940) found markedly low exponents, 2.13 and 2.37, for the relationship between eviscerated weight and BL for Atlantic herring from the North Sea, values that are strikingly lower than those expected for fishes in general. For example, Quast (1968) gave exponents of 2.7-4.5 for 32 species of marine fishes in southeastern California, including 3.9 for the northern anchovy, *Engraulis mordax*. Hickling's exponents may be too low because the

TABLE 2.—Body lengths (BL's) of Pacific herring from the Alexander Archipelago and the eastern Bering Sea, AK. Found lengths are mean BL's at capture (Blankenbeckler's<sup>1</sup> data) or mean back-calculated BL's; fitted lengths are predicted by the constant-proportion growth model (see text) from found lengths. Parentheses indicate sample sizes <5 (found data) or extrapolations with the growth models. Average differences between the fitted and found data (bottom line) were based on absolute values and exclude values in parentheses. For Pacific herring in the Auke Bay vicinity, average differences between fitted lengths based on length at capture (col. 3) and fitted lengths based on back-calculations (col. 5) was 1.96%.

Age	Terminal lengths (mm) Auke Bay vicinity		Auke Bay vicinity		Hood Bay, Chatham Strait		Katlian Bay		Carroll Inlet		Eastern Bering Sea	
	Found	Fitted	Found	Fitted	Found	Fitted	Found	Fitted	Found	Fitted	Found	Fitted
	Back-calculated lengths (mm)											
1	—	—	93.3	—	90.8	—	101.5	—	102.7	—	112.8	—
2	133.0	—	130.8	131.0	125.9	126.6	153.3	152.3	148.5	148.5	163.3	161.3
3	163.6	160.2	159.2	157.8	151.9	150.4	182.6	181.9	176.7	177.5	198.4	196.5
4	176.0	179.6	178.0	176.8	165.6	166.2	196.7	201.4	196.9	195.8	221.4	222.1
5	190.6	193.6	189.5	190.2	175.1	176.6	213.4	214.2	208.9	207.3	236.5	240.7
6	203.7	203.5	198.0	199.8	183.7	183.6	223.6	222.7	214.4	214.6	247.8	254.3
7	211.5	210.7	203.6	206.5	181.1	188.2	228.7	228.2	219.2	219.3	261.2	264.1
8	215.6	215.8	209.2	211.3	186.1	191.3	(223.4)	(231.9)	(221.5)	(222.2)	274.2	271.3
9	219.9	219.4	214.5	214.7	—	(193.3)	—	(234.3)	(220.9)	(224.0)	(284.4)	(276.5)
10	220.7	222.0	217.8	217.1	—	(194.7)	—	(235.9)	(223.8)	(225.2)	(288.4)	(280.3)
11	225.4	223.9	221.2	218.8	—	(195.6)	—	(237.0)	(225.9)	(225.9)	(293.0)	(283.0)
12	(213.2)	(225.3)	220.9	220.0	—	(196.2)	—	(237.7)	(248.2)	(226.4)	—	(285.0)
13	(231.7)	(226.2)	(229.3)	(220.9)	—	(196.6)	—	(238.1)	—	(226.7)	—	(286.5)
Average difference (%)	0.86		0.66		0.56		0.73		0.32		1.28	

<sup>1</sup>Blankenbeckler, D. 1978. Age, growth, maturation and parasite occurrence of Pacific herring (*Clupea pallas*) from southeastern Alaska, 1974 through 1976. Alaska Dep. Fish and Game Tech. Data Rep. 39, 88 p.

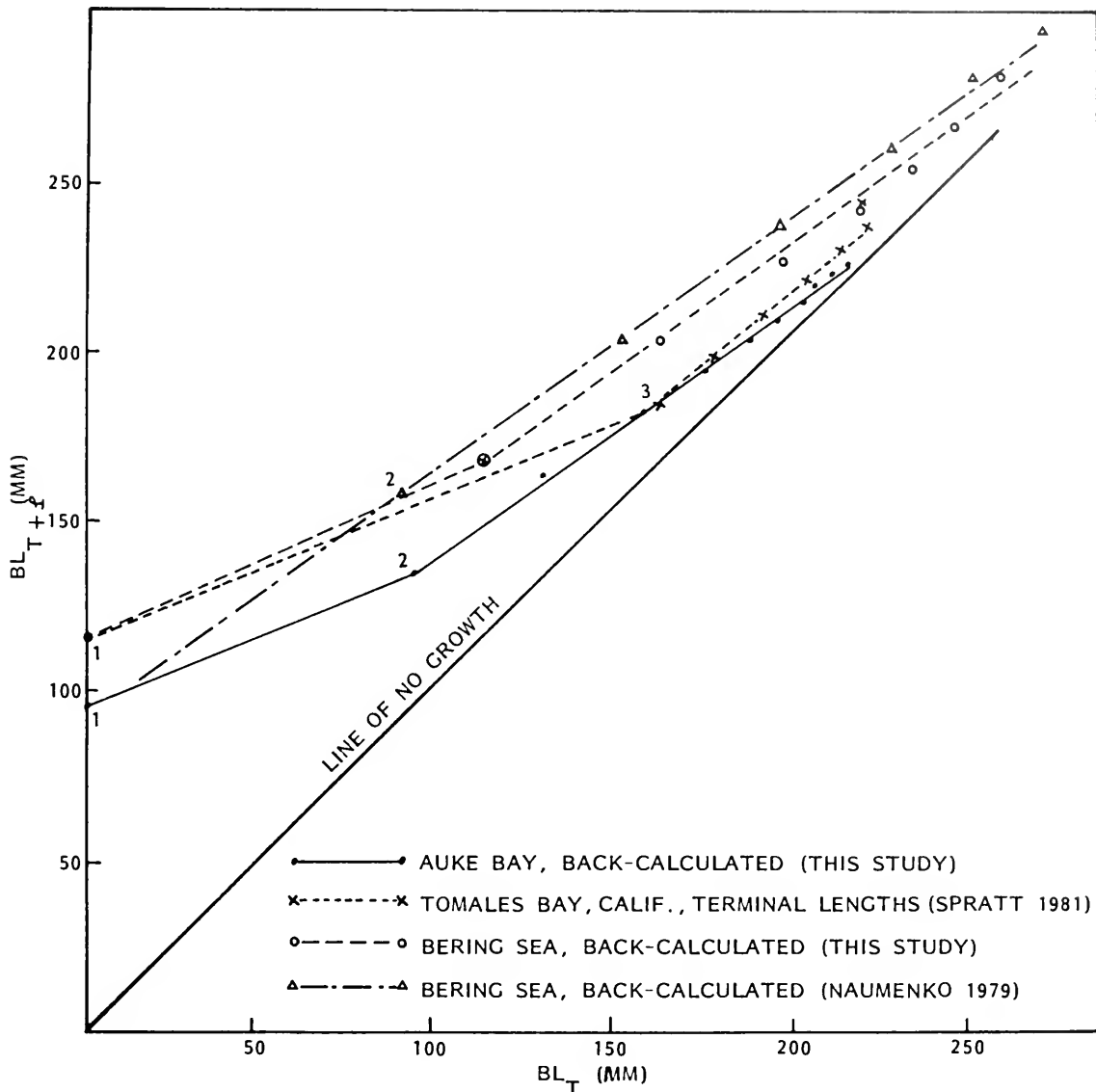

FIGURE 3.—Examples of Walford trends in body length of Pacific herring from widely separated locales in the eastern Pacific Ocean and Bering Sea. Heavy solid line through origin is the line of zero growth, and numbered points indicate ages in years. Adult stanzas were fit by least squares, and the juvenile stanzas were fit by eye. Data from Naumenko (1979) represent 25 yr of collections.

effective range of BL's was limited (near 50 mm) in his data sets and his data were grouped in 10 mm size classes. (In contrast, BL's extended over about 130 mm in the Auke Bay herring, and lengths were taken to 1 mm.)

In Pacific herring, the relationship between eviscerated weight and BL varies with season and sex (Fig. 5), and the relationship for Atlantic herring should vary similarly. Although Hickling (1940) concluded that regressions of eviscerated weight on BL

differed by sex in Atlantic herring ( $W = 0.0661 BL^{2.312}$  in males, and  $W = 1.1471 BL^{1.456}$  in females), his samples probably were too restricted seasonally to estimate reliably the relationship between eviscerated weight and BL for all seasons. Because of seasonal variation in fat content of the musculature (discussed in the next section), data for a single season cannot represent an average over all seasons in Pacific or Atlantic herring of either sex.

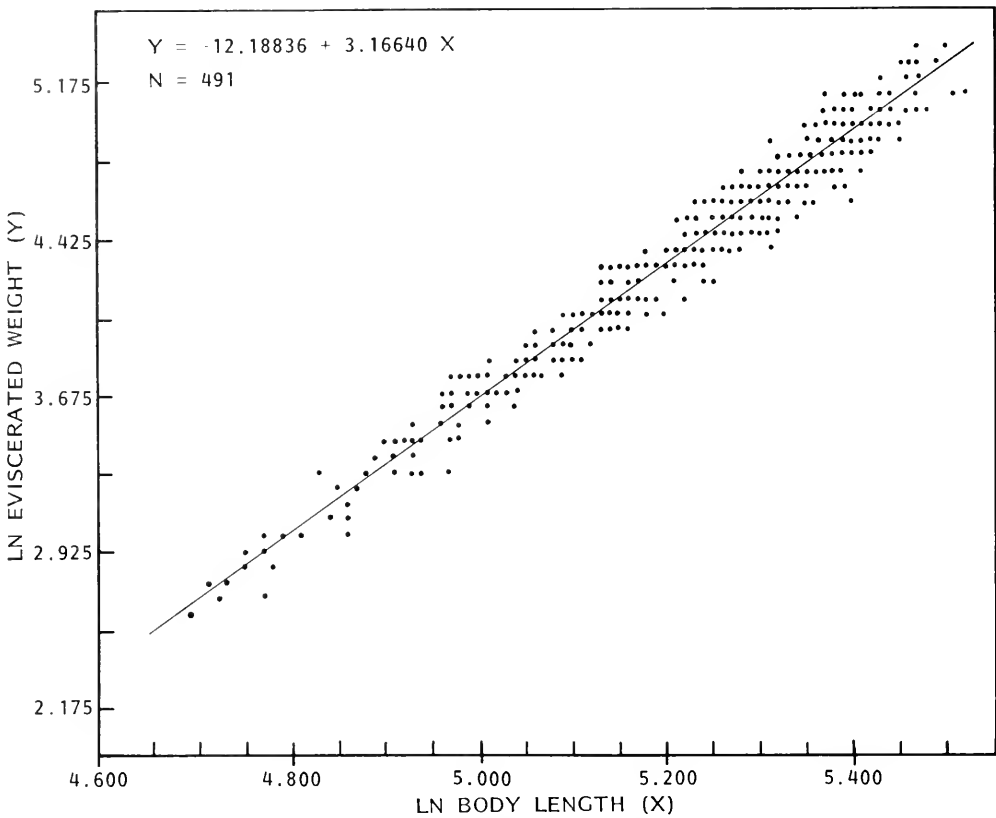

FIGURE 4.—Relationship between body length and eviscerated body weight in fresh Pacific herring in the vicinity of Auke Bay, AK, sexes combined. Variates transformed to their natural logarithms (LN). Points represent 1-9 specimens.

### Seasonal Cycles in Fat and Gonads

Adult Pacific herring feed chiefly on zooplankton and small fishes (Hart 1973). In the Auke Bay vicinity, zooplankton peak in abundance in June or July and are virtually absent from November to March (Fig. 6; fig. 3 in Carlson 1980). In an unpublished study of Auke Bay herring, stomachs were mostly empty during late fall and winter (R. E. Haight, cited in Carlson 1980).

Pacific herring spawn in Auke Bay in late April or May but may spawn as late as 4 June (Wing<sup>2</sup>). Eggs hatch 14-20 d after spawning, based on incubation temperatures for herring in British Columbia (Outram 1965<sup>3</sup>) and temperatures for mid-April and May in Auke Bay, which are similar to

those for British Columbia (Wing<sup>4</sup>). The time of spawning seems optimal to allow spawned fish and their newly hatched larvae to feed during the heaviest zooplankton concentrations of the year (Fig. 6).

Because the peak in zooplankton abundance is relatively brief, the period immediately after spawning is critical for fattening of adults and for growth and survival of newly hatched larvae. Feeding and fattening of all life stages of Auke Bay herring may also be aided by the submarine illumination afforded by the longest days and highest levels of light, early in the summer.

Fat accumulated about the viscera during the period of maximum zooplankton abundance and reached highest indices shortly afterward, about mid-July (Fig. 6). It then declined rapidly but slightly differently in each sex. There is evidence, also, based

<sup>2</sup>B. L. Wing, Northwest and Alaska Fisheries Center Auke Bay Laboratory, National Marine Fisheries Service, NOAA, P.O. Box 210155, Auke Bay, AK 99821, pers. commun. November 1981.

<sup>3</sup>Outram, D. N. 1965. Canada's Pacific herring. Dep. Fish. Can., Ottawa, Fish. Res. Board Can., Biol. Stn., Nanaimo, B.C., 23 p.

<sup>4</sup>B. L. Wing, Northwest and Alaska Fisheries Center Auke Bay Laboratory, National Marine Fisheries Service, NOAA, P.O. Box 210155, Auke Bay, AK 99821, pers. commun. July 1983.

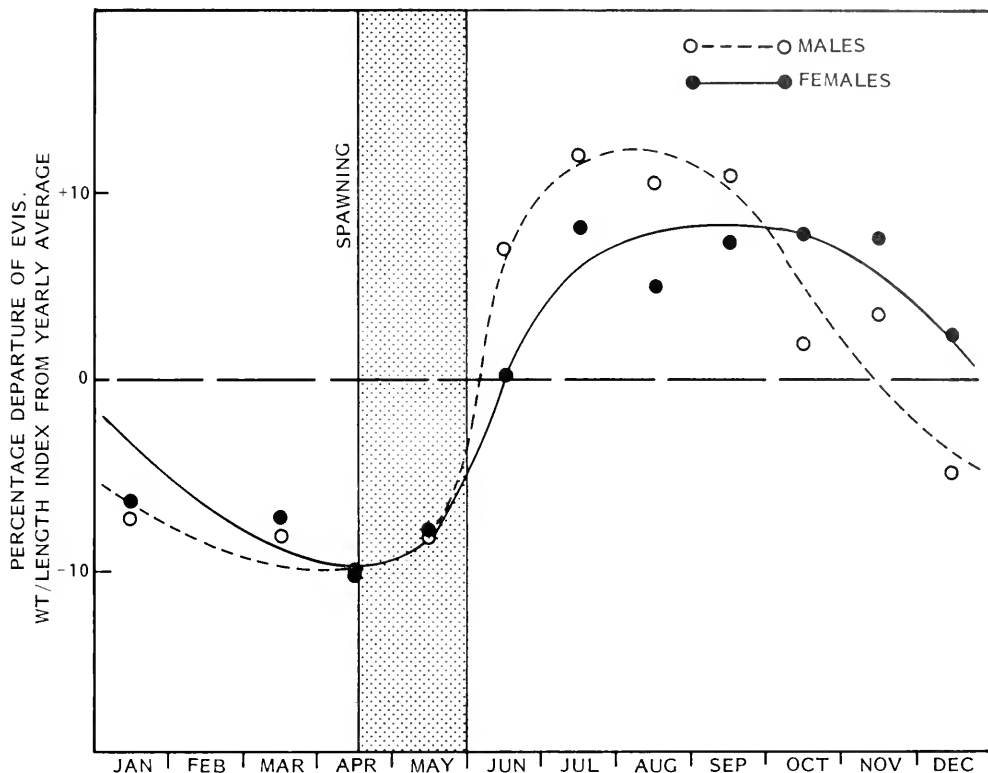

FIGURE 5.—Seasonal variation in eviscerated weight as shown by monthly samples of fresh Pacific herring near Auke Bay, AK, given as percentage departure from the weight predicted by the general eviscerated weight/BL regression for these fish (see Figure 4). The percentage departure is given relative to its yearly average to highlight seasonal changes. Data fit by eye.

on the water content of the musculature, that intramuscular fat varied seasonally and paralleled the development of visceral fat—water content of eviscerated body sections for the sexes behaved in an opposite fashion to visceral fat, being highest in April-May and at low levels between June and October (Table 3). In contrast to the water content of the musculature, eviscerated weight increased relative to BL after May (Fig. 5). If the increase in eviscerated weight were caused by increased somatic hydration, variation in hydration would have paralleled variation in eviscerated weight, but instead, the values for hydration decreased after May. Some other factor must be responsible for the increased eviscerated weights after May, and a likely candidate is fat, because eviscerated weight increased over the same period that visceral fat was building. Hart et al. (1940) also described an apparent reciprocal relationship between water and oil content in Pacific herring from British Columbia, and Love (1970) discussed the same relation-

TABLE 3.—Average hydration of musculature as a percentage of wet weight, by month in Pacific herring from Auke Bay, AK.

Month	Males		Females	
	N	Percent	N	Percent
January	15	69.2	6	68.4
March	17	71.1	19	71.0
April	26	75.3	25	76.0
May	29	77.0	29	76.0
June	8	61.7	12	66.5
July	8	60.8	12	61.5
August	10	60.7	10	61.1
September	23	61.7	30	62.7
October	12	61.9	18	61.5
November	1	62.6	6	60.6
December	3	65.0	25	63.1

ship in Atlantic herring and other fish species with fatty tissues.

The timing of gonad development, as indicated by seasonal development of gonads, differed in the sexes in Pacific herring from Auke Bay. Males were

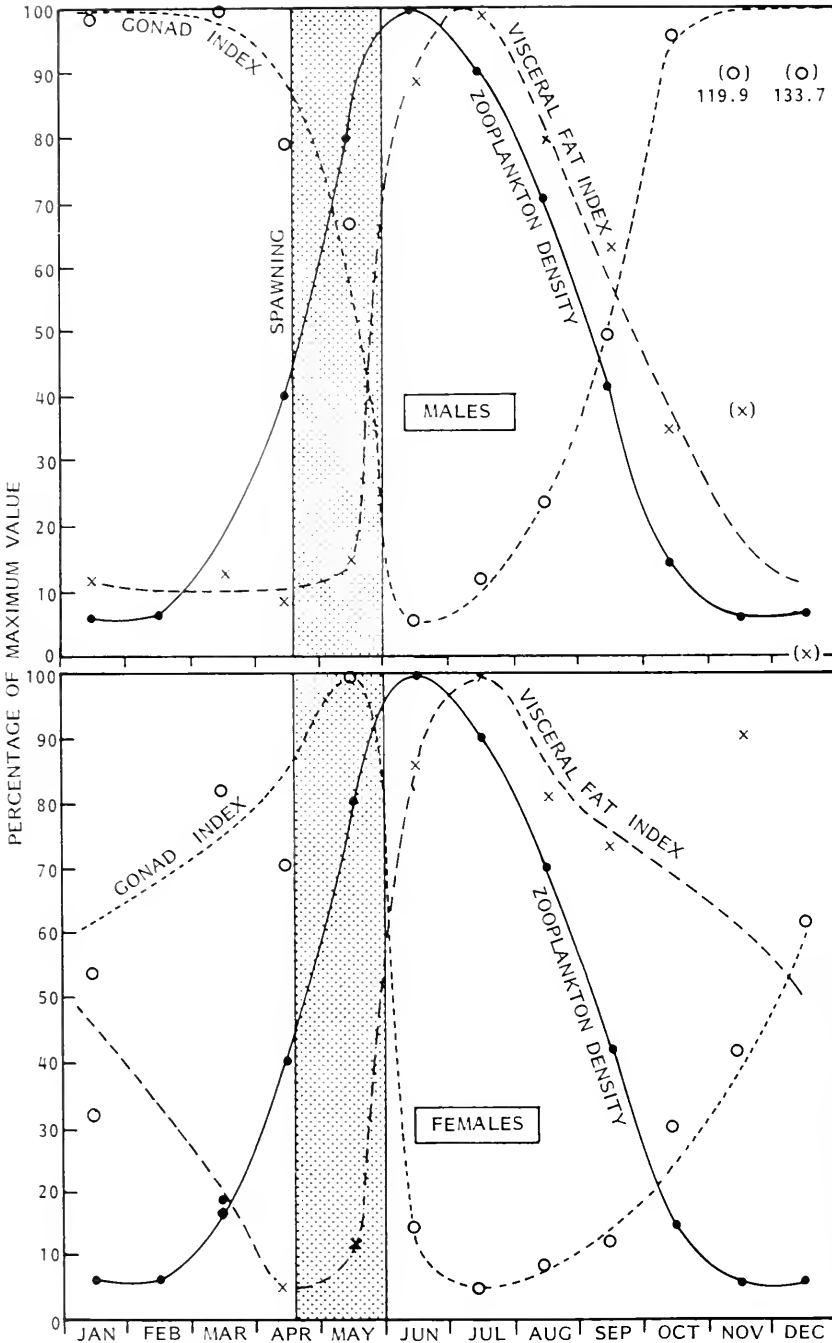

FIGURE 6.—Three annual cycles that relate to the condition of Pacific herring in the vicinity of Auke Bay, AK: A visual index of visceral fat (see text); gonad indices based on (wet) gonad weights as a percentage of the eviscerated (wet) body weights that would be expected at various BL's (see Figure 4); and an annual cycle of zooplankton density, from displacement volumes for 1962-64 given in Wing and Reid (1972). Points based on less than five specimens are enclosed in parentheses. Curves fit by eye.



nearly ready to spawn in November but females delayed readiness until perhaps 4 mo later (Fig. 6), a delay that was confirmed by visual judgments of maturity, see table below (sample size in parentheses):

*Percentage of herring judged ripe*

	<i>Sept.</i>	<i>Oct.</i>	<i>Nov.-Jan.</i>	<i>Mar.</i>
Males	4(23)	92(12)	95(19)	94(18)
Females	0(31)	11(18)	79(38)	90(20)

These data differ in some important respects from those of Hay and Outram (1981) for Pacific herring in British Columbia. Their gonadosomatic index has sharper peaks in maturity of gonads and different timing of the peaks than the Pacific herring from Auke Bay. For example, in their data, testes were only developing (a low gonadosomatic index) in October (the fish spawned in late February and early March), but testes were near maximum fullness (high index values) in October in herring from Auke Bay (Fig. 6). However, Hay and Outram used total weight in their index. If total weight is used for the index, the divisor will include a considerable weight of fat about the viscera in the fall and negligible weight in the spring, with the result that even if gonad weights remain the same from November to February, the decline in the amount of fat would cause the index to increase. In my study of the Pacific herring in Auke Bay, I divided gonad weight by eviscerated body weight, which should avoid an appreciable error in the gonadosomatic index that would be caused by variation in visceral fat.

Within each sex, seasonal profiles for gonad indices are nearly opposite the profiles for indices of visceral fat (Fig. 6). The annual cycles in fat and gonad indices (Fig. 6) in Pacific herring from Auke Bay resemble those noted by Blaxter and Holliday (1963) for spring spawning in Atlantic herring: "In winter-spring herring the good feeding conditions in late spring and early summer (after spawning) build up the fat reserves. With development of the gonads in late autumn feeding stops and spawning in December-March means that the fish overwinter and spawn with fat reserves considerably lower than the autumn spawners." Visceral fat in male Auke Bay herring is lowest in winter (perhaps as early as November), but in females does not reach lowest values until April. Correspondingly, the testes build rapidly in late summer and fall and appear to be heaviest by October or shortly after, but the ovaries

are not at their heaviest until shortly before spawning, in April or May. Hydration is not responsible for sexual differences in development of gonad weight from January to March because, as the following table indicates, hydration remains virtually constant from November to March in both sexes (Table 4).

TABLE 4.—Average hydration of gonads, as a percentage of wet weight, by month in Pacific herring from Auke Bay, AK.

Month	Males		Females	
	<i>N</i>	Percent	<i>N</i>	Percent
January	14	76.2	5	73.6
March	16	76.1	17	71.3
April	39	82.6	33	84.5
May	24	83.7	24	77.2
June	6	75.5	9	77.7
July	18	73.6	19	76.2
August	25	77.9	21	80.7
September	19	77.6	25	78.6
October	12	76.9	18	74.5
November	1	76.1	6	72.7
December	3	74.2	25	71.2

This seasonal, mirror imagery between development of fat and gonads, with the images differing for sexes, is evidence for a strong physiological coupling between fat depots and gonads. Fat depots enable Pacific herring to accommodate two critical cycles in their life history that are badly out of phase: The zooplankton cycle, with its brief, summer peak that builds fat depots rapidly and is followed by low levels of food abundance from October to March; and the gonad cycle that slowly removes fat from the depots with the slow building of testes from July through October and the slower building of ovaries from July through March.

Are the seasonal cycles of gonad maturity in Pacific herring from Auke Bay determined by genetics or are the gonads responding principally to cyclical changes in the immediate environment? Iles (1984) felt that Atlantic herring are remarkably independent of their environment. Genetic control of gonad maturity seems likely except for spawning, which appears to respond to local temperatures (Outram 1965, see footnote 3). Gonads must build well in advance of spawning, and spawning dates vary from November in the southern limits of the eastern Pacific range (Spratt 1981) to June in Auke Bay. Female Auke Bay herring mature sexually and use fat deposits later in the fall than do males and thus anticipate a later spawning date. Male herring in the eastern Pacific Ocean, in contrast, appear to build testes early enough to spawn at any date be-

tween November and June. Only the ovarian cycle seems to correspond closely to the local environmental conditions that seem optimal for larval growth and survival. Possibly, the genes that are responsible for local adaptation of spawning stocks are sex linked for females and are selected through larval survival.

### Annual Production of Eviscerated Weight and Reproductive Tissues

Although Pacific herring usually have only one major spawning per site in the Auke Bay vicinity, there may be a succession of lesser spawnings each spring. Unspawned fish are rarely seen as late as July (author's observations and comments by salmon fishermen who jig herring for bait). Although Wing (see footnote 2) recorded spawnings in Auke Bay between 24 and 29 April 1973, herring must spawn for at least 2 mo in Auke Bay because some fish sampled in 1973 were partially spawned or ripe and running in May and June (Fig. 7). Presumably, local conditions influence the number of eggs deposited on any date.

The relationship between fecundity, as indicated by mature ovarian weight, and BL was greater than

cubic, in agreement with data on other clupeoid species (Blaxter and Hunter 1982). Samples of Auke Bay herring had an exponent of 3.94 (Fig. 8), within the range (3.07-4.50) for Atlantic herring as given by Paulson and Smith (1977), from the literature. These authors gave an exponent of 3.32 for Pacific herring they sampled in Prince William Sound. Perhaps, the exponent for fecundity would have been higher for the herring Paulson and Smith sampled in Prince William Sound had their collections included smaller fish (their smallest were near 180 mm long, but fish as small as 130 mm were available in samples from Auke Bay). The exponent for testicular weight was considerably higher than that for ovarian weight in Auke Bay herring (Fig. 8); however, the difference may not be real because the confidence limits for the two exponents overlapped considerably.

The scatter in the plots of gonad and testes weights on BL for Auke Bay herring (Fig. 8) and for Pacific herring from Prince William Sound (fig. 1 in Paulson and Smith 1977) indicate that some of the herring may have been partially spawned when they were collected (fully spawned fish were not used in my data). If samples for fecundity are taken in the spawning season, there is the risk that some

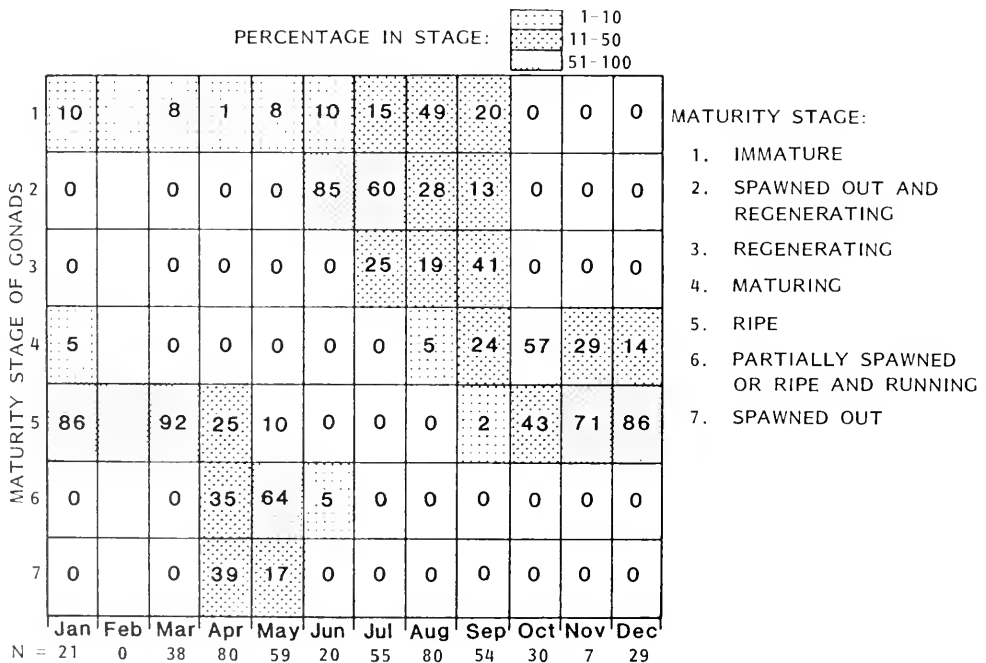

FIGURE 7.—Maturity of Pacific herring near Auke Bay, AK, by month (sexes combined). Numbers in boxes are percentages of herring that were visually classified into maturity stages on examination. Total fish by month are given in the bottom line. Data for February were extrapolated from January and March.

fish will have spawned partially and that fecundity estimates will be too low.

When the relationships between BL, weight, and fecundity in Pacific herring from Auke Bay were used in a model of annual changes in gonad weight and eviscerated weight, production of eviscerated

weight decreased rapidly with age or size (Table 5, col. 3). Gonad production (Table 5, col. 4), in contrast, increased yearly but appeared to approach an asymptote at about 31-34 g in the oldest fish. With age, more of the annual product (annual increment in eviscerated weight plus gonad weight) was par-

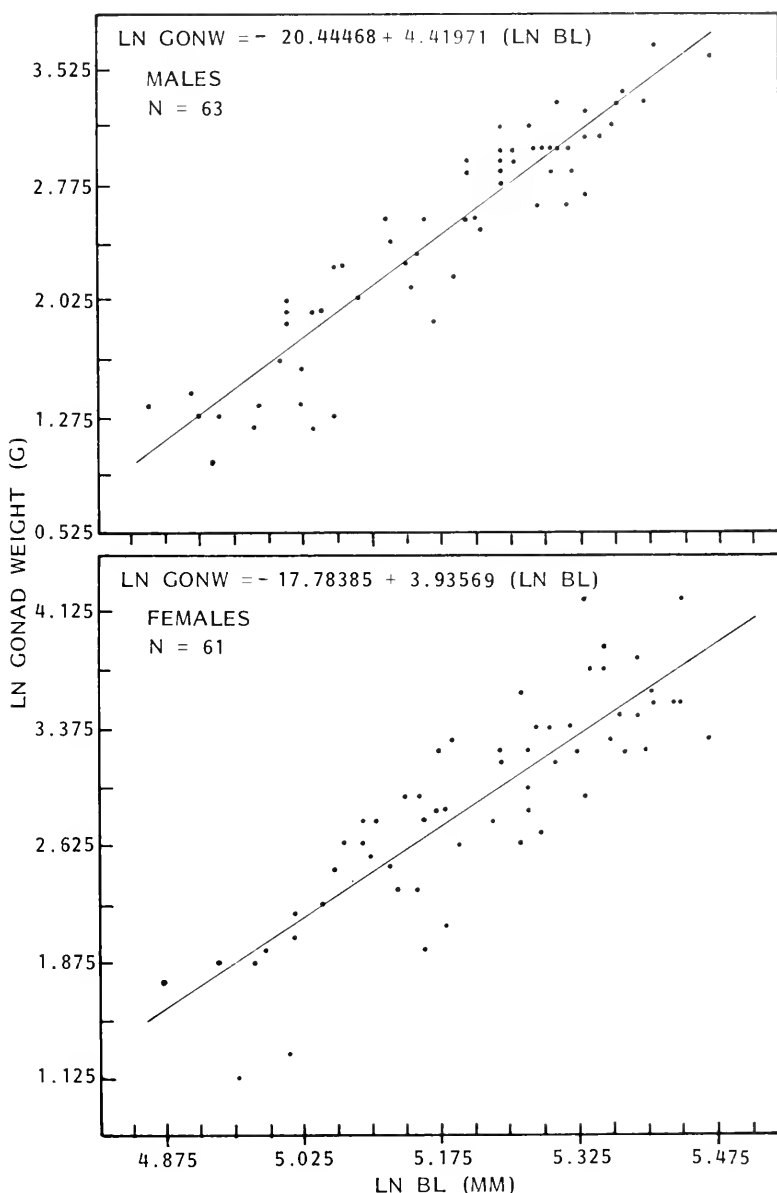

FIGURE 8.—Relationships between (wet) gonad weight (GONW) and BL in fresh Pacific herring collected from March to May 1973 near Auke Bay, AK (variates transformed by natural logarithms (LN). Data (not shown) that formed a separate cluster of points near the abscissa for each sex probably represented spawned fish and were not used in the regressions. Points represent 1-2 specimens.

TABLE 5.—Annual production of (wet) eviscerated weight and gonads in Pacific herring from the vicinity of Auke Bay, Alaska, as estimated from growth, length, and eviscerated-weight relationships, and length and gonad-weight relationships (Table 1, Figs. 4, 8). Column numbers are referenced in the text.

Annulus	(1) Fitted BL (mm)	(2) Estimated eviscerated weight (g)	(3) Eviscerated weight increment (g)	(4) Maximum gonad weight March-May		(5) Annual product (gonads plus eviscerated body weight)		(6) Annual product (5) as a percentage of BL the preceding year		(7) Annual product (5) as a percentage of evis- cerated weight the preceding year		(8) Gonads as a percentage of annual weight product (5)	
				Males (g)	Females (g)	Males (g)	Females (g)	Males	Females	Males	Females	Males	Females
2	131.0	25.8	—	—	—	—	—	—	—	—	—	—	—
3	157.8	46.4	20.6	6.9	8.3	27.5	28.9	21	22	107	112	25	29
4	176.8	66.5	20.1	11.3	13.2	31.4	33.3	20	21	68	72	34	40
5	190.2	83.9	17.4	15.6	17.7	33.0	35.1	19	20	50	53	47	50
6	199.8	98.0	19.1	19.5	21.4	38.6	40.5	20	21	46	48	50	53
7	206.5	108.8	10.8	22.5	24.4	33.3	35.2	17	18	34	36	68	69
8	211.3	117.0	8.2	24.9	26.7	33.1	34.9	16	17	30	32	75	76
9	214.7	123.1	6.1	26.7	28.4	32.8	34.5	15	16	28	29	81	82
10	217.1	127.5	4.4	28.1	29.7	32.5	34.1	15	16	26	28	86	87
11	218.8	130.7	3.2	29.1	30.6	32.3	33.8	15	16	25	27	90	90
12	220.0	133.0	2.3	29.8	31.3	32.1	33.6	15	15	25	26	93	93

tioned into gonads, which by age 12 composed nearly all of the annual production (Table 5, col. 8). As the herring grew, the annual product was more closely related to BL than to eviscerated body weight (Table 5, cols. 6, 7), evidence that individual herring in the Auke Bay vicinity may use food more in proportion to their BL than their weight. Furthermore, although the relationship between annual product and BL was nearly constant within age groups 3-6 and 8-12 (Table 5, col. 6), productivity was much lower in the 8-12 group. Young Auke Bay herring may be more successful for their size in finding food than are older individuals, because important foods needed by older herring may be scarce in the Auke Bay vicinity, which is about 80 nmi (148 km) by water from the open ocean.

There is indirect evidence from the characteristics of growth and production in Auke Bay herring and growth characteristics of other Pacific herring in the northeastern Pacific Ocean and Bering Sea that not only growth but the annual product relative to herring size and the partitioning of the annual product may vary with the population. If the relationship between eviscerated weight and BL in Auke Bay herring is used with growth data of Pacific herring from other locales in the eastern Pacific Ocean and Bering Sea (Table 1), striking differences are visible in the annual product of eviscerated weight (Fig. 9). For example, if 190 mm herring (3-yr-olds) in the Bering Sea produce gonads in the same proportion to eviscerated weight as 190 mm herring in Auke Bay (5-yr-olds; Table 5, col. 8), gonads and eviscerated weight would each form about one-half of the annual product of Bering Sea herring. However, this proportion would be much too high for herring in Bering Sea during their first year of gonad production, according to the model based on Auke Bay herring, if Bering Sea herring mature as 2- or 3-yr-olds. If production of eviscerated weight and gonads is scheduled according to age, rather than proportion of annual product, similar conflicts result; thus, Pacific herring from different regions probably differ in characteristics for production of eviscerated weight and gonads.

## CONCLUSIONS

Pacific herring grow in the eastern Pacific Ocean according to the constant-proportion model; i.e., growth in one year is a constant proportion of the amount grown the previous year. Growth stanzas (regions of constant growth parameters) for juveniles and adults usually inflect near age 2, and the change in growth is probably related to sexual

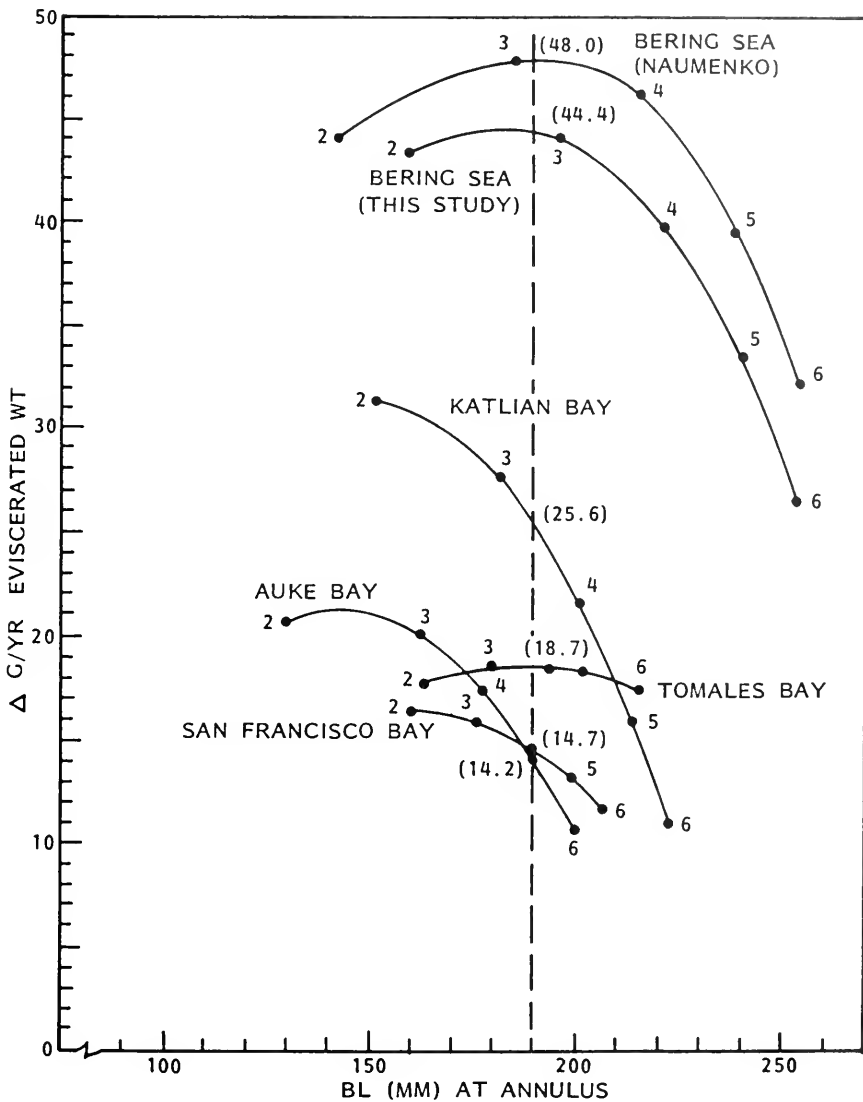

FIGURE 9.—Hypothetical growth in (fresh) eviscerated body weight by Pacific herring at locales in the eastern Pacific Ocean and eastern Bering Sea. Data were based on relationships between eviscerated body weight and BL in samples from the Auke Bay vicinity and data on growth reported in the literature (see Table 1). Numbered points are ages at the beginning of annual growth increments. The dashed vertical line is for comparative purposes and intersects the graphs at 190 mm BL. The second annulus was taken as the first year mark in specimens from Auke Bay, Katlian Bay, and Bering Sea (this study).

maturity. Size of adults is influenced more by growth rate of juveniles and the size at inflection of growth stanzas than by the constant of proportional growth after inflection.

In the Auke Bay vicinity, a sharp increase of zooplankton abundance in June is the determinant for the annual cycles of fattening and spawning in Pacific herring, and spawning in April or May seems optimally timed for growth of newly hatched fry.

In summer, fat builds rapidly about the viscera and in the musculature of adults, as a reserve for gonad development and metabolism in fall and winter when food is scarce and herring do not feed. Iles (1984) found that in Atlantic herring fat is assimilated and deposited almost unchanged during the feeding cycle and is not utilized for metabolism until the metabolic pool of protein is exhausted. He also hypothesizes that annual somatic growth declines

with gonad growth and ceases with depletion of the protein pool.

Male Pacific herring from Auke Bay build gonads and use their fat reserves more rapidly than do females. Testes may be near spawning condition in November, but ovaries are not full sized until April. Males may be ready or nearly ready to spawn in November over the entire eastern Pacific Ocean, but females delay spawning until local conditions of temperature and food abundance are optimal for larval growth.

The exponents for total and eviscerated body weights, as functions of BL, exceed 3.0 in Pacific herring from Auke Bay, and probably in Atlantic herring as well because of their similar morphology. Weight of mature gonads also have a greater-than-cubic relationship to BL in Auke Bay herring (the exponent was 4.4 for testes; the exponent of 3.9 for ovaries was within the range for ovaries in Atlantic herring).

The annual product (eviscerated body weight and gonad weight) is constantly proportional to BL through ages 2-6 and also through ages 8-12 in Pacific herring from Auke Bay, but the proportion is considerably lower in the 8-12 group. However, despite the two levels of production relative to BL, annual production corresponds more closely to BL than to eviscerated weight. Annual production may be lower relative to BL in the older group because suitable foods for adults may not be abundant in the Auke Bay vicinity. Most annual production in young Auke Bay herring goes into growth of eviscerated body weight. After age 6, production of sex products predominates, and by age 12, sex products compose over 90% of annual production.

Pacific herring probably develop genetic stocks that are distinguished by locale, spawning time, and cycles of gonad maturity and fat utilization in the females. The stocks probably are distinguished also by growth rate, age, or size at growth inflection and by partitioning of annual product between eviscerated body weight and gonads.

### ACKNOWLEDGMENTS

I especially thank Elizabeth L. Hall, NMFS Auke Bay Laboratory, for her exacting scale measurements and painstaking preparation of specimens, and H. Richard Carlson and Richard E. Haight, also of the Auke Bay Laboratory, who obtained the herring samples from the Auke Bay vicinity, sometimes under severe weather conditions. My thanks to the Alaska Department of Fish and Game for samples from Carroll Inlet, Katlian Bay, and the eastern Ber-

ing Sea, and to Petersburg Fisheries, Inc., for the opportunity to collect specimens from the herring fishery at Hood Bay. Helpful reviews of the manuscript were provided by H. Richard Carlson, Robert R. Simpson, and Bruce L. Wing of the Auke Bay Laboratory.

### LITERATURE CITED

- BLAXTER, J. H. S., AND F. G. T. HOLLIDAY.  
1963. The behavior and physiology of herring and other clupeids. In F. S. Russell (editor), *Advances in marine biology*, Vol. 1, p. 261-393. Acad. Press, N.Y.
- BLAXTER, J. H. S., AND J. R. HUNTER.  
1982. The biology of the clupeoid fishes. In J. H. S. Blaxter, F. S. Russell, and M. Young (editors), *Advances in marine biology*, Vol. 20, p. 1-223. Acad. Press, N.Y.
- CARLSON, H. R.  
1980. Seasonal distribution and environment of Pacific herring near Auke Bay, Lynn Canal, southeastern Alaska. *Trans. Am. Fish. Soc.* 109:71-78.
- HART, J. L.  
1973. Pacific fishes of Canada. *Fish. Res. Board Can. Bull.* 180, 740 p.
- HART, J. L., A. L. TESTER, D. BEALL, AND J. P. TULLY.  
1940. Proximate analysis of British Columbia herring in relation to season and condition factor. *J. Fish. Res. Board Can.* 4:478-490.
- HAY, D. E., AND D. N. OUTRAM.  
1981. Assessing and monitoring maturity and gonad development in Pacific herring. *Can. Tech. Rep. Fish. Aquat. Sci.* 998, 31 p.
- HICKLING, C. F.  
1940. The fecundity of the herring of the southern North Sea. *J. Mar. Biol. Assoc. U.K.* 24:619-632.
- HOURSTON, A. S.  
1958. Population studies on juvenile herring in Barkley Sound, British Columbia. *J. Fish. Res. Board Can.* 15:909-960.  
1980. Timing of herring spawnings in British Columbia, 1942-1979. *Can. Ind. Rep. Fish. Aquat. Sci.* 118, 101 p.
- ILES, T. D.  
1984. Allocation of resources to gonad and soma in Atlantic herring, *Clupea harengus* L. In G. W. Potts and R. J. Wootton (editors), *Fish Reproduction: Strategies and tactics*, p. 331-347. Acad. Press, N.Y.
- JONES, J. D.  
1978. Growth of larval Pacific herring in Auke Bay, Alaska, in 1975 and 1976. M.S. Thesis, Univ. Alaska, Juneau, 23 p.
- LOVE, R. M.  
1970. The chemical biology of fishes. Acad. Press, N.Y., 547 p.
- MCLEAN, R. F., AND K. J. DELANEY.  
1978. Alaska's fisheries atlas. Alaska, Dep. Fish Game, 2 vol., 81 p.
- NAUMENKO, N. I.  
1979. Features of growth of young eastern Bering Sea herring, *Clupea harengus pallasi*. *J. Ichthyol.* 19(6):152-156.
- PAULSON, A. C., AND R. L. SMITH.  
1977. Latitudinal variation of Pacific herring fecundity. *Trans. Am. Fish. Soc.* 106:244-247.
- QUAST, J. C.  
1968. Estimates of the populations and the standing crop of

- fishes, pp. 57-79. In W. J. North and C. L. Hubbs (editors), Utilization of kelp-bed resources in southern California, 264 p. Calif. Dep. Fish Game Fish Bull. 139.
- REID, G. M.  
1971. Age composition, weight, length, and sex of herring, *Clupea pallasii*, used for reduction in Alaska, 1929-66. U.S. Dep. Commer., NOAA Tech. Rep. NMFS SSR-F 634, 25 p.
- RICKER, W. E.  
1975. Computation and interpretation of biological statistics of fish populations. Fish. Res. Board Can. Bull. 191, 382 p.
- ROUNSEFELL, G. A.  
1930. Contribution to the biology of the Pacific herring, *Clupea pallasii*, and the condition of the fishery in Alaska. Bull. U.S. Bur. Fish. 45:227-320.
- ROUNSEFELL, G. A., AND E. N. DAHLGREN.  
1935. Races of herring, *Clupea pallasii*, in southeastern Alaska. Bull. U.S. Bur. Fish. 48:119-141.
- SKUD, B. E.  
1963. Herring tagging experiments in southeastern Alaska. U.S. Fish and Wildl. Serv. Fish. Bull. 63:19-32.
- SPRATT, J. E.  
1981. Status of the Pacific herring, *Clupea harengus pallasii*, resource in California, 1972 to 1980. Calif. Dep. Fish Game Bull. 171, 107 p.
- SVETOIDOV, A. N.  
1952. Clupeidae. In E. N. Pavlovskii and A. A. Shtakel'berg (editors), Fauna of U.S.S.R., Fishes, Vol. II, No. 1. Israel Program for Scientific Translations (translated from Russian by Z. Krauthamer and E. Roifer), 428 p.
- WALFORD, L. A.  
1946. A new graphic method of describing the growth of animals. Biol. Bull. 90(2):141-147.
- WHITNEY, R. R., AND K. D. CARLANDER.  
1956. Interpretation of body-scale regression for computing body length of fish. J. Wildl. Manage. 20:21-27.
- WING, B. L., AND G. M. REID.  
1972. Surface zooplankton from Auke Bay and vicinity, southeastern Alaska, August 1962 to January 1964. U.S. Dep. Commer., NOAA, NMFS Data Rep. 72, 764 p.





# CONTRIBUTIONS TO THE LIFE HISTORY OF BLACK SEA BASS, *CENTROPRISTIS STRIATA*, OFF THE SOUTHEASTERN UNITED STATES<sup>1</sup>

CHARLES A. WENNER, WILLIAM A. ROUMILLAT, AND C. WAYNE WALTZ<sup>2</sup>

## ABSTRACT

Ages of black sea bass, *Centropristis striata*, from the South Atlantic Bight were determined from otoliths. Analysis of marginal increments showed that annulus formation occurred in April and May. The von Bertalanffy growth equation derived from back-calculated mean standard lengths at age was  $l_t = 341(1 - e^{-0.2309(t + 0.3010)})$ , where  $t$  is age in years and  $l_t$  = standard length at age. The oldest fish was age 10.

*Centropristis striata* is a protogynous hermaphrodite that undergoes sex succession at ages 1 through 8. The process of sex succession is described from histological examination of the gonads. The major spawning period is from March to May, and a minor spawn occurs in September-October. Mature males and females were encountered at age 1. Fecundity estimates ranged from 17,000 in a 108 mm SL female to 1,050,000 in a 438 mm SL fish, and were significantly related to length, weight, and age.

The instantaneous rate of total mortality of *C. striata* from catch curve analysis, ranged from 0.721 in 1978 to 1.320 in 1981 for commercial fish traps and 0.726 in 1979 to 1.430 in 1981 for hook-and-line gear. Petersen mark-recapture techniques were used to determine the population size of *C. striata* on two shallow-water patch reefs. Conversions of these estimates to densities gave 14-125 individuals per hectare.

The black sea bass, *Centropristis striata* (Linnaeus), is an important recreational and commercial seranid (Huntsman 1976; Musick and Mercer 1977; Low 1981) that occurs along the east coast of the United States from Massachusetts to Florida, with occasional individuals as far south as the Florida Keys (Fischer 1978). Within this range, *C. striata* is thought to form two populations separated at Cape Hatteras (Mercer 1978). The northern population migrates seasonally from shallow waters along the Middle Atlantic and southern New England coasts during summer to deeper water in the southern part of the Middle Atlantic Bight during the winter (Musick and Mercer 1977). Black sea bass in the Middle Atlantic Bight are harvested commercially with traps in shallow water during summer and with otter trawl gear when aggregated in deeper water in winter (Frame and Pearce 1973). Commercial catches are almost exclusively from traps in that part of the South Atlantic Bight from Cape Fear, NC to Cape Canaveral, FL where fishing is largely confined to patch reefs (live bottom habitat of Struhsaker 1969 or inshore sponge-coral

habitat of Powles and Barans 1980) at depths from 20 to 46 m. South Carolina commercial landings were as high as 350.7 metric tons (t) in 1970, but show large annual fluctuations (Fig. 1).

Both the northern and southern populations have been aged by analyzing otoliths (Mercer 1978), with nine age groups identified north of Cape Hatteras and eight along the southeastern U.S. coast. However, sampling techniques could have biased the findings on southern *C. striata* since fishes came from commercial catches which are frequently culled at sea (Mercer 1978).

Black sea bass are protogynous hermaphrodites (Lavenda 1949), wherein most individuals function first as a female and later as a male. Most females mature by age 2; older age classes are composed predominately of male fish although sexually active males are in all age groups. Sexual succession occurs at ages 1 through 5 (Mercer 1978). The northern population spawns from June to October with peak reproduction in July and August off Virginia (Mercer 1978).

There is insufficient published information to describe the life history of this valuable commercial and recreational species in the South Atlantic Bight in detail. This report describes aspects of the life history of *C. striata* from the South Atlantic Bight, including age and growth, sex ratios, size and age

<sup>1</sup>Contribution No. 205 from the South Carolina Marine Resources Center, Marine Resources Research Institute.

<sup>2</sup>Marine Resources Research Institute, South Carolina Wildlife and Marine Resources Department, P.O. Box 12559, Charleston, SC 29412.

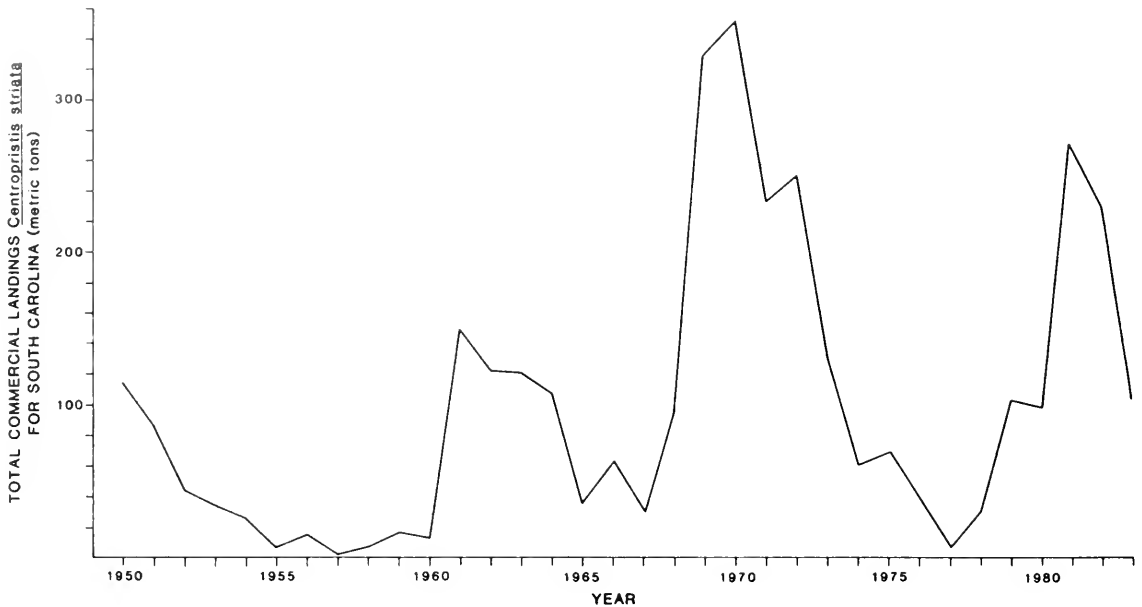

FIGURE 1.—Annual commercial landings of *Centropristis striata* in South Carolina.

at maturity and sexual succession, and fecundity. Additional information includes Petersen mark-recapture estimates of standing crop on reefs, and trends in the size and age composition with increased exploitation.

## MATERIALS AND METHODS

### Age and Growth

Most specimens were taken from the inshore sponge-coral habitat between lat. 31.5° and 33.5°N by commercial black sea bass traps (Rivers 1966), Antillean-S traps (Powles and Barans 1980), hand-lines, and trawl surveys from June 1978 through September 1981. Supplemental specimens were obtained from South Carolina commercial landings and other research programs to determine seasonal gonadal condition and time of annulus formation.

*Centropristis striata* were weighed to the nearest g and total (TL) and standard (SL) lengths were recorded to the nearest mm. Sagittae were removed and stored dry in envelopes for subsequent age determination. Unless damaged, the left sagitta was placed concave side up in a dish of water over a dark field and viewed at 12× magnification using a binocular microscope. When viewed with reflected light, sagittae displayed a central opaque field surrounded by alternating translucent and opaque bands. The

central field varied in size and shape from a small opaque nucleus to a large opaque zone consisting of one or more broken rings (Fig. 2A, B). Since apparent daily growth rings have been observed on both the sagitta and lapillus of *C. striata* (Johnson<sup>3</sup>), this zone was interpreted by counting rings from the primordium to the edge of the central field. Otoliths were finely ground on both sides until the central area of apparent daily rings could be observed (Fig. 3A, B). They were then viewed with transmitted light on a compound microscope at 500× and/or 1,000× magnification.

The intercept of the otolith radius-SL relationship was used to derive mean back-calculated size at age by the Fraser-Lee method (Poole 1961; Carlander 1982). The von Bertalanffy growth equation (Bertalanffy 1938) was fitted to mean back-calculated SL at age using the SAS NLIN procedure (Helwig and Council 1979) employing Marquardt's algorithm and the SAS NLIN weight statement; mean back-calculated lengths were weighted by the reciprocal of the standard error of the mean squared. Both standard least squares linear regression (Sokal and Rohlf 1981) and geometric mean (GM) functional regression analyses were used to describe the relationship of length to length and length to weight.

<sup>3</sup>G. David Johnson, Fish Division, U.S. National Museum, Washington, D.C. 20560, pers. commun. April 1982.

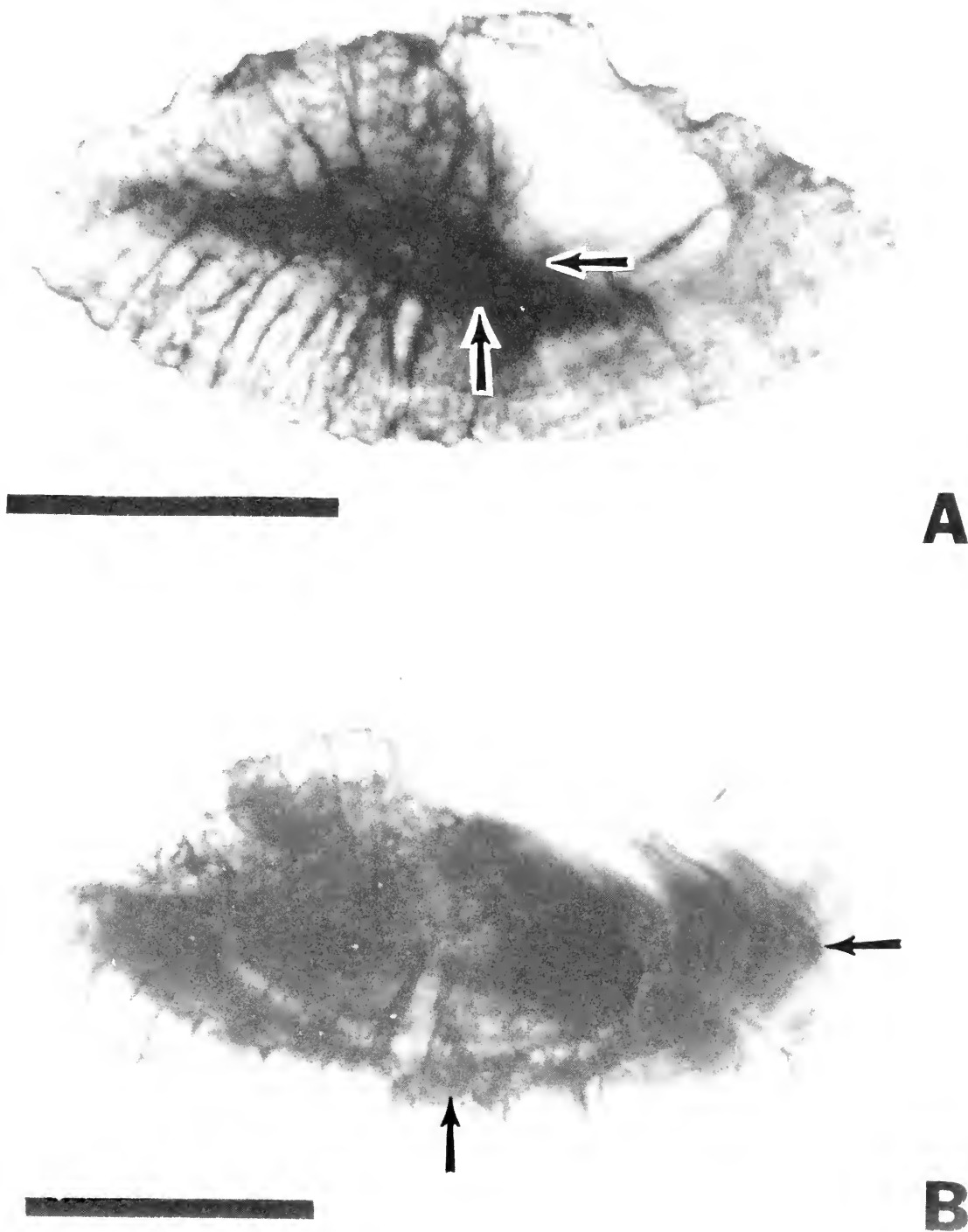

FIGURE 2.—Photomicrograph (16 $\times$ ) of the left sagittae from young-of-the-year *Centropristis striata*. A) Otolith with a small central nucleus (between arrows). B) Otolith with a large central zone consisting of a few broken rings (between arrows). Bars equal 1 mm.

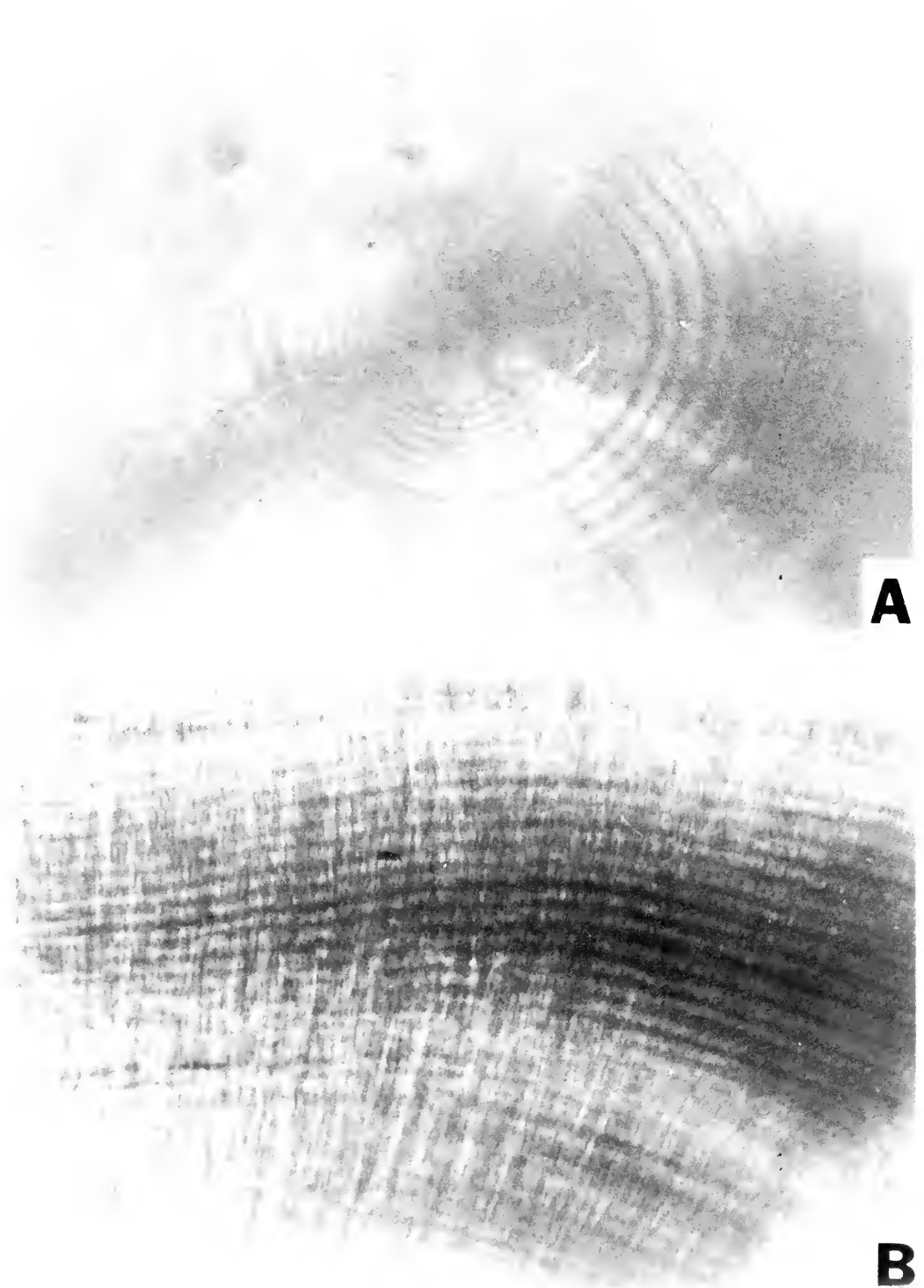

FIGURE 3.—Photomicrograph of sagittae from young-of-the-year *Centropristis striata*. A) Central primordium of the opaque nucleus showing growth rings for fish #1, Table 2; 400 $\times$  magnification. B) Area of otolith near the edge of the central zone showing growth rings of fish #8, Table 2; 250 $\times$  magnification.

## Reproduction

Reproductive organs from 6,685 *C. striata* were resected at sea and fixed in formol-alcohol solution (Humason 1972) or 10% seawater Formalin<sup>4</sup>. After 2-6 wk fixation, the tissues were transferred to 50% isopropanol, processed through an Auto-Technica 2A Tissue Processor, vacuum infiltrated, and blocked in paraffin. Sections (7  $\mu\text{m}$ ) were cut from each gonad by a rotary microtome, stained with Harris hematoxylin, and counter-stained with eosin-y. Histological sections from 300 fishes were read by two observers to develop agreement on sex and maturity stages; the remaining sections were then examined by a single observer. Sex and maturity stages (Table 1) which provided an accurate and objective estimate of reproductive status were modified from Smith (1965), Hilge (1977), and Mercer (1978) to determine size and age at first maturity, spawning season, and sex composition. The stage of gametogenesis and terminology used in gonadal descriptions follow Smith (1965), Combs (1969), Hyder (1969), Moe (1969), Mercer (1978), and Wallace and Selman (1981).

We included as males not only individuals whose gonads consisted entirely of testicular tissue but also those with functional testicular tissue (as judged by active spermatogenesis) as well as traces of inactive ovarian tissue. Females were defined as either having entirely ovarian gonads or inactive testicular

tissue in a functional ovary. Transitional gonads included only those with obviously proliferating testicular tissue within a nonactive, regressing ovary. Simultaneous gonads were those combining equally developed male and female tissue. Immature bisexual gonads were designated as simultaneous juveniles to avoid any implication as to their function at maturity.

We successfully sexed 80-90% of the fish sampled by histological examination every month but April. More than 75% of those sampled in April were sexed by gross examination of the gonads, and although our determinations of the functional sexes of these gonads were probably correct, the relative occurrence of transitional and simultaneous gonads in April samples remains unclear. These data were thus used only to complete the seasonal frequencies of functional sexes.

Gonads from 115 maturing females collected during April 1979 were removed at sea, split open with a longitudinal incision, and placed in Gilson's solution (Bagenal 1967). Separated oocytes were washed and stored in 70% isopropyl alcohol after digestion of the ovarian tunic and connective tissue and then were decanted into a separatory funnel and diluted to 1 L for enumeration. Three to five 1 mL subsamples were removed from the suspension, which was well mixed by continuous aeration through the bottom of the funnel. Each subsample was transferred to a petri dish and counted at a magnification of 10 $\times$ . Only ova >0.15 mm in diameter were counted since histological examination of the gonads of maturing and spent females showed only oocytes >0.15 mm developed during the spawning season. Total fecundity was estimated by expanding the mean of the subsamples to the total sample volume. Total fecundity was related to length and weight by standard least squares linear regression (Sokol and Rohlf 1981) and GM functional regression (Ricker 1973).

## Mortality Estimates

Plots of  $\log_e$  frequency on age indicated that black sea bass are fully recruited to commercial traps and hook-and-line gear at age 4, so mortality analysis applies to age 4 and older. The instantaneous rate of total mortality ( $Z$ ) was estimated by standard least squares regression (Sokol and Rohlf 1981) from the slope of the right descending limb of the catch curve (Ricker 1975). Values of  $Z$  were also obtained by converting (appendix I in Ricker 1975) rates of survival ( $S$ ) derived by Heinke, and Chapman and Robson estimates (Everhart and

<sup>4</sup>Reference to trade names does not imply endorsement by the National Marine Fisheries Service, NOAA.

TABLE 1.—Histological criteria used in determining gonadal condition of black sea bass, *Centropristis striata*.

Gonad class	Testicular state	Ovarian state
Immature	Little or no spermatocyte development.	Small (<100 $\mu\text{m}$ ) basophilic oocytes.
Developing	A few primary and secondary spermatocytes through lumina filled with spermatozoa.	Predominance of oocytes with yolk vesicle formation through late vitellogenesis.
Ripe (running)	Predominance of spermatozoa, little active spermatogenesis.	Late vitellogenesis and presence of hydrated oocytes.
Spent	No spermatogenic activity, some residual sperm present in tubules.	Unspawned, mature oocytes undergoing atresia.
Resting	Some mitotic regeneration of spermatogonia and interstitial tissues.	Predominance of small basophilic oocytes with residual traces of atresia.
Transitional	—	Inactive or regressing ovarian tissue with concurrent testicular proliferation.

Youngs 1981). Not all fish collected were aged, so fish of known age were grouped into 1 cm length intervals by gear type for each survey to calculate percentages of each age in each size interval. These percentages were applied to the number of *C. striata* in each length interval to estimate age composition for the unaged fish (Ricker 1975).

### Population Estimates at Specific Reef Sites

Petersen mark-recapture experiments were conducted at site 1 (lat. 32°30.3'N, long. 79°41.9'W; depth = 20 m; area  $\cong$  160 ha) during the summer of 1981 to estimate the population size of *C. striata* on this reef. In the summers of 1982 and 1983, we studied a second reef also (site 2; lat. 32°28.3'N, long. 78°14.5'W; depth = 23 m; area  $\cong$  120 ha). These reef areas were defined by the presence of attached algae and invertebrate growth (porifera, corals, echinoderms, bryozoans, anthozoans, and ascidians) as observed with a HYDRO products TC-125-5DA low-light-level underwater television camera during transects across the sites (for more details, see Wenner 1983). Study areas were mapped with an EPSCO C-Plot II LORAN-C plotter interfaced with a SITEX 707 LORAN-C receiver.

Black sea bass were captured and recaptured at each site with commercial traps (Rivers 1966) and Florida snapper traps (0.9 m wide  $\times$  1.2 m long  $\times$  0.6 m high) fished for 45-90 min with cut clupeid bait (*Brevoortia tyrannus* and *Alosa aestivalis*). Black sea bass >20 cm TL, the approximate size of full retention in the traps, were measured to the nearest mm TL and tagged with 13 mm diameter plastic disc tags attached under the first dorsal fin with a nickel pin trimmed to the proper length and held in place with a 13 mm diameter plastic backing disc. Expansion of the swim bladder, due to reduced hydrostatic pressure, caused captured fish to float, so gas was released from the swim bladder with a 20-gauge hypodermic needle to enable fish to return to the bottom. For each experiment, 50-75 tagged fish, handled in the same fashion as those released, were held on the bottom in wire cages for about 24 h to determine tag-related mortality. Tagged fish were released over the reef, and sampling for recaptures started 24 h after tagging began. Experiments were completed in 48 h except at site 2 during the summer of 1982 when tagging was interrupted for 48 h by weather.

Preliminary estimates of population size are needed to determine sample sizes required for precise Petersen estimates (Everhart and Youngs

1981). Powles and Barans (1980) estimated the mean density of *C. striata* on reefs was 51 fish/ha from underwater television transects; expansion to the areas of our study sites gave preliminary estimates of 8,160 *C. striata* on site 1 and 6,120 on site 2. At site 1 we needed to tag 1,000 fish and examine 550 for tags to have an error no greater than 25% for 19 times out of 20 ( $1 - \alpha = 0.95$  and  $P = 0.25$ ). At site 2, we needed to tag 1,000 fish and examine 500. We used the adjusted Petersen estimate (Ricker 1975, p. 78):

$$N^* = \frac{(M + 1)(C + 1)}{(R + 1)}$$

where  $N^*$  = estimated population size  
 $M$  = number of fish tagged  
 $C$  = sample taken for census  
 $R$  = number of tags returned in the sample taken for census.

The biomass of *C. striata* for each year and site was estimated as

$$\text{Biomass} = \sum_1^a \left( \frac{n^1}{n} \times PE \times g \right)$$

where  $n^1$  = number of tagged fish in each 1 cm TL interval  
 $n$  = total number of tagged fish  
 $PE$  = population size from the Petersen estimate  
 $g$  = weight in grams for the midpoint of each 1 cm TL size interval derived from the total length-weight relationship  
 $a$  = number of 1 cm TL intervals of tagged fish.

In addition, the upper and lower confidence limits were substituted for  $PE$  in the above expression for estimates of the biomass at those population sizes.

## RESULTS

### Age and Growth

We believe that the central opaque zone of the sagitta may represent the first 1-4 mo of life in *C. striata*. This zone varied in length from 1.16 to 3.60 mm in the anteroposterior plane and from 0.56 to 1.54 mm in the dorsoventral plane (Fig. 4). We were not always able to make counts along a continuous

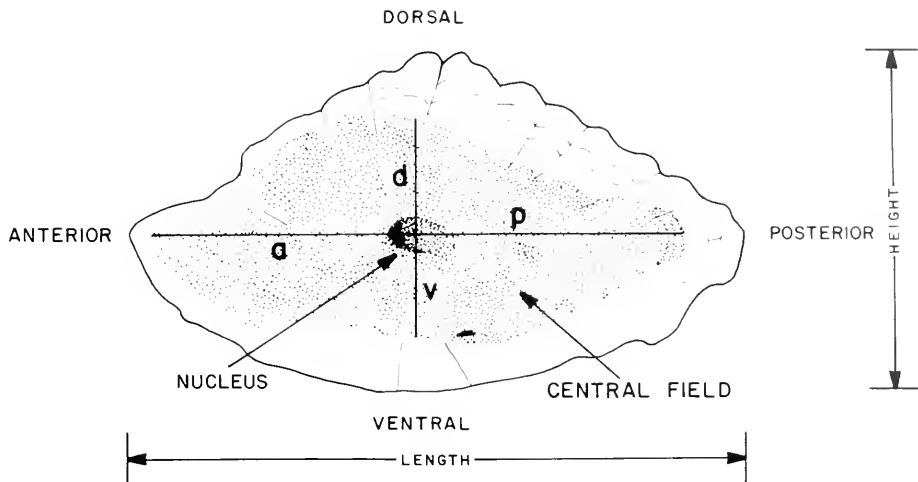

FIGURE 4.—Schematic representation of the left sagitta in young of the year *Centropristis striata* showing the orientation and direction of growth ring-counts in the central opaque zone. a = anterior, d = dorsal, p = posterior, v = ventral.

line because grinding did not expose all rings equally in the central zone. Also, in some instances, counting was halted at a distinct mark, such as a ring more distinctive than others, and we followed this mark around the sagitta to a site where rings were again visible and resumed counting. The number of rings in the central zone varied because of the otolith asymmetry and with the direction of the count (Table 2). For example, we obtained the following counts from the central primordium in one specimen (number 9 of Table 2): 90 rings to the dorsal edge of the central field (d of Fig. 4); 95 rings to the ventral edge (v of Fig. 4); 129 rings to the posterior edge (p of Fig. 4).

Since marginal increments on the otoliths should approach zero during the time of annulus formation, we calculated their monthly means to determine if one opaque band was laid down during each year

on the sagittae of *C. striata*. Generally, a single annulus was formed during April and May in all age groups (Fig. 5). We found that the ring was deposited unevenly around the sagitta, with the dorsal margin of the annulus being the last to be completed.

We identified 10 age groups in the South Atlantic Bight population of *C. striata*, which exceeded the previous reports of 7 (Cupka et al. 1973<sup>b</sup>) and 8 (Mercer 1978) groups. Observed mean lengths and weights increased with age; however, small sample sizes in ages 8 through 10 masked this trend (Table 3). Regressions of weight on length (TL and SL) and length on length are in Table 4.

<sup>b</sup>Cupka, D. M., R. K. Dias, and J. Tucker. 1973. Biology of black sea bass, *Centropristis striata* from South Carolina waters. Unpubl. manuscr. South Carolina Wildlife and Marine Resources Department, P.O. Box 12559, Charleston, SC 29412.

TABLE 2.—Data from *Centropristis striata* examined for daily growth rings. Refer to Figure 2 for otolith morphology and terms (d, v, p, and a) used in the counts. Numbers in parentheses are ranges of several counts; dashes indicate no counts made.

No.	Fish			Otolith				Central field			
	TL (mm)	SL (mm)	WT (g)	Height (mm)	Length (mm)	Height (mm)	Length (mm)	Daily ring counts			
								d	v	p	a
1	66	54	4	1.56	broken	0.92	1.76	—	—	(84-89)	—
2	60	48	2	1.52	3.08	0.56	1.16	28	(25-26)	(50-51)	—
3	95	74	11	2.24	4.44	1.54	3.25	—	(109-120)	—	—
4	125	98	30	2.92	4.88	1.54	3.60	—	135	—	—
5	78	61	4	1.82	broken	0.98	broken	105	—	—	—
6	76	58	5	1.84	3.44	1.08	2.68	106	—	121	—
7	78	60	4	1.78	3.40	1.12	2.88	(98-106)	—	—	—
8	81	63	5	1.92	3.60	1.52	3.40	51	—	—	81
9	—	64	6	1.84	3.52	1.16	3.08	90	95	—	129

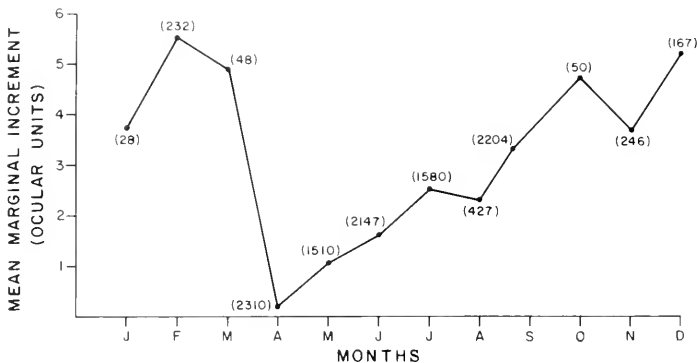

FIGURE 5.—Mean marginal increment by month for otoliths of *Centropristis striata*. Number in parentheses represent monthly number of otoliths examined.

TABLE 3.—Means ( $\bar{x}$ ), standard deviations and sample sizes for observed lengths (mm) and weights (g) by age for *Centropristis striata*.

Age	Total length			Standard length			Weight		
	<i>n</i>	( $\bar{x}$ )	SD	<i>n</i>	( $\bar{x}$ )	SD	<i>n</i>	( $\bar{x}$ )	SD
0	185	94	25	186	73	20	186	17	16
1	818	163	27	830	127	21	822	70	38
2	2,712	215	28	2,714	167	21	2,688	152	65
3	4,271	249	34	4,263	192	24	4,246	228	102
4	2,376	291	40	2,371	222	28	2,350	348	142
5	951	337	46	950	256	32	904	520	206
6	497	375	48	497	284	35	460	711	266
7	138	395	50	139	299	38	121	823	280
8	48	394	50	48	301	38	43	838	289
9	10	406	58	10	305	46	7	816	383
10	4	404	45	4	303	35	3	685	85

TABLE 4.—Least square linear and geometric mean functional regression equations of weight (WT) on total length (TL) and standard length (SL), and length-length for *Centropristis striata*. Weight units are grams and lengths are millimeters. All least squares regressions were significant at  $\alpha = 0.01$ .

Least squares equation	<i>n</i>	<i>r</i> <sup>2</sup>	GM functional equation
$\log_{10} WT = -4.375 + 2.800 \log_{10} TL$	12,281	0.97	$\log_{10} WT = -4.478 + 2.844 \log_{10} TL$
$\log_{10} WT = -4.328 + 2.978 \log_{10} SL$	12,284	0.98	$\log_{10} WT = -4.398 + 2.949 \log_{10} SL$
$TL = -9 + 1.4 SL$	12,473	0.97	$TL = -12 + 1.4 SL$
$SL = 12 + 0.7 TL$	12,473	0.97	$SL = 9 + 0.7 TL$

Least squares regressions of SL (mm) on otolith radius (OR in ocular units) are

$$\log_{10} SL = 0.668 + 1.056 \log_{10} OR;$$

$$n = 12,011; r^2 = 0.89.$$

The intercept of the SL-OR relationship was used to obtain the mean back-calculated SL's at age which were lower than observed SL's in all cases (Table 5). Weighted least square estimates of von Bertalanffy parameters, asymptotic 95% confidence

TABLE 5.—Observed and back-calculated mean standard length in mm and von Bertalanffy standard length at age for *Centropristis striata*.

Age	<i>n</i>	Observed SL	Back-calculated SL	von Bertalanffy SL
1	830	127	88	88
2	2,714	167	142	141
3	4,263	192	180	182
4	2,371	222	212	215
5	950	256	244	241
6	496	284	271	261
7	139	299	283	278
8	48	301	289	291
9	10	305	296	301
10	4	303	303	309



limits and asymptotic standard errors were also derived from these data (Table 6). Estimates of an average asymptotic size ( $L_{\infty}$ ) depended not only on the number of age groups present and the distribution of individuals within each group, but also on the curvature of the age-size relationship. An average asymptotic size of 341 mm SL appeared conservative. The largest fish aged was 390 mm SL and only 0.6% of all *C. striata* sampled were larger than 341 mm SL. The largest specimen caught off the South Carolina coast was estimated to be about 490 mm SL (S.C. Wildlife and Marine Resources Department<sup>6</sup>). Comparisons of von Bertalanffy back-calculated and observed SL at age are in Table 5.

TABLE 6.—Estimated von Bertalanffy parameters describing the growth of *Centropristis striata*. The weighted residual sums of squares = 238.46. SE = standard error; C.L. = confidence limits.

Parameter	Estimate	Asymptotic SE	Asymptotic 95% C.L.	
			lower	upper
$L_{\infty}$	341	17.818	298	383
$k^{\infty}$	0.2309	0.0221	0.1787	0.2831
$t_0$	-0.3010	0.0560	-0.4335	-0.1685

## Reproduction

The generalized ovarian structure of *C. striata* is similar to that of *Epinephelus fulva* (Smith 1965), *E. morio* (Moe 1969), and *Hemanthias vivanus* (Hastings 1981). The bilobed organ is suspended by mesenteries from the swim bladder in the posterior region of the body cavity. The lobes fuse posteriorly, and their lumina form a common oviduct. Blood vessels and nerves enter the ovary at the anterior point of each lobe's suspension and continue posteriorly medial to the supportive mesenteries along the dorsomedial surface of each lobe. The lumina are lined with folded germinal epithelium (ovarian lamellae), within which oocytes develop and mature. The lamellae are first seen protruding from the dorsal region of the lumen at the boundary of the ovary and the lamellar oviduct. They continue along both sides of the lumen in the area of gonadal confluence until only the ventralmost region of the ovary is lamellar. This lamellar area is confluent with the oviduct and extends anteriorly to half of the lengths of each ovarian lobe (Fig. 6A). The lamellar regions of female gonads were bordered throughout their extent by testicular precursor cells (Figs. 6A, B; 7A).

<sup>6</sup>Office of Conservation, Management, Marketing and Recreational Fisheries, S.C. Wildlife and Marine Resources Department, 1982. South Carolina Saltwater Sport Fishing Tournaments and State Record Fish. S.C. Wildlife and Marine Resources Department, P.O. Box 12559, Charleston, SC 29412.

Although these bands of cells were found in varying stages of development in all ovarian tissues, the most active proliferation of identifiable spermatogenic tissue (as manifested by transitional gonads; Table 7) occurred after the spring and fall spawning seasons (described later). Both increased ovarian inactivity and degeneration coincided with the proliferation of testicular tissue during sexual succession (simultaneous hermaphroditic development is treated below). No instance of active ovarian development concurrent with testicular degeneration was observed.

Sexual transition commenced in the posterior region of the ovary with the expansion of testicular lobes into the ovarian lumen. This proliferation proceeds anteriorly, with sperm sinus forming in the ovarian tunic adjacent to the testes. Testicular growth appears to be the result of mitotic spermatogonial development, although limited spermatogenic processes, including spermatozoa formation, are not uncommon (Fig. 7B). The sperm sinuses, as well as the vas deferens (which form within the oviductal wall) apparently result from ruptures in their respective surrounding tissues, as suggested by Hastings (1981), because there was no cell lining associated with these structures (Fig. 7B).

Simultaneously developed hermaphroditic gonads were found in all maturity stages. However, only 3% of the fishes exhibited this phenomenon, and we were unable to determine if the vas deferens had an external opening; therefore, we lack definitive proof that these fish were functional simultaneous hermaphrodites.

Histological sections of immature ovaries contained only oogonia and small basophilic, previtellogenic oocytes about 8-100  $\mu\text{m}$  in diameter. Maturing ovaries had oocytes 100-500  $\mu\text{m}$  in diameter, in

TABLE 7.—Monthly sex composition data for *Centropristis striata* along with  $\chi^2$  values for tests of a 1:1 sex ratio. \*\* =  $P < 0.01$ , 1 df; \* =  $P < 0.05$ , 1 df.

Month	Males	Females	Transitional	Transitional (%)	$\sigma:\varphi$	$\chi^2$
January	13	13	1	3.7	1:1	—
February	111	107	8	3.6	1:0.96	0.07
March	15	7	0	0	1:0.47	2.91
April	928	1,685	122	4.5	1:1.82	219.30**
May	404	497	145	13.9	1:1.23	9.60**
June	509	1,039	383	19.8	1:2.04	181.46**
July	132	368	84	14.4	1:2.79	111.39**
August	112	246	42	10.5	1:2.20	50.16**
September	668	1,109	262	12.8	1:1.66	109.44**
October	35	17	1	1.9	1:2.05	5.12*
November	64	150	27	11.2	1:2.34	34.56**
December	34	19	13	19.7	1:0.56	4.45

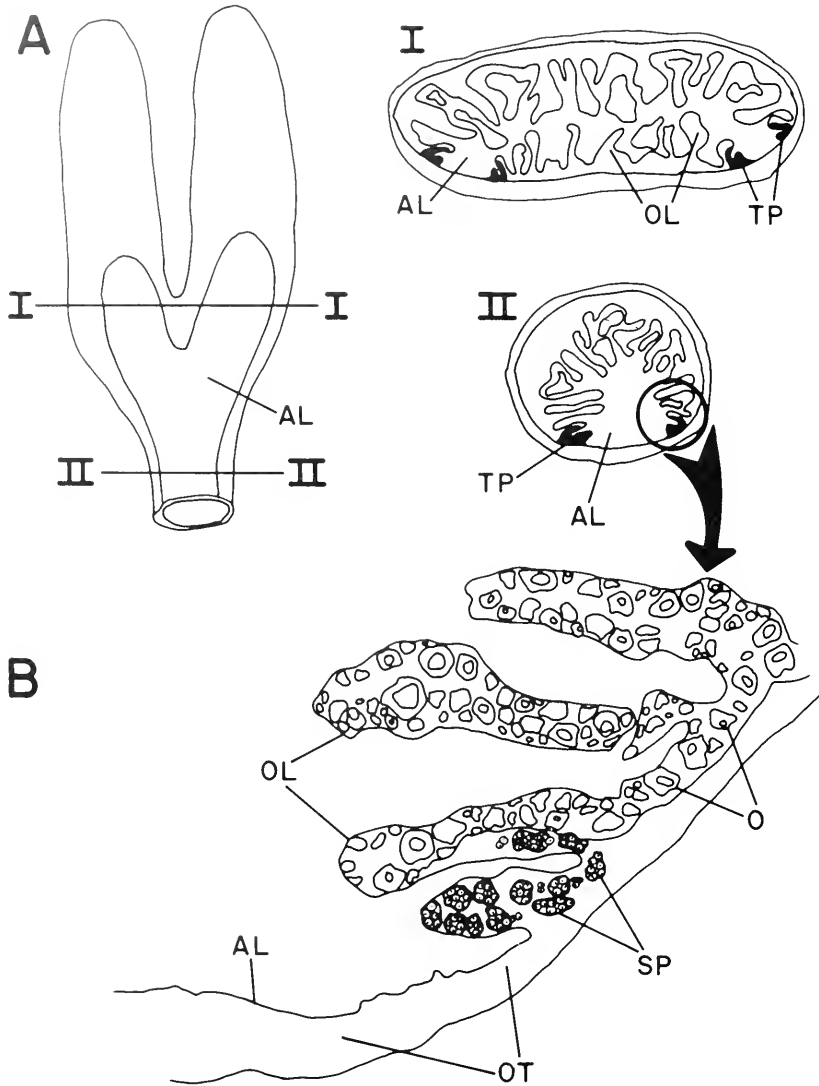
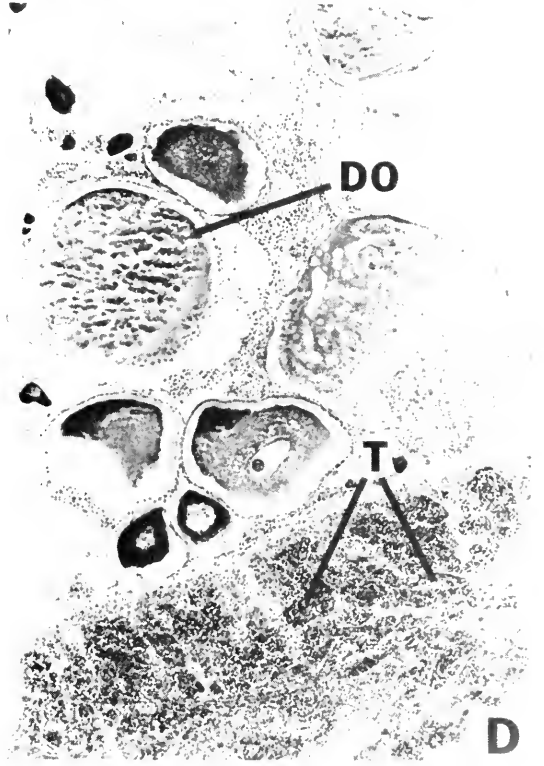
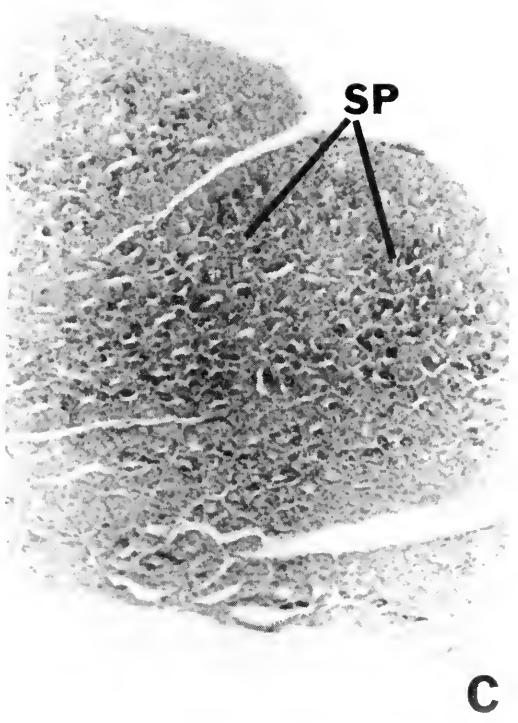
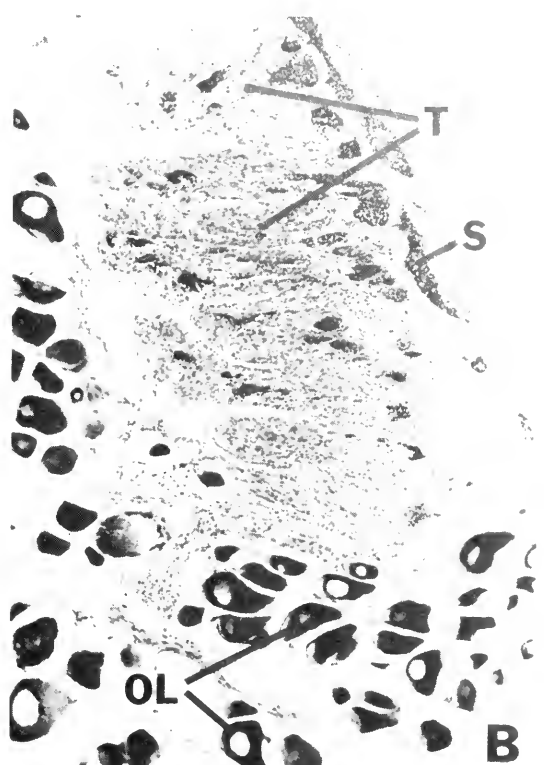
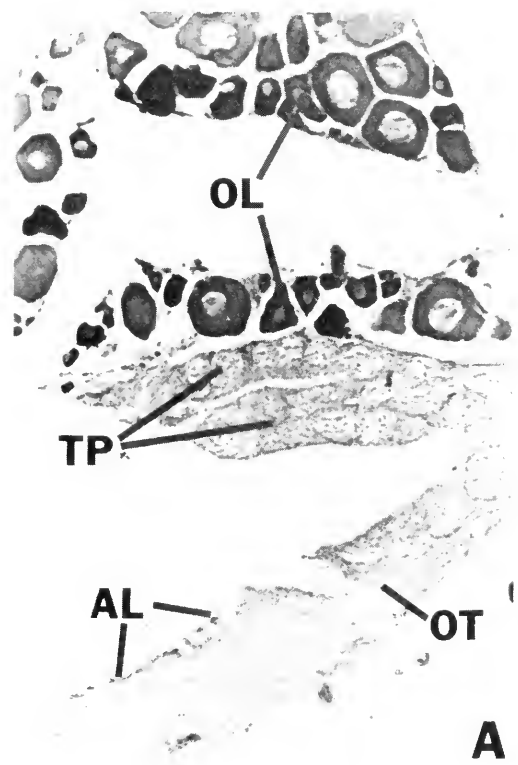

FIGURE 6.—Schematic representation of a functionally female ovary from *Centropristis striata*. A) Ventral view of ovary showing the lamellar region. Cross sections of the ovary were made in planes I-I and II-II, and show the positioning of the primordial testicular tissue at the boundary of the lamellar regions. B) An enlargement of the area indicated, showing the cellular relationships of the lamellar area, testicular primordia and ovarian lamellae. AL = lamellar region, O = oocytes, OL = ovarian lamellae, OT = ovarian tunic, SP = chords of spermatogonia, TP = testicular primordia.

FIGURE 7.—Photomicrographs of histological sections of gonads from *Centropristis striata*. A) Cross section taken from the posterior region of a functional ovary showing the lamellar region and testicular primordia, 250× magnification. B) Cross section taken from the posterior region of a gonad undergoing transition, 250× magnification. C) Cross section of immature testicular tissue from a 133 mm SL fish, 100× magnification. D) Cross section of a simultaneous gonad showing active testicular and ovarian development, 100× magnification. AL = lamellar region, DO = developing oocyte, OL = ovarian lamellae, OT = ovarian tunic, S = spermatozoa, SP = spermatogonia, T = testicular tissue.



stages from yolk vesicle formation (Wallace and Selman 1981) through late vitellogenesis. Oocytes (500-740  $\mu\text{m}$  in diameter) in ripe ovaries showed coalescence of yolk globules and hydration. Gonads from spent and resting females contained decreasing amounts of unspawned, atretic oocytes and empty, ruptured follicles.

Gonads from immature males were characterized by primary and secondary spermatogonia (Fig. 7C), and isolated, more fully developed seminiferous crypts in some instances. In developing testes we saw several stages that included gonadal tissue composed mostly of primary and secondary spermatocytes, as well as sperm sinuses filled with mature spermatozoa. Ripe testes had sperm sinuses and ducts packed with spermatozoa; the remainder of the gonad showed only a little spermatogenesis. Spent testes showed both the lack of spermatogenic activity and the presence of large amounts of unshed sperm, whereas gonads in resting males showed mitotic proliferation of next season's spermatogonia and interstitial tissues.

Females comprised 52% of the sexed *C. striata* and were mature in ages 1 through 8. We found mature gonads in none of the females at age 0, 48.4% at age 1, 90.3% at age 2, 99.1% at age 3, and 100% at all older ages. Immature females were 50-180 mm SL, and the smallest mature specimen was 110 mm SL. Males made up 30.6% of the fishes sexed, and 1.3% of these males were immature and were in ages 0-1 with lengths of 50-180 mm SL. The smallest mature male was 100 mm SL.

Gonads of 14% of the *C. striata* examined histologically showed these fishes undergoing sex succession. These were found primarily after the major spawn (January-April), and during a brief period after the lesser spawn during September-October (Table 7). The smallest individuals exhibiting sex succession were in the 120-139 mm SL interval (Table 8); however, the greatest frequency of transitional gonads (77%) occurred in fishes 160-259 mm SL. Males made up 15.4% of the age 0 *C. striata* and 10.5% of fishes <120 mm SL (Tables 8, 9; Fig. 8). The relative abundance of males increased with both size and age, and fish containing transitional gonads increased in abundance during the period of the most rapid decline in the relative number of females (Fig. 8).

Both male and female tissue developed simultaneously in the same gonad in 3% of the *C. striata* examined histologically (Fig. 7D). This occurred in immature, developing, spent, and resting fishes. Both testicular and ovarian tissues showed equivalent maturity stages within the same gonad; that

is, male and female germinal tissue developed concurrently.

The overall sex ratio for *C. striata* in the South Atlantic Bight was 1 $\sigma$ :1.71 $\phi$ . We found significantly more females than males from April through November, and inconsistency in the ratio between December and March probably reflected both inadequate and biased samples from these months. Ratios were significantly different at all sizes from an hypothesized 1:1 (Table 8) except at 200-219 mm SL. The abundance of males begins to increase in that size group and also in age class 4 (Table 9) as the abundance of females declines, reflecting the increased frequency of the sex succession process.

*Centropristis striata* has a major spawn from January through April when 80-100% of the ovaries were developing or ripe (Fig. 9). Although a second period of ovarian activity was found in September, it was interpreted as being of a lesser nature since only 30% of the females were developing or ripe.

TABLE 8.—Sex composition and  $\chi^2$  values for tests of a 1:1 sex ratio of *Centropristis striata* by 20 mm SL intervals. \*\* =  $P < 0.01$ , 1 df; \* =  $P < 0.05$ , 1 df.

SL	Males	Females	Transi- tional	Transi- tional (%)	$\sigma$ : $\phi$	$\chi^2$
- 119	16	136	0	0	1:8.50	94.74**
120-139	28	206	4	1.7	1:7.36	135.40**
140-159	74	525	46	7.1	1:7.10	339.57**
160-179	170	1,145	200	13.2	1:6.74	722.91**
180-199	301	796	289	20.8	1:2.64	223.36**
200-219	347	423	112	15.3	1:1.22	7.50*
220-239	335	185	94	14.8	1:0.55	43.27**
240-259	278	106	67	13.0	1:0.38	77.04**
260-279	179	41	33	4.2	1:0.23	86.56**
280-299	154	26	8	2.5	1:0.17	91.02**
300-319	111	5	3	3.3	1:0.04	96.86**
320-339	57	1	2	3.5	1:0.02	54.07**
>339	55	0	2	3.6		
Total	2,105	3,595			1:1.70	

TABLE 9.—Sex composition and  $\chi^2$  values for tests of a 1:1 sex ratio of *Centropristis striata* by age. \*\* =  $P < 0.01$ , 1 df.

Age	Males	Females	Transi- tional	Transi- tional (%)	$\sigma$ : $\phi$	$\chi^2$
0	10	55	0	0	1:5.50	31.2**
1	42	315	20	5.3	1:7.50	208.8**
2	251	1,066	185	12.3	1:4.20	504.3**
3	561	1,449	447	18.2	1:2.60	392.3**
4	635	479	223	16.7	1:0.75	21.8**
5	274	84	59	5.0	1:0.31	100.8**
6	189	17	8	3.7	1:0.09	143.6**
7	54	2	2	3.4	1:0.04	48.3**
8	13	0	0	0		
9	2	0	0	0		
10	2	0	0	0		

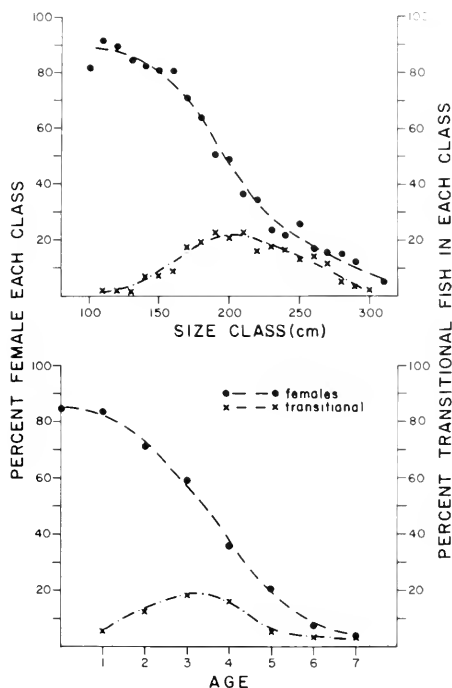

FIGURE 8.—Percent female and transitional *Centropristis striata* by size and age.

Fall spawning probably extended into October because many fishes obtained in November had recently spent ovaries.

Fecundity was significantly related to SL, TL, weight, and age with the former three equations having by far the highest  $r^2$  values (Table 10). The

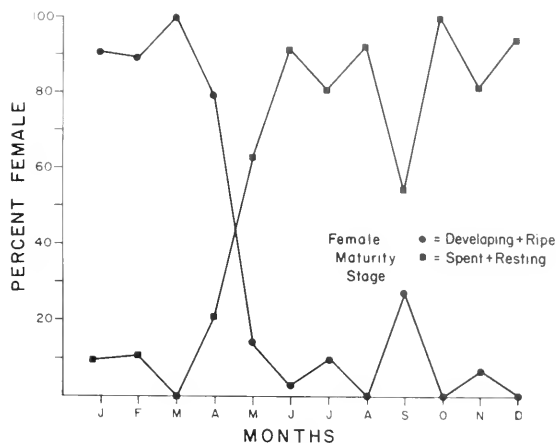

FIGURE 9.—Maturity stages of female *Centropristis striata* by month to illustrate bimodal spawning.

least squares linear regression model of fecundity on age explained only 33% of the variation in fecundity. Observed mean fecundity and its standard error increased with age (Table 11). The lowest observed fecundity (17,000) was in a 2-yr-old fish (SL = 108 mm; TL = 140 mm; weight = 45 g) and the largest (1,050,000) was in a 438 mm SL fish (TL = 454; weight = 1,371 g) of undetermined age.

## Mortality

Instantaneous rates of total mortality, as derived from catch curves, for *C. striata* ranged from 0.721

TABLE 10.—Least squares linear and geometric mean functional regression equations of fecundity (fec) on total length (TL), standard length (SL), weight (WT), and age for *Centropristis striata*. Weight units are grams and lengths are millimeters. All least squares regressions were significant at  $\alpha = 0.01$ .

Least squares equation	$n$	$r^2$	GM functional equation
$\log_{10} \text{ fec} = -0.605 + 2.335 (\log_{10} \text{ TL})$	115	0.62	$\log_{10} \text{ fec} = -2.098 + 2.959 (\log_{10} \text{ TL})$
$\log_{10} \text{ fec} = -0.309 + 2.318 (\log_{10} \text{ SL})$	115	0.65	$\log_{10} \text{ fec} = -1.589 + 2.879 (\log_{10} \text{ SL})$
$\log_{10} \text{ fec} = 3.057 + 0.822 (\log_{10} \text{ WT})$	115	0.65	$\log_{10} \text{ fec} = 2.587 + 1.022 (\log_{10} \text{ WT})$
$\log_{10} \text{ fec} = 4.529 + 0.913 (\log_{10} \text{ Age})$	110	0.33	$\log_{10} \text{ fec} = 4.196 + 1.580 (\log_{10} \text{ Age})$

TABLE 11.—Observed mean fecundity at age and its standard error ( $S_x$ ) for *Centropristis striata*, in the South Atlantic Bight.

Age	Mean fecundity	$S_x$	$n$
2	61,846	8,089	13
3	94,801	4,406	55
4	115,411	8,900	27
5	160,000	50,720	7
6	226,040	46,706	5
7	287,350	80,650	2
8	137,400	—	1

to 1.430, and actual mortality rates were from 0.513 to 0.761. Values increased from 1978 to 1981. For example, values of A rose from 51.3 to 73.3% for trap-caught fish and from 51.6 to 76.1% for hook-and-line caught fish older than age 4 (Table 12). Mortality values of trap-caught and hook-and-line caught *C. striata* were similar within years for each estimation procedure. Mortality values, moreover were similar between estimation procedures. We found a significant correlation between the instantaneous

TABLE 12.—Instantaneous (*Z*) and actual (*A*) rates of total mortality for *Centropristis striata* in the South Atlantic Bight. Gear types: T = trap; H&L = hook and line.

Year	Gear	Catch curve		Heinke		Chapman-Robson		Means	
		Z	A	Z	A	Z	A	Z	A
1978	T	0.721	0.513	0.841	0.568	0.991	0.628	0.851	0.569
1979	T	0.906	0.595	0.819	0.559	0.872	0.582	0.866	0.579
1979	H&L	0.726	0.516	0.759	0.532	0.650	0.478	0.712	0.509
1980	T	1.030	0.643	1.020	0.639	1.181	0.693	1.077	0.658
1980	H&L	0.905	0.595	0.944	0.611	1.016	0.638	0.955	0.615
1981	T	1.320	0.733	1.347	0.740	1.328	0.735	1.332	0.736
1981	H&L	1.430	0.761	1.347	0.740	1.492	0.775	1.423	0.759
1982	T	1.279	0.722	1.382	0.749	1.443	0.764	1.368	0.745
1982	H&L	1.246	0.712	1.277	0.721	1.309	0.730	1.277	0.721

rate of total mortality from trap data and the South Carolina commercial landings from 1978 to 1982 (Fig. 10).

### Population Estimates at Specific Sites

Mortality of *C. striata* attributable to tagging occurred only once, during the 1983 experiment of site 2 when 6% of the fishes (3 of 50) died during the holding period. Therefore, we reduced the number of tagged fish-at-large (*M*) by 6% to account for this tagging related mortality.

Between 1981 and 1983, a decline in the order of magnitude from 20,070 to 2,236 individuals (88.9%) occurred in the estimated abundance of *C. striata* at site 1. On this reef, the abundance declined 60.6% from 1981 to 1982 and another 75.5% from 1982 to

1983 (Table 13). Abundance at site 2 declined 52.9% between 1982 and 1983. Biomass of *C. striata* declined by an order of magnitude on site 1 from 4,836 kg in 1981 to 491 kg in 1983 (Table 13). This was an overall decrease of 89.9%. Site 2 had a 62% decline in biomass from 2,150 kg in 1982 to 810 kg in 1983. Our estimates are for fish >20 cm TL, the only ones vulnerable to the traps. Therefore, density and biomass estimates are minimum values.

In addition to the declines in population size and biomass of *C. striata*, there were decreases in mean size and age. Mean TL was 3 cm less in 1983 than in 1981 at site 1, whereas *C. striata* were on average 2 cm smaller in 1983 than 1982 at site 2. Not only were the means reduced, but also the frequency distribution became more skewed towards the smaller size intervals and the contributions of larger

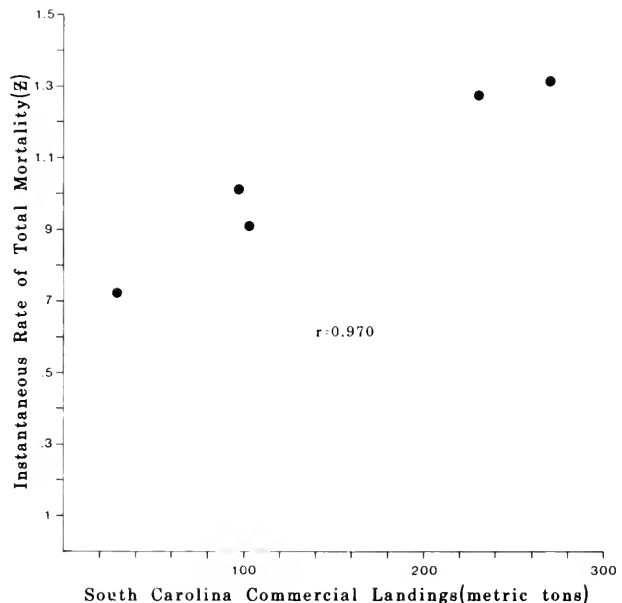

FIGURE 10.—Plot of the instantaneous rate of total mortality (*Z*) as determined from resource survey data (1978-81) and the South Carolina commercial landings of *Centropristis striata* for that year.

TABLE 13.—Summary of Petersen mark-recapture population estimates, biomass, and density (number and kg/ha) estimates for black sea bass, *Centropristis striata*, on two sponge-coral habitat sites. 95% confidence limits (C.L.) of  $p (= R/C)$  were determined by the methods of Cochran (1977).

	Site 1			Site 2	
	1981	1982	1983	1982	1983
C	634	529	438	446	679
M	1,042	1,169	1,084	901	854
R	32	67	212	50	155
95% C.L. of R	21.9-44.2	53.4-83.1	193.2-230.8	33.9-57.5	135.1-175.2
p	0.50	0.127	0.484	0.112	0.228
95% C.L. of p	0.035-0.070	0.101-0.157	0.441-0.527	0.076-0.129	0.199-0.258
N*	20,070	9,119	2,236	7,906	3,727
95% C.L. of N*	14,653-28,921	7,347-11,399	2,055-2,453	6,892-11,553	3,300-4,272
$\mu$	0.032	0.058	0.196	0.056	0.182
95% C.L. of $\mu$	0.022-0.043	0.046-0.072	0.179-0.213	0.039-0.065	0.159-0.206
Biomass (kg)	4,836	2,077	491	2,150	810
95% of biomass (kg)	3,530-6,959	1,673-2,595	451-539	1,874-3,142	717-928
Number/ha	125	57	14	66	31
95% C.L. of number/ha	92-181	46-71	13-15	57-96	28-36
kg/ha	30.2	13.0	3.1	17.9	6.7
95% C.L. of kg/ha	22.1-43.5	10.5-16.2	2.8-3.4	15.6-26.2	6.0-7.7

\*Adjusted Petersen estimate (Ricker 1975).

fishes to the populations was greatly reduced (Fig. 11). Mean age declined 0.5 years at site 1, and the age composition shifted towards younger age classes

(Fig. 12). Fishes age 4 and older went from 42% of the population in 1981 to 25% in 1982 and 9% in 1983.

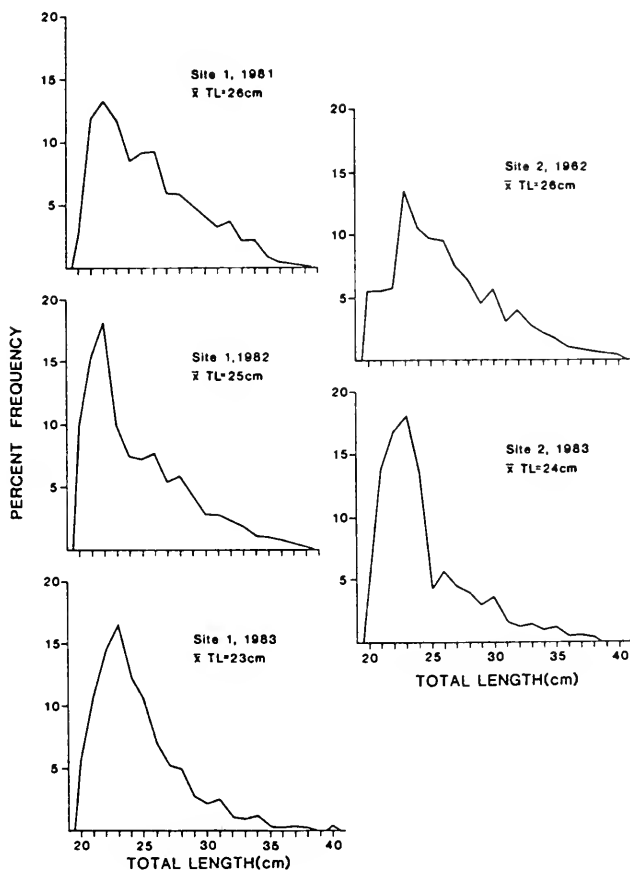

FIGURE 11.—Size-frequency distribution of *Centropristis striata* from five discrete mark-recapture tagging studies.

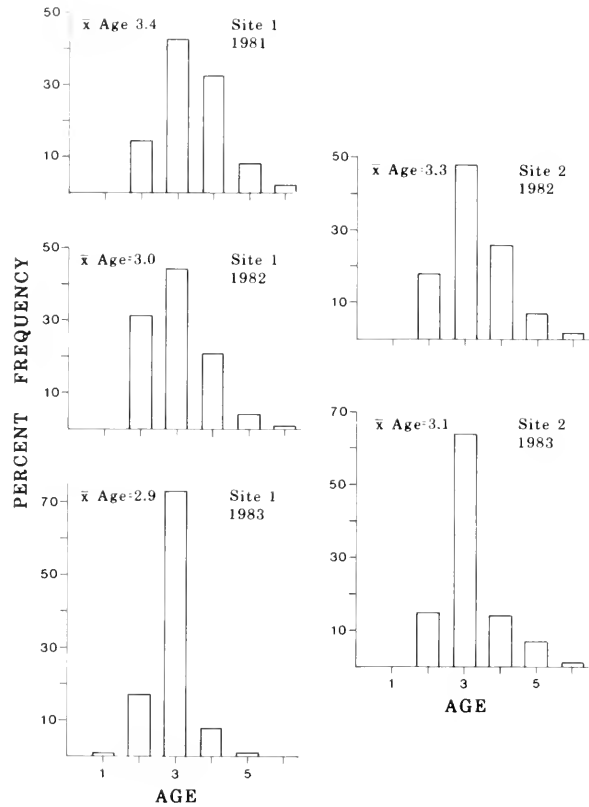

FIGURE 12.—Age composition of *Centropristis striata* at the two experimental mark-recapture sites.

## DISCUSSION

### Age and Growth

The cause of the variation in size and shape of the sagitta's central field in *C. striata* is unknown, however, differing size of the nuclei of Atlantic herring, *Clupea harengus*, can be related to spawning season (Postuma 1974). Further studies are needed to determine if these differences can be related to spawning time of *C. striata* in the South Atlantic Bight.

Inadequate validation in many studies that estimate age have been noted by Beamish and McFarlane (1983), and they have reemphasized the need for verification of aging technique. Our attempts at validation have shown that one annulus is formed each year during April-May. Also, our counts of presumed daily growth rings have provided circumstantial support for the formation of the first annulus. A similar approach was used by Radtke et al. (1985) in their study of the oyster toadfish, *Opsanus tau*.

Our mean back-calculated lengths agree well with Mercer's (1978) data for *C. striata* from the South

Atlantic Bight up to age 5; however, ours are much smaller than Cupka et al. (fn. 5). Our lengths at age are consistently smaller than *C. striata* from the Middle Atlantic Bight (Mercer 1978). Mercer (1978) attributed size at age differences between the two areas to gear selectivity, yet our results suggest that *C. striata* from the South Atlantic Bight are smaller than those of the Middle Atlantic Bight. The larger size at age found by Cupka et al. (fn. 5) may reflect the population of *C. striata* in the South Atlantic Bight prior to heavy exploitation that began in 1969.

Since estimates of  $L_{\infty}$ ,  $K$ , and  $t_0$  are affected by several nonbiological, methodical factors, direct comparisons of these growth parameters between different studies are of limited value. However, when viewed in relative terms, they can indicate general differences or similarities between studies, species, or areas. Our estimate of  $L_{\infty}$  (341 mm SL) was much closer to Mercer's (1978) value ( $L_{\infty} = 352$  mm SL) than that of Cupka et al. (fn. 5) (625 mm SL). Our growth coefficient ( $K$ ) was higher, indicating that *C. striata* achieves maximum attainable size more rapidly than previously reported. These differences could have been caused by sampling methodologies and/or conditions of the popula-



tion of South Atlantic Bight *C. striata* at the time the studies were conducted.

## Reproduction

Smith (1965) established a phylogeny of serranid fishes based on three types of hermaphroditism. Most primitive is the *Serranus*-type gonad found in *Serranus* and *Hypoplectus*, genera which are simultaneously hermaphroditic with male and female germinal tissues well separated by connective tissues. The middle type of this trio is the protogynously hermaphroditic *Rypticus-Anthias*-type gonad where testicular takeover commences with proliferation of preexisting spermatogonia located in crypts along the alamellar regions of the ovary and gametogenic tissues remain separated by connective tissue throughout sexual transition. Most advanced is the protogynous hermaphroditic *Epinephelus*-type gonad where testicular tissue cannot be found before sexual transition commences. During this process, crypts of spermatogonia differentiate and proliferate within the ovarian lamellae where they are intermixed with oogonia and oocytes.

Citing Lavenda (1949), Smith (1965) classified *C. striata* within the *Epinephelus*-type, an error corrected by Mercer's (1978) demonstration that morphological events during sexual transition in *C. striata* most resemble those of the *Rypticus-Anthias*-type gonad. Sexual succession in *C. striata* results from hypertrophy of bands of testicular primordia that lie along borders of the alamellar region of the ovary, not the proliferation of crypts of tissue that Mercer (1978; see also Smith 1965) reported. The arrangement of the primordial testicular ridges in *C. striata* is the same as in the protogynous *Hemanthias vivanus* (Hastings 1981).

The testicular primordia in *C. striata* is located in a similar region of the gonad as is the testicular portion of the simultaneously functioning gonad of *Serranus tigrinus* (Smith 1965). Though not stated by Smith (1965), the testes of *S. tigrinus* might border the alamellar region of the ovarian section as does the testicular primordial cells in *C. striata*, a gonadal similarity also noted between *H. vivanus* and *S. tigrinus* (Hastings 1981). No phylogenetic inferences should be drawn from these data, because gonadal development varies even among the closely related simultaneous hermaphrodites of the genera *Serranus* and *Diplectrum*. *Centropristis striata*, *H. vivanus*, and probably *R. maculatus* (see Smith 1965) have similar gonadal morphologies and strategies of sex succession, but these species are usually not considered closely related. Gonadal mor-

phologies may one day be important in determining serranid phylogenetic relationships, but more observations of all serranids are necessary.

The simultaneously functioning gonad of *C. striata* has morphology similar to that of *Serranus* (Smith 1965) in which discrete areas of testicular tissue empty into peripherally located sinuses, and oocytes discharge centrally. Sperm sinuses within the wall of the simultaneous gonads are well developed in *C. striata*, but it is not known if they are functional, i.e., permit sperm to exit the body along with the oocytes.

We found sizes and ages of *C. striata* undergoing sex succession which were similar to those Mercer (1978) reported in the South Atlantic Bight; however, we found a much higher incidence of transitional fish. Since Mercer (1978) found only 4% of *C. striata* from this area were undergoing sex succession, she offered two mechanisms for her abundance (38%) of mature males: 1) development of mature males from both immature males and juvenile hermaphrodites was very important, or 2) the rate of sexual transition was very rapid in this species.

We feel that both of Mercer's arguments were at best incomplete because of her small sample sizes from the South Atlantic Bight. Since we found few immature males and juvenile hermaphrodites in our samples, the probability is low that mature males develop solely from these. Also, we acknowledge the presence of serranids which show rapid sex succession (Fishelson 1970; Fricke and Fricke 1977) and believe the low frequency of individuals undergoing sex succession seen in most Epinepheline groupers probably reflects a similarly short-lived process. However, the presence of *C. striata* undergoing sex succession throughout the year, and their occurrence at sizes where the frequency of females declines, leads us to conclude that the primary source of mature males is through sex succession from active females.

We found secondary testes (sensu Harrington 1971) in all male *C. striata* including immature specimens. This morphology is not unique to *C. striata*. Hastings (1981) observed no primary male *H. vivanus* and suggested they all passed through an initial female phase. This same secondary gonadal morphology occurs in the secondarily gonochoristic serranid *Paralabrax clathratus* (Smith and Young 1966), and Reinboth (1970) indicated all male serranids are derived from females.

Overall, sex ratios of *C. striata* were significantly different from an hypothesized 1♂:1♀ in favor of females. Females significantly outnumbered males

up to an intermediate size and age, at which time the significantly different ratios favored males. Fishelson (1975) stated that sex ratios should approximate 1♂:1♀ at some stage if all protogynous females undergo sex succession. Given the alternating ratios of sexual abundance with size and age, and considering that no female older than age 7 and few larger than 330 mm SL were found in our samples, leads us to conclude that all *C. striata* have the potential to undergo sex succession.

### Population Estimates

The underlying assumptions of the Petersen method for population estimates were met in this study. We found tag-related mortality in only one experiment and adjusted the number of fish marked for it. We feel all tags were accounted for and tag loss was minimal, because tags were firmly anchored to the fish and were bright orange. Tagged fish were not randomly distributed over the study site, but they were released during vessel drifts governed by wind and surface currents and may be effectively random. We assumed minimal immigration and emigration because our experiments covered a brief time period.

Powles and Barans (1980) estimated density of *C. striata* in the sponge-coral habitat of the South Atlantic Bight. The estimates of 51 fish/ha and 7.6 kg/ha derived from the data of Powles and Barans (1980) were 37-66% and 23-44% of our mark-recapture values. Powles and Barans (1980) indicated that possible sources of error in their study were distance determinations from loran-A, which are much less precise than distances derived from loran-C readings, and variable visibility.

### ACKNOWLEDGMENTS

This work was funded by the National Marine Fisheries Service under contract NA-84-WCC-06101 to the South Carolina Wildlife and Marine Resources Department. We appreciate the Assistance of A. J. Kemmerer and W. Nelson of NMFS.

We thank Captain John Causby and First Mate Julian Mikell of the RV *Oregon* for the exceptional navigational and vessel handling skills enabling us to sample open ocean patch reefs not much larger than a few football fields with a 90-ft vessel. The difficulties involved can be appreciated only by one who has been there. It would not have been possible to process the numerous histological samples without the help of D. Stubbs. We are grateful to the many individuals who participated in the field

effort, several of whom suffered punctures by fish spines and lacerations by sea bass preopercles during the tagging study. A. G. Gash provided assistance with the computer analysis, K. Swanson drew the figures and N. Beaumont and M. Lentz typed the manuscript. Helpful critical reviews of the manuscript were made by C. A. Barans, E. L. Wener, R. Warner, P. Hastings, G. Huntsman, P. Eldridge, and two anonymous reviewers.

### LITERATURE CITED

- BAGENAL, T. B.  
1978. Aspects of fish fecundity. In S.D. Gerking (editor), Ecology of freshwater fish production, p. 75-101. John Wiley & Sons, Inc., N.Y.
- BEAMISH, R. J., AND G. A. MCFARLANE.  
1983. The forgotten requirement for age validation in fisheries biology. Trans. Am. Fish. Soc. 112:735-743.
- BERTALANFFY, L. VON.  
1938. A quantitative theory of organic growth. II. Inquiries on growth laws. Hum. Biol. 10:181-213.
- CARLANDER, K. D.  
1982. Standard intercepts for calculating lengths from scale measurements for some centrarchid and percid fishes. Trans. Am. Fish. Soc. 111:332-336.
- COCHRAN, W. C.  
1977. Sampling techniques. 31st ed. John Wiley & Sons, Inc., N.Y., 428 p.
- COMBS, R. M.  
1969. Embryogenesis, histology and organology of the ovary of *Brevoortia patronus*. Gulf. Res. Rep. 2:333-436.
- EVERHART, W. H., AND W. D. YOUNGS.  
1981. Principles of fishery science. Cornell Univ. Press, Ithaca, N.Y., 349 p.
- FISCHER, W. (editor).  
1978. FAO species identification sheets for fishery purposes. Western Central Atlantic. FAO., Rome, Vol. 4, pag. var.
- FISHELSON, L.  
1970. Protogynous sex reversal in the fish *Anthias squamipianis* (Peters), (Teleostei:Anthiidae). In R. Reinboth (editor), Intersexuality in the animal kingdom, p. 284-294. Spring-Verlag, N.Y.  
1975. Ecology and physiology of sex reversal in *Anthias squamipianis* (Peters), (Teleostei:Anthiidae). In R. Reinboth (editor), Intersexuality in the animal kingdom, p. 284-294. Spring-Verlag, N.Y.
- FRICKE, H., AND S. FRICKE.  
1977. Monogamy and sex change by aggressive dominance in coral reef fish. Nature (Lond.) 266:830-832.
- FRAME, D. W., AND S. A. PEARCE.  
1973. A survey of the sea bass fishery. Mar. Fish. Rev. 35 (1-2):19-26.
- HARRINGTON, R. S., JR.  
1971. How ecological and genetic factors interact to determine when self-fertilizing hermaphrodites of *Rivulus marmoratus* change into functional secondary males, with a reappraisal of the modes of intersexuality among fishes. Copeia 1971:389-432.
- HASTINGS, P. A.  
1981. Gonad morphology and sex succession in the protogynous hermaphrodite *Hemanthias vivanus* (Jordan and Swain). J. Fish. Biol. 18:443-454.

- HELWIG, J. T., AND K. A. COUNCIL (editors).  
1979. SAS users guide. 1979 ed. SAS Instit., Inc., N.C., 294 p.
- HILGE, V.  
1977. On the determination of the stages of gonad ripeness in female bony fishes. *Meeresforschung* 25:149-155.
- HUMASON, G. L.  
1972. Animal tissue techniques. W. H. Freeman and Co., San Francisco, CA, 641 p.
- HUNTSMAN, G. R.  
1976. Offshore headboat fishing in North Carolina and South Carolina. *Mar. Fish. Rev.* 38(3):13-23.
- HYDER, M.  
1969. Histological studies on the testes of *Tilapia leucosticta* and other species of the genus *Tilapia* (Pisces:Teleostei). *Trans. Am. Microsc. Soc.* 88:211-231.
- LAVENDA, N.  
1949. Sexual differences and normal protogynous hermaphroditism in the Atlantic sea bass *Centropristis striata*. *Copeia* 1949:185-194.
- LOW, R. A., JR.  
1981. Mortality rates and management strategies for black sea bass off the southeast coast of the United States. *No. Am. J. Fish. Manage.* 1:93-103.
- MERCER, L. P.  
1978. The reproductive biology and population dynamics of black sea bass, *Centropristis striata*. Ph.D. Thesis, College of William and Mary, Williamsburg, VA, 196 p.
- MOE, M. H., JR.  
1969. Biology of the red grouper *Epinephelus morio* (Valenciennes) from the eastern Gulf of Mexico. *Fla. Dep. Nat. Resour. Mar. Res. Lab., Prof. Pap.* 10, 95 p.
- MUSICK, J. A., AND L. P. MERCER.  
1977. Seasonal distribution of black sea bass, *Centropristis striata*, in the Mid-Atlantic Bight with comments on the ecology and fisheries of the species. *Trans. Am. Fish. Soc.* 106:12-25.
- POOLE, J. C.  
1961. Age and growth of the fluke in Great South Bay and their significance in the sport fishery. *N.Y. Fish Game J.* 8:1-11.
- POSTUMA, K. H.  
1974. The nucleus of the herring otolith as a racial character. *J. Cons. Int. Explor. Mer* 35:121-129.
- POWLES, H., AND C. A. BARANS.  
1980. Groundfish monitoring in sponge-coral areas off the southeastern United States. *Mar. Fish. Rev.* 42(5):21-35.
- RADTKE, R. L., M. L. FINE, AND J. BELL.  
1985. Somatic and otolith growth in the oyster toadfish (*Opsanus tau* L.). *J. Exp. Mar. Biol. Ecol.* 90:259-275.
- REINBOTH, R.  
1970. Intersexuality in fishes. *Mem. Soc. Endocr.* 18:515-544.
- RICKER, W. E.  
1973. Linear regressions in fishery research. *J. Fish. Res. Board Can.* 30:409-434.  
1975. Computation and interpretation of biological statistics of fish populations. *Fish. Res. Board Can. Bull.* 191, 382 p.
- RIVERS, J. B.  
1966. Gear and technique of the sea bass trap fishery in the Carolinas. *Commer. Fish. Rev.* 28(4):15-20.
- SMITH, C. L.  
1965. The patterns of sexuality and the classification of serranid fishes. *Am. Mus. Novit.* 2207, 20 p.
- SMITH, C. L., AND P. H. YOUNG.  
1966. Gonad structure and the reproductive cycle of the kelp bass, *Paralabrax clathratus* (Girard) with comments on the relationships of the serranid genus *Paralabrax*. *Calif. Fish Game* 52:283-292.
- SOKAL, R. R., AND F. J. ROHLF.  
1981. *Biometry*. 2d ed. W. H. Freeman & Co., N.Y., 859 p.
- STRUHSAKER, P.  
1969. Demersal fish resources: composition, distribution, and commercial potential of the continental shelf stocks off southeastern United States. *U.S. Fish. Wildl. Serv., Fish. Ind. Res.* 4:261-300.
- WALLACE, R. A., AND K. SELMAN.  
1981. Cellular and dynamic aspects of oocyte growth in teleosts. *Am. Zool.* 21:325-343.
- WENNER, C. A.  
1983. Species associations and day-night variability of trawl caught fishes from the inshore sponge-coral habitat, South Atlantic Bight. *Fish. Bull., U.S.* 81:537-552.



## NOTES

### COMPARISON OF VISCERAL FAT AND GONADAL FAT VOLUMES OF YELLOWTAIL ROCKFISH, *SEBASTES FLAVIDUS*, DURING A NORMAL YEAR AND A YEAR OF EL NIÑO CONDITIONS

One of the severest El Niño events of the century occurred off California during late 1982 and most of 1983 (Rasmusson 1984). Associated with the warm water and lack of upwelling were impressions by many fishermen and biologists that macroplanktonic organisms were at low densities and that fish were thinner than normal. A semiquantitative sampling program off of San Francisco indicated that euphausiids, a major component of the macroplankton, were considerably less common in 1983 than in either 1982 or 1984 (Smith<sup>1</sup>).

Yellowtail rockfish are abundant off northern California and are an important component of recreational and commercial catches in some areas. The species feeds mostly on macroplanktonic organisms such as euphausiids, salps, and small fish (Phillips 1964; Pereyra et al. 1969; Lorz et al. 1983). Annual cycles of visceral fat volume and gonad volume are documented in Guillemot (1982) and Guillemot et al. (1985). The studies showed that visceral fat volume in both sexes of yellowtail rockfish is at a maximum during fall. The viviparous species (Boehlert and Yoklavich 1984) mates in early fall (September) and releases larvae during winter (January-March) (Wyllie Echeverria<sup>2</sup>). Guillemot (1982) and Guillemot et al. (1985) showed that male gonad volumes peak in fall and female gonad volumes peak in winter.

The purpose of this study is to determine possible effects of El Niño conditions by comparing visceral fat and gonad volumes during 1983, a year of El Niño conditions, with data collected during 1980, a normal year (Guillemot 1982).

#### Methods and Materials

Guillemot (1982) and Guillemot et al. (1985) util-

ized data collected throughout the year. The 1983 data were collected only on 21 September, the approximate sexual activity peak for males, and 20 December, which slightly precedes the peak time of larval release for females. Only 1980 data collected within 20 d of the two 1983 collection dates and samples collected from central California, between Bodega Bay and Half Moon Bay, were used in this study. In 1983 all specimens were collected from landings made at Bodega Bay.

Specimens were sexed, measured to the nearest millimeter for total length, and viscera were removed and preserved in 10% buffered Formalin<sup>3</sup> in the field following the procedures of Guillemot et al. (1985). After about 90 d of storage, visceral fat and gonad volumes were measured to the nearest milliliter by water displacement. Visceral fat of some fish had dissolved to form a floating liquid. The volume of this liquid was measured and added to the total fat volume. Data from males larger than 379 mm, when 90% are mature, and from females larger than 380 mm, when 85% are mature, were used (Wyllie Echeverria fn. 2).

As in Guillemot (1982) and Guillemot et al. (1985) we used the following power equation to describe the relationship between fat or gonad volume and length:

$$Y = \alpha X^\beta$$

where  $Y$  = fat or gonad volume, and  
 $X$  = total length.

The parameters were estimated by first transforming the variables to natural logarithms and then using standard least squares linear regression techniques. Analysis of covariance was used to determine if separate lines for the two years significantly reduced the variance from a common line (Kleinbaum and Kupper 1978). This is a fairly robust test in that if there is not a significant linear relationship between the two variables for one or both time periods, the test is nearly as powerful for comparing the two means as an analysis of variance.

<sup>1</sup>Smith, S. Unpublished data. Tiburon Laboratory, Southwest Fisheries Center, National Marine Fisheries Service, NOAA, 3150 Paradise Drive, Tiburon, CA 94920.

<sup>2</sup>Wyllie Echeverria, T. 1983. Reproductive seasonality and maturity of the rockfishes (Scorpaenidae; *Sebastes*) off central California. Unpubl. manusc., 66 p. Southwest Fisheries Center,

Tiburon Laboratory, National Marine Fisheries Service, NOAA, Tiburon, CA 94920.

<sup>3</sup>Reference to trade names does not imply endorsement by the National Marine Fisheries Service, NOAA.

## Results

The regression lines for the male fat volume for the two years intersect and are not significantly different (Table 1). The results of the analysis of covariance for fat volume of females are highly significant (Table 1). Females had significantly higher fat volumes in 1980 for both months (Fig. 1).

The comparisons of gonad volumes produced highly significant results in December for both sexes, and for females in September (Table 2). Female gonad volumes were higher in 1980 during December and lines intersected in September (Fig. 2). Male gonad volumes were significantly higher in December 1983 than in December 1980.

The seasonality of gonad development was similar in the two years, but appeared to be delayed in 1983.

TABLE 1.—Results of analysis of covariance of fat volumes of yellowtail rockfish regressed on length. Observations were transformed to natural logarithms for the analysis.

Sex	Month	1980			1983			F
		Sample size	Intercept	Slope	Sample size	Intercept	Slope	
Male	September	20	-9.884	2.011	38	22.272	-3.355	2.753
Male	December	17	7.198	-0.978	35	35.402	-5.693	2.571
Female	September	25	-9.327	2.003	46	5.443	-0.449	11.917**
Female	December	19	21.813	-3.262	50	1.609	-0.058	5.889**

\*\*Significant at 99% level of confidence.

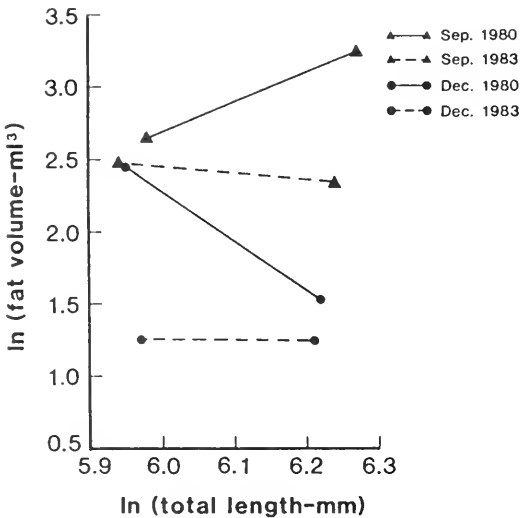

FIGURE 1.—Relationships between ln (visceral fat volume) and ln (total length) for female yellowtail rockfish in 1980 and 1983.

Males were 50% maturing and 50% resting in September 1980, and 100% resting during December. In 1983 males were 100% maturing during September, and 8% maturing and 92% resting during December. Females were 35% maturing and 65% resting in September 1980, and 83% maturing and 17% resting in December. In 1983 females were 100% maturing during September, and 97% maturing and 2% resting during December. Data on season or parturition for 1981-84 (Table 3) indicate that parturition was delayed in 1983 and 1984 compared with 1981 and 1982.

## Discussion

The results tend to agree with expectations. Female fat volumes were lower in 1983 than in 1980, which is in agreement with the impressions of fishermen and the expectation that El Niño would produce relatively poor feeding conditions and consequently result in thin fish.

TABLE 2.—Results of analysis of covariance of gonad volumes of yellowtail rockfish regressed on length. Observations were transformed to natural logarithms for the analysis.

Sex	Month	1980			1983			F
		Sample size	Intercept	Slope	Sample size	Intercept	Slope	
Male	September	20	-35.589	6.161	38	-25.205	4.450	0.274
Male	December	17	-50.003	8.290	35	-11.037	1.962	8.170**
Female	September	25	-54.09	9.171	46	-31.019	5.406	3.404*
Female	December	19	-56.674	9.855	50	-45.723	7.908	12.224**

\*\*Significant at 99% level of confidence.

\*Significant at 95% level of confidence.

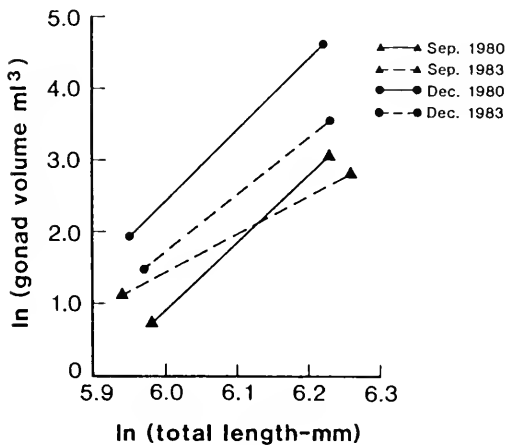
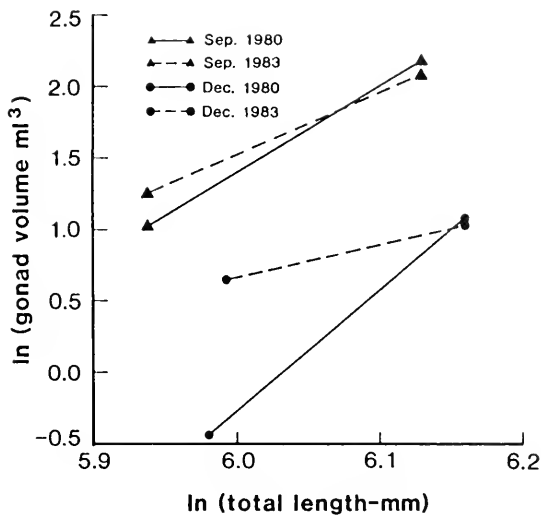

FIGURE 2.—Relationships between ln (gonad volume) and ln (total length) for yellowtail rockfish in 1980 and 1983. (Top) males; (bottom) females.

TABLE 3.—Percent of yellowtail rockfish females with eyed-larvae observed in samples collected in central and northern California, 1981-1984.

Year	January	February	March	April	May	June
1981	5	0	0	0	0	0
1982	0	15	0	0	0	0
1983	0	18	16	6	0	4
1984	3	10	15	0	0	0

The lower ovary volumes in 1983 than 1980 could have been related to either delayed parturition and/or lower reproductive effort. Wootton (1979) described relationships between feeding conditions and fish fecundity. The significantly higher gonad volumes for males in December 1983 compared with

1980 were not expected. December is later than the normal period of sexual activity for males, but the unexpected gonad volume results may be caused by delayed mating. The gonad stage data indicated that male sexual activity was later in 1980.

While fish condition and reproduction were different in 1983 than in the preceding non-El Niño years, the documentation of such differences for marine fish is uncommon. The season of parturition of yellowtail rockfish is more variable than we realized when the study was designed and the data on fish condition and gonad volume should have been collected over a wider period of time. The results of our study indicate that the assumption of constant adult fish condition and reproductive effort that is usually made in models of the population dynamics of fish is questionable.

#### Literature Cited

- BOEHLERT, G. W., AND M. M. YOKLAVICH.  
1984. Reproduction, embryonic energetics, and the maternal-fetal relationship in the viviparous genus *Sebastes* (Pisces: Scorpaenidae). Biol. Bull. (Woods Hole) 167:354-370.
- GUILLEMOT, P. J.  
1982. Seasonal cycles of fat content and gonad volume in species of northern California rockfish (Scorpaenidae; *Sebastes*). M.A. Thesis, San Francisco State Univ., San Francisco, CA, 167 p.
- GUILLEMOT, P. J., R. J. LARSON, AND W. H. LENARZ.  
1985. Seasonal cycles of fat and gonad volume in five species of northern California rockfish (Scorpaenidae; *Sebastes*). Fish. Bull., U.S. 83:299-311.
- KLEINBAUM, D. G., AND L. L. KUPPER.  
1978. Applied regression analysis and other multivariable methods. Duxbury Press, North Scituate, MA, 556 p.
- LORZ, H. V., W. G. PEARCY, AND M. FRAIDENBURG.  
1983. Notes on the feeding habits of the yellowtail rockfish, *Sebastes flavidus*, off Washington and in Queen Charlotte Sound. Calif. Fish Game 69:33-38.
- PEREYRA, W. T., W. G. PEARCY, AND F. E. CARVEY, JR.  
1969. *Sebastes flavidus*, a shelf rockfish feeding on mesopelagic fauna, with consideration of the ecological implications. J. Fish. Res. Board Can. 26:2211-2215.
- PHILLIPS, J. B.  
1964. Life history studies on ten species of rockfish (genus *Sebastes*). Calif. Dep. Fish Game, Fish Bull. 126, 70 p.
- RASMUSSEN, E. M.  
1984. El Niño: the ocean/atmospheric connection. Oceanus 27 (2):5-12.
- WOOTTON, R. J.  
1979. Energy costs of egg production and environmental determinants of fecundity in teleost fishes. Symp. Zool. Soc. Lond. No. 44, p. 133-159.

WILLIAM H. LENARZ  
TINA WYLLIE ECHEVERRIA

Southwest Fisheries Center Tiburon Laboratory  
National Marine Fisheries Service, NOAA  
3150 Paradise Drive  
Tiburon, CA 94920

**DIEL FORAGING ACTIVITY OF  
AMERICAN EELS,  
*ANGUILLA ROSTRATA* (LESUEUR),  
IN A RHODE ISLAND ESTUARY**

Although the American eel, *Anguilla rostrata* (LeSueur), is abundant and commercially exploited along the entire Atlantic coast of North America, its basic biology is not well understood (Tesch 1977; Fahay 1978; Helfman et al. 1984). Foraging activity has not been studied. Helfman et al. (1983) examined daily movement patterns in an estuary and found, as had laboratory studies (Bohun and Winn 1966; Edell 1976; van Veen et al. 1976; Westin and Nyman 1979), that American eel locomotor activity is nocturnal and suggested that American eel foraging activity is also nocturnal. This study sought to describe the diel foraging patterns of wild estuarine American eels by monitoring capture rates in baited eel traps on a 24-h basis.

Eight eel traps were set 10 m apart along a transect in a tidal portion of the Pettaquamscutt River estuary, R.I. The water was turbid (the bottom could not be seen at midday in areas <1 m deep) and the salinity ranged from 20 to 30‰, depending on the tide. Cylindrical traps are commercially constructed of 0.64 cm<sup>2</sup> wire mesh and are 78 cm long and 20 cm in diameter with two single funnel openings of 5 cm in diameter. The traps were baited with 500-700 g pieces of freshly killed horseshoe crab, *Limulus polyphemus*, an effective eel bait (Bianchini et al. 1981).

Capture rates probably reflected contemporaneous foraging because the traps were thought to have a high escape rate. A high escape rate was suspected for two reasons: 1) When we changed from checking the traps once every afternoon to once every 3 h, the daily capture rate increased nearly 50 fold; and 2) when 40 eels were placed into 4 unbaited traps in the river, only 1 eel remained 24 h later. Feeding activity in the traps was evidenced by several factors: an examination of the gut content of 10 captured eels found 6 to contain horseshoe crab and the rest to be empty, anesthetized animals frequently regurgitated bait, eels were often found burrowing in the bait, and unbaited traps rarely caught anything.

Starting at 1200 e.d.t., traps were checked and rebaited at 3-h intervals for six 24-h periods evenly spaced over a 15-d span in early September 1982. This design removed any possible tidal influence because the lunar tidal period is 14.8 d. Within 10 min of their capture, eels were released 10 m to one side of the transect's center point. Traps were

rebaited every 6 h or whenever the bait was found to have been consumed (which rarely occurred). Baiting schedules were designed so that every other trap was rebaited at each 3-h check, and all portions of the crabs (heads and tails of both males and females) were equally distributed with respect to time and location. A total of 322 American eels were captured (some were probably recaptures): 178 (55% of the total) were caught just after sunset at 2000 e.d.t., 140 (44%) were caught during the remainder of the night, and 4 (1%) were caught during daylight (Fig. 1). Although daily capture rates were variable and ranged from 113 to 22, all exhibited this pattern.

To determine when foraging activity commenced, the traps were checked and rebaited at 30-min intervals between 1715 e.d.t. (40 min before sunset) and 2015 e.d.t. for 6 evenings during a 15-d period in early October. Eels were consistently first captured just after sunset, with captures peaking 1 h after sunset and declining thereafter (Fig. 2). Daily capture totals varied considerably but all exhibited this

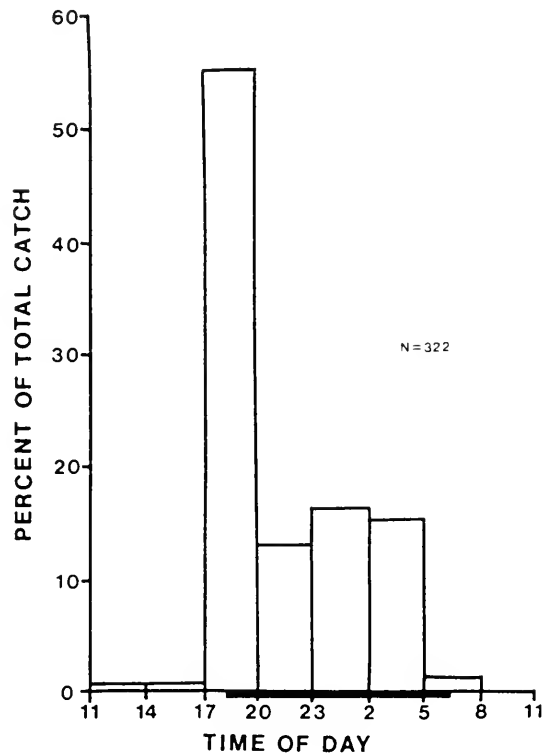

FIGURE 1.—Percentage of total catch of American eels by time of day for the 24-h experiment. The histograms cover the time between checks; i.e., their right boundaries mark the times when traps were checked. The bold section of the x-axis denotes the period between sunset and sunrise.



pattern. A total of 588 American eels were captured, 83% more than in the 24-h experiment, possibly reflecting the intensity of foraging activity just after sunset. To characterize the population, eels caught on the third evening were measured. They had an average total length of 30.7 cm (SD = 5.4,  $n = 121$ ), and 10 of the 121 animals caught had the silvered pigmentation pattern which characterizes maturing individuals (Tesch 1977).

These data show that the foraging activity of estuarine American eels in late summer through autumn is nocturnal and peaks sharply at nightfall. Whether the subsequent decline in captures was caused by a decrease in foraging because of satiation or by an unrelated decline in locomotor activity cannot be determined. The swimming activity of unfed eels in the laboratory often exhibits a dramatic peak at lights-off (Bohun and Winn 1966; Edel 1976; van Veen et al. 1976). Spring and autumn captures of wild short-finned New Zealand eels, *Anguilla australis schmidti*, in baited traps displayed the nocturnal activity pattern described here (Ryan 1984). However, capture patterns in the latter study changed with the season, as did the locomotor patterns of the yellow European eel, *Anguilla anguilla*, studied by Westin and Nyman (1979). Further research is required to understand the relationship between foraging and locomotor activity patterns

and how environmental and physiological factors might influence them.

### Literature Cited

- BIANCHINI, M., P. W. SORESENSEN, AND H. E. WINN.  
1981. Horseshoe crabs as bait for estuarine American eels, *Anguilla rostrata*. J. World Maricul. Soc. 12:127-129.
- BOHUN, S., AND H. E. WINN.  
1966. Locomotor activity of the American eel (*Anguilla rostrata*). Chesapeake Sci. 7:137-147.
- EDEL, R. K.  
1976. Activity rhythms of maturing American eels (*Anguilla rostrata*). Mar. Biol. 36:283-289.
- FAHAY, M. P.  
1978. Biological fisheries data on American eel, *Anguilla rostrata* (LeSueur). Natl. Mar. Fish. Serv. Sandy Hook Lab., Highlands, NJ, Rep. 17, 87 p.
- HELPMAN, G. S., D. L. STONEBURNER, E. L. BOZEMAN, P. A. CHRISTIAN, AND R. WHALEN.  
1983. Ultrasonic telemetry of American eel movements in a tidal creek. Trans. Am. Fish. Soc. 112:105-110.
- HELPMAN, G. S., E. L. BOZEMAN, AND E. B. BROTHERS.  
1984. Size, age and sex of American eels in a Georgia river. Trans. Am. Fish. Soc. 113:132-141.
- RYAN, P. A.  
1984. Diet and seasonal feeding activity of the short-finned eel, *Anguilla australis schmidti*, in Lake Ellesmere, Canterbury, New Zealand. Environ. Biol. Fishes 11:229-234.
- TESCH, F.-W.  
1977. The eel. Chapman and Hall, Ltd., Lond./J. Wiley & Sons, N.Y., 434 p. J. Greenwood, translator.
- VAN VEEN, T., H. G. HARTWIG, AND K. MÜLLER.  
1976. Light-dependent motor activity and photonegative behavior in the eel (*Anguilla anguilla* L.). J. Comp. Physiol. 111:209-219.
- WESTIN, L., AND L. NYMAN.  
1979. Activity, orientation, and migration of Baltic eel (*Anguilla anguilla* L.). Rapp. P.-v. Réun. Cons. int. Explor. Mer 174:115-123.

PETER W. SORESENSEN

Graduate School of Oceanography  
University of Rhode Island  
Narragansett, RI 02882  
Present address:  
Zoology Department  
University of Alberta  
Edmonton, Alberta T6G 2E9, Canada

MARCO L. BIANCHINI

Graduate School of Oceanography  
University of Rhode Island  
Narragansett, RI 02882  
Present address:  
I.P.R.A., Consiglio Nazionale Delle Ricerche  
Via Nizza 128  
00188 Roma, Italy

HOWARD E. WINN

Graduate School of Oceanography  
University of Rhode Island  
Narragansett, RI 02882

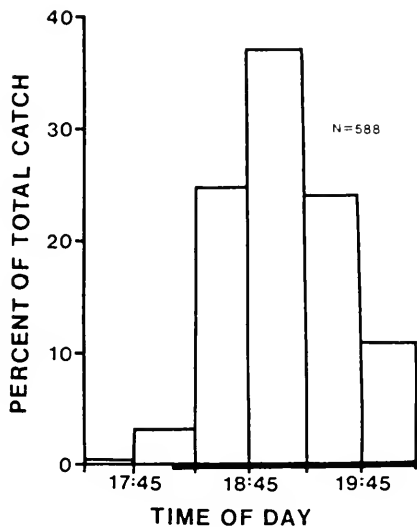

FIGURE 2.—Percentage of total catch of American eels by time of day for the evening experiment. The histograms cover the time between checks; i.e., right boundaries mark the times when traps were checked. The bold section of the x-axis denotes the period after sunset.

FIRST RECORD OF  
THE LONGFIN MAKO, *ISURUS PAUCUS*,  
IN THE GULF OF MEXICO

The longfin mako, *Isurus paucus*, (Guitart-Manday 1966) is a large, pelagic shark that has been reported from the western Indian, central Pacific, eastern North Atlantic, and the western North Atlantic Oceans (Compagno 1984). Guitart-Manday (1975, cited by Dodrill and Gilmore 1979) described the longfin mako as a relatively common catch of pelagic longliners off northwest Cuba. They are usually captured off the continental shelf at depths of 60-120 fathoms and infrequently at 10-50 fathoms. Dodrill and Gilmore (1979) reported the first North American continental longfin mako, found beached in the surf at Melbourne Beach, FL. This paper reports the first recorded occurrence of the longfin mako in the Gulf of Mexico.

A large female *I. paucus* was collected 1 April 1985 by longline fisherman, 80 mi south of Panama City, FL (lat. 28°55'N, long. 85°35'W) near the surface, over 300 fathoms of water. Standard length (precaudal length) measured 313.0 cm and fork length measured 342.0 cm. Total length could not be measured directly because of the sharks position on the boat deck and was estimated using a ratio of total length to fork length (TL/FL = 1.152) calculated from 7 large *I. paucus* (Harold Pratt<sup>1</sup>). Using this ratio, total length was estimated to be ca. 390 cm. Although no embryos were present in the oviduct, this fish appeared reproductively mature. The oviducts were 3-4 cm in diameter and ovarian eggs measured 2-3 mm in diameter. Gilmore (1983) proposed the reproductive strategy of *I. paucus* to be oviphagous, as remnants of yolk were found in the digestive tract and mouth of an examined embryo.

The ventral surface of the snout and gill areas of our shark exhibited a dark grey coloration. Garrick (1967) reported this coloration as an important distinguishing characteristic between *I. paucus* and the shortfin mako, *I. oxyrinchus*, which exhibits a creamy white coloration in that area. Gilmore (1983) reported the dusky coloration to be more extensive in larger *I. paucus*.

Pectoral fin length of our shark measured 80.6 cm. Gilmore (1983) compared an adult and embryo *I. paucus* and found that the pectoral fin length represented a greater percentage of SL in the embryo (31% of SL) than in the adult (28% of SL). Our

Gulf of Mexico specimen was slightly larger than the specimen reported by Gilmore (1983) (313.0 cm vs 303.5 cm SL), and the pectoral fin represented 26% of SL. Guitart-Manday (1966) examined smaller *I. paucus*—195, 203, and 226 cm TL—and found pectoral fin length as percent total length to be 30.4%, 30.0%, and 29.2%, respectively. For this specimen, pectoral fin length as percent TL was about 21%. It appears that as *I. paucus* increase in length, the pectoral fins do not increase proportionately, resulting in reduced pectoral length to total length ratios in larger sharks.

This record suggests that the longfin mako at least occurs infrequently in the northern Gulf of Mexico. Three male *I. paucus* (191, 193, and 220 cm SL) captured 16 April 1985 off the Mississippi River (lat. 27°35'N, long. 89°55'W) further supports this suggestion (Stephen Branstetter<sup>2</sup>). These captures extend the known range of this species well into the northern Gulf of Mexico.

#### Acknowledgments

We would like to extend a most sincere thanks to Lew Bullock of the Florida Department of Natural Resources for his help in examining this shark. We are grateful to Stephen Branstetter and Wes Pratt for reviewing the manuscript and providing unpublished data.

#### Literature Cited

- COMPAGNO, L. J. V.  
1984. FAO species catalogue. Vol. 4. Sharks of the world. An annotated and illustrated catalogue of sharks species known to date. Part 1. Hexanchiformes to Lamniformes. FAO Fish. Synop. 125, Vol. 4(Pt. 1), 249 p.
- DODRILL, J. W., AND R. G. GILMORE.  
1979. First North American continental record of the longfin mako (*Isurus paucus* Guitart-Manday). Fla. Sci. 42:52-58.
- GARRICK, J. A. F.  
1967. Revision of sharks of genus *Isurus* with description of a new species (*Galeoidea*, Lamnidae). Proc. U.S. Natl. Mus. 118:663-690.
- GILMORE, R. G.  
1983. Observations on the embryos of the longfin mako, *Isurus paucus* and the bigeye thresher, *Alopias superciliosus*. Copeia 1983:375-382.
- GUITART-MANDAY, D.  
1966. Nuevo nombre para una especie de tiburón del genero *Isurus* (Elasmobranchii: Isuridae) de aguas Cubanas. Poeyana Ser. A, No. 15, 9 p.  
1975. Las pesquerías pelágico-oceánicas de corto radio de acción en la región noroccidental de Cuba. Oceanogr. Inst.,

<sup>1</sup>Harold Pratt, Northeast Fishery Center Narragansett Laboratory, National Marine Fisheries Service, NOAA, South Ferry Road, Narragansett, RI 02882-1199, pers. commun. June 1985.

<sup>2</sup>Stephen Branstetter, Department of Wildlife and Fisheries Science, Texas A&M University, College Station, TX 77843-2258, pers. commun. August 1985.

Department of Marine Science  
University of South Florida at St. Petersburg  
140 7th Avenue South  
St. Petersburg, FL 33701

### MOVEMENT OF SEA-RUN SEA LAMPREYS, *PETROMYZON MARINUS*, DURING THE SPAWNING MIGRATION IN THE CONNECTICUT RIVER<sup>1</sup>

Adult sea lampreys, *Petromyzon marinus*, first enter New England rivers in late March and early April (Bigelow and Schroeder 1953). The only information on river water temperatures during the migration were collected in 1974 from the St. John River, New Brunswick, where Beamish and Potter (1975) captured the first prespawning adults in a fish lift at Mactaquac Dam (river km 140) at 13°C in mid-June and the run peaked at 17°-19°C. Because thousands of sea lampreys are annually passed upstream of Holyoke Dam (river km 140) on the Connecticut River, the passage records provide an ideal opportunity to characterize the run relative to temperature. River flow was partially or totally controlled by the hydroelectric facilities at the dam, so we did not examine the effects of flow on the run.

The behavior and rate of movement of landlocked sea lampreys in the Great Lakes was determined using mark and recapture of adults at stream weirs (Applegate 1950; Applegate and Smith 1950; Smith and Elliot 1952; Moore et al. 1974). The only estimate of the rate of movement of sea-run sea lampreys was done by Beamish (1979) who used the energy expended during an upstream movement to estimate the distance traveled and the rate of movement of adults in the St. John River. Because this estimate of the rate of movement was not verified by direct observations on fish in the field, we believed that additional study was necessary. We selected radio telemetry to determine the rate of movement and diel behavior of sea lampreys. The

abundance, size, and sex ratio of the Connecticut River population were reported by Stier and Kynard (1986).

### Methods

Radio-tagged sea lampreys were observed in the 46 km stretch of the Connecticut River from Brunelle's Marina to Cabot Station, a hydroelectric facility located 4.5 km below Turners Falls Dam (Fig. 1). The downstream half of this stretch flows slowly, creating a deep channel and shoals; the upstream half flows swiftly with pools and riffles. Major spawning areas are in the upper main-stem near Cabot Station, Russelville Brook, and the Fort, Mill, Sawmill, and Deerfield Rivers (Fig. 1).

The number of sea lampreys passed daily by the fish lifts from 1980 to 1983 were counted by personnel of the Massachusetts Cooperative Fishery Research Unit. Daily maximum river temperature was recorded at Holyoke Dam.

Sea lampreys were captured in the trap at the fish lifts during May and June 1982, measured for total length, and held for <24 h in a 1,325 L circular tank supplied with river water. We anesthetized fish with MS-222 (1:20,000) and tagged them first with a Floy tag inserted through the posterior dorsal fin, and second with a transmitter placed on the left side of the body along the first dorsal fin. Sex could not be accurately determined visually.

Cylindrical radio transmitters were constructed from the design of Knight (1975) and operated at a frequency of 30.05-30.25 MHz. Tags measured 34 × 10 mm, weighed 3.5-4.5 g in air, and transmitted for about 20 d. Each fish was identified by frequency and pulse rate. We located fish to within about 10 m, using receivers equipped with an omnidirectional, 1/8-wave antenna and a directional, tuned-loop antenna.

We released two to six sea lampreys at a time and observed them continuously for ≥6 h or until darkness. Subsequently, sea lampreys were located each day until they reached Cabot Station or entered a tributary. During all surveys, we noted the locations of fish to the nearest river kilometer. Diel movement was monitored for five 24-h periods. Additional fish were released during the day for this study.

### Results and Discussion

The water temperatures, and the year in parentheses, when sea lampreys first entered the fish lifts were 12.5°C (1980), 10.5°C (1981), 12.5°C (1982), and 15.5°C (1983) (Fig. 2). The lifts sampled the en-

<sup>1</sup>Contribution No. 101 of the Massachusetts Cooperative Fishery Research Unit, which is supported by the U.S. Fish and Wildlife Service, Massachusetts Division of Fisheries and Wildlife, Massachusetts Division of Marine Fisheries, and the University of Massachusetts.

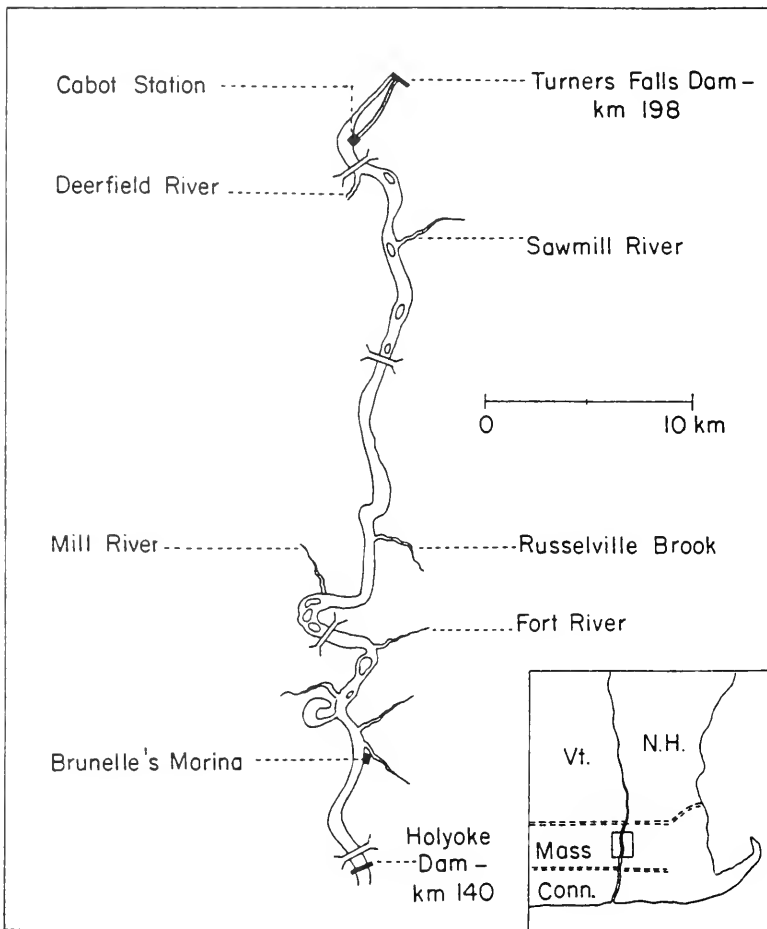

FIGURE 1.—Section of the Connecticut River from river km 140 to 198, showing the locations of the Holyoke and Turners Falls Dams, the release site for radio-tagged sea lampreys at Brunelle's Marina, and the major spawning tributaries between the two dams.

tire run each year except in 1981 when sea lampreys were present in the first lifts of the year (the lifts began operating on 29 or 30 April of each year). During the peak 7 d, the temperature ranges, and year in parentheses, were 16°-19°C (1980), 17°-19°C (1981), 16°-17°C (1982), and 17°-21°C (1983). Movement into the fish lift ceased at 24°C in 1983 and at 21°-22°C in the other years (Fig. 2).

Information on the maximum daily temperature during the migration of landlocked sea lampreys in a large river comes from the Ocqueoc River (Lake Huron drainage) which for some years supported an annual run of 25,000-40,000 (Applegate 1950; Applegate and Smith 1950). The temperatures, and date in parentheses, when the first sea lampreys entered a weir near the mouth of the river were 10°C (27 April 1949) and 6°C (11 May 1950); and the run

peaked at 14°-17°C (first week of May 1949) and 18°-20°C (third week of May 1950). Most movement at the weir ceased at 21°C (about 11 July), but during both years one or two sea lampreys per day continued to enter the weir throughout the summer at 22°-26°C.

The temperature regimes in the Ocqueoc and Connecticut Rivers during the peak and at the end of the principal migration were in general agreement. Runs peaked at 14°-20°C in the Ocqueoc River and 16°-21°C in the Connecticut River; most of the run ceased at 21°C in the Ocqueoc River and at 21°-24°C in the Connecticut River. The migrations differed because a few adults in the Ocqueoc River continued to migrate throughout the summer, whereas none were captured after 25 June during 3 yr in the Connecticut River. Therefore, even

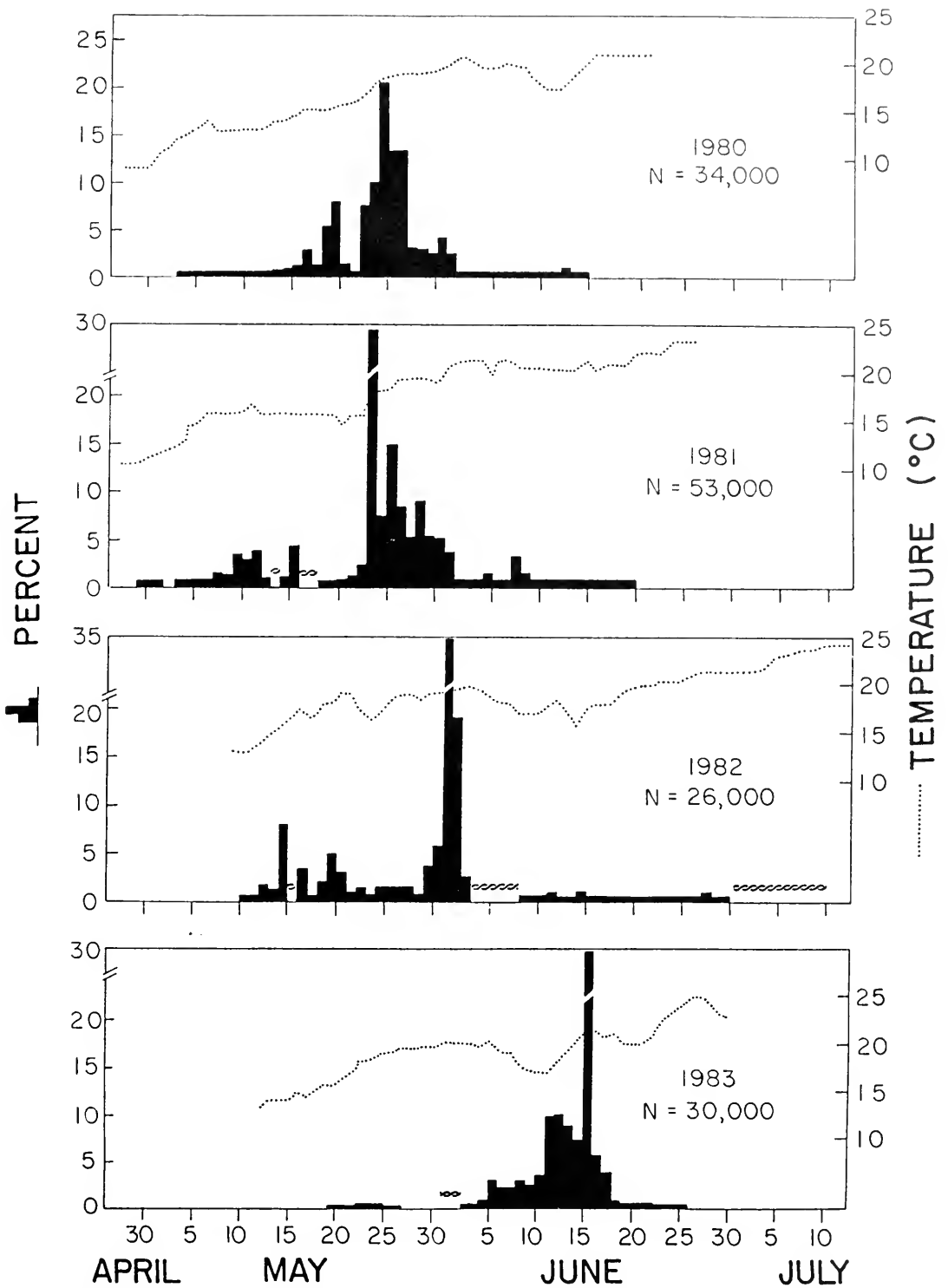

FIGURE 2.—Daily percent of total sea lampreys lifted at the Holyoke fish lifts each year, 1980-83. Temperatures are the daily maximum river temperatures. The lifts began operating about 1 May in all years and ceased about 15 July. Wavy line near the base of each panel identifies days on which the lifts were not operated.

though the data from the two runs differed greatly in time and space, the general migration pattern in relation to river temperature was remarkably similar.

The behavior of the sea lampreys in the St. Johns and Connecticut Rivers also appeared similar. In 1974, the first migrants were collected at 13°C at the Mactaquac fish lift (Beamish and Potter 1975), and from 1980 to 1983 the first migrants were passed in the Holyoke fish lift at 10.5°-15.5°C. The peak of the run was also similar—17°-19°C in the St. Johns River and 16°-21°C in the Connecticut River.

Mean length of the 45 sea lampreys tagged was 73.2 cm (range, 63.0-80.0 cm). Five were not re-located either because the tag failed or the fish moved downstream over the dam. No tagged sea lamprey died during the study. The remaining 40 fish were followed for a total of 224 h during 24 d (12 May-4 June; Fig. 3). Since sea lampreys migrated upstream at Holyoke until 30 June 1982 (Fig. 2), for the most part we observed the movement of early migrants. During the study, water temperature increased from 13° to 22°C; river discharge gradually decreased from 60.4 m<sup>3</sup>/s on 12 May to 50.9 m<sup>3</sup>/s on 31 May. Twenty sea lampreys moved >23 km and 4 reached Cabot Station. Nineteen were last located near the mouths of the Fort or Mill Rivers or Russelville Brook (Fig. 1). Spawning of tagged fish was verified in the tributaries—an indication that normal behavior resumed after the sea lampreys were tagged.

Sea lampreys moved upstream at ground speeds of 0.1-3.5 km/h. The daily mean rate of movement including rest periods was 1.01 km/h  $\pm$  0.75 (mean

$\pm$  SD; range, 0.1-2.7 km/h; *N* = 40) or 0.4 body length/s. The mean rate, excluding rest periods, was 1.51 km/h  $\pm$  0.53 (range, 0.1-3.5 km/h; *N* = 39) or 0.6 body length/s. Early migrants moved a mean of 0.1-1.2 km/h; and three migrants that were observed during the peak passage at the fish lift on 2 June had the fastest mean daily rate of 2 km/h (Fig. 3).

Among landlocked sea lampreys, early migrants have a slower rate of movement than peak migrants because they rest more (Applegate 1950; Skidmore 1959; Larsen 1980). Our observations during the peak period after 30 June did not indicate a sustained increase in the rate of movement (Fig. 3). Because we only observed a few peak migrants, additional study is necessary to compare the rates of movement between early and peak migrants.

The movement rates of sea lampreys in the Connecticut River were the highest reported for the species. Landlocked sea lampreys moved at much lower rates of 0.02-0.21 km/h (Applegate and Smith 1950; Skidmore 1959; Wigley 1959). Beamish (1974) found a maximum swimming speed of 1.08 km/h (30 cm/s) for landlocked adults in the laboratory. Using the energetics of adult sea-run sea lampreys during a 35-d upstream move into the fish lift at Mactaquac Dam on the St. John River, Beamish (1979) estimated the rate to be 0.23 km/h for males and 0.26 km/h for females, or 0.1 body length/s for both. This rate was similar to that of the landlocked form. Because the sea-run adults are much larger than landlocked adults, they should swim faster. Our results suggest that the 0.2 km/h rate which was estimated for the St. John River adults may be incorrect, possibly because the fish were delayed

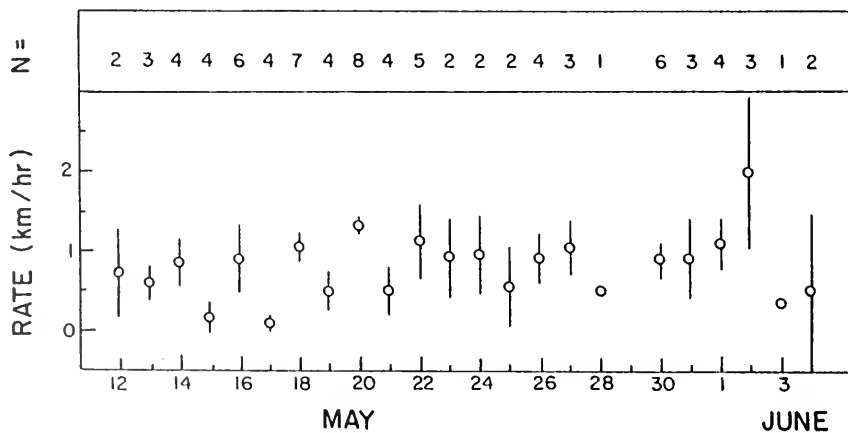

FIGURE 3.—Daily mean rates of movement of radio-tagged sea lampreys (open circles). (Vertical lines show standard errors; numbers of lampreys monitored are shown above each mean.)

several days before finding the entrance to the fish lift at Mactaquac Dam.

Diel movement rates were monitored on 13 and 17 May (early migrants) and 26 and 30 May and 1 June (peak migrants). Movement was slowest from 1200 to 1700 h (Fig. 4). Nocturnal behavior was strongest among the early migrants; peak migrants had a higher rate of movement because they also moved during the day (mornings only). A similar pattern for landlocked adults was found by Kleerekoper et al. (1961).

In summary, except for the longer summer migration and the slower rate of upstream movement, the behavior of sea-run sea lampreys in the Connecticut and St. Johns Rivers was similar to that of the landlocked sea lampreys in the Ocqueoc River. The timing of the runs in relation to temperature and the diel movement patterns appears very stable, probably with important survival or reproductive advantages.

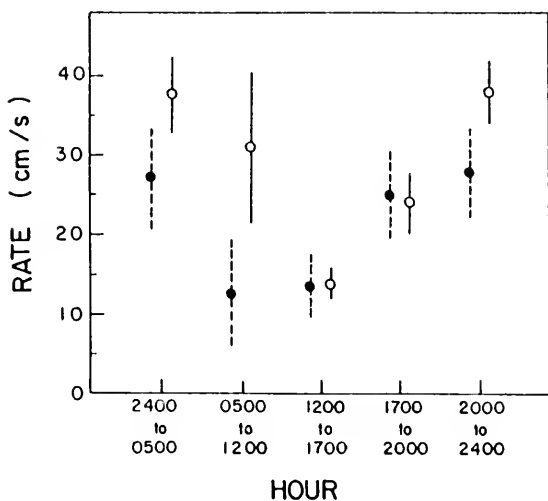

FIGURE 4.—Mean movement rates of early migrants (solid circles) monitored 13 and 17 May ( $N = 13$ ), and peak migrants (open circles) monitored 26 and 30 May and 1 June 1982 ( $N = 7$ ). (Vertical lines show standard errors.)

#### Acknowledgments

We thank D. Stier, A. Richmond, J. Nicholson, T. Clifford, C. Hall, J. Burnett, J. Bain, and J. Idoine for assistance with field work. The project was funded by Federal Aid Project AFS-4-R-21 and Dingell-Johnson Project 5-29328 to the Massachusetts Cooperative Fishery Research Unit. We thank Holyoke Water Power Company for providing space for the holding tanks.

#### Literature Cited

- APPLEGATE, V. C.  
1950. Natural history of the sea lamprey, *Petromyzon marinus*, in Michigan. U.S. Fish Wildl. Serv., Spec. Sci. Rep. Fish. 55, 237 p.
- APPLEGATE, V. C., AND B. R. SMITH.  
1950. Sea lamprey spawning runs in the Great Lakes in 1950. U.S. Fish Wildl. Serv., Spec. Sci. Rep. Fish. 61, 49 p.
- BEAMISH, F. W. H.  
1974. Swimming performance of adult sea lamprey, *Petromyzon marinus*, in relation to weight and temperature. Trans. Am. Fish. Soc. 103:355-358.  
1979. Migration and spawning energetics of the anadromous sea lamprey, *Petromyzon marinus*. Environ. Biol. Fishes 4:3-7.
- BEAMISH, F. W. H., AND I. C. POTTER.  
1975. The biology of the anadromous sea lamprey (*Petromyzon marinus*) in New Brunswick. J. Zool. (Lond.) 177: 57-72.
- BIGELOW, H. B., AND W. C. SCHROEDER.  
1953. Fishes of the Gulf of Maine. U.S. Fish Wildl. Serv., Fish. Bull. 53:1-577.
- KLEEREKOPER, H., G. TAYLOR, AND R. WILTON.  
1961. Diurnal periodicity in the activity of *Petromyzon marinus* and the effects of chemical stimulation. Trans. Am. Fish. Soc. 90:73-78.
- KNIGHT, A. E.  
1975. A tuned-antenna radio telemetry tag for fish. Underwater Telem. Newsl. 5:13-16.
- LARSEN, L. O.  
1980. Physiology for adult lampreys, with special regard to natural starvation, reproduction, and death after spawning. Can. J. Fish. Aquat. Sci. 37:1762-1779.
- MOORE, H. H., F. H. DAHL, AND A. K. LAMSA.  
1974. Movement and recapture of parasitic phase sea lampreys (*Petromyzon marinus*) tagged in the St. Marys River and Lakes Huron and Michigan, 1963-67. Great Lakes Fish. Comm. Tech. Rep. 27, 19 p.
- SKIDMORE, J. F.  
1959. Biology of spawning-run sea lampreys (*Petromyzon marinus*) in the Pancake River, Ontario. M.S. Thesis, Univ. Western Ontario, London, Ont., 87 p.
- SMITH, B. R., AND O. R. ELLIOTT.  
1952. Movement of parasitic-phase sea lampreys in Lakes Huron and Michigan. Trans. Am. Fish. Soc. 82:123-128.
- STIER, K., AND B. KYNARD.  
1986. Abundance, size, and sex ratio of adult sea-run sea lamprey, *Petromyzon marinus*, in the Connecticut River. Fish. Bull., U.S. 84:476-480.
- WIGLEY, R. L.  
1959. Life history of the sea lamprey of Cayuga Lake, New York. U.S. Fish Wildl. Serv., Fish. Bull. 59:559-617.

KATHLEEN STIER  
BOYD KYNARD

Massachusetts Cooperative Fishery Research Unit  
University of Massachusetts  
204 Holdsworth Hall  
Amherst, MA 01003

VARIATIONS IN THE MORPHOLOGY OF  
*FISTULICOLA PLICATUS* RUDOLPHI (1802)  
(CESTODA:PSEUDOPHYLLIDEA) FROM  
THE SWORDFISH, *XIPHIAS GLADIUS* L.,  
IN THE NORTHWEST ATLANTIC OCEAN

During the course of a survey of the helminth parasites of the swordfish, *Xiphias gladius* L., from the Northwest Atlantic Ocean, several morphological variations were observed in specimens of the pseudophyllidean tapeworm, *Fistulicola plicatus*. The most notable of these variations were pseudoscolex form and proglottid shape and size. Methods of scolex attachment to the organ wall, descriptions of pseudoscolex structures, and organ specific variations in the morphology of *F. plicatus* are given.

#### Materials and Methods

A sample of 303 gills and gastrointestinal tracts of swordfish was collected from four geographical areas in the Northwest Atlantic Ocean in the late summer and early fall of 1980. The areas sampled and the number of swordfish collected from each geographical area are as follows: Cape Hatteras (74), Georges Bank (90), Scotian Shelf (69), and Grand Bank (70); all collected by longline gear and frozen at sea. The swordfish were later dissected and examined for helminth parasites in the laboratory.

Pseudophyllidean cestodes were removed from the infected organ and fixed whole in 70% alcohol or 10% Formalin<sup>1</sup>. Several infected organs were fixed whole in Bouin's fluid or 10% Formalin. Specimens used for taxonomic examinations were stained in Erlich's hematoxylin, Blachin's lactic acid carmine, or Semichon's aceto-carmine. Camera lucida drawings were made from fixed, unstained specimens.

#### Results

*Fistulicola plicatus* has been reported from the swordfish by Linton (1901), Cooper (1918), Nigrelli (1938), and Iles (1970). In this study *F. plicatus* was found in the intestines and rectums of swordfish from all four sampling areas. Considerable morphological variation was found between individuals of this species. Variations were in scolex form, overall parasite length, and proglottid shape and size. About 50% of specimens recovered exhibited a scolex and proglottid structure characteristic of specimens

described by Yamaguti (1959). Scolices from these were arrow-shaped and possessed two simple, leaf-shaped bothridia (Fig. 1). Any variation from this scolex form were considered to be pseudoscolices. Proglottids from specimens described by Yamaguti (1959) were short and broad with foliate lateral edges. Internal proglottid morphology was not easily seen in any of the specimens examined during the present study, although nerve trunk location (near lateral margins), cirrus-sac and vagina location (on opposite lateral margins), and egg shell structure (thick-shelled and operculate) were occasionally observable.

A total of 29 specimens recovered had penetrated the wall of the infected organ. Occasionally the tapeworms penetrated the organ wall and retained typical scolex form, i.e., arrow-shaped with simple, well-developed bothridia but, in the majority of cases, complete perforation of the organ wall resulted in the formation of a pseudoscolex. Attachment to the organ wall (rectum and intestine) was achieved in the following four ways:

- 1) By complete perforation of the organ wall, the scolex and a portion of the neck encapsulated in a rounded, host-produced cyst attached to the organ serosa. Scolices recovered from these cysts were usually arrow-shaped with typical bothridia, or occasionally found as a round, transparent, fluid-filled bag, which possessed rudimentary or no apparent bothridia (Fig. 2).
- 2) By complete perforation of the organ wall, the scolex and a portion of the neck encased in a tubular, host-produced sheath, attached along its entire length to the organ serosa. Occasionally this sheath was entwined with the mesenteries associated with the infected organ. Pseudoscolices found within these sheaths were long, rounded, and slender, and exhibited no bothridia (Fig. 3).
- 3) By complete penetration of the organ wall, the scolex markedly enlarged (up to 6 cm in length), lying free, and unencapsulated in the peritoneal cavity. Pseudoscolices of this type were long, broad, pseudosegmented, and possessed well-developed bothridia (Fig. 4).
- 4) In this case the scolex did not fully penetrate the organ wall, but perforated the wall to a slight depth, and remained in that position. Often specimens were found to exhibit this slight organ wall penetration and re-emerge into the lumen of the organ. In these cases the

<sup>1</sup>Reference to trade names does not imply endorsement by the National Marine Fisheries Service, NOAA.



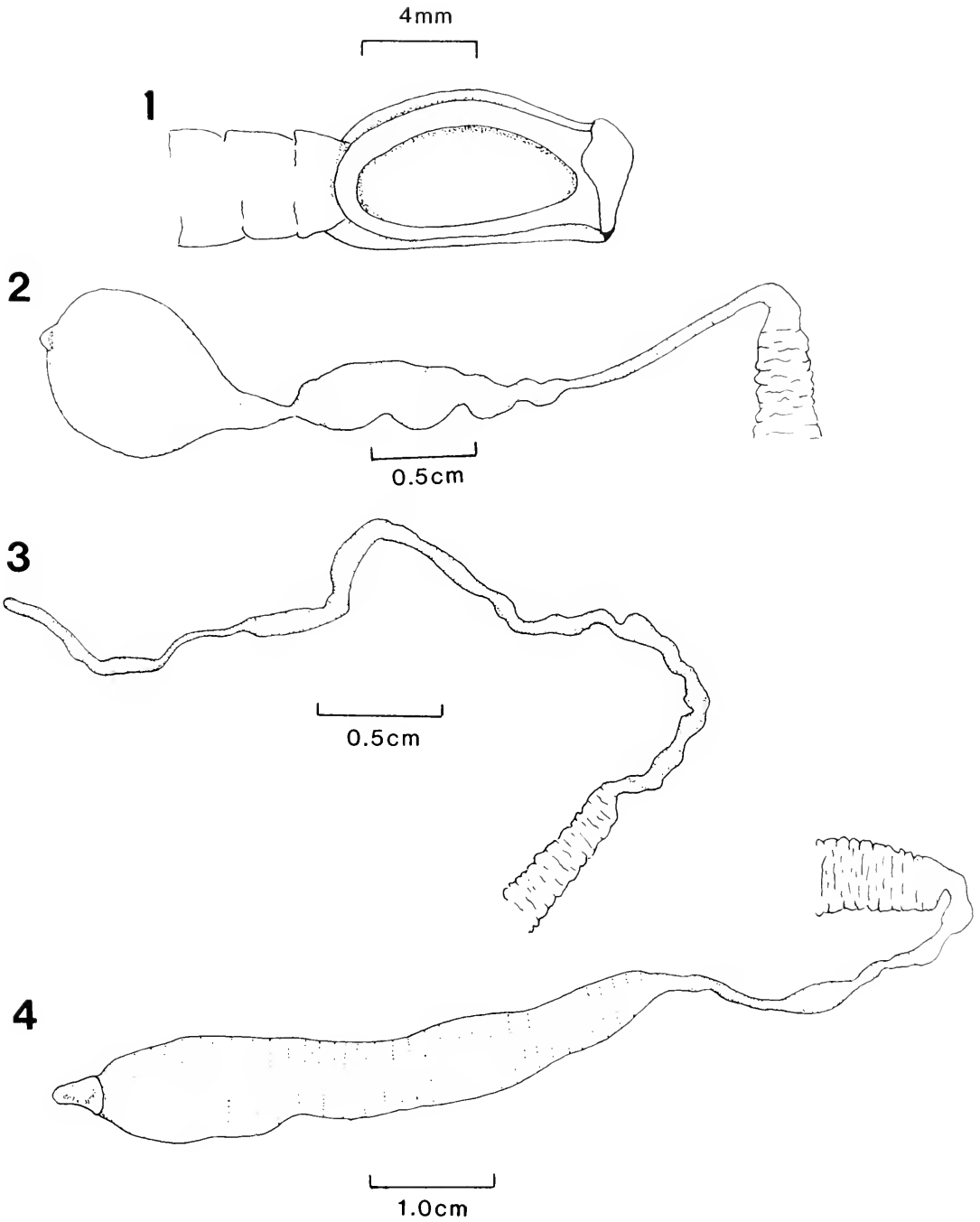

FIGURE 1.—Typical scolex from *Fistulicola plicatus*, as described and figured by Yamaguti (1959).

FIGURE 2.—Pseudoscolex (1st type).

FIGURE 3.—Pseudoscolex (2d type).

FIGURE 4.—Pseudoscolex (3d type).

1) scolex type described by Yamaguti (1959) was retained.

*Fistulicola plicatus* specimens recovered from the lumen of the intestines were morphologically different from those collected from the rectum. They were long, up to 1 m in length, and exhibited longer, less-broad strobila than those characteristic of the rectal forms. All specimens of *F. plicatus* recovered from the anterior portion of the intestine exhibited the previously described first type of scolex attachment to the organ wall, i.e., the scolex perforated the organ wall and was encapsulated in a rounded, host-produced cyst attached to the intestinal serosa. The scolex penetrated the anterior portion of the intestine, with the strobila projecting posterior through the length of the organ. Very small *F. plicatus* were found in the posterior portion of the intestine. These exhibited shallow penetration by an unmodified scolex.

*Fistulicola plicatus* specimens found in the rectum of swordfish were usually <20 cm in length and possessed very broad strobila. These rectal forms exhibited all of the previously described types of scolex attachment and structure, penetrating the organ wall near the rectal sphincter (Fig. 5). Occa-

sionally, several tapeworms were found with their necks passing through a single perforation of the rectal wall, their scolices jointly encapsulated in a rounded serosal cyst.

### Discussion

Apex type predators such as the swordfish eat and digest large amounts of prey species and, consequently, the intestines and rectums of these fish exhibit high levels of muscular activity. Without perforation of the organ wall (by the scolex and neck), many tapeworms would probably be voided with the faeces. The development of the pseudoscolex is an adaptation for anchoring the simple, unarmed scolex to the organ wall. It is clear that *F. plicatus* secretes a powerful digestive enzyme which enables the scolex to penetrate the very muscular walls of the intestine and rectum of swordfish. Iles (1970) found many examples of pseudoscolex variation in 24 specimens from swordfish in the Northwest Atlantic Ocean. Several of these variations are similar to those found in this study. It is obvious from this study, and studies such as Iles (1970), that *F. plicatus* is a very adaptable tapeworm and will develop any pseudoscolex structure which is neces-

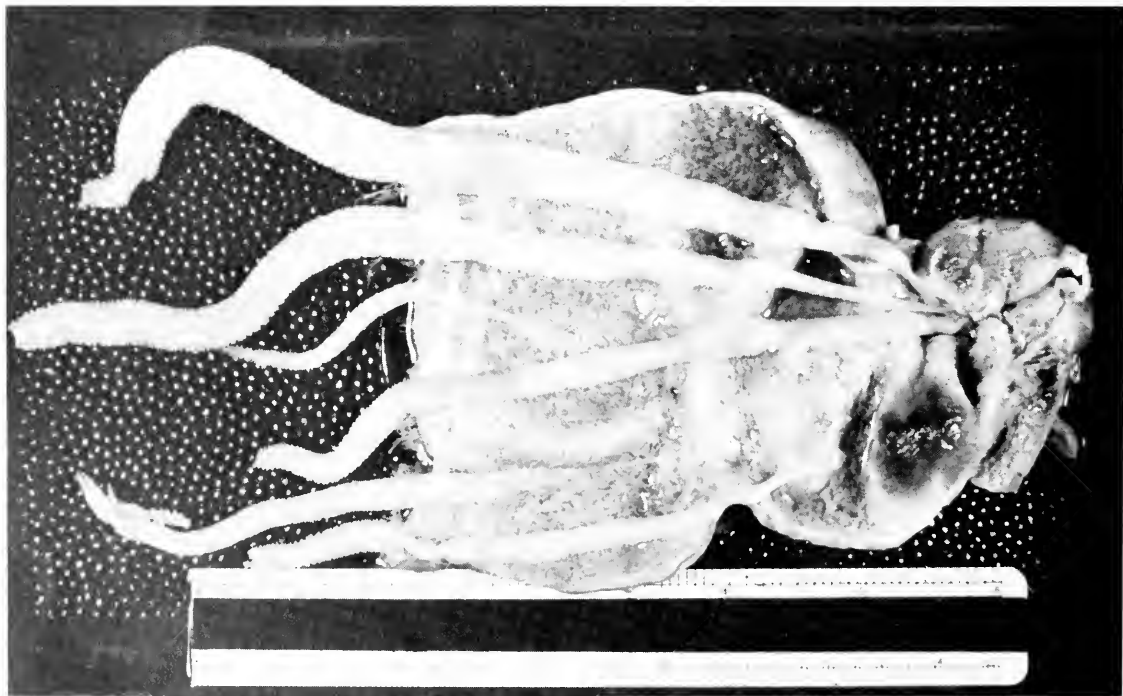

FIGURE 5.—*Fistulicola plicatus* (in situ) from rectum of *Xiphias gladius*.

sary to anchor itself to the organ wall. Large samples of swordfish intestines and rectums will invariably show many variations in the pseudoscolex structure of *F. plicatus*.

### Acknowledgments

We thank L. S. Uhazy for initiating the study of these parasites, C. Iles for comments on the manuscript, P. W. G. McMullon for advice on figures, and B. Garnett for preparing the typescript.

### Literature Cited

- COOPER, A. R.  
1918. North American pseudophyllidean cestodes from fishes. III. Biol. Monogr. 4:1-243.
- ILES, C.  
1970. A preliminary investigation of the parasites of the gills and gastrointestinal tract of the swordfish *Xiphias gladius* L. from the Northwest Atlantic. J. Fish. Res. Board Can. MS Rep. Ser. 1092, 11 p.
- LINTON, E.  
1901. Parasites of fishes of the Woods Hole region. Bull. U.S. Fish. Comm. 19:405-492.
- NIGRELLI, R. F.  
1938. Parasites of the swordfish, *Xiphias gladius* Linnaeus. Am. Mus. Novit. 996:1-16.
- YAMAGUTI, S.  
1959. Systema helminthum. Vol. 2. The cestodes of vertebrates. Intersci. Publ., N.Y., 860 p.

W. E. HOGANS

*Identification Centre  
Department of Fisheries and Oceans  
Biological Station  
St. Andrews, Nova Scotia E0G 2X0, Canada*

P. C. F. HURLEY

*Marine Fish Division  
Bedford Institute of Oceanography  
Department of Fisheries and Oceans  
P.O. Box 1006  
Dartmouth, Nova Scotia B2Y 4A2, Canada*



# INFORMATION FOR CONTRIBUTORS TO THE *FISHERY BULLETIN*

Manuscripts submitted to the *Fishery Bulletin* will reach print faster if they conform to the following instructions. These are not absolute requirements, of course, but desiderata.

## CONTENT OF MANUSCRIPT

The **title page** should give only the title of the paper, the author's name, his affiliation, and mailing address, including ZIP code.

The **abstract** should not exceed one double-spaced page.

In the **text**, *Fishery Bulletin* style, for the most part, follows that of the *U.S. Government Printing Office Style Manual*. Fish names follow the style of the American Fisheries Society Special Publication No. 12, *A List of Common and Scientific Names of Fishes from the United States and Canada*, Fourth Edition, 1980.

**Text footnotes** should be typed separately from the text.

**Figures and tables**, with their legends and headings, should be self-explanatory, not requiring reference to the text. Their placement should be indicated in the right-hand margin of the manuscript.

Preferably **figures** should be reduced by photography to 5¾ inches (for single-column figures, allowing for 50% reduction in printing), or to 12 inches (for double-column figures). The maximum height, for either width, is 14 inches. Photographs should be printed on high-quality or glossy paper.

Do not send original drawings to the Scientific Editor, if they, rather than the photographic reductions, are needed by the printer; the Scientific Publications Office will request them.

Each **table** should start on a separate page. Consistency in headings and format is desirable. Vertical rules should be avoided, as they make the tables more expensive to print. Footnotes in tables should be numbered sequentially in arabic numerals. To avoid confusion with powers, they should be placed to the *left* of numerals.

**Acknowledgments**, if included, are placed at the end of the text.

Literature is cited in the text as: Lynn and Reid (1968) or (Lynn and Reid 1968). All papers referred to in the text should be listed alphabetically by the senior author's surname under the heading "Literature Cited." Only the author's surname and initials are required in the **literature cited**. The accuracy of the **literature cited** is the respon-

sibility of the author. Abbreviations of names of periodical and serials should conform to *Serial Sources for the BIOSIS Data Base* (*Chemical Abstracts* advises the system which was developed by the American Standards Association).

Common **abbreviations and symbols**, such as mm, in, g, L, mL, mg, °C (for Celsius), °F, etc., and so forth, should be used. Abbreviate units of measure only when used with numerals. Periods are only rarely used with abbreviations.

We prefer that **measurements** be given in metric units; other equivalent units may be given in parentheses.

## FORM OF THE MANUSCRIPT

The original of the manuscript should be typed, double-spaced, on white bond paper. Please triple-space above headings. We would rather receive good duplicated copies of manuscripts than carbon copies. The sequence of the material should be:

- TITLE PAGE
- ABSTRACT
- TEXT
- LITERATURE CITED
- TEXT FOOTNOTES
- APPENDIX
- TABLES (Each table should be numbered with an arabic numeral and heading provided)
- LIST OF FIGURES (Entire figure legends)
- FIGURES (Each figure should be numbered with an arabic numeral, legends are desired)

## ADDITIONAL INFORMATION

Send the ribbon copy and two duplicated or carbon copies of the manuscript to:

Dr. William J. Richards, Scientific Editor  
*Fishery Bulletin*  
Southeast Fisheries Center Miami Laboratory  
National Marine Fisheries Service, NOAA  
75 Virginia Beach Drive  
Miami, FL 33149-1099

Fifty **separates** will be supplied to an author free of charge and 50 supplied to his organization. No covers will be supplied.

ROGERS, S. GORDON, HIRAM T. LANGSTON, and TIMOTHY E. TARGETT. Anatomical trauma to sponge-coral reef fishes captured by trawling and angling . . . 697

QUAST, JAY C. Annual production of eviscerated body weight, fat, and gonads by Pacific herring, *Clupea harengus pallasi*, near Auke Bay, southeastern Alaska . . . 705

WENNER, CHARLES A., WILLIAM A. ROUMILLAT, and C. WAYNE WALTZ. Contributions to the life history of Black sea bass, *Centropristis striata*, off the southeastern United States . . . 723

**Notes**

LENARZ, WILLIAM H., and TINA WYLLIE ECHEVERRIA. Comparison of visceral fat and gonadal fat volumes of yellowtail rockfish, *Sebastes flavidus*, during a normal year and a year of El Niño conditions . . . 743

SORENSEN, PETER W., MARCO L. BIANCHINI, and HOWARD E. WINN. Diel foraging activity of American eels, *Anquilla rostrata* (Lesueur), in a Rhode Island estuary . . . 746

KILLAM, KRISTIE, and GLENN PARSONS. First record of the longfin mako, *Isurus paucus*, in the Gulf of Mexico . . . 748

STIER, KATHLEEN, and BOYD KYNARD. Movement of sea run sea lampreys, *Petromyzon marinus*, during the spawning migration in the Connecticut River . . . 749

HOGANS, W. E., and P. C. F. HURLEY. Variations in the morphology of *Fistulicola plicatus* Rudolphi (1802) (Cestoda:Pseudophyllidea) from the swordfish, *Xiphias gladius* L., in the Northwest Atlantic Ocean . . . 754



# Fishery Bulletin

Vol. 84, No. 4

October 1986

POLOVINA, JEFFERY J. and STEPHEN RALSTON. An approach to yield assessment for unexploited resources: with application to the deep slope fishes of the Marianas.	759
YANG, W. T., R. F. HIXON, P. E. TURK, M. E. KREJCI, W. H. HULET, and R. T. HANLON. Growth, behavior, and sexual maturation of the market squid, <i>Loligo opalescens</i> , cultured through the life cycle.	771
BODKIN, JAMES LEE. Fish assemblages in <i>Macrocystis</i> and <i>Nereocystis</i> kelp forests of central California.	799
STEPHEN, CAROL A. Life history and larval development of the giant kelpfish, <i>Heterostichus rostratus</i> Girard, 1854.	809
PAULY, DANIEL. A simple method for estimating the food consumption of fish populations from growth data and food conversion experiments.	827
FINUCANE, JOHN H., L. ALAN COLLINS, HAROLD A. BRUSHER, and CARL H. SALOMAN. Reproductive biology of king mackerel, <i>Scomberomorus cavalla</i> , from the southeastern United States.	841
FARLEY, C. A., S. V. OTTO, and C. L. REINISCH. New occurrence of epizootic sarcoma in Chesapeake Bay soft shell clams, <i>Mya arenaria</i> .	851
FOLKVORD, ARILD, and JOHN R. HUNTER. Size specific vulnerability of northern anchovy, <i>Engraulis mordax</i> , larvae to predation by fishes.	859
SMITH, JOSEPH W., and JOHN V. MERRINER. Observations on the reproductive biology of the cownose ray, <i>Rhinoptera bonasus</i> , in Chesapeake Bay.	871
McGOWAN, MICHAEL E. Northern anchovy, <i>Engraulis mordax</i> , spawning in San Francisco Bay, California, 1978-79, relative to hydrography and zooplankton prey of adults and larvae.	879
HUNTER, J. ROE, BEVERLY J. MACEWICZ, and JOHN R. SIBERT. The spawning frequency of skipjack tuna, <i>Katsuronus pelamis</i> , from the South Pacific.	895
HOUDE, EDWARD D., and LAWRENCE LUBBERS III. Survival and growth of striped bass, <i>Morone saxatilis</i> , and <i>Morone</i> hybrid larvae: laboratory and pond enclosure experiments.	905
DAILEY, MURRAY D., and STEPHEN RALSTON. Aspects of the reproductive biology, spatial distribution, growth, and mortality of the deepwater caridean shrimp, <i>Heterocarpus laevigatus</i> , in Hawaii.	915
RALSTON, STEPHEN. An intensive fishing experiment for the caridean shrimp, <i>Heterocarpus laevigatus</i> , at Akunagan Island in the Mariana Archipelago.	927
DITTY, JAMES G. Ichthyoplankton in neritic waters of the northern Gulf of Mexico off Louisiana: composition, relative abundance, and seasonality.	935

(Continued on back cover)

# U.S. DEPARTMENT OF COMMERCE

Malcolm Baldrige, *Secretary*

## NATIONAL OCEANIC AND ATMOSPHERIC ADMINISTRATION

Anthony J. Calio, *Administrator*

### NATIONAL MARINE FISHERIES SERVICE

William F. Evans, *Assistant Administrator*

## Fishery Bulletin

The *Fishery Bulletin* carries original research reports and technical notes on investigations in fishery science, engineering, and economics. The Bulletin of the United States Fish Commission was begun in 1881, it became the Bulletin of the Bureau of Fisheries in 1904 and the Fishery Bulletin of the Fish and Wildlife Service in 1941. Separates were issued as documents through volume 46, the last document was No. 1103. Beginning with volume 47 in 1931 and continuing through volume 62 in 1963, each separate appeared as a numbered bulletin. A new system began in 1963 with volume 63 in which papers are bound together in a single issue of the bulletin instead of being issued individually. Beginning with volume 70, number 1, January 1972, the *Fishery Bulletin* became a periodical, issued quarterly. In this form, it is available by subscription from the Superintendent of Documents, U.S. Government Printing Office, Washington, DC 20402. It is also available free in limited numbers to libraries, research institutions, State and Federal agencies, and in exchange for other scientific publications.

### SCIENTIFIC EDITOR, *Fishery Bulletin*

Dr. William J. Richards  
Southeast Fisheries Center Miami Laboratory  
National Marine Fisheries Service, NOAA  
Miami, FL 33149-1099

### Editorial Committee

Dr. Bruce B. Collette  
National Marine Fisheries Service

Dr. Jay C. Quast  
National Marine Fisheries Service

Dr. Reuben Lasker  
National Marine Fisheries Service

Dr. Carl J. Sudermann  
National Marine Fisheries Service

Mary S. Fukuyama, Managing Editor

The *Fishery Bulletin* (ISSN 0090-0656) is published quarterly by the Scientific Publications Office, National Marine Fisheries Service, NOAA, 7600 Sand Point Way NE, BIN C15700, Seattle, WA 98115. Second class postage is paid in Seattle, Wash., and additional offices. POSTMASTER: send address changes for subscriptions to Fishery Bulletin, Superintendent of Documents, U.S. Government Printing Office, Washington, DC 20402.

Although the contents have not been copyrighted and may be reprinted entirely, reference to source is appreciated.



# Fishery Bulletin

## CONTENTS

Vol. 84, No. 4

October 1986

POLOVINA, JEFFERY J., and STEPHEN RALSTON. An approach to yield assessment for unexploited resources with application to the deep slope fishes of the Marianas. . . . .	759
YANG, W. T., R. F. HIXON, P. E. TURK, M. E. KREJCI, W. H. HULET, and R. T. HANLON. Growth, behavior, and sexual maturation of the market squid, <i>Loligo opalescens</i> , cultured through the life cycle. . . . .	771
BODKIN, JAMES LEE. Fish assemblages in <i>Macrocystis</i> and <i>Nereocystis</i> kelp forests of central California . . . . .	799
STEPIEN, CAROL A. Life history and larval development of the giant kelpfish, <i>Heterostichus rostratus</i> Girard, 1854 . . . . .	809
PAULY, DANIEL. A simple method for estimating the food consumption of fish populations from growth data and food conversion experiments . . . . .	827
FINUCANE, JOHN H., L. ALAN COLLINS, HAROLD A. BRUSHER, and CARL H. SALOMAN. Reproductive biology of king mackerel, <i>Scomberomorus cavalla</i> , from the southeastern United States . . . . .	841
FARLEY, C. A., S. V. OTTO, and C. L. REINISCH. New occurrence of epizootic sarcoma in Chesapeake Bay soft shell clams, <i>Mya arenaria</i> . . . . .	851
FOLKVORD, ARILD, and JOHN R. HUNTER. Size-specific vulnerability of northern anchovy, <i>Engraulis mordax</i> , larvae to predation by fishes . . . . .	859
SMITH, JOSEPH W., and JOHN V. MERRINER. Observations on the reproductive biology of the cownose ray, <i>Rhinoptera bonasus</i> , in Chesapeake Bay . . . . .	871
McGOWAN, MICHAEL F. Northern anchovy, <i>Engraulis mordax</i> , spawning in San Francisco Bay, California, 1978-79, relative to hydrography and zooplankton prey of adults and larvae . . . . .	879
HUNTER, J. ROE, BEVERLY J. MACEWICZ, and JOHN R. SIBERT. The spawning frequency of skipjack tuna, <i>Katsuwonus pelamis</i> , from the South Pacific . . . . .	895
HOUDE, EDWARD D., and LAWRENCE LUBBERS III. Survival and growth of striped bass, <i>Morone saxatilis</i> , and <i>Morone</i> hybrid larvae: laboratory and pond enclosure experiments . . . . .	905
DAILEY, MURRAY D., and STEPHEN RALSTON. Aspects of the reproductive biology, spatial distribution, growth, and mortality of the deepwater caridean shrimp, <i>Heterocarpus laevigatus</i> , in Hawaii . . . . .	915
RALSTON, STEPHEN. An intensive fishing experiment for the caridean shrimp, <i>Heterocarpus laevigatus</i> , at Alamagan Island in the Mariana Archipelago . . . . .	927
DITTY, JAMES G. Ichthyoplankton in neritic waters of the northern Gulf of Mexico off Louisiana: composition, relative abundance, and seasonality . . . . .	935

(Continued on next page)

Seattle, Washington

1986

REXSTAD, ERIC A., and ELLEN K. PIKITCH. Stomach contents and food consumption estimates of Pacific hake, <i>Merluccius productus</i> . . . . .	947
PEREZ, MICHAEL A., and MICHAEL A. BIGG. Diet of northern fur seals, <i>Callorhinus ursinus</i> , off western North America . . . . .	957
TESTER, PATRICIA A., and ANDREW G. CAREY, JR. Instar identification and life history aspects of juvenile deepwater spider crabs, <i>Chionoecetes tanneri</i> Rathbun . . .	973

Notes

CODY, TERRY J., and BILLY E. FULS. Comparison of catches in 4.3 m and 12.2 m shrimp trawls in the Gulf of Mexico . . . . .	981
POWELL, ALLYN B., and GERMANO PHONLOR. Early life history of Atlantic menhaden, <i>Brevoortia tyrannus</i> , and gulf menhaden, <i>B. patronus</i> . . . . .	991
PODNIESINSKI, GREG S., and BERNARD J. McALICE. Seasonality of blue mussel, <i>Mytilus edulis</i> L., larvae in the Damariscotta River estuary, Maine, 1969-77 . . . . .	995
Index . . . . .	1003
Notices . . . . .	1017

The National Marine Fisheries Service (NMFS) does not approve, recommend or endorse any proprietary product or proprietary material mentioned in this publication. No reference shall be made to NMFS, or to this publication furnished by NMFS, in any advertising or sales promotion which would indicate or imply that NMFS approves, recommends or endorses any proprietary product or proprietary material mentioned herein, or which has as its purpose an intent to cause directly or indirectly the advertised product to be used or purchased because of this NMFS publication.

# AN APPROACH TO YIELD ASSESSMENT FOR UNEXPLOITED RESOURCES WITH APPLICATION TO THE DEEP SLOPE FISHES OF THE MARIANAS

JEFFREY J. POLOVINA AND STEPHEN RALSTON<sup>1</sup>

## ABSTRACT

A comprehensive approach to estimate the maximum sustainable yield (MSY) for a tropical multispecies resource which lacks catch and effort data is presented. This yield assessment approach was used to design a fishery resource assessment survey of the Mariana Archipelago. An application of the method is presented to estimate the MSY for a multispecies bottom fish resource, based on data collected during the survey. The annual MSY for the deep slope fishes (primarily snappers and groupers) of the Mariana Archipelago is estimated to be 109 t, which for comparative purposes is equivalent to 222 kg/nmi of 200 m isobath or 0.3 t/km<sup>2</sup>.

Assessment of tropical resources has always created major problems in fisheries research (Saila and Roedel 1979; Pauly and Murphy 1982). This has been largely due to three factors: technical difficulties in aging, a high species diversity in tropical communities, and what is typically a multiplicity of artisanal gears used in these fisheries. The latter problem has been especially difficult to surmount, making it difficult to determine not only the level of fishing effort but sometimes even the total catch. Without these data many standard fisheries techniques such as stock-production methods are inapplicable (but see Csirke and Caddy 1983).

In recent years, however, new methods and modifications of existing methods have been proposed to estimate growth and mortality parameters, standing crop, and yield for fish stocks in the absence of a time series of commercial catch and effort data (Beddington and Cooke 1983; Pauly 1983; Polovina 1986a; Wetherall et al. in press). We will show that several of these techniques can be combined, producing an integrated approach to yield assessment designed specifically for tropical fisheries resources in situations where catch and effort data are lacking. The approach is then applied to data gathered in a fishery survey of the Mariana Archipelago to estimate maximum sustainable yield (MSY) for a multispecies resource of deep slope snappers and groupers.

## YIELD ASSESSMENT

The equilibrium yield assessment is presented schematically in Figure 1. This approach assumes that growth follows the deterministic von Bertalanffy curve with parameters  $K$  and  $L_{\infty}$ , that the mortality of fish above the smallest length fully represented in the catch ( $L_c$ ) occurs at a constant instantaneous rate ( $Z$ ), and that recruitment is constant with  $R$  recruits entering the first vulnerable age class annually. It is also assumed that the resource is essentially pristine, such that an estimate of the biomass recruited to the fishery in the absence of exploitation ( $B_{\infty}$ ) can be obtained from a catch-per-unit-effort (CPUE) survey and an estimate of catchability. In the discussion section, the effect of relaxing some of these assumptions will be considered.

For each species under consideration, the data required for this program, at a minimum, consist of a large length-frequency sample, otolith data and/or a time series of length-frequency data, a systematic CPUE survey, and an estimate of catchability, such as that obtained from an intensive fishing experiment. The large length-frequency sample is used to jointly estimate the asymptotic length ( $L_{\infty}$ ) and the ratio of total instantaneous mortality ( $Z$ ) to the von Bertalanffy growth parameter ( $K$ ) based on the following relationship:

$$\Theta = Z/K = (L_{\infty} - \bar{l})/(\bar{l} - L_c),$$

where  $L_c$  is a parameter defined above and  $\bar{l}$  is the mean length of all fish greater than  $L_c$  (Beverton

<sup>1</sup>Southwest Fisheries Center Honolulu Laboratory, National Marine Fisheries Service, NOAA, 2570 Dole Street, Honolulu, HI 96822-2396.

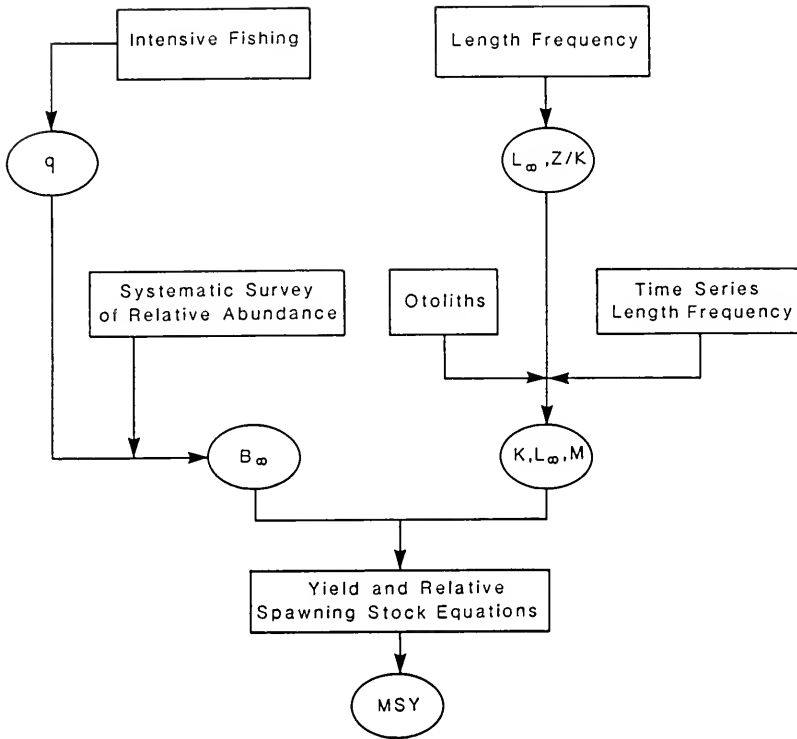

FIGURE 1.—Schematic of the yield assessment approach. A more general approach to fishery assessment which includes a treatment of catch and effort data as well is given in Munro (1983); our Figure 1 represents a detailed subset of Munro's figure 1 (1983).

and Holt 1956). For a series of  $L_c$  values at intervals beginning with the smallest  $L_c$  and going up to  $L_\infty$ , there will be a corresponding set of  $\bar{l}$  values. By solving the  $Z/K$  equation above for  $\bar{l}$  as a function of  $L_c$ , the following relationship is obtained:

$$\bar{l} = L_\infty / (\Theta + 1) + L_c (\Theta / (\Theta + 1)).$$

Thus, regressing a sequence of  $\bar{l}$  values on the corresponding  $L_c$  values will produce estimates for the slope and intercept which can be solved for estimates of  $L_\infty$  and  $Z/K$  (Wetherall et al. in press).

Once an estimate of  $L_\infty$  has been obtained by this method, otolith data and/or a time series of length-frequency data can be fit to the von Bertalanffy growth curve to estimate the growth coefficient  $K$ . Estimation of  $L_\infty$  from length-frequency data was used for the Marianas bottom fish data because a large length-frequency sample was available and otolith readings were difficult to interpret for old stages of growth. With an estimate for  $K$ , the total mortality rate,  $Z$ , can then be estimated as the product of  $K$  and the ratio of  $Z/K$  obtained in the

previous step. Alternatively, one can estimate  $Z$  from a catch curve constructed from a length-frequency sample which has been corrected for nonlinear growth and converted to an age-frequency sample (Pauly 1983).

If these techniques are applied to unexploited or lightly exploited resources, the estimate of  $Z$  provides an estimate of the instantaneous rate of natural mortality ( $M$ ). However, if fishing mortality is believed significant, an equation to estimate  $M$  as a function of  $K$ ,  $L_\infty$ , and mean annual water temperature ( $T$ ) (in °C) has been developed as follows (Pauly 1983):

$$\begin{aligned} \log_{10} M = & -0.0066 - 0.279 \log_{10} L_\infty \\ & + 0.6543 \log_{10} K + 0.4634 \log_{10} T. \end{aligned}$$

Given estimates of  $K$ ,  $M$ , and age of entry to the fishery ( $t_e$ ), the Beverton and Holt (1957) yield per recruit ( $Y/R$ ) equation can be used to compute the ratio of equilibrium yield to unexploited recruited biomass as a function of fishing mortality ( $F$ ). The

equilibrium yield ( $Y$ ) can be expressed as

$$Y = R F \int_{t_c}^{\infty} \exp(-tM - (t - t_c) F) w(t) dt,$$

where  $w(t) = W_{\infty} (1 - \exp(-Kt))^b$ , and where  $W_{\infty}$  is the asymptotic weight and  $b$  is the exponent of the length-weight relationship. The unexploited recruited biomass ( $B_{\infty}$ ) can be expressed as

$$B_{\infty} = R \int_{t_c}^{\infty} w(t) \exp(-Mt) dt.$$

The ratio of equilibrium yield to unexploited recruited biomass ( $Y/B_{\infty}$ ) is then independent of  $W_{\infty}$  and  $R$ , depending only on  $K, M, t_c, F$ , and  $b$ . Tables and computational formulae are readily available to evaluate these integrals for  $Y$  and  $B_{\infty}$  as functions of  $t_c$  and  $F$  (Beverton and Holt 1966; Beddington and Cooke 1983). Upon estimation of  $B_{\infty}$ , the equilibrium yield is estimated for a given level of  $F$  as the product of  $Y/B_{\infty}$  and  $B_{\infty}$ .

If a stock is unfished,  $B_{\infty}$  can be estimated by mapping the relative abundance of the stock in terms of CPUE from a systematic survey and then converting estimates of relative abundance into biomass with an estimate of catchability. There are a number of methods which have been used to estimate catchability (Ricker 1975). For work on Pacific island fishery resources, an intensive fishing approach, which fishes a small isolated location heavily and regresses CPUE on cumulative catch (Leslie model), has been used successfully to estimate catchability for bottom fishes and shrimp (Polovina 1986a; Ralston 1986). If only one estimate of catchability is obtained, then the standing stock per unit of area is determined as the ratio of CPUE to catchability in the appropriate units of weight or numbers. If several estimates of catchability are available corresponding to different levels of CPUE, then it might be appropriate to fit a more general power function relationship between CPUE and standing stock (Bannerot and Austin 1983).

The product of  $Y/B_{\infty}$  and  $B_{\infty}$  as a function of  $F$  is the equilibrium yield based on the assumption of constant recruitment. While this assumption will be valid for low levels of exploitation, there will come a point as  $F$  increases that recruitment will begin to decline and sustainable yield may thus be less than the yield predicted under the assumption of constant recruitment. Estimating MSY yield as the maximum equilibrium yield obtained over all  $F$  from the prod-

uct of  $Y/B_{\infty}$  and  $B_{\infty}$  may, therefore, overestimate the actual MSY. There are two adjustments which have been proposed to estimate MSY in the absence of detailed knowledge of the spawner-recruit relationship. One approach is to estimate MSY from the constant recruitment yield curve as that yield corresponding to that level of  $F$  where the addition of one unit of mortality increases the yield by 10% of the amount caught by the first unit of  $F$  (Gulland 1983, 1984). This level of mortality and corresponding yield have been denoted as  $F_{0.1}$  and  $Y_{0.1}$ , respectively. A second approach to estimating MSY from the constant recruitment yield curve is to use the Beverton and Holt equation to calculate the ratio of the spawning stock biomass under exploitation ( $S$ ) to the spawning stock biomass in the absence of exploitation ( $S_0$ ) and to use this ratio as an indicator of the sustainability of a yield for a given combination of  $F$  and  $t_c$ . For simplicity, we assume that the age of sexual maturity ( $t_m$ ) is identical for both sexes. Then the unexploited spawning stock biomass ( $S_0$ ) is

$$S_0 = R \int_{t_m}^{\infty} \exp(-Mt) w(t) dt,$$

and

$$S = R \int_{t_m}^{\infty} \exp(-Mt - (t - t_c) F) w(t) dt.$$

Thus, the ratio of  $S/S_0$  depends only on  $M, K, t_c, t_m$ , and  $F$ .

It has been suggested that the spawning stock biomass of a species should not be reduced below 20% of its unexploited level if a substantial reduction in the recruitment is to be avoided (Beddington and Cooke 1983). Thus, the estimate of MSY is determined as the maximum yield from the constant recruitment curve subject to the constraint that  $F$  does not exceed the level which reduces the relative spawning stock biomass below 0.20 of  $S_0$ .

## ASSESSMENT OF SNAPPERS AND GROUPERS IN THE MARIANAS

The Mariana Archipelago consists of a chain of islands and banks on a north-south axis beginning with Galvez Banks and Santa Rosa Reef at the southern end and extending northward to Farallon de Pajaros (30 nmi north of Maug Island). A chain of seamounts also runs on a north-south axis

about 120 nmi west of the high island chain (Fig. 2).

Six resource assessment cruises of 40 d each were conducted in the Marianas during the period from May 1982 through June 1984. During these cruises,

the deepwater snapper and grouper community along the outer slope was sampled at all 22 islands and banks labeled in Figure 2. Thirteen of these 22 sampling sites were visited at least once during the first three cruises and, again, during the second set

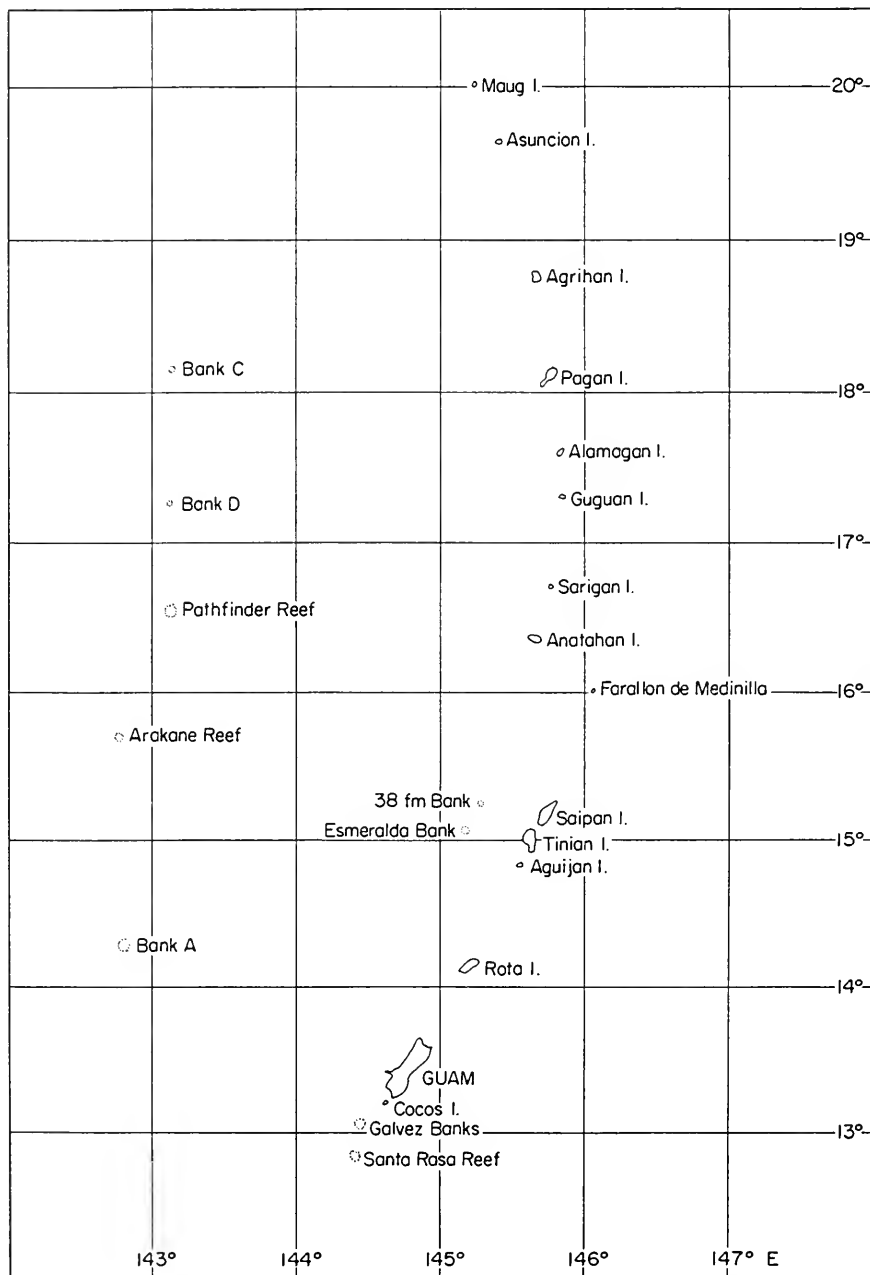

FIGURE 2.—The Mariana Archipelago with the 22 islands and banks sampled.

of three cruises. Two sites, Pagan Island and Esmeralda Bank, were sampled on each of the six cruises to establish a time series of length-frequency data.

The NOAA ship *Townsend Cromwell* was used as the fishing vessel for all the cruises. The fishing was conducted from four hydraulic gurdies equipped with 365 m of braided 90 kg Dacron<sup>2</sup> line. The terminal rig consisted of four hooks spaced about 1 m apart and of 2 kg weight.

At each island and bank, an attempt was made to perform a systematic fishing survey of the bottom fish community along the 200 m contour. Fishing was conducted while the vessel drifted and targeted the 125-275 m depth range. Fishing effort was measured in line-hours, defined as the product of the number of lines fished with the length of time, in hours, that they are fished.

Seven species—one jack, *Caranx lugubris*, and six snappers, *Pristipomoides zonatus*, *P. auricilla*, *P. filamentosus*, *P. flavipinnis*, *Etelis carbunculus*, and *E. coruscans*—accounted for about 92% of the catch (Polovina 1986b). Large length-frequency samples were collected for all seven species, primarily from the unfished islands and banks, and were used to jointly estimate  $M/K$ , the ratio of instantaneous natural mortality ( $M$ ) to the growth parameter of the von Bertalanffy growth curve ( $K$ ), and the asymptotic length ( $L_{\infty}$ ) by regressing a sequence of mean lengths on minimum lengths (Wetherall et al. in press). Otoliths were collected for all seven species and the growth coefficient  $K$  was estimated by fitting a von Bertalanffy growth curve to otolith data with  $L_{\infty}$  fixed at the value estimated from the length-frequency analysis (Ralston and Williams<sup>3</sup>). Once  $K$  and the ratio of  $M/K$  were estimated, an

estimate of  $M$  was obtained from their product. The size of entry to the fishery was estimated as the integrated midpoint of the ascending limb of the size-frequency distribution (Gulland 1969). This size was then converted to an age of entry into the fishery ( $t_c$ ) by application of the von Bertalanffy growth curve. The values of  $L_{\infty}$ ,  $K$ ,  $M$ ,  $t_m$ , and  $t_c$  for the seven species which are required by the yield analysis are given in Table 1. The exponent of the length-weight equation ( $b$ ) for most of the species is not significantly different from 3.0, so to simplify the computation, it will be taken as 3.0 for all the species (Ralston in press).

An estimate of the catchability of the bottom fishes which was used to convert CPUE into standing stock was derived from an intensive fishing experiment conducted at Pathfinder Reef (Polovina 1986a). Thirteen days of intensive handline fishing with the *Townsend Cromwell* at Pathfinder Reef produced a substantial and significant decline in CPUE. Application of the Leslie model (Ricker 1975), which regresses CPUE against cumulative catch, produced estimates of catchability for three species—*Pristipomoides zonatus*, *P. auricilla*, and *Etelis carbunculus* (Polovina 1986a). While interesting differences in catchability among species were found, the estimate of the total unexploited biomass for the three species obtained from the species specific Leslie model was not significantly different from the total unexploited biomass computed from the Leslie model applied to the catch and CPUE data pooled over all three species. Catchability from the pooled Leslie model is estimated to be 0.0066 nmi/line-hour. This value was used as an estimate of total

<sup>3</sup>Ralston, S., and H. A. Williams. Age, growth, and mortality of deep slope lutjanid fishes from the Mariana Archipelago. Manuscr. in prep. Southwest Fisheries Center Honolulu Laboratory, National Marine Fisheries Service, NOAA, Honolulu, HI 96822-2396.

TABLE 1.—Population parameters for the seven major species caught by handlining in the Marianas.

Species	Von Bertalanffy growth parameters		Instantaneous natural mortality ( $M$ )	Age of entry to the catch $t_c$ (yr)	Age of maturity $t_m$ (yr)
	$L_{\infty}$ (cm)	$K$ (1/yr)			
<i>Caranx lugubris</i>	75.1	0.430	0.53	1.3	1.8
<i>Pristipomoides filamentosus</i>	67.3	0.228	0.57	4.3	2.0
<i>P. auricilla</i>	42.6	0.335	0.81	3.6	2.4
<i>P. flavipinnis</i>	54.1	0.238	1.12	3.7	2.2
<i>P. zonatus</i>	47.0	0.245	0.63	4.65	3.25
<i>Etelis coruscans</i>	97.6	0.166	0.38	6.2	4.1
<i>E. carbunculus</i>	69.1	0.175	1.55	3.45	2.75

<sup>2</sup>Reference to trade names does not imply endorsement by the National Marine Fisheries Service, NOAA.

bottom fish catchability and was used to estimate standing stock from CPUE.

The systematic survey of relative abundance uses the fishing drift as the basic sampling unit. A drift is defined as the fishing which occurs during an uninterrupted drift by the vessel while fishing continuously in the 125-275 m depth range. The CPUE measured is the number of fish per line-hour and can be computed in two ways for each bank. Bank CPUE will be defined as the total number of fish caught at an island or bank divided by the total number of line-hours fished. Bank mean drift CPUE or simply mean drift CPUE will be defined as the mean of all the individual drift CPUE values for a bank, where the drift CPUE is computed as the number of fish caught within a drift divided by the drift line-hours. While the two measures of CPUE are highly correlated, they are not identical. In our analysis the mean drift CPUE was used as a measure of relative abundance because in a systematic survey the drifts within a bank can be thought of as replicates drawn from the total bank population allowing estimation of within bank variation in CPUE. For a bank, the total standing stock or number of exploitable bottom fishes ( $N$ ) can be calculated from CPUE, the length ( $L$ ) of the 200 m contour, and the catchability ( $q$ ) expressed per nautical mile of 200 m contour as follows:

$$N = (\text{CPUE}) (L/q).$$

The values of  $N$ , CPUE, and  $L$  for the banks sampled are given in Table 2.

The catch at any bank can be grouped into eight groups—the seven major species defined previously, plus a group called “others” for all other species. The fraction of the catch (by number) of the total bank catch as determined from fishing surveys, is given in Table 3. The mean weight of each species caught at each site is given in Table 4. For each bank, the unexploited recruited biomass ( $B_{\infty}$ ) for each of the eight groups is estimated by partitioning the total standing stock into a standing stock for each species group from Tables 2 and 3 and then converting the standing stock for each species group into biomass for each group based on the mean weights in Table 4. Estimates of  $B_{\infty}$  for the eight species groups at each bank are given in Table 5 and the total unexploited biomass is given in Table 6. The estimates of biomass per nautical mile of 200 m contour at Saipan, Tinian, Rota, and Guam are less than half the levels at most other banks. These four islands are the only islands in the Marianas with a substantial resident population. The local fishermen at these islands are known to exploit the bottom fish stocks locally so that estimates of biomass based on bank CPUE values are likely to underestimate unexploited levels. The mean of the biomass per nautical mile of 200 m contour for the two uninhabited islands and one bank in the southern islands is 600 kg. This value was used for unex-

TABLE 2.—Mean drift catch per unit effort (CPUE) and the estimated number of exploitable bottom fish recruited at each bank samples. SE indicates standard error.

Banks and islands	Mean drift CPUE (fish/line-hour)	SE	Length of 200 m contour (nmi)	Total number of fish at each bank
Maug	5.03	1.02	10.4	7,580
Asuncion	2.16	0.49	11.1	3,480
Agrihan	4.20	0.31	18.3	11,140
Pagan	4.57	0.40	30.0	19,870
Alamagan	2.37	0.19	11.3	3,881
Guguan	3.01	0.30	9.3	4,060
Sarigan	2.82	0.37	8.5	3,470
Anatahan	2.31	0.23	17.2	5,760
Farallon de Medinilla	3.29	0.65	76.9	36,670
Saipan	1.72	0.34	52.6	13,110
38-Fathom	3.12	0.26	2.8	1,270
Tinian	1.96	0.29	28.9	8,210
Aguijan	3.84	0.98	15.9	8,850
Esmeralda	2.29	0.15	12.3	4,080
Rota	1.91	0.40	31.7	8,780
Guam	1.53	0.35	85.2	18,890
Galvez-Santa Rosa	2.95	0.31	52.5	22,450
Bank C	5.91	1.57	3.0	2,570
Bank D	5.85	0.51	3.0	2,540
Pathfinder	4.58	0.23	3.0	1,990
Arakane	3.36	0.24	2.9	1,410
Bank A	3.71	0.57	3.6	1,940



TABLE 3.—The fraction of the number of fish caught at each bank in the eight species groups.

Banks and islands	<i>Caranx lugubris</i>	<i>Pristipomoides filamentosus</i>	<i>P. auricilla</i>	<i>P. flavipinnis</i>	<i>P. zonatus</i>	<i>Etelis coruscans</i>	<i>E. carbunculus</i>	Others
Maug	0.016	0.000	0.347	0.016	0.425	0.000	0.102	0.094
Asuncion	0.036	0.036	0.089	0.000	0.589	0.018	0.036	0.196
Agrihan	0.016	0.041	0.103	0.064	0.602	0.016	0.110	0.048
Pagan	0.007	0.002	0.089	0.013	0.699	0.023	0.126	0.042
Alamagan	0.010	0.013	0.232	0.011	0.495	0.143	0.059	0.037
Guguan	0.020	0.004	0.182	0.004	0.613	0.047	0.083	0.047
Sarigan	0.016	0.010	0.141	0.010	0.646	0.042	0.057	0.078
Anatahan	0.015	0.035	0.119	0.148	0.540	0.040	0.045	0.059
38-Fathom	0.064	0.028	0.228	0.047	0.434	0.019	0.045	0.136
Esmeralda	0.017	0.051	0.040	0.366	0.397	0.029	0.026	0.074
Farallon de Medinilla	0.052	0.021	0.093	0.166	0.477	0.021	0.093	0.078
Saipan	0.013	0.138	0.087	0.338	0.225	0.000	0.075	0.125
Tinian	0.000	0.000	0.083	0.694	0.000	0.056	0.139	0.028
Aguijan	0.021	0.188	0.063	0.417	0.271	0.000	0.000	0.042
Rota	0.019	0.143	0.162	0.114	0.362	0.029	0.067	0.105
Guam	0.064	0.161	0.258	0.129	0.161	0.000	0.129	0.097
Galvez-Santa Rosa	0.085	0.017	0.364	0.051	0.322	0.009	0.059	0.093
Bank C	0.000	0.017	0.390	0.000	0.356	0.017	0.212	0.009
Bank D	0.015	0.010	0.091	0.005	0.480	0.045	0.349	0.005
Pathfinder	0.059	0.011	0.172	0.004	0.506	0.000	0.215	0.032
Arakane	0.116	0.057	0.188	0.003	0.412	0.000	0.169	0.055
Bank A	0.008	0.004	0.184	0.008	0.607	0.000	0.159	0.029

TABLE 4.—Mean weight (kg) of the fish caught by bank and species group.

Banks and islands	<i>Caranx lugubris</i>	<i>Pristipomoides filamentosus</i>	<i>P. auricilla</i>	<i>P. flavipinnis</i>	<i>P. zonatus</i>	<i>Etelis coruscans</i>	<i>E. carbunculus</i>	Others
Maug	3.784	1.930	0.815	1.585	0.977	6.113	0.893	2.559
Asuncion	3.784	1.930	0.848	1.265	1.344	6.113	0.670	4.595
Agrihan	3.784	1.930	0.784	1.235	1.169	6.113	0.741	7.787
Pagan	3.784	1.930	0.651	1.169	1.094	6.113	0.652	5.068
Alamagan	3.784	1.930	0.834	1.354	1.326	6.113	1.010	2.992
Guguan	3.784	1.930	0.773	1.780	1.216	6.113	0.815	2.400
Sarigan	3.784	1.930	0.642	1.025	1.204	6.113	0.811	5.279
Anatahan	3.784	1.930	0.556	1.169	0.874	6.113	0.586	2.631
38-Fathom	3.784	1.930	0.532	1.193	0.874	6.113	0.798	2.523
Esmeralda	3.784	1.930	0.567	1.014	0.782	6.113	0.702	8.409
Farallon de Medinilla	3.784	1.930	0.439	1.265	0.891	6.113	0.575	1.963
Saipan	3.784	1.930	0.577	0.992	0.837	6.113	0.773	1.353
Tinian	3.784	1.930	0.653	1.003	1.017	6.113	0.422	0.520
Aguijan	3.784	1.930	0.480	0.927	0.760	6.113	0.753	0.770
Rota	3.784	1.930	0.542	1.222	0.667	6.113	0.506	3.168
Guam	3.784	1.930	0.606	1.112	0.780	6.113	0.673	0.600
Galvez-Santa Rosa	3.784	1.930	0.522	1.206	0.979	6.113	0.801	2.085
Bank C	3.784	1.930	0.761	1.265	1.267	6.113	0.923	0.920
Bank D	3.784	1.930	0.961	1.710	1.169	6.113	0.983	1.070
Pathfinder	3.784	1.930	1.953	1.381	1.218	6.113	0.875	7.348
Arakane	3.784	1.930	0.860	1.350	0.949	6.113	0.791	2.338
Bank A	3.784	1.930	0.636	1.605	0.984	6.113	0.811	5.504

TABLE 5.—The unexploited recruited biomass by bank for each species groups in metric tons.

Banks and islands	<i>Caranx lugubris</i>	<i>Pristipomoides filamentosus</i>	<i>P. auricilla</i>	<i>P. flavipinnis</i>	<i>P. zonatus</i>	<i>Etelis coruscans</i>	<i>E. carbunculus</i>	Others
Maug	0.5	0	2.2	0.2	3.3	0	0.7	1.9
Asuncion	0.5	0.2	0.3	0	2.9	0.4	0.1	3.3
Agrihan	0.7	0.9	0.9	0.9	8.2	1.1	0.9	4.4
Pagan	0.6	0.1	1.2	0.3	15.9	2.9	1.7	4.4
Alamagan	0.1	0.1	0.8	0.1	2.7	3.5	0.2	0.5
Guguan	0.3	<0.1	0.6	<0.1	3.2	1.2	0.3	0.5
Sarigan	0.2	0.1	0.3	<0.1	2.8	0.9	0.2	1.5
Anatahan	0.3	0.4	0.4	1.0	2.8	1.5	0.2	0.9
38-Fathom	0.3	0.1	0.2	0.1	0.5	0.2	<0.1	0.5
Esmeralda	0.3	0.4	0.1	1.6	1.3	0.7	0.1	2.7
Farallon de Medinilla	7.5	1.5	1.6	8.0	16.3	4.9	2.1	5.8
Saipan	0.6	3.6	0.7	4.6	2.6	0	0.8	2.3
Tinian	0	0	0.5	6.0	0	2.9	0.3	0.1
Aguijan	0.7	3.3	0.3	3.6	1.9	0	0	0.3
Rota	0.7	2.6	0.8	1.3	2.2	1.6	0.5	3.1
Guam	4.8	6.1	3.1	2.8	2.5	0	1.7	1.1
Galvez-Santa Rosa	7.5	0.8	4.5	1.4	7.4	1.2	1.1	4.6
Bank C	0	0.1	0.8	0	1.2	0.3	0.5	<0.1
Bank D	0.2	0.1	0.2	<0.1	1.5	0.7	0.9	<0.1
Pathfinder	0.5	<0.1	0.4	<0.1	0.3	0	0.4	0.5
Arakane	0.6	0.2	0.2	<0.1	0.6	0	0.2	0.2
Bank A	0.1	<0.1	0.2	<0.1	1.2	0	0.3	0.3
Total	32.5	32.0	24.5	43.1	85.4	26.2	15.9	42.8

TABLE 6.—The total unexploited recruited biomass ( $B_{un}$ ) in metric tons (t) and the total unexploited recruited biomass per nautical mile (nmi) of 200-m contour in kilograms (kg) by bank.

Banks and islands	Total unexploited recruited biomass (t)	Biomass per nmi of 200 m contour (kg)
Northern banks and islands		
Maug	8.8	850.3
Asuncion	7.7	689.7
Agrihan	18.1	991.1
Pagan	27.0	900.7
Alamagan	8.0	706.8
Guguan	6.1	659.7
Sarigan	6.1	714.0
Anatahan	7.6	440.6
38-Fathom	1.8	637.1
Esmeralda	7.2	584.1
Total	98.4	Mean 717.4
Southern banks and islands		
Farallon de Medinilla	47.7	620.2
Saipan	15.3	290.9
Tinian	10.0	346.0
Aguijan	10.1	637.0
Rota	12.4	391.2
Guam	22.2	260.6
Galvez-Santa Rosa	28.5	542.4
Total	146.2	Mean 441.2
Western seamounts		
Bank C	2.9	973.0
Bank D	3.6	1,207.0
Pathfinder	3.1	1,024.0
Arakane	2.0	695.9
Bank A	2.1	594.7
Total	13.7	Mean 898.9

ploited biomass per nautical mile of 200 m contour in the subsequent yield estimation, in place of the values computed from the bank CPUE values for the inhabited southern islands (Saipan, Tinian, Rota, and Guam).

For each species group with values of  $K$ ,  $M$ ,  $t_c$ , and  $F$ , the ratio of fishery yield to unexploited recruited biomass ( $Y/B_\infty$ ) can be computed from the Beverton and Holt yield equations (Beddington and Cooke 1983). The product of  $Y/B_\infty$  with the species group unexploited recruited biomass estimates (Table 5) results in estimates of equilibrium yield for the seven species for which estimates of  $K$  and  $M$  are available. For the eighth group, which consists of all other species, the ratio of yield to  $B_\infty$  is taken as the ratio of total yield for the seven species divided by their total  $B_\infty$ . For a fixed  $F$ , the sum of the equilibrium yield of the eight species groups at a bank is the bank equilibrium yield, and the sum of the equilibrium yields for a species group over all the banks is the species group equilibrium yield.

The equilibrium yield for the multispecies bottom fish complex fished with handline gear in the 125-275 m depth range for the 22 islands and banks of the Mariana Archipelago increases rapidly as a function of  $F$  to a level of about 90 t and beyond that exhibits a gradual increase with increased fishing mortality (Table 7). The MSY estimation approach estimates MSY as the yield from the constant recruitment yield curve corresponding to that level of mortality where a marginal increase in one unit of

mortality increases the catch by 0.1 of the amount caught by the first unit of  $F$ . The value of  $F_{0.1}$  for the bottom fish resource in the Marianas is estimated to be  $F = 1.0$  and the corresponding annual equilibrium yield is 82 t (Table 7).

The equilibrium yield value of 82 t, which corresponds to a fishing mortality of 1.0, is based on the current estimated age of entry to the fishery and not necessarily the age of entry which maximizes the  $Y/R$ . For a fishery mortality of 1.0, the estimated age of entry which maximizes  $Y/R$  is computed from the Beverton and Holt equation and compared with the current age of entry for each species (Table 8). With the exception of the jack, *Caranx lugubris*, the age of entry which maximized  $Y/R$  is less than the current age of entry (Table 8). Based on the age of entry which maximized the  $Y/R$ , new levels of sustainable yield for each species group as a function of  $F$  can be computed as the product of the yield for the current age of entry with the ratio of  $Y/R$  maximized over age of entry to the  $Y/R$  for the current age of entry. The values of  $F_{0.1}$  and  $Y_{0.1}$  for the ages of entry which maximize the  $Y/R$  are 1.0 and 109 t, respectively (Table 9). An approximate confidence interval (C.I.) for this yield estimate can be obtained from a Taylor series expansion which incorporates the variance estimate for catchability (Polovina 1986a) and a sampling variance of the bank CPUE values (Table 2). The standard error of the yield estimate is 14 t, and thus a 95% C.I. for the yield at  $F_{0.1}$  for the archipelago is 81-137 t annually.

The estimation of MSY based on the relative spawning stock approach requires estimates of the age of sexual maturity ( $t_m$ ). A relationship expressing the length at sexual maturity ( $L_m$ ) as a fraction of the length of the upper one percentile ( $L_{max}$ ) for tropical bottom fishes is as follows (Anonymous 1977, from Brouard and Grandperrin 1984):

$$L_m = 0.576 L_{max}$$

TABLE 7.—Total annual sustainable handline yield in metric tons (t) for a range of fishing mortalities.

Fishing mortality (F)	Total yield (t)
0.1	23
0.5	64
<sup>1</sup> 1.0	<sup>1</sup> 82
1.5	89
2.0	92
2.5	94

<sup>1</sup> $F_{0.1}$  and  $Y_{0.1}$ , as defined by Gulland (1983).

TABLE 8.—Current age at entry and age at entry which maximizes the yield per recruit ( $Y/R$ ) at  $F = 1.0$ .

Species	Current age at entry $t_c$ (yr)	Age at entry which maximizes $Y/R$ (yr)
<i>Caranx lugubris</i>	1.3	1.75
<i>Pristipomoides filamentosus</i>	4.3	2.75
<i>P. auricilla</i>	3.6	2.25
<i>P. flavipinnis</i>	3.7	2.00
<i>P. zonatus</i>	4.65	3.00
<i>Etelis coruscans</i>	6.2	4.50
<i>E. carbunculus</i>	3.45	2.50

TABLE 9.—Annual sustainable handline yield in metric tons (t) for the age at entry which maximizes the yield per recruit for each species.

Fishing mortality (F)	Total yield (t)
0.1	35
0.5	91
<sup>1</sup> 1.0	<sup>1</sup> 109
1.5	114
2.0	116
2.5	116

<sup>1</sup> $F_{0.1}$  and  $Y_{0.1}$ , as defined by Gulland (1983).

The  $t_m$  can then be computed from  $L_m$  with the von Bertalanffy growth equation. The  $t_m$  for the seven species, which is assumed to be the same for both sexes of a species, is given in Table 1, and the ratio of spawning stock biomass under exploitation to the unexploited spawning stock biomass is presented for three levels of  $F$  (Table 10). As expected, the ratio decreases as  $F$  increases. However, without the spawner-recruit relationship, it is difficult to determine the extent that the spawning stock biomass can be reduced before recruitment is substantially affected. It has been suggested that as a lower bound, the spawning stock biomass should not be reduced below 20% of its unexploited level before there is a deleterious reduction in recruitment (Beddington and Cooke 1983). The level of  $F = 1.0$  is the largest level of  $F$  which insures that the relative spawning stock biomass for all the species does not fall below 20% and hence the spawning stock approach also estimates the MSY for the bottom fish in the Marianas at 109 t/year.

TABLE 10.—The ratio of spawning stock biomass to unexploited spawning stock biomass for three levels of fishing mortality ( $F$ ) at the age of entry which maximizes the yield per recruit.

Species	$F = 0.5$	$F = 1.0$	$F = 2.0$
<i>Caranx lugubris</i>	0.44	0.26	0.12
<i>Pristipomoides filamentosus</i>	0.46	0.33	0.25
<i>P. auricilla</i>	0.45	0.29	0.19
<i>P. flavipinnis</i>	0.45	0.26	0.12
<i>P. zonatus</i>	0.39	0.24	0.14
<i>Etelis coruscans</i>	0.31	0.20	0.13
<i>E. carbunculus</i>	0.58	0.42	0.30

## DISCUSSION

The assessment proposed here is a multispecies approach which is most suitable for resources where prey-predator interactions are negligible. Two assumptions initially required to implement this program, i.e., constant recruitment and that the resource be essentially unexploited, can in some instances be relaxed. Simulation results suggest that if recruitment is seasonal and a pooled length frequency is constructed from individual length-frequency samples collected over the year, the length-frequency based method used here to estimate mortality produces an essentially unbiased estimate (Ralston<sup>4</sup>). Furthermore, the assumption

that stocks be unexploited can be relaxed if an estimate of the average of  $F$  for the archipelago can be obtained. Then  $M$  can be estimated by the difference between  $F$  and total mortality, and instead of estimating unexploited recruited biomass from the CPUE survey, the biomass under  $F$  will be estimated, and yields calculated as the product of exploited biomass with the ratio of yield/biomass resulting from  $F$  computed from the Beverton and Holt yield equation.

The estimate of maximum equilibrium yield from the Beverton and Holt (1957) equation for the deep slope snappers and groupers from 22 banks in the Mariana Archipelago is 109 t annually with a fishing mortality of 1.0. About 70% of this yield would be expected to come from the southern islands of the chain, including Guam and Saipan. Another 27% would come from the northern islands and only 3% from the seamounts (Table 11).

The mean of the annual sustainable yield levels per nautical mile of 200 m contour for the northern banks, southern banks, and western seamounts are 212.9, 228.5, and 264.4 kg, respectively, with a ratio of total yield for the archipelago to the total length of the 200 m contour of 222.4 kg/nmi (95%) C.I. of 165.3-279.6) (Table 11). Detailed bathymetry data to establish a correspondence between contour length and area are available from Guguan Island in the northern Marianas, and it is estimated that 1 nmi of 200 m isobath corresponds to 0.23 nmi<sup>2</sup> of habitat in the 125-275 m depth range (Polovina and Roush<sup>5</sup>). Based on this correspondence the unit MSY of 222.4 kg/nmi of 200 m contour for the Marianas is equivalent to about 1.0 t/nmi<sup>2</sup> or 0.3 t/km<sup>2</sup>.

These values suggest that the Marianas may be slightly less productive for bottom fishes than the Hawaiian Archipelago where a lower bound estimate for MSY of 272 kg/nmi of 200 m contour was obtained from a stock production model applied to commercial catch and effort data that did not include the recreational fishing component of snappers and groupers. Also, an estimate of 286 kg/nmi of 200 m contour was derived from an ecosystem model applied to an island system in the Northwestern Hawaiian Islands (Ralston and Polovina 1982; Polovina 1984).

The species composition of the catch should depend to some extent on levels of  $F$  and  $t_c$ . As  $F$  increases and  $t_c$  decreases, the contribution of

<sup>4</sup>Ralston, S. The effect of pooling length-frequency distributions on mortality estimation in seasonally breeding fish populations: A Monte Carlo simulation. Manuscr. in prep. Southwest Fisheries Center Honolulu Laboratory, National Marine Fisheries Service, NOAA, Honolulu, HI 96822-2396.

<sup>5</sup>Polovina, J. J., and R. C. Roush. 1982. Chartlets of selected fishing banks and pinnacles in the Mariana Archipelago. Southwest Fish. Cent. Honolulu Lab., Natl. Mar. Fish. Serv., NOAA, Admin. Rep. H-82-19, 7 p.

TABLE 11.—Annual sustainable yield in metric tons (t) and yield in kilograms (kg) per nautical mile (nmi) of 200 m contour for the age at entry which maximizes the yield per recruit at a level of fishery mortality of  $F = 1.0$ .

Banks and islands	Total yield (t/yr)	Yield (kg per nmi of 200 m contour/yr)
<b>Northern banks and islands</b>		
Maug	2.7	262
Asuncion	2.1	188
Agrihan	5.6	304
Pagan	7.7	255
Alamagan	2.0	178
Guguan	1.7	179
Sarigan	1.6	194
Anatahan	2.5	144
38-Fathom	0.5	187
Esmeralda	2.9	237
Total	29.3	Mean 213
<b>Southern banks and islands</b>		
Farallon de Medinilla	16.7	217
Saipan	13.4	254
Tinian	8.8	304
Aguijan	4.2	267
Rota	6.1	192
Guam	17.2	202
Galvez-Santa Rosa	8.6	164
Total	76.0	Mean 229
<b>Western seamounts</b>		
Bank C	0.9	288
Bank D	1.1	351
Pathfinder	0.9	304
Arakane	0.6	200
Bank A	0.6	180
Total	4.1	Mean 264
Total yield from all banks: 109 t/yr.		
Total yield/length of 200 m contour = 222.3 kg/nmi.		

those species to the catch with the high  $M/K$  values, particularly *P. flavipinnis* and *E. carbunculus* tends to increase (Table 12). A form of succession is, therefore, predicted as exploitation proceeds.

There are two approximations which have been used to determine MSY which express it as a fraction of the unexploited biomass. Gulland's formula estimates MSY as  $0.5 MB$ , where  $M$  is the instantaneous rate of natural mortality and  $B$  is the unex-

ploited biomass. An approach proposed by Pauly estimates MSY as  $B 2.3w^{-0.23}$ , where  $w$  is the mean of the weight (in grams) at sexual maturity and the asymptotic weight (Gulland 1983; Pauly 1983). A comparison of these two estimators with the values obtained here shows that for four out of seven species the  $Y/B$  values estimated with the Beverton and Holt equation lie between the values obtained from the Pauly and Gulland approximations.

TABLE 12.—The percentage of annual sustainable yield by species groups for two ages at entry with two levels of fishing mortality.

Species groups	Percentage of total catch by weight			
	Current age of entry		Age at entry which maximizes yield per recruit	
	$F = 0.10$	$F = 1.50$	$F = 0.10$	$F = 1.0$
<i>Caranx lugubris</i>	10.0	5.5	7.3	8.3
<i>Pristipomoides filamentosus</i>	10.3	8.5	9.4	8.2
<i>P. auricilla</i>	8.5	9.4	7.4	7.3
<i>P. flavipinnis</i>	15.6	21.7	24.3	28.7
<i>P. zonatus</i>	28.1	26.7	26.1	23.1
<i>Etelis coruscans</i>	7.6	5.1	7.1	5.0
<i>E. carbunculus</i>	5.9	9.2	4.6	5.9
Others	14.0	13.8	13.8	13.5

For the other three species, the  $Y/B$  values fall slightly below the Pauly and Gulland approximations for two species and substantially above for the third species. The mean  $Y/B$  values obtained by the Pauly and Gulland approximations are, moreover, in substantial agreement with the mean value of  $Y/B$  obtained with the approach proposed here (Table 13).

TABLE 13.—Annual maximum sustainable yield as a fraction of unexploited recruited biomass ( $Y/B_{\infty}$ ) at  $F = 1.0$  together with 0.5 M and  $2.3 w^{-0.26}$ .

Species groups	$Y/B_{\infty}$	0.5 M	$2.3 w^{-0.26}$
<i>Caranx lugubris</i>	0.261	0.335	0.252
<i>Pristipomoides filamentosus</i>	0.262	0.270	0.296
<i>P. auricilla</i>	0.306	0.325	0.403
<i>P. flavipinnis</i>	0.680	0.475	0.348
<i>P. zonatus</i>	0.280	0.270	0.363
<i>Etelis coruscans</i>	0.201	0.175	0.226
<i>E. carbunculus</i>	0.375	0.515	0.289
Mean	0.338	0.338	0.311

## ACKNOWLEDGMENT

This paper is the result of the Resource Assessment Investigation of the Mariana Archipelago at the Southwest Fisheries Center Honolulu Laboratory, NOAA.

## LITERATURE CITED

### ANONYMOUS.

1977. Inventaire critique des données utilisées pour l'étude de la reproduction. In Rapport du groupe de travail sur la reproduction des espèces exploitées du Golfe de Guinée, p. 8-20. ORSTOM-ISRA, Dakar.

### BANNEROT, S. P., AND C. B. AUSTIN.

1983. Using frequency distributions of catch per unit effort to measure fish-stock abundance. Trans. Am. Fish. Soc. 112:608-617.

### BEDDINGTON, J. R., AND J. G. COOKE.

1983. The potential yield of fish stocks. FAO Fish. Tech. Pap. 242, 47 p.

### BEVERTON, R. J. H., AND S. J. HOLT.

1956. A review of methods for estimating mortality rates in exploited fish populations, with special reference to sources of bias in catch sampling. Rapp. P.-v. Réun. Cons. int. Explor. Mer 140:67-83.

1957. On the dynamics of exploited fish populations. Fish. Invest. Ser. II, vol. 19, Mar. Fish., G. B. Minist. Agric. Fish. Food, 533 p.

1966. Manual of methods for fish stock assessment. Part II. Tables of yield functions. FAO Fish. Tech. Pap. 38 (Rev. 1), 67 p.

### BROUARD, F., AND R. GRANDPERRIN.

1984. Les poissons profonds de la pente récificale externe à

Vanuatu. Mission ORSTOM, Vanuatu, Notes et Documents D'Océanographie 11, 131 p.

### CSIRKE, J., AND J. F. CADDY.

1983. Production modeling using mortality estimates. Can. J. Fish. Aquat. Sci. 40:43-51.

### GULLAND, J. A.

1969. Manual of methods for fish stock assessment. Part 1. Fish population analysis. FAO Fish. Ser. 3, 154 p.

1983. Fish stock assessment. A manual of basic methods. John Wiley & Sons, 223 p.

1984. Advice on target fishery rates. ICLARM Fishbyte 2(1):8-11.

### MUNRO, J. L.

1983. A cost-effective data acquisition system for assessment and management of typical multispecies, multi-gear fisheries. ICLARM Fishbyte 1(1):7-12.

### PAULY, D.

1983. Some simple methods for the assessment of tropical fish stocks. FAO Fish. Tech. Pap. (234), 52 p.

### PAULY, D., AND G. I. MURPHY (editors).

1982. Theory and management of tropical fisheries. ICLARM Conf. Proc 9, 360 p. ICLARM, Manila, Philippines, and Division of Fisheries Research, CSIRO, Cronulla, Australia.

### POLOVINA, J. J.

1984. Model of a coral reef ecosystem. I. The ECOPATH model and its application to French Frigate Shoals. Coral Reefs 3:1-11.

1986a. A variable catchability version of the Leslie model with application to an intensive fishing experiment on a multispecies stock. Fish. Bull., U.S. 84:423-428.

1986b. Variation in catch rates and species composition in handline catches of deepwater snappers and groupers in the Mariana archipelago. Proc. 5th Int. Coral Reef Congr. 1985, Tahiti.

### RALSTON, S.

1986. An intensive fishing experiment for the caridean shrimp, *Heterocarpus laevis*, at Alamagan Island in the Mariana Archipelago. Fish. Bull., U.S. 84:927-934.

In press. Length-weight regressions and condition indices of lutjanids and other deep slope fishes from the Mariana Archipelago. Micronesia.

### RALSTON, S., AND J. J. POLOVINA.

1982. A multispecies analysis of the commercial deep-sea handline fishery in Hawaii. Fish. Bull., U.S. 80:435-448.

### RICKER, W. E.

1975. Computation and interpretation of biological statistics of fish populations. Bull. Fish. Res. Board Can. 191, 382 p.

### SAILA, S. B., AND P. M. ROEDEL (editors).

1979. Stock assessment for tropical small-scale fisheries. Proceedings of an International Workshop Held September 19-21, 1979, at the University of Rhode Island, Kingston, RI, 198 p.

### WETHERALL, J. A., J. J. POLOVINA, AND S. RALSTON.

In press. Estimating growth and mortality in steady state fish stocks from length-frequency data. In D. Pauly and G. R. Morgan (editors), Length-based methods in fishery research. The ICLARM/KISR Conference on the Theory and Application of Length-Based Methods for Stock Assessments, Sicily, Italy, February 1985. Vol. 1.

# GROWTH, BEHAVIOR, AND SEXUAL MATURATION OF THE MARKET SQUID, *LOLIGO OPALESCENS*, CULTURED THROUGH THE LIFE CYCLE

W. T. YANG, R. F. HIXON, P. E. TURK, M. E. KREJCI,  
W. H. HULET, AND R. T. HANLON<sup>1</sup>

## ABSTRACT

*Loligo opalescens*, a commercially important species of the eastern Pacific, is the first pelagic cephalopod to be cultured through the entire life cycle. Squid were cultured twice to viable second generation progeny in closed seawater systems using artificial and natural seawater. The reasons for success compared with previous attempts were 1) increased depth in the culture tank, 2) improvements in water conditioning methods, and 3) an increase in availability, density, and species diversity of food organisms. The diet consisted of live zooplankton (predominantly copepods), mysid and palaemonid shrimp, and estuarine fishes. Mean daily group feeding rates of subadults and adults were 14.9% and 18.0% of body weight. Growth was fast, increasing exponentially the first 2 months of the life cycle (8.35% increase in body weight per day) then slowing to a logarithmic rate thereafter (5.6-1.6% increase per day). Growth rings in statoliths corresponded to one per day for the first 65 days. Maximum life span was 235 and 248 days in the two experiments, with a maximum size of 116 mm dorsal mantle length. Viable eggs were produced within 172 and 196 days, respectively. Eggs developed in 30 days at 15°C. Survival through the life cycle was low, with the highest mortality occurring in the first few weeks when squid made the transition from feeding on yolk to active predation on fast-moving plankton. Fin or skin damage and senescence after reproduction accounted for late mortality. The laboratory life cycle of less than a year is compatible with existing field data that propose either a 1- or 2-year life cycle, depending upon the season of hatching.

Since 1975 we have been studying loliginid squid to develop methods of providing a consistent supply for neuroscience research. These studies include aspects of fishery biology (Rathjen et al. 1979; Hixon 1980a, b, 1983; Hixon et al. 1980), capture and maintenance methods (Hanlon et al. 1978, 1983; Hulet et al. 1979; Hanlon and Hixon 1983), behavior (Hanlon 1978, 1982), and mass-culture methods (Hanlon et al. 1979; Yang et al. 1980a, b, 1983a, b). Much of the baseline information acquired through these controlled culture experiments will also be important to the fisheries biology of commercially exploited loliginid squids (cf., Roper et al. 1983).

About 20 major attempts have been made to culture loliginid squids through the life cycle, but none have been successful (see review in Yang et al. 1980b), even though wild-caught mature females of *Loligo* and *Doryteuthis* spawn readily in captivity (Hamabe 1960; Fields 1965; Takeuchi 1969, 1976; Hurley 1977; Arnold et al. 1974; Hanlon et al. 1983). Fields (1965) attempted unsuccessfully to culture *Loligo opalescens* as early as 1947. Hurley (1976)

reared *L. opalescens* for 100 d to a mantle length (ML) of 13 mm. Hanlon et al. (1979) reared this species to 17 mm ML in 79 d and, based upon that work, reared *L. opalescens* from hatching to subadults (Yang et al. 1980b, 1983a). We have now improved previous culture methods by increasing the rearing population density and by improving the space requirements for young and adult squid. With a more consistent supply of foods and improvement of water management, we have now successfully cultured this squid twice from egg to second generation, thus closing the life cycle.

## MATERIALS AND METHODS

Two culture experiments are reported herein: L.O. 1981 (full life cycle partly published in Japanese by Yang et al., 1983b); and L.O. 1982 (full life cycle). A third experiment, L.O. 1980, was published by Yang et al. (1980b, 1983a) and is referenced for comparison in the Discussion and figures.

For L.O. 1981, freshly laid eggs were obtained from wild-caught squid kept in holding tanks at Sea Life Supply (Sand City, CA 93955). Eggs were collected from spawning grounds in Monterey Bay, CA for experiment L.O. 1982. Eggs were air-shipped

<sup>1</sup>The Marine Biomedical Institute, The University of Texas Medical Branch, 200 University Boulevard, Galveston, TX 77550-2772.

to Galveston (Yang et al., 1980b; 1983a, b). Only early stage eggs were shipped and cultured (never beyond stage 19, Arnold 1965). The eggs were acclimated gradually to the temperature and salinity of the culture tank water; incubation temperature was maintained around 15°C while salinity ranged between 34 and 36‰. Bundles of a few capsules each were suspended from a rack at the water surface to ensure oxygenation and uniform development of eggs. Styrofoam panels covered the rearing tank and the illumination level was kept below 1 lux to prevent the growth of benthic diatoms on egg capsules.

A circular tank (CT) system consisting of two circular tanks (each 1,300 L) was used for incubation and early rearing of hatchlings and juvenile squid. Water circulation was modified in L.O. 1982 when compared with earlier culture experiments (Yang et al. 1980b: fig. 1, 1983a: fig 1). Prior to L.O. 1982, a laboratory-constructed particle/carbon filter was used with circulation first passing through an ultraviolet (UV) sterilizer. L.O. 1982 used modular type particle and carbon filters, with the UV sterilizer in the last position in the water conditioning process. The raceway (RW) system (RW culture tank volume—10,970 L in L.O. 1981, and 13,180 L in L.O. 1982) was used for final grow-out after transferring the squid from the CT culture tanks. The transfer was necessary to give the squid greater horizontal swimming space. The initial RW system in experiment L.O. 1981 had been modified from previous experiments (Yang et al. 1980b, 1983a) to improve water quality by 1) adding a rectangular, 960 L capacity water conditioning tank (0.46 × 1.22 × 1.83 m, water depth 0.43 m) with water circulation of 54 L/minute, 2) adding another cooling unit, 3) adding three protein skimmers, 4) adding three UV light sterilizers (each 30 W, total 90 W), 5) modifying the water uptake system in the RW with a float near the center to remove near-surface water without sucking up squid or food organisms and to increase the lateral swimming space for the squid, 6) painting an irregular mottled pattern on the sides of the RW to make the walls more visible to the squid, and 7) most importantly, by increasing RW water depth gradually from 24 cm initially to 40 cm (average depth 38.8 cm) to provide swimming space for the squid and to increase the average culture water volume in the RW from 5,990 to 8,610 L.

A further improved RW system (Fig. 1) was used in experiment L.O. 1982. It consisted of two biological filter tanks (A, C) with oyster shell subgravel filters and airlifts for water circulation, a tank for growing macroalgae (B), the RW where the squid

were cultured (D), and a separate tank where protein skimmers were operated continuously (E). The surface water was taken from the RW through pipes suspended in a screened floating core. Water within the system was recirculated by three routes. First, water was pumped to filter tank A that contained approximately 0.15 m<sup>3</sup> of oyster shell over a false bottom. Water passed through the filter bed, then flowed through a constant-level siphon to tank B where algae were illuminated by two 400-W metal halide lamps. Water flowed by gravity into the second filter tank C that contained 0.18 m<sup>3</sup> of oyster shell substrate and two 1-hp cooling units, and finally returned by gravity to the RW proper. Second, water was pumped through two sets of six modular filters: four modules containing pleated 20 μm fiber particle filters and two containing activated carbon. From the modular filters, water either flowed directly into the RW or through a 60 W UV sterilizer before returning to the RW. Third, water was pumped at 36 L/minute to a tank that contained five protein skimmers and then flowed back into the RW. The outflow of the three recirculating routes created a clockwise water flow in the RW proper. This motion accumulated dead squid and food organisms in one place on the bottom. The bottom was painted solid black with nontoxic Thioxchlor<sup>2</sup> paint and the sides were painted with an irregular mottled pattern. Three 11 × 28 cm windows were mounted in one side of the RW for observing the squid's feeding and behavior. The tanks were insulated with polystyrene sheeting and 2.3 cm thick polystyrene covers.

To ensure activation of the biological filter for both CT and RW systems, filter beds were inoculated 2 to 3 wk beforehand with nitrifying bacteria on oyster shell from other systems. Fish and shrimp were placed in the water conditioning tank to build up the bacterial population. Thus the filter beds were established by organic conditioning methods (Moe 1982) instead of by directly adding ammonia source chemicals.

A set of black silk nets was used to transfer squid from the CT system into the RW system. A triangular lift net was laid on the bottom of the tank while two rectangular net curtains were slowly drawn from the left and right sides of the tank to concentrate the small squid above the lift net. The lift net was gradually raised, a wash tub placed underneath, and both were moved to the RW tank where the squid were gently released into the tank.

<sup>2</sup>Reference to trade names does not imply endorsement by the National Marine Fisheries Service, NOAA.



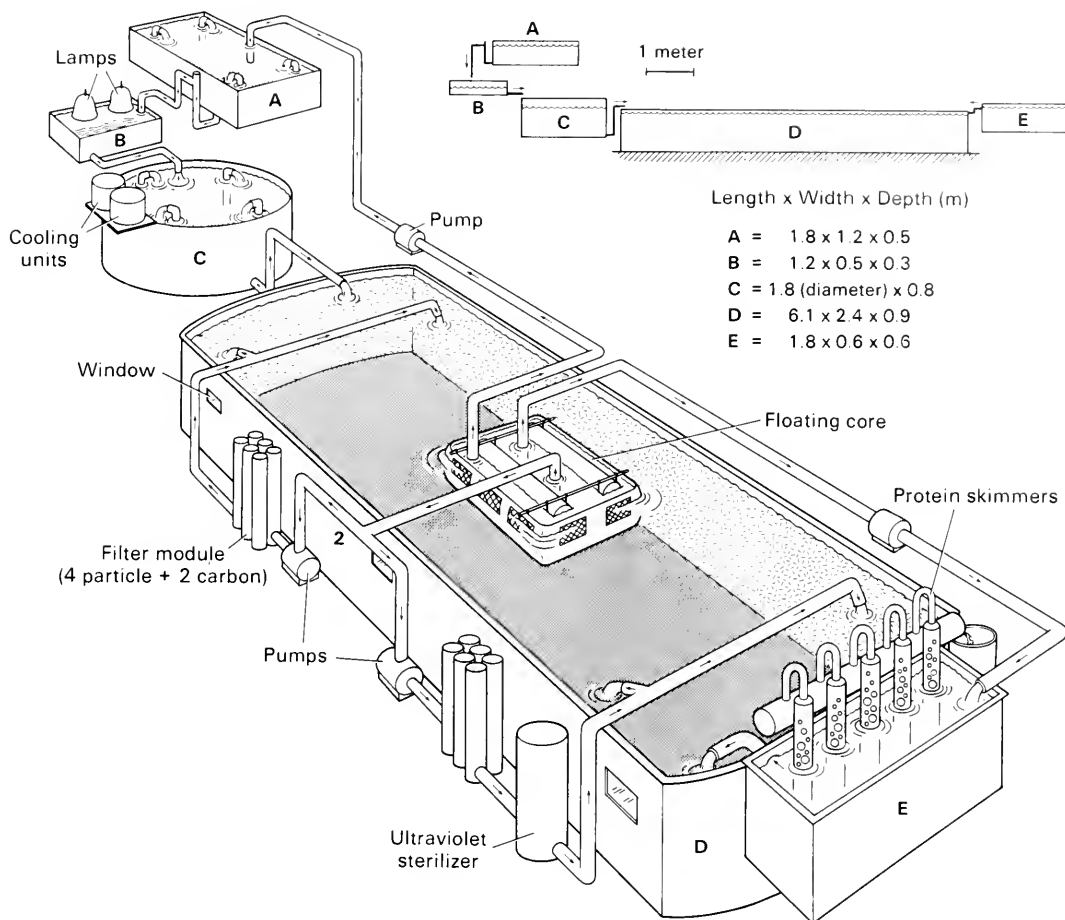

FIGURE 1.—Raceway (RW) system (L.O. 1982) with recirculating culture seawater (17,000 L total) for grow-out of juvenile and adult squid.

In L.O. 1981, 129 squid were not transferred from the CT tank and they continued to grow in the CT, thereby allowing comparisons of temperature tolerance and survival in small versus large culture systems.

Natural seawater and artificial sea salts (Instant Ocean) dissolved in deionized water were used in CT systems for L.O. 1982 and L.O. 1981, respectively, and artificial seawater was used exclusively in the RW system in both experiments. Salinity was maintained between 34 and 37‰. Trace elements were supplemented regularly with Wimex Trace Elements. Temperature was maintained at 15°C unless otherwise noted. The pH was maintained between 7.8 and 8.2, and low pH was corrected by the gradual addition of sodium bicarbonate.

Temperature and salinity were measured daily, pH every other day, and metabolic waste products

(ammonia, nitrite, and nitrate) were measured weekly. Ammonia-nitrogen levels were determined by the Solorzano method (Strickland and Parsons 1972), and nitrite-nitrogen was determined by the Shinn method (applied to seawater by Bendschneider and Robinson in Strickland and Parsons 1972). Nitrate-nitrogen levels were determined using a prepacked Hach reagent kit.

Various live food organisms were fed to the squid several times daily throughout the experiments. Live planktonic organisms such as zooplankton (mainly copepods) and small mysidacean shrimp (*Mysidopsis almyra*) were the primary foods during the first 60 d in the CT system. Brine shrimp, *Artemia salina*; larval red drum, *Sciaenops ocellatus*; and mysis stage penaeid shrimp were fed as supplemental foods. Food organisms were added to the CT system four or five times daily. Thereafter

in the RW system, adult mysids; palaemonid shrimp, *Palaemonetes pugio*; and a variety of marine or estuarine fishes were fed to the squid at least twice daily.

Zooplankton were washed carefully in clean seawater. Mysids and palaemonid shrimp were treated overnight with quinacrine, while erythromycin and/or tetracycline were used to treat fish (Yang et al. 1980b, 1983a, b). Before feeding, all foods were counted or weighed and slowly acclimated to the temperature and salinity of the cultured water.

Dead squid and dead food organisms from previous feedings were removed by siphoning once or twice daily from the CT or RW systems. Daily food consumption in the RW was derived by subtracting the weight of uneaten food remains siphoned each day from the weight of food organisms added daily to each culture system. Daily feeding rate (wet weight) is expressed as the percentage of food consumed by the total estimated biomass of the squid. Daily biomass of squid was estimated by multiplying the number of live squid on a given day by the average weight of an individual squid on that day. Daily squid weight estimates were projected from linear regression of the weights of freshly dead squid against time. All measurements and wet weights (WW) were usually made with freshly dead squid although live squid were occasionally used. Badly damaged or partially cannibalized squid were not measured or weighed for this analysis. The initial squid population was derived from the number of dead or sacrificed specimens removed from the culture systems.

Overhead fluorescent lights provided illumination. In the CT systems for both experiments there was constant light that measured 11 to 15 lux in the middle of the water column. In the RW systems there was also constant light although light only filtered in through plastic-covered holes in the polystyrene tops. In L.O. 1981 it measured 17 lux in the center of the RW and 0.5 to 0.7 lux at each end. In L.O. 1982 it measured 4 to 7 lux near the ends under the opaque top and 11 lux near the center where light passed through the clear plastic.

Statoliths from hatchlings of known age in L.O. 1982 were dissected from the squid and decalcified in a 1:1 mixture of 4% EDTA in distilled water and 0.2 M sodium cacodylate buffer (pH 7.4). Decalcification facilitated the counting of rings in statoliths from squid age 65 d or younger, but older statoliths were distorted by the process. The rings were counted from photographs taken with a Leitz Combiophot II and Kodak copy film #4125.

## RESULTS

### Water Quality

There were no obvious differences in growth or survival between squid cultured in artificial seawater (L.O. 1981) and filtered natural seawater (L.O. 1982). Water quality in the CT systems was maintained in very good condition due to the short culture period, while water quality in the RW system was more difficult to maintain because of the long grow-out period and the greater biomass of squid and food organisms. In L.O. 1981 (Fig. 2) from days 180 to 190 the estimated total biomass reached the maximum peak of 1,706 g (cf., Fig. 7), which is equivalent to 155 g/m<sup>3</sup> of rearing water volume. After the 160th day, food organism biomass increased to between 300 and 400 g/day. As a result, the amount of nitrate-nitrogen gradually accumulated to over 23.0 mg/L during the period from day 180 to day 193 (Fig. 2). On day 164, 1,900 L (17% of total volume) of fresh Instant Ocean was replaced in this system. However, the nitrate-nitrogen level did not drop in proportion to the percent water change. Concurrently, pH dropped to 7.75 by day 169 and dissolved sodium bicarbonate (Atz 1964; Bower et al. 1981) was introduced to the system to adjust the pH above 7.9. The sodium bicarbonate solution required very strong aeration to be effective when it was put into the culture water. A similar trend of slightly increased nitrate-nitrogen and decreased pH occurred (about day 200) in L.O. 1982 (Fig. 2). This was corrected in the same manner.

The vegetative macroalgae, *Gracilaria tikvahiae*, was cultured in the water conditioning tank of the RW system in L.O. 1982 to remove ammonia and prevent the accumulation of nitrate-nitrogen, but its effectiveness was not clear.

### Incubation and Hatching of Eggs

Average hatchling size in both experiments was 2.7 mm ML (range 2.3-2.8 mm ML) with a hatching success of over 90%. In L.O. 1981, hatching began on 14 October and lasted until 17 October. Embryonic development required 27 to 30 d at 15°C. The hatching period lasted 4 d, compared with L.O. 1982 that took 5 to 6 d. The period of embryonic development in L.O. 1982 was not precisely known because the eggs were collected in nature. Development of eggs within the same egg cluster was different depending upon the capsule position within the cluster. Moreover, hatching time within the same capsule

differed, since distal embryos usually hatched first. Since we used early stage eggs removed from their habitat in California, no polychaete worms (*Capitella ovincola*) were observed in the egg capsules (cf., McGowan 1954), although we had observed worms in other late stage California egg capsules.

During embryonic development, granules or crystals appeared in the perivitelline fluid of some eggs, but no significance to survival or development could be associated with this condition. The outer tunics of the egg capsules incubated in Instant Ocean were more elastic until the later stages (around stage 27) than those incubated in natural seawater. More bacteria and other benthic organisms grow on the capsules incubated in natural seawater. These differences did not influence development or hatching success. Embryos near hatching (stage 29) generally moved little or were nearly static, but in most individuals the external yolk sac was already broken off within the egg. External yolk sacs were observed on a few hatchlings. In L.O. 1981, bright illumination stimulated hatching in very late stage eggs and therefore light levels were increased during later stages of egg development in L.O. 1982.

### Foods and Feeding

The species and size of food organisms were similar in the two experiments. The general progression of food types began with zooplankton, then mysidae shrimps, then palaemonid shrimp larvae and adults, and finally fishes (Fig. 3). The use of brine shrimp has been curtailed since they were found to be unattractive to the hatchlings.

The size range of food organisms fed in the first 30 d is large, especially when compared with the size of 1-d-old hatchlings (2.3-2.8 mm ML, Fig. 4). However, as shown in Figure 4, the hatchlings have only small fins and are not strong swimmers; therefore, feeding on active prey at this stage is not excellent. A summary of the types and quantities of food offered in the experiments (L.O. 1981 is used as an

example) is given in Figure 5. Large amounts of food were available to the squid; this was important during the first weeks when hatchlings could only capture food organisms drifting very close to them. The relationship of hatching to food organism density during the first 59-d period in each experiment is summarized in Table 1. Unfortunately there was no clear relationship between densities and survival. For example, in L.O. 1982, there were twice as many food organisms per squid as in L.O. 1981, but survival (cf., Fig. 13) was not better. Figure 5 shows more specifically the number of food organisms fed daily in L.O. 1981.

The early rearing period in L.O. 1981 and 1982 coincided with the spawning of mysid shrimp in the Galveston estuaries. Therefore, small mysids with a total length of about 2.0 mm (Fig. 4B) were abundantly supplied. This was particularly important since small mysids swim more frequently in the water column than do adults. Young mysid hatchlings were given as food by day 12 in L.O. 1981 and immediately in L.O. 1982 (Fig. 3). Small mysids distribute themselves more evenly in the culture tanks and are easier for hatchlings to capture. *Palaemonetes* spp. were fed to juvenile and adult squid (Fig. 3). Shrimp ranged in size from 2.0 to 25.0 mm. They were graded by size and fed based on size and availability. Daily siphoned remains indicated that only the abdominal flesh was consumed, with the thorax and carapace discarded.

Fish were generally used for juvenile or older squid. However, fertilized red drum eggs were available in L.O. 1981, and larvae up to 13-d old (Fig. 4E) were given to the hatchlings. In the two experiments, a total of over 14 fish species of 10 families were fed (Table 2). To determine the diet preference for fish species, the actual consumption of fish (i.e., total weight of fish put in tank minus total weight of fish remains) was compared for a total of 5 kg fish fed in L.O. 1982 (Fig. 6). The cyprinodont fish were most preferred (consumption of 83%). Only small *Fundulus* spp., smaller than 31 mm (Cyprinodontidae), were fed because large *Fun-*

TABLE 1.—The mean density of squid and food organisms per liter of culture water from days 0-30 and 30-59.

Exp. No.	Initial hatchling population	Day 0-30			Day 30-59		
		Squid No./L	Food organisms No./L	Ratio of food organisms to squid	Squid No./L	Food organisms No./L	Ratio of food organisms to squid
L.O. 1980	864	0.46	14.2	30:1	0.35	9.4	26:1
L.O. 1981	2,061	0.93	24.0	25:1	0.54	12.4	23:1
L.O. 1982	1,704	0.27	14.6	54:1	0.14	5.6	40:1

### 1981 EXPERIMENT

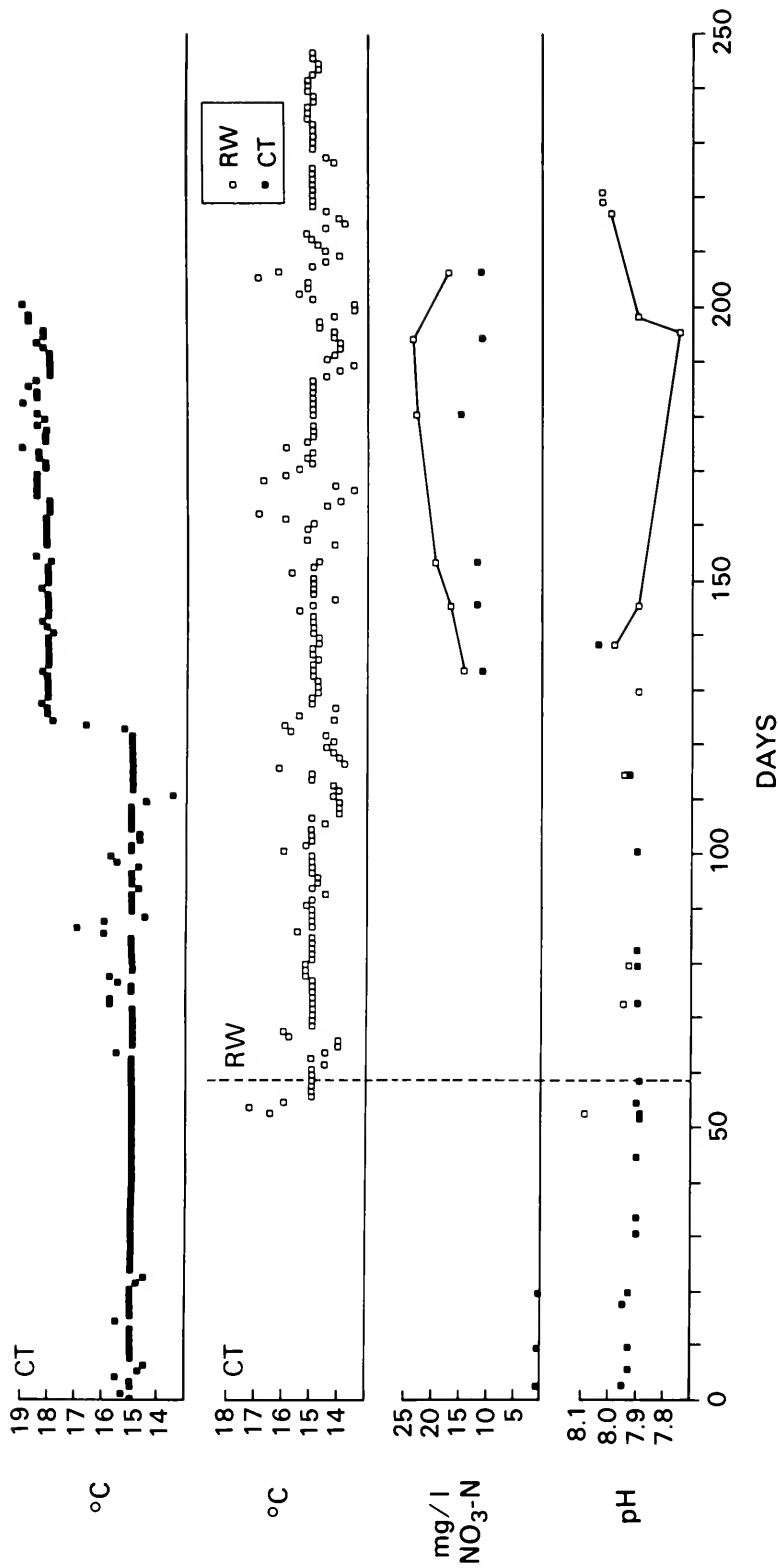

1982 EXPERIMENT

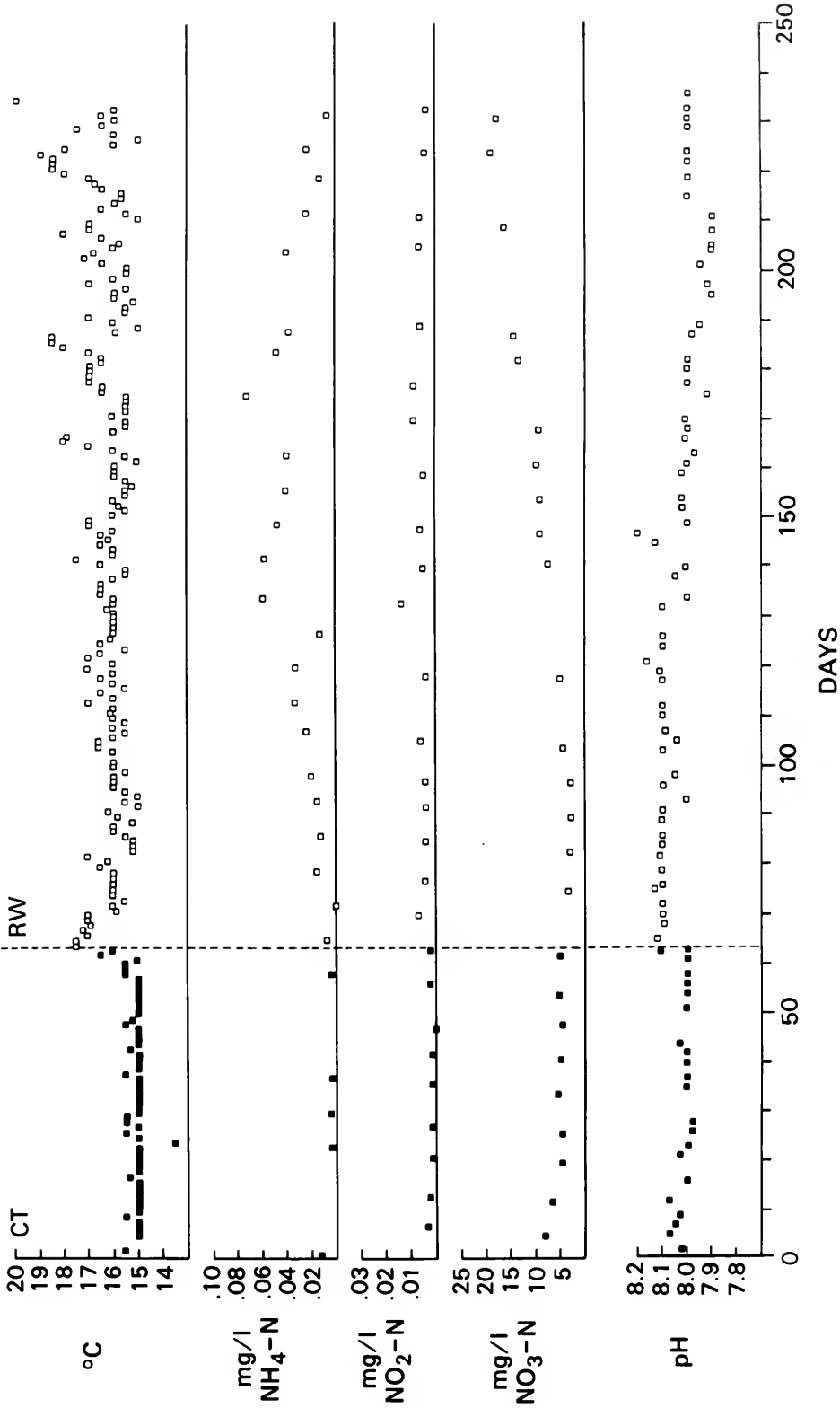

FIGURE 2.—Water quality measurements in CT (circular tank) and RW (raceway) systems throughout the life cycle (L.O. 1981 and 1982). Some squid in L.O. 1981 were kept in

the CT system (see top temperatures) while others were moved to the RW system (bottom temperatures).

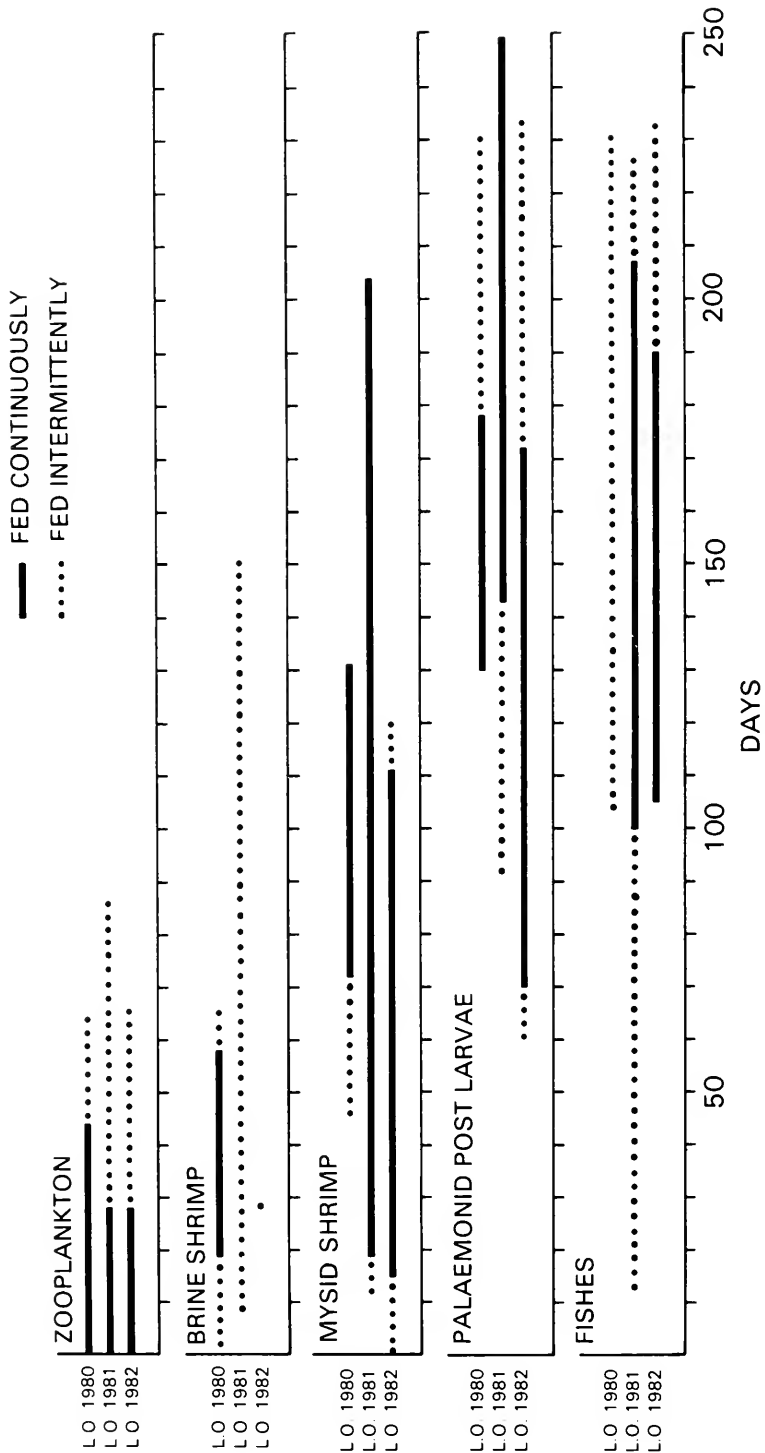

FIGURE 3.—Comparative use of food organisms fed to *Loligo opalescens* during three culture experiments.

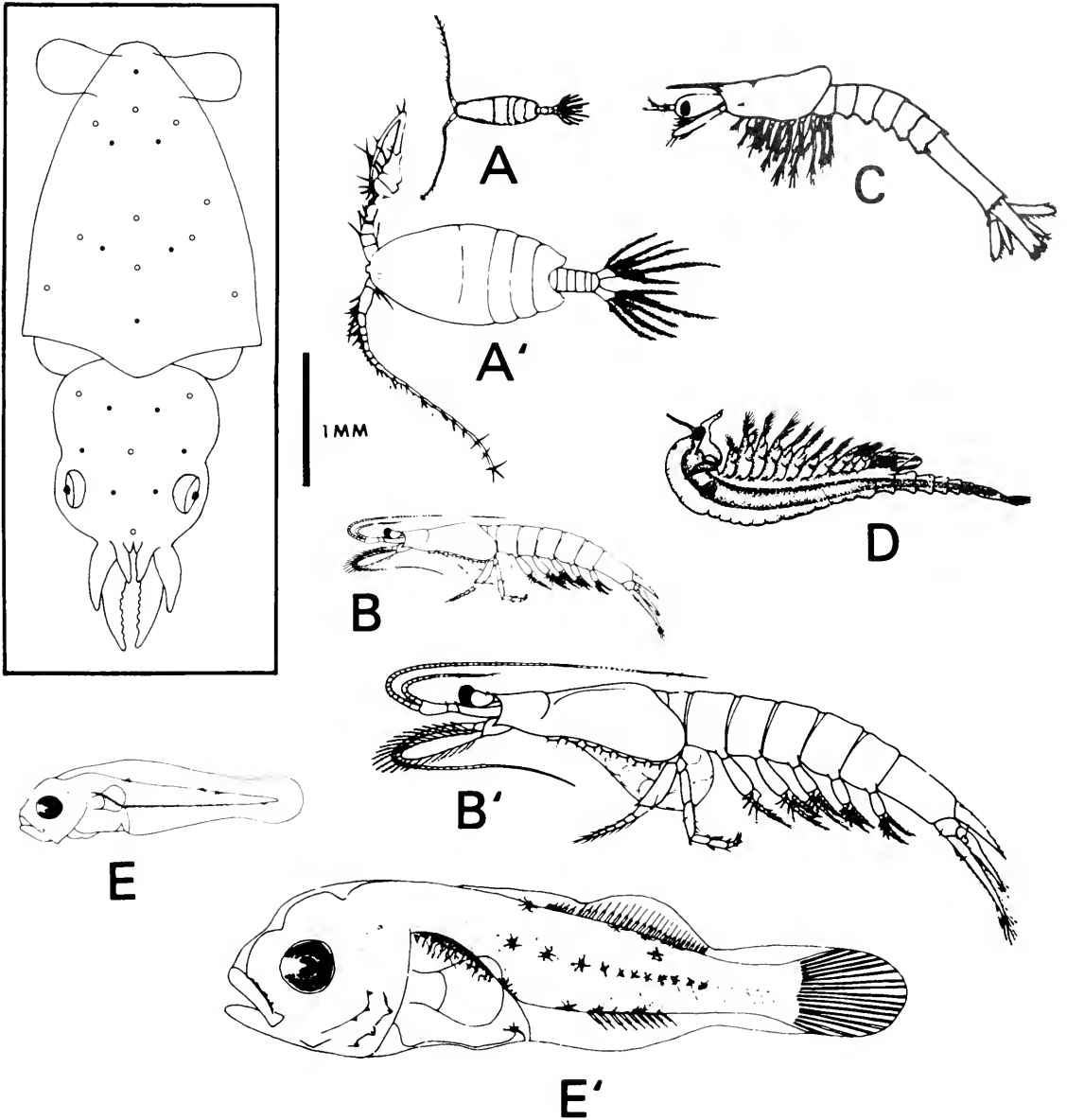

FIGURE 4.—Size relationship of hatchling *Loligo opalescens* and various food organisms fed squid for the first 30-d posthatching. A, copepod *Acartia tonsa*; A', copepod *Labidocera aestiva*. B, hatchling *Mysidopsis almyra*; B', adult *M. almyra*. C, mysis stage of *Penaeus* spp. D, adult *Artemia salina*. E, 1-d-old larva of red drum *Sciaenops ocellatus*, E', 13-d-old larva of *S. ocellatus*.

*dulus* spp. competed with the squid for crustaceans in the tank. Uneaten mullet (*Mugilidae*) accumulated to form small schools, that the squid would not approach or feed upon as readily as fish that swam individually. Squid consumed 44% of the mullet even though the amount fed was equal to amounts of *Poecilidae* and *Sciaenidae*, which were consumed more (72% and 68%, respectively). The food remains

indicated that the squid ate only the flesh of fish, leaving the head and vertebrae.

Figure 7 gives the estimated daily group feeding rate (L.O. 1981) based upon the daily biomass of squid and the daily food consumption from day 108 to day 232. Daily group feeding rate averaged 14.9% (range 4-29%). Squid biomass reached a maximum on day 183 and continued high for 11 d before the

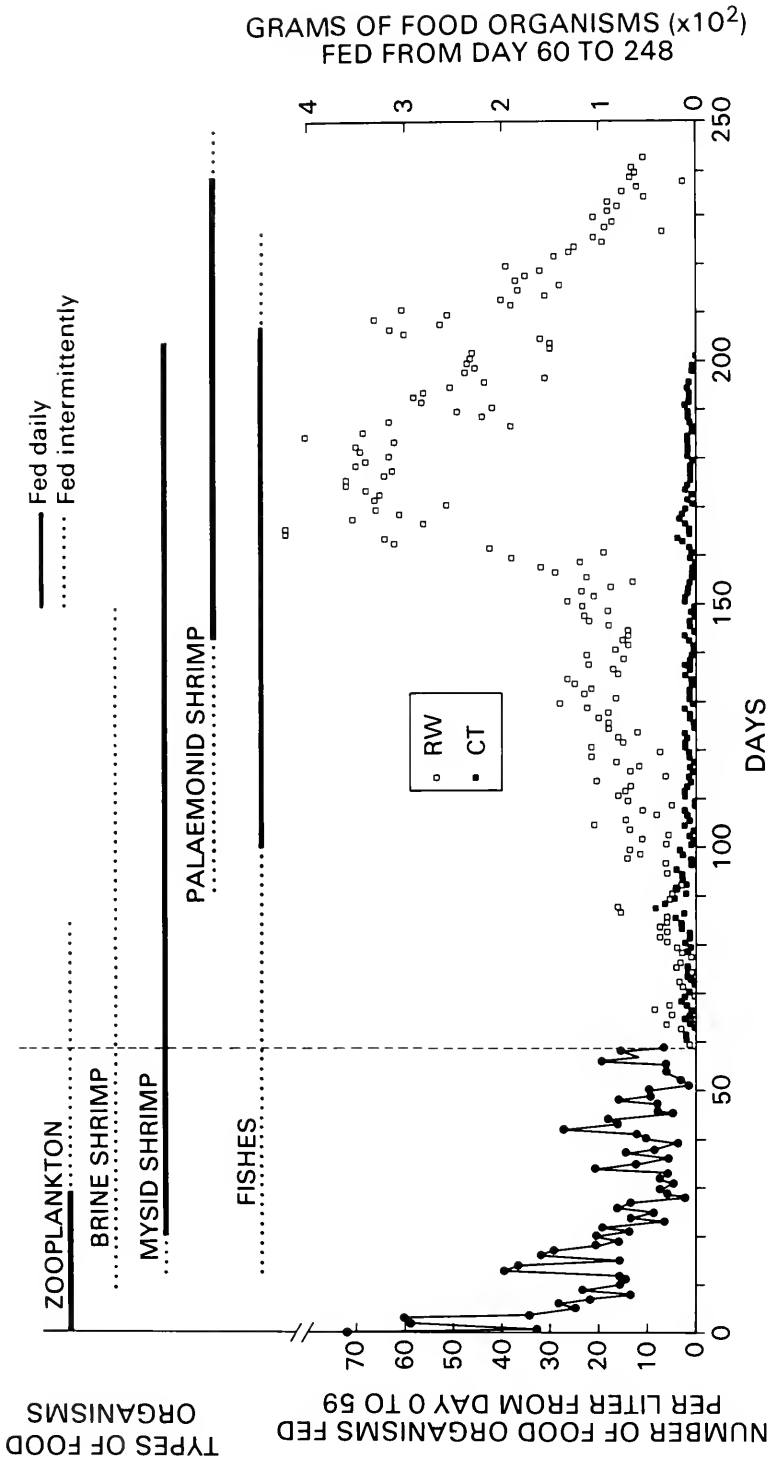

FIGURE 5.—Types, quantities and densities of food organisms fed daily in experiment L.O. 1981. Vertical line represents the culture day 59.



TABLE 2.—Fish species and size range given as food in all three experiments.

Family and species	Size (TL in mm)	L.O. experiment		
		1980	1981	1982
Family: Clupeidae				
<i>Brevoortia</i> spp.	15.0-31.0	—	—	X
Family: Engraulididae				
<i>Anchoa mitchilli</i> (Valenciennes)	20.0-25.0	—	—	X
Family: Cyprinodontidae				
<i>Adinia xenica</i>	—	—	—	X
<i>Cyprinodon variegatus</i> Lacepede	10.0-28.0	X	X	X
<i>Fundulus</i> spp.	15.0-31.0	X	X	X
Family: Poeciliidae				
<i>Gambusia affinis</i> (Baird and Girard)	12.0-28.0	X	X	X
<i>Poecilia latipinna</i> (Lesueur)	22.0-41.0	X	X	X
Family: Atherinidae				
<i>Menidia beryllina</i> (Cope)	18.0-52.0	X	X	X
Family: Carangidae				
<i>Hemicaranx amblyrhynchus</i> (Cuvier)	—	—	—	—
Family: Gerreidae				
<i>Eucinostomus gula</i> (Quoy and Gaimard)	—	—	X	X
Family: Sparidae				
<i>Lagodon rhomboides</i> (Linnaeus)	—	—	X	X
Family: Sciaenidae <sup>1</sup>				
<i>Sciaenops ocellatus</i> (Linnaeus)	1.5-14.5	—	X	X
<i>Pogonias cromis</i> (Linnaeus)	10.0-15.0	—	X	X
Family: Mugilidae				
<i>Mugil</i> spp.	18.0-38.0	X	X	X

<sup>1</sup>There were about six more species of Sciaenidae; minority species were not identified.

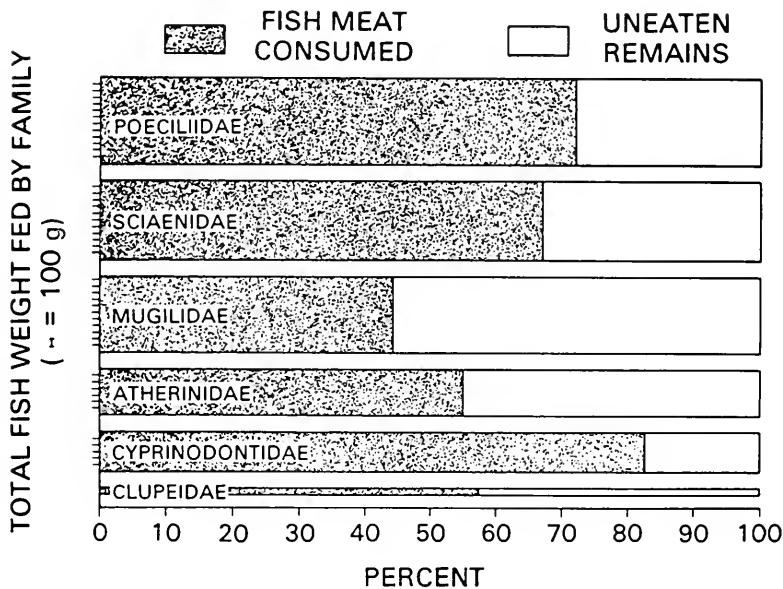

FIGURE 6.—Food preference for fishes by squid in experiment L.O. 1982. Total fish weight fed to the squid was 5.0 kg.

initiation of spawning; biomass then decreased because of the mortality accompanying spawning. Squid in L.O. 1982 were fed ad libitum and daily group feeding rates could not be determined. How-

ever, the average group feeding rate calculated weekly for L.O. 1982 allowed an estimate of 18.0% for the daily feeding rate.

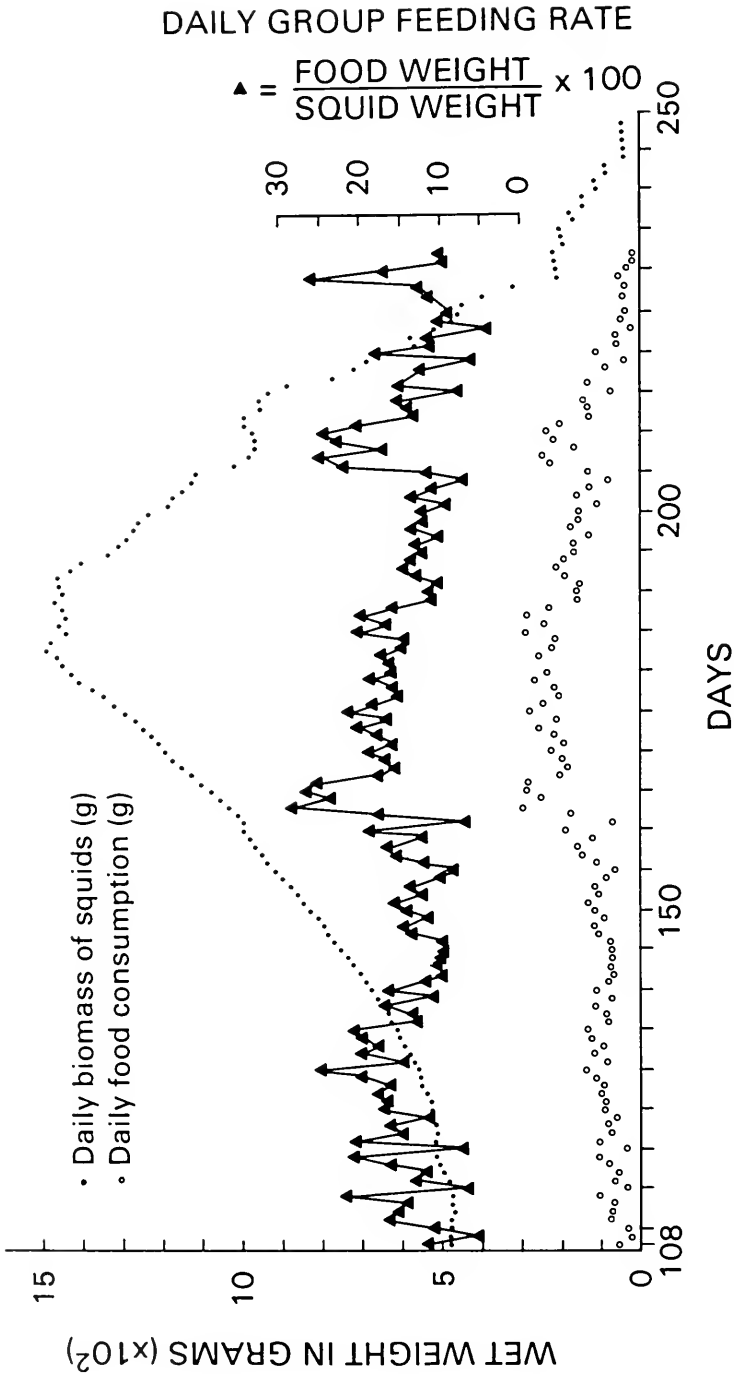

FIGURE 7.—Analysis of the daily group feeding rate of subadult and adult *Loligo opalescens* in the RW system from day 108 to 248 in experiment L.O. 1981.

**Growth**

Figure 8 illustrates growth data through the life cycle for both experiments. At hatching, *Loligo opalescens* has a mean mantle length of 2.7 mm, a wet weight of 0.001 g, and has approximately 100 chromatophores on its body. In L.O. 1981, the largest reared squid was a male of 113 mm ML and 58 g. In L.O. 1982, the largest reared squid was a female of 116 mm ML and 63 g. Mean sizes for adults from the two experiments were 87 mm ML

( $S\bar{x} = 2.7$ ) and 23.8 g ( $S\bar{x} = 1.9$ ) for 35 males, and 83 mm ML ( $S\bar{x} = 1.9$ ) and 21.2 g ( $S\bar{x} = 1.5$ ) for 58 females.

Growth equations for the squid in L.O. 1981 clearly describe two separate phases of growth. The mantle length of squid cultured in the CT system (days 1-56) increased at an exponential rate ( $ML = 2.121 e^{0.02398t}$ ;  $r^2 = 0.92$ ) or 2.4% increase per day, while those cultured in the RW system (days 56-248) grew logarithmically ( $ML = 0.2884 t^{1.495}$ ;  $r^2 = 0.97$ ). Weights were only measured on squid from the RW

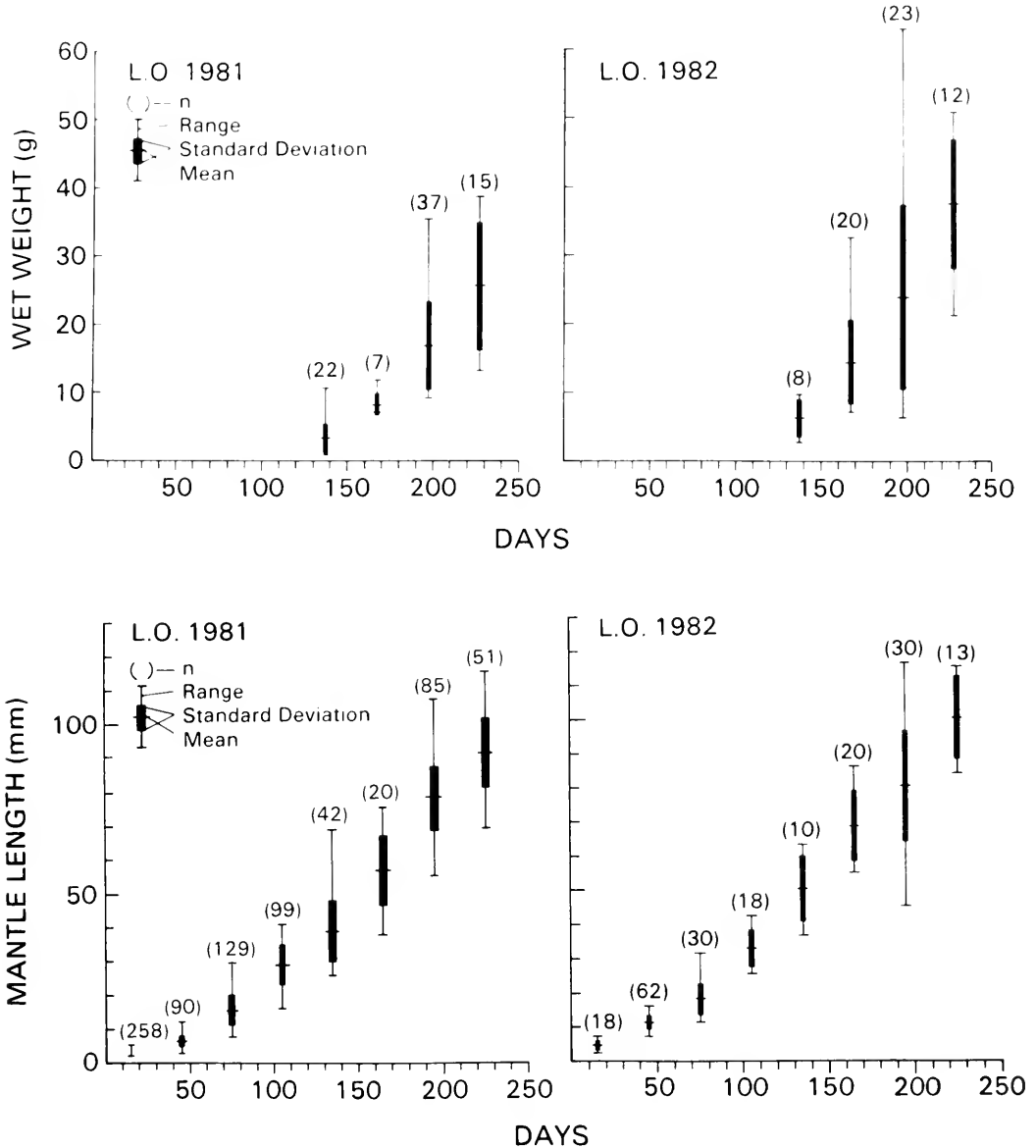

FIGURE 8.—Comparison of growth (wet body weight and mantle length) in experiments L.O. 1981 and L.O. 1982.

system (days 108-248) and the growth curve showed a logarithmic increase ( $W = 6.283 \times 10^{-7} t^{3.660}$ ;  $r^2 = 0.92$ ). Hence, younger squid grew at an exponential rate and growth slowed to a logarithmic rate in older squid.

Squid exhibited fast exponential growth for the first 2 mo in L.O. 1982 and slower logarithmic growth thereafter (Fig. 9). Wet weight data from

live animals in L.O. 1982 indicated a mean growth rate of 8.35% increase in body weight per day for the first 2 mo. Mantle length increased 3.19%/day or the equivalent of 8 mm/month. The squid were doubling their weight every 8 d and doubling their length every 21 d. Growth rates declined from 5.6%/day WW at day 60 (and 2.2%/day mm ML) to 1.6%/day WW (and 0.63%/day mm ML) at day 240.

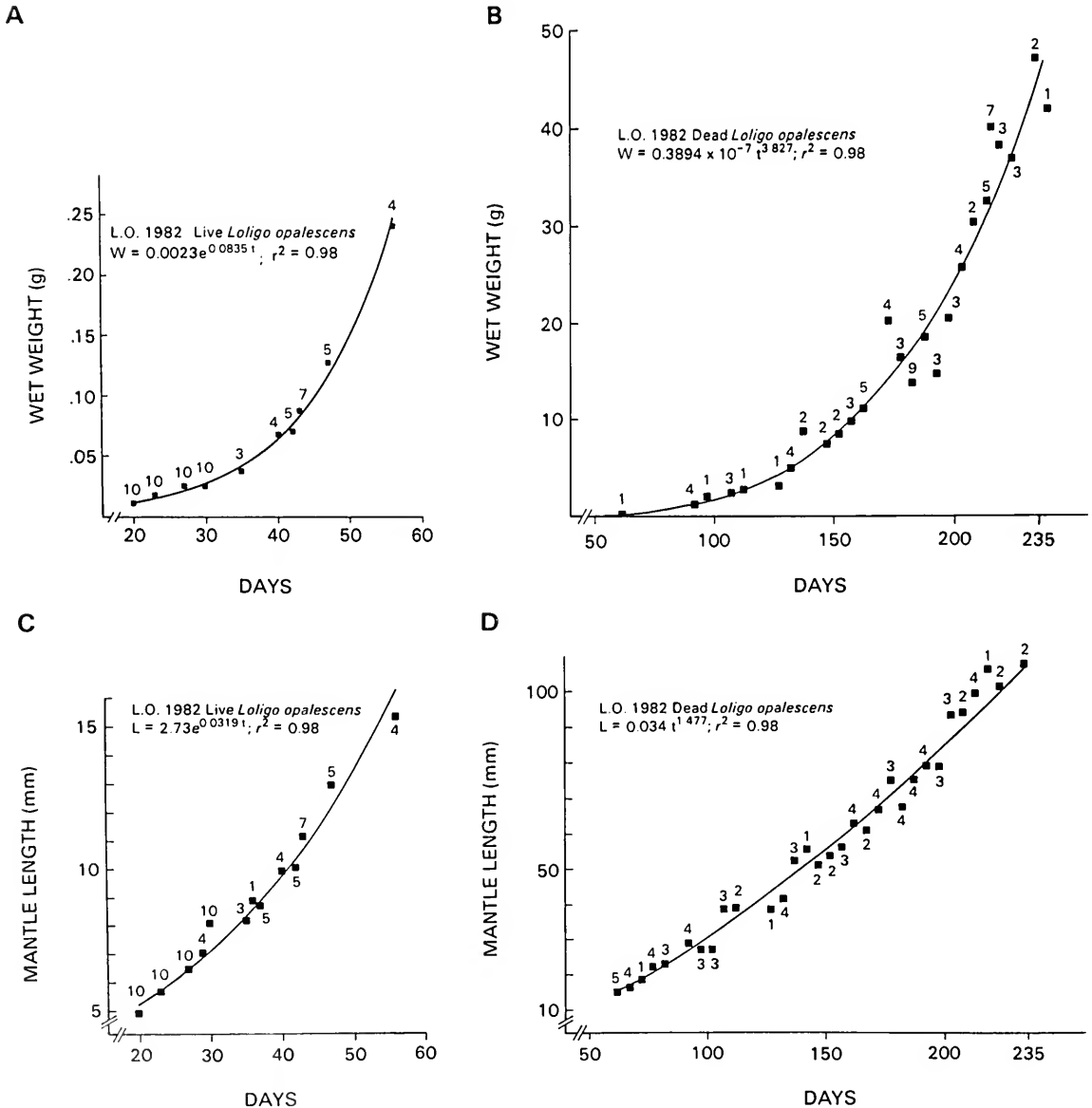

FIGURE 9.—Early exponential growth of *Loligo opalescens* in experiment L.O. 1982: A, Live wet weight, illustrating exponential growth through day 60. B, Dead wet weight, illustrating logarithmic growth from day 60 to maturity. C, Live mantle length measurements, showing exponential growth as in A. D, Dead mantle length measurements, showing logarithmic growth to maturity as in B. Numbers above rectangles indicate actual number of squid measured for that mean.

Mean growth was 16 mm/month for this period. Doubling times for weight increased from 12 d at day 60 to 42 d at day 240, and for length from 31 d at day 60 to 109 d at day 240.

The length-weight relationships of squid in L.O. 1981 and 1982 are illustrated in Figure 10 and are compared with data on wild squid (Fields 1965). The slopes of the curves are slightly higher in laboratory-reared animals, indicating that these squid are heavier per unit length than wild squid. Table 3 illustrates differences in predicted weights for representative mantle lengths from L.O. 1982 data versus Fields' (1965) data. The length-weight relationship for males vs. females in L.O. 1981 is shown in Figure 11; no significant differences between sexes were detected ( $P > 0.05$ ).

Statoliths from 55 early hatchlings (L.O. 1982) aged 21 to 79 d ( $\pm 5$  d) were examined to correlate statolith ring numbers with the age of individual

TABLE 3.—Examples of length-weight differences between L.O. 1982 and the data of Fields (1965). Reference Figure 10. ML = mantle length; WW = wet weight.

ML (mm):	25	50	75	100	125
L.O. 1982: WW (g)	0.86	5.22	15.00	31.70	56.60
Fields : WW (g) (1965)	1.31	5.80	13.90	25.90	41.90

squid (Fig. 12). The linear relationship between the number of rings ( $R$ ) and the age in days ( $D$ ) for 43 statoliths aged 21 to 65 d was  $R = -7.24 + 1.13 D$ , with an  $r^2$  value of 0.90. Counts of rings differed from the actual age by an average of  $\pm 4.2$  d (range  $-12$  to  $+8$  d).

### Survival

Figure 13 compares survival in the two experiments. The longest lived squid were 248 d in L.O. 1981 and 235 d in L.O. 1982. Survival dropped below 50% on day 15 in L.O. 1981 and on day 2 in L.O. 1982. In L.O. 1982, the early rapid population reduction was due to the removal of newly hatched squid for a different experiment. Mortality rates slowed after the early heavy population reduction; 10% survival occurred on day 120 in L.O. 1981 and on day 49 in L.O. 1982. In all cases, mortality gradually slowed after 60- to 70-d posthatching. Survival reduction after day 180 in both experiments was considered to be related to spawning (Figs. 13A, B).

In L.O. 1981 experiment (Fig. 13A), 50% survival of 391 squid transferred to the large RW system occurred at day 114, but at day 84 for the 129 squid left in the same small CT system. For example, 10 d after transfer the squid in the CT system had 30% mortality whereas those in the RW system experienced only 20% mortality. Thus, transferring squid at about 60 d gave better results by reducing the mortality from fin and skin damage that accrues in the smaller CT system.

In the middle of L.O. 1981 (day 108) cannibalism was observed. The fins and/or posterior mantle were clearly eaten in some squid; these squid differed from those that died from fin damage or from scraping on the bottom of the tank since the latter developed lesions near the tip of the mantle (Fig. 14). From days 108 to 206 there were 16 partly eaten squid in the RW system (7% of the population on day 108), compared with two squid (of 10 total) in the CT system between days 157 and 172. Slightly higher levels of cannibalism (19% between days 97 and 191) were observed in L.O. 1982.

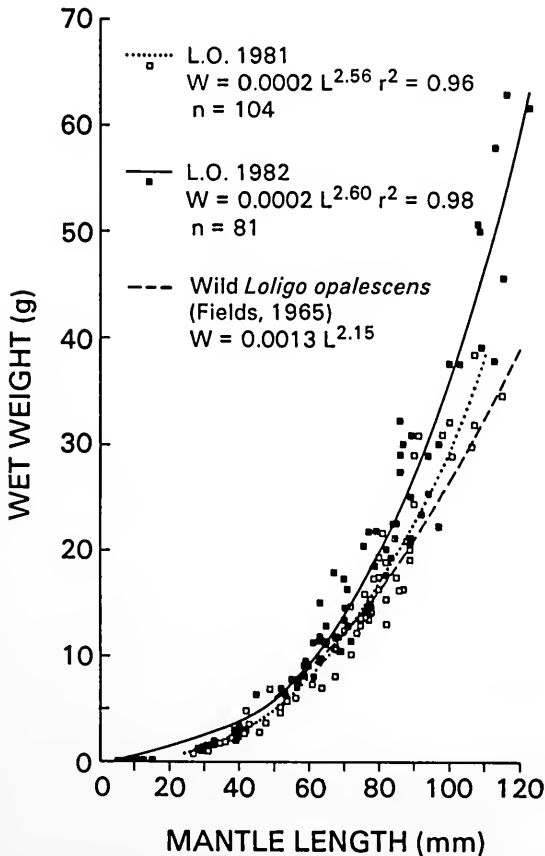

FIGURE 10.—Comparison of length-weight relationship of squid cultured in L.O. 1981 and 1982, and squid collected in the field at Monterey Bay, CA by Fields (1965).

FIGURE 11.—Length-weight relationship of males versus females in L.O. 1981, compared with the data of Fields (1965).

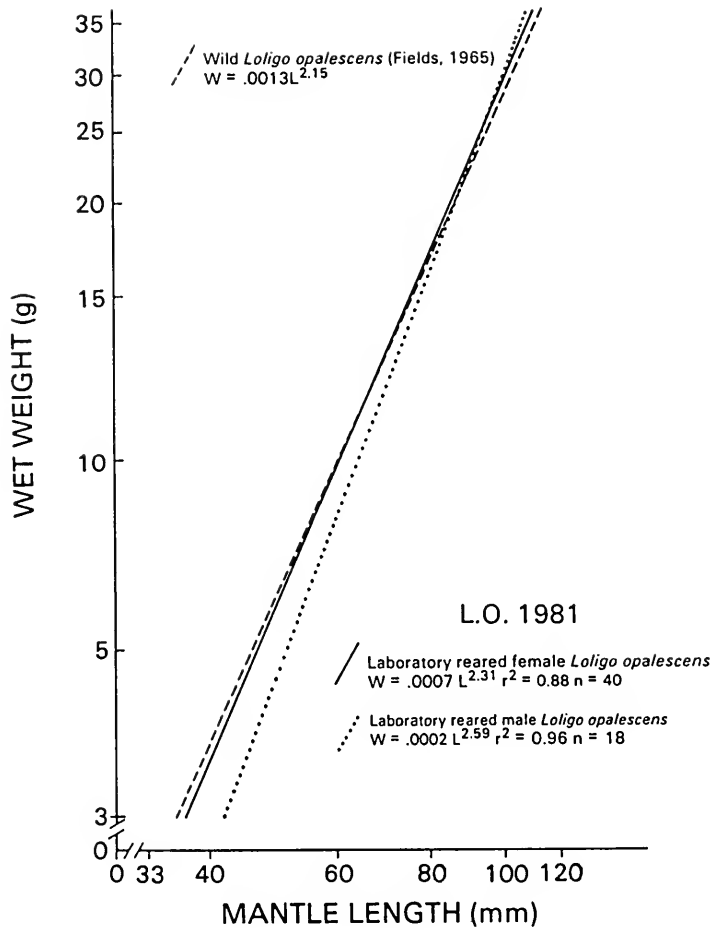
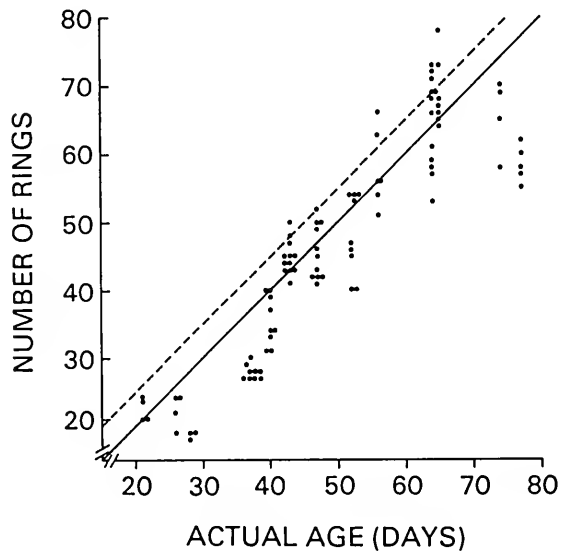

FIGURE 12.—Increase in statolith rings with age (L.O. 1982). Closed circles represent ring counts of 55 statoliths from *L. opalescens* of known-age (21-79 d). Each statolith was counted twice from different photographs. Unclear exposures (16) were not counted. The solid line represents a linear relationship of age and ring numbers. The space between the solid and dashed lines reflects the 5 d of hatching.



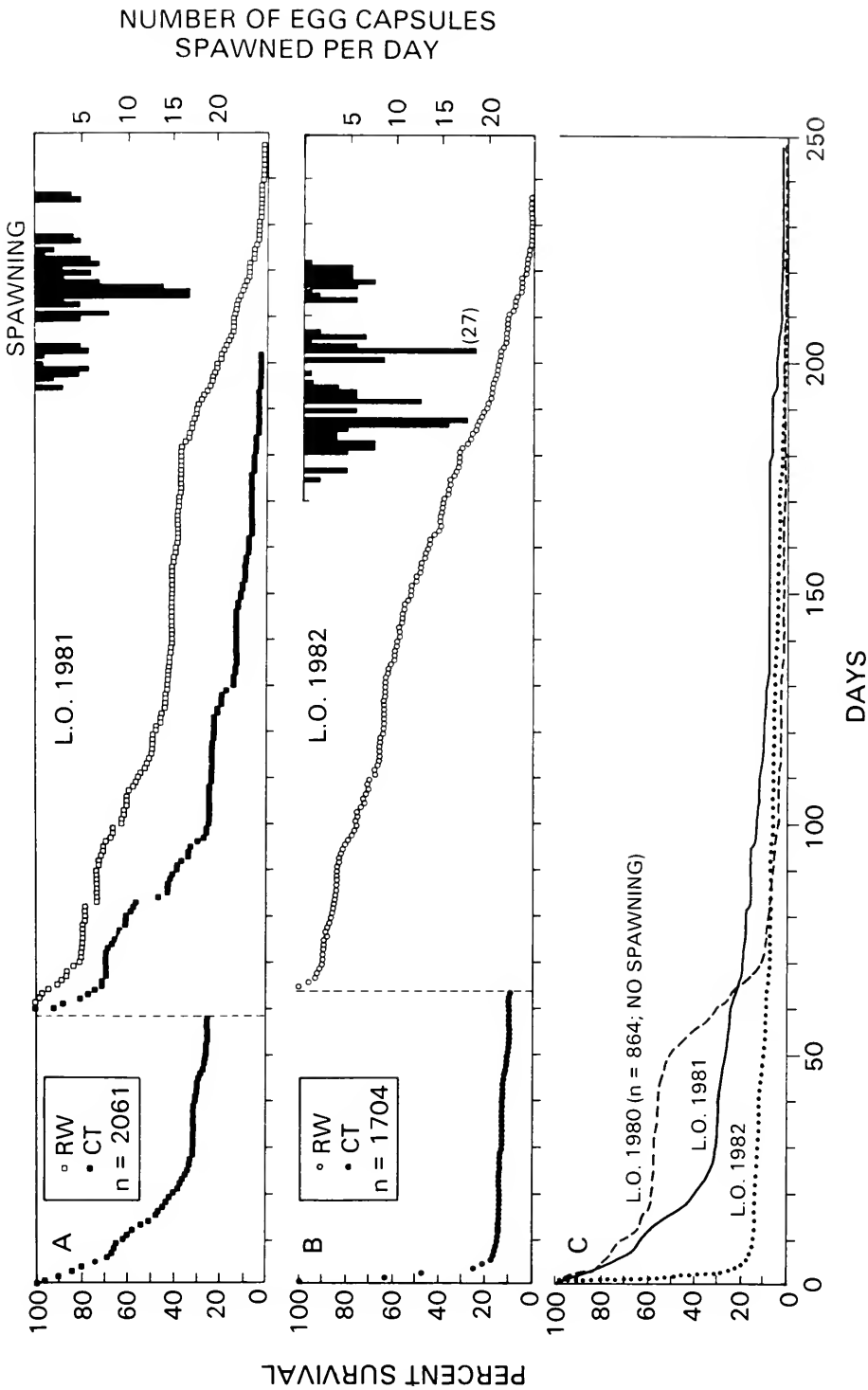

FIGURE 13.—Comparison of daily percent survival and spawning (number of egg capsules in inverted histogram) activity of *Loligo opalescens* in three culture experiments. A, on day 59 (vertical dashed line), 391 squid were transferred to the 10,000 L RW system for the rest of the experiment; the remaining 129 squid were cultured in the CT system. Survival thereafter was calculated as a percent of the number of squid alive on day 59 in each tank system. B, The cultured 147 squid were transferred to the RW system on day 63. Spawning began early on day 173. A maximum of 27 egg capsules were spawned in 1 d. C, Comparison of the daily percent survival data from all three *L. opalescens* culture experiments. CT and RW data were pooled for each experiment for this analysis.

Other causes of injury and death in the later part of RW culture were 1) swimming into the water intake pipes, 2) jetting out of the water and hitting the bottom of the polystyrene tank covers, and 3) colliding occasionally with the walls and slowly accruing fin damage. The resulting abrasions on the body and fins (Fig. 14) were probably the main factor influencing mortality after about 60 d of culture.

1 or 2 d. They usually had some obvious skin damage and were probably unable to maintain disciplined swimming with the school.

### Sexual Maturation, Mating, and Egg Laying

In L.O. 1981, the first signs of sexual maturation were when chromatophore patterns associated with

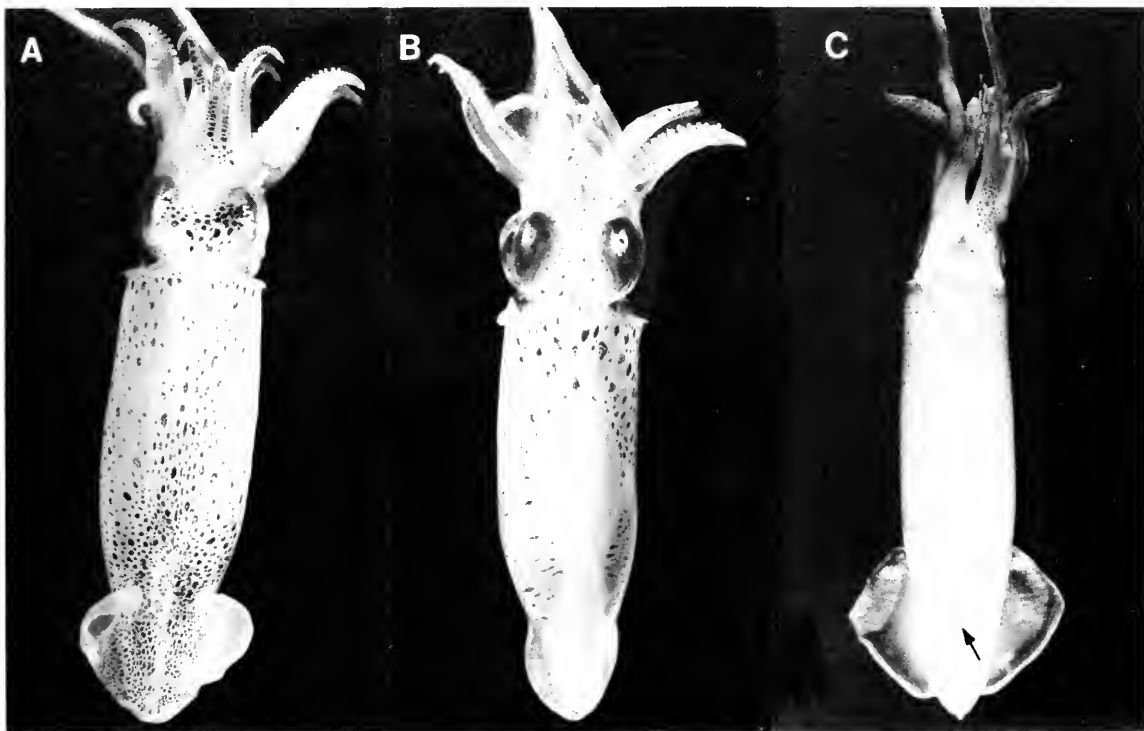

FIGURE 14.—Fin and skin damage that resulted in mortality of cultured squid. A, Epidermis and dermis missing on periphery of fins, with fin margin thickened from scar tissue. B, More extreme case with damage extended to mantle. C, Excessive skin damage on ventral mantle caused by scrapping the tank bottom. A hole (arrow) was produced in the mantle wall and prevented jet-propulsed swimming.

### Schooling Behavior

The squid were able to hold a swimming position in the tank between days 41 and 44 in both L.O. 1981 and 1982, corresponding to a mantle length of about 10 mm. In the early phase of RW culture in L.O. 1981 and 1982, squid swam in two or three loose groups throughout the RW. Later, they schooled together at both ends. The reasons for this behavior are unknown, but it may have been related to lower illumination levels at the RW ends or to the well-aerated seawater entering the RW at these points. Individuals not schooling were often found dead in

courting were observed in males. On day 174 two males showed the "Shaded testis" component of patterning similar to that described in *Loligo plei* (Hanlon 1982). Later, other chromatic components of patterns seen in mature males of *Loligo plei* were observed: faint, lateral stripes on the mantle ("Lateral flame"); a discontinuous suture line along the fin margin ("Stitch work fins"); a clear area in the dorsal portion of the mantle above the testis ("Accentuated testis").

Maturation and spawning occurred earlier in L.O. 1982 than L.O. 1981 (Fig. 13). The penis was first recognizable in a 100-d-old male (25 mm ML) and



the nidamental gland was observed in a 101-d-old female (23 mm ML) in L.O. 1981. The penis was first recognizable in a 93-d-old male (29 mm ML, 1.15 g WW), and the nidamental gland was observed in a 92-d-old female (33 mm ML, 1.71 g WW) in L.O. 1982. Figure 15 shows that females become mature at approximately 60 mm ML. This maturation index is based upon reports by Hixon (1980a) and Macy (1982) in which the ratio of nidamental gland length to mantle length is  $>0.20$ . Squid this size could produce fully formed egg capsules. The smallest male with spermatophores was 71 mm ML in L.O. 1982.

In L.O. 1981, first mating activity was observed on day 193. A pair was swimming together, a second male interrupted, and a third male grasped the female in the midmantle area but she jetted away. On day 197 another pair was swimming together at the end of the RW and a brief head-to-head mating was observed. They separated for about 1 min, then

the male grabbed the female by the arms for a second time. Drew (1911) illustrated this copulating position in *Loligo pealei*. A second mating position was observed on day 226. A male grasped a female's mantle one-third of the way from the posterior tip of the mantle, then he gradually moved to the female's head near the mantle opening and then let go. This was done very swiftly and it was impossible to see if a spermatophore was passed. Freshly dead females had spermatophores attached under the sperm receptacle below the mouth after head-to-head matings. Mating activity was not as closely monitored in L.O. 1982, but first observations were several weeks earlier (before day 175).

Spawning started on day 196 and lasted till day 239 in L.O. 1981. Of 151 egg capsules, 24 (16%) were unfertilized (Table 4). Squid kept in the CT system (3°C higher temperature from day 125) spawned first on day 185, 11 d earlier than the RW system, but none were fertile. Spawning occurred earlier in L.O. 1982, beginning day 175 and ending day 222. All of the 199 spawned capsules were infertile. The maximum number of spawned capsules in a single day was 27 on day 203 (Fig. 13B). Most eggs were collected in the morning indicating that spawning

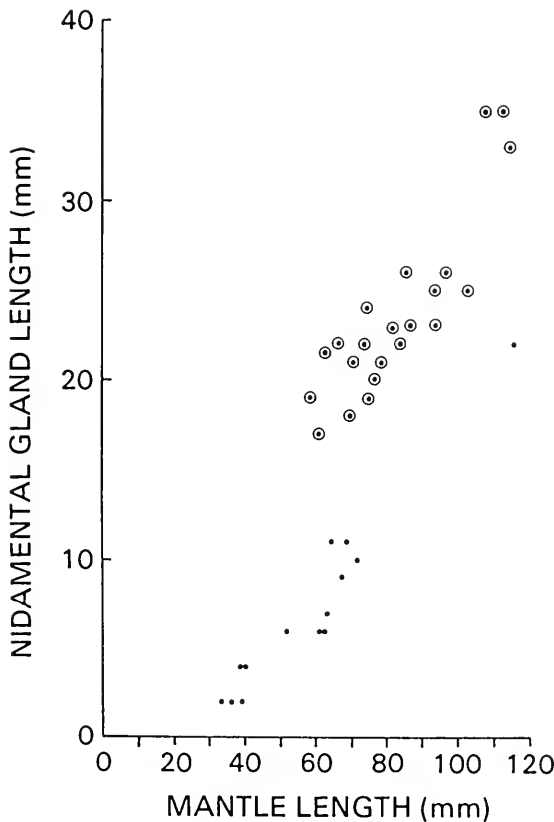

FIGURE 15.—Maturation index for females from pooled data of L.O. 1981 and 1982. Dots with circles indicate sexually mature females in which the ratio of nidamental gland length to mantle length is  $>0.20$ . See text.

TABLE 4.—Spawning date and number of egg capsules spawned in the raceway system (L.O. 1981).

Month/ day	Age/ day	Capsules spawned	Capsules without eggs
05/01	196	3	0
05/03	198	2	0
05/04	199	5	0
05/05	200	6	0
05/06	201	1	0
05/08	203	1	0
05/09	204	6	0
05/10	205	5	0
05/16	211	5	1
05/17	212	8	0
05/19	214	5	2
05/20	215	3	3
05/21	216	17	8
05/22	217	17	2
05/23	218	14	0
05/24	219	7	0
05/25	220	3	0
05/26	221	6	0
05/27	222	3	0
05/28	223	7	2
05/29	224	6	1
05/30	225	1	0
05/31	226	2	1
06/02	228	5	2
06/03	229	4	2
06/11	237	5	0
06/12	238	4	0
<b>Total</b>		<b>151</b>	<b>24 (16%)</b>

took place mainly at night, but some individuals spawned during the day. Egg capsules in the early portion of the spawning period were small, with a length of 2.2 to 4.7 cm when laid. Superficially there were no differences with normal capsules, but usually the early ones contained only a few eggs while a few had none. Typical newly laid egg capsules were between 6.0 and 9.0 cm and contained an average of 156 eggs (range 107-199). These egg capsules were normal in length and egg number compared with *L. opalescens* in nature (Hixon 1983).

A large number of typical egg capsules were incubated and a normal second generation hatched. The average mantle length of second generation hatchlings was 2.3 mm ML (range 1.9-2.7 mm ML,  $n = 13$ ). This was smaller compared with first generation hatchlings (average 2.7 mm ML) but there was no difficulty in rearing them on copepods for 10 d. Since initial survival was confirmed, further rearing ceased.

In L.O. 1982, three patches of artificial egg capsules made of silicon glue were placed on the bottom of the RW tank to stimulate spawning. The squid spawned 15 fertilized egg capsules around the artificial capsules (Fig. 16).

## DISCUSSION

### Water Quality and System Design

Water quality was consistently good throughout both experiments and was probably a major contributor to culture success. The CT systems were particularly clean (Fig. 2) because the water volume was relatively large for the small biomass of animals. In the large RW system, water quality changed only slightly when the biomass of squid and food organisms reached its maximum from approximately days 150 to 220 (Figs. 2, 5, 7). The highest total biomass level was 1,706 g between days 180 and 190 in L.O. 1981, which is equivalent to approximately 155 g/m<sup>3</sup> of water. At this point, the nitrate-nitrogen level reached 23 mg/L, which is still low [Spotte (1979a) gave a conservative safe level of 20 mg/L for most marine organisms]. Ammonia-nitrogen and nitrite-nitrogen levels always stayed below the recommended safe level of 0.1 mg/L (Spotte 1979a) in both experiments. We know from our recent unpublished data that a drop in pH (which accompanies nitrogen level increase; Hirayama 1966) is more dangerous to squid; therefore, addition of sodium bicarbonate was necessary to keep the pH near 8.0. Several improvements in system design helped improve water quality over our *L. opalescens*

experiment in 1980 (Yang et al. 1983a), when nitrite-nitrogen reached 1.22 mg/L and nitrate-nitrogen reached 39.20 mg/L. These included increased culture water depth and volume in the RW (5,990 to 8,610 L), increased number of protein skimmers from 2 to 5 and generally more oyster shell substrate area for increased biological filtration. Furthermore, regular addition of trace metals assured high levels since losses occur through foam fractionation in protein skimmers (Spotte 1979b) and metabolism of filter bed bacteria, squid, and food organisms.

### Growth and Survival

Growth in *L. opalescens* is very fast (Figs. 8, 9) and conforms to a general trend among cephalopods in which the early life cycle is characterized by rapid exponential growth, followed by slower logarithmic growth until reproduction and death (Boyle 1983; Forsythe and Van Heukelem in press).

Egg development is temperature-dependent and takes 19 to 25 d at 16.5°C (Fields 1965), 27 to 30 d at 15°C (L.O. 1981, this report) and 30 to 35 d at 13.6°C (McGowan 1954). Hatching success was high, and young squid survived several days on internal yolk. Many squid will feed before internal yolk is absorbed (Boletzky 1975). The young will feed on a variety and wide size range of crustaceans and fishes (Fig. 4). Zooplankton, but especially copepods, are readily attacked and eaten by very young squid. It is noteworthy that relatively large mysids could be fed successfully to hatchlings within the first week (Fig. 3: L.O. 1982) and for 3 to 4 mo thereafter as a primary food. Mysids are easier to collect and acclimate to laboratory conditions and are thus attractive to the culturist for pragmatic reasons. *Loligo opalescens* hatchlings (2.3-2.8 mm ML) are much larger than those of *L. pealei* (1.7 mm ML) or *L. plei* (1.6 mm ML) (McConathy et al. 1980) and are consequently easier to rear because larger food organisms can be used immediately. Larval fish were attractive to young squid but are difficult to provide.

Major mortality occurred within 10 d posthatching. Although high food densities and variety were provided (Tables 1, 2; Figs. 3, 4, 5), many squid appeared to have difficulty making the transition from passive yolk absorption to active feeding on live organisms. A learning process may be involved, because capturing copepods was initially difficult (squid have been observed to miss 40 times consecutively) and improved when squid attacked from behind. Past experience (cf., Yang et al., 1983a) suggested that increasing food abundance relative to

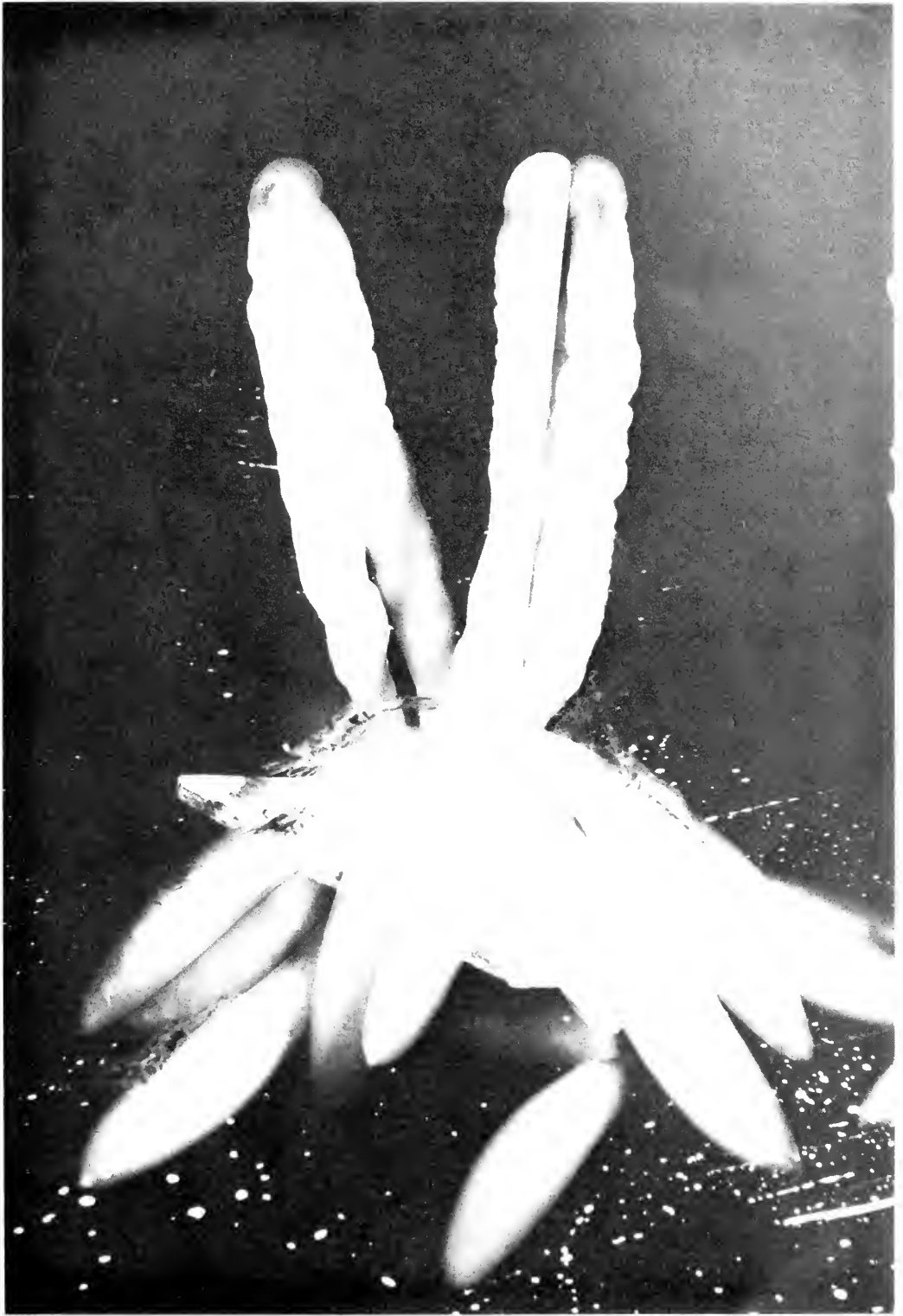

FIGURE 16.—Fertilized egg capsules laid at the base of artificial silicon egg capsules (erected).

squid abundance would enhance survival, but no change has been observed. Further experimentation is required, but a central question is whether many squid are genetically unfit to survive or whether we have not yet provided the proper foods and environment for good survival. Although the former prospect seems unlikely from the evolutionary viewpoint, our experimental design has certainly promoted outstanding growth in surviving squid.

With the growth data from live squid in L.O. 1982, we confirmed that squid grow exponentially both by weight and length during the first 2 months (Fig. 9). Weight increases at a rate of 8.35% body weight/day (doubling their weight every 8 d) and this compares very favorably with octopods (4-7%), other squid (5-7%), and cuttlefishes (5-12%) (Forsythe and Van Heukelem in press). Logarithmic growth during the rest of the life cycle also conforms generally to other cephalopods, except that some cephalopods have a longer exponential growth period up to one-half their life cycle (Forsythe and Van Heukelem in press). The length-weight relationship (Figs. 10, 11) generally conforms to those of wild-caught squid, but indicates that laboratory-reared squid weigh more per unit length (Table 3), possibly, as a result of reduced swimming. The slopes of the lines (all <3.0) indicate allometric growth (Forsythe and Van Heukelem in press). The estimated feeding rates of 18.0% body weight/day (days 121-176) in L.O. 1982 and 14.9% (days 108-230) in L.O. 1981 compare well with the estimate of 14.4% (on a dry weight basis) for *L. opalescens* of a similar size in the natural population (Karpov and Cailliet 1978). Younger *L. opalescens* (48-56 d) fed on *Artemia* were estimated by Hurley (1976) to feed at rates of 36 to 80%/day (dry weight). Another loliginid squid, *Sepioteuthis sepioidea*, had feeding rates of 20 to 25% (wet weight) between days 70 and 105 (La Roe 1971). Other squids of similar size show comparable rates: *Loligo plei*, 10 to 18% (Hanlon et al. 1983); *L. pealei*, ca. 11% (Macy 1980); *Illex illecebrosus*, ca. 10% (Hirtle et al. 1981); and *Todarodes pacificus*, ca. 24% (Soichi 1976).

Maximal survival and size in our three major experiments were L.O. 1980 - 233 d, 77 mm ML (Yang et al. 1983a); L.O. 1981 - 248 d, 113 mm ML; L.O. 1982 - 235 d, 116 mm ML. Figure 13 illustrates survival throughout these experiments and shows that there was a long, steady mortality after the initial high mortality of the first 2 wk. Once in the RW systems (i.e., after 2 mo) most mortality was attributed to fin and skin damage (Hulet et al. 1979; Fig. 14) that accrued slowly from colliding with the sides of the tank. The painted designs on the walls were

clearly helpful in reducing wall collisions but damage over time was lethal in many squid. Cannibalism accounted for a minor number of deaths (ca. 7-10%). Most mortality after day 170 in L.O. 1981 and L.O. 1982 was due to 1) sexual maturation and spawning and 2) an unusual situation where fully mature females scraped the bottom of the tank often enough to wear a large lesion through the ventral mantle (Fig. 14C).

It should be noted that survival rate was greater where large tanks such as the RW were used. In L.O. 1981 (Fig. 13A), 50% survival of squid left in the smaller CT system occurred only on day 84 compared with day 114 for those transferred to the RW.

In summary, growth was excellent, indicating that estuarine foods were sufficient and that system design and water quality were conducive to growth, especially in the first 2 mo. Survival was good from the historical perspective (cf., Arnold et al. 1974; Yang et al. 1983b) but rather poor from the production standpoint. A recent hypothesis concerning temperature effects on growth (O'Dor and Wells in press) indicates that higher temperature in the first half of the life cycle and lower temperature in the latter half may enhance growth and survival of laboratory-reared squid. In future work it would be desirable to enhance growth during the latter half of the life cycle and to provide an environment in which somatic growth continues for a longer period before sexual maturation occurs.

## Behavior

Squid are generally sensitive laboratory animals, responding very quickly with their sophisticated sensory systems to any fast environmental change. They habituate to many daily disturbances in the tank system (e.g., tank cleaning, etc.) provided everything is done slowly. Later in the life cycle they become slightly less sensitive.

Hatchlings were positively phototaxic and often swam at the water surface. In nature, young squid have been caught mainly by plankton nets mounted on a sled and towed along the bottom (Recksiek and Kashiwada 1979). It is not possible at this time to explain the movements of hatchlings in nature based upon laboratory observations of positive phototaxis.

A key component in feeding behavior was movement by the prey, regardless of the size or age of the squid or food organisms. Young squid preferred copepods but ate a variety and a very wide size range of organisms (Fig. 4). In general, the squid preferred crustaceans over fish, but the relatively

restricted diet offered to them may have influenced that. Fields (1965) and Karpov and Cailliet (1978) agreed that *L. opalescens* adults prefer fish over crustaceans but there was no clear-cut preference in younger squid. It is clear from laboratory observations that squid learned to associate certain events with feeding (e.g., opening the tank top), and the general level of activity increased markedly during these periods. We were also able to stimulate feeding in the CT systems by dimming and brightening the lights to attract the planktonic food organisms into the water column near the squid.

Schooling behavior was correlated with size. Larger body size and growth of the fins were required before squid could swim in place against a current; this occurred at about 10 mm ML (41-44 d in L.O. 1981 and 1982). Hurley (1976) reported that *L. opalescens* 4 to 5 mm ML could briefly form loose schools when disturbed, but this may have been in static water. At 15 mm ML, *L. opalescens* were powerful enough to form distinct schools (Yang et al. 1983a), indicating the size at which one could expect schooling to appear in nature. How and why squid begin schooling in nature has not been investigated.

Cannibalism was not seen in L.O. 1980 (Yang et al. 1980b, 1983a) and accounted for 7 to 19% of mortalities in experiments L.O. 1981 and 1982. Lack of food did not precipitate this behavior. On the spawning grounds in Monterey, CA, mature squid often have cephalopod remains in their stomachs (Loukashkin 1977; Karpov and Cailliet 1978); in one case as many as 75% of males had squid remains in their stomachs (Fields 1965). This could be a behavioral response to overcrowding (Fields 1965) or to restrict prey organisms on the spawning grounds. We anticipate that cannibalism in tanks would be a significant problem only during prolonged food shortage or if squid of a very wide size range were in the same system (cf., Hanlon et al. 1983).

Body patterning was not studied in great detail but several observations are noteworthy. Young animals are capable only of simple chromatic expression such as "All dark" or "Clear". When excited, *L. opalescens* of all sizes show some degree of darkening; this is similar to other loliginid squids (cf., Hanlon 1982; Hanlon et al. 1983). By the time the squid are approximately 80 to 100 mm ML they can show a repertoire that includes about a dozen chromatic components of patterning (e.g., Dark arm tips, Ring on the mantle, etc.). This places *L. opalescens* in a category of rather simple patterning, making it comparable to *L. pealei* and *L.*

*vulgaris*, slightly more complex than *Lolliguncula brevis* (Dubas et al. 1986), but simpler than *Loligo plei* (Hanlon 1982; Hanlon et al. 1983). Further analysis is warranted because much behavior is expressed through patterning and may yield important behavioral clues.

Social behavior was first manifest in schooling (see above) then much later in mild intraspecific aggression. Occasionally two squid would fight over one fish, but the first firm observations came at the time of sexual maturation when mating was seen. As Hurley (1977) noted, there were no obvious interactions among males to form a dominance hierarchy for mate selection. Mating was initiated by males, and both typical forms of mating were observed: "head-to-head" matings in which spermatophores were stored in the *bursa copulatrix*; and male-underneath matings in which spermatophores were deposited in the mantle near the oviduct (cf., Drew 1911; McGowan 1954; Hurley 1977). Females mated promiscuously as they do in nature, and females were also stimulated visually to lay eggs around artificial facsimiles of egg mops (Fig. 16). Males were not observed to guard or defend egg capsules as described by Hurley (1977), but this may have been because relatively few egg capsules were left in the tank each day.

## Reproduction

In L.O. 1980 only the subadult stage was reached in 233 d (Yang et al. 1980b, 1983a). Full sexual maturity was achieved in L.O. 1981 and 1982 and spawning of viable eggs occurred from days 196 to 239 and 175 to 226, respectively (Fig. 13). Relatively few egg capsules were laid per female, and these capsules were generally shorter and contained slightly fewer eggs per capsule than those reported from natural populations, but this was probably due to the smaller size of these spawning females (Hixon 1983).

Laboratory cultured *Loligo opalescens* matured precociously and since they are terminal spawners this prevented attainment of full adult size. In the laboratory, males as small as 71 mm ML had fully formed spermatophores and females became sexually mature beginning at about 60 mm ML (Fig. 15). In nature, the average adult size is 150 mm ML for males and 140 mm ML for females, although size at onset of maturity is variable and can be as low as 72 mm ML for males and 81 mm ML for females (Fields 1965; Hixon 1983). Precocious maturation has also been reported in other squid maintained in the laboratory (cf., Durward et al. 1980; Hanlon et

al. 1983). The stimuli (or stressors) that cause this are unknown.

Van Heukelem (1979) reviewed environmental factors that influence maturation in cephalopods and reported that light, temperature, and nutrition are the key stimuli. In our experiments, light was constant (24 h on), temperature was consistent (ca. 15°C) and food was relatively constant and highly available compared with natural populations. However, all three conditions are different from nature. The most interesting result concerns light, which is thought to have a major effect on maturation through the light-optic gland-gonad pathway (cf., Mangold and Froesch 1977; Wells and Wells 1977). Long daylength of high intensity is thought to delay maturation; in our experiments daylength was 24 h but intensity (ca. 4-17 lux) was low compared with full sunlight. However, we do not know what light intensity subadult *L. opalescens* are subject to in nature. Clearly, long daylength alone does not delay maturation in *L. opalescens*. Future experimentation will be necessary to identify the combinations of environmental factors that affect maturation in the laboratory.

### Life Cycle Comparisons: Laboratory vs. Fishery Data

In general, five major rearing attempts have been successful in varying degrees: 1) Hurley (1976), to 100 d; 2) Hanlon et al. (1979), to 79 d; 3) L.O. 1980, to 233 d and subadult stage (Yang et al., 1980b, 1983a); 4) and 5) L.O. 1981 and 1982, to sexual maturity and egg laying within 8 mo (this report). From this it is clear that the life cycle can be <1 yr under laboratory conditions.

Fields (1965) stated, based upon fishery data, that "Almost all females spawn at the age of 3 years...." However, more recent field (cf., Recksiek and Frey 1978) and laboratory studies of *L. opalescens* (above) indicate that life span estimates beyond 2 years are excessive. Furthermore, recent books on cephalopod life cycles (Boyle 1983, in press) indicate that few squid live beyond 2 years.

Growth information on laboratory populations is now quite good. The present data allow an accurate assessment by weight from hatching onwards (Fig. 9) and firmly verify that young squid are capable of dramatically fast, exponential growth when food is not limiting. This indicates that in nature squid are capable of exploiting plankton blooms and other instances of greater food availability; the highest feeding rates we estimated (29%) also confirm field

observations that squid will eat large quantities of food when available and when necessary. Field estimates of growth by Fields (1965) and Spratt (1978) are compared with laboratory data in Figure 17. Field's data are very conservative (averaging 4 mm/month) and based only upon monthly modal length-frequency diagrams from squid on or near spawning grounds. Spratt (1978) estimated growth from statolith rings and hypothesized that growth is rapid during the first few months then decreases with age. Laboratory growth was much faster, but animals were not subject to environmental fluctuations. We estimate that growth in nature approximates something between the laboratory data and Spratt's data, and that date of hatching, seasonal temperature fluctuations, and food availability result in life cycle variations between 1 and 2 years. One would expect to observe exponential growth of young squid during spring and summer when temperatures and food availability are high, slower logarithmic growth in fall and winter, and spawning the following spring.

Field evidence (McGowan 1954; Fields 1965) and reproductive physiology studies (Grieb and Beeman 1978; Knipe and Beeman 1978) indicate that *L. opalescens* is a terminal spawner (Hixon 1983), and our laboratory observations verify this since all animals died shortly after spawning (Fig. 13).

Rings in statoliths may eventually be used as a reliable age marker to determine growth rate and life span. Our preliminary results in this paper from 43 statoliths of known age support Spratt's (1978) conclusion that ring deposition occurs roughly on a daily basis during the first 65 d. However, our laboratory data indicate that the relationship does not hold well beyond that age, although Spratt suggested that daily ring deposition occurs up to 150 d. Thereafter, Spratt (1978) hypothesized lunar (monthly) rings on statoliths but there are no laboratory data for comparison. Daily, fortnightly, or monthly growth rings have been hypothesized in the squid *Gonatus fabricii* (Kristensen 1980), *Todarodes sagittatus* (Rosenberg et al. 1981), *Illex illecebrosus* (Hurley and Beck 1980), and *Loligo forbesi* (Martins 1982), but there are no hard data to confirm these estimates. The mechanism of ring formation is unclear but may be related to feeding, since in this part of our laboratory study the squid received food during 12 h and none for the next 12, while concurrently there was constant light and no temperature fluctuation (Hixon and Villoch 1984). Hurley et al. (1985) and Dawe et al. (1985) found evidence of daily rings in statoliths by inoculating squid with tetracycline or strontium. Further work is required to

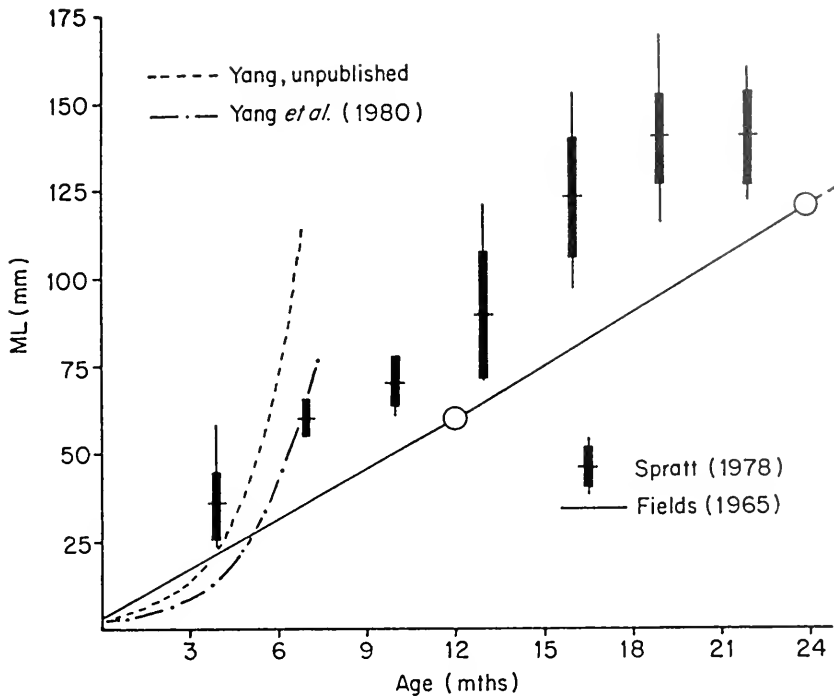

FIGURE 17.—From estimates of growth rate in mantle length of *Loligo opalescens*. Fields (1965) used population data. Spratt (1978) combined age (statolith ring counts) and ML data and calculated a mean (horizontal line), range (vertical line) and standard deviation (vertical bar) values for 3-month intervals throughout the life cycle. Yang et al. data are from laboratory rearing studies (1980b, 1983a, this report) (modified from figure 7.1, Hixon 1983).

determine if and how statolith rings are correlated with age.

A major gap in fisheries studies concerns where the hatchlings go from the spawning grounds. Very few young squid have been captured (Okutani and McGowan 1969; Recksiek and Kashiwada 1979) even in the vicinity of spawning grounds. Hatchlings are positively phototaxic and this may serve to disperse them immediately from the spawning grounds. Thereafter their movements are unknown, although rarely young squid 3.5 to 7.0 mm ML have been caught in neritic plankton samples, usually at depths of 25 to 40 m nearshore in water between 12.5° and 21.0°C (Okutani and McGowan 1969). Detailed knowledge of water currents between spawning grounds and nearshore, combined with monitoring of plankton abundance (especially copepods and larval fish) by surface, bottom and oblique tows may provide important clues about movements and feeding patterns of young-of-the-year squid. Laboratory studies indicate that squid can swim well enough to hold their position against a current by 10 mm ML, or about 40 to 45 d posthatching. By 15 mm ML (ca.

60-80 d) they can form and maintain well-formed schools. The functions of schooling in nature probably relate to defense, feeding and migratory behavior.

The California squid fishery has nearly collapsed since El Niño of 1983, and the squid population has been generally displaced northward as far as southern Canada. Some small spawning populations are still present in southern and central California. It may be rewarding to investigate feeding and migratory patterns of young and adult squid to better understand population recruitment into this ecologically and economically important fishery resource.

### Biomedical Research Applications

*Loligo opalescens* has proved to be a suitable model for giant axon preparations (e.g., Llano and Bezanilla 1980). However, for most axon experiments the largest axons (>400  $\mu\text{m}$  diameter) are needed; this requires the largest squid taken in the fishery, usually 150 mm ML and larger. Our largest squid, 116 mm ML, had an axon about 240  $\mu\text{m}$  in

diameter. Unknown factors in our laboratory environment resulted in precocious sexual maturation and thus smaller animals. Therefore, we are now evaluating the culture potential of *Loligo forbesi*, a much larger squid from the eastern Atlantic, since precocious maturation in that species would still result in axons  $>500 \mu\text{m}$ . Preliminary experiments bear out this proposition as we have recently cultured *L. forbesi* to 140 mm ML and 400  $\mu\text{m}$  diameter axons. However, *L. opalescens* would be an excellent model for the giant synapse preparation in which smaller squid are most suitable. Therefore, *L. opalescens*, with a now substantial amount of culture information, may be a highly suitable species in the United States for providing squid on a consistent basis for neuroscience research. Moreover, the recent disappearance of *L. opalescens* (1983-85) from traditional fishing grounds in California make laboratory culture an attractive alternative for animal supply.

### ACKNOWLEDGMENTS

We acknowledge funding from DHHS grant RR01024, Division of Research Resources, National Institutes of Health, and from the Marine Medicine General Budget 7-11500-765111 of The Marine Biomedical Institute, The University of Texas Medical Branch. We especially appreciate the assistance of John W. Forsythe on the rearing experiments and the growth data analyses. We also thank Joseph P. Hendrix Jr. for assistance in rearing and Lea A. Bradford for water analyses and data gathering. Connie Arnold and Joan Holt of the Port Aransas Laboratory, University of Texas, kindly supplied the red drum eggs. We are grateful to Aquabiology (Seibutsu Kenkyusha Publishing Co., Tokyo) for permission to reprint several figures. Academic Press Inc. kindly gave us permission to use a modification on Figure 17. Phillip G. Lee kindly read and improved the final draft.

*Note:* We dedicate this paper to our coauthor and dear friend Dr. Raymond F. Hixon, who passed away on 19 March 1984 as he valiantly fought to recover from chronic myelogenous leukemia.

### LITERATURE CITED

- ARNOLD, J. M.  
1965. Normal embryonic stages of the squid, *Loligo pealei* (Lesueur). Biol. Bull. (Woods Hole) 128:24-32.
- ARNOLD, J. M., W. C. SUMMERS, D. L. GILBERT, R. S. MANALIS, N. W. DAW, AND R. J. LASEK.  
1974. A guide to laboratory use of the squid *Loligo pealei*. Marine Biological Laboratory, Woods Hole, MA, 75 p.
- ATZ, J. W.  
1964. Some principles and practices of water management for marine aquariums. In J. R. Clark and R. L. Clark (editors), Sea-water systems for experimental aquariums, p. 3-16. U.S. Fish Wildl. Serv., Res. Rep. 63.
- BOLETZKY, S. V.  
1975. A contribution to the study of yolk absorption in the Cephalopoda. Z. Morphol. Tiere 80:229-246.
- BOWER, C. E., D. T. TURNER, AND S. SPATTE.  
1981. pH maintenance in closed seawater culture systems: limitations of calcareous filtrants. Aquaculture 23:211-217.
- BOYLE, P. R. (editor).  
1983. Cephalopod life cycles, Vol. I: Species accounts. Acad. Press, Lond., 475 p.  
In press. Cephalopod life cycles, Vol. II: Comparative reviews. Acad. Press, Lond.
- DAWE, E. G., R. K. O'DOR, P. H. ODENSE, AND G. V. HURLEY.  
1985. Validation and application of an ageing technique for short-finned squid (*Illex illecebrosus*). J. Northwest Atl. Fish. Sci. 6:107-116.
- DREW, G. A.  
1911. Sexual activities of the squid, *Loligo pealei* (Les.). J. Morphol. Wistar Inst. Ana. Biol. Phila. 22(2):327-359.
- DUBAS, F., R. T. HANLON, G. P. FERGUSON, AND H. M. PINSKER.  
1986. Localization and stimulation of chromatophore motoneurons in the brain of the squid *Lolliguncula brevis*. J. Exp. Biol. 121:1-25.
- DURWARD, R. D., E. VESSEY, R. K. O'DOR, AND T. AMARATUNGA.  
1980. Reproduction in the squid, *Illex illecebrosus*: first observations in captivity and implications for the life cycle. ICNAF, Sel. Pap. 6, p. 7-13.
- FIELDS, W. G.  
1965. The structure, development, food relations, reproduction, and life history of the squid *Loligo opalescens* Berry. Calif. Dep. Fish Game, Fish Bull. 131, 108 p.
- FORSYTHE, J. W., AND W. F. VAN HEUKELEM.  
In press. Cephalopod growth. In P. R. Boyle (editor), Cephalopod life cycles, Vol. II: Comparative reviews. Acad. Press, Lond.
- GRIEB, T. M., AND R. D. BEEMAN.  
1978. A study of spermatogenesis in the spawning population of the squid, *Loligo opalescens*. In C. W. Recksiek and H. W. Frey (editors), Biological, oceanographic, and acoustic aspects of the market squid, *Loligo opalescens* Berry, p. 11-21. Calif. Dep. Fish Game, Fish. Bull. 169.
- HAMABE, M.  
1960. Observations of early development of a squid, *Loligo bleekeri* Kieferstein. [In Jpn. with Engl. abstr.] Ann. Rep. Jpn. Sea Reg. Fish. Res. Lab. 6:149-155.
- HANLON, R. T.  
1978. The biology of the squid *Loligo (Doryteuthis) plei* in captivity. Ph.D. Thesis, Univ. Miami, Coral Gables, 120 p.  
1982. The functional organization of chromatophores and iridescent cells in the body patterning of *Loligo plei* (Cephalopoda: Myopsida). Malacologia 23:89-119.
- HANLON, R. T., AND R. F. HIXON.  
1983. Laboratory maintenance and culture of octopuses and loliginid squids. In C. J. Berg, Jr. (editor), Culture of marine invertebrates: Selected readings, p. 44-61. Hutchinson Ross Publishing Co., Stroudsburg, PA, 386 p.
- HANLON, R. T., R. F. HIXON, AND W. H. HULET.  
1978. Laboratory maintenance of wild-caught loliginid squids. In N. Balch, T. Amaratunga, and R. K. O'Dor (editors), Fisheries and marine service technical report 833, p. 20.1-20.14. Dalhousie University, Halifax, Nova Scotia.  
1983. Survival, growth, and behavior of the loliginid squids



- Loligo plei*, *Loligo pealei*, and *Lolliguncula brevis* (Mollusca: Cephalopoda) in closed sea water systems. Biol. Bull. (Woods Hole) 165:637-685.
- HANLON, R. T., R. F. HIXON, W. H. HULET, AND W. T. YANG. 1979. Rearing experiments on the California market squid *Loligo opalescens* Berry, 1911. Veliger 21:428-431.
- HIRAYAMA, K. 1966. Influence of nitrate accumulated in culturing water on *Octopus vulgaris*. [In Jpn. with Engl. abstr.] Bull. Jpn. Soc. Sci. Fish. 32(2):105-111.
- HIRTLE, R. W. M., M. E. DEMONT, AND R. K. O'DOR. 1981. Feeding, growth, and metabolic rates in captive short-finned squid, *Illex illecebrosus*, in relation to the natural population. J. Shellfish Res. 1:187-192.
- HIXON, R. F. 1980a. Growth, reproductive biology, distribution and abundance of three species of loliginid squids (Myopsida, Cephalopoda) in the northwest Gulf of Mexico. Ph.D. Thesis, Miami, Coral Gables, 233 p.
- 1980b. Potential commercial squid resources of the Gulf of Mexico - an updated review. Sea Grant Rep. MASGP-80-012 (Mississippi-Alabama Sea Grant Consortium), p. 54-73.
1983. *Loligo opalescens*. In P. R. Boyle (editor), Cephalopod life cycles, Vol. I: Species accounts, p. 95-114. Acad. Press, N.Y., 475 p.
- HIXON, R. F., R. T. HANLON, S. M. GILLESPIE, AND W. L. GRIFFIN. 1980. Squid fishery in Texas: biological, economic, and market considerations. Mar. Fish. Rev. 42(7-8):44-50.
- HIXON, R. T., AND M. R. VILLOCH. 1984. Growth rings in the statoliths of young laboratory cultured squids (*Loligo opalescens*). Am. Malacol. Bull. 2:93.
- HULET, W. H., M. R. VILLOCH, R. F. HIXON, AND R. T. HANLON. 1979. Fin damage in captured and reared squids. Lab. Anim. Sci. 29:528-533.
- HURLEY, A. C. 1976. Feeding behavior, food consumption, growth, and respiration of the squid *Loligo opalescens* raised in the laboratory. Fish. Bull., U.S. 74:176-182.
1977. Mating behavior of the squid *Loligo opalescens*. Mar. Behav. Physiol. 4:195-203.
- HURLEY, G. V., AND P. BECK. 1980. The observation of growth rings in statoliths from the Ommastrephid squid, *Illex illecebrosus*. NAFO SCR. Doc. 80/II/1, 17 p.
- HURLEY, G. V., P. H. O'DENSE, R. K. O'DOR, AND E. G. DAWE. 1985. Strontium labelling for verifying daily growth increments in the statolith of the short-finned squid (*Illex illecebrosus*). Can. J. Fish. Aquat. Sci. 42:380-383.
- KARPOV, K. A., AND G. M. CAILLIET. 1978. Feeding dynamics of *Loligo opalescens*. In C. W. Recksiek and H. W. Frey (editors), Biological, oceanographic, and acoustic aspects of the market squid, *Loligo opalescens* Berry, p. 45-65. Calif. Dep. Fish Game, Fish. Bull. 169.
- KNIPE, J. H., AND R. D. BEEMAN. 1978. Histological observations on oogenesis in *Loligo opalescens*. In C. W. Recksiek and H. W. Frey (editors), Biological, oceanographic, and acoustic aspects of the market squid, *Loligo opalescens* Berry, p. 23-33. Calif. Dep. Fish Game, Fish. Bull. 169.
- KRISTENSEN, T. K. 1980. Periodical growth rings in cephalopod statoliths. Dana 1:39-51.
- LA ROE, E. T. 1971. The culture and maintenance of the loliginid squids *Sepioteuthis sepioidea* and *Doryteuthis plei*. Mar. Biol. (Berl.) 9:9-25.
- LLANO, I., AND F. BEZANILLA. 1980. Current recorded from a cut-open giant axon under voltage clamp. Proc. Natl. Acad. Sci. USA 77(12):7484-7486.
- LOUKASHKIN, A. S. 1977. On biology of the market squid, *Loligo opalescens*, a contribution toward the knowledge of its food habits and feeding behavior. Calif. Coop. Ocean. Fish. Invest. Rep. 18:108-111.
- MACY, W. K., III. 1980. The ecology of the common squid, *Loligo pealei* LeSueur, 1821, in Rhode Island waters. Ph.D. Thesis, Univ. Rhode Island, Kingston, 249 p.
1982. Development and application of an objective method for classifying long-finned squid, *Loligo pealei*, into sexual maturity stages. Fish. Bull., U.S. 80:449-459.
- MANGOLD, K., AND D. FROESCH. 1977. A reconsideration of factors associated with sexual maturation. Symp. Zool. Soc., Lond. 38:541-555.
- MARTINS, H. R. 1982. Biological studies of the exploited stock of *Loligo forbesi* (Mollusca: Cephalopoda) in the Azores. J. Mar. Biol. Assoc. U.K. 62:799-808.
- MCCONATHY, D. A., R. T. HANLON, AND R. F. HIXON. 1980. Chromatophore arrangements of hatchling loliginid squids (Cephalopoda, Myopsida). Malacologia 19:279-288.
- MCGOWAN, J. A. 1954. Observations on the sexual behavior and spawning of the squid, *Loligo opalescens*, at La Jolla, California. Calif. Fish Game 40:47-54.
- MOE, JR., M. A. 1982. The marine aquarium handbook: beginner to breeder. Norns Publishing Co., Marathon, FL, 169 p.
- O'DOR, R. K., AND M. J. WELLS. In press. Energy and nutrient flow in cephalopods. In P. R. Boyle (editor), Cephalopod life cycles, Vol. II: Comparative reviews. Acad. Press, Lond.
- OKUTANI, T., AND J. A. MCGOWAN. 1969. Systematics, distribution, and abundance of the epipelagic squid (Cephalopoda, Decapoda) larvae of the California current April, 1954 - March, 1957. Bull. Scripps Inst. Oceanogr. 14, Univ. Calif. Press, Berkeley, 89 p.
- RATHJEN, W. F., R. F. HIXON, AND R. T. HANLON. 1979. Squid fishery resources and development in the Northwest Atlantic and Gulf of Mexico. Gulf Caribb. Fish. Inst. 31:145-157.
- RECKSIEK, C. W., AND H. W. FREY (editors). 1978. Biological, oceanographic, and acoustic aspects of the market squid, *Loligo opalescens* Berry. Calif. Dep. Fish Game, Fish. Bull. 169, 185 p.
- RECKSIEK, C. W., AND J. KASHIWADA. 1979. Distribution of larval squid, *Loligo opalescens*, in various nearshore locations. Calif. Coop. Ocean. Fish. Invest. Rep. 20:31-34.
- ROPER, C. F. E., C. C. LU, AND F. G. HOCHBERG (editors). 1983. The biology and resource potential of cephalopods. Memoirs of the National Museum of Victoria, Melbourne, Australia, No. 44, 311 p. Brown-Prior-Anderson Pty. Ltd., Burnwood, Victoria.
- ROSENBERG, A. A., K. F. WIBORG, AND I. M. BECH. 1981. Growth of *Todarodes sagittatus* (Lamarck) (Cephalopoda, Ommastrephidae) from the Northeast Atlantic, based on counts of statolith growth rings. Sarsia 66(1):53-57.
- SOICHI, M. 1976. On the growth and food quantity of young common

- squid, *Todarodes pacificus*, in captivity. [In Jpn.] *Dosuishi* 13(4):79-82.
- SPOTTE, S.  
 1979a. Fish and invertebrate culture. Water management in closed systems. 2d ed. Wiley-Interscience, N.Y., 179 p.  
 1979b. Seawater aquariums: The captive environment. John Wiley and Sons, N.Y., 413 p.
- SPRATT, J. D.  
 1978. Age and growth of the market squid, *Loligo opalescens* Berry, in Monterey Bay. In C. W. Recksiek and H. W. Frey (editors), Biological, oceanographic, and acoustic aspects of the market squid, *Loligo opalescens*, Berry, p. 35-44. Calif. Dep. Fish Game, Fish. Bull. 169.
- STRICKLAND, J. D. H., AND R. T. PARSONS.  
 1972. A practical handbook of seawater analysis. 2d ed. Fish. Res. Board Can., Bull. 167, 310 p.
- TAKEUCHI, T.  
 1969. Strange spawning of the YARI-IKA (*Doryteuthis bleekeri*); letting incubate the eggs by a crab. [In Jpn.] *Fish Mag.* 1969:86-89.  
 1976. Spawning behavior of YARI-IKA (*Doryteuthis bleekeri*). [In Jpn.] *Fish Mag.* 1976:1-4.
- VAN HEUKELEM, W. F.  
 1979. Environmental control of reproduction and life span in *Octopus*: an hypothesis. In S. E. Stancyk (editor), Reproductive ecology of marine invertebrates, p. 123-133. The Belle W. Baruch Library in Marine Science, No. 9, Univ. So. Carolina Press, Columbia.
- WELLS, M. J., AND J. WELLS.  
 1977. Cephalopoda: Octopoda. In A. C. Giese and J. S. Pearse (editors), Reproduction of marine invertebrates 4, p. 291-336. Acad. Press, Lond.
- YANG, W. T., R. T. HANLON, R. F. HIXON, AND W. H. HULET.  
 1980a. First success in rearing hatchlings of the squid *Loligo pealei* Lesueur 1821. *Malacol. Rev.* 13:79-80.
- YANG, W. T., R. T. HANLON, M. E. KREJCI, R. F. HIXON, AND W. H. HULET.  
 1980b. Culture of California market squid from hatching - first rearing of *Loligo* to sub-adult stage. [In Jpn. with Engl. abstr.] *Aquabiology* 2:412-418.  
 1983a. Laboratory rearing of *Loligo opalescens*, the market squid of California. *Aquaculture* 31:77-88.
- YANG, W. T., R. F. HIXON, P. E. TURK, M. E. KREJCI, R. T. HANLON, AND W. H. HULET.  
 1983b. Culture of California market squid from hatching - completion of the rearing cycle to second generation hatchlings. [In Jpn. with Engl. abstr.] *Aquabiology* 5:328-339.

# FISH ASSEMBLAGES IN *MACROCYSTIS* AND *NEREOCYSTIS* KELP FORESTS OFF CENTRAL CALIFORNIA

JAMES LEE BODKIN<sup>1</sup>

## ABSTRACT

The abundance and species composition of conspicuous fishes were compared within two canopy forming kelp forests (giant kelp, *Macrocystis pyrifera*, and bull kelp, *Nereocystis luetkeana*) in Central California. The primary investigative method was a subtidal belt transect, in which visual observation was used. The species composition of fish assemblages in the two canopy types was similar. Densities of fish were generally greater in *Macrocystis* than in *Nereocystis* forests. The major difference was the density of midwater species of the genus *Sebastes*. The blue rockfish, *Sebastes mystinus*, was the numerically dominant species in both canopy types. Estimates of the biomass of fish were about 2.4 times greater in *Macrocystis* beds than in *Nereocystis* beds.

Many species of fish exhibit an affinity for substrate and cover within their habitat, such as rock or coral reefs or kelp beds, as well as man-made objects such as piers, jetties, and offshore oil platforms. This structure may provide shelter, a base for foraging activity, or nursery habitat for young fish. Within the temperate nearshore marine environment, macroalgae may provide a large portion of this substrate and cover. Kelp forests are one of the major features of the nearshore environment along the west coast of North America. The two most conspicuous canopy-forming kelps are the giant kelp, *Macrocystis pyrifera*, a perennial, and the bull kelp, *Nereocystis luetkeana*, an annual (Abbott and Hollenberg 1976). Besides the difference in perennial versus annual growth pattern, *Macrocystis* and *Nereocystis* differ markedly in physical structure (Fig. 1) and seasonal patterns of abundance. *Macrocystis* plants typically have many stipes originating from a single large holdfast, and large fronds attached to each stipe throughout its length. *Nereocystis* plants consist of a single stipe, with large fronds only at the distal end. During periods of full development (typically late summer), *Macrocystis* can develop a completely closed canopy, whereas *Nereocystis* typically has a broken canopy. Winter storms usually remove large portions of the *Macrocystis* canopy, but many plants remain secured to the substrate and provide structure within the water column to varying depths throughout the year. *Nereocystis* canopies are also typically removed dur-

ing these storms, and, because *Nereocystis* is an annual, it provides little or no structure from mid-winter through late spring.

*Nereocystis* may be more abundant than *Macrocystis* in the presence of severe and persistent disturbances such as continued exposure to large swells or heavy grazing pressure (Dayton et al. 1980). In the absence of this pressure, *Macrocystis* may be competitively dominant, in that it forms a dense and often complete surface canopy earlier in the year, and thus may exclude or limit *Nereocystis* which has light-sensitive germination requirements (Dayton et al. 1980, 1984).

This study was designed to test the hypothesis that the fish component of the *Macrocystis pyrifera* community differs from that of the *Nereocystis luetkeana* community in Central California.

## METHODS

Studies were conducted from 6 km south to 15 km north of Point Piedras Blancas, San Luis Obispo County, CA (lat. 35°40'N, long. 121°17'W) (Fig. 2). Additional studies were also done near Big Creek, Monterey County, CA (lat. 36°04'N, long. 121°36'W). The surface canopies of kelp beds consist almost exclusively of *Nereocystis* from Point Piedras Blancas north to Ragged Point, an area about 13 km long, but are dominated by *Macrocystis* south of Piedras Blancas. I searched 74 transects in the Piedras Blancas study area and 4 in the Big Creek area: 26 transects in *Macrocystis* forests and 14 in *Nereocystis* in 1982 and 17 in *Macrocystis* and 21 in *Nereocystis* in 1983. Field studies extended from June

<sup>1</sup>U.S. Fish and Wildlife Service, P.O. Box 70, San Simeon, CA 93452.

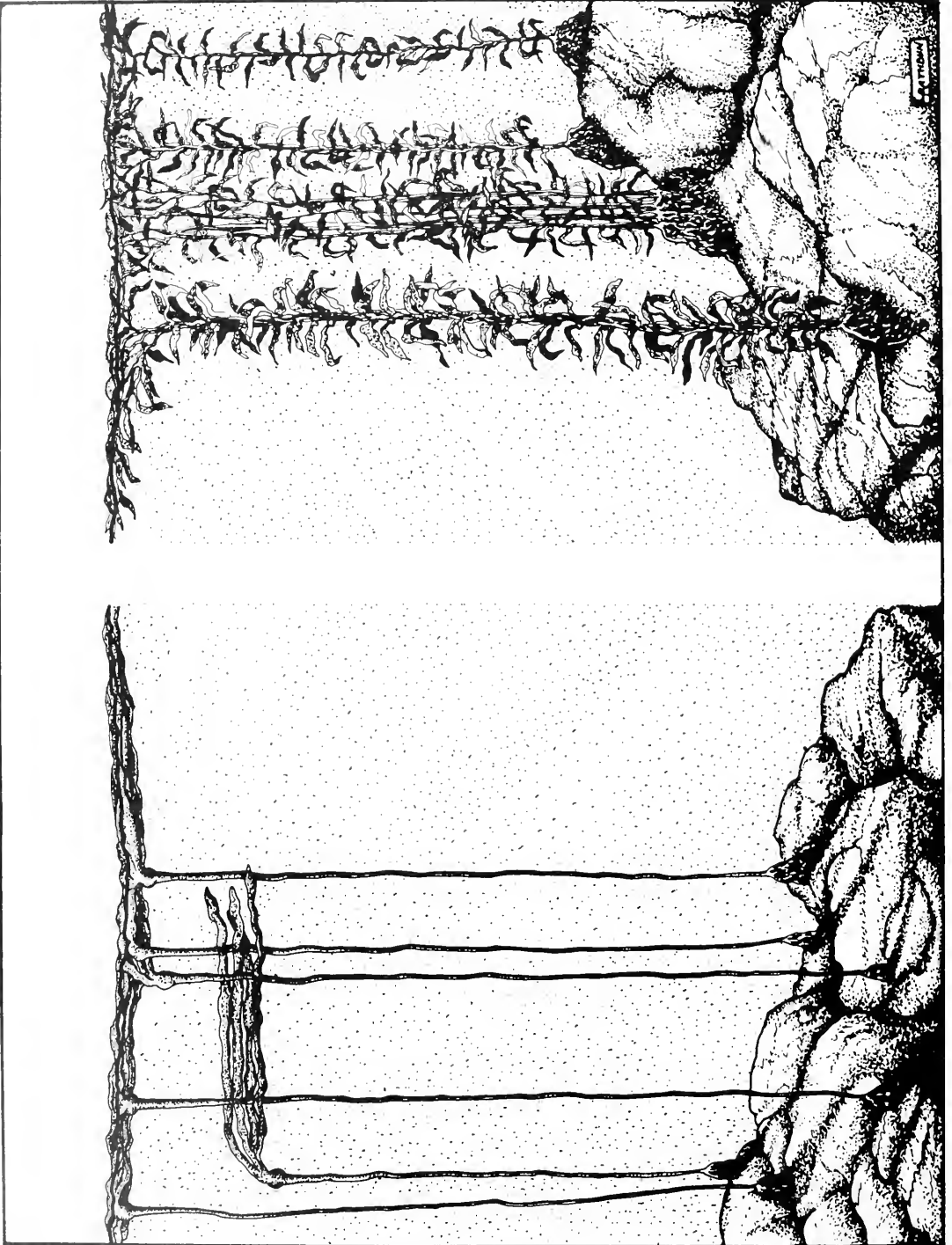

FIGURE 1.—A comparison of the physical structure of *Nerocystis luetkeana* (left) and *Macrocyctis pyrifera* (right) kelp forests.

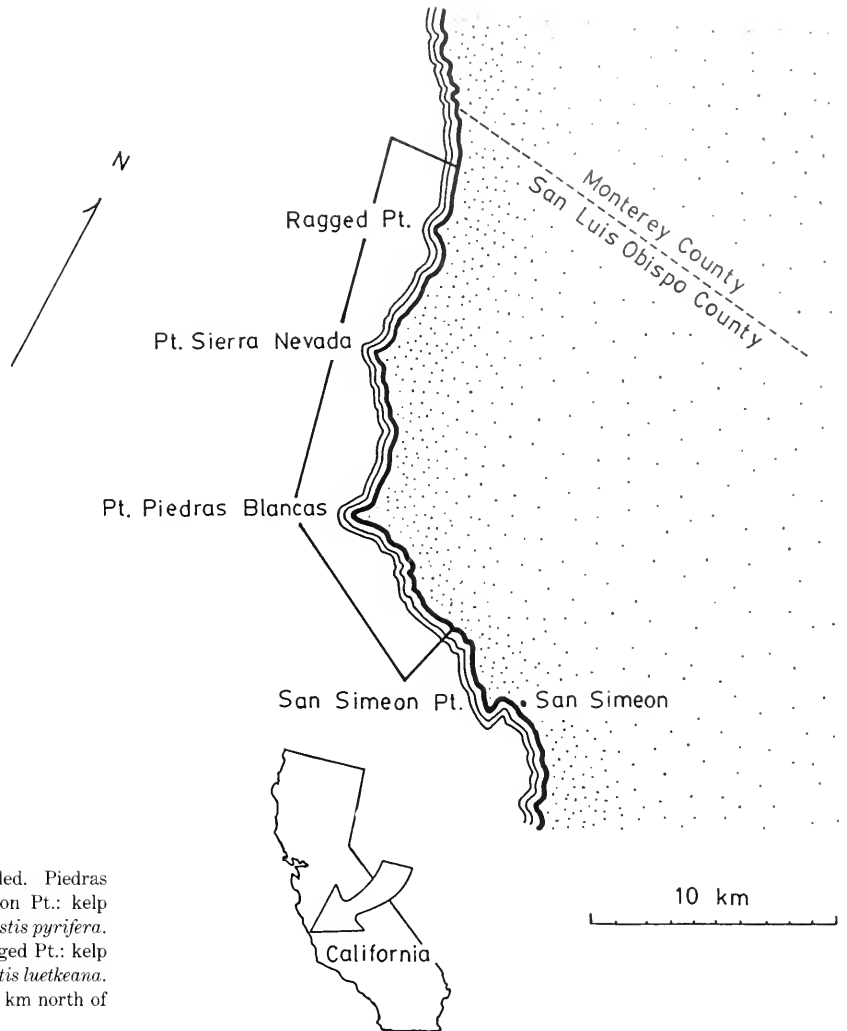

FIGURE 2.—Location of areas sampled. Piedras Blancas Pt., south, to San Simeon Pt.: kelp canopies are dominated by *Macrocystis pyrifera*. Piedras Blancas Pt. north, to Ragged Pt.: kelp canopies are dominated by *Nereocystis luetkeana*. Big Creek (not shown) is about 38 km north of Ragged Pt.

1982 to October 1983. Transects were apportioned evenly throughout early summer to late fall in each of the forest types.

A belt transect, as described by Brock (1954) and modified by Quast (1968), was used with the aid of scuba to conduct subtidal fish surveys. Each survey consisted of two components, benthic and midwater. A 50 m fiberglass tape was extended across the ocean floor in differing compass courses, extending from eye bolts permanently embedded in the substrate, or from the anchor of a dive boat on haphazardly located transect sites. The width of the midwater transect was determined by measuring the horizontal water visibility 2 m above the substrate. This was done by sighting down the transect line (fiberglass tape) toward the zero end, where a

small bicolored float (13.5 × 5.5 cm) was suspended 2 m off the bottom. The observer moved away from the float along the line. When the float could not be readily discerned, the position on the tape was recorded. This value was doubled (to include observations on either side of the transect line) to obtain the width of the midwater transect. This survey technique may lead to a slight underestimation of fish densities due to decreasing searching efficiency with increasing distances from observer to observed (Caughley 1977). Surveys were conducted only when visibility exceeded 4.4 m. Horizontal water visibility ranged from 4.4 to 12.1 m (*Macrocystis*  $\bar{x}$  = 6.6 m, SE = 2.6; *Nereocystis*  $\bar{x}$  = 7.4 m, SE = 0.49). The width of the benthic survey was 4 m (2 m on each side of the transect tape). All sampling

was conducted beneath and within either of the two forest types, in water 6 to 22 m deep. Underwater observations were recorded on formatted data sheets using plastic paper.

In conducting the benthic survey, I slowly swam from one end of the transect to the other and identified and enumerated the fish that were observed. A fish was included in the benthic survey if it was observed within 0.5 m of the bottom and was not a member of a school of typically midwater fish located momentarily near the bottom. A fish observed swimming through the transect in front of the diver was included. An effort was made to inspect all crevices, caves, and ledges, and to move aside algae to locate fish. A description of unfamiliar fish was made in the field and its identity later determined in field guides if possible. Small, relatively cryptic species were probably underestimated in the process of these visual surveys (Brock 1982).

The midwater transect was searched about 3 m above the tape. Repetitive ascents and descents were made at 5 m intervals to detect fish occurring throughout the water column. The sizes of very large schools were estimated. All fish observed within the length of the 50 m tape were recorded. Unidentified species were treated as they were during the benthic survey.

After the survey was completed, an index of the bottom profile was recorded by measuring the water depth at each meter mark along the tape. Two methods of determining bottom profile were used: first, an objective, and later, a subjective measure. The objective relief index was the sum of the differences between each of the 50 consecutive depth measurements along the 50 m transect. During the second half of this study (1983) a subjective relief index was assigned to the general vicinity of each transect; this was determined by the greatest vertical relief observed along the transect line: 0 = flat, no relief; 1 = low relief (<1 m); 2 = moderate relief (1 to 2 m); 3 = high relief (2 to 4 m); and 4 = extreme relief (more than 4 m).

Two measures of species diversity were used to compare the fish assemblages in *Macrocystis* and *Nereocystis* forests: 1) total number of species found on all transects within one canopy type and 2) the Shannon-Weaver index of diversity,  $H'$  (Pielou 1966).

Because of heterogeneity between sample variances, fish density distributions were compared with the nonparametric Mann-Whitney test. A minimum acceptable level of significance of 0.05 was assigned.

## RESULTS

Twenty-seven species of fish were identified within the spatial limits of the transects (Tables 1, 2, 3). An additional 8 species were identified within the kelp forest, but outside the transect limits. Juvenile rockfish were considered a single group, and occasionally an unidentified fish was observed.

In *Macrocystis* forests, 26 species were identified within the transects and 10 species outside the transects; in *Nereocystis* forests, the respective totals were 23 and 4 species. Three additional types of fish were observed that could be identified only to the family level (Table 3). Four species observed only in *Macrocystis* forests were white seaperch, *Phanerodon furcatus*; rainbow seaperch, *Hypsurus caryi*; China rockfish, *Sebastes nebulosus*; and black-eye goby, *Coryphopterus nicholsi*. One species was observed only in *Nereocystis* beds, the jacksmelt, *Atherinopsis californiensis*. Species not observed within both transect types were relatively uncommon, but were observed in and around both forest types during this study.

Fishes that could not be identified to species or family level were rare, occurring on only 6 (8%) of the transects (Table 3).

TABLE 1.—Summary of presence/absence of fish species encountered [midwater (M) and benthic (B), years pooled] throughout study.

Species	Macro- cystis	Nere- cystis	Principal habitat
<i>Sebastes mystinus</i>	X	X	M
<i>Sebastes serranoides</i>	X	X	M
<i>Sebastes atrovirens</i>	X	X	M
<i>Sebastes melanops</i>	X	X	M
<i>Sebastes chrysomelas</i>	X	X	B
<i>Sebastes carnatus</i>	X	X	B
<i>Sebastes miniatus</i>	X	X	B
<i>Sebastes rastrelliger</i>	X	X	B
<i>Sebastes caurinus</i>	X	X	B
<i>Sebastes nebulosus</i>	X		B
<i>Sebastes</i> sp. (juveniles)	X	X	M/B
<i>Oxyjulis californica</i>	X	X	M
<i>Aulorhynchus flavidus</i>	X	X	M
<i>Atherinopsis californiensis</i>		X	M
<i>Phanerodon furcatus</i>	X		M
<i>Oxylebius pictus</i>	X	X	B
<i>Hexagrammos decagrammus</i>	X	X	B
<i>Embiotoca lateralis</i>	X	X	B
<i>Embiotoca jacksoni</i>	X	X	B
<i>Orthonopias triacis</i>	X	X	B
<i>Scorpaenichthys marmoratus</i>	X	X	B
<i>Ophiodon elongatus</i>	X	X	B
<i>Rhachochilus vacca</i>	X	X	B
<i>Coryphopterus nicholsi</i>	X		B
<i>Anarrhichthys ocellatus</i>	X	X	B
<i>Jordania zonope</i>	X	X	B
<i>Hypsurus caryi</i>	X		B

## Midwater Transects

Differences in abundance of fish in the *Macrocystis* and *Nereocystis* forests were most apparent among the midwater species, primarily within the genus *Sebastes*. Of the nine species of midwater fish (juvenile *Sebastes* treated as a single "species"), three were significantly more abundant in *Macrocystis* than in *Nereocystis* forests: blue rockfish, *S. mystinus*; kelp rockfish, *S. atrovirens*; and olive rockfish, *S. serranoides* (Tables 1, 2). A fourth species, the black rockfish, *S. melanops*, was not observed on *Nereocystis* transects, though it was only occasionally seen in *Macrocystis*.

Although there were no general changes in fish abundance between 1982 and 1983 among the midwater species, some individual species differences were noted. Densities of blue rockfish were significantly lower in 1983 than in 1982 (Table 2). During this same period there was an insignificant increase in the density of juvenile rockfish. Densities of the señorita, *Oxyjulis californica*, appeared to increase within both forest types in 1983, but the increase was significant only when canopy types were com-

bined for each year. This annual variation should be considered in light of the extremely anomalous El Niño event which occurred during this period (Cane 1983), and may be atypical.

## Benthic Transects

Among the 19 principally benthic species found in both the *Macrocystis* and *Nereocystis* benthic transects, three (16%) were significantly more abundant in *Macrocystis* forests: Striped seaperch, *Embiotoca lateralis*, painted greenling, *Oxylebius pictus*, and the gopher rockfish, *Sebastes carnatus* (Tables 1, 3). One other species, the kelp rockfish, which occurred on benthic transects, was considered as primarily a midwater species. Gopher rockfish are bathymetrically segregated from the sibling species, *S. chrysomelas* (black-and-yellow rockfish). Gopher rockfish are relatively more abundant at depths >12 to 14 m (Larson 1980). In my study, the densities of black-and-yellow rockfish increased significantly in the second year while during the same period, densities of gopher rockfish decreased.

Due to sampling methodology and the occurrence

TABLE 2.—Mean densities (no. fish/100 m<sup>2</sup>) and frequency of occurrence of fishes on midwater transects through kelp (standard error of mean in parenthesis).

Species	Mean densities (fish/100 m <sup>2</sup> )						Frequency of occurrence	
	<i>Macrocystis</i>			<i>Nereocystis</i>			<i>Macrocystis</i>	<i>Nereocystis</i>
	1982	1983	1982-83	1982	1983	1982-83		
<i>Sebastes mystinus</i> <sup>1,2</sup>	19.4	8.25	15.0	6.68	2.09	3.9	1.00	0.82
Blue rockfish			(1.8)			(1.0)		
<i>Sebastes serranoides</i> <sup>1</sup>	0.51	0.36	0.45	0.17	0.07	0.11	0.74	0.34
Olive rockfish			(0.09)			(0.03)		
<i>Sebastes atrovirens</i> <sup>1</sup>	0.19	0.16	0.18	0.007	0.005	0.006	0.44	0.06
Kelp rockfish			(0.05)			(0.004)		
<i>Sebastes melanops</i> <sup>1</sup>	0.03	0.01	0.02	0	0	0	0.16	0
Black rockfish			(0.009)					
<i>Sebastes</i> sp.	3.4	7.7	5.1	0.06	0.95	0.59	0.19	0.11
Juvenile rockfish			(3.1)			(0.5)		
<i>Oxyjulis californica</i> <sup>2</sup>	3.1	26.6	12.4	1.6	18.7	11.9	0.40	0.40
Señorita			(6.6)			(6.2)		
<i>Aulorhynchus flavidus</i>			0.43			0.014	0.07	0.06
Tube-snout			(0.4)			(0.01)		
<i>Atherinopsis californiensis</i>			0			6.0	0	0.20
Jacksmelt						(6.5)		
<i>Phanerodon furcatus</i>			1.37			0	0.05	0
White seaperch			(1.4)					
Species observed incidental to transects								
<i>Scomber japonicus</i>							0	0.09
Chub mackerel								
<i>Myliobatis californica</i>							0	0.03
Bat ray								
<i>Sphyræna argentea</i>							0.02	0
Pacific barracuda								
<i>Torpedo californica</i>							0.02	0
Pacific electric ray								

<sup>1</sup> Difference significant between *Macrocystis* and *Nereocystis*, years combined.

<sup>2</sup> Difference significant between years, kelp canopies combined.

TABLE 3.—Mean densities (no. fish/100 m<sup>2</sup>) and frequency of occurrence of fishes on benthic transects through kelp forests (standard error of mean in parenthesis).

Species	Mean densities (fish/100 m <sup>2</sup> )						Frequency of occurrence	
	Macrocystis			Nereocystis			Macrocystis	Nereocystis
	1982	1983	1982-83	1982	1983	1982-83		
<i>Sebastes chrysomelas</i> <sup>1</sup>	1.52	1.91	1.67	1.11	2.21	1.77	0.74	0.91
Black-and-yellow rockfish			(0.25)			(0.26)		
<i>Oxylebius pictus</i> <sup>2,3</sup>	1.13	1.35	1.2	0.21	0.79	0.56	0.86	0.51
Painted greenling			(0.1)			(0.1)		
<i>Hexagrammos decagrammus</i>	0.33	0.35	0.34	0.36	0.43	0.40	0.44	0.57
Kelp greenling			(0.07)			(0.07)		
<i>Sebastes carnatus</i> <sup>1,2</sup>	1.29	0.76	1.04	0.75	0.22	0.43	0.61	0.31
Gopher rockfish			(0.2)			(0.15)		
<i>Embiotoca lateralis</i> <sup>2</sup>	0.63	1.1	0.84	0.25	0.12	0.17	0.58	0.20
Striped seaperch			(0.2)			(0.08)		
<i>Sebastes atrovirens</i> <sup>2</sup>	0.52	0.97	0.70	0.04	0.15	0.11	0.58	0.14
Kelp rockfish			(0.1)			(0.05)		
<i>Sebastes</i> sp.	0.87	0.21	0.62	0.23	0.14	0.17	0.42	0.26
Juvenile rockfish			(0.2)			(0.07)		
<i>Embiotoca jacksoni</i>	0.39	0.44	0.41	0	0.27	0.16	0.42	0.17
Black perch			(0.1)			(0.06)		
<i>Orthonopias triacis</i>	0.20	0.23	0.21	0.04	0.13	0.09	0.33	0.14
Snubnose sculpin			(0.06)			(0.04)		
<i>Sebastes mystinus</i>	0.08	0.26	0.15	0.04	0.17	0.15	0.23	0.17
Blue rockfish			(0.05)			(0.05)		
<i>Scorpaenichthys marmoratus</i>			0.107			0.11	0.16	0.20
Cabezon			(0.04)			(0.04)		
<i>Ophiodon elongatus</i>			0.13			0.09	0.21	0.09
Ling cod			(0.04)			(0.04)		
<i>Sebastes melanops</i> <sup>2</sup>			0.209			0.029	0.23	0.06
Black rockfish			(0.06)			(0.02)		
<i>Rhachochilus vacca</i>			0.135			0.0149	0.21	0.06
Pile perch			(0.04)			(0.01)		
<i>Sebastes miniatus</i>			0.042			0.094	0.07	0.14
Vermilion rockfish			(0.03)			(0.04)		
<i>Coryphopterus nicholsi</i>			0.198			0	0.21	0
Blackeye goby			(0.09)					
<i>Sebastes rastrelliger</i>			0.0116			0.0143	0.05	0.11
Grass rockfish			(0.01)			(0.01)		
<i>Sebastes caurinus</i>			0.035			0.0143	0.07	0.03
Copper rockfish			(0.02)			(0.01)		
<i>Anarrhichthys ocellatus</i>			0.023			0.0143	0.05	0.03
Wolf-eel			(0.02)			(0.01)		
<i>Jordania zonope</i>			0.014			0.0143	0.02	0.03
Longfin sculpin			(0.01)			(0.01)		
<i>Hypsurus caryi</i>			0.034			0	0.05	0
Rainbow seaperch			(0.01)					
<i>Sebastes nebulosus</i>			0.019			0	0.02	0
China rockfish			(0.02)					
Unidentified fish			0.128			0.29	0.05	0.11
			(0.09)			(0.3)		
Species observed incidental to transects								
<i>Sebastes serriceps</i>							0.02	0.03
Treefish								
<i>Cephaloscyllium ventriosum</i>							0.05	0
Swellshark								
<i>Sebastes auriculatus</i>							0.02	0
Brown rockfish								
<i>Sebastes pinniger</i>							0.02	0
Canary rockfish								
Clinidae							0.12	0
Clinids								
Cottidae							0.07	0
Sculpins								
Gobiesocidae							0.02	0
Cling fishes								
Unidentified fish							0.12	0.06

<sup>1</sup>Difference significant between years, kelp canopies combined.<sup>2</sup>Difference significant between *Macrocystis* and *Nereocystis* years combined.<sup>3</sup>Difference significant between years, *Nereocystis*.



of *Macrocystis* in water up to 4 m deeper than that occupied by *Nereocystis* within the study area, the mean water depth at which surveys were made differed between sites (*Macrocystis* mean depth = 12.2 m; *Nereocystis* mean depth = 10.5 m,  $t = 2.73$ ,  $P = 0.008$  (two sample  $t$ -test)). When the five transects in *Macrocystis* which occurred at depths beyond the maximum depth of *Nereocystis* transects (16 m) were excluded from analysis, the difference in water depths between sites became insignificant. Following the removal of these deep transects, all species of fish, both midwater and benthic, were reevaluated. There were no changes in the results presented above following this treatment.

There was little correlation between densities of fish and either of the bottom relief indices ( $r$  values, 0.025 to 0.482). Throughout the study, bottom relief typically ranged from 1 to 4 m and relief <1 m was not encountered. Mean values of the objective relief index were 44.1 (SE = 2.8) for *Macrocystis* transects and 37.2 (SE = 2.2) for *Nereocystis* transects. This difference resulted in a  $P$  value of 0.061 (two sample  $t$ -test), which I considered significant. However, when all species of fish which demonstrated significantly different densities between canopy types were reevaluated, after excluding the six *Macrocystis* transects with relief values more than one standard deviation above the mean, no change in results was observed for any species tested.

The total number of species encountered on the transects was 26 in *Macrocystis* and 23 in *Nereocystis*. The two kelp forests had 22 species in common. Five species were found in only one of the two canopy types, although none of these were present in more than 21% of the transects within the canopy in which it was found. The  $H'$  values calculated were 1.76 for *Macrocystis* transects and 1.58 for the *Nereocystis* transects. Although the value of diversity indices has been questioned (Goodman 1975), such indices are widely used in ecological literature. Neither measure of diversity used in the present study indicated differences in the diversity of fish assemblages between the two kelp forest types investigated.

## DISCUSSION

Several measures of comparison were considered in the analysis of these two kelp communities: species composition, species diversity, and abundance of fishes. The data presented here demonstrate very little difference in either composition or diversity of fish assemblages (Table 1), while estimates of biomass were markedly higher in giant kelp compared with bull kelp (Table 4).

The single most obvious difference between the two kelp communities was in the abundance of the blue rockfish: mean density of fish (no./100 m<sup>2</sup>) was

TABLE 4.—Estimates of biomass of fish of *Macrocystis* and *Nereocystis* kelp forests. Species that were uncommon, (<20% of transects), or small are not included.

Species	<i>Macrocystis</i>			<i>Nereocystis</i>		
	Density (#/100 m <sup>2</sup> )	Mean weight <sup>1</sup> (kg)	Biomass (kg/100 m <sup>2</sup> )	Density (#/100 m <sup>2</sup> )	Mean weight <sup>1</sup> (kg)	Biomass (kg/100 m <sup>2</sup> )
<b>Midwater transects</b>						
<i>Sebastes mystinus</i>	15.0	0.44	6.6	3.92	0.50	1.96
<i>Sebastes serranoides</i>	0.45	0.63	0.28	0.11	0.72	0.08
<i>Sebastes atrovirens</i>	0.18	0.54	0.09	0.006	0.57	0.003
<i>Sebastes melanops</i>	0.02	0.44	0.009	0	0	0
<i>Oxyjulis californica</i>	12.4	0.024	0.30	11.9	0.024	0.29
<b>Benthic transects</b>						
<i>Sebastes chrysomelas</i>	1.7	0.36	0.61	1.8	0.36	0.65
<i>Sebastes carnatus</i>	1.0	0.36	0.36	0.43	0.36	0.15
<i>Sebastes atrovirens</i>	0.70	0.38	0.27	0.11	0.38	0.04
<i>Sebastes mystinus</i>	0.15	0.44	0.07	0.15	0.50	0.07
<i>Sebastes melanops</i>	0.21	0.44	0.09	0.03	0.44	0.01
<i>Sebastes miniatus</i>	0.04	2.0	0.08	0.09	2.0	0.18
<i>Hexagrammos decagrammus</i>	0.34	0.5	0.17	0.40	0.5	0.2
<i>Embiotoca lateralis</i>	0.84	0.47	0.39	0.17	0.47	0.08
<i>Embiotoca jacksoni</i>	0.41	0.47	0.19	0.16	0.47	0.08
<i>Scorpaenichthys marmoratus</i>	0.11	0.7	0.08	0.11	0.7	0.08
<i>Ophiodon elongatus</i>	0.13	2.6	0.34	0.09	2.6	0.23
<i>Rhachochilus vacca</i>	0.13	0.47	0.06	0.01	0.47	0.005
<b>Total</b>			9.99 kg/100 m <sup>2</sup> = 0.0999 kg/m <sup>2</sup>			4.11 kg/100 m <sup>2</sup> = 0.0411 kg/m <sup>2</sup>

<sup>1</sup>Mean weights from collections at Piedras Blancas Field Station, U.S. Fish and Wildlife Service, or estimated from mean total lengths.

15.0 in *Macrocystis* and 3.9 in *Nereocystis*. Blue rockfish probably are the largest contributor to the total biomass of kelp forest fish communities in Central California. Miller and Geibel (1973) estimated blue rockfish densities at 6.66 fish/100 m<sup>2</sup> in 1969 and 8.35 in 1970 in *Macrocystis* beds at Hopkins Marine Life Refuge, Monterey County, CA. They suggested that this represents about 50% of the actual biomass because their survey method under-represented midwater species. Considering this adjustment, my data for blue rockfish in *Macrocystis* forests agree well with theirs. Near Pt. Piedras Blancas, blue rockfish made up 33% and 18% of the mean number of fish within the *Macrocystis* and *Nereocystis* forests, respectively. Assuming an average weight of 440 g (Table 4), blue rockfish contributed about 70% of the total biomass of the *Macrocystis* fish assemblage and about 50% of *Nereocystis* (species weighing a few ounces or less were not included in this analysis). The importance of juvenile blue rockfish as forage for large carnivorous kelp forest fishes (primarily *Sebastes* sp.) has been well documented (Miller and Geibel 1973; Burge and Schultz 1973; Hallacher and Roberts 1985). Tagging studies have suggested that the home range of blue rockfish is relatively small (Miller and Geibel 1973). The evidence given here illustrates the important role that blue rockfish play in the kelp forest communities of central California.

My estimate of the biomass of fish within each of the two canopy types (Table 4) included only species that were relatively common and of sufficient size to contribute significantly to the total. For example, although the estimated mean weight of *Oxyjulis californica* was only 24 g, its abundance made its total contribution rather large.

My data showed that in this study area off Central California *Macrocystis* supported a larger standing crop of fish, primarily midwater species of the genus *Sebastes*, than did forests of *Nereocystis* (Table 4). The following explanations are offered for the observed differences. These explanations are not mutually exclusive; several or all of the proposed explanations may have contributed to the observed patterns.

1) The amount of algae consumed by blue rockfish fluctuates seasonally. Hallacher and Roberts (1985) showed that blue rockfish may use algae as a major source of energy during the non-upwelling period (September through March), which partly coincides with the period of minimum development in *Nereocystis* forests. During this period blue rockfish may rely on *Macrocystis* directly as a food

source, or indirectly as a substrate from which invertebrates are taken. The resulting increased biomass of blue rockfish in *Macrocystis* may help support larger numbers of other carnivorous fish. Four of the seven species that were densest in *Macrocystis* (Table 5) forests are known to rely heavily on juvenile rockfish for food (Hallacher and Roberts 1985). Although juvenile rockfish densities were not statistically greater in the *Macrocystis* forest (Table 2) because of large variations in densities (occurring on transects in either very large or very small schools), they were generally more available in *Macrocystis* forests. Subsequent field observations of juvenile rockfish in central California kelp forests have indicated that kelp forest rockfish recruitment may have been poor during the course of this study.

TABLE 5.—Summary of species for which densities in the two kelp types differed significantly.

Species	Canopy type which presented significantly higher density
Midwater	
<i>Sebastes mystinus</i> Blue rockfish	<i>Macrocystis</i>
<i>Sebastes serranoides</i> Olive rockfish	<i>Macrocystis</i>
<i>Sebastes atrovirens</i> Kelp rockfish	<i>Macrocystis</i>
<i>Sebastes melanops</i> Black rockfish	Observed on <i>Macrocystis</i> mid-water transects only
Benthic	
<i>Sebastes carnatus</i> Gopher rockfish	<i>Macrocystis</i>
<i>Embiotoca lateralis</i> Striped seaperch	<i>Macrocystis</i>
<i>Oxyblepius pictus</i> Painted greenling	<i>Macrocystis</i>
<i>Sebastes atrovirens</i> Kelp rockfish	<i>Macrocystis</i> (considered primarily as a midwater species)

2) The perennial nature of *Macrocystis* forests compared with the annual nature of *Nereocystis* forests may contribute to increased fish densities in *Macrocystis* forests. *Macrocystis* forests provide some structure throughout the year with new growth providing both vertical and canopy structure 1 to 3 mo earlier than *Nereocystis*. This temporal stability may afford necessary habitat structure within the water column permitting relatively higher densities of fish.

3) Differences in abiotic factors such as the physical orientation of the reef systems to oceanic swells and the resultant surge and scour effects may play a role in determining habitat suitability for some species of fish. The effects of sediment transport and scouring, caused by water movement,

would be most evident at the sea floor and may in fact have contributed to the observed differences in densities in the bottom dwelling surf perch (Table 5). My data indicated that the major differences in densities of fish were in midwater species, suggesting that exposure to bottom disturbance per se was not a primary influence on observed patterns.

4) The differing physical characteristics of the *Macrocystis* and *Nereocystis* plants themselves may play a role in determining their suitability as habitat for kelp bed fishes. During periods of full development, within this study area, *Macrocystis* typically has widely spaced, thick bundles of stipes with large fronds throughout the water column, leading to a canopy that is frequently closed. *Nereocystis*, in contrast, has single, frondless stipes with large terminal fronds that generally form a broken surface canopy (Fig. 1). Due to the distinct physical structure of these two plants, both within the water column and at the canopy, the foliage biomass is usually considerably greater within the *Macrocystis* forest. This abundance of structure, combined with its persistence over time, may enhance the carrying capacity of giant kelp forests compared with those of bull kelp (Leaman 1980).

A comparison of the standing crop estimates presented in this study is made with those from other marine reef systems in Table 6. While values for both *Macrocystis* and *Nereocystis* forests are below those representing fringing coral reefs (Brock 1954; Randall 1963), my estimates for *Macrocystis* forests

compare favorably with the upper values obtained in Monterey, CA (Miller and Geibel 1973) and north-east New Zealand (Russell 1977), while the *Nereocystis* estimate corresponds to the estimates from Southern California *Macrocystis* forests (Quast 1968; Larson and DeMartini 1984).

In conclusion, *Macrocystis* forests supported a biomass of fish about 2.4 times greater than that supported by *Nereocystis* forests (Table 4) where perennial, water column foliage provided a more persistent, structurally diverse habitat. Larger numbers of midwater fish, primarily *S. mystinus*, found in the *Macrocystis* forest can account for this difference.

## ACKNOWLEDGMENTS

This work was supported by the U.S. Fish and Wildlife Service, Denver Wildlife Research Center, Marine Mammal Section. I thank R. Brownell, R. Curnow, J. Estes, R. Jameson, C. Jones, M. Layman, L. Rathbun, P. Vohs, and S. Wright for their support. D. Hilger, D. Martin, F. Scott, M. Shawver, and G. VanBlaricom contributed their time as dive partners to this work. I would like to thank the members of my graduate committee—A. Roest (advisor), F. Clogston, R. Gambs, and R. Nakamura—and staff—R. Bowker and L. Maksoudian, and the Biological Science Department, California Polytechnic University, San Luis Obispo, CA. Valuable comments on earlier drafts of this manuscript were offered by P. Eschmeyer, R.

TABLE 6.—Comparison of biomass estimates of fish from marine communities (after Russell 1977).

Location and reference	Bottom type	Standing crop (kg.m <sup>2</sup> )
Hawaii (Brock 1954)	Fringing coral reef: open sand, broken rock, coral reef, reef flat	0.001-0.0184
Virgin Islands (Randall 1963)	Fringing coral reef: boulders, coral	0.160
Southern California (Quast 1968)	Kelp bed: broken rocky bottom, dense algal cover	0.035 <sup>1</sup>
Southern California (Larson and DeMartini 1984)	Cobble, low relief <i>Macrocystis</i> forest	0.039-0.065
	Cobble, low relief kelp-depauperate	0.024
Monterey Bay, CA (Miller and Geibel (1973)	Kelp bed: broken rocky bottom dense algal cover, rocky reef	0.001->0.112
N.E. New Zealand (Russell 1977)	Rocky reef: open low relief, sparse algal cover.	<0.001
	Rocky reef: high bottom relief, extensive algal cover	0.103
Central California (Present study)	Rocky reef: high bottom relief; <i>Macrocystis</i> canopy	0.0999
	<i>Nereocystis</i> canopy	0.0411

<sup>1</sup>Average estimate.

Jameson, R. Nakamura, G. Rathbun, A. Roest, and G. VanBlaricom and three exceptional anonymous reviewers. A special thanks to D. Bodkin and G. VanBlaricom for their support and encouragement.

## LITERATURE CITED

- ABBOTT, I. A., AND G. J. HOLLENBERG.  
1976. Marine algae of California. Stanford University Press, Stanford, CA.
- BROCK, R. E.  
1982. A critique of the visual census method for assessing coral reef fish populations. *Bull. Mar. Sci.* 32:269-276.
- BROCK, V. E.  
1954. A preliminary report on a method of estimating reef fish populations. *J. Wildl. Manage.* 18:297-308.
- BURGE, R. T., AND S. A. SCHULTZ.  
1973. The marine environment in the vicinity of Diablo Cove with special reference to abalones and bony fishes. *Calif. Dep. Fish Game, Mar. Res. Tech. Rep.* 19, 433 p.
- CANE, M. A.  
1983. Oceanographic events during El Niño. *Science* 222: 1189-1195.
- CAUGHLEY, G.  
1977. Analysis of vertebrate populations. John Wiley and Sons, Lond.
- DAYTON, P. K., V. CURRIE, T. GERRODETTE, B. D. KELLER, R. ROSENTHAL, AND D. VEN TRESCA.  
1984. Patch dynamics and stability of some California kelp communities. *Ecol. Monogr.* 54:253-289.
- DAYTON, P. K., B. D. KELLER, AND D. A. VEN TRESCA.  
1980. Studies of a nearshore community inhabited by sea otters. Final Report MMC-78/14. *Mar. Mammal Comm.*, Wash., D.C., 91 p. (Available U.S. Dep. Commer., Natl. Tech. Inf. Serv., as PB81-109860.)
- GOODMAN, D.  
1975. The theory of diversity-stability relationships in ecology. *Q. Rev. Biol.* 50:237-266.
- HALLACHER, L. E., AND D. ROBERTS.  
1985. Differential utilization of space and food by the inshore rockfishes (Scorpaenidae: *Sebastes*) of Carmel Bay, California. *Environ. Biol. Fish.* 12(2):91-110.
- LARSON, R. J.  
1980. Competition, habitat selection, and the bathymetric segregation of two rockfish (*Sebastes*) species. *Ecol. Monogr.* 50:221-239.
- LARSON, R. J., AND E. E. DEMARTINI.  
1984. Abundance and vertical distribution of fishes in a cobble-bottom kelp forest off San Onofre, California. *Fish. Bull.*, U.S. 82:37-53.
- LEAMON, B. M.  
1980. The ecology of fishes in British Columbia kelp beds. I. Barkley Sound *Nereocystis* beds. *Fish. Dev. Rep.* 22. Ministry of Environment, British Columbia, 100 p.
- MILLER, D. J., AND J. J. GEIBEL.  
1973. Summary of blue rock fish and ling cod life histories; a reef ecology study and a giant kelp, *Macrocystis pyrifera*, experiments in Monterey Bay, California. *Calif. Dep. Fish Game, Fish Bull.* 158, 137 p.
- PIELOU, E. C.  
1966. Species-diversity and pattern-diversity in the study of ecological succession. *J. Theoret. Biol.* 10:370-383.
- QUAST, J. C.  
1968. Estimates of the population and standing crop of fishes. In W. J. North and C. L. Hubbs (editors), *Utilization of kelp bed resources in southern California*, p. 57-79. *Calif. Dep. Fish Game, Fish Bull.* 139.
- RANDALL, J. E.  
1963. An analysis of the fish populations of artificial and natural reefs in the Virgin Islands. *Caribb. J. Sci.* 3:31-47.
- RUSSELL, B. C.  
1977. Population and standing crop estimates of rocky reef fishes of northeastern New Zealand. *N.Z. J. Mar. Freshw. Res.* 11:23-36.

# LIFE HISTORY AND LARVAL DEVELOPMENT OF THE GIANT KELPFISH, *HETEROSTICHUS ROSTRATUS* GIRARD, 1854

CAROL A. STEPIEN<sup>1</sup>

## ABSTRACT

Life history data from about 1,200 giant kelpfish, including age, length, and weight relationships, are described and analyzed. Additionally, differences in habitats and behavior between larvae, juveniles, and adults are reported. Female giant kelpfish were found to be larger than males at given ages past sexual maturity. Age data indicate that females live longer and all individuals larger than 28 cm TL collected in this study were females. Males guard the algal nests until hatching, about 2 weeks after spawning. Giant kelpfish from nests collected in the field were reared in the laboratory, surviving for up to 9 months. Feeding and development of laboratory-reared larvae were compared with field-collected specimens. In situ, they school in the kelp canopy until 2 months old, gradually developing juvenile coloration and becoming increasingly thigmotactic and solitary. Giant kelpfish reach sexual maturity at 1-1.5 years, at which time they commence to defend territories in given plant habitats.

The cryptically colored giant kelpfish, *Heterostichus rostratus*, is abundant in southern California kelp forests and surrounding subtidal plant habitats. *Heterostichus* is one of the largest members of the clinid family, reaching a length of 41.2 cm and an age of 5 yr (J. E. Fitch in Feder et al. 1974). Although ranging from British Columbia, Canada, to Cape San Lucas, Baja California, Mexico, it is most commonly found from Point Conception to central Baja in depths of 35 m (Roedel 1953). Giant kelpfish occur in three different colormorphs—red, brown, and green—which closely match the color of their surrounding plant habitats (Hubbs 1952; Stepien 1985, 1986). They additionally exhibit four different dark melanin patterns, which appear superimposed on the basic color of the fish and, unlike colormorphs, can change rapidly (Stepien 1985, 1986).

Giant kelpfish spawn year-round, but most frequently during spring months (Limbaugh 1955; Feder et al. 1974). The eggs are attached to algal nests with entangling threads that extend from the egg membranes (Holder 1907; Feder et al. 1974). The males alone guard the nests from predators until hatching, averaging 2 wk after spawning (Coyer 1982). Giant kelpfish are relatively well-developed at hatching and are planktonic for several weeks. They school in the kelp canopy until they are about 6 cm long, then develop juvenile coloration

and become solitary, living close to nearshore algae (Limbaugh 1955).

Although *Heterostichus* larvae are not uncommon in the nearshore ichthyoplankton, their development has not been previously described. *Heterostichus* egg morphology was described by Barnhart (1932), and the egg-laying process was described by Holder (1907). Matarese et al. (1984) published two drawings of kelpfish larvae. Although diet and some aspects of general life history have been described qualitatively by several investigators (Hubbs 1920, 1952; Roedell 1953; Limbaugh 1955; Quast 1968; Hobson 1971; Feder et al. 1974; Hobson et al. 1981; Coyer 1982) and one quantitative study was conducted on feeding and distribution of juveniles and adults in giant kelp (Coyer 1979), specific morphometric data for larval, juvenile, and adult stages have not previously been reported. This paper presents life history data, including the following: 1) Differences in larval, juvenile, and adult habitats and behavior; 2) size, weight, and age relationships, including differences between males and females; and 3) the sequence of larval development and metamorphosis.

## MATERIALS AND METHODS

### Collection and In Situ Observations

In situ observations were made during approximately 280 scuba dives from 1978 to 1983, the majority in the vicinity of the University of Southern California's Catalina Marine Science Center

<sup>1</sup>Department of Biological Sciences, University of Southern California, Los Angeles, CA 90089; present address: Marine Biology Research Division A-002, Scripps Institution of Oceanography, University of California at San Diego, La Jolla, CA 92093.

(CMSC) on Santa Catalina Island (Fig. 1). Most observations and collections were made in protected cove areas having well-developed kelpbeds of the giant kelp, *Macrocystis pyrifera*, and associated plant habitats, including surfgrass, *Phyllospadix torreyi*, and red and brown algae. Approximately 1,200 giant kelpfish were observed during the course of the study. The aging and sexing study material from Catalina was also supplemented by 42 specimens col-

lected from subtidal sites off the southern California mainland, including Ventura, Lunada Bay on the Palos Verdes Peninsula, Huntington Beach, and La Jolla (Fig. 1).

Kelpfish were collected using a  $0.5 \times 0.8$  m net, mounted on a 1 m long handle and constructed of 0.25 cm mesh dyed either brown or red to match the kelpfish algal habitats (it was found that white netting alarmed the fish, making them difficult to

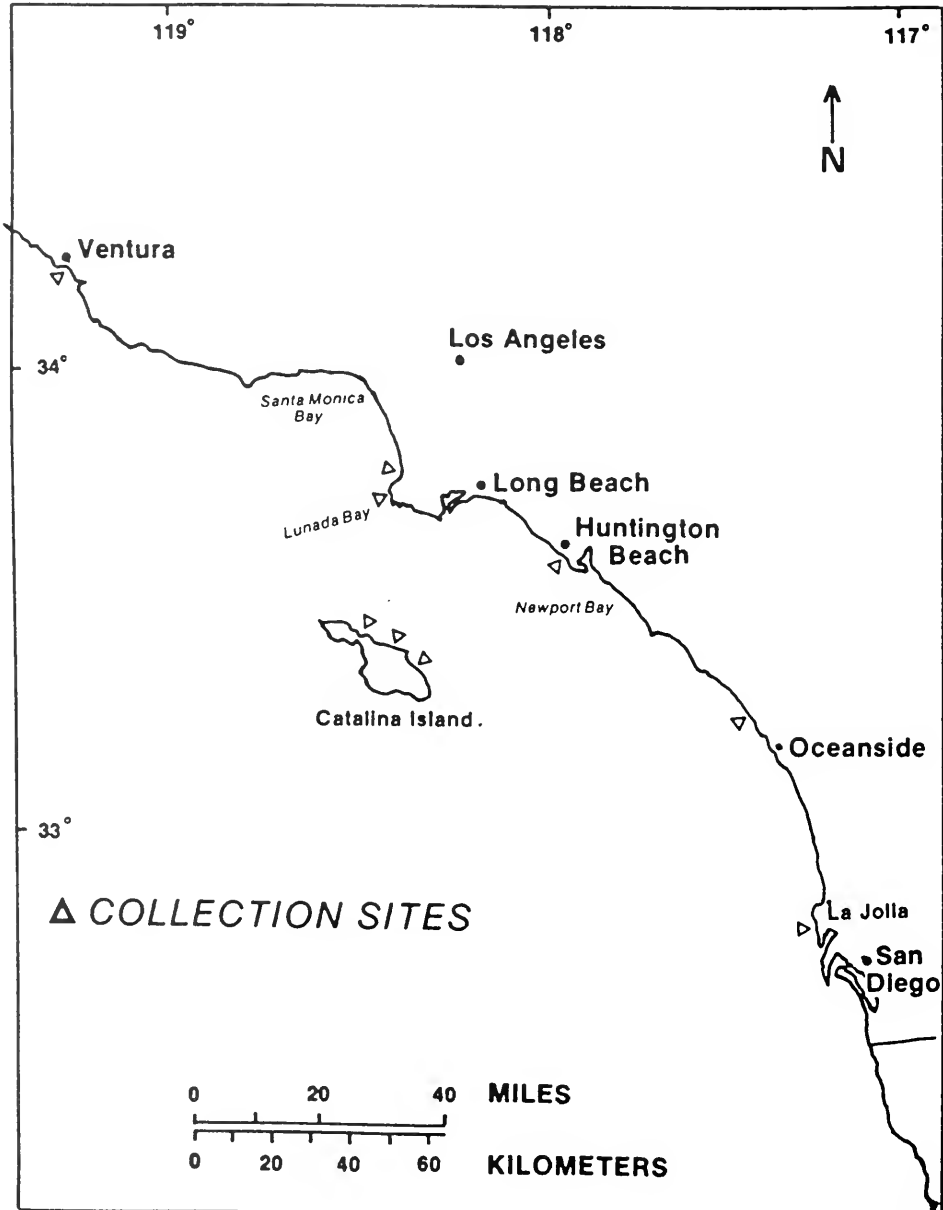

FIGURE 1.—Giant kelpfish collection sites (open triangles) off the southern California coast.

catch). Kelpfish were collected by sliding the net forward and downward over the fish. Collection of kelpfish was facilitated by their habit of hiding in algae when pursued rather than escaping by rapid swimming. Those that were actively swimming (usually through the kelp canopy) were less frequently captured. They were placed in a collecting bucket having mesh sides, a snap-on lid, and a funnel entryway, preventing escapes when the lid was opened for other fish. Care was taken to avoid putting the larger kelpfish in the same bucket as the smaller ones, because the smaller ones were occasionally eaten by the larger ones.

### Life History Data From Juveniles and Adults

In the present study, 140 juveniles and adults of representative sizes (ranging from 10 to 42 cm TL) were measured live to the nearest 0.1 cm. Total length (TL) was found to be more quickly measurable than standard length (SL). Both SL and TL

were measured, in order to allow comparisons with other studies. Kelpfish were weighed to the nearest 0.1 g on a triple-beam balance while briefly contained in plastic bags, in which they were quiescent and unabraded. These data were graphed, and regression and  $F$ -test analyses were performed (Sokal and Rohlf 1981; Zimmerman and Kremer 1983).

The fish were sexed and aged. Females had clear or pink, rounded ovaries and most individuals over 14 cm TL had clearly visible developing eggs. Male gonads were cream-colored and had a characteristic ventral groove. In cases when sex of juveniles was questionable, the gonads were examined under a dissection microscope.

Otoliths (sagitta) were removed and stored dry in labeled glass. They were briefly submerged in water and examined against a black background with a dissecting microscope (25-50 $\times$  magnification) for ring counting (Fig. 2). Ages were determined by counting alternating white (opaque) and translucent (hyaline) bands, each representing 6 mo of growth,

### KELPFISH OTOLITH

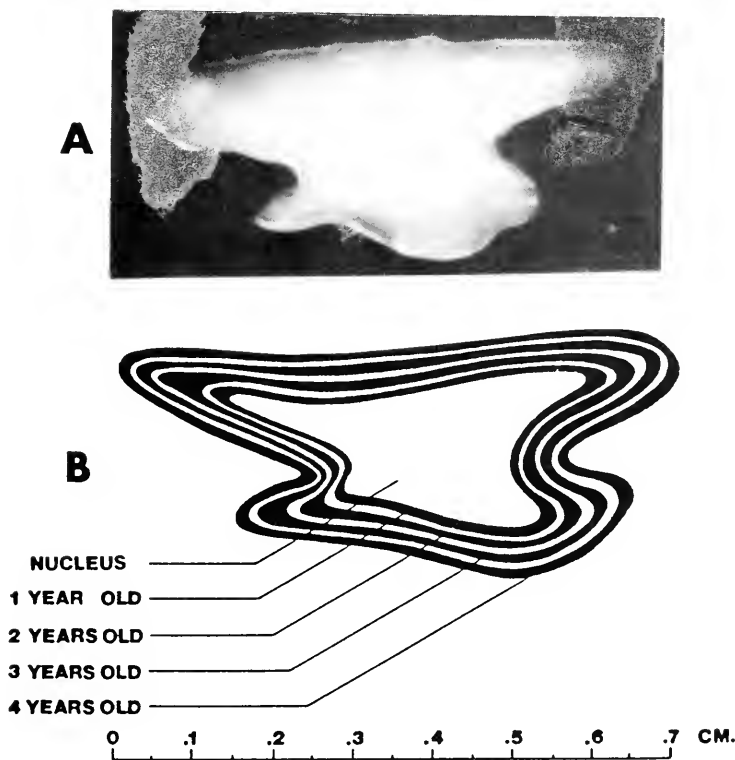

FIGURE 2.—(A) Photograph of otolith (actual length = 6.5 mm) of a 4 yr-old female giant kelpfish, 33 cm TL. (B) Drawing of otolith (sagitta) showing ring counts.

using standard methods outlined by Fitch (1951), Jensen (1965), and Collins and Spratt (1969). Each pair of otoliths was read independently by me and another reader, neither knowing the identity of the fish. Our age estimates were in agreement in 80% of the examinations. When differences in ring count occurred, a joint reevaluation was made.

Total length versus age comparisons were graphed, and regression analysis and  $F$ -tests were performed on the log-log transformations. Mean sizes of male and female kelpfish in age classes where differences appeared to occur were tested for significance using  $t$ -tests and 2-way ANOVA. Separate regression equations were also calculated for males and females, and ANCOVA was performed to determine whether the distributions were significantly different (Sokal and Rohlf 1981).

Seasonal population structure was estimated from collection data taken from February 1981 through January 1983. Kelpfish were grouped in six size classes. Distribution of kelpfish in size classes was analyzed for significant seasonal variations using contingency tables and  $G$ -tests (Sokal and Rohlf 1981).

### Larval Rearing

Nine giant kelpfish nests were collected, four in spring 1980 and five in spring 1982, off Santa Catalina Island. Both parents of the eggs were collected in three cases when spawning was observed. In six cases, only the male parents, which were guarding the nests, were collected. Eggs were also laid in the laboratory on five separate occasions, but did not hatch normally, apparently because of inadequate dispersion in the nests.

Algal nests containing eggs were suspended from a glass rod connected to an electric stirring device, simulating wave motion in shallow subtidal habitats (Fig. 3A). This method substantially decreased bacterial and fungal attacks. Parents were not kept with the eggs, as both males and females were sometimes found to eat eggs in the laboratory. Nests were placed in aerated 190 L plastic containers cooled in 1 m deep aquaria of running seawater. Filtered seawater in the containers was replaced every few days. Several eggs were removed daily for examination of development.

Newly hatched larvae were isolated in lightly aerated 76 L brown plastic containers bathed in large aquaria. Kelpfish larvae were fed laboratory-raised *Brachionus plicatilis* (marine rotifers) within 24 h after hatching. *Brachionus plicatilis* were cultured in high densities of the green flagellate,

*Tetraselmis tetrahele*, which was grown in a nutrient-rich medium under constant light, following methods developed for feeding northern anchovy larvae (Theilacker and McMaster 1971). *Brachionus plicatilis*, ranging from  $0.01 \times 0.02$  mm to  $0.07 \times 0.20$  mm in size, were maintained in the larval kelpfish containers at concentrations of 10-40/mL. At age 1 wk, kelpfish larvae were changed from closed to open containers of filtered and aerated running seawater, having two  $20 \times 30$  cm panels of  $100 \mu$ m mesh.

After age 2 wk, kelpfish larvae were also fed wild plankton, which primarily contained various developmental stages of the copepod *Acartia* sp. (92% wet weight) and some barnacle nauplii and cyprid larvae (7% wet weight). Wild plankton were collected using a submersible pump attached to a float off the laboratory pier. A light was suspended over the pump and the system connected to an electrical timer. Plankton were filtered through a  $335 \mu$ m mesh bag into a 190 L plastic container. The container had a removable inner  $100 \mu$ m mesh lining and a spillover pipe, retaining only appropriate-sized plankton between the two filter bags (Fig. 4). Best copepod catches were obtained from dusk to 2 h after sunset. Running filtered seawater and an aerator were used to maintain temperature and oxygen levels in the collecting container until the fish larvae were fed the following morning. Densities averaged 1-3/mL, which have been shown to support high survival rates in laboratory rearing of other fish larvae (Houde 1973; Hunter 1981).

When plankton catches were low, giant kelpfish diet was supplemented with cultured *Artemia salina* (brine shrimp) nauplii. *Brachionus plicatilis* were discontinued after age 3 wk and plankton continued until age 3 mo. After age 2 mo, diet was supplemented with frozen adult brine shrimp, Tetramin<sup>2</sup> commercial flake food, and live mysids captured from net tows in kelpbeds.

Ten larvae were removed every 2 d during the first 2 wk of development for measurement and description. After this period, 10 larvae were examined weekly until 2 mo had elapsed. All measurements were made on fresh material. Drawings of several stages of larval development were made using a camera lucida and a dissecting microscope.

Gut contents of three specimens from each weekly sample through age 4 wk were analyzed. While viewing with a dissecting microscope, guts were dissected away from the body and food particles

<sup>2</sup>Reference to trade names does not imply endorsement by the National Marine Fisheries Service, NOAA.



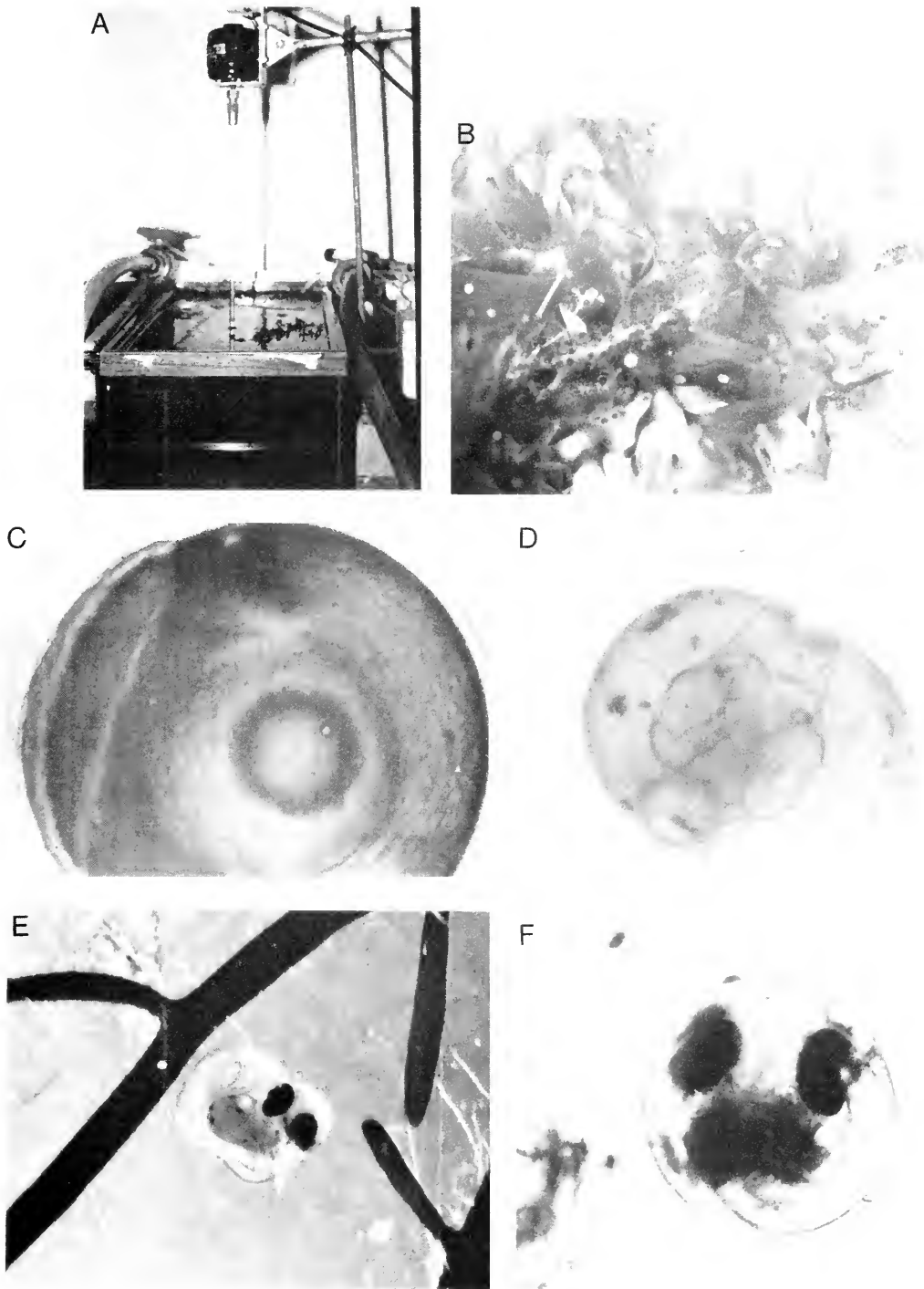

FIGURE 3.—(A) Giant kelpfish nest in aquarium, attached to an electric stirrer, which simulated wave motion. (B) Photograph of nest with eggs in brown algae, taken with 70 mm macrolens. (C) Photograph under compound scope of 24-h kelpfish egg showing blastodisc, egg diameter = 1.4 mm. (D-F) Developing kelpfish eggs photographed under dissection microscope (diameters = 1.4 mm). (D) 72 h after spawning. (E) 10 d after spawning. Note adhesive threads attaching egg to red alga. (F) 12 d after spawning.

## PLANKTON COLLECTOR DESIGN

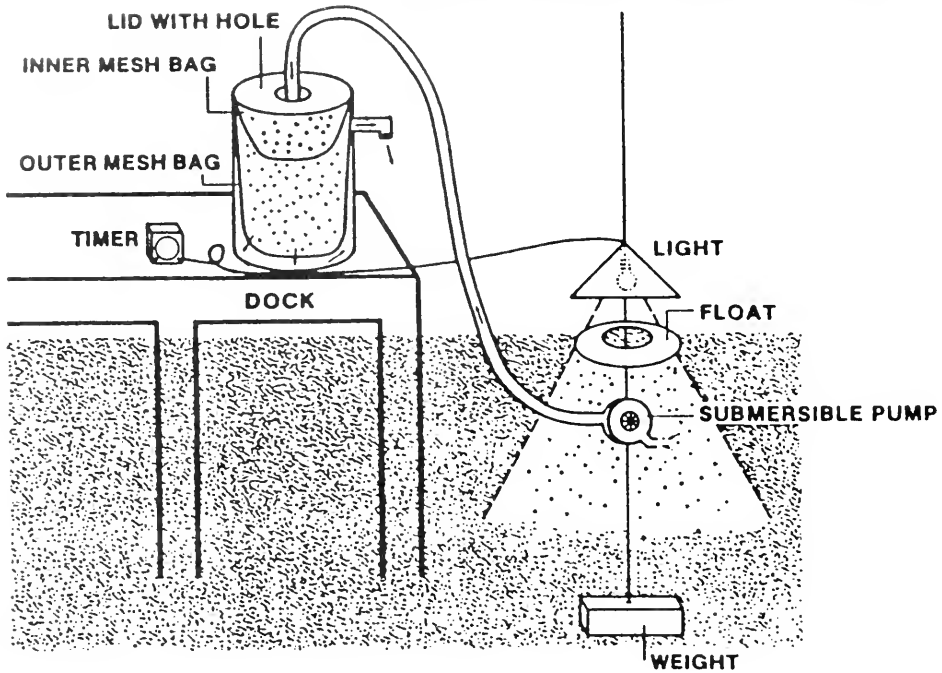

FIGURE 4.—“Automatic” plankton collector design for feeding giant kelpfish larvae. Plankton were attracted to light on timer after dark. Submersible pump, suspended beneath the float, pumped plankton into large plastic container on dock. Plankton ranging from 100 to 325  $\mu\text{m}$  were filtered between two mesh bags. Aeration and running seawater kept the plankton alive.

teased out using either a single human hair or a modified paint brush from which only a few long strands protruded. Gut contents were viewed under a compound microscope and identified, and average lengths and widths of prey items were recorded.

At age 2 mo, the kelpfish larvae were moved to containers having 0.3 cm mesh panels and containing artificial plant habitats (see Stepien 1985 and 1986). They were subsequently measured bimonthly and their development described. Development and feeding of laboratory-reared kelpfish larvae were also compared with 20 field-collected individuals. Kelpfish larvae of various ages and sizes were collected in hand nets while night-lighting from a dock and while scuba diving in kelpbed canopies using a 1 mm mesh handnet. Other kelpfish larvae were examined from bongo net collections made in Santa Monica Bay in 1982. Their development was compared with similar-sized laboratory-reared larvae. Gut contents of four early-stage larvae (estimated 0-9 d old) were analyzed for food types and sizes, in comparison with laboratory-reared kelpfish.

## RESULTS

### Spawning

Giant kelpfish nests were guarded by the male parent, the eggs being interspersed and held by adhesive threads in either red or brown algae (Fig. 3B). Seven of the nine nests collected were located in isolated clumps of algae, and all were found between 6 and 12 m deep. Kelpfish nests were most common in the red alga *Gelidium nudifrons* (6 of 9 nests collected) in areas where clumps of taller brown algae covered patches of red algae. Three of the nests were located in brown algae, two in *Cystoseira neglecta*, and one in *Sargassum muticum*.

The male parent hid in the overlying clump of brown algae, emerging to chase away intruding fishes. Male kelpfish were observed to defend their nests against other kelpfish, sheephead, and rock wrasse. Female kelpfish may spawn several times a year since a female kept in the laboratory laid eggs twice within 3 mo. Gonads of all females examined after spawning were almost entirely spent. Since

all eggs in the nests examined were in similar stages of development, it is likely that each nest contains the eggs of a single female. After spawning (the behavior sequence of which is described in Coyer 1982), the male kelpfish chases away the female parent, as was observed in the laboratory on three separate occasions. In one case, the male's repeated pursuits resulted in the female jumping out of the aquarium.

Eggs occurred in two different colors, red and brown, which microscopic examination showed was due to color of the yolk. All eggs in a given nest were either red or brown and remained that color throughout development. Nest and egg color did not always match. Brown eggs were found in four nests of red algae and two nests of brown algae, while red eggs were found in two nests of red algae and one nest of brown algae.

Fertilized eggs laid in the laboratory developed poorly and few of them hatched, apparently due to abnormal dispersal in the algal nests by the females. In all three cases of laboratory spawnings, eggs were laid in clumps rather than being well-spaced throughout the algae, as observed in field-collected nests. Freshly laid nests were collected in the field on three occasions from pairs that had just completed spawning. Two of the three spawning females were brown colormorphs and one was a red morph, but all three showed the barred melanin pattern. All nine field-collected male parents were brown colormorphs exhibiting the characteristic male nuptial striped melanin pattern (Coyer 1982; Stepien 1985, 1986).

### Egg Development and Hatching

Eggs from freshly laid nests hatched in 12-17 d at 18°C, the largest number hatching in 13 d. Eggs averaged 1.4 mm in diameter and nests contained an average of 700 eggs, ranging from 400 to 1,200 eggs. An estimated 800 of the 1,200 eggs hatched from the most successful laboratory incubation. Nests that were rotated vigorously and kept well-aerated produced the most successful hatchings.

The sequence of egg development is summarized in Table 1 and photographs of the developing eggs are shown in Figure 3. Hatching occurred from day 14 through day 15. Hatching took about 20 min, the larvae emerging head-first from the egg membrane.

### Early Larval Development (Prenotochord Flexion)

Giant kelpfish larvae can be distinguished from

other southern California clinid larvae by their large numbers of myomeres, averaging 55-59. Newly hatched larvae had large yolk sacs and well-developed mouths, guts, melanophores, and fin folds and averaged 6.2 mm TL (Fig. 5A). Larvae floated upside-down, yolk up, for the first 24-36 h after hatching. They swam with wriggling movements, lasting about 30 s, interspersed with longer periods of inactivity, lasting up to several minutes.

Yolk sacs were present 36-48 h after hatching. Two-day-old larvae averaged 7.0 mm TL and swam strongly upright, showing positive attraction to light and concentrating near the white mesh areas of the containers. After 4 d, the larvae were less positively phototactic, concentrating towards the bottom of the containers. Mean sizes and a summary of the sequence of larval development are listed in Table 2. Illustrations of larvae are found in Figure 5.

### Later Larval Development (Postnotochord Flexion)

Flexion of the notochord had begun by 7-9 d and an average size of 8.5 mm (ranging from 7.6 to 8.9 mm,  $N = 12$ ). Field-collected giant kelpfish larvae also showed the beginnings of notochord flexion at a similar size (7.4-9.3 mm,  $N = 5$ ). Size at notochord flexion is smaller than that reported by Matarese et al. (1984) for other clinid larvae.

Two-week-old giant kelpfish larvae began swimming in organized schools, which also were observed in situ in giant kelp canopies. Other researchers have also noted this phenomenon (Feder et al. 1974), which was not observed in giant kelpfish past the age of 2 mo in both the laboratory and the field. By 3 wk, the schooling larvae became progressively more difficult to catch with dip nets, exhibiting well-

TABLE 1.—Summary of kelpfish egg developmental stages.

Time after spawning	Developmental features
24 h	well-developed blastodisc, beginnings of epiboly
36 h	head fold apparent, neural tube forming
72 h	embryo wrapped 180° around egg's circumference; notochord, somites, eyes, and lenses visible
6 d	embryo wrapped 240° around egg's circumference, myomeres well-developed, lenses of eyes pigmented, heart beating 95 times per minute
10 d	yolk shrunk to 1/2 size of egg; embryo curled 1.5 times around egg; mouth differentiated; gut, liver, and inner ear developing
12 d	otoliths and pectoral and dorsal fin folds visible, vigorous tail movements, heart beats 90 to 100 times per minute
14 d	hatching at 18°C., larva exits head-first, hatching takes about 20 min

A

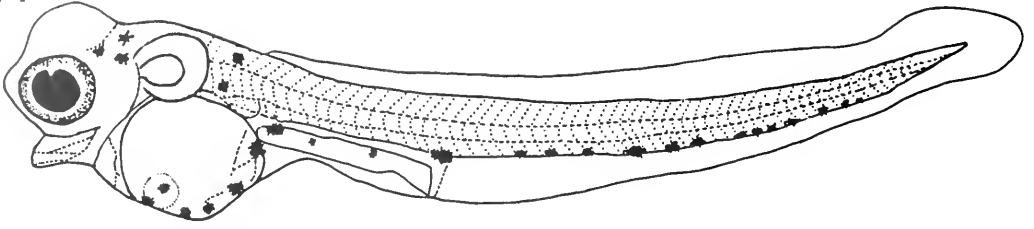

B

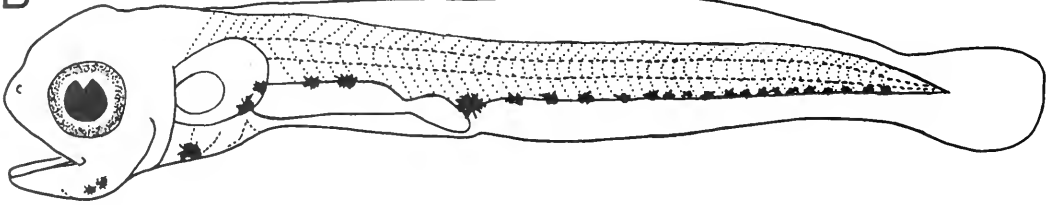

C

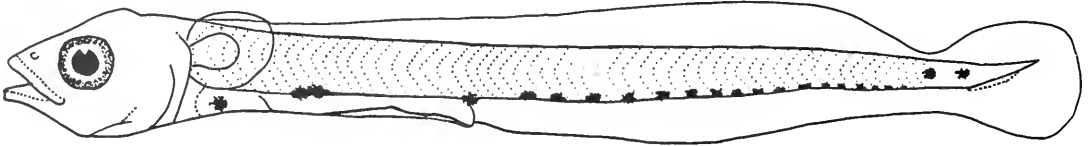

D

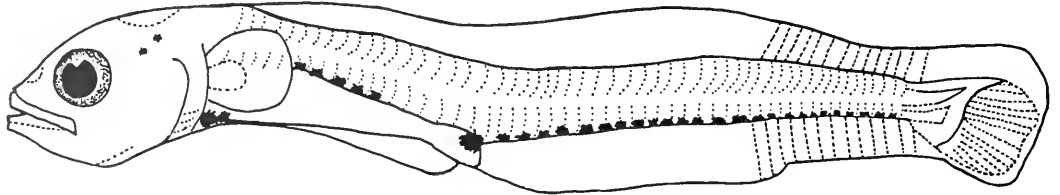

E

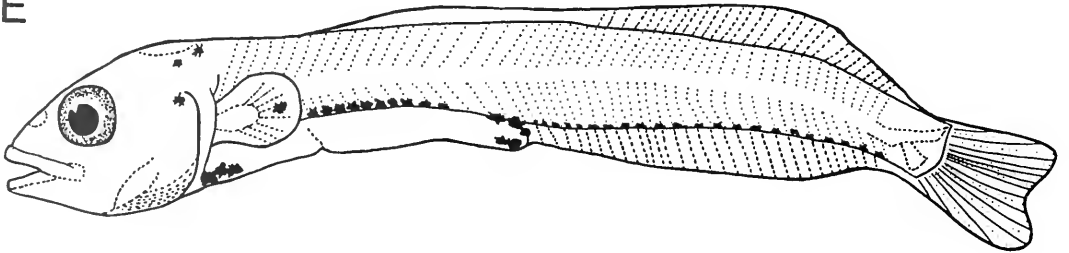

F

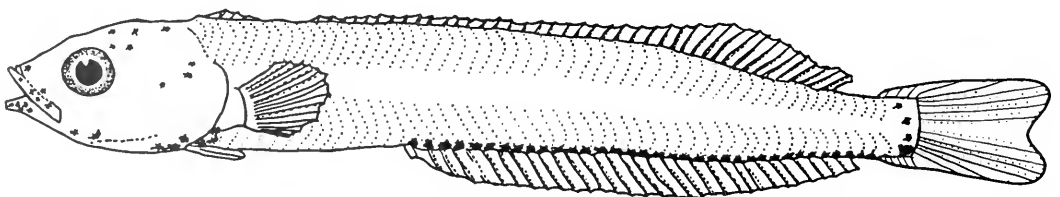

TABLE 2.—Mean sizes (TL, mm) and developmental stages of laboratory-reared giant kelpfish larvae 0-60 d.

Age <sup>1</sup> (d)	Mean length	Range (TL, mm)	No.	Developmental features
0	6.2	6.0-6.5	10	well-developed mouth, gut, and fin folds; 12 postanal serial melanophores
2	7.0	6.7-7.5	10	12-19 postanal melanophores, first feeding, yolk sac 1/3 original size
4	7.7	7.0-8.0	5	20 postanal melanophores, 2 melanophore spots on liver, melanophores dorsal to anus, yolk sac disappeared
6	7.9	7.4-8.4	10	some ventral caudal fin rays visible, gill rakers formed, operculum visible
7	8.3	7.5-9.0	5	notochord flexion begun in some
9	8.8	7.9-9.4	10	notochord flexion completed, swim bladder formed
11	9.7	7.9-10.7	10	caudal fin rays well-developed
13	10.3	8.2-11.2	5	schooling behavior is pronounced
15	10.9	9.5-11.7	10	fin rays in rear of dorsal and anal fin folds
17	11.4	10.0-12.3	10	scattered melanophores on top of head and lower jaw, melanophores over gut
19	11.5	10.1-12.5	5	well-developed schooling and avoidance behavior
21	11.7	10.6-13.6	10	pectoral, dorsal, and anal fin rays formed
23	12.0	11.4-14.3	10	continuous line of stellate melanophores above the gut
25	12.2	10.3-16.8	10	pelvic fins beginning to develop, melanin pigmentation in pelvic region
30	16.8	13.0-19.0	10	orange xanthophore pigmentation on top of the head, over the gut and at the base of the caudal fin; teeth visible
39	23.8	18.0-28.0	5	pelvic fins formed, 32 postanal ventral melanophores
46	25.6	22.0-27.0	10	larvae are pale gold in color
53	25.7	18.0-35.0	10	schooling no longer pronounced
60	30.6	25.0-37.0	10	most have settled onto algae

<sup>1</sup>Age (d) after hatching.

developed avoidance patterns and fright responses. By 5 wk, schooling was no longer as pronounced and the larvae were observed to stalk their copepod prey very efficiently.

### Larval Feeding

Unless giant kelpfish larvae were given food within the first 48 h, a point of no-return was reached, after which they starved to death even if given food. Best results were obtained if larvae were fed within 24 h of hatching. *Brachionus* (rotifers) and *Tetraselmis* (algae) were found in the guts of 2-d-old larvae in the laboratory. Three-day-old larvae, even those still having yolk sacs, contained an average of 5.6 *Brachionus* and 2.9 *Tetraselmis* (Table 3). High mortality (nearly 60% of those hatched) occurred after hatching and through day 5. Dead larvae examined had apparently never eaten, despite relatively high levels of appropriately sized food items.

Gut contents of field-collected kelpfish larvae (estimated to range from 0 to 9 d old) showed that they fed on a wide variety of food items, including single-celled algae, rotifers, mollusk larvae, and barnacle and copepod larvae (Table 4). Similar sizes and quantities of food items were consumed by both the laboratory-reared and field-collected larvae (Tables 3, 4).

Significantly larger food items were consumed by 2-wk-old laboratory-reared larvae, the largest widths being 52% of the mouth size (Fig. 6). Larger copepods were eaten more frequently than rotifers, although both food items were present in guts (Table 3). High mortality (ranging from 20 to 40%) also occurred at about 2.5 wk of age in both the 1980 and 1982 rearing experiments. At this age, gut examinations indicated that the larvae were switching from the smaller prey (rotifers and algae) to the larger copepods. Older larvae progressively consumed larger copepods whose size reached 70% of the mouth width by week 3 (Fig. 6, Table 3).

### Settlement and Metamorphosis

After 8 wk and at a mean length of 30.6 mm, giant kelpfish larvae had well-developed, pale gold-brown pigmentation. They became increasingly thigmotac-

FIGURE 5.—Drawings of laboratory-reared giant kelpfish larvae, made with camera lucida and dissection microscope. (A) Day 0 (after hatching), 6.1 mm TL. (B) Day 4 after hatching, 7.0 mm TL. (C) Day 7 after hatching, 8.4 mm TL. (D) 2 wk, 10.9 mm TL. (E) 3 wk, 11.6 mm TL. (F) 5 wk, 22.2 mm TL.

TABLE 3.—Gut contents of laboratory-reared giant kelpfish larvae, 3 d to 5 wk, indicating mean numbers and sizes of prey items.  $N = 18$  ( $N = 3$ /sample). Laboratory diets 0-3 wk consisted of *Tetraselmis* and *Brachionus*. *Acartia* copepods were added to the diet at 2 wk. Sizes of kelpfish (TL, mm) and mean sizes of prey items (width  $\times$  length) given.

Kelpfish larvae	Size (mm)	Prey items					
		<i>Tetraselmis</i> algae		<i>Brachionus</i> rotifers		<i>Acartia</i> copepods	
Age		Mean No.	Size (mm)	Mean No.	Size (mm)	Mean No.	Size (mm)
3 d	6.8 7.1 7.4	2.9	0.039 $\times$ 0.120	5.6	0.10 $\times$ 0.149	—	—
1 wk	8.0 8.2 8.2	3.3	0.050 $\times$ 0.120	14.7	0.103 $\times$ 0.157	—	—
2 wk	9.4 9.7 10.8	10.0	0.078 $\times$ 0.130	10.2	0.160 $\times$ 0.220	1.2	0.100 $\times$ 0.390
3 wk	10.7 11.5 13.6	—	—	6.8	0.130 $\times$ 0.195	2.4	0.221 $\times$ 0.520
4 wk	11.9 13.3 16.4	—	—	—	—	3.3	0.221 $\times$ 0.520
5 wk	19.7 22.0 23.0	—	—	—	—	7.9	0.220 $\times$ 0.850

TABLE 4.—Gut contents of field-collected giant kelpfish larvae 6.24-8.2 mm TL.  $N = 4$ . Mean TL of kelpfish = 6.93 mm (range 6.24-8.82 mm). Mean mouth width = 0.42 mm (0.40-0.44 mm).

Food item	Mean no./larva	Mean width and range (mm)	Mean length and range (mm)
Diatoms	3.00	0.03 (0.01-0.07)	0.06 (0.04-0.08)
Dinoflagellates	2.00	0.03 (0.01-0.07)	0.04 (0.02-0.20)
Tintinnid protozoans	0.75	0.04 (0.03-0.07)	0.13 (0.10-0.16)
Rotifers	0.75	0.08 (0.03-0.13)	0.19 (0.08-0.35)
Barnacle nauplii and cyprids	0.75	0.10 (0.07-0.13)	0.16 (0.12-0.23)
Copepod nauplii and copepodites	3.50	0.12 (0.07-0.21)	0.40 (0.14-0.46)
Mollusk larvae	1.00	0.11 (0.09-0.12)	0.25 (0.22-0.29)
Nemertean worms	0.25	0.10	0.34
Siphonophores	0.25	0.29	0.30

tic during the next few weeks, darting amongst the artificial plants placed in their containers. Similarly, kelpfish individuals observed in situ had "settled" onto juvenile habitats by 30-50 mm TL. Juvenile habitats included the fronds of giant kelp; the brown alga, *Sargassum muticum*; and green surfgrass. Juveniles were usually in loose aggregations of three to seven similar-sized individuals until reaching a size of 7-9 cm TL.

At 5-7 cm (between 2 and 4 mo), laboratory-reared and field-collected giant kelpfish lost their transparent light gold-colored appearance, developing either green, gold, or brown pigmentation depending on their juvenile habitat, whether surfgrass, kelp, or *Sargassum*. The majority of juveniles found in surfgrass were green with striped or mottled

melanin patterns and had silvery horizontal patches. Those in kelp were usually plain or mottled gold-brown with gold bellies while those in *Sargassum* developed brown pigmentation and barred or mottled melanin patterns (see Stepien 1985 and 1986 for detailed descriptions of color patterns).

### Morphometrics of Larvae, Juveniles, and Adults

The SL and TL of giant kelpfish larvae were linearly related (Fig. 7). Early growth (to 40 d) of laboratory-reared larvae was logarithmic (Fig. 8A) while length and age were linearly related between 1 and 9 mo of age (Fig. 8B). Otoliths of laboratory-reared kelpfish showed abnormal ring patterns,

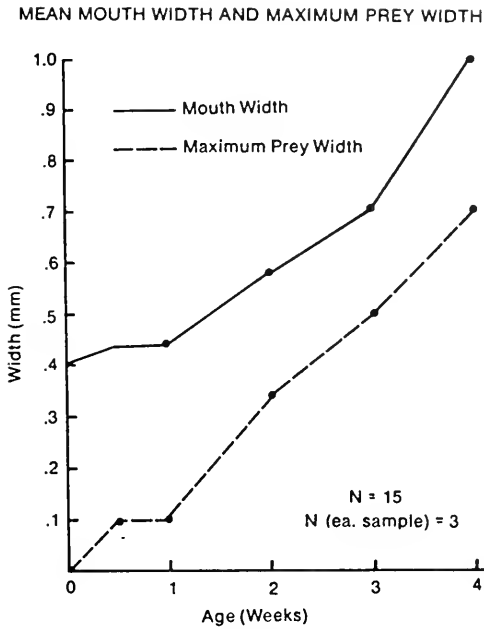

FIGURE 6.—Mean mouth width and maximum prey width consumed by laboratory-reared giant kelpfish larvae 0-4 wk old.  $N = 15$  ( $N$  each sample = 3).

having several “checks” (false rings). Maximum age reached by laboratory-reared kelpfish in these experiments was 9 mo, at which time they succumbed to a bacterial infection.

Weight versus length of juvenile and adult kelpfish was exponentially related (Fig. 9), and SL and TL were directly linearly related (Fig. 10). Length versus age determinations also followed an exponential curve (Fig. 11). Sexual maturity occurred at a mean size of 18.6 cm TL and an age of 1-1.5 yr.

Regressions of sizes of adult males and adult females on age class were found to be significantly different using ANCOVA (see Fig. 11 legend). When sizes at given ages were compared using  $t$ -tests, females were found to be significantly larger than males at given ages past 2 yr (Fig. 12). The largest males sampled in this study were not older than 3 yr or larger than 28 cm TL. In contrast, large females, reaching ages of 4.5 yr and sizes of 42 cm (TL) were collected. Larger individuals collected throughout the 5-yr sampling regime were consistently females.

### Population Structure

Seasonal size class structure of the giant kelpfish population was consistent over 2 yr of regular sam-

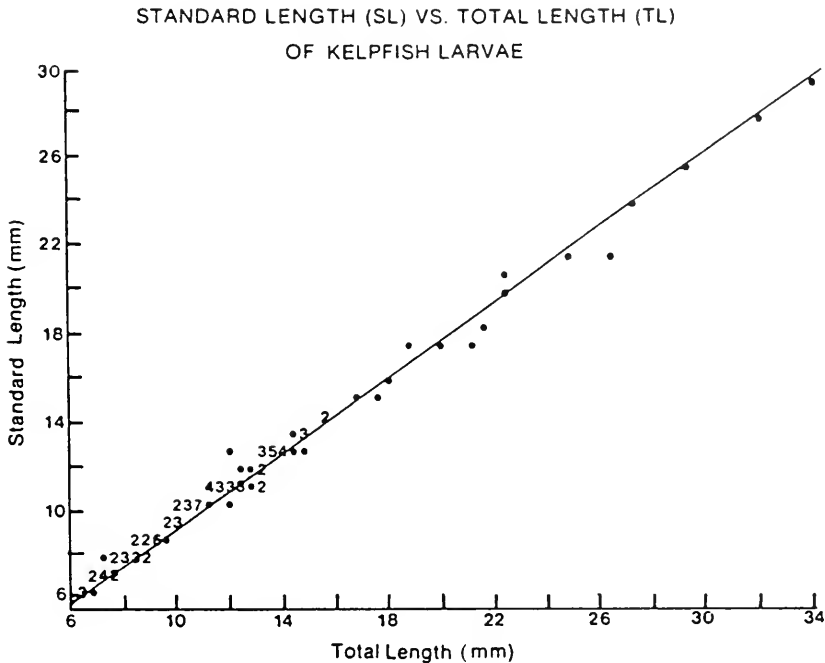

FIGURE 7.—SL (mm) versus TL (mm) of laboratory-reared giant kelpfish larvae 0-30 d old. \* = one fish.  $N = 108$ . Regression equation:  $SL = 0.598 + 0.819 (TL)$ .  $F = 11,588.62$ ,  $P < 0.00001$ .

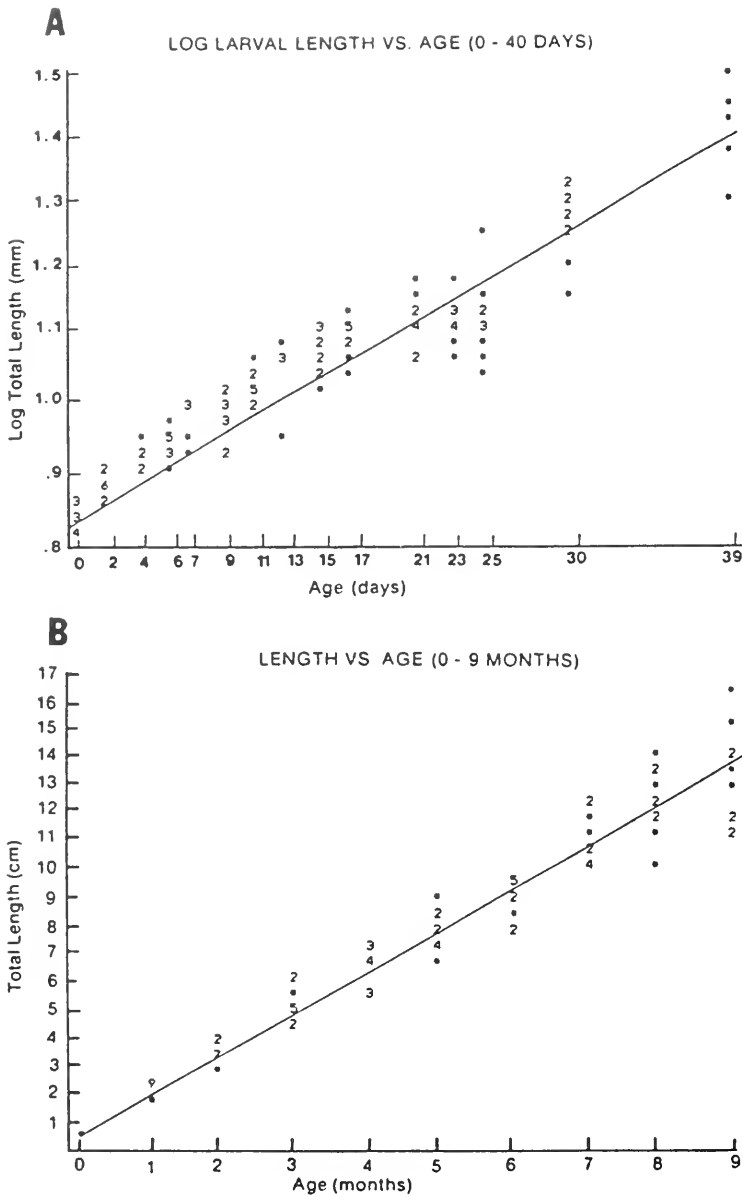

FIGURE 8.—(A) Log length (TL, mm) versus age (0-40 d) of laboratory-reared giant kelpfish larvae. \* = one fish.  $N = 130$ . Regression equation:  $\text{Log TL} = 0.814 + 0.013 (\text{days})$ .  $F = 1,211.9$ ,  $P < 0.0001$ . (B) Growth of laboratory-reared giant kelpfish (0-9 mo), length (cm) versus age (months). \* = one fish.  $N = 100$ . Regression equation:  $\text{TL} = 0.379 + 1.482 (\text{months})$ .  $F = 2,230.8$ ,  $P < 0.0001$ .

pling (Fig. 13). Contingency tests of independence showed that numbers of individuals in various size classes differed significantly with season in 1981-82 and 1982-83. Juveniles appeared in significant numbers during the spring and summer months. These data agreed with observations on spawning and

appearance of larvae in the water column, indicating that most Catalina Island kelpfish in these years spawned from January through May. During spring and summer, a large portion of the population was estimated to be 1 and 2 yr old, composed of individuals of reproductive age. During the fall



LOG WEIGHT VS. LOG LENGTH OF JUVENILES AND ADULTS

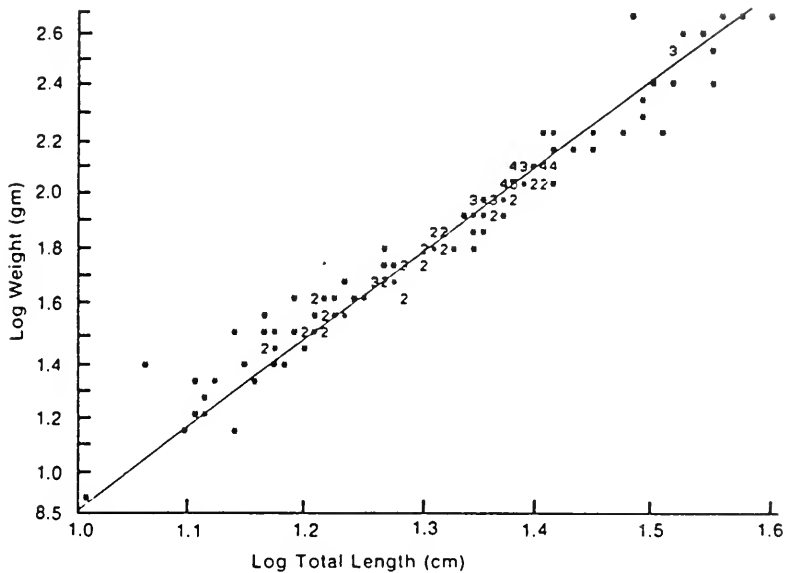

FIGURE 9.—Log weight (g) versus log TL (cm) of juvenile and adult giant kelpfish. \* = one fish.  $N = 140$ . Regression equation:  $\text{Log weight} = -2.508 + 3.243 (\text{log TL})$ .  $F = 3,622.7$ ,  $P < 0.0001$ .

STANDARD LENGTH (SL) VS. TOTAL LENGTH (TL)  
OF JUVENILES AND ADULTS

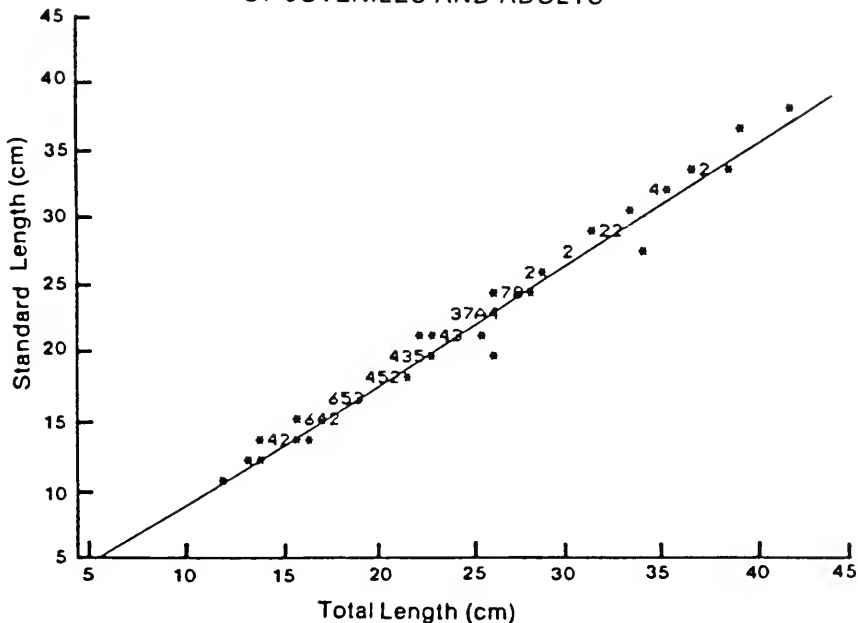

FIGURE 10.—SL (cm) versus TL (cm) of juvenile and adult giant kelpfish. \* = one fish. A = 11 fish.  $N = 140$ . Regression equation:  $SL = -0.580 + 0.906 (TL)$ .  $F = 15,993.0$ ,  $P < 0.0001$ .

## LOG LENGTH VS. LOG AGE

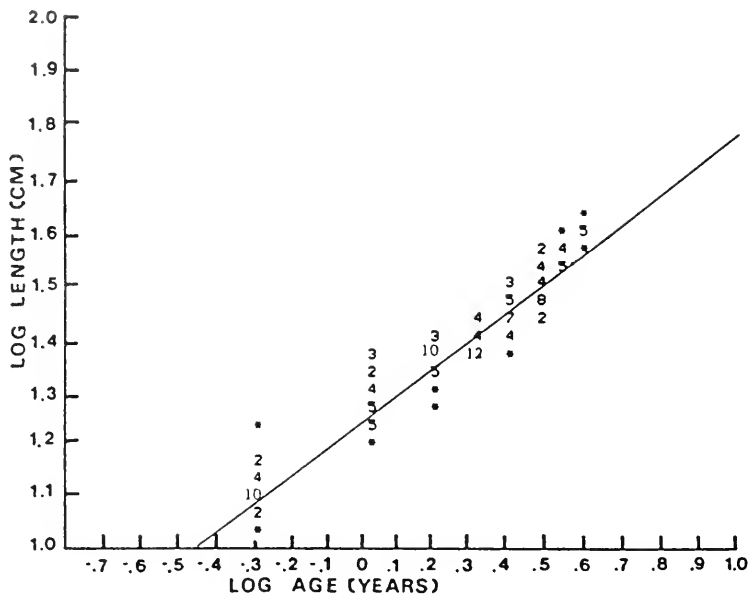

FIGURE 11.—Log TL (cm) versus log age class (years) of juvenile and adult giant kelpfish (males and females). \* = one fish.  $N = 137$ . Regression equation:  $\text{Log TL} = 1.234 + 0.528 (\text{log age})$ ;  $F = 1,589.28$ ,  $P < 0.0001$ . Regression equation for females only ( $N = 77$ ):  $\text{Log TL} = 1.234 + 0.561 (\text{log age})$ ;  $F = 1,460.7$ ,  $P < 0.0001$ . Regression equation for males only ( $N = 60$ ):  $\text{Log TL} = 1.235 + 0.453 (\text{log age})$ ;  $F = 535.0$ ,  $P < 0.001$ . ANCOVA regression analysis of log TL for males and females (two different groups versus log age class (years):  $F = 5.82$  ( $P < 0.05$ )).

## MEAN LENGTH VS. AGE OF FEMALES AND MALES

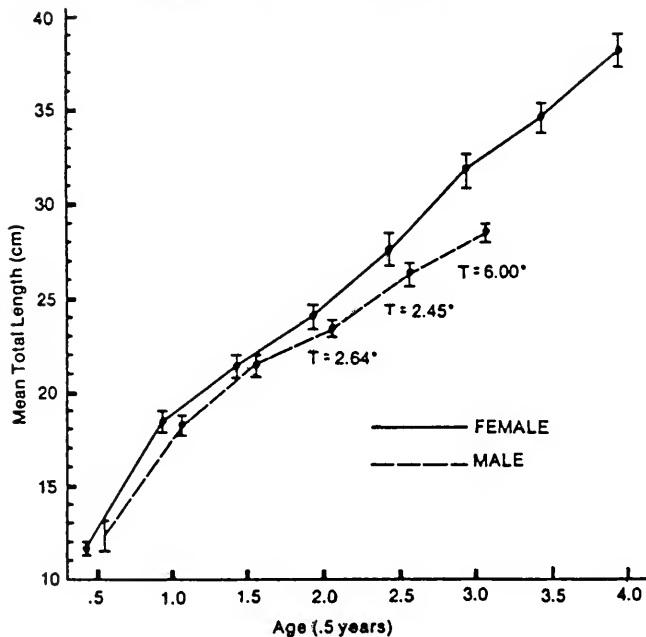

FIGURE 12.—Mean TL (cm) versus age class (years) of female and male giant kelpfish. Significant differences between male and female mean sizes indicated. \* = Significant difference in  $t$ -test results (0.05 level). Standard error bars shown.  $N = 137$ . Two-way ANOVA with replication for mean lengths of male and female kelpfish at three ages (2.0, 2.5, and 3.0 yr) showed significant differences between the sexes ( $F = 38.52$ ,  $P < 0.001$ ) and the age classes ( $F = 78.01$ ,  $P < 0.001$ ), but no interaction (sex  $\times$  ages;  $F = 3.37$ ).

## SIZE FREQUENCIES OF KELPFISH

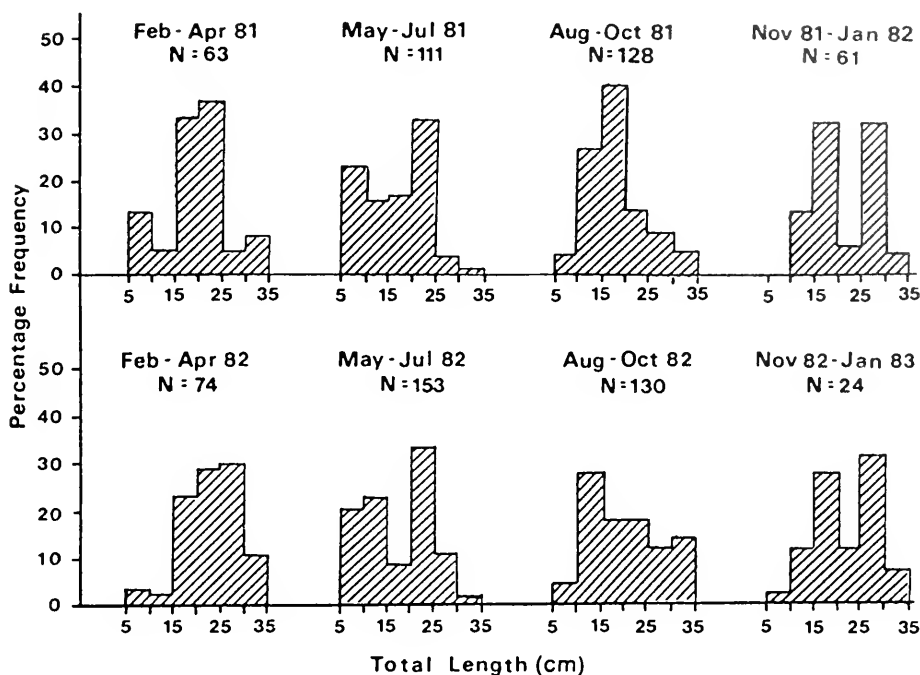

FIGURE 13.—Percentage frequencies of giant kelpfish size classes collected seasonally from February 1981 to January 1983.  $N = 744$ . Contingency table  $R \times C \times G$  tests of independence showed significant seasonal variations in frequencies of kelpfish size classes in 1981-82 ( $N = 363$ ;  $\chi^2 = 167.73$ , 15 df,  $P < 0.001$ ) and 1982-83 ( $N = 381$ ;  $\chi^2 = 86.07$ , 15 df,  $P < 0.001$ ). (Sokal and Rohlf 1981.)

months, the most abundant size classes were estimated as 0.5 and 1.5 yr of age. These size frequencies also indicate that a relatively low percentage of the population is composed of individuals 3 yr and older.

## DISCUSSION

### Reproduction and Development

Unlike *Heterostichus*, whose nests contain eggs in similar stages of development, those of the fringehead *Neoclinus bryope* (family Clinidae; subfamily Chaenopsidae) contain various developmental stages, apparently from several spawnings (Shiogaki and Dotsu 1972). *Heterostichus* eggs have a single large oil globule (see Barnhart 1932 and Figure 3C), while other described clinid eggs have several (Sparta 1948; Shiogaki and Dotsu 1972; Matarese et al. 1984). Unfertilized eggs of *Gibbonsia elegans* contain a mass of 6-16 small oil globules (Stepien<sup>3</sup>). Like

*Heterostichus* (see Figure 3D), *Clinus argentatus* eggs develop large black melanophores over the surface (Sparta 1948).

Early larval development in other clinids resembles that of *Heterostichus*, although few species have been studied and none have been reared past the yolk-sac stage. Other clinids are reported to hatch at similar sizes and at comparable development (Sparta 1948; Shiogaki and Dotsu 1972; Matarese et al. 1984). As in *Heterostichus*, the yolk-sac stage persists for 2-3 d (Shiogaki and Dotsu 1972), caudal fin rays develop first (Matarese et al. 1984), and dorsal and anal fin rays form posteriorly to anteriorly (Risso 1948; Shiogaki and Dotsu 1972; Matarese et al. 1984). Flexion of the notochord appears to occur at a smaller size in *Heterostichus* (mean 8.5 mm TL) than in some other clinids (by 11.1 mm TL in *Neoclinus* and 11.52 mm TL in *Clinus argentatus*) (Sparta 1948; Shiogaki and Dotsu 1972).

<sup>3</sup>*Gibbonsia elegans* Cooper. Unpubl. manuscr. Marine Biology Research Division A-002, Scripps Institution of Oceanography, University of California at San Diego, La Jolla, CA 92093.

<sup>3</sup>Stepien, C. A. 1986b. Life history of the spotted kelpfish, *Gib-*

Swimming behavior of newly hatched kelpfish larvae, characterized by short periods of swimming interspersed with longer periods of inactivity, is common in many small marine yolk-sac larvae (Hunter 1972; Ellertsen et al. 1980; Weihs 1980). Like kelpfish, some other newly hatched larvae including cod, *Gadus morhua*, (Ellertsen et al. 1980) and white seabass, *Atractoscion (Cynoscion) nobilis*, (Orhun<sup>4</sup>) swim upside-down for the first 24 h after hatching. This behavior is due to positive buoyancy of the yolk (Hunter<sup>5</sup>). Kelpfish larvae, in situ as well as in the laboratory, schooled between 2 wk and 2 mo of age. Larval schooling is common in species of nearshore fishes which also school as adults (Smith 1981; Hunter 1981) and may serve to increase the probability of locating patches of food and/or may help them avoid predation. No reference to larval schooling in fishes that do not school as adults was found in the literature.

### Larval Feeding

A point of no-return at which starvation occurs even if larvae are fed appears to occur earlier in giant kelpfish (after 36 h) than in fish larvae hatching from pelagic eggs (Hunter 1981) and is probably due to their greater degree of development at hatching (i.e., smaller yolks and well-developed mouths and digestive tracts). Only a small number of species are sufficiently developed to consume exogenous food shortly after hatching (Balon 1984a, b). Early feeding during the yolk-sac stage may be critical for the larvae to develop a "search" image and capture skills (Hunter 1981).

In this study, high mortality following the yolk-sac stage was apparently due to starvation, despite relatively high levels of appropriate-sized food items. In many marine fishes, relatively low feeding success is apparently common in field-collected, as well as laboratory-reared, larvae (Hunter 1981). During the first week, field-collected, as well as the laboratory-reared, larvae consume a wide variety of food items, primarily smaller ones such as unicellular algae. Like *Heterostichus*, most species of larval fishes have been found to eat many more small prey items than larger ones (Hunter and Kimbrell 1980; Hunter 1981).

High mortality also occurred in the laboratory at about 2.5 wk, when larvae were apparently switching from smaller to larger prey. This may be a critical period when the larvae have to learn to capture larger, faster swimming crustaceans as the primary dietary component in order to obtain sufficient caloric intake. Studies on other fish larvae have demonstrated the necessity of increasing prey size with growth (Hunter 1977; Hunter and Kimbrell 1980).

### Juvenile and Adult Life History

Ages of juveniles and adults calculated in the present study agree with estimates for giant kelpfish determined by J. E. Fitch (in Feder et al. 1974) and by R. Collins<sup>6</sup>. Ages by Coyer (1982), based on 42 kelpfish samples, do not agree with those in the present study. Coyer appeared to have overestimated the oldest kelpfish by 3 yr. This may have been due to the prevalence of "checks" or partially completed false rings on the otoliths which are commonly formed during spawning (Collins and Spratt 1969) and were frequently observed in the present study. Estimated size at sexual maturity (mean 18.6 cm TL) agrees with that reported by Coyer (1982).

Past the age of sexual maturity, female giant kelpfish are significantly larger than males and also live several years longer. Size discrepancy between adult males and females may have evolved from the females' behavior of venturing away from their territories during the spring spawning season into those occupied by males (Stepien 1985, 1986). They are often readily visible at this time while away from plants of matching colors. Large size may help females to avoid predation or, alternatively, may be the result of selection for increased fecundity.

### ACKNOWLEDGMENTS

Grants and funds supporting this research included Sigma Xi, the Lerner Fund for Marine Research, the Theodore Roosevelt Memorial Scholarship Fund of the American Museum of Natural History, the University of Southern California Department of Biological Sciences and Graduate School, and a Sea Grant Traineeship. Laboratory facilities were provided by the Catalina Marine Science Center, U.S.C.'s Fish Harbor Research Laboratory, and Southern California Edison (Redondo Beach).

<sup>4</sup>Orhun, R. M. 1986. Culture and growth of larval and early juvenile white seabass, *Atractoscion (Cynoscion) nobilis*. M.S. Thesis in preparation, Center for Marine Studies, Department of Biology, San Diego State University, San Diego, CA 92182.

<sup>5</sup>John Hunter, Southwest Fisheries Center La Jolla Laboratory, National Marine Fisheries Service, NOAA, 8604 La Jolla Shores Drive, La Jolla, CA 92038, pers. commun. January 1986.

<sup>6</sup>Robson Collins, California State Department of Fish and Game, Long Beach, CA 90813, pers. commun. March 1982.

I thank the following people for giving technical assistance and information: Robson Collins, John Hunter, Kenneth Rich, C. Robert Bostick, Charles Winkler, Peter McGroddy, Steve Edwards, Eric Lynn, Robert Lavenberg, Gerald McGowen, Gary Brewer, and Laura Alderson. Steven Naffziger, Donald Wilkie, Robert Moore, Neale Jones, Mark Carr, Brandon Kulik, Richard Wright, John Sudick, Neale Jones, and Larry Allen assisted in collecting kelpfish. Robert Provin helped draw the figures and Stanley Azen provided statistical advice. This manuscript benefited substantially from critical reviews by Basil Nafpaktitis, Richard Brusca, Gerald Bakus, Gerald McGowen, and Bernard Abbott.

### LITERATURE CITED

- BALON, E. K.  
 1984a. Reflections on some decisive events in early life of fishes. *Trans. Am. Fish. Soc.* 113:178-185.  
 1984b. Patterns in the evolution of reproductive styles in fishes. In G. W. Potts and R. J. Wootton (editors), *Fish reproduction: strategies and tactics*, p. 35-53. Acad. Press, Lond.
- BARNHART, P. S.  
 1932. Notes on the habits, eggs, and young of some fishes of southern California. *Bull. Scripps Inst. Oceanogr., Univ. Calif.* 3:87-99.
- COLLINS, R. A., AND J. D. SPRATT.  
 1969. Age determination of northern anchovies, *Engraulis mordax*, from otoliths. *Calif. Fish Bull.* 147:39-55.
- COYER, J. A.  
 1979. The invertebrate assemblage associated with *Macrocystis pyrifera* and its utilization as a food resource by kelp-forest fishes. Unpubl. Ph.D. Thesis, Univ. Southern California, Los Angeles, 314 p.  
 1982. Observations on the reproductive behavior of the giant kelpfish, *Heterostichus rostratus* (Pisces: Clinidae). *Copeia*. 1982:344-350.
- ELLERTSEN, B., P. SOLEMDAL, T. STROMME, S. TILSETH, T. WESTGARD, E. MOKSNESS, AND V. OIESTAD.  
 1980. Some biological aspects of cod larvae (*Gadus morhua* L.). *Fiskeridir. Skr. Ser. Havunders.* 17:29-47.
- FEDER, H. M., C. H. TURNER, AND C. LIMBAUGH.  
 1974. Observations on fishes associated with kelp beds in southern California. *Calif. Fish Bull.* 160:1-144.
- FITCH, J. E.  
 1951. Age composition of the southern California catch of Pacific mackerel 1939-40 through 1950-51. *Calif. Fish Bull.* 83:1-75.
- HOBSON, E. S.  
 1971. Cleaning symbiosis among California inshore fishes. *Fish. Bull., U.S.* 69:491-523.
- HOBSON, E. S., W. N. MCFARLANE, AND J. R. CHES.  
 1981. Crepuscular and nocturnal activities of Californian nearshore fishes, with consideration of their scotopic visual pigments and the photic environment. *Fish. Bull., U.S.* 79:1-30.
- HOLDER, C. F.  
 1907. The nest of the kelpfish. *Am. Nat.* 41:587-588.
- HOUDE, E. D.  
 1972. Some recent advances and unsolved problems in the culture of marine fish larvae. *Proc. World Maricult. Soc.* 3:83-112.
- HUBBS, C.  
 1952. A contribution to the classification of the Blennioid fishes of the family Clinidae, with a partial revision of the eastern Pacific forms. *Stanford Ichthyol. Bull.* 4:41-165.
- HUBBS, C. L.  
 1920. Protective coloration and habits in the kelpfish, *Heterostichus rostratus*. *Copeia* 1920:19-20.
- HUNTER, J. R.  
 1972. Swimming and feeding behavior of larval anchovy *Engraulis mordax*. *Fish. Bull., U.S.* 70:821-838.  
 1977. Behavior and survival of northern anchovy *Engraulis mordax* larvae. *Calif. Coop. Oceanic Fish. Invest. Rep.* 19: 138-146.  
 1981. Feeding ecology and predation of marine fish larvae. In R. Lasker (editor), *Marine fish larvae: morphology, ecology, and relation to fisheries*, p. 33-77. Wash. Sea Grant Program, Seattle.
- HUNTER, J. R., AND C. A. KIMBRELL.  
 1980. Early life history of Pacific mackerel, *Scomber japonicus*. *Fish. Bull., U.S.* 78:89-101.
- JENSEN, A. C.  
 1965. A standard terminology and notation of otolith readers. *Int. Comm. Northwest Atl. Fish. Res. Bull.* 2:5-7.
- LIMBAUGH, C.  
 1955. Fish life in the kelp beds and the effects of kelp harvesting. *Inst. Mar. Res. Ref.* 55-9, 158 p.
- MATARESE, A. C., W. WATSON, AND E. G. STEVENS.  
 1984. Blennioidea: Development and relationships. In H. G. Moser et al. (editors), *Ontogeny and systematics of fishes*, p. 565-577. *Am. Soc. Ichthyol. Herpetol. Spec. Pub.* 1.
- QUAST, J. C.  
 1968. Observations on the food of the kelp-bed fishes. In W. J. North and C. L. Hubbs (editors), *Utilization of kelp-bed resources in southern California*, p. 109-142. *Bull. Calif. Dep. Fish Game* 139.
- ROEDEL, P. M.  
 1953. Common ocean fishes of the California coast. *Calif. Fish Bull.* 91:1-184.
- SHIOGAKI, M., AND Y. DOTSU.  
 1972. The life history of the blennioid fish, *Neoclinus bryope*. [In Jpn., Engl. abstr.] *Bull. Fac. Fish. Nagasaki Univ.* 34, p. 1-8.
- SMITH, P. E.  
 1981. Fisheries on coastal pelagic schooling fish. In R. Lasker (editor), *Marine fish larvae: morphology, ecology, and relation to fisheries*, p. 1-31. Wash. Sea Grant Program, Seattle.
- SOKAL, R. R., AND F. J. ROHLF.  
 1981. *Biometry: The principle and practice of statistics in biological research*. 2d ed. W. H. Freeman and Co., San Franc., 859 p.
- SPARTA, A.  
 1948. Uova ovariche, uova fecondate tenute in colture larva alla schiusa, stadi larvali e giovanile di *Cristiceps argenatus*. *Risso*. [In Ital.] *Arch. Oceanogr. Limnol., Mem.* 315 (1-3): 79-84.
- STEPIEN, C. A.  
 1985. Life history, ecology, and regulation of the colormorphic patterns of the giant kelpfish *Heterostichus rostratus* Girard (Family Clinidae). Ph.D. Thesis, Univ. Southern California, Los Angeles, 318 p.

1986. Regulation of the colormorphic patterns in the giant kelpfish, *Heterostichus rostratus* Girard: Genetic versus environmental factors. J. Exp. Mar. Biol. Ecol. 100:181-208.
- THEILACKER, G. H., AND M. F. MCMASTER.  
1971. Mass culture of the rotifer *Brachionus plicatilis* and its evaluation as a food for larval anchovies. Mar. Biol. (Berl.) 10:183-188.
- WEIHS, D.  
1980. Energetic significance of changes in swimming modes during growth of larval anchovy, *Engraulis mordax*. Fish. Bull., U.S. 77:597-604.
- ZIMMERMAN, R. C., AND J. L. KREMER.  
1983. Crunch: The friendly data analysis program. Zimmerman and Kremer, Los Ang., 17 p.

# A SIMPLE METHOD FOR ESTIMATING THE FOOD CONSUMPTION OF FISH POPULATIONS FROM GROWTH DATA AND FOOD CONVERSION EXPERIMENTS<sup>1</sup>

DANIEL PAULY<sup>2</sup>

## ABSTRACT

Experimental data on the gross food conversion efficiency of fishes ( $K_1 = \text{growth increment/food ingested}$ ) are usually reduced to a model of the form  $K_1 = \alpha W^\beta$ ; it is shown that the model  $K_1 = 1 - (W/W_\infty)^\beta$  has a number of advantages over the traditional model.

The new model can be used to compute the food consumption per unit biomass of an age-structured fish population, by relying on the first derivative of the von Bertalanffy growth formula (VBGF) to express growth increments, and the identity of  $W_\infty$  in the VBGF and in the model expressing  $K_1$  as a function of weight.

Computed examples, using published growth and mortality parameters, and the results of food conversion experiments were used to obtain consumption estimates in a carnivorous grouper (*Epinephelus guttatus*) and an herbivorous angelfish (*Holocanthus bermudensis*). Results were shown to be most sensitive to the parameter  $\beta$ . Various applications of this simple model are discussed, particularly as a method to estimate key inputs in J. J. Polovina's ECOPATH model.

A multiple-regression extension of the basic model is presented which accounts for the impact of factors other than body weight on values of  $K_1$  and  $\beta$ . This method is illustrated with an analysis of data on dab (*Limanda limanda*).

Estimating the quantity of food eaten during a certain period by a fish population from field data is usually a difficult task and various sophisticated methods developed for this purpose have data requirements which can make their routine application impossible (Beverton and Holt 1957; Ursin 1967; Daan 1973, 1983; Andersen 1982; Armstrong et al. 1983; Rice et al. 1983; Stewart et al. 1983; Pennington 1984; Majkowski and Hearn 1984). Polovina (1984) recently presented a technique for construction of ecosystem models which is structured around a well-documented computer program called ECOPATH (Polovina and Ow<sup>3</sup>). In situations where classical fishery data are sparse this technique has the potential of becoming a standard method for consolidating and examining the data available on aquatic ecosystems. ECOPATH estimates equilibrium biomass (B), annual production

(P), and annual consumption (Q) for each group in the model. ECOPATH requires a number of data inputs for each group treated in the model and usually the most difficult to obtain is the average food consumption per unit biomass (Q/B) of each group. The present study derives a method to estimate Q/B through a combination of experimental and field data that are easily obtained. In the process, a model is derived which will allow for more information to be extracted from feeding experiments than has hitherto been the case.

## MODEL FOR REDUCING EXPERIMENTAL DATA ON THE CONVERSION EFFICIENCY OF FISHES

Usually laboratory or pond feeding experiments lead to estimates of  $K_1$ , the gross conversion efficiency, which are obtained, for short intervals, from

$$K_1 = \text{growth increment/food ingested} \quad (1)$$

(Ivlev 1939, 1966).

Usually,  $K_1$  declines with body size (other factors affecting  $K_1$  are discussed below) and it has become

<sup>1</sup>Based on Chapter 3 of a "Habilitationsschrift" presented in December 1984 to the Dean of the Mathematics and Science Faculty, Kiel University (Federal Republic of Germany) and titled "Zur Biologie tropischer Nutztiere: eine Bestandsaufnahme von Konzepten und Methoden." ICLARM Contribution No. 281.

<sup>2</sup>International Center for Living Aquatic Resources Management, MCC P.O. Box 1501, Makati, Metro Manila, Philippines.

<sup>3</sup>Polovina, J. J., and M. D. Ow. 1983. ECOPATH: a user's manual and program listings. Southwest Fish. Cent. Admin. Rep. H 82-83. Southwest Fisheries Center Honolulu Laboratory, National Marine Fisheries Service, NOAA, 2570 Dole Street, Honolulu, HI 96822-2396.

a standard procedure to plot empirical values of  $K_1$  obtained against the corresponding body weights, i.e., the mean weights ( $W$ ) corresponding to each growth increment, or

$$\log_{10} K_1 = \log_{10} a + b \log_{10} W \quad (2)$$

which leads to the model

$$K_1 = aW^b. \quad (3)$$

(See Sprugel 1983 for a method to correct the bias due to log transformation in this and the other models below.) A discussion of this model may be found in Jones (1976) (see Figure 1a for an example).

This model has three liabilities, the first of which is the most serious:

1) The parameters "a" and "b" have no biological meaning, i.e., cannot be predicted from one's knowledge of the biology of a given fish. Converse-

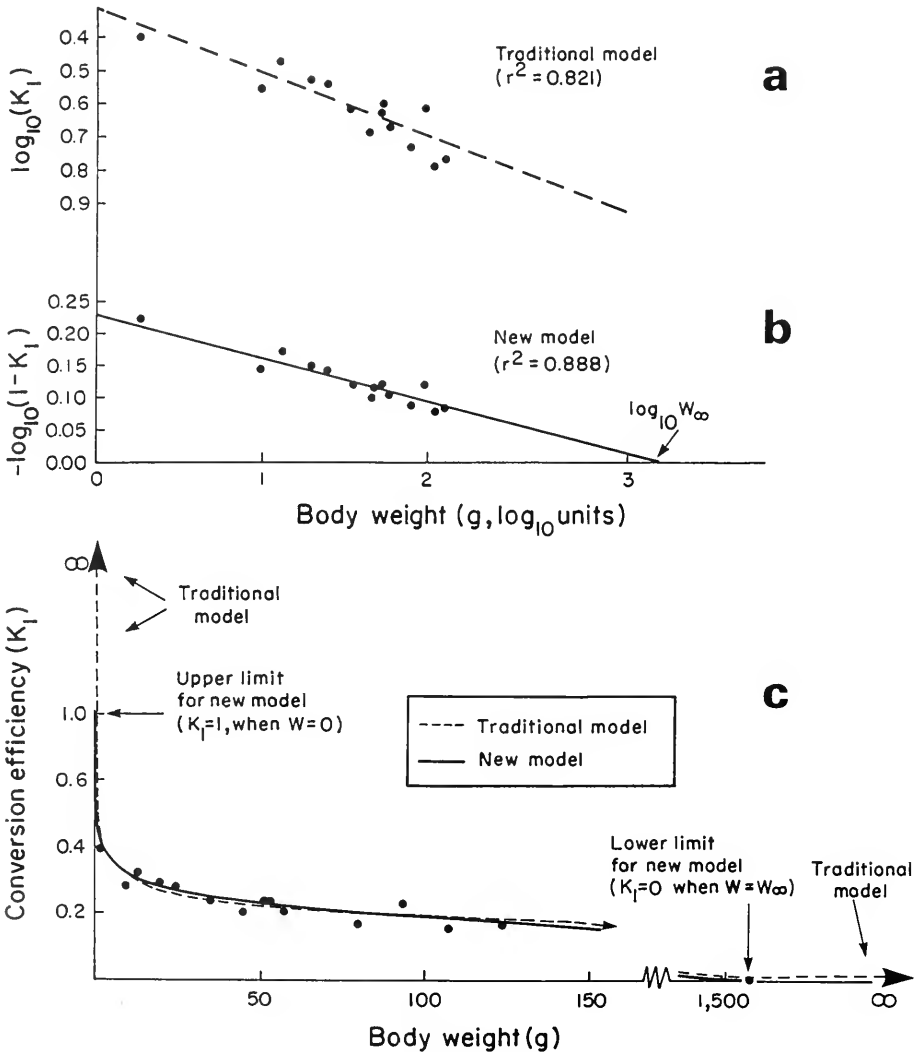

FIGURE 1.—Relationship of gross food conversion efficiency ( $K_1$ ) and body weight ( $W$ ) in *Channa striata*. a) Plot of  $\log_{10} K_1$  on  $\log_{10} W$ , as needed to estimate parameters "a" and "b" of traditional model for prediction of  $K_1$  from body weight. b) Plot of  $-\log_{10}(1-K_1)$  on  $\log_{10} W$ , as needed to estimate parameters  $W_\infty$  and  $\beta$  of new model. c) Comparison of the two models. Note that both fit the data well over the range for which data points are available, but that the traditional model provides nonsensical results beyond this range (see text). Based on the data in Pandian (1967).



ly, these parameters do not provide information which can be interpreted via another model.

2) The model implies values of  $K_1 > 1$  when  $a^{-1/b} > W > 0$ , which is nonsensical.

3) The model implies that, except when  $W = 0$ ,  $K_1$  is always  $> 0$ , even in very large fish, although it is known that fish cannot grow beyond certain species-specific and environment-specific sizes, whatever their food intake.

The new model proposed here has the form

$$K_1 = 1 - (W/W_\infty)^\beta \quad (4)$$

with  $\beta$  as a constant and  $W_\infty$  as the weight at which  $K_1 = 0$ . The model implies that  $K_1 = 1$  when  $W = 0$ , whatever the values of  $\beta$  and  $W_\infty$  (see Discussion for comments on using values other than 1 as upper bound for  $K_1$  in Equation (4)). The new model can, as the traditional model, be fitted by means of a double logarithmic plot:

$$C = \beta \log_{10} W_\infty - \beta \log_{10} W \quad (5)$$

where  $C = -\log_{10} (1 - K_1)$ , the sign being changed here to allow the values of  $C$  to have the same positive sign as the original values of  $K_1$ . Interestingly, it also appears that negative values of  $K_1$  (based on fish which lost weight), which must be ignored in the traditional model, can also be used in this model (as long as they do not drag the mean of all available  $K_1$  values below zero, see Table 1), although their interpretation seems difficult.

The new model requires no more data, nor markedly more computations than the old one. It produces "possible" values of  $K_1$  over the whole range of weights which a given fish can take. The values of  $W_\infty$ , which represent the upper bound of this range can be estimated from

$$W_\infty = \text{antilog}_{10} (C \text{ intercept}/|\text{slope}|). \quad (6)$$

Thus, while  $\beta$  has no obvious biological meaning, the values of  $W_\infty$  obtained by this model do have a biological interpretation, which is, moreover, analogous to the definition of  $W_\infty$  in the von Bertalanffy growth function (VBGF) of the form

TABLE 1.—Data on the food conversion efficiency of *Channa striata* (= *Ophiocephalus striatus*) (after Pandian 1967), *Epinephelus striatus* (after Menzel 1960), and *Holacanthus bermudensis* (after Menzel 1958).

Body weight (g) <sup>1</sup>	Food conv. ( $K_1$ ) <sup>2</sup>	Transformed data		C = $-\log_{10}(1 - K_1)$	Species and remarks
		$\log_{10} W$	$\log_{10} K_1$		
1.86	0.391	0.270	-0.408	0.215	<i>Channa striata</i> (see Figure 1)
9.92	0.274	0.998	-0.562	0.139	
13.09	0.320	1.117	-0.495	0.167	
19.65	0.284	1.293	-0.547	0.147	
24.63	0.278	1.391	-0.556	0.141	
35.09	0.234	1.545	-0.631	0.116	
45.15	0.199	1.655	-0.701	0.096	
50.70	0.227	1.705	-0.644	0.112	
51.30	0.235	1.710	-0.629	0.116	
57.00	0.208	1.756	-0.682	0.101	
79.80	0.177	1.897	-0.752	0.085	
93.80	0.232	1.972	-0.635	0.115	
107.50	0.157	2.031	-0.804	0.074	
123.80	0.166	2.093	-0.780	0.079	
216	0.247	2.334	-0.607	0.123	<i>Epinephelus guttatus</i> ; $\log_{10} \bar{W} = 2.617$ ; $\bar{C} = 0.0894$ (see Figure 2)
285	0.219	2.455	-0.600	0.107	
319	0.160	2.504	-0.796	0.076	
392	0.153	2.593	-0.815	0.072	
424	0.179	2.627	-0.747	0.086	
628	0.161	2.798	-0.793	0.076	
647	0.177	2.811	-0.752	0.085	
649	0.187	2.812	-0.728	0.090	
66	0.222	1.820	-0.654	0.109	<i>Holacanthus bermudensis</i> (28°C only) <sup>3</sup> $\log_{10} \bar{W} = 2.124$ $\bar{C} = 0.031$
139	0.178	2.143	-0.750	0.085	
256	-0.258	2.408	not defined	-0.100	

<sup>1</sup>Mean of starting and end weights.

<sup>2</sup>Growth increment/food intake.

<sup>3</sup>Note that the experiment considered here was conducted with a food which led to deposition of fat, but not of protein (see also Table 2), a consideration that is ignored for the sake of this example.

$$W_t = W_\infty (1 - e^{-K(t-t_0)})^3 \quad (7)$$

(von Bertalanffy 1938; Beverton and Holt 1957), and where  $W_t$ , the weight at time  $t$ , is predicted via the constants  $K$ ,  $t_0$ , and  $W_\infty$ , all three of which are usually estimated from size-at-age data obtained in the field (see Gulland 1983 or Pauly 1984a).

That  $W_\infty$  values obtained via Equations (2) and (6) are realistic can be illustrated by means of that part of the data in Table 1 pertaining to *Channa striata* (= *Ophiocephalus striatus*), the "snakehead" or "mudfish" of south and southeast Asia. These data give, when fitted to the traditional model

$$K_1 = 0.482W^{-0.205} \quad (8)$$

The same data, when fitted to the new model give

$$K_1 = 1 - (W/1,580)^{0.073} \quad (9)$$

(See Figure 1 for both models.) The value of  $W_\infty = 1,580$  g is low for a fish which can reach up to 90 cm in the field (Bardach et al. 1972). However, its growth may have been reduced in laboratory growth experiments conducted by Pandian (1967).

Equation (6) used here to predict  $W_\infty$  is extremely sensitive to variability in the data set investigated, and two approaches are discussed to deal with this problem.

The first approach is the appropriate choice of the regression model used. In the example above (Equation (9)), the model used was a Type I (predictive) regression, which is actually inappropriate, given that

1) the  $\log_{10} W$  values are not controlled by the experimenter and

2) regression parameters are required, rather than prediction of  $C$  values (see Ricker 1973).

The use of a Type II ("functional", or "Geometric Mean") regression appears more appropriate; conversion of a Type I to Type II regression (with parameters  $a'$ ,  $b'$ ) can be performed straightforwardly through

$$b' = b/|r| \quad (10)$$

and

$$a' = \bar{C} - b' \overline{\log_{10} W} \quad (11)$$

where  $r$  is the correlation coefficient between the  $C$  and the  $\log_{10} W$  values (Ricker 1973). In the case

of the example here, one obtains with  $r = 0.942$  a new model:

$$K_1 = 1 - (W/1,290)^{0.077} \quad (12)$$

close to that obtained using a Type I regression, due to the high value of  $r$  of this example. However, in cases where the fit to the model is poor, the use of a Type II regression can make all the difference between realistic and improbable values of  $W_\infty$ .

Another approach toward optimal utilization of the properties of the new model (4) is the use of "external" values of asymptotic weight, which will here be coded  $W_{(\infty)}$  to differentiate them from values of  $W_\infty$  estimated through the model. In such case,  $\beta$  can be estimated from

$$\beta = \bar{C}/(\log_{10} W_{(\infty)} - \overline{\log_{10} W}) \quad (13)$$

in which  $W_{(\infty)}$  is an asymptotic size estimated from other than food conversion and weight data, e.g., from growth data or via the often observed closeness between estimates of asymptotic size and the maximum sizes observed in a given stock (see Pauly 1984a, chapter 4).

These two approaches are illustrated in the example below, which is based on the data in Table 1 pertaining to the grouper *Epinephelus guttatus*. When Equation (6) is interpreted as a Type I regression, these data yield a value of  $W_\infty > 12$  kg, which is far too high for a fish known to reach 55 cm at most (Randall 1968). Interpreting Equation (5) as a Type II regression leads to a value of  $W_\infty = 3.5$  kg which is realistic, although still not close to the asymptotic weight of 1,880 g estimated by Thompson and Munro (1977). Finally, using the latter figure as an estimate of  $W_{(\infty)}$  yields the model

$$K_1 = 1 - (W/1,880)^{0.136} \quad (14)$$

as a description of the relationship between  $K_1$  and weight in *Epinephelus guttatus* (Fig. 2). The value of  $\beta$  in Equation (14) lies within the 95% confidence interval of the value of  $\beta = 0.060$  which generated the first unrealistically high estimate of  $W_\infty$ .

## MODEL FOR ESTIMATING THE FOOD CONSUMPTION OF FISH POPULATIONS

When feeding experiments have been or can be conducted under conditions similar to those prevailing in the sea (food type, temperature, etc.), the

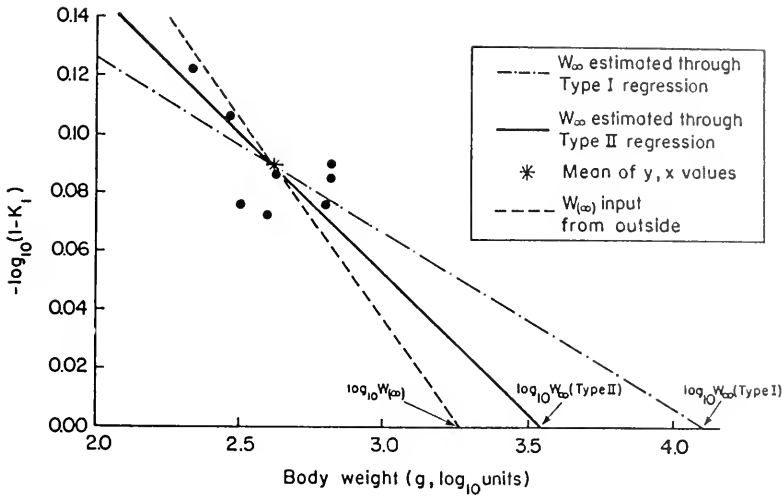

FIGURE 2.—Relationship between gross food conversion efficiency ( $K_1$ ) and body weight in *Epinephelus guttatus*. Note that a Type I “predictive” regression leads to an overestimation of  $W_\infty$  while a Type II “functional” regression leads to a value of  $W_\infty$  close to an estimate of  $W_\infty$  based on growth data (see text). Based on data in Menzel (1960).

model presented above can be made a part of a model for estimation of food consumption per unit biomass ( $Q/B$ ), provided a set of growth parameters is also used in which the value of  $W_\infty$  or  $W_{(\infty)}$  is identical to that estimated from or used to interpret the feeding experiments.

In this case, inserting Equation (8) into Equation (5) leads to

$$K_{1(t)} = 1 - (1 - e^{-K(t-t_0)})^{3\beta} \quad (15)$$

where  $K_{1(t)}$  is the food conversion efficiency of the investigated fish as a function of their age  $t$ , and  $K$ ,  $t_0$ , and  $\beta$  are as defined above.

Equation (1) is then rewritten as

$$dq/dt = (dw/dt)/K_{1(t)} \quad (16)$$

where the “growth increment” is replaced by a growth rate ( $dw/dt$ ) and the “food ingested” is also expressed as a rate ( $dq/dt$ ). The growth rate of the fish is then expressed by the first derivative of the VBGF (Equation (7)) or

$$dw/dt = W_\infty 3K (1 - \exp(-Kr_1))^2 \cdot \exp(-Kr_1) \quad (17)$$

where  $r_1 = t - t_0$ . Equations (17) and (15) may be substituted into Equation (16), which is a separable differential equation and may be solved by direct integration. The cumulative food consumption of an individual fish between the age at recruitment ( $t_r$ ) and the age at which it dies ( $t_{max}$ ) is thus

$$Q_c = W_\infty 3K \int_{t_r}^{t_{max}} \frac{(1 - \exp(-Kr_1))^2 \cdot \exp(-Kr_1)}{1 - (1 - \exp(-Kr_1))^{3\beta}} dt. \quad (18)$$

The food consumption of a population should depend, on the other hand, on the age structure of that population. The simplest way to impose an age structure on a population is to assume exponential decay with instantaneous mortality  $Z$ , or

$$N_t = R e^{-Z(t-t_r)} \quad (19)$$

where  $t_r$  is the age at recruitment (i.e., the starting age at which  $Z$  applies, assuming, if there is any fishery, that  $t_r = t_c$ , the mean age at first capture),  $R$  the number of recruits, and  $N_t$  is the number of fish in the population. As the model below assumes a stationary population, the food consumption of the population per unit time can be expressed on a per-recruit basis or

$$\frac{Q}{R} = W_\infty 3K$$

$$\int_{t_r}^{t_{max}} \frac{(1 - \exp(-Kr_1))^2 \cdot \exp(-(Kr_1 + Zr_2))}{1 - (1 - \exp(-Kr_1))^{3\beta}} dt \quad (20)$$

where  $r_2 = t - t_r$ .

The biomass per recruit in fish whose growth can be described by Equation (7) is, according to the model of Beverton and Holt (1957; see also Ricker 1975, p. 253):

$$\frac{B}{R} = W_\infty (A_1 + A_2 + A_3 + A_4) \quad (21)$$

where  $A_1 = \frac{1 - e^{-Zr_3}}{Z}$

$$A_2 = \frac{-3 e^{-Kr_4} (1 - e^{-(Z+K)r_3})}{Z + K}$$

$$A_3 = \frac{3 e^{-2Kr_4} (1 - e^{-(Z+2K)r_3})}{Z + 2K}$$

and

$$A_4 = \frac{-e^{-3Kr_4} (1 - e^{-(Z+3K)r_3})}{Z + 3K}$$

where  $r_3 = t_{\max} - t_r$

$$r_4 = t_r - t_0.$$

This model assumes, as does Equation (20), a stable age distribution.

Combining Equations (21) and (20) leads to the model for estimating  $Q/B$ , which has the form:

$$\frac{Q}{B} = \frac{3K \int_{t_r}^{t_{\max}} \frac{(1 - \exp(-Kr_1))^2 \cdot \exp(-(Kr_1 + Zr_2))}{1 - (1 - \exp(-Kr_1))^{3\beta}} dt}{(A_1 + A_2 + A_3 + A_4)}. \quad (22)$$

Equation (22) has only 6 parameters ( $K$ ,  $t_0$ ,  $t_r$ ,  $t_{\max}$ ,  $Z$ , and  $\beta$ ); of these,  $K$  and  $t_0$  are estimated from growth data, while  $t_r$  and  $t_{\max}$  can be set more or less arbitrarily (see text below and Figure 3). Total mortality ( $Z$ ), which is here the equivalent of a production/biomass ratio (see Allen 1971) can be estimated easily, e.g., from length-frequency data and growth parameters (see Pauly 1982, 1984a: chapter 5) and is an input required anyway by the ECOPATH program (Polovina 1984). Thus only  $\beta$  and a "hidden" value of  $W_\infty$  applicable to both food experiment and growth data are needed in addition to the easily obtainable parameters required by this model.

## APPLICATION EXAMPLE AND SENSITIVITY ANALYSIS OF THE MODEL

In the following application examples, the newly derived model (Equation (22)) is used to compare the food consumption of a tropical carnivore (*Epinephelus guttatus*) with that of a tropical herbivore (*Holacanthus bermudensis*). A list of the parameter values used is given on Table 2.

The solutions of Equation (22), inclusive of the integration of its numerator, were obtained by means of a short BASIC microcomputer program available from me. Note that the integration, which according to Equation (22) should be performed for the interval between two ages ( $t_r$  and  $t_{\max}$ ), can be performed for the intervals between two sizes ( $W_r$ ,  $W_{\max}$ ), the age corresponding to these sizes being estimated from the inverse of Equation (7), i.e.,

$$t = t_0 - ((1/K) (\log_e (1 - W/W_\infty)^{1/3})). \quad (23)$$

The results, i.e., the values of  $Q/B$ , expressed as a percentage on a daily basis are 0.76 for *E. guttatus* and 2.50 for *H. bermudensis*.

A sensitivity analysis of Equation (22) was performed, following the outline in Majkowski (1982). The results are given in Figure 3, which shows that of the six parameters of Equation (22),  $\beta$  is the one which has the strongest impact on the estimates of

$Q/B$ , while  $t_r$  has the least, the relationships between the importance of these parameters being best summarized by

$$\beta > K > Z \gg t_{\max} > t_0 > t_r \quad (24)$$

These results suggest that, when using this model, most attention should be given to an accurate estimation of  $\beta$  (see below). It should be also noted that  $\beta$  and  $K$  have opposite effects on the estimation of  $Q/B$  (see Figure 3). Thus, a biased (e.g., high) estimate of  $W_\infty$  will be associated with too low values of  $\beta$  and  $K$  which partially compensate each other.

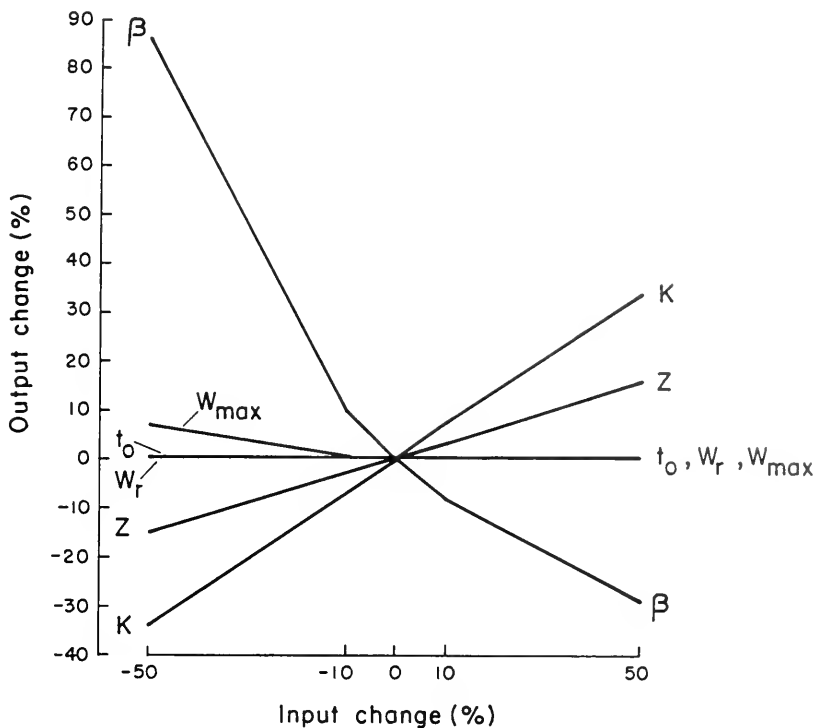

FIGURE 3.—Sensitivity analysis of Equation (22), based on parameter estimates in Table 4 for *Epinephelus guttatus*. Note strong effects of changes in  $\beta$ , intermediate effects of  $K$  and  $Z$ , and negligible effects of  $W_{max}$ ,  $W_r$ , and  $t_0$ .

TABLE 2.—Properties and parameter values of *Epinephelus guttatus* and *Holacanthus bermudensis* relevant to the computation of their food consumption (based on data in Menzel 1958, 1960; See Table 1 and text).

Property/ parameter	<i>Epinephelus guttatus</i>	<i>Holacanthus bermudensis</i>
Asymptotic weight (g)	11,880	2800
$K$ (1/yr)	0.24	0.25
$t_0$ (yr)	4-0.2	-0.2
$t_r$ (yr)	50.35	50.45
$\beta$	60.136	20.040
$Z$ (1/yr)	10.64	70.72
$t_{max}$ (yr)	812	812
food (in experiments)	fish ( <i>Anchoa</i> , <i>Sardinella</i> and <i>Harengula</i> )	Algae ( <i>Monostroma oxysperma</i> and <i>Enteromorpha satina</i> )

<sup>1</sup>From Thompson and Munro (1977);  $Z = 0.64$  refers to an unfished stock and is thus an estimate of  $M$ .

<sup>2</sup>From data in Table 1 and Equation (13).

<sup>3</sup>Based on method in Pauly and Munro (1984) and on growth parameter estimates pertaining to members of the related family Acanthuridae, in Pauly (1978).

<sup>4</sup>Assumed; has little influence on results (see text and Figure 3).

<sup>5</sup>Corresponding to a fish of 1 g with growth parameters  $W_{\infty}$ ,  $K$ , and  $t_0$  as given.

<sup>6</sup>See text and Figure 2.

<sup>7</sup>Based on equation (11) in Pauly (1980), with  $T = 28^\circ$ ,  $L_{\infty} = 30$  cm,  $K = 0.25$ , and  $M = Z$ .

<sup>8</sup>Assumed; has little influence on results (see text and Figure 3).

## QUANTITIES OTHER THAN $Q/B$ ALSO ESTIMATED BY THE MODEL

In addition to estimating  $Q/B$ , the model presented above can be used to obtain other useful quantities; namely, 1) maintenance ration and related information, and 2) trophic efficiency.

Although there are differences between authors, maintenance ration is usually defined as the food used by fish to just maintain their weight at some "routine" level of activity. Usually, maintenance ration is estimated by feeding fish over a wide range of rations and determining by interpolation the ration generating neither weight gains nor losses (Jones 1976).

The model presented here allows the estimation of maintenance ration (even if fish have been fed constant rations) through extrapolation of weight-specific estimates of  $Q/B$ , such as presented in Figure 4 to the size  $W_{\infty}$ , i.e., to the size at which, by definition, all food consumed by a fish is used for maintenance. In the case of the feeding data on *E. guttatus* analyzed here, an estimate of daily main-

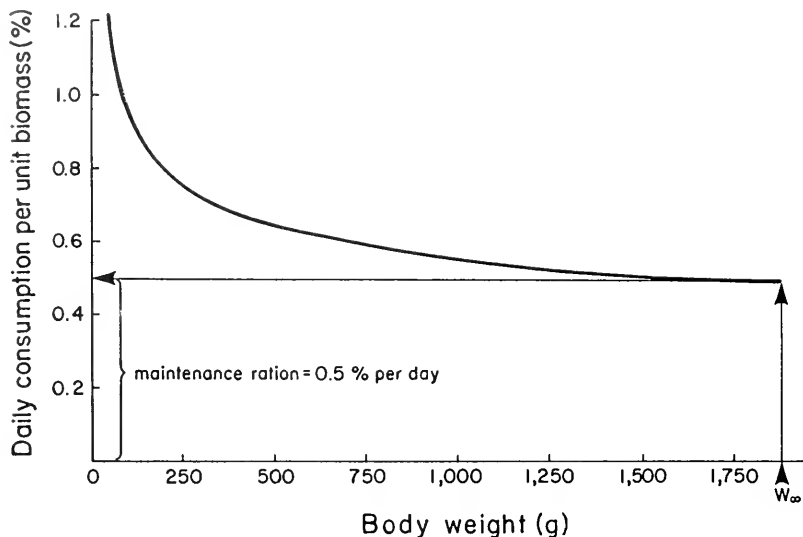

FIGURE 4.—Size-specific estimates of food consumption per unit biomass in *Epinephelus guttatus*, as obtained by integrating Equation (22) over narrow ranges of weight, then plotting the resulting Q/B estimates against the midranges of the weights. Note definition of maintenance ration as “Q/B at  $W_{\infty}$ ”.

tenance ration of 0.5% body weight per day is obtained (Fig. 4), while the corresponding value for *H. bermudensis* is 1.73%.

Using the computed output of Equation (22) one can also obtain an estimate of population trophic efficiency ( $E_T$ ) from

$$E_T = Z \cdot (B/Q) \quad (25)$$

which expresses production per unit food consumed, production being expressed here as total mortality (i.e., production/biomass ratio) times biomass (Allen 1971).

For *E. guttatus*, the estimated value of trophic efficiency is  $E_T = 0.23$ , i.e., slightly less than one quarter of the fish food eaten by a population of *E. guttatus* is turned into production. The corresponding value for *H. bermudensis* is  $E_T = 0.08$ , which is low, as should be expected in an herbivore.

### ACCOUNTING FOR MULTIFACTOR EFFECTS ON $K_1$

Experimental data allowing for the estimation of values of  $W_{\infty}$  and  $\beta$  corresponding exactly to those to be expected in nature cannot be obtained, since no experimental design can account for all the environmental factors likely to affect the food conver-

sion of fishes in nature. Among the factors which can be experimentally accounted for are

- 1) ration size (Paloheimo and Dickie 1966; but see Condrey 1982),
- 2) type of food (see below),
- 3) temperature (Menzel 1958, Taylor 1958, Kinne 1960, and see below),
- 4) salinity (Kinne 1960).

Also, “internal states” affecting food conversion efficiency, such as the sex of the fish, previous thermal history, and stress undergone during an experiment, can be accounted for given a suitable experimental design.

One method of incorporating some of these factors into a linear form of the basic model (Equation (5)) is to extend the model into a multiple regression of the form

$$C = a - \beta \log_{10} W + b_1 V_1 + b_2 V_2 \dots b_n V_n \quad (26)$$

in which  $V_1$ ,  $V_2$ , and  $V_n$  are factors which affect  $C$  ( $= -\log_{10}(1 - K_1)$ ) after the effect of weight on  $C$  has been accounted for.

For example,

$$C = 0.363 - 0.0419W - 0.0116T + 0.0156S + 0.0488M \quad (27)$$

is derived from the results of experiments conducted with dab (*Limanda limanda*) by Pandian (1970, figs. 5, 6)<sup>4</sup> in which the type of food, *M* (0 = herring meat, 1 = cod meat), and sex, *S* (0 = ♂, 1 = ♀), and the temperature, *T* (in °C) were reported in addition to the weight, *W* (in g and log<sub>10</sub> units).

This model permits exact tests on the effects of each factor (Table 3), and permits adjusting parameter values (*W*<sub>∞</sub>, β) so that they relate to conditions resembling those occurring in nature.

Then, *W*<sub>∞</sub> is estimated—at least in principle—from

$$W_{\infty} = \text{antilog}_{10} (1/\beta) (a + b_1V_1 + b_2V_2 \dots b_nV_n). \tag{28}$$

This equation implies that there is, for every combination of *V*<sub>1</sub>, *V*<sub>2</sub>, . . . *V*<sub>*n*</sub> values, a corresponding value of *W*<sub>∞</sub>. This is reasonable, as it confirms that *W*<sub>∞</sub> is environmentally controlled (Taylor 1958; Pauly 1981, 1984b). *W*<sub>∞</sub>-values obtained through Equation (31) will generally be reliable—as was the case with the one-factor model (4)—only when a wide range of weights are included, variability is low, and the correct statistical model is used.

As a first approach toward an improved statistical model, one could conceive of a geometric mean multiple regression which, in analogy to a simple geometric mean regression, would be derived from the geometric mean of the parameters of a series of multiple regressions. This approach would involve, in the case of *n* + 1 variables (= *Y*, *Y*<sub>1</sub>, *Y*<sub>2</sub>, . . . *Y*<sub>*n*</sub>) in the following steps:

- 1) Compute the parameters of *n* + 1 Type I multiple regressions, where each regression (*j*) has another variable as dependent variable (i.e., *Y*, then *Y*<sub>1</sub>, *Y*<sub>2</sub>, . . . to *Y*<sub>*n*</sub>; see *j* = 1 to 5 in Table 4).
- 2) Solve each of the *j* equations for the “real” dependent variable (*Y* = *C*, see *j* = 6 to 10 in Table 4).
- 3) Compute the geometric mean of each partial regression coefficient from

$$b_i' = (b_{1j} \cdot b_{2j} \cdot \dots \cdot b_{nj})^{1/n}. \tag{29}$$

- 4) Compute the intercept of the new Type II

TABLE 3.—Details of a Type I multiple regression to quantify the effects of some factors on the food conversion efficiency of dab (*Limanda limanda*) (see text footnote 3).

Source of variation	Degrees of freedom	Sum of squares	Mean squares	
Regression	4	0.0813	0.0203	
Residual	57	0.0516	0.0009	
Total	61	0.1329		
<i>F</i> (4,57)	22.465	<i>P</i> < 0.001		
	multiple correlation = 0.7822			
	<i>R</i> <sup>2</sup> = 0.6119			
	Corrected <i>R</i> <sup>2</sup> = 0.5846			
	Standard error = 0.0301			
Variable	Coefficient	<i>t</i>	SE	<i>P</i>
Weight	-0.041869	-3.926	0.0107	<0.001
Temp	-0.011584	-7.362	0.0016	<0.001
Sex	0.015635	1.982	0.0079	0.049
Meat	0.048840	5.301	0.0092	<0.001
Constant	0.363416	—	—	—

TABLE 4. Estimation of parameters in a “mixed” multiple regression (see also text).

<i>j</i>	Dependent variable	Constant (“a”)	Independent variables and partial regression coefficients <sup>1</sup>				Remarks and <i>R</i> <sup>2</sup>
1	<i>C</i>	= 0.363	-0.0419 <i>W</i>	-0.016 <i>T</i>	+0.0156 <i>S</i>	+0.0488 <i>M</i>	0.585
2	<i>W</i>	= 3.52	-5.08 <i>C</i>	-0.0820 <i>T</i>	+0.0693 <i>S</i>	+0.300 <i>M</i>	0.199
3	<i>T</i>	= 23.1	-2.45 <i>W</i>	-42.1 <i>C</i>	+1.07 <i>S</i>	+1.94 <i>M</i>	0.490
4	<i>S</i>	= -1.30	+0.151 <i>W</i>	+0.0780 <i>T</i>	+4.13 <i>C</i>	-0.285 <i>M</i>	0.035
5	<i>M</i>	= -2.32	+0.341 <i>W</i>	+0.0739 <i>T</i>	-0.149 <i>S</i>	+6.76 <i>C</i>	0.295
6	<i>C</i>	= 0.363	-0.419 <i>W</i>	-0.0116 <i>T</i>	+0.0156 <i>S</i>	+0.0488 <i>M</i>	—
7	<i>C</i>	= 0.693	-0.197 <i>W</i>	-0.0161 <i>T</i>	+0.0136 <i>S</i>	+0.0591 <i>M</i>	—
8	<i>C</i>	= 0.549	-0.0582 <i>W</i>	-0.0238 <i>T</i>	+0.0254 <i>S</i>	+0.0461 <i>M</i>	—
9	<i>C</i>	= -0.315	-0.0366 <i>W</i>	-0.0189 <i>T</i>	+0.242 <i>S</i>	+0.0690 <i>M</i>	not used,
10	<i>C</i>	= -0.345	-0.0504 <i>W</i>	-0.0109 <i>T</i>	+0.0220 <i>S</i>	+0.148 <i>M</i>	see text
mean partial regression coefficients:							
(for <i>j</i> = 6-8)		<i>b</i> <sub><i>j</i></sub>	= -0.0783	-0.0164	+0.0175	+0.0510	
11	0.1564 = <i>a</i> ' - (0.083 · 1.738) - (0.164 · 13.32) + (0.0175 · 0.581) + (0.051 · 0.226)						
12	<i>C</i>	= 0.4892	-0.0783 <i>W</i>	-0.0164 <i>T</i>	+0.0175 <i>S</i>	+0.051 <i>M</i>	final result

<sup>1</sup>Note that body weight (*W*) is here expressed in log<sub>10</sub> units.

multiple regression from

$$a' = \bar{Y} - (b_1'\bar{Y}_1 + b_2'\bar{Y}_2 \dots + b_n'\bar{Y}_n) \quad (30)$$

where the  $\bar{Y}_i$  are the means of the  $Y_i$ -values and  $b_i'$  the geometric mean partial regression coefficients.

This method cannot be used here without modification because in most cases the multiple regression is "mixed" (Raasch 1983), consisting of variables which can be expected to generate normally distributed residuals when used as dependent variables (here:  $C$ ,  $W$ ,  $T$ ) as well as "dummy" or binary variables ( $S$ ,  $M$ ) which cannot generate normally distributed residuals when they are used as dependent variables.

As might be seen in Table 4, the use of dummy variables as "dependent" variables generates unstable interrelationships between the remaining variables, making the computation of meaningful mean partial regression coefficients impossible.

The best solution here seems to omit for the computation of the mean regression coefficient those multiple regressions which have binary variables as "dependent" variables; Table 4 illustrates this approach.

The mixed model so obtained is

$$C = 0.489 - 0.0738W - 0.0164T + 0.0175S + 0.0151M \quad (31)$$

which corresponds to the standard model

$$C' = 0.62W' - 0.90T' + 0.19S' + 0.46M' \quad (32)$$

in which the original variables  $C$ ,  $W$ ,  $T$ ,  $S$ , and  $M$  are expressed in standard deviation units and in which the slopes (= path coefficients, see Li 1975) allow for comparing the effects of  $W$ ,  $T$ ,  $S$ , and  $M$  on  $C$ . These variables suggest that with regards to their impact on  $C$ ,

$$T > W > M \gg S. \quad (33)$$

See Li (1975) for further inferences based on path coefficients.

In the southern North Sea in late summer-early autumn, *Limanda limanda* experiences temperatures usually ranging between 10° and 20°C (Lee 1972). Solving Equation (31) for  $T = 18^\circ\text{C}$ , the highest temperature in Pandian's experiments (i.e., assuming the higher late summer-early autumn temperatures limit  $W_\infty$ ) leads to estimates of  $W_\infty =$

500 g for the females and 298 g for the males, compared with the values of 756 and 149 g obtained by Lee (1972) on the basis of growth studies.

Estimating values of  $\beta$  that are wholly compatible with the latter estimates of  $W_\infty$  is straightforward, however, since it consists of solving Equation (31) for  $T = 18^\circ\text{C}$ ,  $M = 0$ , and the appropriate value of  $S$ , based on the equation

$$\beta = 1/\log W_\infty (a + b_1'V_1 + b_2'V_2 \dots b_n'V_n) \quad (34)$$

In the present case, this leads to  $\beta$  values of 0.073 and 0.089 for females and male dab, respectively. The "average" relationship (if such exists) between food conversion efficiency and body weight in female dab fed herring meat is thus

$$K_1 = 1 - (W/756)^{0.073} \quad (35)$$

while for males it is

$$K_1 = 1 - (W/149)^{0.089} \quad (36)$$

with both values of  $\beta$  within the 95% confidence interval of the first estimate of  $\beta$  (in Equation (27), see Table 3).

## DISCUSSION

The model presented here for the computation of  $Q/B$  is not meant to compete against the more sophisticated models whose authors were cited above. Rather, it was presented as a mean of linking up the results of feeding experiments with elements of the theory of fishing such that inferences can be made on the food consumption of fish populations which 1) do not invoke untenable assumptions, 2) make maximum use of available data, and 3) do not require extensive field sampling.

A distinct feature of the method is that it does not require sequential slaughtering of fish for the estimation of their stomach evacuation rate, nor field sampling of fish stomachs, which may be of relevance when certain valuable fishes are considered (e.g., coral reef fishes in underwater natural parks).

Several colleagues who reviewed a draft version of this paper suggested that Equation (4) should incorporate an upper limit for  $K_1$  smaller than unity. This model would have the form

$$K_1 = K_{1\max} - (W/W_\infty)^{\beta_m} \quad (37)$$

with parameters  $W_\infty$  and  $\beta_m$  identical and analogous respectively to those in Equation (4) and  $a$  value of



$K_{\text{Imax}}$  to be estimated independently prior to fitting Equation (37) to data.

Data do exist which justify setting the upper limit of  $K_1$  at or near unity. They pertain to fish embryos, whose gross conversion efficiency can be defined by

$$K_1 = \frac{W_h}{W_e - W_y} \quad (38)$$

where  $W_h$  is the larval weight at hatching,  $W_e$  the egg weight, and  $W_y$  the weight of the yolk sac at hatching. Values of  $K_1$  as high as 0.93 have been reported using this approach (From and Rasmussen 1984), extending further toward unity the range of  $K_1$  values reported by earlier authors, e.g., 0.85 in *Solea solea* (Flüchter and Pandian 1968), 0.79 in *Sardinops caerulea* (Lasker 1962), and 0.74 in *Clupea harengus* (Blaxter and Hempel 1966).

Thus, for a wet weight of 0.5 mg corresponding to a spherical egg of 1 mm diameter, one obtains, using Equation (14) for *E. guttatus*, a value of  $K_1 = 0.87$  which is within the range of  $K_1$  values given above. This example is not meant to suggest that  $K_1$  values pertaining to large fish should be used in combination with the model presented here to "estimate"  $K_1$  in eggs or larvae. Rather, it is meant to illustrate the contention that, of the possible choices of an upper bound for  $K_1$  in Equation (4), the one selected here has the feature of making the model robust, particularly with respect to high values of  $K_1$  and extrapolations toward low values of  $W$ .

Apart from  $\beta$ , the key elements of the model (isometric von Bertalanffy growth, constant exponential decay, steady-state population) are all parts of other, widely used models. Thus, whether estimates of  $Q/B$  obtained by this model are considered "realistic" or not will depend almost entirely on the value of  $\beta$  used for the computation.

There are several ways of reducing the uncertainty associated with  $\beta$ . The following may need special consideration:

1) Feeding experiments used to estimate  $\beta$  could be run so as to mimic as closely as possible the crucial properties of the habitat in which the population occurs whose  $Q/B$  value is estimated, inclusive of seasonally oscillating factors.

2) Further research and study should lead to the identification of anatomical, physiological, and ecological properties of fish correlating with their most common value of  $\beta$ .

3) An additional parameter could be added to

account for fish reproduction, which is not explicitly considered in Equation (22).

Little needs to be said about item 1 which should be obvious since (except in the context of aquaculture) feeding and growth experiments are conducted in order to draw inferences on wild populations. With regards to item 2, it suffices to mention that relative gill area (= gill surface area/body weight), which appears to a large extent to control food conversion efficiency (Pauly 1981, 1984b), should be a prime candidate for correlational studies. Item 3 could cause  $Q/B$  values obtained by the model presented here to substantially underestimate actual food consumption, were it not for three circumstances which produce opposite tendencies:

a) The assumption that the energy needed by fish to develop gonads is taken from the energy otherwise available for growth may not apply (Iles 1974; Pauly 1984b). Rather, the reduction of activity occurring in some maturing fish may more than compensate for the energy cost of gonad development (Koch and Wieser 1983).

b) Growth parameters are usually computed using size data from fish whose gonads have not been removed, thus accounting for at least a fraction of the food converted into gonad tissue. When the value of  $Z$  used in the model is high, this fraction will be large because the contribution of the older fish to the overall estimate of  $Q/B$  will be small.

c) Experimental fish are usually stressed and therefore have lower conversion efficiencies than fish in nature, even though they may spend little energy on food capture (see Edwards et al. 1971). This effect leads to low values of  $\beta$  and hence high estimates of  $Q/B$ .

Because of these factors, the values of  $Q/B$  obtained by the method proposed here may lack a downward bias.

## ACKNOWLEDGMENTS

I wish to thank R. Jones (Aberdeen), as well as E. Ursin (Charlottenlund), A. McCall (La Jolla), J. J. Polovina (Honolulu), P. Muck (Lima), and the two anonymous reviewers for their helpful comments on the draft of this paper.

## LITERATURE CITED

- ALLEN, K. R.  
1971. Relation between production and biomass. *J. Fish.*

- Res. Board Can. 28:1573-1581.
- ANDERSEN, K. P.  
1982. An interpretation of the stomach contents of fish in relation to prey abundance. *Dana* 2:1-50.
- ARMSTRONG, D. W., J. R. G. HISLOP, A. P. ROBB, AND M. A. BROWN.  
1983. A preliminary report on the analysis of whiting stomachs collected during the 1981 North Sea Stomach Sampling Project. ICES. Doc. C.M. 1983/G:59.
- BARDACH, J. E., J. H. RYTHER, AND W. O. McLARNEY.  
1972. Aquaculture: the farming and husbandry of freshwater and marine organisms. Wiley-Inter-Science, N.Y., 868 p.
- BERTALANFFY, L. VON.  
1938. A quantitative theory of organic growth (Inquiries on growth laws. II). *Hum. Biol.* 10:181-213.
- BEVERTON, R. J. H., AND S. J. HOLT.  
1957. On the dynamics of exploited fish populations. *Fish. Invest. Minist. Agric. Fish Food (G.B.) Ser. II, Vol. 19*, 533 p.
- BLAXTER, J. H. S., AND G. HEMPEL.  
1966. Utilization of yolk by herring larvae. *J. Mar. Biol. Assoc. U.K.* 46:219-234.
- CONDREY, R. E.  
1982. Ingestion-limited growth of aquatic animals: the case for Blackman kinetics. *Can. J. Fish. Aquat. Sci.* 39:1585-1595.
- DAAN, N.  
1973. A quantitative analysis of the food intake of North Sea cod, (*Gadus morhua*). *Neth. J. Sea Res.* 6:479-517.  
1983. Analysis of the cod data collected during the 1981 stomach sampling project. ICES Doc. C.M. 1983/G:61.
- EDWARDS, R. R. C., J. H. S. BLAXTER, U. K. GOPALAN, C. V. MATHEW, AND D. M. FINLAYSON.  
1971. Feeding, metabolism, and growth of tropical flatfish. *J. Exp. Mar. Biol. Ecol.* 6:279-300.
- FLÜCHTER, J., AND T. J. PANDIAN.  
1968. Rate and efficiency of yolk utilization in developing eggs of the sole *Solea solea*. *Helgol. Wiss. Meeresunters.* 18:53-60.
- FROM, J., AND G. RASMUSSEN.  
1984. A growth model, gastric evacuation and body composition in rainbow trout, *Salmo gairdneri* Richardson 1836. *Dana* 3:61-139.
- GULLAND, J. A.  
1983. Fish stock assessment: a manual of basic methods. John Wiley and Sons, N.Y., 223 p.
- ILES, T. D.  
1974. The tactics and strategy of growth in fishes. In F. R. Harden-Jones (editor), *Sea fisheries research*, p. 331-345. Elek Sci. Books, Ltd., Lond., 511 p.
- IVLEV, V. S.  
1939. Balance of energy in carps. [In Russ.] *Zool. Zh.* 18: 303-318.  
1966. The biological productivity of waters. *J. Fish. Res. Board Can.* 23(11):1727-1759. W. E. Ricker (transl.).
- JONES, R.  
1976. Growth of fishes. In D. H. Cushing and J. J. Walsh (editors), *The ecology of the seas*, p. 251-279. Blackwell Scientific Publications, Oxford.
- KINNE, O.  
1960. Growth, food intake, and food conversion in a euryplastic fish exposed to different temperatures and salinities. *Physiol. Zool.* 33:288-317.
- KOCH, F., AND W. WIESER.  
1983. Partitioning of energy in fish: can reduction of swimming activity compensate for the cost of production? *J. Exp. Biol.* 107:141-146.
- LASKER, R.  
1962. Efficiency and rate of yolk utilization by developing embryos and larvae of the Pacific sardine *Sardinops caerulea* (Girard). *J. Fish. Res. Board Can.* 19:867-875.
- LEE, C. K. G.  
1972. The biology and population dynamics of the common dab *Limanda limanda* (L.) in the North Sea. Ph.D. Thesis, Univ. East Anglia.
- LI, C. C.  
1975. Path analysis: a primer. The Boxwood Press, Pacific Grove, CA, 347 p.
- MAJKOWSKI, J.  
1982. Usefulness and applicability of sensitivity analysis in a multispecies approach to fisheries management. In D. Pauly and G. I. Murphy (editors), *Theory and management of tropical fisheries*, p. 149-165. ICLARM Conf. Proc. 9, 360 p.
- MAJKOWSKI, J., AND W. S. HEARNS.  
1984. Comparison of three methods for estimating the food intake of a fish. *Can. J. Fish. Aquat. Sci.* 41:212-215.
- MENZEL, D. W.  
1958. Utilization of algae for growth by the Angelfish *Holocentrus bermudensis*. *J. Cons. Int. Explor. Mer* 24:308-313.  
1960. Utilization of food by a Bermuda reef fish, *Epinephelus guttatus*. *J. Cons. Int. Explor. Mer* 25:216-222.
- PALOHEIMO, J. E., AND L. M. DICKIE.  
1966. Food and growth of fishes. III. Relations among food, body size, and growth efficiency. *J. Fish. Res. Board Can.* 23:1209-1248.
- PANDIAN, T. J.  
1967. Intake, digestion, absorption and conversion of food in the fishes *Megalops cyprinoides* and *Ophiocephalus striatus*. *Mar. Biol. (Berl.)* 1:16-32.  
1970. Intake and conversion of food in the fish *Limanda limanda* exposed to different temperatures. *Mar. Biol. (Berl.)* 5:1-17.
- PAULY, D.  
1978. A preliminary compilation of fish length growth parameters. *Ber. Inst. f. Meeresk., Univ. Kiel No. 55*, 200 p.  
1980. On the interrelationships between natural mortality, growth parameters, and mean environmental temperature in 175 fish stocks. *J. Cons. Int. Explor. Mer* 39:175-192.  
1981. The relationship between gill surface area and growth performance in fish: a generalization of von Bertalanffy's theory of growth. *Meeresforschung* 28:251-282.  
1982. Studying single-species dynamics in a tropical multispecies context. In D. Pauly and G. I. Murphy (editors), *Theory and management of tropical fisheries*, p. 33-70. ICLARM Conf. Proc. 9, Manila, 360 p.  
1984a. Fish population dynamics in tropical waters: a manual for use with programmable calculators. ICLARM Studies and Reviews 8, Manila, 325 p.  
1984b. A mechanism for the juvenile-to-adult transition in fishes. *J. Cons. Int. Explor. Mer* 41:280-284.
- PAULY, D., AND J. L. MUNRO.  
1984. Once more on the comparison of growth in fish and invertebrates. *Fishbyte* 2(1):21.
- PENNINGTON, M.  
1984. Estimating the average food consumption by fish in the field from the stomach contents data. I.C.E.S., Doc. C.M. 1984/H:28.
- POLOVINA, J. J.  
1984. Model of a coral reef ecosystem. I. The ECOPATH model and its application to French Frigate Shoals. *Coral Reefs* 3:1-11.

- RANDALL, J. E.  
1968. Caribbean Reef Fishes. T.F.H. Publications, Neptune City, NJ, 318 p.
- RASCH, D. (editor)  
1983. Biometrie: Einführung in die Biostatistik. VEB Dtsch. Landwirtschaftsverlag, Berl., 276 p.
- RICE, J. A., J. E. BRECK, S. M. BARTELL, AND J. F. KITCHELL.  
1983. Evaluating the constraints of temperature, activity and consumption on growth of largemouth bass. Environ. Biol. Fishes 9:263-275.
- RICKER, W. E.  
1973. Linear regressions in fishery research. J. Fish. Res. Board Can. 30:409-434.  
1975. Computation and interpretation of biological statistics of fish populations. Bull. Fish. Res. Board Can. 191, 382 p.
- SPRUGEL, D. G.  
1983. Correcting for bias in log-transformed allometric equations. Ecology 64:209-210.
- STEWART, D. J., D. WEININGER, D. V. ROTTIERS, AND T. A. EDSALL.  
1983. An energetics model for lake trout, *Salvelinus namaycush*: application to the Lake Michigan population. Can. J. Fish. Aquat. Sci. 40:681-698.
- TAYLOR, C. C.  
1958. Cod growth and temperature. J. Cons. Int. Explor. Mer 23:366-370.
- THOMPSON, R., AND J. L. MUNRO.  
1977. Aspects of the biology and ecology of Caribbean reef fishes: Serranidae (hinds and groupers). J. Fish. Biol. 12: 115-146.
- URSIN, E.  
1967. A mathematical model of some aspects of fish growth, respiration, and mortality. J. Fish. Res. Board Can. 24: 2355-2453.

## APPENDIX

## List of symbols used in model development and illustration

$A_1$ - $A_4$	terms used in computation of biomass per recruit (Equation (21))	$Q$	- food consumption of a population (per unit time)
$a$	- multiplicative term in equation linking $K_1$ and body weight (Equation (3)) - intercept of a Type I (multiple) linear regression	$Q/B$	- food consumption per unit biomass of an age-structured animal population
$a'$	- intercept of a Type II (multiple) linear regression	$Q_c$	- cumulative food consumed by a single fish between ages $t_r$ and $t_{\max}$ (Equation (22))
$b$	- slope of a Type I linear regression - exponent in equation linking $K_1$ and body weight	$R$	- number of recruits (Equation (19))
$b_c$	- slope of a Type I multiple linear regression	$r$	- product moment correlation coefficient
$b'$	- slope of a Type II linear regression	$S$	- a dummy variable expressing sex
$b'_i$	- slope of a Type II multiple linear regression	$S'$	- a dummy variable expressing sex in standard deviation units
$B$	- biomass (under equilibrium condition)	$t$	- age
$\beta$	- exponent in model linking $K_1$ and body weight (Equation (4))	$t_c$	- mean age at first capture (in an exploited stock)
$\beta_m$	- similar to $\beta$ , but estimated jointly with $K_{1\max}$ (Equation (37))	$t_0$	- $\alpha$ parameter of the VBGF expressing the theoretical age at size zero
$C$	- $(-\log_{10}(1 - K_1))$	$t_{\max}$	- maximum age considered (= longevity)
$C'$	- same as $C$ , but expressed in standard deviation units	$t_r$	- mean age at recruitment to the part of the population considered when computing $Q/B$
$dq/dt$	- rate of food consumption	$T$	- temperature in $^{\circ}\text{C}$
$dw/dt$	- rate of growth in weight	$T'$	- temperature in $^{\circ}\text{C}$ , expressed in standard deviation units (Equation (32))
$E_T$	- trophic efficiency, i.e., production by population/food consumption by population	$V_i$	- any variable beyond $W$ which affects $K_1$
$i$	- counter for number of variables in a multiple regression	VBGF	- the von Bertalanffy growth function
$j$	- counter for number of multiple regressions	$W$	- body weight (in log units in some cases)
$K$	- constant in VBGF	$W'$	- body weight (in $\log_{10}$ units), expressed in standard deviation units
$K_1$	- gross conversion efficiency (Equation (1))	$W_c$	- weight of a fish egg
$K_{1\max}$	- hypothetical upper limit for $K_1$ (with $K_{1\max} < 1$ ) (Equation (37))	$W_h$	- weight of a fish at hatching (yolk sac excluded)
$M$	- instantaneous rate of natural mortality - a dummy variable expressing food type (Equation (27))	$W_{\max}$	- body weight corresponding to $t_{\max}$
$M'$	- a dummy variable expressing food type in standard deviation units	$W_r$	- body weight corresponding to $t_r$
$n$	- number of partial regression coefficient used in computing a given value of $b'_i$	$W_t$	- mean weight at age $t$
$N$	- number of fish in population (Equation (19))	$W_y$	- yolk sac weight in a newly hatched fish
		$W_{\infty}$	- asymptotic weight in the VBGF or in new model (Equation (4))
		$W_{(\infty)}$	- an estimate of asymptotic weight obtained indirectly (i.e., from data of a type different than those in model using value of $W_{(\infty)}$ )
		$Y_i$	- any variable included in a multiple regression
		$Z$	- instantaneous rate of mortality (= $P/B$ ratio)

# REPRODUCTIVE BIOLOGY OF KING MACKEREL, *SCOMBEROMORUS CAVALLA*, FROM THE SOUTHEASTERN UNITED STATES

JOHN H. FINUCANE, L. ALAN COLLINS, HAROLD A. BRUSHER,  
AND CARL H. SALOMAN<sup>1</sup>

## ABSTRACT

The reproductive biology of king mackerel, *Scomberomorus cavalla*, was studied from specimens collected off Texas, Louisiana, and northwest Florida in the Gulf of Mexico and off North and South Carolina in the Atlantic Ocean. Gonads were examined from 1,163 females and 595 males obtained in 1977-78. Spawning was prolonged. Most king mackerel were reproductively active from May through September. A few fish were in spawning condition as early as April and as late as October. All females were mature at 850-899 mm fork length (FL). Estimates of fecundity ranged from about 69,000 to 12,207,000 eggs for fish from 446 to 1,489 mm FL, 618 to 25,610 g total weight (TW), and 1 to 13 years of age. Fecundity (F) was usually significantly correlated with FL, TW, and age in each area but TW was the best predictor of fecundity in all areas combined ( $F = 1.854 \times 10^1 (TW)^{1.361}$ ) with  $r^2 = 0.856$ .

King mackerel, *Scomberomorus cavalla*, is one of the most valuable commercial and recreational fish in the Gulf of Mexico and south Atlantic. It is an epipelagic, neritic species that occurs in the western Atlantic Ocean from Massachusetts to Rio de Janeiro, Brazil (Collette and Russo 1979, 1984). Most of the king mackerel caught off the southeastern United States are landed in Florida (Manooch 1979) where it is an important component of charter boat catches (Moe 1963; Brusher et al. 1978). Commercial landings in Florida during 1983 totaled 2,017 t and the estimated recreational catch from the Gulf of Mexico was 1,090,000 fish in 1984 (U.S. Department of Commerce 1985a, b).

Although much has been written on king mackerel, little is known of its reproductive biology (Manooch et al. 1978). Ovarian histology and size-at-maturity has been described by Alves and Tome (1967) for fish from Brazil and by Beaumariage (1973) for fish from Florida. Maturation based on blood hormone levels from fish off northwest Florida was reported by MacGregor et al. (1981). Spawning times and areas have been inferred from ichthyoplankton collections of king mackerel larvae (Dwinell and Futch 1973; Finucane and Collins 1977; Houde et al. 1978<sup>2</sup>; McEachran et al. 1980). The only fecun-

dity estimates in the literature were made by Ivo (1974) for fish from Brazil.

The purpose of our study was to provide additional information on king mackerel reproductive biology by determining spawning season, length-at-maturity, and fecundity from four areas off the southeastern coast of the United States. This information will be useful in the management of king mackerel since the measure of reproductive potential is a basic element of productivity and stock dynamics (Baglin 1982).

## METHODS

King mackerel were sampled from commercial and recreational catches in four separate areas along the coast of the southeastern United States during 1977 and 1978 (Fig. 1). These areas were I, the northwestern Gulf of Mexico off the central and south coasts of Texas; II, the northcentral Gulf off Louisiana and Mississippi; III, the northeastern Gulf off northwest Florida; and IV, the western Atlantic Ocean off South and North Carolina.

Procedures for processing gonads, weighing, and measuring fish followed the methods of Finucane and Collins (1984). If no total weight had been recorded for a fish, we estimated TW by using the formula  $TW = 1.4959 \times 10^{-5} (FL)^{2.89284}$  ( $TW$  = total weight in grams;  $FL$  = fork length in millimeters). This formula (Ricker 1975) was derived

<sup>1</sup>Southeast Fisheries Center Panama City Laboratory, National Marine Fisheries Service, NOAA, 3500 Delwood Beach Rd., Panama City, FL 32407-7499.

<sup>2</sup>Houde, E. D., J. C. Leak, C. E. Dowd, S. A. Berkely, and W. J. Richards. 1979. Ichthyoplankton abundance and diversity in the eastern Gulf of Mexico. Part I: Executive summary, abstract, text reference. Unpubl. manusc., 119 p. Draft Final Report to

Bureau of Land Management, Contract AA550-CT7-28. Rosenstiel School of Marine and Atmospheric Science, University of Miami, Miami, FL 33149.

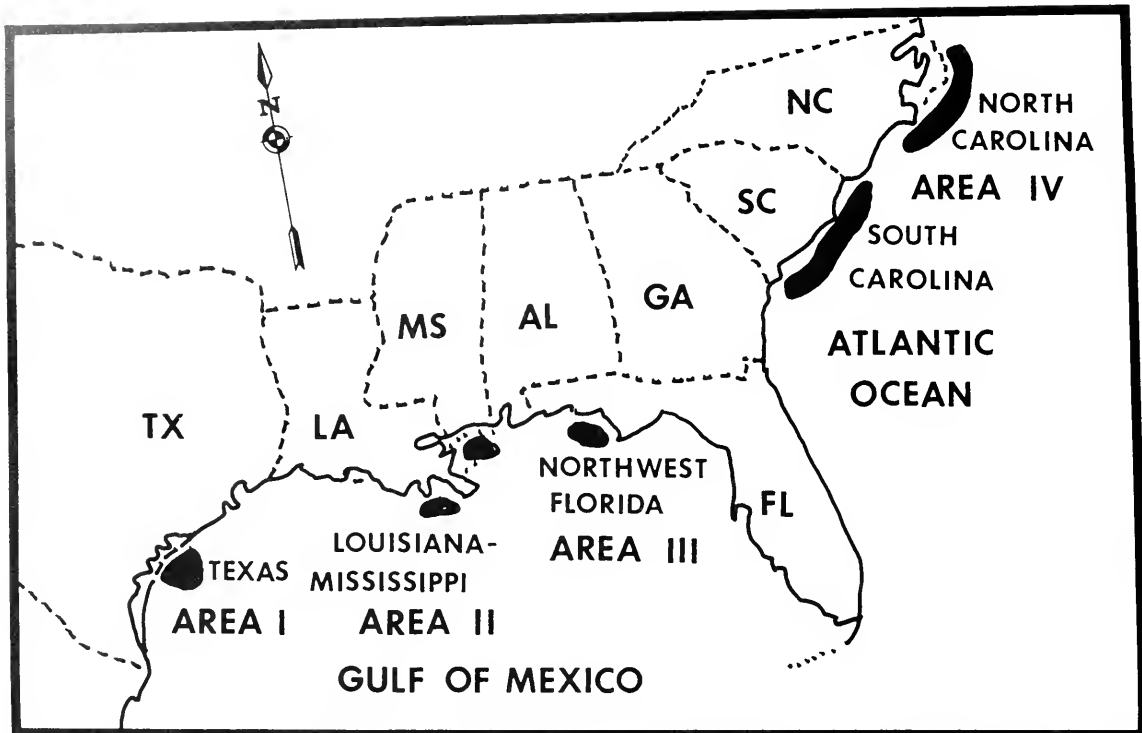

FIGURE 1.—Sampling areas for king mackerel, *Scomberomorus cavalla*, in the Gulf of Mexico and Atlantic Ocean during 1977-78.

from a length-weight regression ( $r = 0.996$ ;  $n = 186$ ) of king mackerel data from all areas.

Egg size distributions within the ovary were statistically compared to ensure that subsamples taken for studies of maturation and fecundity were representative (Yuen 1955; Otsu and Uchida 1959). Both ovarian lobes were divided into three sections (anterior, middle, and posterior) of about equal length. At a selected point along each of these sections, a 2-4 mm thick cross section was cut and removed. A wedged-shaped portion was then taken from each of the three cross sections and divided into three zones: inner, middle, and outer. A sample of 150 yolked eggs from each of the zones was examined with a microscope and all eggs were measured to the nearest 0.02 mm at 500 $\times$  on whatever axis the egg happened to be located in respect to an ocular micrometer scale (Clark 1934). A chi-square test of independence (Steel and Torrie 1960) was used to test for significant differences in mean egg diameters (EDs) among the sections, zones, and zones within a section in each lobe.

Each wedge-shaped sample of eggs was placed in a dish with 10% Formalin<sup>3</sup> and the eggs were then teased apart. Samples containing only unyolked eggs ( $\leq 0.20$  mm ED) were considered to be from

immature fish and only 100 eggs from these samples were measured. Samples with yolked eggs ( $\geq 0.20$  mm ED) were considered to be from mature fish and 300 eggs were measured.

Seasonal maturation was determined by plotting monthly mean EDs of the most advanced eggs found in each ovary and by gonadosomatic indices (GSI = the percentage of TW represented by gonad weight). The range and 95% confidence interval of the monthly mean GSIs were also plotted. To compare the variation of GSIs, we calculated the coefficient of variation for each month. We estimated the length at which the fish first matured by computing mean GSIs for fish in each 50 mm interval and used the length at which the greatest increase in mean GSIs between consecutive FL intervals occurred. For this analysis we only used data that were collected during the fish's most sexually active months as indicated by the highest values of mean EDs and GSIs. An additional estimate was made for females by assigning immature or mature status to each fish according to egg stage and then calculating the percentage of mature fish by FL intervals.

<sup>3</sup>Reference to trade names does not imply endorsement by the National Marine Fisheries Service, NOAA.

Fecundity estimates were based on the number of yolked eggs  $\geq 0.20$  mm in diameter in the most mature ovaries. Similar methods were discussed by Hunter and Goldberg (1980) and used by Morse (1980). A diameter of 0.20 mm was used to separate immature and mature eggs, because it was at this size that yolk first appeared. A gravimetric method was used for fecundity and followed the procedures of Finucane and Collins (1984). Ages of fish were determined from otoliths (Johnson et al. 1983). Analysis of covariance was used to test for differences in fecundity by year and area. Regression and correlation were used to examine the linear and curvilinear relationships between fecundity and fork length, total weight, and age.

## RESULTS

Gonads from 1,165 female and 593 male king mackerel were examined. Fish ranged in FL from 351 to 1,554 mm, in TW from 658 to 31,780 g, and in age from 1 to 13 yr. Temporal coverage varied from 3 mo in area I to 12 mo in area II. Number and percentage composition of fish by area were area I, 85 and 4.8%; area II, 646 and 36.7%; area III, 768 and 43.7%; and area IV, 259 and 14.7%.

Analysis of the egg size distribution indicated that there were significant differences ( $\alpha = 0.05$ ) in ED between the inner, middle, and outer zones within ovarian sections; there were no differences between sections. Therefore, we took a wedge-shaped sample (representing the three cross-sectional zones) from the middle of the right or left ovary as representative of the entire ovary for ED analysis. King mackerel ovaries were grouped into five reproductive stages based on ED. Stage I (immature ovaries) contained eggs  $\leq 0.06$  mm. Eggs in stage II (resting ovaries) ranged from 0.07 to 0.20 mm. Stage III (maturing) and stage IV (mature) ovaries contained eggs 0.21-0.50 mm and 0.51-0.71 mm, respectively. Stage V eggs measured 0.71-1.20 mm and indicated ripe ovaries.

The seasonal progression of mean GSIs and EDs indicated that king mackerel have a prolonged spawning season that varied between areas (Figs. 2-5). Peak spawning months occurred from May through September as observed in 14 ripe females from areas I, II, and IV. A few fish were in spawning condition as early as April and as late as October. In area I, GSIs and EDs peaked in July and August for both sexes. Area II fish had the highest GSIs and EDs for both sexes during May. In area III, GSIs for both sexes were greatest during June

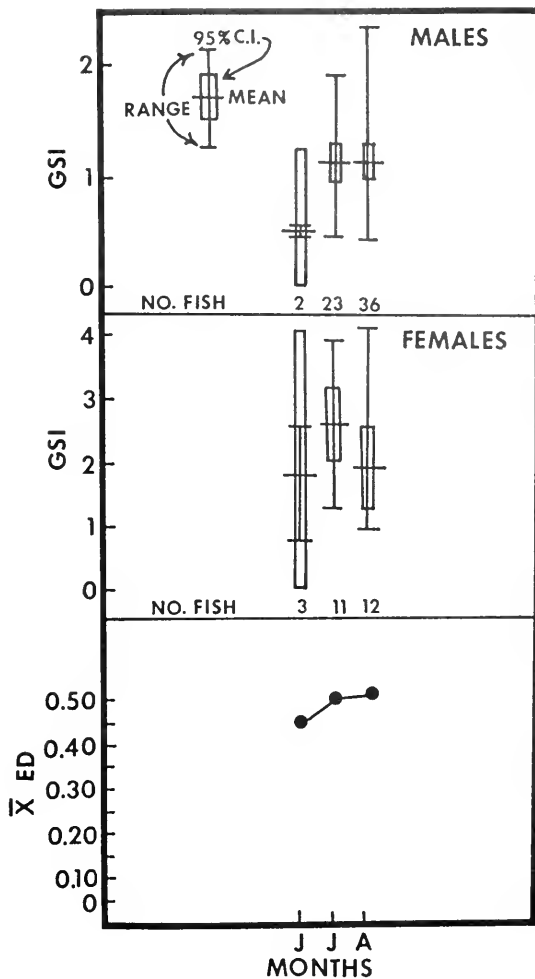

FIGURE 2.—Seasonal maturation cycle of male and female king mackerel from area I (Texas) shown by monthly gonadosomatic index (GSI) and mean egg diameters (EDs) in mm.

while EDs peaked in August. Area IV fish had the highest female GSIs and EDs during July.

Serial spawning was suggested by several lines of evidence. Distribution of EDs was multimodal during spawning months. The highest coefficient of variation for GSIs occurred during the spawning months, suggesting that eggs were maturing and released serially throughout the spawning season (Table 1).

The size at maturation of king mackerel also varied between areas. Maturity was based on the number and percentage of fish with stage III-stage V ova for each 50 mm FL interval. Length intervals in which at least 50% of the females were mature for areas I-IV, respectively, were 450-499 mm, 600-649 mm, 600-649 mm, and 650-699 mm

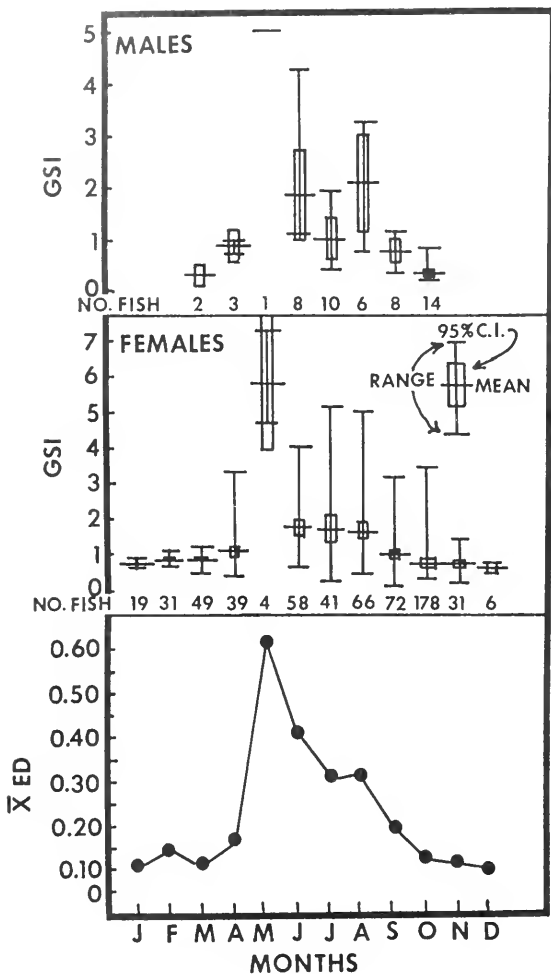

FIGURE 3.—Seasonal maturation cycle of male and female king mackerel from area II (Louisiana and Mississippi) shown by monthly gonadosomatic index (GSI) and mean egg diameters (EDs) in mm.

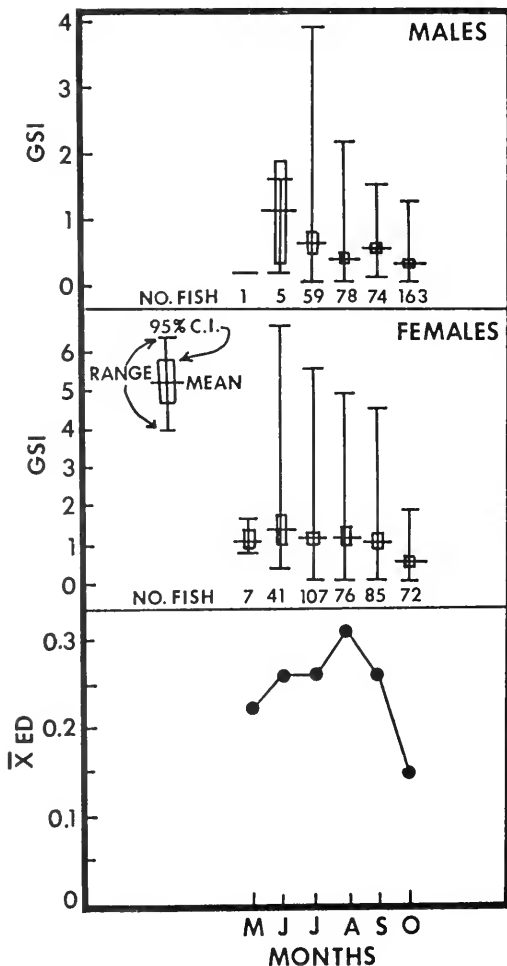

FIGURE 4.—Seasonal maturation cycle of male and female king mackerel from area III (northwest Florida) shown by monthly gonadosomatic index (GSI) and mean egg diameters (EDs) in mm.

TABLE 1.—Coefficient of variation for monthly GSIs of female (F) and male (M) king mackerel in each area.

Month	Area I		Area II		Area III		Area IV	
	F	M	F	M	F	M	F	M
January	—	—	12.7	—	—	—	—	—
February	—	—	12.5	—	—	—	—	—
March	—	—	18.0	7.1	—	—	—	—
April	—	—	43.6	15.3	—	—	—	—
May	—	—	20.4	1	28.2	—	56.3	52.9
June	51.7	16.0	55.0	57.1	96.9	56.4	39.1	—
July	33.6	35.4	77.3	58.2	95.5	104.8	36.2	1
August	54.2	38.9	66.2	43.4	95.5	75.7	44.4	2.5
September	—	—	56.7	38.7	85.9	51.9	64.9	61.5
October	—	—	36.8	48.4	62.7	51.6	41.7	54.5
November	—	—	32.8	—	—	—	—	—
December	—	—	20.0	—	—	—	—	—

<sup>1</sup>n = 1



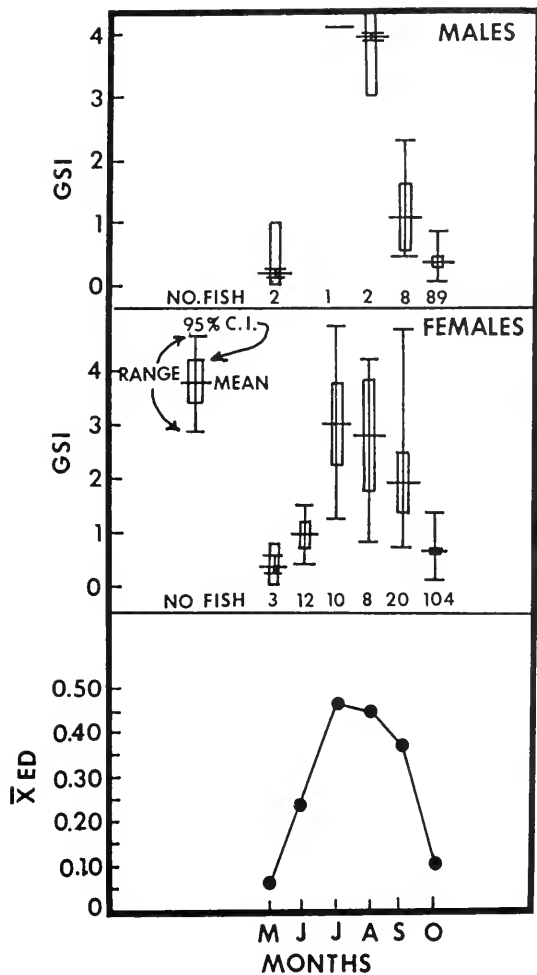

FIGURE 5.—Seasonal maturation cycle of male and female king mackerel from area IV (North and South Carolina) shown by monthly gonadosomatic index (GSI) and mean egg diameters (EDs) in mm.

(Table 2). All females were mature at 850-899 mm. Another maturation pattern was noted when the midpoints of fork length intervals were plotted against mean GSIs for each area (Fig. 6). The size interval where greatest increases in GSIs occurred were 650-699 mm (area I), 700-749 mm (area II), 450-499 mm (area III), and 650-699 (area IV).

Fecundity ranged from 69,000 to 12,207,000 eggs in 65 king mackerel from all areas. Fish ranged in FL from 446 to 1,489 mm, in TW from 681 to 25,610 g, and in age from 1 to 13 yr (Table 3). Analysis of covariance with TW as the covariate showed no significant differences ( $\alpha = 0.05$ ) in fecundity between years or among areas. The best predictor of fecundity based on regression and cor-

relation analysis was TW for areas II, IV, and all areas combined and FL for areas I and III (Table 4). Log transformed linear models were better predictors of fecundity than nontransformed models in all areas but area IV.

## DISCUSSION

Our results on the seasonal maturation and protracted spawning season of king mackerel agree closely with other studies. In waters off Florida, Beaumariage (1973) found late-maturing (stages III and IV) eggs in king mackerel from May through October. In the northeastern Gulf of Mexico (area III), Dwinell and Futch (1973) caught king mackerel larvae during the same time interval and MacGregor et al. (1981) reported early- or late-maturing ovaries from August through October. In the northwestern Gulf of Mexico off Texas (area I), Finucane and Collins (1977) and McEachran et al. (1980) noted catches of larvae from May through August, and April through October, respectively. In the area off Cape Fear, NC, to Cape Canaveral, FL, Powles<sup>4</sup> collected king mackerel larvae from May through September.

Length at maturation was difficult to determine because the sample size of small fish (<600 mm) was limited in all areas except area III (northwest Florida). Using only fish from this area, maturity first occurred about 450-499 mm and 50% of the fish were mature at about 550-599 mm. These estimates of maturity agreed with some of the other studies. Female king mackerel first reached sexual maturity at 630 mm and 4 yr of age (Gesteira and Mesquita 1976) or at 586 mm (Alves and Tome 1967) off Brazil. Another study on Brazilian fish, however, noted that females were first mature at 770 mm and 5-6 yr of age (Ivo 1972). In Florida waters, Beaumariage (1973) estimated that females 3 yr or younger were immature and probably had not spawned. He believed that the first major spawning by females and males occurred at 880 and 770 mm SL, respectively. Some of his 1-yr-old females contained stage IV eggs that had been aborted or reabsorbed since he did not find ripe (stage V) eggs until the fish were 4 yr old. His standard length for king mackerel from Florida at age 1 was 610 mm (651 mm FL), which was higher than our estimate of length at first maturity.

<sup>4</sup>Powles, H. W. Abundance and distribution of king mackerel, (*Scomberomorus cavalla*) and Spanish mackerel (*S. maculatus*) larvae of the southeast United States. Unpubl. manusc. Gouvernement du Canada, Peches et Oceans, Division des Sciences halieutiques, C. P. 15500, Quebec, Canada G1K 7Y7.

TABLE 2.—Total sample number and percentage of mature (Stages III-V) king mackerel females collected during the peak maturation season in each area.<sup>1</sup>

Fork length	Area I (Texas)		Area II (Louisiana, Mississippi)		Area III (Northwest Florida)		Area IV (North and South Carolina)	
	No.	Mature (%)	No.	Mature (%)	No.	Mature (%)	No.	Mature (%)
300-349	0	—	0	—	0	—	0	—
350-399	1	0.0	0	—	1	0.0	0	—
400-449	0	—	0	—	2	0.0	0	—
450-499	1	100.0	0	—	3	33.3	0	—
500-549	0	—	0	—	16	6.3	0	—
550-599	0	—	0	—	28	46.4	0	—
600-649	2	100.0	2	100.0	31	71.0	1	0.0
650-699	0	—	0	—	31	71.0	4	75.0
700-749	4	100.0	1	100.0	35	80.0	2	100.0
750-799	8	100.0	0	—	29	62.1	5	100.0
800-849	6	100.0	0	—	41	75.6	4	100.0
850-899	2	100.0	5	100.0	29	100.0	11	100.0
900-949	2	100.0	6	100.0	21	100.0	8	100.0
950-999	0	—	22	100.0	19	100.0	7	100.0
1,000-1,049	0	—	19	100.0	13	100.0	3	100.0
1,050-1,099	0	—	18	100.0	4	100.0	3	100.0
1,100-1,149	0	—	18	100.0	6	100.0	1	100.0
1,150-1,199	0	—	13	100.0	4	100.0	1	100.0
1,200-1,249	0	—	18	100.0	2	100.0	0	—
1,250-1,299	0	—	14	100.0	1	100.0	0	—
1,300-1,349	0	—	17	100.0	0	—	0	—
1,350-1,399	0	—	11	100.0	0	—	0	—
1,400-1,449	0	—	3	100.0	0	—	0	—
1,450-1,499	0	—	2	100.0	0	—	0	—
Total	26		169		316		50	

<sup>1</sup>Area I, June-August; Area II, May-August; Area III, May-September; and Area IV, June-September.

Factors influencing the maturation cycle of king mackerel are not well known. Presumably, photoperiod and water temperature are important for spawning, egg, and larval development. Beaumariage (1973) indicated that seasonal changes in photoperiod influenced the spawning of king mackerel while McEachran et al. (1980) noted that larvae were more abundant at temperatures from 20.2° to 29.8°C and salinities from 28.2 to 34.4‰. A study by MacGregor et al. (1981) also showed that the levels of serum androgens and estrogens may be indicators of maturation in king mackerel.

Our inferences on spawning peaks and activity of king mackerel, as determined by largest mean EDs, usually coincided with those of other studies. Our largest mean ED of 0.61 mm agrees with the 0.60 mm reported by Alves and Tome (1967). In contrast, the largest mean ED of 0.33 mm shown by Beaumariage (1973) suggests that most of his fish were not ready to spawn. Our largest mean egg sizes from northwest Florida fish were similar to those reported by Beaumariage (1973) and probably indicates that spawning activity off the west coast of Florida is not extensive. Peak spawning months by area in this study were area I, August; area II, May;

area III, August; and area IV, July. In the northwestern and northeastern gulf, (our areas I and III) the highest catches of larval king mackerel occurred during September (Dwinell and Futch 1973; McEachran et al. 1980). Houde et al. (fn. 2) stated that because of their rare catches of larvae, king mackerel does not appear to spawn frequently in the eastern gulf.

The reproductive cycle of king mackerel off the coast of Brazil is probably similar to that of this species from American waters. Ivo (1972) noted that spawning occurred throughout the year off the state of Ceara which is south of the Equator. Other studies indicate that they begin to spawn from October through December (Menezes 1969) with peaks in November and March (Gesteria and Mesquita 1976). Since the seasons are reversed in this area, they would correspond to our spring and late summer spawning peaks for king mackerel.

We were unable to determine the number of times individual king mackerel spawn during the year from the data. Beaumariage (1973) concluded that king mackerel were multiple spawners, based on their extended spawning season and presence of several modal groups of yolked eggs. Morse (1980) reported that individual Atlantic mackerel, *Scomber*

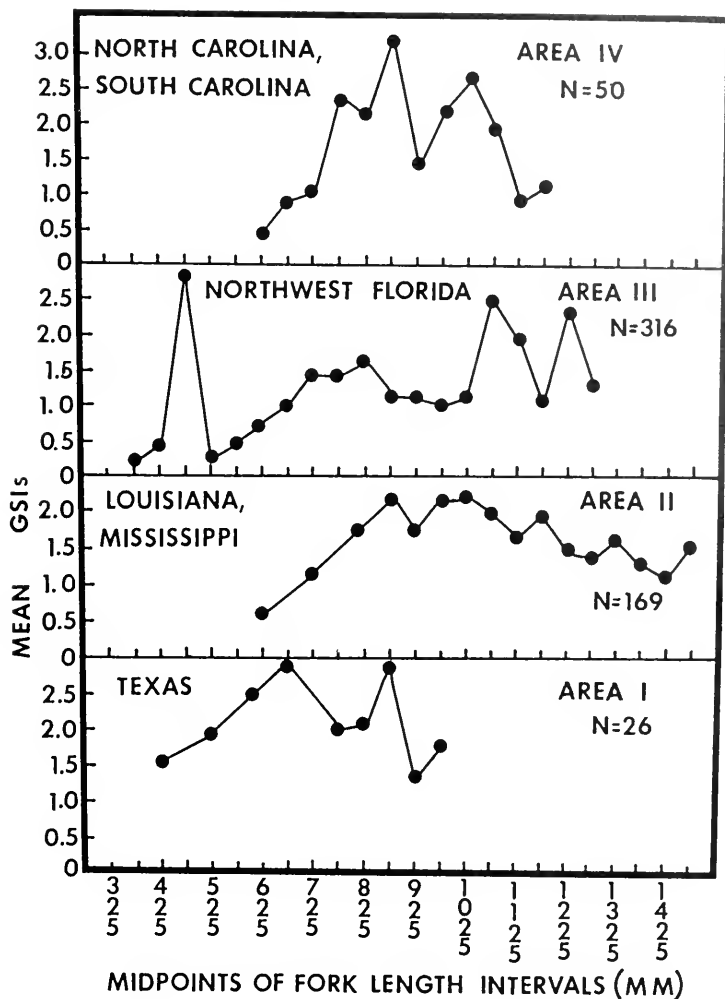

FIGURE 6.—Mean GSI plotted by midpoint of fork length interval for female king mackerel in each area.

*scombrus*, are capable of spawning six batches of eggs during the spawning season. Documentation of spawning frequency and numbers of eggs produced will require that king mackerel be held in captivity.

Major spawning areas for king mackerel could not be determined during this study because of the scarcity of ripe fish. Gonad maturation data suggest that spawning occurs throughout the sampling areas but the magnitude of spawning and extent of spawning areas are unknown. Ichthyoplankton surveys conducted by Wollam (1970), Houde et al. (fn. 2), and McEachran et al. (1980) have revealed general spawning locations of king mackerel by the occurrence of small larvae (<3 mm SL). These studies in-

dicate that spawning probably occurs over the continental shelf of the northwestern and northeastern Gulf of Mexico. Most small larvae collected by McEachran et al. (1980) were captured over the middle and outer continental shelf in water depths of 35-130 m off the Texas coast.

No comparative fecundity data were available from the southeastern U.S.; however, Ivo (1974) determined fecundity for 39 fish from Brazilian waters. He found great variation in fecundity for fish with the same fork length.

The fact that disjunct spawning appears to occur off the Carolinas and in the northcentral and western Gulf of Mexico from spring through fall may suggest separate stocks of king mackerel in these areas.

TABLE 3.—Summary of data on king mackerel for which fecundity was estimated, 1977-78.

Date	Fork length (mm)	Gonad weight (g)	Total weight (g)	Gonad index (× 100)	Age	Fecundity (estimated)	Date	Fork length (mm)	Gonad weight (g)	Total weight (g)	Gonad index (× 100)	Age	Fecundity (estimated)
Area I (Texas)							Area III (Northwest Florida)						
8/26/78	500	18.16	900	2.02	2	185,608	8/8/77	508	9.24	944	0.98	1	196,938
7/8/78	650	55.66	2,270	2.45	—	985,340	8/8/77	568	11.95	1,318	0.91	1	160,722
7/26/78	750	76.09	3,042	2.50	4	1,082,301	8/7/77	608	24.70	1,950	1.27	1	404,982
8/26/78	760	35.23	3,166	1.11	—	466,252	7/2/78	652	39.53	2,497	1.58	1	688,354
7/8/78	770	92.87	3,405	2.73	2	1,194,283	8/14/77	727	105.96	3,180	3.33	2	1,640,497
7/8/78	800	142.53	4,086	3.49	4	2,009,870	7/14/77	780	139.64	3,424	4.08	—	2,102,579
7/8/78	810	135.50	4,313	3.14	—	1,435,752	6/27/78	816	301.26	4,450	6.64	—	5,049,856
7/8/78	835	82.96	4,540	1.83	4	1,380,342	8/7/78	826	167.31	4,903	3.41	2	2,912,649
7/8/78	860	176.00	4,994	3.52	5	2,753,638	6/19/77	862	186.02	4,680	3.98	4	2,509,948
7/8/78	870	130.19	4,994	2.61	5	2,236,664	7/4/78	906	210.33	5,630	3.74	6	3,005,716
8/7/78	895	212.86	5,448	3.91	6	2,309,622	6/27/78	929	96.05	6,492	1.48	—	1,891,588
—	—	239.41	4,183	—	3	4,183,921	7/13/77	980	205.49	8,170	2.52	—	3,346,332
Area II (Louisiana)							Area IV (North Carolina)						
6/24/78	446	8.43	681	1.24	—	69,264	7/13/77	617	171.17	5,765	2.97	—	2,625,338
6/23/77	635	13.45	1,930	0.70	1	182,863	9/9/78	780	131.11	3,632	3.61	3	1,667,418
6/20/77	710	26.92	2,500	1.08	2	2,570,133	7/28/78	841	207.22	5,766	3.59	4	2,330,248
9/13/77	852	96.36	4,380	2.20	4	1,179,625	9/21/78	844	100.07	4,722	2.12	4	969,206
7/13/78	895	158.51	5,130	3.09	4	2,079,204	7/26/78	865	150.50	4,631	3.25	—	1,639,189
8/15/77	951	239.09	6,221	3.84	—	4,448,492	7/15/78	869	227.67	4,767	4.78	—	2,795,451
5/20/78	972	451.68	7,310	6.18	6	6,319,134	9/9/78	880	119.88	4,858	2.47	5	1,236,055
5/20/78	994	577.18	11,120	5.19	6	5,890,631	7/11/78	900	170.57	6,628	2.57	4	3,321,377
7/7/78	1,025	325.56	9,000	3.62	6	4,686,248	8/27/78	972	214.00	7,173	2.98	6	3,204,055
8/7/78	1,037	417.00	8,325	5.01	6	6,437,542	8/27/78	996	282.01	7,718	3.65	6	2,652,453
6/23/78	1,055	314.33	8,626	3.64	11	4,686,598	9/9/78	1,000	267.35	6,992	3.82	8	2,797,301
9/3/77	1,086	303.52	9,750	3.11	—	5,401,961	8/30/78	1,050	416.04	9,988	4.17	8	6,102,347
6/25/78	1,109	247.66	9,534	2.60	—	2,771,744							
6/25/78	1,149	401.59	10,896	3.69	9	4,268,537							
6/16/78	1,178	478.74	13,286	3.60	6	8,899,756							
7/10/78	1,194	447.88	9,045	4.95	10	6,010,133							
4/29/78	1,220	498.52	15,150	3.29	9	7,315,781							
5/20/78	1,229	698.36	14,070	4.96	6	10,116,890							
6/17/78	1,265	611.04	15,095	4.05	9	9,209,082							
6/17/78	1,291	468.64	15,890	2.95	10	7,487,826							
8/10/77	1,312	583.79	17,120	3.41	—	6,689,189							
5/20/78	1,316	840.08	17,800	4.72	10	10,711,026							
6/17/78	1,370	570.66	19,885	2.87	11	7,650,064							
8/15/78	1,489	815.00	25,610	3.18	13	12,206,888							

TABLE 4.—Regressions of fecundity (F) on total weight (TW), fork length (FL), and age (A) of king mackerel by areas.

Area	Predictor	Equation	r <sup>2</sup>
I (TX)	TW	$F = 8.554 \times 10^1(TW)^{1.465}$	0.745
	FL	$F = 8.816 \times 10^{-7}(FL)^{4.206}$	0.781
	A	$F = 2.487 \times 10^5(A)^{1.390}$	0.373
II (LA-MS)	TW	$F = 1.475 \times 10^1(TW)^{1.381}$	0.847
	FL	$F = 9.973 \times 10^{-7}(FL)^{4.175}$	0.840
	A	$F = 4.207 \times 10^5(A)^{1.313}$	0.721
III (NWF)	TW	$F = 1.327 \times 10^1(TW)^{1.408}$	0.877
	FL	$F = 1.918 \times 10^{-7}(FL)^{4.455}$	0.884
	A	$F = 4.684 \times 10^5 + 9.494 \times 10^5(A)$	0.870
IV (NC-SC)	TW	$F = 1.419 \times 10^6 + (6.658 \times 10^3)TW$	0.760
	FL	$F = -2.554 \times 10^6 + (5.840 \times 10^3)FL$	0.257
	A	$F = -2.778 \times 10^5 + (5.579 \times 10^5)A$	0.436
I-IV (All areas)	TW	$F = 1.854 \times 10^1(TW)^{1.361}$	0.856
	FL	$F = 4.391 \times 10^{-6}(FL)^{3.974}$	0.820
	A	$F = 3.399 \times 10^5(A)^{1.356}$	0.730

Williams and Godcharles<sup>5</sup> have postulated on the basis of mark-recapture data that two migratory groups occur: one in the South Atlantic and the other in the Gulf of Mexico. Both of their ranges overlap in south Florida.

## ACKNOWLEDGMENTS

We thank Dale S. Beaumariage, Churchill B. Grimes, and Steven A. Bortone for their critical review of this manuscript.

## LITERATURE CITED

- ALVES, M. I. M., AND G. S. TOME.  
1967. Alguns aspectos do desenvolvimento maturativo das gonadas da cavala, *Scomberomorus cavalla* (Cuvier, 1829). Arq. Estac. Biol. Mar. Univ. Fed. Ceara 7(1):1-9.
- BAGLIN, R. E., JR.  
1982. Reproductive biology of western Atlantic bluefin tuna. Fish. Bull., U.S. 80:121-134.
- BEAUMARIAGE, D. S.  
1973. Age, growth, and reproduction of king mackerel, *Scomberomorus cavalla*, in Florida. Fla. Mar. Res. Publ., No. 1, 45 p.
- BRUSHER, H. A., L. TRENT, AND M. L. WILLIAMS.  
1978. Recreational fishing for king mackerel in Bay County, Florida during 1975. In C. B. Austin et al. (editors), Mackerel Workshop Report, p. 120-142. Univ. Miami Sea Grant, Spec. Rep., No. 14.
- CLARK, F. N.  
1934. Maturity of the California sardine (*Sardina caerulea*), determined by ova diameter measurements. Calif. Dep. Fish Game, Fish Bull. 42, 49 p.
- COLLETTE, B. B., AND J. L. RUSSO.  
1979. An introduction to the Spanish mackerels, genus *Scomberomorus*. In E. L. Nakamura and H. R. Bullis, Jr. (editors), Proceedings of Colloquium on the Spanish and King Mackerel Resources of the Gulf of Mexico, p. 3-16. Gulf States Marine Fisheries Commission. No. 4.
1984. Morphology, systematics, and biology of the Spanish mackerels (*Scomberomorus*, Scombridae). Fish. Bull., U.S. 82:545-692.
- DWINELL, S. E., AND C. R. FUTCH.  
1973. Spanish and king mackerel larvae and juveniles in the northeastern Gulf of Mexico, June through October 1969. Fla. Dep. Nat. Resour., Mar. Res. Lab., Leaflet Ser. 4 (pt. 1, no. 24), 14 p.
- FINUCANE, J. H., AND L. A. COLLINS.  
1977. Environmental assessment of an active oil field in the northwestern Gulf of Mexico, 1976-1977. Ichthyoplankton, NOAA Final Report to EPA, 150 p.
1984. Reproductive biology of cero, *Scomberomorus regalis*, from the coastal waters of south Florida. Northeast Gulf Sci. 7(1):101-107.
- GESTEIRA, T. C. V., AND A. L. L. MESQUITA.  
1976. Epoca de reproducao tamanho e idade na primeira desova da cavala e da serra, na costa do Estado do Ceara (Brasil). Arq. Cienc. Mar. 16(2):83-86.
- HUNTER, J. R., AND S. R. GOLDBERG.  
1980. Spawning incidence and batch fecundity in northern anchovy, *Engraulis mordax*. Fish. Bull., U.S. 77:641-652.
- IYO, C. T. C.  
1972. Epoca de desova e idade na primeira maturacao sexual da cavala, *Scomberomorus cavalla* (Cuvier), no Estado do Ceara. Arq. Cienc. Mar. 12(1):27-29.
1974. Sobre a fecundidade da cavala, *Scomberomorus cavalla* (Cuvier), em águas costeiras do Estado do Ceará (Brasil). Arq. Cienc. Mar. 14(2):87-89.
- JOHNSON, A. G., W. A. FABLE, JR., M. L. WILLIAMS, AND L. E. BARGER.  
1983. Age, growth, and mortality of king mackerel, *Scomberomorus cavalla*, from the southeastern United States. Fish. Bull., U.S. 81:97-106.
- MACGREGOR, R. M., III, J. J. DINDO, AND J. H. FINUCANE.  
1981. Changes in serum androgens and estrogens during spawning in bluefish, *Pomatomus saltator*, and king mackerel, *Scomberomorus cavalla*. Can. J. Zool. 59:1749-1754.
- MANOOCH, C. S., III.  
1979. Recreational and commercial fisheries for king mackerel, *Scomberomorus cavalla*, in the South Atlantic Bight and Gulf of Mexico, U.S.A. In E. L. Nakamura and H. R. Bullis, Jr. (editors), Proceedings of Colloquium on the Spanish and King Mackerel Resources of the Gulf of Mexico, p. 33-41. Gulf States Marine Fisheries Commission No. 4.
- MANOOCH, C. S., III, E. L. NAKAMURA, AND A. B. HALL.  
1978. Annotated bibliography of four Atlantic scombrids: *Scomberomorus brasiliensis*, *S. cavalla*, *S. maculatus*, and *S. regalis*. U.S. Dep. Commer., NOAA Tech. Rep. NMFS Circ. 418, 166 p.
- MCEACHRAN, J. D., J. H. FINUCANE, AND L. S. HALL.  
1980. Distribution, seasonality and abundance of king and Spanish mackerel larvae in the northwestern Gulf of Mexico (Pisces: Scombridae). Northeast Gulf Sci. 4(1):1-16.
- MENEZES, M. F.  
1969. Alimentação da cavala, *Scomberomorus cavalla* (Cuvier), em águas costeiras do Estado do Ceará. Arq. Cienc. Mar. 9(1):15-20.
- MOE, M. A., JR.  
1963. A survey of offshore fishing in Florida. Fla. State Board Conserv. Mar. Lab., Prof. Pap. Ser. 4, 115 p.
- MORSE, W. W.  
1980. Spawning and fecundity of Atlantic mackerel, *Scomber scombrus*, in the Middle Atlantic Bight. Fish. Bull., U.S. 78:103-108.
- OTSU, T., AND R. N. UCHIDA.  
1959. Sexual maturity and spawning of albacore in the Pacific Ocean. Fish. Bull., U.S. 59:287-305.
- RICKER, W. E.  
1975. Computation and interpretation of biological statistics of fish populations. Fish. Res. Board Can., Bull. 191, 382 p.
- STEEL, R. G. D., AND J. H. TORRIE.  
1960. Principles and procedures of statistics (with special references to biological sciences). McGraw-Hill Book Co., Inc., N.Y., 481 p.
- U.S. DEPARTMENT OF COMMERCE, NATIONAL MARINE FISHERIES SERVICE.  
1985a. Fisheries of the United States, 1984. Current Fishery Statistics 8360, 121 p.  
1985b. Marine recreational fishery statistics survey, Atlantic and Gulf Coasts, 1983-1984. Current Fisheries Statistics 8326, 222 p.

<sup>5</sup>Williams, R. O., and M. F. Godcharles. Fisheries stock assessment, king mackerel tagging and stock assessment. Annual report for 1981-82. Florida Department of Natural Resources, Marine Research Laboratory, 100 Eighth Ave., S.E., St. Petersburg, FL 33701.

WOLLAM, M. B.

1970. Description and distribution of larvae and early juveniles of king mackerel, *Scomberomorus cavalla* (Cuvier), and Spanish mackerel, *Scomberomorus maculatus* (Mitchill). (Pisces: Scombridae) in the western north Atlantic. Fla.

Dep. Nat. Resour. Mar. Res. Lab. Tech. Ser. 61, 35 p.

YUEN, H. S. H.

1955. Maturity and fecundity of bigeye tuna in the Pacific. Spec. Sci. Rep. Fish. 150, 30 p.

# NEW OCCURRENCE OF EPIZOOTIC SARCOMA IN CHESAPEAKE BAY SOFT SHELL CLAMS, *MYA ARENARIA*

C. A. FARLEY,<sup>1</sup> S. V. OTTO,<sup>2</sup> AND C. L. REINISCH<sup>3</sup>

## ABSTRACT

Maryland soft shell clams, *Mya arenaria*, from Chesapeake Bay were sampled from 1969 through January 1983. Four cases of sarcomatous neoplasia were diagnosed histologically [1979 (1), 1982 (2), January 1983 (1)] in 3,584 animals. Hemocytologic sampling between December 1983 and May 1984 revealed peak prevalences of 42-65% in clams from five sites. Sarcomas in laboratory-held clams progressed from early to advanced stages and death. This is the first time epizootic neoplastic disease has been observed in a wild molluscan population which was previously documented to be sarcoma-free. An infectious etiology is implied and data indicate the potential for mass mortality of bay clams.

Neoplastic diseases in soft shell clams, *Mya arenaria*, have been reported from New England populations in both polluted and nonpolluted areas (Barry and Yevich 1975; Farley 1976a; Yevich and Barszcz 1977; Brown et al. 1977, 1979; Brown 1980; Cooper et al. 1982a; Reinisch et al. 1984). Generally, the types of neoplasia noted have been considered as having hemocyte (blood cell) (Yevich and Barszcz 1977; Brown et al. 1977, 1979; Brown 1980; Cooper et al. 1982a; Reinisch et al. 1984) and gonadal (Barry and Yevich 1975; Yevich and Barszcz 1977; Brown et al. 1977, 1979; Brown 1980) origins or have been designated as sarcomatous (Farley 1976a). A single neoplastic clam was reported from Chesapeake Bay with an apparent teratoma composed of nerve and muscle tissue and digestive epithelium (Harshbarger et al. 1977). Chesapeake Bay soft clams collected and examined by several authors between 1971 and 1978 were free of the neoplastic disease (Barry and Yevich 1975; Brown 1980) with the exception of 1 case found in a collection of 3,000 clams used as experimental controls (Brown 1980). Evidence for a viral etiology for hematopoietic neoplasia in clams was reported in a Rhode Island study (Oprandy et al. 1981). Improved techniques such as examination of hemolymph using a combination of histologic and cytologic procedures (Cooper et al. 1982b) and the development of a monoclonal antibody test specific for neoplastic clam cells (Reinisch et al. 1983) have facilitated the identification and diagnosis of the disease. High prevalences of sarcomas have been

found repeatedly in populations of Chesapeake Bay clams.

This paper documents the first occurrence of epizootic sarcoma in soft shell clams in Chesapeake Bay, and the first time neoplastic disease has appeared in a wild molluscan population that was previously shown to be free of the disease. Epizootic prevalences of this condition may have a potentially devastating impact on the clam industry of the region.

## MATERIALS AND METHODS

Sixty samples of 25 or more soft shell clams (totaling over 3,500 clams) have been collected periodically by the Maryland Department of Natural Resources (DNR) or purchased from seafood outlets from 51 sites in Chesapeake Bay since 1969. Each animal was necropsied and tissues were fixed, processed, and diagnosed histologically via standard methods (Howard and Smith 1983) for diseases and parasites. Recent samples (Table 1) were examined by cytologic methods to determine the percent prevalence and number of abnormal cells. Late spring samples (YCLP, YSWP, YAGH, and YPIS, Table 1) were diagnosed by both histology and histocytology (technique described below).

Hemolymph was drawn via hypodermic syringe into sterile, ambient (15‰), artificial seawater to produce a 1:9 dilution of cells to seawater. One milliliter of this sample was placed on a 25 mm, chambered, poly-L-lysine coated microscope slide and cells were allowed to settle for 1 h (the poly-L-lysine coating improves the adhesiveness of neoplastic cells which in vitro are rounded and do not usually stick to glass [Cooper 1982a]). Fluid and chambers were

<sup>1</sup>Northeast Fisheries Center Oxford Laboratory, National Marine Fisheries Service, NOAA, Oxford, MD 21654.

<sup>2</sup>Aspen Cove, Bozman, MD 21612.

<sup>3</sup>Tufts University School of Veterinary Medicine, Boston, MA 02111.

TABLE 1.—Prevalence of sarcoma in recent and historic samples diagnosed from Feulgen-stained cytologic and histologic preparations in recent samples and from archived State of Maryland samples. Clams were collected from 1969 through October 1984 from comparable areas.

Location	Clam bed site	Date	Sample code	No. per sample	Advanced sarcomas (stages 4, 5) (%)	Advanced sarcomas in sample (stages 4, 5) (%)	Prevalence diagnosed by histocytology (%)	Prevalence diagnosed by histology (%)	Combined prevalence
Commercial sample	Site unknown	6 Dec. 1983	OXC	18	13	6	44	—	—
Commercial sample	Site unknown	8 Dec. 1983	EBC	16	100	6	6	—	—
Commercial sample	Site unknown	1 Feb. 1984	KNC	74	18	4	23	—	—
Chester River	Long Point	19 Apr. 1984	YCLP	50	0	0	0	0	0
Chester River	Swan Point	19 Apr. 1984	YSWP	50	24	10	46	32	46
West River	Three Sisters	4 May 1984	YAGH	50	56	28	50	52	57
Eastern Bay	Poplar Island	4 May 1984	YPIS	50	52	24	42	27	42
Total sample data					308			31 (%/200) = 29.5	
Chester River	Swan Point	28 June 1984	YSWP 2	50	0	0	0	—	—
Eastern Bay	Poplar Island	July/Aug. 1984	YPIS	50	0	0	0	—	—
Chester River	Swan Point	July/Aug. 1984	YSWP 3	40	0	0	3	—	—
Eastern Bay	Poplar Island	26 Oct. 1984	YPIS	50	35	12	32	—	—
Chester River	Swan Point	26 Oct. 1984	YSWP 5	50	47	14	25	—	—
Chester River	Swan Point	7 Jan. 1985	YSWP 1	68	40	32	59	—	—
Chester River	Swan Point	29 Mar. 1985	YSWP 2	52	60	39	65	—	—
Chester River	Swan Point	17 May 1985	YSWP 3	52	100	15	15	—	—
Historic archived samples									
Choptank River, Eastern Bay & Chester River		Dec.-May 1969-78		362				0	0
Little Choptank River & West River		1979-Jan. 1983		250				1.6	1.6



removed, while slides were wet-fixed in an aldehyde fixative (1% glutaraldehyde/4% formaldehyde) (McDowell and Trump 1976) in half ambient seawater and stained with Feulgen picromethyl blue (Farley 1969), dehydrated, and mounted with a coverslip using a synthetic mounting medium. We are designating the term "histocytology" to describe this technique. The significance of this method is that the monolayer preparations, which result from treating living cells with histologic procedures, are permanent. Cytologic artifacts are minimal and cases can be accurately staged using cell counting procedures. Since histocytologic preparations contain between 100,000 and 500,000 cells in a monolayer, very early stages of the proliferative process can be diagnosed. Staging is arbitrarily determined by estimating the number and determining the ratio of both normal and neoplastic cells (Table 2). A similar diagnostic and staging method using cytologic techniques was reported by Cooper et al. (1982b); however, our method appears to have better accuracy and increased sensitivity to light cases. Diagnosis of histologic sections is reliable for stages 3-5 (Fig. 1A). As an example, comparison of late spring samples shows that histocytology is the more sensitive method while histology alone clearly demonstrates a massive increase in prevalence from zero in 1969-78 to 29.5% in 1984 (Table 1).

Monoclonal antibody was developed against neoplastic clam cells from Massachusetts clams by techniques described elsewhere (Reinisch et al. 1983). Periodic histocytologic diagnosis and mortality observations were made on clams held in 55 L aquaria with 15‰, 10°C artificial seawater, circulated through floss and charcoal filtering systems.

## RESULTS

Sarcomas in clams were diagnosed histologically in 1/25 in November 1979 from Eastern Bay; 1/25 in May 1981 from West River; 1/50 in November 1981 from Little Choptank River; and 1/75 in January 1983 from Chester River. In December 1983, histocytologic diagnoses of clams obtained from a local seafood restaurant showed 8/18 with sarcomas.

An intensive survey and study of local populations was initiated in December 1983 to evaluate the extent of this apparently new epizootic in Chesapeake Bay soft shell clams. Table 1 presents epizootiology of field collections while Table 2 shows comparable information on laboratory-held clams. Field prevalences were found to be high in most samples from December 1983 through April 1985. At the same time, disease intensities which were light in Decem-

TABLE 2.—Sarcoma progression in individual, laboratory-held soft shell clams: Dec. 1983-June 1984. Whole numbers = percent ratios of neoplastic cells to hemocytes and numbers in parentheses = stages of disease. Stages: Early (1) = 0.01-0.09% and (2) = 0.1-0.9%; Intermediate (3) = 1-49%; Advanced (4) = 50-89% and (5) = 90-100%. (Diagnosed from Feulgen-stained cytologic preparations.)

Date	Specimen data										Sample data		
	OXC 1	OXC 2	OXC 4	OXC 8	OXC 10	OXC 11	OXC 13	OXC 18	OXC 6	Advanced cases (%) (N = 10)	Neoplastic clams Cumulative mortality (%) (N = 10)	Normal clams Cumulative mortality (%) (N = 20)	
6 Dec. 1983	70(4)	0.5(2)	0.01(1)	(0)	0.02(1)	12(3)	0.5 (2)	(0)	—	14	0	0	
12 Dec. 1983	76(4)	6 (3)	—	0.03(1)	—	10(3)	0.96(2)	—	5(3)	11	0	0	
19 Dec. 1983	Died	11 (3)	29 (3)	0.9 (2)	0.1 (2)	Died	1 (3)	(0)	62(4)	14	20	5	
3 Jan. 1984		33 (3)	16 (3)	2 (3)	8 (3)		33 (3)	(0)	50(4)	14	20	15	
16 Jan. 1984		40 (3)	50 (4)	8 (3)	8 (3)		25 (3)	0.1(2)	67(4)	25	20	15	
30 Jan. 1984		80 (4)	50 (4)	10 (3)	2 (3)		17 (3)	0.8(2)	57(4)	38	20	20	
22 Feb. 1984		90 (5)	80 (4)	53 (4)	2 (3)		70 (4)	0.1(2)	95(5)	63	20	25	
3 Apr. 1984		Died	95 (5)	85 (4)	40 (3)		92 (5)	10 (3)	99(5)	63	20	25	
13 Apr. 1984		Died	98 (5)	99 (5)	Died		98 (5)	12 (3)	—	83	20	40	
May 1984		Died	Died	—	Died		Died	62 (4)	Died	—	70	50	
June 1984							Died	Died	Died	—	100	55	

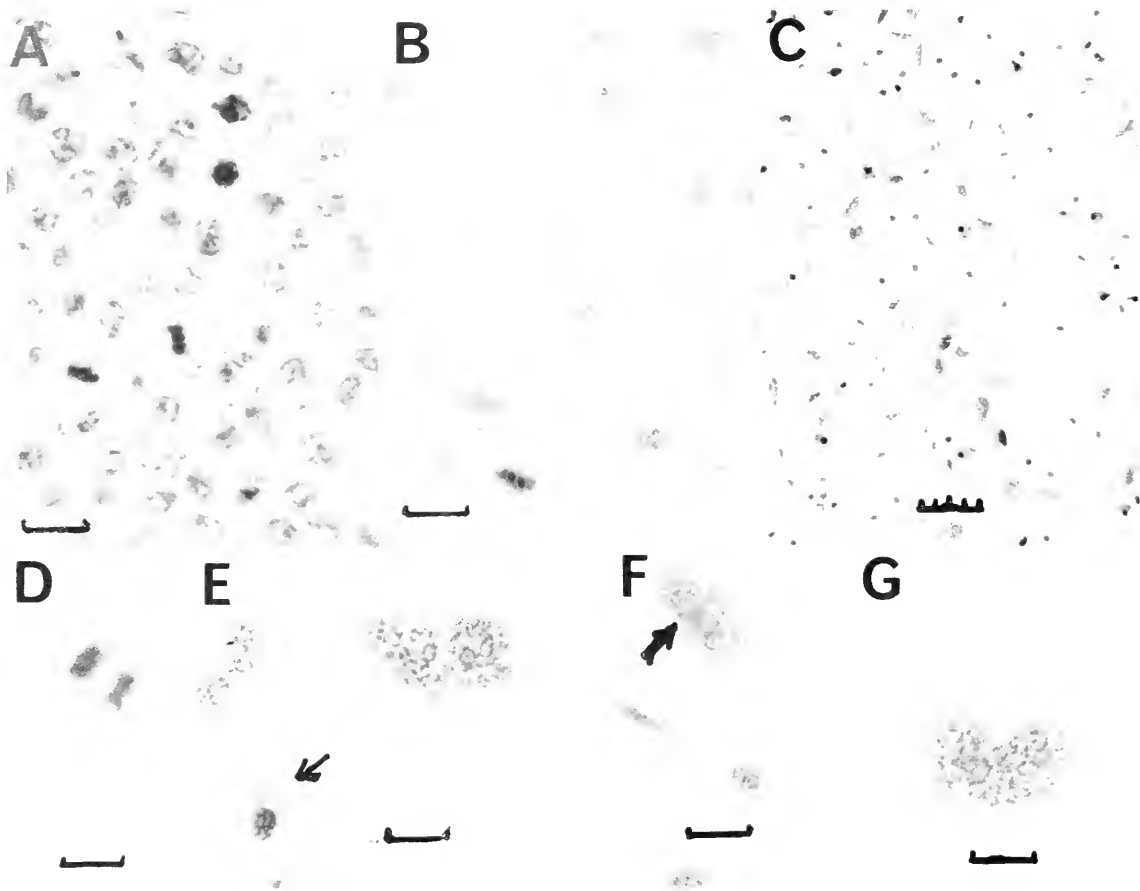

FIGURE 1.—Cytology of clam sarcoma, 1 unit = 10  $\mu$ m. (A) Histologic section: Note large, hyperchromatic nuclei, abundant mitotic figures and metaphase with laggard chromosomes. (B-G) Histocytologic preparations: (B) Stage 5 (all cells neoplastic); rounded cells show mitosis and large, reniform, hyperchromatic nuclei. (C) Stage 3 sarcoma; about 10% of the cells are neoplastic. Compare sizes of normal (small) and neoplastic (large) nuclei. (D) Mitotic figure in anaphase. (E) Binucleate neoplastic cell with prominent, multiple nucleoli (normal hemocyte, arrow). (F) Neoplastic cell with intranuclear inclusion (arrow). (G) Very large neoplastic cell with nucleus and prominent Golgi zone.

ber progressed to advanced and terminal stages by April in laboratory-held animals. This situation was reflected in the field by an increase in the prevalence of advanced cases as the season progressed. The higher histologic prevalence in the YAGH sample was due to four positive cases from sections of dead animals which were not diagnosable by histocytology. This information provides additional evidence of mortality in feral populations. Cooper et al. (1982a) demonstrated in laboratory experiments the lethal nature of this disease in animals with advanced cases and noted similar implications in field monitored populations. A chronic phase with remission was reported by Cooper, but these features were not evident in the Chesapeake Bay epizootic. It is conceivable that some resistance has developed

in the long-term occurrence of this disease over generations of clams in New England. Selection has not, as yet, had a chance to develop resistant animals in Chesapeake Bay. The mortality which began in laboratory-held animals in April was 100% by the end of June (Table 2). Field prevalences also dropped to zero in June. Sarcomas reappeared in the population in October.

Neoplastic clam cells from OXC 1 and EBC 6 (Table 2) were incubated with the murine monoclonal antibody IE7 which is specifically reactive with Massachusetts *Mya* neoplastic cells (Reinisch et al. 1983). Upon fluorescence activated cell sorter analyses, neoplastic cells from OXC 1 (Fig. 2) and EBC 6 were positive when stained with IE7.

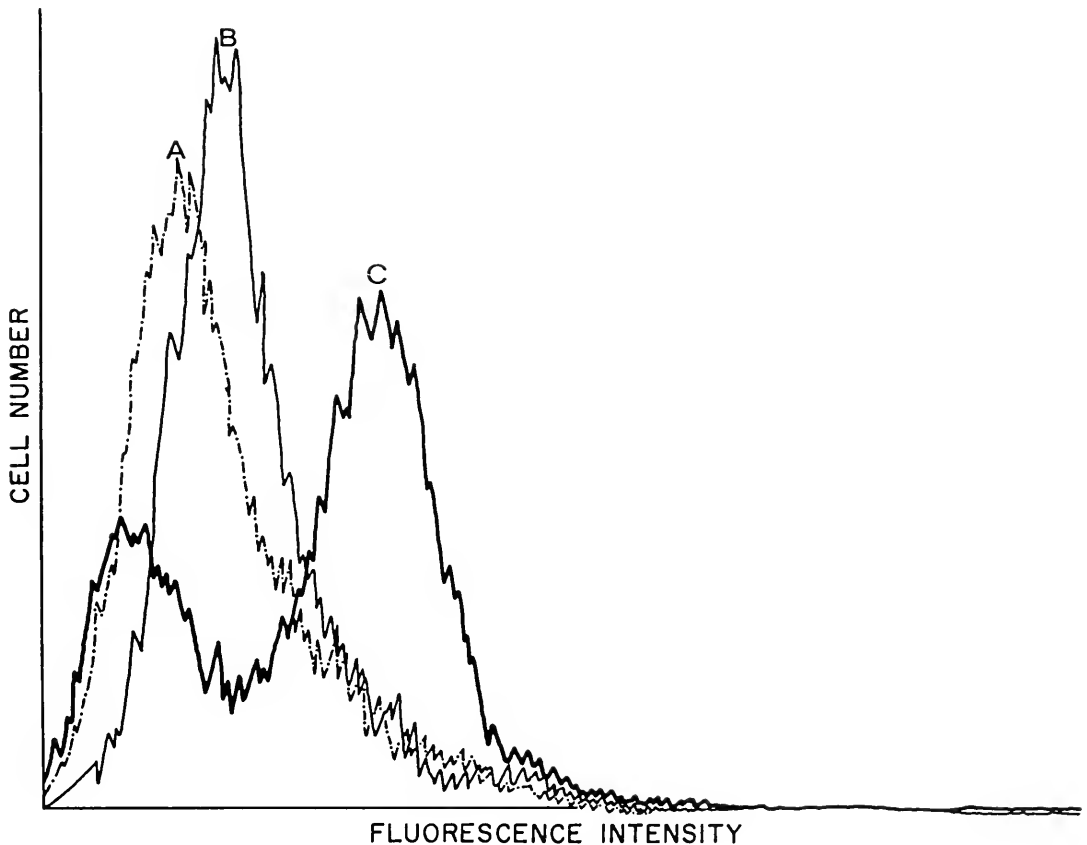

FIGURE 2.—OXC 1 cells were fixed in 0.1% neutral formaldehyde. Following three washes in sterile seawater, the cells were then incubated with: (A) a 1:50 dilution of fluoresceinated (FITC) goat and antimouse IgG antibody (— · — · —), (B) a 1:100 dilution of heat-inactivated normal mouse serum, and subsequently with a 1:50 dilution of FITC-goat antimouse IgG antibody (——), or (C) monoclonal antibody IE7, and subsequently with a 1:50 dilution of FITC-goat antimouse IgG antibody (——). All the antisera were diluted in sterile seawater immediately prior to use. The samples were then evaluated by a Becton-Dickinson Fluorescence Activated Cell Sorter IV (Reference to trade names does not imply endorsement by the National Marine Fisheries Service, NOAA).

## DISCUSSION

### Epizootiology

Laboratory and field observations complement each other and confirm the suspicion that affected animals die from the disease. Individual diseased clams monitored in aquaria from early December 1983 to May 1984 had progressed from early stages 1 and 2 to advanced stages 4 and 5 with 100% mortality. The high prevalences and advancing stages seen in natural populations may signal significant, impending mortalities. Samples collected from Swan Point (YSWP) in July and August 1984 (Table 1) showed 1/15 and 0/25 sarcomas, respectively. Samples from Poplar Island in July and August were

0/25 and 0/25. High sarcoma prevalences reappeared in the fall in smaller clams at Swan Point (25%) and Poplar Island (32%) in October. The decrease in prevalence to zero corresponds with observations of laboratory-held animals, suggesting that the disease was also 100% fatal in field populations. The experiments of Brown (1980) and others (Oprandy et al. 1981) indicate an infectious etiology for the disease. The nature of the new situation in Chesapeake Bay suggests that an infectious agent may have been established in clams by introduction from New England, since previous information indicated that the disease was confined to sites north of New Jersey (Barry and Yevich 1975; Yevich and Barszcz 1977; Brown et al. 1977, 1979; Brown 1980; Koeppe 1984). Introductions of clams from New England to

Maryland have been documented in the past (post-tropical storm Agnes in 1972) (S. V. Otto unpubl. data). Antigenic similarity between neoplastic clams in New England and Maryland suggests that target cells in the disease are the same in both areas. Additionally, the sudden appearance of isolated occurrences of the disease in widespread areas of the Bay and the apparent tenfold increase in frequencies since its appearance in 1978 in populations occurring over most of the geographic range of soft clams in the Bay suggest an infectious etiology rather than point source chemical oncogen activity or pollution (Barry and Yevich 1975; Yevich and Barszcz 1977; Cooper et al. 1982a; Reinisch et al. 1984) as has been implied in some New England studies.

### Classification

Histologically, the clam sarcomas (Fig. 1A) consist of diffusely disseminated round cells with a large, 6-10  $\mu\text{m}$ , hyperchromatic, often lobed nucleus containing one or more prominent nucleoli. Cytoplasm is sparse, mitosis is common, and nuclei are more than twice as large as normal hemocyte nuclei. Histochemical preparations (Fig. 1B-G) reveal sarcoma cells with identical characteristics and which can be definitively recognized on the basis of their morphology.

Other authors (Yevich and Barszcz 1977; Brown et al. 1977; Reinisch et al. 1983) have called this disease a "hematopoietic neoplasm" because of the general similarity of neoplastic cells and hemocytes, and because of its occurrence in vascular spaces. While this is the most probable origin for these cells, previous studies in other species have shown that these criteria can be misleading. The neoplasm in *Macoma balthica* (Christensen et al. 1974), which was characterized by anaplastic cells inhabiting the vascular spaces, was shown ultrastructurally to be of epithelial origin and, therefore, diagnosable as a carcinoma (Farley 1976b). Since no specific identifying organelles have been seen in the soft clam neoplasm (Brown et al. 1977) and since some monoclonal antibodies developed against neoplastic cells do not cross react with normal hemocytes, we prefer the more conservative term "sarcoma" which identifies the disease by behavior and cytology but does not imply a particular cell origin. These data indicate disease irreversibility and satisfy most of the other criteria for sarcoma or carcinoma, namely: 1) loss of cell specialization (anaplasia); 2) cell proliferation; 3) invasiveness (diffuse infiltration of connective tissue and muscle); 4) clonal alteration of genetic material (probable polyploidy evidenced by enlarged,

hyperchromatic nuclei); and 5) clinical features such as progression and malignancy.

### ACKNOWLEDGMENTS

This study was supported in part by the U.S. Department of Commerce, National Marine Fisheries Service (contract no. NA-82-FA-C-00048). We thank Keith R. Cooper for the critical review of the manuscript. We also thank the technical staffs of the Oxford Biological Laboratory, NMFS—G. Roe, C. Roney, D. Howard, M. Prettyman; DNR—R. Scott; James B. Engle Scholarship at Washington College, Chestertown, MD—E. D. Grogan; and Tufts University—H. Sakamoto, P. Cronin.

### LITERATURE CITED

- BARRY, M. M., AND P. P. YEVICH.  
1975. The ecological, chemical and histopathological evaluation of an oil spill site: Part III. Histopathological studies. *Mar. Pollut. Bull.* 6:171-173.
- BROWN, R. S.  
1980. The value of the multidisciplinary approach to research on marine pollution effects as evidenced in a three-year study to determine the etiology and pathogenesis of neoplasia in the soft-shell clam, *Mya arenaria*. *Rapp. P.-v. Réun. Cons. int. Explor. Mer* 179:125-128.
- BROWN, R. S., R. E. WOLKE, S. B. SAILA, AND C. W. BROWN.  
1977. Prevalence of neoplasia in 10 New England populations of the soft-shell clam (*Mya arenaria*). *Ann. N.Y. Acad. Sci.* 298:522-534.
- BROWN, R. S., R. E. WOLKE, C. W. BROWN, AND S. B. SAILA.  
1979. Hydrocarbon pollution and the prevalence of neoplasia in New England soft-shell clams (*Mya arenaria*). *In* *Animals as monitors of environmental pollutants*, p. 41-51. National Academy of Sciences, Washington, D.C.
- CHRISTENSEN, D. J., C. A. FARLEY, AND F. G. KERN.  
1974. Epizootic neoplasms in the clam *Macoma balthica* (L.) from Chesapeake Bay. *J. Natl. Cancer Inst.* 52:1739-1749.
- COOPER, K. R., R. S. BROWN, AND P. W. CHANG.  
1982a. Accuracy of blood cytological screening techniques for the diagnosis of a possible hematopoietic neoplasm in the bivalve mollusc, *Mya arenaria*. *J. Invertebr. Pathol.* 39:281-289.  
1982b. The course and mortality of a hematopoietic neoplasm in the soft-shell clam, *Mya arenaria*. *J. Invertebr. Pathol.* 39:149-157.
- FARLEY, C. A.  
1969. Probable neoplastic disease of the hematopoietic system in oysters, *Crassostrea virginica* and *Crassostrea gigas*. *Natl. Cancer Inst. Monogr.* 31:541-555.  
1976a. Proliferative disorders in bivalve mollusks. *Mar. Fish. Rev.* 38(10):30-33.  
1976b. Ultrastructural observations on epizootic neoplasia and lytic virus infection in bivalve mollusks. *Prog. Exp. Tumor Res.* 20:283-294.
- HARSHBARGER, J. C., S. V. OTTO, AND S. C. CHANG.  
1977. Proliferative disorders in *Crassostrea virginica* and *Mya arenaria* from the Chesapeake Bay and intranuclear virus-like inclusions in *Mya arenaria* with germinomas from a Maine oil spill site. *Haliotis* 8:243-248.

- HOWARD, D. W., AND C. S. SMITH.  
 1983. Histological techniques for marine bivalve mollusks. U.S. Dep. Commer., NOAA Tech. Memo. NMFS F/NEC 25, 97 p.
- KOEPP, S. J.  
 1984. Detection of a DNA virus within an upper New York Bay soft-shell clam population. Coastal Ocean Pollut. Assess. News 3:26-28.
- MCDOWELL, E. M., AND B. F. TRUMP.  
 1976. Histologic fixatives suitable for diagnostic light and electron microscopy. Arch. Pathol. Lab. Med. 100:405-414.
- OPRANDY, J. J., P. W. CHANG, A. D. PRONOVOST, K. R. COOPER, R. S. BROWN, AND V. J. YATES.  
 1981. Isolation of a viral agent causing hematopoietic neoplasia in the soft-shell clam, *Mya arenaria*. J. Invertebr. Pathol. 38:45-51.
- REINISCH, C. L., A. M. CHARLES, AND J. TROUTNER.  
 1983. Unique antigens on neoplastic cells of the soft shell clam *Mya arenaria*. Dev. Comp. Immunol. 7:33-39.
- REINISCH, C. L., A. M. CHARLES, AND A. M. STONE.  
 1984. Epizootic neoplasia in soft shell clams collected from New Bedford Harbor. Hazardous Waste 1:73-81.
- YEVICH, P. P., AND C. A. BARSZCZ.  
 1977. Neoplasia in soft-shell clams (*Mya arenaria*) collected from oil-impacted sites. Ann. N.Y. Acad. Sci. 298:409-426.



# SIZE-SPECIFIC VULNERABILITY OF NORTHERN ANCHOVY, *ENGRAULIS MORDAX*, LARVAE TO PREDATION BY FISHES

ARILD FOLKVORD<sup>1</sup> AND JOHN R. HUNTER<sup>2</sup>

## ABSTRACT

Vulnerability of larval northern anchovy (6-33 mm SL) to predation by adult northern anchovy and juvenile chub mackerel, *Scomber japonicus*, was estimated by measuring the response and escape probabilities of larvae. The proportion of larvae responding to the attacks of either predator increased with larval length and differed little between predator species. About 20% of 6 mm larvae responded to attacks of predators while 85-100% of 33 mm larvae responded. The proportion of larvae escaping attacks also increased with larval length, but more larvae of all sizes escaped the attacks of adult northern anchovy than those of juvenile chub mackerel. The rate of consumption of northern anchovy larvae by adult northern anchovy was highest when the larvae were 8.5-15 mm long, indicating that greater avoidance success of larvae in this size range relative to smaller ones may not completely compensate for their greater visibility to predators.

The events that cause variation in year-class strength in marine fish stocks occur during the first year of life, but no single life stage or period has been identified as being uniquely influential in the establishment of year classes. Mortality rates are size specific over this period with rates being the highest during the egg and yolk-sac stages and declining thereafter (Hunter 1984; Smith 1985). Variation in the relatively low mortality rates of older larval and juvenile stages may be more influential in year-class formation than the variation of the high mortality rates of eggs and first feeding larvae (Smith 1985). Thus all early life stages from egg through juvenile must be considered and knowledge of the size- or age-specific vulnerability of larvae to predation and starvation is central in any attempt at modeling the recruitment process.

Starvation is probably a direct source of larval mortality for only a few weeks after the onset of feeding, and most losses in the first year of life may be attributed to predation. Predation is believed to be the major cause of mortality during the egg and yolk-sac stages (Hunter 1984), and incidence of starving jack mackerel, *Trachurus symmetricus*, and northern anchovy, *Engraulis mordax*, in the sea indicate that significant starvation mortality is

restricted to the first 1-2 wk of feeding or about 10-20% of the larval period (O'Connell 1980; Hewitt et al. 1985; Theilacker 1986). The vulnerability of larvae to predation has been studied over limited size ranges; laboratory data indicate that yolk-sac larvae seem to be vulnerable to small invertebrate predators (copepods, amphipods, and euphausiids [Hunter 1984]). In addition, some egg and larval predators have been identified in field studies and in several cases loss rates due to predation have been estimated (Möller 1984; Frank and Leggett 1984; Van der Veer 1985; Purcell 1985; older literature summarized by Hunter 1984).

The objective of this paper was to determine the size-specific vulnerability of northern anchovy larvae to predation by pelagic fishes. The size-specific vulnerability of larval Cape anchovy, *E. capensis*, to cannibalism has been investigated by Brownell (1985) and vulnerability of larval *E. mordax* to predation by the aquarium fish *Amphiprion percula* was studied by Webb (1981). The results of the current study will be compared to these papers in the discussion.

Our approach was to observe the avoidance behavior of northern anchovy larvae in response to predatory attacks by adult northern anchovy and juvenile chub mackerel, *Scomber japonicus*. Adult northern anchovy were selected as a predator because it is the most abundant fish stock in the California Current region and because it has a planktivorous diet which includes fish eggs and larvae (Baxter 1967; Hunter and Kimbrell 1980). Chub

<sup>1</sup> Scripps Institution of Oceanography, University of California at San Diego, La Jolla, CA 92093; present address: Austevoll Aquaculture Station, 5392 Storebø, Norway.

<sup>2</sup> Southwest Fisheries Center La Jolla Laboratory, National Marine Fisheries Service, NOAA, 8604 La Jolla Shores Drive, La Jolla, CA 92038.

mackerel is also a major fish stock in the region and is both planktivorous and piscivorous, with juvenile and adult northern anchovy being a dominant item in the diet of larger individuals (Schaefer 1980; Hunter and Lynn, unpubl. data, Southwest Fisheries Center, La Jolla, CA).

## MATERIALS AND METHODS

### Experimental Fishes

The northern anchovy larvae used in the experiments were reared from the egg; 2,000-7,000 eggs, from a laboratory brood stock (Leong 1971), were stocked in 400 L black circular fiberglass tanks containing about 150 L of filtered seawater. The culture methods of Hunter (1976) were used to rear the larvae, with extra additions of wild zooplankton when the larvae were 10-25 mm SL. Temperature in the rearing tanks was maintained at about 18°C (range, 17.2°-19.2°C).

Three groups of 5 adult northern anchovy (range of mean standard length [SL] = 8.3-8.9 cm) and a single group of 3 juvenile chub mackerel (mean SL = 19.1 cm) were used as predators. They were fed mainly adult brine shrimp and occasionally northern anchovy larvae. The predators were not fed for 10 h before an experiment.

### Apparatus

Predators were kept in two rectangular fiberglass tanks (0.75 m × 2.15 m × 0.83 m = 1.35 m<sup>3</sup>) with a clear glass window on one side for observation. Two 100 W tungsten household lamps produced 2,000-3,000 mc at the surface of each tank and a black plastic tent enclosed the window, providing a darkened compartment for an observer. Larvae were released into the tank by gently submerging a beaker at the water surface. Horizontal and vertical metric scales on the tank window aided estimation of predator attack distances. The tanks were continuously supplied with ambient seawater ranging from 20.5° to 23.8°C, except during an experiment when the water was static.

### Experimental Procedure

It was necessary to measure the feeding performance of predators fed a standard prey because 1) adult northern anchovy are easily frightened and fright behavior reduces feeding motivation; 2) feeding could be affected by satiation during an experiment; and 3) feeding could be affected by the fish

learning and responding to cues associated with the introduction of food. We used live adult brine shrimp (*Artemia* sp., 6.4 mm mean total length, standard deviation [SD] 1.2 mm,  $n = 25$ ) as a standard prey. Variation in feeding performance of the predators could be more easily detected when *Artemia* were used because unlike the larvae the *Artemia* did not vary in size among experiments nor did they avoid attack by the predators.

Northern anchovy larvae and the adult *Artemia* were added to the tank in groups of three. An addition of three of either prey constituted a trial. A trial ended after 5 min or when all prey were taken. During a trial we used a computer compatible event recorder to record observations of the interactions between predator and prey. All the experiments using northern anchovy as predators started with 5 consecutive trials in which 3 *Artemia* were offered per trial. This was done to insure that northern anchovy predator groups had a similar level of feeding motivation. Preliminary experiments indicated that it normally took a few feeding trials before adult northern anchovy fed consistently. After the 5 initial trials, predators were offered fish larvae and adult *Artemia* alternately for 4-10 trials. Adult *Artemia* were always used in the last trial to determine if satiation had occurred. A less rigorous schedule was used for the chub mackerel predators because their feeding behavior was less variable than that of the northern anchovy. After 3 initial *Artemia* trials, the chub mackerel were given 5 larval trials followed by an *Artemia* trial. In most cases, a second set of 5 larval trials were also given and these were followed by a final *Artemia* trial to check if satiation had occurred.

The number of observations for each larval size class was the total number of predator-prey interactions observed among larvae in that size class. This number exceeded the number of larvae tested in many cases because, if a larva escaped the first encounter with a predator, the subsequent encounter was also recorded as an event. The total number of observations (predatory events) per larval size class (mean SL), when northern anchovy were the predators, was 5.9 mm, 24; 8.5 mm, 55; 11 mm, 48; 15 mm, 53; 21 mm, 82; and 33 mm, 62. Those for the chub mackerel experiments were 6.7 mm, 19; 10 mm, 75; 16 mm, 54; 21 mm, 27; 31 mm, 47; and 50 mm, 39.

### Classification of Behavior

Prey behavior was recorded only when the predator attacked a prey. An attack was defined as



a movement directed toward the prey with the mouth open. During an attack the northern anchovy predator usually increased its swimming speed, but the chub mackerel increased speed only when attacking larvae larger than 10 mm SL.

Four measures of predator-prey interactions were calculated: mean and maximum attack distance; frequency of avoidance responses; frequency of escapes; and predation rate (percentage of larvae captured during the 5-min trials). The attack distance was the distance in decimeters (dm) from the prey to the point where the predator started the attack. An avoidance response was a change in speed or direction of a larva occurring before the predator had completed the attack by closing its mouth.

An escape was defined as a larval response in which the predator failed to capture the larva during a single attack. Repeated attacks were scored as separate events. By definition, adult *Artemia* could not be credited with an escape since they did not respond to an attack. Cases where attacked *Artemia* were not captured were considered predator errors. Predator error could only be assessed for *Artemia*. All interactions between predators and larvae in which the larvae were not captured were recorded as an escape.

### Predator Performance

The feeding success and variation in feeding rates of predator groups fed live adult *Artemia* were analyzed to estimate predator error and to determine if differences existed in feeding performance among predator groups, or among or within experiments. An experiment was 2-5 larval trials conducted on a single size class of larvae on one day using a single predator group.

Predator errors were obvious when *Artemia* were the prey because *Artemia* did not avoid the attack. In such cases the trajectory of the attack was inaccurate and the predator simply missed the prey. Such errors occurred in 3.4% of the attacks on *Artemia*; this estimate is similar to error rates estimated for other predators (Curio 1976). We could not measure the predator error when larvae were the prey because we attributed any failure to capture a larva to larval avoidance success. Presumably our estimates of larval escape probabilities include an unknown number of cases where failure to capture a larva was the direct result of inaccuracies in the predator's attack rather than being the result of larval avoidance.

Considering all northern anchovy predator

groups, predator error in capturing *Artemia* was higher in the first 5 trials than in the subsequent trials of the experiments where *Artemia* trials were alternated with larval trials (Fig. 1A). Predator error averaged 3.4% for all *Artemia* trials, whereas it was 2.1% during the period of alternating larval and *Artemia* trials. Similarly, adult northern anchovy took more time to capture all the *Artemia* in the first trial than in subsequent ones (Fig. 1B). No decline in feeding performance on *Artemia* existed at the end of the experiments, indicating that satiation did not constitute a bias in the experiments. The initial decline in the time required for northern anchovy predators to capture *Artemia* may have been caused by an increase in feeding motivation, learning, or a decrease in fright behavior. As the decline occurred during only the initial 5 *Artemia* trials, the larval data were probably unaffected.

Minor differences in feeding performance also existed among predator groups. In two experiments northern anchovy predatory groups fed markedly less on both *Artemia* and larvae (30% fewer prey taken in 5 min; *t*-test,  $P < 0.05$ ). The effect of omitting these two experiments is indicated in the results. Overall, comparisons of feeding performance among groups, within trials, and among experiments indicated that variation in predator performance as measured by predation rates on *Artemia* was not significantly biased (additional details are given by Folkvord 1985) (see also Figure 1).

## RESULTS

### Probability of a Response to Predators

The most striking feature of the vulnerability of the youngest larval stages of northern anchovy to predators was the low frequency of escape attempts. Only 16% of the 6 mm larvae responded to the attacks of northern anchovy predators (Fig. 2B) and only 26% of 6.7 mm larvae responded to chub mackerel predators (Fig. 3B). The probability of smaller larvae (SL <20 mm) responding to either chub mackerel or northern anchovy predators was about the same (Fig. 4), although size, feeding behavior, and body form of these two fishes were distinctly different. The tendency to respond to attacking predators steadily increased with larval size until by the time northern anchovy larvae were 30 mm all attempted to avoid attacking northern anchovy and over 80% responded to chub mackerel attacks.

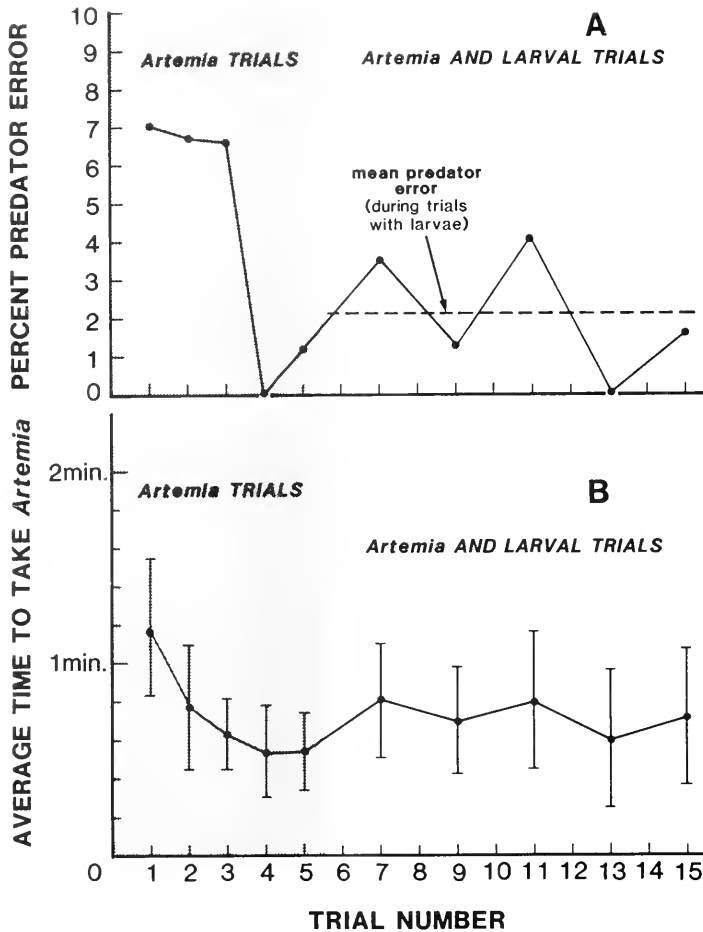

FIGURE 1.—Variation in feeding performance of northern anchovy predators fed live *Artemia* as a function of trial number (equivalent to elapsed time of experiment); shaded area indicates trials in which northern anchovy were fed only *Artemia*; unshaded areas, *Artemia* trials alternated with larval trials. A, percent predator error in capturing adult *Artemia* (percentage of attacks in which a northern anchovy missed the prey); dashed line indicates mean. B, mean time required for predator group to capture 3 adult *Artemia*; bars are  $2 \times$  SE of the mean. ( $N = 21$ .)

### Success of Avoidance Movements

Larval vulnerability depended not only on the responsiveness but also on the success of avoidance movements. The proportion of larvae escaping northern anchovy predators increased from 8% for 6 mm larvae to 92% for 33 mm larvae with an estimated 50% of the 17 mm larvae escaping. The percentage of larvae escaping the attacks of chub mackerel was lower than for adult northern anchovy, but the curves given in Figures 2 and 3 had a similar form. Weibull curves were fit to the data to provide trend lines (equations and parameters given in Figure legends). The fraction of larvae that

escaped increased from 6% of 6.7 mm larvae to an estimated 50% of the 30 mm larvae. Of the 50 mm juvenile northern anchovy used as prey only 64% escaped the attacks of the chub mackerel.

The ability to successfully avoid predator attacks was strongly affected by species-specific differences in predator behavior since the fraction of larvae escaping the attacks of northern anchovy increased much more rapidly with larval length than did the fraction escaping the attacks of chub mackerel. In contrast, the fraction of smaller larvae (SL <20 mm) responding to the attacks of these two predators was similar (Fig. 4). This indicates that probability of a larva responding to an attack is less affected

PREDATOR - *Engraulis mordax*

FIGURE 2.—Vulnerability of northern anchovy larvae to adult northern anchovy predators as a function of larval length. A, Percentage of northern anchovy larvae escaping attack; bars are  $2 \times \text{SE}$ ; line is Weibull curve fit to six points using Marquardt's least squares method (Pielou 1981); equation is  $N = K(1 - \exp(1 - (L/b) - \lambda))$  where  $K = 0.93$ ,  $b = 17.85$ ,  $\lambda = 2.85$ ,  $N$  is the percentage of larvae and  $L =$  larval length; and predation rate of the northern anchovy predators (percentage eaten in 5 min) where dashed line is data when experiments with biased predator feeding motivation are omitted. B, Percentage of northern anchovy larvae that responded to the attack of an adult northern anchovy; bars are  $2 \times \text{SE}$ ; and Weibull parameters for curve are  $K = 1.00$ ,  $b = 13.58$ , and  $\lambda = 1.94$ .

by differences in predator behavior than is its success in avoiding the attack.

The success of avoidance movements can be separated from larval responsiveness by calculating the avoidance success of responding larvae (numbers escaping/numbers responding). Webb (1981) found no change in this fraction over the larval size range he examined (3-12 mm SL), indicating that changes in responsiveness alone were responsible for the decline in the vulnerability of northern anchovy lar-

vae to *Amphiprion* with increasing larval length. In the present study, no significant trend existed in the success of avoidance movements over the size range of larvae studied by Webb (1981) but success of avoidance movements greatly increased in larger larvae (Fig. 5). The figure also indicates that northern anchovy larvae were much more successful in avoiding *Amphiprion* than in avoiding adult northern anchovy and that the larvae had the least success in avoiding chub mackerel.

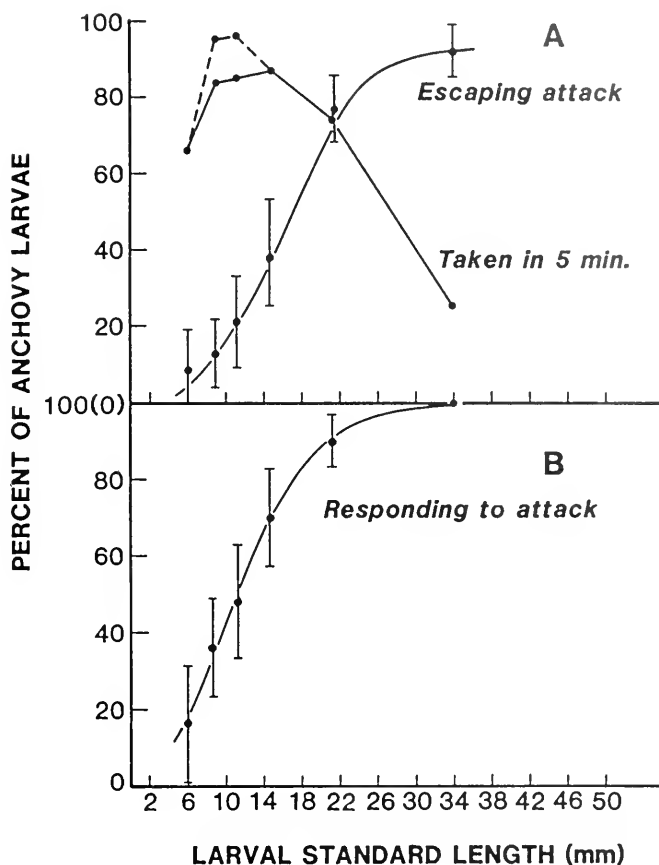
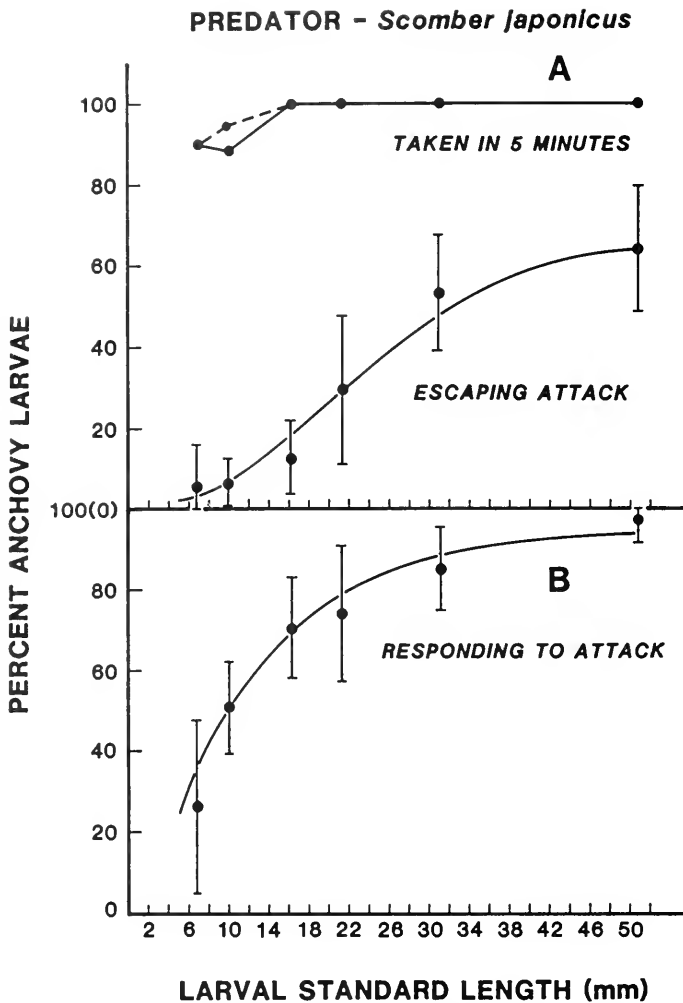

FIGURE 3.—Vulnerability of northern anchovy larvae and juveniles to juvenile chub mackerel predators as a function of anchovy length. A, percentage of northern anchovy larvae escaping attack; bars are  $2 \times$  SE; line is Weibull curve fit to six points using Marquardt's least squares method (Pielou 1981); equation is  $N = K(1 - \exp(1 - (L/b) - \lambda))$  where  $K = 0.66$ ,  $b = 27.41$ ,  $N =$  percentage of larvae,  $L =$  larval length, and  $\lambda = 2.12$ ; and predation rate of chub mackerel predators (percentage eaten in 5 min) where dashed line is data when experiments with biased predator feeding motivation are omitted. B, percentage of northern anchovy larvae that responded to the attack of a chub mackerel, bars are  $2 \times$  SE; and Weibull parameters for curve are  $K = 0.93$ ,  $b = 12.61$ , and  $\lambda = 1.24$ .

### Predation Rates

The predation rate of northern anchovy (proportion of larvae consumed by northern anchovy predators in 5 min) reached a maximum somewhere between larval lengths of 8.5 and 15 mm when all data were used, but it occurred between larval lengths of 8.5 and 11 mm when we deleted the experiment where northern anchovy predator perfor-

mance was lower than average (dashed line in Figure 2A). Statistical comparisons of the fraction of larvae consumed in the various size classes indicated that 6.8 mm larvae were taken less often than larvae in 8.5, 11, and 15 mm size classes despite the fact that these larvae had a low escape ability ( $P < 0.05$ ; normal approximation to the binomial mean;  $n = 35, 48, 40,$  and  $60$ , for 5.9, 8.5, 11, and 15 mm size classes). Owing to their small size and

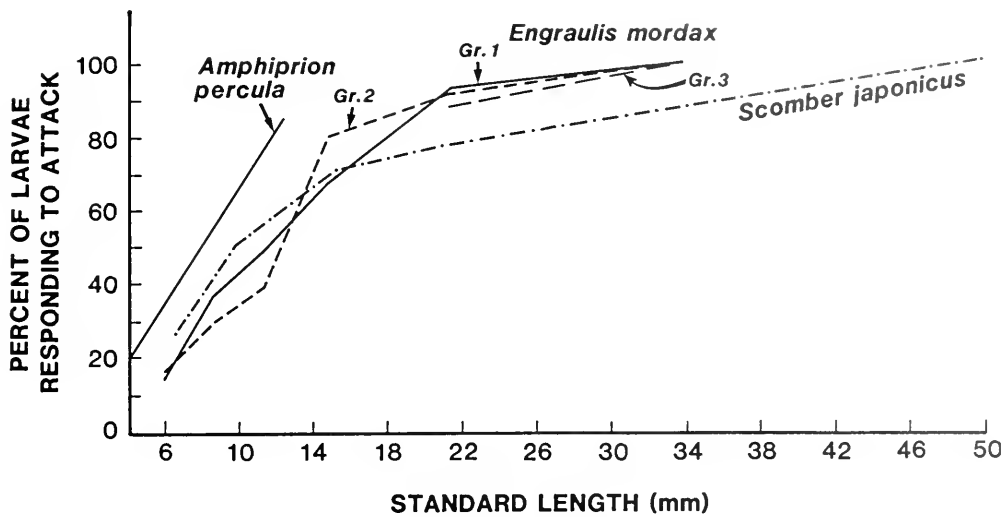

FIGURE 4.—Percentage of northern anchovy larvae that responded to attacks by adult northern anchovy (lines for the three different predator groups shown separately), chub mackerel and the aquarium fish *Amphiprion percula* (from Webb 1981).

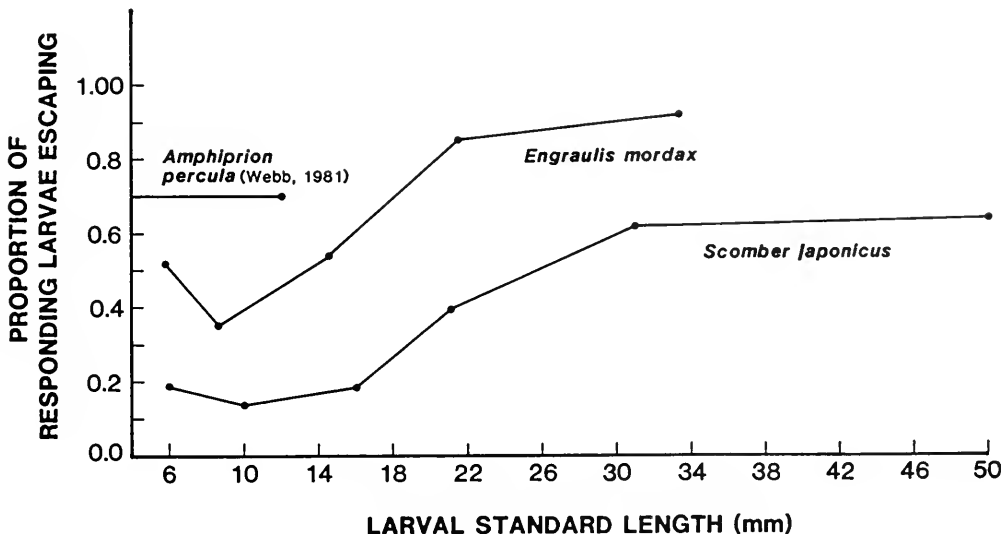

FIGURE 5.—The percentage of responding northern anchovy larvae in various length classes that escaped the predator. Species names identify the predator species.

lack of pigmentation, 6 mm larvae may have been less visible to the predators than larger larvae and consequently were detected less frequently. The decline in predation rates in larvae longer than 15 mm was the result of their greater escape ability.

The number of larvae consumed in 5 min was an insensitive measure of predation rates of chub mackerel, because they usually ate all larvae in the

tank within 5 min regardless of their size. Only in the two smallest larval size groups (6-10 mm SL) were some larvae left after a 5-min elapsed time; the deletion of one experiment because of low chub mackerel predator performance changed the predation rate on 10 mm larvae from 87 to 95% (dashed line in Figure 3A). These adjusted data indicate that the feeding rate of chub mackerel was lowest when

the smallest larval size group (6.7 mm) were the prey.

### Predator Behavior

Sighting distances, persistence of the attack, attack speed, and other characteristics of predator behavior were not well documented in our experiments because our focus was on the larvae. Such information could be quite useful if one were to develop a predation model for northern anchovy larvae, using northern anchovy or chub mackerel predators. We provide some general observations on the behavior of the predators.

Chub mackerel attacked 6.7 mm larvae from a shorter distance than larger larvae ( $t$ -test,  $P = 0.05$ ), but no statistically significant trend was evident when northern anchovy were predators. Mean attack distances were a poor measure of sighting range as they included repeated, short-range attacks on the larger larvae. We observed both predator species swimming within 2-3 dm of the smallest larvae without attacking them, whereas larger larvae were always attacked from this distance indicating that sighting distances may be shorter for small larvae.

Adult northern anchovy usually attacked a larva only once during a feeding sequence, and if the larva escaped, it was rarely attacked again or pursued. On the other hand, if the chub mackerel did not capture the larva on the first attack, it usually turned and attacked again. Chub mackerel usually chased an escaping larva until it was captured. The attack speeds of adult northern anchovy, although not measured, seemed to be similar over a wide range of larval prey sizes, whereas the attack speeds of chub mackerel clearly were faster when attacking larvae greater than about 10 mm SL than when attacking smaller larvae.

## DISCUSSION

### Factors Affecting Larval Vulnerability

A low level of responsiveness seems to be the dominant feature of the vulnerability of northern anchovy larvae to fish predators over the smallest larval size classes we tested (6-10 mm SL). Presumably northern anchovy larvae <6 mm would respond even less frequently, as Webb (1981) found that only 9% of 2.9 mm northern anchovy larvae responded to the aquarium fish *Amphiprion percula*, whereas about 30% of 6 mm larvae did so. During this period vulnerability of northern anchovy larvae to fish

predators seems to be primarily a function of visual detection by the predator, because when the larvae are detected they have a low probability of escaping. Our data on predation rates and maximum attack distances indicate that predation in the sea on the small, young larval stages might be lower than expected because of the short range at which such larvae may be detected. Thus, factors that affect the distance at which larvae are detected by predators, such as larval size, visual contrast, and water clarity (Vinyard and O'Brien 1976), may be the most important variables during the first 3 wk of life. As larvae grow they more often respond to the attacks of predators and escape them more frequently. Maturation of visual and lateral line systems (O'Connell 1981) may be the principal cause of this general increase in responsiveness with larval length. Although older larvae are more responsive, they are also more readily detected by predators because they are larger and have more pigmentation. Improved avoidance behavior may not completely compensate for the greater visibility of larvae in the 8-12 mm range, as our data on predation rates by northern anchovy indicated that the rates of consumption were highest for larvae in this range.

Larvae longer than 20 mm responded more frequently to northern anchovy than to chub mackerel predators, possibly because chub mackerel attacked such large larvae at much higher speeds. At higher attack speeds, less time is available for the larvae to respond; consequently, predators with the most rapid attack speeds evoke the lowest proportion of prey responses (Webb 1982). Thus one might expect a larva to respond to small fish predators more frequently than to larger ones, since attack speed would be expected to increase with predator size. This may explain why northern anchovy larvae (2.9-12 mm SL) responded more frequently to the small *Amphiprion* (44 mm) (Webb 1981) than they did to either northern anchovy or chub mackerel predators (Fig. 4). The pectoral swimming of *Amphiprion* might also provide more cues of an impending attack than did the swimming movements of either northern anchovy or chub mackerel.

In addition to size-specific avoidance capabilities and visibility, many other larval characteristics affect their vulnerability to predators. We briefly consider here three of these: effects of starvation, effects of the onset of schooling, and effects of variations in larval growth rates. Clupeoid larvae undergo degradation of muscle and other tissues during starvation, and a reduced predator avoidance behavior might be anticipated (Ehrlich 1974; O'Connell 1980). In a preliminary experiment Folkvord (1985)

reported that only 50% of starved, 33 mm northern anchovy larvae responded to the attacks of adult northern anchovy as compared with 100% for fed larvae. No starved 10 mm larvae escaped attack whereas 15-20% of the fed 10 mm larvae did so. The numbers of observations were insufficient for a statistical comparison, but recent work by Booman (unpubl. data, Southwest Fisheries Center, La Jolla, CA) indicates starvation can have a statistically significant effect on responsiveness of 10 mm northern anchovy larvae to adult northern anchovy predators.

The effect of the onset of larval schooling was not considered in these experiments; however, escape and response probabilities of individual larvae may not be altered greatly by the onset of schooling. The work of Major (1978) indicates that the most important effect of schooling may be to reduce the rate of attack by predators. He also found that the majority of Hawaiian anchovy captured by predators were isolated individuals that had moved away from the school, and predator success on schooled prey was similar to that on isolated prey. The onset of schooling in larval northern anchovy occurs between 11 and 15 mm SL, but the time spent in organized, cohesive schools increases throughout the northern anchovy's larval and juvenile periods (Hunter and Coyne 1982). Thus attack rates of predators might be expected to decline throughout later larval and juvenile life as the northern anchovy spends more time in cohesive schools. The onset of schooling occurs over the size range in which we observed the maximum predation rate (numbers consumed in 5 min) on individual northern anchovy larvae by northern anchovy predators. Thus predation pressure may be an important evolutionary factor in the timing of the onset of schooling during the larval stage.

The interaction between larval growth rate and size-specific vulnerability to predation may be an important source of interannual variation in larval mortality (Shepherd and Cushing 1980; Smith 1985). A simple calculation illustrates this point using the size-specific vulnerability of northern anchovy larvae (10-20 mm SL) to adult northern anchovy predators. We assumed larval escape ability to be an inverse measure of predator vulnerability and normalized it to the average mortality rate over this size interval (Table 1). Thus in our calculation, the rate larval mortality decreased with increasing larval size was inversely proportional to the rate escape ability increased with size (larval escape ability increased linearly with larval length over the 10-20 mm length range). Our calculation indicated that a 50% increase in growth rate from the average rate

of growth in the sea resulted in a 58% increase in survival in 30 d compared with average conditions. Decreasing the growth rate by 50% gave a 37% decrease in survival over the same interval. A longer period of reduced or enhanced growth rates will, of course, give a larger deviation from average survival values.

TABLE 1.—Calculation of the effect of growth rate on survival of 10-20 mm northern anchovy larvae when mortality is inversely proportional to length specific escape probabilities.

Terms	Parameter values
Z = mortality rate	Z = 0.05 at 16 mm <sup>a</sup>
S = larval length (mm)	10 mm < S < 20 mm
G = growth rate	G = 0.325 mm/d <sup>b</sup>
T = time	T = 30 d
N = relative numbers of larvae	N(0) = 1

Initial equations	
Z	Z = 0.15 - (0.00625 × S) <sup>a</sup>
S	S = 10 + (G × T)
dN/dt	dN/dt = - (Z × N)

Final equations after substitution and integration	
N	N = 0.0724 × exp (2.808 × G)

Estimates of survival after 30 days			
Growing conditions	Growth rate (mm/d)	Relative numbers of larvae	Relative survival (%)
Average	0.325	0.1803	—
50% increase	0.488	0.2850	+ 58
50% decrease	0.162	0.1141	- 37

<sup>a</sup>Mortality function generated from larval anchovy escape data with adult northern anchovy as predators. Values are normalized to Z 0.05 at 16 mm (Smith 1985).

<sup>b</sup>From Smith (1985), 0.325 ± 50% also used in calculation.

## Effect of Predator Size

We examined the existing literature on predators of larval northern anchovies to determine how the ability to escape a predator varied among different predator species. Regardless of the predator species, larval escape ability always increases with larval size, but the rates vary greatly with predator size. In general the smaller the predator, the faster larval escape abilities improve with increasing larval length (Fig. 6). The results of our work on *E. mordax* were similar to those of Brownell (1985) on *E. capensis*. However, capture success of the 85 mm *E. mordax* predators used in our study was about 20% higher than the 34 mm *E. capensis* predators used by Brownell.

The extent of the predator field for a given size and species of predator can be defined as the larval size range in which larval escape success is <100%. For adult northern anchovy predators (85 mm and

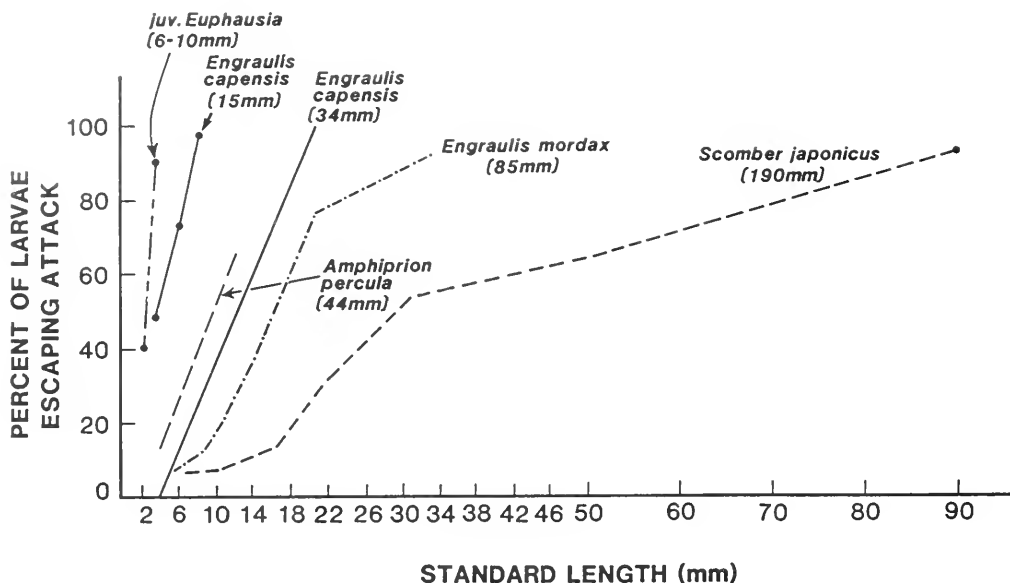

FIGURE 6.—Percentage of larval and juvenile anchovies escaping attacks of various predators as a function of length. Data for *Engraulis capensis* feeding on larval *E. capensis* are from Brownell (1984); juvenile *Euphausia* fed *E. mordax* from Theilacker and Lasker (1974); *Amphiprion percula* fed *E. mordax* from Webb (1981); and others are from this study. Numbers indicate length (mm) of the various predators.

larger), the field extends from the egg (Hunter and Kimbrell 1980) to about 40 mm. The field for juvenile chub mackerel is much wider than that for northern anchovy extending from northern anchovy eggs to adults (120 mm), whereas the predation field for *Euphausia* is restricted to the yolk-sac period (Theilacker and Lasker 1974). The limited data available (Table 2) provide a crude index for the upper limit of the predator field for northern anchovy larvae. When the larval length exceeds about 50% of the predator length little or no predation occurs.

## CONCLUSIONS

Much of the past research on recruitment has focused on early larval stages where mortality rates are the highest (May 1974). Our work supports a growing contention that later larval stages and early juvenile stages may be as important in determining year-class strength (Smith 1985) and that such effects might be mediated through an interaction between larval growth and size-specific vulnerability to predators. Our results and those of others indicate that the ability of northern anchovy larvae to escape pelagic predators increases throughout the larval stage. On the other hand, the susceptibility of larvae to predation may not decrease strictly according to size because large larvae may be more easily

TABLE 2.—Upper limit of some predator fields for larval anchovies, *Engraulis mordax* and *E. capensis*.

Predator Species	Predator length (mm)	Upper limit of predator field <sup>1</sup>	
		Larval length (mm)	Larval length Predator length
<i>Euphausia</i> juveniles (Theilacker and Lasker 1974)	8	4.5	0.6
<i>Engraulis capensis</i> (Brownell 1984)	15	8.2	0.6
<i>Engraulis capensis</i> (Brownell 1984)	34	20	0.6
<i>Amphiprion percula</i> (Webb 1981)	44	18	0.4
<i>Engraulis mordax</i> (this study)	85	2~40	0.5
<i>Scomber japonicus</i> (this study)	190	2~120	0.6

<sup>1</sup>Upper limit = larval size at which all larvae escape predator.

<sup>2</sup>Extrapolated values.

detected by visual feeding planktivorous fishes than smaller ones.

## ACKNOWLEDGMENTS

We wish to thank Roderick Leong for providing the northern anchovy eggs on demand, Carol Kimbrell for editorial assistance, and Clelia Booman and



Paul Smith for reviewing the manuscript and offering helpful suggestions.

## LITERATURE CITED

- BAXTER, J. L.  
1967. Summary of biological information on the northern anchovy *Engraulis mordax* Girard. CalCOFI Rep. 11:110-116.
- BROWNELL, C. L.  
1985. Laboratory analysis of cannibalism by larvae of the Cape anchovy *Engraulis capensis*. Trans. Am. Fish. Soc. 114:512-518.
- CURIO, E.  
1976. The ethology of predation. Springer-Verlag, N.Y., 249 p.
- EHRlich, K. F.  
1974. Chemical changes during growth and starvation of herring larvae. In J. H. S. Blaxter (editor), The early life history of fish, p. 310-323. Springer-Verlag, N.Y.
- FRANK, K. T., AND W. C. LEGGETT.  
1984. Selective exploitation of capelin (*Mallotus villosus*) eggs by winter flounder (*Pseudopleuronectes americanus*): capelin egg mortality rates, and contribution of egg energy to the annual growth of flounder. Can. J. Fish. Aquat. Sci. 41:1294-1302.
- FOLKVORD, A.  
1985. Size specific vulnerability of northern anchovy *Engraulis mordax* larvae to predation by fishes. MS Thesis, University of California at San Diego, 96 p.
- HEWITT, R. P., G. H. THEILACKER, AND N. C. H. LO.  
1985. Causes of mortality in young jack mackerel. Mar. Ecol. Ser. 26:1-10.
- HUNTER, J. R.  
1976. Culture and growth of northern anchovy, *Engraulis mordax*, larvae. Fish. Bull., U.S. 74:81-88.  
1984. Inferences regarding predation on the early life stages of cod and other fishes. Flødevigen rapportser., 1. ISSN 0333-2594 The propagation of cod *Gadus morhua* L, p. 533-562.
- HUNTER, J. R., AND K. M. COYNE.  
1982. The onset of schooling in northern anchovy larvae, *Engraulis mordax*. CalCOFI Rep. 23:246-251.
- HUNTER, J. R., AND C. A. KIMBRELL.  
1980. Egg cannibalism in the northern anchovy, *Engraulis mordax*. Fish. Bull., U.S. 78:811-816.
- LEONG, R.  
1971. Induced spawning of the northern anchovy, *Engraulis mordax* Girard. Fish. Bull., U.S. 69:357-360.
- MAJOR, P. F.  
1978. Predator-prey interactions in two schooling fishes, *Caranx ignobilis* and *Stolephorus purpuraceus*. Anim. Behav. 26:760-777.
- MAY, R. C.  
1974. Larval mortality in marine fishes and the critical period concept. In J. H. S. Blaxter (editor), The early life history of fish, p. 3-19. Springer-Verlag, N.Y.
- MÖLLER, H.  
1984. The reduction of a larval herring population by jellyfish predator. Science 224:621-622.
- O'CONNELL, C. P.  
1980. Percentage of starving northern anchovy, *Engraulis mordax*, larvae in the sea as estimated by histological methods. Fish. Bull., U.S. 78:475-484.  
1981. Development of organ systems in the northern anchovy, *Engraulis mordax*, and other teleosts. Am. Zool. 21:429-446.
- PIELOU, E. C.  
1981. The usefulness of ecological models: a stock-taking. Q. Rev. Biol. 56:17-31.
- PURCELL, J. E.  
1985. Predation on fish eggs and larvae by pelagic cnidarians and ctenophores. Bull. Mar. Sci. 37:739-755.
- SCHAEFER, K. M.  
1980. Synopsis of data on the chub mackerel, *Scomber japonicus*, 1782, in the Pacific Ocean. In W. H. Bayliff (editor), Synopses of biological data on eight species of scombrids. Inter-Am. Trop. Tuna Comm., Spec. Rep. 2, p. 395-445.
- SHEPHERD, J., AND D. H. CUSHING.  
1980. A mechanism for density dependent survival of larval fish as the basis of stock recruitment relationship. J. Cons. int. Mer 39:160-167.
- SMITH, P. E.  
1985. Year-class strength and survival of 0-group clupeoids. Can. J. Fish. Aquat. Sci. 42 (Suppl. 1):69-82.
- THEILACKER, G. H.  
1986. Starvation-induced mortality of young sea-caught jack mackerel, *Trachurus symmetricus*, determined with histological and morphological methods. Fish. Bull., U.S. 84: 1-15.
- THEILACKER, G. H., AND R. LASKER.  
1974. Laboratory studies of predation by euphausiid shrimps on fish larvae. In J. H. S. Blaxter (editor), The early life history of fish, p. 287-299. Springer Verlag, N.Y.
- VAN DER VEER, H. W.  
1985. Impact of coelenterate predation on larval plaice *Pleuronectes platessa* and flounder *Platichthys flesus* in the western Wadden Sea. Mar. Ecol. Prog. Ser. 25:229-238.
- VINYAND, G. L., AND W. J. O'BRIAN.  
1976. Effects of light and turbidity on the reactive distance of bluegill (*Lepomis macrochirus*). J. Fish. Res. Board Can. 33:2845-2849.
- WEBB, P. W.  
1981. Responses of northern anchovy, *Engraulis mordax*, larvae to predation by a biting planktivore, *Amphiprion percula*. Fish. Bull., U.S. 79:727-735.  
1982. Avoidance responses of fathead minnow to strikes by four teleost predators. J. Comp. Physiol. 147:371-378.



# OBSERVATIONS ON THE REPRODUCTIVE BIOLOGY OF THE COWNOSE RAY, *RHINOPTERA BONASUS*, IN CHESAPEAKE BAY<sup>1,2</sup>

JOSEPH W. SMITH AND JOHN V. MERRINER<sup>3</sup>

## ABSTRACT

Cownose rays, *Rhinoptera bonasus*, are abundant in Chesapeake Bay during summer. We made observations on the reproductive biology of specimens collected primarily from commercial pound nets and haul seines from May through October 1976-78. Clasper development suggested that males began to mature at disc widths (DW) of 75-85 cm. Males judged as mature averaged about 90 cm DW. Macroscopic inspection of the oviducts suggested that females began to mature at 85-92 cm DW. Females judged as mature averaged 96 cm DW. Only the left reproductive tract in female cownose rays appeared functional and only one embryo per gravid female was observed. A total of 67 embryos ranging 18-440 mm DW were collected and the sex ratio of the embryos was 1:1. Gravid females carried three-quarter term embryos in May and parturition occurred in late June and July. Full-term embryos averaged about 40 cm DW. Gestation of another group of embryos began by August. Growth of these embryos was rapid and they were relatively large when cownose rays left the Chesapeake Bay in October. Cownose rays exhibited aplacental viviparity. Yolk reserves supplied the initial energy demands of the embryos (up to about 20 cm DW), but histotrophic secretions of uterine villi provided nutrition for the young through the remainder of gestation.

The cownose ray, *Rhinoptera bonasus*, a large myliobatoid ray, which attains a maximum weight of 23 kg, is abundant in Chesapeake Bay during summer (Schwartz 1965; Musick 1972) where it preys heavily on commercially important shellfish (Merriner and Smith 1979). Because of the severe damage to shellfish beds and the paucity of information on the biology of the cownose ray, the Virginia Institute of Marine Science began a study on the life history of the cownose ray in 1976. Prior to our work, information on the cownose ray's reproductive biology was primarily limited to observations of single gravid females, usually included in more general literature (Gudger 1910; Bigelow and Schroeder 1953; Joseph 1961; Hoese 1962; Bearden 1965; Orth 1975), and size at maturity was unknown (Bigelow and Schroeder 1953). Schwartz's (1967) brief abstract represented the most complete statement on the species' reproductive cycle. Here, we report on the reproductive biology of the cownose ray, specifically on 1) the estimated size at matur-

ity for both sexes, 2) the definition of the gestation period, and 3) the description of the embryonic development.

## MATERIALS AND METHODS

Most cownose rays were taken from pound nets in the lower Chesapeake Bay during three summers, 1976-78, but some rays came from haul seines used in spring along the Virginia-North Carolina coast, and from gill nets and rod and reel catches. Disc width (DW = distance between tips of the pectoral fins) was measured in mm on a measuring board. References to specimen size (including embryos) hereafter are disc width measurements.

We judged male cownose rays sexually mature if 1) the clasper rhipidion was fully developed and easily spread and 2) clasper cartilages were well calcified (rigid). We measured clasper length as the distance from the junction of the clasper and pelvic fin to the distal end of the clasper. Criteria modified from Smith (1975) were used to determine the following stages of sexual maturity for females:

- 1) immature - ovaries thin and flaccid; uterus thin and elongate, lining appears rugous.
- 2) maturing - ovary slightly developed, yellowish ova visible, ova <1 cm diameter; uterus somewhat dilated, trophonemata (uterine villi) small, generally <0.5 cm long.

<sup>1</sup>Based on part of a thesis submitted by the senior author in partial fulfillment of the degree of Masters of Arts at the College of William and Mary, Williamsburg, VA 23185.

<sup>2</sup>Contribution No. 1305 from the Virginia Institute of Marine Science and the College of William and Mary School of Marine Science, Gloucester Point, VA 23062.

<sup>3</sup>The College of William and Mary, School of Marine Science, Gloucester Point, VA 23062; present address: Southeast Fisheries Center Beaufort Laboratory, National Marine Fisheries Service, NOAA, Beaufort, NC 28516-9722.

3) mature - ovary with large yellowish ova >1 cm diameter; uterus well-developed and rich in trophonemata, generally >1 cm long.

Uteri and oviducts were opened and inspected for ova or embryos. Embryos were weighed and measured for disc width (mm). Yolk-sac volume (mL) was measured by volumetric displacement in a graduated cylinder.

## RESULTS AND DISCUSSION

Like many other elasmobranch populations which occur along the east coast of the United States, cownose rays are highly migratory and exhibit a northward coastal migration in spring and a southward movement in fall (Schwartz 1965; Smith 1980). Our earliest spring collection of adult rays occurred during 2-5 May 1977 on the North Carolina Outer Banks. Our latest fall collection of adult males was on 7 September 1978 in the lower York River, while the latest fall collection of adult females occurred on 12 October 1977 near Cape Henry, VA, at the mouth of the Chesapeake Bay. Adult rays were absent from pound net catches in the lower bay after mid-October; furthermore, they were unavailable to us until the following spring when they migrated back into Chesapeake Bay.

### Size at Maturity

At the onset of sexual maturity, terminal cartilage elements develop distally on the claspers of male elasmobranchs (Bigelow and Schroeder 1953), and the allometric growth of these appendages has been used to determine the attainment of sexual maturity in various elasmobranchs (e.g., Clark and Von Schmidt 1965; Struhsaker 1969; Gilbert and Heath 1972). In male cownose rays the ratio of clasper length to disc width increases slightly at 75-85 cm DW suggesting the onset of sexual maturity (Fig. 1). Males <75 cm ( $n = 68$ ) appear immature; their testes are thin, white and ribbonlike and their claspers are narrow and flexible. Males ranging 80-98 cm ( $\bar{x} = 89.8$  cm;  $n = 115$ ) appear mature; their testes are pinkish white in color and greatly swollen, and their claspers are rigid and well-calcified. Based on clasper length to disc width ratio and cursory observations of the testes, we estimated that male cownose rays begin sexual maturation at about 80 cm and most are probably mature at disc widths >84 cm.

Considerable discrepancies exist in the literature concerning size of female cownose rays at sexual

maturity. Gudger (1910) claimed a female about 60 cm wide gave birth to a pair of young. Bearden (1965) reported four premature young from a female measuring 712 mm (disc width?) taken in South Carolina. Joseph (1961) and Orth (1975) collected gravid females in Chesapeake Bay of 89 and 90 cm, respectively. We classified females <84 cm ( $n = 86$ ) as immature (immature ovaries are thin and flaccid, and immature uteri are thin and elongate). Females that we judged as mature ranged 84.5-100 cm ( $\bar{x} = 96$  cm;  $n = 117$ ). Mature ovaries possess yellowish ova >1 cm in diameter; the left uterus of mature females is well-developed and rich in trophonemata (uterine villi), which are generally >1 cm long, red in color, and spatulate distally. We classified eight specimens (range: 84-92 cm) as maturing females. Although ova <1 cm in diameter are visible in the ovary, the left uterus is not well-developed and the trophonemata are generally <0.5 cm long. The smallest gravid female measured 87 cm. Based on these observations we estimated that female cownose rays begin sexual maturation at 85-90 cm and are mature at disc widths >90 cm.

Only the left reproductive tract appears functional in female cownose rays. There is no macroscopic evidence of follicular development in the right ovary. The right uterus in mature specimens shows some distension (ca. 3 cm wide), but does not exceed the breadth of the left uterus. Embryos and ova occur only in the left uterus, although we found an empty shell capsule in the right uterus of several gravid females. Nonfunctional right reproductive tracts have been reported in the rougtail stingray, *Dasyatis centroura*, (Struhsaker 1969) and the bluntnose stingray, *D. sayi* (Gudger 1912; Hamilton and Smith 1941; Hess 1959).

### Reproductive Cycle

Numerous literature accounts reported on the capture of singular gravid cownose rays (Smith 1907; Gudger 1910; Bigelow and Schroeder 1953; Joesph 1961; Hoese 1962; Bearden 1965; Orth 1975) and these provided fragmentary information on the ray's gestation cycle. Schwartz's (1967) abstract defined June through October as the breeding cycle and closely parallels our results, although we disagreed on size at parturition. We collected 67 embryos (range: 18-440 mm; sex undetermined for 3 specimens) from the lower Chesapeake Bay and vicinity. Data for 19 embryos (all specimens sexed, length undetermined for 8 specimens) taken in April 1978 near Cape Lookout, NC, were provided to us by W.

S. Otwell<sup>4</sup> (Fig. 2). Only one embryo per gravid

<sup>4</sup>W. S. Otwell, formerly of North Carolina State University Food Science Laboratory, Morehead City, NC; presently at University of Florida, Food Science Department, Gainesville, FL 32611, pers. commun. April and May 1978.

female was observed. The overall sex ratio of embryos (40♂:43♀) did not differ significantly from 1:1.

Gravid female rays migrate into Chesapeake Bay in spring with well-developed embryos that we designated as approximately three-quarter term.

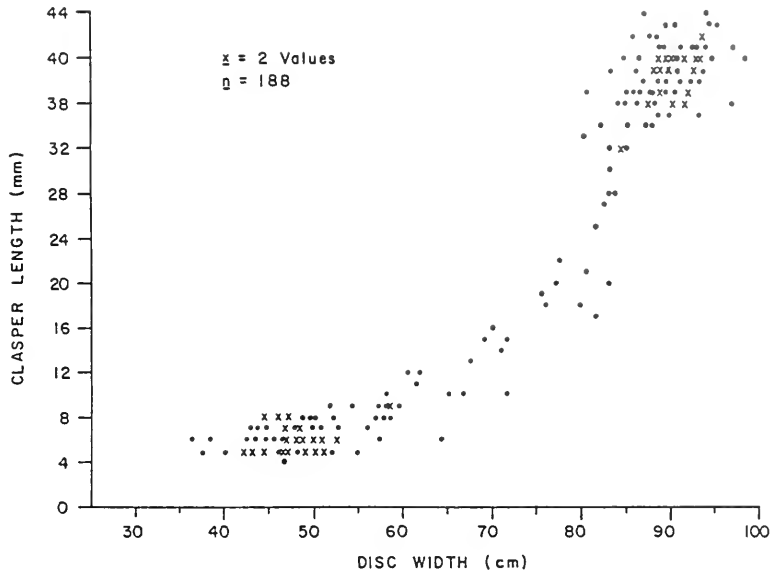

FIGURE 1.—Relationship of clasper length (mm) to disc width (cm) for 188 male *Rhinoptera bonasus*.

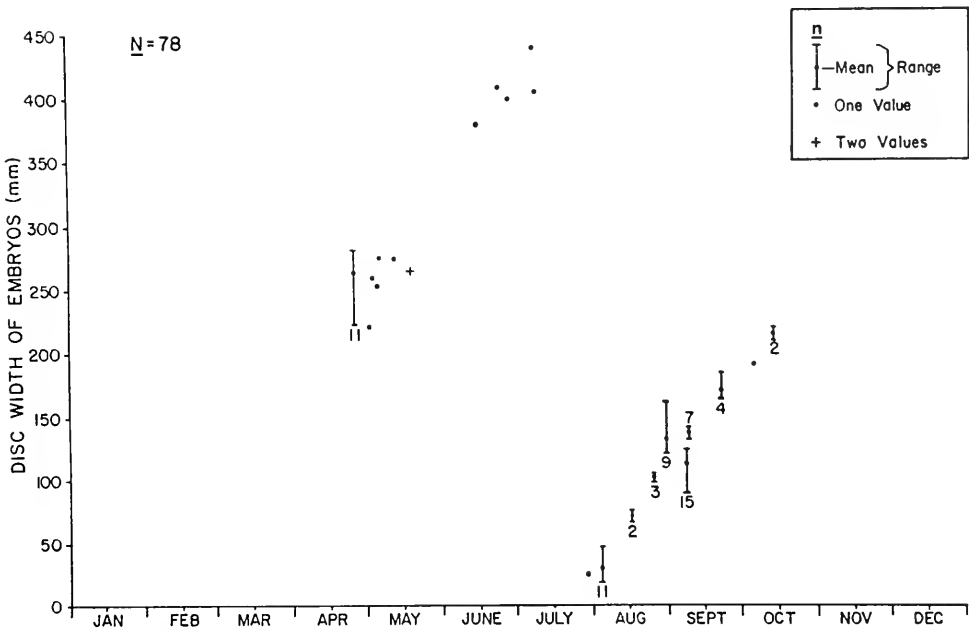

FIGURE 2.—Relationship of disc width (mm) to date of capture for *Rhinoptera bonasus* embryos collected 1976 through 1978.

Embryos collected in early May on the Outer Banks and in the lower York River average 259 mm (range: 221-276 mm;  $n = 7$ ), and those collected from Cape Lookout, NC, in mid-April (Otwell fn. 4) average 264 mm (range: 222-281 mm;  $n = 11$ ) (Fig. 2). By late June and early July the embryos are full term ( $\bar{x} = 413$  mm;  $n = 4$ ). Parturition occurs at this time and the first free-swimming young appear in pound net catches. Embryo weight gain in spring is noteworthy; three-quarter term embryos in April and May average 310 g (range: 192-392 g;  $n = 16$ ), while the weight of full-term individuals in late June increases fourfold averaging 1,291 g (range: 1,134-1,409 g;  $n = 3$ ). Schwartz (1967) reported that term individuals average 305 mm DW, however, embryos we considered full term are considerably larger (ca. 400 mm) and the smallest free-swimming ray we collected was 323 mm. Perhaps, the embryos Schwartz (1967) considered full term were taken in early June and were not yet ready for parturition.

Female rays ovulate following parturition. We found encapsulated uterine eggs in specimens taken

on 28 June and 21 July. In early August the embryos are 20-30 mm wide and have lost the shell capsule. By late August they average 125 mm (Figs. 2, 3). When adult rays leave the Chesapeake Bay in late September and early October, the embryos are relatively large, up to 220 mm.

Reproductive cycles of large elasmobranchs are often difficult to describe because during certain stages of pregnancy, individuals may be inaccessible as a result of schooling and migratory behavior (Holden 1974). Since cownose rays leave Chesapeake Bay by November and do not return until May, we could not determine precisely the length of gestation. Nevertheless, an 11-12 mo gestation period seems most probable. Within this context, the rapid embryonic growth observed in summer would slow during winter. A slowdown or cessation of intra-uterine growth would be expected if gravid females experience high energy demands during an extensive migration to distant wintering grounds, possibly northern South America as suggested by Schwartz (1965). Thus, the embryos from late summer and fall

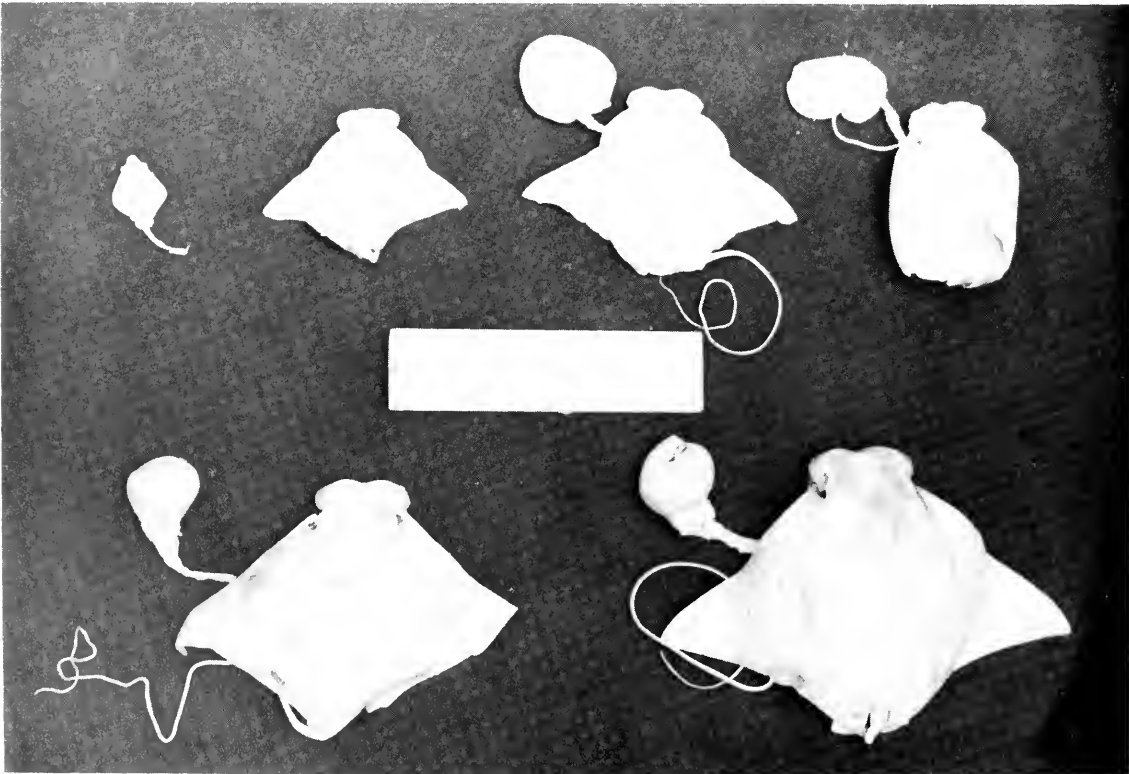

FIGURE 3.—Series of *Rhinoptera bonasus* embryos ranging from 18 to 140 mm disc width collected in late summer and fall.

would be born the following summer when the adults return to Chesapeake Bay, a gestation period of 11-12 mo beginning in July or August and ending in June or July.

The relatively large size of cownose ray embryos in late September and early October suggests the possibility of two 5-6 mo gestation periods. Parturition might occur on the cownose rays' wintering grounds followed by the gestation of another brood of embryos destined for birth the following summer. This hypothesis is not unprecedented, since the presence of well-developed young in the spiny butterfly ray, *Gymnura altavela*, during May in Delaware Bay and during February off the coast of North Carolina (27 fathoms) led Daiber and Booth (1960) to propose two 5-6 mo gestation periods per year for this species. Precise definition of the cownose ray gestation cycle will require collecting gravid female rays on their wintering grounds.

### Embryonic Development and Nutrition

The shell capsule of the cownose ray, which we observed twice in utero, is of a greenish amber, thin diaphanous material, and is about 10 cm long. One capsule held a single ovum, while the capsule from a second female contained three ova. Ova are yellow, extremely flaccid, and about 3-4 cm in diameter.

The embryos in late summer and fall possess yolk stalks and yolk sacs, although these often become detached during collection (Fig. 3). The smallest embryos we collected are about 20 mm wide, batoid in appearance, and unencapsulated. Numerous external branchial filaments (ca. 15-30 mm long), which emerge from the gill slits, are highly conspicuous on small embryos (18-75 mm). These filaments are absent in embryos larger than 89 mm.

Three-quarter term embryos are upright in the uterus (ventral surface of the embryo on the ventral wall of the uterus) with the rostrum pointed forward. The pectoral fins are folded dorsally. The tail and heavily sheathed spine are bent forward along the dorsum of the disc. The yolk sac and stalk are almost completely absorbed; only about 3 mm of the umbilicus protrudes from the abdomen.

Full-term embryos are similarly oriented. However, the umbilicus is completely absorbed, leaving only a small scar that is evident on free-swimming young. Pigmentation is that of the adults, i.e., chocolate-brown dorsally, white ventrally, and black caudally. Several tooth plates were discovered in the left uterus from which a full-term young was removed, confirming Bigelow and Schroeders' (1953) report that tooth replacement begins in utero.

During the early stages of gestation the uterus is rigid and thick-walled, but it gradually expands to accommodate the developing young. Just prior to parturition, it is extremely distended (ca. 15 cm at its greatest breadth), thin-walled, and flaccid.

Myliobatoids overcome spatial restrictions in utero by rolling the pectoral fins dorsally or ventrally, along the anterioposterior axis (Gudger 1951), and some studies report that larger than average females carry more and larger offspring (e.g., Babel 1967). Although we observed multiple encapsulated ova in cownose rays, and others have cited the occurrence of multiple embryos in utero (Smith 1907; Gudger 1910; Bearden 1965), we never found more than one embryo per gravid female. Setna and Sarangdhar (1949) and James (1962, 1970) made similar observations for the Javanese cownose ray, *R. javanica*, from the Indian Ocean. Our data for term embryos ( $n = 4$ ) are insufficient to corrolate embryo size with parent's size; however, we suspect that in general only one cownose ray embryo is carried to term.

Embryonic nutrition is from yolk and histotrophe. Yolk of the late summer and fall embryos ( $n = 33$ ) gradually diminishes between August and October (Fig. 4), and most yolk reserves are probably utilized when embryos are about 20 cm. Histotrophe, a viscid, yellowish secretion of the uterus (as also cited by Schwartz 1967), also nourishes the embryos. The amount of histotrophe, although not quantified, increases considerably as gestation progresses. Trophonemata, the uterine villi that produce histotrophe, are deep red, flattened in cross section and spatulate distally. They attain their greatest length (ca. 2-3 cm) in females with near full-term embryos. The trophonemata occasionally invade the gill slits.

In summarizing chondrichthyan, fetal-maternal relationships, Wourms (1977) noted that the efficiency of placental analogues, the villiform trophonemata, far surpasses that of the yolk-sac placenta exhibited by some carcharhinids. In cownose ray embryos, yolk apparently provides initial nutritional requirements. Embryos may augment yolk supplies during the first month of gestation by absorbing histotrophe via the external branchial filaments, as was suggested for *Urolophus halleri* by Babel (1967). After October, histotrophe supplies nourishment for the remainder of the gestation period, probably engulfed via the mouth, spiracles, and gill slits.

Viviparity and the use of nursery areas that are relatively free of predators, e.g., Chesapeake Bay, no doubt protect young cownose rays. Large carcharhinids, of which batoids are purported to be a

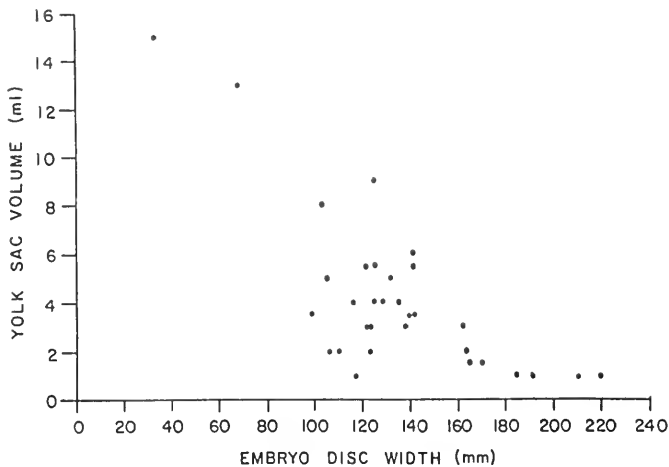

FIGURE 4.—Relationship of yolk-sac volume (mL) to disc width (mm) for *Rhinoptera bonasus* embryos collected in late summer and fall.

favorite prey (Darnell 1958; Budker 1971) are abundant seaward of the Virginia capes during summer (Lawler 1976), but generally only the sandbar shark, *Carcharhinus plumbeus*, and the bull shark, *C. leucas*, frequent the Chesapeake Bay proper (Schwartz 1960; Musick 1972). Although gravid female sandbar sharks utilize the eastern shore of the Chesapeake Bay (Lawler 1976), they may not pose a threat to cownose rays, since the female sandbar sharks generally abstain from feeding while on their pupping grounds and males tend to avoid such areas (Springer 1960). Bull sharks (Schwartz 1959) may represent the only major predators of rays in Chesapeake Bay during summer.

### ACKNOWLEDGMENTS

We thank J. A. Musick, G. R. Huntsman, A. B. Powell, W. R. Nicholson, J. Colvocoresses, and two anonymous reviewers for their comments and critical review of the various drafts of this manuscript. Numerous students and staff at Virginia Institute of Marine Science lent valuable assistance during various phases of this study, especially J. Gourley, R. Lambert, R. K. Dias, E. F. Lawler, R. J. Orth, and C. E. Richards. Captains Buddy Ponton, George Ross, Benny Belvin, and Herman Greene kindly provided "stingers" from their commercial catches. W. S. Otwell and F. J. Schwartz generously shared their life history notes on the cownose ray.

Support for the study was provided by the Sea Grant program of the Virginia Institute of Marine

Science (Grant Nos. 04-6-158-44-047 and 04-7-158-44-109). Additional financial assistance was provided by the Gulf and South Atlantic Fisheries Development Foundation, Inc., Tampa, FL.

### LITERATURE CITED

- BABEL, J. S.  
1967. Reproduction, life history, and ecology of the round stingray, *Urolophus halleri* Cooper. Calif. Dep. Fish Game, Fish Bull. 137:1-104.
- BEARDEN, C. M.  
1965. Elasmobranch fishes of South Carolina. Contrib. Bears Bluff Lab. 42:1-19.
- BIGELOW, H. B., AND W. C. SCHROEDER.  
1953. Fishes of the Western North Atlantic. Pt. 2. Sawfishes, guitarfishes, skates, rays, and chimaeroids. Mem. Sears Found. Mar. Res., Yale Univ. 1:1-588.
- BUDKER, P.  
1971. The life of sharks. Columbia Univ. Press, N.Y., 222 p.
- CLARK, E., AND K. VON SCHMIDT.  
1965. Sharks of the central Gulf Coast of Florida. Bull. Mar. Sci. 15:13-83.
- DAIBER, F. C., AND R. A. BOOTH.  
1960. Notes on the biology of the butterfly rays, *Gymnura altavela* and *Gymnura micrura*. Copeia 1960:137-139.
- DARNELL, R. M.  
1958. Food habits of fishes and larger invertebrates of Lake Pontchartrain, Louisiana, an estuarine community. Publ. Inst. Mar. Sci. Univ. Tex. 5:353-416.
- GILBERT, P. W., AND G. W. HEATH.  
1972. The clasper-siphon sac mechanism in *Squalus acanthias* and *Mustelus canis*. Comp. Biochem. Physiol. A Comp. Physiol. 42:97-119.
- GUDGER, E. W.  
1910. Notes on some Beaufort fishes-1909. Am. Nat. 44:395-403.  
1912. Natural history notes on some Beaufort, N.C., fishes, 1910-11. No. I. Elasmobranchii—with special reference to utero-gestation. Proc. Biol. Soc. Wash. 25:141-156.



1951. How difficult parturition in certain viviparous sharks and rays is overcome. *J. Elisha Mitchell Sci. Soc.* 67:56-86.
- HAMILTON, W. J., JR., AND R. A. SMITH.  
1941. Notes on the sting-ray, *Dasyatis say* (LeSueur). *Copeia* 1941:175.
- HESS, P. W.  
1959. The biology of two sting rays, *Dasyatis centroura* Mitchill 1815 and *Dasyatis say* Lesueur 1871, in Delaware Bay. M.S. Thesis, Univ. Delaware, Newark, 42. p.
- HOESE, H. D.  
1962. Sharks and rays of Virginia's seaside bays. *Chesapeake Sci.* 3:166-172.
- HOLDEN, M. J.  
1974. Problems in the rational exploitation of elasmobranch populations and some suggested solutions. In F. R. Harden-Jones (editor), *Sea fisheries research*, p. 117-137. Wiley, N.Y.
- JAMES, P. S. B. R.  
1962. Observations on shoals of the javanese cownose ray *Rhinoptera javanica* Müller and Henle from the Gulf of Mannar with additional notes on the species. *J. Mar. Biol. Assoc. India* 4:217-223.  
1970. Further observations on shoals of the javanese cownose ray *Rhinoptera javanica* Müller and Henle from the Gulf of Mannar with a note on the teeth structure in the species. *J. Mar. Biol. Assoc. India* 12:151-157.
- JOSEPH, E. B.  
1961. An albino cownose ray, *Rhinoptera bonasus* (Mitchill) from Chesapeake Bay. *Copeia* 1961:482-483.
- LAWLER, E. F.  
1976. The biology of the sandbar shark *Carcharhinus plumbeus* (Nardo, 1827) in the lower Chesapeake Bay and adjacent waters. M.A. Thesis, College of William and Mary, Williamsburg, 48 p.
- MERRINER, J. V., AND J. W. SMITH.  
1979. A report to the oyster industry of Virginia on the biology and management of the cownose ray (*Rhinoptera bonasus*, Mitchill) in lower Chesapeake Bay. *Spec. Rep. Appl. Mar. Sci. Ocean Eng.* 216, 33 p. *Va. Inst. Mar. Sci.*
- MUSICK, J. A.  
1972. Fishes of Chesapeake Bay and the adjacent coastal plain. In M. L. Wass (editor), *A check list of the biota of lower Chesapeake Bay*, p. 175-212. *Va. Inst. Mar. Sci., Spec. Rep. No.* 65.
- ORTH, R. J.  
1975. Destruction of eelgrass, *Zostera marina*, by the cownose ray, *Rhinoptera bonasus*, in the Chesapeake Bay. *Chesapeake Sci.* 16:205-208.
- SCHWARTZ, F. J.  
1959. Two eight-foot cub sharks, *Carcharhinus leucas* (Müller and Henle), captured in Chesapeake Bay, Maryland. *Copeia* 1959:251-252.  
1960. Additional comments on adult bull sharks, *Carcharhinus leucas* (Müller and Henle), from Chesapeake Bay, Maryland. *Chesapeake Sci.* 1:68-71.  
1965. Inter-American migrations and systematics of the western Atlantic cownose ray, *Rhinoptera bonasus*. [Abstr.] *Meet. Assoc. Isl. Mar. Lab. Caribb.*, 1 p. 6th Meet., Isla Margarita, Venez. 20-22 Jan.  
1967. Embryology and feeding behavior of the Atlantic cownose ray *Rhinoptera bonasus*. [Abstr.] *Meet. Assoc. Isl. Mar. Labs. Carib.* 1 p. 7th Meet., Barbados, W.I., 24-26 Aug.
- SETNA, S. B., AND P. N. SARANGDHAR.  
1949. Breeding habits of Bombay elasmobranchs. *Rec. Indian Mus. (Calcutta)* 47:107-124.
- SMITH, H. M.  
1907. The fishes of North Carolina. *N.C. Geol. Econ. Surv.* 2:47.
- SMITH, J. W.  
1980. The life history of the cownose ray, *Rhinoptera bonasus* (Mitchill 1815), in lower Chesapeake Bay, with notes on the management of the species. M.A. Thesis, College of William and Mary, Williamsburg, 151 p.
- SMITH, M. S.  
1975. *A. P. Knight* Groundfish Cruise No. 74-2, October 15-17, 1974 (Data Record). *Fish. Res. Board Can. Manusc. Rep. Ser. No.* 1336, 13 p.
- SPRINGER, S.  
1960. Natural history of the sandbar shark, *Eulamia milberti*. U.S. Fish Wildl. Serv., *Fish. Bull.* 61:1-38.
- STRUHSAKER, P.  
1969. Observations on the biology and distribution of the thorny stingray, *Dasyatis centroura* (Pisces:Dasyatidae). *Bull. Mar. Sci.* 19:456-481.
- WOURMS, J. P.  
1977. Reproduction and development in chondrichthyan fishes. *Am. Zool.* 17:379-410.



# NORTHERN ANCHOVY, *ENGRAULIS MORDAX*, SPAWNING IN SAN FRANCISCO BAY, CALIFORNIA, 1978-79, RELATIVE TO HYDROGRAPHY AND ZOOPLANKTON PREY OF ADULTS AND LARVAE

MICHAEL F. MCGOWAN<sup>1</sup>

## ABSTRACT

Eggs and larvae of *Engraulis mordax* were sampled by nets monthly for one year. Either eggs or larvae were caught every month. Both were most abundant when water temperature was high. Mean egg abundance did not differ among stations but larvae were more abundant within the San Francisco Bay at high and low salinity than near the ocean entrance to the Bay. Larvae longer than 15 mm were collected over the shoals in spring and autumn but were in the channel during winter. Zooplankton and microzooplankton were abundant relative to mean California Current densities. Adult spawning biomass in the Bay was 767 tons in July 1978, based on egg abundance and fecundity parameters of oceanic animals. San Francisco Bay was a good spawning area for northern anchovy because food for adults and larvae was abundant and because advective losses of larvae would have been lower in the Bay than in coastal waters at the same latitude.

The northern anchovy, *Engraulis mordax*, is the most abundant fish in San Francisco Bay (Aplin 1967), but little is known about the seasonal duration or areal extent of northern anchovy spawning there (Eldridge 1977; Sitts and Knight 1979; Wang 1981). In the California Current, spawning is thought to be related to abundance of food for adults (Brewer 1978) or to seasonal patterns of abundance of food for larvae (Lasker 1978). Dense patches of appropriate food for larvae are believed to be necessary for survival of larvae (Lasker 1975; Scura and Jerde 1977). Zooplankton are generally more abundant in estuaries than in coastal and oceanic waters. Therefore, San Francisco Bay, the largest estuary on the west coast of North America, could be a favorable habitat for spawning northern anchovy and their developing larvae.

The northern anchovy could affect plankton dynamics in the San Francisco Bay (the Bay) by preying on zooplankton and by excreting concentrated nutrients for phytoplankton. It is the target of a seasonal bait fishery (Smith and Kato 1979), and it is an important forage fish for many other species (Recksiek and Frey 1978). Quantitative estimates of the adult stock size and numbers of eggs and larvae are needed to understand the ecology of this anchovy in the Bay.

This paper reports the results of a 1-yr survey of

the northern anchovy eggs and larvae, zooplankton, and microzooplankton in San Francisco Bay. Distribution and abundance of eggs and larvae were related to water temperature, salinity, turbidity, stratification, abundances of potential adult prey, and potential larvae prey. The suitability of the Bay for spawning and development of larvae was assessed. An estimate of spawning stock abundance within the Bay was calculated from egg abundance, and the impact of this biomass of anchovies on the zooplankton was estimated.

## MATERIALS AND METHODS

### Study Site

San Francisco Bay consists of three major parts (Fig. 1): 1) Central Bay opens to the Pacific Ocean through the Golden Gate at lat. 37°49'N, long. 112°29'W; 2) North Bay receives the drainage from the Sacramento and San Joaquin Rivers and includes Suisun, San Pablo, and Richardson Bays; 3) South Bay is the largest single embayment, extending some 27 nmi from Coyote Creek in the south to the Oakland-San Francisco Bay Bridge in the north. The following description of San Francisco Bay was taken from Conomos and Peterson (1977). Mean depth is 6 m at mean lower low water, or 2 m if the large expanses of mudflats are included. There is a 10 m deep dredged ship channel in the northern part. Tides are mixed semidiurnal ranging from 1.7 m at the Golden Gate to 2.7 m at the south-

<sup>1</sup>Cooperative Institute for Marine and Atmospheric Studies, Rosenstiel School of Marine and Atmospheric Science, University of Miami, 4600 Rickenbacker Causeway, Miami, FL 33149.

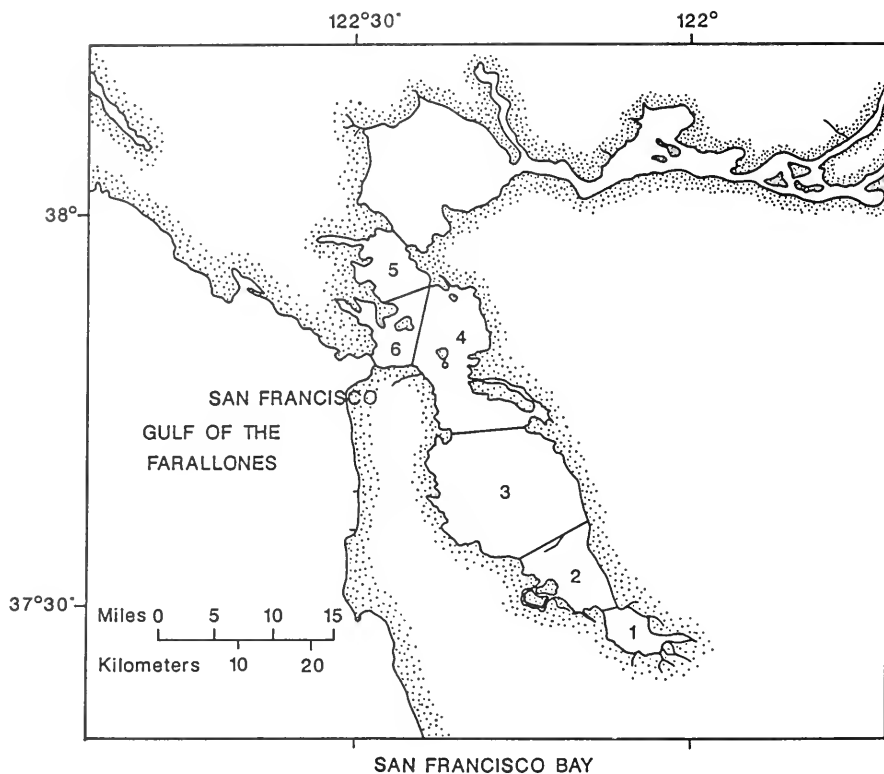

FIGURE 1.—Locations of stations and the areas represented by each station sampled monthly May 1978-April 1979.

ern end of South Bay. The tidal prism is 27% of the Bay volume. Maximum tidal currents occur in the channels and may be 225 cm/s (4.5 kn) at the Golden Gate. More than 90% of the freshwater entering San Francisco Bay enters North Bay from the Sacramento and San Joaquin Rivers. Less than 10% enters South Bay from small tributary streams and sewage. Because of the difference in freshwater inflow the northern and southern reaches are very different types of estuary. North Bay is partially-to-well-mixed with true two-layer estuarine circulation. South Bay, dependent for water exchange on tidal circulation and occasional incursions of freshwater from the north during wet winters, resembles a coastal lagoon.

The heterogeneous nature of San Francisco Bay requires that stations be representative of the diverse areas of the Bay. The stations (Fig. 1) were located in the channel adjacent to the shoals in the South Bay in 5-6 m of water (stations 1 and 2); just north of San Bruno Shoal in 3 m of water (station 3); east of Treasure Island over a dredge borrow pit in 10 m of water (station 4); in midchannel just south

of the Richmond-San Rafael Bridge in 10-13 m of water (station 5); and north of Lime Point just inside the Golden Gate Bridge in 25-35 m of water (Station 6). These sites were near those of a previous trawl study (Aplin 1967) and they represented locations from South Bay, Central Bay, the outflow from North Bay, and the Pacific Ocean entrance to the Bay.

All South Bay stations were sampled in one day, all Central Bay stations were sampled on another day, usually the day following the South Bay sampling. This schedule and the pattern of tidal flow in the Bay (Tidal Current Chart, San Francisco Bay 1973) enabled all stations to be sampled before noon at approximately slack tide, low water. This schedule controlled for the effects of time of day, tide, and currents which can affect catches of ichthyoplankton (Eldridge 1977). Additional samples were taken in October 1978 and April 1979 at station 3 and over the shoals adjacent to this station.

Duplicate oblique ichthyoplankton tows and duplicate surface microzooplankton tows were made monthly at six stations for one year, May 1978-April

1979. Ichthyoplankton and zooplankton samples were collected from a 5 m Boston Whaler with a 1 m diameter, cylinder-cone net of 0.308 mm mesh nylon with a 0.200 mm mesh cod end. The net was attached to a sled which kept the lower rim of the net 10 cm above the bottom and which had a tow-bridle that did not obstruct the mouth of the net. A frame attached to the transom permitted the sled to be launched and retrieved over the stern while underway. The sled was lowered to the bottom while underway at 1-2 kn, towed at the bottom for 1 min, and then retrieved at a constant rate and constant wire angle. Tow time, excluding that spent lowering the net to the bottom, was approximately 6 min. The gear was effective because it often caught anchovies and herring longer than 30 mm, a size not usually captured in towed gear (Clarke 1983) or in a plankton purse seine (Murphy and Clutter 1972).

A calibrated flowmeter suspended off-center in the mouth of the net measured the amount of water filtered during the tow. Volumes calculated from the flowmeter readings were similar to a hypothetical volume calculated from net mouth area and tow distance: approximately 300 m<sup>3</sup>/tow.

Microzooplankton was collected with a 0.5 m diameter net with 0.080 mm mesh, which was towed just submerged at the surface for 2 min during the ichthyoplankton tow. Because the flowmeter in this net frequently malfunctioned, hypothetical volumes calculated from mouth diameter and tow length (approximately 25 m<sup>3</sup>/tow) were used to standardize catches of microzooplankton. The net probably did not filter as much water as calculated so microzooplankton were underestimated. All samples were preserved with 2% formaldehyde in seawater buffered with sodium borate.

Water turbidity was measured with a Secchi disk (Tyler 1968). Water samples for salinity and temperature measurements were taken with a Van Dorn water sampler from 1 m below the surface and from 1 m above the bottom. The temperature was measured to 0.1°C with a laboratory thermometer, and salinity was measured to 0.5‰ with a temperature-compensated refractometer.

### Laboratory Procedures

Northern anchovy eggs were easily recognized and distinguished from other regional pelagic fish eggs by their oval shape and their size, approximately 0.75 mm × 1.25 mm. Eggs were not assigned to stages, but some of the embryos were developed enough to be identified as those of northern anchovies. Northern anchovy eggs were counted

under a dissecting microscope; at the same time, fish larvae were picked from the samples. The northern anchovy can be separated from other similar looking larvae by its myomere count (43-47), its gut length, and its median fin positions (Miller and Lea 1972; McGowan and Berry 1984).

All northern anchovy larvae <10 mm long were measured to the nearest 0.1 mm using an ocular micrometer. Longer larvae were measured to 1 mm using vernier calipers or a plastic ruler graduated in millimeters. The distance from the tip of the snout to the tip of the notochord was measured in preflexion larvae, standard length in larger specimens.

Zooplankton were subsampled from a 500 mL pharmaceutical beaker by stirring and taking an aliquot with a 1 mL or 2 mL Stempel pipet. Zooplankton were identified to major taxonomic group under the dissecting microscope using standard references such as Smith (1977). All holoplanktonic, meroplanktonic, and nektonic invertebrates were considered to be zooplankton if they were suitably sized prey for adult anchovies. Isopods were included; adult shrimp and gelatinous invertebrates were not. Plankton was allowed to settle in water in a graduated cylinder to estimate zooplankton volume.

Microzooplankton were subsampled from a stirred beaker with a pipet. A settling chamber and inverted compound microscope with movable stage were used to count microzooplankton (0.050-0.200 mm diameter) at 100× magnification. Dinoflagellates known to be eaten by anchovy larvae were counted as microzooplankton.

### Precision Estimates

The precision of the microzooplankton counts was estimated by the method of Lund et al. (1958). If the counts are treated as a Poisson variable then the 95% confidence limits for a single count are

$$\begin{aligned} \text{Upper limit} &= X + 2.42 + 1.96(X + 1.5)^{1/2} \\ \text{Lower limit} &= X + 1.42 - 1.96(X + 0.5)^{1/2} \end{aligned}$$

The limits are approximately ±20% if 100 organisms are counted. Confidence intervals for microzooplankton counts in this study range from ±50% at the lowest count (5) to ±9% at the highest count (659).

The precision of the zooplankton subsampling estimates was evaluated by taking triplicate subsamples, with replacement, from 10 randomly selected samples. The mean coefficient of variation (standard deviation divided by the mean) of the triplicates was 0.29.

The precision of the duplicate tows was evaluated by comparing numbers of eggs, larvae, and zooplankton settled volumes from the May, June, and July tows. No statistical difference was detected between first and second tows (2-tailed  $P = 0.407$ , Wilcoxon Matched Pairs test, Hull and Nie 1981:228). The mean coefficient of variation for these paired tows was 0.22. Because there were no statistical differences between these duplicates, only one of each pair of the remaining samples was sorted.

### Data Analysis

Eggs, larvae, zooplankton, microzooplankton, and plankton volume per 1,000 m<sup>3</sup> were calculated based on flowmeter readings. Temperature and salinity stratification variables were created by taking the difference between surface and bottom values. Salinity stratification represented the intensity of estuarine circulation or freshwater runoff; temperature stratification represented water column stability and revealed atmospheric temperature extremes.

Distributions of the variables were examined for skewness, kurtosis, and unreasonable range limits indicative of keypunch errors. Normality of the original variables and of  $\log(X + 1)$  transformations was tested (Kolmogorov-Smirnov test; Hull and Nie 1981:224). Variances of the transformed variables were not heteroscedastic. Biological and environmental variables were plotted against month, station, and each other to look for spatial patterns, seasonal trends, and nonlinear relationships (especially nonmonotonicity) between pairs of variables.

Analysis of variance (ANOVA) was used to assess the effects of month of the year and station location on numbers of eggs and numbers of larvae. Stepwise multiple linear regression was used to examine which of the other variables could account statistically for the variability in numbers of eggs and larvae. Logarithmic transformations of standardized numbers of eggs, larvae, zooplankton, and microzooplankton were used in the regressions and in the ANOVA's.

Ichthyoplankton abundance is often expressed as numbers of ichthyoplankton under an area of sea surface by multiplying density per cubic meter times water depth (Smith and Richardson 1977). In deep water tows are made below the depth range of most eggs and larvae, so the tow depth is used as the effective water depth. Standardizing a unit of sea surface area allows comparisons of total numbers of eggs and larvae in the water column from areas with different water depths. Abundance standardized to

area of sea surface was used to estimate total egg production. However, larvae that were relatively uncommon in deep water could be as abundant as more concentrated larvae in shallow water, but exposed to different concentrations of predators and prey; therefore, densities of larvae and plankton were used to examine relationships between ichthyoplankton, other plankton, and environmental variables.

The method used to estimate spawning stock biomass was a direct estimate because it incorporated batch fecundity from histological data (Hunter and Goldberg 1980) and daily egg production estimates from ichthyoplankton surveys (Parker 1980). Parker's equation for the direct estimate of biomass from egg abundance is

$$S = P(ab'c)^{-1}d$$

- where  $S$  = spawning biomass in tons  
 $P$  = egg production in eggs/day  
 $a$  =  $3.96 \times 10^8$  egg/ton  
 $b'$  = 0.159 the observed daily spawning fraction  
 $c$  = 0.550 the proportional biomass of females  
 $d$  = 1.080 a correction for potential misclassification of daily spawning fraction.

Parker (1980) estimated the coefficient of variation of the estimate of spawning stock to be 0.614. Most of this statistical error was due to error in the estimate of egg production. Daily egg production was estimated in my study by dividing the egg abundance by the number of days needed to hatch at the ambient temperature (interpolated from Zweifel and Lasker 1976, fig. 7).

Numbers per square meter of Bay surface were calculated by multiplying density per cubic meter times water depth at the station. The areas represented by the stations were estimated from the chart of the Bay in Conomos and Peterson (1977). Total numbers of eggs and larvae were calculated from estimates per square meter times the area represented by the sample.

## RESULTS

### Eggs and Larvae

Either eggs, larvae, or both were present every month of the year. Eggs were present every month except December and January. Only one egg was

collected in February and very few were collected in November. Larvae were present every month and at every station each month with four exceptions: during June, no larvae were collected at station 1, the southernmost station; during July and August no larvae were collected at station 6, the Golden Gate Bridge station; during March no larvae were collected at station 3 in South Bay. Eggs were present on each of the occasions when larvae were absent from the samples.

Egg density varied from 0 to 55,000 per 1,000 m<sup>3</sup> (mean = 3,000). The greatest number of eggs in a single sample was 14,640 at station 2 in July. Occurrence of eggs was seasonal: they were abundant in summer and absent in winter (Fig. 2).

Larvae varied from 0 to 4,400 per 1,000 m<sup>3</sup> (mean = 259). The greatest number of larvae in a single sample was 1,420 in September at station 2. Larval abundance was also seasonal with peak density in late summer and fall (Fig. 2).

Two-way ANOVA of log-transformed standardized densities of eggs and larvae were performed with month and station as fixed factors in separate analyses. The interaction mean square (not significant) was used as the denominator in the *F*-tests because there was just one observation per cell of the design (Montgomery 1976:156). Densities of eggs differed significantly among months ( $P < 0.001$ , Table 1) but not among stations ( $P = 0.104$ ). Densities of larvae were significantly different among months ( $P = 0.010$ ) and among stations ( $P = 0.014$ ) (Table 2).

Seasonal patterns of abundance of eggs and lar-

vae were unmistakable, but differences among stations were not as clear so three hypotheses were tested: 1) stations 1, 2, and 3, South Bay stations, differed from stations 4, 5, and 6; 2) stations 4 and 6, Golden Gate and Central Bay stations, differed from stations 1, 2, 3, and 5, South Bay stations plus the station at the outflow of San Pablo Bay; 3) stations 3, 4, and 6, the stations most influenced by ocean water, differed from stations 1, 2, and 5, the Bay stations. These hypotheses were tested using linear contrasts (Nie et al. 1975:425), a procedure that compared the geometric means of the groups of stations.

None of the three contrasts was significant for eggs but all three were significant ( $P < 0.05$ ) for larvae. The difference between the mean of stations 4 and 6 and the mean of stations 1, 2, 3, and 5 was highly significant ( $P = 0.001$ ).

Further comparisons of mean densities of larvae were done using Duncan's Multiple Range test. This a posteriori procedure identified groups of means which did not differ significantly from each other at a specified level (Nie et al. 1975:427). The rank order of the stations in increasing mean density of larvae was 4, 6, 1, 3, 5, 2. Three groupings were produced by the Duncan procedure at the 0.05 level. The mean of stations 4 and 6 was smaller than the mean of the other four. The mean of stations 5 and 2 was greater than that of the other four. Station 4 was significantly lower and station 2 significantly higher than the mean of the other four stations.

A summary of the analyses of variance follows. Eggs and larvae were seasonal in abundance, eggs more strongly than larvae. Numbers of eggs, which would be subject to passive drift and dispersal, were not significantly different among locations in the Bay. Larvae did differ in abundance among the six stations. Based on a priori and a posteriori tests, station 4 and station 6, the stations most influenced by oceanic water, had low densities of larvae while the other stations within the Bay had high mean densities of larvae. This pattern was true for station 5, near the Richmond-San Rafael Bridge, as well as for stations 1, 2, and 3 in the South Bay. Among the within-bay stations, station 1, the southernmost, ranked lowest in both egg density and larval density although it was not statistically different from the other inner stations—2, 3, and 5.

The stations also differed in the proportion of eggs to larvae. While the ratio of eggs to larvae was generally greater than 10:1, at station 3 the ratio of the mean number of eggs to mean number of larvae was <10:1 (Fig. 3). The proportions were statistically different among stations (Chi-square  $P <$

TABLE 1.—Analysis of variance of northern anchovy eggs: month by station.

Source of variation	Sum of squares	df	Mean square	<i>F</i>	Significance
Residual	42.23	54	0.78		
Constant	286.22	1	286.22	366.02	0.000
Month	128.93	11	11.72	14.99	0.000
Station	7.56	5	1.51	1.93	0.104
Month x station	0.48	1	0.48	0.61	0.437

TABLE 2.—Analysis of variance of northern anchovy larvae: month by station.

Source of variation	Sum of squares	df	Mean square	<i>F</i>	Significance
Residual	25.77	54	0.48		
Constant	220.65	1	220.65	462.43	0.000
Month	13.72	11	1.25	2.61	0.010
Station	7.59	5	1.52	3.18	0.014
Month x station	1.16	1	1.16	2.43	0.125

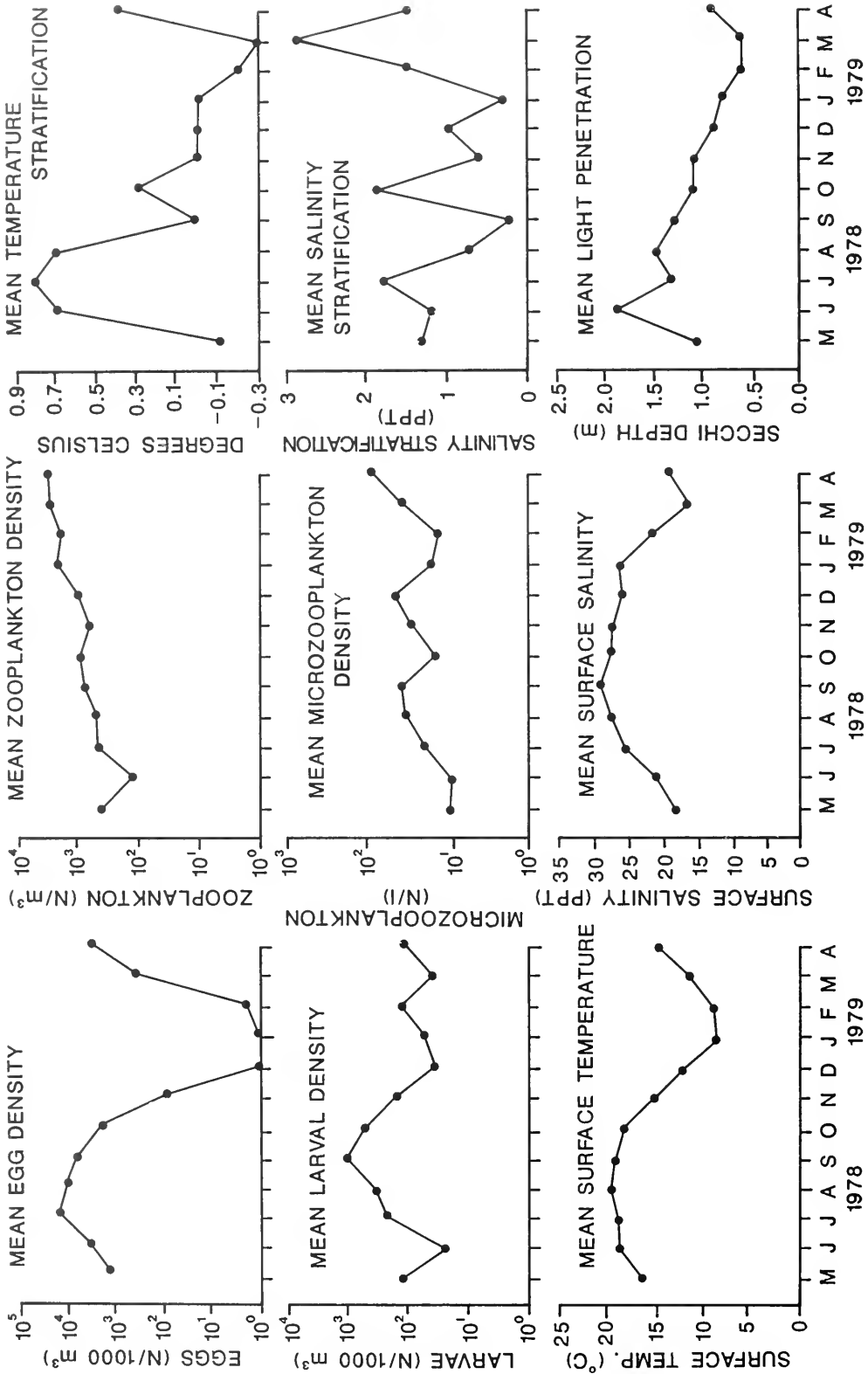

FIGURE 2.—Monthly abundance of northern anchovy eggs, larvae, microzooplankton, zooplankton, and monthly values of surface water temperature, surface salinity, temperature stratification, salinity stratification, and light penetration.



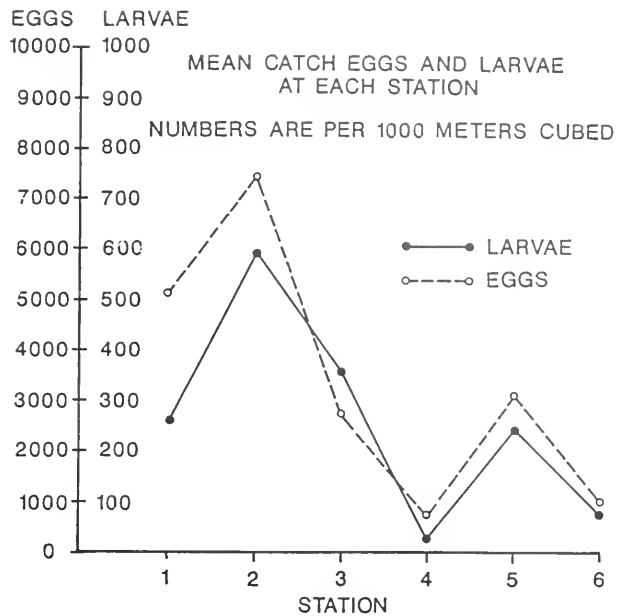

FIGURE 3.—Relative abundances of northern anchovy eggs and larvae at each station showing the difference between station 3 and the other stations.

0.01 with 5 degrees of freedom). Station 3 deviated most from the expected ratio. Station 1 also differed by having relatively fewer larvae than expected.

### Zooplankton

Zooplankton catch varied from 13.6-9,560 individuals/m<sup>3</sup>. Mean catch was 1,170/m<sup>3</sup>. No seasonal pattern was apparent (Fig. 2). There was a gradual increase in zooplankton abundance over the course of the study. This linear trend was significant ( $P < 0.01$ ). Copepods, especially *Acartia* spp., dominated

the catches (Table 3). Brachyuran (crab) zoeae and cirripedian (barnacle) nauplii and cyprids were occasionally abundant. Potential predators on northern anchovy larvae, such as chaetognaths and pontellid copepods, were often present but in relatively low numbers. Counts of zooplankton for each sample are reported in McGowan (unpublished M.A. Thesis, San Francisco State University, San Francisco, CA).

Zooplankton catch was significantly correlated with all variables except surface salinity and salinity stratification. Negative correlations were observed with egg density, surface temperature, temperature stratification, and Secchi depth. Positive correlations were found with larvae and microzooplankton.

TABLE 3.—Zooplankton: relative density, May 1978-April 1979.

Taxon	mean ± 1 SE	n · m <sup>-3</sup>	%
Copepoda			
<i>Acartia</i>	1,120 ± 192		96.05
harpacticoida	4.67 ± 1.55		0.40
other	3.48 ± 0.75		0.30
shrimp zoeae	3.82 ± 1.28		0.33
crab zoeae	12.27 ± 4.27		1.04
mysids	1.31 ± 1.16		0.10
amphipods	0.39 ± 0.16		0.03
pelecypods	1.10 ± 0.35		0.09
chaetognaths	0.59 ± 0.23		0.05
polychaetes	1.26 ± 0.50		0.11
isopods	0.23 ± 0.12		0.02
barnacle nauplii	9.18 ± 2.04		0.78
barnacle cyprids	6.18 ± 1.49		0.52
gastropods	0.74 ± 0.37		0.06
cumaceans	0.08 ± 0.05		0.01
cladocerans	0.81 ± 0.31		0.07

### Microzooplankton

Microzooplankton catch at the surface (0.080 mm mesh net) varied from 1 to 300 per liter (mean = 28.8). No clear seasonal trend was apparent (Fig. 2). Copepod nauplii were the most abundant microzooplankton followed by tintinnids and rotifers (Table 4). Dinoflagellates such as *Ceratium* and *Peridinium* were occasionally more abundant than copepod nauplii. The spiny, armored *Ceratium* species were not included in the density estimates because northern anchovy larvae prefer unarmored forms (Scura and Jerde 1977). Microzooplankton density was negatively correlated with Secchi disk depth ( $r = -0.34$ ,  $P = 0.004$ ) and positively corre-

TABLE 4.—Microzooplankton: relative density, May 1978-April 1979.

Taxon	mean ± 1 SE	n · 1 <sup>-1</sup>	%
copepod nauplii	15.14 ± 1.82		54.97
barnacle nauplii	0.56 ± 0.09		2.03
polychaete larvae	0.36 ± 0.08		1.31
tintinnids	6.56 ± 2.68		23.82
rotifers	1.24 ± 0.45		4.50
harpacticoid copepods	0.03 ± 0.02		0.11
ostracods	0.01 ± 0.01		0.04
gastropod veligers	0.04 ± 0.02		0.15
<i>Peridinium</i>	3.59 ± 1.45		13.03

lated with zooplankton density ( $r = 0.27$ ,  $P = 0.027$ ). All interpretation of the microzooplankton data was done under the assumption that estimates of volume filtered are accurate.

### Environmental Variables

The mean surface water temperature during this study was 15.2°C. The coldest reading was 8.0°C at station 2 in January; the warmest was 22.5°C at station 1 in August (Fig. 2). Water temperature near the bottom varied from 8° to 21.5°C (mean = 15.0°C). Mean temperature stratification, the difference between the surface and bottom temperatures, was 0.2°C. Stratification was generally present June through October, especially at station 5. Mean stratification during these months was 0.5°C (Fig. 2). During February and March 1979 the surface temperature was lower, on average, than the temperature near the bottom thus showing the influence of air temperature on the surface water temperature. Surface salinity varied from 3 to 31‰ (mean = 23.6‰). Bottom salinity was 14-31‰ (mean = 24.8‰). The low readings for both surface and bottom salinity occurred at station 5 during March 1979. Surface salinity at station 1 was usually low, showing the influence of freshwater inflow at the south end of the Bay (Fig. 2). Salinity at station 6 was relatively high, showing the oceanic influence at the Golden Gate. Surface salinity at other stations reflected their relative positions between these two influences. The lowest surface salinity was always at station 5 due to the Sacramento River discharge. During March 1979, salinity at stations 4 and 6 also showed the effects of high freshwater discharge which lowered the salinity at station 5 to 3‰. Salinity was slightly lowered this month at station 3 in South Bay also. Surface salinity followed a seasonal pattern; it was high from July through January and low in the winter and spring months. Relatively high salinity corresponded to

high temperature July through October. Salinity stratification was generally <2‰ except at station 5 where the average stratification was 4.7‰ (Fig. 2).

Surface salinity was negatively correlated with salinity stratification, ( $r = -0.62$ ,  $P < 0.001$ ), and positively correlated with Secchi depth ( $r = 0.39$ ,  $P = 0.001$ ). Salinity stratification was negatively correlated with Secchi depth ( $r = -0.29$ ,  $P = 0.012$ ).

### Turbidity

Light penetration was lowest at stations 1 and 5, and highest at stations 6, 4, and 3 (Fig. 2). The mean depth of light penetration during this study was 1.1 m with a range of 0.1-2.5 m. The data suggest a weak seasonal trend with light transmission higher in summer and lower in winter. The variable with the strongest linear association with Secchi depth was zooplankton density. Light penetration was inversely related to zooplankton density ( $r = -0.58$ ).

### Relationships Among Variables

Northern anchovy egg abundances were positively associated with surface temperature, temperature stratification, and Secchi disk depth and negatively correlated with zooplankton density (Table 5). Eggs were positively associated with larvae but this correlation was not significant at the 5% level ( $P = 0.053$ ). Larvae were positively correlated with surface temperature and zooplankton density (Table 5). They were negatively correlated with Secchi depth. Thus, eggs and larvae both were significantly correlated with zooplankton and Secchi depth but in opposite directions: eggs were associated with clearer water and lower zooplankton density, larvae with more turbid water and higher zooplankton density.

### Stepwise Multiple Regression

Surface temperature alone explained 65% of the variability in egg density ( $r^2 = 0.651$ ). The combination of microzooplankton density with surface temperature explains an additional 1.5% of the variability of egg density. The addition of all other variables only increased the amount of variability explained to 68% ( $r^2 = 0.678$ ). The predictive regression model using the independent variables whose addition to the model improved its prediction by more than 1% is

$$E = -2.20 + 0.317T - 0.502M$$

TABLE 5.—Bivariate correlations between northern anchovy eggs, larvae, and other variables. EGGS:  $\log(\text{eggs} \cdot \text{m}^{-3})$ ; LARV:  $\log(\text{larvae} \cdot \text{m}^{-3})$ ; ZOO:  $\log(\text{zooplankters} \cdot \text{m}^{-3})$ ; MICR: microzooplankton; TEMP: surface water temperature; SALI: surface water salinity; TSTR: temperature stratification; SSTR: salinity stratification; SECC: Secchi disk depth.

	EGGS	LARV	ZOO	MICR	TEMP	SALI	TSTR	SSTR
LARV	0.23*							
ZOO	-0.38**	0.29*						
MICR	-0.11	-0.02	0.27*					
TEMP	0.81**	0.31**	-0.46**	0.02				
SALI	0.18	0.08	-0.20	-0.16	0.19			
TSTR	0.40**	0.17	-0.25*	-0.02	0.46**	0.06		
SSTR	-0.10	0.07	0.05	0.09	-0.03	-0.62**	0.12	
SECC	0.35**	-0.34**	-0.58**	-0.34**	0.32**	0.39**	0.20	-0.29*

\* Significant at  $P = 0.05$ .

\*\* Significant at  $P = 0.01$ .

\*  $P = 0.053$ .

where  $E = \log(\text{eggs}/1,000 \text{ m}^3 + 1)$   
 $T = \text{surface temperature } (^{\circ}\text{C})$   
 $M = \log(\text{microzooplankton}/l + 1)$ , (Table 6).

No single variable explained the majority of the variability in larval density (Table 7). Secchi depth was the single best predictor, accounting for 11% of the variance of larval density ( $r^2 = 0.113$ ). The combination of surface temperature with Secchi depth increased the coefficient of determination to 0.306. All of the variables combined explained just 50% of the variability of larval density ( $r^2 = 0.498$ ). Five variables improved the prediction of the set of independent variables by more than 1% when added to the model. The predictive equation for larval density based on using these five is

$$L = -0.842 - 0.591X + 0.126T + 0.515Z - 0.571M + 0.029S$$

where  $L = \log(\text{larvae}/1,000 \text{ m}^3 + 1)$   
 $X = \text{Secchi depth (m)}$   
 $T = \text{surface temperature } (^{\circ}\text{C})$   
 $Z = \log(\text{zooplankton}/1,000 \text{ m}^3 + 1)$   
 $M = \log(\text{microzooplankton}/l + 1)$   
 $S = \text{surface salinity } (\text{‰})$ .

The results of the multiple regressions show that northern anchovy egg density could be predicted largely by surface water temperature. Larval density could not be predicted well by a single variable or by the five variables which, when combined, accounted for only 49% of the variability.

### Spawning Stock Estimates

Based on estimates of egg production, the spawn-

TABLE 6.—Stepwise multiple regression: northern anchovy egg density vs. biological and environmental variables.

Independent variable	Multiple $r^2$	Change in $r^2$
Surface temperature	0.651	0.651
Microzooplankton	0.666	0.015
Salinity stratification	0.670	0.004
Surface salinity	0.672	0.002
Secchi depth	0.675	0.003
Zooplankton	0.677	0.002
Temperature stratification	0.678	0.001

TABLE 7.—Stepwise multiple regression: northern anchovy larval density vs. biological and environmental variables.

Independent variable	Multiple $r^2$	Change in $r^2$
Secchi depth	0.113	0.113
Surface temperature	0.306	0.194
Zooplankton	0.392	0.085
Microzooplankton	0.459	0.067
Surface salinity	0.486	0.028
Salinity stratification	0.495	0.009
Temperature stratification	0.498	0.003

ing stock biomass of northern anchovies in the part of San Francisco Bay sampled in this study ranged from undetectable in December 1978 and January 1979 (no eggs collected) to 696 t (metric tons) (767 short tons) in July 1978. If the area of the Bay which is <2 m deep were included, the estimate of July biomass would have been 2,030 t (2,240 short tons).

### Length Frequencies of Larvae

Monthly samples could contain larvae from the current month and 2 previous ones because metamorphosis is not complete until 35 mm, age 74 days at 16°C (Hunter 1976). However, larvae longer than 15 mm were not taken at the standard stations from August through October, although eggs and smaller

larvae had been abundant since June (Fig. 4). Larvae >15 mm long were found over the shoals near station 3 in October and April (Fig. 5). Larvae longer than 15 mm were taken in the channel from November through February, months with little or no spawning. Large larvae and juveniles, which had apparently overwintered, were present when spawning resumed in March and April.

## DISCUSSION

Previous suggestions that northern anchovy spawn in San Francisco Bay were based on the presence of small larvae (Eldridge 1977; Sitts and Knight 1979), juveniles (Smith and Kato 1979), or the

spawning season in the California Current (Hubbs 1925). Anchovy eggs collected in this study provide conclusive evidence that the northern anchovy spawns in San Francisco Bay because eggs could not drift upstream to station 5 or into South Bay as far as station 1 or 2. Peak spawning based on the abundance of eggs was May through September when adult anchovies are known to be plentiful in the Bay (Aplin 1967).

Spawning in San Francisco Bay differed from anchovy spawning in the sea. Most spawning of the central subpopulation of northern anchovy in the California Current takes place January-April when the 10 m temperature is 14°-16°C; not June through October when water temperature is 16°-19°C

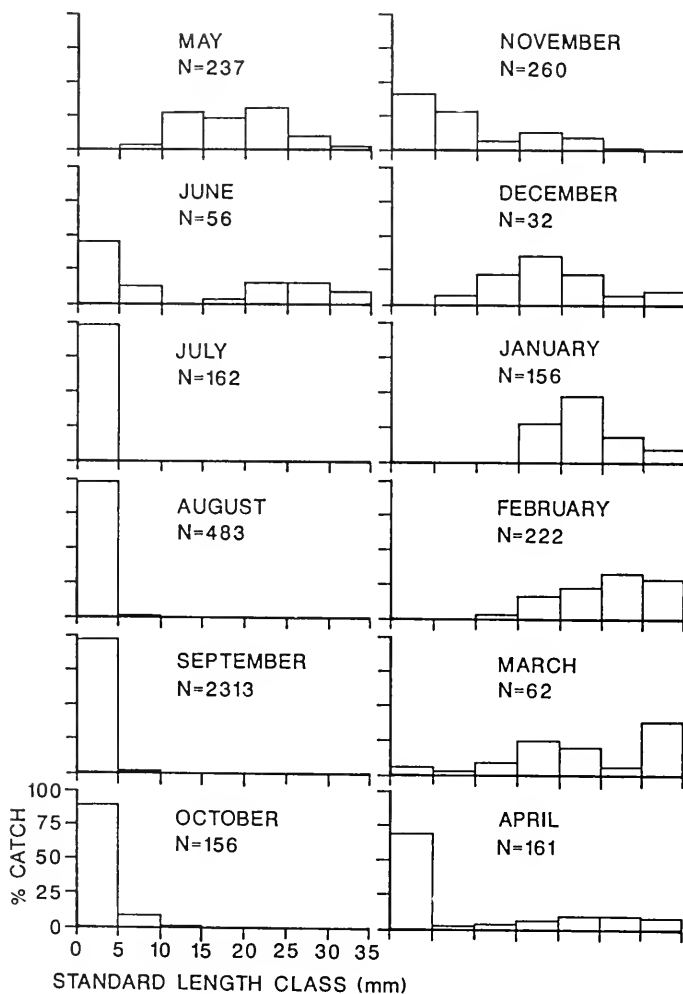

FIGURE 4.—Length-class frequencies of larvae and juvenile northern anchovies for each month of the study.

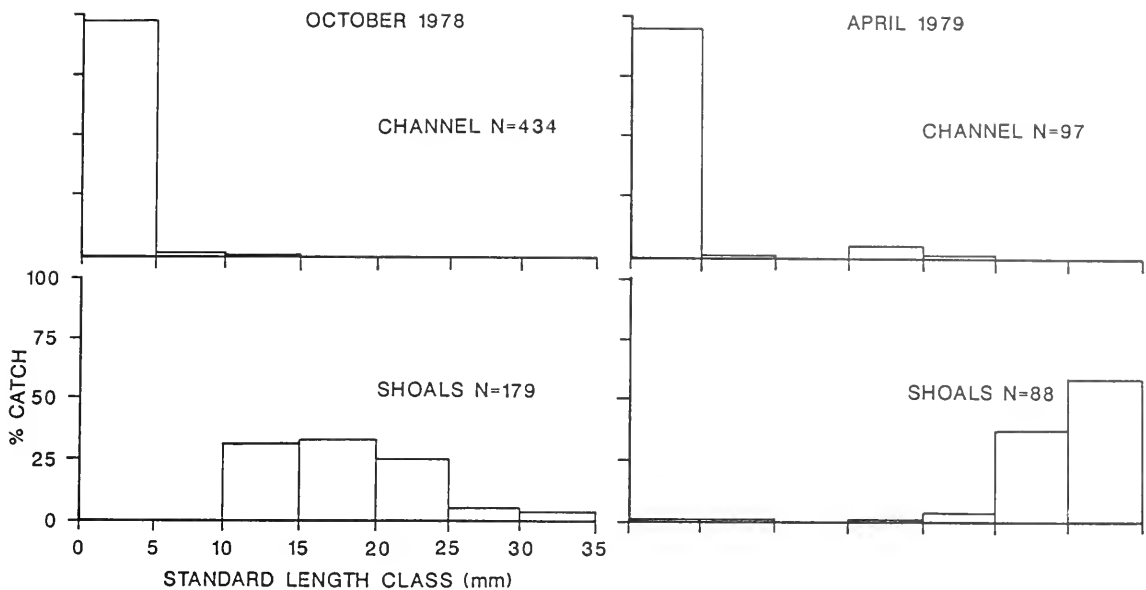

FIGURE 5.—Length-class frequencies of larvae and juvenile northern anchovies for October 1978 and April 1979 showing the different sizes caught in the channel versus those in shallow water.

(Smith and Lasker 1978). The northern subpopulation spawns off Oregon and Washington from mid-June to mid-August when 1 m temperatures are 14°-17°C (Richardson 1980). These two subpopulations overlap at San Francisco (Vrooman et al. 1981) and the spawning season in the Bay overlapped the spawning seasons of both subpopulations. But spawning in the Bay took place at higher temperatures than usual for either population in the ocean (13°-18°C, Brewer 1976). Few eggs were taken in the Bay from December 1978 to March 1979 when water temperature was below 13°C. However, at station 3 in March 1979, 477 eggs were taken at a water temperature of 11.5°C. Peak spawning in the Bay was in July, August, and September when the mean water temperature was 19.0°, 19.8°, and 19.2°C, respectively. The highest catch of eggs occurred at station 2 in July at 21.0°C. Eggs were also plentiful at station 1 in August at 22.5°C. During June, July, and August, eggs were least abundant at stations 4 and 6, where water temperature was relatively low. During September and October, egg densities at stations 4 and 6 peaked, as did water temperature at these stations. Sitts and Knight (1979) found larvae shorter than 4 mm at 18°-22°C in the Sacramento-San Joaquin estuary in July and August. Although much of the northern anchovy spawning took place in the Bay within the previously reported temperature range and some took place at low temperatures, most occurred in water warmer

than in the coastal spawning regions. The strong correlation of egg abundance with temperature includes potential confounding effects of presumed seasonal influx of adults, apparent "preference" for spawning within the Bay, and differences in dilution due to tidal exchange which affected stations 4 and 6 more than the other stations. Therefore the correlations are descriptive, perhaps predictive, but not causal.

In the California Current, temperature, upwelling, and stable stratification of the water column are thought to interact to produce favorable conditions for anchovy larvae (Lasker 1975). In San Francisco Bay there is no upwelling, but salinity or freshwater outflow variability might influence ecological conditions. Freshwater flow may have an indirect effect by promoting blooms of certain phytoplankton or by retaining particles through estuarine circulation (Cloern 1979). Relatively high salinity coincided with warm temperatures at the beginning of the spawning season, but spawning ceased in November when water temperature decreased to 13°C, although salinity remained high until February. Sitts and Knight (1979) found larvae shorter than 10 mm at low salinity (<10‰) and relatively high temperature (>18°C). They found only large larvae (>10 mm) in November when water temperature fell below 13°C.

In this study, only temperature had a strong direct relationship with abundance of eggs and larvae;

peak abundance tracked the seasonal temperature cycle closely. Temperature stratification was most pronounced in June-October when spawning was greatest, especially at station 5 where salinity stratification was also most noticeable.

Offshore transport of eggs and larvae is believed to be one of the environmental hazards to anchovy reproductive success (Bakun and Parrish 1982). Peak spawning in the Bay took place in June-August, the months of greatest offshore directed Ekman transport at the latitude of San Francisco (Parrish et al. 1981). Larvae, retained in San Francisco Bay by estuarine circulation or behavior, would not be subject to offshore drift into areas of low plankton density. Therefore, they may have a higher probability of survival than larvae in the California Current and they might survive during bad years for oceanic larvae.

Within San Francisco Bay there were apparent differences between spawning habitat and larval habitat. Eggs and small larvae were more abundant in warm, clear, thermally stratified water with relatively less plankton; large larvae were found in shallow, warm, less stratified, plankton-rich water with reduced light penetration. Negative correlations between zooplankton and the eggs of zooplanktivorous fishes were attributed to predation on the zooplankton by de Ciechowski and Sanchez (1983). Cannibalism on larvae by adult northern anchovies and competition between adults and juveniles are two reasons why separate habitats would be adaptive. Because spawning and nursery habitats differ in location and environmental properties, it is not surprising that multiple regression variables measured in the spawning habitat did not predict larval abundance. It may be that spawning areas are selected by adults, perhaps for feeding (Brewer 1978) or for water clarity, while larger larvae seek different conditions where their survival is determined by other factors than those which affect first-feeding larvae. If variable mortality on the larger larvae determines eventual recruitment, then recruitment may be largely decoupled from spawning and first-feeding conditions. This could explain why predictions of recruitment from larval surveys (which do not adequately sample large larvae and juveniles) have not been reliable.

The conditions where larvae were more abundant are more characteristic of shallow nearshore water than of the California Current. Juveniles and young of the year are also relatively more abundant nearshore in California (Parrish et al. 1986). In 1978, when spawning was restricted to nearshore areas, apparent recruitment was high relative to 1979

when spawning was offshore (Hewitt and Methot 1982). The 1978 spawning season for California Current anchovy was not typical; storms prevented favorable conditions for larvae until March in southern California (Lasker 1981). Nearshore areas might be refugia during anomalous years and they could contribute a disproportionate number of recruits every year (Brewer and Smith 1982).

It might be argued that the 20-30 mm larvae found nearshore in the Southern California Bight (Brewer and Smith 1982) merely avoided the nets in standard CalCOFI tows, but I found a similar pattern with respect to length frequencies when comparing samples taken in the channels and in shallow water in San Francisco Bay. That is, larger larvae were found in shallower zooplankton-rich areas. Estuaries and nearshore areas may provide conditions favorable enough for survival of larvae and juveniles to compensate for low mean food density and for occasional years of unfavorable oceanographic conditions in the California Current.

San Francisco Bay northern anchovy larvae, especially those which overwinter, are subject to different ecological conditions than those in the California Current, thus they may have slightly different morphology and meristics (Hempel and Blaxter 1961; Blaber et al. 1981). The San Francisco Bay subspecies *Engraulis mordax nanus* Hubbs (1925) may be an ecotype of *E. mordax*.

A female northern anchovy has enough energy stored as fat for 17 of its 20 annual batches of eggs, but protein for egg production must come from feeding during the spawning season (Hunter and Dorr 1982). The primary food of northern anchovy, zooplankton, was abundant in the Bay. I found a mean density of 1 zooplankton/L with a 0.308 mm mesh net, but this is an underestimate of copepodites and small copepods because of the relatively large mesh size. By comparison, Hutchinson (1981) found at least order of magnitude greater densities at nearby stations over the same time period using 0.080 and 0.064 mm mesh nets. Anchovy feed by biting individual organisms or by filter-feeding if particle density is high enough. The laboratory-determined threshold for filter-feeding is 5-18 particles (0.236 mm wide) per liter (Hunter and Dorr 1982). My zooplankton density estimate, which was biased conservatively, is of the order of magnitude required to stimulate filter-feeding. Therefore, I conclude that zooplankton prey for adult northern anchovies were abundant in the Bay during this study.

For the Bay to be a good larval nursery area it should have abundant microzooplankton prey for lar-

vae. I found a mean density of 28.8 per liter using a 0.080 mm mesh net (probably a conservative estimate because of net clogging and meter malfunctioning). This is higher than would be expected in the California Current using the same mesh size (<1 per liter, Arthur 1977). It is comparable to the 36 per liter found with a finer mesh net (Arthur 1977). It is an underestimate of available prey for larvae because they consume particles as small as 0.040 mm, and there is a peak of biomass of small plankton in the California Current at 0.070 mm (Arthur 1977), just below the mesh size of my net. Sitts and Knight (1979) found a mean density of 32.3 copepod nauplii/L in a 1-yr study in the Sacramento-San Joaquin estuary using 0.060 mm mesh. Hutchinson (1981) found approximately 10 nauplii/L over the same period of time as this study. (I calculated this value from her data for density of nauplii at 1 m depth at her stations 19 and 30 which correspond to my stations 6 and 2.) My microzooplankton estimates did not adequately represent the rotifers, tintinnids, and other small larval prey which were collected in high numbers with finer mesh nets (Hutchinson 1981). These organisms are known to be eaten by northern anchovy larvae and I observed tintinnids in the guts of some larvae.

Larvae reared in the laboratory generally require more than 1,000 prey items/L for good survival, but some survival occurs at lower densities. Houde (1978) obtained 1% survival to metamorphosis of *Anchoa mitchilli* with a prey density of 27 per liter. Northern anchovy larvae in the sea which obtain enough food to survive also obtain enough to grow rapidly (Methot and Kramer 1979). The existence of dense patches of food has been suggested to account for the discrepancy between average food densities observed in the sea and those needed in the laboratory. Dense patches of larval prey might not be needed in the Bay where I found mean prey density higher than that typical of the California Current. However, dense patches of microzooplankton would be expected in the Bay because blooms of their prey, phytoplankton, occur (Cloern 1982). Dense patches of microzooplankton, undetected by my sampling design, would make San Francisco Bay a very good feeding area for larval northern anchovies. Because the water was warmer in the Bay than in the California Current, larvae could search a larger volume of water per unit time, they would encounter high densities of prey and would be expected to survive in greater numbers and to grow rapidly. Therefore, San Francisco Bay may be a good feeding area for larvae as well as for spawning adults.

To my knowledge, my estimates of spawning biomass of northern anchovies in the Bay are the first such estimates. Are they reasonable, and what are the implications of this biomass of anchovies in the Bay? The estimate based on egg abundance assumes that parameters estimated for California Current anchovies apply to San Francisco Bay anchovies. I argue they do because parameters for the estimate were obtained from anchovies at the peak of spawning in the California Current in 1978, the year my study began. I believe these parameter values may be applied to the anchovy population in San Francisco Bay because the seasonal pattern of spawning and abundance of anchovies in the Bay indicates that most of these anchovies are seasonal migrants from the California Current stocks. No actual measurements of batch fecundity of anchovy in the Bay have been taken so the values used are the best available. Errors in estimating egg and larval abundances are probably more important than small changes in the estimates of batch fecundity. The egg-based estimate could be high if adults leave the Bay immediately after spawning or if they spawn more frequently due to greater food availability. The estimate could be low if they spawn infrequently because the season is later than the regular spawning season in the California Current or if higher temperatures greatly increase metabolic needs.

The estimate is conservatively biased because I merely divided the number of eggs caught by the number of days to hatch at the measured temperature without considering mortality. During the months with peak egg abundance the estimated time to hatch was 2 d. If egg mortality was  $0.184 \text{ da}^{-1}$  (Picquelle and Hewitt 1984), then the estimate was approximately 25% low. The estimate would be high if eggs were present only in the channel and not over the area used to calculate total abundance. However, station 3, in shallow water near San Bruno Shoal in South San Francisco Bay, had high egg densities; therefore, eggs were distributed in some shallow-water areas. Stations 1 and 2, which had high egg densities, represented small areas, while stations 4 and 6 with low densities represented large areas. San Pablo Bay and the rest of the North Bay were not included in the biomass estimate. Potential biases in the egg-based stock estimate either cancel one another or give a conservative estimate.

My estimate is consistent with information from other studies. I found mean values of 3,360 eggs/1,000 m<sup>3</sup> and 259 larvae/1,000 m<sup>3</sup>. Hutchinson (1981) found 4,730 eggs/1,000 m<sup>3</sup> (my calculations from her stations 19 and 30). Sitts and Knight (1979) calculated a mean larval abundance of 490 per 1,000

m<sup>3</sup>. The estimates of larval densities are similar to estimates for the Southern California Bight near-shore CalCOFI area in 1978-79 (461 per 1,000 m<sup>3</sup>, calculated from table 4 of Brewer and Smith 1982, assuming average tow depth = 210 m; two-thirds of the stations were >210 m according to their table 2). The mean density of eggs in the Bay was much higher than in the Southern California Bight near-shore CalCOFI area (310 per 1,000 m<sup>3</sup>, Brewer and Smith 1982). The seasonal northern anchovies fishery in the Bay took approximately 481 tons for frozen and live bait (Smith and Kato 1979). My estimate is adequate to permit such a yield.

Northern anchovy females need a daily ration of 4-5% of their body weight of copepods per day to support growth and reproduction (Hunter and Leong 1981). Approximately 5% of caloric intake goes into growth. Using these values, 38.35 tons of copepods per day would be consumed by the July biomass of 767 tons of anchovies. Growth would be about 1.92 tons per day. Doing similar calculations for each month and summing for the 12 mo of this study result in an estimate of 3,260 tons of copepods consumed and a net annual production of 158 tons of anchovy growth. If the egg estimates based on the area of the Bay, including the shallow areas were used, the consumption of copepods and growth estimates would be approximately doubled. These calculations are a first order estimate of the impact of a carnivorous planktivore on zooplankton in the Bay. The energy converted to anchovy growth would be removed from the Bay, so the estimate of net growth is also a minimum estimate of a sink for Bay production as growth of a transient consumer. In San Francisco Bay where plankton production from a limited area is being consumed by a large, transient anchovy population, grazing by anchovy could conceivably limit zooplankton abundance seasonally. Although it is impossible to distinguish between grazing and interannual differences without estimates of zooplankton production, zooplankton was more abundant in winter 1978-79 when adult anchovies were absent.

A large biomass of planktivores could have other effects on the ecology of the Bay. Selective feeding by clupeoids on larger organisms in lakes can affect the zooplankton community structure (Brooks and Dodson 1965). Northern anchovy schools can also have an impact on nutrient cycling. Smith and Epley (1982) calculated that ambient ammonium concentration would be nearly doubled behind an anchovy school in the Southern California Bight. McCarthy and Whitlege (1972) estimated that nitrogen excretion by the Peruvian anchoveta is an order of mag-

nitude greater than zooplankton excretion, so fish excretion may be the major source of regenerated nitrogen nutrients for phytoplankton production. These high nitrogen inputs would be patchy (Blaxter and Hunter 1982) and their importance would depend on whether or not background levels of nutrients were limiting. Nutrients may not be limiting in San Francisco Bay where light penetration and residence time control phytoplankton dynamics (Cloern 1979). Laboratory studies of copepod productivity, anchovy predation, and nutrient regeneration are needed to define quantitatively the impact of the northern anchovy on plankton dynamics in the Bay. A complete description of the trophic role of anchovy in the Bay should include estimates of zooplankton consumption by larvae, cannibalism by adults, and predation on adult and larval anchovies.

## CONCLUSION

San Francisco Bay is a favorable area for northern anchovy spawning because it has abundant food for adults, protection from advective loss for eggs, and abundant food for larvae. There is apparent habitat partitioning between spawning adults and larger larvae which could adaptively reduce predation and competition. Recruitment to the California Current stocks may be determined more by events in the nursery habitat of larvae and juveniles than by conditions favorable for spawning adults and first-feeding larvae; therefore, further work in estuaries and nearshore areas is warranted.

## ACKNOWLEDGMENTS

This study was done under the direction of Margaret G. Bradbury as partial fulfillment of the requirement for the M.A. in Biology at San Francisco State University. I thank her and the other members of my committee, Robert Berrend and Thomas Niesen, for advice and assistance in completing the work. Michael Hearne supplied the plankton net and assisted in all the field sampling. The figures were drafted by J. Javech. The preparation of the manuscript was supported in part by the National Oceanic and Atmospheric Administration under Cooperative Agreement #NA 84-WC-H-06098.

## LITERATURE CITED

- APLIN, J. A.  
1967. Biological survey of San Francisco Bay, 1963-1966. Calif. Fish Game, Mar. Resour. Oper. Lab. Ref. No. 67-4, 131 p.



- ARTHUR, D. K.  
1976. Food and feeding of larvae of three fishes occurring in the California Current, *Sardinops sagax*, *Engraulis mordax*, and *Trachurus symmetricus*. Fish. Bull., U.S. 74: 517-530.
1977. Distribution, size, and abundance of microcopepods in the California Current System and their possible influence on survival of marine teleost larvae. Fish. Bull., U.S. 75: 601-611.
- BAKUN, A., AND R. H. PARRISH.  
1982. Turbulence, transport, and pelagic fish in the California and Peru current systems. CalCOFI Rep. 23:99-112.
- BLABER, S. J., D. P. CYRUS, AND A. K. WHITFIELD.  
1981. The influence of zooplankton food resources on the morphology of the estuarine clupeid *Gilchristella aestivalis* (Gilchrist, 1914). Environ. Biol. Fish. 6:351-355.
- BLAXTER, J. H. S., AND J. R. HUNTER.  
1982. The biology of the clupeoid fishes. Adv. Mar. Biol. 20: 1-223.
- BREWER, G. D.  
1976. Thermal tolerance and resistance of the northern anchovy, *Engraulis mordax*. Fish. Bull., U.S. 74:433-445.  
1978. Reproduction and spawning of the northern anchovy, *Engraulis mordax*, in San Pedro Bay, California. Calif. Fish Game 64:175-184.
- BREWER, G. D., AND P. E. SMITH.  
1982. Northern anchovy and Pacific sardine spawning off Southern California during 1978-1980: preliminary observations on the importance of the nearshore coastal region. CalCOFI Rep. 23:160-171.
- BROOKS, J. L., AND S. I. DODSON.  
1965. Predation, body size, and composition of plankton. Science 150:28-35.
- CLARKE, T. A.  
1983. Comparison of abundance estimates of small fishes by three towed nets and preliminary results of the use of small purse seines as sampling devices. Biol. Oceanogr. 2:311-340.
- CLOERN, J. E.  
1979. Phytoplankton ecology of the San Francisco Bay system: the status of our current understanding. In T. J. Conomos (editor), San Francisco Bay: the urbanized estuary, p. 247-264. AAAS Pac. Div., San Franc., CA.  
1982. Does the benthos control phytoplankton biomass in south San Francisco Bay? Mar. Ecol. Prog. Ser. 9:191-202.
- CONOMOS, T. J., AND D. H. PETERSON.  
1977. Suspended particle transport and circulation in San Francisco Bay: an overview. In M. Wiley (editor), Estuarine processes, Vol. 2, p. 82-97. Acad. Press, N.Y.
- DE CIECHOMSKI, J. D., AND R. P. SANCHEZ.  
1983. Relationship between ichthyoplankton abundance and associated zooplankton biomass in the shelf waters off Argentina. Biol. Oceanogr. 3:77-101.
- ELDRIDGE, M. B.  
1977. Factors influencing distribution of fish eggs and larvae over eight 24-hr samplings in Richardson Bay, California. Calif. Fish Game 63:100-116.
- HEMPEL, G., AND J. H. S. BLAXTER.  
1961. The experimental modification of meristic characters in herring (*Clupea harengus* L.). J. Cons. Perm. Explor. Mer 26:336-346.
- HEWITT, R. P., AND R. D. METHOT JR.  
1982. Distribution and mortality of northern anchovy larvae in 1978 and 1979. CalCOFI Rep. 23:226-245.
- HOUDE, E. D.  
1978. Critical food concentrations for larvae of three species of subtropical marine fishes. Bull. Mar. Sci. 28:395-411.
- HUBBS, C. L.  
1925. Racial and seasonal variation in the Pacific herring, California sardine, and California anchovy. Calif. Fish Game, Fish Bull. 8, 23 p.
- HULL, C. H., AND N. H. NIE (editors).  
1981. SPSS update 7-9. McGraw-Hill Book Co., N.Y.
- HUNTER, J. R.  
1976. Culture and growth of northern anchovy, *Engraulis mordax*, larvae. Fish. Bull., U.S. 74:81-88.
- HUNTER, J. R., AND H. DORR.  
1982. Thresholds for filter feeding in northern anchovy, *Engraulis mordax*. CalCOFI Rep. 23:198-204.
- HUNTER, J. R., AND S. R. GOLDBERG.  
1980. Spawning incidence and batch fecundity in northern anchovy, *Engraulis mordax*. Fish. Bull., U.S. 77:641-652.
- HUNTER, J. R., AND R. LEONG.  
1981. The spawning energetics of female northern anchovy, *Engraulis mordax*. Fish. Bull., U.S. 79:215-230.
- HUTCHINSON, A.  
1981. Zooplankton species composition and abundance in the South Bay, 1978-1979. U.S. Geol. Surv. Open File Rep. 81-132.
- LASKER, R.  
1975. Field criteria for survival of anchovy larvae: the relation between inshore chlorophyll maximum layers and successful first feeding. Fish. Bull., U.S. 73:453-462.  
1978. The relation between oceanographic conditions and larval anchovy food in the California Current: identification of factors contributing to recruitment failure. Rapp. P.-v. Réun. Cons. int. Explor. Mer 177:322-354.  
1981. Marine fish larvae. Univ. Wash. Press, Seattle, 131 p.
- LUND, J. W. G., C. KIPLING, AND E. D. LECREN.  
1958. The inverted microscope method of estimating algal numbers and the statistical basis of estimations by counting. Hydrobiologia 11:143-170.
- MCCARTHY, J. J., AND T. E. WHITLEDGE.  
1972. Nitrogen excretion by anchovy (*Engraulis mordax* and *E. ringens*) and jack mackerel (*Trachurus symmetricus*). Fish. Bull., U.S. 70:395-401.
- MCGOWAN, M. F., AND F. H. BERRY.  
1984. Clupeiformes: development and relationships. In H. G. Moser et al. (editors), Ontogeny and systematics of fishes, p. 108-126. Am. Soc. Ichthyol. Herpetol. Spec. Publ. 1, 760 p.
- METHOT, R. D., JR., AND D. KRAMER.  
1979. Growth of northern anchovy, *Engraulis mordax*, larvae in the sea. Fish. Bull., U.S. 77:413-423.
- MILLER, D. J., AND R. N. LEA.  
1972. Guide to the coastal marine fishes of California. Calif. Fish Game, Fish Bull. 157, 235 p.
- MONTGOMERY, D. C.  
1976. Design and analysis of experiments. John Wiley & Sons, N.Y., 418 p.
- MURPHY, G. I., AND R. I. CLUTTER.  
1972. Sampling anchovy larvae with a plankton purse seine. Fish. Bull., U.S. 70:789-798.
- NIE, N. H., C. H. HULL, J. G. JENKINS, K. STEINBRENNER, AND D. H. BENT.  
1975. SPSS: statistical package for the social sciences. 2d ed. McGraw-Hill Book Co., N.Y.
- PARKER, K.  
1980. A direct method for estimating northern anchovy, *Engraulis mordax*, spawning biomass. Fish. Bull., U.S. 78:541-544.

- PARRISH, R. H., D. L. MALLICOATE, AND K. F. MAIS.  
1986. Regional variations in the growth and age composition of northern anchovy, *Engraulis mordax*. Fish. Bull., U.S. 83:483-496.
- PARRISH, R. H., C. S. NELSON, AND A. BAKUN.  
1981. Transport mechanisms and reproductive success of fishes in the California Current. Biol. Oceanogr. 1:175-203.
- PICQUELLE, S. J., AND R. P. HEWITT.  
1984. The 1983 spawning biomass of the northern anchovy. CalCOFI Rep. 25:16-27.
- RECKSIEK, C. W., AND H. W. FREY.  
1978. Biological, oceanographic, and acoustical aspects of the market squid, *Loligo opalescens* Berry. Calif. Fish Game, Fish Bull. 169:1-185.
- RICHARDSON, S. L.  
1980. Spawning biomass and early life of northern anchovy, *Engraulis mordax*, in the northern subpopulation off Oregon and Washington. Fish. Bull., U.S. 78:855-876.
- SCURA, E. D., AND C. W. JERDE.  
1977. Various species of phytoplankton as food for larval northern anchovy *Engraulis mordax*, and relative nutritional value of the dinoflagellates *Gymnodinium splendens* and *Gonyaulax polyedra*. Fish. Bull., U.S. 75:577-583.
- SITTS, R. M., AND A. W. KNIGHT.  
1979. Plankton ecology in the Sacramento-San Joaquin estuary. Water Sci. Eng. Pap. No. 4509, 145 p. Univ. Calif. Davis, Davis, CA.
- SMITH, D. L.  
1977. A guide to marine coastal plankton and marine invertebrate larvae. Kendall/Hunt Publ. Co., Dubuque, IA.
- SMITH, P. E., AND R. W. EPPLEY.  
1982. Primary production and the anchovy population in the Southern California Bight. Limnol. Oceanogr. 27:1-17.
- SMITH, P. E., AND R. LASKER.  
1978. Position of larval fish in an ecosystem. Rapp. P.-v. Réun. Cons. int. Explor. Mer 173:77-84.
- SMITH, P. E., AND S. L. RICHARDSON.  
1977. Standard techniques for pelagic fish egg and larva surveys. FAO Fish. Tech. Pap. No. 175, Rome.
- SMITH, S. W., AND S. KATO.  
1979. The fisheries of San Francisco Bay: past, present, and future. In J. T. Conomos (editor), San Francisco Bay: the urbanized estuary, p. 445-468. AAAS Pac. Div., San Franc., CA.
- TYLER, J. E.  
1968. The Secchi disk. Limnol. Oceanogr. 13:1-6.
- VROOMAN, A. M., P. A. PALOMA, AND J. R. ZWEIFEL.  
1981. Electrophoretic, morphometric, and meristic studies of subpopulations of northern anchovy, *Engraulis mordax*. Calif. Fish Game 67:39-51.
- WANG, J. C.  
1981. Taxonomy of the early life stages of fishes: fishes of the Sacramento-San Joaquin estuary and Moss Landing Harbor-Elkhorn Slough, California. Ecological Analysts, Inc., Concord, CA., 168 p.
- ZWEIFEL, J. R., AND R. LASKER.  
1976. Prehatch and posthatch growth of fishes - a general model. Fish. Bull., U.S. 74:609-621.

# THE SPAWNING FREQUENCY OF SKIPJACK TUNA, *KATSUWONUS PELAMIS*, FROM THE SOUTH PACIFIC

J. ROE HUNTER,<sup>1</sup> BEVERLY J. MACEWICZ,<sup>1</sup>  
AND JOHN R. SIBERT<sup>2</sup>

## ABSTRACT

Histological criteria to age postovulatory follicles were developed from examination of laboratory-spawned skipjack tuna; the criteria were used to estimate the frequency of spawning of skipjack tuna from the South Pacific. Examination of 87 skipjack tuna from field collections taken in October-November indicated that spawning occurred nearly every day. The fraction of mature females with postovulatory follicles, <24 hours old, was 0.85 (standard deviation = 0.071) indicating that the mean interval between spawnings was only 1.18 days.

Estimates of the frequency of spawning of multiple spawning fishes are essential for understanding their reproductive biology. To estimate annual reproductive effort or fecundity, and how these variables are related to size or age structure of a population requires knowledge of the frequency of spawning and the number of eggs produced per spawning. Batch fecundity, the number of eggs produced per spawning, has been estimated for skipjack tuna a number of times (see review by Matsumoto et al. 1984) but the spawning rate of the skipjack is unknown. Thus spawning frequency is one of the missing links in an assessment of the reproduction of skipjack populations.

It has long been recognized that skipjack tuna spawn more than once in a season because more than one mode of advanced oocytes are found in active ovaries (Brock 1954; Buñag 1956; Joseph 1963; Raju 1964; Simmons 1969; Batts 1972; Cayré 1981; Goldberg and Au 1986). The frequency of occurrence of female black skipjack tuna, *Euthynnus lineatus*, throughout the spawning season with ovaries containing hydrated oocytes led Schaefer (1986) to conclude that the average interval between spawnings of black skipjack in the eastern tropical Pacific was 2.1-5.7 d depending on the region.

Over the last 6 years, two methods have been developed for measuring the spawning rate of multiple spawning marine fishes: One method is based on the frequency of ovaries containing hydrated

oocytes and the other is based on the frequency with which they contain postovulatory follicles of known age (Hunter and Macewicz 1985a). These methods have been used to measure the rate of spawning in a number of marine fishes: *Engraulis mordax* (Hunter and Goldberg 1980; Hunter and Macewicz 1980); *Engraulis ringens* (Alheit et al. 1984); *Hypsoblennius jenkinsi* (Present 1985); *Sardinella brasiliensis* (Isaac-Nahum et al. 1985); *Seriphus politus* (DeMartini and Fountain 1981); and *Euthynnus lineatus* (Schaefer 1986). Postovulatory follicles were used in most studies, but DeMartini and Fountain (1981) and Schaefer (1986) used the incidence of females with hydrated oocytes to estimate spawning frequency. The hydrated oocyte method may produce a biased estimate in some species because of increased vulnerability of hydrated females to netting gear (Alheit et al. 1984).

The objective of this paper was to estimate the spawning rate of South Pacific skipjack tuna by applying some of these techniques. It was not possible to use the hydrated ovary method in our study because fish were not caught during the period of the day when the ovary was hydrated. Instead, we used the incidence of females having ovaries containing postovulatory follicles to estimate the frequency of spawning of skipjack tuna. This method requires ovaries to be preserved immediately in formaldehyde solution when the fish is caught, a histological examination of the ovary, and the development of a staging system for estimating the age of the postovulatory follicle. Our histological classification included not only an assessment of spawning frequency but also an assessment of the extent of ovarian atresia. The atretic condition of the ovary is a sensitive index of the reproductive state of

<sup>1</sup>Southwest Fisheries Center La Jolla Laboratory, National Marine Fisheries Service, NOAA, P.O. Box 271, La Jolla, CA 92038.

<sup>2</sup>South Pacific Commission, P.O. Box D5, Noumea, CEDEX, New Caledonia.

females during the spawning season and can be used to identify females approaching the end of their spawning season as well as those in postspawning condition (Hunter and Macewicz 1985b).

## METHODS

Skipjack tuna were captured either by pole and line or were catches associated with moored fish attraction devices or free floating natural flotsam. Two sets of collections of skipjack tuna were analyzed: a group of 12 females taken near Noumea, New Caledonia on 23 February 1984; and a group of 87 females taken in 8 different collections at various locations in the South Pacific from 20 October to 30 November 1984 (Table 1). Our samples were opportunistically taken and spanned a great latitudinal range (0°-23°S). At present the peak spawning months of skipjack tuna are poorly defined over this range of latitudes. Spawning is known to occur throughout the year in some areas (Nishikawa et al. 1985), but regional differences may exist in the peak months of spawning, and the spawning season also varies with skipjack size (Naganuma 1979). Naganuma concluded from analysis of gonosomatic indices (GSI) that peak spawning period for small skipjack tuna (40-60 cm) in the South Pacific is October to December. Argue et al. (1983) examined 11,000 adult skipjack tuna for cannibalism of juveniles (15-70 mm) and for GSI over the same latitude range as this study, but covering 80° of longitude (140°W-140°E). They found that cannibalism and female GSI was highest between October and March in this broad area. More data are needed to identify the regional variation about this general pattern.

The 8 collections of gonads (collections 2-9, Table

1) were treated statistically as 8 "clusters" of random samples of unequal size. The mean proportion of postovulatory follicles <24 h old was calculated as the total number of females with such follicles divided by the total number of mature females. Cochran (1977) pointed out that estimation of variance by the simple binomial probability formula can produce serious errors. The variance was calculated by the appropriate formula recommended by Cochran (1977).

Three female skipjack tuna were spawned in captivity (23°-24°C; June 1985) at the Kewalo Research Facility of the National Marine Fisheries Service using the stress spawning technique of Kaya et al. (1982). One fish (48 cm fork length [FL]) was sacrificed at the time of spawning, another (43.8 cm FL) 12 h later and the third (44 cm FL) 24 h after spawning. The ovaries of these females were used to establish histological criteria for the aging of the postovulatory follicles of the sea-caught females.

Ovaries were preserved in 10% Formalin<sup>3</sup> and embedded in Paraplast. Histological sections were cut at 5-6 µm and stained with Harris hematoxylin followed by eosin-phloxine-B counter stain (H&E).

## Histological Classification

To estimate reproductive condition of skipjack tuna, we used two histological classification systems: one for estimating spawning frequency and the other for assessing the likelihood that a female will continue to spawn (atretic state of the ovary). Each ovary was classified histologically according to both systems. These classification systems were developed for northern anchovy, *Engraulis mordax*, by Hunter and Goldberg (1980) and Hunter and Macewicz (1980, 1985a, b) and are used here with a few modifications appropriate to skipjack tuna ovarian structure and their rates of postovulatory follicle resorption. The descriptions of postovulatory follicles of different ages are from the three captive Hawaiian skipjack tuna. As these fish resorbed their postovulatory follicles much more rapidly than did the northern anchovy, we used stages of shorter duration. The atretic classification system remains unchanged, except for a few minor details of histological structure based on our observations of sea-caught fish. We believe that the reproductive interpretations we associate with the atretic classes are

TABLE 1.—Characteristics of 9 collections of female skipjack tuna taken in the South Pacific in 1984.

Collection number	Time of day (h)	Date	Fork length			Gear <sup>1</sup>	Lat. <sup>2</sup> S	Long. <sup>2</sup> E
			N	Mean (cm)	Range (cm)			
1	0800	2-23-84	12	47	44-51	PL	23.00	167.00
2	0745	10-20-84	7	49	46-50	PS	16.	178-179
3	0700	10-23-84	6	48	46-52	PS	16.	178-179
4	0700	10-24-84	8	49	46-52	PS	16.	178-179
5	0700	10-25-84	7	50	47-52	PS	16.	178-179
6	0700	10-26-84	14	49	45-51	PS	16.	178-179
7	0645	10-27-84	8	48	46-50	PS	16.	178-179
8	0755	11-19-84	25	50	44-62	PS	03.41	144.08
9	1955	11-30-84	12	56	49-60	PS	0.03	147.46

<sup>1</sup>PL = pole and line; PS = purse seine catch of skipjack tuna attracted to either a fish attraction device moored in waters of 350-450 m deep or natural flotsam.

<sup>2</sup>Latitude and longitude given in degrees and minutes when available.

<sup>3</sup>Reference to trade names does not imply endorsement by the National Marine Fisheries Service, NOAA.

meaningful because the oocyte resorption seems to follow a similar sequence of stages in most teleosts (Bretschneider and Duyvene de Wit 1947; Lambert 1970). The rate a skipjack tuna ovary passes from one atretic state to another is not specified and would require an additional study of captive fish. The characteristics of the two classification systems are outlined below.

## Spawning Frequency

### Hydrated and Migratory Nucleus Stages

Ovaries with many translucent hydrated oocytes (oocytes enlarged by fluid uptake just prior to ovulation) are classified in the hydrated stage. Spawning is considered to be imminent. In northern anchovy, spawning takes place in <12 h after the onset of hydration. No skipjack tuna with hydrated oocytes were taken in our field collections. Female skipjack tuna were taken with ovaries in the migratory nucleus stage. This stage occurs just before the onset of hydration and is characterized by the migration of the nucleus to the animal pole of the oocyte

and the beginning of the fusion of its yolk globules (Fig. 1).

### Age 0-H Postovulatory Follicles

Ovaries with new postovulatory follicles with no signs of follicle degeneration are classed as age 0-h postovulatory follicles. Hydrated oocytes may occasionally be present. Estimated elapsed time from spawning is 0-2 h. No skipjack tuna taken at sea were in this stage, but from the laboratory specimen (Fig. 2a, b) we can discern the following histological characteristics: The new postovulatory follicle has an irregular, convoluted shape. The granulosa epithelial cell layer of the follicle appears as an irregularly looped cord of slightly hypertrophied cuboidal cells with prominent healthy nuclei linearly arranged. The granulosa appears only loosely attached to the thecal connective tissue layer. Although the theca is less convoluted than the granulosa layer, it is distinct, contains blood capillaries and appears thicker than the thecal layer seen in northern anchovy.

### Age 12-H Postovulatory Follicles

Twelve-hour-old postovulatory follicles (Fig. 2c, d) show signs of degeneration similar to that observed in northern anchovy after about 24 h. Histological characteristics include the follicle which is smaller with fewer convolutions; a lumen which is evident; the degenerating granulosa which is no longer a recognizable unbroken cord of cells, but rather the cells are scattered in clumps in the lumen or may be irregularly attached to the theca; and some pycnotic or irregular nuclei which are evident. The theca has begun to disintegrate although it still remains thick and distinct. Deterioration of the theca is indicated by its overall smaller size, a more filamentous rather than cohesive cellular arrangement, and some irregular nuclei.

### Age 24-H Postovulatory Follicles

Ovaries containing 24-h-old postovulatory follicles showed pronounced signs of degeneration similar to that observed in northern anchovy 48 h after spawning. At this stage the follicle is much smaller than that at 12 h but a lumen is still evident (Fig. 2e, f). Only few granulosa cells remain; they usually have pycnotic nuclei and generally are loosely attached to the thecal layer. The thecal layer is still fairly thick although it contains some pycnotic

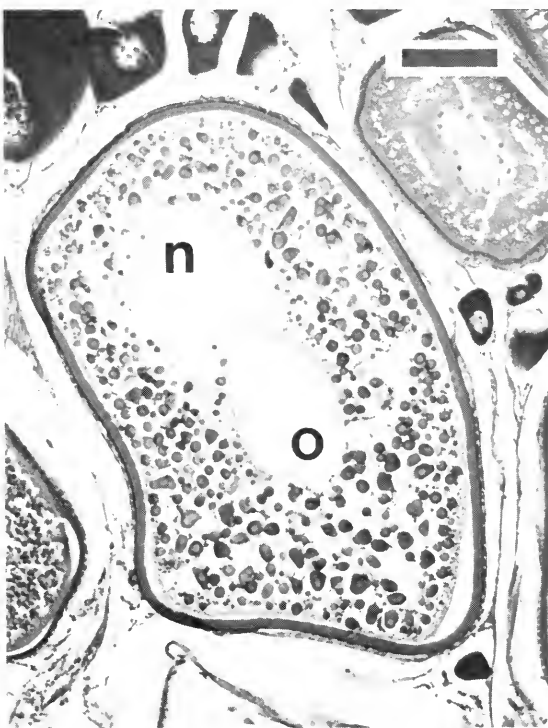

FIGURE 1.—Skipjack tuna oocyte with migratory nucleus (n) and large oil droplet (o); bar = 0.1 mm.

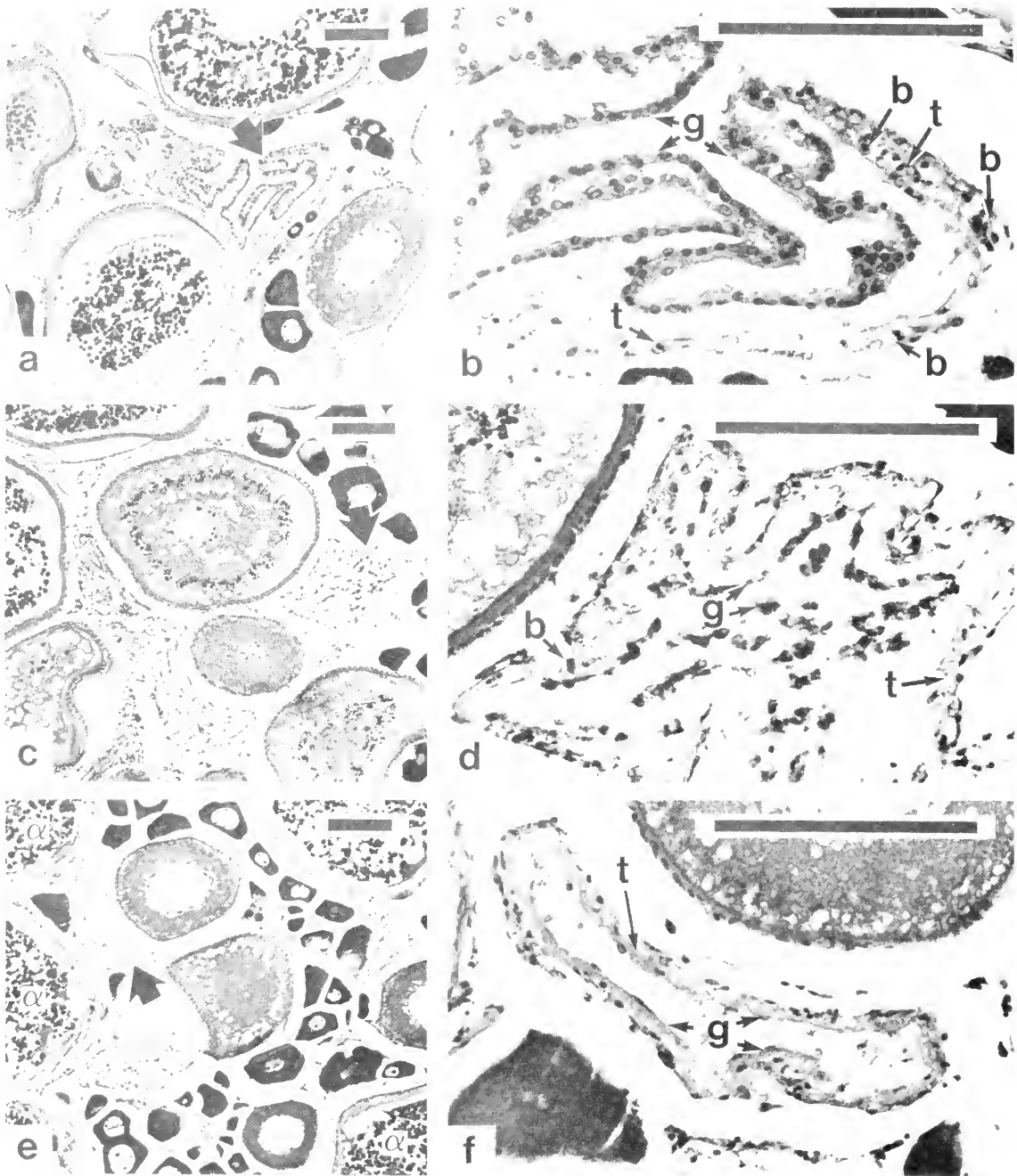

FIGURE 2.—Degeneration of postovulatory follicles of skipjack tuna spawned in the laboratory. Arrow in left panel indicates the postovulatory follicle that is seen under a higher magnification in right panel. a and b, 0 h after spawning (no deterioration); c and d, 12 h after spawning (pronounced degeneration); and e and f, 24 h after spawning (little remains of the degenerating postovulatory follicle). Bar = 0.1 mm; g = granulosa epithelial cell layer; t = thecal cell layer; b = red blood cell(s); and  $\alpha$  = early alpha stage atretic oocytes.

nuclei, and lymphocytes, and has a more filamentous composition.

### Nonspawning (mature)

Ovaries with many yolked oocytes and containing no hydrated oocytes or postovulatory follicles were classified as nonspawning. They may contain postovulatory follicles in advanced stages of degeneration which cannot be readily distinguished from late stage corpora atretica. Elapsed time from spawning was more than 24 h. Also classified as nonspawning (mature) were females in postspawning condition. The ovaries of such females contained no yolked oocytes, but atretic follicles (beta stage) were present indicating that the ovary was active recently (see next section).

### Immature

Ovaries containing no yolked oocytes and no  $\alpha$  or  $\beta$  stage atretic structures were classed as immature.

## Atretic States

It is well known in seasonal spawning fishes that a low incidence of atresia (resorption of the oocyte and its follicle) occurs throughout the spawning season, but it becomes marked as the spawning season closes and the remaining advanced oocytes in the ovary are resorbed. During the initial atretic phase ( $\alpha$ ), the oocyte is resorbed and any yolk globules are broken down and resorbed by the hypertrophying granulosa cells of the follicle (Bretschneider and Duyvene de Wit 1947; Lambert 1970). In the next stage ( $\beta$ ), all the yolk is gone, and there remains a small, rather compact structure with one or more cavities. The structure is composed of granulosa and theca cells with penetrating blood vessels. Further stages of follicle resorption have been described by the same authors, but the incidence and extent of  $\alpha$  and  $\beta$  stages have proven to be the most useful in the classification of atretic states of ovaries (Hunter and Macewicz 1985b). The characteristics of  $\alpha$  and  $\beta$  atretic structures are described and illustrated for northern anchovy by Hunter and Macewicz (1985b) and  $\alpha$  atretic oocytes of skipjack tuna are essentially similar. However,  $\beta$  atresia differs from northern anchovy in containing numerous spherical vacuoles scattered throughout the follicle. The vacuoles are the remnants of the oil droplet which takes longer than yolk to resorb and in H&E sections appear empty. Occasionally,

a large beta stage follicle may be seen in which the granulosa and thecal cells have proliferated.

Listed below are the characteristics of the four atretic states we used to classify skipjack tuna ovaries along with what is known regarding the spawning potential of northern anchovy classed in these states.

### Atretic State 0

Yolked oocytes present, with no  $\alpha$  atresia of yolked oocytes;  $\beta$  stage atresia may be present, but it cannot be distinguished with certainty from late stage postovulatory follicles (>24 h old). Female northern anchovy in this state have a high potential of spawning.

### Atretic State 1

Less than 50% of the yolked oocytes are in the  $\alpha$  stage of atresia. The frequency of spawning for northern anchovy classed in this state is less than half of that for females classed in atretic state 0. Thus, atretic state 1 indicates a decline in spawning rate.

### Atretic State 2

Fifty percent or more of the yolked oocytes are in the  $\alpha$  stage of atresia. The frequency of spawning for female northern anchovy classed in this state is very low and indicates that cessation of spawning is imminent.

### Atretic State 3

Ovaries contain  $\beta$  stage atresia and no yolked oocytes. Such fish have completed their spawning season since they have no yolked oocytes. The presence of  $\beta$  stage atresia indicates that oocyte resorption has taken place and thereby distinguishes such recently mature but postspawning fish from immature females. In northern anchovy, atretic state 3 may persist for 30 d.

## RESULTS AND DISCUSSION

All postovulatory follicles in sea-caught skipjack were less degenerated than those observed in a laboratory specimen examined 24 h after spawning, indicating that all of those in the sea collections were <24 h old. The fraction of mature females with postovulatory follicles <24 h old (155 + 18/86, Table 2) was 0.85 with the standard deviation estimated to

TABLE 2.—Numbers of female skipjack tuna in various spawning and atretic states. The 8 collections taken in the South Pacific between 20 October and 30 November 1984.

Collection number	Atretic state <sup>1</sup>	Age (A) Postovulatory follicles (h)		Non-spawning	Total mature females
		A ≤ 12	12 < A < 24		
2	0	0	0	2	2
	1	1	0	2	3
	2	0	0	1	1
	3	0	0	1	1
	Total	1	0	6	7
3	0	1	0	1	2
	1	4	0	0	4
	2	0	0	0	0
	3	0	0	0	0
	Total	5	0	1	6
24	0	3	0	0	3
	1	3	0	0	3
	2	1	0	0	1
	3	0	0	0	0
	Total	7	0	0	7
5	0	3	0	0	3
	1	2	0	0	2
	2	1	1	0	2
	3	0	0	0	0
	Total	6	1	0	7
6	0	9	0	0	9
	1	5	0	0	5
	2	0	0	0	0
	3	0	0	0	0
	Total	14	0	0	14
7	0	3	0	0	3
	1	5	0	0	5
	2	0	0	0	0
	3	0	0	0	0
	Total	8	0	0	8
8	0	8	5	0	13
	1	5	2	1	8
	2	<sup>3</sup> 1	0	2	3
	3	0	0	1	1
	Total	14	7	4	25
9	0	0	<sup>4</sup> 4	<sup>5</sup> 2	6
	1	0	<sup>6</sup> 6	0	6
	2	0	0	0	0
	3	0	0	0	0
	Total	0	10	2	12
2-9	0	27	9	5	41
	1	25	8	3	36
	2	3	1	3	7
	3	0	0	2	2
	Total	55	18	13	86

<sup>1</sup>Atretic State 0 = no alpha stage atresia of yolked oocytes.  
 State 1 = alpha stage atresia of yolked oocytes present, but <50% affected.  
 State 2 = alpha stage atresia present, 50% or more yolked oocytes affected.  
 State 3 = no yolked oocytes present and beta stage atresia present.

<sup>2</sup>One female skipjack tuna in collection 4 was immature.  
<sup>3</sup>A female with hydrated oocytes and age 0 h postovulatory follicles.  
<sup>4</sup>Three of these females had oocytes in migratory nucleus stage.  
<sup>5</sup>Two of these females had oocytes in migratory nucleus stage.  
<sup>6</sup>Five of these females had oocytes in migratory nucleus stage.

be 0.071 (Cochran 1977; see methods). This means that the average interval between spawnings (1/0.85) was only 1.18 d. Only one female was immature, reducing the denominator for the above fraction spawning from 87 to 86. If we consider only those females with yolked oocytes and no or minor atresia (atretic states 0 and 1) the fraction spawning is 0.90, implying a mean interval of 1.11 d between spawnings. This indicates that the spawning rate of female skipjack tuna in prime reproductive condition is very close to daily.

High levels of ovarian atresia were much more common among the 12 females taken in February than those taken in October-November, indicating that the February fish were nearing the end of their spawning season. Females with highly atretic ovaries (state 2) and postspawning ovaries (state 3) constituted 66% of the fish in the February collections (Table 3), but they made up only 10% of the fish taken in October-November. The February collection was the only one taken by pole and line. It is possible that pole-and-line fishing may be selective against spawning fish (Iverson et al. 1970; Matsumoto et al. 1984) although some spawning fish were taken in this collection.

The most unusual feature of the February collection was that the spawning fraction was high, 0.25 for a group where 50% of the fish were in post-spawning condition, had no yolked oocytes, and were incapable of spawning (atretic state 3). The spawning fraction was 1.0 for the three females with no or minor atresia because all three had postovulatory follicles. Thus skipjack tuna with active ovaries appear to spawn nearly every day. It appears that those unable to maintain this rate may discontinue spawning and resorb the ovary because females with active ovaries, showing no evidence of spawning, were rare in all collections. Postspawning females

TABLE 3.—Numbers of female skipjack tuna in various spawning and atretic states. This single collection was taken 23 February 1984.

Collection number	Atretic state <sup>1</sup>	Postovulatory follicles		Non-spawning	Total mature females
		12 h	24 h		
1	0	2	0	0	2
	1	1	0	1	2
	2	0	0	2	2
	3	0	0	6	6
	Total	3	0	9	12

<sup>1</sup>Atretic State 0 = no alpha stage atresia of yolked oocytes.  
 State 1 = alpha stage atresia of yolked oocytes present, but <50% affected.  
 State 2 = alpha stage atresia present, 50% or more yolked oocytes affected.  
 State 3 = no yolked oocytes present and beta stage atresia present.



might reactivate their ovary sometime later in the year if their physiological condition favored reproduction. Evidence for northern anchovy indicates that the transitions from spawning to postspawning states and vice versa can occur rapidly. In the laboratory at 16°C, northern anchovy can resorb all advanced oocytes within a few weeks (Hunter and Macewicz 1985b) and can produce an active ovary in 30 d (Hunter and Leong 1981). Owing to the higher water temperatures and high metabolism of skipjack tuna they are probably capable of even faster reproductive cycling.

Histological examination of females taken late in the day (1955 h, collection 9) provided additional evidence for daily spawning. Eight of 10 females with postovulatory follicles in this collection also had oocytes in the migratory nucleus stage. This stage is the precursor to hydration. Thus, fish which had spawned <24 h before were beginning to hydrate a new batch of eggs which presumably would be spawned in <12 h. The migratory nucleus stage was observed only in this collection probably because it was the only one taken in the evening, whereas all others were taken in the morning (0645-0755). The rarity of females with hydrated oocytes in our collections and the age of the postovulatory follicles imply that spawning usually took place at night. Spawning in daylight hours has been observed by fishermen and scientists, however (Iverson et al. 1970; Matsumoto et al. 1984).

A single female taken during the morning (collection 8) had small (0.70 mm) early stage hydrated oocytes (hydrated oocytes in which the yolk globules had not fully fused). This female, the only one with hydrated oocytes in our collections, also had new postovulatory follicles despite the fact that the hydrated oocytes were not fully advanced. This female may have been induced to hydrate and spawn by the stress of capture or may be simply an exception to the rule. To capture significant numbers of females with hydrated oocytes would probably require sampling after 2100 h. It is important to capture eventually some females in the hydrated stage because it is the best way to confirm that all oocytes in the most advanced modal group, the group of oocytes considered to be the next spawning batch (Hunter and Goldberg 1980), are in fact spawned. Counts of hydrated eggs are also the easiest and most accurate method of estimating batch fecundity (Hunter et al. 1985).

The "stress" spawning technique of Kaya et al. (1982) was used to produce the spawned skipjack tuna for the aging of postovulatory follicles. In this technique females captured at sea and placed in a

tank spawn spontaneously, usually about 8 h after capture presumably because of the stress of capture and handling. Spawning typically takes place at about 2400 h, which, by our estimate, appears to be close to the usual time of spawning. It now seems likely that many of these fish are naturally expressing their daily spawning activity. On the other hand, eggs less than the normal size range, 0.8-1.17 mm (Matsumoto et al. 1984), are occasionally spawned, indicating that stress may induce premature hydration in some individuals. That the skipjack tuna do not continue to spawn in the tanks is due probably to the stress of captivity. Our examination of a captive skipjack 24 h after spawning indicated that nearly all remaining oocytes containing yolk were in the early stages of alpha atresia (Fig. 2e). Similarly, female northern anchovy nearly always resorb their advanced oocytes a few days after capture although they will subsequently mature and spawn (Leong 1971; Hunter and Macewicz 1985b).

If female skipjack tuna spawn at the frequency we observed (85% of the females per day), the cost of reproduction and annual fecundity will be high because skipjack tuna appear to have a long spawning season. The relative batch fecundity of skipjack (number of eggs per spawning per body weight) is about 100 eggs per gram (Matsumoto et al. 1984; Goldberg and Au 1985). Skipjack tuna eggs are about the same size as those of *Scomber japonicus* which average in weight 0.04 mg (unpubl. data, National Marine Fisheries Service, Southwest Fisheries Center). We estimate the cost of a single spawning (excluding the metabolic cost of egg maturation and reproductive behavior) to be about 2% of the body weight per spawning (*Scomber* egg dry weight  $\times$  relative batch fecundity  $\times$  conversion to wet weight;  $4 \times 10^{-5} \times 100 \times 5 = 0.02$ ). If a female spawned every 1.18 d over 3 mo (90 d), it would produce about 7,600 eggs per gram body weight at an average daily cost of 1.7% of the body weight per day; a 4 kg skipjack tuna would spawn about 30 million eggs over this period.

If the collections used in this study were an unbiased sample of the South Pacific skipjack tuna population, then little doubt exists that spawning occurs almost daily when they have active ovaries. This preliminary study provides the tools necessary for a population-wide assessment of reproduction. We established the time-specific, histological criteria for assessment of spawning rate, and the method was applied to a small sample. A great deal more remains to be done for a proper assessment of reproduction in skipjack tuna. Specifically, many more samples at different times of day, using a

variety of fishing gears, are needed to insure that sampling biases do not exist; a wide range of skipjack tuna sizes or ages need to be sampled so that the age-specific reproductive effort can be estimated; and females with hydrated oocytes need to be collected to verify that nearly all oocytes in the most advanced mode are hydrated and spawned. The last point seems particularly important because our estimated body weight cost of reproduction is high and is very sensitive to the estimate of batch fecundity. It may never be practical to analyze histologically sufficient numbers of specimens to estimate spawning frequency for all months and ages since some spawning occurs the year around (Nishikawa et al. 1985). On the other hand, it may be practical to calibrate the gonosomatic index (GSI) in peak spawning months using histological criteria and to use the GSI as a calibrated index of spawning frequency during months of low spawning frequency. We do not intend to continue this work but we encourage those working on the biology of tunas to include such studies in their research plans.

## ACKNOWLEDGMENTS

We thank the SWFC Honolulu Laboratory of the National Marine Fisheries Service, and particularly Christofer Boggs, for providing the samples of recently spawned skipjack tuna from the Kewalo Research Facility. We also thank Robert Gillett and Richard Farman (South Pacific Commission) for collecting the wild fish and Robert Kearney and Kurt Schaefer (Inter-American Tropical Tuna Commission) for reading the manuscript.

## LITERATURE CITED

- ALHEIT, J., V. H. ALARCON, AND B. J. MACEWICZ.  
1984. Spawning frequency and sex ratio in the Peruvian anchovy, *Engraulis ringens*. Calif. Coop. Oceanic Fish. Invest. Rep. 25:43-52.
- ARGUE, A. W., F. CONAND, AND D. WHYMAN.  
1983. Spatial and temporal distributions of juvenile tunas from the stomachs of tunas caught by pole-and-line gear in the central and western Pacific Ocean. Tuna and Billfish Assessment Programme, Tech. Rep. No. 9, 47 p. South Pacific Commission, Noumea, New Caledonia.
- BATTS, B. S.  
1972. Sexual maturity, fecundity, and sex ratios of the skipjack tuna, *Katsuwonus pelamis* (Linnaeus), in North Carolina waters. Trans. Am. Fish. Soc. 101:627-637.
- BRETSCHNEIDER, L. H., AND J. J. DUYVENE DE WIT.  
1947. Sexual endocrinology of non-mammalian vertebrates. Monographs on the Progress of Research in Holland During the War, Vol. 11, Elsevier, N.Y., 147 p.
- BROCK, V. E.  
1954. Some aspects of the biology of the aku, *Katsuwonus pelamis*, in the Hawaiian Islands. Pac. Sci. 8:94-104.
- BUNAG, D. M.  
1956. Spawning habits of some Philippine tuna based on diameter measurements of the ovarian ova. Philipp. J. Fish. 4(2):145-177.
- CAYRÉ, P.  
1981. Maturité sexuelle, fécondité et sex ratio du Listao (*Katsuwonus pelamis*) des côtes d'Afrique de l'ouest (20°N-0°N) étudiés à partir des débarquements thoniers (1977 à 1979) au port de Dakar, (Sénégal). Int. Comm. Conserv. Atl. Tunas, Collect. Vol. Sci. Pap. 15:135-149.
- COCHRAN, W. G.  
1977. Sampling techniques. 3d ed. John Wiley & Sons, N.Y., 428 p.
- DEMARTINI, E. E., AND R. K. FOUNTAIN.  
1981. Ovarian cycling frequency and batch fecundity in the queenfish, *Seriphus politus*: attributes representative of serial spawning fishes. Fish. Bull., U.S. 79:547-560.
- GOLDBERG, S. R., AND D. W. K. AU.  
In press. The spawning of skipjack tuna from southeastern Brazil as determined from histological examination of ovaries. In P. E. K. Symons, P. M. Miyake, and G. S. Sakagawa (editors), Proceedings of the ICCAT Conference on the International Skipjack Year Program. Int. Comm. Conserv. Atl. Tunas, Madrid, Spain.
- HUNTER, J. R., AND S. R. GOLDBERG.  
1980. Spawning incidence and batch fecundity in northern anchovy, *Engraulis mordax*. Fish. Bull., U.S. 77:641-652.
- HUNTER, J. R., AND R. LEONG.  
1981. The spawning energetics of female northern anchovy, *Engraulis mordax*. Fish. Bull., U.S. 79:215-230.
- HUNTER, J. R., AND N. C. H. LO, AND R. J. H. LEONG.  
1985. Batch fecundity in multiple spawning fishes. In R. Lasker (editor), An egg production method for estimating spawning biomass of pelagic fish: application to the northern anchovy (*Engraulis mordax*), p. 67-78. U.S. Dep. Commer., NOAA Tech. Rep. NMFS 36.
- HUNTER, J. R., AND B. J. MACEWICZ.  
1980. Sexual maturity, batch fecundity, spawning frequency, and temporal pattern of spawning for the northern anchovy, *Engraulis mordax*, during the 1979 spawning season. Calif. Coop. Oceanic Fish. Invest. Rep. 21:139-149.
- 1985a. Measurement of spawning frequency in multiple spawning fishes. In R. Lasker (editor), An egg production method for estimating spawning biomass of pelagic fish: application to the northern anchovy (*Engraulis mordax*), p. 79-94. U.S. Dep. Commer., NOAA Tech. Rep. NMFS 36.
- 1985b. Rates of atresia in the ovary of captive and wild northern anchovy, *Engraulis mordax*. Fish. Bull., U.S. 83:119-136.
- ISAAC-NAHUM, V. J., R. DE D. CARDOSO, G. SERVO, AND C. L. DEL B. ROSSI-WONGSCHOWSKI.  
1985. Some aspects of the spawning biology of the Brazilian sardine, *Sardinella brasiliensis*, (Clupeidae). International Council for the Exploration of the Sea. C.M. 1985/H:63. Pelagic Fish Comm. 12 p. (Mimeo.)
- IVERSON, R. T. B., E. L. NAKAMURA, AND R. M. GOODING.  
1970. Courting behavior in skipjack tuna, *Katsuwonus pelamis*. Trans. Am. Fish. Soc. 99:93.
- JOSEPH, J.  
1963. Fecundity of yellowfin tuna (*Thunnus albacares*) and skipjack (*Katsuwonus pelamis*) from the eastern Pacific Ocean. Inter-Am. Trop. Tuna Comm. 7:255-292.
- KAYA, C. M., A. E. DIZON, S. D. HENDRIX, T. K. KAZAMA, AND M. K. K. QUEENTH.  
1982. Rapid and spontaneous maturation, ovulation, and

- spawning of ova by newly captured skipjack tuna, *Katsuwonus pelamis*. Fish. Bull., U.S. 80:393-396.
- LAMBERT, J. G. D.  
1970. The ovary of the guppy, *Poecilia reticulata*. The atretic follicle, a *corpus atreticum* or a *Corpus luteum praevolutionis*. Z. Zellforsch 107:54-67.
- LEONG, R.  
1971. Induced spawning of the northern anchovy, *Engraulis mordax* Girard. Fish. Bull., U.S. 69:357-360.
- MATSUMOTO, W. M., R. A. SKILLMAN, AND A. E. DIZON.  
1984. Synopsis of biological data on skipjack tuna, *Katsuwonus pelamis*. U.S. Dep. Commer., NOAA Tech. Rep. NMFS Circ. 451, 92 p. [Also FAO Fisheries Synopsis No. 136.]
- NAGANUMA, A.  
1979. On spawning activities of skipjack tuna in the western Pacific Ocean. Bull. Tohoku Reg. Fish. Res. Lab. 40:1-13.
- NISHIKAWA, Y., M. HONMA, S. UEYANAGI, AND S. KIKAWA.  
1985. Average distribution of larvae of oceanic species of scombroid fishes, 1956-1981. Far Seas Fish. Res. Lab. S series 12, 99 p.
- PRESENT, T. M. C.  
1985. Patterns and processes of energy allocation between growth and reproduction in the marine shore fish, *Hypsooblennius jenkinsi*. Ph.D. Thesis, Univ. California, San Diego, La Jolla, 250 p.
- RAJU, G.  
1964. Studies on the spawning of the oceanic skipjack *Katsuwonus pelamis* (Linnaeus) in Minicoy waters. In Proceedings of the Symposium on Scombroid Fishes, p. 744-768. Mar. Biol. Assoc. India, Symp. Ser. 1.
- SCHAEFER, K. M.  
1986. Reproductive biology of the black skipjack, *Euthymus lineatus*. M.S. Thesis, San Diego State Univ., San Diego, CA, 115 p.
- SIMMONS, D. C.  
1969. Maturity and spawning of skipjack tuna (*Katsuwonus pelamis*) in the Atlantic Ocean, with comments on nematode infestation of the ovaries. U.S. Fish Wildl. Serv., Spec. Sci. Rep. Fish. 580, 17 p.



# SURVIVAL AND GROWTH OF STRIPED BASS, *MORONE SAXATILIS*, AND *MORONE* HYBRID LARVAE: LABORATORY AND POND ENCLOSURE EXPERIMENTS<sup>1</sup>

EDWARD D. HOUE<sup>2</sup> AND LAWRENCE LUBBERS III<sup>3</sup>

## ABSTRACT

Survival and growth of striped bass, *Morone saxatilis*, and its hybrids were compared in the first 30 days after hatching to determine if the reported heterosis of hybrid striped bass is evident in the larval stage. Larvae of striped bass (SB); striped bass × white bass (WBX), *M. saxatilis* ♀ × *M. chrysops* ♂; and striped bass × white perch (WPX), *M. saxatilis* ♀ × *M. americana* ♂, were reared under controlled conditions in the laboratory (19°C, 3‰) and under ambient conditions in freshwater pond enclosures. In the laboratory SB had a significantly higher mean survival rate at 30 days of age than either hybrid. In the pond enclosures neither mean survival nor size at 30 days differed significantly among the types of larvae. Mean rates of growth in length, which ranged from 0.28 to 0.36 mm d<sup>-1</sup> in the laboratory and from 0.30 to 0.32 mm d<sup>-1</sup> in the enclosures did not differ significantly among the types of larvae. Mean rates of growth in weight of 15.0 to 19.0% d<sup>-1</sup> were not significantly different in the laboratory, but the rates did differ significantly in the pond enclosures, where the WBX (17.9% d<sup>-1</sup>) and WPX (17.3% d<sup>-1</sup>) rates were significantly higher than the SB (15.5% d<sup>-1</sup>). If 30-day-old fry were to be reared in hatcheries, there is no clear production advantage for hybrids. A possible initial expression of hybrid vigor, recognized by faster rates of growth in weight, was evident in WBX and WPX at 1 month of age in the pond enclosures but not in the laboratory tanks.

A series of recruitment failures (Cooper and Polgar 1981; Boreman and Austin 1985) has stimulated the development of hatcheries to culture juvenile striped bass, *Morone saxatilis*, or its hybrids for stocking in the Chesapeake Bay region. The striped bass and the striped bass × white bass, *M. chrysops*, hybrid have been cultured for stocking in freshwater and estuarine systems for several years and also have potential for commercial aquaculture (Bonn et al. 1976; Kerby et al. 1983). A second hybrid, striped bass × white perch, *M. americana*, has been produced (Bayless 1972; Kerby and Joseph 1979) although its potential is less known. The striped bass × white bass hybrid demonstrates an apparent heterosis and usually grows and survives better during the first two years of life than does striped bass under similar culture conditions (Logan 1968; Ware 1975; Williams et al. 1981; Kerby et al. 1983).

The objective of our experiments was to determine if the apparent heterosis of the striped bass × white bass hybrid is established in the larval stage, between hatching and 30 d posthatch. We compared growth and survival of striped bass, striped bass × white bass, and striped bass × white perch (referred to hereafter as "striped bass", "white bass hybrid", and "white perch hybrid") in laboratory experiments and in fine-mesh enclosures within hatchery ponds.

## METHODS

### Laboratory Experiments

Larvae originated from eggs of a single female striped bass, 15.4 kg, gillnetted in the Patuxent River, transported to the Manning Hatchery, Cedarville, MD, on 24 April 1982 and spawned by injection of human chorionic gonadotropin on 27 April. Sperm from 2 male striped bass (Patuxent River), 12 male white bass (Tennessee Fish Commission), and 2 male white perch (Patuxent River) were used to fertilize portions of the spawned eggs. Embryos were incubated in 114 L polyethylene incubation chambers and larvae were held there in 15°-16°C freshwater until 6 d after hatching when some were brought to the Chesapeake Biological Laboratory.

<sup>1</sup>Contribution No. 1721, Center for Environmental and Estuarine Studies of the University of Maryland.

<sup>2</sup>University of Maryland, Center for Environmental and Estuarine Studies, Chesapeake Biological Laboratory, Solomons, MD 20688-0038.

<sup>3</sup>University of Maryland, Center for Environmental and Estuarine Studies, Chesapeake Biological Laboratory, Solomons, MD; present address: Maryland Department of Natural Resources, Tidewater Administration, Tawes State Office Building, Annapolis, MD 21401.

## Rearing Systems

The striped bass and hybrid larvae were reared from 6 to 30 d after hatching in 36 L, rectangular glass aquaria. Each aquarium was lighted by two 61 cm, 40-W fluorescent lights 25 cm overhead on a 12-h light-12-h dark cycle. Immersion heaters controlled the temperature. For additional control, the aquaria sat in a shallow, refrigerated waterbath. An airstone in each aquarium provided oxygen and kept food dispersed.

Temperature was maintained at  $19^{\circ} \pm 1^{\circ}\text{C}$ . Salinity was held at 3‰ by diluting 5  $\mu\text{m}$  filtered Patuxent River water with well water. All larvae were fed *Artemia* nauplii, eggs of which originated from Shark Bay, Australia. Water quality was maintained by replacing half of the water in each aquarium on alternate days. Feces, dead *Artemia*, and dead larvae were siphoned off each day. Ammonia levels were checked on 13 May (16 d after hatching) and were <0.25 ppm in all tanks. The pH in the nine rearing tanks ranged from 8.0 to 8.4 on 11 May (14 d after hatching) and from 8.3 to 8.4 on 26 May (29 d after hatching).

## Food Levels, Larval Densities, and Sampling

Two *Artemia* nauplii levels, 100  $\text{L}^{-1}$  and 500  $\text{L}^{-1}$ , were tested. The lower level is similar to zooplankton densities in Chesapeake Bay subestuaries where striped bass larvae occur (Miller 1978). For each of the larval types duplicate experiments were run at the 500  $\text{L}^{-1}$  level but only a single experiment was run at 100  $\text{L}^{-1}$ . Food was first offered at 6 d after hatching when the experiments started. *Artemia* nauplii concentrations in each aquarium were checked twice daily by counting the number in pipetted 100 cc aliquots. Food levels were maintained and adjusted by adding suspensions of *Artemia* of known concentration to the aquaria.

In each aquarium, 144 larvae were stocked at an initial, relatively low density of 4.0  $\text{L}^{-1}$ . Some larvae were preserved in 5% Formalin<sup>4</sup> at the start of experiments (6 d after hatching). Three or four larvae from each aquarium were sampled and preserved on days 8, 10, 13, 16, 19, and 25 for growth rate determination. Samples (15-27 larvae) of survivors were preserved at 30 d when experiments were terminated. Preserved larvae were

measured and wet-weighed (nearest 0.1 mg after blotting).

## Analysis

The expected number of survivors in each experiment is the number that would have survived had no larvae been sampled and preserved during the experiments. If  $Z = F + M$ , where  $Z$  is instantaneous total mortality and  $F$  is preservation mortality, then  $M$  is mortality from all other causes. The expression  $N_t = N_0 e^{-(F+M)t}$  applies, where  $N_t$  is number of survivors at age  $t$  (30 d) and  $N_0$  is initial number of stocked larvae (144 at 6 d). Knowing  $N_0$ ,  $N_t$ ,  $Z$ , and  $F$ , we solved for  $M$  and then estimated expected survivors, if no larvae had been preserved, as  $N'_t = N_0 e^{-Mt}$ . Analysis of variance was used to test for survival differences among types of larvae and between food levels.

Lengths and weights of the three types of larvae were compared at 6 d after hatching and when experiments terminated. In addition, lengths and weights at the 100  $\text{L}^{-1}$  and 500  $\text{L}^{-1}$  food levels were compared to determine if food concentration affected mean sizes. Comparisons were carried out using analysis of variance followed by the SNK multiple comparison test.

Growth in length was described by linear regressions of standard length on days after hatching,  $l_t = a + bt$ , where  $l_t$  is estimated length (mm) at age  $t$  and  $b$  is daily growth rate ( $\text{mm day}^{-1}$ ). Growth in weight was determined from the exponential regression of wet weight (mg) on days after hatching,  $W_t = W_0 e^{Gt}$ , where  $W_t$  is estimated weight at age  $t$  and  $G$  is the instantaneous daily growth coefficient ( $\text{day}^{-1}$ ). Percent daily weight gains were calculated as  $100(e^G - 1)$ . Weight-length relationships were obtained from the power function,  $W = aL^b$ , where  $W$  is wet weight (mg),  $l$  is standard length (mm), and  $a$  and  $b$  are coefficients from the fitted regression.

## Enclosure Experiments

Cubic enclosures, 1.32 m on each side, open at the top, and constructed of wood frames and 500  $\mu\text{m}$  Nitex mesh, were submerged to a depth of 1.12 m in a 1-acre, freshwater pond of 1.5 m mean depth at the Manning Hatchery. The nine enclosures, each holding 2  $\text{m}^3$ , were placed in the pond from 3 to 5 d before larvae were stocked. Enclosures were assigned to the striped bass and two hybrids using a linearized Latin-square design (Steel and Torrie 1960) with three replicates for each type of larva. The larvae were progeny of a single 10.4 kg female

<sup>4</sup>Reference to trade names does not imply endorsement by the National Marine Fisheries Service.

striped bass from the Patuxent River. Sperm from Patuxent River male striped bass were used to fertilize eggs. The hybrids resulted from fertilization by Tennessee white bass males and Patuxent River white perch males.

Larvae were held in hatchery troughs and fed *Artemia* nauplii from 6 to 8 d after hatching. A total of 2,500 9-d-old larvae were stocked in each enclosure on 12 May 1983. Larvae were sampled by dipnet and preserved in 5% Formalin at 13, 17, 20, 23, and 27 d after hatching. At 30 d all survivors from each enclosure were counted and samples preserved. Temperatures in the pond ranged from 18.5° to 22.0°C during the course of the experiment.

### Pond Zooplankton

The kinds and abundances of potentially edible zooplankton were sampled on each day that larvae were collected, using a 15 cm diameter, 72  $\mu$ m mesh plankton net that was lifted vertically in each enclosure. For comparison, zooplankton also was collected in three vertical lifts of the net outside the enclosures.

### Analysis

Survival, lengths and weights at age, growth rates, and weight-length relationships were calculated as for the laboratory experiments. Variance, covariance, and regression analyses were used to test for differences in means among the striped bass and two types of hybrid larvae.

## RESULTS

### Laboratory Experiments

#### Survival

Survival at 30 d after hatching ranged from 45.8 to 85.4% (Table 1). Mean percentage survivals were striped bass, 84.7%; white bass hybrid, 60.4%; and white perch hybrid, 73.1%. The mean expected number of survivors differed significantly among types of larvae (ANOVA,  $P < 0.05$ ). Mean survival of striped bass was significantly higher than that of the white bass hybrids (SNK multiple comparison procedure,  $P < 0.05$ ). There were no detectable differences in mean survival between the two *Artemia* nauplii feeding levels (ANOVA,  $P > 0.05$ ).

#### Size-at-Age

The white perch hybrid larvae were significantly shorter and weighed less than either striped bass or white bass hybrid larvae when the experiments began at 6 d after hatching, before larvae had been fed (Table 2; ANOVA,  $P < 0.05$ ).

At 30 d after hatching there were some statistically significant differences in mean lengths and weights among the three types of larvae, and between the two food levels, but no clear result was obtained (Table 2). No significant differences among mean lengths or weights of the white bass hybrid larvae were detected between the 100 L<sup>-1</sup> and 500 L<sup>-1</sup> food levels. But, the striped bass and white

TABLE 1.—Survival at 30 d after hatching of striped bass (SB), striped bass  $\times$  white bass (WBX), and striped bass  $\times$  white perch (WPX) larvae in laboratory experiments at two food levels.

Larvae and experiment numbers	<i>Artemia</i> concentration (number L <sup>-1</sup> )	Number preserved	Number of survivors	Expected number <sup>1</sup> of survivors	Expected instantaneous daily mortality rates (Z)	Expected percentage survival
SB-1	500	20	106	123	0.0066	85.4
SB-2	500	18	108	123	0.0066	85.4
SB-3	100	19	104	122	0.0069	83.3
SB mean			106.0	<sup>2</sup> 122.0	0.0069	84.7
WBX-1	500	18	58	66	0.0325	45.8
WBX-2	500	20	93	108	0.0120	75.0
WBX-3	100	18	76	87	0.0210	60.4
WBX mean			75.7	87.0	0.0210	60.4
WPX-1	500	22	85	100	0.0152	69.4
WPX-2	500	18	100	114	0.0097	79.2
WPX-3	100	18	89	102	0.0144	70.8
WPX mean			91.3	105.3	0.0130	73.1

<sup>1</sup>Expected number of survivors is the adjusted number, accounting for samples of larvae that were preserved during the experiment (see Methods).

<sup>2</sup>The SB mean differed significantly from the WBX and WPX means (Analysis of variance followed by SNK multiple comparison procedure,  $P < 0.05$ ).

TABLE 2.—Mean standard lengths and wet weights of larvae of striped bass (SB), striped bass × white bass (WBX), and striped bass × white perch (WPX) from specimens preserved at 6 d after hatching, immediately before the experiments began and at 30 d after hatching when the experiments were terminated.

SIX DAYS					
Larvae	Number preserved	Mean length (mm) and standard error		Mean wet weight (mg) and standard error	
		$\bar{x}$	$s_{\bar{x}}$	$\bar{x}$	$s_{\bar{x}}$
SB	15	5.49	0.06	0.95	0.04
WBX	19	5.29	0.03	0.96	0.03
WPX	17	5.20	0.06	10.85	0.02

THIRTY DAYS						
Larvae and experiment number	Artemia concentration (number L <sup>-1</sup> )	Number preserved	Mean length (mm) and standard error		Mean wet weight (mg) and standard error	
			$\bar{x}$	$s_{\bar{x}}$	$\bar{x}$	$s_{\bar{x}}$
SB-3	100	18	<sup>2</sup> 12.39	0.17	<sup>2</sup> 25.7	1.4
SB-1	500	20	<sup>3</sup> 14.26	0.17	449.1	2.2
SB-2	500	19	<sup>3</sup> 14.57	0.17	450.4	1.8
SB mean			13.74		41.7	
WBX-3	100	15	13.02	0.30	30.1	2.1
WBX-1	500	18	12.68	0.26	28.8	2.2
WBX-2	500	19	12.73	0.38	29.3	3.6
WBX mean			12.81		29.4	
WPX-3	100	21	<sup>2</sup> 11.86	0.25	<sup>2</sup> 21.1	1.6
WPX-1	500	18	13.22	0.31	33.6	2.2
WPX-2	500	27	13.15	0.22	35.0	2.2
WPX mean			12.74		29.9	

<sup>1</sup>Differ significantly,  $P < 0.05$ , from both SB and WBX. ANOVA followed by SNK multiple comparison procedure.

<sup>2</sup>Differ significantly,  $P < 0.05$ , from the 500 L<sup>-1</sup> means. ANOVA.

<sup>3</sup>Differ significantly,  $P < 0.05$ , from all WBX and WPX mean lengths. ANOVA followed by SNK multiple comparison procedure.

<sup>4</sup>Differ significantly,  $P < 0.05$ , from all WBX and WPX mean weights. ANOVA followed by SNK multiple comparison procedure.

perch hybrid larvae were longer and heavier at the 500 L<sup>-1</sup> level (ANOVA,  $P < 0.05$ ). At the 500 L<sup>-1</sup> food level the striped bass were significantly heavier than either hybrid (ANOVA and SNK multiple comparison procedure,  $P < 0.05$ ). The mean lengths of 30-d-old striped bass at 500 L<sup>-1</sup> food level were significantly longer than the mean lengths of the hybrids (Table 2) (ANOVA and SNK multiple comparison procedure,  $P < 0.05$ ).

### Growth Rates

From 6 to 30 d after hatching larvae grew in length at mean rates ranging from 0.28 to 0.36 mm d<sup>-1</sup> (Table 3, Fig. 1). There were no significant differences in the growth-in-length rates among the three types of larvae at the 500 L<sup>-1</sup> *Artemia* food level.

The exponential regressions of mean weights on age (Table 3, Fig. 2) gave instantaneous growth coefficients ranging from 0.1396 to 0.1739 d<sup>-1</sup>, equivalent to 15-19% d<sup>-1</sup> weight gains. None of the

coefficients differed significantly from each other (ANCOVA,  $P > 0.50$ ).

There were no significant differences in weight-length relationships among types of larvae or between food levels (ANCOVA,  $P > 0.50$ ). An average relationship, based on the total regression component of the ANCOVA, is  $W = 7.17 \times 10^{-4} l^{4.2399}$ .

## Enclosure Experiments

### Survival

Survival of striped bass and hybrid larvae at 30 d after hatching ranged from 13.1 to 33.8% in the nine enclosures. At 30 d there was no indication that striped bass or either hybrid was superior in survival capability. The mean percentage survivals for the three types of larvae ranged from 22.0 to 28.5% (Table 4B) and did not differ significantly (ANOVA on arcsin mean percent survivals). The mean overall survival rate for the three kinds of larvae was 25.0%.



TABLE 3.—Linear regressions describing growth in length and exponential regressions describing growth in weight of striped bass (SB), striped bass × white bass (WBX), and striped bass × white perch (WPX) during the period 6-30 d after hatching. In the linear regression,  $l$  is standard length in mm,  $t$  equals days after hatching,  $b$  equals growth rate in mm, and  $a$  is the  $y$ -axis intercept. In the exponential regressions,  $W$  is wet weight in mg,  $t$  equals days after hatching,  $G$  is the instantaneous growth coefficient, and  $W_0$  is the theoretical weight in mg at time zero.

LENGTH					
Larvae and experiment number	<i>Artemia</i> concentration (number L <sup>-1</sup> )	Equation $l = a + bt$	Standard error of $b$	$r^2$	
SB-3	100	$l = 3.64 + 0.29t$	0.01	0.99	
SB-1	500	$l = 3.13 + 0.36t$	0.02	0.99	
SB-2	500	$l = 3.20 + 0.36t$	0.01	0.99	
WBX-3	100	$l = 3.10 + 0.34t$	0.02	0.98	
WBX-1	500	$l = 3.36 + 0.32t$	0.01	0.99	
WBX-2	500	$l = 3.31 + 0.32t$	0.02	0.98	
WPX-3	100	$l = 3.70 + 0.28t$	0.02	0.98	
WPX-1	500	$l = 3.18 + 0.32t$	0.01	0.99	
WPX-2	500	$l = 3.22 + 0.32t$	0.01	0.99	

WEIGHT					
Larvae and experiment number	<i>Artemia</i> concentration (number L <sup>-1</sup> )	Equation $W = W_0 e^{Gt}$	Standard error of $G$	$r^2$	Percent gain (% d <sup>-1</sup> )
SB-3	100	$W = 0.51 e^{0.1472t}$	0.0158	0.94	15.9
SB-1	500	$W = 0.41 e^{0.1713t}$	0.0141	0.96	18.7
SB-2	500	$W = 0.42 e^{0.1739t}$	0.0146	0.96	19.0
WBX-3	100	$W = 0.41 e^{0.1581t}$	0.0147	0.95	17.1
WBX-1	500	$W = 0.41 e^{0.1576t}$	0.0145	0.95	17.1
WBX-2	500	$W = 0.31 e^{0.1645t}$	0.0154	0.95	17.9
WPX-3	100	$W = 0.48 e^{0.1396t}$	0.0123	0.96	15.0
WPX-1	500	$W = 0.33 e^{0.1625t}$	0.0073	0.96	17.6
WPX-2	500	$W = 0.35 e^{0.1520t}$	0.0091	0.98	16.4

<sup>1</sup>Differ significantly from SB-1 and SB-2,  $P < 0.01$ . ANCOVA followed by SNK multiple comparison procedure.

The mean instantaneous mortality rates during the 9-30 d after hatching ranged from 0.0601 to 0.0713 d<sup>-1</sup>, equivalent to 5.8 to 6.9% d<sup>-1</sup> (Table 4B). Cannibalism probably occurred during the last 10 d of the experiment. Some large survivors had small larvae in their stomachs when the experiments ended.

### Size-at-Age

When larvae were stocked in the enclosures at 9 d after hatching, white bass hybrid larvae were significantly heavier (ANOVA,  $P < 0.01$ ) and slightly, but not significantly, longer than white perch hybrid and striped bass larvae (Table 4A). Because all larvae had been fed *Artemia* nauplii in the hatchery for 3 d prior to stocking it is not known if the sizes at stocking reflect the relative weights and lengths of the three kinds of larvae before they began to feed.

At 30 d after hatching mean lengths of striped

bass and hybrid larvae from the enclosures ranged from 12.58 to 12.96 mm SL (Table 4C). Mean wet weights ranged from 38.38 to 43.28 mg (Table 4C). There were no significant differences in mean lengths or weights among the three types of larvae or among the nine enclosures (ANOVA,  $P > 0.25$ ).

### Growth Rates

Mean rates of growth in length for the striped bass and hybrid larvae ranged from 0.30 to 0.32 mm d<sup>-1</sup> (Table 4D; Fig. 3). There were no significant differences in the rates among types of larvae or among replicate enclosures (ANCOVA,  $P > 0.10$ ).

The common, instantaneous rates of growth in weight were 0.1444 for striped bass (= 15.5% d<sup>-1</sup>), 0.1650 for white bass hybrids (= 17.9% d<sup>-1</sup>) and 0.1593 for white perch hybrids (= 17.3% d<sup>-1</sup>). The rates of growth (Table 4E; Fig. 4) differed significantly among the three types of larvae (ANCOVA,  $P < 0.05$ ) but not among enclosures ( $P > 0.10$ ). The

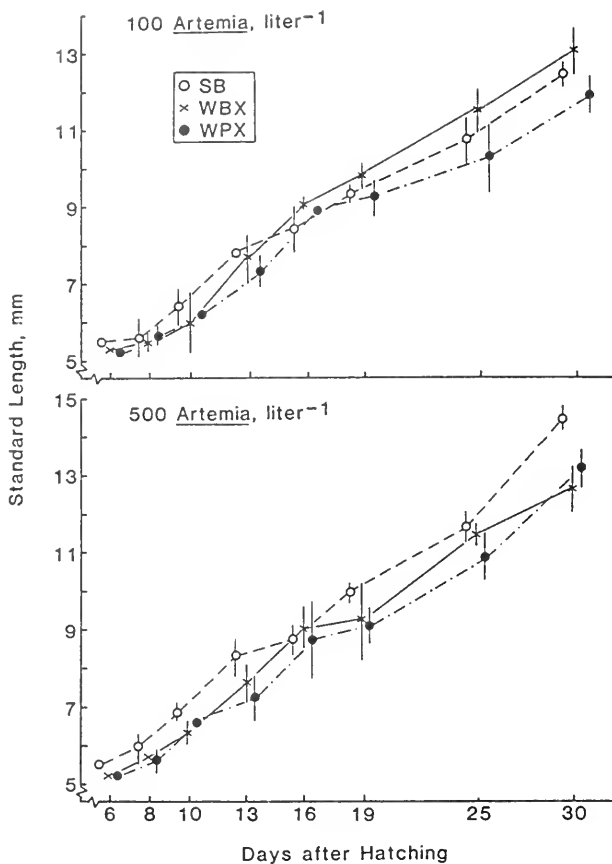

FIGURE 1.—Mean standard lengths  $\pm 2$  standard errors of striped bass (SB), striped bass  $\times$  white bass (WBX), and striped bass  $\times$  white perch (WPX) larvae from 6 to 30 d after hatching, reared at two food levels in the laboratory.

white bass hybrid and white perch hybrid rates were significantly higher than that for striped bass larvae (SNK multiple comparison procedure,  $P < 0.05$ ).

#### Weight-Length Relationships

The wet weight-standard length relationships differed significantly among the three types of larvae (ANCOVA,  $P < 0.001$ ). The power coefficient of the white bass hybrid larvae was higher than those of the striped bass and white perch hybrid larvae (SNK multiple comparison test,  $P < 0.01$ ) (Table 4F).

#### Pond Zooplankton

Copepod nauplii and adults (*Diaptomus* spp. and other calanoid species) and cladocerans (*Bosmina*, *Scapholebris*, *Ceriodaphnia*, and *Daphnia*) were

abundant in the pond and in the enclosures (Fig. 5). The summed cladoceran and copepod densities declined rapidly in the pond from  $>1,000\text{ L}^{-1}$ , when the larvae were stocked, to approximately  $400\text{ L}^{-1}$  during the last 10 d of the experiment. Densities within the enclosures declined from approximately  $1,000\text{ L}^{-1}$  at the time larvae were stocked to  $100\text{ L}^{-1}$  when the experiments ended.

Samples of 12-20 larvae of each type were examined for stomach contents on day 30. The smallest larvae of each type had eaten cladocerans and copepods. The largest individuals had eaten chironomid larvae and zooplankton. Two of 20 individuals of striped bass and white bass hybrids had eaten fish larvae, proof that cannibalism was occurring.

## DISCUSSION

Neither striped bass nor hybrid larvae, in the lab-

TABLE 4.—Summary of data and analyses from 2 m<sup>3</sup> enclosure experiments in the Manning Hatchery pond, 1983. Three replicate enclosures were run for each type of larva: Striped bass (SB), striped bass × white bass (WBX), and striped bass × white perch (WPX). A) Mean standard lengths and wet weights at 9 d after hatching, prior to stocking in enclosures. B) Percent survivals at 30 d after hatching. C) Mean lengths and weights at 30 d after hatching. D) Growth-in-length equations ( $l_t$  = standard length in mm at age  $t$ ;  $t$  = days after hatching;  $S_b$  = standard error of the regression coefficient;  $r^2$  = coefficient of determination). E) Exponential, growth-in-weight equations ( $W_t$  = wet weight in mg at age  $t$ ;  $t$  = days after hatching;  $S_G$  = standard error of the exponential coefficient;  $r^2$  = coefficient of determination). F) Power function equations of the wet weight-standard length relationships ( $W$  = wet weight in mg;  $l$  = standard length in mm;  $S_b$  = standard error of the power coefficient;  $r^2$  = coefficient of determination).

A. Type of larva					D. Type of larva				
	<i>n</i>	Standard length (mm)		Wet weight (mg)		Equation	<i>n</i>	<i>S<sub>b</sub></i>	<i>r</i> <sup>2</sup>
		$\bar{x}$	<i>s<sub>x</sub></i>	$\bar{x}$	<i>s<sub>x</sub></i>				
SB	13	6.12	0.06	1.15	0.08	$l_t = 3.09 + 0.30t$	253	0.0136	0.66
WBX	13	6.19	0.14	1.66	0.11	$l_t = 3.22 + 0.31t$	245	0.0130	0.70
WPX	15	5.87	0.13	1.33	0.11	$l_t = 2.96 + 0.32t$	263	0.0100	0.79

B. Type of larva				E. Type of larva			
	<i>n</i>	Percent survival		Equation	<i>n</i>	<i>S<sub>G</sub></i>	<i>r</i> <sup>2</sup>
		$\bar{x}$	<i>s<sub>x</sub></i>				
SB	22.1	3.4	0.0713	$W_t = W_0 e^{Gt}$	253	0.0044	0.81
WBX	22.0	6.2	0.0695	${}^2W_t = 0.26 e^{0.1650t}$	245	0.0041	0.87
WPX	28.5	2.1	0.0601	${}^2W_t = 0.30 e^{0.1593t}$	263	0.0037	0.88

C. Type of larva					F. Type of larva				
	<i>n</i>	Standard length (mm)		Wet weight (mg)		Equation	<i>n</i>	<i>S<sub>b</sub></i>	<i>r</i> <sup>2</sup>
		$\bar{x}$	<i>s<sub>x</sub></i>	$\bar{x}$	<i>s<sub>x</sub></i>				
SB	78	12.58	0.24	38.38	3.57	$W = 6.23 \times 10^{-4} L^{4.2879}$	253	0.0469	0.97
WBX	78	12.90	0.23	43.28	3.86	${}^3W = 2.27 \times 10^{-4} L^{4.7114}$	245	0.0536	0.97
WPX	78	12.96	0.12	39.73	1.23	$W = 5.44 \times 10^{-4} L^{4.3496}$	263	0.0512	0.97

<sup>1</sup>Significant at  $P < 0.05$ . ANOVA.

<sup>2</sup>The WBX and WPX exponential coefficients differed significantly,  $P < 0.05$ , from the SB coefficient. ANCOVA followed by SNK multiple comparison procedure.

<sup>3</sup>The WBX power coefficient differed significantly,  $P < 0.05$ , from the SB and WPX coefficients. ANCOVA followed by SNK multiple comparison procedure.

oratory and in freshwater pond enclosures, demonstrated clearly superior growth or survival. The apparent heterosis in young-of-the-year and sub-adult white bass hybrids (Logan 1968; Ware 1975; Bonn et al. 1976; Williams et al. 1981; Kerby et al. 1983) was not evident during the first month after hatching. Survival and growth rates of the three types of larvae were relatively high in all of our experiments, indicating that striped bass and its hybrids may have near-equal production potential up to 30 d of age.

Larvae grew and survived surprisingly well at the relatively low food concentrations that we offered in the laboratory. There was evidence that striped bass and white perch hybrid larvae grew faster at the 500 L<sup>-1</sup> than at the 100 L<sup>-1</sup> *Artemia* concentration but there was no significant difference in size of white bass hybrid larvae reared at those two food levels. Survival of all three types of larvae did not differ between the two food levels, demonstrating that high survival and favorable growth can be ob-

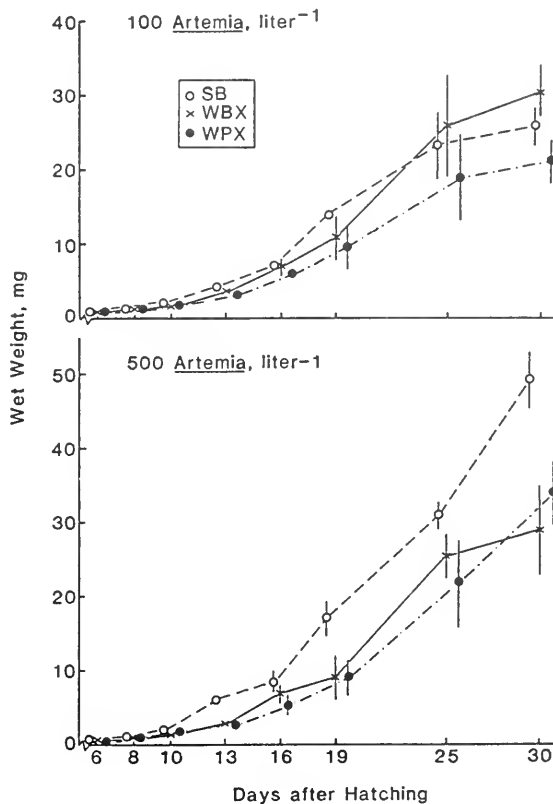

FIGURE 2.—Mean wet weights ± 2 standard errors of striped bass (SB), striped bass × white bass (WBX), and striped bass × white perch (WPX) larvae from 6 to 30 d after hatching, reared at two food levels in the laboratory.

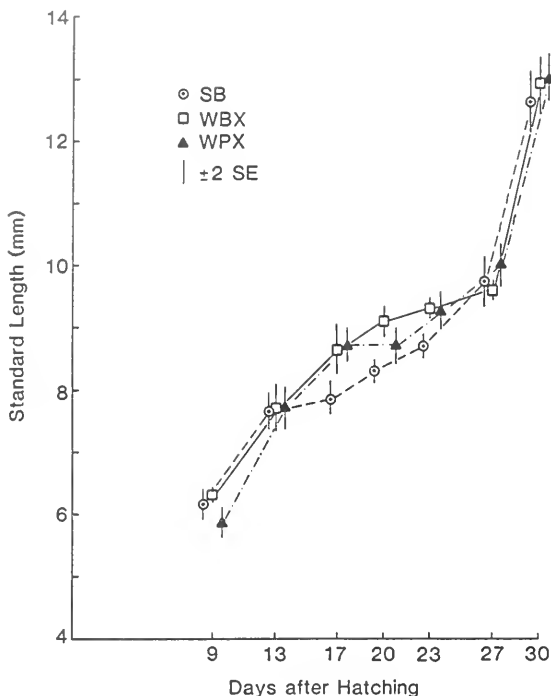

FIGURE 3.—Mean standard lengths ( $\pm 2$  standard errors) of striped bass (SB), striped bass  $\times$  white bass (WBX), and striped bass  $\times$  white perch (WPX) larvae on seven dates in  $2\text{ m}^3$  enclosure experiments, Manning Hatchery pond.

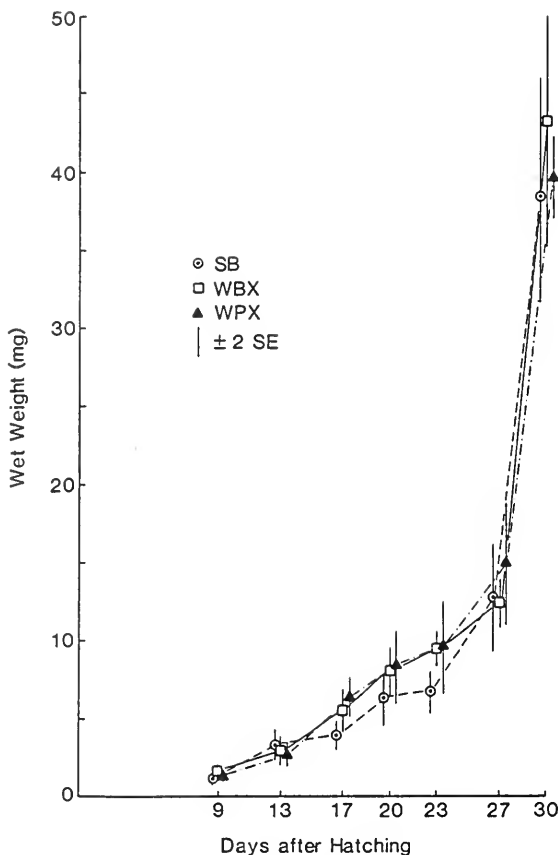

FIGURE 4.—Mean wet weights ( $\pm 2$  standard errors) of striped bass (SB), striped bass  $\times$  white bass (WBX), and striped bass  $\times$  white perch (WPX) larvae on seven dates in  $2\text{ m}^3$  enclosure experiments, Manning Hatchery pond.

tained for *Morone* larvae at low *Artemia* concentrations, if those concentrations are maintained at the nominal levels. Our laboratory survival rates at low food levels were higher than those reported for striped bass larvae in the literature (e.g., Doroshev 1970; Miller 1978; Rogers and Westin 1981; Eldridge et al. 1981, 1982), which generally had indicated that nominal *Artemia* concentrations nearly an order of magnitude higher than  $500\text{ L}^{-1}$  were required to obtain high survival rates.

The laboratory and pond enclosure methods to assess striped bass and hybrid larvae performance differed in many respects and could have influenced results. Besides great differences in enclosed volumes ( $36\text{ L}$  vs.  $2\text{ m}^3$ ), environmental factors and foods differed. Laboratory experiments were run at  $19.0^\circ\text{C}$  and  $3\text{‰}$  salinity, because low salinities are known to improve striped bass larvae survival (Bonn et al. 1976; Kerby et al. 1983). Temperature increased from  $18.5^\circ$  to  $22.5^\circ\text{C}$  in the Manning Hatchery freshwater pond during the 3-wk experiment. The laboratory-reared fish were fed only *Artemia* nauplii at controlled concentrations while enclosure fish had a variable zooplankton diet.

Survival of all larvae was lower in the pond enclosures than in the laboratory tanks (Tables 1, 4). White bass hybrids had the lowest mean survival rate in the laboratory but they survived as well as striped bass and white perch hybrids in the pond enclosures. At the relatively high  $500\text{ L}^{-1}$  *Artemia* level laboratory-reared striped bass larvae were longer and heavier than either of the hybrids at 30 d after hatching. In the pond enclosures no significant differences in mean lengths or weights among the three types of larvae were detected at 30 d. The weight-length relationship of pond enclosure, white bass hybrid larvae had a relatively high exponential coefficient, indicating that they were heavier at a given length than the other types of larvae. Mean weights of both hybrids at 30 d were considerably heavier in the pond enclosures than in the laboratory tanks. Relatively great size variability in the

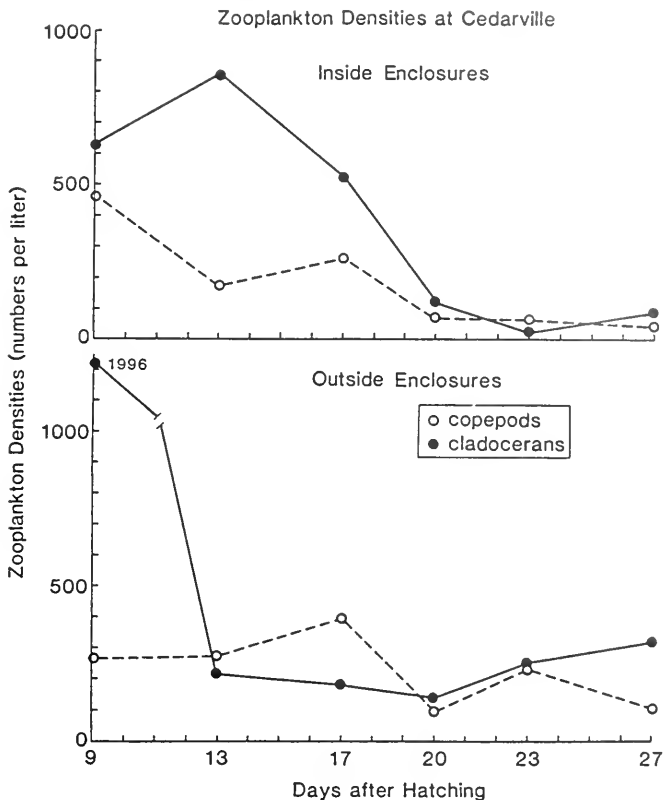

FIGURE 5.—Mean densities of copepods and cladocerans inside and outside of the 2 m<sup>3</sup> enclosures used for striped bass and hybrid larvae experiments in the Manning Hatchery pond.

enclosures may have resulted in part from cannibalism and consumption of chironomids by some larvae, promoting their relatively rapid growth.

Although mean weights and lengths of 30-d-old striped bass and the two hybrids from the pond enclosures did not differ, the instantaneous rate of growth in weight of striped bass larvae was significantly lower than that of either hybrid (Table 4E). Had the enclosure experiments proceeded for a few more days the hybrids would have attained larger size than the striped bass. For example, at 35 d after hatching the striped bass would have weighed 20 mg less than either hybrid. The heterotic effect may begin to express itself at approximately 1 mo of age. Alternatively, the freshwater environment, increasing temperatures, and the prey available in the pond may have selectively favored growth of hybrids during the last few days of the experiment.

If 30-d-old fry are to be produced for stocking, there is no apparent immediate advantage to rear hybrids rather than striped bass. Our laboratory and pond enclosure studies did not demonstrate advan-

tages in survival or production of hybrids. The pond enclosure results did suggest that hybrids may begin to achieve an advantage in growth rates just prior to 1 mo of age. Important questions about comparative energetics, nutrition, and genetics still remain to be answered to understand the biology of larval *M. saxatilis* or its hybrids and the consequences of their possible release into natural systems such as Chesapeake Bay.

#### ACKNOWLEDGMENTS

The research was supported by contracts F26-82-003 and F31-83-008 from the Maryland Department of Natural Resources, Tidewater Administration, Tidal Fisheries Division. Assistance in the laboratory was provided by H. Hornick, W. Roosenburg, and V. Saksena. Larvae were supplied by the Maryland DNR Manning Hatchery at Cedarville. The assistance of DNR personnel, particularly M. Beaven, H. King, and J. Stringer, is gratefully acknowledged. We appreciate the critiques of early

drafts of the manuscript provided by E. J. Chesney, H. King, J. Kraeuter, and L. C. Woods III.

## LITERATURE CITED

- BAYLESS, J. D.  
1972. Artificial propagation and hybridization of striped bass, *Morone saxatilis* (Walbaum). South Carolina Wildl. Mar. Resour. Dep., 135 p.
- BONN, E. W., W. M. BAILEY, J. C. BAYLESS, K. E. ERICKSON, AND R. E. STEVENS.  
1976. Guidelines for striped bass culture. Southern Div., Am. Fish. Soc., 103 p. plus app.
- BOREMAN, J., AND H. M. AUSTIN.  
1985. Production and harvest of anadromous striped bass stocks along the Atlantic coast. Trans. Am. Fish. Soc. 114:3-7.
- COOPER, J. C., AND T. T. POLGAR.  
1981. Recognition of year-class dominance in striped bass management. Trans. Am. Fish. Soc. 110:180-187.
- DOROSHEV, S. I.  
1970. Biological features of the eggs, larvae and young of the striped bass [*Roccus saxatilis* (Walbaum)] in connection with the problem of its acclimatization in the USSR. J. Ichthyol. 10:235-248.
- ELDRIDGE, M. B., J. A. WHIPPLE, AND M. J. BOWERS.  
1982. Bioenergetics and growth of striped bass, *Morone saxatilis*, embryos and larvae. Fish. Bull., U.S. 80:461-474.
- ELDRIDGE, M. B., J. A. WHIPPLE, D. ENG, M. J. BOWERS, AND B. M. JARVIS.  
1981. Effects of food and feeding factors on laboratory-reared striped bass larvae. Trans. Am. Fish. Soc. 110: 111-120.
- KERBY, J. H., AND E. B. JOSEPH.  
1979. Growth and survival of striped bass and striped bass  $\times$  white perch hybrids. Proc. Annu. Conf. Southeastern Assoc. Fish Wildl. Agencies 32:715-726.
- KERBY, J. H., L. C. WOODS III, AND M. T. HUISE.  
1983. Culture of the striped bass and its hybrids: A review of methods, advances and problems. In R. F. Stickney and S. P. Meyers (editors), Proceedings of the Warmwater Fish Culture Workshop, p. 23-54. World Maricult. Soc., Spec. Publ. 3.
- LOGAN, H. J.  
1968. Comparison of growth and survival rates of striped bass and striped bass  $\times$  white bass hybrids under controlled environments. Proc. Annu. Conf. Southeast Assoc. Fish Game Comm. 21:260-263.
- MILLER, P. E.  
1978. Food habit study of striped bass post yolk-sac larvae. Johns Hopkins Univ., Chesapeake Bay Inst., Spec. Rep. 68, 49 p.
- ROGERS, B. A., AND D. T. WESTIN.  
1981. Laboratory studies on effects of temperature and delayed initial feeding on development of striped bass larvae. Trans. Am. Fish. Soc. 110:100-110.
- STEEL, R. G. D., AND J. H. TORRIE.  
1960. Principles and procedures of statistics. McGraw-Hill Book Co., Inc., N.Y., 481 p.
- WARE, F. J.  
1975. Progress with *Morone* hybrids in fresh water. Proc. Annu. Conf. Southeast Assoc. Fish Game Comm. 28:48-54.
- WILLIAMS, J. E., P. A. SANDIFER, AND J. M. LINDBERGH.  
1981. Net-pen culture of striped bass  $\times$  white bass hybrids in estuarine waters of South Carolina: a pilot study. J. World Maricult. Soc. 12:98-110.

# ASPECTS OF THE REPRODUCTIVE BIOLOGY, SPATIAL DISTRIBUTION, GROWTH, AND MORTALITY OF THE DEEPWATER CARIDEAN SHRIMP, *HETEROCARPUS LAEVIGATUS*, IN HAWAII

MURRAY D. DAILEY<sup>1</sup> AND STEPHEN RALSTON<sup>2</sup>

## ABSTRACT

The recent rapid development of fisheries for the *Heterocarpus laevigatus* in Hawaii and elsewhere in the tropical Pacific has created the need for biological information to manage the resource. This study reports on a 16-month sampling program of commercial shrimp catches in Hawaii, during which the depth of capture, carapace length (CL), sex, and reproductive condition of 7,368 *H. laevigatus* were determined.

The overall sex ratio of *H. laevigatus* was 1:1.16 in favor of females and depended on the depth sampled; there were relatively fewer females as depth increased. Seasonal variation in sex ratio was evident which may have been due to changing catchability and availability or a sex related dispersion pattern. Sex ratio also depended on size category, displaying a standard pattern with no evidence of protandry.

Females mature at 40 mm CL (64% of asymptotic length) and ovigerous individuals are found year round. However, the main reproductive season is from August-February, with over 50% of females carrying eggs from October-January. Mature shrimp may undergo a depth related seasonal migration in synchrony with breeding. Mature males and females were found deeper (700 m) during the reproductive season than not (550 m). Females apparently settle in deep water and migrate gradually to shallower water as they grow.

Seasonal length-frequency data suggest *H. laevigatus* is not semelparous. Separate analyses of CL-frequency distributions of male and female shrimp indicate their von Bertalanffy asymptotic sizes are 57.9 and 62.5 mm CL, respectively. Growth coefficients (*K*) estimated by modal progression were 0.35 and 0.25 per year for males and females, and total instantaneous mortality rates were 1.51 and 0.73 per year, respectively.

The deepwater caridean shrimp, also known as "ono" or smooth nylon shrimp, *Heterocarpus laevigatus*, (Family Pandalidae) occurs throughout the tropical Pacific Ocean, where it is found in benthic deepwater habitats (450-900 m) (Wilder 1977; King 1983). While early trapping surveys in the Hawaiian Islands revealed its local abundance (Clarke 1972; Struhsaker and Aasted 1974), little information was available concerning its biology. These early studies did show, however, that *H. laevigatus* was potentially of commercial importance, with a preliminary maximum sustained yield estimate of 454-907 metric tons (t) derived for the Hawaiian Archipelago (Department of Land and Natural Resources 1979). More recently the Western Pacific Regional Fishery Management Council<sup>3</sup> (WPRFMC) has revised this estimate to 400-4,000 t.

A commercial trap fishery for this species subsequently developed in the Hawaiian Islands, and in 1984 the WPRFMC began the process of developing a fishery management plan for the *Heterocarpus* shrimp resources of the region. Landings from the Hawaiian fishery exceeded 135 t in 1983 but have declined sharply since, although commercial interest in the resource remains great (WPRFMC fn. 3). Recent research surveys in Hawaii have now more clearly defined this species' depth, temporal, and geographic distributions (Oishi 1983; Hawaiian Divers 1983<sup>4</sup>; Gooding 1984), although the life history of *H. laevigatus* remains largely unknown. The only substantive biological studies to date were

<sup>1</sup>Hawaiian Fishing Research Company, 737 Bishop Street, Suite 2910, Honolulu, HI 96813; present address: Department of Biology, California State University at Long Beach, Long Beach, CA 90840.

<sup>2</sup>Southwest Fisheries Center Honolulu Laboratory, National Marine Fisheries Service, NOAA, 2570 Dole Street, Honolulu, HI 96822-2396.

915-925

Manuscript accepted July 1986.  
FISHERY BULLETIN: VOL. 84, NO. 4, 1986.

<sup>3</sup>Western Pacific Regional Fishery Management Council. 1984. Status of fisheries assessment of development and management needs for selected crustacean species in the western Pacific region. Unpubl. manuscr., 60 p. Southwest Fisheries Center Honolulu Laboratory, National Marine Fisheries Service, NOAA, 2570 Dole Street, Honolulu, HI 96822-2396.

<sup>4</sup>Hawaiian Divers. 1983. Deepwater shrimp utilization study for Hawaii. Report prepared under NOAA Cooperative Agreement No. 80-ABH-00065 for the Southwest Region, Western Pacific Program Office, National Marine Fisheries Service, NOAA, Honolulu, HI, 47 p.

completed in the Marianas (including Guam) and Fiji (Wilder 1977; King 1983; King and Butler 1985; Moffitt and Polovina<sup>5</sup>).

Evidence also exists to show that this species is highly susceptible to trapping (Ralston 1986) and, according to commercial fishermen, depletion of the resource has occurred over certain fishing grounds in Hawaii (S. Barrows<sup>6</sup>). Because estimates of the shrimp's productive capacity which are currently available are preliminary at best and a fishery has developed rapidly, this study set out to examine aspects of the life history of the Hawaiian stock of *H. laevigatus* to obtain information useful in developing a basis for management of the fishery.

## METHODS

All sampling was conducted by commercial fishing vessels owned by the Hawaiian Shrimp Company (*Easy Rider*, *Mokihana*, and the *Easy Rider Too*) over the 16-mo period from August 1983 to November 1984. During this time, six 35-60 d cruises were completed and samples were obtained during 9 of the 12 calendar months (Table 1). Fishing was conducted throughout much of the Hawaiian Archipelago, from Gardner Pinnacles south to the Island of Hawaii (Fig. 1). Samples were collected at all of the seven main islands (Hawaii, Kauai, Lanai, Maui, Molokai, Niihau, and Oahu) and from Necker, French Frigate Shoals, and Gardner Pinnacles in the Northwestern Hawaiian Islands.

All shrimp were caught during overnight sets of baited pyramidal traps, which measured  $1.5 \times 1.8$  m with a funnel opening at the top center. Fishing was targeted between depths of 500 and 700 m,

<sup>5</sup>Moffitt, R. B., and J. J. Polovina. The distribution and yield assessment of the deepwater shrimp resource in the Marianas. Manuscr. in prep. Southwest Fisheries Center Honolulu Laboratory, National Marine Fisheries Service, NOAA, 2570 Dole Street, Honolulu, HI 96822-2396.

<sup>6</sup>S. Barrows, Hawaiian Shrimp Company, 737 Bishop Street, Suite 2910, Honolulu, HI 96813, pers. commun. 1985.

TABLE 1.—Temporal and geographic distribution of *Heterocarpus laevigatus* samples (FFS = French Frigate Shoals).

Year	Month	Location	Sample size
1983	Aug.	Oahu	79
1983	Sept.	Oahu	26
1983	Oct.	FFS	188
1983	Nov.	FFS	1,942
1984	Jan.	Oahu	285
1984	Mar.	Niihau, Kauai	530
1984	April	Hawaii	631
1984	May	Lanai, Maui, Molokai	1,389
1984	June	Necker	842
1984	Sept.	Gardner Pinnacles, FFS, Necker	1,438
1984	Nov.	Necker	18

although some catches were made in both shallower and deeper water because of the trap drift. The best catch rates were found in areas of hard rough bottom; otherwise, all sampling sites were to all appearances similar.

Systematic subsamples of the catch were taken from every other trap on every second fishing day by randomly scooping approximately 0.9 kg (2 lb) of shrimp from traps prior to emptying. Samples were placed in double bags with tags recording date, location, depth, and condition, and were then frozen and packed for transfer to the laboratory. There all shrimp were identified to species; sexed; examined for embryos on the pleopods; measured to the nearest 0.1 mm for carapace length (CL), carapace width (CW), and total length (TL); and weighed to the nearest 0.1 g on a top loading scale. The data were then keypunched and stored for analysis.

Size-frequency distributions of *H. laevigatus* were analyzed by the regression method of Wetherall et al. (in press) to estimate maximum size ( $L_{\infty}$  of the von Bertalanffy growth equation) and the ratio of total instantaneous mortality rate ( $Z$ ) to von Bertalanffy growth coefficient ( $K$ ). Additionally, the growth coefficient of *H. laevigatus* was estimated by following the progression of size modes evident in three large samples taken: 1) 24 October to 6 November 1983, 2) 24 April to 11 May 1984, and 3) 3 September to 6 November 1984. Sample sizes of  $N = 2,021$ , 1,991, and 1,438 were obtained in these respective samples, accounting for 74% of all shrimp measured in the study. Modal progression of size distributions was determined by the ELEFAN I computer program of Pauly (1982).

## RESULTS

A total of 7,368 *H. laevigatus* were measured and examined for CL, sex, and the presence of eggs (Table 1). Of these 3,956 were females (32.6% of which were ovigerous) and 3,412 were males. This corresponds to an overall male to female sex ratio of 1:1.16, departing significantly from equality ( $P < 0.0001$ ). Measurements of TL, CW, and weight were obtained from 5,920 of the shrimp sampled.

Due to an imbalance in sampling, the effects of location and time on the distribution of *H. laevigatus* could not be completely separated. We therefore assume that all samples were drawn from statistically homogeneous locations in order to isolate and examine temporal and depth effects. The strength of this assumption is based largely on our personal observations and those of fishermen that seasonal change seems to account for most major population



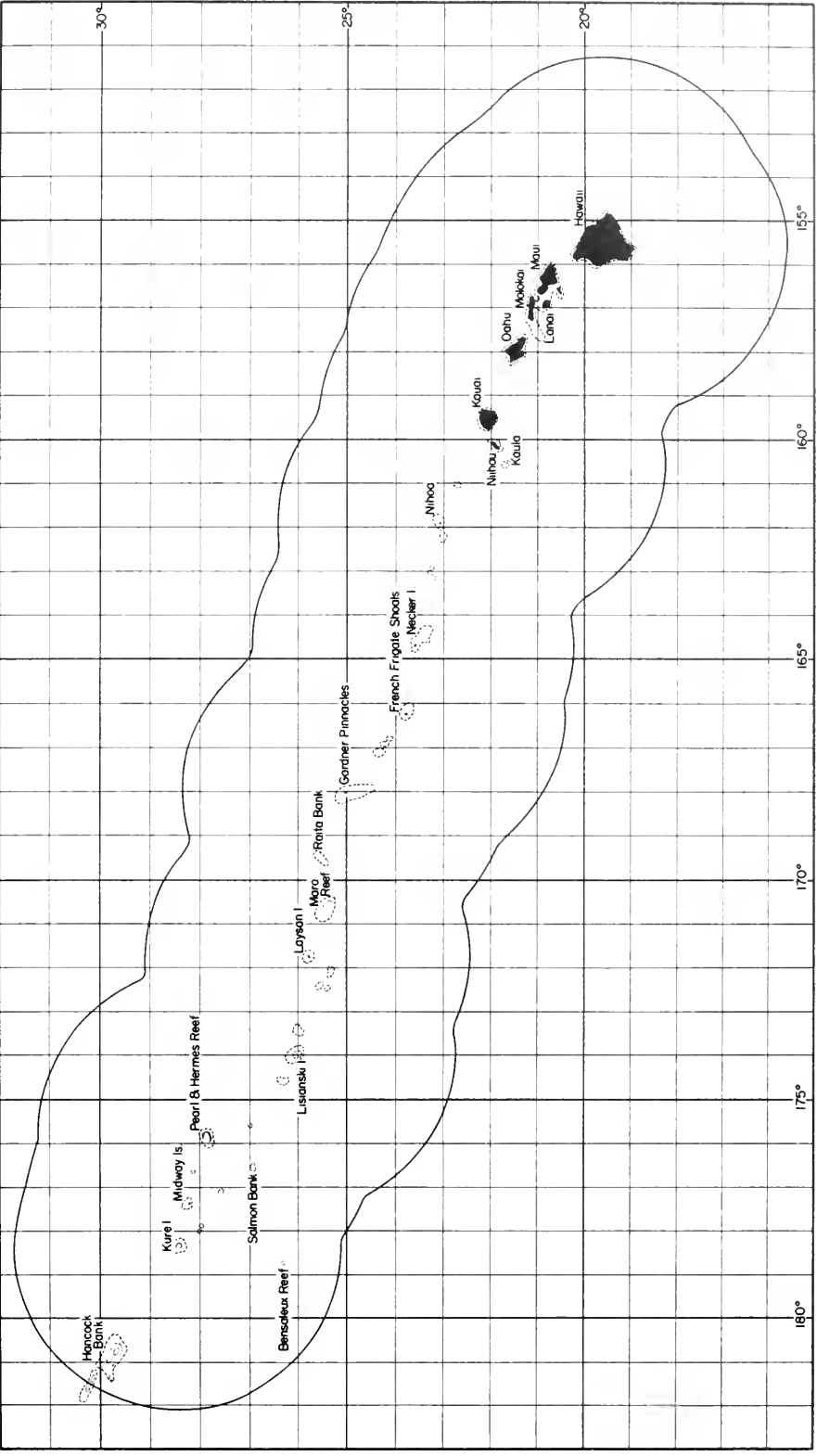

FIGURE 1.—Map of the Hawaiian Archipelago showing sampling locations. Note that the circumscribed area delimits the U.S. fishery conservation zone and that one degree of latitude equals 111 km.

variations in Hawaii, as well as evidence from the Mariana Archipelago which shows that populations of *H. laevigatus* are affected to a greater degree by temporal factors than geographic ones (Polovina<sup>7</sup>).

### Morphometrics

The results of performing functional regressions (Ricker 1973) on the three linear size measurements (CL, CW, TL) are given in Table 2. Estimates of slope and intercept are provided for all possible permutations of these variables. Separate analyses for males (M), females without eggs (F $\emptyset$ ), and females with eggs (FE) were not performed because all have similar gross morphologies (but see King and Mofitt 1984). As expected, the data were well described with a linear fit.

The relationship between weight and CL was examined by analysis of covariance (BMDP 1977) to determine whether the M, F $\emptyset$ , and FE subgroups have different weight-length relationships. Results showed all three were characterized by differing slopes in the regression of  $\log_e$  (weight) on  $\log_e$  (CL) ( $F' = 86.46$ ,  $df = 2$ , 5912,  $P \ll 0.0001$ ). Parameter estimates with standard errors and other regression statistics are presented in Table 3 for each of the three subgroups. Note that the reduced  $r^2$  of the

FE group is due to a substantial reduction in the range of CL over which the data were fitted. The results of performing functional regressions of  $\log_e$  (weight) on  $\log_e$  (CL) are also given.

During the analysis an anomalous bimodal distribution of weight at length emerged. The bimodality was not due to sexual class (M, F $\emptyset$ , or FE) and clearly diminished to a unimodal weight distribution as CL increased from 15 to 40 mm. We have no explanation for these data.

### Reproductive Biology

The reproductive season of *H. laevigatus* was estimated by plotting the percentage of ovigerous females relative to total females against the month sampled. For the data which overlapped 1983 and 1984 no interannual difference was evident (i.e., the timing of reproduction was similar), so the data were pooled by month between these years. The results are presented in Figure 2 where the data have been further aggregated into 2-mo "seasons". For each the percentage of females bearing eggs is plotted with its 95% confidence interval and associated sample size given above.

The data show an increased incidence of ovigerous females from August to February (>30% of females). In particular over 50% of all sampled females carried eggs from October to January. Relatively few shrimp were caught with eggs during the period from April to July (<10%). Moreover,

<sup>7</sup>J. J. Polovina, Southwest Fisheries Center Honolulu Laboratory, National Marine Fisheries Service, NOAA, 2570 Dole Street, Honolulu, HI 96822-2396, pers. commun. June 1985.

TABLE 2.—Parameter estimates of functional regressions on linear size measurements. All measurements in millimeters and all sample sizes  $n = 5,920$ .

Dependent variable	Independent variable	Slope	Intercept	Correlation coefficient
Total length	Carapace length	2.864	10.182	0.963
Carapace width	Carapace length	0.613	-5.562	0.964
Carapace length	Total length	0.349	-3.536	0.963
Carapace length	Carapace width	1.630	9.098	0.964
Carapace width	Total length	0.214	-7.737	0.902
Total length	Carapace width	4.673	36.153	0.902

TABLE 3.—Functional and predictive length-weight regressions for *Heterocarpus laevigatus*. The natural logarithm of weight in grams is fitted to the natural logarithm of carapace length in mm. The standard errors of the slope ( $b$ ) and intercept ( $a$ ) are given by  $S_b$  and  $S_a$  respectively.

		Slope	Intercept	$S_b$	$S_a$	$n$	$r^2$
Males	Predictive	2.755	-6.809	0.0176	0.0629	2,788	0.8976
	Functional	2.910	-7.358	—	—	—	—
Females without eggs	Predictive	2.605	-6.252	0.0185	0.0671	2,202	0.8999
	Functional	2.745	-6.757	—	—	—	—
Females with eggs	Predictive	1.815	-2.986	0.0550	0.2114	928	0.5401
	Functional	2.470	-5.498	—	—	—	—

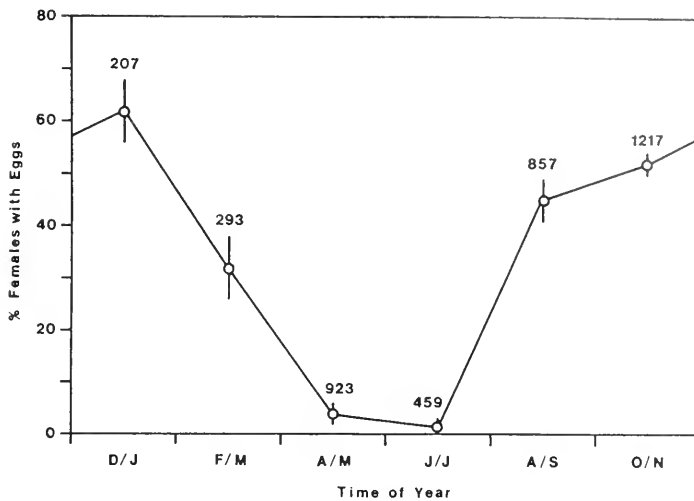

FIGURE 2.—Seasonal incidence of ovigerous *Heterocarpus laevigatus* females in the Hawaiian Islands. Vertical bars represent 95% confidence intervals and sample sizes are presented above. Site locations vary.

when the analysis was restricted to mature females only (see next section) the seasonal pattern of egg-bearing was unchanged. From these results we conclude that in Hawaiian waters *H. laevigatus* reproduces during the fall and winter seasons (August-February).

The size at maturity of female shrimp was determined by aggregating the female data into 5 mm CL classes and plotting the incidence of ovigerous females against CL class (Fig. 3). Only samples obtained during the reproductive season were included in the analysis. As before, the overall percentage

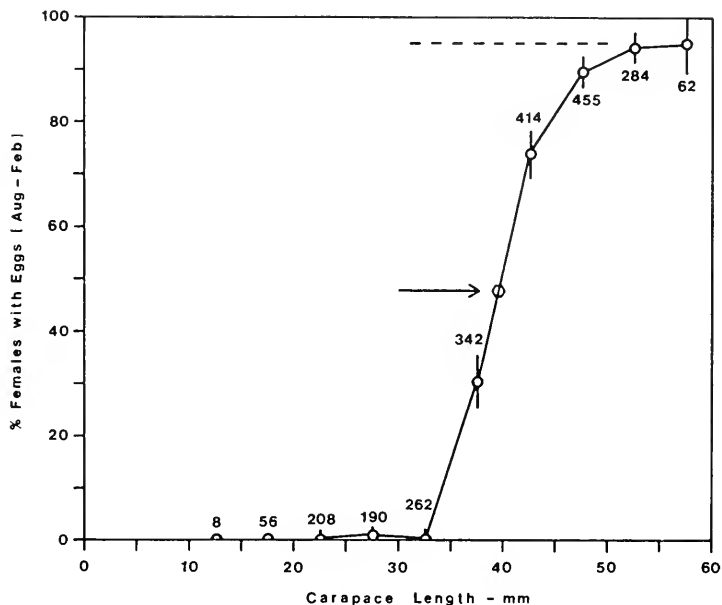

FIGURE 3.—Size at maturity for female *Heterocarpus laevigatus* sampled during the reproductive season. Vertical bars represent 95% confidence intervals and sample sizes are presented above.

with 95% confidence limits and sample sizes are provided.

The data show that the 55-60 mm CL class encompassed the largest shrimp observed. Virtually all (95%) females >50 mm CL that were sampled during August-February bore eggs. Conversely, up to 35 mm CL no more than 1% of the shrimp examined were ovigerous. The figure shows further that at a CL of 40 mm the percentage of ovigerous females is one-half its maximum value, with 48% of all sampled females bearing eggs. We conclude that females become sexually mature at this size (Gunderson et al. 1980). We have no data on maturation in males.

The data presented in Figure 4 show the sex ratio of shrimp as it depends on size (CL mm). Plotted are the percentage females, with 95% confidence intervals and sample sizes, against 5 mm CL size classes. The data clearly show that *H. laevigatus* maintains a relatively uniform sex ratio from 10 to 45 mm CL, but that females predominate in the largest length categories (45-65 mm CL).

Because some studies (Clarke 1972; Wilder 1977) have indicated that *Heterocarpus* females may experience mass mortality after egg bearing, we examined the relationship of sex ratio to season (Table 4). Presented for each 2-mo sampling period are the number of females and total number of shrimp sampled, the proportion which are female, and the standard error of the proportion. The results show

that an unusually high fraction (0.72) of the shrimp sampled during the peak of the reproductive season (December-January) are female. Note that the incidence of females in trap samples declines significantly to a value of 0.45 in April-May as the breeding season wanes. At first inspection these data support the contention that females experience increased mortality after bearing eggs, i.e., that *H. laevigatus* may be semelparous.

TABLE 4.—Sex ratio of *Heterocarpus laevigatus* by month sampled. The standard error of the proportion is given by  $S_p$ .

Month	Number of females	Proportion of females	$n$	$S_p$
December-January	207	0.72	285	0.026
February-March	293	0.55	530	0.022
April-May	923	0.45	2,020	0.011
June-July	459	0.54	842	0.017
August-September	857	0.55	1,542	0.013
October-November	1,217	0.56	2,148	0.011

### Spatial Distribution

The relationship between the sex ratio of *H. laevigatus* and sampling depth is provided in Table 5. These results demonstrate that the relative abundance of the two sexes is not independent of depth ( $\chi^2 = 165.6$ ,  $df = 16$ ,  $P < 0.001$ ). As depth increases (440-760 m) there is a significant decline in the percentage of females in our samples ( $P = 0.05$ ).

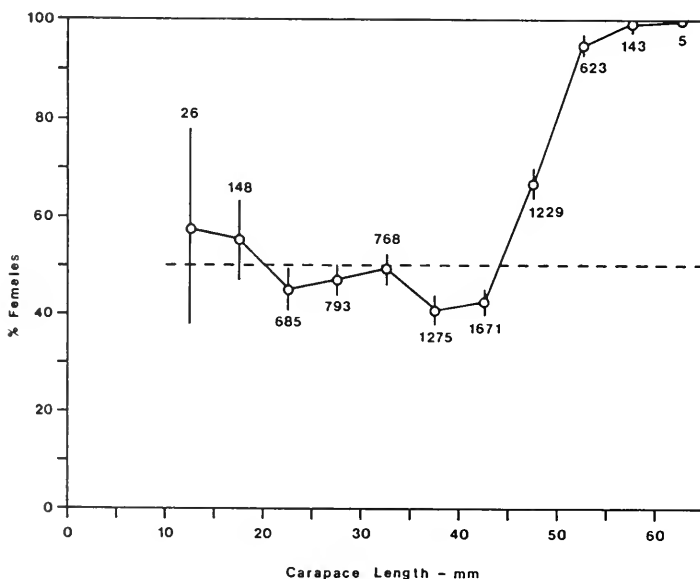

FIGURE 4.—Sex ratio as a function of carapace length. Vertical bars represent 95% confidence intervals and sample sizes are presented above.

TABLE 5.—Sex ratio and size of *Heterocarpus laevigatus* by depth (M is for males, F $\emptyset$  for females without eggs, and FE for females with eggs).  $S_p$  is the standard error of the proportion.

Depth (m)	Number of females	N	Proportion of females	$S_p$	Carapace length			
					All	M	F $\emptyset$	FE
440	41	71	0.58	0.059	40	34	43	48
60	9	11	0.81	0.116	39	36	40	—
80	65	141	0.46	0.042	38	33	42	49
500	155	230	0.67	0.031	42	34	45	49
20	287	430	0.66	0.023	43	40	45	46
40	419	943	0.44	0.016	37	35	40	49
60	193	487	0.39	0.022	37	36	38	45
80	280	500	0.56	0.022	39	35	42	47
600	282	498	0.56	0.022	38	35	38	46
20	284	463	0.61	0.023	39	35	34	48
40	325	581	0.55	0.021	38	37	32	47
60	109	210	0.51	0.034	37	34	35	44
80	95	167	0.56	0.038	39	37	35	48
700	90	222	0.40	0.033	36	36	31	43
20	399	738	0.54	0.018	39	38	32	47
40	68	126	0.53	0.044	40	37	33	48
60	14	46	0.30	0.068	34	34	28	42

The results presented in Table 5 also show the distribution of mean size (CL mm) by depth (m) for all *H. laevigatus* caught, and for the M, F $\emptyset$ , and FE subgroups. For all shrimp combined, average size decreases slightly with increasing depth fished. The trend for decrease in size with increasing depth is not evident in the M subgroup. However, the F $\emptyset$  class demonstrates a strong relationship of decreasing mean CL with depth. For the FE category the decline is much less apparent, if at all. Thus the overall decline in mean CL of all shrimp combined, is clearly due to an overriding influence of females without eggs. We interpret these trends, or lack thereof, to indicate that young (i.e., small) females may move from deep to shallow water as they mature.

There is some evidence that the depth distribution of *H. laevigatus* changes with reproductive activity (i.e., season). Figure 5 presents the depth distributions for reproductively competent (>40 mm CL) male and female shrimp, classified into samples taken outside (March-July) and during the reproductive season (August-February). Note that depth distributions of both male and female shrimp are

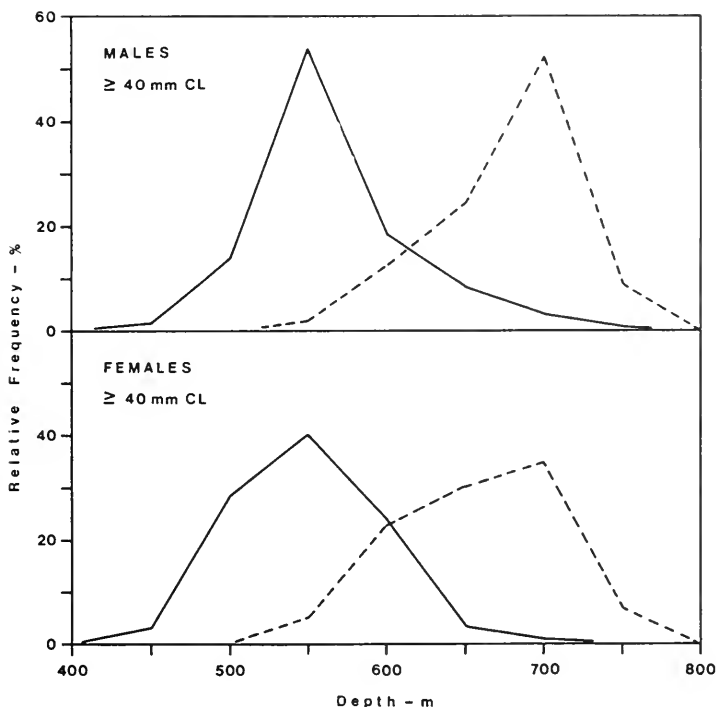

FIGURE 5.—Seasonal distributions of large (>40 mm) male and female *Heterocarpus laevigatus* by depth. The dashed line represents the spawning season distribution (May-February) and the solid line represents the distribution during the nonspawning season (March-July).

shifted 150 m deeper when the females are ovigerous. Although the data are not corrected for what may have been differences in fishing effort by depth, it is true that fishing was targeted to depths of maximum shrimp abundance. Based on these findings, and the results presented in Table 5, our data are consistent with a hypothesis of gradual movement of small females from deep to shallow water, with mature shrimp moving between depths of 550 and 700 m in synchrony with the ovigerous cycle of females.

### Growth and Mortality

Clarke (1972) and King (1983) have suggested that *Heterocarpus* spp. may breed once and die. Indeed

the results already presented in Table 4 may be considered consistent with the hypothesis that at least female *H. laevigatus* are semelparous. To further address this question we examined the size structure of male and female shrimp classified as follows: 1) during the latter half of the reproductive season (January-February) and 2) immediately following the reproductive season (March-July). If postreproductive mortality of shrimp was severe, a decrease in the relative abundance of large, breeding adults would be expected as the reproductive season waned.

The results presented in Figure 6 conflict with this expectation, where it is apparent that the proportional representation of large reproductive individuals (>40 mm CL) is actually greater imme-

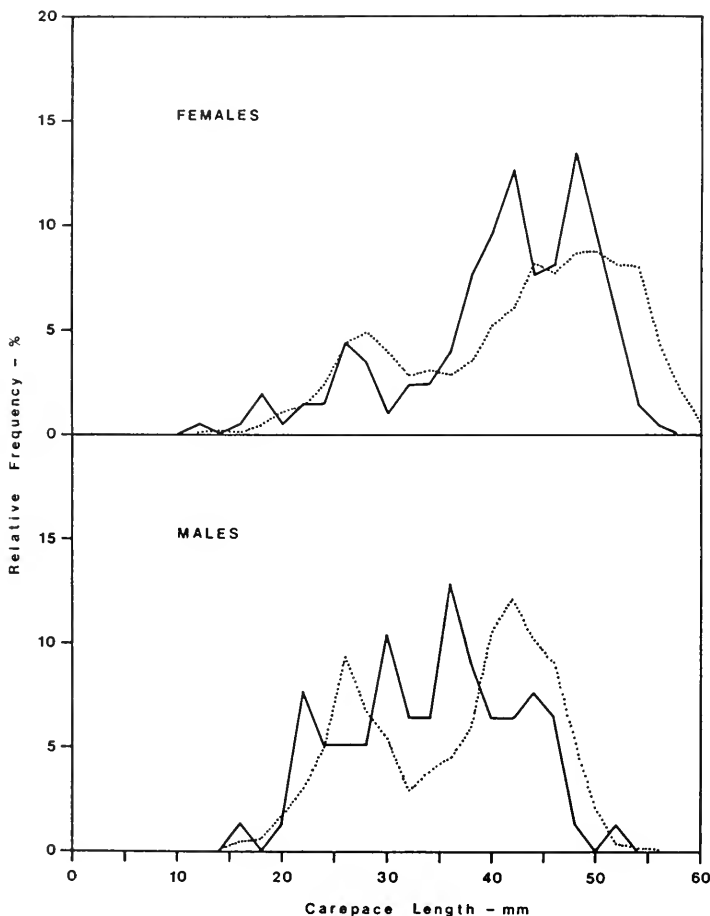

FIGURE 6.—Relative size-frequency distributions of male and female *Heterocarpus laevigatus* during the peak and postreproductive seasons. The solid line represents the peak season (January-February), males  $N = 78$ , females  $N = 207$ ; the dashed line is based on data collected immediately after the peak season (March-July) males  $N = 1,717$ , females  $N = 1,675$ .

diately following than during the latter half of the reproductive season.

The total sample CL-frequency distribution of males and females combined was analyzed by the regression method of Wetherall et al. (in press) to estimate  $L_{\infty}$  and  $Z/K$ . When all shrimp are pooled ( $N = 7,368$ ), an estimate of  $L_{\infty} = 61.7$  mm CL results. Further, the ratio of total mortality rate to von Bertalanffy growth coefficient ( $Z/K$ ) is estimated to be 2.6. Calculations were repeated for separate male and female subgroups, where it was found that  $L_{\infty} = 57.9$  and 62.5 mm CL and  $Z/K = 4.3$  and 2.9 for males and females, respectively. These results indicate that males generally grow to a smaller size than females.

The results of analyzing the progression of CL size modes in frequency distributions of male and female *H. laevigatus* provided preliminary estimates of  $K = 0.35$  yr<sup>-1</sup> for males and 0.25 yr<sup>-1</sup> for females. The former result must be viewed with caution, however, because two "solutions" were detected by the computer search algorithm (Pauly 1982) which differed little in fit. One of these,  $K = 0.70$  yr<sup>-1</sup>, we believe to be unjustifiably high in light of the minor difference (8%) between the  $L_{\infty}$  of males and the  $L_{\infty}$  of females obtained from the regression analysis. Note that estimates of  $K$  and  $L_{\infty}$  typically show a strong inverse correlation (Gallucci and Quinn 1979). These results, in conjunction with the estimates of  $Z/K$  for male and female shrimp presented earlier, provide the basis for preliminary estimation of total mortality rate. We estimate  $Z = 1.51$  yr<sup>-1</sup> for males and 0.73 yr<sup>-1</sup> for females, corresponding to annual survivorship fractions of 22% and 48% per year, respectively. These data indicate that males grow faster while experiencing a substantially greater total mortality rate than females.

## DISCUSSION

Earlier it was assumed that, aside from depth, all shrimp samples were drawn from locations which are dynamically homogeneous; i.e., the behavior of shrimp populations through time does not vary from site to site. This is clearly a restrictive and simplifying assumption and is without doubt the major limitation on the results presented here. Nonetheless, it was a necessary simplification for us to analyze the commercial fishing data upon which this study was based. Consequently, we view those results which rely upon this assumption as tentative and in need for further validation.

Examination of the seasonal trend in the relative

abundance of ovigerous females showed that in Hawaii over 50% of *H. laevigatus* females bear eggs from October to January, with a peak between August and February. Wilder (1977) found a similarly timed but more narrowly defined breeding season for *H. laevigatus* in Guam, where the percentage of ovigerous females in trap catches reached a maximum during December, but was not particularly high in any other month. Clarke (1972) reported that *H. ensifer* in Hawaii also reproduces in the winter. The breeding season of these shrimps is unusual among Hawaiian crustaceans and fishes, which typically reproduce during the spring and summer and uncommonly during the winter (Watson and Leis 1974; Lobel 1978; Uchida et al. 1980; Uchida and Tagami 1984; Walsh 1984).

Our data also indicate that in Hawaii sexual maturity of female ono shrimp occurs at approximately 40 mm CL, a size similar to that reported by King (1983) for shrimp from Fiji, Vanuatu, West Samoa, and Tonga and by Moffitt and Polovina (fn. 5) for samples from the Marianas. Based upon the estimated parameters of the von Bertalanffy growth equation derived here, this corresponds to an age of first maturity of 4 yr. Although we have no data on the maturation of males, we believe they probably mature earlier and at smaller size, perhaps at age 3 when they are 37-38 mm CL. Such a result is consistent with the findings of Moffitt and Polovina (fn. 5) who found that male *H. laevigatus* in the Marianas mature at a smaller size than do females.

Wilder (1977) speculated that both *H. ensifer* and *H. laevigatus* in Guam are protandrous hermaphrodites, as did Clarke (1972) for Hawaiian populations of *H. ensifer*. However, the results presented in King and Moffitt (1984) tend to contradict this conclusion. These authors studied the morphometry and sexuality of five deepwater pandalids, including *H. laevigatus*, in Fiji and the Marianas. Using the relative length of the appendix masculina expressed as a proportion of CL, they found no tendency toward protandrous hermaphroditism. Moreover, the sex ratio reported in their study was approximately 1:1.

Our results also indicate that for Hawaiian populations of *H. laevigatus*, and we speculate for most tropical pandalids, a sex transition does not occur. Wenner (1972) has termed the pattern exhibited in Figure 4 the standard sex ratio pattern, as distinguished from one of reversal. Due to the large numbers of females in small size classes, these data are generally inconsistent with a protandric hermaphroditic life history, as has been hypothesized by previous workers on *Heterocarpus* spp. (Clarke

1972; Wilder 1977). King and Moffitt (1984) also argue for dioecy in this species based upon relative changes in the morphology of the appendix masculina.

Evidence now exists to suggest that the sex ratio of *H. laevigatus* undergoes a seasonal change (Table 4), although the reasons for this are at present unknown. A biological alteration in population structure of this order seems unlikely. Rather, the relatively high catch of females during the December-January period may be due to seasonal changes in catchability or vulnerability of one or both sexes to the traps. Alternatively, the spatial dispersion of *H. laevigatus* may depend on sex. If males and females are spatially segregated, the high proportion of females in the December-January sample may have been due to small sample size ( $N = 207$ ).

We have also shown that sex ratio depends strongly on the depth sampled (Table 5), with diminishing representation of females as depth increases. This spatial heterogeneity between the sexes may be due to directed movements. Based on size trends of females we conclude that they recruit to deeper water and subsequently migrate to shallower water. We have no evidence for similar movement of males.

Studies by King (1983) on Pacific *Heterocarpus* spp. showed cyclic migrations in these shrimps, suggesting that depth distribution may change seasonally, with an annual migration up and down the slope of the sea floor. The data presented in Figure 5 indicate that mature *H. laevigatus* in Hawaii do migrate seasonally, demonstrating distinct shifts in the depth distributions of both sexes during the reproductive season. Because this result is confounded by what may be a location effect, however, we view them as preliminary and in need of further confirmation. King (1983) also reported that *Heterocarpus* spp. were found in stomachs of tuna in Fiji, indicating perhaps some type of vertical migration in the water column.

King (1985), based on work completed in Fiji, examined the question of iteroparity and semelparity in several genera of pandalid shrimp (*Plesionika*, *Saron*, *Parapandalus*, and *Heterocarpus*). Based on the difference between length at sexual maturity and maximum length, he concluded that shallow-water species (e.g., *H. ensifer*) are semelparous. He states that deepwater *Heterocarpus* spp. "have an extended reproductive lifespan, the length of which may be taken to indicate the number of spawnings." We conclude, based on the relative size-frequency distributions of males and females during peak and postreproductive seasons, that both sexes survive well after reproducing—evidence in favor of iteroparity.

Although a high mortality of shrimp following the breeding season would be evidence consistent with a semelparous life history, it is not a sufficient result to prove it. This is because each female, before dying, could have sequential multiple clutches during the October-February ovigerous period. Nonetheless, good survival of *H. laevigatus* females after carrying eggs (Fig. 6) is indicative of iteroparous reproduction.

The regression technique of Wetherall et al. (in press) produced estimates of the ratio of mortality to growth coefficient of 2.9 and 4.3 for females and males respectively. Moffitt and Polovina (fn. 5), using similar methods, estimated  $L_{\infty} = 55.2$  mm CL and  $Z/K = 2.5$  for combined male and female samples of *H. laevigatus* from essentially unfished stocks in Guam and the Marianas. Ralston (1986) also reported that the  $Z/K$  ratio of an unexploited population of *H. laevigatus* at Alamagan in the Marianas was about 2.0. The differences between estimates may therefore relate to differences in levels of exploitation. Moreover, the higher mortality rate of male shrimp when compared with females ( $1.51$  versus  $0.73 \text{ yr}^{-1}$ ) may explain the somewhat biased sex ratio in favor of females.

## ACKNOWLEDGMENTS

We acknowledge the help of the fishing vessels *Easy Rider*, *Easy Rider Too*, and *Mokihana*. Special thanks go to Jack Klein of the *Mokihana* crew for his collection of material. Also, we thank Robert Richlynski and Patricia M. Van Nuis for their technical help during the collection of data.

## LITERATURE CITED

- CLARKE, T. A.  
1972. Exploration for deep benthic fish and crustacean resources in Hawaii. Univ. Hawaii, Hawaii Inst. Mar. Biol. Tech. Rep. 29:1-18.
- BMDP.  
1977. BMDP Biomedical Computer Programs, P-Series. Univ. Calif. Press, Los Ang., 880 p.
- DEPARTMENT OF LAND AND NATURAL RESOURCES.  
1979. Hawaii fisheries development plan. Department of Land and Natural Resources, State of Hawaii, 297 p.
- GALLUCCI, V. F., AND T. J. QUINN II.  
1979. Reparameterizing, fitting, and testing a simple growth model. Trans. Am. Fish. Soc. 108:14-25.
- GOODING, R. M.  
1984. Trapping surveys for the deepwater caridean shrimps, *Heterocarpus laevigatus* and *H. ensifer*, in the Northwestern Hawaiian Islands. Mar. Fish. Rev. 46(2):18-26.
- GUNDERSON, D. R., P. CALLAHAN, AND B. GOINEY.  
1980. Maturation and fecundity of four species of *Sebastes*. Mar. Fish. Rev. 42(3-4):74-79.



- KING, M. G.  
1983. The ecology of deepwater caridean shrimps (Crustacea: Decapoda: Caridea) near tropical Pacific Islands with particular emphasis on the relationship of life history patterns to depth. Ph.D. Thesis, Univ. South Pacific, Suva, Fiji, 258 p.
- KING, M. G., AND A. J. BUTLER.  
1985. Relationship of life-history patterns to depth in deep-water caridean shrimps (Crustacea: Natantia). Mar. Biol. (Berl.) 86:129-138.
- KING, M. G., AND R. B. MOFFITT.  
1984. The sexuality of tropical deepwater shrimps (Decapoda: Pandalidae). J. Crustacean Biol. 4:567-571.
- LOBEL, P. S.  
1978. Diel, lunar, and seasonal periodicity in the reproductive behavior of the pomacanthid fish, *Centropyge potteri*, and some other reef fishes in Hawaii. Pac. Sci. 32:193-207.
- OISHI, F.  
1983. Pacific Tuna Development Foundation - State of Hawaii shrimp industry development project. State Hawaii. Dep. Land Nat. Resour., Div. Aquat. Resour., 22 p.
- PAULY, D.  
1982. Studying single-species dynamics in a tropical multi-species context. In D. Pauly and G. I. Murphy (editors), Theory and management of tropical fisheries. ICLARM and CSIRO, Manila, 360 p.
- RICKER, W. E.  
1973. Linear regressions in fishery research. J. Fish. Res. Board Can. 30:409-434.
- STRUHSAKER, P., AND D. C. AASTED.  
1974. Deepwater shrimp trapping in the Hawaiian Islands. Mar. Fish. Rev. 36(10):24-30.
- UCHIDA, R. N., AND D. T. TAGAMI.  
1984. Biology, distribution, population structure, and pre-exploitation abundance of spiny lobster, *Panulirus marginatus* (Quoy and Gaimard), in the Northwestern Hawaiian Islands. In R. W. Grigg and K. T. Tanoue (editors), Proceedings of the Symposium on Resource Investigations in the Northwestern Hawaiian Islands, Vol. 1, April 24-25, 1980, University of Hawaii, Honolulu, Hawaii, p. 157-198. UNIH-SEAGRANT-MR-84-01.
- UCHIDA, R. N., J. H. UCHIYAMA, D. T. TAGAMI, AND P. M. SHIOTA.  
1980. Biology, distribution, and estimates of apparent abundance of the spiny lobster, *Panulirus marginatus* (Quoy and Gaimard), in waters of the Northwestern Hawaiian Islands: Part II. Size distribution, legal to sublegal ratio, sex ratio, reproductive cycle, and morphometric characteristics. In R. W. Grigg and R. T. Pfund (editors), Proceedings of the Symposium on Status of Resource Investigations in the Northwestern Hawaiian Islands, April 24-25, 1980, University of Hawaii, Honolulu, Hawaii, p. 131-142. UNIH-SEAGRANT-MR-80-04.
- WALSH, W. J., III.  
1984. Aspects of nocturnal shelter, habitat space, and juvenile recruitment in Hawaiian coral reef fishes. Ph.D. Thesis, Univ. Hawaii, Honolulu, 475 p.
- WATSON, W., AND J. M. LEIS.  
1974. Ichthyoplankton of Kaneohe Bay, Hawaii. Univ. Hawaii Sea Grant Publ. UNIH-SEAGRANT-TR-01, 178 p.
- WENNER, A. M.  
1972. Sex ratio as a function of size in marine crustacea. Am. Nat. 106:321-350.
- WETHERALL, J. A., J. J. POLOVINA, AND S. RALSTON.  
In press. Estimating growth and mortality in steady state fish stocks from length-frequency data. ICLARM/KISR Conf. Theory and Application of Length-Based Methods for Stock Assessment.
- WILDER, M. N.  
1977. Biological aspects and the fisheries potential of two deepwater shrimps, *Heterocarpus ensifer* and *H. laevigatus* in waters surrounding Guam. M.S. Thesis, Univ. Guam, Agana, Guam, 79 p.



# AN INTENSIVE FISHING EXPERIMENT FOR THE CARIDEAN SHRIMP, *HETEROCARPUS LAEVIGATUS*, AT ALAMAGAN ISLAND IN THE MARIANA ARCHIPELAGO

STEPHEN RALSTON<sup>1</sup>

## ABSTRACT

During January 1984 an intensive fishing experiment for the deepwater caridean shrimp, *Heterocarpus laevigatus*, was conducted near Alamagan Island in the Mariana Archipelago. Twenty standard shrimp traps were set daily, producing a significant decline in the average catch rate from 3.33 to 1.82 kg/trap-night over a 16-day period. This drop was associated with a removal of 776 kg of shrimp from the study site. Resampling the area 4 months later showed that the catch rate remained depressed. Length-frequency data demonstrate that the decrease in catch per unit effort was due to a decline in the number of shrimp caught. An initial population size of 1,714 kg from 312 ha habitat is estimated, corresponding to one exploitable shrimp per 51 m<sup>2</sup>. The estimate of catchability (0.001945 trap-night<sup>-1</sup>) indicates that *H. laevigatus* may be easily overfished by trapping.

Intensive fishing experiments can provide the ideal complement to resource surveys using catch per unit effort (CPUE) to estimate the relative abundance of exploitable stock. Whereas values of CPUE are usually adequate for studying spatial and temporal variation in resource abundance, often an absolute estimate of exploitable biomass is required. This is particularly true of yield assessments. Due to the relative nature of CPUE statistics, a conversion factor is necessary to translate catch rates into absolute units of biomass. This proportionality is termed catchability, typically a constant parameter (but see Schnute 1983; Polovina 1986) which can be estimated from the results of intensive fishing experiments (Ricker 1975).

The advantages of intensive fishing over alternative methods of estimating the catchability coefficient ( $q$ ) are several. Foremost is that no history of either catch or effort data is needed. This characteristic makes methods of fishing success (Ricker 1975) or survey-removal (Schnute 1983) particularly attractive for use in assessments involving exploratory survey data, as well as for studying emerging new fisheries. A second advantage is that results can be obtained rapidly. Because fishing is, by definition, conducted intensively over a short time period and the necessary computations are quite simple, an estimate of  $q$  is quickly realized.

Although these advantages recommend the approach, two restrictive assumptions must be made in analyzing the data. One must assume, in the absence of information to the contrary, that the population fished is closed, or equivalently, that additions exactly balance removals other than those due to fishing. The basis of this assumption can be strengthened if the intensive fishing site is located in a naturally isolated area. For example, Polovina (1986) performed an intensive fishing experiment on a small pinnacle 5.5 km in circumference which was isolated by 75 km of deep water from the nearest similar habitat. A second assumption is that fishing removals account for all changes in stock biomass, i.e., natural mortality, growth, and recruitment are negligible during the period of fishing. For this reason, removals are carried out intensively over as short a time interval as possible. If both assumptions hold then  $q$  can be estimated directly by the slope of the linear regression of either CPUE on cumulative catch (Leslie and Davis 1939) or  $\log\{CPUE\}$  on  $\log\{\text{cumulative effort}\}$  (DeLury 1947).

Refinements to these two basic methods have been proposed by Braaten (1969), Crittenden (1983), Schnute (1983), and Polovina (1986) among others. Generally, estimators have been found to be most sensitive to a departure from the assumption of constant catchability. A variety of adjustments have been used to correct this and other statistical problems which often occur with real data.

The work reported here is an application of the intensive fishing method to estimate the catchabil-

<sup>1</sup>Southwest Fisheries Center Honolulu Laboratory, National Marine Fisheries Service, NOAA, 2570 Dole Street, Honolulu, HI 96822-2396.

ity and population density of a deepwater caridean shrimp, *Heterocarpus laevigatus*. This circumglobal species is found in depths of 400-950 m in subtropical and tropical latitudes (King 1984). Experimental trapping surveys have shown it to be abundant at widespread localities in the central and western Pacific (King 1983), and a developing commercial fishery for this species has emerged in the Hawaiian Islands (Gooding 1984). Interest by Pacific island nations in promoting the harvest of this shrimp is great (King 1981), providing the impetus for an assessment of the *Heterocarpus* resource in the Mariana Archipelago. Additional results of this research program are reported elsewhere (Moffitt and Polovina<sup>2</sup>).

## MATERIALS AND METHODS

Intensive fishing for *Heterocarpus laevigatus* was conducted in an area 3.5 km off the north end of Alamagan Island in the western Pacific (lat. 17°39'N, long. 145°50'E). Alamagan is part of the Commonwealth of the Northern Mariana Islands, lying 450 km north of Guam (Fig. 1). It is small, uninhabited, and of recent volcanic origin. While the ocean bottom slopes steeply away from the island at an angle of 25° to the east, south, and west, a broad shelf, approximately 6.5 km<sup>2</sup> in area and lying 600-800 m deep, extends well off the north end of the island. This shelf was selected as a study site because 1) good catches of *H. laevigatus* were previously obtained in the area, 2) 700 m is an ideal target depth for trapping this species (Moffitt and Polovina fn. 2), 3) the relatively uniform bottom topography would facilitate setting and retrieving fishing gear, and 4) the area had no known history of prior exploitation.

Fishing was conducted over a 16-d period, 9-24 January 1984, from the NOAA ship *Townsend Cromwell*. Shrimp traps of standard Honolulu Laboratory design were set daily in four strings of five traps each. All traps were half round in shape (91 × 66 × 46 cm), with a frame constructed of 1.27 cm reinforcing steel, covered with 1.27 × 2.54 cm mesh hardware cloth (illustrated in figure 3 of Gooding 1984). Individual traps within a set were spaced 40 m apart and were baited with three chopped Pacific mackerel, *Scomber japonicus*. All traps were set between 1100 and 1300 h in 600-800

m and were retrieved the following day between 0800 and 1100 h. In addition, a large (150 × 150 × 150 cm) pyramidal commercial shrimp trap was sometimes deployed alone.

When fishing gear was recovered, the traps were individually emptied and the contents sorted, counted, and weighed to the nearest 0.01 kg by species lot. On three occasions a random length-frequency sample of trap-caught *H. laevigatus* was saved for later study. All shrimp in these samples were measured to the nearest 0.1 mm CL (carapace length) with dial calipers.

To accurately delimit the bottom topography of the study area, an unregistered reconnaissance hydrographic survey was conducted over the site on 9 February 1984, with the *Townsend Cromwell*. Depth soundings from a Raytheon<sup>3</sup> fathometer were recorded every 3 min over an 8.5-h period as the vessel ran a predefined cruise track which covered the entire study area. The position of the vessel was recorded to the nearest 0.01 min at each sounding.

The *Townsend Cromwell* returned to the study site again from 12 to 16 May 1984, to assess the recovery of the *H. laevigatus* population in the study area and to determine the effect of different baiting practices on CPUE. Four sets of six traps each were set overnight on each of four occasions. Half these traps contained three chopped Pacific mackerel whereas the other half (i.e., every other one) contained two whole Pacific mackerel. The catch was sorted and treated as discussed previously.

## RESULTS

### Hydrographic Survey

A total of 164 depth soundings were obtained over the study site. The data were contoured using the GCONTOUR procedure of SAS/GRAPH (SAS 1981) and the resulting chart is presented in Figure 2. Solid lines represent isobath contours spaced at 200 m depth intervals. Note that the shrimp study site is a saddle point; concave upwards along the north-south axis and concave downwards from east-west. The hydrographic survey revealed a small but steep pinnacle and a deep canyon immediately adjacent to the study area.

In the figure the locations of each string of five standard traps are shown as open circles ( $n = 60$ ) whereas single sets of the large pyramid trap are given as closed circles ( $n = 8$ ). Fishing effort was

<sup>2</sup>Moffitt, R. B., and J. J. Polovina. In prep. Distribution and yield of the deepwater shrimp resource in the Marianas. Southwest Fisheries Center Honolulu Laboratory, National Marine Fisheries Service, NOAA, 2570 Dole Street, Honolulu, HI 96822-2396.

<sup>3</sup>Reference to trade names does not imply endorsement by the National Marine Fisheries Service, NOAA.



FIGURE 1.—Map of the Mariana Archipelago.

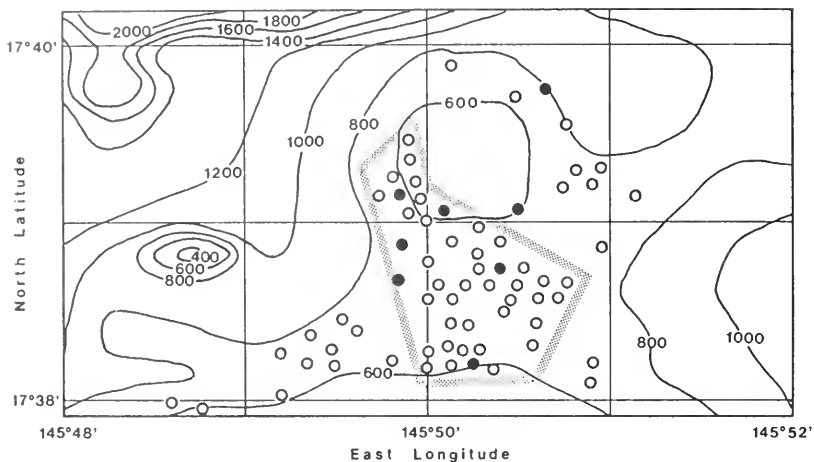

FIGURE 2.—Contour map of the Alamagan study site. Isobaths given in meters. Open circles represent set locations of standard traps (one set is composed of five traps); closed circles show sets of the pyramid trap. The stipple border encloses the area of greatest fishing intensity. One minute latitude = 1.85 km.

concentrated in the area enclosed by stipple borders, where 65% of all sets (44 of 68) occurred. This area represents 312 horizontal ha of shrimp habitat.

### Intensive Fishing Experiment

Although 20 standard shrimp traps were set daily for 15 consecutive days, 29 traps were lost due to entanglement on the bottom. This resulted in 271 effective trap-nights of standard fishing effort and a gear loss rate of 9.7% (Table 1). The loss of shrimp traps is not believed to have affected the outcome of the intensive fishing experiment for two reasons: First, the Pacific mackerel bait was rapidly exhausted in the traps, as evidenced by its condition after a single night's soak; second, large holes were usually evident in traps if the fishing gear was successfully retrieved after being fouled on the bottom.

The catch of *H. laevisgatus* was quite pure; only trace amounts of *H. longirostris*, *H. ensifer*, and the eel *Synaphobranchus affinis* co-occurred in the traps. The latter species was observed to consume individual *H. laevisgatus* on occasion, but this had a negligible impact on overall catch rates of the shrimp.

A total catch of 663.36 kg of *H. laevisgatus* was landed from standard traps, yielding an overall CPUE of 2.45 kg/trap-night (Table 1). In addition, another 112.77 kg were taken in eight sets of the pyramid trap for an overall CPUE of 14.10 kg/trap-night (Table 1). The larger commercial trap outperformed individual standard Honolulu Laboratory

TABLE 1.—Summary of catch and effort statistics of the intensive fishing experiment for *Heterocarpus laevisgatus* at Alamagan Island, 9-24 January 1984. All catches in kilograms and effort in standard trap-nights. CPUE includes only standard trap catches.

Date (mo/d/yr)	Standard trap catch	Pyramid trap catch	Corrected cumulative catch	Daily effort	CPUE
1/9/84	62.52	—	31	20	3.13
1/10/84	42.30	37.65	102	18	2.35
1/11/84	64.61	—	175	20	3.23
1/12/84	44.96	23.86	241	17	2.64
1/13/84	85.80	6.72	322	20	4.29
1/14/84	42.90	22.98	401	19	2.26
1/15/84	47.79	—	458	15	3.19
1/16/84	34.27	6.60	503	14	2.45
1/17/84	34.57	3.18	542	19	1.82
1/18/84	34.57	2.41	579	20	1.73
1/19/84	39.01	9.37	622	20	1.95
1/20/84	41.23	—	667	20	2.06
1/21/84	27.10	—	701	20	1.36
1/22/84	28.75	—	729	14	2.05
1/23/84	32.98	—	760	15	2.20
Total	663.36	112.77		271	

traps by a ratio of 5.76 to 1. Thus, one set of the large trap was roughly equivalent to one set of a string of five standard traps, but the former was much more variable in its performance. Overall, a total of 776.13 kg of *H. laevisgatus* were removed from the study area during the 16-d experiment. These averaged 28 g each (16 shrimp/lb).

The data presented in Table 1 are arranged to be fitted by the Leslie model (Ricker 1975). The CPUE was computed each day based solely on standard trap catch and effort statistics, although cumulative

removals included catches from the large commercial trap. As in Ricker (1975), CPUE is regressed against corrected cumulative catch, defined as the cumulative catch prior to the start of an interval plus half the catch taken during the interval (see also von Geldern 1961).

Standard daily CPUE is plotted against cumulative catch removed in Figure 3. The slope of the regression is significantly less than zero (one-tailed test,  $t = -2.80$ ,  $df = 13$ ,  $P = 0.01$ ). Estimates of slope, intercept, and mean squared error were  $-0.001945$  trap-night $^{-1}$ ,  $3.334$  kg/trap-night, and  $0.3754$  (kg/trap-night) $^2$ , respectively. Consequently, the catchability coefficient is estimated to be  $\hat{q} = 0.001945$  trap-night $^{-1}$  and the initial population size prior to the start of fishing to be  $\hat{n} = 1,714$  kg. Confidence intervals for these estimates are  $P(0.0004 < q < 0.0034) = 0.95$  and  $P(1150 < n < 6005) = 0.95$  (Ricker 1975). Notice that the confidence interval for the estimate of initial population biomass ( $n$ ) is asymmetrical about the point estimate.

Crittenden (1983) and others have warned against unequal variance in plots of CPUE against cumulative catch. To test for this possibility, the absolute values of the residuals from Figure 3 were ranked and the corrected cumulative catches were ranked. A Spearman rank correlation coefficient was then calculated, resulting in  $r_s = -0.189$ ,  $P = 0.50$ . From this analysis there is no evidence of heteroscedasticity. Further, there is little to suggest curvilinearity in Figure 3. A runs test (Tate and Clelland 1957) on the signs of the residuals indicates they are

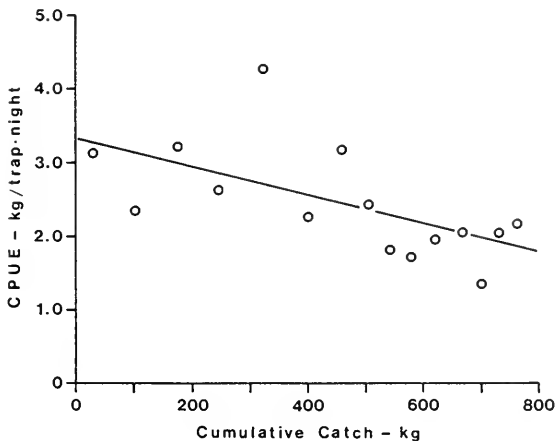

FIGURE 3.—Leslie model applied to *Heterocarpus laevigatus* at Alamagan. Each point represents 1 day of fishing. Data from Table 1.

randomly sequenced ( $P > 0.40$ ). This result supports the assumption of constant catchability.

At the time the experiment was terminated, 776 kg of shrimp had been removed by trapping. An estimate of the concomitant catch rate can be calculated from the regression equation of Figure 3. This estimate of CPUE is  $1.82$  kg/trap-night. When the *Townsend Cromwell* returned to the study site, 4 mo later, the mean catch rate was  $1.91$  kg/trap-night (42 effective standard trap-nights of effort,  $s = 1.33$ ), this based on a total catch of  $80.08$  kg *H. laevigatus*. The preceding calculations include only those traps which were baited comparably to the experimental traps (three chopped Pacific mackerel). Traps with two whole baits ( $n = 42$ ) yielded an average catch rate of  $1.39$  kg/trap-night ( $s = 1.09$ ).

### Length-Frequency Distributions

Examination of size-composition data can help interpret changes in weight CPUE. Declining trap catch rates could, for example, represent fewer individuals of the same size. Conversely, a decline in the average size of individuals caught with no change in numbers would also result in declining CPUE.

The three length-frequency distributions of *H. laevigatus* sampled during the period of experimental fishing are presented in Figure 4. For each distribution the date of capture, depth of capture, sample size, and mean carapace length are provided. Although appearing superficially similar, the results of ANOVA show that significant differences exist in size composition among the three samples ( $F = 10.03$ ,  $df = 2, 343$ ,  $P < 0.001$ ). These differences, however, do not explain the decline in CPUE. The data in the figure show that the mean size of *H. laevigatus* actually increased over time, and that the overall decline in CPUE observed in Figure 2 must therefore have been due to a decrease in the number of shrimps caught.

### DISCUSSION

Powell (1979) has shown that the shape of the descending limb of length-frequency distributions can provide useful information concerning the relationship between mortality and growth. Specifically, the ratio of  $Z$  (instantaneous total mortality rate) to  $K$  (von Bertalanffy growth coefficient) is defined in a simple way by the interrelationship of the least size when fully vulnerable to the gear, the mean size in the catch of fully recruited individuals, and the

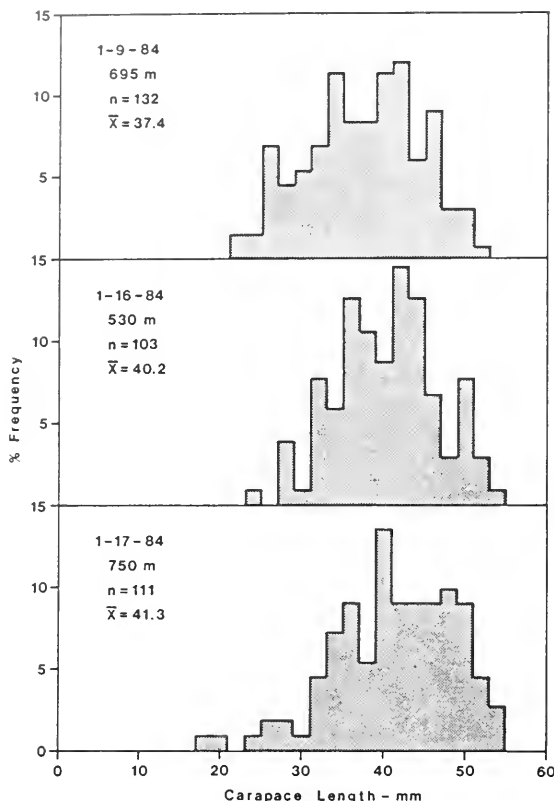

FIGURE 4.—Length-frequency distributions of *Heterocarpus laevigatus* taken in shrimp traps.

von Bertalanffy asymptotic size ( $L_{\infty}$ ). This is true if the following conditions hold: 1) the growth of individuals follows a deterministic von Bertalanffy growth curve, 2) mortality is constant and uniform for all ages, and 3) recruitment is constant and continuous over time (Beverton and Holt 1956).

Results presented in Dailey and Ralston (1986) provide the basis for estimating the minimum CL when *H. laevigatus* becomes fully recruited to the trap fishery. They provide a regression equation relating carapace width (CW) to CL. In this study the smallest mesh dimension of standard shrimp traps was 1.27 cm. This provides a logical cutoff point for measurement of least CW for shrimp that are fully vulnerable to the gear. Based on their functional regression this corresponds to 30 mm CL.

It is evident from the three panels in Figure 4 that the size distribution of *H. laevigatus* above 30 mm CL is characterized by both rising and descending portions. As shown by Powell (1979) this indicates a  $Z/K$  ratio of less than unity (i.e., instantaneous mortality rate is less than the growth coefficient).

Alternatively, it is possible that the rising portions of the length distributions are not representative of the population sampled, but are instead a reflection of behavioral interactions among shrimp of different sizes. Chittleborough (1974), for example, has shown that the presence of large individuals of the decapod crustacean *Panulirus cygnus* inhibited smaller conspecifics from entering baited traps, even though smaller lobsters were vulnerable to the traps in the absence of large ones. If this kind of behavioral interaction was also in evidence here, the effective least size of *H. laevigatus* when fully vulnerable to the traps may be as large as 41 mm CL, the mode of the pooled length-frequency distribution. This would indicate a  $Z/K$  ratio of 2.0 because of the linearity of the descending portions of the size-frequency distributions. Only further experimentation will resolve this issue.

With respect to the intensive fishing experiment it is useful to consider whether or not the basic assumptions of the Leslie model were violated during the course of the study. The first of these was closure of the population. Two factors support the contention that the study population was effectively isolated and that the effects of immigration and emigration were negligible. First, the hydrographic survey showed that the study site comprised a semi-isolated extension of the main island. Continuity of prime habitat (600-800 m depth) with the island proper extended along two narrow corridors to the southeast and southwest. The shrimp has been taken as shallow as 400 m and as deep as 950 m in the Mariana Archipelago, but the 600-800 m depth range encompasses the preponderance of the region's shrimp stock (Moffitt and Polovina fn. 2), although elsewhere (e.g., Fiji, Vanuatu, and Samoa) the depth distribution apparently extends into somewhat shallower water (King 1984). The second factor arguing for closure is that the catch rate of *H. laevigatus* remained low after a 4-mo hiatus in fishing. If movements or migrations of shrimp were biologically significant over this time interval, a larger change in CPUE would be expected. It is tempting to attribute the small increase in catch rate (4.9%) to some type of biological recovery, but the estimate of mean squared error in CPUE from Figure 3 (0.3754 kg<sup>2</sup>/trap-night<sup>2</sup>) indicates that background variation is too large for the observed difference to be significant. Regardless, the data support the assumption that the population is closed.

The second assumption was that growth, natural mortality, and recruitment are negligible factors in accounting for changes in CPUE. That the experiment was completed in only 16 d and the popula-



tion was reduced an estimated 45.3% are persuasive elements here. Additionally, the size-frequency data show no indication of a major alteration in population structure. As long as the selective properties of the fishing gear remain unchanged, alterations in the length composition of the catch are not expected over short time intervals, at least due to the direct effects of fishing. Further, no recruitment of small shrimp is evident. That the mean size of *H. laevis* seemed to increase as the experiment progressed might support the hypothesis that growth of the stock was significant. An alternate explanation, however, is that size structure varies with depth of capture. Results from the Hawaiian Islands (Gooding 1984; Dailey and Ralston 1986) have now demonstrated this. The three samples presented in Figure 4 are confounded by this variable; other unknown factors may also have affected the shrimp size-frequency data (e.g., sexual dimorphism, contagious dispersion, sampling error, etc.). In addition, the estimated growth rate from the data (3.9 mm CL over 8 d = 0.49 mm/d) is biologically untenable.

Other investigators, notably Schnute (1983) and Crittenden (1983), have cautioned against the effects of changing catchability and unequal variance on Leslie model estimates. From the data gathered, there is little statistical evidence to suggest that these factors affected parameter estimates and I therefore assume that 0.001945 trap-night<sup>-1</sup> and 1,714 kg are reasonable estimates of standard trap catchability and virgin population size, respectively.

Given that the virgin biomass of *H. laevis* in the study area was 1,714 kg, the next question is: How large an area was intensively fished? From Figure 2 it is clear that there is no simple answer to this question. A number of sets were located in areas peripheral to the main trapping area. Designating the stipple bordered area as the effective area fished is arbitrary, but provides a useful starting point to allow calculation of shrimp densities. This area was calculated to be 312 ha, corresponding to a projected density of 5.5 kg of exploitable *H. laevis* per hectare. Since individuals weighed 28 g each, on average, this is equivalent to 1 exploitable shrimp/51 m<sup>2</sup> of bottom, a remarkably low density. Furthermore, a catchability coefficient of 0.001945 trap-night<sup>-1</sup> indicates that one unit of standard trap effort can reduce a 312-ha population of shrimp by about 0.2%. This is certainly a significant impact. The vulnerability to trapping that this species demonstrates is cause for attention and careful resource management.

## ACKNOWLEDGMENTS

This paper is the result of the Resource Assessment Investigation of the Mariana Archipelago at the Southwest Fisheries Center Honolulu Laboratory, National Marine Fisheries Service.

I would like to thank the crew of the *Townsend Cromwell* for their help in completing this study and Samuel G. Pooley, Victor A. Honda, Leigh Neil, and Ahser Edward for their tireless efforts and good spirits while at sea. This paper benefited greatly from a review provided by C. D. Knechtel.

## LITERATURE CITED

- BEVERTON, R. J. H., AND S. J. HOLT.  
1956. A review of methods for estimating mortality rates in fish populations, with special reference to source of bias in catch sampling. Rapp. P.-v. Réun. Cons. Perm. int. Explor. Mer 140:67-83.
- BRAATEN, D. O.  
1969. Robustness of the DeLury population estimator. J. Fish. Res. Board Can. 26:339-355.
- CHITTLEBOROUGH, R. G.  
1974. Home range, homing, and dominance in juvenile western rock lobsters. Aust. J. Mar. Freshwater. Res. 25: 227-234.
- CRITTENDEN, R. N.  
1983. An evaluation of the Leslie-DeLury method and a weighted method for estimating the size of a closed population. Fish. Res. (Amst.) 2:149-158.
- DAILEY, M. D., AND S. RALSTON.  
1986. Aspects of the reproductive biology, spatial distribution, growth, and mortality of the deepwater caridean shrimp, *Heterocarpus laevis*, in Hawaii. Fish. Bull., U.S. 84:915-925.
- DELURY, D. B.  
1947. On the estimation of biological populations. Biometrics 3:145-167.
- GOODING, R. M.  
1984. Trapping surveys for the deepwater caridean shrimps, *Heterocarpus laevis* and *H. ensifer*, in the Northwestern Hawaiian Islands. Mar. Fish. Rev. 46(2):18-26.
- KING, M. G.  
1981. Increasing interest in the tropical Pacific's deepwater shrimps. Aust. Fish. 40(6):33-41.  
1983. The ecology of deepwater caridean shrimps (Crustacea: Decapoda: Caridea) near tropical Pacific islands with particular emphasis on the relationship of life history patterns to depth. Ph.D. Thesis, Univ. South Pacific, Suva, Fiji, 258 p.  
1984. The species and depth distribution of deepwater caridean shrimps (Decapoda, Caridea) near some Southwest Pacific islands. Crustaceana 47:174-191.
- LESLIE, P. H., AND D. H. S. DAVIS.  
1939. An attempt to determine the absolute number of rats on a given area. J. Anim. Ecol. 8:94-113.
- POLOVINA, J. J.  
1986. A variable catchability version of the Leslie model with application to an intensive fishing experiment on a multi-species stock. Fish. Bull., U.S. 84:423-428.

- POWELL, D. G.  
1979. Estimation of mortality and growth parameters from the length frequency of a catch. *Rapp. P.-v. Réun. Cons. int. Explor. Mer* 175:167-169.
- RICKER, W. E.  
1975. Computation and interpretation of biological statistics of fish populations. *Fish. Res. Board Can., Bull.* 191, 382 p.
- SAS INSTITUTE, INC.  
1981. SAS/GRAPH user's guide. 1981 ed. SAS Inst., Inc., 126 p.
- SCHNUTE, J.  
1983. A new approach to estimating populations by the removal method. *Can. J. Fish. Aquat. Sci.* 40:2153-2169.
- TATE, M. W., AND R. C. CLELLAND.  
1957. Nonparametric and shortcut statistics in the social, biological, and medical sciences. Interstate Printers Publ., Inc., Danville, IL., 171 p.
- VON GELDERN, C. E., JR.  
1961. Application of the DeLury method in determining the angler harvest of stocked catchable-sized trout. *Trans. Am. Fish. Soc.* 90:259-263.

# ICHTHYOPLANKTON IN NERITIC WATERS OF THE NORTHERN GULF OF MEXICO OFF LOUISIANA: COMPOSITION, RELATIVE ABUNDANCE, AND SEASONALITY

JAMES G. DITTY<sup>1</sup>

## ABSTRACT

Ichthyoplankton samples were collected monthly between November 1981 and October 1982 in neritic continental shelf waters off Louisiana. The survey provided the first quantitative data on the abundance and seasonal occurrence of larval fishes from open coastal waters of this area. At least 48 families of fishes were represented in samples that included 107 taxa, 54 of which were identified to species. Larval densities were lowest during the winter and highest during the summer with a mean monthly density of 208/100 m<sup>3</sup>. Five families accounted for about 90% of total larvae: Engraulidae, Sciaenidae, Clupeidae, Carangidae, and Bothidae. The five most abundant taxa overall, in order of decreasing abundance, were anchovies (Engraulidae); Atlantic croaker, *Micropogonias undulatus*; Atlantic thread herring, *Opisthonema oglinum*; gulf menhaden, *Brevoortia patronus*; and Atlantic bumper, *Chloroscombrus chrysurus*. These taxa accounted for 82% of all larvae collected. Comparison of ichthyoplankton surveys throughout the Gulf of Mexico showed that the 10 most abundant families contributed over 90% of total larval abundance in coastal surveys but less than 70% in offshore surveys. Likewise, the five most abundant taxa contributed over 80% of total larval abundance in all but one of the coastal surveys but less than 40% in the offshore surveys. These data suggest that compared with offshore waters, there are relatively fewer dominant taxa among the ichthyoplankton in neritic waters of the Gulf of Mexico.

The northern Gulf has traditionally been one of the most productive fishery areas in North America (Gunter 1967), yet seasonality and abundance of larval fishes from open waters are poorly known. Previous studies of early life history stages in this area have mainly been focused either on select taxa (Turner 1969; Fore 1970, 1971; Christmas and Waller 1975; Fruge 1977; Ditty 1984; Cowan 1985; Shaw et al. 1985) or to surveys limited in temporal and areal coverage (Walker 1978; Ditty and Truesdale 1984). Stuck and Perry (1982) surveyed the ichthyoplankton community adjacent to Mississippi Sound, while Marley (1983) conducted an egg survey and Williams (1983) a larval fish survey of lower Mobile Bay, AL. The most comprehensive studies of the offshore larval ichthyofauna in the Gulf of Mexico and adjacent areas were those of Finucane et al. (1977) from the south Texas outer continental shelf; Houde et al. (1979) from the eastern Gulf of Mexico off Florida; Richards (1984) from the Caribbean Sea; and Powles and Stender (1976) from the South Atlantic Bight area off the east coast of the United States. The objective of this paper is to provide quantitative data on the abundance and seasonal occurrence of larval fishes from open

coastal waters of the northern Gulf of Mexico off Louisiana.

## MATERIALS AND METHODS

Plankton samples were collected monthly between November 1981 and October 1982 (except March 1982) in neritic continental shelf waters off Louisiana. Samples were collected at six stations in a 3.2 km<sup>2</sup> area located about 12.9 km south-southwest of Caminada Pass, in depths of 10-12 m (Fig. 1). Collections were made with a 60 cm paired-net, opening and closing bongo-type BNF-1 sampler<sup>2</sup>, each net was of 0.363 mm Nitex<sup>3</sup> mesh. Nets were lowered to depth, opened, and towed simultaneously, in series, at discrete depths (surface, middepth, and near-bottom) for about 3 min, at a ship speed of approximately 1.5 kn; all samples were collected during the day. A General Oceanics (Model 2030) flowmeter was placed in the mouth of each net to estimate volume filtered. Samples were preserved in seawater with buffered Formalin and returned to the laboratory for sorting. Fish larvae were removed from each net and identified to the lowest

<sup>1</sup>Louisiana Department of Wildlife and Fisheries, Seafood Division, P.O. Box 15570, Baton Rouge, LA 70895.

<sup>2</sup>Tareq and Co., 8460 S.W. 68th Street, Miami, FL 33143.

<sup>3</sup>Reference to trade names does not imply endorsement by the National Marine Fisheries Service, NOAA.

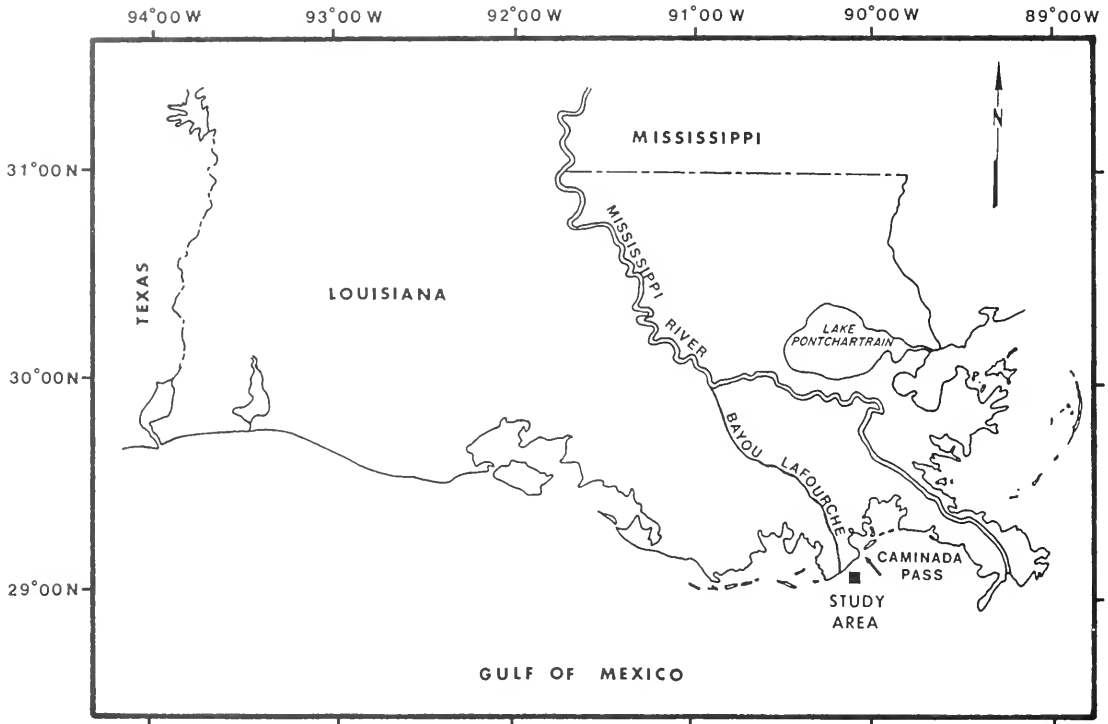

FIGURE 1.—Location of study area.

possible taxon, and standard length was measured with an ocular micrometer; all specimens were subsequently archived in 70% ethanol. Hydrographic profiles of the water column were taken at approximately 1-1.5 m intervals with a Martek Mark VI water quality monitor, except during January, February, and September 1982 when the Martek unit was inoperable. During these 3 mo, water temperatures and salinities were measured with a Beckman RS-5 inductive salinometer near surface, middepth, and bottom. Estimates of monthly mean larval densities were calculated by dividing total larvae by total volume filtered at each depth and integrated over depth. Densities are expressed as number/100 m<sup>3</sup>. Seasonal designations were based primarily on mean surface water temperatures during the year: <20°C (Winter: December-February); 20°-25°C (Spring: April-May); >25°C (Summer: June-August); and rapidly declining surface water temperatures (Fall: September-November).

Additional data on larval occurrence and seasonality only were compiled from surface-towed meter net (0.363 mm mesh) collections at stations sampled between January 1981 and December 1982. These data consisted of four nearshore stations located

adjacent to the bongo stations and were sampled monthly. Two additional groups of stations, one of four and the other of five stations, were located about 24 km south of the nearshore stations in depths of about 30 m. Each group of offshore stations was sampled quarterly but on consecutive months during 1981; thereafter, monthly samples were collected only at the four station group. These seasonality data are not discussed but are included in the Appendix Table.

Ancillary occurrence and seasonality data on larval bothids, scombrids, and sciaenids collected off Louisiana during the spring and early summer of 1982 were compiled from surface-towed 0.5 m ring net (0.505 mm mesh), 60 cm bongo net (0.333 mm mesh), and surface-towed 1 × 2 m neuston net (0.946 mm mesh) samples (SEAMAP 1983). Bongo tows were oblique and from the surface to 200 m or within 5 m of the bottom at shallower depths. Seasonality data for these taxa were compiled only from stations located between long. 88°30'W and 93°30'W and shoreward of lat. 27°00'N and, although not discussed, are also included in the Appendix Table. Additional station and cruise data are provided in Richards et al. (1984).

## RESULTS

### Taxonomic Problems

Larvae of many fishes in the northern Gulf of Mexico are poorly known and taxonomic problems are common, even in some of the most abundant taxa. No attempt was made to identify blennies, gobies, myctophids, synodontids, or cynoglossids to species because of the paucity of literature on larval development for these taxa. Little is also known about the taxonomy and morphological development of engraulid larvae. At least five species of engraulids are known to occur as adults in the north-central Gulf: *Anchoa mitchilli*, *A. hepsetus*, *A. lyolepis*, *A. cubana*, *Anchoviella perfasciata* (Modde and Ross 1981), and possibly *Engraulis eurystole* (Hastings 1977). *Anchoa mitchilli*, *A. hepsetus*, and *A. lyolepis* probably account for most of the engraulid larvae collected. Larvae of *A. hepsetus* and *A. mitchilli* in the Chesapeake Bay Region can be distinguished from each other primarily on placement of dorsal and anal fins (Manseuti and Hardy 1967), but this character is insufficient to separate reliably the additional species of anchovy that may occur in this area. Separation of menhaden larvae is also difficult. Three species of menhaden are known to occur as adults in this area: *Brevoortia smithi* (Chandeleur Sound, LA, eastward), *B. patronus* (Tampa Bay, FL, westward to Veracruz, Mexico) and *B. gunteri* (Mississippi Sound, MS, westward) (Christmas and Gunter 1960; Springer and Woodburn 1960; Dahlberg 1970; Turner 1971). Published descriptions are available for laboratory-reared larvae of *B. smithi* (Houde and Swanson 1975) and *B. patronus* (Hettler 1984) only. *Brevoortia gunteri* have never been described nor positively identified from the northern Gulf. Although the congeners have spawning seasons that reportedly overlap, the center of spawning of *B. patronus* is apparently off Louisiana between the Mississippi and Atchafalaya River Deltas (Turner 1969; Fore 1970; Christmas and Waller 1975). Since *Brevoortia* larvae collected during this study appear similar to that described as *B. patronus* (Hettler 1984) and because I have recognized in subsequent samples (at sizes >7 mm SL) a second morph that could be *B. gunteri*, all larvae were considered *B. patronus*.

Published descriptions of sciaenid larvae are inadequate to reliably distinguish between small larvae of the species of *Menticirrhus* (*M. americanus*, *M. littoralis*, and *M. saxatilis*) or between small *Cynoscion arenarius* and *C. nothus*. Two types of *C. arenarius* larvae were recognized primarily on

the absence (Type A) or presence (Type B) of pigment in the dorsal midline immediately above the enlarged melanophore located in the ventral midline about midway along the anal fin base. Additional data on the separation of these types are provided in Cowan (1985). Small carangid larvae (<5 mm SL) of certain taxa are also difficult to identify and were referred to a morphological type when a generic or specific epithet could not be assigned. The taxonomy and/or larval development of some of the other monthly dominants (e.g., *Lepophidium* spp., *Ophidion* spp., *Auxis* spp., and *Ariomma* sp.) are poorly understood.

### Hydrography

Water temperatures between November 1981 and October 1982 ranged from 16°C in January and February to 31°C in June and were below 20°C from December through February and above 25°C from May through October. There was little thermal stratification except during the summer, with stratification most pronounced in June (Fig. 2A).

Salinity stratification was most pronounced from February through August, with little stratification from September through January. Salinities were lowest near the surface, increased with depth, and ranged from <20‰ near the surface in February to 32‰ in December; salinities near the bottom ranged from 31‰ in September to 36‰ in the spring and early summer. Salinities near the surface steadily decreased from April through July and increased thereafter, whereas those near the bottom were comparatively more stable throughout the study period (Fig. 2B). In February, there was a distinct salinity gradient within the upper 6 m of the water column that ranged from 18‰ at the surface to 30‰ near middepth. In June, two distinct water masses were present with a halocline near middepth. Salinities of these two water masses differed by about 10‰ with the less saline waters above middepth (Fig. 2B). Further information on water temperature and salinity variability and the physical processes that affect the hydrography of the study area are provided in Wiseman et al. (1982).

### Seasonal Composition and Abundance

At least 48 families of fishes were represented in bongo net samples that included 107 taxa, 54 of which were identified to species. About 36,500 larvae were collected, with <5% (primarily damaged or yolk-sac larvae) unidentifiable to family. The majority of larvae collected were <5 mm SL except

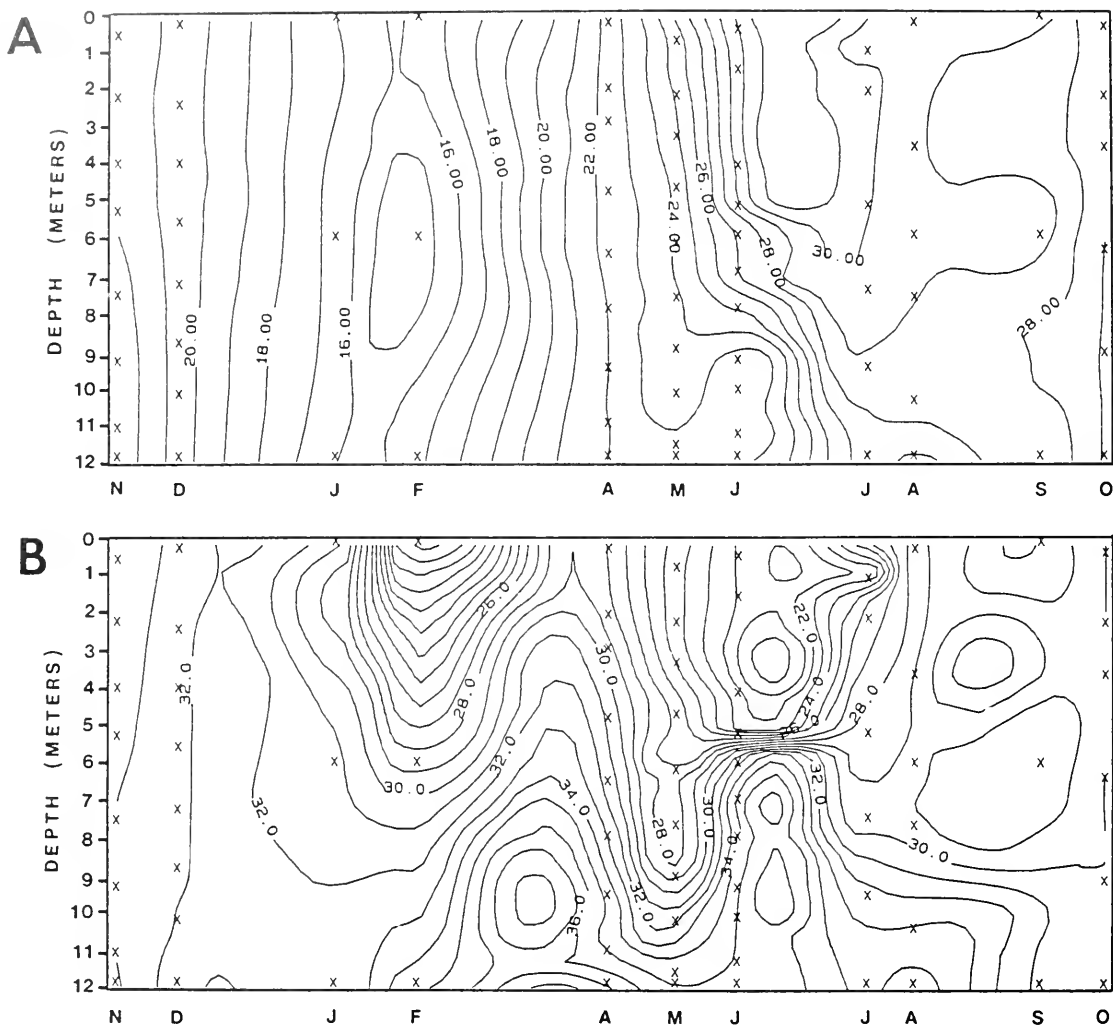

FIGURE 2.—Profiles of water temperature and salinity (November 1981–October 1982) at a representative station from the study area located in neritic waters of the northern Gulf of Mexico off Louisiana. A. Water temperature, B. Salinity. X indicates sampling depths. Collection dates were scaled by Julian calendar.

larvae of clupeiform fishes; these were usually <10 mm SL.

Generally, seasonal larval densities followed water temperatures (T) and were lowest during winter ( $\bar{X} = 51/100 \text{ m}^3$  at  $T < 20^\circ\text{C}$ ), increased during the spring ( $\bar{X} = 207/100 \text{ m}^3$  at  $T < 25^\circ\text{C}$ ), peaked during the summer ( $\bar{X} = 394/100 \text{ m}^3$  at  $T$  near  $30^\circ\text{C}$ ), and declined during the fall ( $\bar{X} = 179/100 \text{ m}^3$  at rapidly declining T). Approximately 6% of all fish larvae were collected during the winter and 47.5% during the summer. Larval densities were lowest in December and highest in June, with a mean monthly density of  $208/100 \text{ m}^3$  (Fig. 3). Overall, December had the fewest taxa (13) and Septem-

ber the most (37). Five families accounted for about 90% of total larvae: Engraulidae, Sciaenidae, Clupeidae, Carangidae, and Bothidae. The five most abundant taxa overall, in order of decreasing abundance, were anchovies (Engraulidae); Atlantic croaker, *Micropogonias undulatus*; Atlantic thread herring, *Opisthonema oglinum*; gulf menhaden, *Brevoortia patronus*; and Atlantic bumper, *Chloroscombrus chrysurus*. These taxa accounted for about 82% of all larvae taken. Thirty-eight taxa occurred in sufficient numbers that they were within the 10 most abundant taxa collected in at least one month. Densities of these taxa are presented in Table 1.

Anchovies accounted for about 49% of all larvae

and were collected throughout the year, but were most abundant in June and least abundant in November (Table 1). Anchovies accounted for 65% of all larvae taken during the spring and 69% during the summer, but declined to about 6% of all larvae collected during the fall and winter, respectively; anchovies were the second most abundant taxon collected during the winter and were fourth during the fall. Most anchovy larvae were collected near the surface and middepths; only 11% were collected near the bottom. A few flat anchovy, *Anchoviella perfasciata*, postlarvae were collected in February only.

Atlantic croaker accounted for 66% of all sciaenid larvae and were most abundant in November (Table 1). This species accounted for 58% of all larvae taken during the fall and for 14% of larvae overall. Most Atlantic croaker (65%) were collected near middepth with only 1% collected near the surface. Two types of sand seatrout, *Cynoscion arenarius*, were recognized with Type A collected from April to September and Type B from April to October. Of all sand seatrout larvae taken, 60% were Type A and 40% Type B, with Type A the second and Type B the third most abundant of all sciaenid larvae. Density of Type A exceeded that of Type B until September

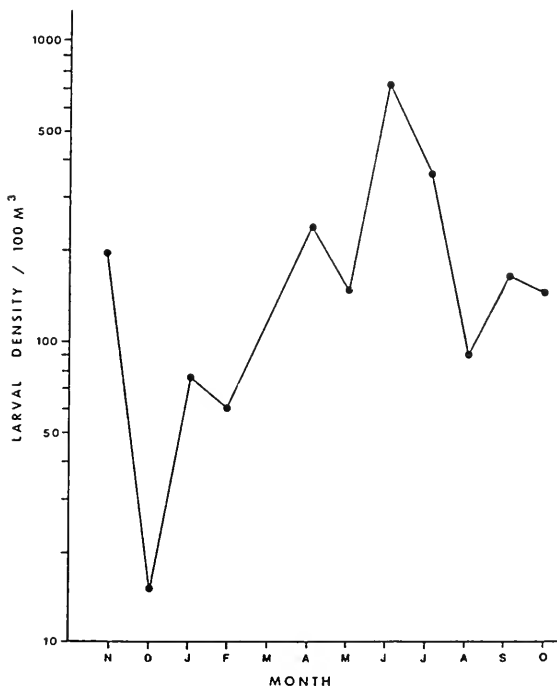

FIGURE 3.—Density of ichthyoplankton (no./100 m<sup>3</sup>) by month, from neritic Gulf of Mexico waters off Louisiana, November 1981–October 1982.

and October when Type B were more abundant (Table 1). Most Type A (66%) and Type B (56%) larvae were collected near the bottom with <5% of Type A and of Type B larvae, respectively, collected near the surface. Larvae of red drum, *Sciaenops ocellatus*, were taken during the fall only and were most abundant in September, whereas *Menticirrhus* spp. were collected in all months except December and January and were most abundant in October (Table 1). Larval densities of other less abundant sciaenids that included black drum, *Pogonias cromis*; banded drum, *Larimus fasciatus*; spot, *Leiostomus xanthurus*; silver perch, *Bairdiella chrysoura*; and silver seatrout, *Cynoscion nothus*, never exceeded 1/100 m<sup>3</sup>. Densities of star drum, *Stellifer lanceolatus*, and spotted seatrout, *C. nebulosus*, were <2/100 m<sup>3</sup> for any month.

Larvae of both the scaled sardine, *Harengula jaguana*, and Atlantic thread herring were collected from April to October, whereas gulf menhaden were collected from October to February and round herring, *Etrumeus teres*, only in January and February. No larvae of Spanish sardine, *Sardinella* sp., were identified. Densities of Atlantic thread herring were greatest in June, scaled sardine in July, and gulf menhaden in January. Densities of Atlantic thread herring accounted for about 58% of all clupeid larvae and for 9% of larvae overall; gulf menhaden accounted for 34% of all clupeids and for 5% of larvae overall. Scaled sardine accounted for 8% of all clupeid larvae. Atlantic thread herring was the second most abundant taxon collected in each season except winter, and accounted for 88% of all clupeid larvae collected between April and October; gulf menhaden accounted for 73% of all winter larvae. Over 99% of Atlantic thread herring and 80% of scaled sardine were collected when surface water temperatures were above 25°C; 90% of gulf menhaden were taken at water temperatures below 20°C. Most scaled sardine (79%) larvae were taken near the surface and only 2% near the bottom. Menhaden larvae were abundant at all depths with 37% collected near the surface and 24% near the bottom. Atlantic thread herring were most abundant near middepth (62%) and least abundant near the surface (6%).

Larvae of Atlantic bumper were collected from June to October but were most abundant in July. This species accounted for about 5% of all larvae and was the third most abundant taxon collected during both the summer and fall months. Atlantic bumper accounted for about 94% of all carangid larvae with most bumper (94%) collected when surface water temperatures averaged 30°C. Atlantic

TABLE 1.—Densities (no./100 m<sup>3</sup>) of abundant taxa from neritic waters of the northern Gulf of Mexico off Louisiana, November 1981-October 1982<sup>1</sup>.

Taxa	Nov.	Dec.	Jan.	Feb.	Apr.	May	June	July	Aug.	Sept.	Oct.
Engraulidae	0.8	4.0	1.6	2.9	193.8	74.3	598.1	213.4	3.0	27.6	3.3
<i>Brevoortia patronus</i>	7.3	2.7	67.1	41.0	—	—	—	—	—	0.8	1.4
<i>Etrumeus teres</i>	—	—	0.4	0.2	—	—	—	—	—	—	—
<i>Opisthonema oglinum</i>	—	—	—	—	0.3	52.1	71.9	2.3	16.6	62.5	(?)
<i>Harengula jaguana</i>	—	—	—	—	5.7	0.2	—	11.9	9.5	0.2	(?)
Synodontidae	(?)	—	(?)	0.6	—	0.3	—	—	—	—	—
Myctophidae	(?)	—	1.0	7.2	0.4	—	—	—	—	—	—
<i>Bregmaceros cantori</i>	0.4	(?)	—	0.1	0.3	0.5	—	—	—	—	0.1
<i>Lepophidium</i> spp.	0.9	—	—	—	—	—	—	—	—	—	—
<i>Ophidion</i> spp.	0.6	—	—	—	—	—	—	—	—	—	—
<i>Membras martinica</i>	—	—	—	(?)	1.0	(?)	—	—	—	—	—
Carangidae Type A	—	—	—	—	—	1.5	—	—	—	—	—
<i>Chloroscombrus chrysurus</i>	—	—	—	—	—	—	7.8	48.3	13.5	39.2	6.7
<i>Oligoplites saurus</i>	—	—	—	—	—	—	1.3	2.8	—	—	—
<i>Trachurus lathami</i>	—	—	—	0.4	—	—	—	—	—	—	—
<i>Orthopristis chrysoptera</i>	—	—	—	(?)	1.0	—	—	—	—	—	—
<i>Archosargus probatocephalus</i>	—	—	—	—	2.9	—	—	—	—	—	—
<i>Lagodon rhomboides</i>	(?)	—	0.3	0.4	—	—	—	—	—	—	—
<i>Cynoscion arenarius</i> (Type A)	—	—	—	—	22.5	6.3	7.2	17.2	10.3	1.9	—
<i>Cynoscion arenarius</i> (Type B)	—	—	—	—	10.6	0.8	6.7	11.1	10.2	5.7	1.5
<i>Leiostomus xanthurus</i>	0.8	0.5	0.1	0.2	—	—	—	—	—	—	—
<i>Menticirrhus</i> spp.	(?)	—	—	(?)	1.2	0.4	1.4	2.5	0.1	2.0	5.2
<i>Micropogonias undulatus</i>	182.8	2.8	—	2.2	—	—	—	—	—	—	126.4
<i>Sciaenops ocellatus</i>	—	—	—	—	—	—	—	—	—	12.8	6.3
<i>Stellifer lanceolatus</i>	—	—	—	—	1.4	0.1	1.6	0.3	0.3	0.3	0.2
<i>Chaetodipterus faber</i>	—	—	—	—	—	(?)	0.6	5.5	0.1	1.3	—
<i>Mugil cephalus</i>	—	—	0.4	(?)	—	—	—	—	—	—	—
Blennidae	0.3	1.6	0.6	(?)	2.8	9.0	1.2	2.0	0.2	0.9	0.1
Gobiidae	0.4	1.0	—	0.4	0.6	0.8	0.2	0.2	—	0.2	0.4
<i>Auxis</i> spp.	—	—	—	—	0.2	1.0	—	—	—	0.5	0.1
<i>Scomberomorus maculatus</i>	—	—	—	—	0.5	0.1	1.7	5.5	4.8	1.5	—
<i>Ariomma</i> sp.	—	—	0.7	—	—	—	—	—	—	—	—
<i>Peprilus burti</i>	1.4	0.1	0.5	0.9	0.1	0.2	0.1	—	—	—	0.5
<i>Peprilus paru</i>	—	—	—	—	—	0.4	0.6	0.5	0.6	4.4	(?)
<i>Etropus crossotus</i>	0.4	—	—	—	—	9.0	9.4	1.9	(?)	0.7	0.5
<i>Citharichthys spilopterus</i>	0.4	(?)	0.4	0.6	0.1	—	—	(?)	—	—	—
<i>Symphurus</i> spp.	0.5	0.1	—	—	0.1	1.5	2.8	1.4	0.1	0.5	0.2
<i>Myrophis punctatus</i>	(?)	0.1	0.1	0.2	—	—	—	—	—	—	—

<sup>1</sup>No data for March 1982.<sup>2</sup>Density <0.1/100 m<sup>3</sup>.

bumper were most abundant near middepth (60%) and least abundant near the bottom (9%). Other abundant carangids included leatherjacket, *Oligoplites saurus*; rough scad, *Trachurus lathami*; and carangid Type A larvae. All carangid Type A larvae were <4 mm SL and appear similar to that described as the round scad, *Decapterus punctatus*, by Aprieto (1974).

Larvae of gulf butterfish, *Peprilus burti*, occurred from October to June and harvestfish, *P. paru*, from May to October (Table 1). Most gulf butterfish (85%) larvae were collected when surface water temperatures were <25°C whereas all harvestfish were collected when surface water temperatures were above 25°C. Spanish mackerel, *Scomberomorus maculatus*, larvae occurred from April to September but were most abundant in July; most (96%) were collected when surface water temperatures exceeded 25°C. Most Spanish mackerel (74%) larvae were collected near middepth; only 5% were collected near

the bottom. King mackerel, *S. cavalla*, larvae were collected only in September and at a density <0.5/100 m<sup>3</sup>.

Many taxa occurred in relatively low abundance, and although not included in Table 1, provided additional data on seasonality. These data are presented in the Appendix Table. Only taxa with larvae <10 mm SL for a given month (except anguilliform leptocephali or sygnathids) were included in the Appendix Table, except where noted.

## DISCUSSION

Data on peak seasonal occurrence of many of the abundant taxa from the present study agree with those of other coastal surveys from the north-central Gulf of Mexico off Mississippi (Stuck and Perry 1982) and off Alabama (Williams 1983). During 1982, greatest densities of larval menhaden off central Louisiana (the present study) occurred in



January-February and off western Louisiana (Shaw et al. 1985) in February-March. Stuck and Perry (1982) found larval menhaden most abundant between January and March adjacent to Mississippi Sound. These data agree with past studies (Fore 1970; Christmas and Waller 1981) from this area that reported high densities of menhaden eggs between December and February. All three of the north-central Gulf studies (Stuck and Perry 1982; Williams 1983; and the present study) reported greatest densities of Atlantic croaker during October and November; densities of sand seatrout were greatest in April, with a second smaller peak in density during either July or August. Both Atlantic bumper and Spanish mackerel were most abundant from July to September in each of these three studies. Stuck and Perry and the present study also found the greatest density of red drum in September; Williams did not sample in September. In the present study, Atlantic thread herring were most abundant in June, with a second peak in September; scaled sardine were most abundant during July and August. Few scaled sardine and Atlantic thread herring larvae were collected by Williams; no Atlantic thread herring and few scaled sardine were collected by Stuck and Perry. All three of these north-central Gulf studies also reported a bimodal peak in abundance of engraulids but differed slightly in month of peak density. Stuck and Perry, and Williams found greatest densities in April, with a second smaller peak in August. The smaller of the two peaks in abundance of engraulids occurred in April, with the greatest density in June in the present study (Table 1).

Comparison of dominant families and taxa collected overall in the present study with those of other ichthyoplankton surveys throughout the Gulf of Mexico are presented in Tables 2 and 3. Lower bay/coastal surveys were those conducted primarily inside the 10 m depth contour, except for Hoese (1965), who had a single transect of six stations out to 50 m. Offshore surveys were those conducted mainly in waters deeper than 10 m but shoreward of the edge of the continental shelf. Although not all the data listed in Tables 2 and 3 are directly comparable because of differences in gear type, mesh size, or tow, these studies provide general information on larval composition and abundance.

Most of the surveys from coastal waters (Hoese 1965; Blanchet 1979; Williams 1983; Collins and Finucane 1984; and the present study) found that engraulids dominated the summer ichthyoplankton, whereas Stuck and Perry (1982) reported engraulids second to Atlantic bumper in abundance. However, Stuck and Perry may have undersampled small engraulid and clupeid larvae because of the large mesh (1.050 mm) of their nets. Menhaden dominated the winter ichthyoplankton in all of the aforementioned coastal surveys, except Collins and Finucane (1984). These authors found that pigfish, *Orthopristis chrysoptera*, larvae were the most abundant taxa during the winter in waters off the Everglades of south Florida. All of these surveys also consistently placed engraulids and sciaenids at or near the top in total larval abundance. Overall, clupeids were relatively more abundant off south Florida (Collins and Finucane 1984) than in the other coastal surveys, except Hoese (1965), who sampled only the

TABLE 2.—Comparison of the five most abundant families collected overall from neritic waters off Louisiana with other ichthyoplankton surveys throughout the Gulf of Mexico.

Study	Engraulidae		Sciaenidae		Clupeidae		Carangidae		Bothidae		Location	Gear type, mesh size, depth of tow, and region <sup>1</sup>
	Rank	%	Rank	%	Rank	%	Rank	%	Rank	%		
Present study	1	49.0	2	19.0	3	16.0	4	5.5	5	1.5	Coastal	1,6,9,10,11,15
Hoese 1965	2	42.0	3	7.0	1	45.0	—	0.5	—	0.5	Coastal	2,4,9,14
Stuck and Perry 1982	2	19.7	3	18.2	6	3.4	1	38.8	4	5.6	Coastal	3,8,9,11,15
Williams 1983	1	69.3	2	14.5	3	4.5	4	2.8	—	0.5	Lower Mobile Bay/Coastal	3,7,9,11,15
Blanchet 1979	1	75.8	2	4.9	8	1.9	7	2.2	—	<0.1	Lower Apalachicola Bay/Coastal	2,6,7,9,16
Collins and Finucane 1984 <sup>2</sup>	2	22.5	4	6.9	1	24.1	5	6.1	—	<0.1	Coastal	2,7,9,12,18
Finucane et al. 1979 <sup>3</sup>	5	6.2	—	<0.1	3	8.1	8	3.7	6	6.1	Offshore	1,7,13,14
Houde et al. 1979	12	2.0	30	0.3	1	20.5	6	3.9	3	6.4	Offshore	1,2,7,12,17
11 60 cm bongo	7	0.505 mm	13	double-oblique			<sup>2</sup> inshore data only					
2 1 m	8	1.050 mm	14	west-central			<sup>3</sup> 1977 bongo net data only					
3 1 × 0.5 m rectangular	9	surface	15	north-central								
4 0.086 mm	10	middepth	16	north-east								
5 0.333 mm	11	bottom	17	east-central								
6 0.363 mm	12	oblique	18	south-east								

TABLE 3.—Comparison of five most abundant taxa from neritic waters off Louisiana with ichthyoplankton surveys throughout the Gulf of Mexico.

Taxa	Present study %	Hoese 1965 %	Stuck and Perry 1982 %	Williams 1983 %	Blanchet 1979 %	Collins and Finucane 1984 <sup>1</sup> %	Finucane et al. 1979 <sup>2</sup> %	Houde et al. 1979 %
Engraulidae	49.0		19.7	69.0	75.8	22.5	7.1	
<i>Micropogonias undulatus</i>	14.0			5.8				
<i>Opisthonema oglinum</i>	9.0					4.5		7.9
<i>Brevoortia patronus</i>	5.0	15.6		4.3				
<i>Chloroscombrus chrysurus</i>	5.0		38.4	2.8	1.8	4.8		
<i>Harengula jaguana</i>		29.1						
<i>Anchoa hepsetus</i>		24.0						
<i>Anchoa mitchilli</i>		17.7						
<i>Menticirrhus</i> spp.		2.6						
<i>Cynoscion arenarius</i>			12.0	8.2				
<i>Citharichthys-Etropus</i> complex			5.6					
<i>Symphurus</i> spp.			3.8					
Atherinidae					3.9			
<i>Gobiesox strumosus</i>					3.2			
<i>Gobiosoma</i> spp.					2.7			
<i>Microgobius</i> spp.						9.1		
<i>Orthopristis chrysoptera</i>						4.8		
Gobiidae							15.8	15.1
<i>Bregmaceros atlanticus</i>							7.1	
<i>Saurida</i> spp.							6.1	
<i>Syacium</i> spp.							4.1	
<i>Sardinella anchovia</i>								8.6
<i>Decapterus punctatus</i>								3.1
<i>Diplactrum formosum</i>								2.8

<sup>1</sup>Inshore data only.<sup>2</sup>1977 bongo net data only.

surface waters of his offshore transect (Table 2).

Offshore, Houde et al. (1979) found that clupeids (Spanish sardine and Atlantic thread herring), gobiids, and bothids (mostly dusky flounder, *Syacium papillosum*) dominated summer ichthyoplankton in the eastern Gulf of Mexico off Florida, whereas clupeids (round herring and Spanish sardine), bothids (mostly gray flounder, *Etropus rimosus*), and bregmacerotids dominated the winter. In the western Gulf of Mexico off the south Texas coast, Finucane et al. (1979) reported that, during 1977, clupeids (mostly scaled sardine) and bothids (mostly *Syacium* spp.) dominated the summer and bregmacerotids and clupeids (menhaden) the winter ichthyoplankton. In the northern Gulf of Mexico off Louisiana, Ditty and Truesdale (1984) found that engraulids and carangids (mostly Atlantic bumper) dominated the summer (July 1976), whereas larvae of clupeids (mostly gulf menhaden) and gobiids dominated the winter (January-February 1976). The most abundant families collected overall off Florida were clupeids and gobiids (35.6% of all larvae), and off south Texas were gobiids and synodontids (26.7% of all larvae). The kinds of larvae (gobiids, bothids, clupeids, and bregmacerotids) that dominated these two offshore surveys were similar, but

with clupeids and bothids relatively more abundant off Florida than Texas; engraulids were relatively more abundant off south Texas than off Florida (Table 2). Ditty and Truesdale (1984) found clupeids and engraulids most abundant overall (67.7% of all larvae), but their surveys were too limited temporally and in areal coverage for adequate comparison to the other two offshore surveys.

The 10 most abundant families accounted for 66.6% of all larvae collected off Florida (Houde et al. 1979) and for 68.6% off south Texas (Finucane et al. 1979). In contrast, the top 10 families in each of the coastal surveys contributed over 90% of all larvae collected. Likewise, the five most abundant taxa contributed over 80% of all larvae collected in all but one (Collins and Finucane 1984) of the coastal surveys but <40% in the two offshore surveys (Table 3).

In conclusion, there was general agreement among all three coastal surveys from the north-central Gulf of Mexico on peak seasonal occurrence of many of the abundant taxa and on the dominant families in overall larval abundance. Comparison of other coastal and offshore ichthyoplankton surveys throughout the Gulf of Mexico with the present study suggests that, when compared with offshore waters, there are relatively fewer dominant taxa

among the ichthyoplankton in neritic waters of the Gulf of Mexico.

## ACKNOWLEDGMENTS

This study represents a portion of an ongoing multiyear synoptic environmental assessment of the Louisiana Offshore Oil Port (LOOP, Inc.) and related facilities conducted by the Louisiana Department of Wildlife and Fisheries. I would like to thank Robert Ganczak and R. Harry Blanchet for their support and advice; Carlos Garces for statistical guidance; Jill Onega for typing the various drafts of the manuscript; Ron Gouguet for computer programming expertise, collection of hydrographic data, and generating the hydrographic profile plots; and to acknowledge Frank M. Truesdale, R. Harry Blanchet, and the other reviewers for their valuable comments and suggestions for manuscript improvement. Thanks to the captain and crew of the LOOP *Vigilance*, to LOOP Inc., and to the Louisiana Department of Wildlife and Fisheries for additional support. Thanks also to the Southeast Area Monitoring and Assessment Program (SEAMAP) for providing data on the bothids, sciaenids, and scombrids collected off Louisiana during 1982 and to William J. Richards and Tom Potthoff for identifying the SEAMAP scombrids.

## LITERATURE CITED

- APRIETO, V. L.  
1974. Early development of five carangid fishes of the Gulf of Mexico and the South Atlantic coast of the United States. *Fish. Bull.*, U.S. 72:415-443.
- BLANCHET, R. H.  
1979. The distribution and abundance of ichthyoplankton in the Apalachicola Bay, Florida area. Master's Thesis, Florida State Univ., Tallahassee, 143 p.
- CHRISTMAS, J. Y., AND G. GUNTER.  
1960. Distribution of menhaden, genus *Brevoortia*, in the Gulf of Mexico. Gulf Coast Research Laboratory, Ocean Springs, MS, 20 p.
- COLLINS, L. A., AND J. H. FINUCANE.  
1984. Ichthyoplankton survey of the estuarine and inshore waters of the Florida Everglades, May 1971 to February 1972. U.S. Dep. Commer., NOAA Tech. Rep., NMFS 6, 75 p.
- COWAN, J. H., JR.  
1985. The distribution, transport and age structure of drums (Family Sciaenidae) spawned in the winter and early spring in the continental shelf waters off western Louisiana. Ph.D. Thesis, Louisiana State Univ., Baton Rouge, 182 p.
- DAHLBERG, M. D.  
1970. Atlantic and Gulf menhadens, genus *Brevoortia* (Pisces: Clupeidae). *Bull. Fla. State Mus. Biol. Sci.* 15:91-162.
- DITTY, J. G.  
1984. Seasonality of sciaenids in the northern Gulf of Mexico. *Assoc. Southeastern Biol. Bull.* 31(2):55.
- DITTY, J. G., AND F. M. TRUESDALE.  
1984. Ichthyoplankton surveys of nearshore Gulf waters off Louisiana: January - February and July, 1976. *Assoc. Southeastern Biol. Bull.* 31(2):55-56.
- FINUCANE, J. H., L. A. COLLINS, L. E. BARGER, AND J. B. MCEACHRAN.  
1979. Ichthyoplankton/mackerel eggs and larvae. NOAA Final Report to BLM. Environmental Studies of the South Texas Outer Continental Shelf 1977. BLM Contract AA550-1A7-21, 504 p.
- FORE, P. L.  
1970. Oceanic distribution of eggs and larvae of the Gulf menhaden. In Report of the Bureau of Commercial Fisheries Biological Laboratory, Beaufort, N.C., for the fiscal year ending June 30, 1968, p. 11-13. U.S. Fish Wildl. Serv. Cir. 341.  
1971. The distribution of the eggs and larvae of the round herring, *Etrumeus teres*, in the northern Gulf of Mexico. *Assoc. Southeastern Biol. Bull.* 18(1):34.
- FRUGE, D. J.  
1977. Larval development and distribution of *Micropogonias undulatus* and *Leiostomus xanthurus* and larval distribution of *Mugil cephalus* and *Bregmaceros atlanticus* of the southeastern Louisiana coast. Master's Thesis, Louisiana State Univ., Baton Rouge, 75 p.
- GUNTER, G.  
1967. Some relationships of estuaries to the fisheries of the Gulf of Mexico. In G. Lauff (editor), *Estuaries*, p. 621-638. Am. Assoc. Adv. Sci. Spec. Publ. No. 83.
- HASTINGS, R. W.  
1977. Notes on the occurrence of the silver anchovy, *Engraulis eurystole*, in the northern Gulf of Mexico. *Northeast Gulf Sci.* 1(2):116-118.
- HETTLER, W. F.  
1984. Descriptions of eggs, larvae, and early juveniles of Gulf menhaden, *Brevoortia patronus*, and comparisons with Atlantic menhaden, *B. tyrannus*, and yellowfin, *B. smithi*. *Fish. Bull.*, U.S. 82:85-95.
- HOESE, H. D.  
1965. Spawning of marine fishes in the Port Aransas, Texas area as determined by the distribution of young and larvae. Ph.D. Thesis, Univ. Texas, Austin, 144 p.
- HOUDE, E. D., J. C. LEAK, C. E. DOWD, S. A. BERKELEY, AND W. J. RICHARDS.  
1979. Ichthyoplankton abundance and diversity in the eastern Gulf of Mexico. Report to BLM, Contract No. AA550-CT7-28, 546 p.
- HOUDE, E. D., AND L. J. SWANSON, JR.  
1975. Description of eggs and larvae of yellowfin menhaden, *Brevoortia smithi*. *Fish. Bull.*, U.S. 73:660-673.
- MANSEUTI, A. J., AND J. D. HARDY, JR.  
1967. Development of fishes of the Chesapeake Bay region: an atlas of egg, larval, and juvenile stages. Nat. Resour. Inst., Univ. Maryland, Baltimore, 202 p.
- MARLEY, R. D.  
1983. Spatial distribution patterns of planktonic fish eggs in lower Mobile Bay, Alabama. *Trans. Am. Fish. Soc.* 112: 257-266.
- MODDE, T., AND S. T. ROSS.  
1981. Seasonality of fishes occupying a surf zone habitat in the northern Gulf of Mexico. *Fish. Bull.*, U.S. 78:911-922.
- POWLES, H., AND B. W. STENDER.  
1976. Observations on composition, seasonality and distribution of ichthyoplankton from MARMAP cruises in the South Atlantic Bight in 1973. *South Carolina Mar. Resour. Cent., Tech. Rep. Ser. No. 11*, 47 p.

RICHARDS, W. J.

1984. Kinds and abundances of fish larvae in the Caribbean Sea and adjacent areas. U.S. Dep. Commer., NOAA Tech. Rep., NMFS SSRF-776, 54 p.

RICHARDS, W. J., T. POTTHOFF, S. KELLEY, M. F. MCGOWAN, L. EJSYMONT, J. H. POWER, AND R. M. OLVERA L.

1984. SEAMAP 1982 - Ichthyoplankton: Larval distribution and abundance of Engraulidae, Carangidae, Clupeidae, Lutjanidae, Serranidae, Coryphaenidae, Istiophoridae, Xiphidae, and Scombridae in the Gulf of Mexico. U.S. Dep. Commer., NOAA Tech. Mem., NMFS-SEFC-144.

SEAMAP.

1983. (plankton). ASCII characters. Data for 1982. [Fisheries-independent survey data]/National Marine Fisheries Service; Southeast Fisheries Center: Gulf States Marine Fisheries Commission [producer].

SHAW, R. F., J. H. COWAN, JR., AND T. L. TILLMAN.

1985. Distribution and density of *Brevoortia patronus* (Gulf menhaden) eggs and larvae in the continental shelf waters of western Louisiana. Bull. Mar. Sci. 36:96-103.

SPRINGER, V. G., AND K. D. WOODBURN.

1960. An ecological study of the fishes of the Tampa Bay area. Fla. State Board Conserv., Mar. Lab., Prof. Pap. Ser. 1, 104 p.

STUCK, K. C., AND H. M. PERRY.

1982. Ichthyoplankton community structure in Mississippi coastal waters. In Fishery Monitoring and Assessment Completion Report, 1 January 1977 to 31 December 1981, p. VI-I-1 thru VI-I-53. Proj. No. 2-296-R, Gulf Coast Research Laboratory, Ocean Springs, MS.

TURNER, W. R.

1969. Life history of menhadens in the eastern Gulf of Mexico. Trans. Am. Fish. Soc. 98:216-224.

1971. Occurrence of *Brevoortia gunteri* in Mississippi Sound. Q. J. Fla. Acad. Sci. 33:273-274.

WALKER, H. J., JR.

1978. Ichthyoplankton survey of nearshore Gulf waters between Barataria Bay and Timbalier Bay, Louisiana, during July, August, and December, 1973. Master's Thesis, Louisiana State Univ., Baton Rouge, 59 p.

WILLIAMS, L. W.

1983. Larval fish assemblages of lower Mobile Bay. Master's Thesis, Univ. Southern Alabama, Mobile, 55 p.

WISEMAN, W. J., JR., S. P. MURRAY, J. M. BANE, AND M. W. TUBMAN.

1982. Temperature and salinity variability within the Louisiana Bight. Contrib. Mar. Sci. 25:109-120.

APPENDIX TABLE.—Seasonality of larval fishes in the northern Gulf of Mexico off Louisiana, January 1981-December 1982.

Taxa	Jan.	Feb.	Mar.	Apr.	May	June	July	Aug.	Sept.	Oct.	Nov.	Dec.
<i>Neoconger mucronatus</i>										-----		
Muraenidae				-----								
<i>Gymnothorax</i> sp.				-----								
<i>Hoplunnis</i> sp.	-----											
Congridae							-----					
Ophichthidae				-----								
<i>Bascanichthys bascanium</i>								-----				
<i>Myrophis punctatus</i>	-----											
<i>Ophichthus gomesii</i>							-----					
<i>Pseudomyrophis</i> 'D'												
<i>Brevoortia patronus</i>	-----			-----					-----			
<i>Etrumeus teres</i>	-----											
<i>Harengula jaguana</i>				-----								
<i>Opisthonema oglinum</i>				-----								
<i>Sardinella</i> sp.										-----		
Engraulidae	-----											
<i>Anchoviella perfasciata</i> <sup>1</sup>	-----											
Gonostomatidae		-----										-----
<i>Cyclothone</i> sp.	-----											
<i>Vinciguerra nimbaria</i>	-----											
Synodontidae	-----						-----					
Paralepidae		-----			-----							
<i>Lestidiops affinis</i>		-----			-----							
Myctophidae	-----									-----		
<i>Centrobranchus nigriocellatus</i>												-----
<i>Diaphus</i> sp.											-----	
<i>Diogenichthys atlanticus</i>		-----										
<i>Hygophum</i> sp.		-----										
<i>Lampanyctus</i> sp.		-----										
<i>Gobiesox strumosus</i>		-----										
Ceratiodei					-----							-----
Antennariidae					-----							
Gigantactinidae					-----							
<i>Bregmaceros cantori</i>	-----								-----			
<i>Bregmaceros atlanticus</i>												
<i>Urophycis</i> spp.	-----											
Ophidiidae					-----				-----			
<i>Brotula barbata</i>	-----											
<i>Lepophidium</i> spp.										-----		
<i>Ophidion</i> spp.										-----		
<i>Ophidion welshi</i> /Grayi			-----							-----		
<i>Ophidion selenops</i>			-----							-----		
Exocoetidae						-----			-----			-----
<i>Hyporhamphus unifasciatus</i>									-----			
Atherinidae		-----			-----				-----			
<i>Membras martinica</i>					-----							
<i>Holocentrus</i> sp.					-----							
<i>Macrorhamphosus scolopax</i>	-----											
<i>Syngnathus</i> spp.		-----			-----				-----			
Serranidae	-----											
Anthinae	-----											-----
<i>Hemanthias leptus</i>	-----											
Grammistinae												-----
<i>Rypticus maculatus</i>								-----				
Serraninae		-----			-----							
<i>Serraniculus pumilio</i>												-----
<i>Pomatomus saltatrix</i>					-----							
Carangidae Type A <sup>2</sup>					-----							
Carangidae Type B <sup>2</sup>			-----					-----				
Carangidae Type C <sup>2</sup>					-----							
Carangidae Type D <sup>2</sup>			-----					-----				
<i>Chloroscombrus chrysurus</i>												
<i>Oligoplites saurus</i>												
<i>Selene</i> sp.												
<i>Trachurus lathami</i>	-----											
<i>Coryphaena equiselis</i>					-----				-----			
<i>Lutjanus</i> sp.												
Gerreidae						-----			-----			
<i>Orthopristis chrysoptera</i>		-----			-----							
<i>Archosargus probatocephalus</i>		-----			-----							

APPENDIX TABLE.—Continued.

Taxa	Jan.	Feb.	Mar.	Apr.	May	June	July	Aug.	Sept.	Oct.	Nov.	Dec.
<i>Lagodon rhomboides</i>	-----	-----										-----
<i>Bairdiella chrysoura</i>				-----	-----	-----	-----	-----	-----	-----	-----	-----
<i>Cynoscion arenarius</i> Type A				-----	-----	-----	-----	-----	-----	-----	-----	-----
<i>C. arenarius</i> Type B				-----	-----	-----	-----	-----	-----	-----	-----	-----
<i>C. nebulosus</i>				-----	-----	-----	-----	-----	-----	-----	-----	-----
<i>C. nothus</i>						-----	-----	-----	-----	-----	-----	-----
<i>Larimus fasciatus</i>									-----	-----	-----	-----
<i>Leiostomus xanthurus</i>	-----	-----								-----	-----	-----
<i>Menticirrhus</i> spp.		-----	-----	-----	-----	-----	-----	-----	-----	-----	-----	-----
<i>Micropogonias undulatus</i>	-----	-----								-----	-----	-----
<i>Pogonias cromis</i>	-----	-----								-----	-----	-----
<i>Sciaenops ocellatus</i>								-----	-----	-----	-----	-----
<i>Stellifer lanceolatus</i>				-----	-----	-----	-----	-----	-----	-----	-----	-----
Mullidae	-----	-----					-----	-----	-----	-----	-----	-----
<i>Chaetodipterus faber</i>					-----	-----	-----	-----	-----	-----	-----	-----
Labridae				-----	-----	-----	-----	-----	-----	-----	-----	-----
Scaridae												-----
<i>Mugil cephalus</i>	-----	-----	-----	-----	-----	-----	-----	-----	-----	-----	-----	-----
<i>Mugil curema</i>					-----	-----	-----	-----	-----	-----	-----	-----
<i>Sphyraena</i> spp.								-----	-----	-----	-----	-----
Blennidae	-----	-----	-----	-----	-----	-----	-----	-----	-----	-----	-----	-----
<i>Callionymus pauciradiatus</i>									-----	-----	-----	-----
Gobiidae	-----	-----	-----	-----	-----	-----	-----	-----	-----	-----	-----	-----
<i>Gobionellus hastatus</i>	-----	-----								-----	-----	-----
<i>Microdesmus</i> spp.					-----	-----	-----	-----	-----	-----	-----	-----
<i>Diplospinus multistriatus</i>		-----	-----	-----	-----	-----	-----	-----	-----	-----	-----	-----
<i>Trichiurus lepturus</i>									-----	-----	-----	-----
<i>Auxis</i> sp.								-----	-----	-----	-----	-----
<i>Euthynnus alletteratus</i>					-----	-----	-----	-----	-----	-----	-----	-----
<i>E. pelamis</i>					-----	-----	-----	-----	-----	-----	-----	-----
<i>Scomber japonicus</i>											-----	-----
<i>Scomberomorus cavalla</i>						-----	-----	-----	-----	-----	-----	-----
<i>S. maculatus</i>												-----
<i>Thunnus albacares</i>												-----
<i>T. atlanticus</i>												-----
<i>T. thynnus</i>												-----
<i>Ariomma</i> sp.	-----	-----	-----	-----	-----	-----	-----	-----	-----	-----	-----	-----
<i>Cubiceps pauciradiatus</i>									-----	-----	-----	-----
<i>Nomeus gronovii</i>	-----	-----										-----
<i>Peprius burti</i>	-----	-----	-----	-----	-----	-----	-----	-----	-----	-----	-----	-----
<i>P. paru</i>												-----
<i>Scorpaena</i> spp.					-----	-----	-----	-----	-----	-----	-----	-----
<i>Prionotus</i> spp.					-----	-----	-----	-----	-----	-----	-----	-----
<i>Dactylopterus volitans</i>					-----	-----	-----	-----	-----	-----	-----	-----
<i>Bothus</i> sp.				-----	-----	-----	-----	-----	-----	-----	-----	-----
<i>Citharichthys</i> sp.	-----	-----	-----	-----	-----	-----	-----	-----	-----	-----	-----	-----
<i>Citharichthys</i> sp. Type A				-----	-----	-----	-----	-----	-----	-----	-----	-----
<i>Citharichthys</i> sp. Type B				-----	-----	-----	-----	-----	-----	-----	-----	-----
<i>Citharichthys</i> sp. Type C				-----	-----	-----	-----	-----	-----	-----	-----	-----
<i>C. cornutus</i>				-----	-----	-----	-----	-----	-----	-----	-----	-----
<i>C. gymnorhinus</i>												-----
<i>C. spilopterus</i>	-----	-----	-----	-----	-----	-----	-----	-----	-----	-----	-----	-----
<i>Cyclosetta</i> sp.												-----
<i>Engyophrys senta</i>					-----	-----	-----	-----	-----	-----	-----	-----
<i>Etopus crossotus</i>					-----	-----	-----	-----	-----	-----	-----	-----
<i>Monolene sessilicauda</i>					-----	-----	-----	-----	-----	-----	-----	-----
<i>Paralichthys</i> sp.	-----	-----	-----	-----	-----	-----	-----	-----	-----	-----	-----	-----
<i>Syacium</i> sp.											-----	-----
<i>S. gunteri</i>						-----	-----	-----	-----	-----	-----	-----
<i>S. papillosum</i>						-----	-----	-----	-----	-----	-----	-----
<i>Trichopsetta ventralis</i>					-----	-----	-----	-----	-----	-----	-----	-----
<i>Achirus lineatus</i>												-----
<i>Trinectes maculatus</i>							-----	-----	-----	-----	-----	-----
<i>Symphurus</i> spp.												-----
<i>Monacanthus setifer</i>												-----
<i>Sphaeroides</i> spp.				-----	-----	-----	-----	-----	-----	-----	-----	-----

<sup>1</sup>Juveniles.<sup>2</sup>Morph Type A may represent *Decapterus* *Elagatis*; Type B - *Selar crumenophthalmus*; Type C - *Seriola* spp.; Type D - *Caranx* spp.

# STOMACH CONTENTS AND FOOD CONSUMPTION ESTIMATES OF PACIFIC HAKE, *MERLUCCIUS PRODUCTUS*<sup>1</sup>

ERIC A. REXSTAD<sup>2</sup> AND ELLEN K. PIKITCH<sup>3</sup>

## ABSTRACT

Analysis of 466 stomachs of Pacific hake, *Merluccius productus*, collected during August 1983 off the coasts of Washington and Oregon indicates euphausiids comprise the most important food resource in terms of percent by weight, numbers, and frequency of occurrence for the species at that time of year. The importance of fish in the Pacific hake diet increases with the size of the hake, constituting 87% of the diet by weight in the largest individuals. Weak evidence of a nocturnal feeding pattern was observed. This indistinct nocturnal feeding pattern could have been caused by poor food availability due to El Niño. Estimates of food consumption by Pacific hake indicate that this species may have a substantial impact on some commercially valuable species such as pink shrimp, *Pandalus jordani*, even though pink shrimp is a fairly minor component of the diet. A statistically significant negative relationship between Pacific hake catch-per-unit-effort (CPUE) and pink shrimp CPUE off the west coast of the United States, using a lag of 2 years, was found.

Pacific hake, *Merluccius productus*, constitute an important component of the California Current ecosystem off the west coast of North America. It is estimated that a standing stock of approximately 1.5 million metric tons (t) exists off the Pacific coast between central California and Vancouver Island (Bailey et al. 1982). This biomass represents a substantial prey base for a variety of fish in the ecosystem: great white sharks, *Carcharodon carcharias*; soupfin sharks, *Galeorhinus zyopterus*; Pacific electric ray, *Torpedo californica*; bonito, *Sarda chiliensis*; albacore, *Thunnus alalunga*; bluefin tuna, *Thunnus thynnus*; rockfishes, *Sebastes* spp.; sablefish, *Anoplopoma fimbria*; lingcod, *Ophiodon elongatus*; dogfish, *Squalus acanthias*; and arrowtooth flounder, *Atheresthes stomias* (Bailey et al. 1982). Pacific hake also constitute a major prey item for a number of marine mammals, including the California sea lion, *Zalophus californianus*; northern sea lion, *Eumetopias jubatus*; northern fur seal, *Callorhinus ursinus*; saddleback dolphin, *Delphinus delphis*; Pacific whiteside dolphin, *Lagenorhynchus obliquidens*; and northern right whale dolphin, *Lissodelphis borealis* (Fiscus 1979).

Pacific hake also have an important impact on species below them in the food chain. Best (1963) described Pacific hake as opportunistic feeders. Their diet includes numerous species of crustacea, particularly euphausiids, several genera of shrimp, crab megalopae, and a variety of fish including Pacific herring, *Clupea harengus pallasi*; rockfish; sablefish; and flatfish (Livingston 1983). Pacific hake may compete for food resources with a host of other species that feed on the abundant euphausiid resource (Tyler and Percy 1975; Karpov and Cailliet 1978; Brodeur and Percy 1984), including commercially prized salmonids (Peterson et al. 1982).

At the top of the trophic structure is the commercial fishing fleet, comprised mainly of foreign joint-venture fishing boats that have harvested, on average, 127,000 t of Pacific hake per year since 1966 (R. C. Francis<sup>4</sup>).

Pacific hake migrate seasonally along the west coast of North America (Swartzman et al. 1983) and spawn in winter in the warm waters off southern California and the Baja peninsula. During the spring and summer, the adults migrate as far north as Vancouver Island to feed. The Pacific hake tend to stratify along the coast by size, with the largest individuals traveling farthest from the spawning areas and smaller juveniles remaining off the coast of California. In autumn, the adults return to the southern spawning areas (Bailey et al. 1982).

<sup>1</sup>Technical paper No. 7718, Oregon Agricultural Experimental Station.

<sup>2</sup>Department of Fisheries and Wildlife, Hatfield Marine Science Center, Oregon State University, Newport, OR 97365; present address: Colorado Cooperative Fish and Wildlife Research Unit, Department of Fishery and Wildlife Biology, Colorado State University, Ft. Collins, CO 80523.

<sup>3</sup>Department of Fisheries and Wildlife, Hatfield Marine Science Center, Oregon State University, Newport, OR 97365.

<sup>4</sup>R. C. Francis, Fisheries Research Institute, University of Washington, Seattle, WA 98195, pers. commun. May 1985.

The pink shrimp, *Pandalus jordani*, fishery off Oregon was one of the most economically viable fisheries during the late 1970s with landings in excess of 26,000 t in 1978. Subsequent to that time, pink shrimp landings have declined, with slightly over 2,000 t being landed in 1984 (Saelens and Zirges 1985). The purpose of this study was to describe the dietary habits of the Pacific hake and, in particular, to determine whether predation by Pacific hake on pink shrimp could explain some of the fluctuations seen in pink shrimp landings.

## MATERIALS AND METHODS

In August and September 1983, during the National Marine Fisheries Service (NMFS) West Coast Groundfish Survey, Pacific hake stomachs were sampled from 41 hauls taken during daylight hours between Coos Bay, OR, and Grays Harbor, WA (Fig. 1). Tows were of 0.5-h duration using a Nor'easter<sup>5</sup> high-opening bottom trawl equipped with roller gear which has an approximate horizontal opening of 13.4 m and vertical opening of 8.8 m. Further details of the sampling regime can be found in Gunderson and Sample (1980) and Weinberg et al. (1984). Between 5 and 15 individuals of each sex from a 5 cm size class (30-34 cm, 35-39 cm, 40-44 cm, 45-49 cm, 50-54 cm, 55+ cm) were sampled from each haul where practical. A total of 466 stomachs were extracted at sea and placed in cheesecloth bags. Stomachs with evidence of regurgitated contents were not included in the sample. Stomachs were preserved in a 10:1 solution of seawater to Formalin.

### Stomach Content Analysis

In the laboratory, stomachs were transferred to ethyl alcohol and examined under a dissecting microscope. Stomach fullness and degree of digestion were visually estimated and given a qualitative rating (0-4 from empty to distended, and from unrecognizable to recently consumed). Contents were identified to the lowest taxon and enumerated. Wet weight of each taxon was also determined.

Diet composition was characterized by percent of total number of food items (%N), percent of total diet by weight (%W), and frequency of occurrence in nonempty stomachs (FO). An index of relative importance (IRI) was then derived from these values  $IRI = FO (\%N + \%W)$  (Pinkas et al. 1971).

The data were further stratified by sex, time of

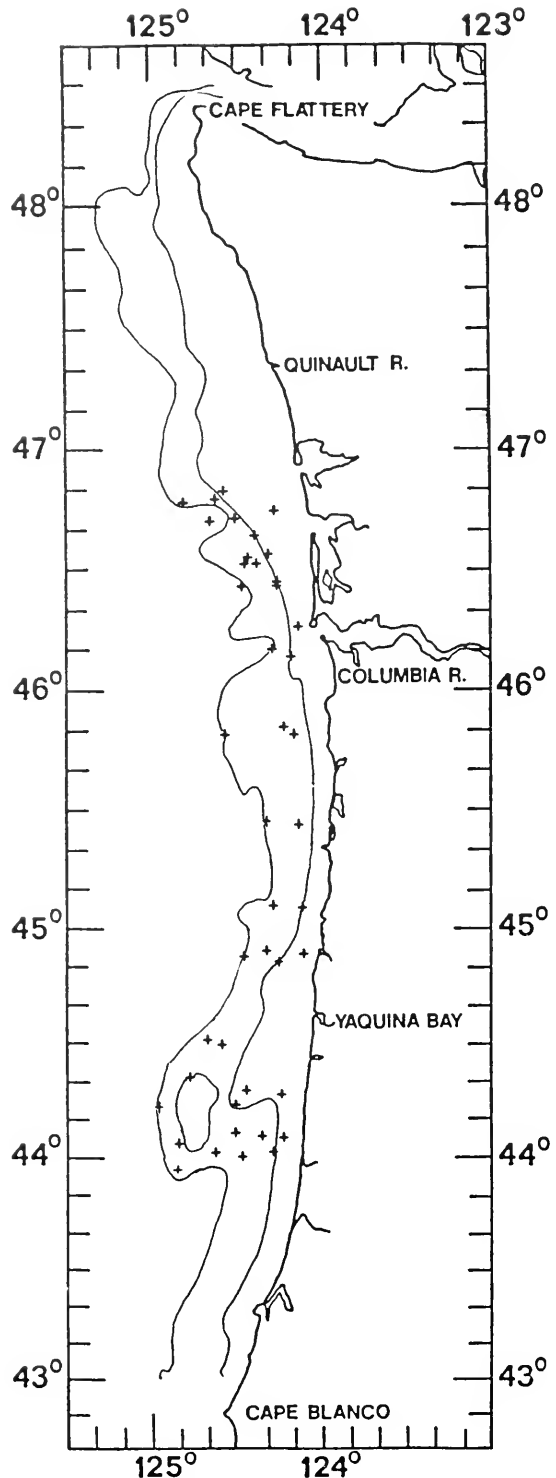

FIGURE 1.—Stations where Pacific hake stomachs were taken during 1983 NMFS West Coast Groundfish Survey; 100 and 200 m isobaths are also shown.

<sup>5</sup>Reference to trade names does not imply endorsement by the National Marine Fisheries Service, NOAA.



collection (morning, afternoon, and evening), depth of capture (0-100 m, 100-200 m, >200 m), and size. Chi-square tests of homogeneity (Ostle and Mensing 1975) were performed on the frequency of occurrence data for each prey species in these categories.

### Consumption Estimates

Using the size-specific prey consumption information derived from this study, Pacific hake population abundance estimates from the 1983 NMFS survey (Weinberg et al. 1984; Francis fn. 4) and bioenergetics estimates from Francis (1983), trophic calculations were performed to estimate ecosystem-level impacts of prey consumption by Pacific hake in the Columbia INPFC (International North Pacific Fisheries Commission) statistical area in 1983.

Biomass estimates were derived from two distinct surveys. The bottom trawl survey estimated the benthic component of the population. Details of these estimates can be found in Weinberg et al. (1984). The pelagic component of the population was estimated by hydroacoustic methods. Size composition of the pelagic segment of the population was estimated from companion midwater trawls conducted from the hydroacoustic vessel. Biomass estimates for each of the five size classes sampled were determined from estimated numbers in each centimeter size interval and length-weight regressions (Francis fn. 4).

Using a mean body weight for each size class, the percent of total body weight consumed daily was calculated based on the equations of Francis (1983). This total biomass consumption was then broken down into the constituent prey categories found in the stomachs of fish sampled using the percent of the diet by weight. These calculations were repeated for each of the five classes, and both the pelagic and benthic components of the population, to derive daily consumption estimates.

Residence times provided by Francis (1983) for each age class within each statistical area were converted to residence time by size class to account for the migratory behavior of Pacific hake. This provided consumption rate estimates summed over the length of time Pacific hake are found in the Columbia statistical area. An example of the calculations used to estimate total consumption of each prey item category is shown in Table 1.

### Pacific Hake-Pink Shrimp Interaction

The relationship between the abundance of Pacific hake and pink shrimp was examined via regression

TABLE 1.—Calculations used to compute total consumption of *Thysanoessa spinifera*. Column E1 =  $A \times B/100 \times C/100$ . Column E2 =  $E1 \times D$ . Biomass is combined benthic and pelagic components of the population, BWD is percent body weight consumed per day, W is percent of the diet by weight composed of *T. spinifera*, and Days is number of days each size class resides in the Columbia INPFC Area. Note total biomass differs from value given in text due to biomass of population <35 cm in length.

Size class (cm)	(A)	(B)	(C)	(D)	(E1)	(E2)
	Biomass (1,000 t)	%BWD	%W	Days	Consumption Daily Seasonal (1,000 t)	
35-39	331.252	1.10	14.7	80	0.540	42.85
40-44	69.126	0.98	9.4	69	0.060	4.20
45-49	21.272	0.84	17.2	45	0.030	1.38
50-54	17.640	0.65	14.9	42	0.020	0.72
55+	8.936	0.40	6.4	41	0.002	0.09
Total	448.226				0.652	49.24

analysis. Data from Francis et al. (unpubl. data) on Pacific hake catches in U.S. waters from 1967 to 1982 were converted to catch per unit effort (CPUE) based on the number of days of effort of foreign stern-trawling factory ships (BMRTs). Pounds per hour of pink shrimp taken in the equivalent of single-rigged shrimp trawls (SRE) in California, Washington, and Oregon from 1968 to 1984 (Saelens and Zirges 1985) were used as the dependent variable in regression analyses.

Two regressions were performed. The first used hake CPUE in year  $i$  to predict shrimp CPUE in year  $i$ , while the second involved a 2-yr lag (i.e., Pacific hake CPUE in year  $i$  versus shrimp CPUE in year  $i + 2$ ).

## RESULTS

### Stomach Content Analysis

A breakdown of the stomach contents by size class of Pacific hake is presented in Table 2. Euphausiids dominate the diet of small hake while decapods and fish become increasingly important as Pacific hake increase in size. Considering percent of the diet by weight, the importance of euphausiids monotonically decreases from 100 to 7.9% with increasing predator size. Likewise, the importance of fish rises from 0 to 87.1% with increasing predator size. Pink shrimp comprise only a minor portion of the diet, the largest percentage being 4.9% for the largest size class. Commercially important herring comprise nearly one-third of the diet of the larger size classes.

A previously unreported prey item, the ghost shrimp, *Callinassa* sp., appeared in the diet of the Pacific hake sampled in this study. These burrow-

TABLE 2.—Summary of stomach contents of *Merluccius productus* collected during the 1983 NMFS Pacific Coast Groundfish Survey. T = <0.1%.

Prey category	30-34 cm			35-39 cm			40-44 cm			45-49 cm			50-54 cm			>55 cm		
	FO <sup>1</sup>	%N <sup>2</sup>	%W <sup>3</sup>	FO	%N	%W	FO	%N	%W	FO	%N	%W	FO	%N	%W	FO	%N	%W
Euphausiacea																		
<i>Thysanoessa spinifera</i>	—	—	—	14.9	15.0	14.7	27.5	10.6	9.4	32.5	79.6	17.2	52.4	65.1	14.9	61.9	62.3	6.4
<i>Euphausia pacifica</i>	25.0	16.7	17.1	56.4	73.7	72.7	68.1	78.5	70.8	10.4	9.0	2.2	19.5	18.7	3.9	33.3	23.4	1.3
Unidentified	100.0	83.3	82.9	33.0	10.4	6.2	33.3	10.3	10.7	31.2	9.2	2.5	35.4	12.4	1.9	19.0	9.0	0.2
Decapoda																		
<i>Pandalus jordani</i>	—	—	—	1.1	T	0.2	—	—	—	1.3	0.1	0.1	—	—	—	19.0	2.3	4.9
<i>Sergestes similis</i>	—	—	—	2.1	0.7	2.9	5.8	0.3	2.5	—	—	—	—	—	—	—	—	—
<i>Pasiphaea pacifica</i>	—	—	—	—	—	—	1.5	T	2.0	—	—	—	—	—	—	14.3	1.5	0.4
<i>Crangon</i> sp.	—	—	—	—	—	—	—	—	—	2.6	0.1	0.2	4.9	1.1	12.0	—	—	—
<i>Callinassa</i> sp.	—	—	—	—	—	—	—	—	—	11.7	0.7	13.4	8.5	1.1	14.5	—	—	—
Osteichthyes																		
<i>Engraulis mordax</i>	—	—	—	—	—	—	—	—	—	1.3	0.1	1.5	2.4	0.3	2.7	—	—	—
<i>Clupea harengus</i>	—	—	—	—	—	—	2.9	0.1	3.8	3.9	0.2	34.7	3.7	0.2	28.4	—	—	—
<i>Thaleichthys pacificus</i>	—	—	—	—	—	—	1.4	T	0.6	9.1	0.4	23.0	1.2	0.1	T	—	—	—
Osmeridae	—	—	—	—	—	—	—	—	—	1.3	0.1	T	1.2	0.1	2.8	—	—	—
Gadidae	—	—	—	—	—	—	—	—	—	1.3	0.1	1.2	2.4	0.2	2.4	4.8	0.2	83.6
Pleuronectidae	—	—	—	—	—	—	—	—	—	1.3	0.2	0.1	2.4	0.2	14.5	9.5	0.6	3.4
Agonidae	—	—	—	—	—	—	—	—	—	—	—	—	1.2	0.1	0.4	—	—	—
Myctophidae	—	—	—	0.8	T	1.5	—	—	—	—	—	—	—	—	—	—	—	—
Unidentified	—	—	—	5.3	0.2	1.8	5.8	0.2	0.3	9.1	0.4	3.6	7.3	0.5	1.8	14.3	0.6	0.1
Number of stomachs (empty)	11 (7)			120 (26)			97 (28)			118 (41)			93 (11)			27 (6)		
Number of prey items	6			2,006			2,029			1,921			1,206			478		
Weight of stomach contents (g)	0.4			77.0			78.0			376.5			319.3			293.0		

<sup>1</sup>Frequency of occurrence in non-empty stomachs.<sup>2</sup>Percent of diet by number of items.<sup>3</sup>Percent of diet by weight of stomach contents.

ing animals were found in stomachs of Pacific hake taken at towing stations between 8.3 and 15.6 km (4.5 and 8.5 mi) offshore but not in immediate proximity to estuaries where ghost shrimp are most often found.

Chi-square tests (Table 3) illustrate the patterns in prey consumption by various stratifications of the data. There was little statistical difference in stomach contents of males compared with females. The analysis of prey categories by depth is essentially an inshore-offshore comparison as isobaths run roughly parallel to the coastline in the study area. Statistically significant differences were found in depth of capture for both species of euphausiids found in this study. *Thysanoessa spinifera* was more important in the diet of fish taken close to shore whereas *Euphausia pacifica* was important for fish taken further offshore. Eulachon, *Thaleichthys pacificus*, was found in stomachs more often in shallow waters than at depth. These animals, being anadromous, are often found in bays and estuaries, i.e., close to shore.

A significant difference exists in the presence of the two species of euphausiids in stomachs collected at different times of the day. The data collected in this study show that *T. spinifera* were seldom found in stomachs collected after 1600 h while *E. pacifica*

TABLE 3.—Chi-square analysis of difference in stomach content by prey category and various factors.

Prey category	Factor			
	Sex df = 1	Depth df = 2	Time df = 2	Size df = 4
<i>Thysanoessa spinifera</i>	2.48	15.65***	23.67***	36.69***
<i>Euphausia pacifica</i>	1.42	17.45***	6.23*	76.90***
<i>Pandalus jordani</i>	0.48	1.02	3.53	39.60***
<i>Sergestes similis</i>	0.02	28.07***	0.12	9.86*
<i>Pasiphaea pacifica</i>	0.80	17.47***	3.92	34.39***
<i>Crangon</i> sp.	0.02	6.40*	3.07	8.27
<i>Callinassa</i> sp.	0.05	3.69	9.14*	20.30***
<i>Engraulis mordax</i>	0.46	0.68	3.87	3.99
<i>Clupea harengus</i>	0.76	3.95	10.14**	4.30
<i>Thaleichthys pacificus</i>	0.72	9.35**	4.14	16.71**
Osmeridae	2.24	1.44	2.49	2.33
Gadidae	0.01	0.16	2.20	5.44
Pleuronectidae	4.55*	1.45	2.21	12.49*

\* =  $P \leq 0.05$ , \*\* =  $P \leq 0.01$ , \*\*\* =  $P \leq 0.001$ .

were often found in stomachs collected during that time (Fig. 2a).

To further examine the diel feeding pattern of Pacific hake, the percent of all stomachs in each of two fullness categories (<25% full; >75% full) was calculated by time of day. A three-point moving average was computed for each fullness category, and the resulting averages plotted (Fig. 3). There

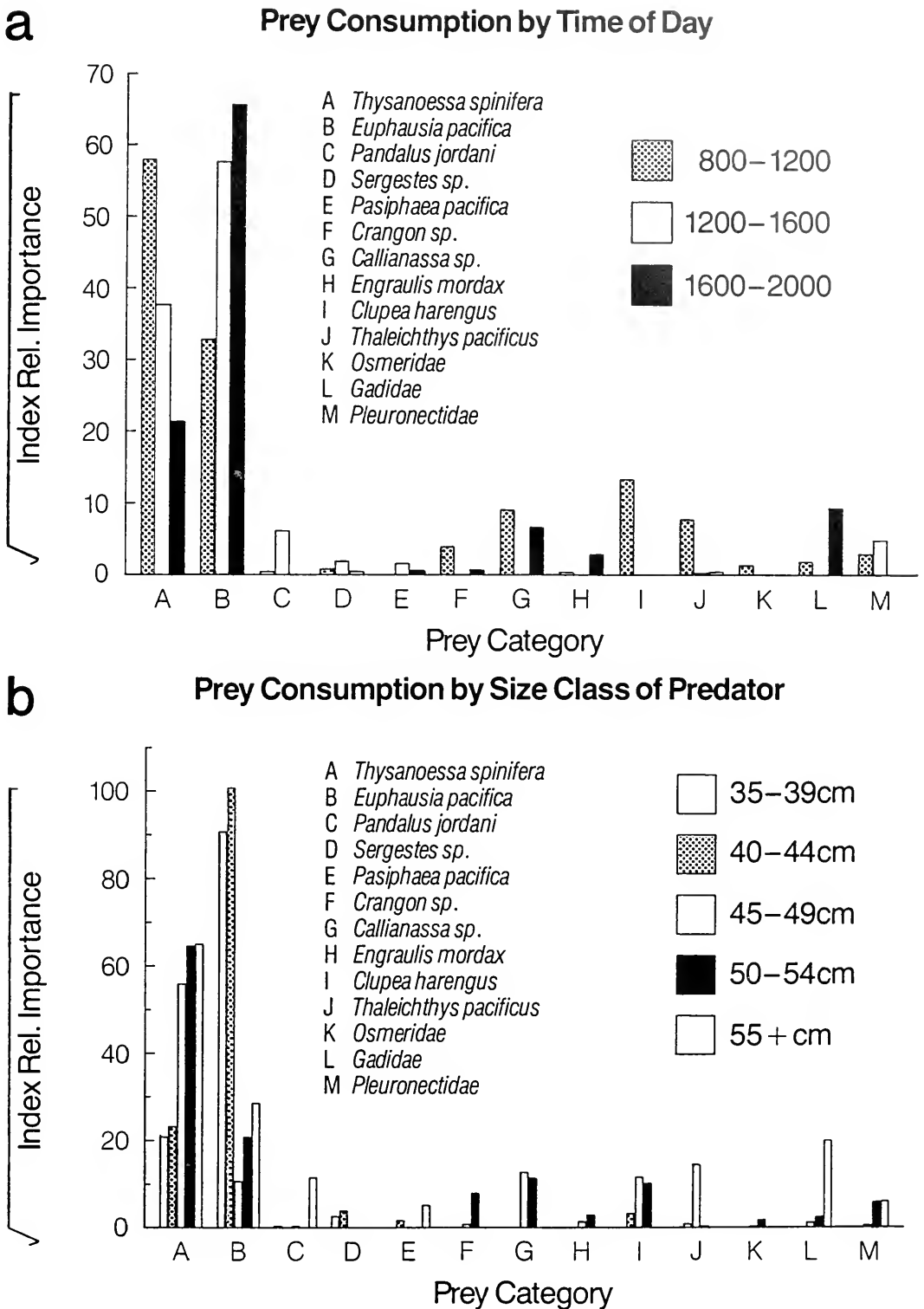

FIGURE 2.—Index of relative importance for major prey categories by a) time of collection and b) size of Pacific hake. Square root transformation used for scaling purposes.

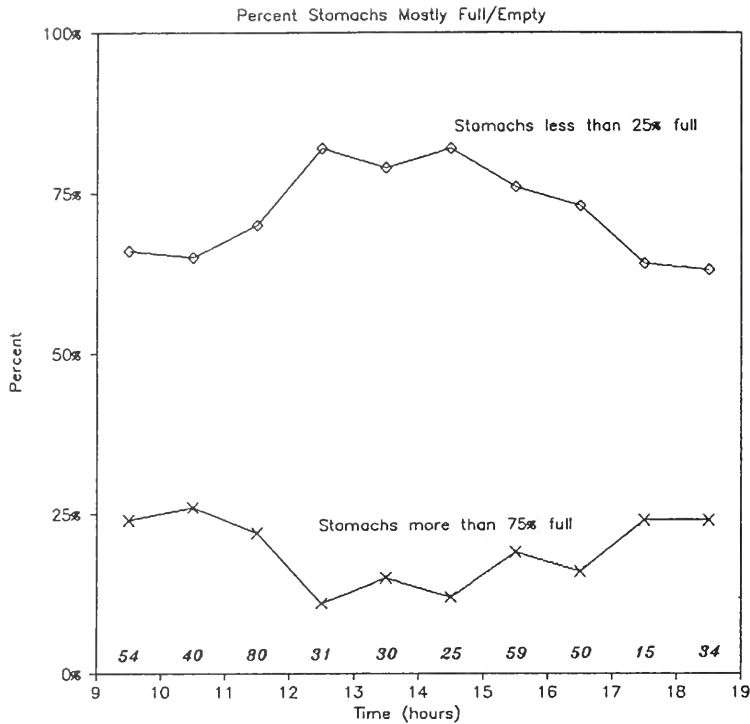

FIGURE 3.—Diel pattern of stomach contents of Pacific hake as demonstrated by percent of stomachs <25% full (upper curve) and >75% full (lower curve). Three-point moving average used to smooth the curves. Sample sizes shown above x-axis.

is a weak indication that these fish exhibit a pattern of feeding more heavily at night than during the day. For a predator feeding nocturnally, the expected pattern of this curve would be low percentages of empty stomachs early and late in the day, and high percentages of empty stomachs at midday. No tows were made between the hours of 2000 and 0700 thus direct evidence of nocturnal feeding was not available.

Comparison of stomach contents by size class showed the greatest amount of variation (Table 3, Fig. 2b) because of the shift in diet composition from euphausiids in early life stages to fishes in later stages.

The estimated consumption by Pacific hake in the Columbia statistical area over all prey categories is 4,651 t/d (Table 4). The amount of euphausiids consumed (over 4 kt/d), exceeds that of all other prey categories combined, but several commercially valuable species are also consumed in significant quantities. Consumption of pink shrimp is estimated at over 9.2 t/d, and almost 120 t/d of herring are consumed. Residence time for each size class of Pacific hake was derived from data presented by

Francis (1983) (size class 1: 80 d; size class 2: 69 d; size class 3: 45 d; size class 4: 42 d; and size class 5: 41 d) to extrapolate estimates of annual prey consumption from the daily consumption rate in the Columbia area. The annual consumption of pink shrimp, based on these data, is estimated at 659.3 t.

### Pacific Hake-Pink Shrimp Interaction

The regression of Pacific hake CPUE versus pink shrimp CPUE resulted in a nonsignificant correlation ( $r^2 = 0.114$ ,  $df = 15$ ,  $P = 0.185$ ). However, the regression performed with a 2-yr lag (hake CPUE in year  $i$  versus shrimp CPUE in year  $i + 2$ ) showed a significant negative correlation between the variables ( $r^2 = 0.418$ ,  $df = 15$ ,  $P = 0.005$ ). Note that the significance of the latter analysis stems largely from data obtained in recent years (Fig. 4).

## DISCUSSION

One of the most striking patterns found in the data is the distinct change in diet composition that Pacific

TABLE 4.—Diet composition by size class on a daily basis (t) and on seasonal basis (kt). Values based on biomass for the Columbia INPFC area estimated from bottom trawl survey (Weinberg et al. 1984) and hydroacoustic survey (Francis, see text fn. 4). T = <0.1 t/d or 0.05 kt seasonally.

Prey category	Size 1		Size 2		Size 3		Size 4		Size 5		Totals	
	Daily	Season	Daily	Season	Daily	Season	Daily	Season	Daily	Season	Daily	Season
<b>Euphausiacea</b>												
<i>Thysanoessa spinifera</i>	535.1	42.5	64.0	4.4	30.6	1.4	17.2	0.7	2.3	0.1	649.2	49.1
<i>Euphausia pacifica</i>	2,646.4	210.4	481.8	33.2	3.9	0.2	4.5	0.2	0.5	T	3,137.1	244.0
Unid. euphausiid	225.7	17.9	72.8	5.0	4.5	0.2	2.2	0.1	0.1	T	305.2	23.3
Total euphausiid	3,407.3	270.9	618.6	42.7	39.0	1.7	23.9	1.0	2.8	0.1	4,091.6	316.4
<b>Decapoda</b>												
<i>Pandalus jordani</i>	7.3	0.6	0.0	0.0	0.2	T	0.0	0.0	1.8	0.1	9.2	0.7
<i>Sergestes</i> sp.	105.6	8.4	17.0	1.2	0.0	0.0	0.0	0.0	0.0	0.0	122.6	9.6
<i>Pasiphaea pacifica</i>	0.0	0.0	13.6	0.9	0.0	0.0	0.0	0.0	0.1	T	13.8	1.0
<i>Crangon</i> sp.	0.0	0.0	0.0	0.0	0.4	T	13.8	0.6	0.0	0.0	14.2	0.6
<i>Callinassa</i> sp.	0.0	0.0	0.0	0.0	23.9	1.1	16.7	0.7	0.0	0.0	40.6	1.8
<b>Osteichthyes</b>												
<i>Engraulis mordax</i>	0.0	0.0	0.0	0.0	2.7	0.1	3.1	0.1	0.0	0.0	5.8	0.2
<i>Clupea harengus</i>	0.0	0.0	25.9	1.8	61.8	2.8	32.8	1.4	0.0	0.0	120.5	5.9
<i>Thaleichthys pacificus</i>	0.0	0.0	4.1	0.3	41.0	1.8	0.1	T	0.0	0.0	45.1	2.1
Osmeridae	0.0	0.0	0.0	0.0	0.4	T	3.2	0.1	0.0	0.0	3.6	0.2
Gadidae	0.0	0.0	0.0	0.0	2.1	0.1	2.8	0.1	30.2	1.2	35.1	1.4
Pleuronectidae	0.0	0.0	0.0	0.0	0.2	T	16.7	0.7	1.2	0.1	18.1	0.8
Agonidae	0.0	0.0	0.0	0.0	0.0	0.0	0.5	T	0.0	0.0	0.5	T
Myctophidae	54.6	4.3	0.0	0.0	0.0	0.0	0.0	0.0	0.0	0.0	54.6	4.3
Unid. fish	65.5	5.2	2.0	0.1	6.4	0.3	2.1	0.1	T	T	76.1	5.7
Grand total	3,640.2	289.4	681.2	47.0	178.0	8.0	115.7	4.8	36.2	1.5	4,651.4	350.7

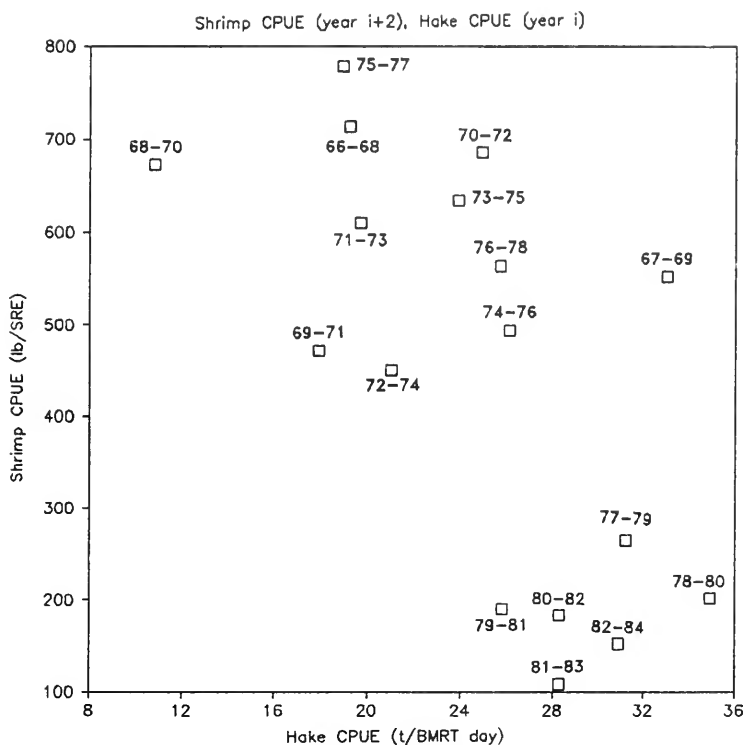

FIGURE 4.—Pink shrimp CPUE in year  $i + 2$  ( $y$ -axis) plotted against Pacific hake CPUE in year  $i$  ( $x$ -axis). Regression expression is  $y = 1029 - 23.23x$  ( $r^2 = 0.418$ ). Numbers on the plot represent the years of the CPUE data.

hake undergo as they increase in size. *Thysanoessa spinifera* appears to be more important to larger hake whereas *Euphausia pacifica* is more important to smaller individuals. Pink shrimp and glass shrimp, *Pasiphaea pacifica*, were consumed almost exclusively by fish >55 cm. Eulachon and pleuronectids were also predominantly consumed by larger hake. Cannibalism was also observed among larger individuals.

### Diel Feeding Pattern

A number of previous researchers have postulated that species in the genus *Merluccius* exhibit a diel feeding pattern (Outram and Haegele 1972; Bowman and Bowman 1980). Alton and Nelson (1970) as well as Livingston (1983) described Pacific hake as nocturnal predators that migrate vertically to feed near the surface during hours of darkness and dive to deeper water during daylight hours. Brinton (1967) and Alton and Blackburn (1972) showed that this same vertical migration pattern exists for the two species of euphausiids found in this study. If the Pacific hake follow the euphausiids on their vertical diel migration, the expectation is that the relative proportion of both species of euphausiids in the diet should not vary significantly by time of day. As reported above, our findings conflict with this expectation.

To further examine this apparent deviation, we considered potentially confounding factors; such as differences in the distributions of the euphausiid species and various size classes of Pacific hake. Brinton (1962) reported that *T. spinifera* is a neritic species and *E. pacifica* is a more oceanic species. Analysis of length-frequency data from the cruise during which this study was conducted shows that Pacific hake of different size classes segregate by depth. Pacific hake <40 cm in length made up 37% of the catch in <100 m of water, but these same size classes comprised 62% of the catch taken in >100 m of water. Hence, the smaller individuals were found in greater abundance in the habitat associated with *E. pacifica*.

This phenomenon of smaller fish occurring in deeper water and consequently consuming greater quantities of *E. pacifica* explains the apparent difference in importance of the two species of euphausiids by time of day (Fig. 2a). Only 7% of the non-empty stomachs taken before 1200 h were from fish <40 cm in length whereas of the fish sampled after 1600 h, 34% were <40 cm in length. Thus, we regard the observed differences in consumption of *T. spinifera* and increasing importance of *E. pacifica* by

time of day as spurious, confounded by the differences in the diets and distributions of various size classes of Pacific hake.

This study coincided with the strong presence of El Niño in 1983 which may have altered the normal migration pattern of Pacific hake and consequently the residence time estimates, and may also have affected the abundance of the prey base. Hence, there may be some error in the consumption estimates presented herein. Miller et al. (1984) noted a decline in the relative abundance of *T. spinifera* off the Oregon coast during 1983 in comparison with other years. Thus, feeding to satiation during evening hours may have been impossible; consequently, feeding occurred whenever euphausiids were encountered. Additional circumstantial evidence of aberrant feeding behavior of Pacific hake in 1983 is their severely depressed growth (Francis and Hollowed 1985). Food resources may only have been sufficient for maintenance metabolism with little energy remaining for growth. These observations may explain why the diel feeding pattern observed was weak.

### Trophic Interaction

The seasonal migration pattern and consequent latitudinal stratification of Pacific hake stocks by size class makes it difficult to compare food habit studies conducted at different times of the year and at different locations on the Pacific coast. Nonetheless, examining only the role of pink shrimp in the diet, we find first mention of Pacific hake preying on this species by Gotshall (1969a, b). Analyzing Pacific hake stomachs collected off California between 1966 and 1969, Gotshall found high incidences (54% frequency of occurrence) of pink shrimp during late summer and early fall, particularly in Pacific hake collected over shrimp beds. The study was an attempt to use Pacific hake as biological samplers to estimate pink shrimp abundance, focusing sampling effort on known pink shrimp beds, and, as such, the sampling design was quite different from other studies.

Outram and Haegele (1972) reported that 3% of the Pacific hake stomachs collected off the coast of British Columbia contained pink shrimp. Pink shrimp were found in 5.7% of the Pacific hake stomachs collected during the summers of 1965 and 1966 off Washington and Oregon (Alton and Nelson 1970). Livingston and Alton (1982) found that pandalid shrimp constituted 0.3% by weight of the contents of the 1,430 stomachs of Pacific hake taken off the coasts of Washington and Oregon during the

summer of 1967. From 204 stomachs collected during the 1980 NMFS West Coast Groundfish Survey off the coasts from Oregon to Vancouver Island, Livingston (1983) found pink shrimp constituted 0.7% by weight of the Pacific hake diet. Pink shrimp occurred in 1.7% of the Pacific hake stomachs collected in the study described in this paper. Thus, with the exception of Gotshall's work, studies of the food habits of Pacific hake have shown pink shrimp generally comprise well under 10% of the Pacific hake diet, and thus do not appear to be an important food source for hake. However, due to the large biomass of Pacific hake in the North Pacific, it is possible that Pacific hake may represent a significant source of mortality even for those species, including pink shrimp, that are not significant components of the Pacific hake diet (Francis 1983).

The estimated consumption of 659.3 t/season of pink shrimp compares with a commercial catch of 2,197 t of pink shrimp landed in Oregon during 1984 by 59 vessels (Saelens and Zirges 1985). It is conceivable that the magnitude of Pacific hake predation on pink shrimp may increase in the near future. Small Pacific hake, preying mainly on euphausiids, constituted the bulk of the consumers in this study. The strong 1980 year class of Pacific hake, seen as the 35-39 cm size class in these 1983 data, will have substantially greater impact on commercially valuable species upon reaching larger sizes when these valuable species comprise a larger fraction of the diet.

Francis (1983) inferred, from catch statistics of Pacific hake and pink shrimp, that increased catches of Pacific hake since the inception of the foreign and subsequent joint-venture fisheries may have contributed to the dramatic increase in the landings of pink shrimp during the late 1970s. The causal mechanism inferred is the release of predation pressure on the pink shrimp population as a result of decreased Pacific hake abundance due to fishing. This "surplus" in the pink shrimp population was harvested by the increasingly vigorous shrimp fishery.

This contention is disputed by Livingston and Bailey (1985). Their analysis focuses on pink shrimp CPUE during two time periods: 1952-65 during which Pacific hake were unexploited and 1966-77 during which a substantial joint-venture fishery occurred. They found no appreciable change in average pink shrimp CPUE between the two periods. Extending their analysis to include the most recent catch statistics, we also fail to find the existence of a significant difference between the periods 1957-65 and 1966-84 ( $t = 1.05$ , 26 df,  $P = 0.303$ ).

However, if pink shrimp have constituted a fairly constant proportion of the Pacific hake diet over time, as suggested by this and previous Pacific hake food habit studies, then there may indeed be a relationship between the release of predator pressure by the Pacific hake and increased catches of pink shrimp. The regression-correlation analysis presented above has an advantage over the average pink shrimp CPUE analysis because it incorporates information about both hake and shrimp abundances. The regression-correlation results provide weak statistical support to Francis' contention that there is a relationship between Pacific hake and pink shrimp population dynamics. However, further observations are needed to obtain greater confidence in this relationship. In particular, it will be interesting to note that the impact of the strong 1980 year class Pacific hake on pink shrimp catches in the near future.

## CONCLUSION

Pacific hake occupy a unique trophic position, serving not only as predators but also as prey for a variety of species carrying valuations other than those of an economic nature (endangered species and species managed under the Marine Mammal Protection Act). Euphausiids constitute the primary source of food for Pacific hake in the North Pacific. However, as Pacific hake mature, euphausiids decrease in importance and fish take on greater importance. Owing to the vast quantity of hake biomass living in the North Pacific, it has been shown that Pacific hake may consume large quantities of several commercially valuable species, even though these species comprise a fairly small percentage of the diet. It has also been demonstrated that a statistically significant relationship exists between CPUE of Pacific hake and pink shrimp. Additional years of data are required to have a clearer understanding of this relationship.

## ACKNOWLEDGMENTS

Bill Barss and Mark Saelens of the Oregon Department of Fish and Wildlife (ODFW) assisted in the collection of the Pacific hake stomachs at sea and with the identification of decapods. Leslie Lutz of ODFW helped with the laboratory analysis and Rick Brodeur, Chris Wilson, and Bruce Mundy of Oregon State University aided in the identification of fish remains. Rick Brodeur also gave suggestions on statistical analysis. Helpful comments were provided by Mac Zirges, Mark Saelens, Robert Fran-

cis, Rick Brodeur, Chuck Harding, Barb Knopf, Chris Wilson, David Erickson, and two anonymous reviewers. Robert Francis, Northwest and Alaska Fisheries Center, NMFS, provided data on historical Pacific hake catch data and hydroacoustic survey estimates. This publication is the result, in part, of research sponsored by NOAA, Office of Sea Grant, Department of Commerce, under contract No. NA81AA-D-00086 (Project No. R/OFP-20), and by the Oregon Department of Fish and Wildlife.

## LITERATURE CITED

- ALTON, M. S., AND C. J. BLACKBURN.  
1972. Diel changes in the vertical distribution of the euphausiids, *Thysanoessa spinifera* Holmes and *Euphausia pacifica* Hansen in coastal waters of Washington. Calif. Fish Game 58:179-190.
- ALTON, M. S., AND M. O. NELSON.  
1970. Food of Pacific hake, *Merluccius productus*, in Washington and northern Oregon coastal waters. In Pacific hake, p. 35-42. U.S. Fish Wildl. Serv., Circ. 332.
- BAILEY, K. M., R. C. FRANCIS, AND P. R. STEVENS.  
1982. The life history and fishery of Pacific whiting, *Merluccius productus*. Calif. Coop. Oceanic Fish. Invest. Rep. 23: 81-98.
- BEST, E. A.  
1963. Contribution to the biology of the Pacific hake, *Merluccius productus* (Ayres). Calif. Coop. Oceanic Fish. Invest. Rep. 9:51-56.
- BOWMAN, R. E., AND E. W. BOWMAN.  
1980. Diurnal variation in the feeding intensity and catchability of silver hake (*Merluccius bilinearis*). Can. J. Fish. Aquat. Sci. 37:1565-1572.
- BRINTON, E.  
1962. The distribution of Pacific euphausiids. Bull. Scripps Inst. Oceanogr., Univ. Calif. 8(2):51-269.  
1967. Vertical migration and avoidance capability of euphausiids in the California Current. Limnol. Oceanogr. 12: 451-483.
- BRODEUR, R. D., AND W. G. PEARCY.  
1984. Food habits and dietary overlap of some shelf rockfishes (genus *Sebastes*) from the northeastern Pacific Ocean. Fish. Bull., U.S. 82:269-293.
- FISCUS, C. H.  
1979. Interactions of marine mammals and Pacific hake. Mar. Fish. Rev. 41(10):1-9.
- FRANCIS, R. C.  
1983. Population and trophic dynamics of Pacific hake (*Merluccius productus*). Can. J. Fish. Aquat. Sci. 40:1925-1943.
- FRANCIS, R. C., AND A. HOLLOWED.  
1985. Status of the Pacific hake resource and recommendations for management in 1985. Status of stocks document to Pacific Fisheries Management Council, Portland, OR.
- GOTSHALL, D. W.  
1969a. Stomach contents of Pacific hake and arrowtooth flounder from northern California. Calif. Fish Game 55: 75-82.  
1969b. The use of predator food habits in estimating relative abundance of the ocean shrimp, *Pandalus jordani* Rathbun. FAO Fish. Rep. 57, p. 667-685.
- GUNDERSON, D. R., AND T. M. SAMPLE.  
1980. Distribution and abundance of rockfish off Washington, Oregon, and California during 1977. Mar. Fish. Rev. 42 (3-4):2-16.
- KARPOV, K. A., AND G. M. CAILLIET.  
1978. Feeding dynamics of *Loligo opalescens*. In C. W. Recksiek and H. W. Frey (editors), Biological, oceanographic, and acoustic aspects of the market squid, *Loligo opalescens* Berry, p. 45-65. Calif. Dep. Fish Game, Fish Bull. 169.
- LIVINGSTON, P. A.  
1983. Food habits of Pacific whiting, *Merluccius productus*, off the west coast of North America, 1967 and 1980. Fish. Bull. U.S. 81:629-636.
- LIVINGSTON, P. A., AND M. S. ALTON.  
1982. Stomach contents of Pacific whiting off Washington and Oregon, April-July 1967. U.S. Dep. Commer., NOAA Tech. Memo. NMFS F/NWC-32.
- LIVINGSTON, P. A., AND K. M. BAILEY.  
1985. Trophic role of the Pacific Whiting, *Merluccius productus*. Mar. Fish. Rev. 47(2):16-22.
- MILLER, C. B., H. P. BATCHELDER, R. D. BRODEUR, AND W. G. PEARCY.  
1984. Response to the zooplankton and ichthyoplankton off Oregon to the El Niño event of 1983. In W. S. Wooster and D. L. Fluharty (editors), El Niño North: Niño effects in the eastern subarctic Pacific Ocean, p. 185-187. Wash. Sea Grant Prog., Univ. Wash., Seattle.
- OSTLE, B., AND R. W. MENSING.  
1975. Statistics in research. 3d ed. Iowa State Univ. Press, Ames, 596 p.
- OUTRAM, D. N., AND C. HAEGELE.  
1972. Food of Pacific hake (*Merluccius productus*) on an offshore bank southwest of Vancouver Island, British Columbia. J. Fish. Res. Board Can. 29:1792-1795.
- PETERSON, W. T., R. D. BRODEUR, AND W. G. PEARCY.  
1982. Food habits of juvenile salmon in the Oregon coastal zone, June 1979. Fish. Bull., U.S. 80:841-851.
- PINKAS, L., M. S. OLIPHANT, AND I. L. K. IVERSON.  
1971. Food habits of albacore, bluefin tuna, and bonito in California waters. Calif. Dep. Fish Game, Fish Bull. 152: 1-105.
- SAELENS, M. R., AND M. H. ZIRGES.  
1985. The 1984 Oregon shrimp fishery. Oreg. Dep. Fish Wildl. Inf. Rep. 85-6.
- SWARTZMAN, G. L., W. M. GETZ, R. C. FRANCIS, R. T. HAAR, AND K. ROSE.  
1983. A management analysis of Pacific whiting (*Merluccius productus*) fishery using an age-structured stochastic recruitment model. Can. J. Fish. Aquat. Sci. 40(4):524-539.
- TYLER, H. R., JR., AND W. G. PEARCY.  
1975. The feeding habits of three species of lanternfishes (family Myctophidae) off Oregon, USA. Mar. Biol. (Berl.) 32:7-11.
- WEINBERG, K. L., M. E. WILKINS, AND T. A. DARK.  
1984. The 1983 Pacific west coast bottom trawl survey of groundfish resources: estimates of distribution, abundance, age and length composition. U.S. Dep. Commer., NOAA Tech. Memo. NMFS F/NWC-70.



# DIET OF NORTHERN FUR SEALS, *CALLORHINUS URSINUS*, OFF WESTERN NORTH AMERICA

MICHAEL A. PEREZ<sup>1</sup> AND MICHAEL A. BIGG<sup>2</sup>

## ABSTRACT

Data recorded from the stomach contents of 18,404 northern fur seals, *Callorhinus ursinus*, mostly females aged  $\geq 3$  years collected off western North America during 1958-74, were analyzed to determine the relative importance of each prey species by region, subregion, and month. When weighted for energy content, the primary food species were small schooling fishes. Between western Alaska and California from December to August the most significant prey species were northern anchovy, *Engraulis mordax* (20%); Pacific herring, *Clupea harengus pallasi* (19%); capelin, *Mallotus villosus* (8%); Pacific sand lance, *Ammodytes hexapterus* (8%); Pacific whiting, *Merluccius productus* (7%); salmon, *Oncorhynchus* spp. (6%); Pacific saury, *Cololabis saira* (4%); and rockfishes, *Sebastes* spp. (4%). Other food species eaten in this area consisted of a wide variety of squids (17%) and other fishes (7%). In the eastern Bering Sea the main prey species from June to October were juvenile walleye pollock, *Theragra chalcogramma* (35%); capelin (16%); Pacific herring (11%); and squids, *Berryteuthis magister* and *Gonatopsis borealis*, which comprise most (30%) of the remaining diet of northern fur seals in this region. In all areas off western North America, fishes were the main food species of these pinnipeds in neritic waters, while squids were the most important prey in oceanic waters. Typically three prey species comprised 80% of their diet in any one area, although the composition of the diet varied in type and importance by region and month.

The northern fur seal, *Callorhinus ursinus*, is found in the Bering Sea, Sea of Okhotsk, and throughout the North Pacific Ocean, north of approximately lat. 32°N off western North America and lat. 36°N off Asia (Baker et al. 1970; Fiscus 1978). Although its pelagic distribution is extensive, the main concentrations lie over the continental shelf. There are three main stocks of this species. The largest stock breeds on the Pribilof Islands in the eastern Bering Sea and migrates primarily to coastal waters between the Gulf of Alaska and California. The other two stocks breed on the Commander Islands in the western Bering Sea and on Robben Island off northern Japan. Both stocks migrate primarily along the Asian coast. To determine the diet of the Pribilof Islands population, the United States and Canada, under the auspices of the North Pacific Fur Seal Commission, conducted annual pelagic studies during 1958-74 to collect stomach contents and other biological information.

The results of research on the diet of northern fur seals by the United States and Canada during 1958-74 have been presented in many annual and 2-6 yr summaries submitted by each country to the

North Pacific Fur Seal Commission. Kajimura (1984) cited most of these reports. Spalding (1964), Stroud et al. (1981), and Kajimura (1985) also published reports on diet collected since 1958. Studies on the food habits of the northern fur seal prior to 1958 include Lucas (1899), Clemens and Wilby (1933), Clemens et al. (1936), Schultz and Rafn (1936), May (1937), Wilke and Kenyon (1952, 1954, 1957), Taylor et al. (1955), and Kenyon (1956).

Investigations to date have reported that northern fur seals eat a wide variety of fishes and squids. However, the relative importance of each prey species has remained uncertain because substantial differences often existed between values of relative importance derived by volumetric measure and those derived by frequency of occurrence. For example, squids were important (averaging 39%) in the diet using frequency of occurrence but not significant (15%) using volume (Bigg and Fawcett 1985; Perez and Bigg<sup>3</sup>). The long-suspected reason for this difference was that squid beaks accumulated

<sup>1</sup>Northwest and Alaska Fisheries Center, National Marine Mammal Laboratory, National Marine Fisheries Service, NOAA, 7600 Sand Point Way N.E., Seattle, WA 98115.

<sup>2</sup>Department of Fisheries and Oceans, Pacific Biological Station, Nanaimo, British Columbia V9R 5K6, Canada.

<sup>3</sup>Perez, M. A., and M. A. Bigg. 1980. Interim report on the feeding habits of the northern fur seal in the eastern North Pacific Ocean and eastern Bering Sea. In H. Kajimura, R. H. Lander, M. A. Perez, A. E. York, and M. A. Bigg, Further analysis of pelagic fur seal data collected by the United States and Canada during 1958-74, Part 2, p. 4-172. Unpubl. rep. Northwest and Alaska Fisheries Center, National Marine Mammal Laboratory, National Marine Fisheries Service, NOAA, 7600 Sand Point Way N.E., Seattle, WA 98115.

in stomachs of seals thereby inflating the importance of squid (Scheffer 1950; Spalding 1964; Bigg and Fawcett 1985). Recent experimental studies confirmed that squid beaks accumulate in fur seal stomachs (Bigg and Fawcett 1985).

To date, no reports have been published on the diet of northern fur seals that take this bias into account. However, Bigg and Perez (1985) suggested a method, called modified volume, which reduces the bias and also accounts for differences in digestion rates between fish and squid. In this method, evidence of diet based on trace remains, such as squid beaks and fish bones, is omitted in the analyses, and a combination of the frequency of occurrence and volumetric methods is used to establish the relative importance of individual prey species.

We use the modified volume method in this report to analyze data from the stomach contents collected by the United States and Canada during 1958-74. We will describe the annual diet of northern fur seals in the eastern North Pacific and eastern Bering Sea by region and subregion. We also incorporate the energy content of important prey species to determine whether this might affect relative importance, a procedure not tried previously with this seal.

## METHODS

Lander (1980) and Kajimura (1984, 1985) described the methods used to take northern fur seals at sea during 1958-74 and to identify and measure the prey items found in their stomachs by volume and frequency of occurrence. A total of 18,404 stomachs were collected of which 7,373 contained food and an additional 3,326 had only trace remains. Perez and Bigg (fn. 3) summarized the data on volume and frequency of occurrence for all species of northern fur seal prey by month and region.

Perez and Bigg<sup>4</sup> and Bigg and Perez (1985) gave a detailed discussion of the procedure used to calculate modified volume values. First, prey species represented in any stomach only by trace amounts ( $\leq 10$  cc) were omitted. Second, the proportions of total fish and total squid in the diet by subregion, region, and month were then determined by non-trace frequency of occurrence. Third, the ratio of each species within only the fish category and within

only the squid category was determined by volume. The taxonomic groupings recorded in the original data which overlapped each other were either pooled with higher taxa or were proportionally divided among component species depending upon which level of taxa had the most data. This prevented food groupings from being partially compared against themselves. Next, the volumetric ratios for individual fish and squid species were adjusted to sum, respectively, to the total proportion of fish and squid in the diet. Finally, all values were readjusted to total 100%.

The relative importance of prey species has been presented in this report in two ways: 1) modified volume values for each region by month, and for each subregion with data from all months pooled; and 2) modified volume values for each region based on combined months data which were weighted for

TABLE 1.—Estimated energy values (wet mass) for important northern fur seal prey. C = bomb calorimetry combustion value; P = proximate analysis value<sup>1</sup>; muscle = edible portion only of raw material; whole = raw material from entire specimen.

Prey	Energy value (kcal/g)	Analysis and tissue	Reference
American shad	2.08	P, muscle	Sidwell (1981)
Pacific herring	2.17	P, whole	Sidwell (1981); Bigg et al. (1978)
Northern anchovy	1.79	P, whole	Sidwell (1981)
Salmonids	2.01	P, muscle	Sidwell (1981)
Capelin	1.31	C, whole	Miller <sup>2</sup>
Eulachon	1.41	P, muscle	Stansby (1976)
Deep-sea smelts	0.76	P, whole	Childress and Nygaard (1973)
Myctophiform fishes	1.58	P, whole	Childress and Nygaard (1973) <sup>3</sup>
Pacific saury	2.20	P, muscle	Sidwell (1981)
Jacksmelt	1.24	P, muscle	Watt and Merrill (1963)
Pacific cod	1.00	P, muscle	Sidwell (1981)
Pacific whiting	1.17	P, whole	Sidwell (1981)
Walleye pollock	1.41	C, whole	Miller <sup>2</sup>
Threespine stickleback	1.15	C, whole	Wootton (1976)
Jack mackerel	1.24	P, whole	Sidwell (1981)
Rockfishes	1.17	P, muscle	Sidwell et al. (1974)
Sablefish	2.17	P, muscle	Sidwell (1981)
Atka mackerel	1.58	P, muscle	Kizevetter (1971)
Pacific sand lance	1.22	P, muscle	Sidwell (1981)
Flounders	1.20	P, muscle	Sidwell (1981) <sup>4</sup>
Market squid	1.15	P, muscle	Sidwell (1981)
Onychoteuthid squids	1.29		Perez <sup>5</sup>
Goniatid squids	1.27		Perez <sup>5</sup>

<sup>1</sup>Values were calculated with the following energy factors derived from Watt and Merrill (1963): 9.50, 5.65 and 4.00 kcal/g respectively for fat, protein and carbohydrate.

<sup>2</sup>Miller, L. K. 1978. Energetics of the northern fur seal in relation to climate and food resources of the Bering Sea. U.S. Mar. Mammal Comm. Rep. MMC-75/08, 27 p.

<sup>3</sup>Myctophidae and Paralepididae.

<sup>4</sup>Pleuronectidae.

<sup>5</sup>Perez, M. A., Natl. Mar. Mammal Lab., Northwest and Alaska Fish. Cent., Natl. Mar. Fish. Serv., NOAA, 7600 Sand Point Way N.E., Seattle, WA 98115, unpubl. data, 1984.

the energy value of prey. Data from all years of collection were pooled. We assumed that the importance of a prey species to northern fur seals depended, at least in part, on its energy content. Table 1 lists the estimated caloric values for prey species consumed most often. These estimates are provisional because little is known about changes in energy content within each species by season. Energy values for squids tend to be lower than those for fishes, although large variability exists among fish species.

No attempt was made to describe diet by age, sex, and reproductive condition. In our sample, 88% of the northern fur seals were females aged  $\geq 3$  yr, of which 53% were pregnant and 29% were nonpregnant. Thus, the diet described is primarily that for pregnant and nonpregnant females aged  $\geq 3$  yr.

The eastern North Pacific Ocean and eastern Bering Sea were divided into 7 regions and 21 subregions (Fig. 1). The boundaries for the seven regions were those which have been traditionally

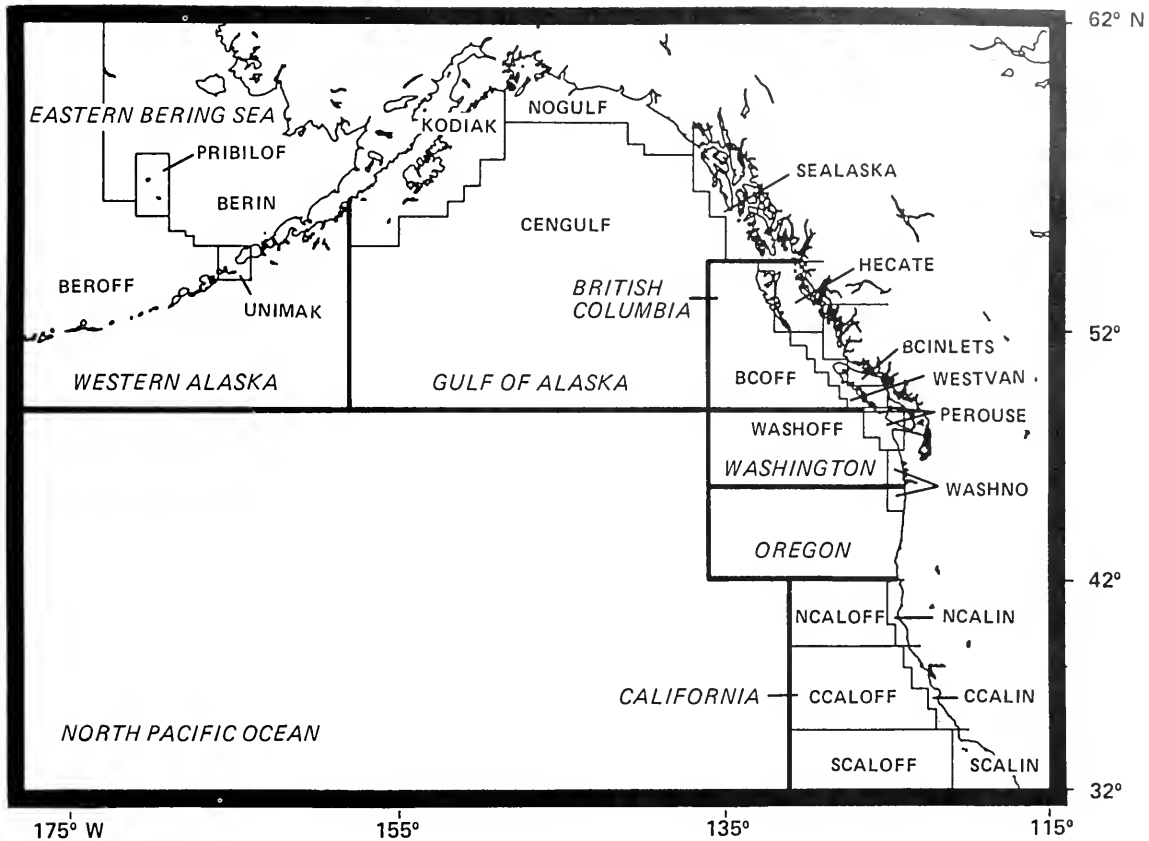

FIGURE 1.—Seven regions (denoted by darker lines) and 21 subregions used in the northern fur seal analyses: 1) California comprised of subregions SCALIN (southern California, inshore), SCALOFF (southern California, offshore), CCALIN (central California, inshore), CCALOFF (central California, offshore), NCALIN (northern California, inshore), and NCALOFF (northern California, offshore); 2) Oregon which includes half of subregion WASHNO (southern Washington and northern Oregon, inshore); 3) Washington which includes subregions PEROUSE (area west of Juan de Fuca Strait from Barkley Sound to Cape Flattery, including La Perouse Bank and Swiftsure Bank; inshore), WASHOFF (Washington, offshore), and half of WASHNO; 4) British Columbia which includes subregions BCINLETS (inside passages and inlets of B.C., inshore), WESTVAN (area west of Vancouver Island and Queen Charlotte Strait, inshore), HECATE (Hecate Strait area, inshore), and BCOFF (British Columbia, offshore); 5) the Gulf of Alaska which includes subregions SEALASKA (southeast Alaska, inshore), NOGULF (northern Gulf of Alaska, including Fairweather Bank; inshore), KODIAK (area around Kodiak Island, including Portlock Bank and Albatross Bank; inshore), and CENGULF (oceanic region of the Gulf of Alaska, offshore); 6) western Alaska which includes part of subregion UNIMAK (Unimak Pass area); and 7) the eastern Bering Sea comprised of subregions BERIN (Bering Sea shelf, inshore) and BEROFF (Bering Sea basin, offshore), and also includes subregions PRIBILOF (area around the Pribilof Islands) and most of UNIMAK. Subregions in which  $\geq 50\%$  of the area is  $\leq 100$  fathoms are noted as inshore; the remainder are noted as offshore.

used in analyses of pelagic data for northern fur seals. The subregions were selected to compare diet between inshore (neritic) and offshore (oceanic) areas and to indicate diet in certain localities where collection effort was relatively high. Inshore areas were defined as those generally occurring on the continental shelf (depths up to 100 fathoms) and offshore areas as those beyond the continental shelf.

## RESULTS

The cruise tracks (Fig. 2) taken by research vessels of the United States and Canada for the collection of northern fur seals during 1958-74 indicate the relative distribution of research effort. Most collections were made in the coastal areas between California and British Columbia, off Kodiak Island, and in the eastern Bering Sea between Unimak Pass and the Pribilof Islands. Few specimens were taken more than 160 km from shore.

## Diet by Region and Month

An examination of the number of prey species that made up the diet indicates that at least nine species may be consumed within any one subregion. However, typically only three prey species made up about 80% of the diet (Fig. 3). Thus, relatively few species of food are of primary importance in any one locality. As will be made clear in the following regional and subregional accounts, the primary food species can change among localities.

Our interpretation of Figures 4-11 which follow requires clarification. These figures show modified volume values only for those individual species that we felt were important and that had sufficient sample sizes to be reliable. Thus, we arbitrarily presented only those species that were of  $\geq 5\%$  in importance for samples with at least 20 stomachs containing food. Species of less importance were pooled either as miscellaneous fishes or squids. Also, be-

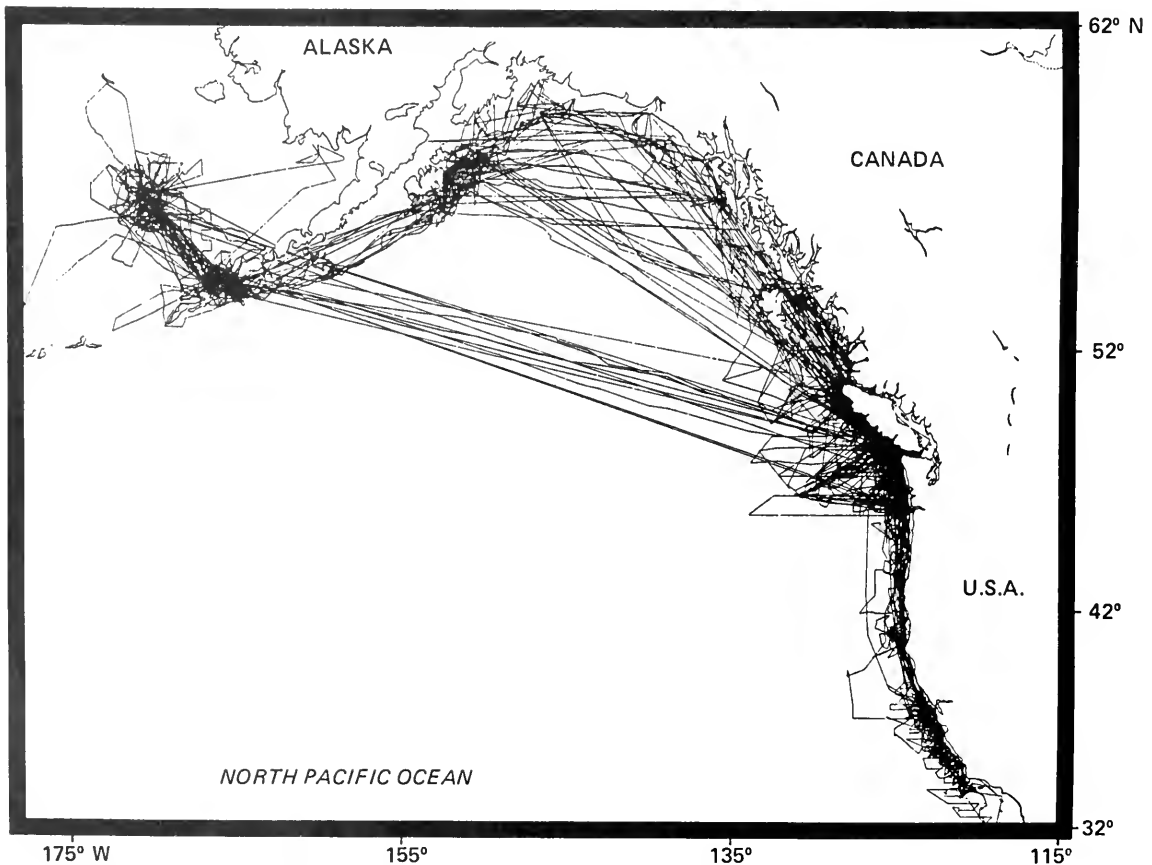

FIGURE 2.—Cruise tracks of northern fur seal research vessels from the United States and Canada during 1958-74.

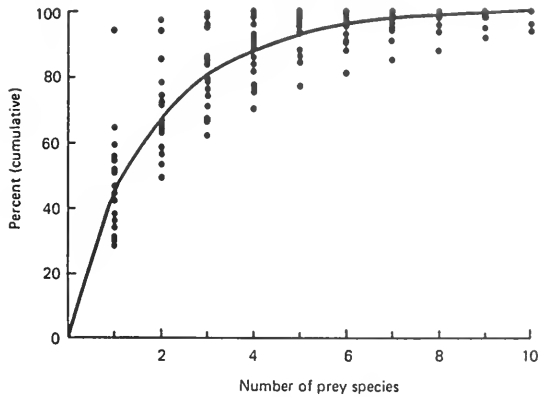

FIGURE 3.—The cumulative percentage distribution of the number of prey species eaten in the total diet of northern fur seals taken during 1958-74. Data for each of the 21 subregions are plotted, although only the average relationship is graphed.

cause the prey consumed by month within subregions were not presented here, we take these data from Perez and Bigg<sup>5</sup> in our interpretation of subregional data.

### California

Northern anchovy, *Engraulis mordax*, was the most important food eaten by the northern fur seals off California (Fig. 4A) whether its energy content was considered or not. However, it was more important when its caloric value was taken into account. Northern anchovy was eaten mainly during January to March in inshore and offshore waters of central and southern California (Fig. 4B, C). Pacific whiting, *Merluccius productus*, was second in importance (Fig. 4A) and was preyed upon in all areas of California, although primarily during April and May (Fig. 4B, C). Market squid, *Loligo opalescens*, was eaten from January to June, but only in neritic locations (Fig. 4B, C). Onychoteuthid squids (Onychoteuthidae) were eaten offshore and were the more important squid species consumed in the southern areas off California (Fig. 4C). Other prey types were of relatively minor importance, although some were locally significant, such as Pacific saury, *Colo-labis saira*, mainly in oceanic areas off northern and central California (Fig. 4A, B, C).

<sup>5</sup>Perez, M. A., and M. A. Bigg. 1981. An assessment of the feeding habits of the northern fur seal in the eastern North Pacific Ocean and eastern Bering Sea. Unpubl. draft rep., 146 p. Northwest and Alaska Fisheries Center, National Marine Mammal Laboratory, National Marine Fisheries Service, NOAA, 7600 Sand Point Way N.E., Seattle, WA 98115.

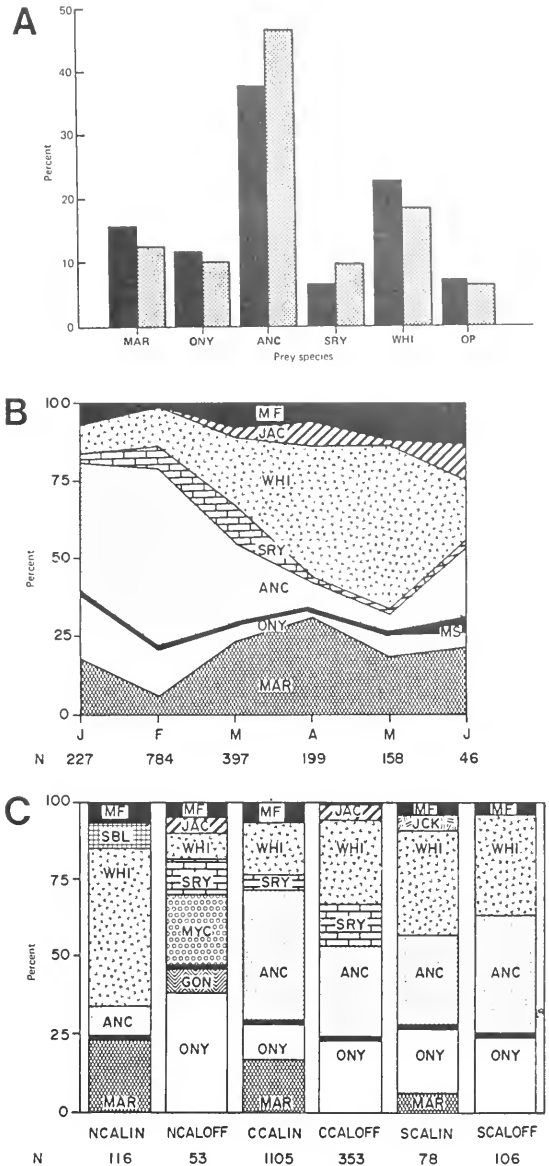

FIGURE 4.—Composition (percent) of diet of northern fur seals by prey species off California during 1958-74 (A) for pooled January-June samples ( $N = 1,811$ ), using modified volume (dark bars) and energy-adjusted modified volume; (B) by month using modified volume; and (C) by subregion with pooled January-June samples using modified volume. A dark line separates squid and fish categories in the latter two figures. Key: ANC = northern anchovy; GON = gonatid squids; JAC = jack mackerel; JCK = jacksmelt; MAR = market squid; MF = miscellaneous fish species; MS = miscellaneous squid species; MYC = myctophiform fishes; ONY = onychoteuthid squids; OP = other prey; SBL = sablefish; SRY = Pacific saury; WHI = Pacific whiting.

Oregon

Only 69 northern fur seals with food in their stomachs were collected in Oregon between January and May during 1958-74, with 58 of these taken during April. Thus, diet could not be determined by month or by inshore and offshore areas. As in California, the main food was northern anchovy (Fig. 5). Other important prey were market squid, onychoteuthid squids, Pacific whiting, and rockfishes (*Sebastes* spp.).

Washington

Pacific herring, *Clupea harengus pallasii*, was the most important food for northern fur seals off Washington, particularly when energy content was considered (Fig. 6A). It was only slightly more significant than rockfishes, salmonids (Salmonidae, primarily *Oncorhynchus* spp.), and northern anchovy when caloric values were not incorporated. Pacific herring was eaten from December to June but only

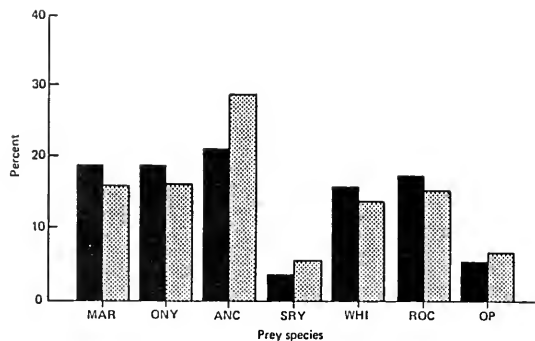

FIGURE 5.—Composition (percent) of diet of northern fur seals by prey species off Oregon during 1958-74 for pooled January-June samples ( $N = 69$ ), using modified volume (dark bars) and energy-adjusted modified volume. Key: ANC = northern anchovy; MAR = market squid; ONY = onychoteuthid squids; OP = other prey; ROC = rockfishes; SRY = Pacific saury; WHI = Pacific whiting.

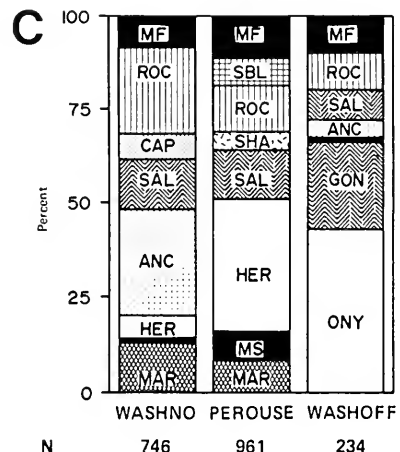
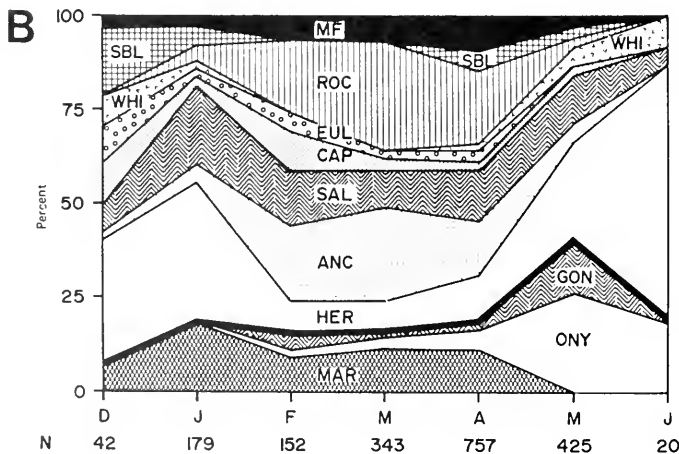
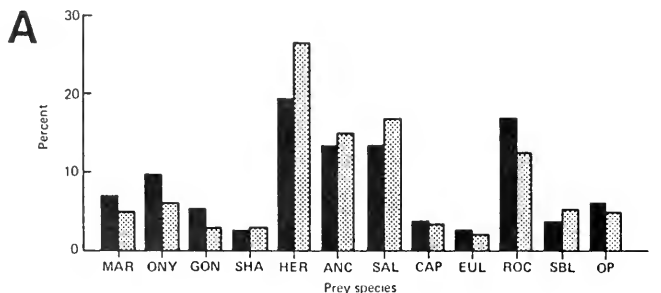

FIGURE 6.—Composition (percent) of diet of northern fur seals by prey species off Washington during 1958-74 (A) for pooled December-June samples ( $N = 1,918$ ), using modified volume (dark bars) and energy-adjusted modified volume; (B) by month using modified volume; and (C) by subregion with pooled December-June samples using modified volume. A dark line separates squid and fish categories in the latter two figures. Key: ANC = northern anchovy; CAP = capelin; EUL = eulachon; GON = gonatid squids; HER = Pacific herring; MAR = market squid; MF = miscellaneous fish species; MS = miscellaneous squid species; ONY = onychoteuthid squids; OP = other prey; ROC = rockfishes; SAL = salmonids; SBL = sablefish; SHA = American shad; WHI = Pacific whiting.

in neritic areas (Fig. 6B, C). Rockfishes, salmonids, and northern anchovy were also consumed by seals during this time, both inshore and offshore. Northern anchovy was primarily important in the southern area of the region (Fig. 6C). The main food in oceanic waters consisted of two families of squids, Onychoteuthidae and Gonatidae (Fig. 6C). Market squid was the primary squid species preyed upon in neritic areas.

### British Columbia

As in Washington, Pacific herring was the prim-

ary food of the northern fur seals from February to June in most inshore areas, particularly when energy content was taken into account (Fig. 7A, B, C). It was mainly consumed by northern fur seals off the west coast of Vancouver Island and in Hecate Strait. In coastal inlets, market squid was important, but not significantly for the region as a whole. The diet of northern fur seals in oceanic waters during May and June was almost exclusively onychoteuthid squids and salmonids (Fig. 7B, C). Other prey species were relatively insignificant (Fig. 7A). However, because the coastline of British Columbia is complex, and sample sizes were small, additional local differences in diet may exist in inshore areas (Fig. 7C).

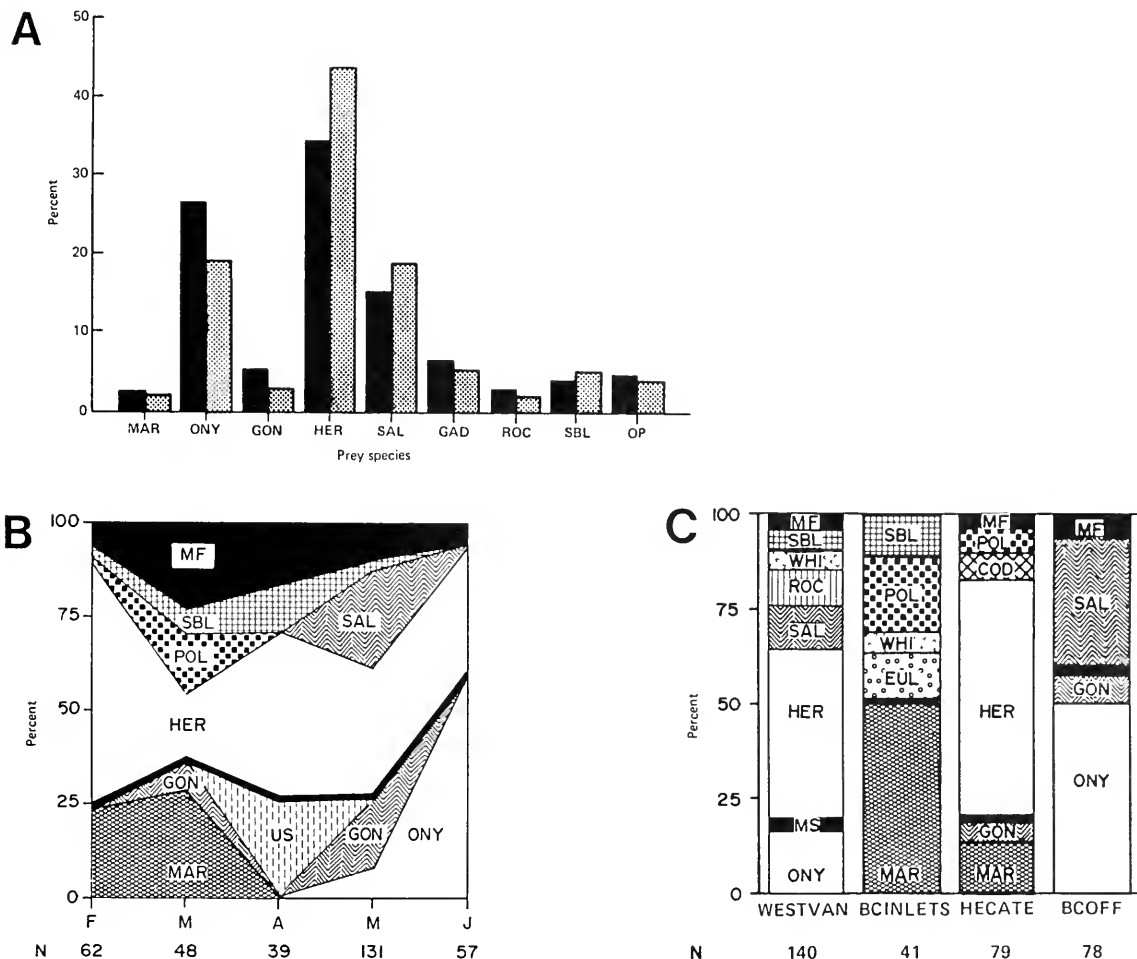

FIGURE 7.—Composition (percent) of diet of northern fur seals by prey species off British Columbia during 1958-74 (A) for pooled January-June samples ( $N = 354$ ), using modified volume (dark bars) and energy-adjusted modified volume; (B) by month using modified volume; and (C) by subregion with pooled January-June samples using modified volume. A dark line separates squid and fish categories in the latter two figures. Key: COD = Pacific cod; EUL = eulachon; GAD = gadid fishes; GON = gonatid squids; HER = Pacific herring; MAR = market squid; MF = miscellaneous fish species; ONY = onychoteuthid squids; OP = other prey; POL = walleye pollock; ROC = rockfishes; SAL = salmonids; SBL = sablefish; US = unidentified squid; WHI = Pacific whiting.

## Gulf of Alaska

Based on all samples collected in the Gulf of Alaska, the main diet of northern fur seals was Pacific herring when energy content was considered, but Pacific sand lance, *Ammodytes hexapterus*, was most important when caloric values were not considered (Fig. 8A). However, there were subregional differences in diet. Off southeastern Alaska, collections were made in Sitka Sound during February and March where the diet was almost exclusively Pacific herring (Fig. 8B, C). In the northernmost area of the region the diet consisted chiefly of capelin, *Mallotus villosus*, but also to a lesser degree of both walleye pollock, *Theragra chalcogramma*, and Pacific sand lance (Fig. 8C). Off Kodiak Island during April to July, the diet was mainly Pacific sand lance and capelin (Fig. 8B, C). Gonatid squids (Gonatidae) were the primary foods of northern fur seals in oceanic waters of this region

from April to June. Rockfishes and salmonids were also eaten by northern fur seals in offshore and northern inshore areas of the region (Fig. 8C).

## Western Alaska

Of the 309 stomachs with food collected in this region from May to October 1958-74, 239 were taken during June, with most of these collected south of Unimak Pass. The main foods of the northern fur seals were Pacific sand lance and capelin, as off Kodiak Island, with the energy content of each having little effect on their relative importance (Fig. 9). Other important prey were Atka mackerel, *Pleurogrammus monopterygius*, salmonids, walleye pollock, and the squid *Berryteuthis magister*. Sablefish, *Anoplopoma fimbria*, and Pacific herring were also eaten by northern fur seals south of Unimak Pass during summer months.

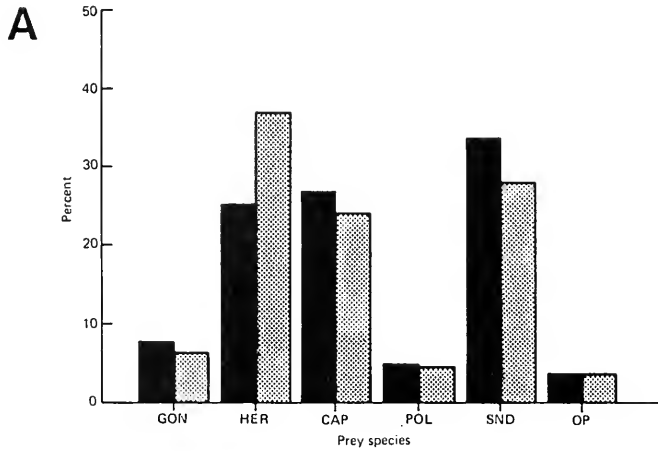
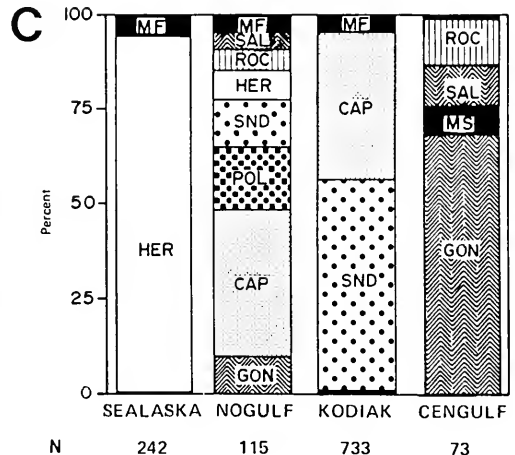
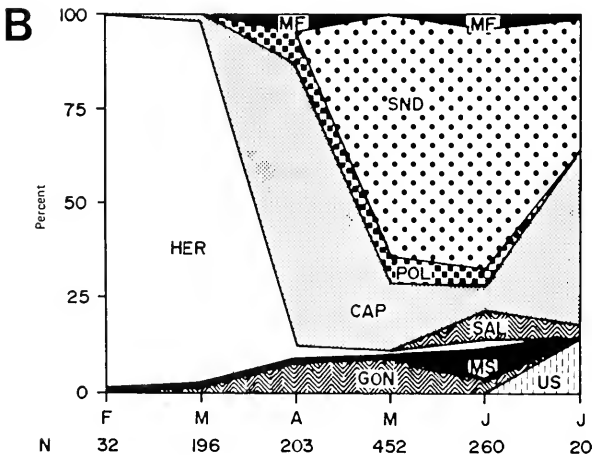

FIGURE 8.—Composition (percent) of diet of northern fur seals by prey species in the Gulf of Alaska during 1958-74 (A) for pooled February-July samples ( $N = 1,163$ ), using modified volume (dark bars) and energy-adjusted modified volume; (B) by month using modified volume; and (C) by subregion with pooled February-July samples using modified volume. Key: CAP = capelin; GON = gonatid squids; HER = Pacific herring; MF = miscellaneous fish species; MS = miscellaneous squid species; OP = other prey; POL = walleye pollock; ROC = rockfishes; SAL = salmonids; SND = Pacific sand lance; US = unidentified squid.





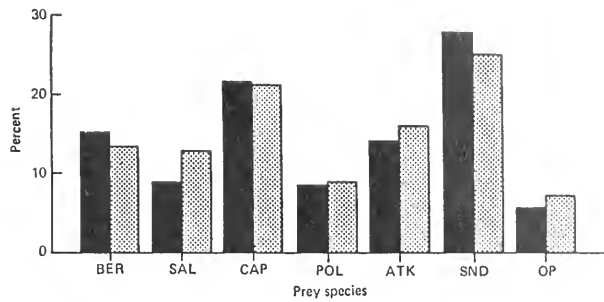

FIGURE 9.—Composition (percent) of diet of northern fur seals by prey species in western Alaska during 1958-74 for pooled May-October samples ( $N = 309$ ), using modified volume (dark bars) and energy-adjusted modified volume. Key: ATK = Atka mackerel; BER = *Berryteuthis magister*; CAP = capelin; OP = other prey; POL = walleye pollock; SAL = salmonids; SND = Pacific sand lance.

### Eastern North Pacific

Northern anchovy (20%) and Pacific herring (19%) were the main species eaten by the northern fur seals in the eastern North Pacific when data from all regions and months were pooled (Fig. 10). These prey were the most important whether energy content was considered or not, although importance increased when the caloric values were included. Salmonids (6%), capelin (8%), Pacific whiting (7%), walleye pollock (2%), Pacific sand lance (8%), and rockfishes (4%) were also commonly eaten. The re-

maining diet was made up of a wide variety of squids (mainly market squid, 6%; onychoteuthid squids, 6%; and gonatid squids, 5%) and other fishes (mainly Pacific saury, 4%; sablefish, 2%; and Atka mackerel, 2%). Squids were the primary food species in oceanic waters between California and the Gulf of Alaska, and fishes were the main prey in the neritic areas. Although not eaten in large amounts, salmonids and rockfishes were the main fishes consumed in oceanic areas between Washington and the Gulf of Alaska (Figs. 6C, 7C, 8C).

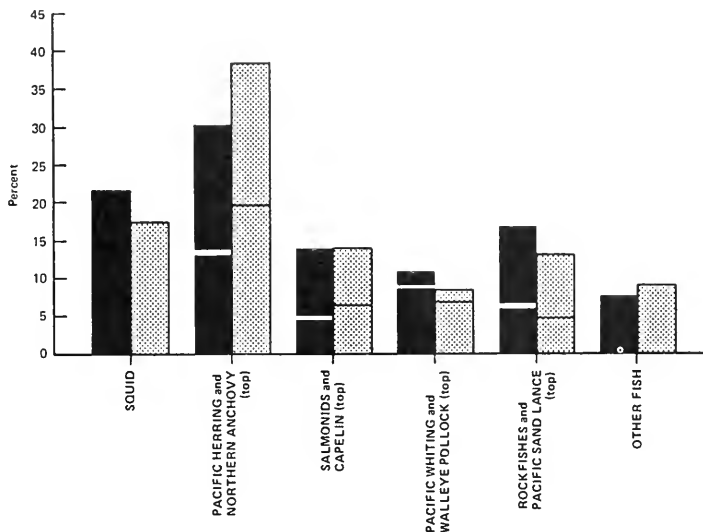

FIGURE 10.—Composition (percent) of diet of northern fur seals by prey species in the eastern North Pacific (excluding the Bering Sea) during 1958-74 using modified volume (dark bars) and energy-adjusted modified volume. Data from all months and years were pooled ( $N = 5,624$ ).

Eastern Bering Sea

Walleye pollock was the most important food for northern fur seals in the eastern Bering Sea, particularly around the Pribilof Islands and in other in-shore waters during July to September (Fig. 11A, B, C). Capelin was the main food near Unimak Pass during June to October. The squids, *Berryteuthis magister* and *Gonatopsis borealis*, were the primary prey species of fur seals in the oceanic areas (Fig. 11C). Deep-sea smelts (Bathylagidae) were eaten offshore, mainly in association with squid. The relative importance of each prey species was not markedly affected by the energy content adjustments (Fig. 11A).

Effect of Energy Value of Prey

In general, the ranking of prey species in the diet

of northern fur seals was similar when using either modified volume or modified volume weighted for the energy content of prey. However, caloric values affected relative importance in regions where high energy foods (e.g., Pacific herring, northern anchovy, salmonids), or where low energy foods (e.g., market squid, Pacific whiting) were commonly eaten. In such cases, the adjustment shifted importance of a prey species in the same direction as the relative value of their caloric content compared with other prey in the diet. A species with high energy content increased in importance, but this caused others to decrease because the relative values of prey species in the diet all totaled 100%.

DISCUSSION

The results of earlier investigations on the diet of northern fur seals indicated that basically the

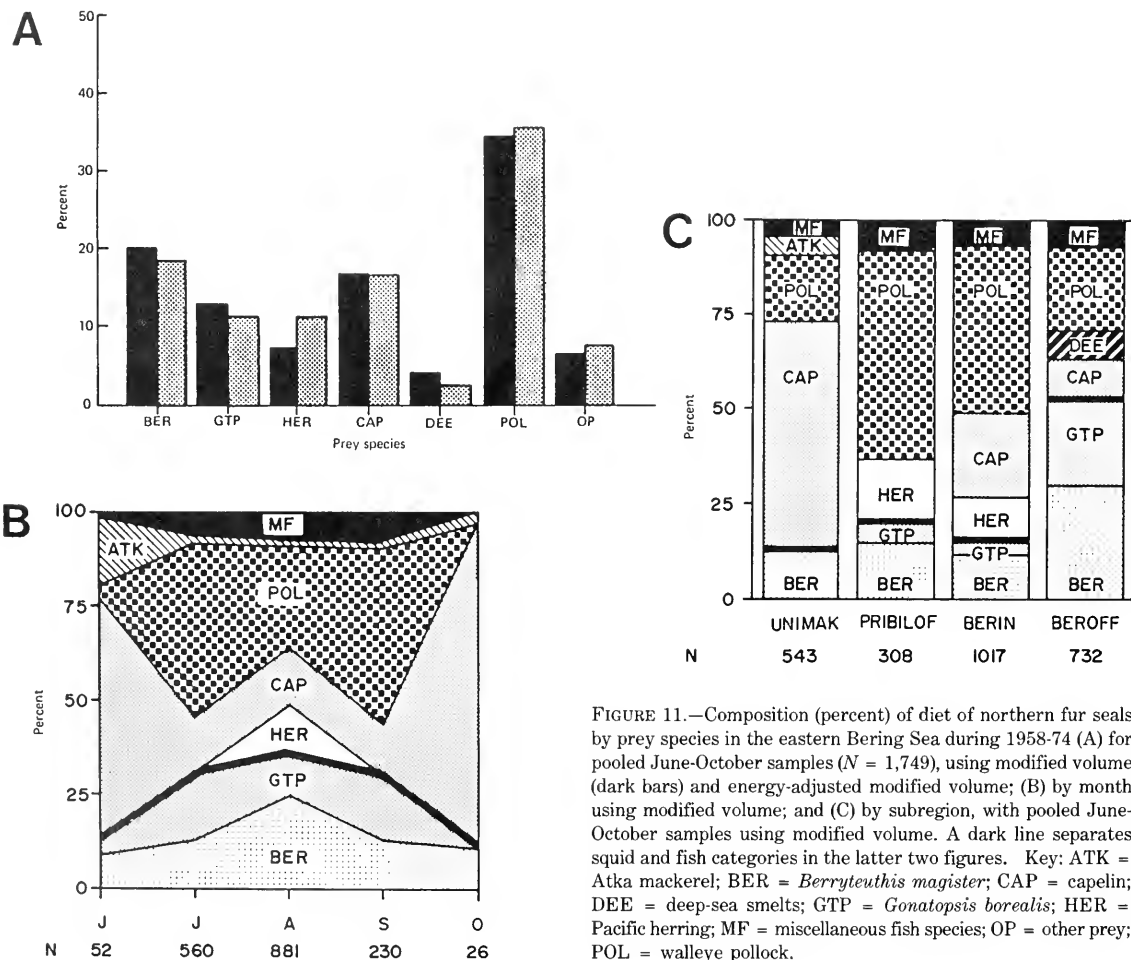

FIGURE 11.—Composition (percent) of diet of northern fur seals by prey species in the eastern Bering Sea during 1958-74 (A) for pooled June-October samples (N = 1,749), using modified volume (dark bars) and energy-adjusted modified volume; (B) by month using modified volume; and (C) by subregion, with pooled June-October samples using modified volume. A dark line separates squid and fish categories in the latter two figures. Key: ATK = Atka mackerel; BER = *Berryteuthis magister*; CAP = capelin; DEE = deep-sea smelts; GTP = *Gonatopsis borealis*; HER = Pacific herring; MF = miscellaneous fish species; OP = other prey; POL = walleye pollock.

same species of prey were important by region and month as reported in the current study. This was true for the numerous annual and intermittent summary reports prepared by the United States and Canada for the North Pacific Fur Seal Commission during 1958-74. However, they are not reviewed here because they typically described diet for a particular year or 2-6 yr period and were based on subsets of the samples that we used. In other studies, Stroud et al. (1981) and Kajimura (1984, 1985) mentioned, although did not demonstrate, that squids were the main food species in offshore areas, whereas fishes were the most important inshore. This observation was confirmed in our findings. The phenomenon appears to exist throughout the feeding range of northern fur seals off western North America.

Also, as found in our study, Taylor et al. (1955) and Kajimura (1985) reported that the main food for the northern fur seal off California was northern anchovy. Similarly, Clemens and Wilby (1933), Clemens et al. (1936), Schultz and Rafn (1936), May (1937), Wilke and Kenyon (1952), Spalding (1964), and Kajimura (1985) all indicated that Pacific herring was the primary prey between Washington and southeastern Alaska. Taylor et al. (1955) and Kajimura (1985) found that capelin was prominent in the diet off Kodiak Island; and Lucas (1899), Wilke and Kenyon (1952), and Kajimura (1985) found that walleye pollock was the most significant species in the eastern Bering Sea; and Wilke and Kenyon (1957) reported that capelin was important to northern fur seals near Unimak Pass.

However, there were some differences between the results of earlier research and the current analysis. Taylor et al. (1955) stated that 1) jacksmelt, *Atherinopsis californiensis*, was second in importance for northern fur seals off California rather than insignificant as we reported; 2) salmon was the main food off Oregon rather than a minor diet item; 3) walleye pollock was more important than Pacific herring off Washington; and 4) Pacific sand lance was rarely foraged off Kodiak Island rather than eaten almost as frequently as capelin. Kenyon (1956) found Pacific sandfish, *Trichodon trichodon*, to be the most commonly consumed food of seals which were taken on rookeries of the Pribilof Islands, whereas the current study found that it was rarely eaten. Most of these differences probably resulted from small sample sizes of earlier studies or dissimilar measures of importance. Also, some differences in diet will result from interannual variability in prey abundance and movement patterns owing to environmental conditions or other factors.

Factors other than just the relative importance by region and month must be taken into account when determining the significance of each prey species to the seal. Robbins (1983) stated that the nutritional value of food should also be considered. For example, food species with high caloric values will be more important than those with low caloric values because the amount of food required for metabolic functions depends to some extent upon the energy content of that food. However, high energy foods are more valuable only when they are not more difficult to capture and do not contain more indigestible or toxic substances than lower energy content species. These detrimental factors do not appear to be involved when considering the most important foods eaten by northern fur seals in the eastern North Pacific Ocean. Northern anchovy and Pacific herring were already the most important prey species even without accounting for their energy content. But because they also had relatively high energy values, their importance increased in the seal's diet. Thus, relative importance with an adjustment for energy content appears to be a better measure of diet than when energy content is not incorporated.

Another factor to consider is the proportion of the year that the northern fur seal population spends in each locality. Each prey species in the total annual diet should be weighted by the importance of each subregion and region where the prey is eaten. This weighting requires understanding the route and timing of migration, and the changes in local seasonal abundance of northern fur seals. The general pattern of migration for the Pribilof Islands stock is well known (Baker et al. 1970; Fiscus 1978; Bigg 1982<sup>6</sup>). Essentially all population components, except most 1-2 yr-olds, are thought to occur in the eastern Bering Sea during June-July to October where they pup, mate, nurse, and rest on the Pribilof Islands. Most 1-2 yr-olds remain in the North Pacific Ocean during this time. The stock leaves the eastern Bering Sea in November-December and travels mainly to the coastal areas between southeastern Alaska and California, with the largest number apparently going to California by January. Most males remain in Alaskan waters, and seals aged 1-2 yr remain offshore. The return migration starts in March-April with most seals arriving in the northern Gulf of Alaska by May. However, while this general pat-

<sup>6</sup>Bigg, M. A. 1982. Migration of northern fur seals in the eastern North Pacific and eastern Bering Sea: an analysis using effort and population composition data. Unpubl. rep., 77 p. Department of Fisheries and Oceans, Pacific Biological Station, Nanaimo, British Columbia V9R 5K6, Canada.

tern of migration is known, no estimates have been made of the seasonal abundance of seals by region, and thus total diet cannot be weighted by the significance of each locality.

Nonetheless, we are of the opinion that the lack of estimates of local abundance of northern fur seals may not be a major bias in our descriptions of diet for the large coastal regions of the eastern North Pacific (Fig. 10) and the eastern Bering Sea (Fig. 11). We reason that the sampling effort in the eastern North Pacific was extensive from December to June, as indicated by the size of samples collected by month and region (Figs. 4-9; see also Figure 2), and may have largely reflected the seasonal changes in relative abundance of seals during their coastal migration. For the eastern Bering Sea, essentially all samples were taken during July-October, which was the time most seals resided there.

The most general conclusion to be made about the diet of coastal northern fur seals is that it consists primarily of small schooling fish. Previous studies have made the point that the diet consists of small schooling fish and squid (Spalding 1964; Kajimura 1985; others). However, our findings suggest that squid are no more important in the overall diet to the seal than are the larger sized fish. In the coastal regions of the eastern North Pacific the northern fur seal's diet consists of 60% small schooling fish, 23% other fish, and 17% squid. When northern fur seals arrive off the coast of southeastern Alaska to California during winter, they feed on northern anchovy, Pacific herring, capelin, and Pacific saury. When most northern fur seals arrive along the coast of the Gulf of Alaska in spring, they eat capelin and Pacific sand lance. These are fish <30 cm in length (Table 2). Typically they are eaten whole whereas larger fish are first broken into small pieces (Spalding 1964). Walleye pollock is the primary food in the eastern Bering Sea. It is a large fish as an adult (Smith 1981), and these fish school. However, northern fur seals feed mainly upon the juvenile stages, i.e., <20 cm (McAlister and Perez<sup>7</sup>). Thus, the diet in this region consists up to 64% small schooling fish, 6% other fish, and 30% squid.

On the Asian coast the diet of northern fur seals also includes small schooling fishes such as myctophiform fishes (lanternfishes), Pacific saury, Pacific sand lance, and the Japanese anchovy, *Engraulis*

TABLE 2.—Summary of the size range and general habitat of northern fur seal prey.<sup>1</sup> A = anadromous; BC = British Columbia; BER = eastern Bering Sea; CAL = California; GULF = Gulf of Alaska; I = inshore; NS = near surface; O = offshore; ORE = Oregon; S = schooling fish; WASH = Washington; WEST = western Alaska.

Prey	Average adult size (cm)	Size range (cm) of specimens in fur seal stomachs (sample size in parentheses) <sup>2</sup>	General habitat
Pacific herring	<20-30	10-25 (11,>27)	Pelagic (I,S)
Northern anchovy	<18	9-18 (7,27)	Pelagic (I-O,S)
Salmonids <sup>3</sup>	<80	15-41 (22,>26)	Pelagic (I-O,A)
Capelin	22	7-14 (7,64)	Pelagic (I,S)
Eulachon	23-30	12-21 (3,11)	Pelagic (I,S,A)
Deep-sea smelts	2-18	8-12 (6,986)	Pelagic (O,S)
Myctophiform fishes	13-20	—	Pelagic (O,S)
Pacific saury	10-32	25 (1,4)	Pelagic (O,S)
Pacific whiting	66-76	15 (1,2)	Pelagic and semidemersal (I-O,S)
Walleye pollock	<90	4-40 (71,1721)	Pelagic and semidemersal (I-O,S)
Rockfishes	30-53	11-31 (6,>19)	Demersal (I-O,S)
Sablefish	57-60	20-31 (3,>3)	Pelagic and semidemersal (I-O,S)
Atka mackerel	<120	15-23 (5,>5)	Pelagic and semidemersal (I,S)
Pacific sand lance	20	—	Demersal (I,S)
Market squid	14-17	7-15 (6,43)	Pelagic (I)
Onychoteuthid squids <sup>4</sup>	10-37	14-22 (3,>3)	Pelagic (I-O)
Goniatid squid	12-32	5-24 (10,>59)	Pelagic (I-O)

<sup>1</sup>Data on average lengths of prey and ecology were compiled from Aki-mushkin (1963), Bakkaia et al. (1981), Baxter (1967), Baxter and Duffy (1974), Carl (1964), Childress and Nygaard (1973), Childress et al. (1980), Fields (1965), Fitch (1974), Fitch and Lavenberg (1968, 1971, 1975), Hart (1973), Inada (1981), Miller and Lea (1976), Naito et al. (1977), Niggol (1982), Percy (1965), Percy et al. (1979), Smith (1981), Taka et al. (1980), and Westpestad and Barton (1981).

<sup>2</sup>Total length for fish and dorsal mantle length for squid. The first number in parentheses is the number of fur seal stomachs examined, and the second number in parentheses is the number of prey specimens measured. These data were derived from an analysis of the original unpublished 1958-74 data.

<sup>3</sup>Maximum size of salmonids found at sea. Adults in freshwater are larger (to 147 cm) depending upon species.

<sup>4</sup>Does not include size range of *Moroteuthis* (<140 cm) which has been taken by northern fur seals, but rarely off North America.

*japonicus*, in addition to walleye pollock and squid (Taylor et al. 1955; Lander and Kajimura 1980). Of interest is the fact that in recent years the Japanese sardine, *Sardinops melanosticta*, has become more important in the diet of northern fur seals off Asia (Yoshida et al.<sup>8,9</sup>; Yoshida and Baba<sup>10,11</sup>). This sardine was depleted during the 1930's and 1940's and

<sup>7</sup>McAlister, W. B., and M. A. Perez. 1977. Ecosystem dynamics—birds and marine mammals. Part I: preliminary estimates of pinniped-fish relationships in the Bering Sea (final report). In Environmental assessment of the Alaskan continental shelf, Annual Report 12, p. 342-371. U.S. Department of Commerce, Environmental Research Laboratory, Boulder, CO.

<sup>8</sup>Yoshida, K., N. Okumoto, and N. Baba. 1979. Japanese pelagic investigation on fur seals, 1978. Far Seas Fish. Res. Lab., Shimizu, Jpn., Fur Seal Resour. Sect., Contrib. No. 41-9, 66 p.

recovered only recently (Kondo 1980). The northern fur seal appears to have reacted to this recovery by eating more sardines. A similar change in diet may have taken place off California during the past 50 years. The Pacific sardine, *Sardinops sagax*, was once the most abundant small, schooling fish off California, whereas now northern anchovy is (Murphy 1966; Smith 1972; Mais 1974). The Pacific sardine population was drastically reduced during the 1940's mainly because of fishing pressure and has remained at a relatively low level since, while the northern anchovy increased in abundance during the 1950's and the 1960's (Vrooman and Smith 1971; Hart 1973; Wolf and Smith 1985). The Pacific sardine may undergo long-term periodic fluctuations in population size (Thompson 1921), and it may now once again be increasing in biomass (Wolf and Smith 1985). Northern fur seals have not eaten Pacific sardine in recent years, but perhaps they fed on this species prior to the 1940's. The seal may have changed its diet from largely Pacific sardine to northern anchovy. Unfortunately, the stomach contents of only two northern fur seals were collected from California prior to the 1950's (Scheffer 1950). Clemens and Wilby (1933) gave the only evidence that sardines were once consumed by these seals in the eastern North Pacific Ocean. They found that sardines were commonly eaten during 1931 off southwestern Vancouver Island.

An interesting speculation regarding the significance of small schooling fish to northern fur seals is the relationship between diet and the migration route of the seal. Small schooling fish could be important just because they are abundant and lie along the coastal migration path of northern fur seals. Kajimura (1985) argued for this possibility. He suggested that the migration pattern of northern fur seals is genetically established and that the seal feeds opportunistically upon whatever prey species are most abundant in its path. He believes that, although food is not a major factor in determining the migration route of northern fur seals, the movements of prey species can still alter the local distribution of fur seals. An alternative possibility is that the seals learn the location of the main foods and then select its migration route to include them.

Baker (1978) argued for this alternative. He proposed that, while some inherited factors may be involved in migration, northern fur seals could mainly search the North Pacific Ocean for the most preferred or abundant food, and thereafter establish the migration route. Such being the case, perhaps inexperience explains why 1-2 yr-old seals are rarely seen inshore feeding with older seals. Also, perhaps squid is not a preferred or sufficiently available food for northern fur seals offshore, because most seals older than 1-2 yr feed inshore on fish. However, at this stage, not enough is known about the factors that control migration of the northern fur seal to establish which alternative is true. As Kajimura (1985) has pointed out, factors other than diet are no doubt involved as indicated by the fact that males do not migrate as far south as females.

## ACKNOWLEDGMENTS

The following people assisted us with the preparation of data for analysis, and with the construction of tables and figures presented in unpublished preliminary reports of this study: Julia Bosma, Patricia Bouthillette, Laurie Briggs, Carl Brooks, David Crystal, Ian Fawcett, Gary Fidler, Job Groot, Carol Hastings, Marta Hladyshevsky, Kerry Hobbs, Gerald Hornof, Marilyn Marshall, Elizabeth Mooney, R. Perez, Kenneth Pierce, and Marsha Schad.

## LITERATURE CITED

- AKIMUSHKIN, I. I.  
1963. Cephalopods of the seas of the U.S.S.R. [In Russ.] Izd. Akad. Nauk, Mosc. (Transl. by Isr. Prog. Sci. Transl., 1965, avail. U.S. Dep. Commer., Natl. Tech. Inf. Serv., Springfield, Va., as TT65-50013, 223 p.)
- BAKER, R. C., F. WILKE, AND C. H. BALTZO.  
1970. The northern fur seal. U.S. Fish Wildl. Serv., Circ. 336, 20 p.
- BAKER, R. R.  
1978. The evolutionary ecology of animal migration. Holmes and Meier Publ., N.Y., 1012 p.
- BAKKALA, R., K. KING, AND W. HIRSCHBERGER.  
1981. Commercial use and management of demersal fish. In D. W. Hood and J. A. Calder (editors), The eastern Bering Sea shelf: Oceanography and resources, vol. 2, p. 1015-1036. Univ. Wash. Press, Seattle, WA.
- BAXTER, J. L.  
1967. Summary of biological information on the northern anchovy *Engraulis mordax* Girard. Calif. Coop. Oceanic Fish. Invest. Rep. 11:110-116.
- BAXTER, J. L., AND J. M. DUFFY.  
1974. Inshore fishes of California, 4th revision. Calif. Dep. Fish Game, Sacramento, CA, 78 p.
- BIGG, M. A., AND I. FAWCETT.  
1985. Two biases in diet determination of northern fur seals
- <sup>9</sup>Yoshida, K., N. Okumoto, and N. Baba. 1981. Japanese pelagic investigation on fur seals, 1979-1980. Far Seas Fish. Res. Lab., Shimizu, Jpn., Fur Seal Resour. Sect., Contrib. No. 41-10, 150 p.
- <sup>10</sup>Yoshida, K., and N. Baba. 1983. Japanese pelagic investigation on fur seals, 1981-1982. Far Seas Fish. Res. Lab., Shimizu, Jpn., Fur Seal Resour. Sect., Contrib. No. 41-11, 118 p.
- <sup>11</sup>Yoshida, K., and N. Baba. 1984. Japanese pelagic investigation on fur seals, 1983. Far Seas Fish. Res. Lab., Shimizu, Jpn., Fur Seal Resour. Sect., Contrib. No. 41-12, 67 p.

- (*Callorhinus ursinus*). In J. R. Beddington, R. J. H. Beverton, and D. M. Lavigne (editors), Marine mammals and fisheries, p. 284-291. George Allen & Unwin (Publ.), Lond.
- BIGG, M. A., I. B. MACASKIE, AND G. ELLIS.  
1978. Studies on captive fur seals. Progress Rep. No. 2. Can. Fish. Mar. Serv. Manuscr. Rep. 1471, 21 p. Nanaimo, B.C.
- BIGG, M. A., AND M. A. PEREZ.  
1985. Modified volume: a frequency-volume method to assess marine mammal food habits. In J. R. Beddington, R. J. H. Beverton, and D. M. Lavigne (editors), Marine mammals and fisheries, p. 277-283. George Allen & Unwin (Publ.), Lond.
- CARL, G. C.  
1964. Some common marine fishes of British Columbia. B.C. Prov. Mus., Victoria, B.C., Handb. No. 23, 86 p.
- CHILDRESS, J. J., AND M. H. NYGAARD.  
1973. The chemical composition of midwater fishes as a function of depth of occurrence off southern California. Deep-Sea Res. 20:1093-1109.
- CHILDRESS, J. J., S. M. TAYLOR, G. M. CAILLIET, AND M. H. PRICE.  
1980. Patterns of growth, energy utilization and reproduction in some meso- and bathypelagic fishes off southern California. Mar. Biol. 61:27-40.
- CLEMENS, W. A., J. L. HART, AND G. V. WILBY.  
1936. Analysis of stomach contents of fur seals taken off the west coast of Vancouver Island in April and May 1935. Can. Dep. Fish., Ottawa, 20 p.
- CLEMENS, W. A., AND G. V. WILBY.  
1933. Food of the fur seal off the coast of British Columbia. J. Mammal. 14:43-46.
- FIELDS, W. G.  
1965. The structure, development, food relations, reproduction, and life history of the squid *Loligo opalescens* Berry. Calif. Dep. Fish Game, Fish Bull. 131, 108 p.
- FISCUS, C. H.  
1978. Northern fur seal. In D. Haley (editor), Marine mammals of eastern North Pacific and arctic waters, p. 152-159. Pac. Search Press, Seattle, WA.
- FITCH, J. E.  
1974. Offshore fishes of California. 5th rev. Calif. Dep. Fish Game, Sacramento, CA, 80 p.
- FITCH, J. E., AND R. J. LAVENBERG.  
1968. Deep-water teleostean fishes of California. Univ. Calif. Press, Berkeley, CA, 155 p.  
1971. Marine food and game fishes of California. Univ. Calif. Press, Berkeley, CA, 179 p.  
1975. Tidepool and nearshore fishes of California. Univ. Calif. Press, Berkeley, CA, 156 p.
- HART, J. L.  
1973. Pacific fishes of Canada. Bull. Fish. Res. Board Can. 180, 740 p.
- INADA, T.  
1981. Studies on the Merlucciid fishes. Bull. Far Seas Fish. Res. Lab. (Shimizu) 18:1-172.
- KAJIMURA, H.  
1984. Opportunistic feeding of the northern fur seal *Callorhinus ursinus*, in the eastern North Pacific Ocean and eastern Bering Sea. U.S. Dep. Commer., NOAA Tech. Rep. NMFS SSRF-779, 49 p.  
1985. Opportunistic feeding by the northern fur seal, (*Callorhinus ursinus*). In J. R. Beddington, R. J. H. Beverton, and D. M. Lavigne (editors), Marine mammals and fisheries, p. 300-318. George Allen & Unwin (Publ.), Lond.
- KENYON, K. W.  
1956. Food of fur seals taken on St. Paul Island, Alaska, 1954. J. Wildl. Manage. 20:214-215.
- KIZEVETTER, I. V.  
1971. Chemistry and technology of Pacific fish. Dal'izdat, Vladivostok. (Transl. by Isr. Prog. Sci. Transl., 1973, avail. U.S. Dep. Commer., Natl. Tech. Inf. Serv., Springfield, VA, as TT72-50019, 304 p.)
- KONDO, K.  
1980. The recovery of the Japanese sardine - the biological basis of stock-size fluctuations. Rapp. P.-v. Réun. Cons. int. Explor. Mer 177:332-354.
- LANDER, R. H. (editor).  
1980. Summary of northern fur seal data and collection procedures. Vol. 2: Eastern Pacific pelagic data of the United States and Canada (excluding fur seals sighted). U.S. Dep. Commer., NOAA Tech. Memo. NMFS F/NWC-4, 541 p.
- LANDER, R. H., AND H. KAJIMURA (editors).  
1980. Summary of northern fur seal data and collection procedures. Vol. 3: Western Pacific pelagic data of the Soviet Union and Japan, 1958-1978 (excluding fur seals sighted). U.S. Dep. Commer., NOAA Tech. Memo. NMFS F/NWC-5, 304 p.
- LUCAS, F. A.  
1899. The food of the northern fur seals. In D. S. Jordan et al. (editors), The fur seals and fur-seal islands of the North Pacific Ocean, Part 3, p. 59-68. Gov. Print. Off., Wash., DC.
- MAIS, K. F.  
1974. Pelagic fish surveys in the California Current. Calif. Dep. Fish Game, Fish Bull. 162, 79 p.
- MAY, F. H.  
1937. The food of the fur seal. J. Mammal. 18:99-100.
- MILLER, D. J., AND R. N. LEA.  
1976. Guide to the coastal marine fishes of California. Calif. Dep. Fish Game, Fish Bull. 157, 249 p. [1972, addendum added 1976.]
- MURPHY, G. I.  
1966. Population biology of the Pacific sardine (*Sardinops caerulea*). Proc. Calif. Acad. Sci. (4th Ser.) 34:1-84.
- NAITO, M., K. MURAKAMI, AND T. KOBAYASHI.  
1977. Growth and food habit of oceanic squids (*Ommastrephes bartrami*, *Onychoteuthis borealijaponicus*, *Berryteuthis magister* and *Gonatopsis borealis*) in the western subarctic Pacific region. [In Jpn., Engl. summ.] In Fisheries biological production in the subarctic Pacific region, p. 339-351. Res. Inst. North Pac. Fish. Fac. Fish., Hokkaido Univ., Spec. Vol. 1977.
- NIGGOL, K.  
1982. Data on fish species from Bering Sea and Gulf of Alaska. U.S. Dep. Commer., NOAA Tech. Memo. NMFS F/NWC-29, 125 p.
- PEARCY, W. G.  
1965. Species composition and distribution of pelagic cephalopods from the Pacific Ocean off Oregon. Pac. Sci. 19:261-266.
- PEARCY, W. G., T. NEMOTO, AND M. OKIYAMA.  
1979. Mesopelagic fishes of the Bering Sea and adjacent northern North Pacific Ocean. J. Oceanogr. Soc. Jpn. 35: 127-134.
- ROBBINS, C. T.  
1983. Wildlife feeding and nutrition. Acad. Press, N.Y., 343 p.
- SCHEFFER, V. B.  
1950. The food of the Alaska fur seal. U.S. Fish Wildl. Serv., Bur. Commer. Fish., Wildl. Leaflet 329, 16 p.

- SCHULTZ, L. P., AND A. M. RAFN.  
1936. Stomach contents of fur seals taken off the coast of Washington. *J. Mammal.* 17:13-15.
- SIDWELL, V. D.  
1981. Chemical and nutritional composition of finfishes, whales, crustaceans, mollusks, and their products. U.S. Dep. Commer., NOAA Tech. Memo. NMFS F/SEC-11, 432 p.
- SIDWELL, V. D., P. R. FONCANNON, N. S. MOORE, AND J. C. BONNET.  
1974. Composition of the edible portion of raw (fresh or frozen) crustaceans, finfish and mollusks. I. Protein, fat, moisture, ash, carbohydrate, energy value, and cholesterol. *Mar. Fish. Rev.* 36(3):21-35.
- SMITH, G. B.  
[1981.]. The biology of walleye pollock. *In* D. W. Hood and J. A. Calder (editors), *The eastern Bering Sea shelf: Oceanography and resources*, Vol. 1, p. 527-551. U.S. Gov. Print. Off., Wash., DC.
- SMITH, P. E.  
1972. The increase in spawning biomass of northern anchovy, *Engraulis mordax*. U.S. Natl. Mar. Fish. Serv., *Fish. Bull.* 70:849-874.
- SPALDING, D. J.  
1964. Comparative feeding habits of the fur seal, sea lion, and harbour seal on the British Columbia coast. *Bull. Fish. Res. Board Can.* 146, 52 p.
- STANSBY, M. E.  
1976. Chemical characteristics of fish caught in the northeast Pacific Ocean. *Mar. Fish. Rev.* 38(9):1-11.
- STROUD, R. K., C. H. FISCUS, AND H. KAJIMURA.  
1981. Food of the Pacific white-sided dolphin, *Lagenorhynchus obliquidens*, Dall's porpoise, *Phocoenoides dalli*, and northern fur seal, *Callorhinus ursinus*, off California and Washington. U.S. Natl. Mar. Fish. Serv., *Fish. Bull.* 78: 951-959.
- TAKA, S., M. KITAKATA, AND T. WADA.  
1980. Food organisms of saury, *Cololabis saira* (Brevoort) and vertical distribution of zooplankton in the southeast waters off Kuril Islands in July, 1976-1978. [In Jpn., Engl. summ.] *Bull. Hokkaido Reg. Fish. Res. Lab.* 45:15-41.
- TAYLOR, F. H. C., M. FUJINAGA, AND F. WILKE.  
1955. Distribution and food habits of the fur seals of the North Pacific Ocean. U.S. Dep. Inter., Fish Wildl. Serv., Wash., DC, 86 p.
- THOMPSON, W. F.  
1921. The future of the sardine. *Calif. Fish Game* 7:38-41.
- VROOMAN, A. M., AND P. E. SMITH.  
1971. Biomass of the subpopulations of northern anchovy *Engraulis mordax* Girard. *Calif. Coop. Oceanic Fish. Invest. Rep.* 15:49-51.
- WATT, B. K., AND A. L. MERRILL.  
1963. Composition of foods... raw, processed, prepared. U.S. Dep. Agric., *Agric. Handb.* 8, 190 p.
- WESPESTAD, V. G., AND L. H. BARTON.  
[1981.]. Distribution, migration, and status of Pacific herring *In* D. W. Hood and J. A. Calder (editors), *The eastern Bering Sea shelf: Oceanography and resources*, Vol. 1, p. 509-525. U.S. Gov. Print. Off., Wash., DC.
- WILKE, F., AND K. W. KENYON.  
1952. Notes on the food of fur seal, sea lion and harbor porpoise. *J. Wildl. Manage.* 16:396-397.  
1954. Migration and food of the northern fur seal. *Trans. North Am. Wildl. Nat. Resour. Conf.* 19:430-440.  
1957. The food of fur seals in the eastern Bering Sea. *J. Wildl. Manage.* 21:237-238.
- WOLF, P., AND P. E. SMITH.  
1985. An inverse egg production method for determining the relative magnitude of Pacific sardine spawning biomass off California. *Calif. Coop. Oceanic Fish. Invest. Rep.* 26:130-138.
- WOOTTON, R. J.  
1976. The biology of the sticklebacks. *Acad. Press, Lond.*, 387 p.





# INSTAR IDENTIFICATION AND LIFE HISTORY ASPECTS OF JUVENILE DEEPWATER SPIDER CRABS, *CHIONOECETES TANNERI* RATHBUN

PATRICIA A. TESTER<sup>1</sup> AND ANDREW G. CAREY, JR.<sup>2</sup>

## ABSTRACT

For the deepwater spider crab, *Chionoecetes tanneri*, seven instars from first crab stage (3.8 mm carapace width (CW)) to instar VII (26.8 mm CW) are identified from size-frequency histograms. The average growth per molt for the first seven instars is 39% and the time from egg to instar VII is estimated to be 20 months.

Measurements of chela length, abdomen width and carapace width were used to define two growth phases for *C. tanneri* and to determine size at maturity for males (142.7 mm CW) and females (102.3 mm CW). The unequal sex ratio of adults (29% males) and presence of chitinoclastic lesions on 76% of the adult females as compared with only 29% of the adult males suggest that adult females are anecdytic.

In this study of material collected off the southern Oregon coast, the mean adult carapace widths for males and females is very close to the sizes reported for adult males and females (148.9 and 102.5 mm CW respectively) from the northern Oregon coast. The similarity in size extends to the material collected from near the type location (Gulf of the Farallons) where instars VI and VII are 19.4 and 27.3 mm CW compared with 19.8 and 26.7 mm CW for the same instars from the southern Oregon coast. The biotic stability at depths of maximum abundance (500-775 m) contributes to this uniformity.

The spider (or tanner) crab, *Chionoecetes tanneri* Rathbun, is similar in size and morphology to the better known and commercially harvested species *C. bairdi* and *C. opilio*. Unlike *C. bairdi* and *C. opilio* which are typically encountered in shallow waters and are not reported deeper than 400 m in the eastern Pacific, *C. tanneri* is a deep-water species which ranges to 1,925 m and has its maximum abundance at 500-775 m (Pereyra 1972).

Although *C. tanneri* is not likely to be fished commercially because of its deep-water habitat and certain aspects of its biology, Somerton (1981) suggested that fluctuating supplies of Alaskan crab species might promote more economical methods for fishing in deep water. Red crab, *Geryon quinquedens*, taken from depths of 257-1,000 m between Georges Bank and Cape Hatteras are landed commercially in limited numbers on the eastern seaboard (Lux et al. 1982; U.S. National Marine Fisheries Service Fisheries Statistics 1985).

In part, because of its deep-water habitat, certain life history aspects of *C. tanneri* are not well known. Pereyra (1966, 1968) determined size at maturity

and described the seasonal distribution of adult and late juvenile crabs. Egg development follows a yearly cycle with release of matured eggs and ovulation of new eggs during the winter (Pereyra 1966). After hatching, the total larval (pelagic) phase (prezoea, zoea I, II and megalopa) is estimated to be 80 d (Lough 1974). Samples collected mainly from a series of cruises off the Oregon coast from 1972 to 1975 have provided us with *C. tanneri* specimens from the first crab stage to adult. These specimens have made it possible to identify a series of early instars and to determine juvenile growth rates; they also provided life history information on size at maturity and adult and juvenile sex ratios for comparison with earlier work. In addition, observations of the carapace condition of adults helped to substantiate the anecdytic condition of adult females.

## METHODS

### Sampling

Samples of *C. tanneri* were collected off the continental shelf and slope areas adjacent to Coos Bay, OR (lat. 42°25'N, long. 124°50'W) in depths ranging from 300 to 1,200 m during 10 cruises between April 1973 and March 1975. A total of 1,625 crabs

<sup>1</sup> College of Oceanography, Oregon State University, Corvallis OR 97331; present address: Southeast Fisheries Center Beaufort Laboratory, National Marine Fisheries Service, NOAA, Beaufort, NC 28516-9722.

<sup>2</sup> College of Oceanography, Oregon State University, Corvallis OR 97331.

of both sexes ranging in size from 10 to 165 mm carapace width (CW) were captured using two types of trawl gear: a 9 m semi-balloon Gulf of Mexico shrimp trawl and a 3 m beam trawl (Carey and Heyamoto 1972). The stretched dimension of the mesh for both trawl nets was 38 mm (1.5-in), and the cod ends were lined with 12.7 mm (0.5-in) mesh. In addition 47 of the smallest crabs (3-10 mm CW) were found in the gut contents of sable fish, *Anoplopoma fimbria*, and Dover sole, *Microstomus pacificus*, caught in these trawls. The Smithsonian Institution provided another 306 juvenile tanner crabs taken near the type location for *C. tanneri* west of the Farallon Islands (lat. 37°30'N, long. 122°59'W) (Rathbun 1925) at 500-783 m.

### Size at Maturity

The size at maturity for both male and female *C. tanneri* was based on allometric measurements. Allometry compares the difference in the proportions of specific body parts with changes in absolute size of a major body axis (Gould 1966). In Brachyura the allometric growth of secondary sex characters is well documented (Tessier 1960; Hartnoll 1969). In the genus *Chionoecetes* it takes the form of differential enlargement of the abdomen and modification of pleopods in females whereas the size and shape of the chelae are modified in the males (Watson 1970; Brown and Powell 1972).

Carapace width for both male and female crabs was measured at its widest part (mesobranchial region) exclusive of spines (Fig. 1A). The male carapace width was compared with the length of the chelar propodus (CPL) which is measured from the joint between the carpus to the tip of the fixed finger of the propodus (Fig. 1B), whereas the female carapace width was compared with the width of the abdomen (AW) which is measured at its widest part (fifth segment) (Fig. 1C). Males with worn or broken chelipeds were not used. All measurements were made to the nearest 0.01 mm using precision dial calipers, and numbers were rounded to the first decimal for plotting. Plots of the measurements of CW vs. CPL and CW vs. AW were used to identify size at maturity for males and females.

### Size-Frequency Histograms, Growth, and Sex Ratio

Measurements of the carapace width were taken from the 1,978 crabs available. Size-frequency histograms were constructed and seven juvenile instars were identified from dominant modes. Adult *C. tan-*

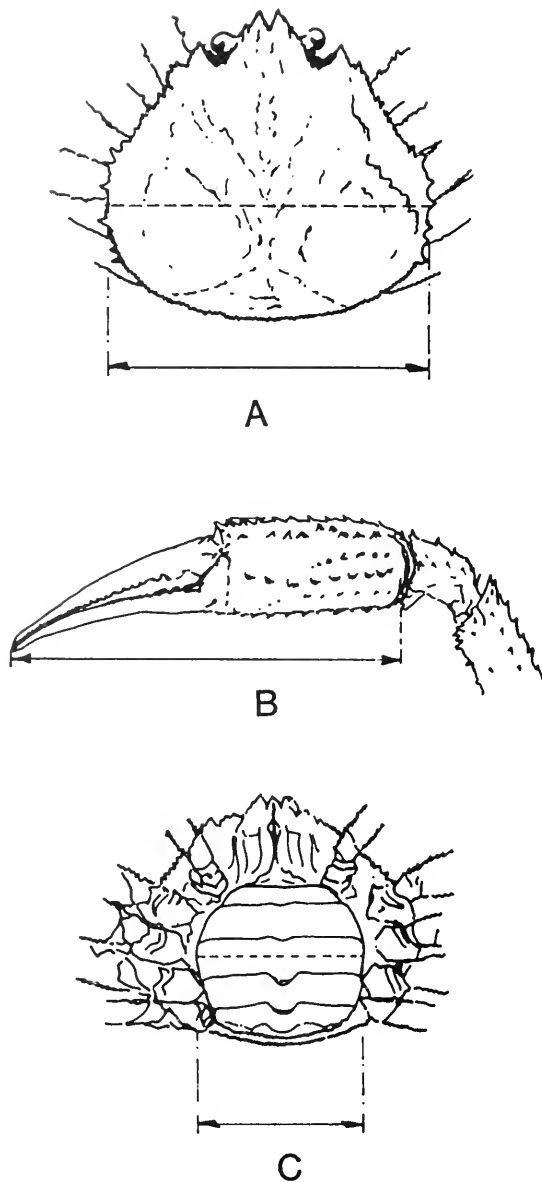

FIGURE 1.—Body dimensions of *Chionoecetes tanneri* measured for size-frequency and allometric analyses. (A) Carapace width ( $\sigma$  and  $\varphi$ ) measured at its widest part across the mesobranchial region and exclusive of spines. (B) Chelar propodus length ( $\sigma$ ) measured from the joint between the carpus and the tip of the fixed finger of the propodus. (C) Abdomen width ( $\varphi$ ) measured at its widest part, across the fifth segment.

*neri* are sexually dimorphic with respect to body size (Pereyra 1972). Since we did not know at which molt this size dimorphism was first evident, the data for males and females was shaded differently in the size-frequency histogram. The juvenile sex ratio was

calculated for each instar, and when it was clear from the equal sex ratio that juvenile males and females were not dimorphic, the percent increase in carapace width per molt was computed as

Percent increase in CW (mm) =

$$\frac{\text{Postmolt CW (mm)} - \text{Premolt CW (mm)}}{\text{Premolt CW (mm)}} \times 100$$

In one series of size-frequency histograms from samples collected in June, July, and August 1974 and January and March 1975, the progression of modes (representative of instars of the small juveniles from fish gut contents) was used to estimate growth rate. The next larger instar (CW = 10 mm) was the first to be consistently sampled by the trawl gear. Starting with the 10 mm CW instar from April 1973, growth of juvenile tanner crabs was followed through August, October, and November 1973 and March 1974.

## Carapace Condition

Detailed observations were made of the carapace on each specimen and included hardness, amount of attached fauna, and general condition. Darkened and softened or weakened areas on the carapaces were similar to those caused by chitinoclastic bacteria (Sindermann 1970) and were thought to be associated with age. Adult female *C. tanneri* were especially subject to carapace deterioration.

## RESULTS AND DISCUSSION

Since a high degree of correlation between gonad maturity and external morphology has been shown for the genus *Chionoecetes* (Brown and Powell 1972; Donaldson et al. 1981), a plot of carapace width and chela length (Fig. 2) was used to define adult males. Specimens with chelae longer than 85 mm (corresponding to carapace width >118 mm) were assumed to be sexually mature males. Those females

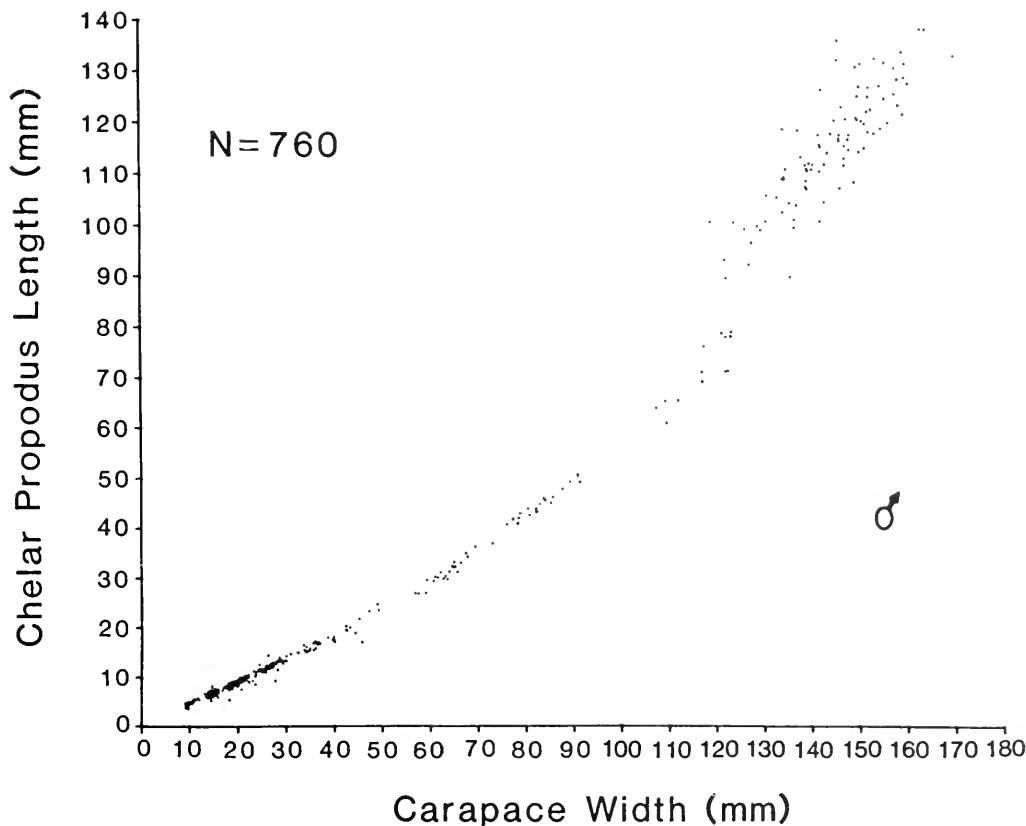

FIGURE 2.—Relationship between carapace width and chelar propodus length for juvenile and adult male *Chionoecetes tanneri*.

with abdomen widths > 50 mm (corresponding to carapace widths >85 mm) form a well-defined group (Fig. 3) of adults. The mean carapace width for adult male and female crabs in this study was 142.7 and 102.3 mm respectively and was compared with the mean carapace widths of 148.9 and 102.5 mm for females given by Pereyra (1972) for adult *C. tanneri* collected south of the Columbia River mouth. Brown and Powell (1972) reported a similar correspondence in adult carapace widths for *C. bairdi* collected from locations in Alaska. The large variation in size of mature male *C. bairdi* in the eastern Bering Sea was clearly related at the clinal variation temperature (Somerton 1981).

Seven modes representing juvenile instars are evident from the size-frequency histograms (Fig. 4). The mean carapace widths for each juvenile instar were calculated and subsequently the increase in CW per molt was computed (Table 1). The average increase at each molt for instars I-VII is 39% and there is no difference in growth increment of juvenile males and females. In a laboratory study using *C. opilio*, Miller and Watson (1976) reported that growth per molt for immature females was significantly greater than for immature males. But the findings of Hilsinger et al. (1975) agree with ours. They found no difference in growth rate for juvenile

male and female *C. bairdi* and reported a constant growth rate of 27% for juvenile females. The change in the slope of the regression lines of the log-log plots of the allometric measurements of *C. tanneri* (Fig. 5) indicated a change in the rate of growth only at sexual maturity. *Chionoecetes tanneri*, like *C. opilio* (Watson 1970), showed two growth phases, one for juveniles and one for adults.

If *C. tanneri* eggs hatch predominantly in winter (January-March) and the total larval life is 80 d, the recruitment of the smallest crab stage (CW = 4) to the population in June-July is in agreement with our findings. Instars can be followed from 4 mm CW (instar I) in June and July 1974, to 5.5 cm CW (instar II) in August 1974, to 7.5 mm CW (instar III) in January 1975 (Fig. 6). The smallest specimens sampled by the trawls were about 10 mm CW, and there were relatively large numbers of these instar IV specimens in April 1973 which molted to instar V by August and to instar VI in October 1973 (Fig. 7). No growth of these instar VI crabs is evident from the November 1973 or March 1974 data. We estimate approximately 20 mo from egg hatching to instar VII (CW = 26.8 mm) (Fig. 8).

Observations on general carapace condition and abundance of epifauna indicate that adult male *C. tanneri* do molt frequently enough to maintain their

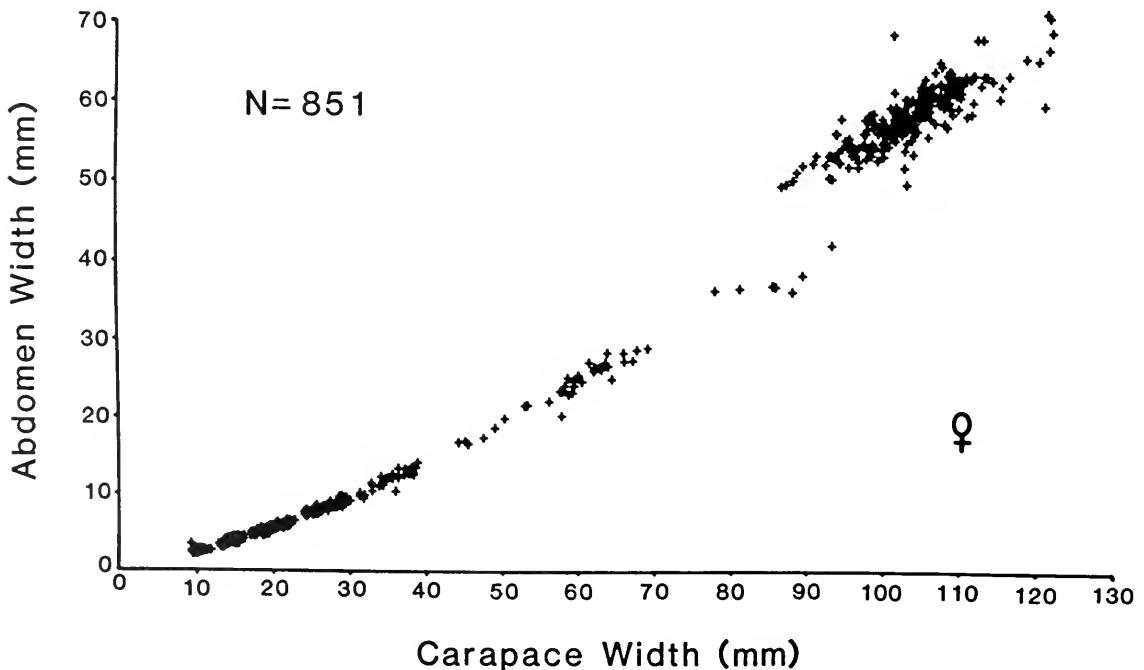

FIGURE 3.—Relationship between carapace width and abdomen width for juvenile and adult female *Chionoecetes tanneri*.

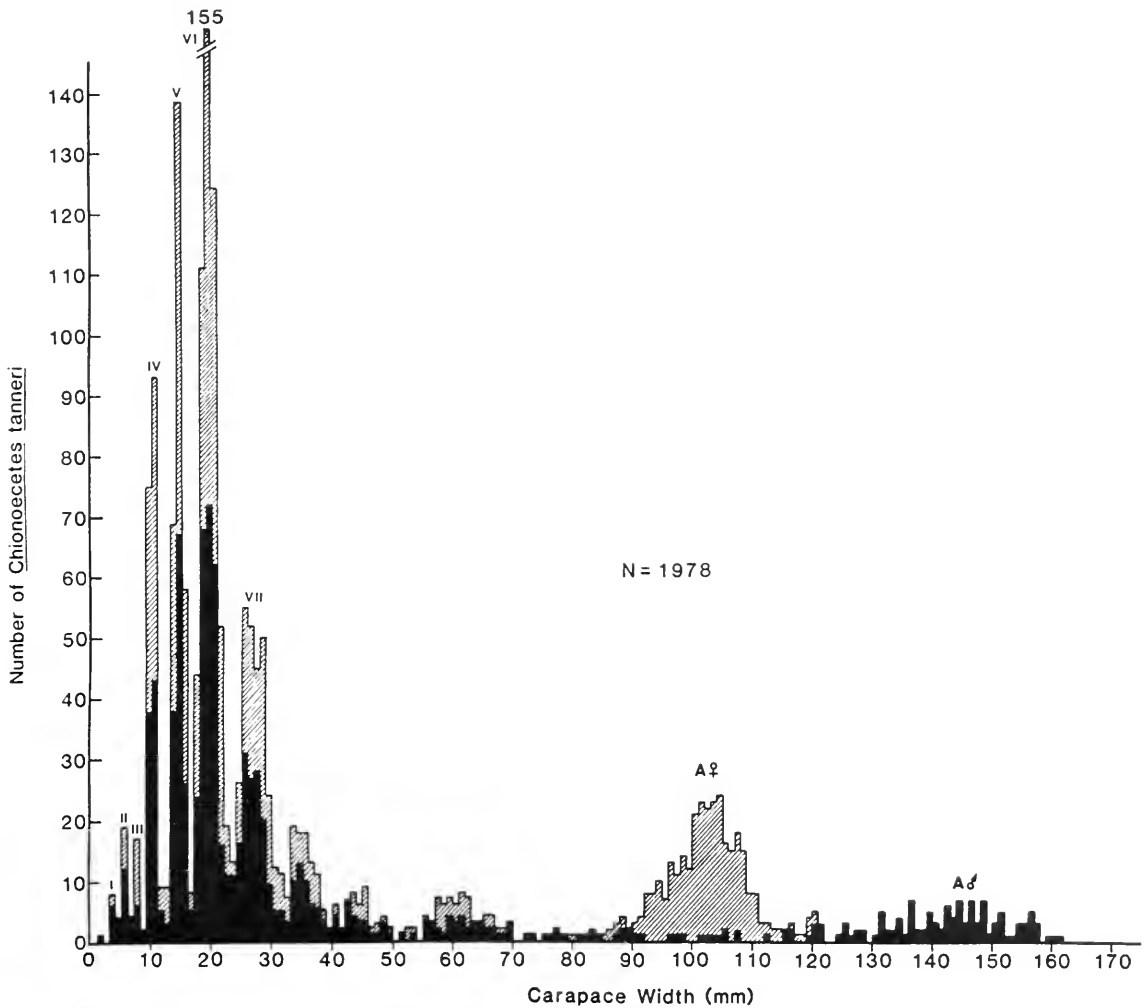

FIGURE 4.—Size-frequency histograms representing all specimens of *Chionoecetes tanneri* collected off the Oregon coast 1973-75 and from the Gulf of the Farallons. Instars I-VII are indicated. Males are shown in solid color.

carapaces relatively free of epifauna and lesions caused by bacterial infections (Baross et al. 1978). Of the 290 adult female specimens examined, 87% showed exoskeleton lesions and these adult females also had the highest diversity and abundance of epifauna on their exoskeletons. Only 29% of the 124 adult males observed showed the effect of chitino-clastic bacterial infection. No lesions or epifauna were found on any of the 1,447 juveniles examined. In contrast to the findings of Hartnoll (1969) who worked with shallow-water spider crabs, observations of the carapace condition of adult male and female *C. tanneri* suggests adult males continue to molt after maturity while adult females are anecydysic, a finding consistent with Watson's (1970) data

for *C. opilio*. The unequal adult sex ratio (29% males, Table 1) is also an indication that males may be subjected to the differential mortality of continued molting.

The agreement of mean CW for adults collected off the Oregon coast in the study and that of Pereyra's (1966) work has an interesting corollary in the material collected from near the Farallon Islands. The mean carapace width of instars VI and VII for *C. tanneri* collected west of the Farallon Islands is 19.4 and 27.3 mm respectively. The carapace widths for the same instars collected from Oregon is 19.8 and 26.7 mm. Childress and Price (1978) credited the constant increase in size between each pair of instars in the deep-living, midwater

FIGURE 5.—Growth phases for juvenile and adult *Chionoecetes tanneri*. CPL = Chelar propodus length (mm); CW = Carapace width (mm); AW = Abdomen width (mm).

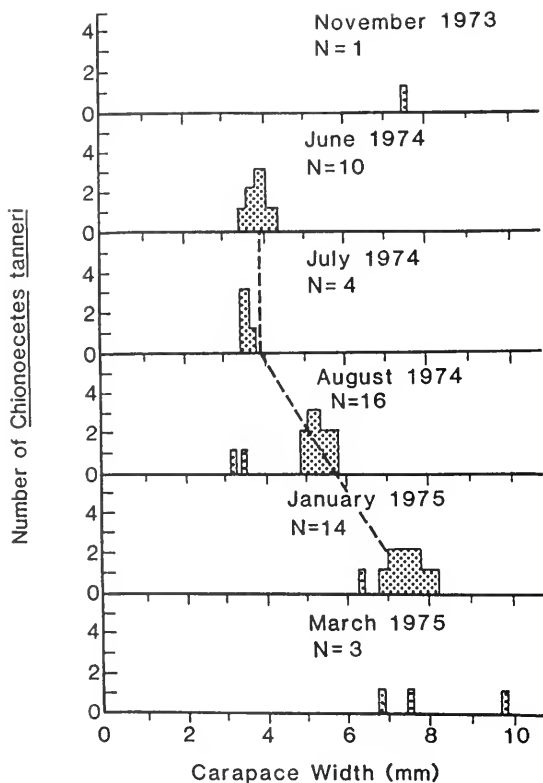
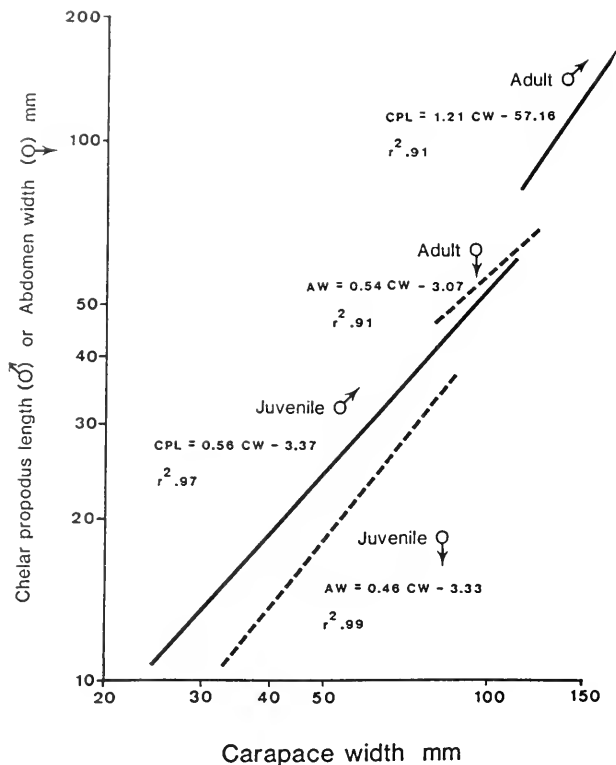

TABLE 1.—Percent increase in mean carapace width and sex ratio (males %) for successive instars of *Chionoecetes tanneri*.

Instar	N	Males (%)	Carapace width (mm)		Increase in carapace width (%)
			Mean	s <sup>2</sup>	
I	16	53	3.80	0.25	48.4
II	19	—	5.64	0.62	35.8
III	18	53	7.66	0.53	31.7
IV	175	49	10.09	0.57	43.0
V	281	49	14.43	0.68	36.5
VI	499	50	19.69	1.18	36.6
VII	268	53	26.83	3.40	
—					
Adults	411	29			

FIGURE 6.—Size-frequency histograms representing early juveniles with carapace widths < 9 mm. These samples were collected from stomachs of benthic fish. The dashed line represents the progression of instars through time with first crab stage in June to instar II in August and instar III in January.

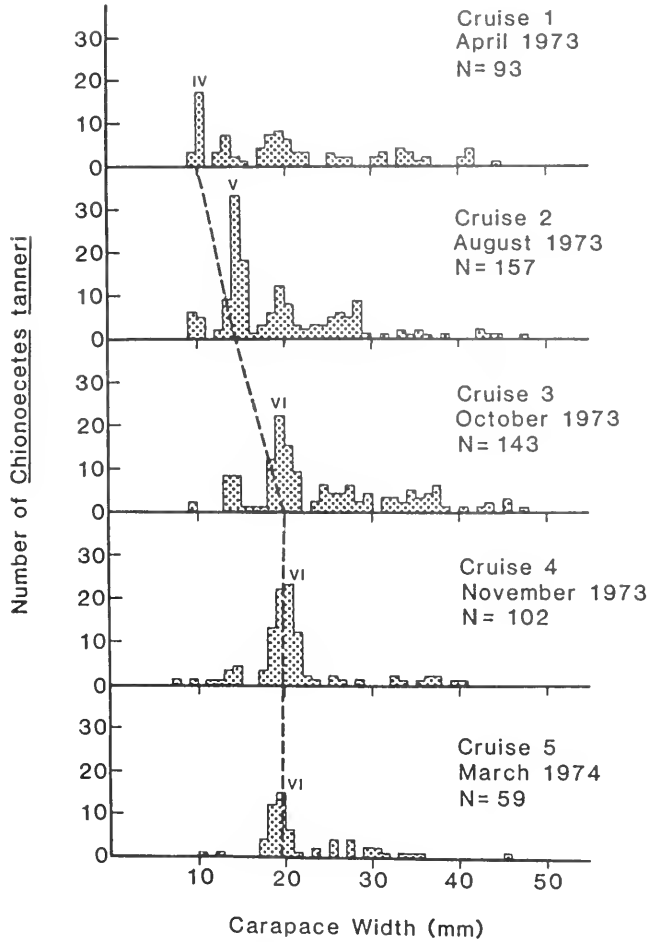

FIGURE 7.—Size-frequency histograms representing juveniles with carapace widths 10-50 mm wide. The dashed line represents progression of instars through time with instar IV in April, instar V in August and instar VI in October through March.

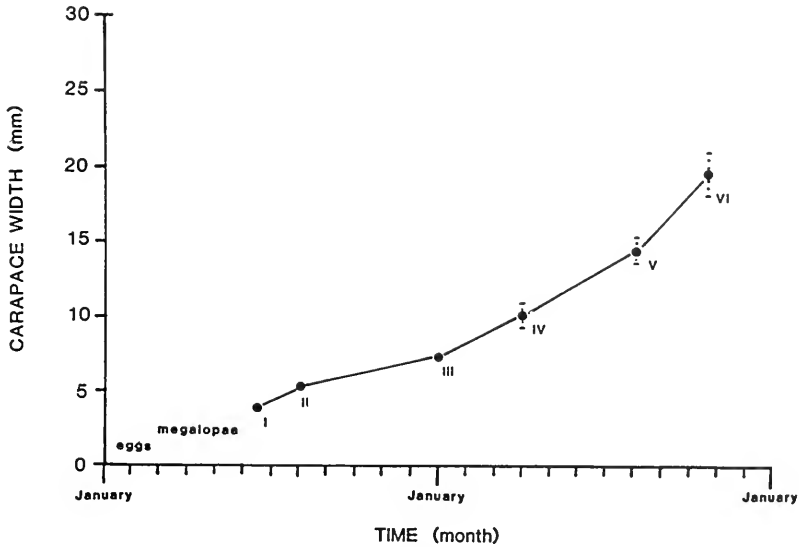

FIGURE 8.—Growth rate of *Chionoecetes tanneri* from egg to seventh instar is estimated to be at least 20 mo. Dotted lines indicate standard deviation.

mysid, *Gnathophausis ingens*, to the physical and biotic stability of this species' environment. Various environmental factors can alter both the dimensions and the number of molts in many species of crustaceans. At depths of maximum abundance (500-775 m) of *C. tanneri*, the annual water ranges from 2.3° to 5.6°C and certainly this uniform environment contributes to the consistency of instar size and size at maturity.

## ACKNOWLEDGMENTS

We appreciate the assistance of Brian Oliver. Howard Horton and David Colby reviewed this manuscript and their time and efforts have greatly contributed to it. Robert S. Carney was responsible for the loan of *Chionoecetes tanneri* from the Smithsonian Institution. This research was funded by NOAA (maintained by the U.S. Department of Commerce) Sea Grant Institution Grant Nos. NOAA 04-3-158-1 and NOAA 04-5-158-2. Data analysis was facilitated by a grant from the Oregon State University Computer Center.

## LITERATURE CITED

- BAROSS, J. A., P. A. TESTER, AND R. Y. MORITA.  
1978. Incidence, microscopy, and etiology of exoskeleton lesions in the tanner crab, *Chionoecetes tanneri*. J. Fish. Res. Board Can. 35:1141-1149.
- BROWN, R. B., AND G. C. POWELL.  
1972. Size at maturity in the male Alaskan tanner crab, *Chionoecetes bairdi*, as determined by chela allometry, reproductive tract weights, and size of precopulatory males. J. Fish. Res. Board Can. 29:423-427.
- CAREY, A. G., AND H. HEYAMOTO.  
1972. Techniques and equipment for sampling benthic organisms. In A. T. Pruter and D. L. Alverson (editors), Columbia River estuary and adjacent ocean waters: Bioenvironmental studies, p. 378-412. Univ. Wash. Press, Seattle.
- CHILDRESS, J. J., AND M. H. PRICE.  
1978. Growth rate of the bathypelagic crustacean *Gnathophausia ingens* (Mysidacea: Lophogastridae). I. Dimensional growth and population structure. Mar. Biol. (Berl.) 50:47-62.
- DONALDSON, W. E., R. T. COONEY, AND J. R. HILSINGER.  
1981. Growth, age and size at maturity of tanner crab, *Chionoecetes bairdi* M. J. Rathbun, in the northern Gulf of Alaska (Decapoda, Brachyura). Crustaceana 40:286-302.
- GOULD, S. J.  
1966. Allometry and size in ontogeny and phylogeny. Biol. Rev. 41:587-640.
- HARTNOLL, R. G.  
1969. Mating in the Brachyura. Crustaceana 16:161-181.
- HILSINGER, J. R., W. E. DONALDSON, AND R. T. COONEY.  
1975. The Alaskan snow crab, *Chionoecetes bairdi*, size and growth. Univ. Alaska Sea Grant Rep. No. 75-12, Inst. Mar. Sci., 75-6 p.
- LOUGH, R. G.  
1974. Dynamics of crab larvae (Anomura, Brachyura) off the central Oregon coast, 1969-1971. Ph.D. Thesis, Oregon State Univ., Corvallis, 299 p.
- LUX, F. E., A. R. GANZ, AND W. F. RATHJEN.  
1982. Marking studies on the red crab (*Geryon quinquedens*) Smith off southern New England. J. Shellfish. Res. 2:71-80.
- MILLER, R. J., AND J. WATSON.  
1976. Growth per molt and limb regeneration in the spider crab, *Chionoecetes opilio*. J. Fish. Res. Board Can. 33:1644-1649.
- PEREYRA, W. T.  
1966. The bathymetric and seasonal distribution, and reproduction of adult tanner crabs, *Chionoecetes tanneri* Rathbun (Brachyura: Majidae), off the northern Oregon coast. Deep-Sea Res. 13:1185-1205.  
1968. Distribution of juvenile tanner crabs (*Chionoecetes tanneri*) Rathbun, life history model, and fisheries management. Proc. Natl. Shellfish. Assoc. 58:66-70.  
1972. Bathymetric and seasonal abundance and general ecology of the tanner crab, *Chionoecetes tanneri* Rathbun (Brachyura: Majidae) off the northern Oregon coast. In A. T. Pruter and D. L. Alverson (editors), Columbia River estuary and adjacent ocean waters: Bioenvironmental studies, p. 538-582. Univ. Wash. Press, Seattle.
- RATHBUN, M. J.  
1925. The spider crabs of America. Bull. U.S. Natl. Mus. 129, 613 p.
- SINDERMANN, C. J.  
1970. Principal diseases of marine fish and shellfish. Acad. Press, N.Y., 369 p.
- SOMERTON, D. A.  
1981. Regional variation in the size of maturity of two species of tanner crab (*Chionoecetes bairdi* and *C. opilio*) in the eastern Bering Sea, and its use in defining management subareas. Can. J. Fish. Aquat. Sci. 38:163-174.
- TESSIER, G.  
1960. Relative growth. In T. Waterman (editor), The physiology of Crustacea, Vol. 1, p. 537-560. Acad. Press, N.Y.
- U.S. NATIONAL MARINE FISHERIES SERVICE.  
1985. Fisheries of the United States, 1984. U.S. Natl. Mar. Fish. Serv., Curr. Fish. Stat. 8360, 121 p.
- WATSON, J.  
1970. Maturity, mating, and egg laying in the spider crab, *Chionoecetes opilio*. J. Fish. Res. Board Can. 27:1607-1616.



## NOTES

### COMPARISON OF CATCHES IN 4.3 M AND 12.2 M SHRIMP TRAWLS IN THE GULF OF MEXICO

Shrimp trawls used to assess shrimp and fish populations in the southern United States have varied in length, width, and basic design, making comparisons of results among studies difficult. Fishery management plans by State and Federal agencies emphasize the need for data that can be reliably compared. Techniques and equipment necessary to measure trawl performance so that data collected with different trawls can be compared is costly and time consuming (Watson 1976; Loesch et al. 1976; Wathne 1977; Kjelson and Johnson 1978). Recent emphasis has been placed on standardizing gear and sampling methods (Watson and Bane 1985) and determining the effects on catch and mean length of organisms for different tow durations, mesh sizes, trawl widths, and towing vessels (Clark 1963; Chittenden and Van Engle 1972; Green and Benefield 1982; Matthews 1982; Cody and Fuls 1985). However, sample sizes generally have been small and only selected species have been analyzed.

The present study evaluates small trawls as population sampling devices for penaeid shrimp and other organisms in the Gulf of Mexico. The objective of this study was to compare the catch rates and mean lengths of organisms caught with 4.3 m and 12.2 m trawls pulled during day and night.

#### Materials and Methods

The study area was the Gulf of Mexico off Texas between the Colorado River and Port Mansfield in depths from 7 m to 24 m (Fig. 1). Sample sites were established in 1° latitude by 1° longitude grids within the study area. Twenty randomly selected sites were sampled monthly from November 1982-February 1983. Samples were equally and randomly distributed between day and night.

At each site two trawls were towed simultaneously for 15 min at approximately 3 km from the Texas Parks and Wildlife Department (TPWD) RV *Western Gulf*, a double-rigged 21.9 m steel-hull shrimp trawler. The 4.3 m trawl (small net) was spread by wooden trawl doors 0.4 m high and 0.8 m long and the 12.2 m wide trawl (large net) was spread by wooden trawl doors 0.9 m high and 2.1

m long. Both nets had 5.1 cm stretched mesh webbing in the body, 4.4 cm mesh in the bag, and were equipped with tickler chains.

Trawl catches weighing  $\leq 10$  kg were processed by identifying and counting all organisms in the catch. For larger catches a 10 kg subsample was randomly selected from the total catch, and the total number for each species was estimated by dividing subsample counts by the proportion of subsample weight to total weight. Total lengths were measured on no more than 50 individuals of each *Penaeus* shrimp species and no more than 20 individuals of all other species. The arithmetic mean for length data was calculated for each species in each sample.

The relationship between number caught (or mean length) in the two trawls was tested for linear, multiplicative and exponential models, and log and square root transformations (Sokal and Rohlf 1981). No significant improvement was found over a linear regression with no transformation. Mean length regressions were developed for species with 10 or more pairs of mean length data ( $\geq 2$  measurements) in each size of trawl (Fig. 2). Catch regressions were developed for those species that were present in at least 20 samples in the large net and were represented by at least 5 samples with  $>20$  individuals in the small net. This insured a sufficiently wide distribution to yield meaningful results (Fig. 3).

Differences ( $P \leq 0.01$ ) between day and night regressions for each species were evaluated using analysis of covariance (Snedecor and Cochran 1980).

#### Results

Small trawls can be used to obtain trend data on mean lengths of species caught in offshore waters. Relationships exist between the catch in the 4.3 m trawl vs. the catch in the 12.2 m trawl. No significant differences were found in the day-night regressions of mean length for any species tested. There was no difference in the day-night catch vs. catch relationship for total organisms or *Penaeus setiferus* but one did exist for *Trachypenaeus* sp. and *Squilla empusa*.

Mean lengths in the two trawls were directly correlated for all species that met criteria for regression analysis (Table 1). The regressions of the mean length of fish caught in one net vs. the other for day and night were not significantly different for any

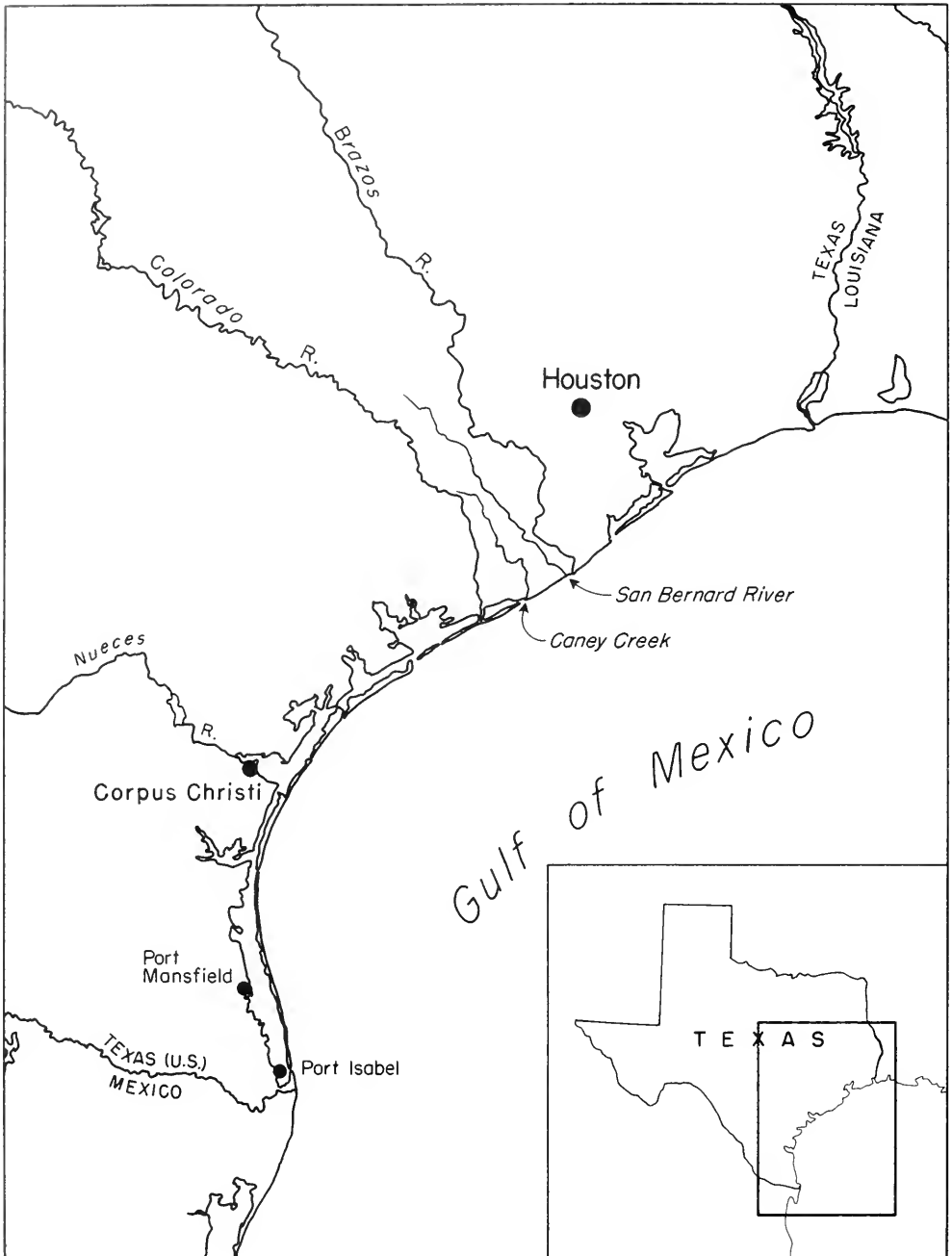

FIGURE 1.—Gulf of Mexico sampling area off the Texas coast for 4.3 m and 12.2 m trawls towed simultaneously during November 1982-February 1983.

of the species tested (Table 2). The combined regressions had significant positive correlations (0.51-0.89) explaining 26-79% of the variation.

Catch per tow in the two trawls was positively correlated. Correlation coefficients (0.48-0.93) were

significant for all species meeting the criteria for analysis (Table 3). The percent of variation explained ( $r^2$ ) varied from 23 to 86%.

There were no significant differences in the day-night catch vs. catch relationships for total organ-

TABLE 1.—Linear regression results of 4.3 m trawl mean length ( $X_i$ ) versus the 12.2 m trawl length ( $Y_i$ ) for selected species.

Species	Time	Range of $X_i$	Number	Y-intercept	Slope (b)	Correlation coefficient	$S^2 Y \cdot X$	95% confidence interval of b
<i>Penaeus setiferus</i>	Day	93-135	29	12.31	0.91	0.85**	61.33	0.68-1.13
	Night	94-164	32	16.29	0.87	0.93**	22.98	0.74-1.00
	Combined	93-164	61	14.48	0.89	0.88**	39.86	0.76-1.01
<i>Stellifer lanceolatus</i>	Day	44-125	11	26.35	0.70	0.91**	88.77	0.45-0.95
	Night	44-115	24	28.32	0.67	0.88**	65.60	0.51-0.83
	Combined	44-125	35	27.42	0.68	0.89**	68.19	0.56-0.80
<i>Trachypenaeus</i> sp.	Day	50-78	22	38.03	0.47	0.61**	17.55	0.18-0.76
	Night	50-84	36	43.03	0.40	0.61**	19.28	0.22-0.58
	Combined	50-84	58	41.77	0.42	0.62**	18.03	0.28-0.56
<i>Portunus gibbesii</i>	Day	30-48	14	26.44	0.39	0.53*	11.78	-0.01-0.78
	Night	30-55	30	23.81	0.41	0.62**	9.70	0.21-0.61
	Combined	30-55	44	25.43	0.38	0.56**	10.53	0.21-0.56
<i>Squilla empusa</i>	Day	77-104	10	49.37	0.46	0.62ns	48.08	0.04-0.89
	Night	48-132	31	69.43	0.32	0.51**	86.95	0.11-0.52
	Combined	48-132	41	65.78	0.34	0.51**	83.87	0.15-0.53
<i>Cynoscion nothus</i>	Day	62-110	25	52.02	0.42	0.63**	43.87	0.20-0.64
	Night	70-122	21	45.59	0.44	0.71**	30.64	0.23-0.65
	Combined	62-122	46	46.18	0.46	0.67**	42.16	0.31-0.62

\* $P < 0.05$ .  
\*\* $P < 0.01$ .

TABLE 2.—Summary of ANCOVA for mean length of selected species.

Species	df	Calculated $F_s$ for $H_{0:\alpha_1} = \alpha_2$	df	Calculated $F_s$ for $H_{0:\beta_1} = \beta_2$	df	Calculated $F_s$ for $H_{0:\alpha_1} = \alpha_2$
<i>Penaeus setiferus</i>	(27,30)	2.67 ns	(1,57)	0.04 ns	(1,58)	0.07 ns
<i>Stellifer lanceolatus</i>	(9,22)	1.35 ns	(1,31)	0.03 ns	(1,32)	0.04 ns
<i>Trachypenaeus</i> sp.	(34,20)	1.10 ns	(1,54)	0.09 ns	(1,55)	0.00 ns
<i>Portunus gibbesii</i>	(12,28)	1.22 ns	(1,40)	0.00 ns	(1,41)	2.89 ns
<i>Squilla empusa</i>	(29,8)	1.81 ns	(1,37)	0.15 ns	(1,38)	4.46 ns
<i>Cynoscion nothus</i>	(23,19)	1.43 ns	(1,42)	0.01 ns	(1,43)	7.12 ns

TABLE 3.—Linear regression results of 4.3 m trawl catch/tow ( $X_i$ ) versus the 12.2 m trawl catch/tow ( $Y_i$ ) for total organisms and selected species.

Species	Time	Range of $X_i$	Number	Y-intercept	Slope (b)	Correlation coefficient	$S^2 Y \cdot X$	95% confidence interval of b
Total organisms	Day	16-212	40	352.71	5.83	0.58**	143,234.17	3.18-8.47
	Night	43-210	40	593.65	6.04	0.48**	310,412.80	2.45-9.64
	Combined	16-212	80	420.42	6.53	0.55**	237,569.91	4.31-8.75
<i>Penaeus setiferus</i>	Day	0-55	40	12.21	5.37	0.90**	1,129.54	4.51-6.23
	Night	0-51	39	-0.87	6.96	0.87**	2,291.77	5.65-8.26
	Combined	0-55	79	7.40	6.14	0.88**	1,757.99	5.38-6.90
<i>Squilla empusa</i>	Day	0-28	40	6.03	4.50	0.93**	139.44	3.92-5.07
	Night	0-37	39	-5.58	6.81	0.85**	1,438.75	5.38-8.25
<i>Trachypenaeus</i> sp.	Day	0-45	40	20.63	13.38	0.80**	13,040.70	10.15-16.60
	Night	0-43	40	60.23	19.51	0.73**	40,354.41	13.46-25.67
<i>Portunus gibbesii</i>	Night	0-114	40	24.65	5.92	0.78**	9,961.84	4.40-7.45
<i>Lolliguncula brevis</i>	Day	0-42	40	9.92	1.66	0.72**	292.57	1.14-2.19

\*\* $P < 0.01$ .

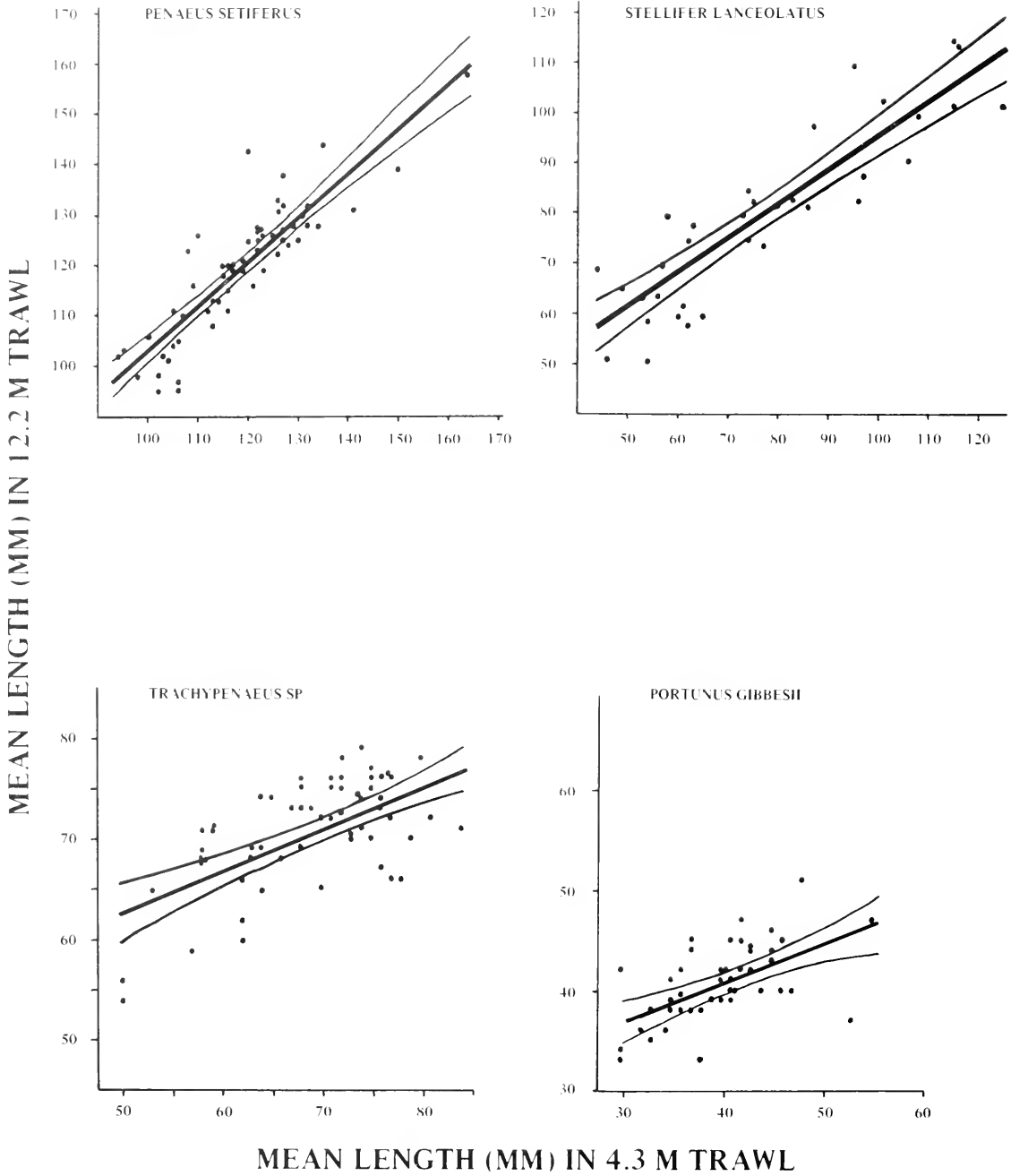

FIGURE 2.—Regression of mean length in 12.2 m trawl ( $Y_i$ ) on mean length in 4.3 m trawl ( $X_i$ ) for comparative tows during November 1982-February 1983. Observations, regression line, and 95% confidence intervals are shown.

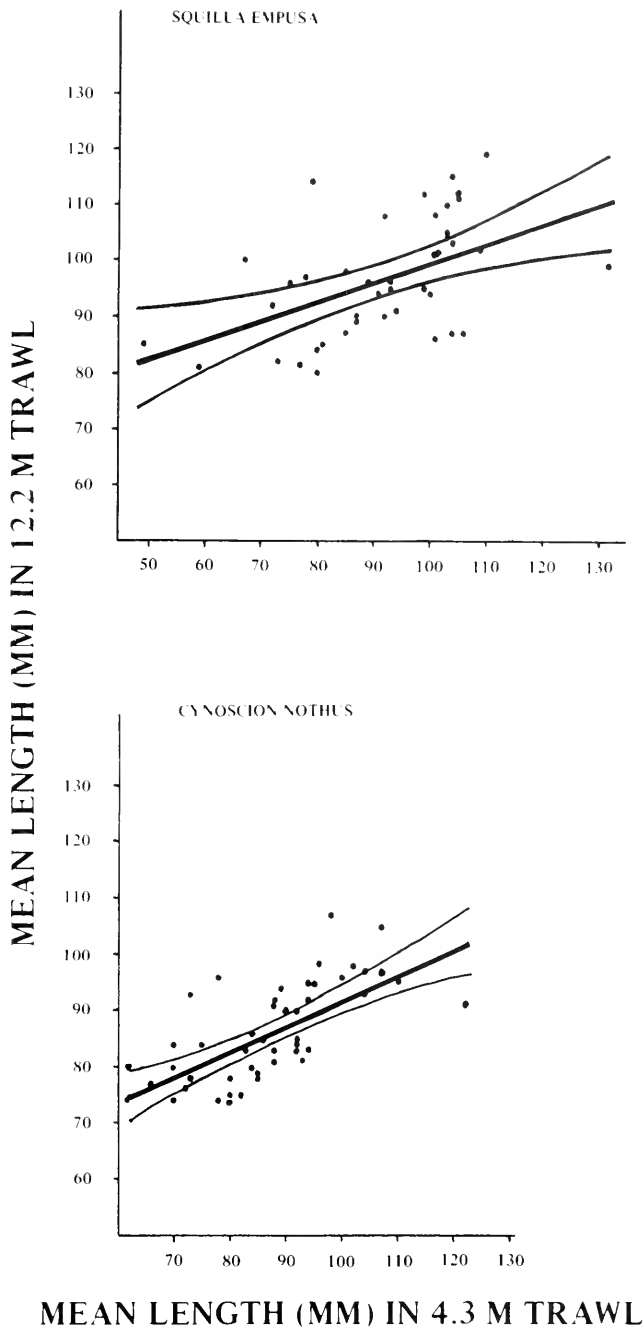

FIGURE 2.—Continued.

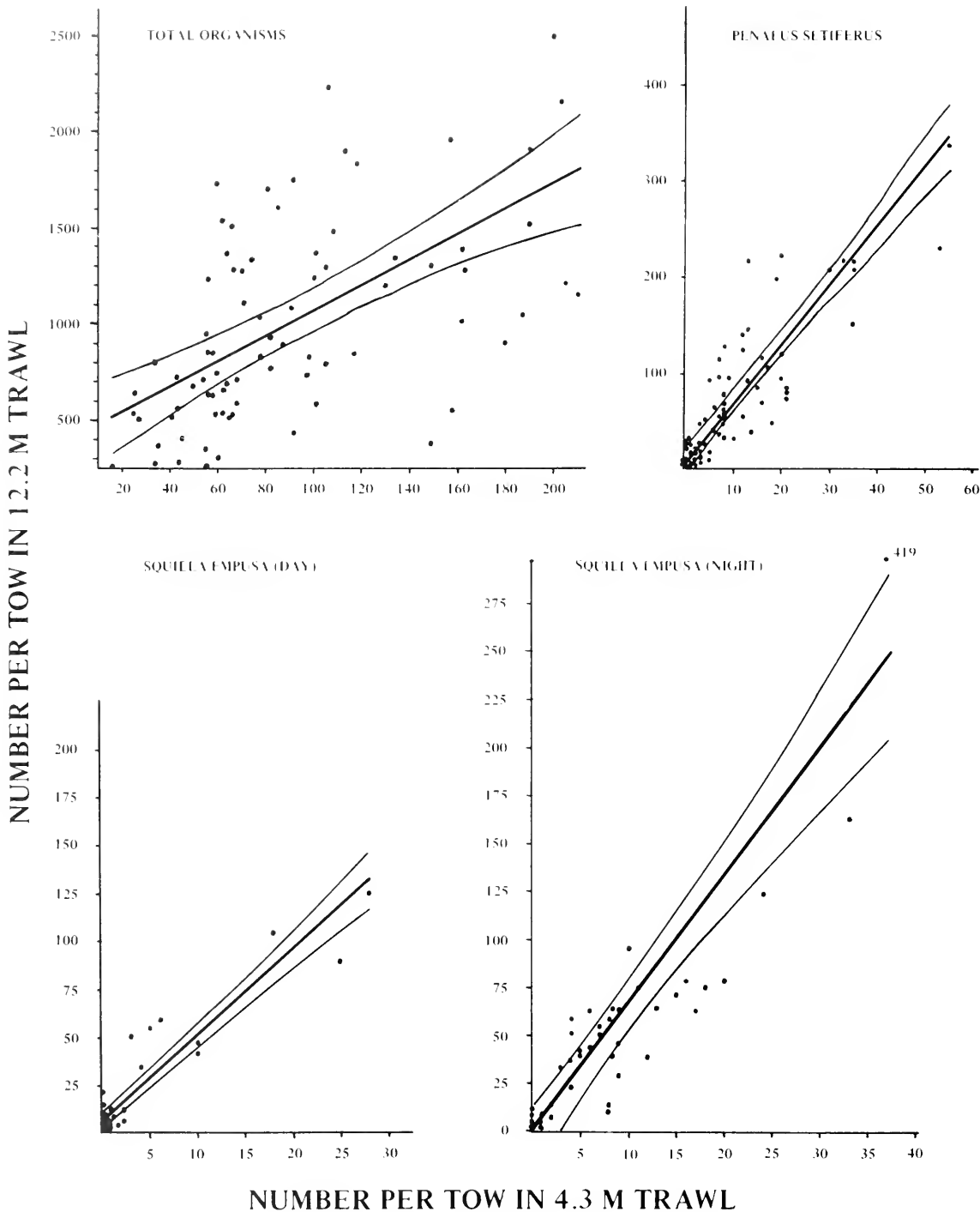

FIGURE 3.—Regression of catch per tow in 12.2 m trawl ( $Y_i$ ) on catch per tow in 4.3 m trawl ( $X_i$ ) for comparative tows during November

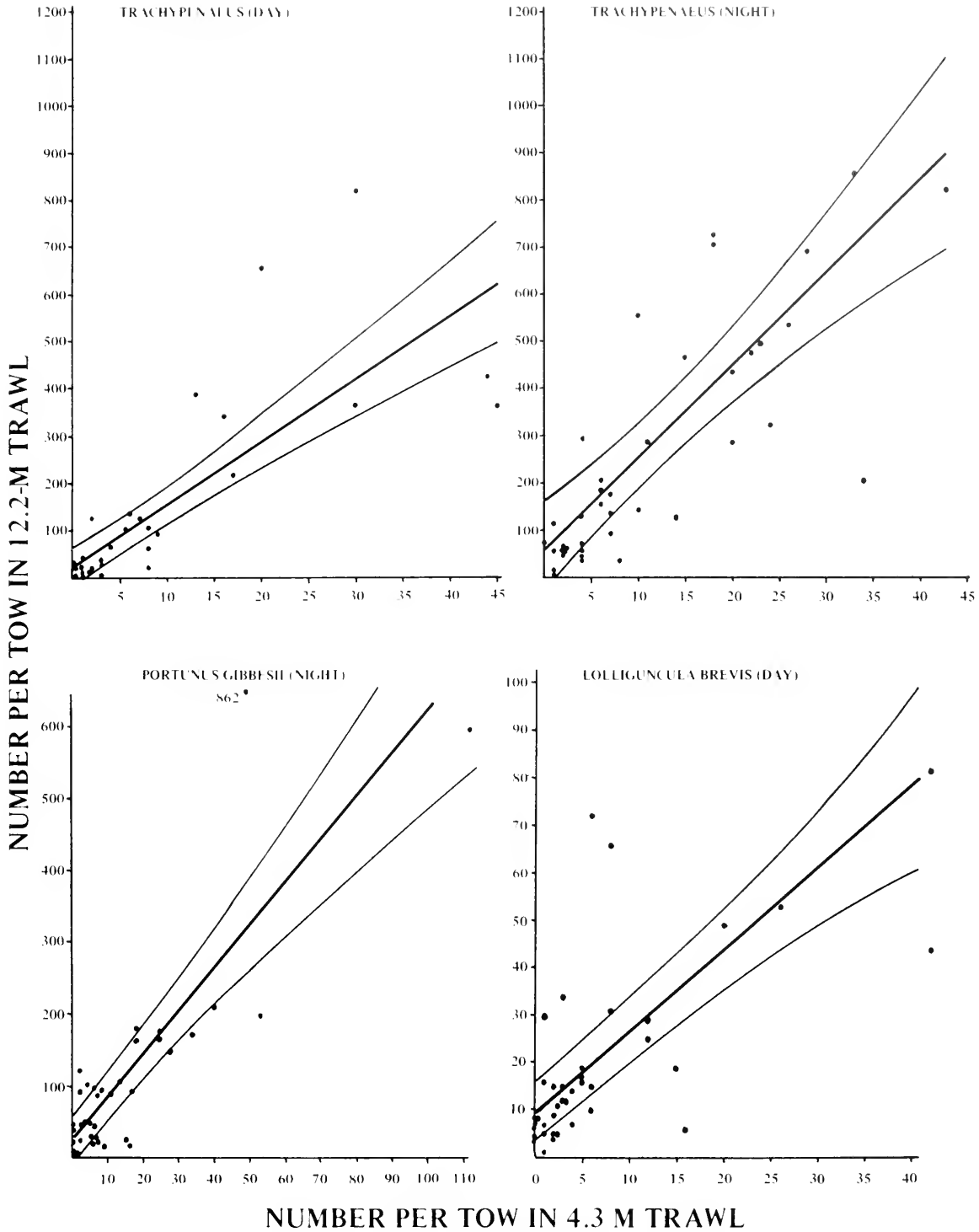

FIGURE 3.—Continued.—1982-February 1983. Observations, regression line, and 95% confidence intervals are shown.

isms or *P. setiferus*. Significantly different residual variances were found for *S. empusa* and *Trachypenaeus* sp. (Table 4).

The 12.2 m trawl caught more individuals and more species than the 4.3 m trawl (Table 5). The large trawl caught 30,000 organisms during the day and 46,000 during the night. The small trawl caught 3,000 during the day and 3,800 during the night. The large trawl caught 99 species during the day and 107 during the night, while the small trawl caught 63 species during the day and 82 during the night. The trend of more species caught in the large trawl was apparent for vertebrates both day and night and invertebrates during the day. The same number of invertebrate species were caught at night in both trawls. Species caught exclusively in one trawl were usually represented by fewer than 30 individuals during the entire study.

Only 26 of 125 species were represented by a mean catch  $\geq 5$ /tow in either trawl (Table 6). These 26 species comprised 95% of the total catch.

small trawl it was 0.03. The fishery manager must decide if an increase in species diversity helps manage a particular fishery and ultimately whether it is cost effective to go after these "rare" individuals.

Catch in the large trawl may be higher than in the small trawl because of higher efficiency. Kjelson and Johnson (1978) reported higher catch efficiencies for a 6.1 m trawl than for a 3.0 m or 4.6 m trawl. Loesch et al. (1976) reported 5% efficiency for *Leiostomus xanthurus* in a 4.0 m trawl while Kjelson and Johnson (1978) reported 32% for the same species in a 6.1 m trawl.

The relationship between trawl width and catch may be asymptotic. This study showed the 12.2 m trawl caught more organisms than the 4.3 m trawl. Cody and Fuls (1985) found the same trend but reported that the catch in the 12.2 m trawl was not significantly less than the catch in the 13.7 m trawl. Matthews (1982) found no difference in mean total weight caught in 12.2 m and 13.7 m trawls. He did

TABLE 4.—Summary of ANCOVA for catch per tow of total organisms and selected species.

Species	df	Calculated $F_s$ for $H_0: \sigma_1 = \sigma_2$	df	Calculated $F_s$ for $H_0: \beta_1 = \beta_2$	df	Calculated $F_s$ for $H_0: \alpha_1 = \alpha_2$
Total organisms	(38,38)	2.17 ns	(1,76)	0.01 ns	(1,77)	5.76 ns
<i>Penaeus setiferus</i>	(37,38)	2.03 ns	(1,75)	4.32 ns	(1,76)	0.16 ns
<i>Squilla empusa</i>	(37,38)	10.32 **				
<i>Trachypenaeus</i> sp.	(38,38)	3.09 **				

\*\* $P < 0.01$ .

## Discussion

Catches in the large trawl were consistently higher than in the small trawl. Chittenden and Van Engel (1972) stated there must be some relationship between catch and tow duration because of the amount of bottom sampled, but they found that increased tow duration (which increases area covered) did not significantly increase the catch of blue crabs in a 9.1 m trawl. However, they tested only a small range of tow durations (5-15 min) and concluded that variation in the trawl catches was a significant factor. Tow duration in this study was constant, so higher catches were most likely a result of more area being sampled by the larger net.

It also seems reasonable that a large trawl would have a greater chance of encountering organisms especially if they have patchy distributions such as found with shrimp (Matthews 1982). The large net caught more species than the small net in this study. The highest mean catch per tow was 0.37 for species found exclusively in the large trawl; for the

not, however, compare the total number or size of organisms. Because of the inherent variation found in sampling with trawls, the inability to detect differences in the 12.2 m and 13.7 m trawls would be expected.

Implications of this may apply to the commercial trawl fishery. Through the years shrimp fishermen have been reducing the size of trawls and increasing the number of trawls used in order to increase catch efficiency (Christmas and Etzold 1977). These changes may reflect the asymptotic relationship of trawl width and at the same time help reduce unwanted bycatch.

Cody and Fuls (1985) reported a regression coefficient of 2.52 for the catch vs. catch relationship for *P. setiferus* in daytime samples in contrast to 5.37 for this study. Only 13 data points over a much wider range of  $X_i$  (0-136/tow vs. 0-55/tow) were used by Cody and Fuls. When the ranges of  $X_i$  were made comparable the slopes of the two regressions were not significantly different.

The use of small trawls and determination of rela-



TABLE 5.—Total number of organisms collected with 4.3 m and 12.2 m trawls towed simultaneously off the central Texas coast from November 1982-February 1983. Blanks = no data.

Species	Day		Night		Species	Day		Night	
	4.3 m	12.2 m	4.3 m	12.2 m		4.3 m	12.2 m	4.3 m	12.2 m
<b>Vertebrates</b>					<i>Prionotus rubio</i>			2	
<i>Cynoscion nothus</i>	257	8,781	190	8,981	<i>Sardinella aurita</i>			1	
<i>Stellifer lanceolatus</i>	80	1,110	333	4,559	<i>Diplectrum bivittatum</i>				1
<i>Cynoscion arenarius</i>	48	1,383	46	2,498	<i>Eucinostomus argenteus</i>		1		
<i>Pepilus burti</i>	106	1,903	20	344	<i>Raja texana</i>				1
<i>Leiostomus xanthurus</i>	118	1,510	9	68	<i>Bregmaceros atlanticus</i>				1
<i>Arius felis</i>	77	775	17	283	<i>Ogcocephalus radiatus</i>		1		
<i>Symphurus plagiusa</i>	40	297	60	470	GERREIDAE (Unidentified)				1
<i>Lagodon rhomboides</i>	43	357	36	360	<i>Bagre marinus</i>				1
<i>Syacium gunteri</i>	29	400	29	235	<i>Lutjanus apodus</i>			1	
<i>Anchoa mitchilli</i>	16	372	12	222	<i>Prionotus ophryas</i>		1		
<i>Larimus fasciatus</i>	30	188	31	356	Total	992	18,995	984	20,699
<i>Menticirrhus americanus</i>	9	164	23	315	<b>Invertebrates</b>				
<i>Micropogonias undulatus</i>	23	218	17	237	<i>Trachypenaeus</i> sp.	297	4,798	467	11,522
<i>Trichiurus lepturus</i>	6	309	3	167	<i>Penaeus setiferus</i>	347	2,352	594	4,180
<i>Selene setapinnis</i>	16	269	4	88	<i>Portunus gibbesii</i>	113	876	561	4,332
<i>Sphoeroides parvus</i>	17	162	16	178	<i>Squilla empusa</i>	115	758	390	2,173
<i>Orthopristis chrysoptera</i>	14	87	19	133	<i>Lolliguncula brevis</i>	304	902	25	515
<i>Pepilurus alepidotus</i>	8	91	4	77	<i>Callinectes similis</i>	73	447	109	1,013
<i>Menticirrhus littoralis</i>	8	66	2	100	<i>Renilla mulleri</i>	157	379	218	369
<i>Etropus crossotus</i>	5	37	16	116	<i>Stomolophus melaegris</i>	165	486	24	294
<i>Prionotus salmonicolor</i>	4	10	6	137	<i>Penaeus duorarum</i>	7	54	34	298
<i>Astroscopus y-graecum</i>	1	37	11	93	<i>Sicyonia dorsalis</i>		19	36	280
<i>Brevoortia patronus</i>	1	6	2	124	<i>Portunus spinimanus</i>	6	16	42	263
<i>Prionotus tribulus</i>	9	43	12	63	<i>Brissopsis alta</i>	181	58	35	36
<i>Chloroscombrus chrysurus</i>		28	4	87	ACTINIARIA (order)	31	42	62	133
<i>Hemicaranx amblyrhynchus</i>	1	63	2	26	<i>Arenaeus cribrarius</i>		15	60	139
<i>Citharichthys spilopterus</i>	8	21	16	43	<i>Astropecten antillensis</i>	110	54	30	21
<i>Halieutichthys aculeatus</i>	6	10	8	62	<i>Luidia clathrata</i>	33	21	61	61
<i>Urophycis floridanus</i>	5	27	6	38	<i>Xiphopeneus kroyeri</i>	11	109		5
<i>Achirus lineatus</i>	2	26		27	<i>Penaeus aztecus</i>	7	70	2	44
<i>Dasyatis sabina</i>	1	19		32	<i>Aurelia aurita</i>	16	52	6	6
<i>Synodus foetens</i>		28	1	13	<i>Libinia dubia</i>	9	19	9	28
<i>Ophidion welschi</i>	1	7	4	25	<i>Millita quinquesperforata</i>	1	21	33	1
<i>Porichthys plectrodon</i>		11	2	24	<i>Persephona aquilonaris</i>	9	2	20	9
<i>Trachurus lathami</i>		28		2	<i>Squilla neglecta</i>	6	3	5	16
<i>Anchoa hepsetus</i>		24			<i>Libinia emarginata</i>		7	3	17
<i>Saurida brasiliensis</i>		16		3	<i>Ovalipes guadulpensis</i>	5	9	4	6
<i>Paralichthys lethostigma</i>		12		6	<i>Hepatus epheliticus</i>	4	2	6	11
<i>Chaetodipterus faber</i>		10	3	4	<i>Persephona crinita</i>	3	2	12	4
<i>Opisthonema oglinum</i>		15		2	<i>Dactylometra quinquecirrha</i>		4		12
<i>Lutjanus campechanus</i>		2	3	11	<i>Luidia alternata</i>	1	10	2	3
<i>Bairdiella chrysoura</i>	1	9	1	5	<i>Polinices duplicatus</i>	2	1	6	6
<i>Chilomycterus schoepfi</i>		9		5	<i>Loligo peali</i>	1	7	1	1
<i>Ogcocephalus parvus</i>		3	4	6	<i>Calappa sulcata</i>	2	5		2
<i>Centropristis philadelphica</i>	1	4		8	<i>Sicyonia brevirostris</i>			1	6
<i>Monacanthus hispidus</i>		4	3	5	<i>Phalium granulatum</i>			4	1
<i>Bollmannia communis</i>		5		4	<i>Squilla chydrea</i>				3
<i>Rhinoptera bonasus</i>		6		3	<i>Thais haemostoma</i>	1		2	
<i>Paralichthys albigutta</i>	1	5		3	<i>Callinectes sapidus</i>		1		1
TRIGLIDAE (Unidentified)			4	4	<i>Anadara ovalis</i>			2	
<i>Lepophidium graellsii</i>			1	7	<i>Albunea paretii</i>			1	1
<i>Pomatomus saltatrix</i>		1	1	6	<i>Dinocardium robustum</i>			1	1
<i>Selene vomer</i>		4		4	<i>Synalpheus fritzmulleri</i>			1	
<i>Gymnachirus texae</i>		3	1	3	<i>Hepatus pudibundus</i>		1		
<i>Polydactylus octonemus</i>		4		1	<i>Mnemiopsis mccradyi</i>		1		
<i>Narcine brasiliensis</i>				5	<i>Architectonica nobilis</i>			1	
<i>Eucinostomus gula</i>		3		2	<i>Busycon perversum</i>			1	
<i>Serranus atrobranchus</i>		2		2	<i>Calappa flammea</i>				1
<i>Sygnathus scovelli</i>		2	1	1	<i>Portunus spinicarpus</i>			1	
<i>Ophidion grayi</i>				3	<i>Sinum perspicuum</i>			1	
<i>Pogonias cromis</i>		1		2	REPTANTIA (suborder)		1		
<i>Mugil cephalus</i>				2	Total	2,017	11,604	2,867	25,814
<i>Serraniculus pumilio</i>				2	Grand Total	3,009	30,599	3,851	46,513
<i>Ancylosetta quadrocellata</i>		2							
<i>Membras martinica</i>				2					

TABLE 6.—Mean catch per tow ( $\pm 1$  SE) of dominant species<sup>1</sup>, November 1982-February 1983. Blank = no catch.

Species	Day		Night	
	4.3 m	12.2 m	4.3 m	12.2 m
<b>Vertebrates</b>				
<i>Cynoscion nothus</i>	6 $\pm$ 1.2	219 $\pm$ 43.0	5 $\pm$ 0.9	225 $\pm$ 33.6
<i>Stellifer lanceolatus</i>	2 $\pm$ 0.7	28 $\pm$ 12.0	8 $\pm$ 2.6	114 $\pm$ 29.8
<i>Cynoscion arenarius</i>	1 $\pm$ 0.3	34 $\pm$ 7.7	1 $\pm$ 0.2	62 $\pm$ 14.5
<i>Peprilus burti</i>	3 $\pm$ 1.0	47 $\pm$ 16.1	0 $\pm$ 0.3	9 $\pm$ 2.9
<i>Leiostomus xanthurus</i>	3 $\pm$ 1.9	38 $\pm$ 27.9	0 $\pm$ 0.1	2 $\pm$ 0.7
<i>Arius felis</i>	2 $\pm$ 1.8	20 $\pm$ 18.0	0 $\pm$ 0.3	7 $\pm$ 3.4
<i>Symphurus plagiusa</i>	1 $\pm$ 0.3	7 $\pm$ 2.1	2 $\pm$ 0.3	12 $\pm$ 2.0
<i>Lagodon rhomboides</i>	1 $\pm$ 0.6	9 $\pm$ 4.7	1 $\pm$ 0.3	9 $\pm$ 3.2
<i>Syacium gunteri</i>	1 $\pm$ 0.2	10 $\pm$ 2.6	1 $\pm$ 0.2	6 $\pm$ 1.6
<i>Anchoa mitchilli</i>	0 $\pm$ 0.2	9 $\pm$ 4.0	0 $\pm$ 0.2	6 $\pm$ 2.4
<i>Larimus fasciatus</i>	1 $\pm$ 0.4	5 $\pm$ 2.2	1 $\pm$ 0.3	9 $\pm$ 3.7
<i>Menticirrhus americanus</i>	0 $\pm$ 0.1	4 $\pm$ 1.3	1 $\pm$ 0.2	8 $\pm$ 1.7
<i>Microgogonias undulatus</i>	1 $\pm$ 0.2	5 $\pm$ 1.4	0 $\pm$ 0.2	6 $\pm$ 1.4
<i>Trichiurus lepturus</i>	0 $\pm$ 0.1	8 $\pm$ 2.1	0 $\pm$ 0.0	4 $\pm$ 0.9
<i>Selene setapinnis</i>	0 $\pm$ 0.3	7 $\pm$ 5.8	0 $\pm$ 0.0	2 $\pm$ 1.5
<b>Invertebrates</b>				
<i>Trachypenaeus</i> sp.	7 $\pm$ 1.8	120 $\pm$ 30.1	11 $\pm$ 1.7	228 $\pm$ 45.6
<i>Penaeus setiferus</i>	9 $\pm$ 2.0	59 $\pm$ 11.9	15 $\pm$ 3.1	104 $\pm$ 24.2
<i>Portunus gibbesii</i>	3 $\pm$ 1.1	2 $\pm$ 4.4	14 $\pm$ 3.3	108 $\pm$ 25.2
<i>Squilla empusa</i>	3 $\pm$ 1.0	19 $\pm$ 5.0	10 $\pm$ 1.7	54 $\pm$ 10.9
<i>Lolliguncula brevis</i>	8 $\pm$ 1.7	23 $\pm$ 3.8	1 $\pm$ 0.2	13 $\pm$ 1.9
<i>Callinectes similis</i>	2 $\pm$ 0.8	11 $\pm$ 4.6	3 $\pm$ 0.6	25 $\pm$ 6.0
<i>Renilla mulleri</i>	4 $\pm$ 1.5	9 $\pm$ 3.0	5 $\pm$ 2.2	9 $\pm$ 3.3
<i>Stomolophus melaegris</i>	4 $\pm$ 3.4	12 $\pm$ 6.0	1 $\pm$ 0.3	7 $\pm$ 3.0
<i>Penaeus duorarum</i>	0 $\pm$ 0.1	1 $\pm$ 0.6	1 $\pm$ 0.4	7 $\pm$ 5.0
<i>Sicyonia dorsalis</i>		0 $\pm$ 0.3	1 $\pm$ 0.3	7 $\pm$ 2.0
<i>Portunus spinimanus</i>	0 $\pm$ 0.1	0 $\pm$ 0.2	1 $\pm$ 0.6	7 $\pm$ 2.9

<sup>1</sup>Mean catch  $\geq 5$ /tow in either net.

tionships between day and night catches in a fishery independent assessment program can increase sampling frequency and decrease the cost of sampling by reducing processing time, manpower requirements, and variability caused by subsampling large catches. Samples from the small trawl could be processed in approximately 25% of the time required for sample processing from the large trawl. The small trawl required no subsampling. Management agencies should consider these findings when planning long-term programs.

#### Acknowledgments

We would like to express our appreciation to each member of the Gulf Research Program who so conscientiously collected scheduled samples. Thanks are extended to the Texas Parks and Wildlife Department review committee and an unknown reviewer for their valuable comments. Nancy Ziegler prepared the manuscript. This study was conducted with partial funding from the U.S. Department of Commerce; National Oceanic and Atmospheric Administration, National Marine Fisheries Service, under P.L. 88-309 (Project 2-385-R).

#### Literature Cited

- CHITTENDEN, M. E., JR., AND W. A. VAN ENGEL.  
1972. Effect of a tickler chain and tow duration on trawl catches of the blue crab, *Callinectes sapidus*. Trans. Am. Fish. Soc. 101:732-734.
- CHRISTMAS, J. Y., AND D. J. ETZOLD.  
1977. The shrimp fishery of the Gulf of Mexico United States: a regional management plan. Gulf Coast Res. Lab., Ocean Springs, MS, Tech. Rep. Ser. No. 2, 128 p.
- CLARK, J. R.  
1963. Size selection of fish by otter trawls. Results of recent experiments in the Northwest Atlantic. D. Effect of duration of tow on codend escapement. Int. Comm. Northwest Atl. Fish. Spec. Pub. 5, p. 55-58.
- CODY, T. J., AND B. E. FULS.  
1985. Comparison of the catch rates of three trawls in offshore Texas waters. In J. W. Watson and N. Bane (editors), Proceedings of the SEAMAP shrimp and bottomfish sampling gear workshop, p. 19-29. Gulf States Mar. Fish. Comm. No. 12.
- GREEN, A. W., AND R. L. BENEFIELD.  
1982. Mesh size selectivity study of penaeid shrimp trawled from Galveston Bay, Texas May 1981. Tex. Parks Wildl. Dep., Coast. Fish. Branch, Manage. Data Ser. No. 40, 9 p.
- KJELSON, M. A., AND G. N. JOHNSON.  
1978. Catch efficiencies of a 6.1-meter otter trawl for estuarine fish populations. Trans. Am. Fish. Soc. 107:246-254.
- LOESCH, H., J. BISHOP, A. CROWE, R. KUCKYR, AND P. WAGNER.  
1976. Technique for estimating trawl efficiency in catching brown shrimp (*Penaeus aztecus*), Atlantic croaker (*Microgogon undulatus*) and spot (*Leiostomus xanthurus*). Gulf

MATTHEWS, G. A.

1982. Relative abundance and size distributions of commercially important shrimp during the 1981 Texas closure. *Mar. Fish. Rev.* 44(9-10):5-15.

SNEDECOR, G. W., AND W. G. COCHRAN.

1980. *Statistical methods*. 7th ed. Iowa State Univ. Press., Ames, 507 p.

SOKAL, R. R., AND F. J. ROHLF.

1981. *Biometry: The principles and practices of statistics in biological research*. 2d ed. W. H. Freeman and Co., San Francisco, 859 p.

WATHNE, F.

1977. Performance of trawls used in resource assessment. *Mar. Fish. Rev.* 39(6):16-23.

WATSON, J. W., JR.

1976. Electric shrimp trawl catch efficiency for *Penaeus duorarum* and *Penaeus aztecus*. *Trans. Am. Fish. Soc.* 105: 135-148.

WATSON, J. W., JR., AND N. BANE (editors).

1985. Proceedings of the SEAMAP shrimp and bottomfish sampling gear workshop. *Gulf States Mar. Fish. Comm.* No. 12, 80 p.

TERRY J. CODY  
BILLY E. FULS

*Texas Parks and Wildlife Department  
Coastal Fisheries Branch  
4200 Smith School Road  
Austin, TX 78744*

## EARLY LIFE HISTORY OF ATLANTIC MENHADEN, *BREVOORTIA TYRANNUS*, AND GULF MENHADEN, *B. PATRONUS*

Atlantic menhaden, *Brevoortia tyrannus*, and gulf menhaden, *B. patronus*, are allopatric, morphologically similar clupeids with contrasting distributional patterns and reproductive traits. The Atlantic menhaden has a meridional distribution and encounters variable environmental conditions during its lifetime. It occurs along the eastern coast of North America from Nova Scotia to Florida, and its distribution is stratified by age and size, with the older and larger fish ranging farther north (Nicholson 1978). Atlantic menhaden are a relatively long-lived clupeid. Their maximum reported age is approximately 10 yr, and they may spawn for approximately 7 yr (Higham and Nicholson 1964; Nicholson 1975). The spatial and temporal spawning habits of Atlantic menhaden are more complex than those of its congener. In Long Island Sound and New England waters, limited spawning occurs in inshore waters during the summer and early fall. From

Long Island to Chesapeake Bay, spawning occurs in offshore coastal waters from October to December and from March to May. From North Carolina to Florida, spawning occurs in offshore coastal waters from October through March and this spawning population consists of fish that have migrated from the north and contains all age groups (Nicholson 1978). The gulf menhaden, which is distributed zonally, is restricted to the Gulf of Mexico and ranges from Cape Sable, FL, to Vera Cruz, Mexico (Reintjes 1969). Their maximum reported age is approximately 4 yr, and they may spawn for approximately 2 yr (Lewis and Roithmayr 1981). They spawn from October through March in nearshore and offshore waters within the 110 m depth contour (Christmas and Waller 1975). Both species use estuaries as nursery areas for more than half their first year of life.

The major objectives of this study were to examine and compare early life history characteristics of these two menhadens and to investigate the effects of temperature on developmental processes. Characteristics examined were egg size, size at hatching, yolk utilization rates, yolk volume at first feeding, size and age at first feeding, and growth.

## Methods

Atlantic menhaden were collected with a commercial purse seine from the Newport River, NC, during the summer. Fish were held in the laboratory at ambient temperatures for approximately 4 mo before spawning. Gulf menhaden were collected in late September by cast net near Gulf Breeze, FL, and transported to the laboratory by methods developed by Hettler (1983). They were held in the laboratory at ambient temperatures for about 1 mo before spawning. For each spawning, about 10 menhaden were induced to spawn by methods described by Hettler (1981, 1983). Eggs were spawned in approximately 20°C water during the night and collected the following morning. All experiments except those dealing specifically with growth were conducted in 10 L rearing tanks; growth experiments were conducted in 60 L rearing tanks. Tanks were set in a temperature controlled water bath with two 40-W fluorescent lamps positioned 40 cm above each tank, and the tanks were illuminated for 12 h daily. Temperatures were controlled to approximately  $\pm 0.5^\circ\text{C}$ . Salinities ranged from 28‰ to 32‰. Rotifers, *Brachionus plicatilis*, were used as food for about the first 10 d, and *Artemia* nauplii and rotifers were used thereafter. Feeding levels were not controlled, but, based on experience, we pro-

vided food in densities we felt would not limit growth.

Growth in standard length (SL) from the time larvae begin feeding to age 21 d at 20°C was modeled by an exponential equation. All measurements were made on eggs and larvae that were preserved in 5% sodium acetate buffered Formalin<sup>1</sup>. Volumes (*V*) of the elliptically shaped yolk mass were calculated using the formula for a prolate spheroid

$$V = (\pi/6) lh^2,$$

where *l* is the length and *h* is the height of the yolk mass (Blaxter and Hempel 1963).

We were unable to treat the two species the same in most experiments. The gulf menhaden was subjected to a greater number of treatments than the Atlantic menhaden. Experiments dealing with starvation and yolk utilization rates were conducted only on the gulf menhaden. In addition, the lack of replications for some experiments limited the application of statistical tests (e.g., ANOVA) and, as a result the differences or similarities between the two menhadens, should be considered tentative.

### Results and Discussion

Based on a sample of eggs from the single spawn of a group of approximately five females from each species, Atlantic menhaden had significantly ( $P < 0.001$ ) larger eggs (1.6 mm diameter,  $N = 20$ ) than gulf menhaden (1.3 mm diameter,  $N = 20$ ). Egg sizes for both these species that have been reported (Houde and Fore 1973; Jones et al. 1978; Hettler 1984) support our observations that Atlantic menhaden eggs are larger than gulf menhaden eggs. Atlantic menhaden larvae measured at hatching also were larger than gulf menhaden (Fig. 1) and sup-

ports Blaxter and Hunter's (1982) view that egg size greatly influences the size of larvae at hatching.

Temperature did not affect the size at hatching of gulf menhaden (Fig. 1), but the rate of yolk utilization was affected by temperature and was roughly 2.5 times faster at the highest temperature (24°C) than at the lowest temperature (14°C) (Table 1). The instantaneous rate of yolk utilization increased linearly with increasing temperature (Fig. 2). The volume of yolk at the onset of exogenous feeding (first feeding) was approximately similar at all temperatures (Table 1) and was not affected by temperature (ANOVA,  $P = 0.13$ ).

The size of gulf menhaden at first feeding was independent of temperature (Fig. 3) (ANOVA  $P = 0.15$ ) and, although data are limited, the size of Atlantic menhaden also was independent of temperature. The age at first feeding, however, was dependent on temperature (Fig. 3). An ANCOVA (log transformed ages on temperature) revealed that the regression slopes were similar ( $P = 0.37$ ), in-

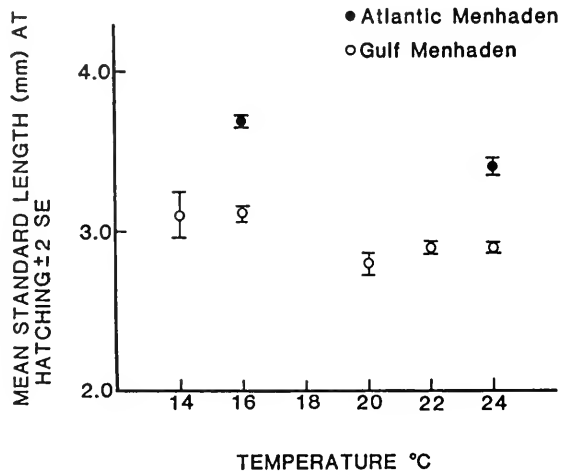

FIGURE 1.—The size at hatching of Atlantic gulf menhadens at different temperatures. Each point represents the mean of 10 fish.

<sup>1</sup>Reference to trade names does not imply endorsement by the National Marine Fisheries Service, NOAA.

TABLE 1.—The effects of temperature on yolk utilization of gulf menhaden. For regression equations,  $Y = \log_e$  preserved yolk volume ( $\text{mm}^3$ ) and  $X = \text{age (d)}$ . The equations were derived from the means of approximately 10 fish per sample. *S* is the number of samples; *N* is the number of larvae.

Temperature (°C)	S No.	Regression equation	$r^2$	Mean volume of yolk at hatching ( $\text{mm}^3$ )	<i>N</i>	Mean volume of yolk at first feeding ( $\text{mm}^3$ )	<i>N</i>
14	15	$Y = -1.189 - 0.96446(x)$	0.93	0.130482	10	0.000340	20
16				0.133397	10	0.000335	10
18	5	$Y = -0.803 - 1.67066(x)$	0.98			0.000211	10
20	10	$Y = -1.375 - 1.61365(x)$	0.91	0.169317	10	0.000549	20
22	7	$Y = -1.447 - 2.04386(x)$	0.96	0.110202	10	0.000506	20
24	8	$Y = -1.509 - 2.22355(x)$	0.95	0.123148	10	0.000289	19

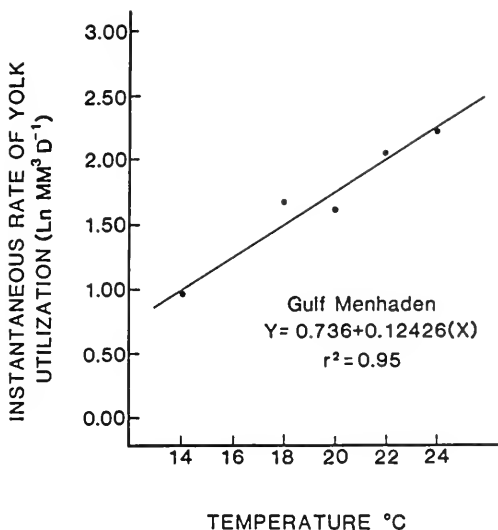

FIGURE 2.—The effects of temperature on the instantaneous rate of yolk utilization for gulf menhaden.

dicating a similar response to temperature by both species. But the  $Y$ -intercepts differed significantly ( $P = 0.02$ ) indicating that, over the range of temperatures tested, the Atlantic menhaden fed at a significantly earlier age than gulf menhaden. For both species the age at first feeding declined exponentially with increasing temperatures. Atlantic menhaden were larger than the gulf menhaden at first feeding (Fig. 3). At 20°C, Atlantic and gulf menhaden growth rates were similar (ANCOVA,  $P = 0.36$ ), but Atlantic menhaden maintained a size advantage during the early larval period (Table 2). This difference was attributed to differential size and age at first feeding.

The ability of early larvae to withstand the deprivation of food was influenced by temperature (Table 3). Although at 20°C mortalities may be attributed to causes other than starvation (compare control and starved), at progressively higher temperatures larvae are less able to withstand the deprivation of food. For example, at 24°C, gulf menhaden must find food within three days after the onset of first

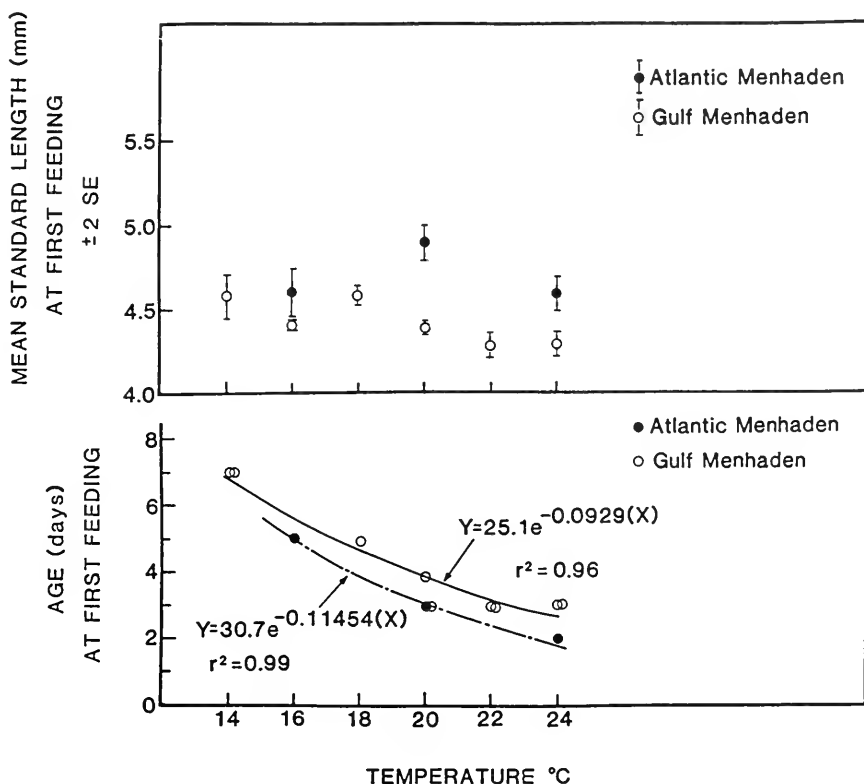

FIGURE 3.—The size and age when gulf and Atlantic menhaden begin feeding on exogenous food sources at different temperatures. Each point represents a sample of about 10 fish. Replicate experiments were only conducted for gulf menhaden and only at 14°, 20°, 22°, and 24°C.

TABLE 2.—Growth of larval gulf and Atlantic menhadens from time of first feeding to age 21 d at 20°C.

Species	N <sup>1</sup>	Growth parameters <sup>2</sup>			Estimated SL (mm)	
		a	b	r <sup>2</sup>	First feeding	Age 21 d
Gulf menhaden	11	3.36	0.04640	0.97	4.0	8.9
Atlantic menhaden	16	4.38	0.04267	0.95	5.0	10.7

<sup>1</sup>Number of samples; about 10 fish per sample.

<sup>2</sup>SL (mm) = a × exp b (age in d).

TABLE 3.—The survival (%) of first-feeding gulf menhaden larvae deprived of food (starved) in relation to temperature. The fed treatment represents the control group.

Temperature (°C)	Treatment	N	Days past time of first feeding						
			1	2	3	4	5	6	7
18	Starved	25	100	100	100	100	92	32	0
	Fed	25	100	100	100	100	96	92	92
20	Starved	25	92	76	72	48	8	4	0
	Fed	25	88	84	84	84	72	68	68
22	Starved	20	100	100	80	75	0		
	Fed	20	100	100	100	100	100		
24	Starved	25	56	40	40	4	0		
	Fed	25	96	96	96	96	96		

feeding or high mortalities will occur; whereas at 18°C they can survive without food for 5 d without incurring high mortalities (Table 3). The gulf menhaden's response to starvation in relation to temperature is comparable to numerous temperate zone, pelagic fish larvae (McGurk 1984).

In conclusion, although temperature is an important factor in controlling the development of marine fish larvae (Blaxter 1970), we observe that temperature was not a determinant of size at hatching, size at first feeding, and yolk volume remaining at first feeding. These data suggest that age is not a good correlate of these developmental events. On the other hand, temperature had an effect on the rate of yolk utilization, the time between hatching and exogenous feeding, and the ability of larvae to withstand the deprivation of food.

Our observations, although limited by a lack of rigorous statistical testing, suggest that, relative to gulf menhaden, Atlantic menhaden produced larger eggs, were larger at hatching, were larger and younger at time of first feeding, and appeared to maintain a larger size throughout the early larval period. We tried to interpret these differences in the context of their entire life history. Relative to gulf menhaden, Atlantic menhaden exhibit life history traits (later maturity, longer life, and more reproductive years) that may be adapted to a more fluctuating environment producing more reproductive uncertainty (Murphy 1968; Stearns 1976). This information suggests to us that the subtle differences we observed may indicate a fine tuning of reproductive strategies that allow these menhadens to persist in their particular environments. A more rigorous comparative study is required before we can understand how menhaden life history characteristics are adapted to their particular environments. Such a study is presently underway by the senior author.

## Acknowledgments

Sincere appreciation is extended to J. Govoni, D. Peters, and two anonymous reviewers for their critical review of the manuscript. W. Hettler and C. Lewis provided technical support during various phases of the study. This research was supported by a contract from the Ocean Assessments Division, National Ocean Service, National Oceanic and Atmospheric Administration.

## Literature Cited

- BLAXTER, J. H. S.  
1970. Development: eggs and larvae. In W. S. Hoar and D. J. Randall (editors), *Fish physiology*, Vol. 3, p. 178-252. Acad. Press, Inc. N.Y.
- BLAXTER, J. H. S., AND G. HEMPEL.  
1963. The influence of egg size on herring larvae (*Clupea harengus* L.). *J. Cons., Cons. Int. Explor. Mer* 28:211-240.
- BLAXTER, J. H. S., AND J. R. HUNTER.  
1982. The biology of clupeoid fishes. *Adv. Mar. Biol.* 20: 1-223.
- CHRISTMAS, J. Y., AND R. S. WALLER.  
1975. Location and time of menhaden spawning in the Gulf of Mexico. *Gulf Coast Res. Lab., Ocean Springs, MS*, 20 p.
- HETTLER, W. F.  
1981. Spawning and rearing Atlantic menhaden. *Prog. Fish-Cult.* 43:80-84.  
1983. Transporting adult and larval gulf menhaden and techniques for spawning in the laboratory. *Prog. Fish-Cult.* 45:45-48.  
1984. Description of eggs, larvae, and early juveniles of gulf menhaden, *Brevoortia patronus*, and comparisons with Atlantic menhaden, *B. tyrannus*, and yellowfin menhaden, *B. smithi*. *Fish. Bull., U.S.* 82:85-95.
- HIGHAM, J. R., AND W. R. NICHOLSON.  
1964. Sexual maturation and spawning of Atlantic menhaden. *U.S. Fish Wildl. Serv., Fish. Bull.* 63:255-271.
- HOUE, E. D., AND P. L. FORE.  
1973. Guide to the identity of eggs and larvae of some Gulf of Mexico clupeid fishes. *Fla. Dep. Nat. Resour., Mar. Res. Lab., Leaflet. Ser.* 4(23):1-14.
- JONES, P. W., F. D. MARTIN, AND J. D. HARDY, JR.  
1978. Development of fishes of the Mid-Atlantic Bight. Vol. 1, Acipenseridae through Ictaluridae. *U.S. Fish. Wildl. Serv., Biol. Serv. Program FWS/OBS-78/12*, 314 p.

- LEWIS, R. M., AND C. M. ROITHMAYR.  
1981. Spawning and sexual maturity of gulf menhaden, *Brevoortia patronus*. Fish. Bull., U.S. 78:947-951.
- MCGURK, W. D.  
1984. Effects of delayed feeding and temperature on the age of irreversible starvation and on the rates of growth and mortality of Pacific herring larvae. Mar. Biol. 84:13-26.
- MURPHY, G. I.  
1968. Pattern in life history and the environment. Am. Nat. 102:391-403.
- NICHOLSON, W. R.  
1975. Age and size composition of the Atlantic menhaden, *Brevoortia tyrannus*, purse seine catch, 1963-71, with a brief discussion of the fishery. U.S. Dep. Commer., NOAA Tech. Rep. NMFS SSRF-684, 28 p.  
1978. Movements and population structure of Atlantic menhaden indicated by tag returns. Estuaries 1:141-150.
- REINTJES, J.  
1969. Synopsis of biological data on the Atlantic menhaden, *Brevoortia tyrannus*. U.S. Fish Wildl. Serv., Circ. 320, 30 p.
- STEARNS, S. C.  
1976. Life-history tactics: a review of the ideas. Q. Rev. Biol. 51:3-47.

ALLYN B. POWELL

Southeast Fisheries Center Beaufort Laboratory  
National Marine Fisheries Service, NOAA  
Beaufort, NC 28516 USA

GERMANO PHONLOR

Fundacao Universidade do Rio Grande  
Departamento de Oceanografia  
Caixa postal 474  
96200 Rio Grande - RS, BRAZIL

**SEASONALITY OF BLUE MUSSEL,  
*MYTILUS EDULIS* L., LARVAE IN  
THE DAMARISCOTTA RIVER ESTUARY,  
MAINE, 1969-77<sup>1</sup>**

The spawning of the blue mussel, *Mytilus edulis* L., has been the subject of many studies (see Bayne 1976 for partial review). In an early paper Field (1922) reported that gametogenesis and spawning were influenced by water temperature, though he provided no data. Chipperfield (1953) found that mussels spawn over a specific range of water temperature (9.5°-12.5°C). In addition, Chipperfield noted that the rate of temperature change prior to spawning influences intensity. Other investigators have found that mussels spawn over a specific temperature range, which may vary among locales

(Engle and Loosanoff 1944; Stubbings 1954; Baird 1966; Bohle 1971; Rasmussen 1973; Jorgensen 1981; Kautsky 1982).

Seed (1975) summarized reproduction in European mussel populations and found that spawning in *M. edulis* varies with latitude, occurring earlier in warm waters and progressively later in cooler, northern waters. However, Newell et al. (1982) reported no latitudinal variation of spawning among mussel populations along the northwestern Atlantic coast. Such geographic variation has been attributed to the existence of physiological races (Stauber 1950; Loosanoff and Nomejko 1951). Newell et al. (1982) and Fell and Belsamo (1985) also found that mussel populations at the same latitude in Long Island Sound spawn at different temperatures and times of the year. They surmised that food availability, rather than temperature, dictates when spawning occurs.

Factors which are important in the timing and intensity of spawning can be determined by monitoring spawning activity. This may be achieved directly, by examination of gonad development in seasonally collected samples, or indirectly, by observing the presence or absence of *M. edulis* larvae in plankton samples (Chipperfield 1953). While the direct method is preferable, the indirect method does allow one to use long-term plankton records. These provide an estimate of the variation in both the timing and intensity of spawning. Since the source of the larvae is not certain, some caution should be used in the interpretation of the results (Seed 1975).

An 8-yr plankton record of *Mytilus* larval abundance presents an unusual opportunity to observe long-term variability in spawning and larval occurrence. Specifically, the data were examined with the following goals:

- 1) Determination of the initiation and the duration of the spawning season and degree of temporal variation between years;
- 2) Determination of the variation in larval abundances within and between seasons;
- 3) Examination of the possible correlation of environmental variables (temperature, phytoplankton abundance, degree days, calendar date, and lunar cycles) with spawning activity.

**Materials and Methods**

The study site was the Damariscotta River estuary (Fig. 1), a narrow embayment, 29 km long, which receives a limited amount of freshwater. The estu-

<sup>1</sup>Contribution No. 183, Ira C. Darling Center, University of Maine, Orono, ME.

arine portion has a MLW (mean low water) volume of  $123.4 \times 10^6 \text{ m}^3$ , a tidal volume of  $56.2 \times 10^6 \text{ m}^3$ , and a mean summer flushing time of 4-5 wk

(McAlicie 1977). The estuary is stratified near its head but approaches a well-mixed condition further seaward. Tides are semi-diurnal with a mean range of 2.7 m and a tidal excursion of about 2.8 km (Lee and McAlicie 1979).

Monthly plankton samples were collected during daylight at station D7 (Fig. 1) from October 1969 to June 1970 and then biweekly until September 1977. Plankton tows were 10-15 min oblique hauls with #20 mesh ( $76 \mu\text{m}$ ) nets of 0.5 m mouth diameter equipped with centrally mounted flowmeters. Maximum depths of tows were 10-15 m (4-5 m above the bottom). Boat speed was  $1-2 \text{ m s}^{-1}$ . Samples were immediately fixed in 4% buffered Formalin<sup>2</sup>.

Laboratory subsampling followed the method recommended by Frolander (1968). The concentrated plankton was diluted to a known volume, thoroughly stirred, and a 1 mL aliquot removed with a Stempel pipette. Initial counts on samples taken from June 1974 to September 1977 did not distinguish among taxa of larval bivalves. We therefore took an additional subsample, determined the percentage of *Mytilus* in 50 bivalve larvae, and multiplied this by the total veliger abundance to obtain *Mytilus* densities for each sampling period.

Several key publications (Loosanoff et al. 1966; Chanley and Andrews 1971; DeSchweinitz and Lutz 1976; Lutz and Hidu 1979) containing photomicrographs and descriptions were used to identify *Mytilus edulis* larvae. The differentiation of *Mytilus edulis* larvae from other mytilid larvae (*Modiolus modiolus* and *Geukensia demissa*) at the straight hinge stage was achieved by comparing the length of the hinge line as well as total shell length and height. The early and late umbo larvae of *Geukensia* were easily distinguishable by their elongated appearance; *Mytilus* larvae tended to be less elongate, though pointed anteriorly (Chanley and Andrews 1971). The differentiation of *Modiolus modiolus* larvae and *Mytilus edulis* larvae was based mainly on the characteristics described by DeSchweinitz and Lutz (1976); hinge line lengths, total shell length in the 95-105  $\mu\text{m}$  range, shell shape of umbo stage larvae, presence of an eye spot in specimens  $<270 \mu\text{m}$ , and the presence of a functional foot in larvae  $<295 \mu\text{m}$ . Further positive identification of late stage *Mytilus* larvae was achieved by examining the hinge teeth of disarticulated valves (Lutz and Hidu 1979).

Spawning dates were estimated by subtracting the approximate age of the larvae from the sampling

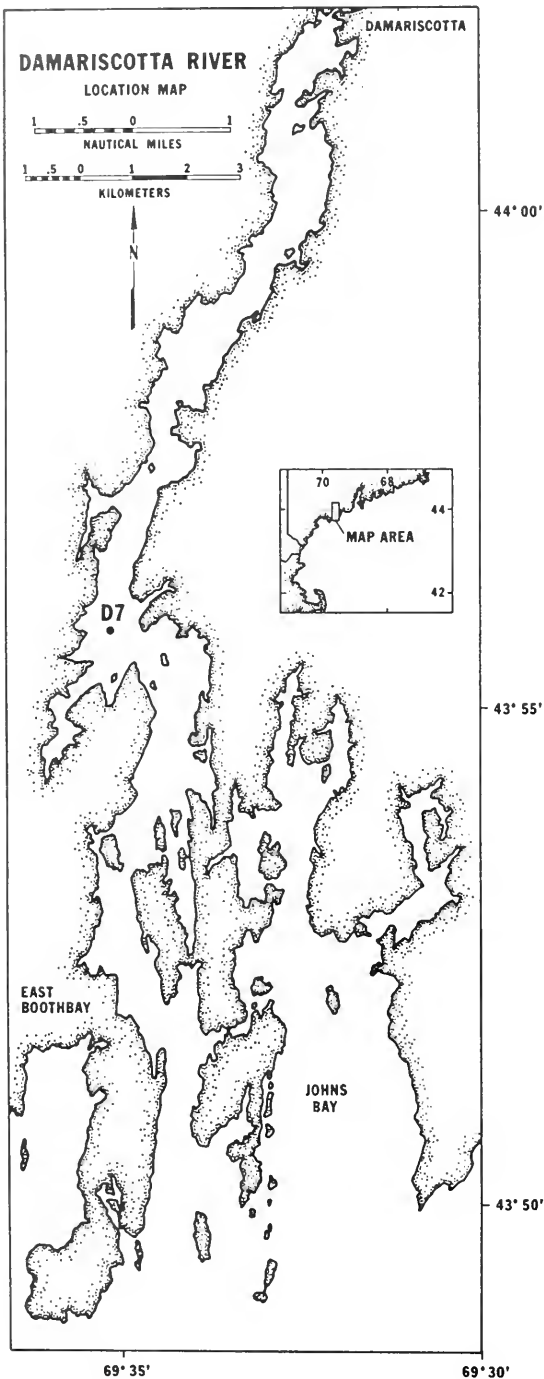

FIGURE 1.—Location map.

<sup>2</sup>Reference to trade names does not imply endorsement by the National Marine Fisheries Service, NOAA.



date. Larval age was estimated using photomicrographs of larvae of known age and size for comparison, available in Chanley and Andrews (1971). The initial occurrence of larvae in each year was dominated by early straight hinge larvae. The spawning season was defined by larval abundances  $>10 \text{ m}^{-3}$ . This level was chosen arbitrarily to distinguish major spawning from occasional low larval abundances ( $<10 \text{ m}^{-3}$ ).

Environmental variables that were examined for correlations with the initiation of spawning and larval abundance included water temperature, phytoplankton abundance, degree days, calendar date, and lunar cycles. Water temperatures were taken concurrently with the plankton samples. Phytoplankton abundances from July 1974 to August 1977 were available for the Damariscotta River (McAlicie unpubl. data). Data from the neighboring Sheepscot River estuary (McAlicie and Denniston<sup>3</sup>) were substituted for the period October 1969 to June 1974. The decision to use the Sheepscot data was based on the highly significant Spearman's rank correlation (Zar 1984) ( $r = 0.67$ ,  $P < 0.001$ ) between the Damariscotta and Sheepscot phytoplankton abundances from July 1974 to August 1977. Degree days were calculated in the manner described by Thiesen (1973). For each year, degree days were summed from the time of peak larval abundance the previous year to the initiation of spawning. Lunar cycle information was obtained from tide tables published by NOAA (1969-76).

## Results

Examination of the age and abundance of mussel larvae from December 1969 to September 1977 indicated that spawning began in late May or early June when temperatures reached  $10^\circ\text{-}12.5^\circ\text{C}$  (Fig. 2). The average date when spawning began was 4 June, with a standard deviation of approximately 7 d. The average number of degree days prior to spawning was 2,853, with a standard deviation of 368. No significant relationship was found between degree days and commencement of spawning or degree days and maximum larval abundances.

Commencement of spawning may be related to the time of spring tides (Table 1). In 7 of the 8 yr examined, spawning began within 5 d, before and after, a spring tide. On four occasions spawning commenced within 2 d of a spring tide. Spawning,

once initiated, probably continued throughout the summer as indicated by the persistence of early stage mussel larvae. Spawning appeared to cease as temperatures fell to  $9^\circ\text{-}14^\circ\text{C}$  in September and October (Fig. 2), when only late stage larvae were present. Maximal larval abundances were observed in mid- to late June, shortly after spawning began. At this time, straight hinge larvae,  $<6$  d old, were dominant. Maximum values for the period 1970-75 ranged from 787 larvae  $\text{m}^{-3}$  to 5,400 larvae  $\text{m}^{-3}$ . In 1976 and 1977, maximum abundances were an order of magnitude larger ( $3.16 \times 10^4 \text{ m}^{-3}$  and  $6.09 \times 10^4 \text{ m}^{-3}$ , respectively). Following the peaks in June, larval densities generally declined through 1 to 3 successively smaller peaks (Fig. 2).

Mussel larvae appeared well after phytoplankton abundances had begun to increase from low winter values to generally high summer values (Fig. 3). Larvae usually disappeared before phytoplankton abundances fell to typically low winter levels.

In addition to the larvae of *Mytilus edulis*, those of *Anomia simplex*, *Geukensia demissa*, *Modiolus modiolus*, and what was probably a complex of *Mya arenaria*, *Hiatella arctica*, and possibly *Sphenia sincera* (Hanks and Packer 1985) larvae were also identified. *Aonomia simplex* occurred most commonly from September through December, though never in great numbers. The *Mya-Hiatella-Sphenia* group was often very abundant, and occurred from early May through September. *Geukensia* and *Modiolus* were never common.

TABLE 1.—Estimated dates and temperatures of the initiation and cessation of spawning for *Mytilus edulis* in the Damariscotta River estuary, and dates of nearest spring tides, 1970-77.

Year	Estimated date and ( $^\circ\text{C}$ ) when spawning		Date of nearest spring tide
	began	ended	
1970	2 June ( $10.0^\circ\text{-}13.2^\circ\text{C}$ )	2 Oct. ( $14.6^\circ\text{-}13.9^\circ\text{C}$ )	June 4
1971	8 June ( $10.2^\circ\text{-}12.2^\circ\text{C}$ )	18 Oct. ( $14.3^\circ\text{-}12.8^\circ\text{C}$ )	June 9
1972	16 June ( $10.5^\circ\text{-}12.1^\circ\text{C}$ )	20 Oct. ( $13.1^\circ\text{-}9.0^\circ\text{C}$ )	June 11
1973	12 June ( $10.0^\circ\text{-}14.0^\circ\text{C}$ )	10 Oct. ( $12.7^\circ\text{-}11.0^\circ\text{C}$ )	June 15
1974	12 June ( $10.7^\circ\text{-}12.3^\circ\text{C}$ )	8 Oct. ( $12.4^\circ\text{-}9.1^\circ\text{C}$ )	June 4
1975	27 May ( $10.3^\circ\text{-}12.5^\circ\text{C}$ )	24 Sept. ( $16.9^\circ\text{-}13.7^\circ\text{C}$ )	May 25
1976	24 May ( $10.1^\circ\text{-}12.8^\circ\text{C}$ )	22 Oct. ( $14.6^\circ\text{-}11.0^\circ\text{C}$ )	May 29
1977	2 June ( $9.3^\circ\text{-}10.2^\circ\text{C}$ )	—	June 1

## Discussion

A temperature threshold for spawning was indicated by the appearance of *Mytilus* larvae when water temperatures exceeded  $10^\circ\text{-}12.5^\circ\text{C}$  and the subsequent disappearance of larvae when temperatures fell below  $9^\circ\text{-}14^\circ\text{C}$ . A number of studies have reported the initiation of spawning in *Mytilus edulis*

<sup>3</sup>McAlicie, B. J., and F. D. Denniston. Dominance and diversity of Sheepscot River estuary phytoplankton. Manuscr. in prep. Ira C. Darling Center, University of Maine, Walpole, ME 04573.

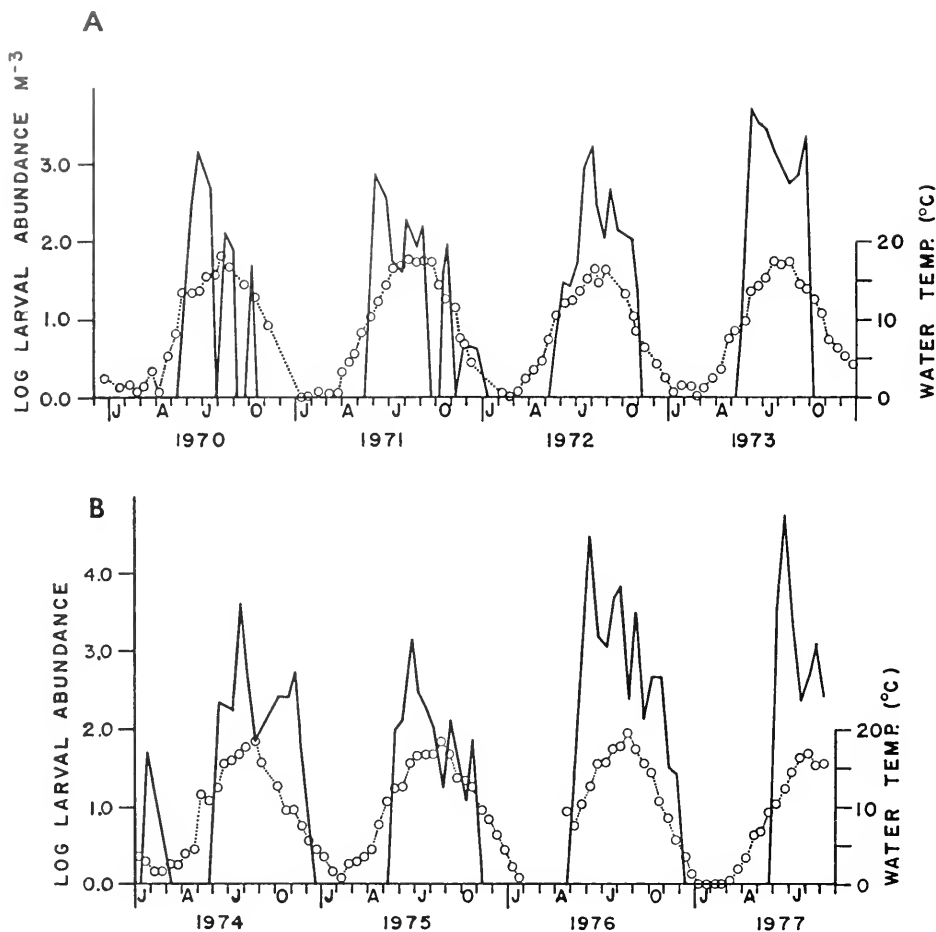

FIGURE 2.—Abundance of *Mytilus edulis* larvae (solid line) and water temperature (broken line) at station D7: A) 1969-73; B) 1974-77.

at temperatures of 10°-13°C or higher while few studies have reported spawning at lower temperatures (Table 2), which also suggests a thermal threshold for spawning. The significance of this threshold may be linked to gametogenesis. Bayne (1965) found that mussels with fully developed gametes would not spawn when held at 5°C under high food concentrations. However, if temperatures were raised to 12°-14°C, gametes matured and spawning ensued. Similarly, Sastry (1968) found that in the bay scallop, *Aequipecten irradians*, oogonia and spermatozoa formed at 15°C and 20°C, but that temperatures higher than 20°C were necessary for oocytes to reach a fertilizable stage. Therefore, the apparent correlation between a particular temperature and the initiation of spawning may actually reflect the maturation of gametes followed by induction of spawning by any of a num-

ber of stimuli. Given the predictable rise in temperature each spring, this may explain the initiation of spawning at approximately the same time each year.

Use of degree days to predict the time of spawning does not appear to be useful. This is due to a very regular pattern of rising and falling water temperatures each year. As a result, the sum of degree days between spawning periods conveyed no more information than did elapsed time. Newell et al. (1982) arrived at a similar conclusion for mussel populations in Long Island Sound. They found that one Long Island Sound mussel population spawned 3 mo later than another, despite nearly identical temperature conditions, difference in degree days due solely to a difference in elapsed calendar days. Bayne (1975), however, did find a relationship between rate of gametogenesis and degree days, but not calendar days.

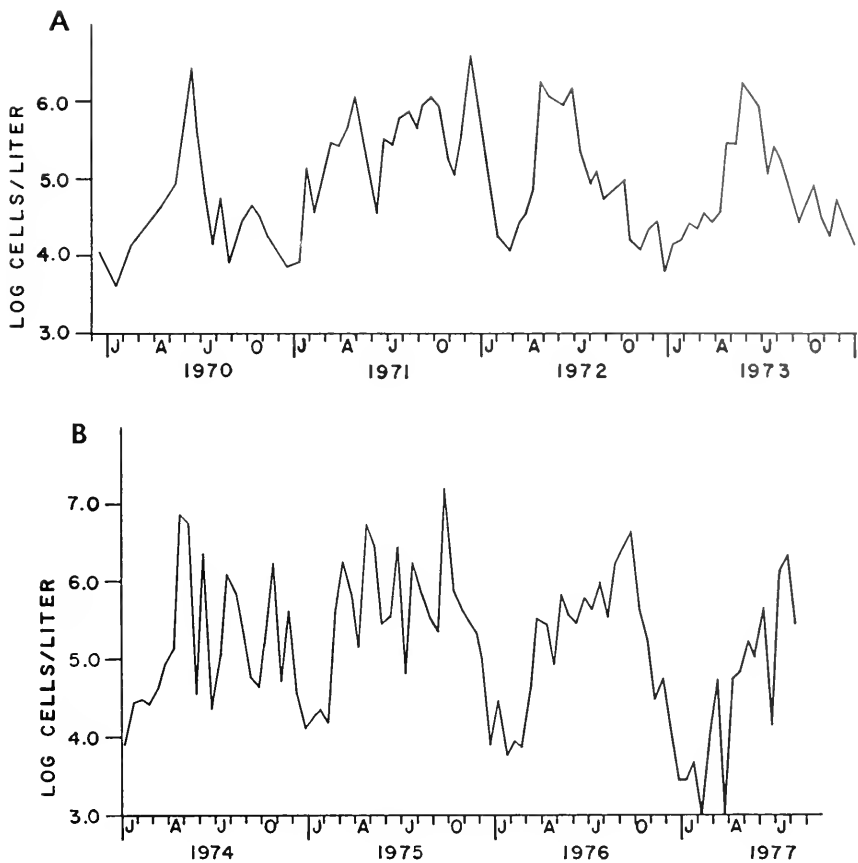

FIGURE 3.—Abundance of phytoplankton in the lower Sheepsct River estuary: A) 1969-73; B) January 1974-June 1974 and at station D7, July 1974-August 1977.

TABLE 2.—Reported spawning temperatures and periods of *Mytilus edulis*.

Location	Temperatures (°C)	Major spawning period	Reference
<b>Europe</b>			
Norway	8	early May	Bohle 1971
Denmark	7-16	May	Jorgensen 1981
England	9.5-12.5	May	Chipperfield 1953
Sweden	12	mid-May-early June	Kautsky 1982
England	13	early May	Baird 1966
Denmark	13-14	May-June	Rasmussen 1973
<b>United States</b>			
Damariscotta River, ME	10-13	late May-mid-June	This study
Milford, CT	15-16	May	Engle and Loosanoff 1944
Branford, CT	14-16	late May-early June	Fell and Balsimo 1985
Stony Brook, NY	11-15	late April-early June	Newell et al. 1982
Shinnecock, NY	16-22	August-October	Newell et al. 1982

Spawning in response to lunar cycles is also a possibility. Korringa (1947) noted that the European oyster, *Ostrea edulis*, spawns around the period of

spring tides and attributed this to increased hydrostatic pressure. Chipperfield (1953) also observed *O. edulis* at several sites in Great Britain shortly after

the occurrence of a spring tide. In our study, spawning began around the time of spring tides, but induction of spawning by hydrostatic pressure has not been reported in mussels. Alternatively, spawning may be induced by other factors associated with spring tides, such as increased temperature fluctuations, air exposure, and water movement. Temperature fluctuations have been shown to induce laboratory spawning in *Mytilus edulis* (Bayne 1976).

While a temperature threshold is suggested, time of year may also be important as indicated by the spawning periods in Table 2. Of the 10 studies examined, all but one reported the initiation of spawning from May to June. Aside from temperature, the initiation of spawning may be influenced by another cyclic phenomena such as photoperiod. Light and photoperiod in particular have been shown to affect the timing of reproduction in a number of marine invertebrates (Segal 1970). While adult mussels are sensitive to changes in light intensity (Bayne et al. 1976), the ability to detect changing photoperiod has not been demonstrated. The results of this study have been attributed to annual temperature cycles, but until light response of mussels is more fully examined photoperiod cannot be ruled out.

Variations in larval abundance from year to year do not appear to be linked to temperature, nor to availability of food energy. Kautsky (1982) reported that Baltic Sea mussel populations were limited to one major spawning by reduced food availability during the remainder of the year. Similarly, Thompson (1979) attributed annual variation in reproductive condition and fecundity of mussels along the coast of Nova Scotia to annual variations in food supply. Bayne (1975) noted that while poor nutrition does not significantly alter the timing of gametogenesis, it can result in resorption of gametes prior to spawning. Newell et al. (1982) suggested that the cycle of food availability could affect both the nutrient storage cycle and the timing of gametogenic events, including spawning. In every year of our study the spring augmentation of phytoplankton was well under way by March or April, with densities  $>10^5$  cells  $l^{-1}$ . Significant numbers of mussel larvae were first detected between late May and early June. Thus, it appears that food is not limiting to either adult or larval mussel populations in our area. Our phytoplankton data, however, do not include the smaller naked nanoplankton which, together with particulate organic matter, could account for more than half of the available energy in the Damariscotta River (Incze 1979). This fraction would be a better index of food available to mussel larvae and should be included in studies attempting to link abundance

or setting success of larvae to their food supply.

Onset of spawning in Damariscotta River mussel populations is predictable from year to year. It occurs when water temperature exceeds  $10^{\circ}$ - $12.5^{\circ}C$ , and near the spring tide portion of the neap-spring cycle. Food does not appear to be limiting to either gametogenesis or the development of larvae.

### Acknowledgments

We thank H. Hidu for stimulating discussions and for criticizing an earlier draft of the manuscript. E. S. Gardella and A. L. Heinig contributed greatly to the sampling efforts. Greg Podniesinski was supported by UMO-UNH Sea Grant R/FD-99 awarded to H. Hidu.

### Literature Cited

- BAIRD, R. H.  
1966. Factors affecting the growth and condition of mussels (*Mytilus edulis* L.). Fish. Invest., Lond., Ser. II, 25:1-33.
- BAYNE, B. L.  
1965. Growth and the delay of metamorphosis of the larvae of *Mytilus edulis* (L.). Ophelia 2:1-47.  
1975. Reproduction in bivalve molluscs under environmental stress. In F. J. Vernberg (editor), Physiological ecology of estuarine organisms, p. 259-277. Univ. South Carolina Press.  
1976. The biology of mussel larvae. In B. L. Bayne (editor), Marine mussels: their ecology and physiology, p. 81-120. Cambridge Univ. Press, N.Y.
- BAYNE, B. L., J. WIDDOWS, AND R. J. THOMPSON.  
1976. Physiology II. In B. L. Bayne (editor), Marine mussels: their ecology and physiology, p. 207-260. Cambridge Univ. Press, N.Y.
- BOHLE, B.  
1971. Settlement of mussel larvae *Mytilus edulis* on suspended collectors in Norwegian waters. 4th Eur. Mar. Biol. Symp., p. 63-69.
- CHANLEY, P., AND J. D. ANDREWS.  
1971. Aids for identification of bivalve larvae of Virginia. Malacologia 11:45-119.
- CHIPPERFIELD, P. N. J.  
1953. Observations on the breeding and settlement of *Mytilus edulis* (L.) in British waters. J. Mar. Biol. Assoc. U.K. 32:449-476.
- DESCHWEINITZ, E. H., AND R. A. LUTZ.  
1976. Larval development of the northern horse mussel, *Modiolus modiolus* (L.), including a comparison with the larvae of *Mytilus edulis* (L.) as an aid in planktonic identification. Biol. Bull. (Woods Hole) 150:348-360.
- ENGLE, J. B., AND V. L. LOOSANOFF.  
1944. On season of attachment of larvae of *Mytilus edulis*. Ecology 25:433-440.
- FELL, P. E., AND A. M. BALSAMO.  
1985. Recruitment of *Mytilus edulis* L. in the Thames estuary, with evidence of differences in the time of maximal settling along the Connecticut shore. Estuaries 8:68-75.
- FIELD, I. A.  
1922. Biology and economic value of the sea mussel *Mytilus*

- edulis*. Fish. Bull., U.S. 38:127-260.
- FROLANDER, H. F.  
1968. Statistical variation in zooplankton numbers from subsampling with a Stempel pipette. J. Water Pollut. Control Fed. 40:R82-R88.
- HANKS, R. W., AND D. B. PACKER.  
1985. A new species of *Sphenia* (*Bivalvia:Myidae*) from the Gulf of Maine. Veliger 27:320-330.
- INCZE, L. S.  
1979. Relationships between environmental temperatures, seston, and the growth and survival of *Mytilus edulis*, L. in a north temperate estuary. M.S. Thesis, Univ. Maine, Orono.
- JORGENSEN, C. B.  
1981. Mortality, growth and grazing impact of a cohort of bivalve larvae, *Mytilus edulis*. (L.). Ophelia 20:185-192.
- KAUTSKY, N.  
1982. Quantitative studies on gonad cycle, fecundity, reproductive output and recruitment in a Baltic *Mytilus edulis* population. Mar. Biol. (Berl.) 58:143-160.
- KORRIGA, P.  
1947. Relations between the moon and periodicity in the breeding of marine animals. Ecol. Monogr. 17:347-381.
- LEE, W. Y., AND B. J. MCALICE.  
1979. Sampling variability of marine zooplankton in a tidal estuary. Estuarine Coastal Mar. Sci. 8:565-582.
- LOOSANOFF, V. L., H. C. DAVIS, AND P. E. CHANLEY.  
1966. Dimensions and shapes of larvae of some marine bivalve mollusks. Malacologia 4:351-435.
- LOOSANOFF, V. L., AND C. A. NOMEJKO.  
1951. Existence of physiologically different races of oysters, *Crassostrea virginica*. Biol. Bull. (Woods Hole) 101:151-156.
- LUTZ, R. A., AND H. HIDU.  
1979. Hinge morphogenesis in the shells of larval and early post-larval mussels (*Mytilus edulis* and *Modiolus modiolus* L.). J. Mar. Biol. Assoc. U.K. 59:111-121.
- MCALICE, B. J.  
1977. A preliminary oceanographic survey of the Damascotta River estuary, Lincoln County, Maine. Maine Sea Grant Tech. Rep. 13, 27 p.
- NEWELL, R. I. E., T. J. HILBISH, R. K. KOEHN, AND C. J. NEWELL.  
1982. Temporal variation in the reproductive cycle of *Mytilus edulis* L. (*Bivalvia, Mytilidae*) from localities on the east coast of the United States. Biol. Bull. (Woods Hole) 162:299-310.
- NOAA.  
1969-1976. Tide Tables: East Coast of North and South America, including Greenland. Tide Tables Natl. Ocean Surv. (U.S.) 1969-1976.
- RASMUSSEN, E.  
1973. Systematics and ecology of the Isefjord marine fauna (Denmark) with a survey of the eelgrass (*Zostera*) vegetation and its communities. Ophelia 11:1-495.
- SASTRY, A. N.  
1968. The relationships among food, temperature and gonad development of the bay scallop, *Aequipecten irradians* Lamarck. Physiol. Zool. 41:44-53.
- SEED, R.  
1975. Reproduction in *Mytilus* (*Mollusca:Bivalvia*) in European waters. Publ. Stn. Zool. Napoli 39(suppl. 1):317-334.
- SEGAL, E.  
1970. Light, animals, invertebrates. In O. Kinne (editor), Marine ecology, Vol. I, Part I, p. 159-211. Wiley-Interscience, N.Y.
- STAUBER, L. A.  
1950. The problem of physiological species with special reference to oysters and oyster drills. Ecology 31:109-118.
- STUBBINGS, H. G.  
1954. The biology of the common mussel in relation to fouling problems. Research 7:222-229.
- THEISEN, B. F.  
1973. The growth of *Mytilus edulis* L. (*Bivalvia*) from Disko and Thule district, Greenland. Ophelia 12:59-77.
- THOMPSON, R. J.  
1979. Fecundity and reproductive effort in the blue mussel (*Mytilus edulis*), the sea urchin (*Strongylocentrotus droebachiensis*) and the snow crab (*Chionocetes opilio*) from populations in Nova Scotia and Newfoundland. J. Fish. Res. Board Can. 36:955-964.
- ZAR, J. H.  
1984. *Biostatistical analysis*. 2d ed. Prentice-Hall, Englewood Cliffs, N.J.

GREG S. PODNIESINSKI

Department of Zoology  
University of Maine, Orono, ME  
Mailing address:  
Ira C. Darling Center  
University of Maine  
Walpole, ME 04573

BERNARD J. MCALICE

Department of Botany and Plant Pathology  
University of Maine  
Orono, ME 04573



# INDEX

*Fishery Bulletin* Vol. 84, No. 1-4

"The abundance and distribution of the family Macrouridae (Pisces: Gadiformes) in the Norfolk Canyon area," by Robert W. Middleton and John A. Musick .....	35	"Annual production of eviscerated body weight, fat, and gonads of Pacific herring, <i>Clupea harengus pallasii</i> , near Auke Bay, southeastern Alaska," by Jay C. Quast .....	705
"Abundance, size, and sex ratio of adult sea-run sea lampreys, <i>Petromyzon marinus</i> , in the Connecticut River," by Kathleen Stier and Boyd Kynard .....	476	<i>Anoplopoma fimbria</i> —see Sablefish	
"Age and growth of the marine catfish, <i>Netuma barba</i> (Siluriformes, Ariidae), in the estuary of the Patos Lagoon (Brasil)," by Enir Gironi Reis .....	679	Anthozoans ecology of Ceriantharia from Cape Hatteras to Nova Scotia .....	625
"Age dependent fecundity, number of spawnings per year, sex ratio, and maturation stages in northern anchovy, <i>Engraulis mordax</i> ," by Richard H. Parrish, Donna L. Mallicoate, and Richard A. Klingbeil .....	503	<i>Arctica islandica</i> —see Quahog, ocean	
Aging studies larval fish .....	91	"Arrival of northern fur seals, <i>Callorhinus ursinus</i> , on St. Paul Island, Alaska," by Michael A. Bigg .....	383
sailfish, Atlantic .....	493	<i>Ascarophis</i> sp. parasites in American lobster .....	197
AHRENHOLZ, DEAN W.—see NELSON and AHRENHOLZ		"Aspects of the reproductive biology, spatial distribution, growth, and mortality of the deepwater caridean shrimp, <i>Heterocarpus laevigatus</i> , in Hawaii," by Murray D. Dailey and Stephen Ralston .....	915
Albacore chromosomal analysis .....	469	<i>Atheresthes evermanni</i> —see Flounder, Kamchatka	
<i>Ammodytes americanus</i> —see Eel, sand		<i>Atheresthes stomias</i> —see Flounder, arrowtooth	
<i>Ammodytes hexapterus</i> —see Sand lance		ATKINSON, C. ALLEN, "Discrete-time difference model for simulating interacting fish population dynamics" ...	535
<i>Ampelisca agassizi</i> —see Amphipods, gammaridean		Backdown dolphin-releasing procedure .....	27
Amphipods, benthic parasites of .....	204, 605	<i>Balaenoptera edeni</i> —see Whale, Bryde	
"Anatomical trauma to sponge-coral reef fishes captured by trawling and angling," by S. Gordon Rogers, Hiram T. Langston, and Timothy E. Targett .....	697	<i>Balaenoptera physalus</i> —see Whale, finback	
Anchovy, northern fecundity and spawning .....	503	BALTZ, DONALD M.—see MOYLE et al.	
drift in the California Current .....	585	BARBER, RICHARD T.—see FORWARD et al.	
life-stage-specific instantaneous mortality rates .....	395	BARLOW, J.—see MYRICK et al. —see REILLY and BARLOW	
spawning in San Francisco Bay .....	879	Bass, black sea anatomical trauma from angling .....	697
vulnerability to predation .....	859	contributions to life history .....	723
"An approach to yield assessment for unexploited resources with application to the deep slope fishes of the Marianas," by Jeffrey J. Polovina and Stephen Ralston ..	759	Bass, striped feeding below a hydroelectric dam .....	220
Anglerfish, lophiid early development .....	429	survival and growth .....	905
Angling trauma to sponge-coral reef fishes .....	697	BAYER, RANGE D., "Seabirds near an Oregon estuarine salmon hatchery in 1982 and during the 1983 El Niño" ..	279
<i>Anguilla rostrata</i> —see Eel, American		BEACHAM, TERRY D., "Type, quantity, and size of food of Pacific salmon ( <i>Oncorhynchus</i> ) in the Strait of Juan de Fuca, British Columbia" .....	77

BIANCHINI, MARCO L.—see SORENSEN et al.		sighted by CETAP aerial and POP surveys . . . . .	349
BIGG, MICHAEL A., "Arrival of northern fur seals, <i>Callorhinus ursinus</i> , on St. Paul Island, Alaska" . . . . .	383	CETAP aerial surveys . . . . .	345
BIGG, MICHAEL A.—see PEREZ and BIGG		"Chinook salmon, <i>Oncorhynchus tshawytscha</i> , spawning escapement based on multiple mark-recapture of carcasses," by Stephen D. Sykes and Louis W. Botsford . . . . .	261
BODKIN, JAMES LEE, "Fish assemblages in <i>Macrocystis</i> and <i>Nereocystis</i> kelp forests off central California" . . . . .	799	<i>Chionoecetes tanneri</i> —see Crab, spider	
BOEHM, PAUL D.—see STEIMLE et al.		Chlorophyll sea surface concentration in the tropical Pacific . . . . .	687
BONNELL, MICHAEL L.—see DOHL et al.		"Chromosomal analysis of albacore, <i>Thunnus alalunga</i> , and yellowfin, <i>Thunnus albacares</i> , and skipjack, <i>Katsuwonus pelamis</i> , tuna," by F. J. Ratty, Y. C. Song, and R. M. Laurs . . . . .	469
Boston		Ciliates parasites of benthic amphipods . . . . .	204
Ex-vessel price in New England fishing industry . . . . .	437	Clam, soft shell description of poecilostomatoid copepods . . . . .	227
BOTSFORD, LOUIS W.—see SYKES and BOTSFORD		occurrence of epizootic sarcoma in Chesapeake Bay . . . . .	851
Bottomfish		<i>Clupea harengus pallasii</i> —see Herring, Pacific	
affect of hypoxia on abundance and distribution . . . . .	19	Cod ex-vessel price in New England fishing industry . . . . .	437
<i>Brevoortia patronus</i> —see Menhaden, gulf		CODY, TERRY J., and BILLY E. FULS, "Comparison of catches in 4.3 m and 12.2 m shrimp trawls in the Gulf of Mexico" . . . . .	981
<i>Brevoortia tyrannus</i> —see Menhaden, Atlantic		<i>Coelorinchus c. carminatus</i> abundance and distribution in Norfolk Canyon . . . . .	37
<i>Briarosaccus callosus</i> —see Rhizocephalan		COLLETTE, BRUCE B., "Resilience of the fish assemblage in New England tidepools" . . . . .	200
BRUNO, RALPH A.—see STEIMLE et al.		COLLINS, L. ALAN—see FINUCANE et al.	
BRUSHER, HAROLD A.—see FINUCANE et al.		"Community studies in seagrass meadows: A comparison of two methods for sampling macroinvertebrates and fishes," by Kenneth M. Leber and Holly S. Greening . . . . .	443
BURCH, RAYMOND, K.—see UCHIYAMA et al.		"Comparison of catches in 4.3 m and 12.2 m shrimp trawls in the Gulf of Mexico," by Terry J. Cody and Billy E. Fuls . . . . .	981
<i>Calanus pacificus</i> abundance, chemical composition, distribution, and size . . . . .	157	"Comparison of visceral fat and gonadal fat volumes of yellowtail rockfish, <i>Sebastes flavidus</i> , during a normal year and a year of El Niño conditions," by William H. Lenarz and Tina Wyllie Echeverria . . . . .	743
California Current . . . . .	157	Connecticut River spawning migration of sea lampreys . . . . .	749
California Cooperative Oceanic Fisheries Investigation northern anchovy drift studies . . . . .	587	"Contributions to the life history of black sea bass, <i>Centropristis striata</i> , off the southeastern United States," by Charles A. Wenner, William A. Roumillat, and C. Wayne Waltz . . . . .	723
California Current <i>Calanus pacificus</i> . . . . .	157	COOPER, RICHARD A.—see SHEPARD et al.	
northern anchovy . . . . .	585		
<i>Callorhinus ursinus</i> —see Seal, northern fur			
CAREY, ANDREW G., JR.—see TESTER and CAREY			
"Cartilage and bone development in scombroid fishes," by Thomas Potthoff, Sharon Kelley, and Joaquin C. Javech . . . . .	647		
Catfish, sea age and growth in Patos Lagoon, Brasil . . . . .	679		
<i>Centropristis striata</i> —see Bass, black sea			
Ceriantharia—see Anthozoans			
"Cetacean high-use habitats of the northeast United States continental shelf," by Robert D. Kenney and Howard E. Winn . . . . .	345		
Cetaceans high-use habitats . . . . .	345		



"Copepodids and adults of <i>Leptinogaster major</i> (Williams, 1907), a poecilostomatoid copepod living in <i>Mya arenaria</i> L. and other marine bivalve mollusks," by Arthur G. Humes .....	227	de MENDIOLA, BLANCA ROJAS—see FORWARD et al.	
Copepods		"Determining age of larval fish with the otolith increment technique," by Cynthia Jones .....	91
size and chemical composition .....	165	"Development and evaluation of methodologies for assessing and monitoring the abundance of widow rockfish, <i>Sebastes entomelas</i> ," by Mark E. Wilkins .....	287
Copepods, poecilostomatoid		Developmental studies	
<i>Leptinogaster major</i> living in mollusks .....	227	scombroid fishes .....	647
taxonomic history .....	227	"Diel foraging activity of American eels, <i>Anguilla rostrata</i> (LeSueur), in a Rhode Island estuary," by Peter W. Sorensen, Marco L. Bianchini, and Howard E. Winn ..	746
<i>Coryphaena equiselis</i> —see Dolphin, pompano		"Diet of northern fur seals, <i>Callorhinus ursinus</i> , off western North America," by Michael A. Perez and Michael A. Bigg .....	957
<i>Coryphaena hippurus</i> —see Dolphin (fish)		"Differentiation of <i>Prionotus carolinus</i> and <i>Prionotus evolans</i> eggs in Hereford Inlet estuary, southern New Jersey, using immunodiffusion," by Walter J. Keirans, Sidney S. Herman, and R. G. Malsberger .....	63
<i>Coryphaenoides armatus</i>		Dinoflagellates	
abundance and distribution in Norfolk Canyon .....	51	swimming speed of <i>Gymnodinium splendens</i> .....	461
<i>Coryphaenoides carapinus</i>		parasites of benthic amphipods .....	605
abundance and distribution in Norfolk Canyon .....	51	"Discrete-time difference model for simulating interacting fish population dynamics," by C. Allen Atkinson .....	535
<i>Coryphaenoides rupestris</i>		Disease	
abundance and distribution in Norfolk Canyon .....	48	epizootic sarcoma in soft shell clams .....	851
COX, JAMES L.—see WILLASON et al.		Dissolved oxygen concentration	
Crab, blue king		effect on shrimp and bottomfish in Louisiana coastal waters .....	19
Rhizocephalan infection .....	177	"Distribution and abundance of common dolphin, <i>Delphinus delphis</i> , in the Southern California Bight: a quantitative assessment based upon aerial transect data," by Thomas P. Dohl, Michael L. Bonnell, and R. Glenn Ford ..	333
Crab, golden king		"Distribution and reproductive biology of the golden king crab, <i>Lithodes aequispina</i> , in the eastern Bering Sea," by David A. Somerton and Robert S. Otto .....	571
distribution and reproductive biology in eastern Bering Sea .....	571	"The distribution of the humpback whale, <i>Megaptera novaeangliae</i> , on Georges Bank and in the Gulf of Maine in relation to densities of the sand eel, <i>Ammodytes americanus</i> ," by P. Michael Payne, John R. Nicolas, Loretta O'Brien, and Kevin D. Powers .....	271
Crab, king		DITTY, JAMES G., "Ichthyoplankton in neritic waters of the northern Gulf of Mexico off Louisiana: composition, relative abundance, and seasonality" .....	935
comparison of blue and golden king crabs .....	327	DOHL, THOMAS P., MICHAEL L. BONNELL, and R. GLENN FORD, "Distribution and abundance of common dolphin, <i>Delphinus delphis</i> , in the Southern California Bight: a quantitative assessment based upon aerial transect data" .....	333
Crab, spider		Dolphin, common	
instar identification .....	973	distribution and abundance in southern California ..	333
life history .....	973		
Culture studies			
squid, market .....	771		
CUMMINGS, WILLIAM C., PAUL O. THOMPSON, and SAMUEL J. HA, "Sounds from Bryde, <i>Balaenoptera edeni</i> , and finback, <i>B. physalus</i> , whales in the Gulf of California" .....	359		
DAILEY, MURRAY D., and STEPHEN RALSTON, "Aspects of the reproductive biology, spatial distribution, growth, and mortality of the deepwater caridean shrimp, <i>Heterocarpus laevigatus</i> , in Hawaii" .....	915		
Dams, hydroelectric			
striped bass feeding area .....	220		
DANDONNEAU, YVES, "Monitoring the sea surface chlorophyll concentration in the tropical Pacific: consequences of the 1982-83 El Niño" .....	687		
DANIELS, ROBERT A.—see MOYLE et al.			
DEAN, JOHN M.—see PRINCE et al.			
<i>Delphinus delphis</i> —see Dolphin, common			

Dolphin (fish)		El Niño	
growth in Hawaiian waters by daily increments . . . . .	186	chlorophyll concentration in tropical Pacific . . . . .	687
stock structure in western central Atlantic . . . . .	451	correlations of seabirds and salmon smolts . . . . .	279
		fat volume of yellowtail rockfish . . . . .	743
Dolphin, spotted		<i>Engraulis mordax</i> —see Anchovy, northern	
reproductive biology in eastern tropical Pacific . . . . .	247		
Dolphins		<i>Euphausia pacifica</i> . . . . .	161
increase in population size . . . . .	527	Euphausiids	
mortality		distribution and abundance in California Current . . . . .	161
due to tuna purse seine fishery . . . . .	27	invertebrate prey of Pacific salmon . . . . .	77
in eastern tropical Pacific tuna fishery . . . . .	559		
		“Ex-vessel price linkages in the New England fishing industry,” by Dale Squires . . . . .	437
“Early development of the Lophiid anglerfish, <i>Lophius gastrophysus</i> ,” by Yasunobu Matsuura and Nelson Takumi Yoneda . . . . .	429		
EARLY, GREG—see SELZER et al.		FARLEY, C. A., S. V. OTTO, and C. L. REINISCH, “New occurrence of epizootic sarcoma in Chesapeake Bay soft shell clams, <i>Mya arenaria</i> . . . . .	851
“Early life history of Atlantic menhaden, <i>Brevoortia tyrannus</i> , and gulf menhaden, <i>B. patronus</i> ,” by Allyn B. Powell and Germano Phonlor . . . . .	991	FAVUZZI, JC N—see WILLASON et al.	
ECHEVERRIA, TINA WYLLIE—see LENARZ and ECHEVERRIA			
Echo integration		“Fecundity of northern shrimp, <i>Pandalus borealis</i> , (Crustacea, Decapoda) in areas of the Northwest Atlantic,” by D. G. Parsons and G. E. Tucker . . . . .	549
assessing widow rockfish abundance . . . . .	287		
		“Fecundity of the Pacific hake, <i>Merluccius productus</i> , spawning in Canadian waters,” by J. C. Mason . . . . .	209
“An ecological survey and comparison of bottom fish resource assessments (submersible versus handline fishing) at Johnston Atoll,” by Stephen Ralston, Reginald M. Gooding, and Gerald M. Ludwig . . . . .	141	FINUCANE, JOHN H., L. ALAN COLLINS, HAROLD A. BRUSHER, and CARL H. SALOMAN, “Reproductive biology of king mackerel, <i>Scomberomorus cavalla</i> , from the southeastern United States” . . . . .	841
Ecology		FIORELLI, PATRICIA M.—see SELZER et al.	
anthozoans . . . . .	625		
bottom fish resource assessment at Johnston Atoll . . . . .	141	“First record of the longfin mako, <i>Isurus paucus</i> , in the Gulf of Mexico,” by Kristie Killam and Glenn Parsons . . . . .	748
community studies in seagrass meadows . . . . .	443		
“Ecology of Ceriantharia (Coelenterata, Anthozoa) of the northwest Atlantic from Cape Hatteras to Nova Scotia,” by Andrew N. Shepard, Roger B. Theroux, Richard A. Cooper, and Joseph R. Uzmann . . . . .	625	Fish	
Economic studies		assemblages in kelp forests . . . . .	799
spiny lobster . . . . .	69, 74	resilience in New England tidepools . . . . .	200
Ecosystems		“Fish assemblages in <i>Macrocystis</i> and <i>Nereocystis</i> kelp forests off central California,” by James Lee Bodkin . . . . .	799
fish population dynamic simulations . . . . .	535	Fish population studies	
Eel, American		food consumption estimates . . . . .	827
diel foraging activity . . . . .	746	simulating population dynamics . . . . .	535
Eel, sand		Fishery	
relationship to humpback whale . . . . .	271	crab, golden king . . . . .	571
“Effects of exposure and confinement on spiny lobsters, <i>Pamulirus argus</i> , used as attractants in the Florida trap fishery,” by John H. Hunt, William G. Lyons, and Frank S. Kennedy, Jr. . . . .	69	hypoxia in Louisiana coastal waters . . . . .	19
		management . . . . .	697
“Effects of temperature on swimming speed of the dinoflagellate, <i>Gymnodinium splendens</i> ,” by Richard B. Forward, Jr., Blanca Rojas de Mendiola, and Richard T. Barber . . . . .	460	menhaden, gulf . . . . .	311
		rockfish, commercial . . . . .	409
		spiny lobster, Florida . . . . .	69
		tuna purse seine and dolphin mortality . . . . .	27
		tuna, yellowfin . . . . .	247, 559
		Fishes	
		community studies in seagrass meadows . . . . .	443
		distribution and abundance in Suisan Marsh . . . . .	105
		Fishes, reef	
		trauma from trawling and angling . . . . .	697

Fishing		GIBSON, DARCY L.—see GRAHAM et al.	
ex-vessel price in New England fishing industries . . .	437	Gloucester	
multispecies intensive fishing experiment . . . . .	423	ex-vessel price in New England fishing industry . . .	437
shrimp		GOLDBERG, STEPHEN R.—see WEBER and	
caridean . . . . .	927	GOLDBERG	
submersible versus handline . . . . .	141	GOODING, REGINALD M.—see RALSTON et al.	
<i>Fistulicola plicatus</i> —see Tapeworm		GRAHAM, JEFFREY B., RICHARD H. ROSENBLATT,	
Flounder		and DARCY L. GIBSON, "Morphology and possible swim-	
ex-vessel price linkages in New England . . . . .	437	ming mode of a yellowfin tuna, <i>Thunnus albacares</i> , lack-	463
Flounder, arrowtooth		GREENING, HOLLY S.—see LEBER and GREENING	
food habits in eastern Bering Sea . . . . .	615	Groupers	
genetic confirmation of specific distinction . . . . .	222	unexploited resources in the Marianas . . . . .	759
Flounder, Kamchatka		GROVER, JILL J., and BORI L. OLLA, "Morphological	
food habits in eastern Bering Sea . . . . .	615	evidence for starvation and prey size selection of sea-	
genetic confirmation . . . . .	222	caught larval sablefish, <i>Anoplopoma fimbria</i> " . . . . .	484
Flounder, yellowtail		"Growth, behavior, and sexual maturation of the market	
statistical methods for estimating abundance . . . . .	519	squid, <i>Loligo opalescens</i> , cultured through the life cycle,"	
FOLKVORD, ARILD, and JOHN R. HUNTER, "Size-		by W. T. Yang, R. F. Hixon, P. E. Turk, M. E. Krejci, W.	
specific vulnerability of northern anchovy, <i>Engraulis mor-</i>	859	H. Hulet, and R. T. Hanlon . . . . .	771
dax, larvae to predation by fishes" . . . . .		"Growth of dolphins, <i>Coryphaena hippurus</i> , and <i>C.</i>	
Food habits		<i>equisetis</i> , in Hawaiian waters as determined by daily in-	
bass, striped . . . . .	220	crements on otoliths," by James H. Uchiyama, Raymond	
fish consumption estimates . . . . .	615	K. Burch, and Syd A. Kraul, Jr. . . . .	186
flounder . . . . .	615, 827	Growth rates	
hake, Pacific . . . . .	947	anchovy, northern . . . . .	503
salmon, Pacific . . . . .	77	bass, black sea . . . . .	723
seal, northern fur . . . . .	957	bass, striped . . . . .	905
"Food habits and diet overlap of two congeneric species,		catfish, sea . . . . .	679
<i>Atheresthes stomias</i> and <i>Atheresthes evermanni</i> , in the	615	dolphin fishes in Hawaiian waters . . . . .	186
eastern Bering Sea," by M. S. Yang and P. A. Livingston . .		herring, Pacific . . . . .	705
FORD, R. GLENN—see DOHL et al.		shrimp, caridean . . . . .	915
FORWARD, RICHARD B., JR., BLANCA de MENDIOLA,		squid, market . . . . .	771
and RICHARD T. BARBER, "Effects of temperature on swim-	460	Gulf of California	
ming speed of the dinoflagellate, <i>Gymnodinium splen-</i>		sounds of Bryde and finback whales . . . . .	359
dens" . . . . .		Gulf of Maine	
FROST, KATHRYN J., and LLOYD F. LOWRY, "Sizes of		distribution of humpback whales . . . . .	271
walleye pollock, <i>Theragra chalcogramma</i> , consumed by	192	Gulf of Mexico	
marine mammals in the Bering Sea" . . . . .		first record of longfin mako . . . . .	748
FULS, BILLY E.—see CODY and FULS		ichthyoplankton . . . . .	935
Gammaridean amphipods . . . . .	204	<i>Gymnodinium splendens</i> —see Dinoflagellate	
"Genetic confirmation of specific distinction of arrowtooth		HA, SAMUEL J.—see CUMMINGS et al.	
flounder, <i>Atheresthes stomias</i> , and Kamchatka flounder,	222	Habitat studies	
<i>A. evermanni</i> ," by Carol L. Ranck, Fred M. Utter, George		cetaceans of the northeast United States . . . . .	345
B. Milner, and Gary B. Smith . . . . .		Haddock	
Genetic studies		ex-vessel price in New England fishing industry . . . .	437
chromosomal analysis of tuna . . . . .	469		
specific distinction of flounder . . . . .	222		
Georges Bank			
distribution of humpback whales . . . . .	271		

Hake, Pacific fecundity in Canadian waters.....	209	HURLEY, P. C. F.—see HOGANS and HURLEY	
stomach contents and food consumption .....	947	Hybrids, bass striped survival and growth .....	905
HANLON, R. T.—see YANG et al.		“Hypoxia in Louisiana coastal waters during 1983: implications for fisheries,” by Maurice L. Renaud .....	19
HARRIS, R. E., JR.—see VAN ENGEL et al.		“Ichthyoplankton in neritic waters of the northern Gulf of Mexico off Louisiana: composition, relative abundance, and seasonality,” by James G. Ditty .....	935
Hatcheries growth and survival of striped bass .....	905	Immunodiffusion differentiation of <i>Prionotus</i> eggs .....	63
HAWKES, CLAYTON R., THEODORE R. MEYERS, and THOMAS C. SHIRLEY, “Length-weight relationships of blue, <i>Paralithodes platypus</i> , and golden, <i>Lithodes aequispina</i> , king crabs parasitized by the rhizocephalan, <i>Briarosaccus callosus</i> Boschma” .....	327	“An improved otter surface sampler,” by J. C. Mason and A. C. Phillips .....	480
HERBOLD, BRUCE—see MOYLE et al.		“Incidental dolphin mortality in the eastern tropical Pacific tuna fishery, 1973 through 1978,” by Bruce E. Wahlen ..	559
HERMAN, SIDNEY S.—see KEIRANS et al.		“Incidental mortality of dolphins in the eastern tropical Pacific, 1959-72,” by N. C. H. Lo and T. D. Smith ..	27
Herring, Pacific annual production .....	705	“Increased food and energy consumption of lactating northern fur seals, <i>Callorhinus ursinus</i> ,” by Michael A. Perez and Elizabeth E. Mooney .....	371
<i>Heterocarpus laevigatus</i> —see Shrimp, caridean		“Instar identification and life history aspects of juvenile deepwater spider crabs, <i>Chionoecetes tanneri</i> Rathbun,” by Patricia A. Tester and Andrew G. Carey, Jr. ....	973
<i>Heterostichus rostratus</i> —see Kelpfish, giant		“An intensive fishing experiment for the caridean shrimp, <i>Heterocarpus laevigatus</i> , at Alamagan Island in the Mariana Archipelago,” by Stephen Ralston .....	927
Histology starvation induced mortality .....	1	<i>Istiophorus platypterus</i> —see Sailfish, Atlantic	
HIXON, R. F.—see YANG et al.		<i>Isurus paucus</i> —see Shark, longfin mako	
HOGANS, W. E., and P. C. F. HURLEY, “Variations in the morphology of <i>Fistulicola plicatus</i> Rudolphi (1802) (Cestoda: Pseudophyllidea) from the swordfish, <i>Xiphias gladius</i> L., in the northwest Atlantic Ocean” .....	754	JAVECH, JOAQUIN C.—see POTTHOFF et al.	
HOHN, A. A.—see MYRICK et al.		JOHNSON, P. T., R. A. MacINTOSH, and D. A. SOMERTON, “Rhizocephalan infection in blue king crabs, <i>Paralithodes platypus</i> , from Olga Bay, Kodiak Island, Alaska” .....	177
<i>Homarus americanus</i> —see Lobster, American		JOHNSON, PHYLLIS T., “Parasites of benthic amphipods: ciliates” .....	204
HOUDE, EDWARD D., and LAWRENCE LUBBERS III, “Survival and growth of striped bass, <i>Morone saxatilis</i> , and <i>Morone</i> hybrid larvae: laboratory and pond enclosure experiments .....	905	JOHNSON, PHYLLIS T., “Parasites of benthic amphipods: dinoflagellates (Duboscquodina: Syndinidae) ...	605
HULET, W. H.—see YANG et al.		Johnston Atoll resource assessment .....	141
HUMES, ARTHUR G., “Copepodids and adults of <i>Leptinogaster major</i> (Williams, 1907), a poecilostomatoid copepod living in <i>Mya arenaria</i> L. and other marine bivalve mollusks” .....	227	Jolly-Seber spawning escapement of chinook salmon .....	261
HUNT, JOHN H., WILLIAM G. LYONS, and FRANK S. KENNEDY, JR., “Effects of exposure and confinement on spiny lobsters, <i>Panulirus argus</i> , used as attractants in the Florida trap fishery” .....	69	JONES, CYNTHIA, “Determining age of larval fish with the otolith increment technique” .....	91
HUNTE, WAYNE—see OXENFORD and HUNTE		<i>Katsuwonus pelamis</i> —see Tuna, skipjack	
HUNTER, J. ROE, BEVERLY J. MACEWICZ, and JOHN R. SIBERT, “The spawning frequency of skipjack tuna, <i>Katsuwonus pelamis</i> , from the South Pacific” .....	895		
HUNTER, JOHN R.—see FOLKVORD and HUNTER			

KEIRANS, WALTER J., SIDNEY S. HERMAN, and R. G. MALSBERGER, "Differentiation of <i>Prionotus carolinus</i> and <i>Prionotus evolans</i> eggs in Hereford Inlet estuary, southern New Jersey, using immunodiffusion" . . . . .	63	sablefish starvation and prey size selection . . . . .	484
KELLEY, SHARON—see POTTHOFF et al.		scombroid cartilage and bone development . . . . .	647
Kelp, bull fish assemblages in kelp forests . . . . .	799	LAURS, R. M.—see RATTY et al.	
Kelp forests fish assemblages . . . . .	799	LEBER, KENNETH M., and HOLLY S. GREENING, "Community studies in seagrass meadows: A comparison of two methods for sampling macroinvertebrates and fishes" . . . . .	443
Kelp, giant fish assemblages in kelp forests . . . . .	799	LEE, DENNIS W.—see PRINCE et al.	
Kelpfish, giant life history and larval development . . . . .	809	LENARZ, WILLIAM H., and TINA WYLLIE ECHEVERRIA, "Comparison of visceral fat and gonadal fat volumes of yellowtail rockfish, <i>Sebastes flavidus</i> , during a normal year and a year of El Niño conditions" . . . . .	743
KENNEDY, FRANK S., JR.—see HUNT et al.		"Length-weight relationships of blue, <i>Paralithodes platypus</i> , and golden, <i>Lithodes aequispina</i> , king crabs parasitized by the rhizocephalan, <i>Briarosaccus callosus</i> Boschma," by Clayton R. Hawkes, Theodore R. Meyers, and Thomas C. Shirley . . . . .	327
KENNEY, ROBERT D., and HOWARD E. WINN, "Cetacean high-use habitats of the northeast United States continental shelf" . . . . .	345	<i>Leptinogaster major</i> —see Copepod, poecilostomatoid	
KILLAM, KRISTIE, and GLENN PARSONS, "First record of the longfin mako, <i>Isurus paucus</i> , in the Gulf of Mexico" . . . . .	748	Leslie model dolphin population studies . . . . .	527
KLINGBEIL, RICHARD A.—see PARRISH et al.		fish population studies . . . . .	535
KRAUL, SYD A., JR.—see UCHIYAMA et al.		variable catchability version . . . . .	423
KREJCI, M. E.—see YANG et al.		"Life history and larval development of the giant kelpfish, <i>Heterostichus rostratus</i> Girard, 1854," by Carol A. Stepien . . . . .	809
KRYGIER, E. E., and W. G. PEARCY, "The role of estuarine and offshore nursery areas for young English sole, <i>Parophrys vetulus</i> Girard, of Oregon" . . . . .	119	Life history studies bass, black sea . . . . .	723
KYNARD, BOYD—see STIER and KYNARD —see WARNER and KYNARD		crab, spider . . . . .	973
Lampreys, sea abundance, size, and sex ratio . . . . .	476	kelpfish, giant . . . . .	809
movement in the Connecticut River . . . . .	749	menhaden, Atlantic and gulf . . . . .	991
LANGSTON, HIRAM T.—see ROGERS et al.		<i>Limanda ferruginea</i> —see Flounder, yellowtail	
Larvae anchovy, northern in the California Current . . . . .	585	Line intercept survey assessing widow rockfish abundance . . . . .	287
instantaneous mortality rates . . . . .	395	Line transect survey assessing widow rockfish abundance . . . . .	287
spawning and predation in San Francisco Bay . . . . .	879	Literature review daily deposition of otolith increments . . . . .	91
vulnerability of . . . . .	859	<i>Lithodes aequispina</i> —see Crab, golden king	
anglerfish, lophiid early development and comparison with other lophiid species . . . . .	429	LIVINGSTON, P. A.—see YANG and LIVINGSTON	
bass, striped survival and growth . . . . .	905	LO, NANCY C. H., "Modeling life-stage-specific instantaneous mortality rates, an application to northern anchovy, <i>Engraulis mordax</i> , eggs and larvae" . . . . .	395
fish age determination . . . . .	91	LO, N. C. H., and T. D. SMITH, "Incidental mortality of dolphins in the eastern tropical Pacific, 1959-72" . . . . .	27
kelpfish, giant . . . . .	809	Lobster, American occurrence of parasites . . . . .	197
mackerel, jack . . . . .	1		
mussels, blue spawning and seasonality . . . . .	995		

Lobster, spiny in Florida trap fishery .....	69	MATSUURA, YASUNOBU, and NELSON TAKUMI YONEDA, "Early development of the lophiid anglerfish, <i>Lophius gastrophysus</i> " .....	429
<i>Loligo opalescens</i> —see Squid, market		McALICE, BERNARD, J.—see PODNIESINSKI and McALICE	
"Longevity and age validation of a tag-recaptured Atlan- tic sailfish, <i>Istiophorus platypterus</i> , using dorsal spines and otoliths," by Eric D. Prince, Dennis W. Lee, Charles A. Wilson, and John M. Dean .....	493	McGOWAN, MICHAEL F., "Northern anchovy, <i>Engraulis mordax</i> , spawning in San Francisco Bay, California, 1978-79, relative to hydrography and zooplankton prey of adults and larvae" .....	879
<i>Lophius gastrophysus</i> —see Anglerfish, lophiid		<i>Megaptera novaeangliae</i> —see Whale, humpback	
Louisiana hypoxia in coastal waters .....	19	Menhaden, Atlantic early life history .....	991
LOWRY, LLOYD F.—see FROST and LOWRY		Menhaden, gulf early life history .....	991
LUBBERS, LAWRENCE III—see HOUDE and LUBBERS		population and fishery characteristics .....	311
LUDWIG, GERALD M.—see RALSTON et al.		<i>Merluccius productus</i> —see Hake, Pacific	
LYONS, WILLIAM G.—see HUNT et al.		MERRINER, JOHN V.—see SMITH, JOSEPH W.	
MACEWICZ, BEVERLY J.—see HUNTER et al.		"Methodological problems in sampling commercial rockfish landings," by A. R. Sen .....	409
MacINTOSH, R. A.—see JOHNSON et al.		MEYERS, THEODORE R.—see HAWKES et al.	
Mackerel, jack histological analysis .....	2	<i>Micropogonius undulatus</i> —see Croaker, Atlantic	
morphological analysis .....	2	MIDDLETON, ROBERT W., and JOHN A. MUSICK, "The abundance and distribution of the family Macrouridae (Pisces: Gadiformes) in the Norfolk Canyon area" .....	35
offshore starvation .....	1	MILNER, GEORGE B.—see RANCK et al.	
reproductive biology .....	841	"A model of the drift of northern anchovy, <i>Engraulis mor- dax</i> , larvae in the California Current," by James H. Power . .	585
starvation-induced mortality .....	1	"Modeling life-stage-specific instantaneous mortality rates, an application to northern anchovy, <i>Engraulis mordax</i> , eggs and larvae," by Nancy C. H. Lo .....	395
<i>Macrocytis pyrifera</i> —see Kelp, giant		Models estimating food consumption of fish populations .....	827
Macroinvertebrates community studies in seagrass meadows .....	443	Leslie .....	423
Macrouridae abundance and distribution in Norfolk Canyon .....	35	life-stage-specific instantaneous mortality rates .....	395
Makalii—see Submersible		Manly-Parr .....	261
Mako, longfin—see Shark, longfin mako		"Monitoring the sea surface chlorophyll concentration in the tropical Pacific: consequences of the 1982-83 El Niño," by Yves Dandonneau .....	687
MALLICOATE, DONNA L.—see PARRISH et al.		MOONEY, ELIZABETH E.—see PEREZ and MOONEY	
MALSBERGER, R. G.—see KEIRANS et al.		<i>Morone saxatilis</i> —see Bass, striped	
Manly-Parr model for spawning escapement of chinook salmon . .	261	"Morphological evidence for starvation and prey size selec- tion of sea-caught larval sablefish, <i>Anoplopoma fimbria</i> ," by Jill J. Grover and Bori L. Olla .....	484
Mariana Archipelago fishing experiment for caridean shrimp .....	927	"Morphology and possible swimming mode of a yellowfin tuna, <i>Thunnus albacares</i> , lacking one pectoral fin," by Jeffrey B. Graham, Richard H. Rosenblatt, and Darcy L. Gibson .....	463
Marine mammals sizes of walleye pollock consumed .....	192		
MASON, J. C., "Fecundity of the Pacific hake, <i>Merluccius productus</i> , spawning in Canadian waters" .....	209		
MASON, J. C., and A. C. PHILLIPS, "An improved otter surface sampler" .....	480		

"Movement of sea-run sea lampreys, <i>Petromyzon marinus</i> , during the spawning migration in the Connecticut River," by Kathleen Stier and Boyd Kynard .....	749	O'BRIEN, LORETTA—see PAYNE et al.	
MOYLE, PETER B., ROBERT A. DANIELS, BRUCE HERBOLD, and DONALD M. BALTZ, "Patterns in distribution and abundance of a noncoevolved assemblage of estuarine fishes in California" .....	105	"Occurrence of some parasites and a commensal in the American lobster, <i>Homarus americanus</i> , from the Mid-Atlantic Bight," by W. A. Van Engel, R. E. Harris, Jr., and D. E. Zwerner .....	197
MUSICK, JOHN A.—see MIDDLETON and MUSICK		OLLA, BORI L.—see GROVER and OLLA	
Mussel, blue larvae in Damariscotta River estuary, Maine .....	995	<i>Oncorhynchus gorbusha</i> —see Salmon, pink	
<i>Mya arenaria</i> —see Clam, soft shell		<i>Oncorhynchus kisutch</i> —see Salmon, coho	
MYRICK, A. C., JR., A. A. HOHN, J. BARLOW, and P. A. SLOAN, "Reproductive biology of female spotted dolphins, <i>Stenella attenuata</i> , from the eastern tropical Pacific" ..	247	<i>Oncorhynchus nerka</i> —see Salmon, sockeye	
<i>Mytilus edulis</i> —see Mussel, blue		<i>Oncorhynchus tshawytscha</i> —see Salmon, chinook	
NELSON, WALTER R., and DEAN W. AHRENHOLZ, "Population and fishery characteristics of gulf menhaden, <i>Brevoortia patronus</i> " .....	311	Oregon nursery areas for English sole .....	119
<i>Nematoscelis difficilis</i> .....	157	"Organic and trace metal levels in ocean quahog, <i>Arctica islandica</i> Linné, from the northwestern Atlantic," by Frank W. Steimle, Paul D. Boehm, Vincent S. Zdanowicz, and Ralph A. Bruno .....	133
<i>Nereocystis leutkeana</i> —see Kelp, bull		Otoliths age validation in Atlantic sailfish .....	493
<i>Netuma barba</i> —see Catfish, sea		catfish, sea .....	679
Neuston sampler an improved otter surface sampler .....	480	disposition rates .....	91
New Bedford ex-vessel price in New England fishing industry ....	437	dolphin fishes in Hawaiian waters .....	186
New England ex-vessel price in New England fishing industry ....	437	increment technique for aging larval fishes .....	493
"New occurrence of epizootic sarcoma in Chesapeake Bay soft shell clams, <i>Mya arenaria</i> ," by C. A. Farley, S. V. Otto, and C. L. Reinisch .....	851	Otter surface sampler .....	480
<i>Nezumia aequalis</i> abundance and distribution in Norfolk Canyon .....	35	OTTO, ROBERT S.—see SOMERTON and OTTO	
<i>Nezumia bairdii</i> abundance and distribution in Norfolk Canyon .....	35	OTTO, S. V.—see FARLEY et al.	
NICHOLAS, JOHN R.—see PAYNE et al.		OXENFORD, HAZEL A., and WAYNE HUNTE, "A preliminary investigation of the stock structure of the dolphin, <i>Coryphaena hippurus</i> , in the western central Atlantic" ..	451
"Northern anchovy, <i>Engraulis mordax</i> , spawning in San Francisco Bay, California, 1978-79, relative to hydrography and zooplankton prey of adults and larvae," by Michael F. McGowan .....	879	Pacific eastern tropical reproductive biology of the spotted dolphin .....	247
Nursery studies estuary studies .....	119	<i>Pandalus borealis</i> —see Shrimp, northern	
"Observations on the reproductive biology of the cownose ray, <i>Rhinoptera bonasus</i> in Chesapeake Bay," by Joseph W. Smith and John V. Merriner .....	871	<i>Panulirus argus</i> —see Lobster, spiny	
		<i>Paralithodes platypus</i> —see Crab, king	
		Parasite studies American lobster .....	197
		benthic amphipods infected with dinoflagellates .....	605
		rhizocephalan infection in king crab .....	327
		swordfish tapeworm .....	754
		"Parasites of benthic amphipods: ciliates," by Phyllis T. Johnson .....	204
		"Parasites of benthic amphipods: dinoflagellates (Duboscquodina: Syndinidae)," by Phyllis T. Johnson .....	605
		Parathemisto (hyperiid amphipod) food items of Pacific salmon .....	77

PARRISH, RICHARD H., DONNA L. MALLICOATE, and RICHARD A. KLINGBEIL, "Age dependent fecundity, number of spawnings per year, sex ratio, and maturation stages in northern anchovy, *Engraulis mordax*" . . . . . 503

PARSONS, D. G., and G. E. TUCKER, "Fecundity of northern shrimp, *Pandalus borealis*, (Crustacea, Decapoda) in areas of the Northwest Atlantic" . . . . . 549

PARSONS, GLENN—see KILLAM and PARSONS

"Patchiness and nutritional condition of zooplankton in the California Current," by Stewart W. Willason, John Favuzzi, and James L. Cox . . . . . 157

"Patterns in distribution and abundance of a noncoevolved assemblage of estuarine fishes in California," by Peter B. Moyle, Robert A. Daniels, Bruce Herbold, and Donald M. Baltz . . . . . 105

PAULY, DANIEL, "A simple method for estimating the food consumption of fish populations from growth data and food conversion experiments" . . . . . 827

PAYNE, P. MICHAEL, JOHN R. NICOLAS, LORETTA O'BRIEN, and KEVIN D. POWERS, "The distribution of the humpback whale, *Megaptera novaeangliae*, on Georges Bank and in the Gulf of Maine in relation to densities of the sand eel, *Ammodytes americanus*" . . . . . 271

PAYNE, P. MICHAEL—see SELZER et al.

PCB's  
organic and trace metals in ocean quahog . . . . . 133

PEARCY, W. G.—see KRYGIER and PEARCY

*Penaeus aztecus*—see Shrimp, brown

*Penaeus setiferus*—see Shrimp, white

PENNINGTON, MICHAEL, "Some statistical techniques for estimating abundance indices from trawl surveys" . . . . . 519

PEREZ, MICHAEL A., and MICHAEL A. BIGG, "Diet of northern fur seals, *Callorhinus ursinus*, off western North America" . . . . . 957

PEREZ, MICHAEL A., and ELIZABETH E. MOONEY, "Increased food and energy consumption of lactating northern fur seals, *Callorhinus ursinus*" . . . . . 371

*Petromyzon marinus*—see Lampreys, sea

PHILLIPS, A. C.—see MASON and PHILLIPS

*Phoca vitulina concolor*—see Seal, harbor

PHONLOR, GERMANO—see POWELL and PHONLOR

Phytoplankton  
zooplankton biomass and nutritional parameters . . . . . 157

PIKITCH, ELLEN K.—see REXSTAD and PIKITCH

Plankton  
identification of *Prionotus* . . . . . 63

PODNIESINSKI, GREG S., and BERNARD J. McALICE, "Seasonality of blue mussel, *Mytilus edulis* L., larvae in the Damariscotta River estuary, Maine, 1969-77" . . . . . 995

Pollock  
ex-vessel price in New England fishing industry . . . . . 437

Pollock, walleye  
sizes consumed by marine mammals in the Bering Sea . . . . . 192

Pollution  
benthic animals as indicator species . . . . . 133

POLOVINA, JEFFREY J., "A variable catchability version of the Leslie model with application to an intensive fishing experiment on a multispecies stock" . . . . . 423

POLOVINA, JEFFREY J., and STEPHEN RALSTON, "An approach to yield assessment for unexploited resources with application to the deep slope fishes of the Marianas" . . . . . 759

POP surveys  
cetacean high-use habitats . . . . . 345

"Population and fishery characteristics of gulf menhaden, *Brevoortia patronus*," by Walter R. Nelson and Dean W. Ahrenholz . . . . . 311

Population sampling devices  
shrimp trawls . . . . . 981

Population studies  
bass, black sea . . . . . 723  
dolphin . . . . . 527  
fish . . . . . 535  
menhaden, gulf . . . . . 311  
sardine . . . . . 540

POTTHOFF, THOMAS, SHARON KELLEY, and JOAQUIN C. JAVECH, "Cartilage and bone development in scombroid fishes" . . . . . 647

POWELL, ALLYN B., and GERMANO PHONLOR, "Early life history of Atlantic menhaden, *Brevoortia tyrannus*, and gulf menhaden, *B. patronus*" . . . . . 991

POWER, JAMES H., "A model of the drift of northern anchovy, *Engraulis mordax*, larvae in the California Current" . . . . . 585

POWERS, KEVIN D.—see PAYNE et al.

Predation  
of northern anchovy . . . . . 859

"A preliminary investigation of the stock structure of the dolphin, *Coryphaena hippurus*, in the western central Atlantic," by Hazel A. Oxenford and Wayne Hunte . . . . . 451

PRESCOTT, ROBERT—see SELZER et al.



PRINCE, ERIC D., DENNIS W. LEE, CHARLES A. WILSON, and JOHN M. DEAN, "Longevity and age validation of a tag-recaptured Atlantic sailfish, <i>Istiophorus platypterus</i> , using dorsal spines and otoliths" . . . . .	493	"Reproductive biology of king mackerel, <i>Scomberomorus cavalla</i> , from the southeastern United States," by John H. Finucane, L. Alan Collins, Harold A. Brusher, and Carl H. Saloman . . . . .	841
<i>Prionotus carolinus</i> —see Searobin, northern		Reproductive studies	
<i>Prionotus evolans</i> —see Searobin, striped		anchovy, northern . . . . .	503, 879
Quahog, ocean		bass, black sea . . . . .	723
organic and trace metal levels . . . . .	133	crab, golden king . . . . .	571
QUAST, JAY C., "Annual production of eviscerated body weight, fat, and gonads by Pacific herring, <i>Clupea harengus pallasi</i> , near Auke Bay, southeastern Alaska" . . . . .	705	dolphin, spotted . . . . .	247
		mackerel, king . . . . .	841
		mussel, blue . . . . .	995
		ray, cownose . . . . .	871
		shrimp, caridean . . . . .	915
		squid, market . . . . .	771
		tuna, skipjack . . . . .	895
RALSTON, STEPHEN—see DAILEY and RALSTON		"Resilience of the fish assemblage in New England tidepools," by Bruce B. Collette . . . . .	200
—see POLOVINA and RALSTON			
RALSTON, STEPHEN, "An intensive fishing experiment for the caridean shrimp, <i>Heterocarpus laevigatus</i> , at Alamagan Island in the Marina Archipelago" . . . . .	927	Resource assessment techniques	
		hydroacoustic echo integration . . . . .	287
		line intercept survey . . . . .	287
		line transect survey . . . . .	287
		abundance of widow rockfish . . . . .	287
RALSTON, STEPHEN, REGINALD M. GOODING, and GERALD M. LUDWIG, "An ecological survey and comparison of bottom fish resource assessments (submersible versus handline fishing) at Johnston Atoll" . . . . .	141	REXSTAD, ERIC A., and ELLEN K. PIKITCH, "Stomach contents and food consumption estimates of Pacific hake, <i>Merluccius productus</i> " . . . . .	947
		<i>Rhinoptera loonassus</i> —see Ray, cownose	
RANCK, CAROL L., FRED M. UTTER, GEORGE B. MILNER, and GARY B. SMITH, "Genetic confirmation of specific distinction of arrowtooth flounder, <i>Atheresthes stomias</i> , and Kamchatka flounder, <i>A. evermanni</i> " . . . . .	222	"Rhizocephalan infection in blue king crabs, <i>Paralithodes platypus</i> , from Olga Bay, Kodiak Island, Alaska," by P. T. Johnson, R. A. MacIntosh, and D. A. Somerton . . . . .	177
		Rhizocephalans	
"Rates of increase in dolphin population size," by Stephen B. Reilly and Jay Barlow . . . . .	527	length-weight relationships of king crab . . . . .	327
RATTY, F. J., Y. C. SONG, and R. M. LAURS, "Chromosomal analysis of albacore, <i>Thunnus alalunga</i> , and yellowfin, <i>Thunnus albacares</i> , and skipjack, <i>Katsuwonus pelamis</i> , tuna" . . . . .	469	Rockfish	
		problems in sampling commercial landings . . . . .	409
		Rockfish, widow	
Ray, cownose		behavior studies . . . . .	287
reproductive biology . . . . .	871	methodologies for assessing abundance . . . . .	287
Red tide		Rockfish, yellowtail	
effects on <i>Gymnodinium splendens</i> swimming speed . . . . .	460	fat volume comparisons . . . . .	743
REINISCH, C. L.—see FARLEY et al.		ROGERS, S. GORDON, HIRAM T. LANGSTON, and TIMOTHY E. TARGETT, "Anatomical trauma to sponge-coral reef fishes captured by trawling and angling" . . . . .	697
REILLY, STEPHEN B., and JAY BARLOW, "Rates of increase in dolphin population size" . . . . .	527	"The role of estuarine and offshore nursery areas for young English sole, <i>Parophrys vetulus</i> Girard, of Oregon," by E. E. Krygier and W. G. Pearcy . . . . .	119
REIS, ENIR GIRONDI, "Age and growth of the marine catfish, <i>Netuma barba</i> (Siluriformes, Ariidae), in the estuary of the Patos Lagoon (Brasil)" . . . . .	679	ROSENBLATT, RICHARD H.—see GRAHAM et al.	
RENAUD, MAURICE L., "Hypoxia in Louisiana coastal waters during 1983: implications for fisheries" . . . . .	19	ROUMILLAT, WILLIAM A.—see WENNER et al.	
"Reproductive biology of female spotted dolphins, <i>Stenella attenuata</i> , from the eastern tropical Pacific," by A. C. Myrick, Jr., A. A. Hohn, J. Barlow, and P. A. Sloan . . . . .	247	Sablefish, larval	
		starvation . . . . .	484
		prey size selection . . . . .	484

Sailfish, Atlantic longevity and age validation .....	493	<i>Sebastes flavidus</i> —see Rockfish, yellowtail	
Salmon, chinook methods used to estimate spawning escapement.....	261	SELZER, LAWRENCE, A., GREG EARLY, PATRICIA M. FIORELLI, P. MICHAEL PAYNE, and ROBERT PRESCOTT, "Stranded animals as indicators of prey utilization by harbor seals, <i>Phoca vitulina concolor</i> , in southern New England" .....	217
Salmon, Pacific food habits in the Strait of Juan de Fuca .....	77	SEN, A. R., "Methodological problems in sampling commercial rockfish landings" .....	409
Salmon, smolts correlation with seabirds .....	279	"The sex ratio and gonad indices of swordfish, <i>Xiphias gladius</i> , caught off the coast of Southern California in 1978," by Earl C. Weber and Stephen R. Goldberg ...	185
SALOMAN, CARL H.—see FINUCANE et al.		Shark, longfin mako first record in the Gulf of Mexico .....	748
Samplers improved otter surface sampler .....	480	SHEPARD, ANDREW N., ROGER B. THEROUX, RICHARD A. COOPER, and JOSEPH R. UZMANN, "Ecology of Ceriantaria (Coelenterata, Anthozoa) of the northwest Atlantic from Cape Hatteras to Nova Scotia" ..	625
Sarcoma occurrence in soft shell clams .....	851	SHIRLEY, THOMAS C.—see HAWKES et al.	
Sardine population collapse .....	535	Shrimp affect of hypoxia on abundance and distribution .....	19
population studies .....	535	Shrimp, caridean an intensive fishing experiment .....	927
"Scavenger feeding by subadult striped bass, <i>Morone saxatilis</i> , below a low-head hydroelectric dam," by John Warner and Boyd Kynard .....	220	reproduction, distribution, and growth .....	915
<i>Scomberomorus cavalla</i> —see Mackerel, king		Shrimp, northern fecundity studies in northwest Atlantic .....	549
Scombroid fish cartilage and bone development .....	647	Shrimp, penaid population sampling .....	981
Sea surface studies monitoring chlorophyll concentration in the tropical Pacific .....	687	Shrimp, pink—see Shrimp, northern	
Seabirds correlations with salmon smolts .....	279	SIBERT, JOHN R.—see HUNTER et al.	
"Seabirds near an Oregon estuarine salmon hatchery in 1982 and during the 1983 El Niño," by Range D. Bayer ..	279	"A simple method for estimating the food consumption of fish populations from growth data and food conversion experiments," by Daniel Pauly .....	827
Seagrass meadows community studies .....	443	"Sizes of walleye pollock, <i>Theragra chalcogramma</i> , consumed by marine mammals in the Bering Sea," by Kathryn J. Frost and Lloyd F. Lowry .....	192
comparison of two sampling methods .....	443	"Size-specific vulnerability of northern anchovy, <i>Engraulis mordax</i> , larvae to predation by fishes," by Arild Folkvord and John R. Hunter .....	859
Seal, harbor in southern New England .....	217	SLOAN, P. A.—see MYRICK et al.	
Seal, northern fur arrival times and numbers on St. Paul Island, Alaska ..	383	SMITH, GARY B.—see RANCK et al.	
diet .....	957	SMITH, JOSEPH, W., and JOHN V. MERRINER, "Observations on the reproductive biology of the cownose ray, <i>Rhinoptera bonasus</i> , in Chesapeake Bay" .....	87
food and energy consumption of lactating females ...	371	SMITH, T. D.—see LO and SMITH	
Searobin, northern differentiation of <i>Prionotus</i> eggs .....	63	Snappers yield assessment in the Marianas .....	759
Searobin, striped differentiation of <i>Prionotus</i> eggs .....	63		
"Seasonality of blue mussel, <i>Mytilus edulis</i> L., larvae in the Damariscotta River estuary, Maine, 1969-77," by Greg S. Podniesinski and Bernard J. McAlice .....	995		
<i>Sebastes entomelas</i> —see Rockfish, widow			

Sole, English estuarine and offshore nursery areas . . . . .	119	"Stranded animals as indicators of prey utilization by harbor seals, <i>Phoca vitulina concolor</i> , in southern New England," by Lawrence A. Selzer, Greg Early, Patricia M. Fiorelli, P. Michael Payne, and Robert Prescott . . . . .	217
SOMERTON, D. A.—see JOHNSON et al.		Submersibles resource assessment at Johnston Atoll . . . . .	141
SOMERTON, DAVID A., and ROBERT S. OTTO, "Distri- bution and reproductive biology of the golden king crab, <i>Lithodes aequispina</i> , in the eastern Bering Sea" . . . . .	571	"Survival and growth of striped bass, <i>Morone saxatilis</i> , and <i>Morone</i> hybrid larvae: laboratory and pond enclosure experiments," by Edward D. Houde and Lawrence Lubbers III . . . . .	905
"Some statistical techniques for estimating abundance in- dices from trawl surveys," by Michael Pennington . . . .	519	Swordfish sex ratio and gonad indices . . . . .	185
SONG, Y. C.—see RATTY et al.		morphology of <i>Fistulicola plicatus</i> . . . . .	754
SORENSEN, PETER W., MARCO L. BIANCHINI, and HOWARD E. WINN, "Diel foraging activity of American eels, <i>Anguilla rostrata</i> (LeSueur), in a Rhode Island estuary" . . . . .	746	SYKES, STEPHEN D., and LOUIS W. BOTSFORD, "Chinook salmon, <i>Oncorhynchus tshawytscha</i> , spawning escapement based on multiple mark-recapture of carcasses" . . . . .	261
"Sounds from Bryde, <i>Balaenoptera edeni</i> , and finback, <i>B.</i> <i>physalus</i> , whales in the Gulf of California," by William C. Cummings, Paul O. Thompson, and Samuel J. Ha . . . . .	359	TARGETT, TIMOTHY E.—see ROGERS et al.	
Southern California Bight distribution and abundance of common dolphin . . . . .	333	Taxonomy arrowtooth and Kamchatka flounders . . . . .	222
Squid, market growth, behavior, and sexual maturation . . . . .	771	TESTER, PATRICIA A., and ANDREW G. CAREY, JR., "Instar identification and life history aspects of juve- nile deepwater spider crabs, <i>Chionoecetes tanneri</i> Rathbun" . . . . .	973
SQUIRES, DALE, "Ex-vessel price linkages in the New England fishing industry" . . . . .	437	THEILACKER, GAIL H., "Starvation-induced mortality of young sea-caught jack mackerel, <i>Trachurus sym- metricus</i> , determined with histological and morphological methods" . . . . .	1
"The spawning frequency of skipjack tuna, <i>Katsuwonus</i> <i>pelamis</i> , from the South Pacific," by J. Roe Hunter, Beverly J. Macewicz, and John R. Sibert . . . . .	895	<i>Theragra chalcogramma</i> —see Pollock, walleye	
"Starvation-induced mortality of young sea-caught jack mackerel, <i>Trachurus symmetricus</i> , determined with histological and morphological methods," by Gail H. Theilacker . . . . .	1	THEROUX, ROGER B.—see SHEPARD et al.	
Statistical methods estimating abundance . . . . .	519	THOMPSON, PAUL O.—see CUMMINGS et al.	
STEIMLE, FRANK W., PAUL D. BOEHM, VINCENT S. ZDANOWICZ, and RALPH A. BRUNO, "Organic and trace metal levels in ocean quahog, <i>Arctica islandica</i> Linné, from the northwestern Atlantic" . . . . .	133	<i>Thunnus alalunga</i> —see Albacore	
<i>Stenella attenuata</i> —see Dolphin, spotted		<i>Thunnus albacares</i> —see Tuna, yellowfin	
STIEPIEN, CAROL A., "Life history and larval develop- ment of the giant kelpfish, <i>Heterostichus rostratus</i> Girard, 1854" . . . . .	809	Tidepools fish assemblages in New England . . . . .	200
STIER, KATHLEEN, and BOYD KYNARD, "Abundance, size, and sex ratio of adult sea-run sea lampreys, <i>Petromyzon marinus</i> , in the Connecticut River" . . . . .	476	<i>Townsend Cromwell</i> resource assessment at Johnston Atoll . . . . .	141
STIER, KATHLEEN, and BOYD KYNARD, "Movement of sea-run sea lampreys, <i>Petromyzon marinus</i> , during the spawning migration in the Connecticut River" . . . . .	749	<i>Trachurus symmetricus</i> —see Mackerel, jack	
"Stomach contents and food consumption estimates of Pacific hake, <i>Merluccius productus</i> ," by Eric A. Rexstad and Ellen K. Pikitch . . . . .	947	Trawls, shrimp population sampling devices . . . . .	981
		Trawl surveys statistical methods for estimating abundance . . . . .	519
		Trawling anatomical trauma to sponge-coral reef fishes . . . . .	697
		TUCKER, G. E.—see PARSONS and TUCKER	

Tuna, skipjack		WEBER, EARL C., and STEPHEN R. GOLDBERG,	
chromosomal analysis . . . . .	469	"The sex ratio and gonad indices of swordfish, <i>Xiphias gladius</i> , caught off the coast of Southern California in 1978" . . . . .	185
spawning frequency . . . . .	895		
Tuna, yellowfin		WENNER, CHARLES A., WILLIAM A. ROUMILLAT,	
chromosomal analysis . . . . .	469	and C. WAYNE WALTZ, "Contributions to the life history of black sea bass, <i>Centropristis striata</i> , off the south-eastern United States" . . . . .	723
incidental dolphin mortality . . . . .	559		
morphology and swimming mode . . . . .	463	Whales, Bryde	
TURK, P. E.—see YANG et al.		underwater sounds in the Gulf of California . . . . .	359
"Type, quantity, and size of food of Pacific salmon ( <i>Oncorhynchus</i> ) in the Strait of Juan de Fuca, British Columbia," by Terry D. Beacham . . . . .	77	Whales, finback	
		underwater sounds in the Gulf of California . . . . .	359
UCHIYAMA, JAMES H., RAYMOND K. BURCH, and SYD A. KRAUL, JR., "Growth of dolphins, <i>Coryphaena hippurus</i> and <i>C. equisetis</i> , in Hawaiian waters as determined by daily increments on otoliths" . . . . .	186	Whales, humpback	
		distribution in relation to sand eels . . . . .	271
Underwater sounds		WILKINS, MARK E., "Development and evaluation of methodologies for assessing and monitoring the abundance of widow rockfish, <i>Sebastes entomelas</i> " . . . . .	287
Bryde and finback whales . . . . .	359	WILLASON, STEWART W., JOHN FAVUZZI, and JAMES L. COX, "Patchiness and nutritional condition of zooplankton in the California Current" . . . . .	157
UTTER, FRED M.—see RANCK et al.		WILSON, CHARLES, A.—see PRINCE et al.	
UZMANN, JOSEPH R.—see SHEPARD et al.		WINN, HOWARD E.—see KENNEY and WINN —see SORENSEN et al.	
VAN ENGEL, W. A., R. E. HARRIS, JR., and D. E. ZWERNER, "Occurrence of some parasites and a commensal in the American lobster, <i>Homarus americanus</i> , from the Mid-Atlantic Bight" . . . . .	197	<i>Xiphias gladius</i> —see Swordfish	
"A variable catchability version of the Leslie model with application to an intensive fishing experiment on a multispecies stock," by Jeffrey J. Polovina . . . . .	423	YANG, M. S., and P. A. LIVINGSTON, "Food habits and diet overlap of two congeneric species, <i>Atheresthes stomias</i> and <i>Atheresthes evermanni</i> , in the eastern Bering Sea" . . . . .	615
"Variations in the morphology of <i>Fistulicola plicatus</i> Rudolphi (1802) (Cestoda: Pseudophyllidea) from the swordfish, <i>Xiphias gladius</i> L., in the northwest Atlantic Ocean," by W. E. Hogans and P. C. F. Hurley . . . . .	754	YONEDA, NELSON TAKUMI—see MATSUURA and YONEDA	
WAHLEN, BRUCE E., "Incidental dolphin mortality in the eastern tropical Pacific tuna fishery, 1973 through 1978" . . . . .	559	ZDANOWICZ, VINCENT S.—see STEIMLE et al.	
WALTZ, C. WAYNE—see WENNER et al.		Zooplankton	
WARNER, JOHN, and BOYD KYNARD, "Scavenger feeding by subadult striped bass, <i>Morone saxatilis</i> , below a low-head hydroelectric dam" . . . . .	220	California Current . . . . .	157
		ZWERNER, D. E.—see VAN ENGEL et al.	

## NOTICES

NOAA Technical Reports NMFS published during first 6 months of 1986.

39. Survey of fish protective facilities at water withdrawal sites on the Snake and Columbia Rivers. By George A. Swan, Tommy G. Withrow, and Donn L. Park. April 1986, iii + 34 p., 26 figs., 6 tables.

Some NOAA publications are available by purchase from the Superintendent of Documents, U.S. Government Printing Office, Washington, DC 20402.

### Gulf of Mexico Ichthyoplankton Samples

The **Gulf States Marine Fisheries Commission** wishes to announce the availability of Gulf of Mexico ichthyoplankton samples for loan to qualified researchers. Samples have been and are continuing to be collected for SEAMAP (Southeast Area Monitoring and Assessment Program), a multi-year international federal/state/university program of the GSMFC. Neuston and bongo nets were employed for specimen collection in a one degree latitude/longitude grid over the entire Gulf from 26°N northward and sorted and preliminarily identified by the Plankton Sorting and Identification Center, Szczecin, Poland. At present samples from 1982 (7057 lots, 93 families), 1983 (8351 lots, 106 families) and material from one summer cruise in 1984 (4155 lots, 75 families) are available for loan. Lots of unsorted fish eggs are also available from these years. Most samples are sorted to the family level, although many have identification to generic or species level. Additional 1984 samples are expected to become available by the end of 1986. Specimens are available for loan on a 6-month renewable basis. Researchers interested in obtaining additional information can contact either SEAMAP Ichthyoplankton Curator, Florida Department of Natural Resources, Bureau of Marine Research, St. Petersburg, FL 33701, or SEAMAP Coordinator, Gulf States Marine Fisheries Commission, P.O. Box 726, Ocean Springs, MS 39564.

U.S. POSTAL SERVICE  
**STATEMENT OF OWNERSHIP, MANAGEMENT AND CIRCULATION**  
 (Required by 39 U.S.C. 3685)

<b>1. TITLE OF PUBLICATION</b> Fishery Bulletin		<b>A. PUBLICATION NO.</b> 3 6 6 - 3 7 0		<b>2. DATE OF FILING</b> 1 October 1986
<b>3. FREQUENCY OF ISSUE</b> Quarterly		<b>A. NO. OF ISSUES PUBLISHED ANNUALLY</b> 4		<b>B. ANNUAL SUBSCRIPTION PRICE</b> \$21.00
<b>4. COMPLETE MAILING ADDRESS OF KNOWN OFFICE OF PUBLICATION (Street, City, County, State and ZIP Code) (Not printers)</b> Scientific Publications Office, NMFS 7600 Sand Point Way N.E., BIN C15700 (Bldg. 1), Seattle, WA 98115				
<b>5. COMPLETE MAILING ADDRESS OF THE HEADQUARTERS OR GENERAL BUSINESS OFFICES OF THE PUBLISHERS (Not printers)</b> National Marine Fisheries Service, NOAA, DOC Universal Building, Washington, DC 20235				
<b>6. FULL NAMES AND COMPLETE MAILING ADDRESS OF PUBLISHER, EDITOR, AND MANAGING EDITOR (This item MUST NOT be blank)</b>				
<b>PUBLISHER (Name and Complete Mailing Address)</b> Jack McCormick, Scientific Publications Office, NMFS 7600 Sand Point Way N.E., BIN C15700 (Bldg. 1), Seattle, WA 98115				
<b>EDITOR (Name and Complete Mailing Address)</b> Mary Fukuyama, Scientific Publications Office, NMFS 7600 Sand Point Way N.E., BIN C15700 (Bldg. 1), Seattle, WA 98115				
<b>MANAGING EDITOR (Name and Complete Mailing Address)</b> Mary Fukuyama, Scientific Publications Office, NMFS 7600 Sand Point Way N.E., BIN C15700 (Bldg. 1), Seattle, WA 98115				
<b>7. OWNER (If owned by a corporation, its name and address must be stated and also immediately thereunder the names and addresses of stockholders owning or holding 1 percent or more of total amount of stock. If not owned by a corporation, the names and addresses of the individual owners must be given. If owned by a partnership or other unincorporated firm, its name and address, as well as that of each individual must be given. If the publication is published by a nonprofit organization, its name and address must be stated.) (Item must be completed)</b>				
<b>FULL NAME</b> U.S. Department of Commerce		<b>COMPLETE MAILING ADDRESS</b> 14th St., NW, Washington, DC 20230		
<b>8. KNOWN BONDHOLDERS, MORTGAGEES, AND OTHER SECURITY HOLDERS OWNING OR HOLDING 1 PERCENT OR MORE OF TOTAL AMOUNT OF BONDS, MORTGAGES OR OTHER SECURITIES (If there are none, so state)</b>				
<b>FULL NAME</b> None		<b>COMPLETE MAILING ADDRESS</b>		
<b>9. FOR COMPLETION BY NONPROFIT ORGANIZATIONS AUTHORIZED TO MAIL AT SPECIAL RATES (Section 411.3. DMM only)</b> The purpose, function, and nonprofit status of this organization and the exempt status for Federal income tax purposes (Check one)				
<input checked="" type="checkbox"/> (1) HAS NOT CHANGED DURING PRECEDING 12 MONTHS		<input type="checkbox"/> (2) HAS CHANGED DURING PRECEDING 12 MONTHS		(If changed, publisher must submit explanation of changes with this statement.)
<b>10. EXTENT AND NATURE OF CIRCULATION</b>		<b>AVERAGE NO. COPIES EACH ISSUE DURING PRECEDING 12 MONTHS</b>	<b>ACTUAL NO. COPIES OF SINGLE ISSUE PUBLISHED NEAREST TO FILING DATE</b>	
<b>A. TOTAL NO. COPIES (Not Press Run)</b>		2,197	2,066	
<b>B. PAID CIRCULATION</b> 1. SALES THROUGH DEALERS AND CARRIERS, STREET VENDORS AND COUNTER SALES (handled by U.S. GPO Wash., DC 20240)				
2. MAIL SUBSCRIPTION				
<b>C. TOTAL PAID CIRCULATION (Sum of 10B1 and 10B2)</b> (printed for sales)		750	600	
<b>D. FREE DISTRIBUTION BY MAIL, CARRIER OR OTHER MEANS</b> (requested copies) SAMPLES, COMPLIMENTARY, AND OTHER FREE COPIES		1,447	1,466	
<b>E. TOTAL DISTRIBUTION (Sum of C and D)</b>		2,197	2,066	
<b>F. COPIES NOT DISTRIBUTED</b> 1. OFFICE USE, LEFT OVER, UNACCOUNTED, SPOILED AFTER PRINTING		---	---	
2. RETURN FROM NEWS AGENTS		---	---	
<b>G. TOTAL (Sum of E, F1 and 2 - should equal net press run shown in A)</b>		2,197	2,066	
<b>11. I certify that the statements made by me above are correct and complete</b>		<b>SIGNATURE AND TITLE OF EDITOR, PUBLISHER, BUSINESS MANAGER, OR OWNER</b> Jack McCormick		

(See instruction on reverse)  
 6088 032  
 2

# INFORMATION FOR CONTRIBUTORS TO THE *FISHERY BULLETIN*

Manuscripts submitted to the *Fishery Bulletin* will reach print faster if they conform to the following instructions. These are not absolute requirements, of course, but desiderata.

## CONTENT OF MANUSCRIPT

The **title page** should give only the title of the paper, the author's name, his affiliation, and mailing address, including ZIP code.

The **abstract** should not exceed one double-spaced page.

In the **text**, *Fishery Bulletin* style, for the most part follows that of the *U.S. Government Printing Office Style Manual*. Fish names follow the style of the American Fisheries Society Special Publication No. 42, *A List of Common and Scientific Names of Fishes from the United States and Canada*, Fourth Edition, 1980.

**Text footnotes** should be typed separately from the text.

**Figures and tables**, with their legends and headings, should be self-explanatory, not requiring reference to the text. Their placement should be indicated in the right-hand margin of the manuscript.

Preferably **figures** should be reduced by photography to 5¼ inches (for single column figures, allowing for 50% reduction in printing), or to 12 inches (for double column figures). The maximum height, for either width, is 14 inches. Photographs should be printed on high quality or glossy paper.

Do not send original drawings to the Scientific Editor, if they, rather than the photographic reductions, are needed by the printer; the Scientific Publications Office will request them.

Each **table** should start on a separate page. Consistency in headings and format is desirable. Vertical rules should be avoided, as they make the tables more expensive to print. Footnotes in tables should be numbered sequentially in arabic numerals. To avoid confusion with powers, they should be placed to the *left* of numerals.

**Acknowledgments**, if included, are placed at the end of the text.

Literature is cited in the text as: Lynn and Reid (1968) or (Lynn and Reid 1968). All papers referred to in the text should be listed alphabetically by the senior author's surname under the heading "Literature Cited." Only the author's surname and initials are required in the **literature cited**. The accuracy of the **literature cited** is the respon-

sibility of the author. Abbreviation of names of periodicals and serials should conform to *Serial Sources for the BIOSIS Data Base* (*Chemical Abstracts* uses this system, which was developed by the American Standard Association).

Common **abbreviations and symbols**, such as mm, m, g, l, ml, mg, °C (for Celsius), %, °, and ° forth, should be used. Abbreviate units of measure only when used with numerals. Periods are rarely used with abbreviations.

We prefer that **measurements** be given in metric units; other equivalent units may be given in parentheses.

## FORM OF THE MANUSCRIPT

The original of the manuscript should be typed, double-spaced, on white bond paper. Use one triple-space heading. We would rather receive good duplicated copies of manuscripts than carbon copies. The sequence material should be:

TITLE PAGE

ABSTRACT

TEXT

LITERATURE CITED

TEXT FOOTNOTES

APPENDIX

TABLES (Each table should be numbered with an arabic numeral and heading provided).

LIST OF FIGURES (Entire figure legends)

FIGURES (Each figure should be numbered with an arabic numeral, legends are desired)

## ADDITIONAL INFORMATION

Send the ribbon copy and two duplicated or carbon copies of the manuscript to:

Dr. William J. Richards, Scientific Editor  
*Fishery Bulletin*  
Southeast Fisheries Center Miami Laboratory  
National Marine Fisheries Service, NOAA  
75 Virginia Beach Drive  
Miami, FL 33149-1099

Fifty **separates** will be supplied to an author free of charge and 50 supplied to his organization. No covers will be supplied.

RENSTAD, ERIC A., and ELLEN K. PEKITCH. Stomach contents and food consumption estimates of Pacific hake, *Merluccius productus* . . . . . 947

PEREZ, MICHAEL A., and MICHAEL A. BIGG. Diet of northern fur seals, *Callorhinus ursinus*, off western North America . . . . . 957

TESTER, PATRICIA A., and ANDREW G. CAREY, JR. Instar identification and life history aspects of juvenile deepwater spider crabs, *Chionoecetes tanneri* Rathbun . . . . . 973

Notes

CODY, TERRY J., and BILL E. FULS. Comparison of catches in 4.3 m and 12.2 m shrimp trawls in the Gulf of Mexico . . . . . 981

POWELL, ALBERT, and GERMANO PHONLOR. Early life history of Atlantic menhaden, *Brevoortia tyrannus*, and gulf menhaden, *B. patronus* . . . . . 991

PODNIESIENSKI, JEG S., and BERNARD J. McALICE. Seasonality of blue mussel, *Mytilus edulis*, larvae in the Damariscotta River estuary, Maine, 1969-77 . . . . . 995

NOTICES . . . . . 1003

NOTICES . . . . . 1017

LIBRARY  
MARINE BIOLOGICAL LABORATORY  
WOODS HOLE, MA 02543

F











MBL WHOI LIBRARY



WH 196C H

