

FLY-RODS AND FLY-TACKLE



UC-NRLF



5B 25 724

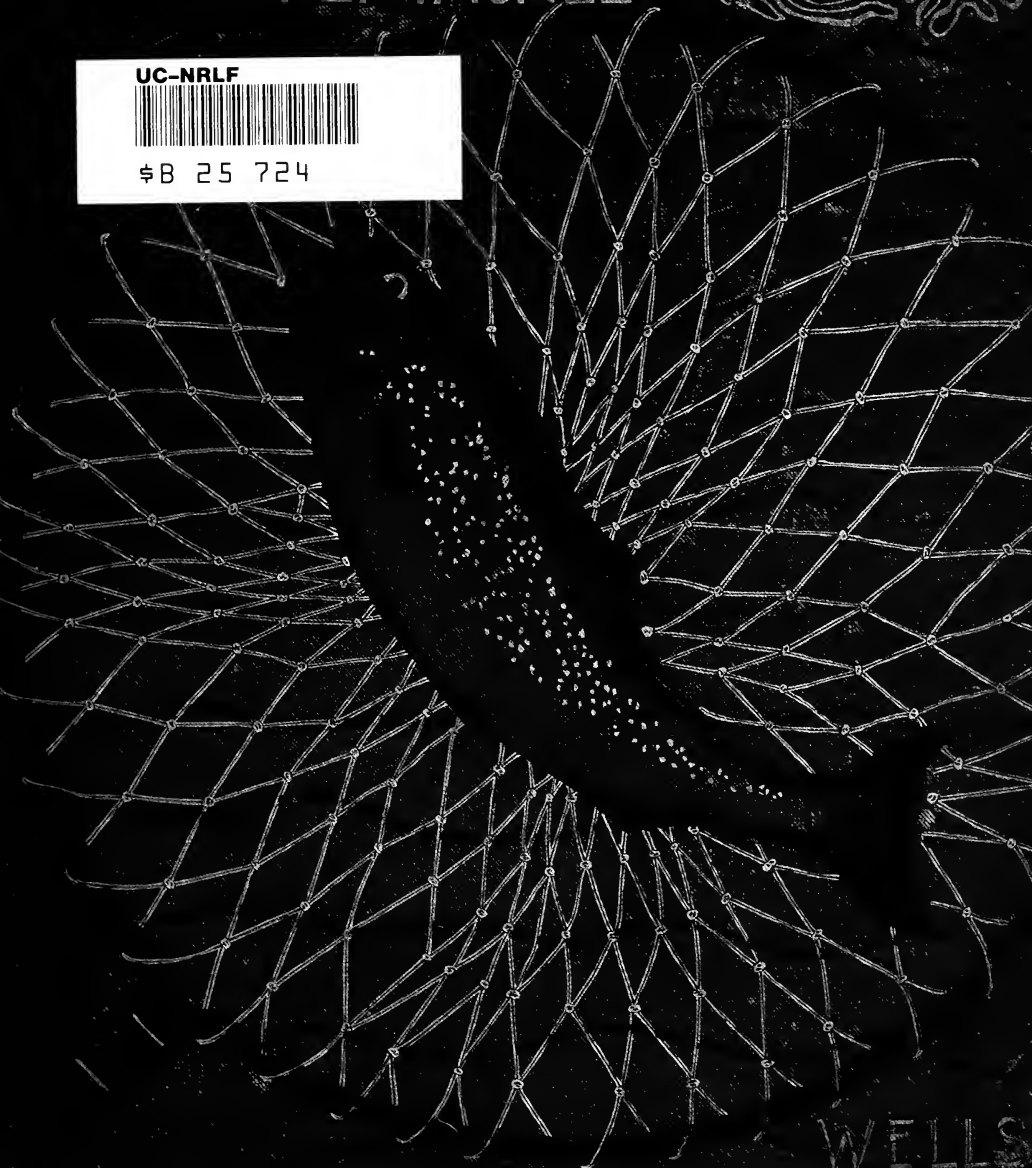

WELLS

BERKELEY
GENERAL
LIBRARY
UNIVERSITY OF
CALIFORNIA

EX
libris

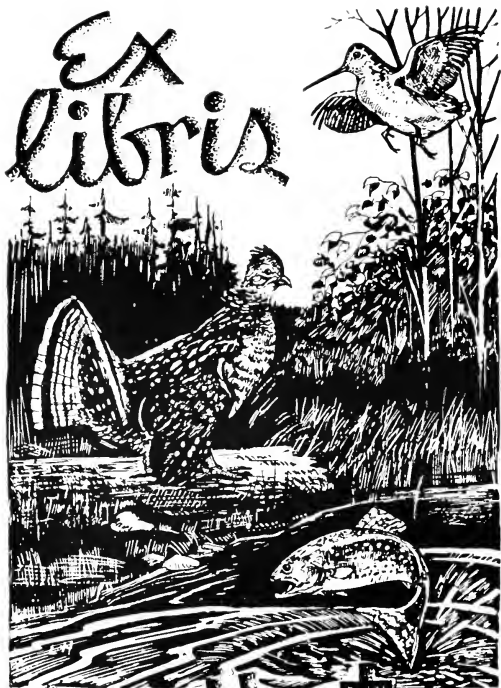

Don Horter

Wm. P. Adams -

Digitized by the Internet Archive
in 2007 with funding from
Microsoft Corporation

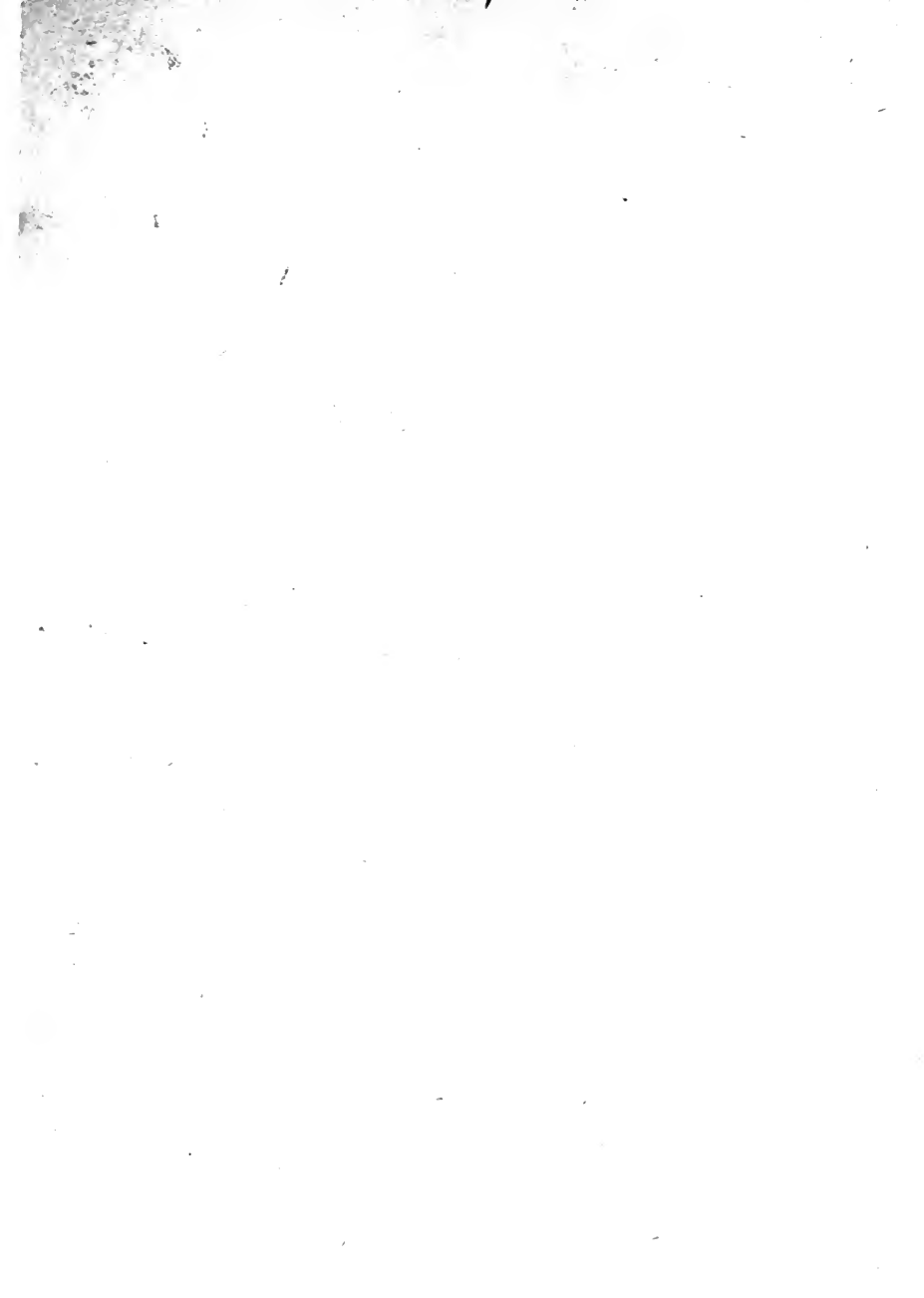

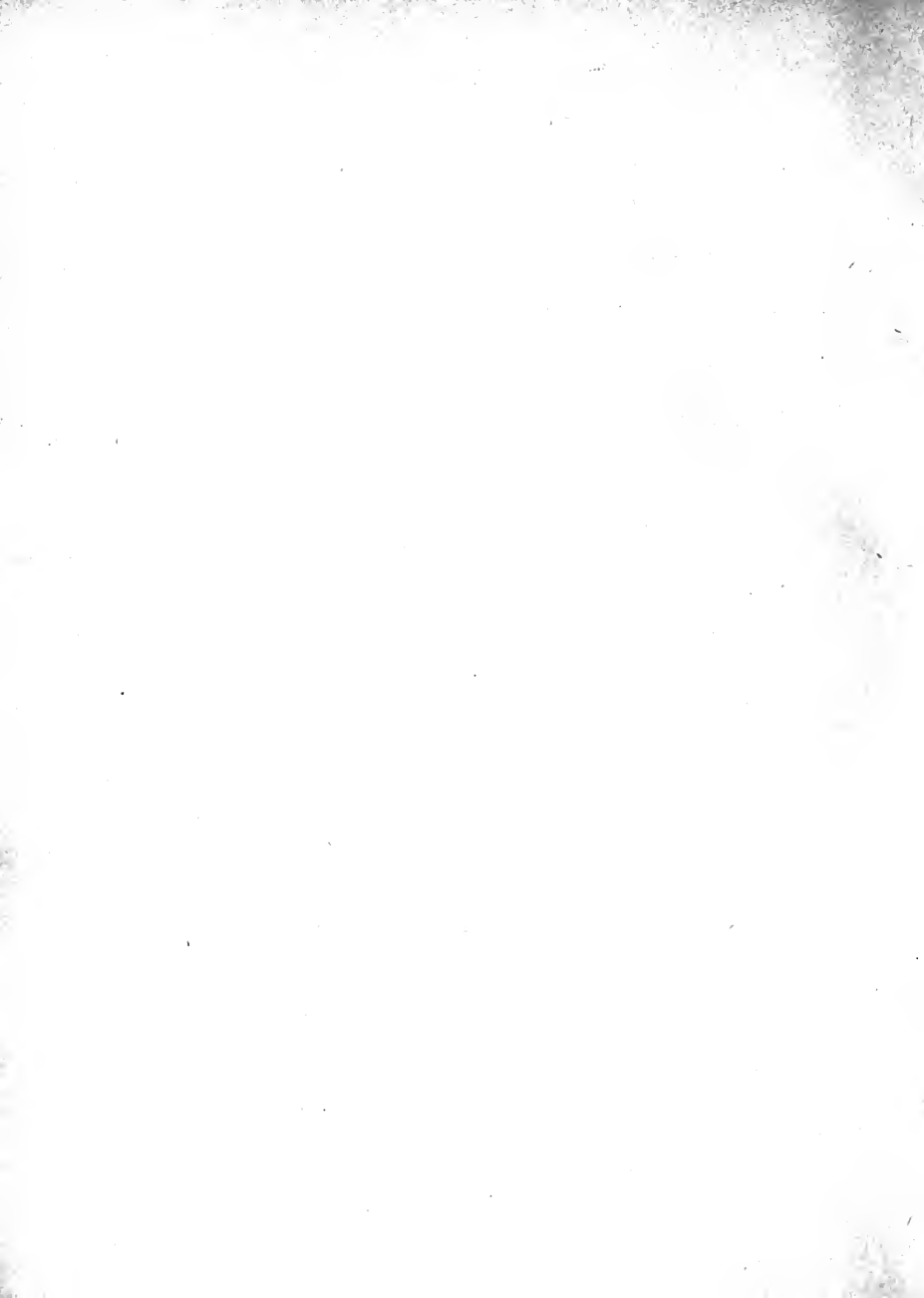

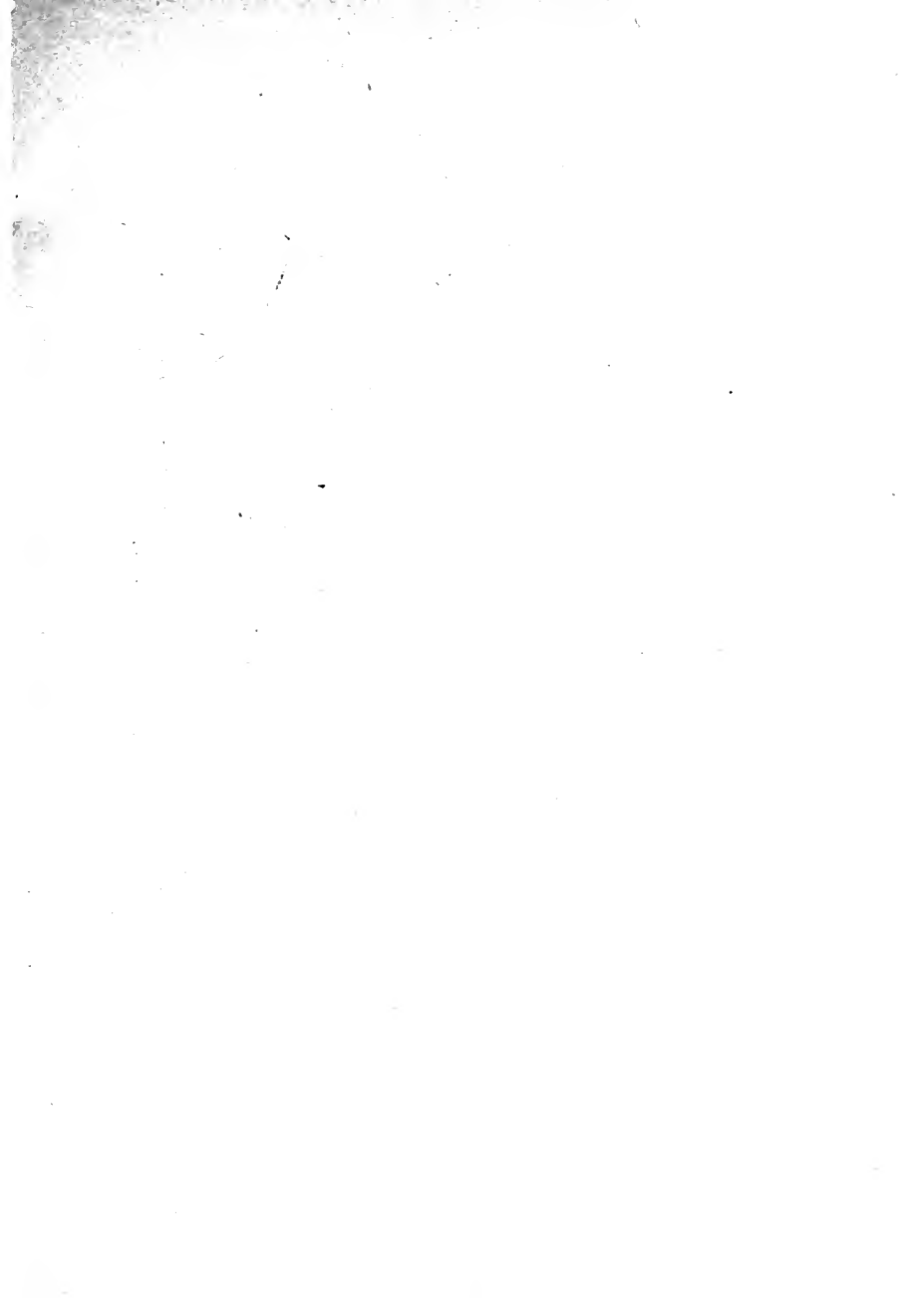



EIGHT-POUND BROOK-TROUT (*SALMO FONTINALIS*), TAKEN AT RANGELY LAKES, AUG. 22, 1884.

[From a Photograph from Life.]

FLY-RODS AND FLY-TACKLE

SUGGESTIONS

AS TO THEIR MANUFACTURE AND USE

By HENRY P. WELLS

ILLUSTRATED

NEW YORK

HARPER & BROTHERS, FRANKLIN SQUARE

1885

Copyright, 1885, by Harper & Brothers.

All rights reserved.

SH451
W37

CONTENTS.

	<i>Page</i>
<i>CHAPTER I.</i>	
<i>Fish-hooks, and the Principles which Govern their Efficiency</i>	9
<i>CHAPTER II.</i>	
<i>How Fish-hooks are Made</i>	33
<i>CHAPTER III.</i>	
<i>Lines</i>	40
<i>CHAPTER IV.</i>	
<i>Leaders</i>	55
<i>CHAPTER V.</i>	
<i>Reels</i>	90
<i>CHAPTER VI.</i>	
<i>Rods and Rod Material</i>	99
<i>CHAPTER VII.</i>	
<i>Rod-making</i>	156
<i>CHAPTER VIII.</i>	
<i>Repairs</i>	232

M842130.

Contents.

<i>CHAPTER IX.</i>		<i>Page</i>
<i>Casting the Fly</i>		<i>257</i>
<i>CHAPTER X.</i>		
<i>Flies and Fly-fishing</i>		<i>287</i>
<i>CHAPTER XI.</i>		
<i>Miscellaneous Suggestions</i>		<i>333</i>
<i>INDEX</i>		<i>359</i>

INTRODUCTION.

NOT before you anglers who have grown gray in the use of the rod do I presume to display my feeble light. It is to the beginner that I address myself, remembering, during my own novitiate, with what longing I sought, and how gratefully I would have received, the information contained in this book.

HENRY P. WELLS.



FLY-RODS AND FLY-TACKLE.

CHAPTER I.

FISH-HOOKS, AND THE PRINCIPLES WHICH GOVERN THEIR EFFICIENCY.

THE hook is the foundation of the Angler's Art: it is the point of attack. Weakness or inefficiency here can be aided little by the art of him who handles it, and not at all by any excellence of tackle elsewhere. The most skilled can but strike at the proper moment, and with the proper degree of force.

What senses a fish has, and to what degree they are developed, has been the subject of frequent discussion; and while there may be and still is some doubt among scientists as to what he does possess, there can be but one opinion among anglers: that he is, at least at times, altogether destitute of the sense of propriety. Without consultation with the angler, and without the slightest deference to his wishes, he rises to the fly or ignores it, as to him seems best; and when he does come he comes in his own way, seizing the fly with resolution or diffidence, and in a manner over which the angler has no control.

Any hook which will hang together will secure the fish at times, and so will a bean-pole and clothes-line; but this is the art of the hippopotamus, who flounders through

jungle and morass by sheer brute force, rather than that of the civilized man, who sweeps the one from his path and bridges the other.

A lady seeking to tickle the ear of a celebrated painter with that refinement of flattery only possible to women, asked how he mixed his colors to produce effects so lovely and so unusual. Like the trout, his sense of propriety was, at least temporarily, dormant. He refused absolutely to rise to that fly, notwithstanding the skill and delicacy of the cast. Gruffly he replied that he mixed them with his brains.

So the angler should fish with his brains, promptly tracing an effect to its cause, taking to heart every hint so obtained, whether it tends to improvement of tackle, or its use. Otherwise he is nothing but a pot-fisherman, whose proper fishing-ground is the market, and whose only tackle should be hard cash.

The Angler considers his pursuit as a fine art, of which merely to obtain fish is but small part—these he can get more cheaply and in greater abundance in the market. It is the way the thing is done—this and the open air, the odor of the woods and flowers, the laughter of the running water, the beauty and song of the birds, and that peace and content which open the heart of man to see and love the ever-changing beauties of nature—these give to that pastime a charm possessed by no other. Though old age and infirmity come on, and the foot once familiar with wood and stream is now confined to the narrow limits of a chamber, when every other earthly pursuit has lost its zest, who ever heard even then that the enthusiasm of the angler had diminished, or that the dim eye failed to kindle at the recollection and tale of earlier triumphs with the rod.

Angler!—the term is to me a title of nobility, an order of knighthood open to personal merit alone. Not to every one who casts the fly is it given to belong to this brotherhood. He who would claim admission must be gentle, kindly, courteous, temperate, unselfish; a lover of nature, a pleasant companion, and a true friend—and let us be thankful there are many such.

The relation of all this to fish-hooks is somewhat obscure, so perhaps it would be well to return to the point.

Since the gratification of a capture is measured largely by the degree of skill required to make it, it is desirable to eliminate as far as possible all chance from affecting the result; so, if it may be, that when the fly is touched, no matter how lightly or from what direction, the hook will fasten if manipulated with skill.

Ignorance of the mechanical principles which should be embodied in a fish-hook, and which govern its efficiency, is altogether too common. Many examine a fly, and if it please in color, size, and neatness, little thought is given to the form of the hook.

The hooks ordinarily sold are none of them quite perfect, while many are very faulty in this respect. To formulate, if it may be, some simple and readily applied rule, guided by which the angler can justly criticise any form of hook at a glance, is the purpose of the remainder of this chapter.

If it is desired to drive a nail into a board to the greatest depth possible with a single blow of a hammer, everybody knows the blow should be delivered fair and straight upon its head, and by no means obliquely. And thus with a fish-hook. Though the power is first applied as a sudden pull, yet as it is transmitted through the

curved form of the hook, eventually its direction is changed, and it becomes strictly a blow, which, to give the maximum of penetration, should be delivered in a direct line with the point.

This result would be well accomplished by any form of hook, were it not that another principle intervenes; for the moment the forward movement of the hook, due to the pull on the line, is arrested by an obstruction at the point, the point tends to halt while the remainder of the hook still advances. Thus a cant is instantly given to the hook, the direction of the point is thrown out of line, and at an angle with the movement—the blow becomes oblique instead of direct—and the hook tends to rake its way out of the fish's mouth, rather than to imbed itself therein. (See *Fig. 2.*)

Try the experiment yourself.

Holding a hook in the position shown in *Fig. 5* (page 19), except that the shank should be horizontal, insert its point lightly in any soft substance which will, like the inside of the mouth of a fish, permit the hook freely to assume its own position—a piece of blotting-paper for example. Now pull on the gut attached to the hook, and at once it will assume the position claimed and indicated. This change of position is the foundation of the main principle hereafter announced. Other considerations there are which affect the construction of hooks, but they are of very secondary importance.

Mr. H. Cholmondely Pennell, in his "Modern Practical Angler" (London, 1870), has treated this subject with marked ability. We feel certain that such of our readers as have not seen his book, will not think it amiss if we quote him somewhat fully. In this feeling it is hoped he will join.

He discusses the question as follows :

“Extraordinary as it may seem in such a mechanical age as ours, we cannot go into a tackle shop, and buy a hook in which one or more glaring defects, or of offences against the first principles of mechanics, cannot be pointed out. The most common fault of all, perhaps, lies in the shape of the bend. I have shown, when alluding to this subject in the Book of the Pike, how great is the difference in the penetrating powers of different bends. Between the two extremes it amounts to no less than cent. per cent. ; and yet even the best of these fall below the point of efficiency which ought to be attainable. Another obvious fault is overfiness in the wire, from which it results that when the point comes sharply in contact with a bone or other hard portion of a fish’s mouth, or even on the sudden jerk occasioned by striking softer material, it ‘springs’—that is, yields by a widening of the bend outward—and so fails to penetrate. On the form of the shank of the hook, again depends, to a considerable extent in fly-fishing, the proper and even swim of the lure; and while the point and barb are the first portions of the hook to be brought into requisition in practice, it would seem that they are the last on which any theoretical consideration has been bestowed.

“The theory of hooks, as based simply on mechanical principles, should probably run somewhat as follows :

“1. What are the objects to be aimed at in a perfect hook?—

“*a.* Penetration.

“*b.* Holding power.

“*c.* Strength.

“*d.* Lightness and neatness.

“2. How are these to be attained and combined ?

“*Penetration.*—*Cæteris paribus*, the penetrating power of any hook will be greater in proportion, as the angle of impact—the angle, that is, at which the point of the hook strikes the fish’s mouth—coincides with the direction of the force applied (*i.e.*, the pull of the line); or to illustrate this by a diagram :

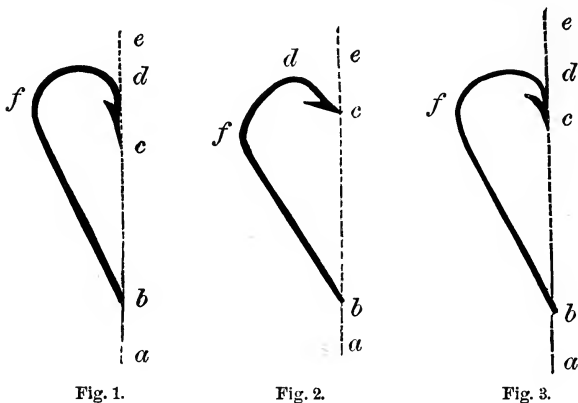

The dotted line $a e$ represents the direction of the applied force ; the penetration will be greater as the direction of the line of the point $c d$ is coincident with that of $a e$. In Fig. 1 these two lines actually correspond, and if there were no other matters to be taken into consideration, this hook, so far as penetration depending on bend is concerned, would be mechanically perfect. Fig. 2 represents a hook in which the converse of the above principle is illustrated.

“These principles hold good equally in the case of hooks the points of which are crooked or turned sideways, as in the Kirbys and Snecks, the penetration dimin-

ishing as the point is turned from the direction of the applied force, and accordingly that is the one particular in which the Limerick is superior to the other bends. The Sproat and Round bends have also a similar advantage. In all these hooks the angle of impact, such as it is, is direct.

“The above arguments are based, it will be observed, on the assumption that in all other respects, except the bend, the hooks under comparison are equal. But in fact hooks are divided into two broad divisions, the one possessing and the other lacking an element which has an obvious bearing on the penetrative power. I refer to the shape of the shank, whether straight or ‘hog-backed’ (curved). The substitution of a necessarily more or less yielding and elastic curve for a perfectly straight and rigid shank, cannot but affect adversely the penetrating powers. As regards the penetration of the point itself, it is clear that, other circumstances being equal, the smaller the hole to be made the less will be the force required to make it; and also that a long, *straightly tapered* point, like that shown in Fig. 1, will penetrate more easily than a shorter and ‘blunter,’ or *hollowed out*, point of the form represented in Fig. 3. This latter principle is merely, in fact, a converse application of the mechanical truism, that what is gained in speed is lost in power. If two barbs are of the same maximum diameter, and one is twice as long as the other, the longer barb will, for practical purposes, penetrate with half the pressure required by the shorter.

“Again, with regard to the ‘point side’ of the barb (*c d* in diagram), it is obvious that in order to insure a firm and deep penetration, this side must be of a proper length. The want of length in this part of the hook is

one of the faults of the 'Sproat bend,' which is exaggerated for sake of illustration in Fig. 3.

"*Holding Power.*—To illustrate this I shall take a case which is both the most common in practice, and will admit of a theoretical demonstration: that of the hook having penetrated *quite through the lip of the fish*, so that the point protrudes. In this case it is evident that, when once hooked, the nearer the point approaches the shank of the hook, the less chance must the fish have of escaping. This will be seen by carrying the principle to the extreme limit—and assuming that the point was so bent in after hooking as actually to touch the shank; the fish's lip would then be enclosed in a complete triangle, from which, of course, there could be no possible escape.

"*Strength.*—It is obvious that those portions of the hook which are nearly or quite in the same line as the penetrating or holding force, have little or no strain to bear. This is the case with the shank and with the short or point side of the hook shown in Fig. 1. The strain, therefore, is thrown on the top side, and more especially on the angle *f*, and it is precisely in this point that the common Sneek bends have hitherto failed in practice. So marked has been this failure, that I have known three salmon to be lost within an hour with Sneek hooks, all by breakages at the angle in question.

"*Lightness and Neatness.*—The lightest form of hook, other points being equal, must evidently be that in which, while retaining the requisite thickness of metal at the portion subject to strain, the parts not so subject—that is, the shank and 'point side'—are tapered away towards the ends. Hooks so tapered are also neater when employed for flies, and more convenient for general use.

“The patterns of hook which at present most nearly fulfil the conditions indicated by a practical application of the foregoing theory are the Sneck and Sproat bend hooks; the former is, however, marred by two faults—the turning to one side of the point, and the lack of strength above described; and the latter by the want of depth and power in the point side, the hollowed out or blunted shape of the barb, and the curved or ‘hog-backed’ form of the shank. Appearance, or neatness, is of course a matter of taste, but whatever other claims the Sproat bend has upon our suffrages they can hardly, I think, be urged on the score of beauty. The Limerick hook also has the disadvantage, though in a less exaggerated form than the ‘Sproat,’ of being hog-backed, which, as I have shown, prevents the fly swimming straight and even, and gives it an inclination to turn in the water, like a miniature spinning-bait. The Round and Kirby bends are very deficient in penetrating power, and disproportionately short in the shank as compared to their breadth of bend, either for appearance or use, more particularly in the matter of flies.

“In the pattern of hook which is now being manufactured by Messrs. Hutchinson, of Kendal, under my name, I have endeavored to hit the medium between theoretical and practical requirements, and to combine as nearly as possible the advantages of the various bends referred to, and especially of the Sproat and Sneck bends, while avoiding what I believe to be their faults.

“Diagrams both of this hook and of the other hooks described are appended, and by applying to them the principles advocated, my readers will be able to form their own conclusions as to how far the pattern I recommend fulfils the ideal sketched out.”

(Four illustrations of forms familiar to American anglers have been added to those in Mr. Pennell's book.)

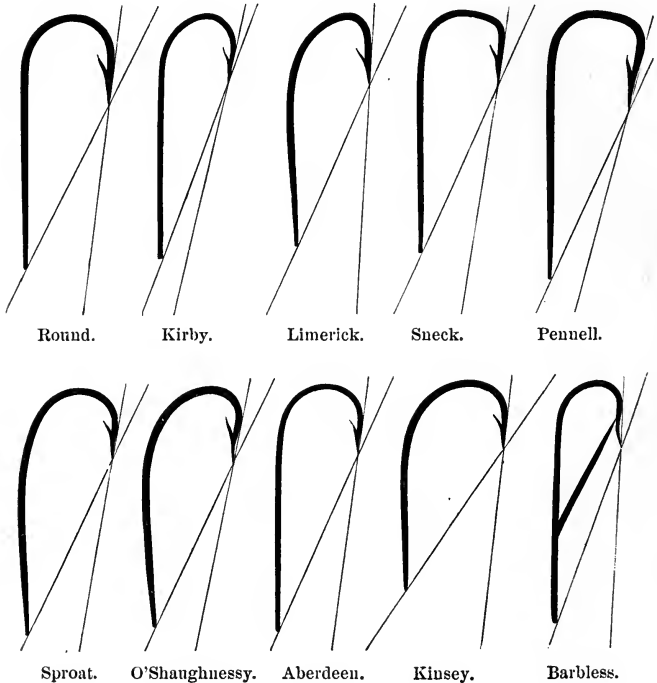

Fig. 4.

The more acute the angle a [Fig. 4], the more certainly the hook will fasten according to Mr. Pennell's theory.)

In the following illustration A represents a hook in the position it will assume in response to the pull of the

line, as shown by our former experiment; BC will then represent the "draft-line." That side of the barb marked a I have termed the "inner" or "advancing side;" that marked d is intended when the "outer" or "following" side is mentioned.

It is hoped that the form of this diagram and the nomenclature of its parts will be well fixed in the mind, since then what follows will be easily understood.

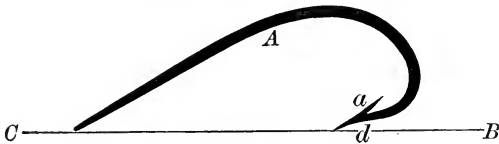

Fig. 5.

It will be noticed that Mr. Pennell has determined the penetrating angle from the *outer line* of the barb. I cannot but think this an oversight on his part, and one which affects his results. It is not the "*following*" (d) but the "*advancing*" side (a) of *such* a cutting edge or penetrating point which determines its promptness to engage, as well as the direction which it will follow.

I say *such* a penetrating point, for if the "*following*" side (d) of the point or edge is in actual contact with the surface to be penetrated (as shown in Mr. Pennell's first figure, page 14), it guides the edge in its own direction, since that is the line of least resistance. It is clear that this is not the case with a fish-hook, since there the "*following*" edge (d) is raised above, and is not in contact with the surface to be penetrated.

But an illustration familiar to all will serve to make this clearer than pages of theory.

Take the common carpenter's chisel, and apply it to a

board, with the bevel down and in contact with the board. The bevel here guides the edge, and forces it to advance parallel with the surface upon which the bevel rests; there is not the slightest tendency to bury. It would seem to follow from this that the hook shown in the first of Mr. Pennell's figures is by no means theoretically perfect as to penetration (or promptness "to bite," which is the idea I understand Mr. Pennell intends to convey), but on the contrary it is both theoretically and practically imperfect in this respect.

Now let us reverse the chisel and apply it to the board with the bevelled side uppermost, and at such an angle that the flat side (which will then become what we have termed the "following" side) does not touch the board. Here we have an exact reproduction of the penetrating point of a fish-hook, one governed by exactly the same laws. Attempt to cut with the chisel held in this position! It buries at once in the board and comes to a halt. The "advancing" edge, the bevel, guides and forces it downward.

In considering the penetration of a fish-hook, it must not be forgotten that the problem is not to pierce an obstacle squarely across the path of the hook; but its point is to engage with an oblique surface, and when so engaged it should turn at once from its former path and bury downward.

If the foregoing is true, then it again follows that the "outer line" of the barb should not point to the shank of the hook, since then the "following" side of the penetrating edge is in contact with the surface to be penetrated, and must guide the point in its own line; and thus any tendency to deviate therefrom—in other words, to bury—is checked.

It is hoped it will now be conceded that the "inner," and not the "outer," profile of the barb determines the direction in which the hook will respond to a pull upon the line. It also results from these considerations that the greater the angle which the "inner" profile of the barb makes with the "draft-line," the deeper the hook will bury, if it penetrates at all.

If it penetrates at all, and here, practically, is the pith of the whole matter. For if the hook does not penetrate at all, the thought of what might have happened had this been otherwise will afford but cold comfort to him who uses it.

Now if we place any hook bought at random in the market, in the position shown in the following figure, it is at once apparent that the "advancing" side of the barb *a* makes a sufficient angle with the "draft-line," to insure that if the barb enters at all it must bury. So we may dismiss this requirement from our minds as being sufficiently satisfied in any hook which has a barb.

We may then turn our undivided attention to the problem how to secure this all-important first engagement. This appears to admit of solution by an easy method, one having, it would seem, the merit that it permits of practical application at a glance, and under almost any circumstances.

Let *A* (Fig. 6) be a hook placed in the position shown upon any flat surface, *B C* (the glass of the dealer's

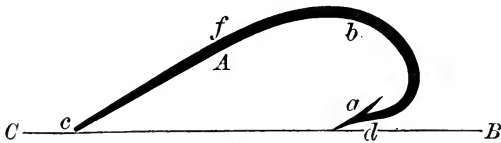

Fig. 6.

show-case, for example). BC (the level of the glass) will then represent the "draft-line" of the hook; and as the line a of the inner side of the barb approaches this line, short of actual coincidence, so will the sureness of the hook increase, since then it will penetrate easily, yet bury sufficiently.

The demonstration of this principle, and the statement of how it may be used to discriminate between hooks of all forms, may be made in one breath. Let Fig. 7 represent the barbs of two hooks so placed; the line BC is the flat surface, and aa the line of the inner side of the barb, as before. Now let us construct the parallelogram $bced$, of which the line a of the inner side of the barb is the diagonal.

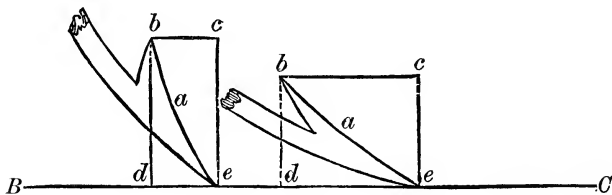

Fig. 7.

This is the well-known "parallelogram of forces" of the books, and its well-settled principles teach us at a glance that the side bc of the parallelogram (or that parallel to the flat surface BC) represents correctly the penetrating power of the hook; while the side ce (that perpendicular to the flat surface) will show the relative tendency of the hook to rake its way out of the fish's mouth. Of course the intending purchaser, when he places any hook upon the glass show-case of the dealer in the position shown, can at once construct this paral-

lelogram in his mind, and at once determine sufficiently for all practical purposes the relative length of the side parallel with the flat surface to that perpendicular to it. To sum up: any hook in which the side parallel to the flat surface is not longer than that perpendicular to it, is of vicious construction and should be rejected.

It was my purpose to prepare a table from actual trial, giving the number of pounds and ounces which each variety of hook shown in Fig. 4 required to bury it to the barb by a direct pull on its shank. But delay in gathering together all the varieties, and of uniform size so as to admit of fair comparison, together with further reflection on the subject, have convinced me that such a table would not be worth the space it would occupy. Each can determine the matter for himself, as far as it can be of any practical importance, by the application of the preceding simple rule.

Any of the forms of hook shown will take fish at times, nor will the general average of the catch of one so greatly exceed that of the other—provided always the fish are rising boldly. But if they are timid and take the fly gingerly, or if they are rising but seldom and the prospect of sport is poor, then, when the discouraged angler is apt to allow his attention to be distracted from his flies and be backward in responding to an offer, heed of this point will make a marked difference in result. And this brings me to the point which was the prime impelling cause of this inordinately long preamble.

It is not my purpose, and I beg in no part of this book to be understood to play the Sir Oracle — for that is at the same time to play the fool. I recognize the wide divergence of opinion as to many points entertained by my confessed superiors in the art of fly-

fishing and its appliances. Somebody must be wrong, and it would be absurd for me to intimate or suppose that I alone was exempt from mistake. Therefore, when an opinion is stated its foundation is also given, trusting to that tribunal, the great fraternity of anglers—from whose judgment in these matters there is no appeal—to sustain me when in the right, and to consign me to merited oblivion when in the wrong. This course I have followed, and shall continue as far as permitted by the consideration that man is not immortal, and that the sole occupation of this life is not to read books on angling.

But to come back to the point.

I would warn my brother anglers, novice and expert alike, against those small hooks (so tempting when embodied in a small fly, because the hook is so well concealed) in which the distance across the bend, from the barb to the shank, is but little exceeded by the length of the shank itself.

Apply one of these hooks to a flat surface, as shown in Fig. 6, on page 21. At once it is apparent that the angle of penetration may be made to depend altogether on the length of the shank ($b c$ in that figure); and that if the shank of the hook there shown terminated at f (it would then show about the proportions of the hooks referred to), the forward edge of the barb a would be nearly perpendicular, and its tendency to penetrate, or in other words to take hold, very slight. If we add to this the fact that these hooks are made of very thin wire, and consequently must spring some, thus enlarging the distance across the curve still more, we obtain a result even more vicious than that shown at the left hand of Fig. 7.

No form of bend, be it never so excellent, can remedy

this fatal error of construction. Such hooks reverse the proprieties, for they are a delusion and a snare, not to the fish, but to the fisherman; and this assertion is made with the more emphasis since, at the first glance, they so seem to present the efficiency of a large hook with the unobtrusiveness of a smaller one, that they are calculated to deceive even the elect.

The writer in his own fishing has usually employed the Sproat-bend hook, and believes it, when made with sufficient barb, as it sometimes is, not only the best obtainable, but very nearly perfect. In slightliness to our eye it seems the most graceful of any form. The shortness between the point of the hook and the bottom of the bend, of which Mr. Pennell complains, is not universal in all makes of that form of hook. The "hog-back" form is justly open to criticism. Some of these hooks are made with a very small barb, on the theory that the wound made by the hook is smaller, and that therefore the probability of disengagement is lessened, while ease of penetration is increased. The latter is undoubtedly true, but the former would seem to be an error sufficiently grave to more than over-balance the conceded advantage. For the integument into which the hook is intended to be driven is not brittle like glass, but elastic like rubber; and the barb of the hook does not cut its way before it as does a knife, but separates the tissue and distends the opening so made; and this closes again close around the hook the moment the passage of the barb will permit. Who ever saw a trout of any size taken from the water in which the wound of the hook had not been enlarged by its struggles? The importance, then, of a fairly prominent barb is apparent, and its just proportions will be a compromise, determined by

a due and combined consideration both of holding power and ease of penetration.

By the preceding simple method the angler can determine the efficiency of any form of hook at once. One other word of caution and I have done. Beware of short angular bends in the curvature of a hook, particularly on the shank side, of which some of the "Sneck" bends will serve as an example. For a moment's consideration will show that such a hook must be far better in material and temper than a hook in which the curves are softened off, before it will bear an equal strain.

That the side rake of the "Sneck" is an evil when used in fly-fishing, is not by any means beyond question. A fish-hook is a creature of compromise—an article formed by the union of several discordant elements, each opposed to the other. What concession each shall make is a matter for sound judgment. A hook theoretically perfect in all respects cannot be, from the nature of the case.

The side rake undoubtedly somewhat augments the power required to bury the hook over the barb, but I am by no means certain that this loss is not more than made good by an increased certainty in that most essential quality of all—promptness of initial engagement in all positions. It will be generally conceded that the demonstration on the part of the angler which answers a rise, leaves a wide margin of power to meet this demand many times multiplied.

Theoretically this shifting the barb end to one side should prevent the fly from swimming on an even keel, but I apprehend this evil may well be classed with the "hog-back" of the Sproat and O'Shaugnessy, as of theoretical rather than practical importance. The form of

barb given to this hook is generally superior to the Sproat, and if its point occupied the same relative position in reference to the "draft-line," I should prefer it; but always, be it understood, with the angle which unites the bend to the shank somewhat softened off, as indeed it now is in some, but not all, makes of this hook. Omitting the "side rake" we should then have Mr. Pennell's form, which I regret is not to be had in this market.

The O'Shaugnessy is also an excellent hook. While the general form of the barb is such as to afford easy penetration, its extreme point is given a slight bend outward to insure prompt initial engagement. Many excellent American anglers consider this the best of all hooks.

The Barbless speaks for itself. It is quite prompt to engage, requires less force than any other to imbed it, and, as to holding power, is so dead sure that to my mind it is almost unsportsmanlike to use it.

Again, for the benefit of the novice we emphasize the caution that he cannot be too particular as to this part of his outfit. Remember it is always the best fish which are lost, and absolutely eschew cheap hooks.

During August, 1884, and since the foregoing was written, a friend presented me with a couple of dozen "Pennell" hooks adapted to the large flies used on the trouting waters of North-western Maine. On these I tied a number of flies, and gave them during the ensuing six weeks, with others tied upon Sneek-bend hooks of like size, a careful trial in that region.

The trout of that locality may, for our purpose, be divided into three classes—the small, including those up to one and a half pounds; the medium, including those

up to three pounds; and the large, embracing those above that weight. The small and the medium fish may readily be taken with two or more flies handled in the usual manner—that is, with the drop flies just skimming the surface of the water; but the habitual caution of the large fish seems best to be overcome by quite a different method of temptation. A single large fly moving very slowly about six inches under water appears most to their taste. The larger the trout the more slowly he approaches and takes in the fly, but the more promptly he realizes and rejects the deception if time is allowed him so to do. The eye alone directs when to strike. To strike, and at the proper moment, is necessary, while the duration of that moment might well serve as a type of brevity. Again the offer comes when least expected, like a thief in the night. Then the utmost promptness of action is requisite, together with no little vigor, to transmit the impulse to the hook through the half-sunken line. The highest attainable excellence in every portion of his outfit, and unremitting vigilance on the part of the angler, alone will prevent the most bitter disappointment, as he gazes, with feelings beggaring description, on the subsiding swirl of the mighty fish, which, though he combats the feeling with all the excuses his ingenuity can devise, his inner consciousness tells him should have been his own. I speak from the heart, for “I have been there.”

Fly-fishing for large trout had been below par during the fall of 1883. On September 29th I was informed that some had been seen that morning rolling in the pool below the lumber-dam. A hasty dinner finished, and I was at the pool. Up rolled a trout two feet long before I could prepare to cast. To my brothers of the

angle who have never seen a trout of over three pounds rise to the surface, I would say they have something yet to live for. I can liken it to nothing better than the swirl made by the propeller of a steamer when it first starts from inaction into motion. It is a sight to quicken the circulation of an iceberg. Till dark I cast, employing every resource of the art known to me. Every four or five minutes one would break the surface, and nearly give me a fit with the eagerness with which I would hasten to lay my fly in front of him, before he could vanish from my sight and its neighborhood. It was all in vain. Night fell, and no fish of over one and a half pounds had rewarded my efforts. So, disappointed and disgusted, but not discouraged, I vowed vengeance on the morrow, and betook myself to camp, studying the problem, and how its conditions could be varied that the next day might have a happier issue. I decided on a new combination of form and color in the fly, and no hook in my own stock being quite suitable, I begged one from a brother angler. I did not like its bend, but still there was a better chance with any hook, if they could be induced to take it, than with the best if it were ignored.

Bright and early the next morning my guide and I landed from our boat upon the boom above the dam, and started to walk it on our way to the pool below. Snow covered the slippery logs, by no means improving the footing; so, gingerly and with the utmost caution I essayed the perilous passage. I don't know how it happened, one moment I was on the boom, the next I was up to my ears in the icy flood, and scrambling for the bank without unnecessary delay. But I clung to my rod, and, with everything but my ardor chilled to the

bone, betook myself to the pool. There, standing beside the fire that the ready axe of my guide quickly made, I began the last day's fishing of the year. A bitter wind drew down the valley, and my hands, covered by a pair of fingerless gloves now sopping wet, ached in a manner that soon became intolerable. I had cast for about five minutes in vain when I essayed to remove them, my fly lying on the water and sinking below the surface. Something told me to strike, I know not what, for I saw nothing; but strike I did, with a vigor accentuated by my personal discomfort, and proportioned to the sunken line to be moved. Had I struck the dam itself the resistance could not have been more stubborn and unyielding. But, alas! I held him but for the moment. I cast till noon, then to camp, changed to dry clothes, dined, and back, and hammered away at that pool till dark, and never got a rise from a fish of over two pounds.

I believed then, and I still believe, that with a properly constructed hook, barring accidents of a different kind, he would have been mine. But I knew the hook was one calculated to rake its way out of a fish's mouth rather than to bury and hold. I took the risk and I paid the penalty. Those who have been in a like position, and after a day and a half's unremitting and unrewarded labor, with a ducking in ice-water, ruin of fly-book, etc., thrown in, alone know with what feelings I returned to camp. It was the last day of that open season too.

Within four weeks I have seen an angler of wide experience, though new to large trout, white to the lips as he told how a few moments before he had lost a large fish after ten minutes' play—a trout, which his experienced guide assured me he had seen plainly, and to which he assigned a weight of not less than six pounds.

I see I have diverged from what I intended to say, and interpolated a narrative which may seem to some out of place. But if it will serve to impress upon the beginner how greatly the pang which follows the loss of a large fish, exceeds the trouble and expense of providing first-class tackle at the outset, its practical utility will, it is hoped, justify the digression. With every appliance of the best, such losses will still occasionally occur even to the most skilful, but this will then happen but seldom, nor is the disappointment embittered by self-reproach. Good-luck comes to all at times, and he is the most successful, in angling as in life, who prepares beforehand to take full advantage of his opportunities.

In the angling, of which it is hoped the foregoing will give some idea, the fish, whatever they may do afterwards, almost invariably take the fly in still, or almost still, water. They will not hook themselves. The fly is some distance under water, and the leader at least, if not the line, is partially submerged as well. If there is any wind, and the cast is not with it, some sag is thrown into the line from this cause, while the slowness with which the fly is moved renders the sense of touch unreliable to indicate when the angler should act. Add to all these the extreme brevity of the interval during which the fish may be fastened at all, and almost every advantage would seem to be against the hook. Certainly far more so than when a trout bounces out of water and dashes, like a tiger upon its prey, at a fly quickly impelled over the surface by a necessarily tight line. If, in addition to all these drawbacks, the angler is handicapped by defects in the construction of the hook itself, it seems to me that these defects should be more apparent than in perhaps

any other form of fly-fishing, and that consequently the merits of a hook may therein receive a most crucial test.

While, after careful consideration, I cannot say the Pennell hook failed less frequently than the Sproat of like size (which I had used for so many years, and in the superiority of which I had so abiding a faith), still I must admit that whenever, during the latter part of my trip, I wished to tie a new fly, I invariably ignored the Sproat and Sneck hooks, and selected the Pennell. For nearly six weeks I rang the changes on these forms of hook in the endeavor to determine practically the relative value of each; and as far as such a trial justifies an opinion, I believe the Pennell hook to be all its inventor claims for it. The Sneck bend did not answer my expectations. These were the first unlacquered (blued) hooks I had ever used, and they will be the last. After a few days' use, they rusted so abominably as to ruin every fly tied upon them. Owing to this cause, perhaps that hook was not as fairly tested as it should have been, and further trial may yet show that its practical is equal to its theoretical efficiency.

CHAPTER II.

HOW FISH-HOOKS ARE MADE.

THE belief that an account of how fish-hooks are made will interest some of my readers, has induced me after some hesitation to include the following description.

Though special machines are now largely used, still the old hand process is at the foundation of all. A statement of this, therefore, will be at once more profitable and easily understood.

Round steel wire in coil is mounted on a reel; the outer end is thrust through a hole until it encounters a stop, and can go no farther; then down comes a cutter, and cuts off a length. As long as the cutter and stop work at a fixed distance from each other, so long, of course, will the wire be cut in uniform lengths (see Fig. 8). It will also be clear that by varying the position of the stop in reference to the cutter, the length of the produced piece can be varied.

During the time occupied in reading the preceding paragraph, you may imagine several lengths have been cut.

Next in order comes the formation of the barb. A length of wire, cut as aforesaid, is laid upon a small block of iron provided with a stop, against which the end of the wire abuts. The workman is armed with a tool such as is shown in the illustration (Fig. 9), in which *a* represents a wooden handle; *b* an iron rod or shank;

and *c* the cutter. If about two inches were broken from the cutting end of an ordinary carpenter's chisel, and if the sides were then ground so that the broken end was



Fig. 8.



Fig. 9.

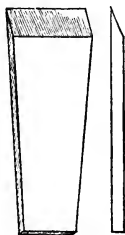

Fig. 10.



Fig. 11.



Fig. 12.

somewhat narrower than the cutting edge, the form of this barb-cutter would be produced. It will be remembered that the cutting edge of a carpenter's chisel is bevelled only on one side. Such is the case with the cutter under consideration, and its edge is applied with the bevel uppermost—*i.e.*, away from the wire. The form of this cutter is shown in Fig. 10. The workman having laid a length of wire upon the iron bed with his left hand, and brought its end against the abutment, seizes the tool (Fig. 9) by its handle *a* in his right hand, hooks the other end *d* behind a pin conveniently placed

for the purpose, which serves him as a fulcrum, applies the edge of the cutter to the wire at a marked distance from the abutment, and pushes the handle and cutter from him. The cutting edge, being formed with only one bevel and that uppermost, tends to bury in the wire, while the shape of the bevel throws up the shaving and determines the "rankness" of the barb. Operation succeeds operation with surprising rapidity. The result is shown in Fig. 11.

This is the method employed in making large hooks. In producing the barb of small ones such as we use, a knife resembling a common table-knife is employed, bevelled and applied, however, in much the same manner.

The wire is now annealed—that is, heated to low redness, and allowed to cool very slowly, thus rendering it quite soft. The annealed pieces are then laid one by one on a small anvil, and under a single blow of a hammer each rapidly assumes the form shown in Fig. 12. They are then one by one placed upon a cutting edge, and a blow from a drop-hammer raised by foot-power produces the result shown in Fig. 13—*a* representing a cut either quite or almost through the metal, detaching the piece *b*. Then two or three strokes of a hand-file complete the point, as shown in Fig. 14. The hook is now to receive the bend. In Fig. 15 *A* represents a block of hard wood; *B* a rib of metal projecting above the surface of the wood; *C* is a pin projecting in a like manner; *D* is the wire about to be bent into a hook. When the wire is applied as shown at *D* in Fig. 15, it is bent around the former (*B*) by a single sweep of the hand, and the hook is complete in form. It will be observed that the contour of the former (*B*) determines the shape of the hook.



Fig. 13.

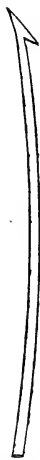

Fig. 14.

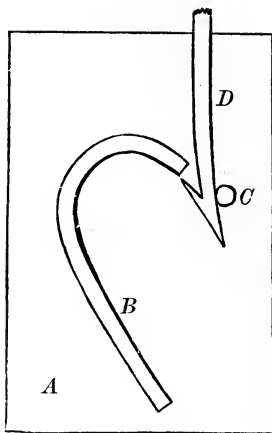

Fig. 15.

Now the hook, which to this point is as soft as it can well be made, must be hardened. Heavy sheet-iron dishes are filled with soft hooks, thrust into an oven, and brought to a cherry-red heat; and when the contents are at that temperature, they are “dumped” into a large vessel of oil. The hooks, when withdrawn from the oil, are as hard and brittle as glass, and they must, before they will be fit for use, be drawn to a spring temper. An iron frying-pan is partially filled with sand, placed over a hole in an oven, the sand heated to a proper temperature, the hooks introduced and stirred round in it, until the requisite temper is reached. The hooks are then removed and cooled off, and this step is complete. Thus it will be seen how intimate is the connection between the frying-pan and the hook, throughout its career.

These last two steps are the crises in the life of the hook which determine its future. For if in the hardening process any are heated to excess, the steel is "burned" as it is termed, and such will always remain brittle and worthless; while if any are insufficiently heated, they will not harden, but continue soft and equally useless. To heat this irregular and tangled mass of hooks uniformly through to its centre, from heat applied to the outside, requires no little skill. And in the tempering process the same difficulty is encountered, for if it is arrested too soon, the hooks remain still brittle; if it is carried too far, their elasticity is gone, and they will straighten under the struggles of the fish to escape.

The tempered hooks are then rolled in a revolving barrel, "tumbled" as it is termed, to remove, by the attrition of one against the other, the surface scale formed during the hardening process, and they are then ready to lacker.

This is accomplished by seizing the hooks by the bend, dipping the shank about half its length in the lacker, withdrawing them and throwing them into a large bowl. With two forks, one held in each hand, the contents of the bowl is well stirred together, until at length the immersed parts have parted with a portion of their lacker to the uncovered parts, and the whole of each hook is covered with a uniform coating. The workman then wets his fingers with the lacker, removes the hooks one by one, hangs them by the bend on iron racks, and places them in an oven to dry. Such is the process of making fish-hooks, in its simplest and usual form. Is it not wonderful they can be sold so cheaply?

One step remains, or should remain, to be taken; and it is the only part of this long description that will, aside

from the gratification of a very laudable curiosity, be of any advantage to you who have so patiently followed it to its end. But if you tie your own flies, or even if you do not, this will require you for your labor and patience. I allude to a test to be applied to each hook, so that the bad may be infallibly separated from the good.

Two pins, *a a*, are inserted in a block, *B* (see Fig. 16). The hook is placed between them as shown, and the shank end bent outward with the hand (see dotted line) until it strikes a pin, *b*, placed near the position shown. If the hook breaks, of course that ends it. If it fails to return to its original form when released, it is too soft to be reliable, and should at once be rejected.

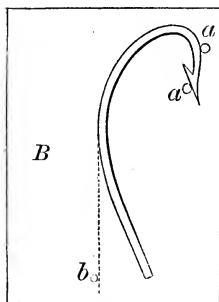

Fig. 16.

Were it not for the iron bands of literary custom, I would print at the head of each page of this book, instead of its title, the words—REMEMBER TO TEST YOUR TACKLE. They embody the angler's Golden Rule.

A few years since I went fishing down in Pennsylvania, a hundred miles by rail and some twenty odd by stage. The trout of that State have quite kept up with the progress of the age, and the angler who expects much pleasure at their expense, will need to employ all the resources of his art. A box of beautiful little hooks was purchased for the occasion, and a quantity of beguiling flies tied thereon. What was the matter I could not tell. Rise after rise was followed by miss after miss at the strike, till a bump of conceit, which at first was quite protuberant, gradually fell to the dead level of medioc-

rity, till at last its former locality was marked by a depression you could put your fist into. Nothing but fingerlings (to basket which, under any circumstances, is of course against the first canon of your and my angling belief) had rewarded my efforts, so I sat me down to seek consolation in a quiet pipe, and study the situation. Those hooks were like lead in softness.

I learned my lesson then. Learn yours now! You will find it far cheaper and more satisfactory. For whether is it better to prove each part of your outfit at home, when the loss of a worthless article readily replaced is the worst that can result; or to involve the good in a common fate with the bad, and lose all, your temper included, in a common ruin.

It is a good rule to try no experiments in the crisis of battle.

CHAPTER III.

LINES.

FORMERLY lines for fly-fishing were made of hair, and were twisted. These were superseded by a mixture of hair and silk, the latter added to increase the strength, and tone down the excessive roughness which characterized the line made of hair alone. Again the twisted line was found liable to kink, and braiding the strands was substituted for twisting, to overcome this. But at the present day the only line used in this country for this purpose, is one braided from silk alone.

Both "raw" and "boiled" silk are used, the raw silk being the silk as spun by the worm, and with the gum, exuded in that process to unite the filaments into the form of a cocoon, still adhering to it; and boiled silk being, as its name implies, the former boiled to dissolve and eliminate this gum.

The Italian silk, from which the best lines are made, when raw, comes in hanks resembling in form and size the common woollen yarn of country stores. It is of a most beautiful golden color, resembling in the sunlight the hair of the giddiest of blondes. It feels somewhat harsh to the touch—very much like linen thread—and lines made from it partake of this characteristic. That generally known as "grass line" is a fair sample, it being wholly of Chinese raw silk, no grass whatever entering into its composition.

When boiled the raw silk parts with its gum, losing about thirty per cent. in weight, and deepening in color. The surface is no longer harsh, but of a smooth and slippery character, and the silk becomes very flexible.

Raw Italian silk is worth about five dollars a pound, while boiled brings in the neighborhood of seven dollars.

Since the gum is removed by the boiling process, thus reducing the size of the fibre without impairing its tenacity, it follows that more material is required for the same diameter, and that the boiled-silk line possesses a far greater degree of strength than a like size line of raw silk. Silk lines are also made from what might be termed "shoddy," a material formed by reducing old scraps of silk—cast-off silk dresses, stockings, umbrella covers, and such trash—to a fluff by machines constructed for that purpose, and spinning the thread composing the line from that. As the length of the fibre in the latter does not exceed a fraction of one inch at the outside, while in the silk direct from the cocoon it may be hundreds of yards, the relative value of the two products may be readily gauged, without entering into the question of how much the material composing the "shoddy" has suffered before entering the machine.

Again, lines are sometimes made of mixed silk and jute, in which case the latter is a pure adulteration, since it adds practically nothing to the strength. Such lines, however, as are sold by reputable dealers, are made from the best Italian silk. The thread is spun direct from the cocoon. Three threads are then loosely twisted together, and thus each strand of the braided line is formed. These lines, for their diameter, are of surprising strength, and they alone are suited to our purpose. But in their

natural condition unnecessary disadvantages attend their use. Though superior to the ordinary linen line in this respect, still if it is desired that they should retain their strength, they must be taken from the reel and carefully dried after use.

Aside from this, the inferior strength of the raw-silk line, and the greater friction caused by its rougher surface in its passage through the rings, would give the preference to that of boiled silk. But that also has serious disadvantages. One trial, particularly if the experimenter be wading, will graduate him as far as this is concerned. They are so very soft and pliable, that on the slightest provocation they take a turn around the outer end of the tip; the line is then locked for the time being, and will render neither way. After having waded to the shore four or five times to find a support for the butt, so that the end of the tip and the entanglement may be reached, an effort will probably be made to vary the monotony of this proceeding, by placing the butt on some neighboring stone protruding above the water. And if this is followed, as it is apt to be, by the butt and reel slipping off into the water at the very crisis of the disentanglement, to the great peril if not disaster to your tip, you will then have opportunity to exercise a wise discrimination as to which of the two annoyances you will elect to suffer in the future. If to this is added the probability that you first discover the mischance after a cautious approach to some extra promising pool, and when you wish to lengthen your line, so as to lay your flies just where you feel sure the aldermen of the brook are assembled together; or worse still, after you have fastened to one of those aldermen, or possibly the chairman of the board, and find that you can neither

give nor take line, you will then agree with me that such a line is more demoralizing to the angler than the fish.

The choice then lies between two varieties of waterproofed line: one being that made from raw silk and treated with linseed oil, and known as an "oiled" line; the other that from boiled silk, and waterproofed by a secret process, and known as "enamelled waterproofed line." The best quality of the former may be had at an expense of from three and a half to four cents a yard; but while the cheaper of the two, its lesser strength, its rough surface, and its inferior durability, make it in effect the dearer.

If Phariseeism be ever pardonable, it is when a good enamelled waterproofed line of American manufacture is compared with the best produced in any other country. If not decrepit through old age—and their longevity is far in excess of any other line—in strength they leave nothing to be desired. Smooth as ivory on the surface, they render through the rings with the minimum of friction. Their weight is sufficient to cast nicely without being excessive, and at the same time this is always uniform; while their flexibility is just as it should be, neither so great as to foul the tip, nor so stiff as to cause inconvenience. In short, they are as nearly perfect as the work of man's hands is permitted to be.

The secret of their preparation is most carefully guarded, and they are in constantly increasing demand abroad, where their imitation has been in vain attempted. Nothing in reference to fly-fishing can be answered with such ease and confidence, as the question what line should be used. Unquestionably the enamelled waterproofed line, and no other.

The following illustration shows the most available of the various sizes manufactured, and the numbers or letters by which they are known to the trade.

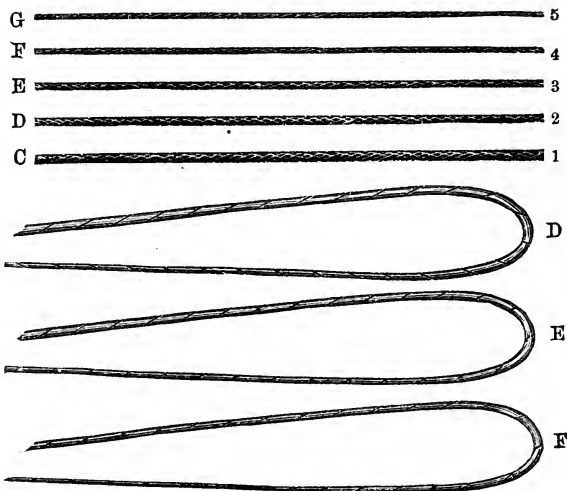

Fig. 17.

Aside from the difference in diameter, two styles of these lines are to be had: "tapered," in which the last twenty feet or less is gradually diminished in thickness by dropping out a strand at proper intervals; and "level," in which that dimension is uniform throughout.

Which shall I use—"tapered" or "level?" The answer to this is not so simple as it might look. The tapered line casts rather a lighter and neater fly, but is open to the objections that not infrequently the tapered part soon loses its strength. The first cost is also greater.

The "tapered" line, E and F sizes, costs eight cents a yard, while the "level" line, size E, costs seven and a half; F and G six cents a yard. It seems to me, after some little experience with both, that the latter casts so nearly as well that, after taking into account its greater longevity, it is to be preferred. After some years, during which nothing but a tapered line was in my judgment appropriate to one at all nice in his fishing, circumstances hereafter related forced me to resort to a level line. My opinion and practice then changed—a change I have since seen little reason to regret; and judging from the remarks of other anglers in frequent discussion of the subject, it would seem that the tapered line does not now enjoy the favor of a few years since.

Again, no person of experience casts a longer line than the necessities of the case require. The eighty feet casts of the tournament have little or no place in practical fishing; and when casting, the line is kept out of the water as much as possible, so that only a few feet of its outer end is constantly wetted. As these lines are practically never taken from the reel to dry, after a greater or less lapse of time the strength of that portion becomes impaired. The expert angler never thinks of inaugurating a new season without carefully testing the strength of this part of his last year's line, breaking it off at the slightest suspicion of weakness, a foot or two at a time, until sound material is reached. Now in the tapered not only does this decay, because of the smaller diameter, reach the danger point much sooner than in the level line, but it extends farther up the line; and if any part must be sacrificed, it is the tapered portion which must go. The result is that the tapered line, after a couple of seasons, becomes a "level"

line, and of a thickness greater than the angler would prefer. Therefore it seems advisable, if economy be any object, to buy a level line of the very best quality, and at least forty yards—better fifty—of it. Such a line will last for years. About twenty-five yards is the minimum length that a trout fly-line should be, so this gives a good reserve to meet either accident or decay; and it will be long before you are encumbered with that mass of trash which is the angler's bane—flies, leaders, and lines, which you dare not use, are ashamed to give away, but still seem too good to throw in the fire where they properly belong.

There is great temptation to economy in the purchase of lines. Plenty that look equally well can be had at half price. But you know the consequences of yielding to temptation, and believe me, this will not prove the exception which makes the rule. A little cold common-sense will teach that in this benighted age and country, no man sells an article in the regular way of trade for two or three cents a yard, the market value of which is seven or eight. The swindler who plies the pocket-book drop game, when viewed in one light, may be regarded as a missionary, teaching his fellow-man his folly that he may turn from it. Take the lesson to heart, though you shun the teacher.

Remember the integrity of your tackle should always be absolutely above suspicion. Buy your line of a house with a reputation to maintain, and ask for the best and pay the price, and you will get it. Be sure if a seeming bargain is offered you in fishing-tackle, you will eventually find it dear at any price. For trout-fishing F is the best size if the line is "level," but E if "tapered."

For actual fly-fishing these seem to me the sizes best

adapted to the average American fly-rod of to-day ; still there is at present unquestionably a tendency among experts towards heavier grades. The enormous distances covered at the recent casting tournaments naturally excite the emulation of those who witness or read of them, and they as naturally turn to that style of line which is best for that purpose. It is undoubtedly an accomplishment to be able repeatedly to cast to the distance of eighty feet, and retrieve the line without fastening a fly in your ear ; since he who can do this can cover the extreme limit of practical fly-fishing with the utmost ease, and can therefore devote all his attention to delicacy and accuracy. But whether the use on a single-handed fly-rod — unless it be very short and stiff — of lines so heavy as C or even D is really an advance in the art, seems to me very questionable. Does it not entail a sacrifice on the part of all, except perhaps the most skilful, of those important requisites, delicacy and accuracy (construing the latter term to include not only reaching the desired point, but doing so with a perfectly straight line) ; and this to attain a command of distance seldom or never of use except for show ?

I tried a D tapered line this year for some weeks of constant daily fishing, expressly to satisfy myself in this respect. The conclusions formed for my own guidance were as follows : On a flexible rod the D line seemed at all times a positive disadvantage. Upon a ten-foot stiff split-bamboo, against the wind, it worked well, since having more momentum it naturally held its way better. In casting over about forty - five feet it really worked like a charm, the line seeming to go backward and forward, as if it were alive and acting of its own volition, rather than from the apparently insignificant impulse

given to the rod. This began to be felt at the distance named, and increased rapidly as more line was used. Indeed so pleasurable was it that I was forced continually to check myself, lest I should fall into the altogether too common error of ignoring good water close at hand, to cast in less promising places at a greater distance. But—ever that dreadful *but*—decided and increasing disadvantages became apparent as the length of the cast was reduced below that distance. I like to see the fly shoot out straight, pause a short distance above the surface of the water, and then fall upon it by its own gravity alone. The momentum of the heavy line was such that it required the very nicest adjustment of the impulse to the distance to be covered, lest the line reach its full length before its inertia was overcome, and thus, suddenly checked, recoil and fall sinuously upon the water; and this difficulty rapidly increased as the line was shortened. Now I am inclined to believe that five and a half times the length of the rod approximates pretty closely to the limit of efficient casting in actual fly-fishing, while we all know that over nine-tenths of all the fish are taken within say forty feet of the angler. Therefore, if it be wise to adapt your tools to your every-day work, rather than to that which you will do only on your birthday, it would seem that the beginner would do well to use no line heavier than a “level E,” and not that unless his rod be quite stiff.

For the benefit of those who like to make their own tackle, and are ambitious to waterproof a line, the following recipes are given:

First buy a boiled-silk braided line of the proper diameter, and of the very best quality if you would not have it rot in the process.

TO OIL-DRESS LINES.

Heat two ounces of linseed-oil until it will singe a feather dipped in it. Melt in and mix thoroughly with it a piece of camphor the size of a hazel-nut. Stir in an equal proportion of good oil-copal varnish. Soak the line in the mixture while the latter is warm, until thoroughly saturated. Then draw the line through the fold of a doubled leather, held in the hand and firmly compressed upon it, to squeeze out all the dressing you can. Stretch in a garret, or similar place, to dry. This will take some days according to weather. When dry, warm your mixture and soak again. Squeeze as before. When this is dry, rub on the third coat with a rag, and wipe the line well afterwards. When this coat is thoroughly dry, rub well with a paraffine candle from one end to the other, then polish by rubbing briskly with a woollen rag. It will take at least a month to so prepare a line, for no second coat must be applied until its predecessor is thoroughly dry.

Norris recommends, quoting from Chitty:

“To a quarter of a pint of double-boiled, cold-drawn linseed-oil add one ounce of gold-size. Gently warm and mix them well, being first careful to have the line quite dry. When this mixture is warm, soak it therein until it is saturated to its very centre—say for twenty-four hours. Then pass it through a piece of flannel, pressing it sufficiently to take off the superficial coat, which enables that which is in the interior to dry well, and in time to get stiff. The line must then be hung up in the air, wind, or sun, out of the reach of moisture for about a fortnight, till pretty well dry. It must then be redipped to give an outer coat, for which less soaking is

necessary. After this, wipe it again but lightly; wind it on a chair-back or towel-horse before a hot fire; let it remain for two or three hours, which will cause the mixture on it 'to flow' (as japanners term it), and give an even gloss to the whole. It must then be left to dry as before: the length of time, as it depends on the weather and place, observation must determine upon."

Personally, the writer has succeeded fairly well with two-thirds boiled linseed-oil and one-third best coach-body varnish mixed together, and warmed till it will singe a feather. To four ounces measure of this mixture about half a teaspoonful of siccative coutraï (to be had at any dealer in artists' materials) may be added, to hasten the drying if you are of an impatient disposition. Otherwise, leave it out, since all dryers impair the result. Soak twice and rub once, having the mixture then warmed to a temperature not exceeding 100° Fahr. Finish and polish with paraffine candle as before.

Boiled-silk braided line only is adapted to these processes. Remember the mixture must in none of them be so warm, when applied to the line, as to be uncomfortable to the touch, otherwise your line will be "rotten" and your experiment a failure. The only object in heating the mixture is that it is thus rendered more fluid, and in this condition is more readily absorbed by the line; but it is an essential step, since otherwise the preparation may not permeate throughout the line, and if it fails to do this at the first soaking, it never will afterwards. On the second application the warmth softens to some extent the preceding dose, and the two amalgamate better, so to speak. Wind is the potent element in drying mixtures of this kind. Therefore, if possible, expose

your line to its influence, since it will then dry more in one day than in three if kept in-doors.

But the preparation of a line by any of these processes, is a nasty, tedious, and ill-smelling job. It is far better to pay seven or eight cents a yard for a good enamelled waterproofed line to some good house. You may feel pretty confident you will wish you had done so before you get through preparing one yourself.

Select a line not too long in stock. Before buying, try the strength of the exposed end of the line, and if it breaks easily have nothing to do with it. Ask the dealer's consent to this, which, if he refuses, try elsewhere. For the best makers or their employés sometimes make mistakes, and rot the line in the process of preparation. This will at once be detected on proving it in this way. This precaution should never be neglected, lest you "sound the depths of dark despair," as did the writer, who, on one occasion, was caught as follows in the wilds of Maine, with a brand-new tapered forty-yard line then used for the first time, and bought from a most reputable dealer. For months the trip had been anticipated and prepared for. You know, or if not, may you soon know, the April fever of the trout fisherman—that restless longing for the green woods and silvery stream which precedes the opening season—when no matter how happily he may be circumstanced, something essential seems wanting. If it has a parallel, it is only in the sensations of the confirmed smoker, who, in a moment of weakness and repletion, has "sworn off."

The legion, who, without other cause, have committed this folly, and who remember with what longing they looked towards the appointed time, and the halting march of the carefully counted days, unrelieved by the assur-

ance of the considerate friend "that the watched pot never boils"—those who remember this, and how "freedom shrieked" when once again the way to the tobacconist was open—such only, outside the brotherhood of anglers, can appreciate the thrill with which my maiden cast was at last delivered.

Two fine trout rose at once to the flies, leaping clear of the water in their eager rivalry, their red and golden sides flashing like jewels in the morning sun. A quick strike, and—the line comes back, but where are the flies and the trout?

He who sits down on an imaginary chair; he who would raise his hat to salute his would-be sweetheart, and is forced instead to follow its gyrations through the mud and filth of a city street; he who eagerly reaches before him in the darkness for an open door, and finds it with his nose—these have experienced the pangs of blasted hope, and can sympathize. Paralysis followed the blow; and when at length the world rolled on once more in its appointed orbit, I began the old familiar process of endeavoring to convince myself that the result of my own stupidity was an arrow of fate. The fault of the leader it could not be, for it had been tested not an hour previously. The shortening line comes slowly in, watched with anxious eyes. But where is the leader—alas! careering round in the depths of the Moose Brook, a bond of union between two most unhappy trout.

Then, I fear, not all the Commandments were remembered.

The angler who, under such misfortune, can preserve his equanimity, must possess a degree of philosophy indeed phenomenal. My philosophy is quite dilute, so I

went for John. John—good, kind, honest John—patient, conscientious, of untiring energy ; courteous and considerate alike in sunshine and storm, in time of plenty or famine ; the prince of guides, whose skill at the trap, the paddle, the rifle, and the rod are unequalled ; who forgets more overnight of the ways of the wilderness than I shall ever know. A most aggravating fellow is that John. We have been together for years, and many are the differences of opinion which have arisen. The worst of him is that he is invariably in the right, and that I am always forced in consequence to eat “humble pie.”

“John, you must have let that knot upset when you bent that leader to the line. You see it’s entirely gone.”

“I think not, sir,” came the quiet answer.

“Well, how else could such a disgusting thing happen ? You know the leader was tested not an hour ago. It was wet then, and was fastened to the line immediately afterwards, so the loop could not have been cracked or weak, and the break must have been there.”

“Perhaps something may be wrong about the line.”

“Nonsense ; the line is brand-new—never through the rings before. Take off that other leader from your hat and put it on the line ; give me a Montreal stretcher and a brown hackle for a dropper. There—let me look at that knot. Yes, that’s all right ; I don’t believe they will get away with that in a hurry. Perhaps we may sicken some of them yet.” For your true fisherman always regards the fish who carries away his tackle as the Englishman looks on the restlessness of his uncivilized subjects—as a monstrous ingratitude, to be atoned for by the offender if catchable ; if not, by his kindred.

Human nature is not altogether confined to the British Isles ; a small surplus still remains for the use of the

American angling fraternity. We generally see things through our own eyes, even though we do wear spectacles.

Cast follows cast—a rise—a strike—and back comes the line once more, but no leader follows it.

When feeling is too deep for utterance, one is generally silent. The line is reeled in and examined. The knot was certainly all right; the fault could not be in the leader. The line alone remains; and though it is folly to try it since it is perfectly new, still to silence John once for all, let us test it. Throughout its whole length of forty yards, not a place could be found that could not be broken between the thumbs and fingers. Though the sky was cloudless, the sun shone no more for me that day. The wise profit by the misfortunes of their fellows.

CHAPTER IV.

LEADERS.

THIS essential to the angler's outfit is composed of the silk fluid secreted by the Chinese variety of the silk-worm. When the worms cease feeding, and a filament of silk is observed hanging from the mouth, they are then about to begin to spin their cocoons, within which to await and undergo their transformation into the perfect insect. On observing this indication, such worms as are to be devoted to this purpose are immersed in vinegar for some hours. When sufficiently pickled they are removed, seized by the head and tail, and forcibly torn

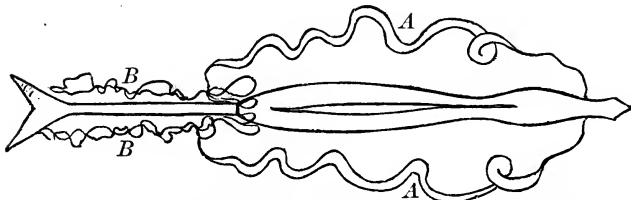

Fig. 18.—Anatomy of the Silk-worm: *A A*, the Silk Sacks, *B B*, the Intestines.
(From the "Encyclopædia Britannica.")

apart. Within are found the intestines, which then resemble boiled spinach, and two silk sacks. The latter are nearly or quite twice the length of the worm, and lie doubled together within it. The diameter of the

middle of these may be about one-sixteenth of an inch, thence gradually tapering to a point at both ends. The preserved specimens, the only ones I have seen, were translucent, and yellowish in color.

Seizing this silk sack by the ends, the operator tears it apart, stretching the contents out to the desired length. These harden almost at once on exposure to the air, and the gut thus produced is stretched upon a piece of board to dry.

This manufacture is carried on mainly in Spain, by the peasantry at their own homes, one producing perhaps half a pound, another possibly fifty, according to the extent of the mulberry orchard the maker may possess. With the remains of the envelope still adhering to the dried gut, it is brought in, and sold to the factors.

Their first step is to free the gut from such portions of the ruptured envelope as may adhere to it. Formerly this was done by drawing the gut between the teeth, and thus stripping off this refuse, but chemical processes are said now largely to have superseded this. The eyewitness, to whom I am indebted for this information, describes the old method as a most disgusting spectacle. The rows of women and girls drawing the entrails of this caterpillar through their teeth, their mouths smeared with blood from the cuts inflicted by the thin gut, mingled with the offal scraped from it by their teeth—spitting and drawing, and spitting again—must indeed be far from a pleasant sight.

I would much rather go a-fishing.

The gut is then sorted, bundled, and marketed. We derive our supply largely through England, whence this business is controlled, consuming by far the greater part of the heavier sizes produced.

But it would seem there are silk-worms native to this country, from which gut far superior in every way to that of the Chinese worm not only can be, but actually has been, made.

At least three of these greatly exceed the Chinese worm in size, and in the quantity of silk they secrete. That they have not attracted the attention of silk manufacturers to a greater extent, is probably due to the difficulty experienced in reeling the silk from the cocoons, an objection which, however serious it may be to him who would substitute these to feed machinery adapted to work the cocoons of the Chinese worm, is of no weight to one who seeks to utilize the silk sacks of the insect prior to its spinning—as would be done in gut-manufacture.

For many reasons, that worm known to the entomologist as the *Attacus cecropia* is most worthy of our attention. It produces the largest quantity of silk of any, and that of great strength. Its habitat is co-extensive with the United States. It is indifferent to the vicissitudes of our climate, and will flourish anywhere in the open air. It is an omnivorous feeder—"as easy to raise to maturity as young ducks or chickens"—and finally from it gut has been drawn "eight and nine feet long, and strong enough to hold a salmon"—"quite round, and all an angler could desire."

I am largely indebted for my information in regard to this worm to Dr. Theodatus Garlick, of Bedford, Ohio, justly celebrated as the father of fish-culture in this country, and to Dr. E. Sterling, of the city of Cleveland in the same State.

The former gentleman, from a bed of sickness and pain, in his eightieth year, responded with alacrity to

my inquiries as to his experience in producing gut from this worm—at the expense of how much suffering he only knows. It is but another example of his well-known public spirit, and a further illustration, if any were needed, that the love which an angler bears towards his favorite pursuit fails only with life itself. We try in vain to convey to the uninitiated a conception of its charm to us; but can the most sceptical refuse to concede that there must be something in a matter that can excite and maintain such unimpaired enthusiasm, even when face to face with the Great Unknown?

Dr. Garlick writes as follows:

“BEDFORD, OHIO, July 17, 1884.

“*Henry P. Wells, Esq.:*

“DEAR SIR,—Your letter finds me very sick, and I attempt a reply lying in bed, so please excuse pencil.

“We have here four native silk-worms—the *Attacus cecropia*, *Attacus prometheus*, *Attacus luna*, and the *Attacus polyphemus*.

“The *Attacus cecropia* spins by far the largest cocoon, and is the one I used in drawing the long silk gut from. The worms (larvæ) feed on the leaves of several kinds of trees and shrubs. In swamps is found a shrub known as the ‘Button-ball bush’ (*Cephalanthus occidentalis*). Among these shrubs I have found the cocoons of the *A. cecropia* in great abundance. I gather the cocoons in the fall or winter, male and female, the cocoon containing the female chrysalis being much the larger. I keep the cocoons in a cool place until spring, when such trees as the apple and plum are in leaf, on the leaves of which the young worms will feed. The plum being the best for them.

“About this time the moths leave the cocoons and

mate. After they have mated I place the females in large paper boxes, in which they lay their eggs, which soon hatch. I feed the young larvæ on tender leaves of the plum-tree, if I have the plum, but the apple or pear will answer. After they grow to about an inch long I place them in the plum or apple trees, and let them take their chance for life against the birds—of course I keep a sharp watch of their progress. When the worm begins to spin his cocoon is the right time to draw the silk gut. This is done by pinning the worm on a board and cutting the body of the worm off, far enough back from the head to cut a little off the two silk sacks that contain the fluid silk, which in consistency looks like the white of a hen's egg. Into this fluid silk I dip a largish pin, drawing it more or less slowly until the silk is exhausted in the sacks; then with another pin I fasten the last end of the gut to the board.

“The fluid silk hardens immediately as it comes in contact with the air. The size of the gut will depend entirely on the rapidity with which the gut is drawn—the faster it is drawn the smaller will be the gut.

“I have drawn this gut eight or nine feet long, and strong enough to hold a salmon. There is no more difficulty in drawing this gut from the *Attacus cecropia*, than from the ordinary silk-worm (*Bombyx mori*). The *Attacus prometheus* feeds on the leaves of the saffras and spice-bush, and makes a beautiful silk.

“Very respectfully, T. GARLICK.”

“BEDFORD, OHIO, July 23, 1884.

“*Henry P. Wells, Esq.:*

“DEAR SIR,—Your favor of the 19th is read, and as usual finds me a great sufferer. You are at liberty to

use any portion or the whole of my letters on the subject of drawing silk gut from our native silk-worms. I do nothing to the worm previous to drawing the gut, except to pin it to a long board in order to prevent it from squirming—pin it at both ends. I cannot tell you exactly at what spot or point to cut the worm, in order to cut the silk sacks at the best point, and would advise you make a careful dissection (a vivisection) of the worm, in order to find the best point to cut the silk sacks, which should not be where the sacks are the largest, but sufficiently large to allow a sufficient flow of the fluid silk to make the gut of the right size. Of course it requires a much longer time for as large a fibre as gut to harden and become silk, than the fine fibre, as spun by the worm, which is instantaneous. If you will examine the floss silk between the outer and inner shell of the cocoon of the *Attacus cecropia*, you will find that fibre a strong silk—provided the cocoon is not an old weather-beaten one. I should think you might find on Long Island both the *Attacus prometheus* and the *Attacus cecropia*—the former on the spice-bush or sassafras; the latter on the button-ball bush, so called, which grows in swampy places. The silk of the *Prometheus* is of the finest and strongest quality, but not near as large as the cocoons of the *Attacus cecropia*. If the silk of the *Attacus cecropia* is strong, why should not the gut be strong?

“Last year there were a few *Cecropias* that fed and spun on my pear-trees. I wish now that I had drawn some gut from them, which I would have cheerfully sent to you, but I wanted the moths to put up with other insects, and let them spin their cocoons on my pear-trees. If I find any this year I will, if alive and well enough,

try and draw some gut, but fear I shall not be able, even if alive and I find the worms, to draw the gut—for I am now well into my eightieth year, and expect and hope to leave soon. With kind wishes,

“I am very truly yours,

“T. GARLICK.”*

In other communications Dr. Garlick states: “I venture the assertion that the fibre of the *Attacus cecropia* is as strong as that of the *B. mori* (common silk-worm) by actual test. I have drawn gut from both of these silk-worms, and encountered no difficulty with either. Dr. Sterling, of Cleveland, saw the gut I drew from the *A. cecropia*. I never place the worm in vinegar prior to drawing the gut; I should as soon think of placing it in concentrated sulphuric acid. I follow nature as near as possible, and draw the gut from the living worm.”

Dr. Sterling confirms this, if confirmation of any statement made by Dr. Garlick be not superfluous. He writes me, “the gut so drawn from the *Cecropia* was quite round, and all an angler could desire.” He further says that the cocoons can be obtained in any quantity in the thickets of the water sycamore which line the swamps and lagoons of Northern Ohio, and that he has gathered half a bushel in half an hour.

The ordinary silk-worm (*B. mori*) is large if three inches long and three-eighths of an inch in diameter; while Dr. Sterling says, “I have seen it (the *Cecropia*) over four inches long, and as thick as a working-man’s thumb.” When it is remembered that this bulk is main-

* Dr. Garlick died December 9th, 1884, universally respected and regretted, and leaving behind him that most enviable of records—his country is the better for his having lived.

ly due to the silk secreted within the worm, and the strength of that silk being universally admitted, its great superiority to the *B. mori* for our purpose seems to be beyond question. In "On Insects Injurious to Vegetation," by F. W. Harris (Orange Judd Publishing Co., New York, 1863), he says, "as a worm for quantity and durability of silk the *Cecropia* has so far no equal."

The worm is apple-green in color, darker below and lighter on the back. Its skin is smooth, except for six longitudinal ranks of fleshy tubercles, two on each side and two on the back. Those on the sides are smaller, cylindrical, and blue in color. On the back the tubercles are larger and yellow, except those on the three segments nearest the head. The latter are larger still, red in color, with small black spots, and shaped like a cabbage head—that is, as though fleshy excrescences, about the size and shape of a No. 1 shot, were joined to the body by a fleshy neck. A single tubercle similar in size and form, and yellow in color, is attached to the middle of the back near the tail. It is the only tubercle on the median line of the back.

The foregoing, it is hoped, will answer for purposes of identification, but those desiring further information can find colored illustrations of both worm and moth (as well as of those hereinafter mentioned, with one exception) in vol. xxxii. of the *Naturalist's Library* (Henry G. Bohn, publisher, York Street, Covent Garden, London). The references will be found on page 132, and the pages following. The *Cecropian* worm is therein called the "*Hyalophora cecropia*." A description can also be found in "On Insects Injurious to Vegetation," heretofore alluded to, and in "The Lepidoptera of North America" (*Smithsonian Institution*, 1862).

The *Attacus prometheus* (described and figured on p. 134, vol. xxxii. of the *Naturalist's Library*) is another native worm adapted to our purpose, and next in point of size to the *Cecropia*. In range it is as extensive as the *Cecropia*. It is not quite so omnivorous in its appetite, feeding on the sassafras (*Lauras sassafras*), the spice-bush (*L. benzoin*), and the swamp button-ball bush (*Cephalanthus occidentalis*). It is green in color, with yellow feet; "each segment of the body, except the posterior, is marked with six blue spots, from which arise small black tubercles; in the second and third segments, however, the two centre tubercles are replaced by club-like projections of a third of an inch in length, and of a bright coral red color. The last segment is furnished with but five tubercles, the central one of which is of the same clavate form as the anterior segments, but is of a fine yellow color." Dr. Garlick says, "These cocoons can be collected in great numbers where the sassafras and spice-bush are abundant, as it is in this region [Cleveland, Ohio]. Silk can be drawn from this worm from three to four feet long, and strong enough for salmon-fishing, of the very best quality."

The *Attacus polyphemus* is another native silk-worm worthy of attention. It is not described in the *Naturalist's Library*, but three exhaustive papers on its natural history and cultivation, by L. Trouvelot, may be found in vol. i. of the *American Naturalist*, pp. 30, 85, 145. Mr. Trouvelot says in substance, the worm is over three inches long and very thick. It is extremely hardy, and will endure with impunity any temperature, even below the zero of Fahrenheit. It feeds equally well on the different species of oaks, maples, willows, poplars, elms, hazels, birches, blueberry, and other plants, with-

out affecting the quality of the silk. "The silk in the reservoirs is sometimes used in commerce, being sold under the name of gut. The process of obtaining the gut is very simple; it consists in preparing worms ready to spin by putting them in strong vinegar for eighteen hours; a transverse opening is then carefully made on the under-side and about the middle of the body, taking care not to injure the silk reservoirs, which are very distinct. The glands or reservoirs are then taken out and stretched parallel to each other on a board, and dried in the shade for several days." It will yield gut twenty-five inches long.

The *Saturnia cynthia*, or, as it is sometimes called, the *Samia cynthia*, though a native of Japan, has become acclimated, and is sometimes found wild in this country on the ailanthus-tree. This is its favorite food, hence it is sometimes called the ailanthus silk-worm. An excellent paper on its natural history and cultivation, by W. V. Andrews, may be found on page 311, vol. ii., of the *American Naturalist*. A colored illustration of both worm and moth may be found on page 149, vol. xxxii., of the *Naturalist's Library*, heretofore alluded to. From its silk is made a "seemingly loose texture, but of incredible durability, the life of one person being seldom sufficient to wear out a garment made of it."

We all know how prolific and how rapid is the growth of the ailanthus, springing from a stub to considerable height in a single season, and this on the poorest soils. This worm is not a wanderer, but remains on the tree on which it is placed as long as its food lasts. It is extremely hardy. Two broods a year may be raised. I am not informed as to the length of gut which may be drawn from it, but its greatly superior size indicates that

it must far excel the ordinary silk-worm (*B. mori*) in this respect. No special facilities seem necessary. The ailanthus can be raised with the greatest ease anywhere, and by pruning can be forced to assume and retain a low growth, so as to be readily accessible by the cultivator to facilitate the care of the worm. It can thus be easily raised in the open air.

Undoubtedly a letter addressed to the Commissioner of Agriculture at Washington would elicit not only any further information which might be desired, but also substantial aid by furnishing eggs or cocoons of any of the species hereinbefore mentioned, since this department of the Government is now exerting itself to foster silk-culture in this country.

I have entered into this subject somewhat at length, in the hope that it is only necessary to call attention to it, to insure before long a supply of domestic gut far superior to that we are now forced to put up with. At present we are compelled to depend on Spanish gut. At least twenty per cent. of this is imperfect, with hardly any two strands of the same thickness, and seldom exceeding fifteen inches in length. If we may judge from the past, with American ingenuity to conduct this manufacture, soon the angler would be able to order gut of a certain number, and receive an article perfectly round, of any desired length, and each strand of uniform thickness from one end to the other; the number as invariably indicating the diameter as a like designation now indicates that of metal wire.

In rods, reels, and lines we lead the world; why not in this as well?

But another consideration suggests itself, of greater moment than an improvement in the art we love so much.

To successfully rear the ordinary silk-worm, patience and capital must first be expended in cultivating the mulberry required for its food. Again, like all animals long domesticated, it has as many diseases as a horse, and the most unremitting attention is required lest both crop and stock be a total failure.

Already the reader will have noticed that the food of all the worms to which his attention has been called is ready to hand, and also that they are very hardy. To collect the cocoons for a new crop, to care for the eggs for a few days until they hatch, and to feed the young until they are an inch or so long, is all that is required; then they can be transferred to the trees, and left with safety to the care of Nature. About twenty-five days after hatching they must be watched, and those ready to spin selected, pickled, and drawn, allowing enough to form their cocoons to produce seed for the next crop.

Here is a new and lucrative industry, eminently adapted to those who, from sex or other causes, are unfitted for severe manual labor, yet whose necessities compel them to do something. Here is a boon to the female population of our rural districts, to whom not energy nor industry, but only the opportunity to provide for themselves, is wanting. No fear of over-production need be felt, for the worms may be allowed to spin their cocoons, and if they cannot be unreeled and made into goods as fine as those from the cocoons of the ordinary silk-worm—which is by no means certain—at all events they can be carded, spun, and woven into an excellent, durable, and desirable fabric. If the raw material can be had in any quantity, no fear need be entertained in this country that it will not be utilized.

As to making the gut, who will claim that a manufact-

ure which is within the scope of the ignorant peasantry of Spain, is beyond the intelligence of our agricultural population? Failure may attend a first effort, but experiment will cost nothing, and success will surely follow perseverance. It is possible that a method of sizing and rounding the gut might be devised, such as drawing it through a "draw-plate," either directly from the silk sack or subsequently to that step, by which roundness and uniformity might be secured automatically, and by the most unskilled. A beginning is but necessary, and American ingenuity will soon elaborate the best method of manipulation.

A recent communication from Dr. Garlick reads as follows:

"BEDFORD, OHIO, August 27, 1884.

"*Henry P. Wells, Esq.* :

"DEAR SIR,—I have been trying to guess why it is that some have failed to draw good gut from the *A. cecropia*. It has occurred to my mind that possibly they may have divided the worm too far back from the head, thus dividing the silk sacks at a point where they are too large to allow the fluid silk to flow just fast enough to make the gut of the right size, also uniform in size.

"You are probably aware that if the spinnerets of the worm were larger than what they are, the fibre of the cocoon would be very much larger than what it is.

"It has also occurred to me that dividing the worm too far back, the fluid silk may have been mixed with other fluids of the worm, thus impairing the strength of the gut.

Very truly yours,

"T. GARLICK."

Drawn gut may now be had if it is true, but it is confined to the very thinnest kinds. It is produced in Eng-

land and Scotland by redrawing imported gut. This impairs the strength, and renders the gut prone to fray and become ragged; but at the same time it takes dye much better and with a much more lustreless surface, a feature of great value. Still, its excessive thinness is unsuited to most of the requirements of the American angler.

To guide in the selection of gut, I cannot do better than repeat the directions of Mr. Chitty:

“In choosing gut of any kind be not too much guided by an apparent thickness, but, as far as your time and patience will permit, select such as is perfectly round; and to prove it so, try each piece by turning it quickly between the forefinger and thumb, for if it be in anywise flat this will only be effected with difficulty, and then you may safely condemn it. Each piece or length should be also to the teeth hard, like wire; colorless and transparent as glass, which testifies strength; free from unravelled fibres, which are attended with an inclination to split or peel; knotted roughness, which shows almost actual rottenness: the space between the knots, when pulled lengthways between the fingers, being soft and weak; or flashing lights, when seen in a slanting direction, which indicate flatness and consequent weakness. It should possess stiffness in bending, and with this should be combined elasticity, so that after being doubled upon itself—in the shape of a loop, for instance—if in thus doubling it assumes anything like an angularity it will not do, for it surely possesses unequal degrees of strength, even if, where it forms into such angles, it be not absolutely rotten. Salmon gut may be in substance as thick as you can find it, and you will possess a treasure if in one hank many lengths are as

thick as a middling-sized pin or stout knittling-needle. In length, the part for use should run from sixteen to eighteen inches at least, and the longer the better, provided the substance be uniform. The thicker trout gut should be of the diameter of ordinary sewing silk, while the thinner sort may be almost the very finest you can procure, provided it be 'round and sound,' and keeping in view all other requisites for strength. Ten to sixteen inches is the usual length of each strand."

To this may be added one point. Soak an average strand or two of your gut, tie a loop in each end, place one end over a hook and the other on a spring-balance, and find what the breaking strain actually is. Gut of the same diameter differs so much in strength that this will not be wasted time. I have made an attempt to tabulate the fair average of strength to be expected from gut of certain sizes, but the measurements are so minute, and require appliances so unusual to determine them, that it has been abandoned as of no practical value. I myself always measure gut before purchasing it. Sometimes I have used a Stubb's wire-gauge for this purpose, but it is much too coarse. Uncolored gut No. 28 on that standard should stand eight pounds steady pull with a spring-balance; the drawn gut measures thereon about No. 31, and should stand two and a half pounds. New gut of No. 30 should not break short of four and a half to five pounds tested in this manner. I now use a gauge similar to that employed to determine the thickness of violin strings. It is very easily made, and is quite satisfactory.

AA represents two pieces of brass touching at one end, but separated about an ordinarily fine sewing-needle's thickness at the other. The adjacent edges must be straight. On each side of the closed ends a flat piece

of brass is placed, *B*, and the whole united with soft solder and then finished up. Its total length is two and a half inches. One of the limbs,

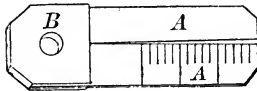

Fig. 19.

one and three-quarter inches long, is divided into tenths of an inch, as shown. Some similar device will be found useful for purposes of comparison by those who tie their own flies and leaders, enabling such to duplicate a satisfactory size—an effort liable to be attended with mistake if the eye and memory alone are relied on. Of course an average must be taken, as no bundle of gut runs perfectly uniform—at least as far as I have ever seen.

Having obtained the gut, the next step is the dyeing.

The books on angling contain receipts without number for this purpose, but my experiments induce me to believe that two, or at most three of these, answer every purpose. I have endeavored to ascertain with some degree of certainty how much the dyeing process weakens the gut, but the investigation is hedged about with difficulties. I first tried looping half a dozen strands of gut from the same bundle, and finding and recording the breaking strain of each strand. Then after knotting the pieces together, and dyeing them in a certain manner, the breaking strain was again determined and compared with that first obtained. From these data it was proposed to compute the loss in strength due to the use of that particular dye; but a moment's reflection suffices to show that this method can afford no sure result; for each strand of course broke in the first instance at its weakest point. Consequently, after the fragments have been united, the then breaking strain is unknown, and it

is with this unknown quantity the comparison is necessarily made. Other methods were tried, but none were free from objection. However, it seems safe to say that from fifteen up to forty and even fifty per cent. of the strength of the gut may be lost in this process, according to the skill and care used therein.

If the following directions are followed, it is believed this will be reduced to a minimum. Before dyeing gut, the ragged ends should be clipped and the useful portion bundled together by tying at one end only. This bundle should be well washed with brown soap and water, and then rinsed in at least three waters until the soap is thoroughly eliminated; it should then be wiped, and allowed to dry. Thus any greasy matter which may be upon the surface of the gut from any cause will be removed, and the dye will bite with greater promptness and the more indelibly. For if all dyes are to some extent corrosive, as seems to be the case, it is well to expose the gut to this influence for as short a time as will produce the desired result.

The least injurious of any which will give a useful color is the ink-dye. Indeed I have thought at times its use was attended with no loss whatever. Doubtless this is partly due to the fact that the gut is then not subjected to heat. The resultant color is a neutral tint of an azure tone, a color excellent in itself. Ink, however, is generally considered inferior to the dyes of which copperas is a component, in that it does not equally neutralize the natural gloss of the surface of the gut. This is of the utmost consequence, since, as will be seen hereafter, from a glossy surface the light is so reflected that a strand of such gut appears in the water like a polished silver wire. Mr. Fred Mather, the widely

and well-known superintendent of the Cold Spring Fish Hatchery, informs me that the juice of the milk-weed will remove this gloss. I have had no opportunity to try this, but if when used in conjunction with the dyes it will produce this effect without injuring the gut, Mr. Mather by his suggestion adds another to the numerous obligations he has already placed upon the angling fraternity.

The comparative merits of the different colors are discussed in the chapter on Flies and Fly-fishing. My experiments seem to indicate that a leader absolutely invisible to the fish, if it ever will be, has not as yet been produced. Experiment and experience alike incline me to believe that more important than fishing up or down stream—more important than wearing brilliant or sober tinted clothing—more important than wading rather than fishing from the bank—more important than being yourself visible or concealed—more important, indeed, than any of the dozen different cautions of the books, is it to have your leader—the connection between you and the flies—absolutely invisible; or, since this seems impossible in the present state of the art, then at least that it present to the fish no unusual or unfamiliar appearance. That in or on smooth water, at least, the leaders in present use fill neither of these conditions, unless my experiments deceive me, I cannot doubt.

Take this case into consideration from the *Forest and Stream* of February 28, 1884: "Near us we have a stream in which fish-trout are scarce and wild. They are exceedingly suspicious of any kind of tackle. . . . I had repeatedly cast the most tempting flies, with a mist-colored leader, without effect. A soliloquy followed: 'That leader is not natural to the every-day life of the fish.'

I adjourned to a neighboring meadow and cut three or four long leafy timothy stalks, which I very loosely whipped to my leader. There was no casting, but simply letting the line float with the current over the most likely places. Complete success was my reward.—‘*Forty-Niner.*’”

“Forty-Niner” leaders, prepared as described, did comply with one of these conditions, and the “complete success” which attended its use is replete with instruction to all such as, in the picturesque language of the Orient, are willing to be admonished.

The ink-dye consists simply of “Arnold’s Writing Fluid,” diluted with an equal bulk of cold water. In this the gut, washed as before directed, is immersed from one-half to three or four hours, according to its thickness, or until the desired color is obtained.

The following process, taken from Chitty by Norris, was originally derived by me from the latter’s most excellent book, “The American Angler.” I do not quote, but give the process as I use it.

In a pint and a half of cold water put one drachm of ground logwood and six grains of powdered copperas. Boil for about five or six minutes, or until a piece of writing-paper immersed therein is promptly colored. Then remove the pot from the fire, and as soon as the liquid becomes quiescent put in the gut, tied to a little stick or a wire so that it may be lifted and examined from time to time. With watch in hand, give it two to three minutes, according to its thickness, and then inspect the result. If not dyed sufficiently, replace it for another half-minute; and so on till the required shade is obtained. Then wash well in cold water, and the process is complete.

This will dye one hank of gut. Then it should be thrown away, and a fresh decoction made if more gut is to be colored; for the dye becomes more and more feeble with use, and a more and more protracted exposure to the heated liquid is therefore required. Though the copperas itself impairs the gut to a certain degree, still this appears to be of small moment when compared to the injury done by long continued immersion in the almost boiling liquid. Indeed it seems to make the difference between a loss of fifteen and possibly fifty per cent., as before intimated. The color thus obtained is a dull neutral tint.

Different samples of logwood vary greatly in the amount of extractive color they contain. This may be tested with a slip of writing-paper, as before intimated. If failure is encountered it will be from this cause, and success will attend a change to logwood procured from another source.

In streams where floating grass and weeds are not uncommon, the following may give better results; for though more visible, it presents a less unusual appearance. I borrow it from Francis Francis's book on "Angling:" "Boil green baize in water, and when this is well charged with color, and still warm, immerse the gut therein until sufficiently dyed." Then wash as before. All these boiling operations should be conducted in earthenware vessels, since most dyes are sensitive to metallic salts or oxides.

Having dyed and washed the gut, while still soft bind it to a stick that it may dry straight. Then proceed to sort it, selecting first and placing by themselves all the thickest strands, rejecting altogether such as are flat and irregular in form; for these are not only deficient in

strength, but, giving more reflection, are consequently far more conspicuous in or on the water. Throw these away without hesitation, for they are worse than useless. When doubt is experienced whether any of the remaining strands should be classified with those first selected, begin at the other end of the scale, and proceed in the same manner to select and separate all the thinnest strands. Thus make three bundles of large, medium, and small gut. You are now ready to tie your leaders.

First, however, the proposed length must be determined, and this should be such that when the tail-fly is hooked upon one of the posts separating the side plates of the reel, the leader will extend to within eight inches or a foot of the tip-end of the rod. Make the upper third of the leader from the bundle composed of the largest gut, the middle from the medium bundle, and the fly end from that containing the thinnest gut.

Having selected the strands, but still keeping them separate by tying each little bundle with a different colored thread, soften by soaking in warm water, such as is not uncomfortable to the touch. Ordinarily cold water is to be preferred to soften a leader preparatory to attaching it to the line, but where knots are to be tied the utmost softness is required, not only that the gut may not crack during the operation, but to insure that each knot draws so tight as thereafter to be beyond the possibility of slipping.

When the gut is perfectly pliable, beginning at the line end, select the largest strand, and doubling one end into a loop, tie this ordinary knot, using the doubled part as though it were a single piece of string. Arrange the position of the knot so as to give a loop from one-

half to three-quarters of an inch long. Then inserting a match through the loop, grasp the short end between the teeth, the long end with the left hand, and draw the knot together, shaking it well when under the final strain to settle the parts together just as far as they can be made to slip.

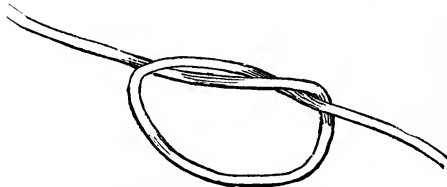

Fig. 20.—The ordinary knot.

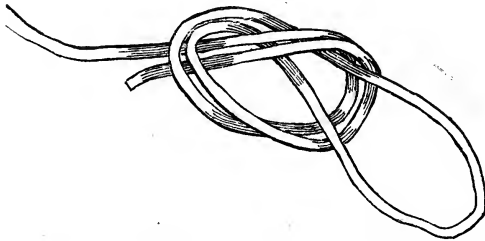

Fig. 21.—Same knot to form loop on leader.

Knots, theoretically more perfect, are generally employed for this purpose, but practically they are no whit better—indeed hardly so good, since they are all more or less complex, while this knot is already known to every child ten years old.

The next step is to unite this looped strand to another, to be the next thickest of the bundle from which

the first was chosen. For this purpose the very same knot may be used, by lapping the ends past each other, and then proceeding as though you were about to tie the same knot in a single string, and adjusting its position so as to fall on the doubled part—thus :

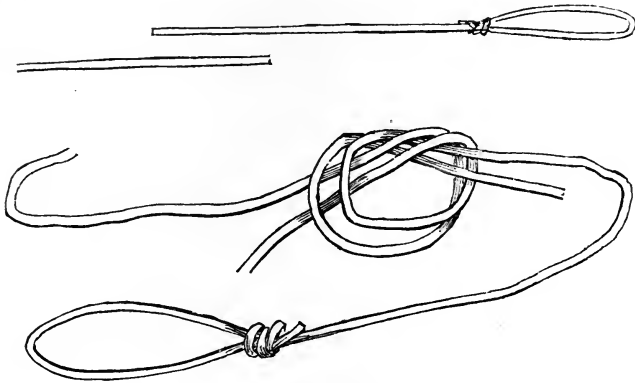

Fig. 22.

This knot is however inconvenient, in that the entire strand must be drawn through the knot every time it is formed.

There is another method, that which I use myself and prefer.

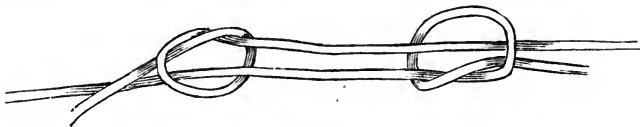

Fig. 23.

It is still the same knot we have used before. The strands are lapped, and two ordinary knots are tied, one

with each short part around each long part. The knots are then drawn tight where they are made; then upon pulling on the long ends the two ordinary knots will slide together, when they should be well shaken while under strain, as and for the purpose above set forth. This is known as the "single water-knot." The "double water-knot" is generally used for this purpose, since then it is claimed the ends can be cut off as close as possible without danger of slipping, and this is true. It is tied in the same way as the single water-knot, except that each short part is passed twice around the neighboring long parts instead of but once, and the end of each short part is passed through both the loops so formed.

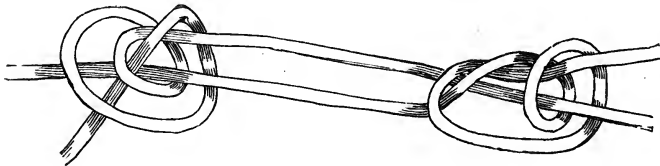

Fig. 24.

Till within the last five years I always used the double water-knot, but then disliking its size and obtrusiveness, I turned to the single water-knot, and have employed that with entire satisfaction ever since. There is unquestionably more margin for carelessness to escape the usual penalty in the double, than in the single knot. But with care, not forgetting when straining the twin knots (if I may use that expression) together to shake them well, the single water-knot is perfectly safe and by no means so bulky.

It is exceedingly difficult verbally so to describe a knot, that one entirely unacquainted with it can at the

first effort successfully follow the given directions. That one possible stumbling-block may be removed, it may be remarked that both of these water-knots are really composed of two separate knots, tied with each short end of the strands, and around the long portion of the strand against which each is lapped. Each of these component knots, therefore, merely embraces the longer neighboring strand, and the latter may freely slide within it. This feature is sometimes taken advantage of as a solution to the difficult question, how the drop-flies may most advantageously be attached to the leader. For if the two knots which compose the water-knot be seized by the finger-nails, theoretically they may be separated an inch or so, leaving the gut doubled between these knots. If then the end of the gut upon which a drop-fly is tied be inserted between this doubled gut, and the component knots be drawn together, the end of the drop-fly gut is secured, and the fly stands out nicely at right angles from the leader.

I say theoretically the water-knot will separate; but practically, after the leader is wet and swollen, it will absolutely refuse so to do at least two-thirds of the time. I have even tied in, when forming the knot, a third thick strand, to be removed when the knot was complete, and thus allow for the swelling of the leader when wet. But it was the same old story; like the Dutchman's pig, sometimes it would and sometimes it wouldn't.

No trifle is more exasperating than to stand knee-deep in water, a choice and favorite pool before you, one fly between your teeth, and your rod tucked under your arm, and pick away and in vain at these knots. I have even heard adjectives of great force then ap-

plied to them, and in a tone which left no question of the heartiness of the condemnation.

If, however, this method of attaching the drop-flies is preferred, the double water-knot should be used rather than the single, since the latter will not bear with safety the incidental manipulation.

The following seems to me preferable, and though a little more visible, still the drop-flies can thus always readily be changed, and that without danger to the angler's peace of mind.

At the place where the drop-flies should be, join the leader by two loops instead of knots—thus :

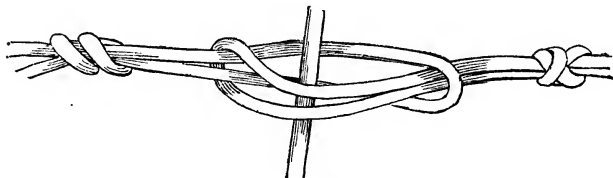

Fig. 25.

By pushing these loops apart, an opening may be formed in which the gut of the drop-fly may be inserted, and securely held when the loops are drawn tight again.

There is nothing in the making of a leader beyond forming the loops at the proper places, and uniting the short lengths by knots. This has been described.

Some recommend fastening a gut loop to the end of the line, and looping the leader to it in the usual manner—that is, by inserting the loop on the line through the loop on the larger end of the leader, and then drawing the entire leader through the former, just as the tail-fly is ordinarily attached to the leader. Others

prefer to knot the line to the leader in the following manner :

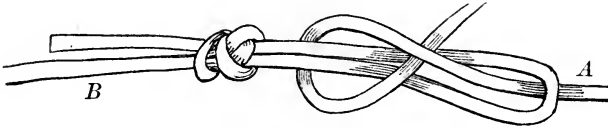

Fig. 26.—A, line; B, leader.

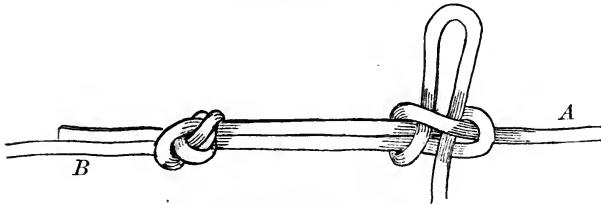

Fig. 27.—A, line; B, leader.

This knot is theoretically a perfect knot, in that it will stand forever if so desired, yet may be loosed with ease at any time. The knot as first figured, is not yet drawn together. Care must be taken that this knot does not “upset” when tightened—that is, the knot must be on the loop of the leader itself, and by no means on the line, since in the one case it will stand, and in the other it will not. This will be more clear if we investigate the principle on which it is constructed. On examining the diagram, it appears that the end of the line is first run through the loop of the leader, then wrapped entirely around the outside of the loop, and lastly is tucked between the line on one side and both parts of the loop on the other. Clearly this knot cannot slip, unless the end of the line slips at the same time. But the greater the strain, the more firmly that end is compressed

and held; while if the knot is pushed down the loop of the leader, as shown in the first figure, it is clear that the end is at once freed from pressure, and may be easily withdrawn and the knot released. To facilitate this, some double the end before putting it under the line, as shown in the second figure. Then a pull on the end loosens the knot, just as a shoe is untied. If, however, the knot is allowed to "upset," this is the result, in which it is clear, first, that the end of the line is not "jammed," and second, that the knot cannot easily be unfastened.



Fig. 28.—A, line; B, leader.

If not already familiar with this knot, try it right here with a piece of string. It is very simple. Half a dozen experiments, guided by the diagram, will indelibly impress it on the memory. No person learns a knot solely from inspection of a drawing. But such inspection becomes study when combined with an effort to follow out the illustration in practice, and this is the way, and the only way, and at the same time a sure way, to master a matter of this kind. Some complain they can never learn a knot from a book. The only difficulty is that such do not attack it in the right way. Any of the simple knots required by the angler can thus readily be mastered, provided the learner will only try string in hand.

How far the drop-flies should be placed from the tail-fly depends on circumstances. With a long rod they may be nearer than with a short rod, so also when wad-

ing as compared to fishing from the bank. With a ten-foot rod about forty inches between the tail and middle fly, and from eighteen to twenty-four inches between the latter and the hand-fly, will be the average.

It is customary to secure the tail-fly to the leader by providing both parts with loops, and looping them together. But I decidedly prefer to have my flies, no matter how diminutive they may be, provided with a small loop at the head instead of the usual looped length of gut, and to attach the leader, or the dropper-gut (as the case may be), to them by the knot shown in Fig. 26. By terminating the gut to be tied with a small hard knot, the projecting end shown in that figure may practically be dispensed with, since the knot will then retain the end in its proper position.

This method has, I believe, many advantages. The customary loops are apt to inmesh more or less air, which, when submerged, shines like polished silver; while all disturbance of the water caused by the knot I advocate is so close to the fly as readily to be attributed to the motion of the fly itself. Again, it is unnecessary to pass the fly through the loop, and the injury it not unfrequently suffers from this cause is avoided, while all flies are alike indifferently available for droppers as well as stretchers; and lastly, an ordinary tin tobacco-box becomes a most convenient fly-book for temporary use. When this method is followed, the dropper-gut lengths of course remain constantly attached to the leader while in use.

Having completed your leader, grading its taper by careful and orderly selection from the thick, medium and thin bundles of gut, snip off the free ends closely. The next step is to test it. This should never be omitted.

Provide yourself with some strips of writing-paper about half an inch wide and an inch long, and gum one end, and let this dry. Then proceed as follows: Soak your leader till perfectly soft. Thrust a brad-awl through one end loop, and into a board. Apply a spring-balance to the other end loop, holding this with the right hand, while you reach before it and grasp the leader with the left. Then strain the leader till it breaks, noting upon the spring-balance at how many pounds this takes place. Then knot the leader again, snip off the ends, coil it about something round to give it a nice appearance, and after removing the leader, fasten the coils so formed by winding one end spirally about them. Then write the date, and "breaks at — pounds," on one of the paper slips, and attach it to the leader. You will thereafter know the history of that leader, and what reliance can be placed upon it. Should the leader break in testing much below what you think it should have endured, prove it again after re-tying it. For in the first instance the gut may have been cracked somewhere, and if this was the case your test gave no indication of its real strength. I believe it will be found wise invariably to test a leader every time it is to be used. This can be done in an instant with the aid of a friend and a spring-balance, which latter will of course form a part of your outfit.

Soften two leaders in cold or tepid water—not hot water, since it dissolves the gluten and impairs the strength of the gut. While a friend holds one loop of the leader on a match, or similar slip of soft wood free from sharp edges, hook your spring-balance into the loop at the other end. Let each grasp the leader between his thumb and finger as far towards the middle as he can reach, so that if it breaks, you may still retain the pieces and not

be obliged to hunt them up. Then put on the strain. It will of course break at the weakest point, and in two or three trials these will be eliminated.

In September of 1883 a friend was about to make his maiden cast in Maine waters, to which he had been attracted by reports of the large trout which might be there taken. Since the trip had been determined on, he had dreamed of nothing but big trout, and his ardor was at fever heat. Beside leaders fit to hold a shark, which had been specially provided for that occasion, he had half a dozen lighter ones, left from a previous excursion to the Adirondacks. He was strongly recommended to test, and, if strong enough, to use the latter. Not one of them, on the first trial, bore a strain of half a pound without rupture. Some broke three times, but not one failed finally to endure four and a half pounds, and that with but trivial loss in length. Had he used the leaders he intended, their excessive thickness and unnecessary obtrusiveness would doubtless have seriously lessened his chances of success with the grade of fish he had come so far to take; while had he employed the others, how great would have been his disappointment when every decent rise he had must have been followed by the loss of the fish, his flies, and a portion of his leader. The fault lay not with the quality of the gut, for that was good enough; but at some time since these leaders were made, they had been subjected to maltreatment when dry, breaking the fibre, and thus rendering the leader worse than useless until the damaged part was eliminated. The most careful and critical ocular inspection would have given rise to no suspicion how defective these leaders really were. Actual test alone could detect their weakness.

Take another instance from my own experience. Some

years ago I purchased a bundle of gut, which, though small in diameter, was of uncommon length, as well as of unusual excellence in every other respect. It was justly regarded as a great prize. Having abundance of other colors, I prepared to dye this lot in a decoction of red onion-peel, under the mistaken impression that a brownish-yellow tint was the least visible in brown waters. The dye did not seem to bite readily, so the aid of heat was sought to hasten the process. This had the desired effect, and a very satisfactory color was obtained. Half a dozen leaders were made from it in the hurry incident to the last day or two of preparation for a somewhat protracted fishing-trip, and with them in my fly-book I set out. Arriving in the evening, the next morning we began our preparations for fishing, when these leaders were produced with a grand flourish before the other anglers then present, and their supposed merits were expatiated upon. From hand to hand they passed, the length and the roundness of the strands, and their uniform and delicate color, eliciting universal admiration. It then occurred to me that they had not been tested; and this, acting on principle, and not because I entertained the most remote suspicion of their strength, I proceeded to do. We have the best of authority that "pride goeth before destruction, and a haughty spirit before a fall," and so it was in this case. The gut before dyeing showed an average breaking strain of eight pounds, and guided by the tests then made, not the slightest doubt was entertained that the leaders made from it, after dyeing, would stand six pounds at least; but the protracted exposure to heat had rotted them throughout, and they broke again and again at two pounds, and less. It may easily be imagined that so little wool after so great a cry was

sufficiently humiliating; but at the same time the cloud had its silver lining, though invisible until its shadow had passed. I then learned the lessons which it is the purpose of these incidents to impress—keep your gut from hot water except in dyeing, and then let the exposure be as brief as possible; and *never* use an untested leader, no matter how great your confidence in its strength may be.

The strain imposed upon a leader by even the largest trout is generally greatly over-estimated. A leader that will endure five pounds steady strain with a spring-balance will, when backed by the elasticity of a fair rod, resist the utmost effort of the largest trout that swims the Rangely Lakes. I doubt whether the largest of them on a steady strain can pull one pound in still water; though of course if it gather momentum, and thus throw its weight and velocity suddenly upon a leader, the momentary strain might be much greater. It is also quite another thing to drag a struggling fish through the water against his utmost effort, from merely holding him at a fixed distance. It is quite true that the strain imposed by a spring-balance is an even and steady pull, most favorable to the endurance of the gut; and also that in actual use, in a moment of inattention on the part of the angler, strains of a different and more sudden nature may be encountered. But still I believe that a leader that will stand a spring-balance pull of four and a half to five pounds, has ample reserve to meet this. A thin leader is a very decided advantage, and nothing heavier than gut adequate to meet a reasonable margin for deterioration by lapse of time and wear, added to the power of the fish against which it is to be employed, should be used.

The thickness of leaders habitually used at the Rangeley Lakes is simply preposterous. Heavier would not be selected for a forty-pound salmon.

Among other reasons, these conclusions rest partly on the following :

In June, 1883, with some other anglers I was in camp in the Maine woods. The conversation turned on this subject, and having seen the experiment tried, I said that the strain of any trout could not by possibility much exceed a pound. This statement was regarded by some with so much surprise, that a trial was suggested. A ten-foot hexagonal split-bamboo rod of my own make, and quite stiff for a fly-rod, was used. Drawing with this upon a spring-balance following up the bend of the rod as a fish would do, with the hand holding the rod and its butt away from the body, the strongest among the half dozen, and he a man of muscle, could with his utmost effort—such an effort that the rod fairly quivered—scarcely raise a strain of one and a quarter pounds. He had caught many large fish, and frankly admitted that he had never exerted any such force as that. We all tried it, I among the number. The very next morning I took a trout which weighed five pounds and two ounces, after a twenty minutes' fight. During this I constantly had in mind the experiment of the preceding evening, and I am confident that at no time did his pull exceed half a pound. This was, however, in still water.

During September of the same year a friend, using quite a fine leader tested to four and a half pounds, fastened a trout in still water but in a very dangerous place. Not only did he hold him without yielding an inch of line, but hung to him till his guide took the boat

into clear water, towing the fish after. It weighed four and a half pounds.

I might multiply instances of this kind, but these seem sufficient.

Therefore, a reasonably fine leader, taking into consideration the circumstances under which it is to be used, but of strictly first-class material, is recommended. Test it frequently. See to it that it never be bent when dry, and especially that no one step on it whether dry or wet—an accident quite likely to happen when mounting the rod at the beginning, or taking it apart at the conclusion of a day's fishing.

Remember it is the large fish that exact the penalty for negligence of this kind. There is no medicine for a mind stricken by such a loss and so caused. Over most misfortunes time kindly draws the veil of oblivion, but this wound never cicatrizes. I meet one gentleman frequently, but never, if angling is mentioned, does he fail to mourn over an eight-pounder he lost through the breaking of his leader years ago. This may be because of the sharp contrast any serious misfortune presents to the generally unalloyed happiness of angling, but whatever is the cause, the fact remains that such mishaps dwell in the recollection long after every other associated incident is forgotten.

Therefore I repeat, test your leaders carefully, and be sure they are up to your work; but do not seek this result by using a cable where a thread is adequate, but by care in selection of material, care in manufacture, and care in preservation. If you do this you will never lose a fish from this cause; if you do not, no matter how large the gut you may employ, it will sooner or later play you false.

CHAPTER V.

REELS.

HOWEVER useful the later forms of reel, which can be changed from a click to a multiplier at will, may be where casting the minnow is the usual, and casting the fly the exceptional method of fishing, all the authorities agree that for fly-fishing pure and simple a plain click-reel is the best.

The spool, or part on which the line is wound, should be quite narrow—say from one-half to three-quarters of an inch wide. The narrower this is, the less attention need be given to the distribution of the line on the spool when reeling in. With a wide reel the line, unless watched, has a tendency to bunch in one place. From this bunch some of the lateral coils slip off sideways, and thus become loose; these become involved with the succeeding turns of the line, which then fouls and refuses to render. This state of affairs is not only very annoying, but it is also exceedingly dangerous; since, should this happen when any fish of a size the angler would regret to lose is fast, something will probably break and the fish escape.

Another point of importance is the handle of the reel. This should be so arranged that when the line is drawn from the reel preparatory to the back cast, the loop so formed will find no point of attachment on the handle, should it be accidentally thrown over it; for if this

happens and the line catches, the reel is locked and the line will not render. An ordinary unprotected crank-handle, therefore, should never be allowed on a reel for fly-fishing. Two preventive methods are in use: first, using a mere button attached to a circular plate for a handle; and second, protecting the ordinary crank-handle by providing the side plate with a flange, thus forming a recess within which the handle revolves. The object is to prevent the slack line from passing between the plate and the crank. Either of these methods accomplishes this purpose; while, should the line pass over the handle, its shape is such that the line slips off, and thus disengages itself automatically.

Another desideratum in a reel for fly-fishing is that the click should be as light as possible, yet offer sufficient resistance to prevent the reel from overrunning. The friction of the line through the rings and in the water is quite enough, when supplemented by rather a feeble click, to impose sufficient load upon the fish. It is however a matter of the first importance that the line be at all times solidly wound upon the reel, since otherwise snarls will occur and the line refuse to render—always at the most inopportune moment. With too light a click the reel is apt to overrun a little every time the line is drawn out, and this danger cannot be avoided.

No music is so sweet to the angler's ear as the whirr of the reel, for it announces not only the triumph of his individual skill in tempting the fish to forget their habitual caution, but it promises the pleasure of, and a happy issue to, the coming contest. Therefore I prefer one which speaks with a crisp, clear voice, though of course this is of no practical value beyond increasing the pleas-

ure of him that uses it; but this it does, at least in my own case, to no small degree.

This portion of the reel should be well made, for the wear-and-tear upon it is great. The spring, pawl, and click-wheel should all be made of tempered steel; while the pivot upon which the pawl vibrates should be supported above as well as below the pawl, or no man can tell when it will give out and refuse to act. To say nothing of the tangles of line due to the reel overrunning, and the annoyance and danger which follow the disability of this part, to one who is accustomed to its voice, a sense as though a friend were stricken dumb follows, when it should, yet does not speak.

It is to be regretted that the old method of placing the parts which compose the click within a box upon the outside of the reel has gone out of fashion. Then these were open to inspection and adjustment both by maker

and purchaser, and they were well and durably made. Now, but too frequently, the pawl is merely secured by a headed pin on which the pawl works, which pin has no support except what it derives from the insertion of one end into the side plate. This is totally inadequate to withstand for any length of time the racking to which it will be subject, and to use such a reel is

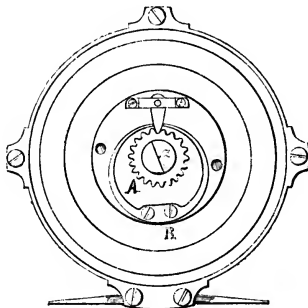

Fig. 29.

but to invite misfortune. No part of an angler's outfit should be more absolutely above suspicion, since, with

the facilities commonly at hand, an accident here is beyond immediate repair, and unless another reel can be had, the pleasure of his trip if not altogether ruined, is much impaired.

The preceding illustration shows how this part should be constructed. *A* is the click-wheel, which should be of hardened steel. The axle of the spool is squared to receive the wheel which fits on this square, and is there secured by a large-headed screw, *a*. Thus this part is a fixture, and cannot by possibility get adrift. The spring, *B*, is rigidly secured to the side of the reel by two screws, and should be actually tempered and not made from wire or metal which owes its elasticity solely to rolling, as is too often the case. *C* is the pawl working on a pivot, both ends of which are secured, the lower in a hole in the plate itself, and the upper in the cap, *D*. This latter is fastened to the plate by two screws as shown. Here it is plain nothing can get out of order; and this was the usual method when reels were provided with an exterior box in which the working parts were enclosed. This box, however, was usually made so unnecessarily large as to be unsightly, while the reels themselves were inconveniently wide. Consequently these were superseded in popularity by a narrower reel, of that form in which the working parts constituting the click are placed between one side of the spool and its adjacent side plate.

Though some reels of this form are well made in this respect, still by far the greater part are not; and brass click-wheels and brass pawls inadequately supported, and wire springs riveted to the side plate of the reel, are the usual components of the click. Of course brass is totally unfit as a material for parts destined to such severe usage, and cannot wear for any length of time.

These defects only become apparent in actual use on the stream, to the utter demoralization of the angler. Therefore a reel so made should be rejected; and that such should not be bought unawares, the dealer should be questioned as to how the click is made, or the buyer should insist that the reel be taken apart. Indeed, if he does not already know how to do this, he should insist on being shown, since annual cleaning, oiling, etc., will be advisable, and he should be able to do this without injury to the reel by experimental efforts directed to this end.

Another objection to the reel as at present made, though by no means so serious, is the smallness of the axle on which the line is wound. This seldom exceeds the diameter of an ordinary lead-pencil. Thus at first hardly an inch of line is taken up to a complete revolution of the spool, while it is always retrieved with a slowness neither desirable nor necessary. Some seek to overcome this by first enlarging the axle with ordinary twine, upon which the line is then wound, others by using multiplying or automatic reels.

The illustration on the following page shows the form of reel I make for my own use, and it is the best in principle of which I have knowledge.

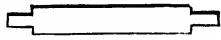
In this reel each side of the spool is cast separately. These are faced off on the inner sides, soft-soldered together, and six holes equally spaced are drilled through both. Thus these holes correspond exactly. I then unsolder the sides. Then six short wires (*a a a* in the diagram) are made of this form,  and by inserting the smaller ends in the holes, and soft-soldering, and then riveting the ends down, the sides of the spool are rigidly and per-

manently joined together. It is then finished as though it were one single piece. The line is then fastened to one of these wires, and the first revolution of the handle takes in about four inches of line. All the click machinery is contained in the box, *B*. The handle, *A*,

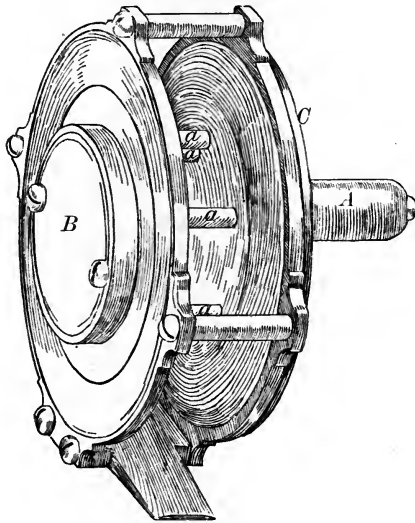

Fig. 30.

is attached to an ordinary crank, united to the shaft by a square bearing and secured by a screw. The flange, *C*, covers the crank, and prevents the line from fouling it.

Automatic reels in which a spring is coiled by withdrawing the line, and the reaction of which is supposed to retrieve it, have been made and are upon the market.

I have never used one, but the reports that I receive from those who have, do not bias me in their favor. Irrespective of the question of whether they do or do not do in practice what is claimed for them in theory, they certainly, if good for anything, greatly reduce the margin for skill and judgment on the part of the angler, and tend in my opinion to degrade the art to the level of pot-fishing.

Of what material the reel should be composed remains to be considered. Brass and german-silver, or these metals combined with celluloid or rubber, are usually employed and give good results. I prefer an all metal reel, since metal affords a more substantial hold to the fastenings of the click-machinery than rubber or celluloid. The latter save weight, but I do not consider this as important as some do in trout-fishing, where the reel is habitually located below the hand. A moderate weight helps to counterpoise the rod, and thus overcome the leverage of the longer portion against the angler; and we all know it is this leverage, rather than the actual weight of the rod, which causes fatigue.

Aluminum reels are coming into the market and into use, upon the plea of saving weight, as they most certainly do. But they are very expensive—more so than their advantages will warrant. Besides, this metal is very sensitive to any alkaline solution, and is easily corroded by sea-water; or by perspiration, if the latter happens to be alkaline, as it frequently is. Therefore such reels, if employed, should be plated with some more durable metal.*

* Since this was written, a new process of production is said to have reduced the cost of this metal from over a dollar an ounce to less than

All are agreed that the reel for a single-handed fly-rod should be located below the hand, but there is some difference of opinion as to whether it should be at the extreme butt or farther up. If at the extreme butt, it is claimed to counterbalance the longer portion of the rod more efficiently, and for this reason it is generally there placed. For small fish this unquestionably answers well. But no man can stand the continued strain of playing a large fish at arm's-length. The butt is then supported against the body, and if the reel is located too low down, a blow in the stomach is received from the hand at every revolution of the reel-handle. For this reason it is my practice to secure the reel by inserting one end of the reel-plate under a band just below the hand, instead of below the butt-cap itself, fastening the other end by a sliding band in the usual manner. I then reduce the length of that part of the handle appropriated to the reel as much as possible, and yet retain sufficient length to insure convenient manipulation of the reel when the butt is supported against the body.

For the benefit of such as make their own reels, I give the following method of tempering the spring, taught me by one of the best tool-makers in this country. With

that for a pound. The advantage of its low specific gravity (2.60) is offset by softness, lack of stiffness and elasticity, its solubility in alkaline solutions, and that it cannot be soldered. In itself, therefore, it would seem to merit little attention on the part of the angler. But its alloys with copper are quite another matter. That composed of ninety parts of the latter and ten parts of aluminum some authorities assert to be the most rigid metal known. It is of a red-gold color, tarnishes with reluctance, is somewhat lighter than brass or german-silver, and will solder. For reels and rod-trimmings, now that it should be cheaper than german-silver, it seems well worthy serious consideration.

nothing beyond the same verbal instructions here given to guide me, I have never failed to produce a spring of apparently perfect temper.

Having turned and filed my spring out of a plate of the best obtainable steel, about $\frac{1}{32}$ of an inch thick, and drilled the screw holes, I next polish out every transverse scratch. After hardening the spring in water in the usual way, I heat some sperm-oil in a small vessel until it takes fire. Securing my spring to a wire, I submerge it in the burning oil until I think both are at the same temperature, and then withdraw it, ignite the adhering oil, and allow it to burn off. Having repeated this three times, I immediately swing it around my head until it is cold.

*CHAPTER VI.**RODS AND ROD MATERIAL.*

IN no matter pertaining to the art of fly-fishing is there such discordance of opinion as in regard to the proper action and balance of the rod. In nothing does the old adage "what is one man's meat is another man's poison" more fully apply.

The lengths preferred by different anglers, all thoroughly experienced and skilled, vary in about the same proportion as do the noses on their respective faces.

Perhaps the extreme limits now used in this country lie between twelve feet and nine feet six inches. Abroad, twelve feet is considered rather a short rod. Here the tendency is decidedly to shorten and lighten the rod, and those of twelve feet will even now only be found in the hands of veterans, in whose ideas change finds no place.

The American angler regards the fly-fishing outfit of our transatlantic cousins with mingled admiration and surprise—admiration for the filmy leader and the exquisite flies—but astonishment approaching almost to incredulity at the engine with which these are said to be propelled. The rod and the tackle seem to him utterly incongruous, like wedding a man of eighty-five to a girl of sixteen.

Francis Francis, in his book on "Angling," gives a table of the length and weight of four single-handed

fly-rods, which he evidently regards as about the proper thing, as follows :

Maker.	Weight.	Length.
1. Gould.....	13 ounces 12 drachms.	12 feet 8 inches.
2. Cheek	14 " 6 "	11 " 7 "
3. Bownes	13 " 4 "	11 " 8 "
4. Aldred.....	13 " 8 "	12 " 4 $\frac{1}{2}$ "

No wonder he recommends that a double-handed rod should be used in preference to a single-handed, giving the following, among other reasons, for his preference : "But to fish a whole day with a single-handed rod is very trying to the forearm, and more particularly to the grasp of the right hand. Many a time has my hand and arm ached so after a long spell of casting, that I have been compelled to leave off to rest them."

It would be indeed surprising were this not so. After all, what are we after—what is the end in view? It is not merely obtaining possession of the fish, for that result can be had at far less cost and much greater certainty with a silver hook in the fish-market. Recreation and amusement are the objects anglers seek—British and American alike ; and therefore it seems reasonable to conclude, that whatever methods and whatever appliances best conduce to these results, are the best in themselves even though the total catch be a little diminished thereby.

Should this meet the eye of a British angler, let me recommend him to try one of our rods—or one there made on our plan, say ten or even eleven feet long, and from six to even nine ounces in weight. And if from some local peculiarity of fish or water, of which we are ignorant and cannot imagine, this does somewhat diminish his total catch, still we believe the increased comfort and pleasure the use of such a rod must afford

over the poles of the preceding table, will induce a willing consent to the sacrifice.

Dame Juliana Berners, in the "Boke of St. Albans," published in 1486, recommends the following rod: It is to be at least fourteen feet long—the butt measuring a "fathom and a half" (nine feet), and of the thickness of an "arm grete" (as thick as a man's arm), with joints bound with long "hoopes of yren" (iron hoops).

Certainly this remarkable implement possessed advantages not found in the modern rod. In stream fishing, with its aid as a leaping-pole, the stream could be crossed from side to side, as occasion required, dry shod; or it might even be used as a bridge, if the angler had a good knack of balance; while on the pond or lake, labor at the weary oar could be relieved by erecting it at the bow and extemporizing a sail for the mast so made. Again, at sea it would well serve as a staff to a harpoon or boat-hook, or as an extra light spar according to the exigencies of the moment. Truly there must have been "giants in those days," to wield such a weaver's beam as this, bound with long "hoopes of yren."

As to the action preferred in a fly-rod, even greater discordance of opinion is found. One likes a rod stiff as a poker for the lower third, and withy for the remainder of its length. Another will look at nothing not stiff in butt and tip, and sloppy in the middle joint. A third must have plenty of action in the butt, and not much elsewhere; a fourth uniform action from the handle to the tip, but quite stiff withal; a fifth the same general spring, but great flexibility; and so on to the end of the chapter. Therefore the writer, when he describes what a fly-rod should be, gives but his own personal preference, from which many a better angler will dissent.

All will admit that comfort in use, efficiency in casting the fly, and power to control and land the fish after it is fastened, are the desiderata; strength to withstand the incidental strain, and elasticity to recover on the removal of the deflection caused thereby, being in all cases presumed.

It needs no Sir Isaac Newton to assure us that with two rods of equal weight, and respectively ten and twelve feet long, the former will occasion far less fatigue than the latter; since, while the shorter arm of the lever is equal in both cases, the longer arm, which is to do the work, is greater in the latter. Nay, further, even though the shorter rod exceed in actual weight, still it may retain its advantage in this respect.

The importance of this consideration to one who attempts to cast from early morn to dewy eve, as does every fisherman whose days on the stream are few and far between, cannot well be exaggerated. Whether the latter half of the day shall be a toil or a pleasure, is determined thereby.

As to efficiency in casting the fly, certainly none of the hundreds who witnessed the fly-casting tournament at Central Park, in New York City, on October 16, 1883, and saw a fly cast eighty-five feet with a ten-foot rod weighing only four and three-eighths ounces, will question the ability of a ten-foot rod of six and a half to seven ounces to meet all reasonable expectations in this respect. To those who are unfamiliar with these events, it may be remarked that the caster stands on a platform one foot above the water, built out at a right angle to, and about thirty feet distant from the shore. The contestants thus cast parallel with the shore, and beside a rope supported by small floats placed five feet

apart. To the floats marking each ten feet, appropriately numbered tin tags are attached, indicating the distance from the edge of the platform. The weight and length of each of the competing rods is accurately ascertained, and the divisions on the rope are verified by the judges before the contest takes place.

The spectators occupy the bank, while the judges note the results from a boat on the other side of the rope, the boat being moved to and fro as circumstances require. The distance between the edge of the platform and where the tail-fly strikes the water is taken as the length of the cast. A possible error of eighteen inches in the determination of this would be a very liberal allowance.

Killing power, and the ability to control the movements of the fish in those delicious moments which separate the rise from the capture of the victim, depend not on the length, but on the power of the rod; and this, other things being equal, must be greater in a ten than in a twelve foot rod, since the leverage against the controlling power is less.

Induced by these considerations, and confirmed by practical experience with rods from twelve feet six inches to nine feet eight inches in length, the writer is fixed in the belief that ten feet is an ample length for any single-handed fly-rod, and that with it any fish of any weight within the scope of a single-handed fly-rod, can be as successfully enticed and more easily overcome than with a rod of greater length. If we add to this the difference of comfort in the use of the one over the other, the question may well be asked, why does any one who knows his business neglect to avail himself of these manifest advantages. Is there no flaw in your premises—no error in your conclusions? Dear reader, I sincerely believe both

to be sound; nor can I doubt either, unless at the same time I call in question the most elementary principles of natural philosophy, and the testimony of my own eyes.

I believe the sole reason why a rod of over eleven feet is to-day found in the hands of any experienced angler in this country, is that it became his when the art was younger than it now is, or when he was younger in it; that he has grown accustomed to its use, and that he has lacked the opportunity or inclination to try, or is unwilling to undergo the expense of a shorter and lighter rod.

One advantage, however, should in fairness be accredited to the longer rod, and, as far as I can learn from the teachings of theory and practice, it is the only one. In fishing for the small trout of much-fished waters, so handling the flies that the droppers just dap upon the surface undoubtedly gives the best result. It is clear the length of cast can be more varied without losing this advantage with a longer, than with a shorter rod. Still, by adjusting the flies on the leader at somewhat increased intervals, it is believed that the disadvantage of the shorter rod in this respect becomes slight, and by no means sufficient to offset its other and decided points of superiority.

Again and again has the writer seen anglers visit the Rangely region of Maine (where brook-trout grow to a size elsewhere unknown), armed with a longer and a shorter rod. There, if anywhere, the longer rod should find its fitting place, and with the truth of that opinion firmly in mind has the new-comer prepared himself. With the longer rod he intends to do the greater part of his fishing, while confining the shorter solely to picking up a few of the little fellows on the smaller streams. And what is the result? It follows as surely as the wrong-

doer goes from bad to worse. The longer rod is less and less frequently used, until it is altogether discarded for its shorter rival; and this not "with malice aforethought," but in natural obedience to the logic of events.

However these things may be, this at least is certain: to one escaping but seldom from the weary routine of office-work, to swing even a seven-ounce rod all day may become a burden, while to him whose muscles are braced by abundant exercise and robust health it seems but as a feather's weight. The truth is, that there is in this matter no hard and fast line where dogmatism may take its stand and say, *this is right and that is wrong*. Let each use that rod which to him affords the most pleasure, and for him that rod is the best, whether it be forty feet long or only two.

When the fly-rod is under discussion, we not unfrequently hear it urged, as the highest of encomiums, that some particular rod can be so bent with safety that the tip will touch the butt. This has a very imposing sound, well-calculated to impress the unthinking; but like many other statements equally impressive, it will well bear a little investigation. If the prime object and sphere of usefulness of a fly-rod was to tickle the butt with the tip, there would be nothing to be said. But this is not the case. To cast the fly with fluency and precision, and without a sense of dread in the caster when his line exceeds the length of his rod, lest on the back cast he fasten his flies in his own ears—this, and the power to control at will the course of the struggling fish with an implement adequate to any possible emergency, yet imposing on its user not one ounce of superfluous labor—these are the desiderata in a fly-rod. Every material has its elastic limit. Keep within this, and anything

will serve the purpose; exceed it, and the very best fails. A strip of the weakest pine can be so reduced in thickness as to successfully pass this vaunted test. It is absolutely no indication whatever of the strength and elasticity of the material of which a rod is composed, unless at the same time its length and calibre are taken into the account. To the judicious, therefore, a statement of this kind not only utterly fails to convince him of the excellence of the rod in question, but even raises in his mind a strong presumption that every quality of real value has been sacrificed, for what he will hardly fail to think is a catchpenny purpose. There are good rods with which this may be done, but in my judgment they would have been far better, and practically much more agreeable and efficient in use, had they been given sufficient "backbone" to render this impossible. I have stood upon a boom of logs, and, with a split-bamboo of some eight ounces weight, successfully withstood every effort of a freshly caught four and a half pound trout, in the full vigor of perfect health, to regain the shelter from which he had been seduced by the delusive fly. The rod bent under, and recovered from each fresh effort, as we sometimes see the water-level fluctuate in the glass gauge of a steam-boiler—the resistance always in exact equilibrium with the pressure upon it. The tip never came near the butt, though at times perhaps nearly upon the same level; nor was this a very stiff rod, nor one with which casting was other than a pleasure. The truth is, the ultimate strain which a fish can impose is grossly exaggerated in public opinion, as we have endeavored to show elsewhere. A firm, but above all things a steady pressure, the most vigorous of them strive in vain successfully to resist. The result for some time

may fluctuate in the balance, but the angler's pan, accidents excepted, invariably proves the heavier at last.

Probably a decent fly-rod will bear with impunity a steady strain, considerably in excess of anything under which the angler can hold it up. The proximate cause why rods fail in actual fly-fishing is not always free from obscurity. The angle which the line bears to the rod when the strain is applied, or in other words the direction of the strain with relation to the axis of the rod, is unquestionably an important factor. If the line and the rod form one straight line, the tensile strength of the material under a direct pull is alone involved; while, if the line and the rod are approximately parallel, the strain assumes many of the characteristics of a shock, the rod has not time to bend and thus distribute the load it cannot bear when localized, and it fails. I was fishing with a friend from an extemporized raft anchored before the outlet of a lake, into the mouth of which we were casting. It was a time and place for large trout, and we had been having fine sport. For some twenty minutes we had not had a rise, so we concluded to have a quiet smoke, and rest the water for a while. He had a rod of my own make, quite new, the butt and middle joint of thoroughly tested and approved greenheart. He turned to me for some purpose, the rod perpendicular, and his fly resting on the water not three feet from him. Suddenly a trout, rising in dignity of size to a little whale, rose from under the raft and seized that fly. The middle joint shivered as though struck by lightning. It was no transverse strain that could produce such a break. The upper part seemed driven down on that below it, until at the point of fracture it first split the wood, and then scattered it outward in a shower of

splinters. It is unnecessary to inform the expert that the trout at once unhooked itself and escaped. How they almost invariably accomplish this little trick under such circumstances, is another of those dark mysteries which overshadow our art.

But not to this, or the like causes, can we attribute many of the accidents which fall under the angler's notice. It is notorious that rods are usually broken on small, rather than on large fish, and this, too, after they have again and again withstood strains apparently far more onerous. Who has not seen a rod, the pride of its owner and the victor in many a hot struggle, fail in some part under the mere stress of casting? Such breaks, as far as my observation enables me to speak, are sharply transverse, as though the material had been subjected to a shearing strain. An effort has been made to account for this on the theory that a wave of vibration starting from the lower, meets another on the way from the upper part of the rod, and that the shock of the encounter is the destructive cause. I cannot say that I have ever been able to detect the existence of any such waves. I suppose the theory requires them to be something like those which meet in the middle of a rope or cloth, sharply and simultaneously shaken at both ends. We all know the sudden kick, so to speak, to which this gives rise, an impulse not perhaps inadequate to produce the result in question. Though I have a constitutional distrust of theories based on uncertain premises, still I am unable to suggest any more plausible explanation; or, as yet, to devise any experiment adequate to determine its truth or falsity, or point out the actual cause.

If this theory be sound, then double-acted rods should be more liable to fracture under these circum-

stances than single-actioned rods, and limber rods than stiff rods—and this I believe to be the fact. I have never known it to happen to rods of my make, which are of the stiffish single-actioned variety; still this may be due to good-luck, rather than the correctness of their principle of construction.

What material will make the best fly-rod?

As to this, too, as indeed in regard to most other imple-
ments of the art, there is considerable difference of opinion.

SPLIT-BAMBOO.

Specific gravity: {Six-strip hexagonal, rind outside, 0.9915.
 {Four-strip square, rind inside, 0.9678.

In the estimation of the American fly-fisherman as a class, the rent and glued, or as it is now more generally termed, the split-bamboo rod, unquestionably ranks first.

The bamboo may be said to be a production of Asia and the contiguous islands, though abundant in South America, where some species not indigenous have been introduced and now flourish. North of Mexico but one native species is found, and the same is true of Africa, while Europe has not even one.

In Col. Monroe's monograph on this grass, published in the proceedings of the Linnæan Society, vol. xxvi., one hundred and seventy distinct species are described, and he says there are many more, the flower of which he has never seen, and which he is therefore unable to classify. For it may be said to be a common, if not general, peculiarity of this plant, that it flowers but once, and that after years of growth, and then dies. This occurs simultaneously through large districts, and is followed by the production of an edible seed, which has not unfre-

quently averted a famine among the swarming population of those countries of which it is a native, when other crops have been blighted. Notwithstanding the length of time which precedes maturity and the production of its flower and seed, its growth is extremely rapid. At the seat of the Duke of Devonshire one is reported to have grown forty feet in forty days, while instances are on record of from two to two and a half feet in a single day. But such at least as is generally exported is not allowed to attain maturity, but is cut annually while still green, the succeeding crop springing up as shoots from the still living roots.

Which of these many varieties is best adapted to our purpose may safely be said to be unknown. Species attaining a height of one hundred and fifty feet, a diameter of fifteen to eighteen inches, and an interval of "several feet" between the nodes or joints, are known. I have myself seen varieties of small diameter perfectly solid throughout, and as stiff and elastic as tempered steel. The veteran rod-maker Mr. William Mitchell, of New York City, showed me a solid joint but little less than half an inch in diameter planed from a single piece of bamboo. A bow of South American origin came into his possession, apparently of bamboo, yet colored so as to leave this in some doubt. Upon removing the exterior this surmise was found to be correct; and though the bow was six feet long, not the slightest indication of a node or knot could be detected. From this he planed the joint in question. While this was not as stiff as a hexagonal joint of similar size, made in the ordinary manner, would have been, still it was nearly if not quite equal to the ordinary run of greenheart, and would make most excellent rod material could it

but be had. An experience of my own with large bamboo is mentioned hereafter in this chapter.

The strength and elasticity of bamboo depends almost altogether on the character of its exterior, the inner or pithy portion adding but little thereto. In the variety commonly used, within perhaps one-sixteenth of an inch measured from the outside lie all its virtues. In the larger varieties (or at least some of them, as my experience proves) this portion is very much thicker, as would be expected from the far greater thickness of the walls of the cane. If, therefore, rods were made from such cane, these would possess far greater strength and far more stiffness and elasticity than those of the present day, if of like dimensions. The diameter and consequent weight could then be considerably reduced, not only without loss, but still leaving considerable gain in these respects. Again, the process of manufacture would be much simplified, since the bamboos now used rarely reach two inches in diameter at the butt. This renders the exterior quite rounding, and it cannot be flattened without ruining it at the same time. Consequently the cane resting on this convex surface tends to roll more or less under the cutting tool, affecting the accuracy of the angle if not carefully watched. From my own experience, I should say that three times the skill was required to make a good six-strip joint from bamboo one and three-quarter inches in diameter, than from that of four or five inches. The waste would also be much less, since defects in the cuticle now fatal, would then be of comparatively little consequence.

There are few fields in which more of benefit to the angling fraternity may be hoped from investigation than this. The burden would seem fairly to fall upon

the English portion of the brotherhood, since under their flag the investigation must be carried on. If not unreasonable, it is at any rate useless to expect this from the professional rod-maker. He either lacks opportunity, or for business reasons keeps his information to himself. It is to be hoped that some of the many English gentlemen now in India, who are interested in fly-fishing, and who may be favorably circumstanced in that vast country, will investigate, and give the angling world some definite information on this subject.

Rapid and unceasing as is communication at the present time between the remotest parts of the world, it is singular, and not very creditable, how vague is the information now obtainable in reference to rod material.

The variety of bamboo of which split-bamboo fly-rods are made, is here known as the "Calcutta bamboo." Its botanical name is believed to be *Bambusa Arundinacea*. From other varieties it may be distinguished by the charred marks on its yellow cuticle, without which none seems to be imported into this country. If this is the variety, it may, if permitted to grow, attain a height of from forty to fifty feet, and a diameter of about three inches.

No one in the least familiar with this bamboo can have failed to remark these burns, always present yet never alike. To the split-bamboo rod-maker they are a perfect nuisance, forcing him to reject altogether many a cane otherwise excellent. So every one, surprised that so much labor should be expended merely, as far as is apparent, to injure the cane, naturally asks how and why this is done.

Reasons being as plenty as blackberries, of course there is no lack in this case. But that these are not

more consistent than the finding of the coroner's jury, that the subject of their deliberations died of consumption from having been hung for horse-stealing, somewhat militates against a perfectly satisfactory conclusion.

Here are a few samples, assigned by those who said they knew all about it:

1st. It is a religious ceremony.

2d. They are roasted over a large gridiron to kill the larvæ of boring insects.

3d. It is merely for purposes of ornament.

4th. That the bamboo grows in jungles, matted together with all manner of climbing and tenacious vines. That before they can be extricated and separated, the jungle must be fired to destroy these creepers.

5th. That the canes are roasted over a gridiron to burn off the leaves and creepers attached to them, as the most simple and expeditious way to get rid of these.

6th. That it is done with a hot iron, each cane being treated separately, merely to straighten them.

I have heard others, but these are quite sufficient for liberal exercise of personal predilection, my own being towards a combination of the reasons numbered 4 and 6. Definite and positive information on this point from personal observation, preparatory to an effort to cause a discontinuance of the practice if not absolutely necessary, is greatly to be desired.

To any of my readers who, animated by the hope of obtaining better material than the open market at present affords, may desire to order a private supply from India, I tender the following advice, wishing them better luck therein than has fallen to my lot: Order nothing but the butts of the cane, and those of the largest attainable diameter, and unburned. Insist that they be

split open lengthwise through the leaf-sides of the cane before shipment, and that they be carried on the vessel lashed under the boats, or where they will have free access of air yet not be exposed to the sun and seawater.

It is hazardous to say anything is quite impossible, so you may succeed in obtaining what you desire; but my own experience leads me to believe that you might as hopefully try to talk a stone wall out of its place, as the inhabitants of that country out of their accustomed methods of procedure.

In the Calcutta bamboo, strength, lightness, and that steely spring which is the acme of perfection in a fly-rod, are found to a degree unequalled in any other known material. But, like most other things in this hollow, hollow world, it has its drawbacks. Good bamboo—that which may truly be called virtuous in that it possesses all the virtues—though not as scarce as hens' teeth, is still a rare prize and difficult to obtain. Mediocrity is the rule here below, and with mediocrity of greater or less degree must the rod-maker be content who would use this material in quantity. Indeed, either the quality now imported has deteriorated when compared to that of say seven or eight years ago, or the writer has become much more exacting in his choice. While as to poor bamboo, that which may justly be so called when compared to the mediocrity aforesaid (and such is by far the greater portion brought to this country), it is—well, the English language is impotent to describe, or at all events to exaggerate, its utter worthlessness for our purpose. Unfortunately there is no test which any dealer would permit to determine the strength of a split-bamboo rod after it is once glued together. It may have hardly the

strength of a piece of pine-wood, and yet present a perfect exterior. The spring and balance of the rod may of course be readily tried, until one is found which suits. But as to the strength of material you are completely at the mercy of the maker. Therefore, in buying a rod of this description go only to a well-known maker, or his agent; for both have a reputation to maintain, and will be glad to make good any defect in material. Also, if you do not mind the extra expense, you will do well to have two, instead of a single middle joint, for this part of the rod is most in danger.

There is still another objection to bamboo rods. If the butt or middle joint is broken, except quite close to the ferrules, the break cannot be spliced so as to stand, and the usefulness of that joint is at an end.

Some years ago a vessel from the East Indies discharged a cargo of sugar at this port. For dunnage to the cargo, which was in mats, large bamboos, some even six inches through, had been used. When the vessel had discharged, these were thrown out upon the dock. A friend secured two or three pieces, and gave me one. It was the toughest and most elastic bamboo I have ever seen. I made one rod from it, placing the rind inside, and was so pleased with it that the temptation to make one more, and exhaust on it all the skill I possessed, was irresistible. Every knot was cut out and the strips spliced, so as to secure absolute uniformity of action, and when the rod was complete I was satisfied with my work. That rod became the bane of my existence. For three seasons I stuck to it, uniting the splices again and again. Every adhesive substance I could hear of was tried; the splices were carefully wrapped with unwaxed silk, and then varnished so as to paste the silk down,

and at the same time swell it and increase the firmness of its embrace upon the bamboo. But it was all useless. The first fish struck would start some splice, and the rod was worthless. Again and again have I spliced bamboo joints for friends where accident has occurred at a distance from the repair shop, using that most adhesive of all glues, "Russian isinglass," but they never stood, nor do I think they can be made to stand, for any length of time. Bamboo tips, however, may be successfully repaired without difficulty.

But notwithstanding all this, if you once become possessed of a really good bamboo rod, you have the best there is—something superior to any wooden rod that can be made.

ASH AND LANCEWOOD.

Specific gravity: { Ash, 0.7786.
Lancewood, 1.0335.

Next in order, through seniority, comes the ash and lancewood rod. The butt is of the white-ash—that of wide grain, and with the dense intervening portion white and bone-like in texture, is the kind available for rods. An old billiard-cue is an excellent source from which to derive the material. If the grain is either very narrow (one-sixteenth of an inch or less) or very wide, the wood is apt to be weak. Select that having a grain about one-eighth of an inch wide, and nine times out of ten it will be good. Anything off the white in color is a bad sign. Red-ash is worthless. Any redness in the grain, though the more solid portions are of good color, is an unfavorable indication.

The middle joint and tip are lancewood. This is imported from the West Indies and South America in poles from fifteen to twenty feet long and three to ten inches

in diameter. It is very stiff, strong, and elastic. Its quality can be quite well judged by its color, that of a bright yellow being the best. It works in a kindly manner under a keen plane, and altogether is an excellent material, and the only one, except bamboo, fit for tips in single-handed rods. The Cuban lancewood is the best.

The ash and lancewood rod has gone out of fashion of late years, and has fallen in general estimation to a position by no means commensurate with its merits. Some still think that, take it all in all, this combination makes the best of wooden rods, and it seems to me they are not very far wrong.

I have seen an ash and lancewood rod do the most surprising work.

I was fishing from a boat in Rangely Lake a few years since. Just beyond reach of my cast another boat was anchored, containing an old gentleman using about a nine-ounce rod of this description and a liberal "gob" of worms.

The bottom was plainly visible, and from time to time large trout of five pounds and upward lazily swam into sight, cruising slowly about in utter indifference to everything except their own private pursuits. Six and seven pounders were common, while one leviathan was a frequent visitor, which I could not place at less than ten pounds. Oh, how my heart went out to him!

I was attending to my own affairs, in that frantic condition of mind incident to an occasion when such trout are rising freely, but positively decline to acknowledge the slightest acquaintance with such an insect as the fly. Again and again my fly would settle in a swirl like that made by the blade of an oar, and that too before the fish could have been three feet from the spot.

Every five minutes the fly was changed, ranging from the smallest gnat to a good-sized salmon-fly. I tried it on the water—under the water—in every way and under every condition I could devise, but all in vain. So it may reasonably be surmised that peace was not with me.

Suddenly my guide exclaimed, "He's got one!" I looked. I was at once struck by the perfect curve of the rod, which was doubled up to a degree that few could regard without apprehension, for the old gentleman clearly was handling his fish "without gloves." Momentarily I expected to see it break. But no; ten—fifteen minutes—half an hour passed—and still the rod triumphed over that fearful strain, while the fish seemed as fresh as ever. At last a boy climbed a tree overhanging the bank and not twenty feet distant from the boat. No sooner had he reached his perch and taken in the situation, than he shouted, "Why he's got him by the tail!" For at least an hour the struggle lasted, and when, after landing his trout, the old gentleman passed me on his way home, I asked him if I might see it. It weighed seven pounds by my own tested scales, and there, sure enough, about three inches in front of the tail and on the right side was the wound of the hook. Permission having been granted to examine the rod, no sign could be detected of the fearful ordeal through which it had passed.

If the amount you feel willing to pay for a rod be limited, an ash and lancewood rod is the safest investment; but select one in which the ash is white and of wide grain, and the lancewood yellow and free from bluish stains. If, however, the rod is colored, as is frequently the case, you cannot judge of this; then you must rely on the maker, and should buy only from the

maker, and from one who has a reputation to sustain. You will probably have to pay a dollar or two more, but you will get your money's worth. This remark holds good, and cannot be too strongly emphasized in regard to all fishing-tackle.

These bluish stains so frequently seen in lancewood seem not to be inherent in the tree, but to be due to faulty treatment in seasoning. They arise from storing the logs in a close, damp locality, and indicate inferior elasticity and strength.

CEDAR.

Specific gravity, 0.6396.

We will next consider cedar as a material.

Such cedar as is used in lead-pencils is worthless for our purpose. The rod-cedar is darker in color, harder, heavier, stronger, and much stiffer. I have never been able to find it at the wood-dealers in the vicinity of New York, and am inclined to believe that if it is used at all in the arts, it is so but sparingly.

Certainly a rod well proportioned from one of those old logs which have lain buried for centuries, possibly, in the morasses of Florida, for lightness and promptness of action cannot be excelled. Strain it as you will short of the breaking point, it will take no set, nor will any change in its feel show that its powers have been over-taxed. But it is the weakest of all material used for that purpose, and only fit for a *dilettante* angler who fishes open water where there is no danger of a foul on his back cast, and who is ever on his guard to give the fish no opportunity to strike his fly when the rod is approaching the perpendicular. For a rod of this wood the ferrules should be considerably larger than for the preceding.

MAHOE.

Specific gravity, 0.6607.

For this wood I have quite a predilection, not shared, it must be confessed, by the majority of those who have used it. It is a native of Cuba, grows to a considerable size, and is there used for the springs of their peculiar two-wheeled vehicle the "volante." In color it closely resembles black-walnut—indeed it might well be mistaken for that wood by a cabinet-maker. But when varnished and rubbed down, faint narrow lines transverse to the length appear, such as sometimes may be seen on fine violin bows, giving the wood a beautiful appearance and distinguishing it at once from black-walnut. Next to cedar it is the lightest generally known rod material, and requires ferrules of like size. The general complaint against it may be formulated thus: if you can get a joint of mahoe that will stand, you have a fine thing, but its strength is very uncertain, and only to be determined in the field. This criticism we think hardly fair. If the grain is perfectly straight, a good firm pressure in each of the four directions when the joint is tapered and in the square, will disclose its strength or lack of strength. Protecting myself by this precaution, I have used mahoe with great satisfaction and without accident, both in the streams of the Middle States and in the heavier fishing of Maine. Though certainly far stronger than cedar, still the best of it has not the strength of good ash or lance-wood of like dimensions; but this is, in a measure at least, made good by the larger diameter which the rod may and should receive.

Its virtues are an attractive appearance, promptness of action, lightness, and indifference to moisture. Those who so laud the action of a cedar rod should be pleased

with that of mahoe, since the resemblance of the two in this respect is so marked that many place them on an equal footing.

Tips should be of lancewood, or, better still, split-bamboo.

HICKORY.

Specific gravity, 0.7963.

This wood may be said to have gone entirely out of fashion in this country, though still in favor in England, where it has for many years been held in high esteem. Its great strength is well known and freely admitted, but at the same time it is charged with being "logy" in action. But this, while generally quite true, is not universally so, since hickory joints which would please the most fastidious are by no means unknown. It would also seem that this difference may be accounted for and guarded against, and this in the following manner:

A second-growth tree of the "shag-bark" variety should be selected, which has grown in an exposed situation and not in a forest. For trees are like men, a hardy middle-age following a youth of vigorous struggle. In an open pasture, or on a knoll exposed to the keen blasts of winter, weakling trees perish in their infancy, and only the most vigorous attain their growth. As the child whose every muscle has been in daily use develops into a vigorous man, so a tree so situated strengthens its fibres and improves their elasticity by its daily struggle with the elements. Having found a tree so located, its character may be safely presumed. It must then be cut either in December or January, when the sap is entirely out of the wood, otherwise no amount of seasoning seems to impart the required elasticity.

As soon as cut, the white portion of the wood must be

sawn into square sticks of the desired length and size. These should then be immersed in fresh water from six to eight weeks. For the cells, though free from sap, still contain the starch, etc., to furnish the first growth of the ensuing spring. Water soaking removes this, and it is conceded by all the authorities that wood so used seasons sooner and becomes lighter than if otherwise treated. All kiln-drying or boiling of the wood is injurious.

When this process is complete, the wood can and should be straightened, if this is required. Two courses are then open: first, to pile the sticks in a criss-cross manner, cover them with boards, and pile stones thereon, and leave them to season; or second, to hang them up, each separately, and by one end, so that the air may have free access to all sides. The latter is the more speedy method. In the former case weighting the boards is to prevent season-crooks, which always tend to cause the wood to curve from the heart. These almost invariably will show themselves, if permitted, and are quite persistent, tending to recur notwithstanding straightening by heat, if present when the wood is seasoned. If the latter method is followed, the sticks should be handled frequently, and such as are found crooked should be straightened, and given a slight bend in the opposite direction. Thus they may be compelled to dry perfectly straight.

The seasoning must be carried on out of the sun and rain, and with free access of air. Why rain should be avoided is obvious. If exposed to the sun, season-cracks will appear in the wood to its utter ruin.

In Hough's "Elements of Forestry" is given a table of the percentage of moisture in wood, at six, twelve, eighteen, and twenty-four months. From this it appears

that little, if anything, is gained by seasoning wood over eighteen months. All woods are hygroscopic, absorbing water from the atmosphere. Some, after the period specified, actually gained in weight by absorption of moisture, while others, though they continued to part with it, did so but very slowly. The difference in weight between green and perfectly dry hickory is therein stated to be nearly one-third.

These remarks apply equally to seasoning all domestic woods, and are here made once for all.

An ash butt and lancewood tip will work well with hickory; or if the butt joint is to be of the latter, use a handle of lighter wood, say butternut.

IRONWOOD.

Specific gravity, 0.8184.

This wood has as many different local names as the black bass. It is known as barwood, leverwood, and hornbeam. Norris gives its botanical name as *Carpinus ostrya*—and the Government Book on Forestry, as *Ostrya virginica*. In appearance it closely resembles dogwood. The sapwood resembles ash in color, the heart having a reddish tinge like red-ash. Both seem equal in merit. Two varieties are known, the one having a smooth bark without fissures is inferior. The other has a thin yellowish gray bark, with abundant shallow fissures, but otherwise rather smooth, and this latter is the tree from which the wood used for rod-making should be taken.

It prefers damp places, and grows from Canada to the Gulf. Further description, with illustrations of leaf and flower, may be found in the American Encyclopedia, article "Hornbeam." It was a special favorite of Mr. Thaddeus Norris, author of "The American Angler," who

highly extolled its merits; and unquestionably it is one of the best of native woods for our purpose. But it must be selected, and cut as directed under the head of "Hickory," or it will be worthless. I have some ironwood cut fourteen years ago, and then sawn into strips about one-third of an inch square. It was felled in June, otherwise the conditions were all followed, and to this day it is not fit to put in a rod.

The tree is small, eight or nine inches being the limit of its diameter, and apt to be crooked and knotty. But with patience, material fit for rods can be found almost anywhere in the country.

Ironwood is very strong, not over heavy, and at its best is sufficiently elastic; and if really choice, will produce an excellent rod when combined with lancewood, or, better still, split-bamboo tips. But if in craving after lightness, as is now the fashion, you are niggardly in material, your rod will be slow and withy, and lack that nervous promptness of action without which a fly-rod is like a counterfeit five-dollar bill. It will not bear to be reduced to the calibre of lancewood, greenheart, or bethabara.

It breaks with a long splintering fracture. This can be taken advantage of, and its strength and elasticity greatly improved by the following method of manufacture: Color one end of the stick, for which purpose ink will answer; then saw it into four strips about a quarter of an inch square. Plane them up and glue them

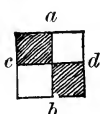

Fig. 32.

in pairs, so the ends will appear thus: then face up the side, *a*, of both pairs and glue them together in the way represented in Fig. 32. Straighten them



Fig. 31.

while the glue is warm, when they will bend

like lead, and all season-crooks can be taken out once for all. Now plane in your taper, touching only the sides, *a* and *b*, until you have quite finished them, for you can then see the glue line, *c d*, and so work the surfaces, *a* and *b*, as to keep that line central. Then finish the taper by working off the sides, *c* and *d*. Use every precaution to keep the intersection of the lines, *ab* and *cd*, in the middle of the joint. If your glue joints are as they should be, they ought to be almost invisible; and this may bother you, since they are your only guide. Therefore, if you do not object to having the glue line appear on the finished rod, rub the glue sides, before you apply the glue, with red chalk. This will not injure, but rather increase the tenacity of the glue.

Remember to use glue that has never been melted before, and without the admixture of any old glue whatever. Soak it in cold water during the night before it is to be used. You will find it in the morning much swollen and flabby, and in this condition you should melt it without adding further water.

It will be noticed that by this method the direction of the would-be lines of fracture cross one another, and that a break in a joint so made must occur, not in the natural direction, but directly across the fibre. Thus results a great gain both in strength and elasticity. This is decidedly the best way to make an ironwood rod. Wrap with silk, as though the rod were of split-bamboo.

One precaution the ironwood rod requires beyond every other—water must be excluded, or it becomes leaden and soggy at once. Nothing but the best coach-body varnish, and plenty of it, should be applied to such a rod, and one coat at least should precede any wrappings.

GREENHEART.

Specific gravity: { Dark-colored, 1.0908.
 { Light-colored, 0.9643.

This wood is a native of the West Indies and South America, though our supply comes principally from Demarara in British Guiana, often through England. It is a tree of large size, yielding timbers from twenty-four to fifty feet long, and from twelve to twenty-four inches square. The wood is dense in grain and heavy, some specimens dark as the darkest black-walnut, and others of a yellowish brown or light snuff-color—a difference which does not seem to affect the strength and elasticity of the wood. It is very strong and elastic, is unaffected by moisture, and takes a very attractive finish. In my opinion it takes the first place among rod-woods.

Some complain of it as treacherous, but I have not found it so. Indeed it may well be questioned whether upon close investigation this fault, so freely charged against more than one rod material, should not more justly be attributed to negligence on the part of the maker. Before any wood of any and every kind is ennobled by conversion into a fly-rod, its fitness can and should be thoroughly tested. When the proposed joint is still in the square, and after the taper has been planed in, a strong bend should be given it towards each of the four sides. If it breaks, be thankful that it failed in the shop and not in actual battle; and on the principle that it is better for a fire-arm to burst in the proving-room than in the hands of its owner, congratulate yourself as one delivered from danger. Also, if it “sets”—that is, does not recover its former straightness when the strain is removed—reject it till time and further seasoning remedy this. To one with but limited time to devote to the amuse-

ment of rod-making, and who has arranged his affairs, possibly with inconvenience, that he may have a little leisure to devote to this, I know the temptation is great to use material which does not altogether meet his approval—particularly if none other be at hand. But he who yields to temptation must expect the incident retribution, and this will prove no exception to the rule.

Greenheart files, scrapes, turns, and planes well, but like most other rod-woods a keen tool is required. Shavings of this wood from the plane have nothing of the usual ribbon-like character, but crumble during their formation, as if the wood was very deficient in tenacity. But such is not the case.

It may be bought in the plank at from thirty to fifty cents a foot, board measure, at almost any of the dealers in hardwood in Centre Street, New York City. But unless personally selected, knots, crooked grain, season-cracks, and other defects will greatly increase the cost of such portions as may be available. Such planks as I have seen have been from ten to eighteen feet long, one and a quarter inches thick, and from twelve to twenty inches wide. The whole plank selected must be taken, the dealers refusing to cut it. If to this is added the fact that one-half waste is a very moderate loss indeed, it will probably be more satisfactory to send for it to one of those houses that make a specialty of supplying amateurs with material. The price demanded may seem severe when compared with the cost in plank, but this is more apparent than real. You may then expect selected and seasoned wood, and may safely conclude that for every stick you receive, the seller has bought and thrown into the scrap-heap waste sufficient to make three or four. Of course this loss, together with inter-

est on money idle during the seasoning process, must be charged upon that which is merchantable, in addition to its first cost.

If the before-mentioned test be applied as directed, I confidently recommend this wood for the amateur's first efforts in rod-making, but for butts and middle joints *only*. Though sometimes employed for that purpose, I think it too heavy for tips. A trifling increase of weight at that part makes a serious and disagreeable difference in the feel and action of the rod, as might be expected the moment its distance from the hand and consequent leverage is considered. Also, for the handle of such a rod a lighter wood should be employed, such as ash, butternut, or sumach. This may easily be arranged, either by boring into the handle at least the whole length of the grasp, and gluing the greenheart butt-joint therein, or by placing a ferrule immediately above the handle. The latter, for reasons hereafter stated, I believe to be the best construction for any rod of any material.

BETHABARA.

Specific gravity, 1.2140.

The merits of this wood have been more highly extolled than any other. That it may be worked $\frac{1}{32}$ of an inch thinner than split-bamboo, and have the same strength and better action; also that a rod made from it will cast a line ten feet farther than any rod made from split-bamboo of the same calibre, are perhaps fair samples of the claims urged in its behalf.

If all this is true, here is the long sought substitute for split-bamboo. When the difficulty of obtaining good material for the latter, the greater skill and time required in its manufacture, the practical impossibility of altering

its action if, unsatisfactory, or of repairing a break, are considered, certainly this is "a consummation devoutly to be wished" by all, except, perhaps, the makers of that form of rod.

My own experience, confined, however, to two butts and four middle joints (used with split-bamboo tips), does not confirm these statements.

The wood of these rods was selected with great care, not only for the express purpose of determining its merits as far as so limited a test would permit, but also with an earnest desire to find it at least equal if not superior to the split-bamboo.

In this I was disappointed.

Of two joints of equal diameter and length, that of six-strip split-bamboo was considerably the stiffer, and weighed about one-third less; or in other words, the same power to cast a fly and control a fish could be obtained from a hexagonal split-bamboo of considerably smaller diameter, and probably, exclusive of ferrules, of little more than half the weight.

It has unquestionably great strength, fully equal to, perhaps somewhat in excess of, the average hexagonal split-bamboo of the same diameter; but if the bamboo is of really good quality, I cannot accord bethabara any superiority in this respect.

As compared with good greenheart, about the same elasticity was found. No superiority in stiffness, which would permit the bethabara to be worked to a less diameter and retain equal power, could be detected. In strength it might, perhaps, average a little better, but its greater weight would seem to offset this, since the greenheart being the lighter wood could be made thicker.

On the whole, contrary to my earnest desire, the con-

clusion was forced upon me that in this material no successful rival of first-class split-bamboo was to be found. That it is the equal of good greenheart in every respect except slightly greater weight, possibly with some slight advantage in strength, was the opinion formed, and it is believed to be just.

Beyond that bethabara is a native of a hot climate, and grows from three to three and a half feet in diameter and twenty feet to the first branch, I have been able to acquire no certain information of its origin or growth. It is supposed to be, like greenheart, a native of British Guiana, and there known as Wasahba, "bethabara" being a "fancy" name.

Some think it a variety of greenheart, but he who has worked the two woods will hesitate to accept this opinion. It resembles greenheart in color, but still with a difference easily seen on close inspection, though difficult to describe. It is denser in grain, more bony in texture, and requires a sharper tool to work it. It has the peculiarity of depositing a gummy substance on the edge of the plane blade, producing the effect of dulness, which must at short intervals be removed on the oil-stone before the plane will resume its cut. When under the plane a yellow powder, closely resembling pulverized gamboge in appearance, is profusely deposited on the bench and tools, as well as on the hands and person of the worker. This instantly turns a strong salmon color in contact with soap and water, due doubtless to the action of the alkali in the former. Its shavings have nothing of the crumbling character of those of greenheart, from which all the foregoing marked peculiarities distinguish it.

Though amenable to the plane, turning-tool, file, and scraper, it must be considered difficult and disagreeable

to work—more so than any rod-making material, except possibly split-bamboo.

For a rod 10 to 10½ feet long, 7 to 8 ounces in weight, handle 12 to 14 inches long, of lighter wood, female ferrules as follows (measured inside) are recommended by that house to whom we are indebted for its name, and introduction to the notice of the anglers of this country:

Female ferrule uniting butt and second joint, 10½ to 11 thirty-seconds of an inch.

Female ferrule uniting second joint and tip, 6½ to 7 thirty-seconds of an inch.

Heavy bass fly-rod, 12 and 8 thirty-seconds of an inch.

Though it is sometimes used for tips, its usefulness in that position may well be questioned, for the reason stated under "Greenheart."

Assuming for the present that this wood is identical with that mentioned by many travellers in the Guianas as "Washiba," "Washeba," and "Wasahba," it is there a common tree, growing to the height of one hundred and ten feet. It is also locally known as "Bow-wood," and is used by the Indians for their bows and war-clubs. It is also well known in England, and there used for fly-rods and bows.

Further experience with this wood, had since the foregoing was written, inclines me to believe that I have done full justice to, if I have not somewhat exaggerated its merits. I do not now think it, in any respect whatever, superior to good greenheart, while it is considerably heavier.

SLAKEWOOD.

Specific gravity, 1.3718.

This wood is also a native of the Guianas. It is called "Bourra-courra" by the natives, with whom it is a fa-

vorite bow-wood. Almost all travellers in these colonies mention and describe the powerful bows carried by the natives, and the skill with which they are used. These accounts extend at intervals for over one hundred years, beginning with Captain Stedman's narrative of an expedition to Surinam, in 1772-1776. From these it appears the natives use for this purpose either purpleheart, washiba, or snakewood. Captain Stedman thus describes this tree:

"The bourra-courra or brazil grows to between thirty and forty feet high, but not very thick, with a reddish bark. The heart only of this tree is valuable after the white pithy part is cut away, though then much reduced. The wood is as truly beautiful as it is useful, the color being a fine crimson, variegated with irregular and fantastical black spots, from which by the French it is called *bois-de-lettres*. It is heavy, hard, and capable of taking a brilliant polish."

The name of snakewood arose from the resemblance this wood bears to the skin of the more highly-colored snakes, just as the French name was given because of the fancied resemblance of the irregular black spots to letters. It is not unfrequently called "Letterwood" by English writers. Captain Stedman's description cannot be improved, except that the ground-tint of the wood, as seen in this country at least, is a reddish brown rather than crimson. It has been well known in this country for a long time, and is esteemed to be the most beautiful of all the fancy woods, as it is the most expensive. It is imported in billets of various lengths and up to about nine or ten inches in diameter, the sapwood having been first removed. The market price is from sixteen to twenty cents a pound, being sold by weight and not by

measure. It has been sparingly used for fly-rod making, but chiefly for bows, and sometimes for violin bows.

It is extremely hard and close-grained, indeed were it not for the ease with which it splits, it might be supposed to have no grain at all. It has abundant elasticity and strength, its excessive weight and high first cost being the only objections to its use. No other material approximates to it in beauty, but it should be employed only in butts in combination with a handle of lighter wood, and in middle joints. Its great weight renders it unfit for tips.

BEEFWOOD.

Specific gravity, 1.3090.

This wood seems generally to be identified with the beefwood or she-oak of Australia. But I believe this to be a mistake, and for the following reasons: first, the she-oak is described as a tree about eighteen feet high and twelve inches in diameter, a size utterly inadequate to furnish planks of the width common in this market; second, I have seen an affidavit in the possession of a dealer, accompanying an invoice of this wood, which declared that it was a native of the Guianas and from the bullet-tree—called by travellers by that name, as well as “Bullit-tree” and “Bully-tree,” supposed to be a corruption of the native name, “Ballata.” The botanical name is *Achras ballata*.

This tree grows to a height of sixty feet and more, and is often six feet in diameter. The bark is gray and smooth.

Beefwood is well known in this market. I have seen it only in planks, of various lengths and up to twenty inches in width. It is as hard as snakewood, very heavy, strong, and elastic. The wood is red in color,

resembling the lean of the boiled salt-beef of the sailors. It has been used in this country for bows, but the dealers say it is principally employed for making violin bows, to the wood of the red and more usual variety of which it certainly bears the closest resemblance.

It has been sparingly used for fly-rods. Though I have worked this wood for other purposes, I have never either made, or seen a rod which was made from it. But aside from its great weight, which is but little less than that of snakewood, I should think it would serve well for butts and middle joints, if these were arranged as suggested under the head of snakewood. Its market price is from twenty to twenty-five cents a square foot.

PADDLEWOOD.

Specific gravity, 0.8363.

This wood is another native of British Guiana. It is there known among the English-speaking portion of that community by the name given above and as "Rollerwood," and among the natives as "Yarura" or "Massara."

This wood was first called to my attention by Mr. H. L. Leonard, the well-known rod-maker, and subsequently by Mr. A. N. Cheney. To the latter and Mr. Charles F. Orvis I am indebted for a specimen. It is a large tree, attaining a height of eighty feet and a diameter of five to six feet. The trunk presents a singular appearance, as though composed of a central mass from which radiated a number of flanges six to eight inches wide, and about two and a half inches thick, thus closely resembling a coarse cog-wheel. From these flanges the natives make their paddles; hence the name. One traveller describes it as appearing as though a number of small trees had grown together, and that this extends the en-

tire length of the trunk. It is well known, being mentioned by most travellers who have recorded their experiences in that country. The wood resembles lancewood somewhat in appearance, but is deeper in tint, inclining to a salmon or flesh color, and is neither so close in the grain nor so hard.

All authorities unite in assigning to it great strength and elasticity, while some say that it possesses these qualities in a degree unequalled by any other material not exceeding it in weight.

BOIS D'ARC.

Specific gravity, 0.9690.

This wood is a native of the South-western portion of the United States. It is also called "Bodock," obviously a corruption of the above, as well as the "Osage-orange," from the combined facts that it produces an inedible orange-like fruit, and that it was first noticed by French Canadian trappers in the country of the Osage Indians. These Indians employed it for bow-making, whence the name first given. Though it will live anywhere south of New York, and is not uncommon elsewhere, still it attains its maximum development in Texas, Arkansas, and the Indian Territory. There it attains a height of from fifty to seventy feet, and a diameter of from three to four feet. When growing alone it branches rather close to the ground, but when shaded, shoots upward towards the light, as do other forest-trees, and then the branches start at a somewhat greater height. The botanical name is *Machura aurantica*.

The wood resembles locust closely in appearance, being yellow, hard, and extremely durable and elastic. It is much prized for wagon-building. The sapwood should

not be used, since it does not possess the merits of the inner portion. It may be safely accepted as a general rule, that anything which will make a good bow will make a good rod.

I have never seen a rod made from this wood, but the fact that the Osages used it for their bows, coupled with the recommendation of that most excellent and well-known angler and writer, Mr. A. N. Cheney (to whom I am indebted for calling it to my attention), together with the appearance of the wood itself, encourage me to hope that here we may find a domestic material equal, if not superior, to most of the foreign woods.

In "Trees of America," by D. J. Brown, it is described in substance as follows: The *Machura aurantica* in its natural habitat is a beautiful deciduous tree, usually growing to a height of twenty-five to thirty feet, with a trunk from twelve to eighteen inches in diameter: but in very favorable situations it sometimes attains double these dimensions. The branches, which are covered with a grayish bark, are armed with spines. The leaves are broad, two to four inches long, oval, with a pointed end, smooth, and of a bright shining green. The spines are rather strong and an inch or more in length. The flowers produced in April or May are inconspicuous and nearly green, with a slight yellow tinge. The fruit matures in Pennsylvania in September or October, and is of the size and appearance of a large Seville orange with a rough warty surface.

"The wood of the *Machura* is of a bright yellow color, somewhat resembling the fustic, and like the wood of that tree, it is said, affords a yellow dye. It is solid, heavy, durable, uncommonly fine-grained, and elastic; and on account of the latter property it is used for

bows by all the tribes of Indians of the region where it abounds. When wrought it receives a beautiful polish, of the appearance and brilliancy of satinwood."

SHADBLOW.

Specific gravity, 0.8620.

This shrub is known also as Juneberry, Serviceberry Shadbush, and Wild-plum. It grows throughout the Eastern and Middle States and Canada. Its botanical name is *Amelanchier canadensis*. Its blossoms precede its leaves in April or May, about the time the shad ascend the rivers, whence one of its names; while another is due to the fact that its edible fruit ripens in June. Many varieties are found, differing in size from a mere bush to a small tree of thirty or forty feet in height. The wood greatly resembles the outer wood of the hornbeam in color and texture, being quite white and close-grained. It is very strong and tough, but inclined like hornbeam to be "logy"—*i.e.*, not very prompt to recover when bent; still I have seen one rod made from it throughout by Mr. William Mitchell of this city, which seemed about as good as a rod could be, the promptness of action of which left nothing to be desired. My personal experience of this wood is confined to an examination of this rod and quite a number of specimens of the wood in the square. From these I should judge there was an unusual difference in the stiffness and elasticity of different samples, which may be partly due to the many varieties which occur; also that, though occasionally better may be had, still the general run of this rod material would require pretty good-sized ferrules and a liberal allowance of timber if other than a withy rod were desired.

We are indebted, I believe, to Judge F. J. Fitch for calling attention to this wood. He speaks of it as follows, in the *American Angler* of June 24, 1882: "Of the various woods that I have used I prefer Amelanchier. Its strength, lightness, and springiness are all in its favor, but great care must be taken in selecting it. The tree should grow where it is exposed to the sun and light—not in a dense wood or thicket. It should be straight-grained and free from knots. It is difficult, nay almost impossible, to find one growing straight. If the stick is good in all other respects I do not mind one or more curves. Such sticks I saw out with a narrow saw, following the grain of the wood. This I do while the wood is yet green. I lash, or with doubled-pointed tacks secure, each stick to a straight board or plank, and when they have seasoned one or two years they come out straight."

Three hundred different varieties of hard woods grow within the United States. Of this great number the hickory, ash, hornbeam, shadblow, and osage - orange, cannot be the only ones adapted to fly-rod making, nor is it probable they are the best. It is the duty of every man who aspires to be called an angler, to do what lies in his way to advance the art. It is desirable that anglers should bear this in mind; and when opportunity serves, seek out and make known any new material likely to prove useful. The field is certainly of sufficient magnitude to promise ample reward for any labor bestowed on investigation—always assuming that the well-deserved thanks of the angling fraternity may be considered in the light of a reward.

To facilitate identification, it may be further remarked that this shrub also bears the local names of Wild-pear, Sugar-plum, and Shad-flower. In favorable localities it

attains a diameter of from ten to twelve inches. The wood is white throughout. Its leaves are from two to three inches long, alternate, a lengthened oval in shape, finely-toothed, veined on the under side, and when beginning to open are covered with a thick down. This subsequently disappears, leaving them perfectly smooth on both sides. The flowers are white, rather large, and disposed in panicles at the ends of the branches. The fruit is globular, about a quarter of an inch in diameter, red when immature, dark purple when ripe, and covered with a bloom.

The foregoing is believed to include most of the materials which have been used for fly-rod making in this country. The Alaska cedar has recently received some attention for this purpose. I have seen but one specimen of it, and that in the square. It was white in color and seemed to be somewhat heavier and harder than Florida cedar. It is reputed to have the same action, and somewhat greater strength.

Reports of rods made all in one piece, without any joints, from a stick split from a small, tough spruce, have reached me, and these were said to be excellent. But I have never seen them.

ADDITIONAL WOODS.

The following woods would appear well worthy of the attention of the rod-maker. The information is collated from "Timber and Timber Trees." (Laslett, London, 1875) and "The Forests and Gardens of South India" (Cleghorn, London, 1859). The author of the former was timber inspector to the Admiralty, which

sufficiently vouches for his opportunities for, and the reliability of, his investigations. The latter was conservator of forests, Madras Presidency.

The character of the tables which Mr. Laslett gives would seem to enable the reader to form a very correct judgment of the comparative value of the different woods therein mentioned for our purpose, the more so since greenheart is included therein; and this, as previously stated, I believe to be, in perfection, the best of the generally known rod-woods.

The transverse strengths were ascertained by supporting a piece of wood two inches square upon two edges placed six feet apart. A receptacle was suspended from it midway between these points, and into this water was gradually introduced to the weight of three hundred and ninety pounds. The deflection in inches was then noted. The weight was then removed and the resulting deflection (or set) taken. From this we can well judge two important factors which go to make a good fly-rod material—its stiffness and power of recovery. Next comes the deflection in inches at the breaking point; then the weight required to break each piece in pounds is given; then the specific gravity from which we may compare the weights; and finally the weight required to break one square inch. In each case a number of specimens, usually six, were tested. In Mr. Laslett's book each determination is separately given, and an average deduced therefrom. In the table presented hereafter these averages only are given, stating in the first column from how many separate experiments the given average was determined. For convenience of comparison all the determinations are presented in a single table, rather than in detached form under each separate wood.

PYENGADU.

This wood is a native of Burmah. It is also called the Ironwood-tree, and is the *Ingazylocarva* of the botanists. It is a species of acacia, of straight growth. It grows to a height of seventy or eighty feet without a branch, and of corresponding diameter, and yields logs even up to thirty inches square and of great length. The wood is of a reddish-brown color, hard, heavy, tough, strong, rigid, and frequently possesses some figure in the grain, which has the appearance of being both waved and twisted; its pores are filled with a remarkably thick, glutinous, oily substance "which oozes out upon the surface after the wood has been worked, leaving a clamminess which cannot be completely got rid of until the piece is thoroughly seasoned. This oily substance has probably a preservative property about it, and may be conducive to the durability of the timber."

Mr. Laslett quotes from Lieut.-col. H. W. Blake in effect, that it is one of the largest trees in Burmah, and combines in itself the properties of wood and iron. It is heavier than water and more indestructible than iron. Time and exposure seem to harden it, since a rifle-ball, fired at a distance of twenty yards, rebounded and failed to penetrate an ancient post of this material.

He quotes from Dr. Hooker in effect, that it is found, but not universally, in India. Throughout the Malay peninsula it is called "Peengado." It is abundant in the Bombay Presidency, where it is called "Jambea" and "Yerool;" in the Godavery forests it bears the name of "Boja;" it is common in Singapore, and is plentiful in the Philippine Islands. Everywhere the wood bears a high character for hardness and durability.

Four of the specimens tested by Mr. Laslett, broke with about twelve inches length of fracture, and two with somewhat less. All were fibrous and wiry.

THE CHOW,

Also called the Menkabang Penang tree, is a native of Borneo; is of large dimensions, yielding logs from thirty to seventy feet long and from fifteen to twenty-six inches square, and is of straight growth. The wood is yellowish or straw-color, close and fine in texture, straight in grain, hard, heavy, tough, and exceedingly strong. It is used in Borneo and the countries bordering on the China Seas for masts, and for house and ship building.

Of the samples tested by Mr. Laslett four broke with fractures about twelve inches in length, and two rather shorter.

THE PINGOW

Is also a native of Borneo, where it is said to be plentiful. It is straight and of considerable size, yielding timber from twenty-five to forty feet long and eleven to eighteen inches square. The wood is of a dark brown color, hard, heavy, tough, rigid, and remarkably strong; it is straight in the grain, close in texture, and not difficult to work. It is used for the same purposes as the Chow. All the specimens tested by Mr. Laslett broke short.

THE KRANJI, OR RED KRANJI TREE.

There are probably varieties of some other color. It is another native of Borneo. It grows straight and of large size. The wood is red in color, hard, heavy, exceedingly tough, and "is one of the strongest with which we are acquainted, every one of the specimens, when

tried transversely, taking a very heavy strain and breaking with an unusually long fracture; the grain is close, and somewhat resembles Cuba or Spanish mahogany, but is very plain" (Laslett). It takes a high polish.

Cleghorn says, "The strength of the wood is very remarkable, being more than double that of oak. The Chinese use it for the stern-posts of their junks and for anchors, and they export it from Singapore. A log twenty-four feet long and one and a half feet square is worth ten dollars."

Of the specimens tested by Mr. Laslett, three broke with a very long fracture, and three much shorter and scarf like.

THE IRONBARK TREE

Is a native of, and abundant in, Australia. It is a lofty tree of moderate circumference, and yields timber from twenty to forty feet in length and from eleven to thirteen inches square. It receives its name from the hardness of its bark. The botanical name is *Eucalyptus resinifera*.

The wood is of a deep red color, very hard, heavy, strong, extremely rigid, and rather difficult to work. It has a plain straight grain. It is used extensively in Australia in ship-building and engineering works, as well as in England for the former purpose.

But four specimens of this were tested by Mr. Laslett. No. 1 broke with a wiry fracture sixteen inches in length; No. 2 wiry fracture of twelve inches; No. 3 wiry fracture of ten inches; No. 4 broke short to one-third depth, then splintering fracture ten inches in length.

Attention is particularly called to the last two woods in the following table, which, if correct, shows both to be lighter, stronger, stiffer, and more elastic than green-

heart. They are readily to be had, since every China vessel stops at Singapore, the market for the one; while communication between this country and Australia, the home of the other, is frequent. If any wood really does possess the merits of bamboo, and if it is desirable to find such a wood, certainly these two, at least, seem to deserve attention.

TABLE ABRIDGED FROM LASLETT.

MATERIALS.	Number of Specimens.	DEFLECTIONS.			Weight required to break.	Specific Gravity.	Weight required to break 1 sq. inch.
		Under 390 pounds.	After weight was removed.	At crisis of breaking.			
		<i>Inches.</i>	<i>Inches.</i>	<i>Inches.</i>	<i>Pounds.</i>		<i>Pounds.</i>
Greenheart.	6	2.15	.066	4.625	1332.5	1149.6	333.
Ironwood . .	6	0.958	.033	4.25	1273.3	1176.3	318.
Chow	6	0.916	.025	2.833	975.	1115.6	243.
Pingow . . .	6	0.775	.058	3.816	1263.3	747.5	315.
Kranji . . .	6	0.625	.025	4.04	1482.6	1029.3	370.
Ironbark . .	4	0.94	.000	3.812	1407.5	1142.	351.

Two other woods, natives of Cuba, seem to merit mention, and to be worthy of practical test. My information concerning them is derived from two papers on "The Strength and other Properties of Cuban Woods," in the November and December (1883) numbers of Van Nostrand's *Engineering Magazine*, by E. D. Estrada, M.E.

It is to be regretted that Mr. Estrada did not facilitate comparison by reducing his test pieces to one uniform size, though the necessity of "cutting his coat according to his cloth" will probably account for this. He describes these woods substantially as follows:

DAGAME (*Coltycophyllum candidissimum*).

This is one of the most plentiful trees of the forests of Cuba, being generally found near mountains and in

reddish soils. A common height is from forty to fifty feet. Its trunk is straight and quite free from branches. The wood is of a pale yellow color, very fibrous, is close-grained, thus resembling boxwood, is moderately heavy, and very strong and elastic. It is very easily worked, either across or with the grain. It turns remarkably well, is entirely free from knots, takes a fine polish, and is very durable.

It is used extensively in general carpentry, for the wood-work of ploughs, cart-axles, spokes, and spikes, and is an excellent material for house-framing because of its strength and durability; and joiners prefer it for their work to most other woods. It is also extensively employed by carriage manufacturers, in ship-yards, and for other similar purposes. The largest section that can be obtained after squaring is twelve inches. Its specific gravity is 0.90. A cubic foot weighs 56.1 pounds.

Mr. Estrada's tests show this wood to be exceedingly strong and elastic, a piece 1.94 inches broad by 2.28 inches deep and forty inches between supports, breaking only under a load of 3450 pounds, and with a deflection of 1.9 inches.

JUCARO PRIETO (*Bucida*).

This tree is abundant near the southern coast of Cuba, and attains a height of from sixty to eighty feet, for which it requires fifty to fifty-five years' growth; it has lateral roots and yields gum by incision.

The wood is of a dark brown color, much resembling black-walnut, is very strong, tough and elastic, and is heavy, fine-grained, and free from knots. It stands the weather remarkably well, is worked easily, and is susceptible of good polish, thus producing a handsome effect. It is largely employed in naval constructions, for purposes

where strength and durability are required. It is also extensively used by millwrights, and is an excellent material for posts, piles, and general dock constructions. It can be obtained in logs of thirty-six feet in length, and sixteen inches square. Its specific gravity is 1.08. A cubic foot weighs 67.3 pounds.

A piece of the wood 1.45 inches broad, 1.75 inches deep, and twenty-eight inches between supports "broke at 1675 pounds, with a deflection of 0.85 inches. Continued to break, and at the last break the total deflection was six inches. A remarkably tough wood."

Since writing the above, through the kindness of Mr. Charles Mallory, of the Mallory Steamship Line, I have received specimens of the Jucaro Prieto and the Dagame from Cuba. They were in the form of two timbers, each thirteen inches wide, five inches thick, and nearly six feet long. The Jucaro Prieto resembled black-walnut in color and greenheart in density. It was free from knots and straight in the grain. Though sufficiently strong, it was not, and is not yet, elastic enough to warrant its recommendation for rod-making. It does not, however, appear to be thoroughly seasoned, so the future may possibly develop merits not now apparent.

So greatly may different samples of the same wood vary in elasticity, that it is premature to condemn a material altogether because a single specimen may be defective. This, however, is the exception that makes the rule, "that it is a poor rule that don't work both ways;" for it is quite proper to recommend a wood, one specimen of which is excellent, since it is certain that others of equal merit can be had, and probably with but little difficulty.

The Dagame, when sawn into sticks, resembled lance-

wood so closely in grain and color as to make it difficult to distinguish between them. It seems, however, inclined to take on a browner shade from exposure to the air, so that it is probable this resemblance will diminish with time. The grain was very straight, altogether free from knots, especially those small knots sometimes called "pins," which are the bane of the worker of lancewood. Though apparently not perfectly seasoned, yet a degree of stiffness, elasticity, and freedom from set was shown which would be considered remarkable in any wood. It broke with great difficulty, and then with a wiry fibrous fracture—resembling hickory in this respect. Compared with a stick of approved greenheart of equal size, the Dagame showed no inferiority that I could detect, while it was certainly much lighter, and I thought decidedly stronger. Should I praise this wood in terms as high as I believe this sample would justify me in doing, I fear I might be deemed extravagant.

I presented the well-known physicist, Professor Alfred M. Mayer, of the Stevens Institute of Technology, author of that superb book, "Sports with Gun and Rod," with some which he converted into a light minnow casting-rod, believing that in this manner the quality of the wood could be better tested than in a fly-rod. He informs me that he has used the rod extensively in black-bass fishing, and purposely in the most unsparing manner. He speaks in the highest terms of its performance, emphasizing particularly its ability to endure the heaviest strains—strains which doubled it up so as to cause his boatman again and again to beg him to spare so good a rod, and not doom it to certain destruction—and this with perfect impunity and entire apparent freedom from set. Should I express myself in its favor in as decided

terms as I am tempted to do, not even then would his encomiums be exceeded. At all events it is well worthy the rod-maker's attention, especially for tips.

PURPLEHEART.

All travellers in British Guiana enlarge on the magnificence of this tree, growing as it does to the largest size, straight as an arrow, and without a branch for sixty feet or more. Its wood is universally commended by them as of great beauty, durability, strength, and elasticity. Black greenheart and purpleheart were the only woods that withstood the concussion of service when used for mortar-beds at the siege of Fort Bourbon, Martinique. From the bark of this tree the natives construct their "wood-skin" canoes, some of which are large enough to carry twenty-five people in smooth water. It is also a favorite bow-wood of the Indians. It appears to be unknown in this country, none of the dealers seeming ever even to have heard of it—at least as far as I can ascertain.

From the concurrent testimony of many travellers, covering nearly one hundred years, it seems unquestionable that this wood is of great value for our purpose, and since it may be had quite as easily as greenheart, both being in common use in that colony, I commend it to the attention of rod-makers. I regret that I am unable to give its specific gravity or describe the wood more exactly. As to the first it is heavier than water, and as to the second it is purple in color.

Composite rods of many different materials I have experimented upon, with much labor but less profit.

Cedar, inlaid with four strips of split-bamboo set in

edgewise to a depth as near to the centre of the joint as possible, was the first effort in this direction. This was imitated from a beautiful rod made by that most excellent amateur rod and fly maker, Mr. J. James Hyde, of New York City.

A like combination of bamboo and mahoe was tried. Both of these yielded good results. But having at that time adopted, and intending in the future to adhere to, one fixed size for my ferrules, so that my joints and tips should be interchangeable, the object sought was to so stiffen these two woods that a reduction to the standard diameter, without excessive reduction in length, would be possible. As far as this was concerned they were a failure, and were consequently dropped. Then flat steel hoop-skirt wire was substituted for the bamboo. This experiment gave me more trouble than any in my experience of rod-making; for not only was the construction of a special plane first necessary to channel out the very narrow grooves to receive the flat wire edgewise, but some kind of a guide had to be devised to direct the channel down the exact centre of the stick, and this after the stick had been tapered, since when the tempered steel was in position planing was at an end. But the gain in stiffness and strength did not compensate for the increased weight. The rod, to my hand, felt top-heavy and unpleasant.

This latter effort is mentioned that, should another experiment in the same direction, he may profit by and avoid my mistakes. It is to be understood that the flat steel strip was set into the wood edgewise, and so that its upper edge was flush with the surface. I used a strip of even width, supposing that, since the taper of the wood would separate the four steel strips farther and farther

apart, this would graduate the stiffness nicely and in the desired manner—on the principle of the truss. This turned out to be an error, and to him who feels disposed to venture in this direction is offered the advice to taper the width of his strips with a file before insertion. Gutta-percha gum, either alone or, if on cooling it does not harden sufficiently, mixed with some Burgundy pitch, will be found a good cement to secure the steel in place, since it is extremely adhesive both to wood and metal, is perfectly water-proof, and, in addition, melts at a low temperature.

Wooden rods with a steel core are not unknown, but I have never seen one.

For convenience of comparison, the specific gravities, before given under their appropriate materials, are arranged in tabular form in the order of their weights, the heaviest first (p. 151). The weight of a cubic foot of each is also given in pounds and hundredths of a pound. Those specific gravities not marked with an asterisk, were computed with the kind assistance of Messrs. S. E. Hopkins and Wallace G. Levison, Director of the Cooper Institute Laboratory. Distilled water was the standard.

The determinations were made with great care, and are believed to be reliable for the specimens tested to at least the third decimal place. Different samples of the same species differ somewhat in weight, but those tested in this instance were of woods carefully selected for the express purpose of rod-making, and were as nearly as possible the very best of their kind. Therefore it is believed that they, and the relative weights determined from them, more correctly represent the material used in fly-rods, than would anything selected at random in the market, or any table computed thereon.

The specimens of split-bamboo were of excellent quality, and of my own preparation. The six-strip hexagonal piece was taken from an old and well-ried middle joint. The angles of this were very slightly rounded. The four-strip piece was put together with the rind inside, for the purpose of comparison. The cedar was from a very choice Florida specimen.

Material.	Specific Gravity.	Weight of 1 Cubic Foot.
Snakewood.....	1.3718	85.74
Beefwood.....	1.3090	81.81
Bethabara.....	1.2140	75.88
*Ironwood.....	1.176	73.50
*Ironbark.....	1.142	71.37
*Chow.....	1.116	69.75
Greenheart (dark-colored).....	1.0908	68.18
*Jucaro Prieto.....	1.08	67.30
Lancewood.....	1.0335	64.59
*Kranji.....	1.029	64.31
Split-bamboo: Six-strip hexagonal, rind outside.....	.9915	61.96
Bois d'Arc.....	.9690	60.56
Split-bamboo: Four-strip, rind inside.....	.9678	60.49
Greenheart (light-colored).....	.9643	60.26
*Dagame.....	.90	56.10
Shadblow.....	.8620	53.87
Paddlewood.....	.8363	52.27
Ironwood (<i>Hornbeam</i>).....	.8184	51.15
Hickory.....	.7963	49.77
Ash.....	.7786	48.66
*Pingow.....	.748	46.75
Mahoe.....	.6607	41.29
Cedar (Florida).....	.6396	39.98

To facilitate computation, as is customary where absolute accuracy is not required, the weight of a cubic foot of distilled water was taken at 62.5 pounds. This table does not bear out the statement heretofore made that

the ironbark wood was lighter than greenheart. The comparison was then made with Mr. Laslett's specimens of greenheart, which were considerably heavier (71.81 pounds to the cubic foot) than those tested by me. Attention has been called before to the fact that different samples of the same variety of wood vary considerably in weight, due largely, doubtless, to difference in seasoning. I have seen specimens of lancewood, of apparently equal density, some of which would float, while others would sink in ordinary well-water.

The same may be said as to the hexagonal split-bamboo. Since the rind of this is heavier and the pithy portion lighter than water, it follows that the specific gravity of any portion of such a rod must vary as the relative proportions of these constituents vary. Therefore this must be greatest at the end of the tip, and thence gradually diminish towards the handle. It is believed, however, that the average specific gravity of a good eight-ounce rod of this description will approximate closely to the figures of the table.

THE ROD OF THE FUTURE.

Vuillaume, the celebrated French violin-maker, at one time made tubular steel violin and violoncello bows. Having been somewhat familiar with both the construction and use of those instruments, the idea at once struck me that this was the direction in which the perfect rod should be sought.

The requisite conditions are alike in both cases—lightness, strength, and temporary and permanent elasticity, being equally the desiderata in violin-bows as in fly-rods. That which will make a good violin-bow should serve

equally well for rod-making. These steel bows seemed to fill all the conditions, and it is with the utmost confidence I hazard the opinion that in the—it is to be hoped not distant—future, a fly-rod will be thus made which will be as great an improvement over the split-bamboo, as that invention was in advance of the wooden rods. Lack of time (since rod-making is merely an amusement with me) and the necessary facilities, alone have prevented me from trying this long since.

Two or three years ago I made a hollow german-silver middle joint, hoping to condense the metal sufficiently by rolling to obtain the necessary spring, but by no means at my command could the metal be sufficiently compressed, and it was a failure.

While it cannot be denied that the hardening and tempering of a hollow steel joint, particularly when made of as thin metal as would be required to insure lightness, would present some difficulty, still, harder things are done every day.

It is to be hoped that some of the many manufacturers who supply the market with rods will try this, at least for butts and middle joints. For tips, those in present use would work very satisfactorily in this combination. That a rod so made, if well made, would transcend in merit everything now in use needs no argument. Think of its perfect, uniform, and permanent elasticity, its indifference to moisture when merely bronzed and lackered, its matchless strength, the absolute certainty of uniformly excellent material—indeed, what quality that a fly-rod should possess would not this have in absolute perfection? The only questions are of thickness of metal, justness of proportion, and obtaining a good temper.

As to the first, “cold-rolled” French steel, of any thick-

ness from that of the thinnest paper to a thirty-second of an inch, can be had at Frasse & Co.'s, No. 95, or of Montgomery & Co., No. 105, both in Fulton Street, New York City. It comes in strips about four inches wide, coiled in rolls several feet in length. As sold, it is extremely soft, but it hardens at a low heat and takes an excellent temper. The strip could readily be cut to shape with a pair of shears after a wooden or even paper pattern, lapped over a mandrel, and the edges brazed, or, perhaps better still, silver-soldered. Then, introducing the mandrel again, the joint could be rounded by a roller, or even with a large pair of grooved pincers, while it revolved in the lathe. Several could then be hardened together, packed with charcoal in a piece of gas-pipe, and an absolutely uniform temper secured in the way sword-blades are treated, or by use of one of the metallic alloys mentioned in the American Encyclopædia under the article "Steel." Or a lesson on this point might be taken from the makers of steel hoop-skirt wire.

It might and probably would be advisable, if very thin steel were used, to fill the inside of the tubular joint with a core, that the tube might be collapsed neither by accident nor undue strain. For this cedar could well be used, fastened in place with any readily fusible cement, like gutta-percha gum. Ordinary shoemaker's-wax or gas-wax would undoubtedly answer quite well. A rod so made would be almost beyond accident—entirely so, unless attacked with an axe, or in some similar, and as little likely, fashion. Of course a wooden handle should be used with such a rod, both to save weight and to simplify manufacture.

This matter has been treated at some length in the hope that it may reach some one having the proper skill

and facilities, and that he may be tempted to try it. Perfect success at the first attempt it would be sanguine to expect; but that, with little effort and experiment, a perfect rod of this description can be produced, and when once produced can be indefinitely reproduced, I have no doubt. For such a rod there is a ready market, and he who first places it within reach of the angler will receive a sure and ample reward.

CHAPTER VII.

ROD-MAKING.

THIS chapter differs nothing from the others of this book, in that it does not presume to direct, instruct, admonish, or advise the initiated, whether professional or amateur.

If he who proposes for the first time to occupy his leisure during the close season with the amusement of rod-making, finds encouragement and aid in its precepts, the purpose for which it was written will be fully answered.

Before proceeding with specific directions, a word of caution.

Do not expect at the first effort and without experience to rival the production of the trained mechanic, guided by the skill acquired through years of daily practice, for this will but result in disappointment and discouragement. Be but patient in your labor, never hurrying or slighting your work; honest to yourself in the selection of your material, and honest to the material you select in your work upon it; and though the result may for some time lack the beauty of finish of that of the professional rod-maker, still your work will have one great merit which his too often lacks — though the apparel may be less attractive, real intrinsic worth will still be there.

Do not suppose because his tools are few and simple,

and perhaps somewhat primitive as compared to those of the present day, that you can or should use the same. You are handicapped by your lack of preliminary training in their use, at least as applied to the purpose in hand, and all the aid to be derived from the best possible tools will be required to overcome this.

Your planes must be strictly first-class, and for this purpose the "Bailey" planes, made by the Stanley Rule and Level Company, are far superior to any others which I have seen. In my own work I consider them indispensable. These planes are of iron, are true on the bottom, and the bit is thin and easily sharpened. But their greatest merit for our purpose consists in that the set of the bit is governed by turning a screw, so that the thickness of the shaving can be instantly regulated at will, and to the utmost nicety. These may be had at almost any hardware dealer's, or may be ordered direct from the company, at No. 29 Chambers Street, New York City. It advertises, if the price-list be sent with the order, to forward to any part of the United States at its expense. Though the first cost of these planes is in excess of the wooden plane, their great superiority for our purpose renders them far cheaper in the end.

If it is proposed to work both wood and split-bamboo, two sizes will be required—a fourteen-inch (No. 5 on their price-list, at \$3.75) and a six-inch (No. 1 on their price-list, at \$2.25). The former you will mainly use in working wood, the latter upon split-bamboo; but the purchase of both is strongly recommended, no matter with what you intend to deal, since at times in the progress of every rod you will find one serve far better than the other. A third plane, about three and a quarter inches long, made by the same company (No. 50 on their price-list, at forty-

five cents), will be found exceedingly convenient in rounding and altering wooden joints.

You will also require a ten-inch "mill-saw" file, a Morse twist-drill one-sixteenth of an inch in diameter, and means for driving it—say a common brace—and a true surface to plane on. You must also have a few scraps of thin saw-steel, which a broken saw will well supply. If no broken saw is at hand, look in some trades-paper for the advertisement of a saw-maker, and order them from him, but be sure you ask for thin tempered stuff. Or you may buy a steel wood-scraper, such as cabinet-makers use, at any hardware store; but these

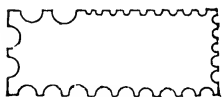

Fig. 33.

seem generally to be inferior to the saw-steel for our use. Having obtained these steel scraps, lay them on a flat surface, and file a number of round notches of various sizes around the edge, thus:

finishing with a pretty fine file. File at a right angle with the steel, and sharpen when dull in the same manner.

By scraping the joint with this tool after rounding with the plane, you will easily make your joints circular, and be able to dispense with an expensive set of grooved planes. This scraper must be inclined to the joint when used; a moment's trial will determine the angle at which it cuts best.

A few other tools will be required, to be described at that stage in the process to which they are applicable. If not already done, the chapter on Rods should be read in conjunction with this, since such special peculiarities in working as each material was thought to possess, have been there stated.

As to those materials, it may be said once for all that

an excellent rod can be made from almost any of them. If the stuff is good of its kind, the result depends upon the proportionate thickness and taper used. And here you have a decided advantage over the professional rod-maker. He makes his rods to earn his daily bread. Often he must select the worse when a better course is well known to him, and this to meet the real or fancied whim of the ordinary purchaser, upon whom he relies to dispose of his goods.

Among these may be mentioned the actual or supposed requirement that the butt, middle joint, and tip shall each be of equal length. This certainly has something in its favor, since, when the rod is apart, each joint lends support to the others against accident in transportation. But a little lengthening of the tip-case will accomplish the same result, unless it be in carrying the rod from the temporary lodging-place of the angler to the stream he intends to fish, when the tip-case is usually left behind. The life of a rod is in the middle joint; and by the usual method the ferrule uniting the butt to that joint is about as injuriously located as it well can be. It is advisable, therefore, to compromise on this, and make the butt as short and the middle joint as long as the distance you expect to carry your rod to water, and the risk and inconvenience of your usual means of travel, will permit.

Another fashion which you will do well to eschew is the struggle for excessive lightness. Some seem to fancy that an angler is entitled to rank in the brotherhood in inverse proportion to the weight of rod he uses, and that irrespective of the waters to be fished. But such is not the opinion of the judicious. He views with a smile of pity the effort to make a wooden rod with its

solid handle, as light or lighter than a split-bamboo of equal length, with its hollow half-cedar gripe. To save weight, or, what is equivalent, leverage against the angler, by shortening the rod as far as is consistent with perhaps a little more than a fair working cast, is wise. For who wishes to lug useless weight all day long to no good purpose; the same end, and with far less inconvenience, would be accomplished by filling the pockets with stones. Ten feet, or ten feet six inches, I believe to be quite sufficient length to give to any single-handed fly-rod. With this, ordinary skill can handle sixty feet of line at a pinch; and we all know that in actual fishing nine hundred and ninety casts out of a thousand will fall within forty measured feet. When you read or hear (as you have or will) of an angler wading down stream, or sitting in a boat, and casting seventy feet as a mere matter of course, and not at all aside from his usual practice, you may feel confident those feet were of other than the English standard.

The skilled angler limits his cast by preference to that distance, within which he can without effort deliver a fair straight line and a light fly. It is only he who occupies debatable ground, who while not quite a greenhorn is yet by no means an angler, whom you will see, in boat or on stream, needlessly swishing his sixty or seventy feet of line. Better by far to cast fifty feet clean and clear, than to boggle about at sixty or sixty-five, and then by some happy combination of circumstances, and after repeated effort, at last reach even eighty. With excellent and protracted opportunity to observe many very skilful anglers, I cannot recall one single instance of a cast in actual fishing that would exceed sixty-five measured feet. Not that many of these

could not considerably surpass that distance, but the effort would have been purposeless and was not made. But this is a digression. Let us return to rod-making.

Give your rod nerve—backbone—so that when you take it in hand it feels as if the tip were absolutely under command, even when weighted with forty feet of the line it is proposed to use. It should be pliable, and when swung horizontally, holding the handle quite still, it should work evenly from the butt, and with a constant and even increase of uniform action quite to the tip. Look first to this, then give it as much lightness as the material you use will permit. Should you by accident or mistake carry the latter so far as to impair the former, shorten the middle joint at the smaller end. An inch or two will make a wonderful difference in this respect. Every way better and more efficient is a rod of nine feet six inches, of just proportion and true action, than a faulty one of ten feet six.

Now let us lay out our rod. It will be noticed I give no sizes for ferrules. Almost any size within reason may be used, depending solely on where you place them. But one direction in this respect is of any practical value; all else will determine itself. Begin the taper of the rod as near the handle as possible, that with the length you have determined on, you may make the greatest possible proportion of that length efficient. Through neglect of this, many a rod which actually measures a good eleven feet, is practically the inferior of one of six inches or even a foot less. It is the part that springs—the part that works that does the business; therefore make your handle short, and give as much action to the butt joint as you can, but always retaining perfect command of the upper portion of the rod.

It must be admitted that many excellent anglers prefer a "top-heavy" rod—one weak in the middle joint. They say it casts more easily. This may be, doubtless is, true as far as they are concerned, for habit will reconcile man to anything except the toothache. But that a beginner will find this so may well be questioned. Conceding, however, this point, there is no other one thing which a fly-rod should do, in which such a rod is not at a disadvantage. It is neither so sure on the strike, nor so certain in the hold. It will not begin to give the angler the same all-important control of a heavy fish; while the curve it assumes under strain, instead of being a thing of beauty, is an eyesore to every one but its infatuated owner. It is as sightly as a broken-backed steamboat, and not a whit more so.

For a twelve-foot fly-rod, half an inch in diameter at the point where the taper begins is quite sufficient. For a rod of ten and a half feet, fifteen thirty-seconds of an inch is ample. Start then with this, and procure the ferrule, to be placed immediately above the handle, of a corresponding size. Should you find the butt joint too stiff when the rod is together, you can reduce it by a sudden taper immediately above the ferrule.

Now lay out your work, thus: Take a smooth pine board, say four feet long. Mark the diameter of the inside of your butt ferrule at one end, and of the small end of your tip at the other, separated by a distance in inches easily divisible as shown in the illustration on the opposite page (Fig. 34).

Length of rod 10 feet 6 inches, equals 126 inches; less length of handle, 10 inches, equals 116 inches; divide this into a number of equal parts—13 will answer well—making each division bear the same proportion to the

length of the diagram, that 9 inches does to the working length of the rod—116 inches (so very nearly that we may neglect the error). Draw straight lines at a right angle to the axis of the rod at each of these 13 divisions, and number them as in the diagram, calling each space so formed 9 inches long. It will be seen that we have thus determined the diameter of the rod for every 9 inches of its working length; and that to find what it should be at any point—say 54 inches from the handle, for example—all we have to do is to measure the perpendicular line at the point 54, and we have it.

From the diagram already constructed you have determined where the ferrules shall be located, and also the inner diameter of the outside or female ferrule. Now having cut your wood about an inch longer than the ultimate length of the proposed joint, square it with the

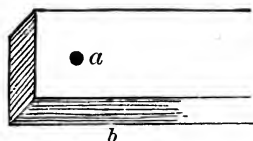

Fig. 35.

plane. Then drill two holes, *a* and *b* (Fig. 35), through each of the joints at right angle with one another: one, say at half an inch, and the other at three-quarters from that which is to be the larger end.

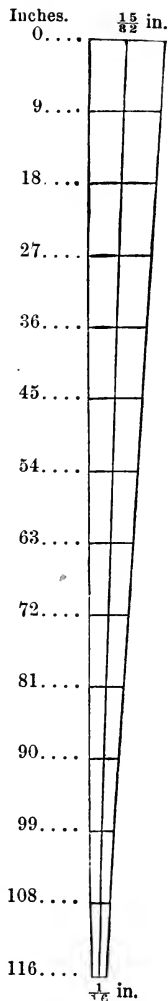

Fig. 34.

Provide a piece of brass wire a little smaller than the holes, from which you are to make a pin, and drive it into your planing-board. By placing the holes over the pin you will be able to hold your joint while planing; and the strain will be a pull, and not a push, as would be the case if your joint was kept in place in the usual manner, by butting the end against a support. Thus your joint will be less likely to crook, or break under the plane. But before beginning to plane, you should prepare gauges to caliper the joint from time to time during the progress of the work.

Take a thin piece of metal—brass is best—and file in its edges thirteen square notches, each equal in width to the length of one of the perpendicular lines in your diagram, as in Fig. 36. Do this with care, that the sides of each notch be parallel—of a depth equal to their width, and of a

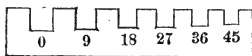

Fig. 36.

width exactly equal to the length of the appropriate line. Then number each notch to correspond with its appropriate line; the widest will then be numbered 0, the next 9, the next 18, and so on. Also, by drawing a diagram for the purpose, or by using an ordinary square, file up a small square in a piece of brass of about three-quarters of an inch to the side, as in Fig. 37.



Fig. 37.

You will have noticed before applying the plane whether the wood you are about to work into a joint is straight or not, and probably have found it crooked. These crooks arise from unequal contraction in seasoning, the tendency being to curve away from the heart of the tree. They incline to be persistent, and to recur after straightening. Therefore, if possible, plane the joint

straight. But if not, the stick must be straightened by the aid of heat. To do this, heat the wood as hot as you can well bear your hand upon it. Unless the stick is small, this must be done gradually, heating it as hot as you dare, then letting it stand a while for the exterior to impart its warmth to the interior, and then, when the surface has cooled somewhat, heating again, repeating this until it is warmed through. It can then be straightened, and may remain straight provided no attempt is made to work upon it until it is perfectly cold. You will also often find the joint crook under the plane. In this case, it is best to wait until the joint is finished before correcting it. It need cause no uneasiness, since nearly every joint before varnishing and when otherwise finished, requires attention in this respect.

Now drive your brass pin into the planing-board, or board upon which you propose to rest your joint when planing it. Then, making proper allowance for the excess of length in the joint, draw a straight line on the board equal in length to the proposed joint when finished. Divide it up into spaces, each nine inches long, and number them plainly. By laying your joint beside this line, you can at any moment ascertain exactly where any caliper notch should be applied to determine when the proper thickness is reached, without the trouble of measuring every time. Then secure your joint by placing one of the drill-holes over the pin, and plane away—first on one and then on the opposite side, changing frequently from one to the other. Use the utmost care to keep the two sides parallel. You will know this is the case if both edges are of like width. When you approach the proper taper, set your plane very fine, and use your gauge often. Be patient, remembering that haste is the sure

precursor of error. Having finished two of the sides, plane the taper into the remaining two in like manner, but be sure to keep the stick square.

This is the time to test your material. Bend it towards each of the four sides, and don't be gingerly about it either. If your ship must sink, let it be while you are ashore. The strain should be applied when the taper is almost, better still if quite, complete. Hold the bend in the joint till you can count thirty with moderate slowness. Then release it, and see if it has regained its original shape. If it has, your wood is first-class; and congratulating yourself on your good-fortune, redouble your care that no error on your part spoil it. If it neither splinter nor break, but does "set," *i.e.*, does not resume its original shape, the better course is to suspend it by one end where the air will have free access to it, and let it season for a few months. Do not be tempted, or, if tempted, do not yield to the temptation, to hang it in a hot closet, through which the furnace pipes pass, since then it will dry unequally, and season-cracks may occur. If the "set" is slight, you may at the same time regret and ignore it, and proceed to finish the rod; though even then the former course is the more judicious.

Let us assume the test has been applied, and with satisfactory result. Take the joint in your left hand, and with your pocket-knife trim off the corners for about half or three-quarters of an inch at the larger end, till you have reduced the section of that end to an octagon, as shown by Fig. 38 (the dotted lines represent where your cutting is to cease).

Work a little at each edge in succession, using care that when you finish, each of the eight sides is equal, and your octagon perfect in form. You must by no means

in so doing touch either of the four planed sides—only the corners are to be cut. Now, treat the smaller end in the same way. The two ends will then serve as a guide to inform you when you have planed the whole joint to an octagon, which is your next step.

To do this successfully you should have a grooved strip of pine in which to lay the joint. Any carpenter can make one for you, or you can make it yourself by planing off the corners of two pieces of $\frac{3}{4}$ -inch stuff, and afterwards nailing, screwing, or gluing them together, as in Fig. 39.

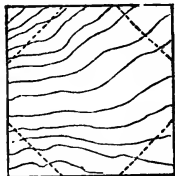

Fig. 38.

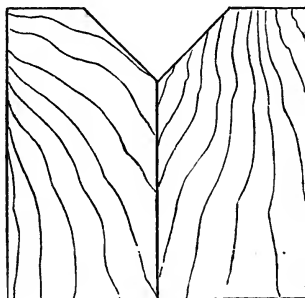

Fig. 39.

Or a strip sawn off the grooved edge of a "tongued and grooved" board will answer, though not so well.

Now, drill two more holes as before, but this time in the middle of the new faces; put a brass pin in the bottom of the groove, hook on the joint, and plane off the corners in turn, till the joint is octagonal throughout, and your eye informs you that the taper is uniform. Be careful, be patient, and don't hurry. Now, with your small plane take off each of the eight corners, rounding them a little, and your joint will be nearly circular.

Set it one side, and proceed to square and taper the other joints in the same way, but not to round them till you have taken the following step: Apply your male, or inside, ferrule to the larger end of your middle joint or tip. You will find it too large to enter. Turn that end from you, and plane off a shaving or two, and the same number, from each face, and try it again. Continue this until small enough, using the utmost caution to avoid excess, and also to treat each side alike, lest your ferrules set crooked when in position. You will thus take the taper out of a few inches at that part of your joint, which will then be of uniform diameter, and you must work with that end in view; for the rod is flexible, but the ferrule is not, and this method seems best to harmonize these discordant characteristics. Then reduce the joint to an octagon, and after that test and round as before. The next step is to fit the ferrules, for which use your scraper, file, and care. Locate the male ferrules so that the excess of length originally allowed will protrude beyond them; and after the ferrule is fastened, cut off this excess. You will thus be rid of the holes, and for this purpose the extra length was allowed. If you get the wood a little too small you need not break your heart over it, since many purposely do this, and then enlarge the wood to fit by wrapping it with thread, claiming that the ferrules thus hold better, and are less likely to become loose. If you use thread for this purpose, wind it on evenly, so one part does not overlay another (unless more than one layer is required to make a fit), and paste it down with some of the cement you propose to fasten your ferrules with. Then melt the cement thoroughly through the thread, completely saturating it. Next warm your ferrule, place a small piece of cement inside on that

part which is to be united to the joint, and work it about with a small stick till the inside is coated.

In setting a female, or outside, ferrule, it must not be pushed on beyond the proper distance, or a part of that portion of its interior intended to receive the male ferrule may become coated with cement, and compel the removal and cleansing of the ferrule. To avoid the possibility of this, prepare a piece of wood one-sixteenth of an inch longer than the entering part of the male ferrule, and drop it inside of the female ferrule when about to set it. As that ferrule is pushed on, the wood will move before the entering joint. If the last quarter of an inch is inserted by thrusting the ferrule against any solid substance, the wood will strike when the proper point is reached, and prevent the ferrule from being pushed beyond it.

Having coated both the joint and the inside of the ferrule, melt the cement on both, and push the ferrule into place, giving it a twisting motion in so doing, if possible. The excess of cement (and an excess should be applied) will be crowded before the ferrule. Then wet a knife, that the cement may not adhere to it, and take it up for use another time. Warm the rest till fluid, and wipe it off clean with a rag. Should any of the thread have been pushed down before the ferrule, be careful in removing it to make no transverse cut in the wood, for such a cut, though hardly perceptible, will detract thirty per cent., if not more, from the strength of the joint.

Here it might well be asked what cement should be used. To this it may be answered, avoid shellac and red-lead—or white-lead, or anything which sets as hard as a stone, and which, should the joint break at the ferrule, will require a degree of heat sufficient to anneal the metal before the broken piece can be pushed out.

I have used hard shoemaker's wax, gas-fitter's red-wax, engraver's wax, marine glue, Bottom's cement, gutta-percha gum, and shellac. The latter is most commonly used in scales, not in solution unless it be very thick. The desiderata are a cement which will melt and release the ferrule at a low temperature, but which will otherwise hold fast. At the edge of the ferrules is the weakest part of the rod, and there at least three out of five—I think it would be safe to say four out of five—breaks occur. To be able to repair such damage with the aid of a few matches and a pocket-knife, and to resume fishing promptly, is therefore very important. Even though this could be had but at the cost of ten times the time and trouble at home, the difference of occasion and facility considered, it would still be cheap. During the winter, ferrules so fastened are apt to become loose, particularly if the rod has been kept in a heated room. But ten minutes' work at the beginning of the open season will remedy all that. If you have the ability to make a rod, you certainly can reset the ferrules on that rod.

Shellac melts at rather a high temperature for our purpose, and the same may be said of Bottom's cement. Shoemaker's wax and gas-fitter's wax I have used with satisfaction. They melt easily, and will hold through the season, at any rate, very well. Marine glue—a compound of rubber and shellac—is better than either, but expensive and difficult to obtain. But gutta-percha gum seems to quite "fill the bill," and is easily to be had. It melts at a low heat, is extremely adhesive, and sufficiently elastic to admit of considerable expansion and contraction of the wood without losing its hold. Any dentist can supply the little you will require, or you can go to your shoemaker for some of the cement used

to paste patches on shoes, which generally consists of this gum dissolved in carbon bisulphide. I have not used this long enough to speak positively, but it is confidently expected that a ferrule once fastened with it, will withstand every vicissitude of time and weather, and only become loose when desired.*

Avoid all fastening pins. The professional rod-makers fancy they are necessary to the sale, or at least the reputation, of their rods. Some fishermen think that any rod they buy and pay for should stand every form of abuse, and if it does not, the rod-maker is blamed and his work decried. The makers know this, and that their reputation for skilled and honest work is as sensitive as that of a woman. It is for this class the fastening pin is intended. You will hear each of the better known makers abused in turn, something in this fashion: "Oh, yes, John Doe made a good rod once upon a time, but now his business is so grown that he trades upon his reputation, and uses any kind of material, good, bad, and indifferent. Why, my

* Gutta-percha gum hardens after fusion with such extreme slowness that a rod to which it has been applied should not be jointed for at least twenty-four hours. This tax upon the patience may be avoided by adding to it about one-fourth part of shellac in scales, or of Burgundy pitch. Melt the shellac or pitch first, then add the gutta-percha, and stir with a stick until amalgamation is complete. Then pour the melted mass into cold water, and work it well with the fingers while submerged, finally drawing it out into a cylinder about one-third of an inch thick and three inches long. This quantity will last quite a while, and, since it seems to improve with age, it is well to arrange to produce at least so much. Any small tin dish will serve to melt it in, and this can readily be cleaned by heating and wiping with a rag.

The reader is cautioned that the solution of the gum alluded to above has an odor that is simply appalling. Chloroform dissolves it readily, is equally volatile, and much less offensive.

friend bought one of his rods, and the very first fish he caught—and it wasn't longer than your hand—it broke;" or, "after he had used it one season it was crooked as a ram's horn," etc. The facts in such cases are usually true, but they are not unfrequently cases of partial truth only. If you knew in the one case that the fish struck when the rod was perpendicular, so that it could not bend; or in the other, that the rod was habitually left standing or lying supported on the butt and tip alone, or kept bent month after month in a bag tied tight around the middle, you would draw quite a different inference. To such of my readers as wish to buy and do not care to make, I would say that that maker who has a reputation, will do his best to maintain it. If he once turned out good work, competition will force him to do so still. If he has the skill, you may be sure he will use it. No one knows better than he that one bad rod will do him more harm than a hundred, first-class in every respect, will benefit him; and if he sells the rod with his name upon it, he believes it, and chances are ninety-nine out of a hundred you will find it, all right, as far as concealed defects are concerned.

During this digression you are supposed to have fastened your ferrules, for which you have had ample time. Now, take your scraper with the semicircular notches, and proceed to round your rod. This is soon done. Joint your rod, put the butt joint to the handle, and with reel in place see how it feels. If any ferrule is not in line, warm and straighten it if you can. If you cannot, set the rod so the crook is uppermost, *i.e.*, so that the rod sets upward from the straight line. If too withy, shorten the middle joint at the small end an inch or two, and try it again. A very little change here makes a great differ-

ence in the leverage, and consequently in the feel and action. If still too weak, shorten the tip at the larger end; and if the fault still exists, shorten the small end of the middle joint again. This method will at last surely remedy this fault, but whether at too great a sacrifice of length you must judge. But I would not advise that the rod be thrown away as a failure if the material is good, unless you are obliged to reduce it below nine feet six inches, a contingency hardly possible if you planned a ten foot six, or even a ten-foot rod. If too stiff, before you proceed to weaken it, impress a friend to hold the handle, hang a weight on the tip, and put a good smart strain on the rod. If its curve is even and true, thin the rod all over, except the upper part of the tip. If it is not, mark the stiff places with a pencil, and work them off. Get a true curve first before you begin to think of reducing the rod generally, for without this a fly-rod is an abortion. When present, you will know the strain is diffused equally, and that each inch is contributing its best to the general integrity of the whole. When you think the golden mean between stiffness and flexibility is reached, if circumstances permit fasten on a few rings temporarily, rig your line, and go out on the grass, or on top of the house—any place where you can get a clear range—and try its casting powers. If you can borrow a good rod, or secure the assistance of a friend who has one, try first one and then the other—alter if need be, and try again; be patient and painstaking, and I shall be much mistaken if you do not turn out a very respectable rod, even at your first effort.

Finish with sand-paper, first No. 1, afterwards No. 0, turning the joint constantly, while you rub the sand-paper longitudinally. Get a good smooth finish, for it

will save much time and trouble in varnishing, and is essential if you wish the rod to look well.

If the material of which the rod was composed were perfectly homogeneous, and without ferrules, strict adherence to our diagram would give the desired result. But such is never the case. No two pieces of wood are alike, even though from the same tree. Much less then can this be the case when the rod is composite in character. Our diagram is as the place of departure to the navigator, a fixed and known point from which to shape our course towards a goal we cannot see. In all cases it will require some, in no two cases the same, modification. Here enters in the skill and personal equation of the maker. In this I can give you no assistance, beyond the advice to make your changes slowly—allow no departure from a true curve when the rod is bent—and insist that the action is such that the tip is absolutely under the command of the lower portion of the rod. Remember that a rod twelve feet, and one nine feet six inches long, should and may have the same flexibility and action. Some, to-day, still praise the long rod and decry the shorter, just as some still oppose the breech-loader. Six or seven years ago the cry was that the short rod was fit only for short casts and baby-fishing. Now the tune has changed, and the short rod is fit only for long distance casting. Neither is true. Because a short rod is desired that the excessive weight of the long rod (or apparent weight of its greater leverage) may be avoided, it by no means follows that resort must be had to a poker. So again I say, give your rod all the flexibility you can, but be sure it is uniform, and that you retain beyond suspicion absolute command of the tip. In so doing, do not overlook the fact that the rod is

weighted with the line when in use, and consequently, that a degree of flexibility which seems excellent in the shop may be excessive when on the stream. Hence, govern the final adjustment of the rod by actual casting, if possible.

FERRULES.

It does seem as though some precise diameter should be given for the ferrules of fly-rods, but from the very nature of the case it is impossible. As well ask a tailor for the size of a coat to fit all men.

I have used the following for years: Handle female ferrule, inside measurement, $\frac{8}{16}$ of an inch, length $2\frac{3}{4}$ inches, unless ferrule is sunk into the handle so only its mouth appears. Then it should run the whole length of the gripe, and be fastened with cement as heretofore directed. This is the better construction, since then the utmost possible length of the rod is efficient. The female ferrule uniting the butt and middle joint is $1\frac{1}{2}$ of an inch inside and $2\frac{1}{2}$ inches long. The female ferrule uniting the middle joint and tip is $1\frac{3}{4}$ of an inch inside and $2\frac{1}{2}$ inches long. One-eighth of an inch may be taken off these ferrules throughout the series with profit, if the fitting is tolerably good. I vary the position of the ferrule, uniting the butt and middle joint considerably, shortening the butt and lengthening the middle joint for stiffer material such as split-bamboo, greenheart, or bethabara. These sizes I have used without change, and find that with them, in conjunction with a forty-one inch split-bamboo tip, I can make a rod of any material from nine feet eight inches to ten feet six inches in length, by varying the position of the juncture of the butt and middle joint as aforesaid. The male ferrule on the larger end of the tip is $1\frac{7}{8}$ inches long, of

which $\frac{7}{16}$ of an inch is cap.

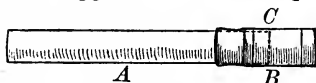

Fig. 40.—A, male ferrule; B, cap; C, point where male ferrule ends.

The tip I cap, that it may be of the same diameter as the small end of the middle joint. The cap is united to the other portion of the ferrule by soft

solder, and for one-third its length, and the shoulder formed within is removed by a reamer.

When these sizes of ferrule are used with ash and lancewood, or hickory, or ironwood, the rod, exclusive of tip, should be divided into two equal portions, very nearly, to give the best result. These, and the sizes given under the head of Bethabara in the preceding chapter, will furnish as precise information as it is in my power to give. If they are followed, it is not believed any error can result beyond correction by local readjustment of the taper. But if ignorance of the length and material you propose to use, and the style of action you may prefer, render it impossible precisely to define the diameters you should employ, there are some other points in reference to your ferrules which I most earnestly recommend to your attention.

First, your ferrules should by no means exceed the lengths already given. You may even reduce them one-eighth of an inch with profit, if your fitting is tolerably good. The male ferrules to correspond should not exceed—butt ferrule, uniting same to handle, $1\frac{8}{16}$ inches; larger end of middle joint $1\frac{7}{16}$ inches; tip has been already given. Why you are thus advised will appear in discussing the following points.

Second, shun the dowel-pin and its socket.

I am well aware that fully ninety-five per cent. of the fly-rods in use are furnished with dowelled ferrules. In

the face of such decided and prevalent custom, full reasons for the faith that is in me will not be out of place. You can then judge between us, and make your action conform to your decision.



Fig. 41.—Dowelled Ferrule: *A*, end of middle joint; *B*, end of tip; *C*, dowel; *D*, its socket.

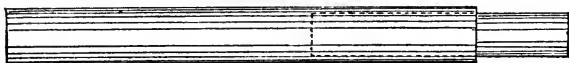

Fig. 42.—Simple Ferrule.

You will at once perceive the simplicity of the one, and the complexity of the other construction. Properly to make and adjust the dowels and their sockets without the use of a lathe, requires more skill and care than to make a split-bamboo tip. Special tools, at least a special reamer for each sized dowel, is absolutely necessary to form each corresponding socket—tools altogether dispensed with if the simple ferrule is used. Unless, therefore, the dowelled ferrule offer very decided advantages over the simple ferrule—unless it is practically impossible to make a good serviceable rod without the dowelled ferrule, your choice has already been made, and I have your verdict.

But not only do I hope to show that a rod, at least as good in every respect, can be made with the simple ferrule; but that the dowel is a useless, a mistaken, and a disadvantageous construction—injurious alike to the action and to the endurance of the rod. Therefore, to all of the great brotherhood of anglers who may favor me

with their attention, I now address myself, asking but a patient hearing and a just and impartial decision.

1st. It is an elementary principle of fishing lore, that a one-piece rod without any joints whatever, is the most uniform in action, and efficient in use. But convenience of transportation, since it is given to but few to cast the fly at their own threshold, precludes such a rod. Nevertheless it is, confessedly, the ideal rod, and the nearer it can be approached, the better. So far there will be little difference of opinion.

Unquestionably the chief feature to which the merit of such a rod is due, is the absence of stiff and inelastic places therein. Its bend is uniform from one end to the other. This can be approached in a jointed rod only by reducing the inelastic portions to a minimum; or, in other words, by shortening the ferrules to the utmost extent consistent with safety. If this is so, it is conclusive that the dowelled ferrule is, in this, inferior to one without dowels, since not only must the ferrule itself be longer, but it must be capped at the junction of the ferrule and joint as well, thus further prolonging the unbendable portions of the rod.

2d. Though little complaint can now be made of the prices asked for good rods, considering the really elegant workmanship displayed and the great difficulty and expense of obtaining fit material—a difficulty and outlay not justly appreciated by the uninitiated—still the purchaser might with propriety wish the benefit of any diminution of cost which neither impaired the value of the rod, nor lessened the already reasonable profit of the maker.

The dowelled ferrule and its mate practically consist of two ferrules, one cap for female ferrule, metal dowel

fitted to end of joint, wooden dowel within, and on which the metal dowel is fitted, boring out recess to receive dowel, and lining same with metal.

The simple ferrule and its mate are two pieces of plain tubing, one fitted to enter the other. As the male ferrule in either case may or may not be capped, such cap is not included in the above enumeration.

Therefore it is clear that, as far as cheapness of construction is concerned, the dowelled ferrule is at a disadvantage.

3d. It will not be questioned that a large majority of breakages take place at the ferrules. Nor will facility of repair be lightly valued by any one who has once met with this accident when distant from the repairer, and after a considerable journey to his favorite stream.

To repair the dowelled ferrule on the ground, in camp, or at such lodgings as troutng regions usually afford, presents these difficulties. If the break is above the male ferrule, it becomes necessary to shorten the rod by the length of both dowel and ferrule, to say nothing of extracting the broken wood from the metal parts, and the nice fitting required to make even a temporary success of the job. If the ferrule is secured by that abomination, a pin, the difficulty is increased. It must be borne in mind that not only must the wooden spike, upon which the metal dowel is to be placed, be made central and in line with the axis of the rod, but it must fill the metal nearly or quite its whole length, and also fit tight therein. Otherwise, in the first case, the rod will not come together so as to be safe against that most disgusting mishap of throwing apart; while in the second case, when the rod is unjoined, the metal dowel will remain behind in its socket.

Again, shortening a favorite rod between the butt and middle joint by two inches or more, will so change the action as to make its owner fairly sick at heart.

On the other hand, if the rod breaks below the ferrule, he is even more helpless; for aside from ridding the ferrule and cap of the broken portion, how is the tapered hole to be bored to receive the dowel? Yet unless this is done somehow, the dowel will strike against the end of the joint within the ferrule, and the male ferrule, if it enter at all, will not do so sufficiently to permit the rod to be used.

Again and again have I known this accident to occur, and never knew it to be remedied short of some kind of a shop; while, except in a few rare cases and with common rods of little value, it has been a case of immediate quarantine, and subsequent hospital treatment by a professional rod doctor.

But if a rod provided with the simple ferrule is so broken, a few matches softens the cement which retains the ferrule in position, the broken piece is pushed out, and the ferrule replaced with the very minimum loss in length, and that by the merest tyro in repairs. And in fifteen or twenty minutes he goes on his way, if not rejoicing, still not a fit candidate for a mad-house. Here surely the advantage is not with the dowelled ferrule.

4th. But it strengthens the rod:

A sane man would hardly anchor a sixteen-foot cat-boat with a frigate's best bower anchor, though that would undoubtedly strengthen that boat's hold on the bottom. And so, if without the dowel and its complications the requisite strength can be obtained, it would scarcely seem common-sense to retain it for that reason alone.

Through ten trips in Maine I have used the simple fer-

rules. That on the end of the butt joint is scant two and a half inches long, and made from metal of the thickness of an ordinarily heavy visiting-card, and considerably thinner than any other make of ferrule that I have ever noticed on a fly-rod. Yet I am unsparing in my demands upon a rod. When the September sun is just about to vanish behind the hills of Western Maine, there comes a time when all that gambling spirit which actuates enterprise in man, takes possession of that angler so fortunate as to be on the ground. He wants no third or fourth prize in the lottery. His casts are for the first, or at least a good second—five pounds, no less, will pass; while if beneath the water there is any sense whatever of the fitness of things, it is the plain duty of an eight or ten pounder to offer.

At such an appointed time, and it is brief at best, minutes are precious, and a two and a half or three pounder—anything which it is humanly possible to derrick with the tackle in use—is reeled in and got rid of without the slightest ceremony, and with the reverse of thanks for its attentions. I have done my share of this with simple ferrules, and never yet has one bent or given way. It is to be borne in mind that before a tube will bend it must collapse, and if the rod is so put together that the ends of the joints within the metal are close together (say one-eighth to one-sixteenth of an inch, which is quite ample to allow for wear), it is plain that to bend the ferrule will require a power almost equal to the tensile strength of the metal itself, a strain to which, in use, no fly-rod is ever even approximately subject. It would, therefore, appear that in this particular the simple ferrule, properly constructed and applied, is practically quite the equal of its dowelled rival.

5th. It strengthens the rod! And this is the only assertion in its favor I have ever been able to elicit.

But is this assertion true? I believe that it is not only false, but that the direct contrary is the truth. A ferrule may be able to endure any possible strain with impunity, while the rod to which it is applied may be as brittle as a pipe-stem. Of course the weakest point in the rod measures the strength of the rod.

This is just the case in point. A dowelled ferrule in itself is undoubtedly stronger than a simple ferrule, but the rod to which it is applied is weakened thereby, and is not as strong as it would be were a simple ferrule of proper construction substituted in its place. The strain brought on the unyielding metal is localized and concentrated at its extremities. The ferrule and its mate act as one single lever, in which the power is applied at one end, while the fulcrum is at the other. It is elementary and axiomatic that the longer the lever the greater will be its power. If the effort which the lever transmits exceeds the endurance of its fulcrum (in this case the timber at the lower edge of the ferrule), the latter will surely be crushed, *i. e.*, the rod will break at the ferrule.

This simple principle of natural philosophy seems to demonstrate that, other things being equal, the introduction of any ferrule weakens a rod, and that a longer ferrule weakens a rod more than a shorter; since with equal pull at the tip, more strain is concentrated at the end of a long ferrule (or lever) than at the end of a short ferrule (or lever).

It is a corollary to this that in all jointed rods the points where the ferrules terminate, are subject to a degree of strain considerably in excess of the proportion due to their location—or in other words, in excess of the

strain imposed at the same point, under like conditions, upon a like single-piece unjointed rod.

Therefore, fracture at those points should be more common than at others; and that such is the fact every one knows. Our theory tells us such *should be* the result—our experience shows such *is* the result. Therefore, it would seem the theory has stood the regulation verification by experiment, and that it may be safely accepted as sound.

A dowelled ferrule must of necessity be long; a simple ferrule may and should be short. Wherefore it again appears the verdict must be against the dowel.

But it may be justly urged, the simple ferrule is not new; Thaddeus Norris used it years ago, and advocated it in his most excellent book "The American Angler." You have had your say against the dowelled ferrule. What do its adherents, who, you admit, are the large majority of anglers, charge against the simple ferrule?

They charge that the simple ferrule will work loose and throw apart, or bend, or burst open when subjected to a sudden strain. It must be admitted that in the first charge they have the inferential support of no less an authority than Mr. Norris himself; for though silent in words, he nevertheless recommends and figures in his book ferrules provided with small hooks, so that they can be lashed together obviously to guard against this accident.

These are the standing and only objections of those who favor the dowelled ferrule; and, if answerable, they should be met. They have each, however, one inherent weak point. *They are each and every of them devoid of truth.*

What man who forms his judgment on the merits, and not from prejudice—and it is to such only that it is worth while to appeal—will for a moment think of taking a poorly-fitted simple ferrule of inferior material (when perfect-fitting and good material is easily to be had), as a standard from which to form a true opinion of its merits? Would the reader think it fair-play should a visitor to his country judge its inhabitants from the most debased of the population, and declare that all were of that stripe, and that the people of the United States were the scum of the earth? I think not. And, as he would justly protest against such an expression as an outrage, so do I protest against these charges, and for the same reason.

Besides quite a number that I still retain, there are many rods of my own make in use, presents to friends. The ferrules of all these are short and without dowels, and all made from german-silver tubing drawn inside and out. None of them are furnished with any device whatever, except the mere cohesion of the inner within the outer ferrule, to hold them together when in use. Never in twelve years or more of my own experience, nor, I believe, in that of those using my rods, has a ferrule either split or bent, or a joint thrown apart. And yet I am but an amateur maker, a professional man without mechanical training, resorting to rod-making merely as an amusement. It stands to reason that a trained mechanic could do better work. Besides, the ferrules used by me for the last five years were drawn too large in the first instance; and in subsequently reducing the diameter, the thickness was also reduced, resulting in a much thinner ferrule than I proposed—certainly not heavier than an ordinary visiting-card. Therefore we have not here

the best possible of either work or material, as a criterion of the merits of the simple ferrule.

These rods have not been used solely against the small fish of the ordinary mountain brook, but much more largely in those waters of Maine where, I believe, it is admitted that the American species of brook-trout attain a size not elsewhere found, or at any rate, only in the Nepigon River of Lake Superior.

In September, 1883, a friend fastened a trout of four and a half pounds (weighed to the ounce, and not guessed at) in a dangerous place, and not only held him without giving an inch of line, but hung to him until his guide took the boat into clear water and towed the fish after.

The rod used on that occasion was a greenheart, with split-bamboo tip, nine feet eight inches long, and united by simple ferrules made by me during that year, and in the manner described. The rod and its ferrules, as far as the eye and constant subsequent use could determine, were as good as new.

It will be admitted, I think, that this was a pretty fair test. But it by no means stands alone in my remembrance. I could instance dozens of other occasions where these ferrules have withstood the severest and most sudden strains, and always without damage.

Should I assert that if a man fell from a window he would not reach the ground, but fly off into space, and forever after gyrate in an orbit around the moon, you would unhesitatingly assert that it was not true. You have seen bodies fall before, and are familiar with the course they will take. For the same reasons, I assert emphatically *that it is not true* that the simple ferrule, if properly made (and this is a much easier matter than to make a good dowelled ferrule), will either throw apart

or bend or split when subjected to any possible practical strain. A ferrule of leaden material, and the fitting of which is a botch, will give a like result, whether dowed or simple in construction.

Still, the charge that the simple ferrule will throw apart has some foundation in fact, and it is this: Some make and advocate the use of a form of simple ferrule, which, for the sake of a name, I will call the "hour-glass" ferrule. By this I mean a ferrule in which the diameter of the bore diminishes from both ends towards and to the middle. Alive to the fact that a fit is desirable, they hope to insure this by thus tapering the bore of the female ferrule, and giving a corresponding conical form to its mate.

But let us analyze this construction for a moment. We have here a conical plug entering a conical hole. It is obvious that the plug may and will enter some distance before any contact occurs. It is also clear that when contact does take place, but a very slight farther insertion is possible before the entering ferrule wedges fast. We have then, on one side of the fit and close to it, a place where the contact and consequent cohesion of the surfaces is nothing; and on the other side, and in equally close juxtaposition, the "jam," where the entering ferrule comes to a stand. Start such a ferrule ever so little, and the frictional contact or cohesion of the surface is so impaired, if it is not altogether destroyed, that it is no longer sufficient to meet and overcome the tendency of the rod to throw apart in casting. That a sudden jar or shock may produce this result, is shown by a familiar example from every-day life. Many have struggled with an obstinate glass stopper stuck fast in its bottle. Here

we have the conditions exactly reproduced—a conical plug fitting in a conical bore. Taking the bottle in the left hand, and constantly turning it, tap the glass stopper alternately on each side with any light piece of metal, and in a few moments a cohesion which resisted all the torsional strain you could apply, is so broken that the stopper may be removed with the thumb and finger.

Contrast with this the action of a perfect cylinder. Insert it one-eighth of an inch, and it fits; insert it another eighth, and it still fits, and a due proportion of cohesion is added to that already obtained; enter it further, and still the same result—each fractional advance increasing the cohesion of the surfaces, until the limit of insertion is reached.

Now, whether a rod will throw apart or not depends upon the relative proportions of the cohesion of the surfaces of the ferrules one with the other, and the centrifugal motion imparted to the rod in the process of casting. So long as the former is in excess the rod can never throw apart. Start the “hour-glass” ferrule at all, and the centrifugal motion preponderates. But the cylindrical ferrule may be withdrawn half an inch, and still leave abundant cohesion to retain the balance in its favor. Ignorance or neglect of these simple and elementary principles have led to the construction of the “hour-glass” ferrule, and to the claim that a simple ferrule *so made* is liable to throw apart, I assent. But a simple cylindrical ferrule is quite another matter, and when the defects of the former are charged against it, guided both by practical experience and theory, I insist that those charges have no foundation in fact. Nor must it be supposed that mathematical exactness of form or fit is essential to its practical success. I have known of a simple

ferrule, uniting the butt and middle joint of a rod, stand perfectly for years, in which the female ferrule had been changed from the tapered to a cylindrical form solely by hammering on a mandrel, and without grinding or finishing the inner surface in any way.

Therefore it is believed that the facts fully justify the assertion that the short form of ferrule I advocate is as much the superior of the long dowelled ferrule in excellence, as it is in simplicity, and that no other should be used to unite the different portions of a fly-rod.*

Returning now to our subject, and addressing the beginner only, as before, we anticipate and answer his ques-

* Since writing the foregoing, my attention has been called to a form of dowelled ferrule, in which the dowel is very short, and the ferrule but little longer, if any, than those I advocate. If the dowelled ferrule has any merit, this possesses it fully, while beyond increased difficulty of repair to a break at the ferrule's edge, I know of no objection to its use. These ferrules were otherwise so well made, and on such sound mechanical principles, that it is with pleasure I except them from the preceding criticism. The dowelled ferrule has, however, one advantage over the other form deserving of mention. At the opening of the season the ferrules of a rod are sometimes found to be a little loose, due to the shrinking of the rod material during the winter. In such case the dowel so wedges any joint to that below it, as to prevent the shake at the points of juncture (which would temporarily disable a rod provided with simple ferrules), and the angler may disregard the defect.

I have spoken, and hereafter speak, of ferrules made from tubing. In all cases tubing "drawn inside and out" is to be understood, the process of manufacture of which is as follows: A polished steel mandrel is inserted within the tube, which is then forcibly drawn through a die with the mandrel still within it. The metal is thus compressed between the mandrel and the die, resulting in a considerable extension in length as well as reduction in diameter. This condensation by compression is essential to the required "temper" of the metal. I neither advocate nor approve of the use of any tubing in the drawing of which the use of such a mandrel is omitted.

tion, Where shall I get my ferrules and rod material? My own ferrules have been made from german-silver tubing, drawn for me by Mr. John H. Knapp, manufacturer of gold and silver pen and pencil cases, No. 17 John Street, New York City. The tubing for the male ferrules, as supplied me in the past by Mr. Knapp, has been just a shade too large to enter the female ferrule, so as to permit nice fitting. This tubing was beautifully drawn inside and out, and of good "temper." Mr. Knapp prefers that samples should be sent with orders. He can supply any size which does not exceed half an inch in interior diameter.

To make ferrules, or even to fit them well, without the use of a lathe is a difficult matter. To buy your ferrules already fitted is the better course, if you have not access to this most useful of machines.

Let me, however, strongly advise, if you intend to make more than one rod, as soon as possible to adopt fixed sizes of ferrules for fly-rods and to adhere to it, for thus you will have all parts of all your rods interchangeable. The advantage of this is too apparent for discussion. But, lest the youthful beginner (and to such, remembering my own embarrassments, my heart goes out), to whom money may be an object, may have ordered a second set and find it a little different from his first, I will give directions for fitting without a lathe, which with patience will remedy the defect.

Let us assume the male ferrule is too large. First cement it on a stick to serve as a handle. Then, if the difference is great, attack it with your "mill-saw" file, otherwise with a "dead smooth" file, or strips of emery cloth glued to flat pieces of wood. In any event finish till it will enter a little with the latter. In this filing

operation you must by no means put the ferrule in a vise. Hold its handle in the left hand, laying the ferrule in a shallow groove not over a quarter of an inch long, so that if you do not apply the file straight, the ferrule will rock a little to meet it. To file flat and true is one of the most difficult of mechanical operations, and few even of trained artisans ever acquire it. Should the male ferrule be too small, insert a round piece of iron which fits it nearly, and stretch it with a hammer until too large. Then finish as before.

If, however, the female ferrule is too small, mount it on a handle inserted only at that end, and not quite as far as the joint is intended to enter. Carefully round a stick of such size that when wrapped with emery-cloth, to be glued on, it will just fit. Oil the latter, and grind out the inside of the ferrule, giving some longitudinal as well as rotary motion to the stick. Unless the quantity to be removed is considerable, the ferrule should not be stretched on a metal rod under the hammer. When you have finished, wipe the oil and abraded material from your files and emery-sticks, and put them away for future use. When the female ferrule is too large, there is no remedy for the amateur but to buy another.

German-silver takes a better temper*—can be made

* When the amateur, at least, speaks of "German-silver," he is apt to suppose that he refers to a fixed alloy of definite characteristics. This is not the case. The term "German-silver" is applied indiscriminately to all alloys of copper, nickle, and zinc, with or without lead or iron, irrespective of the proportions in which they are combined, or the characteristics of the compound—color excepted.

They are by no means equally suited to the angler's use, especially for ferrules. The desiderata are malleability, that the alloy may be easily worked, and stiffness, that it may retain the form given it by the

stiffer by compression—than brass, and it therefore makes a better ferrule; but brass is much cheaper. It, however, tarnishes and becomes dirty and repulsive in appearance so quickly, that some preventive method of finishing its surface is desirable.

The following receipt I give in "rule-of-thumb" fashion, as it was given to me. I habitually use it on my reels, have used it on all kinds of brass work for years, and confidently recommend it as excellent. No very extra finish of the surface is required.

Obtain from any druggist a wide-mouthed glass-stoppered bottle, such as chloral hydrate comes in. Have him put a pound of commercial nitric acid in this; then take it home, drop into it a ten-cent piece, put it in a warm place with the stopper loose, and wait till the silver is dissolved. This will take some days. Or, if you are on friendly terms with the druggist, he can dissolve the silver in a very few minutes by boiling it in a portion of the acid; but unless you are accustomed to chemical manipulation do not attempt this yourself. After the silver is dissolved, add a piece of copper wire about the size of an ordinary knitting-needle and about four inches

artificer under treatment something more severe than the exigencies of ordinary use. Either of these antagonistic qualities may readily be had at the expense of the other; the first by increasing the proportion of copper, or adding lead; the second by augmenting the quantity of nickle, or adding a small percentage of iron. In the one case we have an alloy which, though it works easily, cannot be given the required stiffness; in the other a compound excellent as far as rigidity is concerned, but unmanageable by the workman. Sixty parts of copper and twenty parts each of nickle and of zinc give an excellent color, and is probably the golden—or perhaps we should say in this case, the silver—mean. Less than eighteen per cent. of nickle no german-silver should contain that is to be used for ferrules. Iron and lead should be excluded.

long. This will soon disappear, and the solution is then ready for use. Clean all oil from the brass you wish to color, either with alcohol, ammonia, or brown soap; rinse well, and dry. Then secure it to a piece of copper wire, and the wire to a poker; dip the brass below the surface of the solution; withdraw it at once; give a slight shake within the bottle to avoid dripping, and heat in a fire as quickly as possible. If you have a good alcohol lamp, or one of those gas-burners which give a flame of the alcohol character, either will be better than a fire. Watch the piece carefully. It will first turn green, then a black speck or two will appear on the surface. This will speedily spread, until the whole surface is a dull dead black. The instant this change is complete, remove the brass from the source of heat. The change takes place at the temperature at which ordinary tinman's solder melts, and hotter than this no ferrule should ever be heated after it is soldered together, lest it anneal and lose its stiffness.

Two courses are then open. One is to cool at once with water, and then to scrub well with an old tooth-brush, holding the brass below the surface till clean; the other, less agreeable but giving a better result, is to allow the brass to cool naturally, and then to scrub the surface clean in the same manner, but dry. After being thus scrubbed, rub well with a dry cloth until all crock is removed. You will then have deposited a beautiful soft dead surface of black oxide of copper on your brass. It has a very attractive appearance, wears very well, and when the sharper edges after two or three seasons rub bright, you can, if you wish, re-black in the same way an indefinite number of times. The whole original expense will not exceed fifty cents, and the same solution may

be used again and again, till consumed by evaporation, and the little withdrawn upon the surface of the articles dipped therein. Any copper-alloy may be thus blackened.

THE HANDLE.

Use a handle with a ferrule immediately above it—or, better still, sunk into it—to receive the butt joint, the whole so arranged that while the handle remains still, the butt joint can be turned readily, so as to present the rings either beneath or on top of the rod. One handle will thus do for all single-handed fly-rods, heavy or light. You can cast with the rings underneath or above, while the reel always remains in its normal and only convenient position—that below the hand and under the handle—and you can change from one to the other as your fancy dictates. You can play your fish in the same way, changing the direction of the strain in an instant, and a dozen times on the same fish if you wish. Also in ordering or making a new rod, you will not only save the expense of a new handle and its furniture, but avoid the temptation to use strong language when you find your old reels will not fit. Again, your rod, even if of inferior material, will always remain straight and uniform in action.

Next to discarding the dowel pin, I believe this to be the most valuable improvement which can be applied to the fly-rod as at present made. I am aware this construction is not altogether new; but it is uncommon, while its great merit should make it universal. And even when employed, it is not unfrequently regarded either as a mere ornament or as a device to make possible a cheaper or lighter handle, while its most important function, the ability frequently to reverse the direction in which the

strain is brought upon the rod, is altogether ignored. Let any gentleman have one of his rods, especially if it has already taken a set, cut immediately above the handle, and a short, well-fitted simple ferrule inserted to reunite the divided portions, and then try it for one campaign.

Of course, to bring the rings above, but half a revolution of the butt joint in the handle-ferrule will be required, and the line will then wrap in a long spiral half way round the butt joint. Now if, in reversing the rings to underneath the rod, the precaution be taken always to reverse the motion as well, so that the line will then lead straight to the rings and not wrap all the way around the rod, it (the line) will be found to render equally well in either position of the rings. And unless the teachings of ten years' practical experience are delusive, the more particular he who tries it is in regard to his tackle, the more certain he is to adhere to it ever after.

Remember always to oil or tallow your ferrules, especially the handle-ferrule, and then wipe them dry before jointing your rod. You will then never be plagued by having the joints stick and refuse to separate, and your handle-ferrule will turn with smoothness and ease, as it should.

All the strain imposed on the rod is transferred to, and must be overcome at, the junction of the handle and butt joint. It is well, therefore, to give special attention to this point. If the ferrule to receive the butt is to be sunk into the handle—which is the method I prefer—so that only its mouth appears, it should run the whole length of the grasp. Otherwise, if you overstrike, and on a solid fish, there is danger of splitting the handle. With this construction nine and a half inches is long enough for this part. In this case, having bored the hole

to receive it, warm the ferrule, coat it with cement, and push it into place with a twisting motion. If the cement cools by contact with the interior of the handle, and inclines to stick, warm a round metal rod and insert it inside of the ferrule. This will re-melt the cement, and you will easily be able to enter the ferrule the remaining distance.



Fig. 43.



Fig. 44.

If the ferrule is to project outside of the handle, it should not exceed two and a half inches in length. The pin on which it sets, and which unites it to the handle, should be the strongest part of the rod. Unless the material of which the handle is composed is in itself very strong, a piece of ash, or some wood having the required strength, should be inserted to fill a hole the whole length of the grasp, and glued in place, leaving enough projecting to place the ferrule on. If this method is followed, any light wood that suits the fancy will answer for a handle—red cedar for instance, or sumach, either of which finishes to look well. Or bird's-eye maple may be used, and the projection be formed with the handle, and of the same material, thus dispensing with the labor of boring, etc. Curly maple makes a handsomer job, but it is not so strong. In this case the handle should be ten inches long, measured from the edge of the ferrule, where it

comes in contact with the handle, to the extreme end of the butt cap. Make that portion of the handle devoted to the reel, and which will of course be below the hand, as short as you can. It should be equal to the sum of lengths of the butt cap, that portion of your reel by which it is attached to the handle (the reel plate), and your two reel bands. Or you may procure from the same source from which you would order your other material, a hollow metal reel seat, which includes in itself butt cap and all bands, at about double cost. Then to fit the lower end of your handle to it, and cement it on, is all that is necessary.

It is usually recommended to place the reel as near the butt end of the handle as possible, since then the weight acts more efficiently to counterpoise, and thus diminish the apparent weight of the rod. Therefore, one end of the reel plate is inserted directly under the edge of the butt cap itself, and one reel band, sliding from above, confines the other extremity. This arrangement dispenses with one reel band. It does very well for small fish; but where those are expected which will give from five to thirty minutes' play, no man can stand the fatigue of so protracted a struggle at arm's-length. The butt of the rod is then placed against the body, and when the reel handle is manipulated, a blow in the stomach is received at each revolution. Influenced by this annoyance, I place a fixed band immediately below the grasp, under which I insert one end of the reel plate. The sliding band, used to confine the other end of the reel plate, is placed between this and the butt cap.

In forming your reel seat, in case you do not use that of metal mentioned above, do not endeavor to shape out a depression to fit, since to do this neatly requires time

and care, and it is difficult to finish; but simply file the place off flat, which will answer every purpose, finish easily, and look quite as well if not better. Of course care must be used and frequent trial of the fit, that you do not take off too much.

It is better to have your handle turned, than try to make it yourself; though you can do so, governing yourself by the principles already given for making your joints. In the former case, the hole to receive the handle ferrule or its support should be bored first, and the handle turned on it as a centre, that it may surely coincide with the axis of the handle.

After the handle is shaped, and sand-papered nicely, wet it and let it dry. This will roughen it—"raise the grain," as it is termed. Now take the finest sand-paper you have, not coarser than "0," and smooth it again. Repeat this three or four times, using the same piece of sand-paper. Then when dry, varnish with shellac dissolved in alcohol; giving it three or four coats, applied at about three-hour intervals. When this is perfectly hard, rub it down to the bare wood with powdered pumice-stone and raw linseed-oil, applied with a rag. This will stuff the grain. Then apply three or four more coats of the same, and rub it down in the same manner till all brush-marks are removed, and it is perfectly smooth. Then polish, first with powdered rotten-stone and the same oil, and afterwards with dry rotten-stone. This will give a nice durable finish.

VARNISHING.

The next step in making a wooden rod is varnishing; and for this purpose shellac is the worst, and coach-body varnish the best. The object sought is to cover the rod with a coating that will be absolutely water-proof, will

not crack; and should it receive a blow, will dent and not chip out. The former gives an easy, speedy, and poor result; the latter is more tedious, but once on is a permanent protection. Rod-makers complain of coach-body varnish that it is a very tedious drier, but this is mainly because they do not know how to use it. Hung up in a room, a thick coat may not be dry enough to handle in two weeks; but if you will be governed by the following directions, your patience will not be subject to anything like such a tax.

First fit a plug provided with a wire hook to each of your ferrules, to hang the joint up by when drying. Then apply your varnish in as thin a coat as you can. This is one of the secrets of success—as thin a coat as you can apply. To aid in this, thin the varnish with spirits of turpentine until it works freely, and all brush-marks flow together readily and soon after application. A stiffish brush must be used. Now, if the weather permit, hang the varnished work out in the sun and wind—the wind especially. It is this that hardens varnish, and a coat that will remain “tacky” for a week in-doors, will, thus treated, become perfectly hard in twelve hours. Apply no second coat till the first is hard, and remember to lay it as thinly as you can, and you will have no trouble. Apply four or five coats.

When these are perfectly hard, rub down with powdered pumice-stone and water, till the surface is smooth. Rub the work frequently with a damp sponge to clean the surface, that you may inspect your progress, lest you cut through the varnish altogether, and be compelled to begin again. When this is finished, rub well with powdered rotten-stone and water, and then polish with dry rotten-stone. Wash again to remove any that may ad-

here, and when dry rub briskly with buckskin or a piece of silk. This will give a beautiful and durable finish. I use "Valentine's Quick Levelling Varnish." In good drying weather, when treated as directed, a coat may be applied every twenty-four hours.

It must be remembered that all wood is hygroscopic—*i.e.*, absorbs moisture from the atmosphere; therefore apply the first coat of varnish only after two or three days of dry weather. An unvarnished joint which is perfect in dry weather, will be found to take a bad set after some days of rain, unless it has been where the air is artificially dried.

WRAPPING ON THE RINGS.

This is the next step in order. Assuming that you have never either done this yourself or seen it done, the first requisite is the mastery of the "invisible knot." In the Chapter on Repairs you will find illustrated directions for tying this. Another method is also given of accomplishing the same result—the fastening off of the silk wrappings. But the acquisition of the true "invisible knot" is strongly recommended, since it may be applied in many cases where the other cannot. I believe it one of the most important and useful additions that the angler can make to his general knowledge of the art; and this not only on account of the benefit to your individual self, but because it will enable you to help many a brother angler, much your senior in experience and skill, out of a scrape, and thus requite him for advice and instruction. The value of aid from the experienced to the beginner, when given at the water's side and rod in hand, cannot be exaggerated, and you should lose no opportunity to avail yourself of such assistance.

Therefore, study the Chapter on Repairs carefully, trying each step practically until it is perfectly familiar. Supposing this to have been done, and that you can now not only wrap on the silk but fasten it off as well, let us proceed to put the rings on your new rod.

First as to the sizes to be used. That the rings should be large is one of the traditions of fly-fishing. While

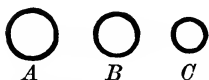

Fig. 45.—*A* for butt, *B* for middle joint, *C* for tips.

this may have been, doubtless was, advisable when a rough horse-hair, or horse-hair and silk line was employed, it is no longer so, since an enamelled water-proofed line with its polished surface, is practically

the only thing used. The sizes I prefer are here shown.

They are known to the trade as Nos. $4\frac{1}{2}$, 4, and $3\frac{1}{2}$, in the order given, *A* being $4\frac{1}{2}$.

Be liberal in the use of rings. If you seize a piece of wood of uniform strength by the ends, and break it, it does not give way where it is grasped, but at some intermediate point. And thus with a fly-rod. By being liberal in the matter of rings you diffuse the strain, so that though its aggregate be great, yet at no place will it reach the breaking point.

Place a ring close to each ferrule and its mate—*i.e.*, so that when the rod is jointed a ring will be both above and below the unyielding metal; for thus, for reasons before stated or implied, you lessen the danger of accident at those points.

I place two rings on the butt joint, one at the ferrule uniting it to the middle joint, and one about a foot below. Seven rings, or even eight, if the joint is very long and the butt correspondingly short, I allow for the middle joint, and seven for the tip. These rings should be

so spaced, that the intervals between them constantly and uniformly diminish from the butt to the tip.

Now unite your rod and try it in every position, turning the several joints till you find that adjustment with which the action is best. You will find it in that position in which the rod is most flexible, for all flexible bodies tend to bend in the line of least resistance. If you attempt to force it to bend otherwise by adjustment of the rings, a compromise between the two, varying in proportion at different parts of the rod, will result, and the action of the rod will not be fair and true. A glance will tell you whether the ferrules coincide with the axis of the rod. If they do not, strive to find some adjustment that will permit the crook to be set so that it inclines upward. Having arranged this, look your rod carefully over, and if you find any place where the grain appears to run out to the surface, try to bring this on the side, and not on the upper or under surface of the rod; for this indicates the natural line of cleavage, or tendency to split. The cohesion between the fibres of the wood here is much less than their tenacity; or in other words, it would require far less force to split the fibres apart than to tear them asunder. When the rod is bent, the upper surface, since it is the longer part of the curve, must stretch, and the lower, for an analogous reason, must condense somewhat. Under a heavy strain, if the part in question were placed above or below, the fibres would be apt to separate and slide over one another on this line, or in other words split; whereas on the sides the tendency to this is less, and the fibre must rather rupture before the rod can give way.

Having carefully studied all these points, avoiding all the evils you can, and compromising with judgment

between those you cannot avoid, make a scratch with a pin on the varnish of each joint, to indicate the side upon which the rings are to be placed. Do not trust to a lead-pencil mark, since it is too much trouble to find this place to risk losing it; and neither on metal nor varnish will such a mark bear much handling. Also make the scratch close to the ferrules, where they will eventually be covered by wrappings, so as not to disfigure the rod. Then with a lead-pencil mark the point where each wrapping is to begin.

The next step is to prepare your "keepers;" for those sold are not nearly as good, and are much more difficult to manage, than those you can make. Procure a piece of sheet-brass or german-silver about the thickness of a sheet of good writing-paper. For this you can write to Frasse & Co., No. 95, or to Montgomery & Co., No. 105, both in Fulton Street, New York City, who can deliver it by mail. Twenty-five cents' worth, exclusive of post charges, will last for a long time. Cut with scissors a strip from one edge $\frac{1}{16}$ of an inch wide. Heat it red hot and let it cool; this will anneal it, and make it manageable. Now cut off strips at right angles to the length and about this width—

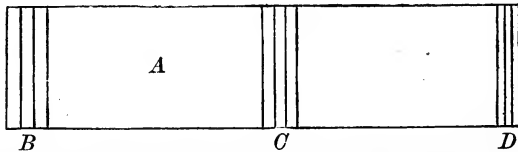

Fig. 46.—*A*, annealed strip of metal; *B*, width-keeper for butt; *C*, same for middle joint; *D*, same for tip.

The illustration gives the general idea; but you should vary the width a little, that as the diameter of the rod de-

creases, the width of your keeper may correspondingly diminish. Next point all your keepers thus with scissors. Next lay each point on a piece of iron, and thin it with a small hammer to obtain the result shown in an exaggerated manner in the following figure, in which an edge view of

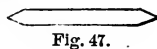

Fig. 47.

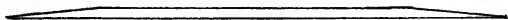

Fig. 48.

a keeper so treated is shown. When this is complete you are prepared to attach the rings.

Use such colored silk as you may fancy—scarlet is most usual—but of the very best sewing-machine quality. Nothing is more disgusting than to encounter a knot or other imperfection when a winding is almost complete, and thus be forced to undo your work and begin again. The size indicated by the letter *A* is best for butts and middle joints; that known as *O* for tips.

There are three ways of treating the silk, each having its good and its bad features. The first materially lightens the labor of winding, and the silk retains its color fairly well, but it does not have the hold on the rod of the others.

Take an empty spool, place it on the winding attachment of a sewing-machine, and reel the silk off from the spool on which it came on to the empty spool, drawing it through a piece of white beeswax while so doing. When this is completed, re-wind the silk on to its original spool in the same manner, waxing it a second time. It may require a 100-yard spool of *A* and a 50-yard spool of *O* silk to a rod; and though some surplus will usually remain, it will not be safe to begin with less, for fear a new

spool might be of different color, or assume a different tint under the wax and varnish.

Having wound on about four or five turns, insert one point of the keeper under these, far enough not to drop out when the joint is inverted. This the thinness of the point of the keeper will enable you easily to do. Then

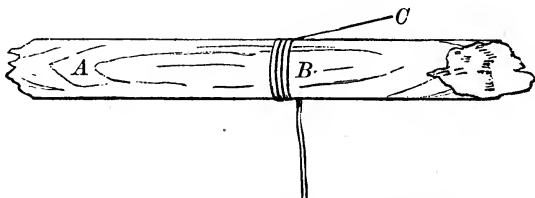

Fig. 49.—A, joint; B, winding; C, keeper.

wind it on tightly nearly to its middle, with care that each turn of the silk lies close to, and by no means overlaps, its neighbor. Then holding the turns already made in place with the left thumb, bend the uncovered end of the keeper upward, thus:

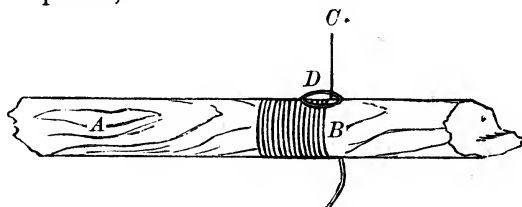

Fig. 50.—A, joint; B, winding; C, keeper; D, ring.

and wind where the ring is to be placed. Having covered this (about one-eighth of an inch, a little more or less according to the size of the ring), drop on the ring, holding it with the left thumb in the position shown at

D in the preceding figure. Then bend the free end of the keeper down on to the joint, and with the back of a scissors or knife apply a sharp pressure close to the ring, and this will be the result:

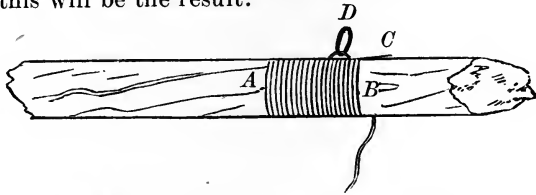

Fig. 51.—*A*, joint; *B*, winding; *C*, keeper; *D*, ring.

Then finish the winding, and fasten it off. Next, with the handle of an old tooth-brush, or other similar hard and smooth substance, polish the winding all over. This will smooth down all fuzziness and burnish each thread into close contact with its neighbor. If this is carefully done, it is wonderful how well a rather botchy job can be made to look, unless knots or overlaps are present. Now, and not till now, proceed to cut off the projecting end of the silk. First give it a pull to be sure the burnishing process has not loosened the fastening; then straining it tightly towards the left, cut it off as close as you can with a sharp knife. Burnish down the little projection left by the end, if any, and proceed to the next ring. When all the windings are finished, brush them over with a single coat of shellac. Before the shellac has time to set, oil the end of the forefinger slightly that the shellac may not adhere to it, and smooth the varnish and any remaining fuzziness down by rubbing the winding in the direction in which the thread runs. This, I believe, is the usual method of the professional rod-maker, though I never saw one wind a rod.

In the other methods the winding, and the ring, and its keeper are all manipulated in the same way, but the burnishing is omitted. The first of these is to wind with silk directly from the spool without waxing, and when the joint is finished to varnish with the same varnish as the rod. The silk, thus swollen by the varnish it absorbs, becomes very tight, and is pasted down and adheres to the rod itself; but every roughness of the silk remains and is increased, so, though it makes the most durable and efficient job, it looks so badly as to outweigh its advantages.

The remaining method is to wind without waxing the silk or burnishing, then to wet the wrapping with hot water, and lastly to brush it over with thin glue. The silk must first be wet, or the glue will not penetrate and bind the silk to the wood as it should. This, as intimated, fastens the silk securely to the wood, and gives it almost the firmness of a metal band. The original color of the silk, too, is preserved far better than by any other method, and every projecting fibre is glued down smoothly. It also stuffs the silk so that at least two less coats of varnish are required to finish. Were it not for the difficulty of handling the slippery silk without neutralizing that property by the aid of the wax, this would be the best method. But taking all things into consideration, it is advisable to begin with the first. When you make a split-bamboo then resort to this.

VARNISHING THE WRAPPINGS.

This is the concluding step. Use the same varnish recommended for the rod, though it may be thinned even a little more to advantage, at least for the initiatory coat. First, with a small chisel-pointed stick, insert a drop of

varnish under the rings on each side. This is important, lest water find its way under the silk and turn it white, to the ruin of its appearance. Then apply the varnish to the wrapping so treated with a small, flat, artist's bristle brush, being careful not to run over on to the polished joint. Lay on the varnish in a thin coat, and by no means so that it will run. If you have applied an excess, wipe your brush dry with a piece of paper, and take it up therewith. Treat each winding in succession. Continue this process, drying as when varnishing the rod itself, until you have a smooth solid surface. Your rod is then complete, and the pleasure its use will afford over and above even a better one, which is the handiwork of another, will be at least fifty per cent.

TIPS.

Already the importance of having this part as light as possible, because of its distance from the hand and consequent leverage, has been dwelt on. But it must also be elastic and prompt in action to pick the fly sharply off the water and send it behind the caster without effort, since otherwise nice casting, if not out of the question, is at all events much more difficult.

I know of but two materials at all suitable for tips—lancewood and split-bamboo.* They are related in order of merit, the former to the latter, as the silver dollar of our fathers is related to a five-dollar gold-piece. Many amateur rod-makers stand aghast at the idea of working split-bamboo, and to make a good six-strip hexagonal rod does require considerable skill and judgment. But to

* Some light-colored greenheart equals lancewood for this purpose; also see Chapter on Rod Material, under head of "Dagame."

make a four-strip split-bamboo tip is not a difficult job, and one even poorly made is better than one of the best lancewood. I strongly advise you to try it if it is proposed to make rod-making a standing amusement. In this case it is better to make, say, half a dozen, one right after the other, for if you do botch the first and second, you will by that time have acquired the necessary skill, and will have your hand in, as the saying is. The others will then turn out all right. You will then, too, have a stock of tips available for any rods you may thereafter make.

For this purpose you will select the butt ends of the Calcutta bamboo, that distinguished from other kinds by the charred markings on its yellow exterior. Many saw their cane into strips, but I believe splitting with an ordinary table-knife the better method. As you examine the cane, you will notice on opposite sides and at alternate joints, depressions where the leaf grew. Through the middle of these your first split should be made, and the cane be thus halved; then quarter it; next, holding each quarter in a vise, remove the remains of the inner divisions (which in the cane separate the joints one from the other) with a mallet and $\frac{3}{4}$ -inch gouge.

To save repetition, you are referred to the remarks on making six-strip bamboo rods for such information as I am able to give to aid in the discrimination of fit from unfit material; but it may be remarked that a tip does not absolutely require as good stuff as a butt or middle joint, though of course it should be had, if possible.

Next split your four quarters into strips about one-half wider than the inner diameter of the cap of your tip ferrule, rejecting the strips in which the eyes left by the leaves occur. Or, if the bamboo is excellent and the distance between the joints considerable, you may cut

out these knots, and splice on a piece to be the smaller end of the tip. The process is explained in the Chapter on Repairs. This splice should be at least three inches long—should be glued, and made with care to insure a perfect fit, and that the rind on one part meets that on the other. The rind or exterior cuticle should be continuous on the longer part of the tip, thus :

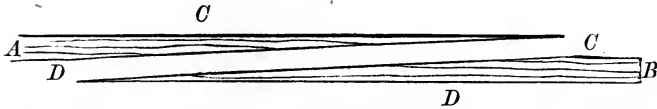

Fig. 52.—A, longer part of tip; B, shorter part of same; C, rind side; D, pith side.

This splice should not exceed eighteen inches at most from the small end of the tip, and must be wrapped with silk its whole length when the tip is finished. This is only advisable when your bamboo is really excellent in quality, and you feel that you cannot afford to throw aside any that can by possibility be made available. Make your first effort with your poorest material, reserving the better till you have acquired a little experience.

Having split out four good strips, level off the knots on the inside with a rasp, and on the outside with a file. Then plane off the edges, trying to get them as square with the rind side as possible, and thus approximate, but only approximate, to your taper. The subsequent steps will be facilitated, if all the strips

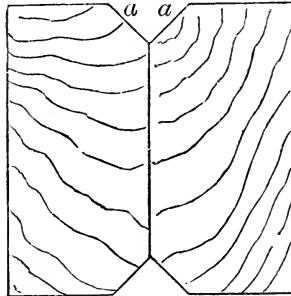

Fig. 53.

have nearly a uniform taper and width. You will now require a couple of strips of pine, say one and a quarter inches square, with right angled triangular grooves running the whole length, of which the preceding illustration is a cross-section.

A carpenter can plane these out for you, in which case have a groove in each surface, or you can build it up by uniting two pieces of wood, on the edge of each of which one-half of the groove is formed. It is essential that the angle at the bottom of this groove be a right angle, and that the sides, *aa*, be equal; for on the accuracy of this depends the accuracy of your result. The former you can test with the corner of your square; the latter by your eye. When this is arranged to your satisfaction, lay one bamboo strip in the groove in the position indicated, and plane off to the dotted line in Fig. 54.

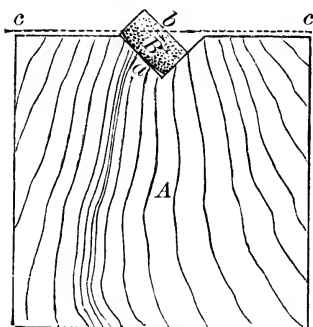

Fig. 54.

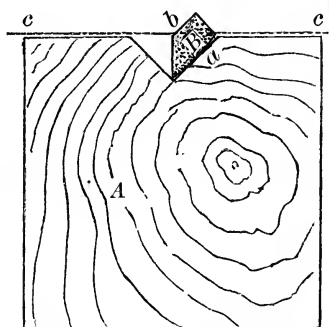

Fig. 55.

A, grooved wooden strip; B, bamboo strip; *a*, rind side, and *b*, pith side of latter; *cc*, the dotted line.

Now change the bamboo, so as to plane the other edge as shown in Fig. 55, like letters indicating like parts.

Treat each strip thus in turn, when you should have the result, shown by this cross-section, the letters still indicating the same parts. The angle at d should be a true right angle, to be tested by your square. This would be easily obtained were the rind side, a (which you must by no means touch with the plane), flat instead of rounding.

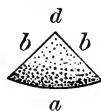

Fig. 56.



Fig. 57.

If much out, you must true this angle up by drawing it through a V-shaped scraping notch filed in one of your steel scraps. Not only must this be a right angle, but the apex must coincide with the middle of the strip—not thus, in which the angle, d , is clearly off to one side, as shown by the lack of equality in the sides, $b b$. This will probably bother you more than the other, but your scraping notch will easily rectify this. It was to allow for this scraping that the taper was but approximated to, rather than completed, when planing the edges of the strip.

Now number the strips with a lead-pencil on the rind sides, in the order you intend them to go. Then place two adjacent strips together in the groove, thus: $a a$ being the rind as before—that is, with the rind side of each strip in contact with the sides of the groove. It may be said once for all, that this is always and invariably to be the position of the rind side when applying the plane to the strips.

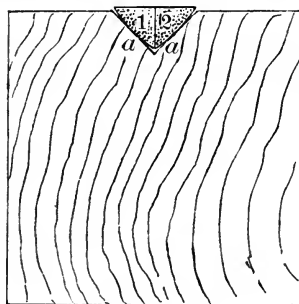

Fig. 58.

Now pass your plane over

the exposed surface twice, or at most three times. Then change the relative position of the strips, placing 1 where 2 was. The pith sides which were in contact will now be exposed, and the surfaces you planed before will be in contact. Take off two or three shavings, and then return the strips to their original position, and repeat. Continue this until the taper and size are very nearly but not quite reached.

Both pairs having been thus treated, melt some fresh glue, closely following therein the directions in the Chapter on Repairs. The glue you so prepare you may re-melt for future use three times, and not more. Then wash your glue-pot out clean, and the next time start fresh. Glass or china makes the best glue-pot, but any small tin vessel—an old spice-box for example—will answer till the tin rusts through. In the latter case solder on three copper-wire legs about one-third of an inch long, and punch a couple of holes near the rim that you may attach a wire handle, like that usually used on pails. To succeed with glue, not only must it be fresh, but in melting it must not be heated above the boiling-point of water. Merely placing the glue-pot in another vessel containing water, and applying heat to the latter is not sufficient to insure this, since the heat may be conducted directly through the bottom of one to the bottom of the other. In the neglect of these seemingly trifling precautions will be found the reason why a violin-maker will unite to last for centuries the many parts of his complicated structure, and this with glue alone, and without a single nail or screw, while another cannot thus join anything to hold even for a few days. Therefore do not fail to raise your glue-pot above the bottom of your water-bath, so the fluid may surround it on all sides.

But we have made undue haste. Before the glue stage we must see that we have a glue joint, that is, a contact between the surfaces to be united, so close that the place of union is scarcely perceptible. To accomplish this your plane-blade must have had frequent intercourse with the oil-stone, for in this material more than any other nothing but ruin can be accomplished with a dull tool. But no matter how careful you may have been in this, the fibre will be more or less roughened at the knots. Smooth these by "draw-filing" with your "mill-saw" file, holding each strip singly and by itself in the groove. In ordinary filing the file is actuated in the direction of its length; but this is not the case in "draw-filing." To do the latter successfully, hold the file loosely in the hand and close to the blade; extend the first finger so as to bear upon the upper surface of the blade, and apply that part of the under surface which is beneath the finger to the work. Should you grasp the file firmly, and rely upon the guidance of your hand alone to direct the file, you would probably round the work more or less, thereby impairing rather than improving your glue joint. But by following the directions, if the file is not properly applied at first, it instantly adapts itself to the surface beneath; and this, if flat at first, as it will be from the operation of the plane, remains flat.

Now move your file to and fro, but *sideways* instead of in the direction of its length. It is important that this be well understood, because of its frequent use in rod-making. Whenever inequalities occur to which it is inconvenient to apply the plane, as for example, should you so mismanage your rounding scraper as to form local ridges, these are removed in this manner.

Having thus removed any local roughness caused by

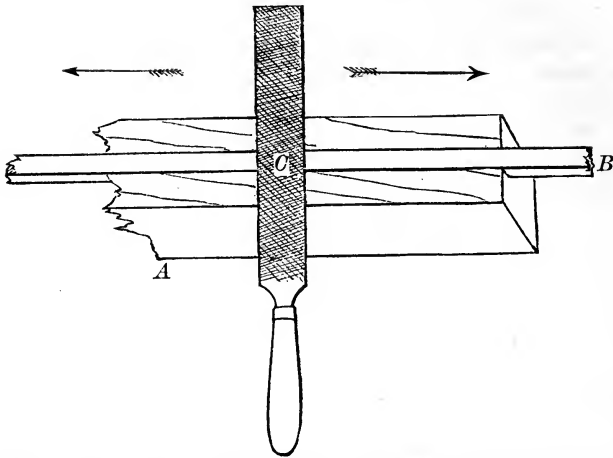

Fig. 59.—A, grooved strip; B, bamboo strip; C, file; arrows show direction of motion.

the plane, make a loop in the end of a seven-foot piece of strong linen thread such as is used in carpet-sewing; pass the loop over a hook secured in any convenient manner, place together in their proper position two of the bamboo strips which have been planed as a pair, and fasten them temporarily together by winding the thread spirally from the larger to the smaller end. To do this, wind the end of the thread two or three times around the strips until caught, and in such a manner that it leads from the under side towards the hook; then putting a strain on it, wind it on spirally by turning the strips from you. Having wound it, with the turns about half an inch apart, to the small end, fasten off with a couple of half hitches. Then examine the glue joint carefully that it is a perfect fit; and this it should be

everywhere, except where the plane has torn up the grain, if you have brought the bamboo to a knife edge. Mark any defective places, and draw-file them till the contact is perfect. Treat the other pair in the same way; then tie all four together in their proper order.

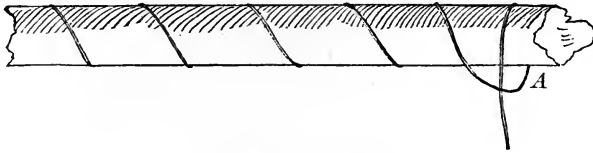

Fig. 60.—A, half hitch.

Scrutinize the accuracy of the joints carefully, and especially see that they so unite as to form a solid whole, for the outer edges may meet perfectly, while the inner are separated by an interval. If you are satisfied that the union of all four is perfect to the centre, you may proceed to finish your taper (which up to this point you have only approximated to), and glue all four together at once; but if you are not positive as to this, then glue each pair together separately, winding them with strong thread as before. In either case apply the glue to each surface, and be sure it is not too thick lest it chill and gelatinize before you can complete the winding, in which case the glue will not stick. Having completed the gluing, heat the entire tip over a gas flame or chimney of a kerosene lamp, to re-melt any chilled glue, should, by any chance, such be present. Then with a second thread re-wind the tip in the opposite direction. This will be correctly done if the two threads so cross each other as to outline diamond-shaped patterns upon the surface of the bamboo; for

during the first winding the tip will probably have become twisted on its own axis. The second winding will tend to twist it in the opposite direction, and thus neutralize and remedy the defect. This treatment may be resorted to with profit, when uniting the parts of any split-bamboo joint, no matter of how many strands it may be made up.

Now, to return to the case in which it was deemed advisable to glue the tip in pairs. Assuming them to have been so glued and to have dried, file out from the angle near the larger end a concave place to receive the point of your drill—thus :

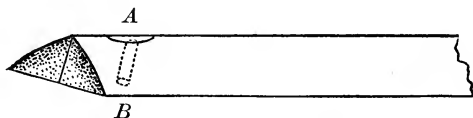

Fig. 61.—A, concavity; B, hole.

Then wind twine tightly on both sides of the concavity, that your drill may not split the glue joint apart, and drill the hole, B. Insert a brass pin in the bottom of one of the grooves and plane off the flat pith surface, until your size and taper are both correct. Treat both halves in this manner, glue them together as before directed, and, when dry, your tip is ready to finish. By this latter method solidity is assured, but the tip is not so apt to turn out a perfect square as when all the four quarters are united in one operation. If, however, you accept and act on the sound principle that utility is paramount to beauty, you will uniformly adopt it in every case in which the perfect solidity of the union of the four strips is suspected.

To finish, draw-file the surface lightly to remove the

glue ; then draw - file the edges to form an octagon, and thus leave it ; or apply your rounding scraper to make it circular, as you may prefer. Either will answer. Next sand-paper, after which fasten on your ferrule and tip-ring. Then wind with *O* silk, wrapping at first four, and afterwards three, narrow windings at equal distances between each ring. Lastly varnish, finishing with a coat or two of what is known in the trade as "flowing varnish," and dry as heretofore directed.

Except where otherwise specified, you will be obliged to hold the strips in the groove, when planing, with your left hand. Should you set your plane too rank, the strip may slide under your hold ; and, since no glue joint can be had without bringing the strips to a knife edge, danger of a nasty cut is risked. Therefore, hold the strip in place by pressing upon it with a piece of leather or rubber.

Bamboo is very severe on a cutting edge, yet no good result can be had unless that edge is keen. Therefore, sharpen your plane frequently, giving particular attention to this when near the finish of any strip. Otherwise, though it may cut smoothly between the knots, it is apt to tear the fibre at those points, and give trouble. This is also much more likely to occur if the strips are sawed, instead of split out of the cane.

It is plain that this method is equally applicable to the construction of a four-strip butt and middle joint, but in this case use a wooden handle, since the formation of this from the butt strips themselves will augment the difficulties, without any corresponding advantage.

HEXAGONAL SPLIT-BAMBOO RODS.

This is the top notch of the art.

Up to the present writing I have never seen a profes-

sional rod-maker at work on a rod of this kind, nor have I ever heard or read any description of the method by them employed, except in such vague and general terms as to be of little value as a practical guide. The following process is one of some fifteen or twenty I have elaborated, and though it may excite a smile from the professional when compared with his simpler and perhaps more certain method, still I can say one thing with confidence for it—it will, if carefully followed, give the desired result.

But more difficult than to make the rod, is it to find material of a quality fit for the purpose. For such a rod of poor material, even though the workmanship be unexceptionable, recalls the remark of Cicero concerning Bibulus—“He is a man [it is a rod] upon whom [which] no one but a philosopher can look without a groan.”

Good bamboo is very rare, as has been before intimated. The Calcutta variety is that almost universally used in rod-making—that distinguished by the charred marks on its exterior.

In selecting it choose the heaviest canes. Examine them narrowly for worm holes, particularly at the knots, pounding with the butt of the cane, when in an approximately horizontal position, upon the floor, to see if any yellow worm-dust shakes out. The effect which these pests produce on the cane is singular. They seem to feed on the pithy interior only, perforating the rind comparatively but seldom. But where they have crossed the fibre, though the exterior is apparently unaffected, still the strength at that point is absolutely destroyed. No strip so marked, even at but one single point, must ever be introduced into a rod, for there it has not the strength of the weakest pine. Make this a matter of principle at

the outset, for you will often be tempted to use a piece excellent in all other respects, except that one little transverse groove on its inner surface. But you must resist the temptation, or you sacrifice the one merit which amateur work should always have—honesty.

Next examine the cane, to see how much available material it contains. The opposite sides, marked at the knots by the eyes where the leaves once grew, are always worthless. Therefore, direct your attention to the intermediate portions. Scrutinize the burns carefully, for if these are so deep as to destroy the cuticle, the strength has been destroyed as well. One deep burn may utterly ruin a cane otherwise excellent. Next see that it is fairly straight, and the knots not too protuberant. Then look to the color of the cuticle. A boxwood yellow is a good sign, while a uniform, or partly uniform, bluish cast of color is a bad indication. Neither of these color rules are, however, without frequent exception, so if everything else seems propitious, you may risk a defect in this.

I am aware that a bluish color is usually regarded as fatal, while a bright straw-colored interior is considered an equally sure indication of merit; and I have reason to believe that the conscientious maker not unfrequently rejects or accepts his material on these characteristics alone—exterior defects of course excepted. During the last fifteen years I have split very many canes, and never without applying the tests described in the following paragraph. One of the strongest and most elastic bamboos I ever saw was decidedly off color. While running a rapid stream in a canoe last September, I was thrown backward from my seat by a tree which had fallen across the stream. We thought we could squeeze under it, and thus save the

trouble of hauling the canoe over the obstruction. We discovered our mistake only when fully committed to abide the result. My rod, a hexagonal split-bamboo nine feet and eleven inches long, and between seven and eight ounces in weight, and of my own make, lay upon the thwarts of the canoe, so that it might not become entangled in the overhanging bushes and trees, under which the tortuous channel frequently compelled us to take our way. I fell with the whole weight of my body upon the middle joint, striking it between the thwarts, there some three feet apart, and where the bamboo had nothing but its own strength to oppose to the shock. But two of the six strands gave way, and those splintered in such a fashion that they were readily returned to position, and, with the aid of a little glue, the joint was restored to its pristine strength and usefulness. Such is the strength of this material when really first-class. Yet the bamboo of which this joint was composed was quite blue in color.

I theorize in regard to this matter in the following manner, and deduce the following conclusion: A cane may discolor from a fermentation, or analogous change, in its own constituent elements; or from contact with a discolored fluid. If the cane is free from sap, it is but a bundle of capillary tubes, and the immersion of one end of these tubes in such a fluid would cause them to be filled by it, in accordance with well-known natural laws. In the first case the change in color would indicate a change in structure, while in the second it would but show the presence of foreign coloring matter, not necessarily more injurious than the dust upon a shelf is to the strength of that shelf. My conclusion, based upon this theory, and so amply confirmed by actual experiment that I assert it with as much confidence as any other

declaration in this book, is that the tests described in the last paragraph below are the only sure guide to a correct conclusion as to the quality of bamboo, and that they should never be omitted. I desire to be quite emphatic in the expression of this opinion, that the beginner may take it to heart, and make it a cardinal principle in split-bamboo rod-making.

Again and again have gentlemen selected bamboo for me, who insisted and believed that they could discriminate at a glance between the fit and the unfit. This I knew I could not do. The event has invariably shown that the utmost value which could be given to the choice was a balance of probability in favor of its correctness, and by no means the certainty of excellence which should always precede the expenditure of the skill and labor required in this work. Remember it is just as difficult to make a rod from poor stuff as good, and that the first, no matter how exquisite the workmanship, will be as inferior, practically, to the poorest wooden rod, as a split-bamboo of first-class cane is superior to the best that can be constructed from any other known material.

Five feet from the butt end will be all you can use, unless the cane is unusually large. Next split with a table-knife, as directed under "Tips," and get out the strips which include the "eyes" from which the leaf grew, and which, though worthless for rod-making, are invaluable for testing purposes. First bend them with the rind concave, and thus determine how elastic it is. Most bamboo will, however, respond to this test pretty well. Then bend them with the rind convex. Here they will "take a set"—*i. e.*, not recover entirely. If this is considerable, more seasoning is required, and the cane is not yet fit to put in a rod. If it is slight, and

the strip feels prompt to recover, and sprightly, it is all right so far. Now test the strength by breaking both strips at short intervals throughout their length. If they uniformly break gradually and with difficulty, and with a splintering and broom-like fracture, the bamboo is good; but if, as will more frequently be the case, they break short off, and the bamboo splinters but little, they are worthless. Any cane which has strength, but is deficient in elasticity, tie together with the interior exposed to the air, label it "strong but not elastic," and store it away till further seasoning cures this defect; but if wanting in strength, saw it up for kindling-wood, and be rid of it.

Now let us assume that six good strips have been obtained. Arrange them side by side, so that no knot is abreast of another—"slip the joints" as some term it—and cut off to the proper length, or an inch in excess of that. File off the knots, and square up the edges as directed in the preceding section, approximating closely to the taper and width. Now a little tool-making is in order.

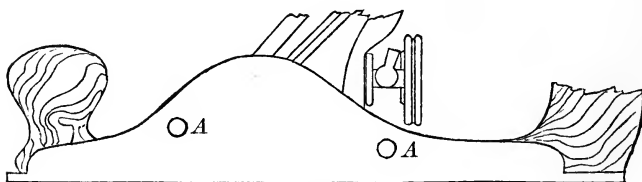

Fig. 62.

Let the diagram above represent your smaller "Bailey" plane. Drill two holes through the sides (*A A*), so as to admit the passage of a $\frac{5}{8}$ -inch round-headed wood-screw, and this so that the interior construction

of the plane will permit the screw to be inserted from within outward—*i. e.*, so the head is inside, and the point appears on the exterior of the plane. It will be a close shave at the handle end, but it is possible. Any one who has a lathe will do this for you in five minutes.

Now construct the following diagram, or as much of it as may be considered necessary to obtain the result indicated hereafter:

A represents a $1\frac{1}{4}$ inch strip of pine, four feet long; *B* your Bailey plane, of which *C* is the bottom and *D D* the sides; *E* an equilateral triangle, which, since all sides are equal, must also have equal angles of sixty degrees each, and this is the angle you re-

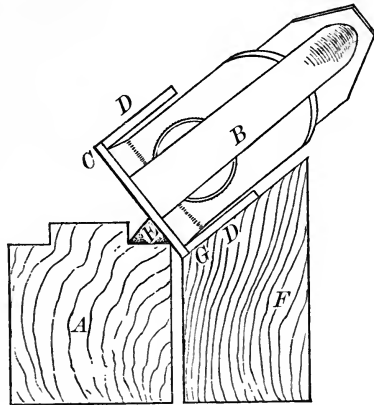

Fig. 63.

H

quire; *F* an end sectional view of a block of wood, to be screwed to the side of your plane; and the object of the diagram is to enable you to so set a bevel square, or to so cut a piece of thin sheet metal, as to guide you in obtaining the angle, *G*, on such a block.

It is clear that if a piece of bamboo is rigidly confined in the rabbet of the strip, *A*, and your plane is applied with a block (*F*), so formed, attached, that if the bottom, *H*, of that block rests on your planing board while the plane is actuated, it must produce the proper angle of six-

ty degrees. Unfortunately these conditions are difficult to produce exactly in practice, for the rind side of the bamboo, which rests on the bottom of the rabbet, and which must in this, as in all the steps of rod-making with this material, by no means be touched with the plane, is not flat but rounding, and is consequently inclined to roll somewhat and thus vary the angle. Therefore we must devise some means of holding the bamboo during this process as rigidly as possible.

Having procured two or three of the rabbeted strips, *A*, screw two cross-pieces to the upper surface, about twenty-four inches apart—as shown in the following plan and sectional views (Figs. 64 and 65), in which *A*

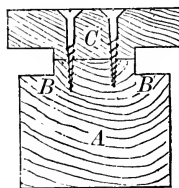

Fig. 64.

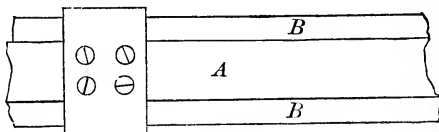

Fig. 65.

represents the strip, *BB* the rabbets, and *C* one of the cross-pieces :

If then the bamboo strip is placed in position, and soft wood wedges be inserted between its upper surface and the cross-pieces, it will be held as firmly as one can well secure it. Then apply the plane as directed, and bevel off as much as you can of the bamboo lying between the cross-pieces, say about eighteen inches. Bring the bevel almost, but not quite, to a knife edge with the rind side. Then shift the bamboo, so as to present a fresh

surface between the cross-pieces, proceed as before, and repeat this until you have one side of the strip bevelled its whole length. Then turn the bamboo strip end for end, and finish the other side in the same manner. This should be the result (Fig. 66), *A* being the rind side; *B* the apex of the angle formed by the two pith sides, *C C*.



Now test your angle, *B*, with a notch filed in a piece of brass with an ordinary triangular saw-file—that variety known by the astonishing name of a “three-square” file is meant. This file having three equal sides, must have three equal angles, and consequently the angle we wish—viz., sixty degrees. It would be well to file such a notch, and also an angle to fit it, as shown by Fig. 67, and keep them for permanent use as gauges.

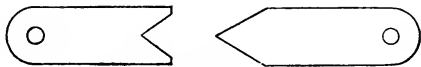

Now we will suppose that the six strips have been bevelled. The gauge is applied, and we will assume that you find the angle either incorrect or “lop-sided.” File up two or three scraping notches in a scrap of your saw steel (mentioned near the beginning of this chapter) with your triangular file, and holding the steel in the vise, draw the strip through one of these notches, being careful to insist that the rind be horizontal. Thus true the angle wherever it may require it. The accompanying illustration represents such a scraper.



It is obvious that it is possible, and for a first effort,

or if but a single rod is proposed, it may be profitable, to employ this scraper alone to bring us thus far on our way, instead of preparing the plane and providing the rabbeted strip, as heretofore described. Or one fairly skilled in the use of the plane may place his square strip of bamboo in a groove, as shown under the head of "Tips;" but the groove, however, must be one of sixty, instead of ninety degrees as there shown. Then by using the plane as there described, aided by frequent resort to the gauge shown in the preceding figure, he may accomplish the same result with far less labor than if the scraper alone were relied on. The object sought is to obtain a true angle of sixty degrees opposite the middle of the rind side of the piece of bamboo in hand—not to make a glue joint, which is a subsequent step. I have successfully used all these, and many other ways to accomplish this result, and doubtless additional, and possibly better methods still, will suggest themselves to the ingenious reader.

Next you must provide some grooved strips differing from those described in the preceding section, only in that the angle at the bottom of the groove must be sixty, instead of ninety degrees.

You will be compelled either to order, or make yourself, a special plane to make this groove, or to build up these strips of two pieces, glued or screwed together. Assuming you have chosen the latter course, you will at once perceive your Bailey plane with its block attachment will be a great aid. For if it will, when applied as directed, give the proper angle to a strip of bamboo, it will serve the same purpose when applied to a strip of wood. So procuring two pieces of wood, take off the corners, as shown by the dotted lines (Fig. 69), and fasten

them together. If the angle is incorrect, remove the handle of your triangular file, and rub it to and fro in the groove until the error is rectified.

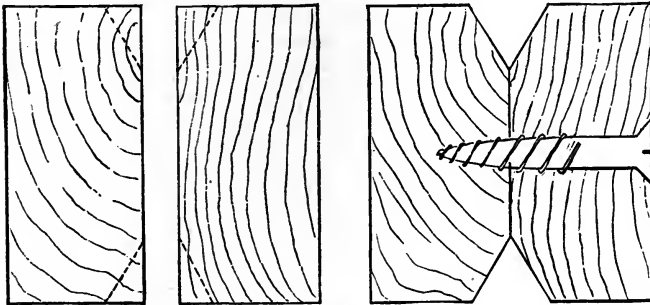

Fig. 69.

Should you conclude to order a plane for the purpose, consult a hardware dealer or a carpenter as to the maker. My plane cost \$1.90. Make a sample of the groove you wish, and send with order, to lessen the possibility of mistake.

The grooved strips in which you intend to finish the component parts of each joint should be of hard wood—pine will serve for the others. For since a joint of this kind cannot well be altered after it is glued together, it is plain the taper and consequent action of the rod must be determined at the same time with the angle, and this without the opportunity for trial and local modification which a wooden rod affords. Therefore some definite rule for this must be established at the outset. Perhaps, all things considered, a true taper for each joint promises the most certain result—at all events for the middle

joint and tip. The butt may be modified a little, to diminish its stiffness near the handle.

With a hexagonal piece of hard wood, tapered somewhat, aided by a small hammer, give an hexagonal form to that end of all of your ferrules which is to overlie a joint. A careful measurement of these will give the width of each end of each strip. Then, having determined the length, with your largest Bailey plane, plane off the grooved side of the strip until the groove corresponds with that width at the proper points, and tapers, or narrows, uniformly between those points. Though no guide but the eye regulates the process, it will be found sufficient, provided care be used and undue haste to finish be avoided. Remember it is easier to take off than add on, and therefore use your utmost skill and patience. Have your plane-bit keen, and set it "fine" towards the finish, frequently "sighting" the groove, as though it were a rifle, during the progress of the job. You cannot be too careful, for you are now deciding the action of your rod, and whether it shall be good, bad, or indifferent. This being properly completed, place each strip in turn in one of the pine grooves, selecting one above the surface of which the bamboo projects but little, and take off a shaving, first on one side and then on the other, alternately. When the bamboo is worked down to a level with that groove, change to a shallower, and so continue till you think it is time for the finish. When all the strips are in this condition, put the keenest possible edge on your plane-bit, and set it "fine." Mark the surface of your appropriate finishing grooved strip all over with a lead-pencil, or otherwise, so that nothing can be taken from it by the plane without attracting your attention at once. Then plane down each strip, first a

shaving from one side and then one from the other, and thus alternately, until the strip is flush with the surface of the groove, as it lies within it. Lest you should unintentionally remove, during this process, something from the grooved strip, and thus destroy the integrity of the groove, which is the sole guide to the required taper and width of the bamboo itself, you were directed to mark the surface; and that should this accident happen, that it may be of as little moment as possible, hard rather than soft wood was advised for the finishing grooved strips.

Not only should the glue joints be perfect, and the action true, but a well-made hexagonal rod should present a perfect hexagon at every part of its length. Therefore all those strips which are to be united together must everywhere correspond in width. This, as well, is determined by your finishing grooved strips. Indeed I may say they are the key to the position, therefore see to it they are well made.

Now proceed to number each strip in its intended order, to wind them together with string, to examine the character of your glue joints, to draw-file the imperfections, and finally to glue them together, straighten them, and in all things relevant follow the directions for making four-strip tips, as given in the preceding section. The process of winding on the rings is elsewhere described in this chapter, as well as varnishing, except that the winding should precede the varnishing, and the rubbing down with pumice-stone should be omitted. Between each ring a number of narrow windings should be placed at any distance, less than three inches on the butt, that may suit the fancy. The interval between and width of these windings should gradually diminish towards and to

the end of the tip. When about to glue together, number each strip on each of its faces, so you can select the proper one at once. Get the assistance of another if you can, apply the glue to each strip in turn on both sides for half its length, then as they are taken up one after the other, before you lay each beside its neighbor, run the glued surfaces over a gas or lamp flame to restore the glue to perfect fluidity, and then wind as directed to within about three inches of where the glue ends. Then, your friend holding the strips apart, apply the glue to the remaining surfaces, warm as before, particularly near where the first gluing ended, and wind together as directed.

Four-strip tips will work in perfect harmony with a hexagonal butt and middle joint. Indeed the tip, so long as it be light, and nervous in action, is the least important part of the rod. I assume that an independent handle will be used, whether united to the butt joint with a ferrule, or permanently glued thereto.

I finish this chapter with many misgivings. At one moment I fear I have been prolix beyond endurance, at the next, lest some important step has been overlooked, taken by me as a matter of course, but not necessarily so by the beginner for whose benefit I have written. I can well imagine the smile with which the professional rod-maker will regard my doubtless clumsy and unnecessarily elaborate methods. In self-defence I can only say that beyond what I was able to gather from Thaddeus Norris's "American Angler," I have never had the advantage of advice or assistance in rod-making. Each step has been sought and found through much experiment, and many a failure. Simpler and better methods

there well may be ; but one thing I know, though the way may be devious the end is sure.

If others, in following the precepts of this chapter, shall derive therefrom some portion of the recreation rod-making has afforded me—if the coming generation of anglers feel towards me but a tithe of the gratitude and sense of obligation with which I regarded Mr. Norris when I was a beginner, I shall be quite content with the reward of my labor.

CHAPTER VIII.**REPAIRS.**

THIS chapter has been written on the assumption that the reader is utterly ignorant of this most important branch of the art. That such actually is the case with altogether too many who are otherwise experts, we all know. That such should not be the case we are also aware. Nothing in relation to the art will better repay the beginner, and those who lack this information, than a careful study—not merely reading over, but careful study in the scholar's sense of the term—of this chapter. For to say nothing of benefit to yourself at a crisis, what pleasure can be greater than to be able to rescue a brother angler from the consequences of disaster to his tackle, and to receive thanks which you know are really sincere and heartfelt. At the expense of a little trouble, nay, rather while amusing yourself, you have at the same time made a friend, and put him on the watch for opportunity to requite the obligation.

But it is to the first of these inducements we most confidently appeal; for if that elicits no response, a moral defect is evidenced fatal to the hope that that man will ever become a true angler.

Many think this art hopelessly intricate, and are discouraged from any effort to acquire it; but this is a great mistake, for there is nothing in it insurmountable to the humblest mechanical skill. The most common

error is to attempt the result, while utterly ignoring the means by which the result is to be obtained—as though a man should wish to keep books without first learning how to write.

First acquire a few very simple principles, and the rest follows “like rolling off a log.”

As we said before, this chapter is written as addressed to one utterly ignorant of this branch; and this for two reasons: first, because for the benefit of such it is intended; and second, because it is the most direct way to accomplish the end in view.

At the foundation of the majority of repairs lies covering and strengthening the injured part with a layer of silk thread, tightly wrapped around it. It is thus that rings are secured to rods, and breaks repaired.

Do you know how to wind a string around a stick? That is what we are about to do. But if you really wish to learn from what follows—if you really wish for success, you must, as in your every-day life, accept the conditions of success.

As to knots, and manipulations of that kind, the condition of success is this: Actually try each step with the book before you, and following its directions; be sure you understand that step before you essay the next. Thus you will be led to the goal as easily as you walk from your parlor to your dining-room, with hardly an appreciable effort. But if you attempt to cover the ground in either case with a leap, you court and will meet failure.

Now to our lesson (see Fig. 70).

Take a round cane and a piece of fish-line—or string of similar size. Wax your string. It will facilitate you. Hold the cane in your left hand, knuckles up and thumb

to the right. Place the end, *A*, on top of the cane somewhere near the middle, and nip it at *B* with the thumb to keep it in place. Bring the end *C* over the cane on

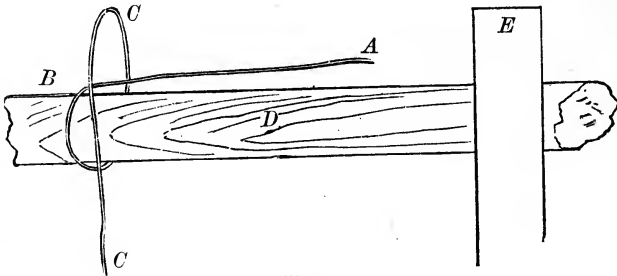

Fig. 70.

the side towards you, and downward; next under the cane, and upward, but on the side away from you; then over the top of the cane and the end *A*, and hold *C* in your right hand. In brief you have wrapped the part *C* once around the cane and over the part *A*, confining that part to the cane. Now placing some part of the cane to the right of where you have begun to wind, behind anything, *E*, against which you can pull, proceed to turn the cane around on the axis of its length, keeping a steady strain on the end *C* with your right hand. You thus roll the line upon the cane, just as thread is rolled on a spool, or a rope on a windlass, drawing your right hand up to the cane, unless you allow the line to slip through your fingers. You will have no difficulty in guiding the part *C*, so that each turn shall lie in close contact with its predecessor.

You have rolled on four complete turns, which envelope the cane and the part *A* (Fig. 71), confining the lat-

ter to the cane. Now shift your left thumb over upon, and nip the coils you have just made, *c*, so they cannot unwind. Seize the end *A*, and draw the slack of the first turn, *b*, up to and against the others. Then continue

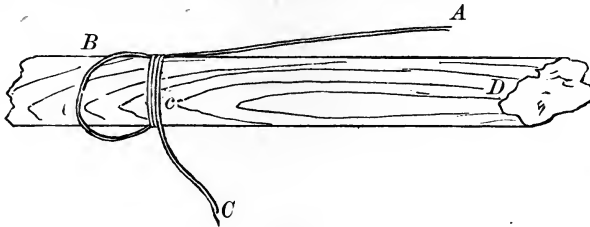

Fig. 71.

your winding for any desired length, always doing this by using the cane as a roller, turning it from you. You will make each succeeding turn lie more neatly against its predecessor, if you allow your right hand to be drawn up to the cane, rather than permit the line to slip through your fingers. When shifting the right hand backward for a fresh hold on the part *C*, nip the turns you have completed with the thumb of your left hand, lest they unwind; as, indeed, you will do in any case when you wish to free your right hand for the moment.

We have now completed the first step. You see that it is a simple matter, and one within the scope of the most limited mechanical ability. Notwithstanding, repeat this at least four times more, winding an inch and a half each time, before proceeding to the next step.

This is to fasten off the end *C*, for we cannot hold it forever.

There are two methods of accomplishing this—one easily acquired but of more limited applicability; the

other a little more difficult, but at the same time equal to every emergency.

The first consists merely in this—that instead of placing the end *A* as before, you double it as shown in the following figure, placing the bight, *a*, where the end *A*

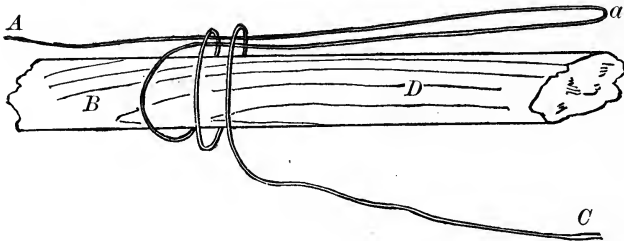

Fig. 72.

was in the former case, and letting the actual end *A* extend at least three or four inches to the left of where you wish to wind. Having completed your winding, nip the coils with the right thumb. Then with the left hand pull on the end *A* until you have reduced the bight, *a*, to very small dimensions—say one-quarter of an inch or less. Now with the right hand cut the part *C* about two inches in length, and insert the end through the bight, *a*, close to the winding. Then seizing the end *A*, draw the bight, *a*, through and under the winding, which will of course carry the end *C* with it, and confine it under the coils. Then cut off the ends close, and the job is complete. Try this at least four times, and then proceed to the next step.

This is the real “invisible knot,” and a knowledge of it should be considered absolutely indispensable to the angler. Begin as before. Having wrapped four or five

times over the end *A*, so that it is perfectly secured, cut it off as close as you can to the wrapping, so that you have only the end *C* remaining. Now proceed with the winding until within four turns of as far as you wish it to extend; then nip the coils already made with the left thumb so they cannot unwind, cutting off the end *C*, so that it is about a foot long. Now drop it down between you and the cane, next under and then upward behind the cane, so as to form a loop, say, three inches across, hanging below the cane, thus:

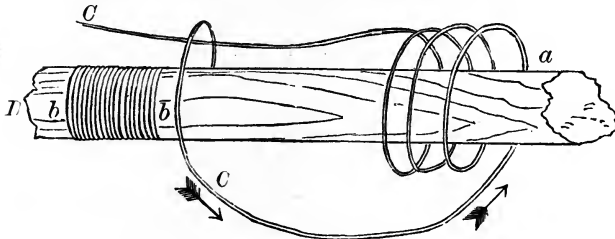

Fig. 73.

If you meet any difficulty at all with this knot it will be here. Remember the end *C* passes downward on the side *towards* you, and upward on the side *away* from you. Hold the cane, as soon as you nip the coils with your left thumb, so that hand points to the right, and the first and second fingers are free. Throw the large loop over those fingers to keep it open. Then make three or four turns of the end *C*, *between* the point where the large loop meets the cane, *a*, and the windings you wish to fasten, *b*, winding *towards* the latter. You will find this operation facilitated by throwing the end *C* at every turn, after making the large loop, be-

tween the first and second fingers of the left hand, holding it thus until you can reach over the cane with the right hand, and draw the end *C* through the loop. Now pass the end *C* to the left, under the left thumb, and hold it down on the windings already made, *b*; then hook your right first finger in the large loop, and putting a strain on it, revolve the cane and proceed with the winding as at first. You will thus wind on as many turns over the end *C* as you made between *a* and *b*, and in close contact with those you wish to fasten. For every wind you so add you will, if you have followed the directions carefully and correctly, see one of those between *a* and *b* unwind, and will at length have the result shown, thus:

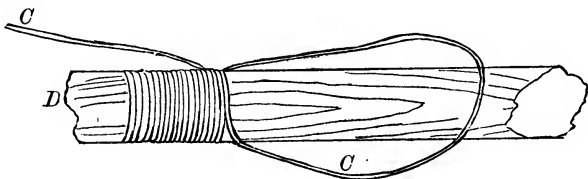

Fig. 74.

Now seize the end *C*, and draw up the slack of the large loop until it lies in close contact with the windings you are fastening. Cut off the end as close as you can, and it is done. Repeat this until firmly fixed in your mind, and you have made an acquisition that will many times repay the trouble.

Now let us apply this lesson, taking at the same time another step forward.

SCENE.—*Trout-stream.*

ANGLER, *meeting a very melancholy-looking individual with the fragments of a trout-rod in his hands*; NOVICE, *equipped for fishing, but with a broken rod.* Time, 8 A.M.

ANGLER. Good-morning, sir; what luck?

NOVICE. The trout are rising fairly well; I have caught a few nice ones. But I have just had the misfortune to break my middle joint about a foot below the smaller end. I have come a long distance to enjoy a couple of days' fishing, and my opportunities are few; and as I have no spare piece to take its place, I am afraid my fishing is at an end unless I take to bait, and for that I have little taste. So I suppose I may say I have had poor luck.

ANGLER. How did it happen?

NOVICE. It may be I was using too long a line for the distance I wished to cover. I saw a nice-looking spot, and when I cast, my flies reached the water considerably beyond it. Instead of shortening my line, I undertook to draw my flies across the spot; and when my rod was nearly upright, a nice fish struck my drop-fly, and you see the result. I am but a beginner, having fished with the fly but a few times before, and am self-taught; I suppose I must expect to make mistakes, but it is none the less provoking to lose all the sport which I had anticipated with so much pleasure.

ANGLER. Many a good rod is broken in that way. Let me see the break. Why, this is not so bad. Why don't you splice it?

NOVICE. I don't know how.

ANGLER. Have you silk, wax, and a file in your fly-book?

NOVICE. No, I have nothing of the kind, I am sorry to say.

ANGLER. It will make no difference, for I have them. And since you say you are a beginner, I will repair this accident for you, and at the same time give you a few hints which may be of value in the future.

NOVICE. I shall be very much obliged if you will be so kind.

ANGLER. It is, or should always be, a pleasure for one angler to help another; so look and listen, and if there is anything you do not understand stop me at once. But first I would say, never go on a stream again without plenty of silk, of the sizes known in the stores as *A* or *B*, in your fly-book, together with a little cobbler's wax flattened out between the folds of a piece of an old kid-glove. A quantity of wax which, if spherical, would measure half an inch in diameter is about the thing. Also you should have a flat file of rather coarse cut, and with the blade from five to six inches long and from one-half to three-quarters of an inch wide, like this. You see the tang is broken off the file, and thus shortened I can carry it in my fly-book, and never know it is there till I need it for use.

Now see; I take my pocket-knife, and cut a long slope on each of the broken ends, being careful to make them incline in different ways, and of such slope that when they are laid together the rod will not be larger than before. I also see to it that the splice is so situated, that the rings on the two pieces will be in line when they are united. There, I have finished cutting, and you see when I place the pieces together the rings are in line; but you also notice that the joint is not a very good fit. Now we will resort to the file. You notice that I lay

the file down and place the splice upon it; and while rubbing the joint to and fro on the file, I press the wood down upon it with the fingers of my left hand. From time to time I look at the splice, and see how the filing progresses.

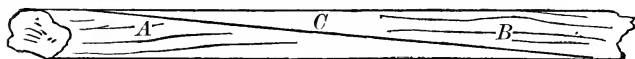

Fig. 75.—A B, portions of broken joint; C, splice.

The file will cut most rapidly where the pressure is greatest, so that by varying the pressure with a little judgment, the splice is soon made perfectly true, as I have done this. Now we will finish the other; so, there they are complete. Now place them together and see what you think of it.

NOVICE. They fit perfectly. The rod is not enlarged and the rings are in line. I am astonished that it could be done in so short a time, and by means so simple. I really believe I could do it myself.*

ANGLER. Without the slightest doubt. In mechanics as in life, skill consists in adapting your means to your end; the desired result then almost necessarily follows. You see that when I rubbed the splice on the file only the high places touched. Of course these were soon cut away, and the surface became even of itself, so to speak.

Now we have to unite the splice, and you will then be

* If the means or the skill to make a perfect fit are wanting, the splice should be so made that the joint is there enlarged; otherwise it may be "soft" at the splice—*i.e.*, inferior to the neighboring parts of the rod in stiffness—when it will almost certainly give way again. Subsequently, and under more favorable circumstances, the splice can be taken apart, properly fitted, and permanently repaired with glue.

ready to continue your sport. If this was in the evening I should melt some fresh glue—fish-glue (or isinglass as it is sometimes called) if it could be had. Having completely melted some of this in sufficient water, so that it felt between the thumb and finger as if it had considerable, but not too much body, I should apply it to each surface, bring them together, wrap them tightly with a dry string, then wet the string with warm water to swell it and make it still tighter, and set it away till morning. Then you would hardly have been able to find where the wood was joined together.

NOVICE. I have tried to use glue, but could never make it stick any to speak of.

ANGLER. Considerable art, or, I should say, a little knowledge is required to use glue successfully. In the first place, where all possible strength is required, as in fishing-rods, the glue used should be perfectly fresh. By that I mean glue that has never been melted before. It should by no means be too thick, since then it rapidly gelatinizes, and in this condition it has no adhesive power. The best test is to try a drop between the finger and thumb; if it feels slightly unctious, it is thick enough. Then warm the surfaces to be united, apply the glue, and tie them together as described, and you will have no difficulty. Fish-glue is to be preferred, particularly that known as "Russian isinglass," since it has more strength in the first place, and that strength is not so apt to become impaired by time; but it must be handled promptly since it soon jellies, in which condition it will not stick at all. Some advocate adding a drop or two of nitric acid to the melted glue, or melting the glue in vinegar, either of which will destroy this gelatinizing property, so you can take your time in uniting the

fragments; and they insist that this does not impair the strength of the glue. Some prefer to melt it in skimmed milk, since glue so prepared is insoluble in water after it dries. Some, again, soften the glue by soaking it over-night in cold water. The next day it will resemble a stiff jelly, though retaining its original form. These pieces are then dried with a cloth, and melted in boiled linseed-oil, and thus another waterproof glue can be made. This last is, however, a tedious drier. But I have always feared to try these when anything depended on the result, and so cannot speak of their respective merits from my own knowledge. One thing, however, I do know, that if your joints fit and are tightly brought together, so as to squeeze out all the glue possible, it will, even with ordinary glue, take hours of soaking in water, and the subsequent application of considerable and continued heat, before they can be separated.

But this repair must be made on the spur of the moment, so gluing is out of the question. You see I warm the splices and my cobbler's wax, and coat both the former with the latter. I now place them together in the position in which they are to remain, squeeze them tightly together so the layers of wax between will coalesce, and hold them in that position a moment for the wax to stiffen a little. I now wind this string around them for about half their length to hold them in position, and they are ready to wrap with silk. Having waxed my silk well with the cobbler's wax, I wind it on, as you see, as tightly as the strength of the silk will well bear, being careful that each turn shall lie close beside its predecessor. I have wound up to the string, which may now be removed since the wrappings already on will steady the splice; and now I have wrapped the splice its whole

length, and it only remains to fasten the winding, and we are through. Watch me closely. You will notice I cut the silk so I have about a foot of end. I hold the windings already made in place with my left thumb, pass the end of the silk downward between me and the rod, under it, upward on the other side, and then over the rod. Thus I make a large open loop, *within* which I take three or four turns of the end around the rod, and running *towards* the completed winding that I am holding with my left thumb. To these two points I wish particularly to call your attention, since if you make no mistake here you will have no difficulty in mastering this knot. I then finish thus, and cut off the end as close as I can. You see it requires close inspection to discover how the silk is fastened, so neat is the finish. This is one of the most valuable acquisitions an angler can make, for without this knot I could not have securely repaired your rod. As soon as you conveniently can, cover the winding with two or three coats of shellac, or better still some oil varnish, if you can wait for it to dry, and your rod will, if you meet with no further accident, last for years. Now put it together and try it. How does it feel?

NOVICE. It seems a little stiffer, and lighter in the hand than before.

ANGLER. Both necessarily follow from shortening the rod, which of course cannot be avoided in making a splice. But I notice a ring is missing from your rod. Bring it to me this evening at the farm-house where I am lodging and I will replace it.

NOVICE. I am a thousand times obliged to you for your kindness.

ANGLER. Not at all. Only remember never to go fish-

ing again without silk, wax, a knife, and a file; for with these you can repair on the spot most of the accidents to which an angler is liable, while without them you will be helplessly crippled. Good-day, and good-luck.

TIME, evening; same parties.

NOVICE. Good-evening. You see I have brought my rod as you suggested.

ANGLER. You have done well. What luck did you have after we parted this morning?

NOVICE. Oh, not so bad. But it is not essential to my enjoyment of stream fishing that I take a trout every five minutes. The cool fragrant air, the music of the running water, and the beauties of the trees and flowers which shade and grace the stream—these, together with the constant endeavor to improve my cast, and the sense that my efforts were not in vain, made the day one constant pleasure, though I caught but few fish and those not large.

ANGLER. You have the true angler's spirit, and this makes it a double pleasure to assist and instruct you.

NOVICE. While you are finishing your cigar, and before we enter on new ground, I should like to ask you one or two questions about mending broken rods. How long should the splice be by which the fragments are united? For it seems to me that a short splice can hardly stand the strain inseparably from use; while, on the other hand, an excessive length unnecessarily shortens the rod.

ANGLER. The question is very pertinent. The length of the splice should be at least twelve times the diameter of the joint at the break, perhaps even a little more if the rod is very dense in the grain. It is well in such

case to roughen the surfaces you propose to unite, or to score them obliquely and in a criss-cross manner, thus:

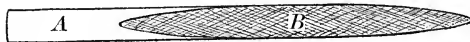

Fig. 76.—A, joint; B, splice, scored.

But these scores should be very oblique and very shallow, or you may divide and so lose the strength of some of the fibres. The purpose is to give a better hold to whatever adhesive substance you use to unite the parts.

NOVICE. It has occurred to me that the method you showed me this morning is not applicable to a break close to a ferrule, for there is then nothing to form one part of the splice from. What course should then be followed?

ANGLER. This is either one of the most difficult, or one of the simplest of emergent repairs, according to the construction of the rod. If the rod is united by simple ferrules without dowels, and if the ferrules are merely cemented in place instead of fastened by a pin, then the repair is a trifling matter. And after balancing all I have heard or can imagine on all sides of the question, I cannot but think that both the dowel and the fastening pin should be excluded from fly-rods. I have been driven to this conclusion not merely because of difficulty of repair, but by other considerations of equal or even greater force, into the discussion of which we will not enter now.

When the rod gives away at the ferrule, the break is always short across. If you have no dowels to consider, trim the broken end square with your knife, warm the ferrule and push out the broken portion, and replace the ferrule on the joint, using some of your cobbler's wax to

cement it in place. But if your rod has dowelled ferrules—by which I mean those in which the upper ferrule is provided with a tenon to enter and fit a hole in the joint below—then, if your rod is a fine one, you are indeed in trouble. Let us assume the break is above the “male,” or entering ferrule. You have now the accident in its least embarrassing form. For if you have means at hand to drive out the fastening pin, you can burn out the broken piece, and proceed as before. The construction of a new dowel from the body of the joint itself should never be attempted, since, aside from the difficulty of making it perfectly central and a good fit, it shortens the rod to a degree not to be thought of, except in case of absolute necessity. The maker will, on your return home, insert a new piece, and the loss will be only equal to the length of your ferrule.

If, on the other hand, the break is below the female, or outside ferrule, the accident is more serious. Assuming you have cleared the ferrule of the broken portion, and can replace it as before, how are you to bore the hole to receive and fit the dowel? This clearly requires a special tool not readily found in the neighborhood of most trout streams. The only practical recourse is, then, to cut off the dowel from the male ferrule, replace the female ferrule as before, and use your rod without the dowel, until you can put it in the maker’s hands.

If the dowel seems part of the metal of the male ferrule, as is generally the case in fine rods, you must file or saw it off, only as a very last resort. It is usually only united to the ferrule by soft solder, and if you heat it well you can unsolder and remove it without injury.

Some rods, however, are mounted with ferrules the bore of which is smaller at the mouth than within. In

such the dowel is absolutely indispensable, since it alone steadies the end of the entering joint and prevents it from shaking. I cannot but think this a vicious construction, if for no other reason, because it offers not the slightest advantage over the cylindrical ferrule, while a break of the kind under consideration at once disables the rod beyond immediate repair.

NOVICE. One other question : bamboo is so dense and flinty that I should think it difficult successfully to mend such a rod by splicing. Am I correct in this?

ANGLER. Partly so. Tips may be repaired without difficulty, and a break in the upper portion of the second joint is not hopeless. But I have never been able to make a splice stand in the lower half of such a rod, though I have tried repeatedly. The splices must then be made extra long, and well scored; and with this the user must rest content until he can replace the broken joint by a new one. His rod will then hang together and can be fished with, but he will find its action so impaired that its use will give little pleasure. Does any other question occur to you?

NOVICE. No, I think of nothing more.

ANGLER. Then let us replace that ring on your rod. But I see you have lost the end ring from your tip as well.

NOVICE. Oh, never mind that; I have another one.

ANGLER. We may just as well do both, and then at some future time you will be able to aid or instruct some brother angler in both of these particulars.

If we had some spare rings, or even some small copper or brass wire, it would help matters; but as neither of these is at hand we must resort to pins for our material. You see I insert the points of these pins in a stick, and

heat them red hot in this lamp, for a pin as it comes from the manufacturer is too stiff for our purpose. Now that the points are cool, I cut off the heads and insert those ends in the stick, and repeat the process. Now they are annealed, and we can proceed. I take a small round stick—a match will do—and applying it to the middle of the pin, bend the latter around it, thus forming a loop.

I now insert the loop in a crack in the floor or in a cleft stick to serve as a vise (since we have neither the latter nor a pair of pincers), and twist the ends of the pin around till they are at a right angle with their former position. We now have, in effect, a straight wire provided with a loop at a right angle to its middle. I then file the two ends, top and bottom, tapering them gradually away from the loop to a sharp edge at each extremity. I now wind this on with waxed silk in its proper place, and it is finished.

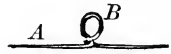

Fig. 78.—A, body of pin, showing sharpened ends; B, loop.



Fig. 77.—A, body of pin; B, loop made in middle of pin; c and d, ends of pin.

NOVICE. I am very much obliged; but had I not been so anxious to learn this, I should not have permitted you to trouble yourself over so trifling a matter.

ANGLER. You must not think so. A rod should be provided with plenty of rings, since they equalize and distribute the strain over the whole length of the rod. Thus while its aggregate may be great, it will at no one place reach the breaking-point. And while I would not recommend you to suspend fishing at a favorable moment, merely because a single ring became detached, still you should replace it before the next day.

Now let us put a new end on your tip. I bend the

second pin around the match as before. I then thin the ends in the same manner, omitting, you notice, to twist the loop. I now bring the ends together, thus,

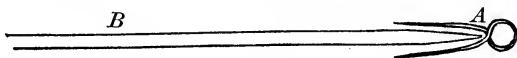

Fig. 79.

in the form of a tuning-fork, give a slightly wedge-shape to the end of the tip, insert it in the fork of the tip end, and wind it on with silk. It will not be amiss to give the loop a bend towards the ring side of the tip, since then the line will render better.

NOVICE. But I notice that in this case you did not make your "invisible knot" in the way you showed me. This seems much simpler.

ANGLER. The principle is exactly the same. In the case to which you allude it was tied in the middle of a joint, and under such conditions it must be made in the way shown you. But here there is no long piece extending beyond where the knot is to be, and we can take advantage of this circumstance. I will repeat the knot for your benefit. Having wound as far as we wish, I

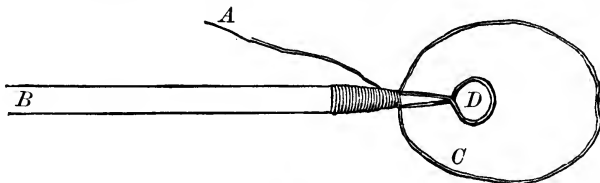

Fig. 80.

make the loop, *C*, holding the windings already made firmly with my left thumb, exactly as before. Having first cut off the silk so as to leave me about a foot of

end, *A*, I place this end upon the windings, and hold it there; I then proceed to wind *over* it, *A*, exactly as if it were not there, and as though I were merely extending my winding; and this to the extent of four turns or so. If in so doing the silk has fouled the ring, *D*, I clear it; and you see I have the end, *A*, projecting towards the left and fastened by some turns of silk over it, and a loop, *C*, on the right. Now when I pull on the end, *A*, the loop, *C*, diminishes in size, until it disappears altogether, and the fastening is complete. This knot is the one with which the heads of flies are finished.

NOVICE. You seem so willing to give information that I should like to ask you a few more questions. This evening I could hardly get my rod apart, the ferrules stuck so tightly; yet they went together easily enough in the morning. Is there a remedy for this?

ANGLER. Yes, and a most simple one. If you will tallow or oil your ferrules, and then wipe them dry before you joint your rod, you will never be troubled that way; and this should be repeated every third or fourth day, if the rod is left together so long. But if you have neglected this precaution, and the ferrules stick fast, do not call a friend and go at the joints as though you were wringing clothes; but warm the obstinate ferrule over a lamp-chimney, and it will easily separate. You must remember that the object is to expand the outer before the heat reaches the inner ferrule; and to do this the heat must be applied but for a few seconds, turning the ferrule constantly so that all parts may receive their due proportion, and then try to separate it. If it refuses, repeat the operation until it consents.

Heat, properly and continuously applied, is extremely efficacious when opposed to obstinacy of any form—a

principle well known even prior to the Middle Ages, though its highest development was then reached. If, however, the angler seizes one joint and his friend the other, a sudden and powerful jerk will often separate ferrules, which have obstinately resisted both torsion and a steady pull.

NOVICE. Here is a fly, the only one of the kind I have. The trout seemed to have a decided preference for this to-day, but the gut is so frayed I fear to use it to-morrow. Can it be repaired?

ANGLER. Yes; it will not look very well, but it may be used. Let me see the fly. Have you a spare piece of gut, or if not, a spare leader, from which we can cut a foot or so?

NOVICE. Here is a leader.

ANGLER. First we will soak it in tepid water till it is soft; then saving the looped end intact, we tie a hard knot in the other end to prevent its slipping; then we wrap it above the knot with well waxed silk on to the upper side of the hook, just below the body, and over the tail; then part the wings with a pin, and lay the gut in the division and upon the upper side of the body, and fasten it again with silk over the wing fastening. Now we catch the hook in or around anything that will hold, take a good pull on the gut to be sure it will stand, and it is complete.

NOVICE. Are there any other accidents likely to happen to the angler which you have not mentioned, and which admit of repair?

ANGLER. We have certainly covered almost all—and I can think of no others. You see the “invisible knot” lies at the foundation of all these repairs, so be sure to perfect yourself in it.

It sometimes occurs that an angler buys a new rod, or a new reel, and finds the one will not fit the other; but he can tie the reel to his rod with a string, or better still a leather thong, and it will work just as well.

It may happen that he frays his line on a sharp stone or otherwise, so that he thinks it no longer safe. In this case, if unprovided with a spare line, he may cut out the doubtful part, melt his wax, or at least make it quite soft so that it will penetrate well into the line, coat about an inch of each end well with the wax, lap and squeeze, and sew them together with a fine needle, and then wrap tightly with well waxed silk, and thus remedy the defect. If it is an enamelled waterproof line, the ends may be scarfed a little with the file to roughen them, and give the wax a better hold. This splice, if neatly made, will render through the rings very well, but a test strain of at least six pounds should be applied before using it; for if it will not hold it is better to know it, and repeat the operation.

He may forget or lose his landing-net. In stream-fishing he can then land his fish on the bank, if it is sloping, or if not, slide his hand down the leader and grasp the fish by the gills. In either case he should play his fish until quite exhausted. Then throwing his rod behind him and over his shoulder, grasp the leader with his left hand, carry the part seized to his right hand which holds the rod, there take it between his thumb and finger, holding it so he can at once let go if the fish shows signs of activity, and repeat this until the fish is quite close. But during this delicate operation there must not be the slightest approximation to a jerk; everything must proceed quietly and by an even, steady motion. He can then slide his hand down the leader

and grasp the trout, in which he will be much aided by a thread-glove with the fingers cut off; or he can lead the fish towards the bank, and by a sudden but steady increase of force throw him out.

Any effort to lift or throw the trout out by the rod will probably be followed by disaster. Not that the rod will break, but the weight of the fish in air so exceeds that in water, that the impulse given will carry it but a short distance on the shore; and when it strikes the ground it unhooks itself with the first flop, while the angler performs like a cat on a stove in the vain endeavor to kick it higher up on the bank. I have seen, nay, I have myself, lost many good fish in this way.

If he is to fish from a boat, and no landing-net can be borrowed, let him make a gaff out of a piece of telegraph or other stiff wire, or tie three or four hooks, the largest that can be had, on a stick, and use that for the same purpose.

Occasionally the screws of a reel show a tendency to work loose, caused by the jar of the click and indifferent fitting. The remedy is simple: withdraw the screw, and insert a thread to the bottom of its hole; enter the screw beside the thread, and about three-quarters of its length; then cut off the projecting end close, and turn the screw down to its head.

There, I think I have covered all the reparable contingencies.

NOVICE. One last question I would like to ask. Can you suggest a method to repair an angler's morals after he has lost a large fish?

ANGLER. That is indeed a heavy blow; and so long as human nature is weak, I fear that under such affliction the original sin, which is the heritage of all, will come

to the surface. It is a misfortune not only of the moment, but in the future as well.

In September of 1880 I stood on the boom which restrains the drift-trash from clogging the sluiceways of the lumber dam located on the Magalloway River, about a mile below Parmacheene Lake, in Maine. The dam had been used that spring for the first time. It was built to aid in sluicing the logs cut in the surrounding wilderness down the river to civilization, and was, except for a couple of weeks or so in the spring, idle and apparently uncared for. The deep black water shoaled as it approached the dam, quickened its pace, bent downward like oil, and then, breaking into foam, rushed forty feet through the sluices, and thundered into the pool below.

I stood upon the logs forming the boom, and cast a large single fly—the queen of those waters, the “Parmacheene Belle”—to where, about thirty-six feet distant, the current just began to gather its strength. As I now recollect, some four or five fair trout had rewarded my efforts, running from two up to three and a half pounds. At last up rolled the very Monarch of the River. His swirl was like the eddy made by an eighteen-foot oar. He was a monster. An exclamation from my guide, a bound of my heart that sent the blood like fire to every extremity of my body, greeted the rise. I struck sharply of course, but he never touched the fly, and it came back empty handed. With sinking hearts, for we knew from experience that such fish seldom rise the second time, we changed the fly to another as different in color as possible, and tried again. For two hours or more we rested and fished the water in alternate five-minute intervals, changing and rechanging the fly, but though we took others which would elsewhere be accounted large fish, yet he,

upon whom we had set our hearts, was proof against temptation.

I have caught as large, perhaps larger, trout since, but never in such a location. And to this day, and as long as I live and cast a fly, the loss of that fish will be a sore spot in my memory. Even now while I write, for the thousandth time the scene in every detail is present before me, and I wonder could I have played him his half hour in the water above, or would he, despite my every effort, have shot through the sluice into the pool below the dam, and what could I then have done to save him?

I have asked—I will ask—this question whenever memory recalls the picture, but its solution, alas! I shall never know.

CHAPTER IX.

CASTING THE FLY.

EVERY book on angling contains directions for acquiring this art, almost universally prefaced by the statement that little can be learned from them. Without calling in question the advantage of practical instruction by an expert, still it is believed no little progress can be made in its absence.

Assuming the possession of the required implements, the next essential in learning to cast without a master is companionship. Thus one can rest and encourage the other, and each observe and coach his friend during his innings at the rod. In nothing does the old adage, "the outsider sees most of the game," more directly apply. Unconscious faults are instantly noted by "the coach" and brought to the attention of the caster, as well as the greater or less degree of success which may attend effort to correct these. The innings should not exceed five minutes each, for they should be made a pleasure and not a toil. No very appreciable fatigue should be incurred, since tired muscles respond imperfectly to the will.

Access to water is quite unnecessary — I question whether it is even desirable. In the city, the house-roof may be the practice-ground; in the country, any grass-plot or a snow-field. Mark your stand, and measure from it about twenty-five or thirty feet. There place a folded

newspaper, retaining it in position by stones or similar weights placed on the corners. Let this, your target, be about eighteen to twenty-four inches square, and of several thicknesses, that a hit may at once be distinguished from a miss by the rustle of the line on the paper. Use a cheap linen line for practice, E in size, and without leader or flies. A braided line is to be preferred. This will perfectly serve the purpose, and save whipping out the more expensive water-proof line you will employ in actual fishing.

To acquire a proper back cast—throwing the line behind preparatory to the forward cast—usually gives the beginner the most trouble. He cannot see behind him, and though he fully appreciates that his forward cast is a botch, he cannot locate the difficulty, and knows neither to what this is due nor how it is to be overcome. Here the eyes of his friend supplement those of the caster. Each effort to improve is appraised; the successful is distinguished from the unsuccessful attempt—the one condemned, the other approved—until in a very short time and with very little trouble a habit of casting is formed which is not only efficient, but at the same time easy and graceful.

Therefore I say again, and I say with the more emphasis because I believe I stand alone in this recommendation, practise this art with a companion, and alternately at brief intervals let each coach the other. Let the coach make some comment on every cast made, as, for example, "Your back cast was too low," "Your line did not straighten out behind," "Your forward cast was too quick," "Keep your body still," "Keep your elbow to your side," "There, that back cast was all right—try to repeat it," etc., etc., remembering to approve the good



Fig. 81.

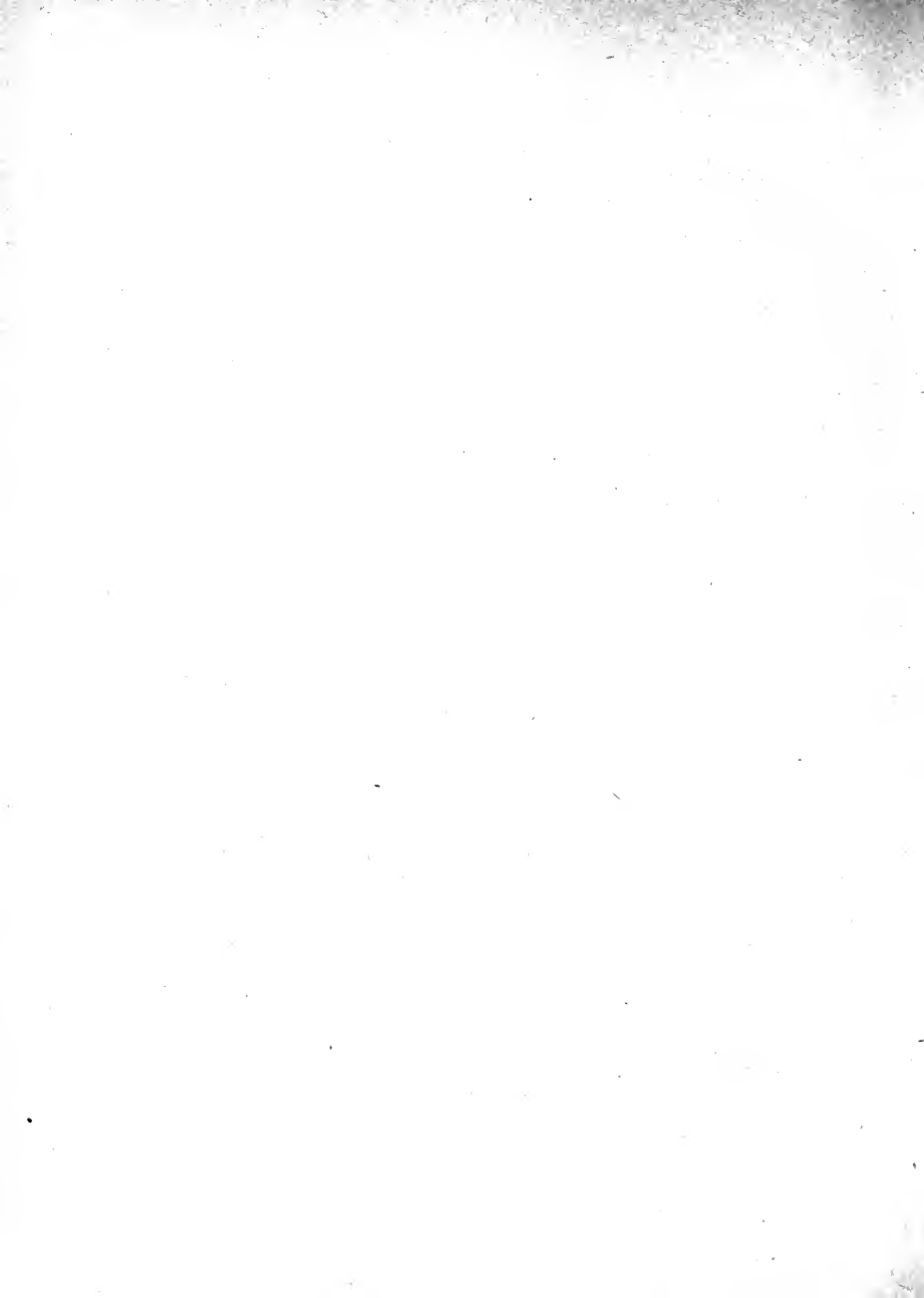

as well as condemn the bad; for the very object in view is to inform the caster what to cultivate as well as what to avoid.

I confidently believe that two persons of ordinary cleverness each thus aiding the other, can, in two weeks' time, with say one hour's daily practice, learn to cast a very fair fly and in an easy and graceful manner. If a really experienced instructor can be had, all the better; but the supervision of a self-taught caster of limited experience, who insists on being guided solely by that experience, is to be avoided.

The coach taking his stand abreast of and on the right of the caster, and at such a distance as conveniently to observe every motion, let the latter withdraw from the reel line equal in length to about one and a half times the length of his rod. The thumb of the casting hand must not be closed up on its fingers, but be extended and bear upon the rod itself. Now throw the tip of the rod upward and behind a little, but only a little, beyond the perpendicular.

The illustration on the preceding page (Fig. 81), from a photograph from life, shows the extreme limit of this movement, a limit by no means to be exceeded, while it may well be somewhat abridged.

In actual fishing the casting elbow is always and invariably to be held quite close to the side, and the forearm should not be raised beyond an angle of forty-five degrees with the horizon. The wrist, however, is to take a further bend upward and as far as possible, for from the action of this joint should the impulse of the cast be almost exclusively derived.

I am aware that I am at variance with the precepts of many writers, as well as with the practice of many excel-

lent anglers, in the direction that the elbow be invariably close to the side. Some cast at arm's-length, and largely with the shoulder-joint. This is a thoroughly bad method, fatiguing, inefficient, and rivalling in grace a duck on land. Others cast with the elbow to or near the body, but just before the flies light extend the arm to its full



Fig. 82.

length, as though they were about to impale something on the point of the rod. This method is used by many anglers, whom I freely acknowledge to be my superiors. Notwithstanding, I am convinced that it serves no useful purpose (except in casting for distance only) not otherwise readily attainable, while it certainly looks labored

and awkward. The one method resembles the postures of a trained athlete, no portion or member of his body in motion except those in actual use; the others approximate in greater or less degree to the contortions of the greenhorn, every limb pawing the air.

Though the elbow partakes slightly at the beginning of both the cast and recover, still it is the wrist that is really the motive power in casting. The novice cannot too early and too firmly impress this on his mind.



Fig. 83.

The illustrations on this and preceding page are taken from photographs from life. Fig. 82 represents the position of the wrist when on the back cast; Fig. 83 the wrist on the forward cast. Note the position of the thumb.

The position should be an easy one, and the body and the unemployed arm should be kept perfectly still. No

habit is worse in casting than unnecessary contortions of the one, or flourishes of the other. Not only is it exceedingly awkward, but it is injurious as well, since it is motion rather than the mere sight of an object which demoralizes the fish.

The coach will pay particular attention to the back cast, for if this is mastered all else follows. It is the secret of success. In practice, the end of the line, when behind him, should in no case fall below the level of the caster's head; everything below that should be regarded as a fault. There is nothing in fly-fishing which so promptly grades an angler as a high back cast, when circumstances permit its use, while nothing will more prejudice reputation for skill than the habit, even when sitting in a boat, of allowing the flies to touch the water behind the caster. The expert knows how few possess the former accomplishment, and that to him who has it the highest development of the art is possible; while he equally recognizes that the latter is a vicious habit, difficult to overcome, and a perfect bar to real excellence.

Therefore cultivate a high back cast with the utmost assiduity. It is not difficult to acquire at the beginning, though this is no longer the case when another and different habit has been formed.

The secret of this is to throw the rod but little, if any, beyond the perpendicular on the back cast. The first view in this chapter illustrates the extreme limit. While the butt joint is nearly upright, the upper portion of the rod will bend backward still more. Rods of varying flexibility vary somewhat in this respect. The stiffer may be thrown a little farther back, and still, since they bend less, give the line the required upward direction. I trust I have emphasized the importance of this sufficient-

ly, as well as made clear the method by which it may be attained.

The coach must next see to it that the caster by no means begins the forward impulse, until the line has extended behind to the limit of its length.

Ignore the front cast altogether in the first lessons, considering it merely as a necessary preparation for the back cast, and as otherwise of no consequence whatever. Concentrate the attention on these two features of the back cast altogether (except, of course, to insist that the body and unemployed arm are motionless, and that the impulse proceeds from the wrist). Hang to these two points as if they were all there was to fly-casting, for really this assumption will be but little wide of the truth.

Having given the backward impulse to the line, it will be found that an interval must intervene between this and the forward impulse, during which the line is occupied in straightening itself out. This pause is absolutely essential, and an undue abridgment of its duration is the most common of all faults. It varies, of course, with the length of line used; and since the caster cannot see behind him, that he may know when the exact moment for the forward impulse has arrived, he must use the eyes of another, or experiment in the dark.

The coach will therefore watch the line, and when it has thus extended its full length give the word "Now!" Thereupon let the caster at once give the forward impulse. It will require a little practice on the part of the former to give the word at the proper moment, and on the part of the latter promptly to respond, but this will be soon overcome.

By a rigid adherence to this method of coaching and

practice, a high back cast, and the allowance of the proper interval for the line to straighten out, will soon become purely automatic—a mere matter of instinct adjusting itself to whatever length of line may be in use, without a thought or an effort on the part of the caster.

When this is accomplished, *and stick to it until it is*, the game is in your own hands, for everything else follows almost of itself.

Now some attention may be profitably given to the forward cast. That the line shall fall gently upon it, the end reaching the level of the mark first, are the desiderata. To accomplish this, throw the rod forward, remembering to derive the impulse from the wrist, until it assumes the position shown by Fig. 84 on the following page.

Cast not at the mark, but as though an object three or four feet above it were the bull's-eye. Then when the line has unfolded almost its entire length, raise the point of the rod a couple of feet or so. This will turn the line point foremost, and cause the end to alight first. If the force of the impulse is justly proportioned to the distance to be covered, the line will fall by its own gravity alone upon the paper; but if too much power has been applied, it will strike hard, or recoil and fall short of the mark. That cast is the most perfect in which the minimum of force is employed, and the beginner must make constant effort to see with how little exertion he can accomplish the result. He will find that very little power is required even for quite a long line—say fifty-five feet—and that the line falls most lightly and straightest in those casts where the power is justly proportioned, and not in excess of the work to be done. But if careful, patient, and persevering, this too will soon become



Fig. 84.



purely automatic, adjusting itself to circumstances without conscious muscular or mental effort.

But remember the back cast is the foundation, and that unless it is solid the superstructure will be rickety. Remember also that the motion of the rod through the air should be almost, or quite noiseless. Nothing offends the angler's ear more than the "swish" of a fly-rod. It is like a false note to an educated musical ear. It indicates a degree of force about as appropriate to the end in view, as a burglar's jimmy to opening a watch. This should never be, except possibly when casting directly against the wind or for distance only.

After about a week's daily practice has given considerable skill to the right hand, and the habit of a high back fly and the pause is pretty well formed, begin to educate the left hand as well, and after that practice both alternately. To be able to use either hand indifferently is a great accomplishment. Whatever is worth doing, is worth doing well. Begin and continue your practice with the fixed intention to become second to none in skill, and educate the left hand, with the right, as one of the steps in that direction.

Experience by this time will have taught that the line must be so thrown behind on the back cast, as neither to strike the caster nor the rod in its flight.

When the overhead cast is mastered, and you can get out fifty-five to sixty feet of line fair, straight, and light, and without much conscious exertion of force, and this with a high back fly and the proper pause, then you are ready for another step forward. Practise casting over the left shoulder for two or three lessons, and then casting sideways, *i.e.*, moving the rod horizontally or nearly so. The same principles govern success in

these as in the overhead cast. But first thoroughly master the overhead cast; these modifications will then seem a mere bagatelle.

Permit me to caution you in the most decided manner not to strive after a long cast, for this is the sure way never to attain it. Let this take care of itself. By no means attempt thirty-five feet, until thirty can be cast without perceptible effort, and that in good, cleanly fashion. Do your practising, after you have attained the complete mastery of forty feet, at that distance. At the end of the lesson take a couple of innings or so at forty-three to forty-five feet, thus making your distance practice an entirely separate and distinct thing. Hang to that distance until you master it completely and with perfect ease, and then, and not till then, add two or three feet and not more. Proceed in this way adding but two or three feet at most at each increase, and sticking to that until you master it completely before attempting more. At over forty-five feet you should devote at least a week to the next additional three feet, without a thought of anything beyond. Fifty feet is about the maximum fishing distance ordinarily employed; but by rigid adherence to these rules you will easily acquire command of seventy feet, provided you master the high back cast and the pause. Otherwise you will never be able to do fifty-five feet decently.

Remember that to cast sixty feet is not to boggle at fifty or fifty-five, with a line full of loops and projected with the force of a catapult, and then, by good-luck rather than good management, at last attain even seventy-five feet. This is mere botchwork, and nothing will more surely arrest progress than such misdirected efforts. He only can properly be said to be able to cast sixty feet

who can lay out a fair, straight, and light line to that distance, not once, but time and time again in succession. And let me assure you that very few proficient anglers can do this. Not that they could not readily attain this and more with practice, but simply because all the casting they do is done in actual fishing; and those who really understand themselves then proportion their means to their ends. Nevertheless, though to be able to cast a long line will, perhaps, make very little difference in the number and size of the fish taken at the end of a season, it certainly adds a very elegant finish to the angler's acquirements, just as a fine steeple adds to the beauty of a church. Having mastered thoroughly forty feet, so that the rod and line work with the precision of a machine, then comes the strike.

In swift water the fish generally hook themselves, but not so in still water. Here the strike must follow the rise, as its shadow follows a cloud. This too may be acquired without approaching the water, and must be practised until purely automatic. To acquire this the caster must cast, draw his line towards him, trailing it on the ground, and at the word "Strike!" from the coach, retrieve the line at once. The coach should use care to give the word at irregular times, so that the caster may not anticipate him. When considerable skill and promptness in response has been acquired, the coach should abandon giving the word, and signal the proper moment by dropping a pebble on the paper, standing close to it for this purpose. The instant the pebble falls, the strike should follow. Strike lightly if you can, but at all events strike quickly.

In actual fishing, strike with the line free to render from the reel, and thus compensate for undue violence.

For small fish or small flies a mere turn of the wrist is the proper and artistic thing, but for large ones this method is a delusion. Then you must "sock it to them." After all, promptness to respond to the rise, without a suspicion of hesitancy, is practically the important point.

In the spring of 1883, fishing was good where I was so fortunate as to be. And as is my custom, the locality permitting, we made a little pond in which to imprison and watch the fish taken. Again and again we filled the pond with trout, and after a brief confinement returned them to the water and liberty. At last a spring pond at no great distance abounding in minnows yet destitute of trout occurred to our minds, and we determined to stock it. Water transportation was available for the greater part of the distance, but the last two or three hundred yards was land carriage. Across this my guide John carried the fish in a tin milk-pail, his hat floating on the surface of the water therein contained, lest in their struggles they should flop out to their injury, for they were all good-sized fish and very lively.

Upon reaching the border of their new home the fish were completely exhausted by their struggles, and when placed in the water were quite content to breathe and rest, without an effort to move away. During the hour or more occupied in this portage—for the pail would not hold more than three or four at a time—I stood and watched these fish lying at my feet in not more than a foot of crystal water. Occasionally as they breathed a dead leaf would drift into the mouth of some one of them. For a brief second it would remain before its presence seemed to be realized; then it was shot out with a velocity sufficient to project it several inches through the water. I say shot out, and that phrase ex-

actly describes the suddenness of the operation. I then thought that thus does the trout reject the artificial fly when the deception is discovered, and realized how very, very brief was the interval in which advantage might be taken of a rise.

I have here laid out what I take to be about two months' to two and a half months' work. Certainly it can be compassed in a single close season. Access to water, I believe, will prove rather a drawback than an advantage, tending to distract the attention from the main object in view, the formation of a correct habit.

At the expiration of that period, I believe that two persons of average adaptability, each aiding the other, can with patience and perseverance, and by strictly following the directions contained in this chapter, become proficient in casting the fly to a degree not by any means common even among experienced anglers. True, this is not all of fly-fishing; but then the attention is thereafter free to devote itself to those lessons learned only from Nature's book, face to face with Nature herself. Then what the mind directs, that the muscles can execute, and thus the experience of years can be compressed into a comparatively brief period.

He who is complete master of his scales and intervals will have little trouble to learn to play a set piece; and so in this case the scales and intervals have been mastered, the hours of toil are over, and their reward is at hand.

The violin player sees a note on the written page. He does not stop to think "that is D, and must be played with the fourth finger in the third position." It is before him, and without a thought of what the note is or where it lies, his hand flies to the accustomed place, he

cannot tell you how. There is practically a sort of memory of the muscles, sometimes called force of habit, and it is this that the fly-caster must sooner or later acquire if he would reach even mediocrity.

It is as easy to acquire a good habit as a bad, and far more profitable. To aid the beginner in this is the object of this chapter. It cannot more fitly close than by reiterating once more, *remember the secret of success lies in the back cast.*

This chapter was ready for the printer when that day looked forward to with such impatience for the preceding ten months, the day when I was to depart for my annual six weeks in the Maine woods, arrived. Had any man told me the year before, when with a half-suppressed groan I disjoined my rod on the evening of the last day of the open season, that I should never wet line again unless beyond the river of life, I should have assented to its possibility. But had he said that before another season I should write a book on fly-fishing—a subject involving so much, and of which, compared with its extent, I know so little—I should have thought he was mad. Who can resist to the end the flattery and the solicitations of the friends he loves?

Many anglers of all grades in the art, from the lady beginner on the outskirts of the wilderness, to the finished expert within its inmost recesses, have passed under my observation, I know not without profit to me—I hope not without advantage to the beginner to whom I have addressed myself.

Casting is by no means all of fly-fishing. It is an art, and one not easy to acquire in perfection; but the greater part of the difficulty usually experienced is due

to a faulty beginning, and to vicious and pertinacious habits thus unconsciously formed.

I believe with even greater confidence than when it was written, that the system set forth in this chapter will, if followed with patience and perseverance, surely accomplish the desired result. As some acquire manual skill more readily than others, so will the degree of patience and practice required to attain this end vary with different individuals. But I sincerely believe that his or her clumsiness must be indeed phenomenal, who cannot, without a sight of water other than that in some domestic utensil, acquire the art of casting the fly with more than the average degree of skill in a single close season. Remember the secrets of its success lie in the friendly aid of a coach willing to be guided by its precepts, and in the back cast.

Some act and talk as though casting were the entire art of fly-fishing, and grade an angler solely by the distance he can cover with his flies. This is a great mistake and pernicious in its influence. Casting is but a method of placing the fly before the trout without alarming it, and within its reach. It is merely placing food before a guest. The selection of such food as will suit, and so serving it as to please a fastidious and fickle taste, still remain indispensably necessary to induce its acceptance.

Further than I have done in this book, and I am well aware how inadequate it is, I cannot advise what flies will please. The most experienced are often at their wits' ends in this respect, and if they find any solution at all to the problem in hand, find it where they least expect, and when, after having exhausted every resource of their skill, they leave the selection to chance rather than judgment.

But the manipulation of the fly after it has touched the water is quite another matter. Without undue violation of the proprieties it may be considered a part of the cast, and it is proposed so to treat it.

Nothing during the past season has more impressed me than the fact, if fact it be, that in no single point in fly-fishing was error more common than in this. Not so much where a strong current lends instant aid to the angler is this apparent; as in the fishing of pools and of still-water—the very places where the best fish are usually to be found. Nor is it a fault of the beginner, but rather of those whose proficiency is otherwise considerable.

To such, if any, who with limited practical experience may become facile casters by following the precepts of this chapter, a careful consideration of the following problem is recommended, for they stand in a position of special danger. The problem is:

1st. To place the fly within reach of the trout without alarming it.

2d. So to handle it as to simulate a living creature, and one tempting to its appetite.

3d. To do this in such a manner that if the fly is touched, the trout shall infallibly be fastened.

It is neither to the first nor to the second of these points that I would call attention. But the third is well worthy the study of every angler, old or new.

Confining our attention to pool and still-water angling, it is rare that a trout, unless gaunt with famine, takes a fly the moment it touches the water, and then only when the stratum which intervenes between it and the fly is shallow. Taking any season through, and I am inclined to think that at least ninety-nine out of every hundred

trout captured in such water, will be found to have taken the fly after it has been moved from the place where it first fell. It is also true that in such water some demonstration on the part of the angler is usually necessary to fasten the hook after the fly has been taken, or it will be rejected and the opportunity lost; also that the interval during which this may successfully be done is brief.

Now it is mathematically certain that when the rod is at a right angle with the line, a given movement of the tip of the rod will transmit its impulse with the greatest rapidity, and with the maximum of effect, through the line, since then there is the least possible lost motion. It is also certain that when the rod and line form one straight line, a very considerable upward movement of the tip is followed by but slight retraction of the line; there is then much lost motion, and consequently the impulse is tardily conveyed to the hook.

It is equally indisputable that when the rod is so raised that the line is parallel with it, or nearly so, all command over the former is gone; the rod has already shortened the line all it possibly can, and the power to strike is lost.

The problem is a most simple one.

Let us suppose the tip of the rod to be pointing at an object exactly forty feet distant from it. Now suppose the tip to be raised three feet, the end describing in so doing the arc of a circle of which the hand is the centre, as in actual fishing. Clearly, now, that end is more distant from the assumed point than before, and more line would be required to reach it; or, in other words, the line, if it did not break, must either stretch or move that difference. Thus a theoretical measure of the efficiency

of the "strike" at any angle of the rod may be obtained. Construction of the proper diagrams will also show that the strike becomes less and less efficient as the length of the line increases, and also as the hand actuating the rod approaches the level of the water.

I have said *a theoretical measure*, and advisedly, since we have been treating the fly-rod as though it were as stiff as a telegraph-pole. Clearly we must take its flexibility into account, since before the movement of the tip can overcome the inertia of the line and the friction of the water upon it, the rod must bend until the tension of its elasticity is in excess of that inertia and friction combined. Thus we see that another deduction must be made from the efficiency of the strike, one rapidly increasing in amount as the length of line, and its consequent inertia and friction from contact with the water, increases.

Based upon these considerations was the suggestion heretofore made, that a cast of five and a half times the length of the rod approximated closely to the extreme efficient limit in practical fly-fishing—assuming the caster to be wading knee-deep or sitting in a fairly high-sided boat. A quick eye and a prompt hand, trained by long practice, may extend this distance somewhat, but I believe not much. The stiffness of the rod used is also a variable factor effecting the result. I therefore personally prefer a rod as stiff as is consistent with pleasurable casting. Furthermore, it was with these considerations in view that I have, in the Chapter on Rod-making, sought to give all emphasis to the direction, so to proportion the lower part of the rod as to give absolute command over the tip.

If our mathematics are correct, the following practical conclusions would seem necessarily to follow:

1st. Invariably use as short a line as circumstances will permit.

2d. If it has not been done in the cast itself, at once elevate the tip of the rod until it forms an angle with the line, and let that angle be as near a right angle as the length of line in use and the reserved movement of the rod required to manipulate and retrieve the flies will permit.

3d. By no means draw the flies so far towards you as seriously to impair, much less altogether to lose, the power to strike. In either case you will almost certainly lose your fish, and in the latter your rod will probably be shattered.

The fault, or I should say faults, for there are two in number, notice of the prevalence of which impelled me to add to this chapter, are,

1st. A tendency to use an altogether unnecessary length of line; or, in other words, to shirk good water within distances in which the advantage would be with the angler, to fish more distant and less promising places at a disadvantage.

2d. Postponing the back cast until the power to strike is nearly or quite lost.

I repeat, that he who has acquired the knack of casting with facility, without other and further knowledge of the art, is almost sure to err in these respects. I cannot too strenuously urge this upon the attention of the beginner. If the fish are very shy, the pool promising, and to be fished from the bank, cut a bush your own height; approach the pool slowly, holding it between you and where you suppose the trout to lie, and when you have reached your station rest the butt end on the ground, supporting your blind with the left hand. When a fish is fastened get

him into barren water as soon as possible, following him still, if you can, under cover of your blind. A very slight cover and the avoidance of quick motion are sufficient to insure success, if the fish are disposed to feed.

Perhaps it may not be out of place to narrate exactly under what circumstances this addition to the present chapter was decided upon.

John and I were fishing for large trout at the outlet of a lake in North-western Maine. The wind drew up the outlet with sufficient force to make it advisable to anchor our boat pretty well down, and cast up into the lake. The strait was shallow, but the water rapidly deepened within the lake, forming a horseshoe-shaped bar, the convexity towards us, over the edge of which I cast into the deep water and drew my flies towards the shallow. The fishing was not very fruitful, but still it was a recognized haunt of large trout, and one might be expected at any moment. Soon a new-comer approached with his guide, skirmished around the shore of the lake so as not to disturb the water, anchored near us, for there was plenty of room for two to fish, and began to cast. He was a superb caster. As he sat in the boat, his flies soon touched the water at a distance I then estimated at not less than seventy feet from him.

There was no bungling about it; his flies went out before and behind as fair and straight as it is possible to cast that length of line under like conditions. He was clearly a master of the art. For about half an hour he ranged his flies over that water, at distances varying from fifty-five up to, I believe, over seventy feet. He got no rise, became discouraged, pulled up his anchor, and moved to seek better fortune elsewhere.

“That was elegant casting, John.”

John, before whom as guide hosts of anglers of all grades had passed in review year after year, "sized" it in a moment.

"Yes, it was elegant casting, but it was mighty poor fishing, all the same."

For consider it a moment. The fish cruised in deep water around the break of the bar. That was where they concentrated, coming from all directions down the lake. There, too, the water was not so deep but that a slow-moving fly might tempt them from the bottom itself. This water, the very cream of the whole, was utterly ignored. His flies lit where the depth was not far from twenty feet, beyond the possibility of tempting anything not considerably nearer the surface than the bottom. Again, the fish were working from all directions towards the outlet, and consequently the chance of one being there within the reach of his fly was mathematically far more remote than at the bar itself. Also, with that length of line, had he allowed his flies to rest a moment on the water, it would have been impossible to retrieve them for the back cast. They but touched it and were off. Large trout seldom, if ever, take a fly with the dash of a four-ounce fish. They at all times, till the sting of the hook galvanizes them into action, comport themselves with dignity, and their movements are made with a consistent deliberation. There was hardly a possibility of his taking anything in that way; and so John justly characterized it when he said, "It was elegant casting, but mighty poor fishing, all the same."

It may, however, be that the gentleman was merely amusing himself, and showing us how he could cast. If so, "I take off my hat to him," for anything more elegant in that line I have seldom or never seen.

In regard to the second fault in our enumeration, that of postponing the back cast till the power to strike is impaired, there is a way to surmount it, which, though it may be in common use in some localities, I have never seen employed except by the gentleman from whom I borrowed it. For it may well happen that, when the angler would prefer to take his flies off the water, he has reason to suppose a trout is on the way to them. If the fish is a large one, the probability of coaxing a second rise may be doubtful. It is not wise to arrest the motion of the fly, since one has been formed that is attractive, and who can tell, if it halts, whether he will not follow suit. So the temptation to postpone the back cast becomes almost irresistible, usually entailing the consequences of yielding to temptation.

I can give a case in point, and from my own recent experience.

September of 1884 was decidedly an off month in Maine waters. The weather held on warm, and the customary cold rains held off, in a most exasperating manner. So the big fish held off too. John and I made up our minds to follow them to where they lived. It was a tough job, involving lots of hard work, poling a light canoe-shaped boat over rapids, paddling it over pools, and lifting it over or crowding it under the numerous giants of the forest, which the winter gales of years had uprooted and thrown into the stream. Thus we traversed some three miles of a river which, as far as known, had been fished but once before, and that five years previously. It was the perfection of a trout-stream—clear and cold, a succession of deep pools alternated with rapids, while the primeval forest through which it took its way shaded the waters, and furnished

with its ruins abundant cover. Above and below I knew the stream well, and hundreds of trout had taken my flies therein.

The descending sun warned us that we would be benighted in the woods before we could regain our camp, as we entered the foot of the pool which we determined should mark our return. Yet not even one single rise had I had all day. It may be they had abandoned that portion of the river on the way to their spawning-beds, or they may have taken a pledge of total abstinence; but whatever the cause, such was the result, and a sufficiently aggravating result it was. For we had footed it four miles through the woods, and had forced a boat through some six or seven miles of quick water, the latter part greatly obstructed, and had cast all day long at every available opportunity, and had as yet caught nothing. A like return intervened between us and both food and shelter.

We entered the pool, the canoe gliding slowly over its placid surface under the impulse of John's skilful paddle. The still water was perhaps a hundred and fifty feet long, some seventy-five feet wide, and of unknown depth. Over and among "coarse rocks" the river poured in a heavy rapid into its upper end, and left it in the same manner. Surely few pools approach more closely the angler's ideal. The overhanging forest forced us to take pretty well to the middle; that there might be room for the back cast, and the position of the canoe compelled a cast somewhat ahead rather than abeam, in order that the fly should light where the trout, if any, might be expected to lie. The motion of the boat in the direction of the cast continually tended to slacken the line, for which compensation had to be made by abbreviating the time

during which the fly was allowed to remain on the water, by accelerating the motion of the rod when moving it, and by abridging the length of the cast.

At last I saw a gleam of gold down in the depths, and a trout appeared wagging his way upward towards my fly, with the deliberation characteristic of trout of size in those waters. As he approached the surface, his vivid colors proclaimed his sex through the crystal water, and I was enabled to gauge his weight at about five pounds. Clearly he was a nice fish, and I assured myself of from twenty minutes to half an hour of such sport as would fully make good the labors and disappointments of the day.

But the time for the back cast had come, and he had not reached the fly. What was to be done? If it were taken from the water, and he turned to go back after seeing me, as he must do, and especially after seeing the motion incident to the back cast, there would not be one chance in ten of coaxing him up again. So, hoping that he would take it before the power to strike should be utterly gone, I reduced the motion of the fly to the minimum, and awaited the event.

At last he reached it, and the fly vanished. Then I struck with the vigor rendered necessary by the disadvantage that I was under, and stimulated by the consciousness that I had committed a stupid blunder. He turned downward, the bamboo doubled up, and the reel sang. In a moment the sound ceased, the rod straightened itself, the fly came back to me empty handed, and he was gone.

No offer could have been fairer, and I could not for a moment blind myself to the fact that the loss was clearly my own fault. So I fell to abusing myself in no meas-

ured terms. Now when a man attacks himself he is sure to get the worst of it; so John, who at heart was doubtless as much disappointed as I, came to the rescue, and exercised his ready wit in the invention of excuses. But I silenced him with, "John, you know you are just as much disgusted with me as I am with myself. You know that that fish was lost by my own gross stupidity; there is really no excuse for it, not even that I knew no better. There, let us drop the subject and go back to camp. I am through fishing, at any rate for to-day."

Emergencies of this character arise continually in the experiences of every angler, especially if he fishes much in strange waters where he seeks to locate the trout by casting from a moving boat. The following is a remedy:

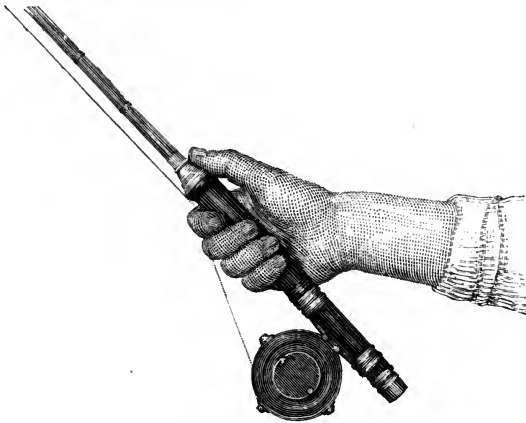

Fig. 85.

The rod should be so held that the line leads from the reel over all the fingers of the hand employed, except the

first. Under that finger it passes, so that it may be compressed against the handle of the rod and checked at will, or relaxed, and allowed to render from the reel, by partially opening or tightly closing that finger.

Now when the angler has reason to believe a rising fish will not reach his fly before it ought to be taken off the water, or when he has overcast a choice spot, and cannot draw his flies across it without wholly or in part losing the power to strike, if he will arrest his rod when in the most favorable position, and then seizing the line with his left hand near the lower ring of the rod, draw it through the rings, being careful always to nip it with the first finger of his right hand when he shifts his left for a fresh hold, he can thus keep his fly still in motion, even to the extent of all the line he has out, and at the same time always retain unimpaired the power to strike. After the fish is fastened, he may be played upon the slack-line hanging between the lower ring and the reel, by allowing it to render between the thumb and finger of the left hand, thus keeping up the required tension. In this manner he may be brought to the net if small; while if of such size that a protracted contest is to be expected, the slack-line will probably be wholly taken up by his first dash, and the angler will have him upon the reel, thereafter to be played in the usual manner.

This point I consider of great practical value. Hardly a day passes in my own fishing that I do not resort to it more or less, and by it I have taken many nice trout that otherwise I believe I should have lost. I should have resorted to it at once in the instance cited, and the consciousness that had I done so the result would probably have been different, was harder to bear than the loss of the fish.

CHAPTER X.

FLIES AND FLY-FISHING.

DIRECTIONS for fly-making have been given in nearly every book on angling. I can add nothing new to what has already been said time and again on the subject, and therefore pass it by.

Considerable difference of opinion exists as to how closely the artificial fly should resemble the actual insect. At best the similarity is by no means striking; still the question remains, is it worth while to strive for it at the increased cost of money or labor necessarily involved. On this point fly-fishermen of experience are pretty equally divided.

In my opinion both parties are correct; sometimes and in some localities it being advisable, while in others it is not. This is fairly debatable ground, for our only appeal seems to be to experience, or, in other words, to the individual opinion which each angler may have formed from the experience he has had. The circumstances under which experience is gained are so important an element in determining the value and the applicable limit of the teachings derived therefrom, that divergent opinion must necessarily follow. It may well be conceived that he whose angling has been confined to much fished waters, and he who habitually fishes far from the haunts of men, where trout are both numerous and uneducated, would differ in experience, and consequently in opinion.

We must remember that our horizon does not include the whole habitable globe. It may rain in the State of New York, while the sun is shining in full splendor elsewhere. The truth is there are few points in regard to fly-fishing of which it may justly be said this is right and that is wrong irrespective of attendant circumstances. As the inhabitants of the Eastern States differ from those of the West or South, so the fish of different localities differ in habit and inclination. The most killing flies on the Maine waters would scare the trout of a Pennsylvania brook into fits. We know next to nothing of the causes which influence the conduct of fish. To-day they will take any kind of humbug greedily—to-morrow, without apparent change of conditions, they act as though it were a solemn fast, and ignore every form of temptation. To-day they swarm—to-morrow they have vanished. Every angler can recall many instances of this kind. I remember, six or seven years ago, I went out on one of the piers which support the "Upper-dam" of the Rangely Lakes. Before I could joint my rod, up rolled one of those gigantic trout for which that locality is famous. A swirl in the water like that from the blade of an oar, and the sight of a tail as broad as my hand is long, set me to work without unnecessary delay. From about nine o'clock in the forenoon until late in the afternoon I cast, except for a hurried lunch, without a moment's cessation. Twelve rods were at work within sight all this time, and except a comparatively little fish of three and a half pounds which fell to my rod, not another trout was taken during all that time; yet these large fish were constantly rising throughout the day. This is by no means a solitary or unusual instance. Every one accustomed to those waters has seen the same happen

again and again. Indeed I have come to regard it as an unfavorable indication for sport when the large trout roll to the surface freely. I have heard many reasons assigned for this, but I notice that the confidence with which these are asserted is in inverse proportion to the opportunities for observation of the asserter. The really experienced freely confess themselves altogether at a loss to account for this state of affairs. For some reason or other that the fish will not bite is apparent, but why has so far eluded investigation. I know that some brook fishermen will jump to the conclusion that these trout are then feeding on gnats, and that with such flies they might then be taken. Let me assure such, that the angler's golden rule, "If one thing don't work, try another," is not altogether unknown to the Maine fishermen. Flies of all sorts and sizes have been tried under these circumstances together with every wile known to fishermen (except a shot-gun), and all in vain. Indeed I have heard of one gentleman who, driven to desperation, discarded the fly and took to bait. Three hooks were attached to his line, armed respectively with a mouse, a piece of salt pork, and a raisin.

Again, two years ago, I went with a friend up the Magalloway River, in the same State, above Parmacheene Lake. It seemed as though one could easily catch a tubful of trout that day. Using but a single fly, we stopped at one hundred and fifty apiece long before the day was done, returning all to the water except the few which were injured beyond recovery. They were small fish, few above a pound and a quarter or below half a pound. Two days afterwards I accompanied some friends, then visiting that region for the first time, over the same ground. No rain had fallen, and the height of the wa-

ter was unchanged. That, and the intervening day, were fair, and as like the day first mentioned as one pea is like another. Yet though we really worked hard, and devoted the entire day to it, the total catch of the whole party would hardly amount to two dozen. Never in all my experience there had I seen such an utter failure of sport. Why was it? It was not because we had fished the place out on the first occasion, since we did not then kill twenty fish altogether, nor had the stream been fished in the mean time.

For years, between the 10th of September and the 1st of October, the outlet of that lake has invariably been as a bank, on which one could always draw for large fish, with the certainty that his efforts would be honored. Yet last year the utmost diligence was fruitless. The large fish did not "show up" there at all, those that were taken being found at other, and hitherto not very fruitful localities. It was not because the fish were gone, since they swarmed in the preceding spring; and during the very time when they were so misusing us, they could be seen and heard on any still evening breaking into and through schools of minnows all over the lake. Again and again I have had excellent fishing in the morning, while the afternoon spent in the same places has been quite barren, and *vice versa*.

I have at times thought I knew something about the habits of trout, and that I could approximate in the morning to the probable sport of that day, but I now freely admit I know little or nothing about them. That trout are governed by something it is reasonable to suppose; but why they should throng together at one time and vanish at another—why they should take the most transparent fraud on one occasion, and with-

in a few hours refuse everything, not only flies, but live and dead bait as well, and this without any apparent change of light, air, food, or water, is a problem the solution of which I have often attempted, but always in vain.

And so it is with regard to flies. A very few varieties, probably not over seven or eight at the outside, will answer every purpose, and any increase in this respect is useless lumber—always provided, however, that the angler fishes in but one locality. I know many writers have expressed the same view before me, but always, as far as I can recollect, without this, as it seems to me, all-important proviso. It by no means follows, nor is it the fact, that the flies which kill in one State will be equally efficient in another. On almost every water some one fly will for a time prove superior. How long this will last no man can tell. It may be for years, and it may be for a single season, or for but a few days, or even for a single occasion only. The form and colors of this are by no means invariably a copy of any natural insect then upon the water. Not only may it differ from these, but it may be quite unlike anything known to the most profound in bug-lore; indeed I am inclined to think the latter is far more frequently the case. But conceding, for the sake of argument, that trout are as discriminating as an entomologist in reference to form and color, how can we deny their utter ignorance of, or indifference to, the manner in which winged insects comfort themselves upon the water. Discarding for a moment the enthusiasm with which we all regard everything pertaining to the art, and descending to the basis of cold fact, who ever saw a real insect light upon the water, and then rush across it with the energy of a broker's clerk seek-

ing to make a delivery, when the hand of the clock is but a hair's-breadth from the hour which will mark his default. The truth is we cannot, with any appliance in common use in this country at all events, even approximate to the usual motions of a fly when upon the water. We do, however, imitate somewhat the action of a minnow or water-bug. Again and again has the doubt intruded itself on my mind, whether trout regard the artificial fly in any other light than that of a living thing small enough to be eaten, without a thought as to what portion of the animal kingdom it may belong.

No living man can say, when upon unfamiliar waters, what fly will prove most alluring. The greater his experience the more tentative does he consider his first efforts. He then makes up his cast to resemble, for lack of other guidance, as nearly as his facilities will permit, both in size and color, those flies he may observe upon the water. Failing this, he is governed by the appearance of the sky and water. If it is a bright day and the water is clear, he selects dark flies of small size. If the sky is overcast and the water turbid or brown in color, those chosen will be larger, lighter colored, and more gaudy in hue. Color is a very important factor in the choice, perhaps the most important. He therefore makes up his cast of flies, the colors of which contrast sharply with one another, until he can ascertain which best suits the fickle fancy of his game.

Therefore, for one who fishes in no fixed locality—for a cosmopolitan angler, so to speak—a well-stocked fly-book, containing many varieties and of various sizes, is not at all to be decried. The veteran angler never neglects when about to fish unknown waters, to interview and question some one who has fished there, if such can

be found. If not, he resorts to his host, or anybody else who seems able to afford information.

Every stream has its own peculiarities, not only as to the most successful fly, but as to the habits of its trout as well.

Some years ago, when I knew more about fly-fishing than I ever shall again, I made a fishing trip to Tobyhanna, in Pennsylvania. I had frequently fished streams within thirty or forty miles of there, and supposed I at least knew where to look for sport. The weather was propitious, rather showery perhaps, but still a good fishing day. The stream was a wading brook of brownish color, quick water being succeeded by still reaches, apparently stagnant. I fished the rapid water with care and indifferent success. The still waters, though they were less obstructed and easier to cast over, I ignored altogether, because the look of the banks and the water indicated a muddy bottom, and I then believed trout never frequented such localities. When I returned in the evening to the hotel, I was astonished to no small degree when the landlord informed me that these were the very cream of the whole fishing. Nor was this all. I found that the small, sober-tinted flies I had been accustomed to were next to worthless, and that flies larger than I supposed were ever successfully used for trout, and much more gaudy in color, were needed in those waters. These revelations had not a little undermined my self-confidence, but its utter annihilation was reserved for the next day. I then met my landlord on the stream. I was casting in what I considered very fair style, and when my flies lit upon the water I drew them diagonally across the stream, the droppers just skimming the surface. I had then never seen nor heard of any other method of ma-

nipulating artificial flies in trout fishing, and that this was not the only proper manner to display them at all times, in all places, and under all conditions, I had never entertained the most remote suspicion. After feeling his way with some caution, in order to be sure the suggestion would not be deemed officious, he said, "That method of handling the flies may be all right on small streams and in clear water, but here it is next to useless." Had he told me that the flies should be displayed on the bank, rather than on the stream, I could scarcely have been more astonished. Utterly demoralized, I surrendered the rod, and asked for a practical exhibition of his method. The first cast at once indicated the expert. The flies lit lightly on the water, and there remained for at least thirty seconds, without other motion than that they gradually sunk below the surface. Then he drew them towards him by a series of very slow and short pulls, each separated by a brief pause from its predecessor, till near enough for another cast.

That trip, though the net result in the way of fish was nothing to boast of, was one of the most remunerative fishing excursions I have ever made; for I then learned to be extremely diffident when strange waters were under discussion, and invariably to listen, with at least apparent patience and respect, to the suggestions or views of others.

Though the method I then used is undoubtedly correct as a general rule in clear waters, at least if of no great depth, it is by no means invariably, or even usually, advantageous in the brown-colored waters of which so many of our trouting streams are composed, especially on deep pools.

One of the most marked cases in point is the Rangely

region of Maine. I dwell somewhat at length on the, as I believe, proper method of fishing there, at least for large fish: first, because I think it the best readily accessible fishing country; and secondly, because from my own personal observation it seems not generally known to, or at any rate practised by, many of the anglers who visit its waters. The local guides are accustomed to the society of gentlemen, and have, as a general rule, gentlemanly instincts. They are usually anxious to please their temporary employers, and spare no pains to afford them the best possible sport. Ignorant how great their confidence may be in their own skill, as well as in what spirit suggestion may be received, they make it an invariable rule never to comment in any way on the manner in which they fish, except in response to a direct question. Even then their answers are couched in terms so modest as not always to have the weight they deserve.

It is not to be forgotten that these men possess powers of observation sharpened by constant exercise from their earliest boyhood. Year after year, from the beginning of each open season to its end, and upon almost every day of the season, fly-fishing is constantly going on in their presence. Their employers frequently change. They see not only the methods employed by the many gentlemen they may happen to be with from time to time, but also those used by the sportsmen employing their comrades, and when off duty these are frequent subjects of conversation among them. Thus they are familiar with every phase of the art, have seen each practically tested, and know its value. As might be supposed, they are all skilled anglers.

He who had passed one entire season in daily fishing in that locality, would believe himself, and others would

consider him, entitled to speak with authority on whatever pertained to the sport there; yet his range of observation would be much narrower than that of these guides.

I have not jumped to the conclusions stated below. Though my personal experience amply confirms them, it is not so much my own views that I am about to express as those of the guides, in which, I believe, they are quite unanimous.

The matter first came to my attention in the following manner: During the first of a companionship in which some of the happiest moments of my life have since been passed, I was fishing under the tutelage of that well-known guide, John S. Danforth. I asked him, "John, who catches the most big fish of any sportsmen who come here?" He replied that a Mr. S——, of Boston, was the most successful in that respect. I asked him how he handled his flies, and made him show me, rod in hand. But a single fly was used, and that large—one tied on a No. 2 Harrison Sproat hook is none too big. The fly was cast fair and straight, allowed to sink six inches or even a foot where it fell, then it was moved very slowly three or four feet, then followed quite a pause, when it was again put in motion, drawn slowly to within convenient distance for the back cast, and taken quietly and smoothly from the water. The main points were to keep the fly below rather than on the surface, and to move it slowly. Better fortune at once attended the adoption of this system, especially in the size of the fish taken.

Those having the best opportunities of observation think that in that region the large fish are not surface-feeders, at least on insects. Of course every one has seen

them, when in the twilight the lakes are unrippled by a breeze, and the slightest dimple of the mirror-like water is conspicuous—every one has then seen large trout dash from underneath through a school of minnows playing on the surface. For large trout to roll up during the month of September is also of frequent occurrence. But I believe no one has as yet fathomed the cause of this. The most careful observations fail to show that any food is then taken; and, as I have said before, it is by some regarded as an unfavorable indication, as far as successful fishing is concerned. But I have no recollection, in ten quite protracted fishing excursions to those waters, ever having seen a trout of over two pounds take a natural fly at all, nor have I ever seen a trout of over four pounds take the artificial fly or even a bait on the surface of the water. It may happen, but it is certainly by no means common. Small fish up to two, or even two and a half pounds, may readily be enticed to take a fly manipulated in the usual manner; but if the larger fish are desired, and a surfeit of the smaller is soon had, a large fly must be used, and it must be moved slowly and somewhat below the surface, the deeper the better.

In this manner of fishing a fair cast is absolutely indispensable to success. The line and leader must fall perfectly straight, and the spring of the rod must be upon them at all times when the fly is in the water. By this I mean, that the tip of the rod must always be raised while the fly is in motion, so that should the fly be arrested, the rod will at once bend and throw its spring on the line. Not that the angler is to rely in the slightest degree on feeling the fish; his eye, and his eye alone, is his guide.

The period of time during which the strike may be successfully delivered is very, very brief. Large fish do not come to the fly with that "bounce" which is so delightful a characteristic of their younger brethren; they feel the dignity of their years and experience, and move with calmness and deliberation. He who there or elsewhere expects to take the larger fish with the fly, without patience, perseverance, and skill, will be disappointed. My experience has been that the largest fish of a water, whether scaling ten pounds or but half as many ounces, is cautious, deliberate, and difficult to deceive, while any one can take the smaller ones, be they fingerlings or two-pounders; and I believe this experience is general. Smaller fish will come again and again to the fly, but not so the large ones. These may rise once, but if the opportunity is lost, it is seldom, indeed, that they can be induced to make a second offer.

The notion prevails among those whose knowledge of the Rangely region is derived solely from guide-books and newspapers, that there eight-pounders swarm, and that any number of chances from such may be had in a single day's fishing. This is a delusion. The large and the small fish do not, as a general thing, frequent the same localities, at least at the same time. The angler must choose whether small fish will be sought, with reasonable certainty of getting plenty of them, or large fish, with very dubious prospects of success. It is to be remembered that it is only exceptionally good-luck which is ever made matter of record; it is human nature to be silent as to its failures.

The plain truth is, that if an angler there succeeds in attracting one eight-pounder in eight days' fishing, his luck is decidedly above the average. By trolling, the

chances are somewhat increased; but that has little attraction for the fly-fisherman. No man, however, can tell when his opportunity will come. The very first cast may be the lucky one.

In September, 1884, a gentleman took a trout in Rangely Lake of a fraction over nine pounds in actual weight, not only at almost his first cast in those waters, but also at his very first attempt to use the fly at all in fishing—and this directly under the noses of many expert and locally experienced anglers. It was a bitter pill to them, and though it was swallowed, it was not without many a grimace and much railing at fortune.

Fish may be had, but the big ones seldom at the best. Therefore it behooves him who would boast of the capture of a large trout (and it is a thing to boast of), to remember, "if he wants to catch any fish, he must keep his line wet," and be patient and persevering. His vigilance must never flag; ever expecting the very next cast may draw the wished-for prize.

The eye must never for an instant stray from the fly, and at the slightest commotion in the water near where the fly is, or where it is supposed to be, strike at once and strike hard, for the friction of the water on the sunken line and leader will neutralize a feeble demonstration. The delicate turn of the wrist of the books sounds well and has its sphere of usefulness, but it is not here; therefore I say again strike, strike promptly, and strike hard, but let it always be from a free reel that an excess of force may be neutralized. Or, if you can see your fly, watch it carefully, and should it disappear, strike without the loss of a single instant. The critical period is during the intermediate pause or just after the fly again begins to move. Not unfrequently

have I seen at this stage of the cast a large fish rise slowly to the fly and take it in. As far as feeling him was concerned, he might as well have been in another county; then the eclipse of the fly alone indicates that he has it, and you must act without the delay of a fraction of a second or the chance is gone.

Locate your boat first, if you fish from a boat, as is there usual; or, if your stand is ashore, take your stand. Then allow some minutes to elapse that any alarm occasioned by your approach may subside, after which begin. Start at about thirty or thirty-five feet, and cast around your position, directing the fly at each cast about six feet to one side of where it last fell, and so cover the water like the rays of a fan. When one circuit has been completed without a rise, lengthen out about six feet, and beginning at the same starting-point repeat. Continue this until you have all the line out you can cast perfectly straight every time, and do not go a single foot beyond. Should, however, a distant rise be seen, yet within reach, go for it, but in the following manner: Lengthen the line in the usual way, but without allowing the fly to touch the water. When enough line to reach is out, let the fly settle, and elevating the point of the rod well, reel slowly in. To retrieve the line by the back cast will be impossible, if the fly is left long enough in the water to tempt the fish. I repeat, in this fishing more than any other, it is indispensable to success that the line fall absolutely straight. The fish will not hook itself, nor will it afford time to gather slack line before it rejects the fly.

Nor should discouragement follow because success is deferred. In the month of September, as far as I have been able to observe, these large trout are in almost con-

stant motion, slowly cruising about some fixed locality which they have selected for their spawning bed. For an hour or more not a single fish may be within reach, yet the next ten minutes a dozen may have approached. Fishing over or near a spawning bed is worthy only of a poacher, in the opinion of most anglers, but in the Rangeley region, during June and September alone the large fish frequent water shallow enough to subject them to the temptation of the fly. But twenty days of the latter month are available, and then nature has thrown about them the protection of a most fickle appetite. If all the large fish caught in the month of September were fairly taken with bait or fly, the loss would be but trifling, while the annual stream of ready money, which the often delusive hope of taking a big trout brings into this remote part of that State, otherwise so little blessed by nature, is of the utmost importance to its scanty but deserving population. Therefore the State of Maine permits fishing till the first of October, and in so doing few will question that it does wisely.

After having been in position for half an hour or so, if in a boat and moderate quiet has been preserved—that is, if there has been no concussion upon its sides or bottom—reel in short and try close to the boat, particularly on the shady side. Here let your fly sink pretty well, and draw it slowly to the surface; for the fish love the shade, and are apt to settle there.

The foregoing is the only method by which I have ever known a fish of over four pounds' weight to be taken with the fly. Occasionally one may rise at and take a fly on the surface, but I have never known or even heard of such a case. I have heard not unfrequently of such rising to the fly of an angler who habitually fished

by drawing his flies over the water in the usual manner; but on investigation it has invariably appeared that the rise took place after he had become discouraged, or when his attention was elsewhere, and that at the time his flies were lying idle and were submerged.

In so far I believe I express the unanimous opinion of the guides of that region. We now enter on more debatable ground.

I strongly prefer one fly for this fishing to a larger number. When first struck these large fish seem utterly uncontrollable by any tackle such as anglers use. Not that they move so rapidly, for their motions are even then, when life itself is at stake, rather deliberate; but there is a power in them that seems irresistible. If any obstruction is near, how heartily does the angler then wish he was rid of that second fly. Besides, these large flies are difficult to retrieve, if they are allowed to sink as they should; and if the resistance of a second is added to that of the first, the range of the cast is considerably diminished. Still there are times when a second fly does good service. It is not uncommon to take a smaller fish on one fly, and for him to tow the other through the water, and thus tempt and actually fasten a much larger fish. It is not very sportsmanlike, but when large trout are known to be within sight of the fly, and they stubbornly refuse to be tempted, this has been tried with success.

What flies take best in those waters? There is a wide divergence of opinion as to this; still I will give my own for what it is worth.

My first favorite is the "Parmacheene Belle." Perhaps I am too partial to this fly, since it is in a measure my own child. John and I seldom fish between half-past eleven and four o'clock. That interval is passed

prowling about the woods, or shooting at a mark with a rifle, or in some other similar way. Often the fly-tying box is produced, and the word is, "Well, John, what shall we tease them with this afternoon?" Thus, on joint suggestion, very many different combinations have been tried, and so some seven years ago was the "Parmacheene Belle" born. It was a success, and since then I have used it four-fifths of the time when fishing the head-waters of the Androscoggin River. It somewhat resembles the "No Name," figured opposite page 87 of Orvis & Cheney's book, "Fishing with the Fly." The body is lemon-yellow mohair, wrapped with silver tinsel; tail two to four strands of white and scarlet; hackle white and scarlet (I have sometimes wound both hackles on at the same time, and sometimes the white first and the scarlet afterwards, and over the white, capping it as it were; the latter is the better); wings white, striped with scarlet, the white decidedly predominating.

Unless I am deceived, these large trout take the fly not as an insect, but as some form of live bait. If this is true, an imitation of some favorite form of food is in itself sufficient under all circumstances, provided it is so conspicuous as readily to be seen. To test this theory the fly in question was made, imitating in color the belly-fin of the trout itself.

Place the whole catalogue of known flies on the one hand, and this single fly on the other, and force me to choose and confine myself to that choice, and for fishing in those waters I would choose the "Parmacheene Belle" every time. I have tried it in sunshine and rain, at noon-day and in the gloaming, and at all times it has proved successful.

My second choice is the "Brown-hackle," the only fly

I believe good in all waters. If I cast two or more flies, except of course at dusk, the Brown-hackle is almost invariably one of the droppers. It is too well known to require description.

Next is the well-known "Montreal," with crimson body and hackle, gold tinsel, scarlet tail, and turkey-brown wing.

Fourth in order comes the "Silver Doctor." This fly should have a mixed wing of yellow, white, scarlet, and mallard, not a wing in which turkey-brown predominates. The body is all silver, the tail yellow, and the hackle blue capped with guinea-hen. It is a most astonishing combination to that angler who has been accustomed to the sad tints of the more killing flies of the Middle States. But it may be said here, that none of the taking flies of the Rangely region bear the remotest resemblance to any insect there, or, I believe, elsewhere to be found. Nay, further, imitations of the local insects are there comparatively quite unsuccessful.

Next (rather on the strength of the experience of others than my own, for I have used this fly but little) comes the "Katoodle Bug," as made by Mr. Whitney, an old and experienced local guide. As I recollect it, the body is yellow for the lower, and a light cinnamon-brown for the upper half, scarlet tail, round gold tinsel, ordinary natural red hackle, and turkey-brown wing. The body is quite fat, as should be all flies for these waters.

Lastly come the "Yellow Professor" and "Grizzly King," both too well known to need description. If the wings of these are made of two separate mallard feathers, set with the concave side outward instead of in the usual manner, they are greatly improved. In the air such a

fly is not attractive, but handle it by a series of short, slow jerks a little below the surface of the water, and its wings will open and shut so that it really appears to swim—a process which seems amazingly to strike the fancy of large trout.

With these flies tied on a hook of the same size as a No. 5 Harrison Sproat hook, for small fish, and on the same sized hook as No. 2 of that make for the big fellows, I consider an angler well fitted out. A greater variety is quite useless.

And here let me caution you once more, if you propose to fish these waters, or any others in which large fish may be had, never put a leader to your line which has not been tested since it was last dry and stiff. Dry gut will crack if bent, and the better and more elastic the gut, the greater will be the injury caused by such a mishap. These cracks in a leader defy the closest inspection, and their presence or absence can only be determined by a test of its strength.

In these waters a guide is essential to the stranger if he wishes good sport; for, as a general rule, one place, as far as surface indications are concerned, looks as well as another, and the best fishing-grounds are and have been discovered only by actual trial, rod in hand. These the guides know of course, and they will place their sportsman where the chances are then best.

Such as are reasonable in their expectations, and not over conceited, can have good sport in this region; but let me strongly advise him who goes there for the first time, at least, to place himself in the hands of his guide without reserve. Say to him, in such terms that he will not doubt your sincerity, that you are a stranger, and propose to be governed as to where and how you fish,

and the flies you use, entirely by his directions; that he is to make such suggestions as he thinks proper at all times, and that you wish him so to do. You may feel sure your confidence will not be abused, and that he will then do the very best for you that circumstances will permit.

June and September are the best months for fly-fishing, the large fish being taken at other times only by deep trolling, or still-fishing with bait in deep water. Fly-fishing is not commonly practised in June, but judging from a single experience in 1883, I think this a mistake.

But little has been written on the development of vision and hearing in fish, and that little has been theory rather than deduction from actual experiment. My own experiments as to the effect that sound produces on trout (and I assume that all fishes are more or less alike in this respect) have been confined to this: Frequently, when able to observe a trout while myself unseen, I have screamed and shouted at the top of my voice. These demonstrations have invariably been without the slightest effect; but when varied by a concussion which could communicate itself to the water this has no longer been the case, and evidence of alarm, or at least that the concussion was felt, has been apparent. In an English work, the name of which I in vain endeavor to recall, an account of some very interesting and more decisive experiments are given. The writer caused a building to be erected over the water, and made his observations through small apertures constructed for the purpose, so that he was quite concealed. His trout were well accustomed to the wiles of the angler, and timid. Sending a man out of sight behind the building, the firing of a gun by him

produced not the slightest effect on the trout, who rose freely during the experiment to flies blown towards them through a tube. I am therefore convinced that no sound is injurious which does not communicate its vibration to the water, such as conversation; but concussion upon the side or bottom of a boat, or jumping from rock to rock, or blows upon a hard bottom with the wading-staff or with hobnailed shoes, I think are so conveyed through and by the water, as to be in some measure perceptible to the fish, and alarm them.

That fish possess the sense of hearing, their anatomical structure goes far to prove, while that they are not insensible to sounds produced in the air must be admitted, unless the doubter is prepared to call in question the numerous accounts by alleged eye-witnesses of their coming to be fed at the sound of a bell, etc. This I, for one, hesitate to do, notwithstanding I have never been able to make a sound in the air which seemed to produce the slightest effect on trout in the water—to which fish my experiments have been confined. It may, however, well be that the sound was perceived, while the fish were so habituated to the roar of the water-fall and similar noises, without any ill consequences ensuing, that sound alone was not regarded by them as an indication of danger.

To what extent the power of vision is developed in trout remains to be considered. To the angler it is a question second in importance to none, since upon its answer depends a more or less perfect solution of the problem—how may the necessary connection between his line and his fly be best disguised?

Every angler has heard, or taken part in, discussion of the best color for leaders; and if it be permissible to judge

of the experience of others from my own, the result has been an expression of doubt by one as to whether the color makes much difference, and a more or less ready assent to this on the part of the others. Never has the writer met any definite opinion on this subject based upon anything more solid than a guess.

As in past years, so every evening of September, 1883, a band of anglers from many distant cities and States gathered around the camp-fire at Parmacheene Lake, in Maine, several of them artists in the use of the fly-rod, and true sportsmen all; and when the power of vision of trout and the best color for leaders came up again and again for discussion, and always with the same negative result, I determined that before the next season I would devise some method, if not to settle, at least to throw some light on this question.

In what manner and with what apparatus my experiments should be conducted, was the subject of grave consideration. It would certainly appear at the first blush that to immerse the eye beneath the water and then to look upwards was the surest and most direct way to determine how a leader would appear to the trout, for thus the natural conditions would seem to be exactly reproduced. But a moment's reflection shakes this opinion. We all know how sensitive is the human eye to any foreign body, and how instantly the slightest irritation of the exterior affects the action of the muscles which control the focussing power of the lens within, and whose office it is to form the image upon the retina. We also know, that unless these muscles duly perform their appointed duty, the eye is as powerless to convey to the brain a truthful image as is a telescope, the different lenses of which have not been relatively adjusted

to distinct vision. We have all, either in frolic or from necessity, tried to see through a pair of spectacles totally unsuited to our eyes, and we all know the result. Again, though the mechanism of the eye work perfectly, still so intimate is the relation of its various parts, so profound their sympathy one with the other, that the power of the retina to receive and transmit a perfect image, even were such a one formed upon it, may well be doubted under such circumstances.

A gentleman well known in angling circles, and an acknowledged authority, when spoken to of the intended experiments, said that it was all useless; that he had tried it when in swimming; that everything appeared black, and that I would be able to see nothing. Subsequently another gentleman tried submerging himself below the surface of the water, and passing gut of different colors before his eyes. He found very dark gut alone was visible, and that only at a distance of twelve or fifteen inches. It is clear, therefore, that in the unusual conditions in which the eyes of the gentleman first mentioned were then placed, they refused to act at all; and that the same was the case in the other instance, though in less degree, and that the same will be the case with every one's eyes to a greater or less degree, under such unusual conditions, I cannot doubt. The gentleman last named could distinguish only very dark gut, and at a distance of twelve or fifteen inches. It is absolutely certain that had his eyes acted in the normal manner, nothing could prevent the formation of a perceptible image, except the absorption of the light proceeding from the object by the water. As the water was clear, it is obvious that a stratum of twelve or fifteen inches was quite inadequate to produce that result, since the bottom can

be distinctly seen in only moderately clear water at a much greater depth.

That the eye of the trout is different from ours is a frequent remark. That it is different in size and different in color is true; but that it is different in function, different in its relation to the reflection and refraction of light, is a mere supposition, resting, I believe, as at present advised, upon no foundation whatever. It may be more sensitive to light than ours; it may render objects visible to them through a stratum of water which would totally obscure them to us. But even this I know no reason to believe, notwithstanding the fact that will here occur to every one of the incessant rise of trout long after the shades of evening have fallen, and after a fly can no longer be distinguished by us upon the water. The difference of background towards which they look sufficiently accounts for this to my mind.

It may be that some of the rays composing the beam of light which are incompetent to excite vision in us, and of the presence of which we only become aware as they evidence their existence by heat or chemical action, may be visible to them; but if we are prepared to grant this, and I for one can see no reason so to do, it but prolongs the spectrum in one or both directions. It is too improbable even for mere surmise, in absence of direct proof, that they can see both ends of the spectrum while the middle is to them a blank; their every action in reference to the color of flies negatives this.

The eye, whether of fish or flesh, is but a lens refracting rays of light, and converging them to form a picture on a screen—the retina. In this respect, and as far as the mechanical principles of construction are con-

cerned, it has its exact counterpart in the camera of the photographer.

Light is light, and by its aid all animated beings see, and in its absence all alike are blind. The laws of nature operate equally and invariably both above and beneath the water; and until it is demonstrated to be otherwise, I cannot think that trout see in any different manner, or by different means than do we. There is probably a difference in degree, but I cannot believe in kind.

Nor is this a matter of mere surmise unsupported by evidence. The eye, whether of fish, flesh, or fowl, up to the point where the image is formed upon the retina, is a mere mechanical arrangement, the effect of which upon light any good optician can compute. That a mechanical arrangement is framed by the hand of Nature instead of by that of man, is sufficient to induce many to believe, and some to insist, that therefore its function must differ in some mysterious and abnormal manner, and unbridled license is given to the imagination. In this spirit the extent of the visual powers of fish is not unfrequently discussed.

But in point of fact a lever is a lever, whether it be a crow-bar in the hands of a quarryman, a fly-rod wielded by an angler, or a bone in a horse's leg; and the action of a lens upon light is but the action of a lens, whether it be located in the living eye, or shaped and placed by man to form the object-glass of a telescope. In each and every similar case the same fixed laws determine the effect which will be produced.

The human eye, if in its normal condition, gives distinct vision of objects, whether distant or close at hand, and this not by any mysterious function of the retina, or

the nerves which convey the impression to the brain, or of the brain itself, but by a simple mechanical adjustment of the lens which forms the image. If the rays of light proceed from a distant object, they strike the lens when substantially parallel, and it has nothing to do but to converge them to a focus. If, however, they proceed from an object close at hand, they then strike the lens while diverging, and must first be made parallel, and afterwards converged to a focus, before a distinct image can be formed. Obviously, then, the focal point in the second case will be farther from the lens than in that first given. In the telescope this is adjusted by varying the distance between the object-glass and the eye-piece, while in the human eye an involuntary alteration of the convexity of its lens accomplishes that result. Unless this adjustment is possible, the human eye cannot and does not give distinct vision at all distances. It is not possible in all individuals, and then near-sightedness or far-sightedness follows—the aid of a compensating lens is required to perform this adjustment, and spectacles must be employed. If the anatomy of the human eye teaches this, and it is beyond question that it does, an examination of the structure of the trout's eye should give at least some indication of its powers.

The lens of the human eye has the ordinary lens form, and is a little more convex on the inner than on the outer side; and by a contraction or expansion of its diameter, thus changing its convexity and consequently its refracting power, does it adapt itself when in health always to form its focus—or in other words, to produce a distinct image—at the same point, the retina.

Does the eye of the trout possess this or any equivalent property? It does not. The lens is as spherical as

a buck-shot, and of a consistency so indurated as apparently to preclude the possibility of any change of form. Therefore, it seems to me trout must necessarily be quite near-sighted, and consequently lack the power to distinguish details of form except within very narrow limits. And it is believed that this defect in vision extends more or less to all fishes; for though I have myself dissected the eye of the trout and one other variety of fish only, still the treatises on comparative anatomy lead me to believe that the eyes of all are constructed in substantially the same manner.

Is not the action of trout towards the artificial fly just what this would lead us to expect? Place the natural insect and its artificial copy side by side, and is the resemblance sufficiently close to deceive the human eye for a single moment? Though in color they may be approximately similar—as to form, only the eye of charity can detect a resemblance. Color trout can undoubtedly distinguish at some distance, as well as that there is an object apparently edible trespassing on their domain, but it would seem that details of form are only perceptible at close quarters.

Motion of any body large enough to do them an injury they are prompt to perceive. In no element is the struggle for life so bitter. To eat others and to avoid being eaten are the sole occupations of the greater part of a fish's life. Constant vigilance against the approach of their many enemies is with them the price of life; therefore, nothing terrifies them so much as motion, and all the more since their imperfect vision fails accurately to apprise them whether the moving body is friend or foe.

The foregoing applies to leaders as well as to any other moving object; and since at some point between

that at which the fly is first perceived and the fly itself, the leader must come within the range of distinct vision, the advisability of concealing it as much as possible cannot be questioned.

True, at times the desire to eat preponderates over the fear of being eaten, and then anybody can catch trout in almost any manner that appeals to their appetite. But the art of fly-fishing is to outwit the fish when in their ordinary mood of distrust, not for the angler to wait until they are driven to desperation by the pangs of hunger. To take one trout with the fly under adverse circumstances, gives more pleasure to the true angler than to derrick out a tubful at the rate of one every ten seconds.

The prudent man, when about to tempt fortune, prepares himself to meet the worst, well knowing that resources adequate to that will enable him to triumph over lesser evils. So with the true angler. He takes it for granted that the fish will be timid and disinclined to feed, and prepares his tackle to meet such contingencies. Then the color and thickness of the leader may be of importance, and to determine if possible to what extent the following experiments were tried.

On reflection it seemed that while the leader should be inspected from the same direction, and against the same background as when viewed by the trout, that this must be done with the eye without the water, and that with properly constructed apparatus this could be accomplished and reliable results be obtained. A water-tight box was therefore made, twenty-eight inches long, and six inches wide, and four inches in the remaining direction, all inside measurements. One end was closed with a thick glass plate, while the other was left open. It was

painted a dark mud color within. A frame was provided in which the box could swing like a cannon on its trunnions, and so arranged that though the normal position of the box was perpendicular, with the glass below and the open end above, yet it could be inclined, and the upper end directed to any part of the sky.

For the purpose of experiment, uncolored, two shades of coffee-colored, and three shades of mist-colored (copperas and logwood dyed) leaders were procured, also three samples of No. 4 enamelled water-proofed line, yellowish, greenish, and brownish in color.

The box was filled with water, the samples moved about upon, or beneath the surface, while the writer, with his head and the glass end of the box wrapped in a dark cloth, like a photographer, directed the apparatus towards the sky and noted the results.

From viewing the under surface of a body of water contained in an aquarium through the lower portion of its glass sides, it was expected that the under surface of the water in the box or tube might look like a mirror, and vision of anything above the surface be cut off. Such was not the case. Objects above the surface could be seen distinctly as through a glass window.

The variously colored leaders were all alike conspicuous to a surprising degree, so much so as to cause wonder that a fish should ever rise to anything connected with them, and this whether above, on, or below the surface. It seemed as though the coffee-colored leader was the most visible, but otherwise one could not be told from the other, all difference of color seeming to be lost. Then some drawn mist-colored leader was tried, quite dark in tint and as fine as a hair. Though about as plain to sight as a pencil-mark on white paper, yet it was ap-

parent that its small diameter made a great difference in its favor.

During all this the idea was gradually gathering force that these experiments only tended to show how the object appeared when viewed by a fish lying directly beneath it; and upon trying some flies, and finding that only with difficulty could the most gaudy be distinguished from those sober in color, the box was dropped, and light sought in another direction.

A bath-tub of considerable size, its length facing a window and the sky, was filled with water to the depth of fourteen inches. Two mirrors were submerged in the water, one at each end of the tub, and so inclined that by looking down upon them the reflected image of anything in or upon the water could readily be seen. A joint from a rod was used to manipulate the leader to be experimented with, and by moving it to and fro in the water, it could be viewed at almost any degree of obliquity.

Here, again, the results were a surprise. Though I have habitually used a colored leader, still I had supposed color was of questionable utility. Such seemed not to be the case. The coffee color was still the most conspicuous, but it was but little more so than the natural-colored gut, which latter, in all positions and angles, looked like a streak of silver. The mist-colored leaders, in some positions, had the same appearance, but always it seemed in a less degree; while at times, and at certain angles and directions of motion with reference to the light, they seemed more or less to disappear. The darkest tinted, a decided azure, gave the best result. I was unable to determine with satisfactory certainty in what positions in reference to light, etc., this partial or total disappearance

took place. It certainly did seem that when the leader was moved towards the light it shone the most, and by the refraction of transmitted light, and I attributed the better result given by the darker leader to its greater opacity to such light. A piece of iron binding-wire, black in color, and of course totally opaque, and of about the same diameter as the leaders, was, however, plainly visible in all positions, though not more so than uncolored gut. Indeed I incline to think that at all times the least conspicuous leader that can be made may be plainly seen from some directions, while at the same time invisible from others.

Here, again, I was impressed by the great difference in result caused by varying the diameter. This dimension appears in the water to be much enlarged, and my experiments are emphatic as to the utility of fine tackle. This was demonstrated beyond question by the drawn gut, *ï.e.*, gut drawn through a plate, which, as before stated, was quite dark in color and hair-fine.

The various samples of line were all equally visible—"plain as a pikestaff"—and not the slightest difference in favor of one over the other could be detected.

It is to be understood that the appearances described are those shown by reflection in the mirrors, also that all the gut used was of the same diameter.

But these experiments, conducted in-doors as they necessarily were, and therefore with the light coming from but one direction, were not satisfactory.

A tin-lined tank was therefore constructed, five feet long, fourteen inches wide, and fourteen and a half inches deep, measured on the inside. Where the bottom met one end, the wood was cut away to form an aperture three inches high and the width of the tank, and a plate

of glass was inserted, inclining slightly inward from the perpendicular. The tank was painted a dark slate color without and within. It closely resembled a coffin with parallel sides, and its advent excited considerable interest both in the neighborhood and in the household itself, since it was delivered in my absence, and I had thoughtlessly omitted to give any intimation of its expected arrival. A stand was also provided, which, when the tank was placed upon it, raised its bottom about three and a half feet from the ground.

The whole apparatus was set up in the back-yard, distant forty feet from the house, which bore nearly east from it. To the westward the nearest building was about one hundred and twenty feet distant, while to the north and south there were none nearer than several hundred feet. Thus the tank was located as nearly as possible in the middle of the space enclosed within an ordinary city block of houses, and perfectly open to the sky. Its length lay nearly north and south. From about half-past eight o'clock in the morning until about five o'clock in the afternoon it was unshaded from the sun.

Having filled the tank with water, the first problem attacked was to determine how trout see objects above the water. That they were able so to do I had often seen demonstrated, not always to my entire satisfaction.

As heretofore intimated, if any one will look through one of the side glasses of an ordinary aquarium, and upward towards the surface of the water, they will find that surface to resemble polished silver, and to be totally opaque to vision. Objects lying above it are as invisible as though a stone wall intervened. Or the experiment may be more conveniently tried with one of those thin uncut glass tumblers now in fashion. Half fill one with

water, and stand a spoon in it. When held above the eye and viewed at any angle through the sides, the described appearance of the surface and the utter invisibility of that portion of the spoon uncovered by the water will be noted. But when viewed directly through the bottom, the surface will then appear transparent, and objects beyond it can easily be seen.

Enveloping my head and the glass with a black cloth, that no light might enter from below (a course invariably followed in all my experiments with this tank), I carefully examined the surface of the water. It appeared perfectly opaque, until happening to cast my eyes directly upward, I saw a clear and transparent space bounded on one side by the end of the tank, and on the other by a curved line strongly fringed with prismatic color. In this clear space the windows of houses, distant two hundred feet and more, could readily be seen, clothed, as was every object visible within it, with all the colors of the rainbow. This unexpected appearance of color seemed to discredit the directions of the books that the clothing of the angler should be sober in hue, since no matter how quiet his clothing, it appeared he must look to the fish as though arrayed like Solomon in all his glory. But subsequent reflection convinced me that this phenomenon was due to a lack of parallelism between the surfaces of the glass and of the water. This gave to the body of water through which the object was viewed the form of a truncated prism, to the well-known action of which upon light I attribute the presence of the colors.

The transition from that portion of the surface which was transparent to that which was opaque, was quite abrupt. With thirteen inches depth of water, the curved

boundary line was part of a circle having a diameter of twenty inches. The diameter of this circle for any depth of water may readily be computed by the following proportion: Assuming five feet to be the required depth, for the purpose of illustration; then $13 : 20 :: 60$ (five feet reduced to inches) : to answer, $92\frac{4}{3}$ inches, or nearly eight feet. These measurements, though not scientifically accurate, are within a fraction of an inch of the truth, and therefore sufficiently near for practical purposes.

The following diagram, in which the relative proportions are carefully preserved, embodies the foregoing.

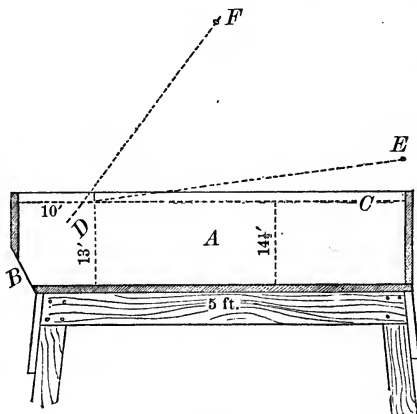

Fig. 86.

A represents the tank; *B* the glass; *C* the water-level at the time; and *D* the position of the division between the transparent and the opaque portions of the surface.

The effort was next made to determine how far above

the surface of the water an object must be at a given distance, to render it visible within the circle; or in other words, to determine the limits within which refraction would produce this result. For this purpose a red rag was used. It was placed on the water-level at the extreme end of the tank, thus being five feet (accurately four feet ten and a half inches) from the observer. It was then slowly raised, as nearly as possible perpendicularly, till it began to appear within the edge of the transparent circle. This took place at an elevation of five inches from the surface; whence I conclude that anything over ten inches above the surface for every ten feet of distance, will be visible.

Herein we find the reason why experience has shown the advantage of wading over fishing from the bank; or when fishing from a boat, that it is better to cast sitting rather than standing.

Though theoretically we all know that an object seen within this circle cannot appear in its true position, still perhaps it is not generally realized how extensive this apparent displacement really is.

In the preceding illustration *E* represents the actual position, and *F* the position of the red rag as it appeared to me during the preceding experiment. As the body seen approaches more and more nearly to a position immediately above the trout, this apparent displacement uniformly diminishes in extent, until, when on the perpendicular, it ceases altogether and the body appears in its true position, since there is then no refraction at all.

We have all cast in vain upon unruffled waters, and prayed for a ripple, and we have all noticed the marked change of luck which followed its advent. The reason

of this was apparent at once. For on disturbing the surface of the water in the tank, even though but little, the transparent place at once disappeared, and the surface became entirely opaque throughout, thus completely cutting off all vision of any object above it. Since this made little or no difference in the visibility of fly or leader when in actual contact with the water, I cannot doubt that the result in question is due to the cause assigned. It would therefore appear that when the water is roughened by a breeze, the angler may, without disadvantage, consult his convenience as to whether he will wade or stand when casting; also that when the ripple is local, that it is advisable, other things being equal, to cast into it, even though its area be quite limited.

The shadow of a moving fly-rod was distinctly and conspicuously visible through the glass and water, as a dark streak moving upon the surface, and this whether the latter was smooth or roughened.

It would require undue space, and be but confusing to the reader, should I separately detail each experiment on the visibility of leaders, extending as they did over months, and including almost every hour of the day and condition of sky. I therefore merely describe how my experiments were conducted, and the conclusions deduced therefrom.

At first the tank was painted dark slate color within and without; subsequently the interior was changed to a mud color, formed by a mixture of brown and green paint. For some time different colored leaders were tested and compared in pairs. Each was weighted, and suspended perpendicularly in the water by an assistant at the farther end of the tank. They were then gradually brought nearer the observer until one became visible, if

neither could be seen before, and the distance noted with such remarks as seemed appropriate. Then they were moved to and fro upon the surface of the water, and the relative excellence of each written down.

Subsequently a square brass frame was constructed, corresponding in size to the cross section of the interior of the tank. Each end of the upper edge was provided with an extension, which rested on the upper edge of the tank and retained the frame where placed. Across this frame silkworm gut of various colors was stretched, like the bars of a gridiron. This frame, bearing the gut to be tested, was at first placed perpendicularly in the tank and parallel with the ends, and the visibility of each strand was noted. Then it was moved six inches nearer to the observer, and the result again recorded; and so on, moving the frame but six inches at each step, until all could be plainly seen. The frame was then returned to the starting-point, and the lower end raised until it was about two inches below the surface of the water, in which position it was secured by a wire hook. The frame was then supported upon the extensions to its upper edge, which rested on the rim of the tank, and the wire hook sustaining the lower edge. Since the upper edge was above the surface of the water and quite close to it, it was invisible, and the various strands of gut appeared to enter the water and lie at quite an acute angle with it. The intention was to reproduce as nearly as possible the position ordinarily assumed by that portion of a leader to which the tail-fly is attached. Ten different colored strands were stretched upon this frame and compared, viz. : black, dirty olive-green, pea-green, dark, medium, and light neutral tint (copperas and logwood), ink-dye, darker and lighter coffee colored, and uncolored. The

tank was filled with Ridgewood water (Brooklyn, New York), which was quite clear. Subsequently this was browned with a concentrated and filtered decoction of coffee, and finally milk was added to give the turbidity of roily water, such as is seen upon the subsidence of a stream after a freshet.

I deduce from my experiments the following conclusions : All leaders are visible when directly over the fish, and in a degree entirely irrespective of their color. Here diameter alone affects the result. This dimension always appears to be much enlarged when the leader is in contact with, or below the surface ; and if it is at all advantageous to conceal the connection between the fly and the line, the thinnest practicable gut should be employed.

Except at twilight, all leaders, when viewed obliquely through clear water, are visible through a stratum of two feet or less, but the color makes considerable difference in their obtrusiveness.

Whether the water is shaded or not affects these results but slightly, and the same may be said of a gloomy or lowering sky.

The under side of the surface forms the background against which the leader is viewed, and as it contrasts or harmonizes with the apparent color of this, so is it more or less conspicuous. On the surface the bottom is reflected, and its color modifies, in a degree diminishing as the depth increases, that received from the sky.

With clear water the following results were obtained: A dark leader, irrespective of its color, should not be used. The black gut was invariably the first that came into sight, closely followed by dark olive-green and a dark neutral tint. At any time of the day, and with

any light, the black could always be seen through a stratum of water which utterly eclipsed the lighter tints; and this was equally true of the olive-green and dark neutral tint, except that in the twilight they appeared to less disadvantage.

When the rays of the sun fell perpendicularly upon the water, or nearly so, say from ten to three o'clock, nothing gave a better general result than uncolored gut. True, occasionally it shone like silver, and then nothing could be plainer; but this did not take place in all positions, and except at such times it had a decided advantage over the others, and even at its worst it was at no great disadvantage.

He who will devise means to destroy the glitter of the surface of gut will deserve the thanks of the angling fraternity. I regret circumstances have prevented me from trying Mr. Fred Mather's method of applying the juice of the milk-weed for this purpose.

The fact that the sun was obscured did not seem to destroy the advantage of the uncolored gut between the hours mentioned; but, except with a rain sky, at other times uncolored gut was far inferior to all the others except the black; indeed it was at times difficult to say which of the two was the most obtrusive, both being visible the entire length of the tank.

I can attribute the difference in the appearance of uncolored gut to nothing but the direction in which the light falls on the water. When the sun is perpendicular or approximately so, it seems to be at its best; while as the rays fall more and more obliquely on the water, it becomes more and more conspicuous.

A light coffee color (obtained by infusing the gut in a strong decoction made by boiling red onion-skins in wa-

ter) almost equalled the uncolored gut at its best, while apparently far less dependent on the direction of the light. For general use at all times, particularly over a light-colored bottom, I incline to think it one of the best of colors.

If however, leaders of but one color are to be used at all times, unquestionably that color should be a light shade of ink-dye—that given by “Arnold’s Writing-fluid” diluted with an equal quantity of water.

This always and at all times gave a good result, while it took the first place in merit oftener than any other one color. Over a neutral tint (copperas and logwood) of as nearly as possible the same shade, it had quite a decided advantage. It was at its worst in the middle of the day.

A pea-green strand also gave an excellent average. Though it could at times be seen when some of the others could not, it was never obtrusive. I believe this would have given better results had it been a shade or two lighter in tint. For meadow-brook fishing it should be excellent—perhaps unequalled.

The preceding comparisons of the various colors relate solely to clear water.

A change in the color of the water was followed by altogether different results. A very strong decoction of coffee was prepared; it was then further concentrated by protracted boiling, and finally filtered through paper. This was added to and mixed with the water, until I thought it as brown as any bog trout-stream I had ever seen. The color, as seen in the tank, was quite marked, while in a clear tumbler a faint tinge of brown was just noticeable. I have done considerable fly-fishing in such waters, and no pains were spared to reproduce the natural color faithfully.

The results obtained on the clear water were here reversed. All the lighter colored leaders were at a decided disadvantage, the uncolored gut being the most visible, while the black was least so, and this irrespective of the time of day, and sun or shade. The dark olive and darker neutral tint gave almost, but not quite, as good results, and in the order named. No leader could be seen through more than three and a half feet of water. The uncolored gut was invariably the first to appear, closely followed by both of the coffee-colored. I had supposed the latter would prove excellent in brown water, but such was by no means the case, since at all times and under all circumstances these were nearly as objectionable as the uncolored, and far more so than the other light colors. The pea-green was the next to appear. The ink-dyed leader gave very fair results, but still inferior to darker shades. The fact that the uncolored leader could always be seen at more than double the distance at which the black first began to be visible, illustrates the relative merits of the two.

Here also may probably be found the reason why large and brighter colored flies are required in such waters. Having completed my experiments with the browned water, it was next rendered turbid by adding a little milk. To imitate the condition of a stream on the subsidence of a freshet, and when its water had begun to clear, though still perceptibly roily, was the object in view. This, as far as the eye could determine, was successfully accomplished, yet no leader could be seen through more than eight inches of the water, even at noonday and with an unclouded sky.

Nothing surprised me more than the difference in obtrusiveness shown by different specimens, so nearly alike

in shade and color in the air as to require careful inspection to distinguish between them. This was marked in comparing the ink-dye and the lighter neutral tint (copperas and logwood). The intensity of color in both was almost exactly equal, while the neutral tint was somewhat duller on the surface. For this reason I had always supposed the latter to be less obtrusive, but I cannot doubt I was mistaken. I was the more pleased with this result, since to obtain the ink-dye color the gut can be dyed cold, and with less trouble and less loss of strength than where copperas or heat is required. The relative merits of the two can be judged from the fact that sometimes the neutral tint was visible through a foot more water than the other.

For years events have been gradually forcing me towards the opinion that success in fly-fishing (particularly where the fish were educated to the angler's wiles), depended as much upon concealing the connection between the line and the fly as upon any other one thing. We have all cast, time and time again, without a rise, where we knew the fly was seen by trout every time it touched the water. We have then changed and changed our cast, yet all in vain. We have all seen a trout rise to the fly, approach it closely, and then turn from it, and revert whence he came. Under these trying circumstances permit me to suggest that after the cast has been varied a reasonable number of times without success, that the leader be changed to one of a different color. I feel confident that in many cases this will solve the difficulty.

For the guidance of the beginner I suggest the following rules, based on what I believe to be the teachings of the preceding experiments. Provide yourself at least with uncolored and ink-dyed leaders, some of light tint,

and some very dark; and if a meadow-stream is to be fished, or water in which an appreciable quantity of green floating matter is present, then with green leaders as well. Under the latter conditions begin and end with the green leader, unless lack of success indicate that a change is advisable or will make no difference.

If the water appears brown-colored use your darkest colored leader at all hours. To produce this the ink may be used undiluted, for you need not fear to get it too dark.

Under ordinary conditions of clear water, commence with a lighter ink-dyed, varying to the uncolored about half-past ten in the forenoon, and returning to the first from three to four o'clock.

If trout are present, and persistently refuse to rise after changing your cast a reasonable number of times, vary the color of the leader, no matter what it may have been. Finally, be not deceived by the way the leader appears as you look down upon it, for this gives little or no indication of its visibility when viewed from underneath.

Nine varieties of enamelled water-proofed line were tested, viz.: light pea-green, Paris-green with black spiral thread, light green with a brown spiral thread, translucent with reddish-brown thread in close spirals, white and brown in equal proportions, translucent with green and red spiral thread, white with black spirals, white with black threads in diamond pattern, and white with brown threads in diamond pattern. All these were quite visible. The least obtrusive was a line which seemed to have been braided from white silk with two black threads passing spirally around it in opposite directions, thus forming a black diamond-shaped pattern upon the white ground. The water-proofing had given to the white silk

a translucent color of a faint, dull, greenish tinge. The next in order of merit seemed to be the pea-green.

The question is often asked from how far below the surface can a trout see a fly.

To this question I sought an answer from Mr. John W. Chittenden, one of the most intelligent of that very intelligent class of men, the submarine divers.

I showed him a "fin-fly" (white wing and crimson body), tied on a hook about a quarter of an inch across the bend. He said that in clear salt water such a fly could be seen on the surface from a depth of fifty feet, and that it would then look larger than it did as he held it in his hand. He instanced a case where he was working on a wreck in sixty-five feet of water, when he easily read the name on the stern of the wrecking-schooner floating overhead, as well as the marks on the packing-cases as they were hoisted over its side, when they were five feet above the surface of the water. These marks and letters were about three inches long. He remembered seeing the end of a rope half an inch in diameter attached to one of those cases as it was hoisted aboard the wrecking-schooner.

At these depths the surface took its color from the sky, uninfluenced by the bottom, looking white with a white sky, and dark inky-blue with a blue sky. A surface wind made no difference in the visibility of objects in the water or on its surface, but with a heavy ground-swell the water was sometimes so turbid that objects but a few feet distant were obscured.

Fresh water was not generally as clear as sea water, particularly in rivers where there was a current. The surface, he said, looked very near, so that when he was at a depth of fifty feet it seemed almost within reach of

his hand. The shadows of moving objects were plainly visible, whether the surface was smooth or rough. A clear white or a red could be seen the greatest distance. When sixty feet below the surface he had read the fine print of a testament from the cargo of a wreck he was at work upon.

On one occasion he was at work on an asphaltum bed at the bottom of Cardenas Bay. The asphaltum was found between strata of white clay, which it was the custom to loosen by light blasting, in order to facilitate the removal of the asphaltum. Worms occurred in this clay, of which the fishes of the vicinity were very fond. Holding one of these worms between his fingers, and stirring up the clay until the water was so turbid that his hand was quite invisible, he could feel the fishes rubbing against his fingers and tugging at this worm. By what sense they were then guided to their food is an interesting question. That they had become accustomed to regard this turbidity as a call to dinner, and that thereafter they were directed by smell to their food, suggests itself as one explanation.

But from whatever depth trout may be able to see a fly, I have never seen reason to suppose they could be coaxed to rise to one from the bottom in depths exceeding nine or ten feet. That in clear water they can see it much farther, particularly if in motion, is probable, even though the details of its form may be obscure.

But we all know they are peculiar creatures and full of whims, and one of these seems to be reluctance to move any great distance for their food. Perhaps experience has taught them that it, too, is endowed with life, and that it may be gone before they can reach it. A fact within the observation and experience of every angler

seems to confirm this view, since we all know that if a trout rises, and we wish him, the fly should be cast nearly or quite over him, without touching the water at any intermediate point.

But however this may be, one thing seems certain, and that is, that neither the angler nor the trout are anything like as acute as is generally supposed. The wiles of the former are by no means so well concealed, nor are the latter so very quick to perceive them. The hook, unless very small, they can always see, and the leader, when within a foot or two of it. Again and again have I wondered during these experiments how was it possible ever to deceive a fish, so prompt to take alarm, by a humbug so transparent.

CHAPTER XI.

MISCELLANEOUS SUGGESTIONS.

No method of fly-fishing possesses the charm of wading. Through scenes where Nature shows her utmost loveliness the trout-stream takes its way, itself a jewel mirroring in its bosom every detail of its faultless setting. Deep shadows, gemmed with specks of sunshine, cover the water. Stately trees, graceful ferns and flowers, and mossy rocks line its banks. Every turn of the stream is a new picture, varied in detail but uniform in beauty—at once the delight and the despair of the artist. The cool damp air gives new life and vigor to lungs charged with the foul vapors of city life, while over all the murmur of the living water proclaims here is peace.

It may happen to the angler to wander far, and cast his fly upon many waters. But no matter what success attends his efforts elsewhere, his memory still delights to linger, above all, on the quiet beauties of those happy days, when youth and he wandered hand-in-hand together down the murmuring stream. Not only is it in every way the most delightful, since every sense is fed, but it is at the same time the most artistic method of fly-fishing.

He who thinks to have much sport with the fly at the expense of the trout of the much fished brooks and streams of the New England and Middle States, must bring every resource of his art to bear, and that from a

well-stocked arsenal. Civilization in its onward march educates trout as well as men, and many an angler whose catch in the wilds of Maine is only limited by his desires, could hardly take enough in the waters first mentioned to impart a smell to his creel.

It is not my purpose to tell when, where, and how to fish these waters, since that has already been fully described by no less a master than Thaddeus Norris himself, as well as many other and lesser lights of the gentle art. I frankly admit I can improve in nothing on what they have said. But some practical hints what to do that the sport of the present may be unalloyed with injury to the health, and pain in the future, may perhaps not be amiss.

Firstly, the clothing should be sober gray in color, that if possible the suspicious game may mistake the motions of the angler for the waving of some branch of a forest-tree wooed by the summer wind. Upon the feet low heavy shoes should be worn, studded on the soles and heels with a few, and but a few, soft hobnails; or better still, those small round-headed nails sometimes seen in cowhide boots. As these wear smooth they should be removed and new ones substituted.

It will be necessary to give your personal attention to this, for the heart of the average shoemaker is modelled on his own lapstone. In vain will be your order to put in but a few, and delusive his promise to comply. Either he revels in the use of hobnails, or his idea of "a few" is complied with as long as any portion of the sole is visible between their heads. It is not alone to the cohesion of iron with stone that the benefit derived from the use of hobnails in wading is due, but also to the interspaces thus formed in the bottom of the sole,

engaging with the inequalities of the rocky surface with which it is brought in contact. If the nails are used in excess, the shoes then practically become paved with iron, and the second element of safety is lost. It will be long before I forget how my thoughts were directed to this problem.

It was in May, many years ago, in Pennsylvania. The stream was at that time a strong one, almost too strong for wading unless great circumspection was used. In many places it was impassable, while elsewhere so dark-colored was the water, that the use of a graduated wading-staff was necessary to inform the angler whether he was venturing into two feet of water or twenty.

That law of nature which makes the most inaccessible places invariably seem the most desirable in fishing, tempted me to leap from rock to rock till I was well out towards one of the deeper parts of the stream. It was not a difficult job, for the bowlders used as a bridge were large and not widely separated. At last my goal, a large flat rock sloping gently downward towards the desired pool, was before me. My shoes were well paved with hobnails, rather worn it is true, but not enough to impair my confidence in them. I stepped upon that rock, where I proposed to stop. Too late I found its surface was coated with a gray lichen, indistinguishable from the natural color of the stone, and more slippery than ice itself. Slowly and steadily, but with a constantly accelerating velocity, I found myself skating downward towards the apparently unfathomable pool below, a helpless victim of misplaced confidence. Then I thought unutterable things, among the least of which were: How deep was the water below?—should I be obliged to abandon my rod?—could I get rid of my creel, already quite

heavy with fish?—and how much would the watchmaker's bill be? But before a satisfactory solution to any of these questions could be reached, the rock came to an end, or rather I came to the end of it, and dropping over the brink, stood up to my chin in the inclement pool below. Before I had walked the three miles which intervened between the scene of the immersion and my temporary home, I had given considerable thought to the question of a secure footing in wading. And by the time I had paid for a new fly-book, and the watchmaker had infused new life into my watch and his demands had been satisfied, I had absorbed a strong prejudice against hob-nails. Since then the small round-headed nails before alluded to have been my dependence in wading, and they have never played me false.

I have never since, while angling, encountered a rock so treacherous as that in Pennsylvania, and I believed it unique until last fall.

John and I were returning from a trip of several days' duration, having gone north through the woods from Parmacheene Lake into Canada, then east to the head-water of Dead River, then down the Seven Pond Valley to Kennebago Lake, and we were now bound across-lots back to Parmacheene. Our way had been through an unbroken forest, a large portion of the time relying on the compass and sun alone to direct our steps, where no indication showed that white men had ever before set foot. We had backed our heavy packs to the very summits of the loftiest peaks of the Boundary Range, and following the ridge for miles, had seen stretching away into space the gap through the otherwise unbroken wilderness which marks the dividing line between Canada and the United States. More than forty years before, and

when the boundary was laid out, a lane two rods wide was cut through the woods, following the water-shed which separated the waters flowing into the St. Lawrence River from those discharging into the Atlantic Ocean. This was the treaty boundary; and to-day the old forest rises on either side of the new and stunted growth which has filled the gap, as the houses rise on either side of a city street, nor is the one more clearly marked than the other. It is not without emotion that one gazes for the first time on this scar upon the face of nature, otherwise without a blemish, especially should he chance upon one of the small cast-iron obelisks which mark it at irregular intervals, and bear in raised letters the words "National Boundary-line." Then for the first time he fully realizes what his surroundings have, till then, seemed utterly to deny, that civilized man has been there before.

But it was not for this that we had toiled so far, for to us it lacked the charm of novelty. Our eyes sought and rested on Megantic, Rush, and Spider Lakes, and the settlements of Canada which fringed the wilderness on the north; on the Dead River County and the Seven Pond Valley, an unbroken forest, gemmed with lakes, to the east; and to the south and west upon a sea of mountains, range following range like the billows of the ocean, each range a different color, to where Mt. Washington, and Owl's Head on Lake Memphremagog, lay dim and shadowy on the distant horizon.

From the first we had recognized that from Kennebec Lake to Parmacheene would be the most difficult part of the trip, for it was utterly unknown ground, and many mountain ranges and one river barred the way. We were unable to gain any information either as to the distance to be traversed, or how the natural obstacles could be

best surmounted; so it was with some surprise I heard John answer an inquiry as to how we were to cross the river, by saying, in the most off-hand way, we would cross on the rocks at the Big Falls—a place which it is doubtful if a dozen men in the whole country had ever seen, and which he himself had visited but once, and then in winter. However, we took to the woods one morning before seven o'clock, John with forty-one pounds on his back and a nine-pound rifle in his hand, and I with twenty-five pounds in my pack and my tin rod-case, containing two rods, which I used as a staff. We climbed West Kennebago Mountain two-thirds to its summit—that mountain over whose perfect cone, so soft and verdant, thousands of anglers on the Rangely Lakes have raved, yet whose sides we found one mass of crags, chasms, and windfalls, which, with the heavy grade, made the most cruel travelling for a loaded man I have ever seen—and finally, after a forced march, without halt except for breath, at two o'clock in the afternoon we heard the welcome roar, and struck out of the woods directly upon the desired spot. The falls were before us. Among gigantic bowlders the river foamed and roared in a series of moderate pitches, interspersed with dark pools, till a bend some distance below hid it from sight. We had crossed the greater part of the stream without difficulty, when we came to a rock about the size of a two-story cottage, sloping gently down to a pool, which looked uncommonly dark and wet. A ledge about two feet wide broke the uniform descent a short distance from the top. John paused, and said, "These rocks are pretty slippery. You will probably have no trouble with your hobnailed shoes, but as I have none, perhaps you had better hold the rifle while I climb down to the ledge."

He did so, and after passing him the rifle I essayed to follow. It by no means appeared difficult, but before I had completed the second step the tin rod-case was clattering down the rock towards the pool, and I, half sitting and half lying on my pack, was gliding in the same direction. The situation was somewhat serious, for unless I could get my knapsack off after I was in the water, I would undoubtedly be drowned like a kitten tied to a brick. However, John managed to "neck" me as I went by, and gaining a footing on the ledge, we worked our way around to a safer descent, rescued the rods, and sat us down to lunch on the rocks, two very leg-weary men.

We then discussed the hobnail in all its bearings, and rendered a unanimous verdict in favor of the small round-headed nails. For when worn at all, the former presents a flat, polished surface, good perhaps where no safeguard is required, but worse than useless in a critical place; while the latter, from the smallness and shape of the head, are far more prompt to engage with slight inequalities; and, at the same time, the weight being thrown on so much smaller and sharper surfaces, they will cut through lichen or dried slime much more readily to the rock beneath. Therefore they seem to me unquestionably safer, as they certainly are lighter, and more easily inserted and replaced.

I am aware that the larger part of the foregoing is pure digression, and that no proper apology can be found for its introduction into a book on angling, unless it be that the incidents occurred during a trip one object of which was to try unfamiliar waters. Yet I must beg further indulgence. The merits of that tin rod-case demand recognition. It was simply a piece of ordinary tin leader of one and a quarter inch bore, closed at the bot-

tom, and provided with a brass screw cap. A simple linen rod-bag went with it. Stowing the detached handle in my pack, two butts, three middle joints, and four or five tips were placed in this bag, and tied up so they could not chafe. The tin case readily held the whole. Not only did I find it a most convenient walking-staff through over seventy-five miles of foot travel, all of it with a pack on my back, and much of it without even a sign of a trail, but also after our return it lay day and night in our boat, containing spare rods and tips, all of which it kept perfectly dry and in good order through rain and shine. The first cost is next to nothing, while its further superiority over the ordinary bamboo tip-case, in its indifference to weather and far greater carrying capacity, have led me to resolve never to go into the woods again without one. Nor am I alone in this opinion, for it was the subject of constant and invariably favorable comment by many other anglers.

But let us return to the wading-shoes, of which we lost sight so long ago.

Through the uppers at the instep and close to the soles, the leather should be pierced three or four times with the small blade of a penknife, that when the stream is abandoned for the bank the water may find egress. But these holes must be small, and made as I have said by a single small cut with closely adjacent edges, or sand and gravel will enter, to the great annoyance of the angler.

The drawers and stockings should be of wool, without the admixture of any cotton whatever. This is of the first importance to health. The difference in comfort arising from this cause is wonderful. After the first immersion, with woollen socks and underclothes, the wader

will experience no chill in or out of the water, except, perhaps, a momentary ring of cold when the water rises to an unaccustomed height. He will hardly know, as far as any sensation of cold is concerned, whether he is wet or dry. But if cotton underclothes are worn, or those with an appreciable admixture of cotton, a chill is experienced at once on exposure to the slightest wind, or even on leaving the water when the air is still. This cannot but be prejudicial to health. Red Shaker flannel is the best material for this purpose, probably because it is honestly made. I cannot too strongly emphasize this.

Upon reaching the temporary lodging after the day's sport, the wet clothes should be changed at once, and the entire body briskly rubbed with a towel; and this before eating. Do not, under any pretext or for any reason whatever, sit round in your wet clothes, but change at once. Then a little drop of spirits, quite dilute and perhaps warm, will do no harm. But on the stream and while wading avoid this by all means, since the difference in temperature between the upper and lower portions of the body is already quite sufficient without any artificial stimulant to increase it. With these precautions I have never been able to see that wading was at all injurious.

When you remove your wading-shoes, offer an inducement to one of the farm-hands to wash them and give them a liberal dose of neat's-foot oil. They will then dry soft, and you will not feel, the next time they are used, as though you had incased your feet in a burglar-proof safe.

Some wear rubber wading-stockings; but unless in early May, when the chill of winter is hardly off the water, I think poorly of them. As far as keeping the wader dry is concerned, they are a delusion; for the

perspiration is so condensed within them by the cold of the stream, that he who wears them will, at evening, be quite as wet as he who does not. If, however, they are preferred, then select those with stocking-feet, and not those ending in boots, since the former can be turned entirely wrong side out to dry, which is impossible with the latter; the inside will always be found the wetter. Also choose those of the pantaloon form, since though the depth be not so great, the water will, when the wader stands in or forces his way against the current, boil up against him, and with mere stockings may overflow the upper edge and load him up with water. Nothing is more disgusting than this mishap, nor does anything so chill the angler's ardor and demoralize him, as to be forced to lie on his back on the bank and elevate his legs in the air to empty his boots. There is then a natural affinity between the fluid and his backbone, and along the latter a goodly portion always flows to make its escape at his collar. But there is to me something abhorrent in the idea of being stewed in my own juice; and though I have them, I have not used rubbers in wading for years.

If the stream is a strong one and its bottom rough, use a wading-staff of about your own height. On this mark two or three rings by removing the bark with a knife, to serve as some guide from which to judge the depth of the water. Secure this to a button-hole of your coat with a string of sufficient length to permit its unembarrassed use. Then, when a fish is fastened and both hands are needed, it can be dropped, relying on the string to prevent it from being swept away by the current, and to insure its recovery. It will save many a nasty fall and ducking.

The landing-net for this fishing should be quite small, of oval form, the bow eight or nine inches wide and a foot long. The handle need not exceed six inches in length, and should be provided with a leather tag containing a button-hole, to be attached to a button secured to the back of the coat just below the collar. This is the most convenient way to dispose of a very inconvenient necessity. Rattan makes as good a bow as anything.

When a fish is struck, get him out of the water in which he was caught as soon as possible, lest the others, which were probably in his company, take alarm—and out of the current as well. Play him till quite exhausted, then reel him in short, drop your wading-staff, and reach behind and unbutton the net. Then throwing the tip of the rod backward, slip the net under him quietly, and lift him out. Next support your rod between your body and the upper part of your right arm, take the net in the right hand, and grasp the fish by the gills with the left. Then tuck your net under your left arm, and proceed to kill your fish. Never neglect this. It is most cruel and unsportsmanlike to force them to writhe their lives slowly away in the creel. This may be instantly accomplished by striking the head once or twice upon the butt of the rod; or the thumb may be placed back of the head, the forefinger hooked under the upper jaw, and the head bent sharply over against the back. Death is instantaneous. Then unhook the fish, replace the net, retrieve your wading-staff, and try for another.

In wading, keep out of the water all you can, and never, if it be possible to avoid it, traverse a spot where trout are likely to lie. Remember there may be some other angler behind you, and do not spoil his sport because you may happen to have found none. It by no

means follows, because you were unsuccessful, that the pool was untenanted, and if you plunge through it you may so alarm the fish that they will refuse to rise for hours.

Not unfrequently gentlemen will be met at a fishing locality, whose outfit, chosen in ignorance of the peculiarities of that water, is utterly unsuited thereto. To a brother angler so situated spare freely from your own superabundance, giving him all possible assistance. Propriety and policy alike forbid that the eager competition of every-day life should contaminate this sport. Anglers gather to a fishing centre from the most distant portions of the country, and scatter again to their homes, carrying with them a fixed opinion of those they may have happened to meet. The acquaintances and friendships so formed should recall no recollection other than of pleasure. That a good name is better than riches is an old saying, but it still retains the vitality of youth. He who is selfish in his sports is a marked man, for what must such a one be in his every-day life? The true angler governs his conduct towards his fellow-fishermen by the Golden Rule: "Do unto others as you would they should do unto you." He who acts otherwise is unworthy the name. As you become proficient, by no means forget that you were once a beginner, and to such ever extend the helping hand.

What angler, as he has removed his catch from the hook, has not again and again said to himself, "I wonder how old it is?" and if this is true of the small fish of the brook, how much more frequent and earnest must be the inquiry when the leviathans of the Rangely Lakes are under observation.

Some there doubtless are, though their number is daily diminishing, who still question the existence of brook trout of the size said to inhabit those waters; but they are invariably those who have never seen them in the water, or fresh from it. It is not surprising that one who regards a two-pound brook trout as a very monster should stare with incredulity when specimens of ten and eleven pounds are spoken of, more especially if he be familiar with the wide discrepancy usual between the estimated and the actual weight of these fish. If he really knows anything about the subject, and has seen many such statements as one which fell under my notice a couple of years ago—that a trout eighteen inches long had been caught in the head-waters of a certain river, which weighed five and a half pounds after it was dressed—his faith must indeed be quite crushed, and unable to answer the most trifling call upon it.

There really is a fearful amount of lying—honest, not mendacious lying—about the weight of trout. Let me urge upon the beginner to provide himself with a spring-balance at the very outset, and to train his eye and his tongue by the graduations upon it. However these things may be, the fact remains unchanged, and it certainly is a fact, that genuine brook trout of ten and even eleven pounds weight have been, and may be taken in the Rangely Lakes—the very same species of trout which inhabit the mountain streams of New York and Pennsylvania; but it is also true that trout of over nine pounds weight are quite rarely caught.

On the 30th of September, 1884, one of the Maine Fish Commissioners netted from a pool on Rangely Stream nine trout, in the following order and of the following respective weights in pounds: $1\frac{1}{2}$, 3, $4\frac{1}{2}$, $5\frac{1}{2}$, 6, 7, 7, $7\frac{1}{2}$,

and 4—total 46 avoirdupois, not guessed, pounds. The pool in which they were found was small, shallow, and accessible, and the fish plainly visible; and it was to protect them from the wiles of a possible poacher that they were netted, and conveyed to the larger pool below the dam. But in the pool last named were then to be seen fish beside which the largest of those above numerated seemed small. It was the general opinion of those accustomed to net, weigh, and handle these large trout, that two of them would each closely approximate to, if they did not exceed, ten pounds. They were seen by perhaps a hundred people, myself among the number.

Now how old were these fish, or rather, how many years does it take for a trout to reach such size? Some think a hundred years, some thirty, some ten; but all admit that their estimate is mere conjecture.

The rate at which trout will gain in weight is universally admitted to be largely a question of food-supply, influenced somewhat by the depth and quantity of water, especially if they are left to provide for themselves. We all know they are very voracious, and if no limit, except their own inclination, were placed upon the quantity they should eat, that they would stuff themselves like pigs. Many a time has every experienced angler taken trout on the fly which were gorged with other food. I remember once thus taking a half-pound trout in a Connecticut stream which was full up to its neck with June bugs.

But if they are at times inordinate feeders, they are equally proficient as fasters. Mr. Henry Stanley, one of the Maine Fish Commissioners, once told me the following case in point. He had carried a number of large trout for breeding purposes in October, when he injured

his hand and was forced to go out to the settlements for medical aid. The consequences of the accident and early and heavy snows prevented his return till the following spring, yet he found his captives alive and active, though all the food they could possibly have had, must have been the almost infinitesimal quantity which entered between the slats of the car. True, this was largely during the winter, when some suppose trout feed but little. Take another case occurring in summer. Some years ago the well-known guide John S. Danforth, to whom I have so frequently alluded, had three or four nice large fish. He was suddenly called away for what he supposed would be but a few days. He had taken the trout for a special purpose, and wished to save them for the end in view; so he put them in a small car, and sunk it in about forty feet of water. He was gone some two months, and often those unhappy fish weighed heavily on his mind. On his return his first step was to raise the car. He found them rather "lathy," as he expressed it, but alive and well. Of course they were restored to liberty.

John told me another interesting incident, perhaps somewhat remote from the matter in hand, but notwithstanding I cannot omit it. While trapping in November of 1883, he came across a spawning-bed, upon which a quantity of trout up to a pound weight were still engaged. The water was but about a foot or so in depth, and was covered with a thin sheet of ice as clear as crystal. He is a natural investigator, as I suppose all real woodsmen must be. He saw his opportunity, and that it was too good to be lost. So unslinging his pack, he stood his rifle against a tree, and fumbling in his pockets, produced a fly and a piece of string. A neighboring alder-bush supplied a rod, and rigging it up he cast his

fly upon, and drew it across the ice over the trout below. Again and again they rose with the utmost eagerness, bumping their little noses against the under surface of the ice.

Those who rear trout say, that under like conditions there is considerable individuality in their growth. Seth Green, in his "Trout Culture" (1870), says with good feeding they will reach one pound in three years; that they grow slower in running water than ponds; that the rate of increase diminishes with age, and puts their average longevity at twelve to fourteen years. Norris, in his "American Fish Culture," gives an instance of four pounds at a little over four years. In a New Jersey pond the fry placed therein, with the yolk-sack still attached, attained two pounds in three years. In a Long Island pond trout one year old and five inches long, grew to eleven inches in their second year, and in their third to fourteen ounces or a pound (thirteen and a half to fourteen and a half inches, about) in weight.

But all these seem to have been cases of domesticated trout artificially fed. Some definite knowledge in regard to the growth of wild trout is very desirable. From the very nature of the case it must vary widely in different localities, since the ultimate result is so different; still it would be well if every angler who had any definite information on the subject, no matter how restricted in scope, should make it a matter of record. Ultimately some enthusiast would collate these scattered facts, and thus and only thus, as far as I can see, can the desired information be obtained.

That I may practise what I preach, I relate the following incident, one of the pleasantest in my fishing experience.

During the latter part of September, 1882, John and I put eighty trout in a fair-sized pond in North-western Maine, having neither outlet nor inlet. It was well stocked with minnows and other trout food, but contained no trout. The water was clear, cool, and quite deep. Though John says three or four of these trout would then weigh a pound and a half, my own recollection is that none exceeded one and a quarter pounds; we both agree that few, if any of them, weighed less than one pound. They were all taken in two days and at one locality, and enough of them were actually weighed at the time to preclude all uncertainty in this respect, except as above stated. On June 1, 1883, we added thirty-six to their number, the largest of which weighed just two and a half pounds. I have no memorandum as to the others, though they were actually weighed at the time, but we agree that not one was of less than one pound, while the majority approximated two pounds, some a little more and some a little less than that weight.

On the morning of September 27, 1884, John suggested we should visit the pond, and see, if possible, how they were getting on. It was something of a job, since the distance was considerable, and moreover it would be necessary to carry a boat quite a portion of the way through the woods, and that without a trail. Though whether anything would be accomplished seemed problematical, since one hundred and thirteen fish in a pond of that size does not allow very many to the superficial foot; still we might find them, and the possibility warranted the effort.

At the expense of considerable perspiration on both our parts the pond was reached, and while he paddled

around parallel to, and at a short distance from the shore, I cast towards it. When about one-eighth of the circumference had been passed, we neared a bend where two white-birch trees had fallen into the water years before. The smaller branches had disappeared to a great extent, but the tops projected some distance under the water, leaving quite a space between them. No sign of a trout had as yet been seen; but when I cast towards these tops, a swirl, evidently caused by a good-sized fish, followed. I struck and fastened him, held him for a moment, when the hook detached and he escaped. It was a bitter disappointment. He was evidently a very nice fish, and the opportunity so long desired to obtain at least a little definite information of the rate of growth in these waters, seemed to have slipped from me at the very moment when within my grasp. "It's tough, John, but I've lost him." A deep sigh was the only response, and the canoe, moving as silently and almost as slowly as the shadow on the dial, withdrew about fifteen feet, and presented its broadside to the snags. Believing I had exhausted all the luck I could reasonably expect in finding one at all, I cast once with but little hope, and raised nothing; again, and the water boiled. This gentleman was evidently in earnest, and I struck him on the instant. At once the canoe began to withdraw towards the middle of the pond, while with all the bend which could be put upon the rod, I supplemented the resistance of the click by additional friction applied by my fingers to the line—always giving a little, and but a little, and making him work for every inch. It was risky—fatal if the hold was slight—but it was imperative he should not regain the shelter of the snags. The struggle was protracted and severe, but at last he swung away from them, and

we had him in clear water. He was a fighter, and for some twenty minutes we played the game of give and take, till at last he lay exhausted in the landing-net. The spring-balance was produced—the identical one used when he was originally taken in his native home—and the four-pound mark was plainly visible as he hung suspended thereon. It was a male, so we knocked him on the head.

“John, do you suppose it is possible we can have struck that two-and-a-half pounder? It seems incredible that even then he could have increased a pound and a half in sixteen months.”

John replied, “I hardly think it can be. My recollection is that fish was a female; still I am not sure. At any rate, even if it is, it shows a much quicker growth than I was prepared for. There were certainly two there, perhaps there may be more. Let’s try again.”

Once more the canoe stole up towards the sunken birches. A cast, and nothing came; a second, and the fly was taken. The same tactics produced a like result, and a female of three and five-eighths pounds was ours. We restored her to the water.

“There, John, that will do; let’s go home.”

But John was not satisfied. He must have just one look to see if there were others there, and what they were about. So we approached with caution, and when about twenty feet from the sunken birches I saw a trout, apparently of the same size as those we had already taken, swim in among the snags and disappear.

“John, did you see that fish?”

“No, where?—For Heaven’s sake, just look there!”

This form of expression, so unusual for him, and the apparent excitement with which it was uttered, startled me.

We have seen many sights, and have passed through many scenes together well calculated to stir the most languid blood, but now, for the first time in our long intercourse, did the even balance of his mind seem disturbed.

I looked, and upon a sight such as I had never before seen. Off the end of the snags, about two feet below the surface of the water, and not more than fifteen feet distant, a school of trout appeared—not three or four, or even half a dozen, but I believe at least twenty in number. Through the clear water their great white-edged fins glistened like silver, and their vivid colors were almost as striking as though we had them in our hands, fresh taken from the water.

For years it had been our constant practice and amusement for each to estimate the weight of our larger fish when they rose, during their struggle for life, and finally when ready for the net; and then at last to compare our estimates with the indications of the spring-balance, to see who had most nearly approached the truth. We had thus acquired no little proficiency in this respect, and a close coincidence between the real weight and that as finally estimated was almost invariable.

Unless we were deceived, not a single fish was in that school which did not exceed two and a half pounds in weight. Some, though we could hardly believe our own eyes, we could not place at less than five, while four-pounders were plenty.

Almost breathless we watched them slowly cruising about, apparently with utter indifference to the canoe, now not five feet from them.

I could not stand it. "John, I must have just one more out of that crowd." And so the canoe was with-

drawn, and a cast or two fastened a male trout of three pounds, which we returned to the water.

There was one lady in camp, the only one, who had accompanied her husband into the woods now for the third season. He was a valued friend, the one who, perhaps more than any other except myself, is responsible for the existence of this book. She had taken many trout with the fly, but none of over a pound weight, and was very anxious to exceed that; so we left the pond without further disturbing the fish, anxiously discussing the possibility of getting her in there.

By the somewhat free use of the axe, and by taking a rather circuitous route it was accomplished. She cast that afternoon for an hour without the slightest apparent indication that there ever had been a trout in the whole water. A heavy rain then obliged us to take her out through the wet woods, without even a rise to reward her for her trouble. I was exceedingly chagrined. I had told her what we had done and what we had seen, and as not the slightest doubt was entertained that our success could not only be repeated but easily surpassed, I had not hesitated to say so.

Then I vowed a vow, which I commend to the careful consideration of all anglers, old and new alike—never again, under any circumstances, will I recommend any fishing locality in terms substantially stronger than these: "At that place I have done so and so; under like conditions it is believed you can repeat it." We are apt to speak of a place and the sport it affords as we find it; whereas reflection and experience should teach us that it is seldom exactly the same, even for two successive days.

The next afternoon was threatening, so we visited the pond alone, merely intending to cast over it a little, so as

to locate and study the habits of the fish. Hardly had we pushed from the bank when we saw a trout roll to the surface over towards the birches. Three or four casts in that neighborhood fastened it or another, which, however, escaped after some five-minutes' play. A cast or two rose another, which went off with a sore mouth, the hook missing a firm hold. In less than two minutes afterwards a four-pound female was fastened, and landed after a capital fight. Another female of three and an eighth pounds followed. This was an exceedingly gamy fish, and took us well out in the pond before it was brought to net. We had just disposed of that one when up rolled a trout which seemed fully two feet long, and slowly swam along the surface of the water for six or eight feet with its back exposed. Around it, and in plain sight, were some eight or ten other large fish, but all of inferior size. Though more distant than the school we had seen the day before, they were within reach, and the first cast among them attracted the attention of one of the smaller ones, which proved to weigh three pounds. Subsequently another of unknown size was lost, and a male of two and a half pounds was taken. All of these fish were returned uninjured to the water. The next afternoon the lady tempted fortune again, and cast for a long time without encouragement. However, I am happy to say that later in the day she took a female of four pounds, which, for so vigorous and constant a fighter, exhibited surprising endurance; also a smaller one of two and a half pounds.

It is difficult to draw any perfectly satisfactory generalization from this, since we only know with certainty that none of the trout we took on September 27th, 28th, and 29th, 1884, weighed less than one nor more than two

and a half pounds sixteen months before ; for it is hardly conceivable that any of the first lot should have attained more than that weight between September 29th, 1882, and June 1st, 1883—only seven months.

It seems to me, on reflection, that we must have been mistaken in the size of the largest fish we saw, though we judged it at the moment to be twenty-four inches long. If so, it must have weighed very closely upon one side or the other of six pounds, and that seems utterly incredible. Clearly the three fish of four pounds which were taken could not all have been the original two-and-a-half pounder, since they were three different fish. Still assuming such to be the case, or assuming every trout in the pond to have weighed two pounds and a half on June 1, 1883, the least it seems possible to allow is an increase of one and a half pounds in sixteen months, a result sufficiently surprising.

That fishing with the fly is not in greater favor as a ladies' amusement is matter for regret. Where the use of a boat is practicable, there is no earthly reason why they should not derive the same mental, moral, and physical benefit from it as do men. It is a gentle pursuit, and a cleanly, and affords an ample field for the exercise of that manual delicacy and skill for which women are pre-eminent ; while at the same time, unlike almost every other out-of-door sport, no great muscular exertion is required, nor over fatigue incurred.

Whether the ladies really have their fair share of the amusements of life may well be questioned ; while it is beyond dispute that the directions in which custom now permits them to seek recreation, are not, to say the least, to their physical advantage.

It is a mistake on their part if they suppose that gentlemen think them in the way at such times, always provided they are reasonable. Some there are, as full of whims as an egg is full of meat, whose sole aim and object seem to be to keep half a dozen men skipping about on frivolous errands. Excluding such from the enumeration, men, not of vicious tastes and habits, have, to put it mildly, not the slightest objection to the companionship of ladies in any out-of-door amusement in which they are physically qualified to take part; nor will it be other than a pleasure to any angler to afford them all necessary assistance and instruction.

I have seen several ladies accompany their husbands to, and take part in fly-fishing. Could they and their lady friends but overhear the terms in which other anglers then present spoke of them—unless I am mistaken in supposing that ladies do not altogether despise the good opinion of men (I speak with diffidence, being a bachelor)—and that others should envy their husbands the great good-fortune which has fallen to them in their wives is not displeasing, then the former would become confirmed in, and the latter would at once begin to cultivate fly-fishing.

Men hope for something from women beyond seeing to the boiling of the potatoes and maintaining discipline among children, and that is companionship; and she who is companionable may feel confident that she has a valid mortgage on the admiration of all decent men, on which not one will make default in the payment of interest.

The time was, and that at no distant day, when he who for a moment deserted the tread-mill of life for any purpose disconnected with money-getting, braved the

disapproval of his friends. Everything which human ingenuity could devise and the most liberal expenditure could accomplish, had been done for the moral and intellectual welfare of the nation, but for its physical well-being, worse than nothing.

That day is past. Wisdom is the child of experience; and, as one after another of the most promising in the race of life dropped from the contest, solely from lack of physical stamina to make use of the ability which natural aptitude had given and careful training had fostered, the eyes of this people opened. That a steam-engine, though perfect in design and faultless in construction, is worthless when coupled with a worn-out boiler, is now generally accepted as a truth applicable to the conduct of life. Though but in middle age, it seems to me I can recognize a marked improvement in the physique of the rising generation over that of my own.

Athletics and out-of-door sports have been, and will continue to be a priceless boon to this nation. It has applied, and it is now applying a remedy to a disease which escaped the notice and comment of no intelligent foreigner who visited our shores. Though we hear it no more, it must not be forgotten that but a few years since the pessimist doomed us to extinction as a people, and that solely from pure physical decay.

To the progress of physical education among us, no true lover of his country can maintain an attitude of indifference. In the hope that I might perhaps add something to the impetus of this, as it seems to me, all-important movement, this book has been written.



INDEX.

- A.
- Adjusting rods, 172, 174, 201.
 - Age of trout, 344.
 - Ailanthus silk-worm, 64.
 - Alaska cedar, 139.
 - Aluminum bronze, 97.
 - reels, 96.
 - Ash, as a rod material, 116.
 - Attacus cecropia silk-worm, 57-61.
 - polyphemus worm, 63.
 - prometheus worm, 63.
 - Automatic reels, 95.
- B.
- Bamboo, as a rod material, 109, 152.
 - burns upon, 112.
 - gluing, 212, 214.
 - how to order, 113.
 - planing, 217.
 - quality of, 219.
 - selection of, 218.
 - testing, 221.
 - tips, 207.
 - to make four-strand rod, 208-213.
 - to make six-strand rod, 217-231.
 - rods, selection of, 114.
 - repair of, 115, 248.
 - Beefwood, or bullit-wood, 133.
 - Bethabara, 128.
 - Bois d'Arc, or bodock, 135.
- Brass, receipt for blacking, 191.
- Breaks, repair of, 239-246.
- C.
- Calcutta bamboo, 109.
 - Casting the fly, 257.
 - how to learn, 257.
 - position on back cast, 260.
 - position on front cast, 268.
 - position of elbow, 261.
 - position of wrist on back cast, 262.
 - position of wrist on forward cast, 263.
 - position of body and unemployed arm, 263.
 - the back cast, 264, 269, 274, 275.
 - the pause, 265.
 - the forward cast, 266, 268.
 - cast to be noiseless, 269.
 - side cast, 269.
 - length of, usual, 160, 270.
 - long-distance casting, 270.
 - purpose of casting, 276.
 - maximum fishing cast, 277.
 - postponing back cast, 279, 282, 284, 285.
 - not all of fly-fishing, 274, 275.
 - practice of left hand, 269.
 - the strike, 28, 271, 277, 299.
 - cautions to the beginner, 279.
 - Cedar, as a rod material, 119.

- Cedar, Alaska, 139.
 Cements for ferrules, 169.
 Chowwood, 142.
 Click of reels, 91, 94.
 tempering springs for, 97.
 Comparative weights of rod-woods,
 table, 150, 151.
 Composite rods, 148.
 Cutting, selection, and seasoning of
 rod-wood, 121.
- D.
- Dagame wood, 144, 146.
 Dowelled *vs.* simple ferrules, 176.
 Dowelled ferrules, 188, 247.
 Draw-filing, 213.
 Drawn gut described, 67.
 Drawn tubing for ferrules, 188.
 Drop-flies, how attached to leader,
 79.
 how spaced on leader, 82.
 to fasten to leader, 79.
 Dyeing gut, 70.
 loss of strength by, 70, 86.
 Dyes for gut—ink-dye, 71, 73, 326.
 logwood and copperas, 73,
 328.
 green dye, 74, 326.
 coffee color, 325.
- E.
- English rods, 99.
 Experiments to determine best color
 for leaders, 314.
- F.
- Ferrules, care in use of, 251.
 cements for, 169.
 dowelled ferrules, 188, 247.
 dowelled *vs.* simple ferrules,
 176.
 fastening pins for, 171.
 fitting and fastening ferrules,
 168, 189.
- Ferrules, from tubing, 188.
 general discussion of, 175.
 hour-glass ferrules, 186.
 separating, 251.
 sizes and lengths for, 162,
 175.
- Fish-hooks, angle of efficiency, 18.
 barbless hooks, 18, 27.
 blued hooks, 32.
 holding-power, 16.
 how made, 33.
 how tested, 38.
 how to criticise, 22.
 lightness and neatness of, 16.
 Limerick, Round, and Kirby
 bends, 17.
 mechanics of, 11, 19.
 O'Shaugnessy bend, 27.
 overfineness of wire, 13, 24.
 penetration of, 14-19.
 Pennell's remarks on, 12.
 comments on same, 19.
 Pennell hook, 27, 32.
 short-shanked hooks, 24.
 side-bend discussed, 26.
 Sneck and Sproat bends, 17,
 25, 26, 27, 32.
 small barb, 25.
 strength of, 16.
 straight and curved shanks,
 15, 25, 26.
 theoretically perfect hook
 impossible, 26.
- Fishing-lines. (*See* Lines.)
 Fishing, color of dress when, 334.
 effect of ripple on, 321.
 by ladies, 355.
 in Maine waters, 27, 255,
 272, 282, 288, 294.
 points for beginners, 279,
 293.
 playing fish when wading,
 343.
 at Rangely Lakes, 288, 294.
 in streams, 253, 279, 333.

- Flies, how attached to leader, 79,
83.
manipulation on water, 279,
293, 296.
rules for same, 279.
for Rangely Lakes, Me., 302.
repair of, 252.
selection of, 275, 287, 291.
from what depth visible, 330.
- Fly-casting. (*See Casting the Fly.*)
- G.
- German-silver, 190.
to black, 191.
- Glue, liquid, 242.
the use of, 212, 215, 242.
water-proof, 243.
- Green dye for leaders, 74, 326.
- Greenheart, 126.
- Growth of trout, 344.
- Gut (silk-worm), 55.
classifying, 74.
dyeing, 70.
domestic manufacture of, 65.
drawn gut described, 67.
from American worms, 57,
61, 64.
gauge for measuring, 69.
how and where made, 56.
loss of strength by dyeing,
70.
selection of, 68.
strength of, 69.
- H.
- Handles for rods, 193.
finishing, 197.
position of reel on, 97, 196.
- Hard woods of the United States,
138.
- Hickory, 121.
- Hobnails, 334, 339.
- Hooks. (*See Fish-hooks.*)
- Hornbeam. (*See Ironwood.*)
- Hour-glass ferrules, 186.
- I.
- Ink-dye for leaders, 71, 73, 326.
- Invisible knot. (*See Knots.*)
- Ironbark wood, 143.
- Ironwood, native, 123.
East Indian, 141.
- J.
- Jucaro prieto wood, 145.
- K.
- Keepers, 202.
- Knots for leaders, 75.
for fastening off wrappings,
236.
invisible knot, 236, 250.
learning to tie, 82, 233.
to join line and leader, 80.
water-knots, 77.
- Kranji-wood, 142, 143.
- L.
- Lancewood, 116, 152.
discoloration of, 119.
- Landing-net for stream fishing, 343.
course when missing, 253.
- Laslett's experiments on woods, 139.
table of results, 144.
- Leaders, best color for, 308, 314, 322.
for coloring. (*See Dye.*)
material of, 55.
securing drop-flies to, 79.
strain on, in fishing, 87.
testing strength of, 83, 305.
tying, 74.
visibility of, 72, 308, 314, 322.
- Letterwood, 131.
- Lines, color of, 317, 329.
enamelled water-proofed, 43.

- Lines, good lines the cheapest, 46.
 grass lines, 40.
 how fastened to leader, 80.
 how to select, 51.
 length of, 46.
 material of, 40.
 oiled lines, 43.
 raw and boiled silk lines, 42.
 repair of, 253.
 shoddy lines, 41.
 table of sizes, 44.
 tapered and level lines, 44.
 testing, 45, 51.
 water-proofed lines, 43.
 water-proofing receipts, 49.
 what size to use, 46.
- Logwood and copperas dye for lead-
ers, 73, 328.
- M.
- Mahoe-wood, 120.
 Maine trout, 27.
 fishing, 255, 272, 280, 282,
 288, 294.
 wilderness, 336.
- N.
- Number of rings, 200.
- O.
- Osage-orange, 135.
- P.
- Paddle-wood, or roller-wood, 134.
 Pingow-wood, 142.
 Planes for rod-making, 157.
 Purpleheart wood, 148.
 Pyengadu, 141.
- R.
- Rangely Lakes, fishing at, 288, 295.
 size of trout in, 345.
- Reels, 90.
 automatic, 95.
- Reels, click of, 91, 94.
 construction of, 93, 94.
 diagram of, 95.
 diagram of click, 92.
 handle of, 90.
 location of, 97, 196.
 loose screws, to remedy, 254.
 material for, 96.
 non-fitting reel, use of, 253.
 of aluminum, 96.
 seat, formation of, 196.
- Repairs, 232.
 break at ferrule, 246.
 broken joints, 239.
 frayed line, 253.
 loose screws in reel, 254.
 material for, 240.
 non-fitting reel, 253.
 of bamboo-rods, 115, 248.
 of flies, 252.
 replacing end ring, 249.
 replacing rings, 248.
 splicing breaks, 239.
- Rings, attaching to rod, 199-202.
 number required, 200.
 replacing end ring, 249.
 replacing missing, 248.
 sizes of, 200.
- Ripple on water, effect of, 321.
- Rods, action of, 101.
 bringing top to butt as a
 test, 105.
 cause of breaking, 107.
 desiderata in, 102.
 English rods, 99.
 killing power, 103.
 proper length for, 102, 160.
 rod of the future, 152.
 top-heavy rods, 162.
 varnishing, 197.
- Rod-case, 339.
- Rod-making, 156, 164.
 adjusting rod, 172, 174, 201.
 cements for ferrules, 169.
 determining taper, 162.

- Rod-making, draw-filing, 213.
 finishing, 173.
 fitting and fastening ferrules,
 168, 171, 189.
 gluing bamboo, 213-216.
 proportioning rods, 159, 162.
 rings and keepers, 199-202.
 rounding joints, 158.
 split-bamboo tips, 207.
 four-strand split-bamboo,
 208, 213.
 six-strand split-bamboo, 217-
 231.
 tips, 207.
 tools for, 157, 164.
 wrapping with silk, 233.
- Rod material, 99.
 Alaska cedar, 139.
 ash and lancewood, 116.
 bamboo. (*See* Bamboo.)
 beefwood, or bullit-wood, 133.
 bethabara, 128.
 bodeock, 135.
 bois d'arc (osage - orange),
 135.
 cedar, 119.
 chow, 142.
 composite rods, 148.
 dagame, 144, 146.
 greenheart, 126.
 hickory, 121.
 hornbeam, 123.
 ironbark, 143.
 ironwood, native, 123.
 ironwood, East Indian, 141.
 jucaro prieto, 145.
 kranji, 142, 143.
 lancewood, 116, 152.
 mahoe, 120.
 paddle-wood, or roller-wood,
 134.
 pingow, 142.
 purpleheart, 148.
 pyengadu, 141.
 shadblow, 137.
- Rod material, snakewood, or letter-
 wood, 131.
 split-bamboo, 109, 152.
 table of weights of, 150, 151.
 washaba, 130.
- Rod-wood, cutting, seasoning, and
 selection of, 121.
 straightening by heat, 165.
 testing, 126, 166.
- Rubbers for wading, 341.
- S.
- Selection and seasoning of rod-wood,
 121.
 Selection of gut, 68, 69.
 Shadblow, 137.
 Shoes for wading, 334, 339, 340,
 341.
 Silk, as a line material, 40.
 Silk, shoddy, 41.
 Silk-worm, anatomy of, 55.
 Silk-worm gut. (*See* Gut.)
 Silk-worms, American, 57.
 attacus cecropia, 57.
 attacus polyphemus, 63.
 attacus prometheus, 63.
 saturnia cynthia, 64.
 the ailanthus, 64.
- Simple ferrules *vs.* dowelled, 176.
 Sizes of rings, 200.
 Sorting gut, 74.
 Snakewood, 131.
 Splicing breaks, 239, 245.
 in bamboo, 248.
- Split-bamboo rods, 109, 152.
 tips, 207.
- Springs, tempering, 97.
 Steel rods, 152.
 Strength of trout, 87.
 Striking fish, 28, 271, 277, 299.
- T.
- Table of weights of rod materials,
 150, 151.

- Testing bamboo, 221.
 hooks, 38.
 leaders, 83, 305.
 lines, 45, 51.
 rod-wood, 126, 166.
- Tips, 207.
- Tournament, fly-casting, 102.
- Trout, age and growth of, 344.
 feeding and fasting powers
 of, 346.
 habits of, 288, 290, 296.
 hearing power of, 306.
 limit of strain by, 87.
 visibility of objects on land
 to, 318.
 vision of, 307.
- V.
- Varnishing rods, 197.
 wrappings, 206.
- Visibility of leaders, 72, 308, 314,
 322.
- Visibility of objects on land to trout,
 318.
 of objects on surface, limit
 of, 330.
 shadow of rod, 322.
- Vision of trout, 307.
- W.
- Wading clothes, 334, 340.
 handling fish when, 343.
 rubbers, 341.
 shoes, 334, 339, 340, 341.
 staff, 342.
- Washaba, 130.
- Water-proofed lines, 43.
- Water-proofing lines, 49.
- Woods for rods. (*See* Rods.)
 comparative weights of, ta-
 ble, 150, 151.
- Wrapping, how done, 233.
 on rings, 199-202.
- Wrappings, varnishing of, 206.

THE END.

TWO BOOKS FOR ANGLERS.

I Go a-Fishing.

I Go a-Fishing. By WILLIAM C. PRIME. Crown 8vo, Cloth, \$2 50.

An admirable piece of literary mosaic. It abounds in fresh descriptions of nature as breezy and fragrant as the spicy woodlands in which they had their birth. The author has brought to its composition a rare familiarity with the daintiest products of literature and art, a passion for curious and out-of-the-way knowledges, extensive and observant travel in regions remote from the beaten track, and a heart-felt love of nature in her hidden ways and sylvan retreats.—*N. Y. Tribune*.

It is a volume that will outlive the summer, and many summers, and be as fresh and pleasant and suggestive by the fireside as by the brook side.—*Boston Journal*.

A very entertaining and equally instructive volume. On his line he hangs all sorts of episodical incident, discussion, antique lore, curious bits of philology, poetry, and story, beguiling the hours on lake and stream with pleasant talk, such as Izaak Walton or Dr. Bethune indulged in.—*Observer, N. Y.*

Hallock's Fishing Tourist.

The Fishing Tourist: Angler's Guide and Reference Book. By CHARLES HALLOCK, Secretary of the "Blooming - Grove Park Association." Illustrated. Crown 8vo, Cloth, \$2 00.

Mr. Charles Hallock is one of the few gentlemen who write a book mainly for the reason that they have something to write about—have something to tell the public which the public desires to know. Mr. Hallock learned how to use the pen in the exacting rounds of a newspaper office, and being a traveller, a patient student of nature, and a practical angler, casting his fly on many waters, he acquired a rich fund of information. The book is called "The Fishing Tourist," and the title is not a misnomer. The shortest routes to pleasure are laid down, and correct information is given as to the best means of conveyance, the expense of the trip, the secrets of the commissariat, etc. The author has avoided the use of technical terms, and thus made his volume all the more acceptable to the majority of readers.—*Turf, Field, and Farm, N. Y.*

PUBLISHED BY HARPER & BROTHERS, NEW YORK.

✉ Either of the above works sent by mail, postage prepaid, to any part of the United States or Canada, on receipt of the price.

BOOKS OF SPORT AND ADVENTURE.

Gibson's Camp Life in the Woods.

Camp Life in the Woods; and the Tricks of Trapping and Trap Making. Containing Comprehensive Hints on Camp Shelter, Log Huts, Bark Shanties, Woodland Beds and Bedding, Boat and Canoe Building, and Valuable Suggestions on Trappers' Food, &c. With Extended Chapters on the Trappers' Art; Full Directions for the Use and for the Construction of Traps of all Kinds; Detailed Instructions for the Capture of all Fur-Bearing Animals, &c. By W. HAMILTON GIBSON, Author of "Pastoral Days." Illustrated by the Author. 12mo, Cloth, \$1 00.

It is a book which will interest every boy, and while he reads and imagines that he is pursuing his game with ingenious contrivances he will be acquiring, at the same time, a wide knowledge of the wild animals of America and Canada. The work is profusely illustrated by the author.—*N. Y. Tribune.*

Murphy's Sporting Adventures in the Far West.

Sporting Adventures in the Far West. By J. M. MURPHY. Illustrated. 12mo, Cloth, \$1 50.

His book is more than a collection of sporting notes and thrilling encounters with wild beasts, and will interest many who care but little for the details of the pursuit and slaughter of animals.—*Observer, N. Y.*

Hunting Adventures on Land and Sea. By Thos. W. Knox.

Part I. The Young Nimrods in North America.

Copiously Illustrated. 8vo, Cloth, \$2 50.

Part II. The Young Nimrods Around the World.

Copiously Illustrated. 8vo, Cloth, \$2 50.

PUBLISHED BY HARPER & BROTHERS, NEW YORK.

Any of the above works sent by mail, postage prepaid, to any part of the United States or Canada, on receipt of the price.

BOOKS ON PHYSICAL CULTURE.

Blaikie's How to Get Strong.

How to Get Strong, and How to Stay So. By WILLIAM BLAIKIE. Illustrated. 16mo, Cloth, \$1 00.

This is an excellent work on physical culture. It shows how every part of the body may be developed and beautified.—*Northern Christian Advocate*.

The author has viewed his subject from every essential stand-point, and has produced a work that merits the earnest attention of all. Mr. Blaikie has treated his theme in a practical common-sense way that appeals at once to the judgment and the understanding. A complete and healthful system of exercise is given for boys and girls; instructions are set down for the development of every individual class of muscles, and there is sound advice for daily exercise for children, young men and women, business men and consumptives. In addition, there are instructions for a system of home gymnastics, and an easy routine of practice laid out. The volume is one that should be in the hands of everybody who places a proper value upon health, and the most practicable way of preserving it.—*Saturday Evening Gazette*, Boston.

It is the best work of the kind we have ever read. * * * An invaluable book, we think.—*Evangelical Messenger*, Cleveland, Ohio.

Blaikie's Sound Bodies for our Boys and Girls.

Sound Bodies for our Boys and Girls. By WILLIAM BLAIKIE. With Illustrations. Pages x., 168. 16mo, Cloth, 40 cents.

Worthy of the heartiest commendation. * * * There can be no two opinions as to the advantages of regular daily exercises such as are here described.—*N. Y. World*.

Mr. William Blaikie's new manual cannot fail to receive a warm welcome from parents and teachers, and should be introduced as a working text-book into thousands of schools throughout the country.—*Boston Herald*.

The directions are so simple and sensible that they appeal to the reason of every parent and teacher.—*Philadelphia Press*.

The influence of judicious exercise upon mind as well as body cannot be overestimated, and this will be a safe guide to this end, requiring no costume nor expensive apparatus.—*Presbyterian*, Philadelphia.

PUBLISHED BY HARPER & BROTHERS, NEW YORK.

✉ Either of the above works sent by mail, postage prepaid, to any part of the United States or Canada, on receipt of the price.

ILLUSTRATED GIFT-BOOKS.

Nature's Serial Story.

By EDWARD P. ROE. Beautifully and Profusely Illustrated with wood-engravings from Drawings by WILLIAM HAMILTON GIBSON and FREDERIC DIELMAN. pp. xx., 430. Square 8vo, Illuminated Cloth, \$5 00; Gilt Edges, \$5 25.

The central idea is the illustration of out-door life, and this is done both with pen and pencil so successfully that the freshness of the country breathes perceptibly through the pages.—*N. Y. Tribune*.

The book is a delight to the eyes and a refreshment to the mind. It comes to us who dwell in cities with a delicious breath of the woods and fields.—*N. Y. Commercial Advertiser*.

It is Mr. Roe's most elaborate production, and, taking it in all its characteristics, his ablest work.—*Observer*, N. Y.

Mr. Roe describes Nature with a loving hand, and from the most intimate familiarity with her moods. * * * We doubt if ever work of fiction had so beautiful a setting.—*Brooklyn Union*.

Writer, artists, and publishers have combined to give an original work which may gratify the best taste of American readers.—*Christian Intelligencer*, N. Y.

Drake's Heart of the White Mountains.

The Heart of the White Mountains. By SAMUEL ADAMS DRAKE, Author of "Nooks and Corners of the New England Coast." Illustrated by W. HAMILTON GIBSON, Author of "Pastoral Days." 4to, Illuminated Cloth, Gilt Edges, \$7 50. *Tourist's Edition*, \$3 00.

It is printed in quarto form, and the illustrations from the pencil of Mr. Gibson are beautiful in design and exquisite in execution. The letter-press is by Mr. Samuel Adams Drake, and is quite worthy of the artistic part of the work. It is a superb production.—*N. Y. Sun*.

Mr. Gibson fairly outdoes himself, and the result is a volume filled with the daintiest and most beautiful pictures and legends and stories.—*N. Y. Commercial Advertiser*.

A book that is as delightful as a literary work as it is exquisite as a work of art.—*N. Y. Evening Express*.

PUBLISHED BY HARPER & BROTHERS, NEW YORK.

✉ Either of the above works sent by mail, postage prepaid, to any part of the United States or Canada, on receipt of the price.



14 DAY USE
RETURN TO DESK FROM WHICH BORROWED

LOAN DEPT.

This book is due on the last date stamped below, or
on the date to which renewed.

Renewed books are subject to immediate recall.

21 Apr '60 EE

REC'D LD

APR 7 1960

JUN 30 1980

REC. CIR. JUN 5 80

LD 21A-50m-4, '59
(A1724s10)476B

General Library
University of California
Berkeley

YC 12486

