

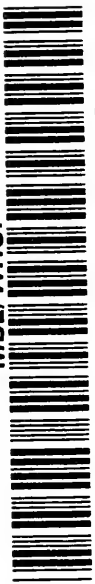

MBL/WHOI



0 0301 0014104 0



THE FUNGI



The father of American mycology.

THE FUNGI

IN TWO VOLUMES

Volume II

By Frederick A. Wolf *and* Frederick T. Wolf

DEPARTMENT OF BOTANY
DUKE UNIVERSITY

DEPARTMENT OF BIOLOGY
VANDERBILT UNIVERSITY

New York: JOHN WILEY & SONS, Inc.

Chapman & Hall, Limited

London

COPYRIGHT, 1947
BY
JOHN WILEY & SONS, INC.

All Rights Reserved

*This book, or any part thereof, must not
be reproduced in any form without
the written permission of the publishers.*

PRINTED IN THE UNITED STATES OF AMERICA



PREFACE

This treatise on fungi is intended as a reference and textbook. Its content falls naturally into two portions. The first portion, included in Volume I, is a consideration of the developmental morphology and taxonomy of fungi and is basic to any comprehensive study of the fungi. The second portion, included in Volume II, deals more specifically with the activities of fungi. It must be borne in mind, however, that we have attempted throughout the treatise to stress the need for more emphasis on problems relating to fungus activities.

The content of Volume II is concerned with metabolic and reproductive activities, the modification of these activities by environment, and the relationship of fungi to the welfare of man. Consideration is also given to certain fungi for which habitat is largely the basis of grouping. This volume may be spoken of as physiological and ecological in its emphasis. It does not purport, however, to constitute a well-rounded "physiology and ecology of fungi" for the reason that experimental data are still too meager to permit the preparation of such a textbook. This explanation is made at the outset to guard the reader against eventual disappointment. The need for a volume on the physiology of fungi is keenly felt by all who seek such information in textbooks on plant physiology, only to find that such books are limited to consideration of the physiology of *seed* plants.

Teachers may at first regard our departure from the traditional emphasis on taxonomy and classification as too radical to put into practice. It should be remembered, however, that lasting impressions come from contact with living, functioning organisms. From experience we know that we remember with facility where and under what circumstances we first encountered many different fungi in their natural habitats, and we recall how intent we became as we watched their development and the changes which they induced. If, on the other hand, we had been presented with an herbarium specimen, as is common

laboratory practice, and had been asked to perform an "autopsy" in order to arrive at an understanding of the structure and possible functioning of the victim, long dead and mummified, little stimulation of thought or interest would have resulted.

The further objection may be raised that knowledge of fungus activities is still too meager to be presented in an organized manner to students. All that need be said in rejoinder is that the seven-league boots of physics, physical chemistry, biochemistry, physiological chemistry, and colloid chemistry will enable the teacher and the student alike to wade far out into the depths of the vast mycologic unknown. Beginnings must be made.

Opinions have a limited value in the field of science. At times, ours are expressed. Mycologists may not find themselves in accord with some of these opinions. Be that as it may, data will some day exist upon which ultimate truth will become securely established, and then, of course, opinions now expressed will lose all value.

Our efforts have been concentrated on helping the student to understand fundamentals. We have chosen to include data and conclusions from certain reports of researches and have omitted, without apparent reason for so doing, to mention others that are equally good and pertinent. No intentional discredit or lack of merit is implied in these omissions. In a volume of this scope it is simply impossible to consider each subject monographically. The relative importance of subjects is not reflected by the amount of space devoted to them. References to reports are given at the end of each chapter; these papers contain additional pertinent references to other researches, so that interested persons can gain a more comprehensive grasp of a particular subject.

Most of the illustrations are adapted from those of others. If in any instance the author of the original drawing or graph has not been mentioned, the omission is unintentional. We herewith acknowledge again, with gratitude, the kindness of those who supplied us with certain illustrative materials, and of Mary H. Wolf for her assistance in the preparation of illustrations.

Since the legends are intended to explain the illustrations adequately, mention of illustrations is omitted from the text.

We are indebted also to Dr. L. E. Wehmeyer, who carefully read the entire manuscript, for his criticisms and suggestions and to Mrs. Fred T. Wolf for her help in reading proof and in the

preparation of the indices. Also we are keenly appreciative of the gift of a wood-cut picture of Louis David de Schweinitz, to whom these volumes are dedicated, from his great-granddaughter, Dr. Adelaide L. Fries.

F. A. WOLF

F. T. WOLF

March, 1947

CONTENTS

1. *NUTRITION OF FUNGI* 1
Mineral nutrition of fungi, 2. Organic nutrients of fungi, 16. Growth factors, 24. Influence of osmotic pressure, 29. Implications, 29.
2. *ENZYMES AND ENZYMIC ACTIVITIES OF FUNGI* . . . 37
3. *RESPIRATION* 53
Historical material, 53. Types of respiration, 56. The respiratory ratio, 62. Respiratory systems, 63. Respirometry, 64. Inhibition of respiration, 65. Stimulation of respiration, 66. Implications, 66.
4. *BIOCHEMISTRY OF FUNGI* 69
Organic acids and other products having six or fewer carbon atoms, 70. Polysaccharides, 79. Fats, 79. Sterols and vitamins, 81. Amino acids, 83. Pigments of fungi, 83. Other metabolic products, 86. Implications, 88.
5. *EFFECTS OF TEMPERATURE ON FUNGI* 96
Cardinal temperatures, 97. Resistance to low temperatures and high temperatures, 103. Influence of temperature on infection, 109. Temperature and reproduction, 111. Temperature and zonation, 114. Temperature coefficients, 114. Temperature and oxygen tension, 117. Implications, 119.
6. *EFFECTS OF RADIATION ON FUNGI* 123
Morphogenic reactions, 125. Phototropism, 129. Luminescence, 137. Inhibitory effects, 138. Stimulatory effects, 143. Effect on sporulation, 144. Effect of X-rays, 145. Induction of saltations, 145. Mode of action of short radiations, 147. Implications, 147.
7. *EFFECTS OF REACTION OF SUBSTRATE ON FUNGI* . 151

8. *SPORE DISSEMINATION* 166
 Distribution of spores, 167. Structural adaptations for expulsion of spores, 179. Hygroscopic mechanism in Myxomycetes, 179. Spore expulsion among Phycomycetes, 180. Spore discharge among Ascomycetes, 186. Spore discharge among Basidiomycetes, 194. Implications, 205.
9. *GERMINATION OF SPORES* 210
 Germination types, 210. Methods of testing spore germination, 212. Hereditary factors and germination, 214. Water relations affecting germination, 218. Effects of temperature on germination, 221. Influence of reaction on germination, 229. Influence of oxygen on germination, 230. Influence of carbon dioxide on germination, 231. Influence of light on germination, 231. Influence of nutrition on germination, 232. Résumé, 232.
10. *HOST PENETRATION* 236
 Direct penetration, 237. Stomatal penetration, 248. Penetration through wounds, 251. Haustoria and their significance, 252. Penetration by ectoparasites, 253. Implications, 254.
11. *PHYSIOLOGIC SPECIALIZATION AND VARIATION AMONG FUNGI* 257
12. *ASSOCIATIVE EFFECTS AMONG FUNGI* 279
 Antagonism, 280. Stimulation by associative interaction, 287. General considerations, 292.
13. *MYCORRHIZAE AND MYCOTROPHY* 297
14. *GENETICS OF FUNGI* 317
 Sexual and asexual stages of fungi, 317. Homothallism and heterothallism, 319. Dominance and lethal factors, 335. Résumé, 336.
15. *POISONOUS AND EDIBLE FUNGI* 339
 Poisonous fleshy fungi, 339. Food value of fleshy fungi, 351. Ergot and ergotism, 354. Toxicity of *Gibberella*

- saubinettii* (*G. zeae*) and *Fusarium* spp., 359. Implications, 361.
16. *MEDICAL MYCOLOGY* 364
 Historical material, 366. *Coccidioides immitis*, 367. *Cryptococcus histolyticus*, 368. *Histoplasma capsulatum*, 369. *Phialophora verrucosa*, 370. *Malassezia ovalis*, 372. *Actinomyces bovis*, 373. *Sporotrichum schenckii*, 375. *Monilia* (*Candida*) spp., 377. *Aspergillus fumigatus*, 379. The Trichophytoneae or ringworm fungi, 379. Implications, 390.
17. *GEOGRAPHICAL DISTRIBUTION OF FUNGI* 395
 Distribution of Myxomycetes, 397. Distribution of Phycomycetes, 399. Distribution of Ascomycetes, 402. Distribution of Basidiomycetes, 405. Distribution of Deuteromycetes, 410. Implications, 412.
18. *MYCOLOGY IN RELATION TO PLANT PATHOLOGY* 416
 Early concepts of disease in plants, 417. Contributory advances in bacteriology, 418. Signposts along the phytopathological path, 419. Developments in terminology, 421. Fungi as antigens and plant pathology, 423. Present trends in mycologic and phytopathologic work, 424. Implications, 427.
19. *SOIL FUNGI* 429
 Taxonomic studies, 429. Biochemical activities of soil fungi, 434. Soil-borne pathogens, 437. Implications, 437.
20. *FUNGUS-INSECT INTERRELATIONSHIPS* 442
 Insects as vectors of plant-pathogenic fungi, 442. Fungi occurring on or within insects, 444. Biological control of insects, 448. Insects in relation to reproduction of fungi, 450. Fungi cultivated by insects, 451. Implications, 455.
21. *MARINE FUNGI* 458
 Historical background, 459. Marine Phycomycetes, 460. Marine Ascomycetes, 466. Marine Fungi Imperfecti, 468. Marine slime molds, 470. Implications, 470.

22. *FOSSIL FUNGI* 474
Geological time, 474. Age of fossil fungi, 477. The nature of fossilized fungi, 478. Preparation of fossils for study, 479. Classification of fossil fungi, 479. Fossil mycorrhizae, 487. Implications, 488.

AUTHOR INDEX 491

SUBJECT INDEX 502

Chapter 1

NUTRITION OF FUNGI

Fungi are commonly regarded as unable to synthesize their own food; that is to say, they are not autotrophic. It is customary therefore to consider them parasites and saprophytes; these groupings are based upon whether they secure their food from living organisms or from dead and decaying plant or animal tissues. Parasitic fungi may better be spoken of as paratrophic, and saprophytic fungi as saprotrophic. A moment's contemplation will reveal, however, that these terms too are quite arbitrary and inadequate. For instance, experience has shown that certain fungi, such as the Peronosporaceae, Erysiphaceae, and Uredinales, are strictly paratrophic. Others—for instance, the Lycoperdales and Phallales—are strictly saprotrophic, and between these extremes all degrees of intergradation exist. In fact, such terminology becomes confusing, because many plant pathogens are paratrophic during part of their annual cycle and saprotrophic during the remainder.

Concepts regarding the nutritional relationships of fungi that underlie such terminology emphasize the fact that fungi lack chlorophyll, and thereby the impression is inferentially fostered that neither parasites nor saprophytes perform syntheses. As a consequence the metabolic changes they induce are not properly appreciated, and too little consideration is given to the determination of how both parasites and saprophytes effect not only analyses (katabolism) but also syntheses (anabolism).

In this discussion the term food is used herein in the broadest sense. Any substance is regarded as food which serves as a source of energy or is used for growth and repair or for the various metabolic processes of the fungus. This usage implies that both inorganic and organic materials play a role in the nutritional requirements of fungi and in this sense constitute food. The inherent implications in this usage of the term food permit dis-

cussion of this subject under two headings: (a) inorganic or mineral nutrition of fungi, and (b) organic nutrition of fungi.

MINERAL NUTRITION OF FUNGI

Problems relating to the mineral nutrition of fungi appear at first to have been approached wholly by empirical methods. The experiences and techniques of bacteriologists constituted the foundation for these early studies. The investigators seem to have employed such chemical compounds and in such proportions as had been found to promote the growth of bacteria. The proper kind and amount of mineral elements were not sought by extended series of experiments in which ash analyses were correlated with rate of growth or with amount of mycelial mat.

Not only were these procedures employed with liquid media but also mycologists followed the bacteriologist in quite the same way in the use of the numerous kinds of semisolid media. It is not unusual to find now that a particular medium, compounded according to a certain formula, is a favorite with a given mycologist and that he attempts to cultivate all species in which he may be interested on this particular medium. It will become apparent in the discussion which follows that this procedure may lead to erroneous conclusions regarding the nutrition of the fungi involved.

Investigations of the mineral nutrition of fungi may be said to have begun with the classical researches of Raulin (1869), a pupil of Pasteur. He employed *Aspergillus niger* as a test organism and secured optimum growth in a medium, now known as Raulin's solution, having the following composition:

Ammonium nitrate	4	grams	Iron sulphate	0.07	gram
Ammonium phosphate	0.6	gram	Potassium silicate	0.07	gram
Magnesium carbonate	0.4	gram	Sucrose	70	grams
Potassium carbonate	0.6	gram	Tartaric acid	4	grams
Ammonium sulphate	0.25	gram	Water	1500	ml
Zinc sulphate	0.07	gram			

He concluded that none of the minerals contained in this medium could be omitted if optimum growth was to be secured.

Raulin's studies stimulated a series of investigations, the outstanding of which were those of von Naegeli (1880), Benecke

(1895), Molisch (1892, 1894), and Wehmer (1895). Von Naegeli believed that sulphur and phosphorus are indispensable for all molds and that potassium and calcium are replaceable, potassium by rubidium or caesium, and calcium by magnesium, barium, or strontium. The experiments of Benecke and Molisch led them to conclude that magnesium is not replaceable by any other mineral element. Benecke secured luxuriant growth of many species of *Aspergillus* and *Penicillium* on a synthetic agar medium, the inorganic salts of which were ammonium phosphate, potassium chloride, and magnesium sulphate. Wehmer considered especially the essentiality of iron and zinc, each of which was regarded as indispensable by Raulin (1869).

Under the stimulus of studies on the mineral nutrition of green plants several other mineral nutrient solutions were compounded and employed not only with green plants but also with fungi. These included the following:

Pfeffer's Solution

Ammonium nitrate	10.0 grams	Cane sugar	50.0 grams
Potassium phosphate (monobasic)	3.0 grams	Ferrous sulphate	Trace
Magnesium sulphate	2.5 grams	Water	1000 ml
Reaction: $pH = 4.3$			

Richards' Solution

Potassium nitrate	1 gram	Ferric chloride	Trace
Potassium acid mono- phosphate	0.5 gram	Saccharose	3.43 grams
Magnesium sulphate	0.25 gram	Water	100 ml
Reaction: $pH = 4.2$			

Ushinsky's Solution

Ammonium lactate	6.7 grams	Sodium chloride	5-7 grams
Sodium asparaginate	3-4 grams	Calcium chloride	0.1 gram
Potassium acid phosphate	2-2.5 grams	Glycerin	30-40 grams
Magnesium sulphate	0.3-0.4 gram	Water	1000 ml

Czapek's Solution

Magnesium sulphate	0.5 gram	Sodium nitrate	2.0 grams
Potassium acid phosphate	1.0 gram	Saccharose	3-4 grams
Potassium chloride	0.5 gram	Water	1000 ml
Reaction: $pH = 6.8$			

SULPHUR REQUIREMENTS. The results obtained with these nutrient solutions make a voluminous literature. There appears little reason to doubt that these experiments prove the essentiality for all fungi of appreciable amounts of potassium, phosphorus, magnesium, and sulphur. Inorganic phosphates constitute entirely satisfactory sources of potassium and phosphorus. Magnesium sulphate serves well as the source of magnesium, but not all fungi are able to use sulphates as a source of sulphur. Armstrong (1921) observed that persulphate, sulphite, and sulphhydryl can be substituted for sulphates in the nutrition of *Aspergillus niger*, *Penicillium glaucum*, and *Botrytis cinerea*. Volkonsky (1933, 1934) made similar observations with certain water molds, such as *Achlya*, *Aphanomyces*, *Dictyuchus*, *Isoachlya*, and *Leptolegnia*, and pointed out that each of these forms grows better on organic than on inorganic sulphur compounds. The results for inorganic sulphur were substantiated by Leonian and Lilly (1938), whose experiments show that the amino acid *l*-cystine is necessary for the growth of *Saprolegnia mixta*, *Achlya conspicua*, *Aphanomyces camptostylus*, and *Isoachlya monilifera*.

Schade (1940), on the other hand, found that *Leptomitus lacteus* and *Apodachlya brachynema* fill their sulphur requirements by reducing sulphates. Steinberg's (1941) experiments show that *Aspergillus niger* utilizes both organic and inorganic sulphur. Of the organic sulphur compounds, alkyl sulphonates and alkyl sulphinates are readily assimilated, but the alkyl mercaptans, sulphides, and disulphides are not utilized. In the case of inorganic sulphur compounds, the sulphur is first reduced to sulphoxalate and then converted to organic sulphur.

CALCIUM REQUIREMENTS. Whether calcium is essential for all fungi is still a controversial question that should be studied, the best techniques known for such tests being utilized. Molisch (1894) came to the conclusion that fungi do not require calcium. Mosher *et al.* (1936) have presented evidence to show that *Trichophyton interdigitale* requires calcium. Young and Bennett (1922) concluded that calcium is generally beneficial in the growth of most fungi and is certainly required by *Fusarium oxysporum*, *Rhizopus nigricans*, and *Aspergillus niger*. They also grew species of *Ascochyta*, *Botrytis*, *Cercospora*, *Colletotrichum*, *Dothiorella*, *Macrosporium*, *Phoma*, *Rhizoctonia*, *Sclero-*

tinia, Sphaeropsis, and Vermicularia in Richards' solution with $\text{Ca}(\text{NO}_3)_2$ substituted for KNO_3 and maintained, although their evidence is not conclusive, that best growth occurred in the solutions containing calcium. They attribute this phenomenon to the neutralization by calcium of the acids formed from sucrose. In support of this theory they demonstrated that growth, when inhibited by acids, can be renewed after neutralization of the acids. They also grew *F. oxysporum*, *A. niger*, and *R. nigricans* on similar solutions with the results shown in Table 1. These data show, for each fungus, greatest growth in the presence of calcium.

TABLE 1

COMPARATIVE GROWTH OF FUNGI IN KNO_3 AND $\text{Ca}(\text{NO}_3)_2$

Organism	Weight of Mycelial Mat (grams)	
	Richards' solution with KNO_3	Richards' solution with $\text{Ca}(\text{NO}_3)_2$
<i>Fusarium oxysporum</i>	0.2094	0.2428
<i>Aspergillus niger</i>	0.5450	0.8270
<i>Rhizopus nigricans</i>	0.2015	0.2787

CONCENTRATION AND PROPORTION OF MINERALS. Manifestly chemical constitution is a factor of primary importance in the preparation of suitable mineral substrata for the growth of fungi, but account must also be taken of the proper balance of elements and of their concentration. Several important papers have appeared dealing with these factors. With *Aspergillus niger* Haenseler (1921) used the same three-salt mineral nutrient and quite the same procedure as has been utilized in physiological studies with green plants. The salts consisted of $\text{Ca}(\text{NO}_3)_2$ or NaNO_3 , MgSO_4 , and KH_2PO_4 . Different concentrations of each salt, making total concentrations of 0.5, 2.1, and 4.2 atm, were employed, and to each culture flask were added equal amounts of sugar and other nutrients. The dry weight of the mycelial mat after 7 days served as Haenseler's basis for evaluating salt concentration and balance. The data in Table 2 show the plan employed by Haenseler in this type of study.

Haenseler concluded that at concentrations equivalent to 4.2 atm. growth is best, so that total concentration must be regarded as very important. Wide variation in the concentration of MgSO_4 and KH_2PO_4 did not greatly modify growth. Better growth was

TABLE 2

GROWTH OF *Aspergillus niger* IN A THREE-SALT NUTRIENT SOLUTION, SHOWING PLAN OF VARYING CONCENTRATION (MOLARITY) OF EACH SALT AND YIELD OF MYCELIAL MAT

Culture Number	Concentration of Salts (M)			Yield (grams)
	KH ₂ PO ₄	Ca(NO ₃) ₂	MgSO ₄	
R1 C1	0.00888	0.00625	0.08648	0.347
R1 C2	0.00888	0.01250	0.07567	0.624
R1 C3	0.00888	0.01875	0.06486	0.874
R1 C4	0.00888	0.02500	0.05405	0.956
R1 C5	0.00888	0.03125	0.04234	0.949
R1 C6	0.00888	0.03749	0.03243	0.983
R1 C7	0.00888	0.04374	0.02162	0.985
R1 C8	0.01776	0.04999	0.01081	0.977
R2 C1	0.01776	0.00625	0.07567	0.351
R2 C2	0.01776	0.01250	0.06486	0.632
R2 C3	0.01776	0.01875	0.05405	0.865
R2 C4	0.01776	0.02500	0.04324	0.947
R2 C5	0.01776	0.03125	0.03243	0.969
R2 C6	0.01776	0.03749	0.02162	0.984
R2 C7	0.01776	0.04374	0.01081	0.991
R3 C1	0.02664	0.00625	0.06486	0.355
R3 C2	0.02664	0.01250	0.05405	0.610
R3 C3	0.02664	0.01875	0.04324	0.875
R3 C4	0.02664	0.02500	0.03243	0.957
R3 C5	0.02664	0.03125	0.02162	0.957
R3 C6	0.02664	0.04374	0.01081	0.976
R4 C1	0.03552	0.00625	0.05405	0.341
R4 C2	0.03552	0.01250	0.04324	0.603
R4 C3	0.03552	0.01875	0.03243	0.874
R4 C4	0.03552	0.02500	0.02162	0.960
R4 C5	0.03552	0.03125	0.01081	0.966
R5 C1	0.04440	0.00625	0.04324	0.354
R5 C2	0.04440	0.01250	0.03243	0.634
R5 C3	0.04440	0.01875	0.02162	0.867
R5 C4	0.04440	0.02500	0.01081	0.958
R6 C1	0.05328	0.00625	0.03243	0.364
R6 C2	0.05328	0.01250	0.02162	0.636
R6 C3	0.05328	0.01875	0.01081	0.886
R7 C1	0.06216	0.00625	0.02162	0.352
R7 C2	0.06216	0.01250	0.01081	0.625
R8 C1	0.07104	0.00625	0.01081	0.324

secured with $\text{Ca}(\text{NO}_3)_2$ than with NaNO_3 , the differences being more pronounced at the higher concentrations.

Young and Bennett (1922) also employed the triangle system in determining the optimum concentration of $\text{Ca}(\text{NO}_3)_2$, KH_2PO_4 , and MgSO_4 in solutions of these three salts. The solutions were made up by molarity so that their osmotic concentrations were equal. Sufficient carbon to make 3.43% was supplied from sucrose. *Fusarium oxysporum*, *Macrosporium sarcinaeforme*, and *Phoma apiicola* were the test organisms. After 15 days' growth on the solutions the mycelial mats were removed, carefully dried, and weighed. The results indicate that a proper balance of inorganic constituents is essential but that each organism appears to require a different medium that can be determined only by trial and by techniques of the kind which Young and Bennett used. In addition, calcium and zinc should be incorporated in synthetic solutions, and it may be necessary to test several sugars before the most desirable one can be known.

Mann (1932) also employed the triangle method, with Pfeffer's solution, to determine the influence of varying concentrations of the three salts, ammonium nitrate, monopotassium phosphate, and magnesium sulphate. She concluded that magnesium is absolutely essential, although good growth of *Aspergillus niger* and *Penicillium* sp. was secured at all concentrations greater than 0.0001 gram molecule per liter of culture solution. Spectroscopic analysis showed that calcium was present as a contaminant in proportions less than 1 part per 25 million. Calcium chloride added to the three salt solution caused no pronounced increase in the growth of *A. niger*.

More recently Talley and Blank (1941) performed a carefully planned series of factorial experiments on the response of *Phymatotrichum omnivorum* to the three salts K_2HPO_4 , MgSO_4 , and KCl and on the effects of changes in the concentration of each salt on responses to the others. Certain of their data which demonstrate these interactions are assembled in Table 3.

Optimum growth of *P. omnivorum* was secured when glucose and nitrogen were not limiting. Solutions containing 0.008 *M* dibasic potassium phosphate, 0.003 *M* magnesium sulphate, and 0.002 *M* potassium chloride were not improved, as indicated by the growth of *P. omnivorum*, by increasing or by decreasing the concentration of any one of the salts or of their ions.

TABLE 3

GROWTH RESPONSES OF *Phymatotrichum omnivorum* ON COMBINATIONS OF K_2HPO_4 , $MgSO_4$, AND KCl AFTER INCUBATING FOR 21 DAYS AT $28^\circ C$

(All solutions had 4% glucose, 0.0125 M NH_4NO_3 , and 2 ppm of Fe, of Mn, and of Zn.)

Solution Number	Molar Concentration of Salts			pH ¹		Mean Weight of Mat (milligrams)
	K_2HPO_4	$MgSO_4$	KCl	Original	Final	
1	0.004	0.0015	0.000	6.74	4.81	4.53
2	0.004	0.0015	0.002	6.78	4.55	4.90
3	0.004	0.0030	0.000	6.81	4.30	4.67
4	0.004	0.0030	0.002	6.84	4.16	5.90
5	0.004	0.0060	0.000	6.77	4.30	5.82
6	0.004	0.0060	0.002	6.78	4.01	5.58
7	0.008	0.0015	0.000	6.92	4.87	4.24
8	0.008	0.0015	0.002	6.93	5.56	4.63
9	0.008	0.0030	0.000	6.83	4.82	5.77
10	0.008	0.0030	0.002	6.82	4.68	5.59
11	0.008	0.0060	0.000	6.72	4.84	6.12
12	0.008	0.0060	0.002	6.72	5.14	5.74
13	0.012	0.0015	0.000	6.93	5.58	3.60
14	0.012	0.0015	0.002	6.92	5.33	3.49
15	0.012	0.0030	0.000	6.88	5.19	4.88
16	0.012	0.0030	0.002	6.88	5.35	4.77
17	0.012	0.0060	0.000	6.85	5.27	5.87
18	0.012	0.0060	0.002	6.85	5.24	6.45

¹ These figures represent averages of the number for pH of each of the replications and are not, of course, the average pH.

These observations furthermore indicate that a proper balance between K_2HPO_4 and $MgSO_4$ in the growth of *P. omnivorum* is equally as important as the direct effect of either salt. This proper balance is maintained without significant change in the amount of mycelial growth even though the concentration of K_2HPO_4 and $MgSO_4$ is decreased one-half or increased fourfold. If the concentration of either salt is increased, however, the concentration of the other must be increased accordingly to maintain this proper balance. The potassium ion is of more importance in maintaining balance than is the phosphate radical.

The support and maintenance of optimum mycelial growth do not constitute the only requirement of fungi for a proper balance of salts. Pratt (1945) demonstrated that the synthesis of penicillin by *Penicillium notatum* is also conditioned by salt balance. By use

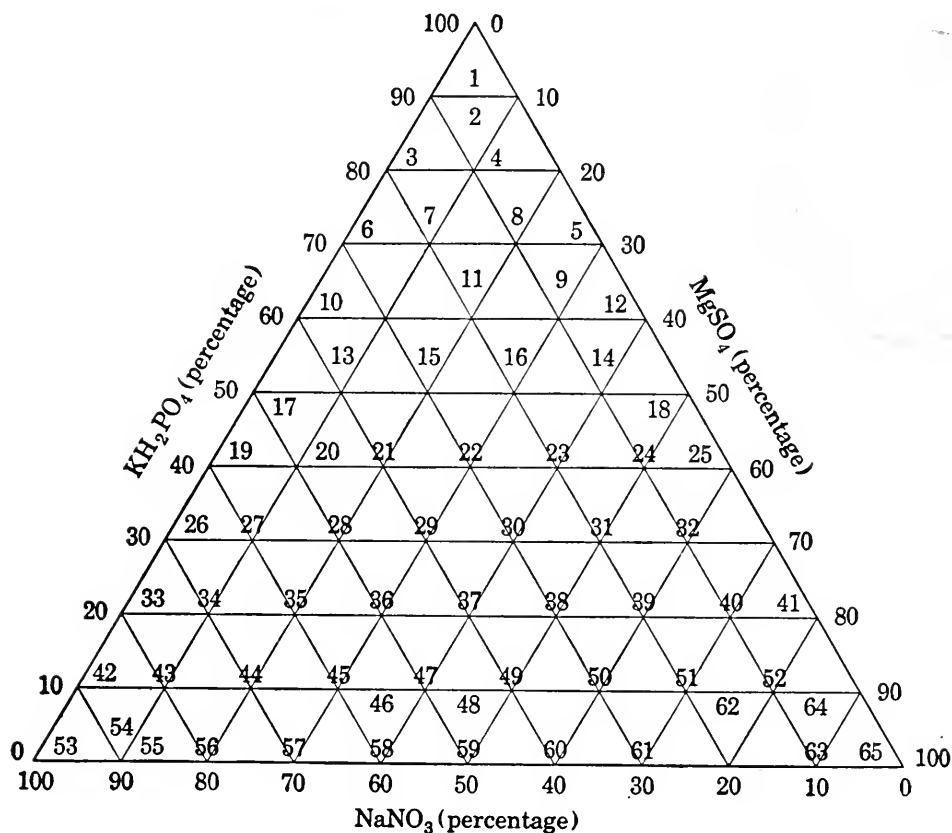

FIG. 1. Graph of triangle system, showing percentage composition of different solutions to be tested. The apex of each triangle represents the constant molarity. Each number within a triangle corresponds to a culture or a series of identical cultures. (After Pratt.)

of the triangle system he made up a series of 65 different nutrient solutions containing KH_2PO_4 , MgSO_4 , and NaNO_3 in different proportions and in such way as to have a total molar concentration of 0.04. Each solution contained in addition lactose, corn-steep liquor, zinc sulphate, and phenylacetic acid, and the $p\text{H}$ was adjusted with NaOH to be the same as that of every other solution. As a result Pratt found that the best yields of penicillin were secured in solutions containing not less than 8 millimoles of KH_2PO_4 per liter and not more than 20 millimoles of NaNO_3 per liter. The absolute concentrations of the three salts in the series

of solutions giving the best yields were as follows: KH_2PO_4 , 0.019 *M*; $\text{MgSO}_4 \cdot 7\text{H}_2\text{O}$, 0.002 *M*; and NaNO_3 , 0.019 *M*.

DIFFICULTIES ENCOUNTERED IN STUDIES OF MINERAL NUTRITION. Lest it be thought that the elements potassium, phosphorus, magnesium, sulphur, and calcium comprise all the minerals requisite for the proper nutrition of fungi, it is pointed out at this juncture that evidence has been gradually accumulating that iron, zinc, manganese, and copper are among other elements now known to be absolutely essential for the normal physiological processes of fungi. The experiments from which these conclusions are drawn will be considered subsequently. It should first be pointed out that the amounts of these elements, as Raulin (1869) first showed for iron and zinc, are so minute that the term trace elements has come to be applied to them. This terminology does not serve any useful purpose, since the amount of a particular element is no index or measure in determining essentiality.

The conclusions from studies of the nutritional use of these elements—for example, iron, calcium, zinc, manganese, and boron—are, as might be expected, contradictory. This situation has come about because it is now known that certain of the elements occur in distilled water or come into solution from test tubes, Petri dishes, and culture flasks in amounts sufficiently large to meet the metabolic needs of the organism. Water redistilled from Pyrex-glass stills should be utilized. Pyrex glass may be quite satisfactory, particularly if it has previously been used in such a way as to leach out the zinc. In addition, the sugars and C.P. nutrient salts contain various elements as impurities. By spectroscopic methods Steinberg (1937) identified in C.P. reagents commonly used in nutritional experiments with fungi the elements listed in Table 4.

The presence of appreciable quantities of various elements in C.P. chemicals constitutes an important difficulty, especially in studies that involve elements utilized by fungi in small amounts, as are iron, zinc, boron, copper, and manganese. Repeated recrystallization of the nutrient salts has proved to be wholly unsatisfactory [Roberg (1928)] in purifying them. Steinberg (1919, 1935) has devised methods to effect practically complete removal of such elements. He heats the nutrient solution in the presence of excess CaCO_3 for 15 minutes at 15-lb pressure. The increased alkalinity in the presence of heat causes the undesirable heavy

TABLE 4

ELEMENTS SHOWN TO BE PRESENT BY THE USE OF SPECTROSCOPIC METHODS OF ANALYSIS

<i>Chemical Reagents</i>	<i>Contaminants</i>
NH ₄ NO ₃	Ca, K, Mg, Na
K ₂ HPO ₄	Al, Ag, Cu, Mg, Na, Pb
MgSO ₄ ·7H ₂ O	Cu, Na
ZnSO ₄ ·7H ₂ O	As, B(?), Cu, Fe, Mg, Mn, Si, Sn(?)
CuSO ₄ ·5H ₂ O	Cu, Fe, Mg, Mn, Pb, Si
MnSO ₄ ·2H ₂ O	Al, Ca, Cu, Cr, Fe, Mg, Na, Si, V
Na ₂ MoO ₄	Al, Ca, Cu, Fe, K, Li, Mg, Mn, Na, Ni, Si, V(?)
Dextrose	Al, Ag, B, Ca, Cu, Fe, K, Li, Mg, Mn, Na, Ni, Rb, Rh, Si, Sn, Sr

metals to be precipitated as phosphates, hydroxides, or carbonates. In some cases MgCO₃ may be substituted for heating.

Bortels (1927) and Roberg (1928) used activated charcoal as an adsorbing agent after adding (NH₄)₂S as a precipitant. Some heavy-metal contaminants may be removed by electrolysis. Wolff and Emmerie (1930) removed copper from their nutrient salts by electrolytic methods.

The spores of *Aspergillus oryzae* were found by Aso (1900) to have iron among their ash constituents. Copper and doubtless other metals as well occur in the spores and mycelium of other fungi. These observations show that in studies involving the mineral nutrition of fungi an appreciable metal contamination may be attributed to the inoculum.

Steinberg (1935) determined that the quantity of the elements essential for optimum growth of *Aspergillus niger* is 0.20 mg of iron, 0.14 mg of zinc, 0.06 mg of copper, and 0.03 mg of manganese per liter of solution. The amount of growth was approximately doubled with as little as 0.001 mg of zinc per liter.

The weight of evidence indicates that these metal contaminants, especially zinc, copper, iron, and manganese, serve in the nutrition of fungi, not as structural materials, but as substances that modify physiological activities. For this reason they have come to be regarded as biocatalysts. This conception is fostered by the numerous publications of Bertrand and of Javillier, which are reviewed by Foster (1939), and by the papers of Bortels (1927), Steinberg (1934), and Stern (1938). The heavy metals become organic components of respiratory enzymes. Stern (1938) has stressed

this fact in connection with iron in Warburg's cytochrome, in other heme-respiratory pigments, in catalase, and in peroxidase. Copper appears to act similarly in the oxidase molecule. Manganese is well known to act powerfully as a coenzyme.

Differences exist in methods of measurements of fungal growth on semisolid substrata. Some workers measure daily radial incre-

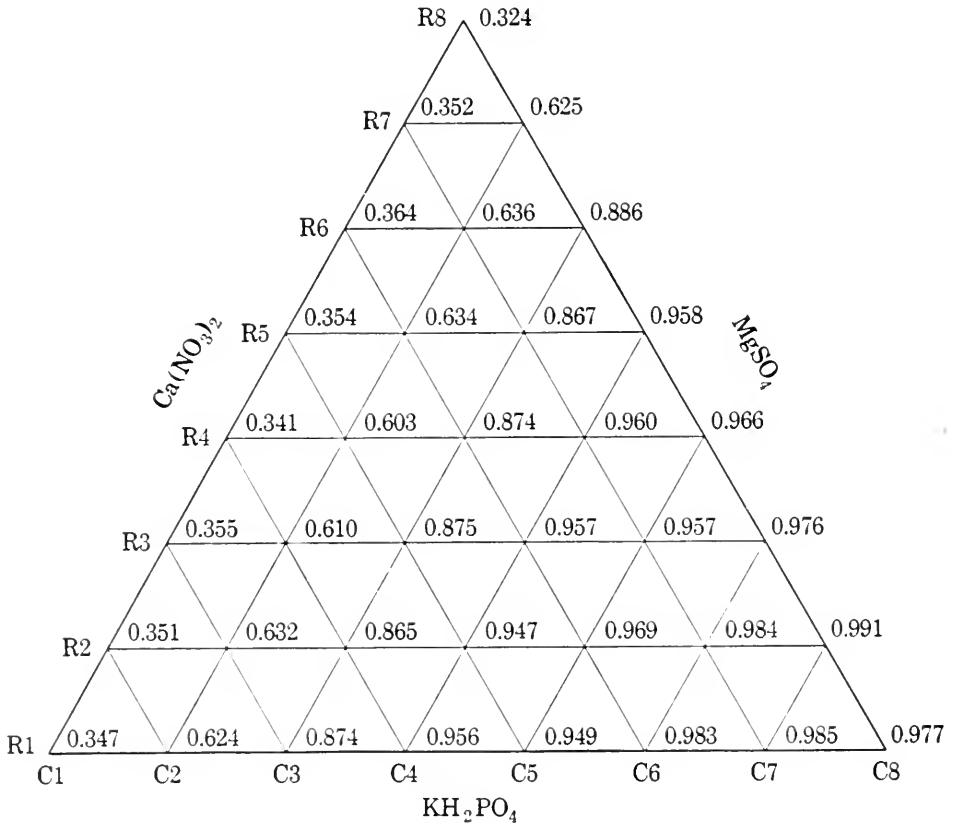

FIG. 2. Diagram illustrating triangle system of varying the concentrations of three-salt nutrient solutions used in nutritional studies and showing the relative yields. (After Haenseler.)

ments; others measure ring area. In a recent report Worley (1939) indicates that several criteria should be considered in growth measurements, namely: (1) growth in a radial direction, (2) growth in a tangential direction, (3) number of units contributing to the subsequent growth, (4) the relationship of new increments of growth to the substrata being compared, and (5) the relative importance of radial and tangential growth quantities. The radial method of measurement ignores the effect of criteria 2, 4, and 5. The ring-area method omits criteria 3 and 4 and mag-

nifies or minifies criterion 5. Worley proposes therefore a sector-area method to use in comparing the effect of substrata on growth for any given time interval.

In making measurements of mycelial growth on semisolid media it must be borne in mind that growth is three-dimensional. On one medium the growth by a given species may be appressed, on another profuse and cottony. Measurements of growth on different media cannot with fairness be compared, regardless of whether radial measurements, ring increments, or sector areas are used.

IRON AS NUTRIENT. Raulin (1869) was perhaps the first to maintain that iron is indispensable for fungi. This hypothesis was confirmed by Molisch (1892), Benecke (1895), and many others, and as a result it is now firmly established that this element is an integral part of fungus protoplasm. Using *Aspergillus niger*, Steinberg (1919) secured a scant mycelial mat in solutions lacking iron; he obtained 43.7 times as much in the presence of iron. In similar studies with this fungus Roberg (1928) secured 75 times more mycelium in cultures containing iron. Benecke (1895) found that iron is essential both for growth and for sporulation among species of *Aspergillus*, *Penicillium*, and *Mucor*, an observation which Bortels (1927), using refined techniques, was able to verify.

Little is known about the functions of iron in fungi. Richards (1899) reported an increased efficiency in the use of sugar by *Aspergillus niger* and *Penicillium glaucum* in the presence of 0.1% FeCl_3 . Wehmer (1891) found that in darkness the presence of iron in sugar solutions being fermented by *Aspergillus* results in decreased production of oxalic acid. Chrzaszcz and Peyros (1935), on the other hand, reported markedly increased production of citric acid by *Aspergillus* and *Penicillium* when the sugar solutions being fermented contain a small quantity of FeCl_3 . Similarly, others have recorded contradictory results, and this lack of agreement can be expected to prevail until the proximate function of iron is better understood.

COPPER AS NUTRIENT. When the growth of fungi in copper-containing nutrient solutions and in solutions lacking copper is compared, as Waterman [Foster (1939)], Bortels (1927), and McHargue and Calfee (1931) have done, all investigators are in accord in ascribing to copper the role of an essential element. The striking feature of studies of this nature is that minute amounts

produce such profound growth responses. The best evidence of the quantitative essentiality of copper is offered by Wolff and Emmerie (1930), who electrolytically purified the culture media in which they attempted to grow *Aspergillus niger*. They secured no growth in the complete absence of copper. When they added 0.2 γ of copper per 250 ml of medium, growth occurred; conidia were produced only if a minimum of 0.3 γ per 250 ml was added. In a copper-free medium, as produced by Metz (1930), *A. niger* was able to produce conidia, but Metz determined them to be twice as numerous in copper-containing media as in copper-free media.

Wolff and Emmerie (1930) also showed that there is no pigmentation of conidia of *A. niger* if the amount of copper provided is the minimum for conidial production, as is maintained also by Steinberg (1934). In 1938 Mulder [Foster (1939)] showed that maximum pigmentation in this fungus requires a minimum of 6.25 γ of copper per 100 ml of nutrient solution. Mulder also ascribed to copper an influence in the formation of acids during fermentation.

MANGANESE AS NUTRIENT. The status of knowledge regarding manganese as a nutritive element for fungi has been reviewed by Foster (1939). A series of studies by Bertrand and Javillier [Foster (1939)] and by Steinberg (1936) shows that much less manganese is required than either iron or zinc. In fact, manganese in a concentration of 1 part in 10 billion is definitely stimulatory to *Aspergillus niger*. Bertrand believed his evidence to show that iron, zinc, and manganese must have a certain balance and that they function together synergetically. With a certain proportionality of manganese, iron, and zinc, he secured a sparse production of conidia by *A. niger*; with a larger amount of manganese, however, the conidia were developed in abundance. Steinberg (1935) was able to confirm these observations to an extent by showing that a lack of manganese in the nutrient either sharply reduces or entirely inhibits conidial production.

Stimulation of growth, as indicated by increased dry weight, followed the addition of manganese to cultures of *A. flavus* and *Rhizopus nigricans* by McHargue and Calfee (1931).

ZINC AS NUTRIENT. As has been indicated by Foster (1939), zinc is the element of first choice in studies dealing with the mineral nutrition of fungi. Numerous experiments involving representa-

tives of each class of fungi show that the presence of zinc in nutrient media stimulates growth [Metz (1930)]. Mosher *et al.* (1936) regard zinc as essential for the dermatophyte *Trichophyton interdigitale*. In comparing the growth of *Aspergillus niger* in media lacking zinc with that in media containing zinc salts, Porges (1932) noted that a scanty, thin, smooth pellicle develops when zinc is lacking, whereas in its presence a heavy, wrinkled mat is produced. Steinberg (1919) secured an increase of mycelial mat of *A. niger* amounting to as much as 230,900%, the increases being correlated with the quantity of zinc present as an impurity in the salts; as he indicates (1934), increases of this magnitude can hardly be interpreted as "stimulatory" effects.

Zinc does not uniformly influence conidial production in the same manner in all fungi. Roberg (1928) and Porges (1932) found that zinc inhibits sporulation of *A. niger*. Zinc represses sporulation of *Trichoderma kőningii* but stimulates conidial production by *Fusarium oxysporum* [Niethammer (1938)].

Pigmentation in fungi, as modified by the presence of zinc, has been considered by Bortels (1927), Roberg (1928), and Metz (1930). Metz's experiments involved species of *Aspergillus*, *Penicillium*, *Fusarium*, *Macrosporium*, and *Botrytis*. He found that the growth in zinc-deficient cultures is abnormal in color. The problem was further complicated, however, because, although mycelial growth is dependent primarily on zinc and to a lesser degree on iron and copper, it is essential that each of these heavy metals be present to produce normal colors in a particular fungus.

The profound effect which zinc exercises on the growth and sporulation of fungi is an index of the influence which this element exerts on digestive and respiratory activities. That this fact has long been appreciated is evident from the work of Richards (1899) and Watterson (1904).

The formation of organic acids as waste products in fungus metabolism is briefly considered in Chapter 4, but emphasis is not placed upon zinc as a modifying factor. Zinc has been shown to prevent the accumulation of different acids in cultures. This effect has been demonstrated by Bortels (1927) and Wassiljew (1935) with oxalic acid production by *A. niger*, by Bernhauer (1928) and Chrzaszcz and Peyros (1935) with citric acid production by the same fungus, by Lockwood, Ward, and May (1936)

and Waksman and Foster (1939) with gluconic acid production by *Rhizopus*.

OTHER ELEMENTS AS NUTRIENTS. A large number of other elements have been tested to determine whether they are essential for the metabolic activities of fungi. The role of boron for *Penicillium glaucum* and *Aspergillus niger* was investigated by Böeseken and Watermann (1912). Molybdenum and gallium have been found to be essential for *A. niger* by Steinberg (1936, 1937, 1938), and the same investigator (1920) determined that uranium and cobalt can partly replace iron and zinc for this species. Lockwood *et al.* (1934) found that columbium, chromium, molybdenum, and tungsten are favorable for the production of fats by *Penicillium javanicum*. Steinberg (1938) tested 76 chemical elements with the result that iron, zinc, copper, manganese, gallium, and molybdenum comprise all that may be regarded as essential for *A. niger*. Other extended systematic studies, especially those of Pirschle (1934, 1935), involve the effects upon growth of many elements. Javillier (1913) concluded that columbium and beryllium cannot replace zinc, which, when present in concentrations of 1 to 2 ppm, increased the amount of growth of *A. niger* 58 times.

ORGANIC NUTRIENTS OF FUNGI

Those investigators who laid the foundations for an understanding of the mineral requirements of fungi also contributed to the establishment of bases for comprehending the organic compounds utilized in the growth of these organisms. They noted that fungi vary in response to the addition of different carbon compounds employed to fortify synthetic media. They arrived at this conclusion by what is commonly designated the "trial and error method." Apparently Pfeffer (1895) was the first to study this problem with the planned purpose of determining the quantitative acceptability to a particular fungus of various organic substances. In nearly all subsequent studies either of two purposes has been maintained: (1) to find whether the given fungus would grow upon the proffered carbon compound, in order to determine its enzyme-producing ability, or (2) to measure the comparative rate of growth of the fungus on different substrata, using the weight of the mycelial mat or the increase in diameter of colonies as a

criterion. These studies, as might be expected, have determined that cosmopolitan species of *Aspergillus* and *Penicillium* thrive on a wide variety of substrata. Specialized pathogens, on the other hand, either grow poorly in artificial culture on organic substrata or may even fail to grow at all. A survey of this situation clearly indicates that the underlying reasons for these differences in organic food requirements of fungi should be sought by intensive studies.

CARBON REQUIREMENTS. Those carbon compounds that can be oxidized with the least expenditure of the energy stored in the compound or can be assimilated most readily appear to constitute the food of first choice for fungi. Evidence indicates that, in general, fungi, like bacteria, prefer carbohydrates as food sources, with proteins as second choice, and that few species thrive well on fats.

Fungi grow more rapidly in proportion to their body weight than do green plants, and consequently expend relatively more energy in converting their food into an assimilable form. With molds an increase in body weight amounting to a thousandfold within a 10-day period, such as occurs in *Phycomyces nitens* and *Aspergillus niger*, is not uncommon.

The method that has been generally employed to determine the food value of carbon compounds is to grow the fungus in a basal mineral-nutrient solution and to vary the carbon or the nitrogen added. By preliminary trials the time required to attain maximum growth can be determined. The mycelial mat, if removed at the end of this period, can be desiccated and weighed. In comparison, another figure, which is the result of an analysis to determine the amount of compound that has been used by the mold, can be considered. Unfortunately, as investigators have indicated, inaccuracies appear as a consequence of the formation and accumulation of by-products, such as acids, alkalis, staling products, and toxins, and of the autolysis and utilization of dying and dead parts of the mycelium.

Another method that has been employed to only a limited extent makes use of microrespirometers. This method, considered in Chapter 3, is adapted for use in determining whether the given carbon compound is acceptable and also the rate at which it is consumed.

Diversity in ability to use carbohydrates is indicated by numerous reports, but in general the literature shows that glucose is the favorite. It may be removed first from a solution containing a mixture of sugars, or it may even be the only one removed. Sucrose, if present, may be first inverted into dextrose and levulose. If *Aspergillus niger* is the test organism, Molliard (1918) found that, when all the dextrose has been utilized, five-sixths of the levulose still remains.

Attempts to employ the amount of carbon dioxide evolved as the sole measure of utilization of the carbon source may lead to erroneous interpretations, for the reason that some of the products metabolized may be stored within the body of the mold, where they may be oxidized subsequently. Most species give better yields on hexoses than on pentoses, although Hawkins (1915) found that *Glomerella cingulata* utilizes the two pentoses, arabinose and xylose. Weimer and Harter (1921) tested the responses to glucose of *Botrytis cinerea*, *Diplodia tubericola*, *Fusarium acuminatum*, *Mucor racemosus*, *Rhizopus tritici*, *Sclerotium bataticola*, and *Sphaeronema fimbriatum*, finding that each organism differs in the amount of this sugar required to produce a unit of dry weight. Brannon (1923) found that glucose and fructose are equally acceptable to *Aspergillus niger* and *Penicillium camemberti*. *Fusarium lini*, however, is said to be unable to utilize glucose [Tochinai (1926)].

In a series of studies that may well serve as a model, Raistrick *et al.* (1931) found that glucose, fructose, and sucrose are excellent sources of food for many molds. They evaluated these sugars by keeping "balance sheets" on the amount of sugar utilized and the amount of certain metabolic products formed or of mycelium produced. By means of such techniques differences in the nutritive values of various carbon sources can be determined. Horr's (1936) observations show that both galactose and mannose constitute poor sources of carbon for *Aspergillus niger* and *Penicillium glaucum*. This observation regarding galactose is confirmed by Steinberg (1939), who added that lactose supports practically no growth of *A. niger*, that glycerol results in poor yields, and that dextrose, fructose, sucrose, and *l*-sorbose are equally effective.

Variation among species in ability to utilize sources of carbon is further shown by the inability of *Achlya proliferata*, *A. racemosa*,

Saprolegnia ferax, and *S. monoica* to utilize sucrose [Pieters (1915)] and by the utilization of galactose by *Trichophyton interdigitale* [Mosher *et al.* (1936)] and *Aspergillus fischeri* [Wenck *et al.* (1935)].

Schade's (1940) observations show that *Apodachlya brachynema* grows well on dextrose, levulose, and sucrose but is unable to utilize maltose and galactose, whereas *Leptomitus lacteus* uses none of these sugars.

By respirometric methods Wolf and Shoup (1943) noted that *Allomyces arbuscula*, *A. javanicus*, *A. moniliformis*, and *A. cystogenus* are able to use dextrin. *Allomyces arbuscula* uses maltose and sucrose; none utilizes *d*-arabinose, *l*-arabinose, cellobiose, glucose, galactose, lactose, levulose, mannitol, or starch.

Certain pathogens possess wide capabilities for utilizing carbohydrates, whether mono-, di-, or polysaccharides, as is illustrated by Moore's studies (1937) of *Phymatotrichum omnivorum*. She determined that this organism uses dextrose, levulose, galactose, maltose, sucrose, lactose, mannite, xylose, inulin, dextrin, starch, glycerin, and cellulose and introduced another factor into the problem by varying the oxygen tension. Decrease in oxygen tension was accomplished by the removal of oxygen with pyrogalllic acid; increase, by the introduction of oxygen from a storage cylinder. Oxygen at normal atmospheric concentration was found optimum for growth.

Foster *et al.* (1941) studied the direct utilization of CO₂ by *Aspergillus niger* and certain other molds. By employing radioactive carbon (C₁₁), they were able to show that carbon is metabolized into cellular material and organic acids. It may achieve a role in respiratory changes connected with the formation of oxaloacetate from pyruvate and CO₂. The oxaloacetate thus formed may in turn give rise to fumaric acid or to succinic and citric acids. Earlier workers had suggested that CO₂ enters into the metabolism of fungi, but proof was not forthcoming until Foster and his associates made use of labelled carbon.

Careful consideration, beginning perhaps with von Naegeli's (1880) investigations in 1880, has been given to certain organic acids as sources of carbon. Much remains, however, to be accomplished. The work of Camp (1923) with citric acid serves to illustrate the ability of fungi to utilize organic acids. He compared the growth of certain fungi on media containing citrates as a

sole source of carbon with their growth on media containing both citrates and dextrose. The organisms tested included those commonly associated with the decay of citrus, namely *Penicillium digitatum*, *P. stoloniferum*, *Diplodia natalensis*, *Phomopsis citri*, *Alternaria citri*, *Oospora citri-aurantii*, and *Sclerotinia libertiana*. All of them were able to grow in orange juice (pH 3.8), but only *P. stoloniferum*, *O. citri-aurantii*, and *S. libertiana* achieved a fair amount of growth on lemon juice (pH 2.5). None of these fungi grew luxuriantly when citrate was the sole source of carbon. After *P. stoloniferum* and *S. libertiana* had been started in dextrose, they could, if transferred to media containing citric acid, achieve fairly good growth. In general, these organisms attained better growth in the solutions containing citrate plus dextrose than in dextrose alone, only *Penicillium digitatum* and *Phomopsis citri* being unable to utilize citrate as a supplement.

Leptomitus lacteus and *Apodachlya brachynema* utilized all the straight carbon-chain fatty acids up to and including capric acid, with the exception of formic acid and propionic acid [Schade (1940)].

A very different approach to the problem of utilization of organic compounds was made by Tamiya (1932), who attempted to determine the relationship of chemical structure to assimilability. For this purpose he employed 123 organic compounds with *Aspergillus oryzae* as the test fungus and noted whether the compounds were favorable for spore germination, were suitable for subsequent growth, and were utilized in respiration. Of those he studied, only 51 were found suitable to promote mycelial growth and were respired by *A. oryzae*; 8 others were used in respiration although they did not support growth. Tamiya concluded that the carbohydrates and polyatomic alcohols constitute the best sources of carbon.

The aromatic series of alcohols and the monoatomic alcohols of the aliphatic series, with the exception of ethyl alcohol, were not utilized. Aldehydes, ketones, and esters were unsuitable. Citric, lactic, malic, pyruvic, and succinic acids were among those utilized. Tamiya concluded that only those compounds are assimilated which possess certain characteristic atomic groups that he called "chief radicals." These chief radicals must be joined either in a ring or straight chain to "residual radicals"; and the

may, for example, $\text{CH}_3 \cdot \text{CHOH}-$, $=\text{CH} \cdot \text{COH}=\text{}$, $\text{CH}_3 \cdot \text{CO}-$, $\text{CH}_2\text{OH} \cdot \text{CH}_2-$, be split off in degradation.

The relationship of molecular configuration of sugars to utilization in amino acid formation by *Aspergillus niger* has been elucidated by Steinberg (1942). This fungus was found to use all pentoses and hexoses having an *l*-3-carbon atom and a *d*-4-carbon atom except the epimers of *d*-xylose.

Attention has been called by Steinberg (1939a, 1939b) to another factor that must be considered in tests to determine the assimilability of a given carbon compound. When *A. niger* was grown in the presence of lactose, galactose, glycerol, or mannitol alone, the yields were 75, 28, 350, or 34 mg, respectively. When the carbon source consisted of a mixture of mannitol and lactose, the yield was 234 mg; of mannitol and galactose, 393 mg; of glycerol and lactose, 458 mg; of glycerol and galactose, 155 mg; of mannitol and glycerol, 545 mg; and of lactose and galactose, 17 mg. Steinberg interpreted these improved yields from mixtures to better proportion of molecular groups.

An introduction to the information concerning the use of fats and oils as sources of carbon may be secured from reports of Tausson (1928) and Hopkins and Chibnall (1932). Tausson found that *Aspergillus flavus* consumes olive oil, cocoa butter, beeswax, tripalmitin, and higher paraffins. His data show that 591.4 mg of paraffin was utilized in 35 days and that 289.1 mg of mycelial mat was formed as a result. Hopkins and Chibnall found that the higher paraffins with chains not exceeding $\text{C}_{34}\text{H}_{70}$ were assimilable by *A. versicolor*. In the breakdown of these substances evidence indicates that ketones first arise and on further oxidation yield fatty acids. Among other vegetable oils that have been found to be consumed by molds are linseed oil and walnut oil.

NITROGEN REQUIREMENTS. The numerous studies that have dealt with the nitrogen requirements of fungi have been primarily directed toward finding the most suitable sources of nitrogen. The results of this work until 1930 were largely summarized by Czapek (1930). Later Robbins (1937) classified fungi into four groups on the basis of the form of nitrogen they are capable of assimilating. One group utilizes organic nitrogen alone; the second, both organic nitrogen and ammonia; the third, not only organic nitrogen and ammonia but also nitrate nitrogen. The fourth group is capable of fixing elemental nitrogen and can also utilize

any or all of the other forms. On this basis it appears that fungi must be regarded as differing among themselves fundamentally in metabolic potentialities as far as usage of nitrogen is concerned.

It might be anticipated that amino acids would constitute the nitrogen form of first choice for the reason that they can be utilized in the synthesis of proteins with the least need for energy. Evidently, however, there are other factors involved in the choice of nitrogen. At any rate, amino acids are well suited to a large number of fungi, and Bacto-peptone serves well as a source for many species. Boas (1919) interpreted his experiments to show that amino acids can be used only after they have been deaminized. In this process energy is required, and Boas regarded ammonium salts as the most suitable nitrogen source, they being much superior to peptones.

In general there is a paucity of convincing experiments on the best source of nitrogen for specific fungi. In their trials with 20 plant pathogens Young and Bennett (1922) found that each species could utilize nitrate nitrogen; thus they fall into the third of the groups proposed by Robbins. In 1910 Hagem [Steinberg (1939a)] noted that *Mucor christianensis*, *M. griseocyanus*, *M. racemosus*, *M. sphaerospora*, and *M. spinosus* utilize either NH_4^+ or NO_3^- with glycerol. *Aspergillus fischeri*, according to Wenck, Petersen, and Fred (1935), uses either NH_4^+ or organic nitrogen, thus falling into the second of Robbins' groups. *Ophiobolus graminis* requires organic nitrogen [Fellows (1936)], and *Basidiobolus ranarum* and *Saprolegnia parasitica* need amino acids [Leonian and Lilly (1938)]. Leonian and Lilly also used 23 other organisms in tests in which various amino acids, singly or in combinations, were substituted for ammonium nitrate, they did not obtain any evidence of ability to utilize these amino acids. If they added thiamin (vitamin B_1), however, proper amino acids induced growth in 14 of the 23 species. Observations by Klotz (1923) showed that *Aspergillus niger*, *Diplodia natalensis*, and *Sphaeropsis malorum* can utilize amino nitrogen. Neither *Apodachlya brachynema* nor *Leptomitus lacteus* is able to utilize nitrate nitrogen or ammonia, but both find *d*, *l*-alanine and *l*-leucine suitable for growth and, if acetate is present, utilize also glycine and asparagine [Schade (1940)].

Allomyces arbuscula makes use of peptone, alanine, aspartic acid, asparagine, arginine-HCl, cystine, glutamic acid, and leucine

[Wolf and Shoup (1943)]. Similarly, Wolf and Shoup found that *A. javanicus* employs peptone, aspartic acid, asparagine, cystine, and glutamic acid; whereas *A. moniliformis* and *A. cystogenus* utilize only peptone, alanine, aspartic acid, and glutamic acid. None of these species was able to use the amino acids glycine and tyrosine.

Nielsen and Hartelius (1938) grew yeast in beer wort, with added thiamin, as a basic medium and then added β -alanine, asparagine, aspartic acid, lysine, and arginine singly and in combinations. They found that alone each was toxic but that growth was improved when all were added.

Claims that certain fungi employ NH_4^+ to the exclusion of all other nitrogen sources and therefore may be called "ammonia organisms" are not fully supported. Among other factors account has not been taken generally in these studies of the influence of pH. This subject was given special consideration by Rippel (1931). Pirschle (1934) found that ammonia organisms will utilize NO_3^- provided that the cultures are aerated. This fact is shown by certain of his data that contrast the weight of yeast in nonaerated and aerated cultures. With ammonium sulphate, the dry weights in nonaerated and aerated cultures were 2.568 and 6.348 grams, respectively; with calcium nitrate 0.703 and 8.089 grams, respectively; with potassium nitrate 0.443 and 5.296 grams, respectively. Smaller growth from the nitrates than from the ammonium nitrogen may be accounted for by HNO_2 formation, since the consensus of opinion is that nitrites are toxic. Removal by aeration of this toxic effect in Pirschle's cultures is evidence that this hypothesis is valid.

Whether any fungi are entitled to be grouped among the nitrogen fixers has been the subject of much controversy. In 1892 Frank [Duggar and Davis (1916)] maintained that *Hormodendron cladosporioides*, grown on nitrogen-free media, fixes nitrogen. The following year Berthelot made a similar claim [Duggar and Davis (1916)] for *Aspergillus niger* and *Alternaria tenuis*. The same ability was attributed to *Phoma betae*, *A. niger*, and *Mucor stolonifer* by Saida in 1901 [Duggar and Davis (1916)]. Latham (1909), working with *A. niger*, also reported the fixation of appreciable quantities of nitrogen, but Pennington (1911) was unable to verify her observations.

The studies of Duggar and Davis (1916) on fixation of atmospheric nitrogen showed gains in cultures of *Phoma betae* on mangel-wurzel decoction and on sugar-beet decoction of 3.022 mg and 7.752 mg of nitrogen, respectively. Under the same conditions there were no gains in cultures of *Aspergillus niger*, *Macrosporium commune*, *Penicillium digitatum*, *P. expansum*, and *Glomerella gossypii*.

Aspergillus niger was employed in experiments involving fixation of atmospheric nitrogen by Schober (1930), but no evidence of any increase in nitrogen in the culture flasks was obtained. Roberg (1931) got negative results of fixation not only with 13 strains of *A. niger* but also with 13 other species of *Aspergillus*. Further confirmation of the inability of *A. niger* to fix atmospheric nitrogen was supplied by Allison, Hoover, and Morris (1934).

Certain symbiotic fungi, however, are able to fix nitrogen, as is shown by the work of Ternetz (1904). She isolated varieties of mycorrhizal fungi belonging to *Phoma radialis* from ericaceous plants and compared their nitrogen-fixing capabilities with those of *Azotobacter chroococcum* and *Clostridium pastorianum*. The strains of *P. radialis* gave yields of 18 to 22 mg of nitrogen per gram of dextrose used.

The nitrogen requirements of fungi appear worthy of further study. Techniques patterned after those employed by the bacteriologist should prove most serviceable. Sources of error in the interpretation of results of such studies should include those which have been mentioned valid in the interpretation of data involving carbon sources.

GROWTH FACTORS

The discovery by Wildiers (1901) in 1901 of the need of a growth factor for the cultivation of yeast on synthetic media marked the beginning of studies on accessory growth substances for fungi. Wildiers attempted without success to use a medium which Pasteur maintained was adequate. When he employed as inoculum a few yeast cells, no growth occurred with this medium; but when he added a sizable mass of inoculum, the yeast grew. He interpreted these results as showing the need for a sufficient amount of a substance that he called "bios." As a result of this

discovery the interest of other workers was directed toward determining whether Wildiers' results could be confirmed, toward learning whether other fungi have similar requirements, and toward making attempts to discover the nature and properties of bios.

As the result of various researches it gradually became apparent that bios is a complex, containing several growth factors. These are now known to include biotin (vitamin H), thiamin (vitamin B₁), pyridoxine (vitamin B₆), *i*-inositol, β -alanine, pantothenic acid, and possibly sterol.

The specific function of each of the bios components is not yet satisfactorily known, although the complex has been subjected to considerable study. From the attempts to learn their functions, however, it may be concluded that they regulate respiration, reproduction, and rate of growth and that some act as coenzymes and are essential in chemical syntheses effected by a particular fungus. Not all species, however, seem to have identical requirements for growth factors. This observation has been interpreted to indicate that the particular factor either is elaborated by the fungus or else is not required at all.

Copping (1929) found that certain wild yeasts, in a vitamin-free synthetic medium, are able to elaborate their own growth factors, whereas "domesticated" or "tamed" yeasts require that the bios substances be supplied.

Williams and Rohrman (1936) maintain that the minimum complement of growth accessory factors required by yeast includes aspartic acid, pantothenic acid, *i*-inositol, β -alanine, and thiamin. In their studies favorable growth responses with *Trichophyton interdigitale* occurred only upon the addition to the media of pantothenic acid, riboflavin (vitamin B₂), thiamin, and *i*-inositol [Mosher *et al.* (1936)].

Robbins and his associates (1942) found that *Trichophyton discoides*, pathogenic to calves, suffers from complete deficiencies of thiamin, pyridoxine, and *i*-inositol. When from 1 to 10 m μ moles of thiamin and pyridoxine and 0.1 to 0.5 mg of inositol were supplied, maximum growth was secured.

Hawker (1936) studied the influence of *i*-inositol isolated from stale cultures of *Botrytis cinerea* and *Gloeosporium fructigenum*. She also utilized baryta and an extractive of lentils to secure a precipitate containing *i*-inositol and a filtrate free from this factor.

Both fractions were found essential for the growth of *Nematospora gossypii*, but *i*-inositol was not necessary for the growth of *Melanospora destruens*. Hawker further found that inositol produced a sporulation response with *Sordaria fimicola*, *Rosellinia necatrix*, and *Zygorhynchus moelleri*.

Schopfer (1936) demonstrated that *Phycomyces blakesleeanus* will not grow in a nutrient solution containing mineral salts, asparagine, and dextrose unless thiamin is added. Kögl and Fries (1937) secured favorable growth responses from the addition of thiamin to cultures of *P. blakesleeanus*, *Phytophthora cactorum*, *Nectria coccinea*, *Sclerotinia cinerea*, *Polyporus adustus*, *P. abietinus*, and *Fomes pinicola*, but no benefit to the growth of *Lenzites saepiaria* was apparent. Biotin and inositol were each beneficial to the growth of *Nematospora gossypii* and *Lophodermium pinastri*.

Robbins and Kavanaugh (1938) observed that the following species show increased growth in the presence of thiamin: *Phytophthora capsici*, *P. cinnamomi*, *P. cryptogea*, *P. drechsleri*, *P. palmivora*, *P. parasitica*, *P. boehmeriae*, *P. cactorum*, *P. cambivora*, *Phycomyces nitens*, *Pythium arrhenomanes*, *P. polycladon*, *Sphaerulina trifolii*, *Schizophyllum commune*, *Sclerotium delphinii*, and *S. rolfsii*. Schopfer (1938) showed the need for thiamin by several Mucorales, including *Absidia ramosa*, *Chaetocladium brefeldii*, *Choanephora cucurbitarum*, *Dicranophora fulva*, *Mucor ramannianus*, *Parasitella simplex*, *Phycomyces blakesleeanus*, and *Pilaira anomala*. Quantz (1943) found that 1 γ of thiamin per 100 ml of solution was optimum for *Allomyces kniepii* and *Blastocladiella variabilis*.

Thiamin increased the production of dry matter by *Collybia velutipes* 400°. [Marczynski (1943)] and was definitely beneficial to *Stereum frustulosum* [Noecker and Reed (1943)]. Both riboflavin and pyridoxine, however, were ineffective with these two wood-destroying species; when biotin in amounts of 5 γ per 26 ml of medium was supplied, definitely increased growth was noted with *S. frustulosum*.

Attention has also been directed in the studies of growth factors to methods of assay of thiamin, biotin, pantothenic acid, inositol, and other substances. These methods depend upon the need for an external source of accessory substance by a particular

fungus. *Phycomyces* was used by Bonner and Erickson (1938) to assay thiamin. Williams and his associates at the University of Texas, who have devised several ingenious methods, employed yeast and various bacteria. The nutritional need for vitamins by fungi has been employed in bio-assays of the thiamin content of green plants [Burkholder and McVeigh (1940)]. When they grew *Phycomyces blakesleeanus* in solutions containing minerals, glycine, and glucose with additions of crystalline thiamin, they were able to substitute small quantities of plant tissues for thiamin. By comparison of the weights of the mycelial mats in the cultures supplied with crystalline thiamin with those of the mats in the cultures in which plant tissues were substituted, they could calculate the thiamin content of the green-plant tissues.

The work of Robbins and Kavanaugh (1938) shows that some organisms are able to synthesize thiamin, which is composed of pyrimidine and thiazole; others can carry out the synthesis if either or both constituents are furnished them; a third group must be supplied with the intact compound if they are to grow normally. Robbins and Kavanaugh found that *Phycomyces nitens* will grow in a nutrient solution containing dextrose, asparagine, and mineral salts if 30 units of pyrimidine and thiazole are added, but that neither of these intermediates alone is effective. Quite a different reaction was noted with *Phytophthora fagopyri*, *Pythium butleri*, *P. polycladon*, *Sclerotium delphinii*, *S. rolfsii*, and *Sphaerulina trifolii*. Each of these species grows well in this nutrient solution if 30 units of pyrimidine are added, but thiazole alone is ineffective. By *Allomyces kniepii* and *Blastocladiella variabilis*, too, thiazole alone is not utilizable [Quantz (1943)], but a mixture of thiazole and pyrimidine is equally as good as thiamin.

Such synthesizing capabilities are further exemplified by the researches of Leonian and Lilly (1940). They report that *Fusarium niveum* and *Rhizopus suinus* possess the ability to synthesize thiamin when grown on a substrate of inorganic salt, amino acids, and dextrose. On the same medium *Phycomyces blakesleeanus* can also form thiamin, but only when furnished with pyrimidine and thiazole. *Pythiomorpha gonapodioides* can elaborate its own thiazole and, if supplied with pyrimidine, will link the two substances together to form thiamin. Finally, *Mucor*

ramannianus is able to produce pyrimidine and, if given thiazole, can unite the two to form thiamin. On the nutrient medium described above, *Fusarium niveum*, *Mucor ramannianus*, *Pythiomorpha gonapodioides*, and *Rhizopus suinus* can synthesize their own biotin. Robbins and Ma (1941) observed upon *Fusarium avenaceum* a beneficial effect of biotin, present in amounts up to 1 μg per gram of the agar used. If they employed crystalline biotin (methyl ester, $\text{C}_{11}\text{H}_{18}\text{N}_2\text{O}_3\text{S}$) stimulation occurred with the addition of as little as 0.001 μg .

Graphium ulmi responds in liquid cultures to the presence of pyridoxine (vitamin B_6) [Burkholder and McVeigh (1942)]. Marked increases in dry weight of mycelial mat followed the addition of 50 γ of this vitamin per liter of basal mineral solution plus asparagine and dextrose. On the other hand, this vitamin was found to be unimportant in the growth of *Saccharomyces cerevisiae* in media supplied with inositol, biotin, and pantothenic acid [Williams, Eakin, and Snell (1940)]. The interaction of biotin, inositol, pyridoxine, pantothenic acid, and thiamin in the growth of yeast has been surveyed in a report by Williams (1941).

Certain amino acids are considered as growth accessory factors in yeast and in various fungi by Nielsen and Sing-Fang (1937). The relationship of vitamin deficiencies to the growth of many specific fungi is treated in a report by Robbins and Kavanaugh (1942). Work of this kind, of course, is dependent largely on the availability of vitamins and the synthesis and commercial production of some of them. Recently biotin was found to be identical with coenzyme R, and it can now be synthesized [Harris *et al.* (1943)]. The excellent treatise by Schöpfer (1943) summarizes the fund of knowledge that has been derived from the researches of vitamins as related to the nutrition of fungi and other plants.

Studies should also be directed toward determining more about the proximate function of growth factors in the physiology of fungi. Host specificity may be found to be correlated with requirements for these factors. Growth factors, if speculation is guided by the developments in recent years regarding their influence on the physiology of animals and of chlorophyll-bearing plants, may be thought to be morphogenic or to regulate reproduction.

INFLUENCE OF OSMOTIC PRESSURE

Special attention has been devoted to the concentration of salts and nutrients in culture media because spores can be germinated and mycelium can be grown in solutions having high osmotic equivalents. Ordinarily the media are prepared with their constituents in such proportions that the osmotic pressure ranges from 0.5 to less than 10 atm.

Knowledge of osmotic pressure finds practical application in food preservation with salt or sugar. Increased percentage of salt in brines, for example, is correlated with increased capabilities for preservation. Molliard (1918) found that conidial formation by *Sterigmatocystis nigra* is prevented in a nutrient solution containing 1% NaCl; within the range of 2 to 5% mycelial growth is retarded, and with 12% there is complete inhibition.

Fungi differ greatly in their tolerance to salts with high osmotic pressures. Raciborski (1905) grew *Torula* sp. in a saturated solution of sodium chloride or of sodium nitrate. Hawkins (1916) grew certain plant pathogens, including *Botrytis cinerea*, *Diplodia tubericola*, *Fusarium radicum*, *F. oxysporum*, *Sclerotinia cinerea*, and *Sphaeropsis malorum*, in potassium nitrate solutions with a calculated diffusion tension of 47 atm. Certain molds, such as *Aspergillus niger* and *Penicillium glaucum*, have been grown in solutions having an osmotic pressure equivalent of 157 atm.

Similarly the preservation of jelly, jam, syrup, and such foods against molds is correlated with the osmotic concentration of the sugar used. Heald and Pool (1908) found that a mold which they named *Torula saccharina* achieved optimum growth in Pasteur's nutrient solution containing 45% sucrose. Slight growth occurred in 75 to 80% sucrose solutions.

IMPLICATIONS

From the foregoing account it is manifest that species of fungi differ from each other in nutritional requirements. Some grow well on almost any substrate that is employed and for this reason may be regarded as "domesticated" or "tamed" fungi. Others, on the other hand, may barely survive on these same media, may grow poorly on a limited number of substrates only, or may not

live on artificial media after the reserve within the spore has become exhausted. Such species, in contrast, cannot be domesticated. Strange diets, never encountered in their natural habitats, are forced upon them in captivity in the test tube. Perhaps the mycologist who attempts to study their physiology in artificial media may actually be studying their pathology.

Many published accounts dealing with the growth of a given species on a wide variety of media are quite pointless and contribute nothing fundamental to an understanding of the nutritional requirements of the species. Similarly the compounding of nutrient formulae may be a misguided procedure, and the use of such formulae may yield only sterile knowledge. The making and using of formulae can be condoned only if their purpose is to reveal the necessity of some factor that conditions a metabolic activity of the fungus.

In future studies more attention should be given to the utilization of specific organic and inorganic materials in particular metabolic activities. This necessity is indicated by the fact that some substances do not support growth, although they are respired. It is further indicated by the fact that many fungi grow well in the presence of a given food but do not reproduce. Evidence shows that some specific element, vitamin, or other growth factor is essential for reproduction but may not necessarily limit any other metabolic activity of the given fungus.

More should be known regarding the mineral requirements of fungi. Account should be taken in such studies of the ash content of the fungus at the conclusion of the growth period, in comparison to the known ash content of the nutrient before the fungus was allowed to grow upon it. It is indicated, furthermore, that fungi may well be used in analytic procedures, especially in the determination of trace elements [Niklas and Toursel (1941)] or of vitamins.

It appears that a more adequate understanding of the nutrition of fungi would result if the terms parasitic (paratrophic) and saprophytic (saprotrophic) largely disappeared from the teacher's vocabulary. More emphasis would then be placed upon the ability of fungi to synthesize foods as well as a variety of other substances. As a consequence, the fact that fungi do not possess chlorophyll would be of little concern to the teacher, and the

student might then come seriously to question whether fungi were derived from algae by degradation.

LITERATURE CITED

- ALLISON, F. E., S. R. HOOVER, AND H. J. MORRIS, "Nitrogen-fixation studies with fungi and actinomycetes," *J. Agr. Research*, 49: 1115-1123, 1934.
- ARMSTRONG, G. M., "Studies in the physiology of the fungi. XIV. Sulphur nutrition: the use of thiosulphate as influenced by hydrogen-ion concentration," *Ann. Mo. Botan. Garden*, 8: 237-280, 1921.
- ASO, K., "The chemical composition of the spores of *Aspergillus oryzae*," *Bull. Coll. Agr. Imp. Univ. Tokyo*, 4: 81-96, 1900.
- BENECKE, W., "Die zur Ernährung der Schimmelpilze notwendigen Metalle," *Jahrb. wiss. Botan.*, 28: 487-530, 1895.
- BERNHAEUER, K., "Über die Säurebildung durch *Aspergillus niger*. IV. Die Bedeutung der Mycelentwicklung für die Säurebildung," *Biochem. Z.*, 197: 287-308, 1928.
- BOAS, F., "Bemerkungen über konidienbildende Stoffe bei Pilzen," *Ber. deut. Botan. Ges.* 37: 57-62, 1919.
- BÖESEKEN, J., and H. I. WATERMANN, "Über die Wirkung der Borsäure und einiger anderer Verbindungen auf die Entwicklung von *Penicillium glaucum* und *Aspergillus niger*," *Folia Microbiol.*, 1: 342-358, 1912.
- BONNER, JAMES, AND JAMES ERICKSON, "The Phycomyces assay for thiamin (Vitamin B₁). The method and its specificity," *Am. J. Botany*, 25: 685-692, 1938.
- BORTELS, H., "Über die bedeutung von Eisen, Zink, und Kupfer für Mikroorganismen unter besonderer Berücksichtigung von *Aspergillus niger*," *Biochem. Z.*, 182: 301-358, 1927.
- BRANNON, J. M., "Influence of glucose and fructose on growth of fungi," *Botan. Gaz.*, 76: 257-273, 1923.
- BURKHOLDER, P. R., AND ILDA McVEIGH, "Studies on thiamin in green plants with the Phycomyces assay method," *Am. J. Botany*, 27: 853-861, 1940.
- "Pyridoxine as a growth factor for *Graphium*," *Science*, 95: 127-128, 1942.
- CAMP, A. F., "Citric acid as a source of carbon for certain Citrus-fruit-destroying fungi," *Ann. Mo. Botan. Garden*, 10: 213-298, 1923.
- CHRZASZCZ, T., AND E. PEYROS, "Optimale Bedingungen der Citronensäureanhäufung, sowie einiger Beobachtung zu Theorie der Citronensäurebildung," *Biochem. Z.*, 280: 325-336, 1935.
- COPPING, ALICE M., "The effect of bios on the growth and metabolism of certain yeasts," *Biochem. J.*, 23: 1050-1063, 1929.
- CZAPEK, F., *Biochemie der Pflanzen*, Vol. 2, 541 pp. Gustav Fischer, Jena. 1930. (Vide pp. 344-352.)
- DUGGAR, B. M., AND A. R. DAVIS, "Studies in the physiology of the fungi. I. Nitrogen fixation," *Ann. Mo. Botan. Garden*, 3: 413-437, 1916.
- FELLOWS, H., "Nitrogen utilization by *Ophiobolus graminis*," *J. Agr. Research*, 53: 765-769, 1936.

- FOSTER, J. W., "The heavy-metal nutrition of fungi," *Botan. Rev.*, 5: 207-239, 1939.
- FOSTER, J. W., S. F. CARSON, S. RUBEN, AND M. D. KAMEN, "Radioactive carbon as an indicator of carbon dioxide utilization. VII. The assimilation of carbon dioxide by molds," *Proc. Nat. Acad. Sci.*, 27: 590-596, 1941.
- HAENSELER, C. M., "The effect of salt proportion and concentrations on the growth of *Aspergillus niger*," *Am. J. Botany*, 8: 147-163, 1921.
- HARRIS, S. A., D. E. WOLF, R. MOZINGO, AND K. FOLKERS, "Synthetic biotin," *Science*, 97: 447-448, 1943.
- HAWKER, LILIAN E., "The effect of certain accessory growth substances on the sporulation of *Melanospora destruens* and some other fungi," *Ann. Botany*, 50: 699-717, 1936.
- HAWKINS, L. A., "The utilization of certain pentoses and compounds of pentoses by *Glomerella cingulata*," *Am. J. Botany*, 2: 375-389, 1915.
- "Growth of parasitic fungi in concentrated solutions," *J. Agr. Research*, 7: 255-260, 1916.
- HEALD, F. D., AND V. W. POOL, "The mold of maple syrup," *Nebraska Agr. Expt. Sta. Ann. Rept.*, 21: 54-68, 1908.
- HOPKIN, S. J., AND A. C. CHIBNALL, "Growth of *Aspergillus versicolor* on higher paraffins," *Biochem. J.*, 26: 133-142, 1932.
- HORR, W. W., "Utilization of galactose by *Aspergillus niger* and *Penicillium glaucum*," *Plant Physiol.*, 11: 81-99, 1936.
- JAVILLIER, M., "Recherches sur la substitution au zinc de diverses éléments chimiques pour la culture de l'*Aspergillus niger*," *Ann. inst. Pasteur*, 27: 1021-1038, 1913.
- KLOTZ, L. J., "Studies in the physiology of fungi. XVI. Some aspects of nitrogen metabolism in fungi," *Ann. Mo. Botan. Garden*, 10: 299-368, 1923.
- KÖGL, F., AND N. FRIES, "Über den Einfluss von Biotin, Aneurin, und Mesoinosit auf das Wachstum verschiedener Pilzarten," *Höppe-Seyler's Z. physiol. Chemie*, 249: 93-110, 1937.
- LATHAM, M. E., "Nitrogen assimilation of *Sterigmatocystis nigra* and the effect of chemical stimulation," *Bull. Torrey Botan. Club*, 36: 235-244, 1909.
- LEONIAN, L. H., AND V. G. LILLY, "Studies on the nutrition of fungi. I. Thiamin, its constituents and the source of nitrogen," *Phytopathology*, 28: 537-548, 1938.
- "Auxithals synthesized by some filamentous fungi," *Plant Physiol.*, 15: 515-525, 1940.
- LOCKWOOD, L. B., G. E. WARD, O. E. MAY, H. T. HERRICK, AND H. T. O'NEILL, "The production of fat by *Penicillium javanicum* van Beijma," *Zentr. Bakt., Parasitenk., II Abt.*, 90: 411-425, 1934.
- LOCKWOOD, L. B., G. E. WARD, AND O. E. MAY, "The physiology of *Rhizopus oryzae*," *J. Agr. Research*, 53: 849-857, 1936.
- MANN, MARY L., "Calcium and magnesium requirements of *Aspergillus niger*," *Bull. Torrey Botan. Club*, 59: 443-490, 1932.

- MARCYNSKI, M., "Studies on the nutrition of *Collybia velutipes* (Curt.) Quel. (Homobasidiomycetes, Agaricales)," *Am. Midland Nat.*, 30: 164-170, 1943.
- McHARGUE, J. S., AND R. K. CALFEE, "The effect of manganese, copper, and zinc on growth and metabolism of *Aspergillus flavus* and *Rhizopus nigricans*," *Botan. Gaz.*, 91: 183-193, 1931.
- METZ, O., "Über Wachstum und Farbstoffbildung einiger Pilze unter dem Einfluss von Eisen, Zink, und Kupfer," *Arch. Mikrobiol.*, 1: 197-251, 1930.
- MOLISCH, H., *Die Pflanze in ihrer Beziehung zu Eisen*. Jena. 1892.
"Die mineralische Nahrung der niederen Pilze," *Botan. Centr.*, 60: 167-168, 1894.
- MOLLIARD, M., "Influence de certaines conditions, sur la consommation, comparée du glucose et du levulose par le *Sterigmatocystis nigra* a partir du saccharose," *Compt. rend.*, 167: 1043-1046, 1918.
- MOORE, ELIZABETH J., "Carbon and oxygen requirements of the cotton-root rot organism, *Phymatotrichum omnivorum*, in culture," *Phytopathology*, 27: 918-930, 1937.
- MOSHER, W. A., D. H. SAUNDERS, L. K. KINGERY, AND R. J. WILLIAMS, "Nutritional requirements of the pathogenic mold, *Trichophyton interdigitale*," *Plant Physiol.*, 11: 795-806, 1936.
- NAEGELI, C. VON, "Ernährung der niederen Pilze durch Kohlenstoff- und Stickstoffverbindungen," *K. b. Akad. wiss. München Sitzenber.*, 10: 267-277, 1880.
- NIELSEN, E., AND F. SING-FANG, "Vergleichende Untersuchungen über Wuchsstoffwirkung auf verschiedene Arten von Hefe und Schimmelpilzen," *Planta*, 27: 367-378, 1937.
- NIELSEN, E., AND V. HARTELIUS, "Wuchsstoffwirkung der Aminosäuren. III. Untersuchungen über die Wuchsstoffwirkung von β -Alanin, β -Alanylglycin, Asparaginsäure, Glycyl-asparaginsäure, und verwandte Stoffe auf Hefe," *Compt. rend. trav. lab. Carlsberg, Ser. physiol.*, 22: 271-280, 1938.
- NIETHAMMER, A., "Wachstumsversuche mit mikroskopischen Bodenpilze," *Arch. Mikrobiol.*, 9: 23-30, 1938.
- NIKLAS, H., AND D. TOURSEL, "The determination of trace elements by means of *Aspergillus niger*," *Bodenkunde Pflanzenernähr.*, 23: 357-360, 1941.
- NOECKER, N. L., AND MERTON REED, "Observations of the vitamin requirements of *Stereum frustulosum* (Pers.) Fr.," *Am. Midland Nat.*, 30: 171-174, 1943.
- PENNINGTON, L. H., "Upon assimilation of atmospheric nitrogen by fungi," *Bull. Torrey Botan. Club*, 38: 135-139, 1911.
- PFEFFER, W., "Über Election organischer Nährstoffe," *Jahrb. wiss. Botan.*, 28: 205-268, 1895.
- PIETERS, A. J., "The relation between vegetative vigor and reproduction in some Saprolegniaceae," *Am. J. Botany*, 2: 529-576, 1915.
- PIRSCHLE, K., "Biologische Beobachtungen über Hefewachstums mit besonderes Berücksichtigen von Nitraten als Stickstoffquelle," *Biochem. Z.*, 218: 412-445, 1930.

- PIRSCHLE, K., "Vergleichende Untersuchungen über die physiologische Wirkung der Elemente nach Wachstumsversuchen mit *Aspergillus niger* (Stimulation und Toxizität)," *Planta*, 23: 177-224, 1934.
- "Weitere Untersuchungen über die vergleichsweise-wirkung der Elemente nach Wachstumsversuchen mit *Aspergillus niger* (Stimulation und Toxizität)," *Planta*, 24: 679-710, 1935.
- PORGES, N., "Chemical composition of *Aspergillus niger* as modified by zinc sulphate," *Botan. Gaz.*, 94: 197-205, 1932.
- PRATT, R., "Influence of the proportions of KH_2PO_4 , MgSO_4 , and NaNO_3 in the nutrient solution on the production of penicillin in surface cultures," *Am. J. Botany*, 32: 528-535, 1945.
- QUANTZ, L., "Untersuchungen über die Nahrungsphysiologie einiger niederer Phycomyceten (*Allomyces kniepii*, *Blastocladiella variabilis*, und *Rhizophlyctis rosea*)," *Jahrb. wiss. Botan.*, 91: 120-168, 1943.
- RACIBORSKI, M., "Über die obere Grenze des osmotischen Druckes der lebenden Zelle," *Bull. intern. acad. polon. sci., Classe sci., math., nat.*, 7: 461-471, 1905.
- RAISTRICK, H., *et al.*, "Studies in the biochemistry of micro-organisms," *Phil. Trans. Roy. Soc. London, Ser. B*, 220: 1-367, 1931.
- RAULIN, J., "Études chimiques sur la végétation," *Ann. sci. nat. Botan.*, 11: 93-299, 1869.
- RICHARDS, H. M., "Die Beeinflussung des Wachstums einiger Pilze durch chemische Reize," *Jahrb. wiss. Botan.*, 30: 665-668, 1897.
- "The effect of chemical irritation on the economic coefficient of sugar," *Bull. Torrey Botan. Club.*, 26: 463-479, 1899.
- RIPPEL, K., "Quantitative Untersuchungen über die Abhängigkeit der Stickstoffassimilation von der Wasserstoffionkonzentration bei einigen Pilzen," *Arch. Mikrobiol.*, 2: 72-135, 1931.
- ROBBINS, W. J., "The assimilation by plants of various forms of nitrogen," *Am. J. Botany*, 24: 243-250, 1937.
- ROBBINS, W. J., AND F. KAVANAUGH, "Vitamin B₁, or its intermediates, and growth of certain fungi," *Am. J. Botany*, 25: 229-236, 1938.
- "Vitamin deficiencies of the filamentous fungi," *Botan. Rev.*, 8: 411-471, 1942.
- ROBBINS, W. J., AND ROBERTA MA, "Biotin and the growth of *Fusarium avenaceum*," *Bull. Torrey Botan. Club*, 68: 446-462, 1941.
- ROBBINS, W. J., J. E. MACKINNON, AND ROBERTA MA, "Vitamin deficiencies of *Trichophyton discoides*," *Bull. Torrey Botan. Club*, 69: 509-521, 1942.
- ROBERG, MAX, "Über die Wirkung von Eisen, Zink, und Kupfersalzen auf Aspergillen," *Zentr. Bakt., Parasitenk., II Abt.*, 74: 333-370, 1928.
- "Zur Frage der Assimilation der Stickstoff durch Aspergillen," *Zentr. Bakt., Parasitenk., II Abt.*, 86: 466-479, 1931.
- SCHADE, A. L., "The nutrition of *Leptomitus*," *Am. J. Botany*, 27: 376-384, 1940.
- SCHÖBER, R., "Luftstickstoffassimilation und Säurebildung bei *Aspergillus niger*," *Jahrb. wiss. Botan.*, 72: 1-105, 1930.
- SCHOPFER, W. H., "Versuche über die Wirkung von reinen kristallisierten Vitamin B₁ auf Phycomyces," *Ber. deut. botan. Ges.*, 52: 308-312, 1936.

- SCHOPFER, W. H., "Aneurine et hétérotrophie chez les micro-organismes," *Arch. Microbiol.*, 9: 116-128, 1938.
- Plants and vitamins*. 293 pp. Chronica Botanica Co. 1943. (Translation by L. Noecker.)
- STEINBERG, R. A., "A study of some factors in the chemical stimulation of the growth of *Aspergillus niger*," *Am. J. Botany*, 6: 330-372, 1919.
- "Effect of zinc and iron compared with that of uranium and cobalt on growth of *Aspergillus*," *Botan. Gaz.*, 70: 465-468, 1920.
- "The so-called chemical stimulation of *Aspergillus niger* by iron, zinc, and other heavy-metal poisons," *Bull. Torrey Botan. Club*, 61: 241-248, 1934.
- "Nutrient solution purification for removal of heavy metals in deficiency investigations with *Aspergillus niger*," *J. Agr. Research*, 51: 413-424, 1935.
- "The nutritional requirements of the fungus *Aspergillus niger*," *Bull. Torrey Botan. Club*, 62: 81-90, 1935a.
- "Some effects of the heavy metals essential for the nutrition of *Aspergillus niger* upon its growth," *Am. J. Botany*, 23: 227-231, 1936.
- "Relation of accessory growth substances to heavy metals, including molybdenum, in the nutrition of *Aspergillus niger*," *J. Agr. Research*, 52: 439-448, 1936a.
- "Role of molybdenum in utilization of ammonium and nitrate nitrogen by *Aspergillus niger*," *J. Agr. Research*, 56: 891-902, 1937.
- "Essentiality of gallium to growth and reproduction of *Aspergillus niger*," *J. Agr. Research*, 57: 569-574, 1938.
- "Growth of fungi in synthetic nutrient solutions," *Botan. Rev.*, 5: 327-350, 1939.
- "Relation of accessory substance and amino requirements to the carbon nutrition of *Aspergillus niger*," *Proc. Third Internat. Cong. Microbiol.*, 491-492, 1939a.
- "Sulfur and trace-element nutrition of *Aspergillus niger*," *J. Agr. Research*, 63: 109-127, 1941.
- "The process of amino acid formation from sugars in *Aspergillus niger*," *J. Agr. Research*, 64: 618-633, 1942.
- STERN, K. G., "Recent experiments on the chemistry and the mechanism of enzyme action," *Enzymologia*, 5: 190-197, 1938.
- TALLEY, P. J., AND L. M. BLANK, "A critical study of the nutritional requirements of *Phycomitrium omnivorum*," *Plant Physiol.*, 16: 1-19, 1941.
- TAMIYA, H., "Über die Verwendbarkeit von verschiedenen Kohlenstoff Verbindungen im Bau und Betriebsstoffwechselphysiologie von *Aspergillus oryzae*," *Acta Phytochim. (Japan)*, 6: 1-129, 1932.
- TAUSSON, W. O., "Über die Oxydation der Wachse durch Mikroorganismen," *Biochem. Z.*, 193: 85-93, 1928.
- TERNETZ, C., "Assimilation des Atmosphärischen Stickstoff durch einen torfbewohnenden Pilz," *Ber. deut. botan. Ges.*, 22: 267-274, 1904.
- TOCHINAI, Y., "Comparative studies on the physiology of *Fusarium lini* and *Colletotrichum lini*," *J. Coll. Agr. Hokkaido Imp. Univ.*, 14: 171-236, 1926.

- VOLKONSKY, M., "Sur les conditions de culture et le pouvoir de synthese de *Saprolegnia* sp. Étude qualitative de l'alimentation carboné, azotée, et sulfurée," *Ann. inst. Pasteur*, 50: 703-730, 1933.
- "Sur la nutrition de quelques champignons saprophytes et parasites," *Ann. inst. Pasteur*, 52: 76-101, 1934.
- WAKSMAN, S. A., AND J. W. FOSTER, "Respiration and lactic acid production by a fungus of the genus *Rhizopus*," *J. Agr. Research*, 57: 873-899, 1939.
- WASSILJEW, G., "Über die Einwirkung von Zink auf den Stoffwechsel von *Aspergillus niger*," *Arch. Mikrobiol.*, 6: 250-275, 1935.
- WATTERSON, A., "The effect of chemical irritation on the respiration of fungi," *Bull. Torrey Botan. Club*, 31: 291-309, 1904.
- WEHMER, C., "Entstehung und physiologische Bedeutung der Oxalsäure im Stoffwechsel einiger Pilze. XIII. Einfluss von Eisensalzen auf der Entstehung freier Oxalsäure," *Botan. Z.*, 49: 417-428, 1891.
- "Zur Frage nach dem Werth der einzelnen Mineralsalze für Pilze," *Ber. deut. botan. Ges.*, 13: 207-265, 1895.
- WEIMER, J. L., AND L. L. HARTER, "Glucose as a source of carbon for certain sweet-potato storage-rot fungi," *J. Agr. Research*, 21: 189-210, 1921.
- WENCK, P. R., W. H. PETERSON, AND E. B. FRED, "The chemistry of mold tissue. IV. Cultural factors influencing growth and sterol production of *Aspergillus fischeri*," *Zentr. Bakt., Parasitenk., II Abt.*, 92: 330-338, 1935.
- WILDIERS, E., "Nouvelle substance indispensable au developpement de la levure," *Cellule*, 18: 311-333, 1901.
- WILLIAMS, R. J., "Growth-promoting nutrilites for yeast," *Biol. Rev.*, 16: 49-80, 1941.
- WILLIAMS, R. J., AND E. ROHRMAN, " β -Alanine and bios," *J. Am. Chem. Soc.*, 58: 695, 1936.
- WILLIAMS, R. J., R. E. EAKIN, AND E. S. SNELL, "The relationship of inositol, biotin, pantothenic acid, and vitamin B₆ to the growth of yeasts," *J. Am. Chem. Soc.*, 62: 1204-1207, 1940.
- WOLF, FRED T., AND C. S. SHOUP, "The effects of certain sugars and amino acid upon the respiration of *Allomyces*," *Mycol.*, 35: 192-200, 1943.
- WOLFF, L. K., AND A. EMMERIE, "Über das Wachstum des *Aspergillus niger* und den Kupfergehalt des Nahrbodens," *Biochem. Z.*, 228: 443-450, 1930.
- WORLEY, C. L., "Interpretation of comparative growths of fungal colonies on different solid substrata," *Plant Physiol.*, 14: 589-593, 1939.
- YOUNG, H. C., AND C. W. BENNETT, "Growth of some parasitic fungi in synthetic culture media," *Am. J. Botany*, 9: 559-569, 1922.

Chapter 2

ENZYMES AND ENZYMIC ACTIVITIES OF FUNGI

ENZYMES AND CATALYSTS. Enzymes may be defined as organic catalyzers, with specific powers of reaction, that are formed by living cells but are capable of functioning independently of them. This definition conveys a clear concept only if the reader has a working understanding of catalyzers. It has long been known that relatively small amounts of certain substances modify the velocity of chemical reactions. Finely divided platinum, for instance, greatly speeds up the decomposition of hydrogen peroxide into water and molecular oxygen. Alteration of rate of reaction may not always be in the direction of acceleration; it may be in the direction of retardation instead, so that the velocity of reaction may be either accelerated or retarded by catalyzers.

According to the old conception, catalyzers are mysterious chemical substances which are unable to initiate a reaction but can change the rate of one already in progress; they do not appear in the end-products, nor are they used up during the reaction. From the newer viewpoint catalyzers are to be regarded as sources of surface energy. They are capable of functioning provided that the spatial configuration of atoms in the surface of the catalyzer is such as to cause certain oriented adsorption relationships, thus permitting the catalyzer to contribute surface energy to the system. Presumably this surface energy induces electron displacements in the adsorbed and oriented molecules, which are, as a result, chemically active. If in catalysis surface-energy forces and oriented adsorption are the important features, it can be understood that diverse chemicals can be used to catalyze a given reaction. Such a concept, moreover, affords a logical explanation for believing that catalyzers, by inducing electron shifts in the reacting molecules, may themselves initiate reactions.

According to this newer conception, even though the catalyzer may not actually appear in the end products of the reaction, the

catalytic surface may have entered into the reaction, or there may have been an oriented adsorption at the catalyst's surface with the result that the reacting molecules are brought within the sphere of chemical attraction and reactivity. If then the products of the reaction are attracted to the reacting materials more strongly than to the catalyst, there is a continuous migration from the catalyst to the reacting materials until the transformation has been completed.

Within certain limits the degree of acceleration of a reaction is proportional to the concentration of catalyst present, although the final equilibrium is entirely independent. With a smaller amount of catalyst, however, a longer time may be required to produce a definite equilibrium.

Water constitutes one of the most important catalysts known. Its effect is evident in the case of pure chlorine gas and hydrogen gas, which will not combine to form HCl at a measurable rate except in the presence of water.

Our knowledge of enzymes begins with the observations of Payen and Persoz, who in 1833 made the observation that germinating seeds contain a substance which transforms starch into sugar. They called this substance diastase, although amylase is the preferred name. This discovery marks the beginning of studies of "organized ferments," which were thought to be the agents that carried on catalytic processes within living cells, as distinguished from "unorganized ferments," which did not require the presence of living cells. Confusion in the use of the word ferment led Kühne in 1867 to suggest the name enzyme for all organized ferments. The distinction between organized and unorganized ferments completely broke down, however, when Buchner in 1897 isolated diastase from yeast. He crushed yeast cells with sand, pressed out a straw-colored fluid, filtered it to free it from living cells or their fragments, and found that the clear fluid was capable of producing alcoholic fermentation. He also demonstrated that this alcohol-forming substance was precipitable by alcohol and easily destroyed by heat. Since then an enormous literature on enzymes has come into existence, much too copious to be summarized in one chapter or even one volume. For brief presentations Waksman and Davison (1926) or Tauber (1937) is very useful, and for a more elaborate summary the set of eight volumes edited by Nord and Weidenhagen (1932-1939)

and of five volumes edited by Nord and Werkman (1941-1945) is recommended.

CLASSIFICATION OF ENZYMES. Several plans have been proposed as bases for the classification of enzymes. The simplest of these is to group them into extracellular or digestive enzymes and intracellular or respiratory enzymes. The two classifications are also sometimes designated as exoenzymes and endoenzymes, respectively. Exoenzymes occur in secretions which pass to the exterior of the living cell through the protoplasmic membrane and cell wall. Ptyalin, the amylolytic enzyme in saliva, pepsin, the proteolytic enzyme in the gastric juice, and sucrase, the inverting enzyme of yeast, are extracellular, and much of our knowledge of enzymes has been gained by study of their activities. Little or no energy that is available to the cell is liberated by these enzymes. The endoenzymes act inside the living cell and are not excreted into its environment. Such enzymes are incapable of diffusing through the cell membrane. Some of them can react when removed from living cells, whereas others produce their characteristic reactions only *in vivo*. In contrast to exoenzymes, they liberate large quantities of energy to provide for the metabolic activities of the cell. In Myxomycetes and certain animals that ingest their food, digestion is intracellular instead of extracellular, as is generally the situation among fungi.

Enzymes may also be classified according to the type of chemical changes produced, that is, whether they are oxidative, hydrolytic, reductive, or synthetic, or on the basis of the type of chemical decomposed, for example, whether it is carbohydrate, protein, fat, glucoside, or pigment. In general, the name of each specific enzyme is formed from the name of the substrate by substituting *ase* for the last syllable. The list on page 40 includes a few of the better-known enzymes occurring in fungi and the end-products of the enzymic reactions.

CHEMICAL PROPERTIES OF ENZYMES. Concerning the chemical nature of enzymes there are two schools of thought. One is typified by the researches of Willstatter, Oppenheimer, and Waldschmidt-Leitz, and the other by those of Sherman, Northrop, Sumner, and others.

The first of these theories is that enzymes contain a special reactive or prosthetic group which possesses a specific affinity or ability to combine with definite groupings in the substrate.

<i>Name of Enzyme</i>	<i>Substrate</i>	<i>End-products</i>
Esterase	Esters	Acids and alcohols
Lipase	Fats	Glycerol plus fatty acids
Lecithinase	Lecithin	Cholin and glycerophosphoric acid and fatty acids
Tannase	Tannin	Glucose and tannic acid
Pectase	Pectin	Pectic acid
Sucrase	Sucrose	Fructose and glucose
Invertase	Raffinose	Fructose and melibiose
Maltase	Maltose	Glucose
Trehalase	Trehalose	Glucose
Cellulase	Cellulose	Cellobiose
Cytase	Hemicellulose	Dextrins and monosaccharides
Diastase	Starch and dextrins	Dextrins and maltose
Inulase	Inulin	Fructose
Raffinase	Raffinose	Fructose and melibiose
Lactase	Lactose	Fructose and galactose
Glucosides	Glucosides	Glucose and other products
Amygdalase	Amygdalin	Gentiobiose and benzaldehyde plus hydrocyanic acid
Rennin	Casein	Paracasein
Emulsin	β -Glucosides	Sugar plus nonsugar residues
Pepsin	Proteins	Proteoses and peptones
Trypsin	Proteins, proteoses, peptones, peptids	Peptids and amino acids
Erepsin	Proteoses, peptones, peptids	Amino acids
Urease	Urea	Ammonium carbonate
Phenolase	Phenols	Quinones
Tyrosinase	Tyrosine	Melanins
Peroxidase	Peroxides	Active oxygen plus reduction products
Zymase	Glucose, fructose, mannose, galactose	Alcohol and carbon dioxide
Glycolase	Sugars	Lactic acid
Fumarase	Fumaric acid	Malic acid
Catalase	Hydrogen peroxide	Water plus molecular oxygen
Luciferase	Luciferin	Oxyluciferin and light by bioluminescent species

This reactive group is attached to a colloidal carrier, and specific action is determined in part by the colloidity of the aggregate and in part by the affinity of the reactive group for the substrate. The enzyme becomes inactivated, therefore, when the colloidal properties of the aggregate are destroyed. The second group of investigators believe that enzymes are specific, definite chemical compounds, probably proteins, and that enzyme specificity is de-

terminated by the arrangement of the groupings in the complex molecule.

Evidence of the protein nature of enzymes rests upon such observations as the following: (1) Many enzymes may be digested by other enzymes, as occurs when pepsin in acid solution is brought into contact with trypsin. (2) It has been shown that certain amino acids, such as arginine, aspartic acid, cystine, glutamic acid, histidine, lysine, tryptophane, and tyrosine, compose pepsin [Calvery, Herriott, and Northrop (1936)].

The first enzyme to be obtained in purified crystalline form was urease, extracted by Sumner in 1926 from jack bean. Since then several others have been obtained in crystalline form, including pepsin, trypsin, chymotrypsin, papain, catalase, carboxypolypeptidase, lipase, and the yellow respiratory enzyme of Warburg. Northrop (1935) regards all of these crystalline enzymes as specific proteins. In opposition to this theory it is maintained that these crystalline proteins are not the enzymes themselves but the adsorption compounds of the enzymatic component. In answer Northrop points out that no specific prosthetic group is known for pepsin, urease, trypsin, and carboxypolypeptidase. It seems well established, however, that certain catalytic enzymes are associated with a carrier and that the facts necessitate acceptance of both viewpoints. The catalytic activity of hematin, for example, is known to increase ten-millionfold when associated with the colloidal carrier, which leads to a question regarding the relative importance of the colloidal carrier and prosthetic group in this type of enzyme.

COENZYMES. Some enzymes, as has been indicated, are "enzyme systems," containing an assisting material that also has the power of catalyzing. These are termed coenzymes. Some coenzymes are organic, whereas others are inorganic. In 1905 Harden demonstrated that the dialysate of expressed yeast juice and the residue are separately inactive but, when combined, are again active. In this instance the dialyzable portion is the coenzyme. Among coenzymes are cozymase (coenzyme I), coenzyme II, cocarboxylase (vitamin B₁), riboflavin, nicotinic acid, and glutathione. Other vitamins and hormones have been postulated to function as coenzymes; this theory, if valid, may explain the essentiality of specific vitamins in the metabolism of certain fungi. Others are so loosely held as to be able to oscillate between

different enzymes. Some behave catalytically in rendering oxygen active; others seem to function as carriers of oxygen, of hydrogen, or of phosphates.

SPECIFICITY OF ENZYMES. Much of the classification of enzymes is based upon the assumption that each enzyme can act upon a single definite chemical compound. In order clearly to comprehend this interpretation, the lock and key analogy has been widely employed to illustrate enzyme specificity. The substrate is analogous to the lock, and the enzyme to the key. A certain key is required to turn each lock, and hence a certain enzyme to decompose each substrate. This analogy is very serviceable but conveys the implication that certain enzymes may be master enzymes, since they act as master keys. Zymase, for example, can decompose the four stereoisomers *d*-glucose, *d*-mannose, *d*-levulose, and *d*-galactose. Similarly maltase will hydrolyze the α -methylglucosides, and emulsin, the β -methylglucosides, but reciprocally these two enzymes are without hydrolytic ability.

Attention may well be called to the fact that different enzymes may produce different end-products from the same substrate. If the trisaccharide raffinose, for example, is decomposed by invertase, melibiose and fructose are formed; if by emulsin, sucrose and galactose. The fact that emulsin may be a complex of several enzymes may account for this result. Similarly there is evidence that amylase, zymase, and tryptophanase are not single enzymes but enzyme complexes or systems.

INFLUENCE OF REACTION, TEMPERATURE, AND TIME. In the light of our knowledge of the chemical nature of enzymes and of the modifying effects of *pH*, temperature, and time on chemical synthesis and analysis in general, it should be unnecessary to elaborate on this subject as applied to enzymic reactions. These three environmental factors are minutely correlated, and none operates independently of the others. Each enzyme reacts best under a definite environmental set-up. With time and temperature constant pepsin shows its optimum activity in a solution of approximately *pH* 2.5, whereas trypsin manifests its greatest activity at approximately *pH* 8.0. With *pH* and time constant, amylase shows greatest activity not at body temperature but at 60° C. It would be anticipated that enzyme activity would double within a limited range for a 10° rise in temperature, as is postulated in van't Hoff's law.

PRODUCTION OF ENZYMES BY FUNGI. Scientific interest in the production of enzymes by fungi had its beginning in Pasteur's studies of the cause of fermentation. Of course, fermentation had been utilized by man for centuries before Pasteur's time, but no adequate explanation of the process had been offered. Pasteur contended that fermentation was a biological process, not a mechanical breakdown of the sugar molecule as Liebig believed, and that it required the presence of living yeasts. The first proof that enzymes produced by the yeasts induced alcoholic fermentation was offered in 1897, when Buchner extracted a fluid from yeast cells and caused sugars to be fermented with this fluid. Since then many studies of the enzymic activities of fungi, dealing either with the enzyme-producing ability of certain species or with the utilization of this ability in the production of end-products of commercial importance, have been made.

METHODS FOR DETECTION OF ENZYMES. Two general methods have been employed to determine the production of enzymes: (a) the *in vitro* method, in which some portion of the fungus is extracted in water and the enzyme is precipitated, the precipitate then being dried to an "enzyme powder"; and (b) the *in vivo* method, in which the fungus is cultivated on some chosen substrate and in which utilization or nonutilization of the substrate can be determined. Each method possesses advantages and disadvantages over the other, and various modifications have been instituted to make each more suitable for the problem in hand. In general, the *in vivo* method, as described by Crabill and Reed (1915), is open to less valid criticisms than the *in vitro* method. Among the criticisms levelled against the *in vitro* method are: (a) extraction diminishes the activity of enzymes; (b) the proteases may decompose some of the other enzymes present in the extracted fraction; and (c) certain enzymes, especially intracellular ones, may not act outside the living cell; that is, the enzymic reactions characteristic of the living organism cannot be duplicated with enzyme extracts.

ENZYMES OF WOOD-DESTROYING FUNGI. A brief summary of essential knowledge regarding the enzymes produced by wood-destroying fungi has been prepared by Bose (1939), who indicates that Bourquelot and Hérissé (1895) first directed attention to this problem in 1895 in connection with their studies of *Polyporus sulphureus*. In 1899 Czapek (1899) discovered that *Merulius lacrymans* is able to digest lignin by virtue of an enzyme that he

called hadromase. Since then a series of studies have appeared that form a basis for a better understanding of the metabolism of heartwood-rotting and sapwood-rotting fungi.

Cellulose and lignin are the most important constituents of wood. Some species of fungi destroy the cellulose portions but are quite unable to utilize the lignin. They constitute a group called the "brown-rot group," typified by *Polyporus schweinitzii*. Other species, which attack lignin primarily but are also able to decompose cellulose, constitute the "white-rot group," typified by *Fomes pini* and *Stereum frustulosum*. The enzymic activity of the brown-rot group is regarded as mainly hydrolytic; of the white-rot group, as both hydrolytic and oxidative.

Although this grouping may be of value to the forest pathologist, it should be interpreted to mean that a given species prefers either cellulose or lignin but yet may be able to use both components. Campbell (1929, 1932) divided the white rots which he studied into three groups. Some attack lignin in early stages, and among them the incidence of attack on cellulose is delayed, as occurs with *Polystictus versicolor*. In another group, exemplified by *Armillaria mellea*, cellulose and associated pentosans are first attacked, and the utilization of lignin is delayed. In the last group both lignin and cellulose are utilized in varying proportions, as they are by *Ganoderma applanatum*, *Polyporus adustus*, *Pleurotus ostreatus*, and *Polystictus abietinus*.

Bavendamm (1928, 1928a) devised a technique to determine the ability of a given fungus to utilize lignin. He prepared agar plates enriched with such substances as tannic acid, pyrogallol, hydroquinone, resorcinol, guaiacol, phloroglucinol, gallic acid, or tyrosine in varying concentrations. On these media he planted *Merulius lacrymans*, *Coniophora cerebella*, *Trametes radiciperda*, and *Stereum purpureum*. After 8 days' growth in the presence of most of these substances, red-brown to dark-brown zones of discoloration had developed in advance of the hyphal tips around colonies of *T. radiciperda* and *S. purpureum*. The production of these zones was ascribed to the secretion into the agar of catechol-oxidative enzymes similar to those that cause the cut surface of an apple or a potato to brown. These species use lignin primarily and are white rots. *M. lacrymans* and *C. cerebella*, on the other hand, did not develop brown pigment and hence utilize cellulose and are brown rots.

Some appreciation of the scope of investigations regarding enzymes produced by wood-inhabiting fungi may be gained from Table 5, in which representative findings are assembled. The list is not inclusive; other enzymes have been demonstrated for some of the species listed, and most of the species have not been tested to determine whether they are capable of producing all the enzymes mentioned. The most prominent feature shown by this compilation is that nearly all species are able to produce amylase, catalase, cellulase, emulsin, maltase, and sucrase.

Whether fungi that are capable of producing many enzymes attack a wide variety of woods, whereas those with restricted enzyme-producing powers are limited to a single species of tree or to closely related species, is as yet unknown. Studies of this kind might be fruitful. Woods differ in nature, as is well known, in the amount and kind of nutrients present, aside from cellulose and lignin, and also in their content of toxic substances. The wood of angiosperms is notably higher in pentosan content than is coniferous wood. These nutritional factors may determine the specificity of fungi for woods. Evidence on this point has been submitted by LaFuze (1937). In cultures he found that *Polystictus versicolor*, a generalized species, was able to oxidize tannin, resorcinol, quinol, tyrosin, and guiacol, whereas *Fomes pinicola*, a specialized species, had very little oxidizing ability. Moreover, *P. versicolor* showed little selective ability for kinds of nutrients, but *F. pinicola* was sensitive to differences in carbohydrates, growing poorly in the presence of pentoses, galactose, and sucrose. In regard to toxic substances in woods, he suggests that glucosides, alkaloids, resins, oils, terpenes, and phenolic groups may be inhibitive to growth.

The complement of enzymes produced by the assimilatory portion of wood-attacking fungi may be different from that in the sporophores, as suggested by Nutman (1929). Evidence in support of this contention is found in the fact that hyphal growth, so far as is known, is apical, and that many fungi are able to effect penetration of woody tissues not by way of the bordered pits but by making boreholes. Smith (1923) noted apical growth in *Rhizopus nigricans*, *Phytophthora parasitica*, *Rhizoctonia solani*, *Botrytis cinerea*, *Pyronema confluens*, *Aspergillus niger*, and *Penicillium expansum*. Boreholes in wood were noted by Hartig

TABLE 5
KINDS OF ENZYMES KNOWN TO BE PRODUCED BY VARIOUS WOOD-INHABITING FUNGI

Investigator	Organism	Amylase	Asparaginase	Catalase	Cellulase	Emulsin	Erepsin	Hemicellulase	Inulase	Laccase	Lactase	Ligninase	Lipase	Maltase	Oxygenase	Pepsin	Pectinase	Peroxidase	Raffinase	Rennetase	Sucrase	Tannase	Trypsin	Tyrosinase	Urease
Bayliss (1908)	<i>Polystictus versicolor</i>	+			+	-	+			+						+					+	+	+	+	+
Buller (1906)	<i>Polyporus squamosus</i>	+			-	++				+			+			+				+	-	+		+	+
Bose and Sarkar (1937)	<i>Polyporus ostreiformis</i>	+		-	+	+					-			+			+				+	+			
Bose and Sarkar (1939)	<i>Polyporus zonatis</i>	+		+	+	+				-				+			+				+	+			
Bose and Sarkar (1937)	<i>Polystictus hirsutus</i>	+		-	+	+				-				+			+				+	+			
Bose and Sarkar (1937)	<i>Polystictus sanguineus</i>	+		+	+	+				-				+			+				+	+			
Bose and Sarkar (1937)	<i>Polystictus leoninus</i>	+		+	+	+				-				+			+				+	+			
Bose and Sarkar (1937)	<i>Trametes cingulata</i>	+		-	+	+					-			+			+				+	+			
Bose and Sarkar (1937)	<i>Trametes lacinata</i>	+		+	+	+					-			+			+				+	+			
Bose and Sarkar (1937)	<i>Dacaldea florida</i>	+		+	+	+					-			+			+				+	+			

and other early workers who studied the pathological effects of wood-inhabiting fungi.

ENZYMES OF FUNGI ASSOCIATED WITH DECAY OF FRUITS AND VEGETABLES. The literature dealing with the decay of fruits and vegetables abounds in studies on the enzymes produced by the causal fungi. An introduction to the problems involved may be obtained by consulting the publications of Reed (1912), Crabill and Reed (1915), Harter (1921), Harter and Weimer (1921, 1921a), Funke (1922), Muhleman (1925), Davison and Willaman (1927), and Menon (1934). In soft rots of fruits and vegetables, caused by species of *Rhizopus*, *Sclerotinia*, *Botrytis*, and *Glomerella*, the middle lamellae, or primary host-cell membranes, are attacked by pectinase, and the cells tend to separate intact. These organisms also possess carbohydrases, by means of which they are able to attack starches and sugars in the decay of root and stem crops used by man as food.

Since soft-rot-producing fungi are of so much economic importance, considerable attention has been devoted to their enzymic activities. Studies by Davison and Willaman (1927) involved the pectic enzymes of *Botrytis cinerea*, *Rhizopus tritici*, *Sclerotinia cinerea*, *Monilia fructigena*, and *M. oregonensis*. They found, as had other workers, that pectic substances are complex carbohydrate derivatives composed of three types of materials: (1) protopectin, the parent pectic material which is water-insoluble but which yields pectins on hydrolysis; (2) pectin, the water-soluble, methoxylated, hydrolytic product derived from protopectin; and (3) pectic acid, the water-insoluble, methoxy-free, hydrolytic product. In this hydrolysis three enzymes, protopectinase, pectase, and pectinase are involved. Protopectinase attacks the pectic constituents of the middle lamella, pectin is formed, and as a final result the plant tissues are macerated. Pectase is able then to hydrolyze the pectin to pectic acid, methyl alcohol, and acetone, results which show that pectin is an ester of pectic acid and that therefore pectase is an esterase. Some or all of the products of hydrolysis are utilized as food by the soft-rot-producing species.

Reed (1912) studied the enzymes, other than pectic enzymes, produced by another soft-rot fungus of apple, *Glomerella rufomaculans* and noted that it produced amidase, diastase, emulsin, creptase, invertase, lipase, protease, and oxidase.

OTHER ENZYMIC ACTIVITIES. The pathological effects induced by disease-producing fungi might be understood if, in such cases, the enzymic potentialities of the pathogen were known. The production of "shot hole" on *Prunus* by species of *Coccomyces* may be used to illustrate and clarify this point. Higgins (1914) found that amygdalin, stored in the leaves of *Prunus*, may be utilized by species of *Coccomyces* which secrete an amygdalin-cleaving enzyme. Glucose resulting from cleavage induces increases in osmotic pressure in invaded tissues. In consequence the cells become swollen, and an abscission layer is formed at the periphery of the invaded tissues. All tissues inside the abscission layer eventually collapse and fall away, and the leaves then have the appearance of having been perforated by a discharge of shot.

Aspergillus oryzae, when cultured on moist sterilized bran for approximately 48 hours, produces sufficient growth so that the mycelium may be macerated and extracted in water, and the enzymes precipitated and concentrated. This extract, which is strongly diastatic, has been used in a variety of ways. In the textile industry it is employed in the treatment of cotton fabrics before mercerization, bleaching, and preparation for printing.

The material from apple pomace or from the peel of citrus fruit that is to become commercial pectin is turbid when extracted and must be clarified by enzymic extract from *A. oryzae*. Furthermore, in clarifying syrups and fruit juices it is often necessary, in order to facilitate filtration, that the starch be removed by the addition of enzymes prepared from this same fungus.

Diastase from *A. oryzae* and *A. flavus* is used in the preparation of soya sauce and in the fermentation of rice to make sake and is administered as a therapeutic agent to infants and invalids who experience difficulty in digesting starchy foods. It is also used in analytical procedures to determine the amount of starch present in assays of organic materials.

The desired flavors of certain cheeses, particularly Roquefort and Camembert, are due to the ability of certain molds to decompose constituents of the cheese. *Penicillium roquefortii*, for example, hydrolyzes the butter fats, producing thereby such aromatic fatty acids as butyric, acetic, capric, and caproic.

Penicillium brevicaulis is among the molds that have been used in the detection of suspected arsenical poisoning. When grown

in a test tube containing a sample of the stomach contents, this fungus possesses the ability to transform metallic arsenic into trimethylarsine, which can be detected by its pungent odor, reminiscent of garlic.

The enzymic activity of fungi is involved in the production of a variety of products, including alcohol, organic acids, pigments, fats, and carbohydrates, as is explained in Chapter 4. From the discussion in that chapter some appreciation can be gained of the influence of food supply, temperature, reaction, and O_2 tension on the enzyme-producing abilities of fungi.

Certain cosmopolitan molds, such as *Aspergillus niger*, *Penicillium glaucum*, and *Rhizopus nigricans*, are omnivorous by virtue of their ability to produce a large number of enzymes, representing each of the groups: carbohydrases, proteases, lipases, oxidases, and reductases.

Humus formation is associated with enzymic activities, as is evidenced in striking manner by the decomposition of litter on the forest floor. Many species of soil-inhabiting molds are capable of transforming the cellulose and lignin portions that are rather resistant to decomposition. The activities of a few of them, notably species of *Trichoderma*, *Chaetomium*, and *Aspergillus*, have been studied in considerable detail. A comprehensive idea of these activities and of their importance in the economy of nature is summarized in *The Microbiology of Cellulose, Hemicelluloses, Pectins, and Gums* by Thaysen and Bunker (1927).

GENERAL CONSIDERATIONS. Although much has been learned about the ability of enzymes from fungi to effect analyses and syntheses, further knowledge of these matters should be sought. Problems of host-parasite relationship, of host specificity, of the synthesis of vitamins by fungi, and of antagonistic and synergetic relationships among species may all be elucidated when more is known about enzymes. The phenomenon of autodigestion among fungi invites further consideration. Pleomorphism, especially the tendency of species that are mycelioid in their natural habitat to become yeast-like on artificial media, or vice versa, may be correlated with enzymic activity. Until techniques have been perfected to the extent that it is possible to measure the activity of small groups of fungus cells or even of single cells and a body of pertinent data has been amassed, material progress with studies of this kind may be impossible.

LITERATURE CITED

- BAVENDAMM, W., "Neue Untersuchungen über die Lebensbedingungen holzzerstörender Pilze. Ein Beitrag zur Frage der Krankheitsempfindlichkeit unser Holzpflanzen. II. Mitteilung: Gerbstoffversuche," *Zentr. Bakt. Parasitenk.*, 76: 172-227, 1928.
- "Über das Vorkommen und den Nachweis von Oxydasen bei holzzerstörenden Pilzen," *Z. Pflanzenk.*, 38: 257-276, 1928a.
- BAYLISS, J. S., "The biology of *Polystictus versicolor* (Fr.)," *J. Econ. Biol.*, 3: 1-24, 1908.
- BOSE, S. R., "Enzymes of wood-rotting fungi," *Ergeb. Enzymforsch.*, 8: 267-276, 1939.
- BOSE, S. R., AND S. N. SARKAR, "Enzymes of some wood-rotting polypores," *Proc. Roy. Soc. London, B*, 123: 193-213, 1937.
- BOURQUELOT, E., AND H. HÉRISSEY, "Les ferments solubles du *Polyporus sulfureus* (Bull.)," *Bull. soc. mycol. France*, 11: 235-239, 1895.
- BULLER, A. H. R., "The enzymes of *Polyporus squamosus* Huds.," *Ann. Botany*, 20: 49-59, 1906.
- CALVERY, H. O., R. M. HERRIOTT, AND J. L. NORTHROP, "The determination of some amino acids in crystalline pepsin," *J. Biol. Chem.*, 113: 11-14, 1936.
- CAMPBELL, W. G., "The chemistry of white rots of wood. I. The effect on wood substance of *Polystictus versicolor* (Linn.) Fr.," *Biochem. J.*, 24: 1235-1243, 1929.
- III. The effects on wood substances of *Ganoderma applanatum* (Pers.) Pat., *Fomes fomentarius* (L.) Fr., *Pleurotus ostreatus* (Jacq.) Fr., *Armillaria mellea* (Vahl.) Fr., *Trametes pini* (Brot.) Fr., and *Polyporus abietinus* (Dicks.) Fr.," *Biochem. J.*, 26: 1829-1838, 1932.
- CRABILL, C. H., AND H. S. REED, "Convenient methods for demonstrating the biochemical activity of microorganisms with special reference to the production and activity of enzymes," *Biochem. Bull.*, 4: 30-44, 1915.
- CZAPEK, F., "Über die sogenannten Ligninreactionen des Holzes," *Höppe-Seyler's Z. physiol. Chem.*, 27: 141-166, 1899.
- DAVISON, F. R., AND J. J. WILLAMAN, "Biochemistry of plant diseases. IX. Pectic enzymes," *Botan. Gaz.*, 83: 329-361, 1927.
- FUNKE, G. L., "Researches on the formation of diastase by *Aspergillus niger* van Tieghem," *Rec. trav. botan. neerland.*, 19: 219-275, 1922.
- GARREN, K. H., "Studies on *Polyporus abietinus*. I. The enzyme-producing ability of the fungus," *Phytopathology*, 28: 839-845, 1938.
- HARTER, L. L., "Amylase of *Rhizopus tritici*, with a consideration of its secretion and action," *J. Agr. Research*, 20: 761-786, 1921.
- HARTER, L. L., AND J. L. WEIMER, "Studies on the physiology of parasitism with special reference to the secretion of pectinase by *Rhizopus tritici*," *J. Agr. Research*, 21: 609-624, 1921.
- "A comparison of the pectinase produced by different species of *Rhizopus*," *J. Agr. Research*, 22: 371-377, 1921a.

- HIGGINS, B. B., "Contribution to the life history and physiology of *Cylindrosporium* on stone fruits," *Am. J. Botany*, 1: 145-173, 1914.
- LAFUZE, H. H., "Nutritional characteristics of certain wood-destroying fungi, *Polyporus betulinus* Fr., *Fomes pinicola* (Fr.) Cooke, and *Polystrictus versicolor* Fr.," *Plant Physiol.*, 12: 625-646, 1937.
- LANPHERE, W. M., "Enzymes in the rhizomorphs of *Armillaria mellea*," *Phytopathology*, 24: 1244-1249, 1934.
- MAYO, J. K., "The enzymes of *Stereum purpureum*," *New Phytol.*, 24: 162-171, 1925.
- MCDONALD, J. A., "A study of *Polyporus betulinus* (Bull.) Fr.," *Ann. Applied Biol.*, 24: 289-310, 1937.
- MENON, K. P. V., "Studies in the physiology of parasitism. XIV. Comparison of enzymic extracts obtained from various parasitic fungi," *Ann. Botany*, 48: 187-209, 1934.
- MONTGOMERY, H. B. S., "A study of *Fomes fraxineus* and its effects on ash wood," *Ann. Applied Biol.*, 23: 465-486, 1936.
- MUHLEMAN, G. W., "The pectinase of *Sclerotinia cinerea*," *Botan. Gaz.*, 80: 325-330, 1925.
- NORD, F. F., AND R. WEIDENHAGEN, *Ergebnisse der Enzymforschung*, Bd. I-VIII. Leipzig, 1932-1939.
- NORD, F. F., AND C. H. WERKMAN, *Advances in enzymology and related subjects of biochemistry*. Vols. I-V. Interscience Publishers, Inc., New York. 1941-1945.
- NORTHROP, J. H., "The chemistry of pepsin and trypsin," *Biol. Rev.*, 10: 263-282, 1935.
- NUTMAN, F. J., "Studies of wood-destroying fungi. I. *Polyporus hispidus* Fr.," *Ann. Applied Biol.*, 16: 40-64, 1929.
- REED, H. S., "The enzyme activities involved in certain fruit diseases," *Ann. Rept. Va. Agr. Expt. Sta.*, 1911-1912, 51-77, 1912.
- SCHMITZ, H., "Enzyme action in *Echinodontium tinctorium* E. and E.," *J. Gen. Physiol.*, 2: 613-616, 1920.
- "Enzyme action in *Polyporus volvatus* Pk. and *Fomes igniarius* (L.) Gill.," *J. Gen. Physiol.*, 3: 795-800, 1921.
- "Studies in wood decay. V. Physiological specialization in *Fomes pinicola* Fr.," *Am. J. Botany*, 12: 163-177, 1925.
- SCHMITZ, H., AND S. M. ZELLER, "Studies in the physiology of fungi. IX. Enzyme action in *Armillaria mellea* Vahl., *Daedalea confragosa* (Bolt.) Fr., and *Polyporus lucidus* (Leys) Fr.," *Ann. Mo. Bot. Garden*, 6: 193-200, 1919.
- SMITH, J. HENDERSON, "On the apical growth of fungal hyphae," *Ann. Botany*, 37: 341-343, 1923.
- TAUBER, H., *Enzyme chemistry*. John Wiley and Sons. 1937.
- THAYSEN, A. C., AND H. J. BUNKER, *The microbiology of cellulose, hemicelluloses, pectins, and gums*. vi + 363 pp. Oxford University Press, London. 1927.
- WAKSMAN, S. A., AND W. C. DAVISON, *Enzymes*. xii + 364 pp. Williams and Wilkins Co. 1926.
- ZELLER, S. M., "Studies in the physiology of fungi. II. *Lenzites saepiaria* Fr. with special reference to enzyme activity," *Ann. Mo. Bot. Garden*, 3: 439-512, 1916.

Chapter 3

RESPIRATION

Present-day concepts of the process of respiration in plants come largely from studies with green plants rather than chlorophyll-less ones. It would appear that respiration among fungi is worthy of more extended study than it has been accorded in the past and that much of value should result from a better understanding of this subject. Just as in green plants, respiration is manifested by the disappearance of food substances within the cells with resultant liberation of energy, by the absorption of oxygen, and by the excretion of carbon dioxide. Many other products besides carbon dioxide are excreted by fungi. Quite a goodly number of these products are of economic importance, and in consequence fungi have been utilized industrially. This matter will be given special consideration in Chapter 4, which deals with the biochemistry of fungi.

HISTORICAL MATERIAL

Much information of value concerning the respiration of fungi has come from the gradual acquisition of knowledge regarding the respiratory process commonly known as fermentation. This phenomenon was undoubtedly known to the ancients long before the days of written records. Although no attempt will be made to give an elaborate historical summary of the growth of information concerning fermentation, a few of the prominent landmarks should be indicated in order that the complex nature of this biological process may be better understood. Among the early workers who contributed to scientific knowledge of fermentation was Fabbroni (1787), from studies of wine making. He believed that the sugar was decomposed by material of a glutenous vegetable-animal nature that was contained within the grapes. When the grapes were crushed, the glutenous material was free to induce fermentation. He showed that air was not essential to the

process and regarded alcohol neither as a constituent of the grapes nor as a product of fermentation. Instead he considered it to arise by the reciprocal action of the sugar and the glutenous material.

The chemical studies of Lavoisier (1789) on fermentation led him to conclude that sugar was merely separated into two constituents, carbon dioxide and alcohol, and that if the two were reunited, sugar would be reconstructed. He thought that one constituent was oxygenated at the expense of the other, that the oxygenated portion became carbon dioxide, and that the deoxygenated portion became alcohol.

Thenard (1802–1803) made the interesting observation that a deposit resembling yeast occurred during fermentation of the juice of gooseberries, cherries, apples, or other fruits. When this deposit was mixed with fresh juice, fermentation was started. He was unable to determine whether this deposit came into existence from a soluble state or whether it was a product of fermentation.

In 1838 the classical work of Cagniard-Latour (1838), in which he described his microscopic studies of yeast, appeared. He stated that the globules which he found in wine and beer constituted the yeast and belonged to the vegetable kingdom. He correctly described their propagation by budding, the buds at first being small and attached to the mother cell.

While Cagniard-Latour was making his discoveries, Schwann (1837) examined the deposit in beer and in grape juice and came to the conclusion that this deposit was yeast and that yeast was a fungus. He clearly established the relationship of yeast to fermentation by the following phenomena: (*a*) the constancy of occurrence of yeasts during fermentation, and (*b*) the checking of fermentation by heat, chemicals, or other agencies that destroy living organisms. According to him, alcohol was a waste product left as the yeast drew its food from the sugary solution. Schwann must properly be credited with founding the germ theory or biological theory of fermentation.

Meanwhile the chemical theory of fermentation had its adherents in such capable chemists as Berzelius and Liebig. They held up to contemptuous ridicule the work of Cagniard-Latour, Schwann, and all others, notably Kützing, who believed that yeasts produce fermentation. Liebig and his pupils [Bulloch

(1938)] in 1839 anonymously published a skit in which the yeast globules were caricatured as blind, toothless animalcules with bristly suctorial snouts and enormously developed genitalia. These animalcules devoured sugar, whereupon alcohol was voided from the anus and carbon dioxide bubbled from the genital organs. If certain alkaloids were present in the sugar solution, the animalcules were capable of emesis, and the vomitus contained fusel oil. Liebig (1839) also published a technical treatise in which he set forth his views on the whole matter of decomposition. He vigorously maintained these views for thirty or more years. In his opinion all decompositions were brought about by chemical instability of a ferment. The ferment itself was not an actual chemical substance, but a nitrogen-containing carrier of activity or inciter of decompositions that could transmit its instability to other substances. In short, according to Liebig, yeasts were nitrogen-containing, but fermentation was not concerned with the life activities of the yeast itself. Instead the yeast was produced from the gluten.

The name of Blondeau [Bulloch (1938)] is also worthy of mention, since his contributions did much to lay secure foundations for Pasteur's researches on fermentation. Blondeau made a study in 1847 of lactic, butyric, and acetic fermentations and the decomposition of urea and concluded that the different types were incited by different fungi, notably *Torula cerevisiae*, *Penicillium glaucum*, *P. globosum*, and *Mycoderma vini*.

Finally came Pasteur's epoch-making series of researches, in which he proved that the activity of living yeast is absolutely essential to fermentation, that alcohol and carbon dioxide are by-products of the respiration of yeast, and that sugar can be fermented in the entire absence of atmospheric oxygen. This last fact, it should be recalled, had been established by Fabbroni in 1787. Pasteur studied not only alcoholic fermentation but also lactic, tartaric, and acetic fermentations. His zeal as a scientific crusader and his professional acumen and forcefulness are evident in certain memoirs, notably those dealing with his findings on lactic and alcoholic fermentations [Pasteur (1857, 1858, 1860)]. That the enzyme of yeast can act in the absence of living cells was first established by Buchner, in 1897, nearly two years after Pasteur's death.

TYPES OF RESPIRATION

Ordinarily respiration is arbitrarily divided into two types, aerobic and anaerobic. Aerobic respiration occurs in the presence of atmospheric oxygen. Anaerobic respiration, on the other hand, occurs in the absence of a supply of atmospheric oxygen and proceeds at the expense of the oxygen that is combined in the substance being respired. Presumably aerobic respiration is of most common occurrence among fungi, but many species possess the ability to respire either aerobically or anaerobically and are spoken of as facultative anaerobes. Few, if any, species are known to be strict anaerobes. The facultative anaerobes, because of the products of their respiration, for example, alcohol, acetic acid, and lactic acid, are of most interest and importance to man.

AEROBIC RESPIRATION. The most important reason that can be given for elaborating upon aerobic respiration in this volume is that such a discussion may help to clarify certain misunderstandings of this process that are all too commonly prevalent and that are sometimes transmitted from teacher to student.

In the first place fungi, in common with all other living things, release energy for their own metabolic activities during the process of respiration. In the oxidation of glucose such aerobic release is conventionally expressed as follows:



This equation, the precise reverse of the reaction for photosynthesis, is correct only in so far as it expresses the energy relations and the final products. It merely indicates that the complete oxidation of 1 molecule of glucose requires 6 molecules of oxygen and that, while 6 molecules of carbon dioxide and 6 molecules of water are formed, 673 calories of energy are released. Such an equation leaves the erroneous impression that at one instant glucose is present and at another, by some miracle, the sugar has become carbon dioxide, water, and liberated energy. As a matter of fact, the process is a complicated one, and intermediate products are formed. For this reason it is indefensible to indicate aerobic respiration as occurring in accordance with the foregoing equation.

ANAEROBIC RESPIRATION. Consideration will be given subsequently to some of the kinds of anaerobic respiration, products

formed being used as the basis of classification. Anaerobic respiration of glucose of the alcoholic type is conventionally expressed as follows:

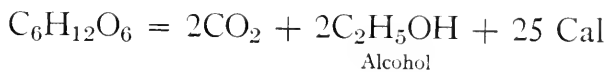

Here again, end results alone are indicated, and no essential information of the steps and mechanisms involved is conveyed. Moreover, this equation shows that only a portion of the potential energy of the glucose molecule has been released, yet in this respect it typifies the energy-release relationships of all other anaerobically respired compounds.

INTERRELATIONS BETWEEN AEROBIC AND ANAEROBIC RESPIRATION. It seems best at this juncture to indicate the existence of evidence to show that aerobic and anaerobic respiratory processes are interrelated and that both may be presumed to occur not only among fungi but also among green plants. Once this interrelationship is appreciated, it will be possible to return to the essential steps in the process. Kostytchew (1927) has schematically represented the relationship in the following manner:

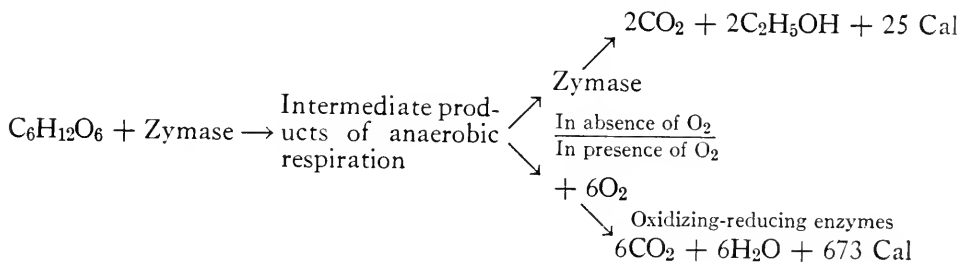

In this scheme the zymase complex (long believed to be a single enzyme but now known to consist of glycolase, which converts hexoses into methylglyoxal, carboxylase, which splits out carbon dioxide from certain organic acids, and in addition certain co-enzymes) is supposed to convert the hexose into labile intermediate products as a first step in both aerobic and anaerobic respiration. This change is an anaerobic one in either case, as Kostytchew's scheme shows. Whether or not atmospheric oxygen is available determines the next step and also the course of the subsequent respiratory reactions.

To support Kostytchew's theory of the course and sequence of events in respiration, the following facts have been marshalled:

1. Green plants, and unquestionably certain fungi also, if deprived of oxygen, respire anaerobically.

2. Glucose and the enzyme complex, zymase, are universally present in plant cells.

3. Acetaldehyde as an intermediate product in the anaerobic respiration of glucose has been detected in plant tissues.

4. Alcohol, an anaerobic respiratory product, has been found in higher plants and in certain fungi. Kostytchew (1908) found that *Agaricus campestris* formed alcohol if the mycelium was submerged, even in media lacking sugar. On the other hand, *Aspergillus niger*, grown in similar media, failed to produce alcohol.

MECHANISM OF AEROBIC RESPIRATION. The mechanism of aerobic respiration among fungi has been presumed to be like that among green plants, and in neither group of plants have the details been fully substantiated. Palladin (1909) long ago postulated a theory whose general plan outlined the mechanism as follows:

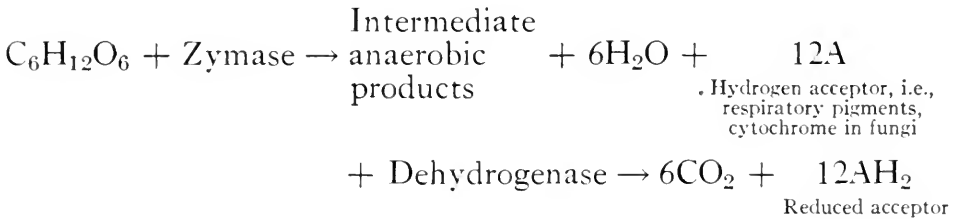

Then

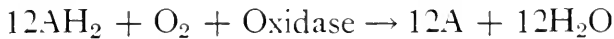

This plan means, if elucidated, that after the intermediate anaerobic products are formed, they are oxidized by the active oxygen that comes from the water molecules, and the freed hydrogen combines with the respiratory pigments. As a next step, the respiratory pigments in the presence of oxidase again acquire oxygen, but they take it from the atmospheric oxygen. In this process the sugar is completely oxidized, and the ratio of the volume of CO_2 released to the volume of O_2 utilized is unity.

MECHANISM OF ANAEROBIC RESPIRATION (ALCOHOLIC FERMENTATION). Two theories have been propounded to explain the mechanism of alcoholic fermentation. One of these, called the pyruvic acid theory, has been elaborated by Neuberg and his associates [Neuberg (1922), Neuberg and Gottschalk (1924)]; and the other, commonly called the sugar-phosphate or the Harden theory [Harden (1932)], by Meyerhof and Kiessling (1935).

According to the pyruvic acid theory, the following steps occur sequentially:

a. The hexose molecules become "activated"; that is, highly reactive γ -glucose or γ -fructose comes into transitory existence. These sugars are not straight carbon-chain complexes, being best represented by a ring type of formula.

b. The "activated" γ -hexose is cleaved by glycolase into two molecules of methylglyoxal and two of water, formally expressed as:

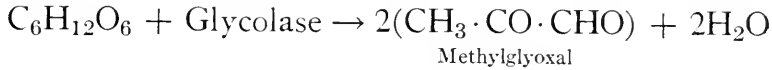

c. As the next step, one molecule of methylglyoxal is reduced to glycerol, and the other is oxidized, by a Cannizzaro reaction, to pyruvic acid with the two molecules of water. A dehydrogenase may catalyze this reaction:

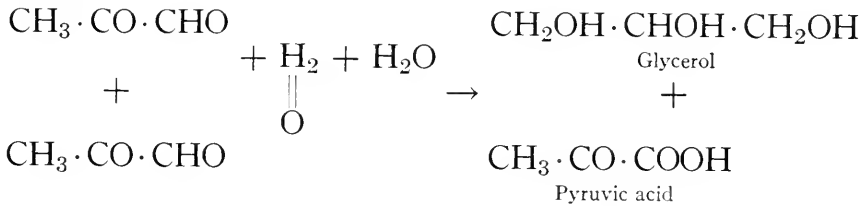

d. Immediately carboxylase splits the pyruvic acid into acetaldehyde and carbon dioxide, as follows:

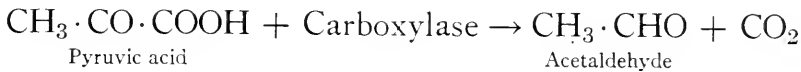

The course of events is identical up to this point, as has been stated, whether the process is aerobic or anaerobic.

e. If then anaerobic conditions prevail, the other molecule of methylglyoxal produced in step b reacts with the acetaldehyde molecule in step d, and by a Cannizzaro reaction a molecule of pyruvic acid and one of alcohol are formed in this manner:

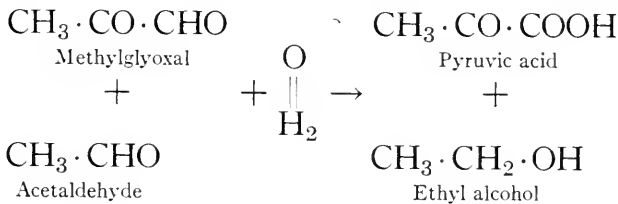

It is of interest to note that no energy is released in the transformations that result in the formation of methylglyoxal, glycerol, and pyruvic acid.

If the fermentation is produced by *Saccharomyces cerevisiae* and sodium sulphite is added to the culture solution, the acetaldehyde is fixed, and its presence can be demonstrated. With the addition of a high percentage of sodium sulphite, glycerine is produced from the acetaldehyde, and the reactions will yield acetic acid and alcohol also.

By the sulphite process as much as 37% of the sugar fermented by the yeast may be transformed into glycerol. This fact is of enormous interest and at the same time of great importance when it is recalled that in ordinary alcoholic fermentation the yield of glycerol is less than 3%. The sulphite modifies reduction of acetaldehyde by hydrogen, and hydrogen can thus act directly to reduce the intermediate compound, glyceric aldehyde, forming glycerol.

These chemical changes may be shown briefly as follows:

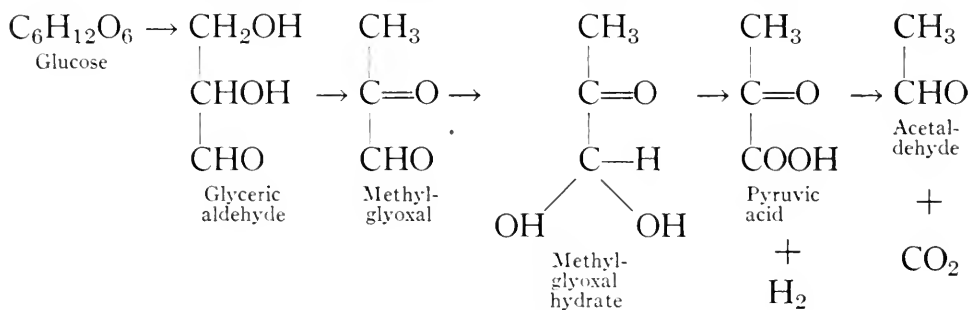

If sulphite is added, it may unite with the acetaldehyde:

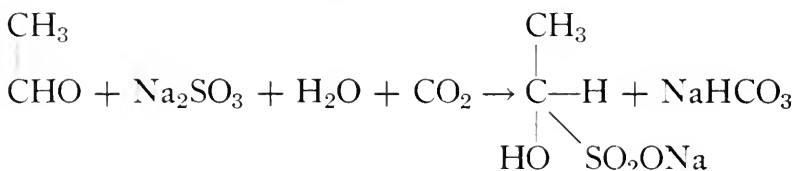

In this event the hydrogen is prevented from reducing the acetaldehyde to alcohol; instead it can react with the glyceric aldehyde directly in this manner:

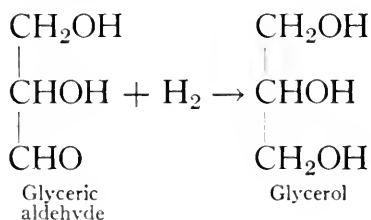

The complexity of the respiratory reactions, as they have just been presented, indicates only a portion of the misconception that is conveyed by the formal expression for fermentation: $C_6H_{12}O_6 \rightarrow 2C_2H_5OH + 2CO_2$. This point is further emphasized by the following data of Rubner [Lutman (1929)] on the products of fermentation by yeast of 100 grams of sucrose and the caloric value of the products formed:

	<i>Kg-cal Value</i>
51.1 grams alcohol	358.36
3.4 grams glycerin	14.38
0.65 grams succinic acid	1.99
1.3 grams miscellaneous products	5.15
49.2 grams carbon dioxide	0.00
	379.88
Total Kg-cal value	379.88
Kg-cal value, 100 grams sucrose	396.80
Energy released, Kg-cal	16.92

According to the sugar-phosphate theory, some phosphate, such as that of sodium or potassium, is necessary in alcoholic fermentation. The phosphate reacts with the hexose to give a diphosphoric acid ester. Apparently the phosphate is not a co-enzyme to make possible the working of zymase, but it acts as a catalytic agent. The formation of the diphosphoric acid ester is accompanied *pari passu* by a second reaction that again liberates the phosphate and the hexose. These reactions may be expressed as follows:

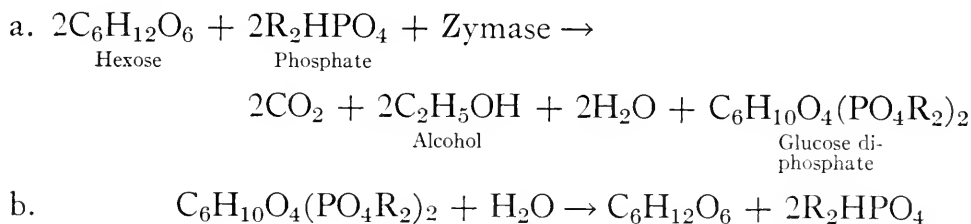

According to Meyerhof and Kiessling (1935), the hexose and phosphate react to form both glucose monophosphate and glucose diphosphate. Then by oxidation-reduction the monophosphate becomes a molecule of glyceric aldehyde phosphoric ester and one of glyceric aldehyde, and the glucose becomes two molecules of glyceric aldehyde phosphoric ester. As a next step, the glyceric aldehyde phosphoric esters are hydrolyzed to glyceric aldehyde, and phosphate is again freed. The glyceric aldehyde

then may be oxidized to methylglyoxal, to be in turn transformed sequentially into pyruvic acid, acetaldehyde, and, as a final product, alcohol. The decarboxylation of pyruvic acid yields the carbon dioxide evolved in the process.

THE RESPIRATORY RATIO

As is well known and has been stated previously, the complete respiration of hexose yields a respiratory ratio of unity. Fungi, however, respire not only hexoses but also various fats and organic acids. When such substances are oxidized in the respiratory process, it may be anticipated that the ratio of O_2 consumed to CO_2 released will differ from that shown by the respiration of hexoses. The anaerobic respiration of oxalic acid, for example, should yield a ratio of 4, as is indicated by the reaction $2(COOH) + O_2 \rightarrow 4CO_2 + 2H_2O + 60.2 \text{ Cal}$. Again, it should be anticipated that the ratio will be small if substances poor in oxygen are respired completely, as appears from the reaction involving the fat tripalmitin:



In this case the ratio is $51CO_2/72.5O_2$, or 0.7.

Richter's experiments with fermentation by yeast (1902) show that factors other than the character of the substrate enter into the problem of the respiratory ratio. He grew the organism in large, flat-bottomed, hermetically sealed flasks containing 50 ml of nutrient salt solution, consisting of K_2HPO_4 , $MgSO_4$, and a trace of Fe. To this solution he added varying amounts of sucrose and peptone. In those to which he added 0.15 gram sucrose and 0.25 gram peptone, the CO_2/O_2 ratio after 24 hours was 4.26; after 48 hours, 2.25. In those to which he added 0.3 gram sucrose and 0.5 gram peptone, the CO_2/O_2 ratio after 24 hours was 8.32; after 48 hours, 6.16. In those to which he added 0.75 gram sucrose and 1.25 grams peptone, the CO_2/O_2 ratio after 24 hours was 11.16; after 48 hours, 27.46. From these experiments he concluded that yeast utilizes sugar in preference to peptone as a source of energy, but that the concentration of food in the substrate becomes an important factor in modifying both the respiratory ratio and the rate of respiration.

Manifestly temperature is also a controlling factor in respiration, just as in almost all other biological reactions. The time factor, which is correlated with temperature, must also be measured, as is indicated by Richter's experiments. The temperature effect, apart from time, is strikingly shown in the classical experiments of Müller-Thürgau [Lutman (1929)], involving *Saccharomyces cerevisiae*, in which all other conditions were identical and fermentation was permitted to proceed until the maximum amount of alcohol had been produced. These experiments yielded the following results:

<i>Constant Temperature</i>	<i>Maximum Alcohol Content by Weight</i>
36° C	3.8%
27° C	7.5%
18° C	8.8%
9° C	9.5%

RESPIRATORY SYSTEMS

The general subject of respiratory enzymes is summarized in an extensive compendium, *Ergebnisse der Enzymforschung* by Nord and Weidenhagen (1932-1939). It need only be stated here that the main respiratory system in plant and animal cells is composed of the following: Dehydrogenase—Substrate—Cytochrome—Oxidase—Oxygen. Not only yeasts but also many, and presumably all, fungi that live aerobically contain cytochrome.

There is evidence that some other system operates in certain anaerobic organisms. One of these systems is due to the presence of glutathione, which can function as an oxidation-reduction system. In the oxidized state it would appear thus:

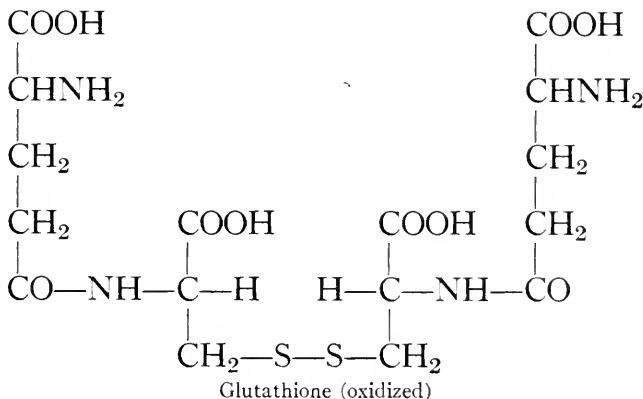

In the reduced form two molecules of glutathione give up the hydrogen of the sulphhydryl groups thus:

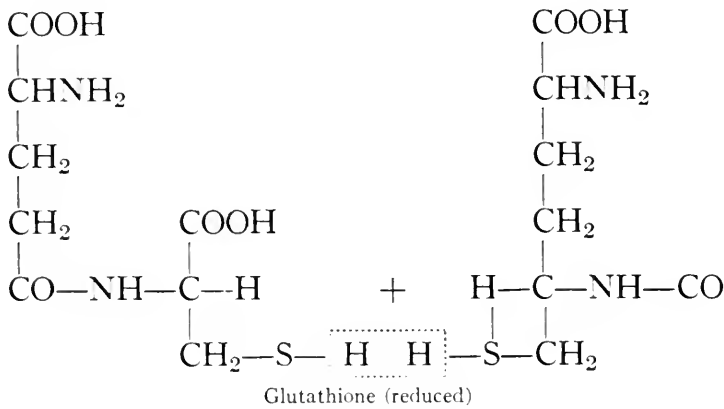

These observations indicate that the presence or absence of free oxygen conditions the respiratory systems in even the same species.

RESPIROMETRY

In recent years use has been made of respirometers of a type called the Warburg apparatus and of its several modifications, which are especially adapted for use with germinating seeds, bits of tissue of special organs, blood cells, and bacteria. To date, however, all too little use of such apparatus has been made in the study of respiration in fungi.

One such study, indicating the usefulness of this procedure, was made by Wolf and Shoup (1943). They employed a Fenn respirometer to test the ability of species of the water mold, *Allomyces*, to utilize certain carbohydrates and organic nitrogen compounds. After a period of starvation to remove the reserve foods the several species were given various compounds singly with the following results:

TABLE 6

UTILIZATION OF ORGANIC COMPOUNDS BY SPECIES OF ALLOMYCES

Organism	Dex- trin	Suc- crose	Malt- ose	Pep- tone	Ala- nine	As- partic Acid	As- para- gine	Gluc- tamic Acid	Cys- tine	Argi- nine- HCl
<i>A. arbuscula</i>	+	+	+	+	+	+	+	+	+	+
<i>A. javanicus</i>	+	-	-	+	-	+	-	+	+	+
<i>A. moniliformis</i>	+	-	-	+	+	+	-	+	-	-
<i>A. cystogenus</i>	+	-	-	+	+	+	-	+	-	-

It may be indicated, in addition, that no species was able to use mannitol, *d*-arabinose, *l*-arabinose, glucose, levulose, galactose, lactose, soluble starch, cellobiose, glycine, or tyrosine.

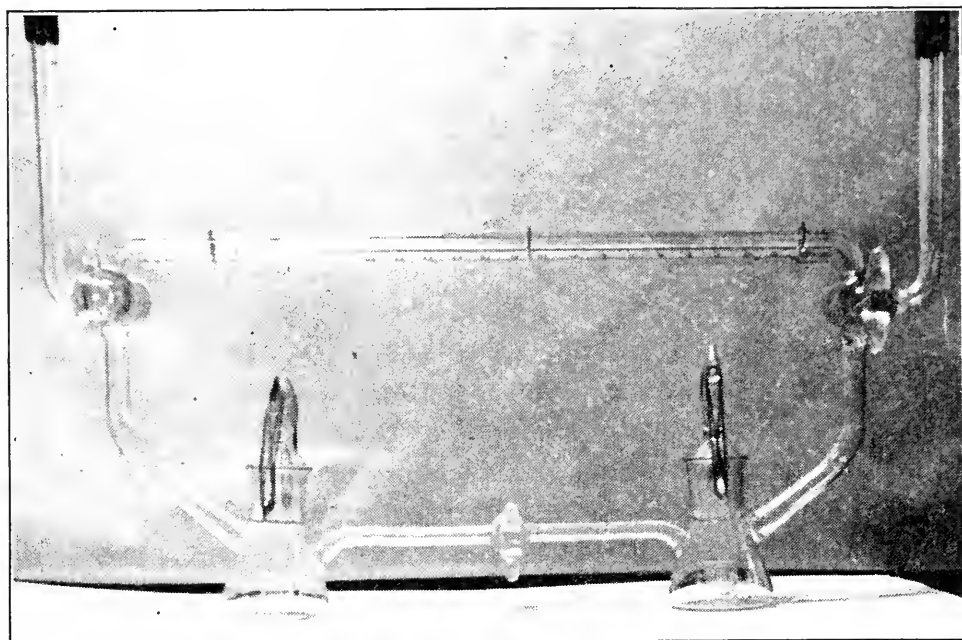

FIG. 3. A Fenn microrespirometer, having identical glass vessels of 15-ml capacity. A closed system is formed when the stopcocks are shut off. There are KOH wells for the absorption of CO_2 in each vessel. The fungus to be tested is placed in a buffered nutrient in one vessel and buffered solution alone in the other. The rate of movement of a droplet of kerosene in capillary toward the vessel with the fungus indicates the rate of O_2 consumption.

INHIBITION OF RESPIRATION

Much information has been acquired concerning the influence of cyanides and carbon monoxide on the respiration of animal cells and bacteria. Little consideration, however, has been accorded the influence of these inhibitors on the respiration of fungi. Such studies, for some reason, seem to have been made quite incidentally. In a report by Tamiya (1942) the observation was made that the respiratory rate of *Aspergillus oryzae* is decreased 26% in an atmosphere consisting of 95% CO and 5% O_2 . He also noted that in liquid media submerged hyphae of this fungus are much more sensitive to cyanide than are aerial hyphae, as is shown in Table 7.

TABLE 7

INHIBITION OF HYPHAE OF *Aspergillus oryzae* BY CYANIDE

Hyphae	Concentration of Cyanide		
	0.001 M	0.002 M	0.01 M
Aerial	14	18	71
Submerged	78	85	..

STIMULATION OF RESPIRATION

That it is possible to stimulate or increase the respiratory rate of fungi has been shown by a number of investigators. Pratt and Williams (1939) determined that thiamin and pantothenic acid increase the respiration of certain yeasts. Dammann *et al.* (1938) showed that *Gibberella saubinettii*, in the presence of thiamin, is able to ferment glucose at an increased rate and that this greater activity is not correlated with increase in mycelial weight.

Similarly Hawker (1944) demonstrated that thiamin (aneurin) in the amount of 10 γ per 100 ml of medium increases the amount of glucose consumed per unit dry weight of mycelium by *Melanospora destruens*.

IMPLICATIONS

Problems related to dormancy of spores and to their germination and early growth appear to be worthy of study by respirometry. The Warburg respirometer or some modification of it is also suitable for testing the ability of the selected fungus to utilize different nutrient complexes, for discovering its metabolic rate, and for determining the kind of enzymes that the organism is able to produce. It is possible that the modifying effect of such environmental factors as temperature, pH, and perhaps light might be better understood by respirometry. In experiments of this sort caution must be exercised in interpreting the results, for the reason that several substrates may be oxidized simultaneously. If a number of oxidative changes are proceeding concurrently and at equal rates, the respiratory ratio cannot be known with any degree of accuracy. If the evidence indicates that one substrate is being oxidized to the extent that its respiration predominates, however, the respiratory ratio becomes meaningful. Again, if the

total volume of CO₂ evolved is in excess of that anticipated by calculation of the quantity which should occur in the carbohydrate being respired, the possibility of autodigestion of reserve glycogen, "mold starch," fats, or other reserves should be considered, since many fungi are known to store foods and to utilize them during periods of stress.

LITERATURE CITED

- BULLOCH, WILLIAM, *The history of bacteriology*. 422 pp. Oxford University Press. 1938.
- CAGNIARD-LATOURE, CHARLES, "Mémoire sur la fermentation vineuse," *Ann. chim. phys.*, 68: 206-222, 1838.
- DAMMANN, E., O. T. ROTINI, AND F. F. NORD, "Mechanism of enzyme action. XVIII. Biochemistry of Fusaria. V. Enzymic transformations by *Fusarium graminearum* Schwabe (*Gibberella saubinetii*). Mode of action of hydrocyanic acid and vitamin B₁," *Biochem. Z.*, 297: 184-202, 1938.
- FABBRONI, ADAMO, *Dell' arte di fare il vino*. 264 pp. Firenze. 1787.
- HARDEN, A., *Alcoholic fermentation*, 4th ed. 194 pp. London. 1932.
- HAWKER, LILIAN E. "The effect of vitamin B₁ on the utilization of glucose by *Melanospora destruens* Shear," *Ann. Botany*, 8: 79-90, 1944.
- KOSTYTCHEW, S., "Der Einfluss des Substrates auf die anaërobe Atmung der Schimmelpilze," *Ber. deut. Botan. Ges.*, 20: 327-334, 1902.
- "Zweite Mitteilung über anaërobe Atmung ohne Alkoholbildung," *Ber. deut. botan. Ges.*, 26: 167-177, 1908.
- Plant respiration*. xi + 163 pp. P. Blakiston's Sons and Co., Philadelphia. (Translated and edited by J. C. Lyon.)
- LAVOISIER, A. L., *Traité élémentaire de Chymie*. Paris. 1789.
- LIEBIG, J. VON, "Über die Erscheinungen der Gärung, Fäulniss, und Verwesung und ihre Ursachen," *Ann. Physik. Chemie*, 2R, 18: 106-150, 1839.
- LUTMAN, B. F., *Microbiology*. x + 495 pp. McGraw-Hill Book Co., New York. 1929.
- MEYERHOF, O., AND W. KIESSLING, "Die Umersterungsreaktion der Phosphobrenztraubensäure bei der alkoholischen Zuckergärung," *Biochem. Zeitschr.*, 281: 249-270, 1935.
- NEUBERG, C., "Von der Chemie der Gärungs-Erscheinungen," *Ber. deut. chem. Ges.*, 55: 3624-3638, 1922.
- NEUBERG, C., AND A. GOTTSCHALK, "Beobachtungen über den Verlauf der anaëroben Pflanzenatmung," *Biochem. Z.*, 151: 167-168, 1924.
- NORD, F. F., AND R. WEIDENHAGEN, *Ergebnisse der Enzynforschung*, I-VIII. 1932-1939.
- PALLADIN, W., "Über das Wesen der Pflanzenatmung," *Biochem. Z.*, 18: 151-206, 1909.
- PASTEUR, LOUIS, "Mémoire sur la fermentation appelée lactique," *Comp. rend.*, 45: 913-916, 1857.

- PASTEUR, LOUIS, "Mémoire sur la fermentation appelée lactique," *Ann. chim. phys.*, 3^{me} ser., 52: 404-418, 1858.
- "Mémoire sur la fermentation alcoolique," *Ann. chim. phys.*, 3^{me} ser., 58: 323-426, 1860.
- PRATT, E. F., AND R. J. WILLIAMS, "The effect of pantothenic acid on respiration activity," *J. Gen. Physiol.*, 22: 637-647, 1939.
- RICHTER, ANDREAS, "Kritische Bemerkungen zur Theorie der Gärung," *Zentr. Bakt., Parasitenk., II Abt.*, 8: 787-796, 1902.
- SCHWANN, THEODOR, "Vorläufige Mitteilung betreffend Versuche über die Weingährung und Fäulniss," *Ann. Physik. Chemie*, 41: 184, 1837.
- TAMIYA, H., "Atmung, Gärung, und die sich daran beteiligenden Enzyme von *Aspergillus*," *Advances in Enzymol.*, 2: 183-238, 1942.
- THENARD, LOUIS JACQUES, "Sur la fermentation vineuse," *Ann. chim.*, An. XI, 46: 1802-1803.
- WOLF, FRED T., AND C. S. SHOUP, "The effects of certain sugars and amino acids upon the respiration of *Allomyces*," *Mycol.*, 35: 192-200, 1943.

Chapter 4

BIOCHEMISTRY OF FUNGI

Essentially all that is known regarding the biochemistry of fungi has come from investigations made since the turn of the present century, and the larger proportion of this knowledge has been acquired during the past few years. Interests in these matters have been divided, both the students with purely academic viewpoints and those concerned with industrial applications having been attracted. There has resulted from these studies of the biochemistry of fungi, including the yeasts and bacteria, a voluminous literature. In one volume, much less in one chapter, it is impossible for one person to convey adequately the scope of these studies, to indicate the evidences in them of scientific acuity and perspicacity, or to venture prophecies on their implications and applications.

Before the nineteenth century little about the biochemistry of fungi was common knowledge among mycologists, except perhaps that yeasts produce alcohol and carbon dioxide. Our present-day concepts of this subject admittedly had their beginning in Pasteur's epoch-making researches on fermentations as accomplished through the agency of yeasts. To be sure, yeasts were used by man in the making of bread and the preparation of alcoholic drinks long before anything fundamental about them or about their biochemical activities was known. For the development of industrial uses of fungi, the initial impetus doubtless came from Hansen's classical work with yeasts and from the studies of Wehmer, performed about the same time, on the production of oxalic and citric acid by *Penicillium*. Such a mass of data on mold biochemistry is now available that only the intrepid would appraise it or venture to view it in perspective and to speculate on the many problems that have been brought into focus and that await solution. For an introduction to this subject the excellent summaries of Raistrick (1931), Raistrick *et al.* (1931), Raistrick (1938), Iwanoff (1932), Iwanoff and Zwetkoff (1933, 1936), Bir-

kinshaw (1937), Lockwood and Moyer (1938), and Tatum (1944) will be found very serviceable.

In these biochemical researches it is of more than passing interest to note that members of the cosmopolitan genera *Aspergillus* and *Penicillium* have been very commonly employed. In fact, *Aspergillus niger* is the biological agent in so many tests that it is easy to understand why this species may appropriately be designated the "fungus guinea pig." This epithet may be applied equally appropriately to *Penicillium glaucum*. The reason for the use of these species and of closely related ones lies in their ability to produce a wide variety of enzymes, making it possible for them to utilize many kinds of substrata as foods, as is indicated in Chapter 1. In the discussion that follows, emphasis will be placed on the metabolic products formed by fungi, only incidental attention being given to the influence of nutritional factors. (The nutrition of fungi is considered separately in Chapter 1.) Inadequate emphasis must of necessity be placed upon the mechanisms by which these metabolic products come into being, mainly because they are in many instances quite unknown or at least not yet fully understood.

ORGANIC ACIDS AND OTHER PRODUCTS HAVING SIX OR FEWER CARBON ATOMS

The foundations for our understanding of the genesis of organic acids by fungi were established between 1896 and 1897 by the classical studies of Wehmer. These studies involved the common carboxylic acids, but later observers have devoted themselves to the production of acids belonging to other groups as well. Certain essentials regarding the mechanisms in these fermentations have been elucidated by such workers as Bernhauer, Chrzaszcz, Butkewitsch, Neuberg, Cohen, Raistrick, and Birkinshaw and their associates and pupils.

OXALIC ACID. Wehmer (1891) observed that crystals of calcium oxalate are present in the mycelium of *Aspergillus niger* and in the culture medium in which this organism grows. He was first to recognize that this acid is a by-product in the fermentation of a variety of substrates and that with the addition of calcium carbonate to the substrate very large yields may be obtained. Subsequently others have confirmed these findings with *A. niger* and

have shown that this acid is produced by fermentations induced by *A. ochraceous* and *A. violaceus-fuscus*. Currie and Thom (1915) described a species, which they named *Penicillium oxalicum*, that has the same ability. Indeed many mycologists have noted that a wide variety of fungi, grown in nutrient agars, induce the production of oxalic acid, evident as octahedral crystals of calcium oxalate.

Butkewitsch and Fedoroff (1930) observed that *Mucor stolonifer* can convert acetates into oxalic acid, and they postulated that this conversion is possible by either of these two courses:

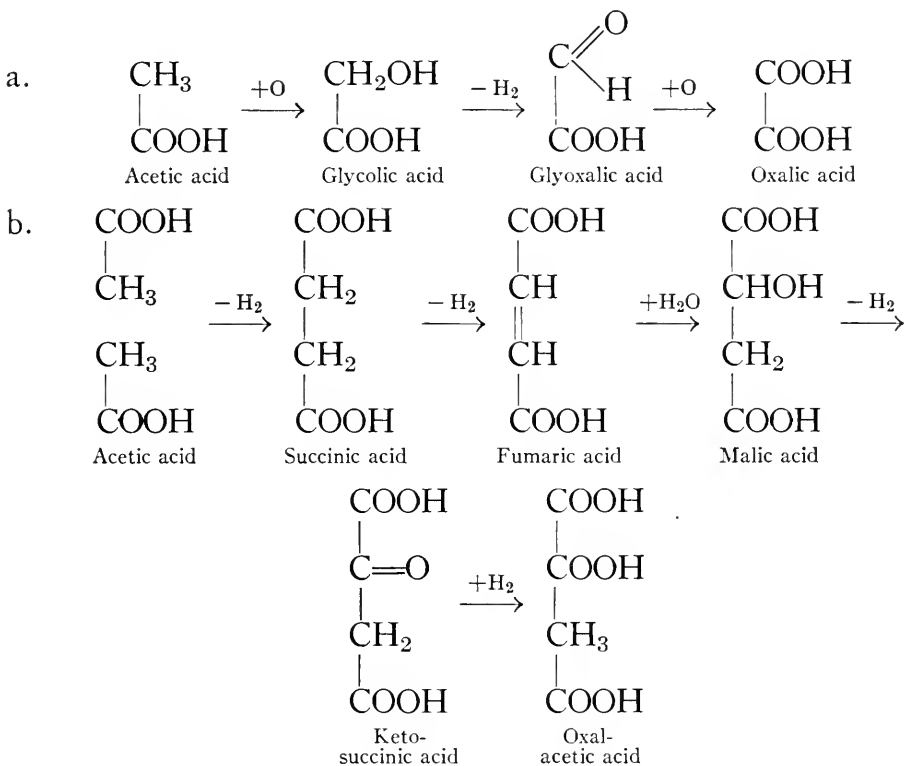

As another essential condition for oxalic acid production Chrzaszcz and Tiukow (1930, 1930a) found that the process varies with the amount and kinds of amino acids present.

CITRIC ACID. The production of citric acid from the fermentation of hexose sugars was demonstrated by Wehmer in 1893. He identified the molds concerned as members of a new genus, *Citromyces*, and named them *C. glaber* and *C. pfefferianum*. He found, as with oxalic acid production, that improved yields can be obtained when calcium carbonate is present in the medium. Later

he established that *Penicillium luteum* has the same fermentative ability. Subsequently *P. expansum*, *P. divaricatum*, *P. citrinum*, and *P. spinulosum* and several species of *Aspergillus*, including *A. niger*, *A. clavatus*, and *A. parasiticus*, were employed under similar conditions to produce citric acid. Wehmer separated *Citromyces* from *Penicillium* because of this ability to produce citric acid, but it soon became apparent that this physiological characteristic constituted an untenable generic basis. The species of *Citromyces*, totalling about twenty, have therefore come to be included in the Genus *Penicillium*.

A number of studies have been concerned with the conditions required for the production of citric acid. Molliard (1922) reported that an insufficient quantity of nitrogenous material in the substratum supplied to *Aspergillus niger* was correlated with the accumulation of citric acid; this finding was not substantiated, however, in the experiments of Bernhauer (1926).

Butkewitsch (1923) reported that both *Penicillium glaucum* and *A. niger* must be grown in an acid medium to stimulate the formation of citric acid. If the medium was neutral, oxalic and nitric acid were produced; if it was alkaline, oxalic acid alone was formed.

In his studies on citric acid production by *A. niger* Porges (1932) used an inorganic mineral nutrient to which sucrose was added as a source of carbon. He found that it was necessary first of all to secure a heavy mycelial mat over the surface of the nutrient solution. As a source of nitrogen NaNO_3 proved far superior to $(\text{NH}_4)_2\text{SO}_4$. Both Fe and Zn were essential. Sugar concentrations of 15 to 20% gave best yields. As a final condition, it was requisite that the mat be undisturbed in order to provide a partially anaerobic environment.

In 1917 Currie (1917) observed that in sugar solutions fermented by the *A. niger* group the lag in acidity can be accounted for by citric acid, which made up the difference between total acidity and oxalic acid.

Kostytchew and Tschesnokow (1927) noted, that so long as no nitrogen is being absorbed, citric acid is not accumulated. At the end of approximately 48 hours the mycelial mat of *A. niger* will have covered over the nutrient solution. This solution must then be replaced by a sugar solution that lacks mineral elements. After 3 days' growth on such a medium *A. niger* will have produced a

maximum of citric acid and will have utilized 40 to 50% of the sugar present. This mineral-nutritional relationship is substantiated by Butkewitsch and Timofeeva's results (1935) with cultures deprived of phosphorus, sulphur, and nitrogen.

Several mechanisms have been suggested to account for the formation of citric acid. Butkewitsch and Fedoroff (1929, 1930) and Chrzaszcz and Tiukow (1930, 1930a) maintain that it forms through acetic acid or from acetates of sodium or potassium. For the formation from acetic acid their scheme is:

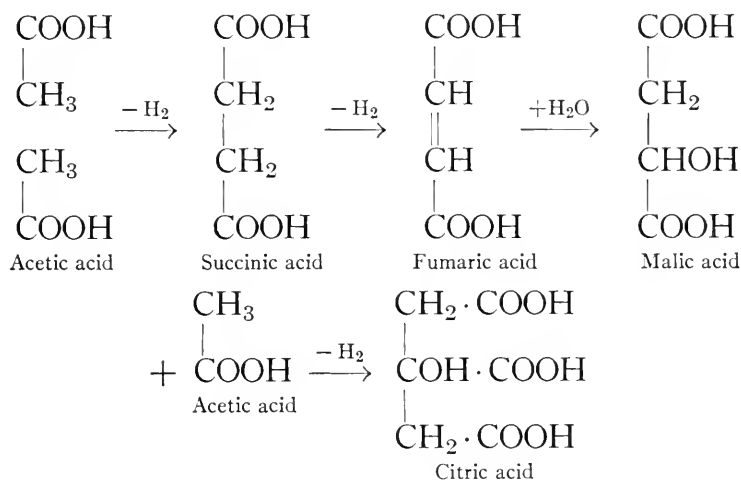

Bernhauer and Siebenäuger (1931) have shown that *A. niger* can convert ethyl alcohol into citric acid. Bernhauer and Böckl (1932) obtained yields of citric acid from alcohol up to 25% of the theoretical amount. They also showed another possible course of formation, in which aconitic acid appears: acetic acid \rightarrow succinic acid \rightarrow fumaric acid \rightarrow aconitic acid \rightarrow citric acid. Their proof rests upon experiments in which they grew *A. niger* on 2.4% potassium aconitate and obtained 23.2 to 25.8% citric acid.

Even more convincing is Kinoshita's [Iwanoff and Zwetkoff (1933)] evidence from the growth of *A. itaconicus* on a sugar solution containing calcium carbonate. Kinoshita got citric acid, which disappeared, and then itaconic acid thus:

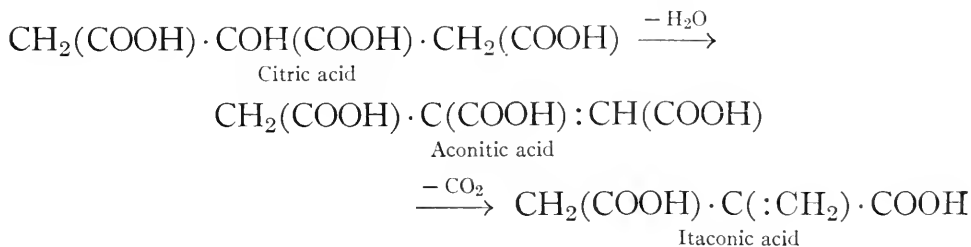

Raistrick and Clark (1919) maintain that the hexose first becomes α - γ -diketoadipic acid, that then acetic and oxalacetic acids arise by hydrolysis, and that finally they combine to form citric acid.

Optimum conditions for citric acid formation vary not only with the substrate but also with the mold concerned and with the pH. This variation is indicated by an optimum pH of 2.0 for *A. niger* and of 3.0 to 4.0 for *Penicillium glaber*. Of the substrates tested, the following carbohydrates have been found suitable for citric acid fermentation: starch, sucrose, glucose, fructose, lactose, maltose, glycerol, and molasses.

Whatever the mechanism, it has been found to be commercially practicable to produce citric acid by mold fermentation, several thousand tons being produced annually, in competition with citric acid extracted from natural sources. It requires an initial concentration of about 15% of sugar, a low concentration of ammonium nitrate, and a pH of 3.5.

d-GLUCONIC ACID. Gluconic acid is of value when used as a calcium salt in food and medicine. It was first isolated by Molliard in 1922 from among the by-products in fermentations induced by *A. niger*. Subsequent workers, notably Bernhauer (1924), Herrick and May (1928), May, Herrick, Thom, and Church (1927), Moyer, May, and Herrick (1936), and May, Herrick, Moyer, and Hellbach (1929) have shown that a variety of other molds possess the ability to ferment this acid, among them being *Aspergillus cinnamomeus*, *Penicillium glaucum*, *P. purpurogenum* var. *rubrisclerotium*, *P. chrysogenum*, and *Fumago vagans*.

Gluconic acid arises from the fermentation of glucose as follows:

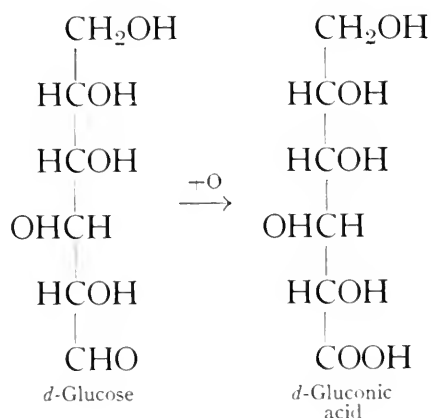

Studies have also been directed toward finding optimum conditions for the formation of gluconic acid. Herrick and May (1928) secured good yields in 10-day-old cultures, incubated at 25° to 30° C, in the following medium:

Glucose	200.00 grams	Potassium chloride	0.05 gram
Magnesium sulphate	0.25 gram	Sodium nitrate	1.00 gram
Disodium phosphate	0.10 gram	Water	1000.00 ml

Kardo-Ssysojewa (1933) recorded increased yields from decreasing total salts but increased yields if the nitrates were increased in acid media. He grew mats of *A. niger* in nutrient-sugar solution in the presence of calcium carbonate, and after pouring off this solution replaced it with one of 20% sugar to which he added calcium carbonate. After 4 days he secured 11.89 grams of gluconic acid from 11.36 grams of sugar, and after 5 days 12.19 grams of gluconic acid from 11.76 grams of sugar. Traces of citric acid were present also, but no oxalic acid.

FUMARIC ACID. In 1911 Ehrlich demonstrated that *Rhizopus nigricans* produces small amounts of fumaric acid from glucose and fructose. These observations have subsequently been confirmed, and in 1918 Wehmer (1918) reported yields of 60 to 70% from a species of *Aspergillus* that he named *A. fumaricus*. This organism gradually declined in fumaric acid-producing ability after repeated subculture and formed instead gluconic, malic, and citric acids. Galactose and arabinose have also been utilized in fumaric acid fermentation. Other fungi that have been found capable of producing this acid include *Rhizopus oryzae*, *R. tritici*, and *Penicillium griseo-fulvum* [Raistrick and Simonart (1933)].

Gottschalk (1926) and Butkewitsch and Fedoroff (1929) secured calculated yields of fumaric acid of approximately 50% from *R. nigricans*. They found that this acid may arise in an alcoholic fermentation as follows:

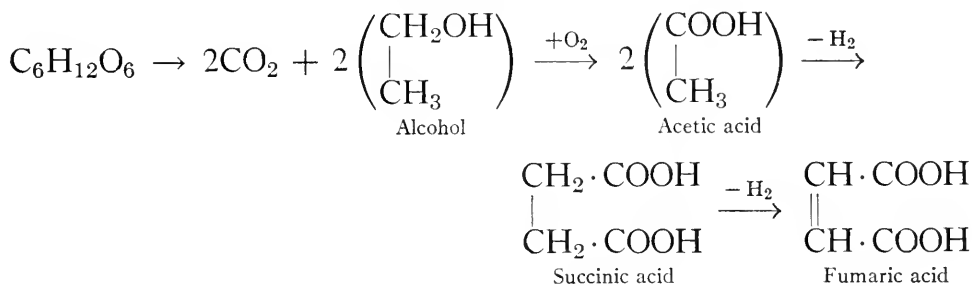

MALIC ACID. Although malic acid has for years been considered to be among the products formed by molds, proof was first provided by Wehmer (1928) in 1928. He secured small yields from sucrose fermentation by *Aspergillus fumaricus*. Raistrick *et al.* (1931) have found that several other fungi, among them species of *Aspergillus* and *Clasterosporium*, can utilize glucose to form malic acid.

SUCCINIC ACID. It has long been known that yeasts produce succinic acid during alcoholic fermentation. Moreover Fitz (1873) recorded its presence in solutions during alcoholic fermentation induced by *Mucor mucedo*. Raistrick *et al.* (1931) showed that a species of *Clasterosporium* isolated from cotton pulp, as well as *Fumago vagans*, formed succinic acid from glucose. It has also been shown to be produced by *Aspergillus terreus* [Raistrick and Smith (1935)] and *Penicillium aurantio-virens* [Birkinshaw and Raistrick (1932)]. This ability is doubtless possessed by a variety of fungi.

Succinic acid, as has been shown, forms during fermentations that give rise to such other acids as citric, gluconic, and fumaric, with which it is chemically related; in consequence its origin may be accounted for by the oxidative breakdown of sugars. On the other hand, it may well arise from yeast proteins themselves or from mold proteins. Accord seems not to have been reached on the matter of the origin of succinic acid.

LACTIC ACID. Until recently it was the general belief that only bacteria, especially such species as *Streptococcus lactis*, *Lactobacillus acidophilus*, and *L. bulgaricus*, are capable of causing lactic acid to be formed. More recently however, several workers have demonstrated this acid in sugar fermentations by species of *Rhizopus* and *Mucor*, including *Rhizopus oryzae*, *R. chinensis*, *R. elegans*, and *R. tritici*. A 40% yield from *R. japonicus* was reported when this species was grown on 10% sugar solution containing calcium carbonate. Waksman and Foster (1938) found a member of the *R. arrhizus* group to be a very efficient lactic acid former when grown in solutions containing glucose or starch. In the presence of calcium carbonate 70 to 75% of the carbohydrate was transformed into lactic acid. This yield is all the more remarkable in that the fungus is supposedly strictly aerobic. Waksman and Foster, however, permitted it to form a film over the surface of the liquid substrate, and within such a film under reduced

oxygen tension an intermediate substance is formed which becomes converted into lactic acid, alcohol, and carbon dioxide, with little loss of potential energy.

ETHYL ALCOHOL. *Saccharomyces cerevisiae* has long been known for its ability to metabolize ethyl alcohol. As long ago as 1873, however, Fitz (1873) noted that *Mucor racemosus* is also capable of transforming sucrose into alcohol. Of the closely related genus *Rhizopus*, ethyl alcohol is known to be formed by *R. nigricans*, *R. tritici*, *R. arrhizus*, and *R. oryzae*.

Fusarium lini, the cause of flax wilt, gives yields of the same order of magnitude as those from cultivated yeasts [Letcher and Willaman (1926), White and Willaman (1928)]. It will ferment almost any hexose and in addition almost any pentose, the pentoses not being utilized in this manner by baker's yeast. Many other species of *Fusarium*, moreover, are able to decompose glucose with the production of alcohol, each differing in relative yields; as might be anticipated, a variety of other products appear during the fermentation [Raistrick *et al.* (1931)].

Species of *Aspergillus* and *Penicillium* have been tested for their ability to produce alcohol. As a result it is known that 96 species or strains of *Aspergillus* and 75 of *Penicillium* possess this capability. Among them are *A. niger* and several members of the *A. glaucus* group and the *A. flavus-oryzae-tamarisii* group. Yuill (1928) is among those who have studied alcoholic fermentation by *A. flavus*. Other notable alcohol-forming molds are *Eidamia catenulata*, *E. viridescens*, *Trichoderma lignorum*, and *Helminthosporium geniculatum*.

ETHYL ACETATE. This fruity ester was demonstrated by Raistrick *et al.* (1931) to be formed by *Penicillium digitatum*, a common mold associated with the decay of citrus fruits, when grown on glucose solution. They state that it is not known to be formed by any other mold. Presumably ethyl acetate originates by a Cannizzaro reaction from acetaldehyde, an anaerobically formed respiratory product.

GLYCEROL. Connstein and Lüdecke (1919) considered the principles involved in the commercial production of glycerol by fermentation. It is a matter of common knowledge that this compound is formed during fermentation by yeasts, and as has been shown in Chapter 3, high yields can be secured by the addi-

tion of sodium sulphite to the nutrient solution. More recently the carbonate has been substituted for the sulphite with good results. Emmerling (1897) reported that *Mucor mucedo* can metabolize glycerol from sucrose. Raistrick *et al.* (1931) showed that other molds, for example, *Aspergillus wentii*, a *Clasterosporium* isolated from cotton pulp, and *Helminthosporium geniculatum*, possess like capability.

KOJIC ACID. This acid is a γ -pyrone of the following constitution:

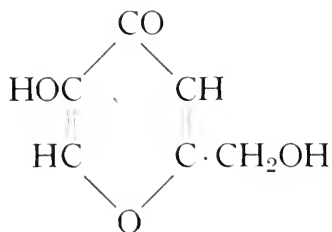

It is of special interest to the toxicologist because, when orally administered to dogs, it produces symptoms like those of epilepsy.

Kojic acid was first isolated by Saito in 1907 from the mycelium of *Aspergillus oryzae*. This fungus was subsequently found capable of utilizing in the production of kojic acid not only sucrose but also maltose, dulcitol, succinic acid, and inulin. Raistrick *et al.* (1931) and Birkinshaw (1937) showed that this capability is possessed also by *Aspergillus flavus*, *A. effusus*, *A. parasiticus*, *A. tamarii*, and *Penicillium daleae*. The conditions for its production were studied by May, Moyer, Wells, and Herrick (1931), who secured yields of 45% of the glucose present. They varied the amount of nitrogen and sugar in the medium, getting best yields with approximately 20% sugar. The mode of its formation is not established, but it may be as follows:

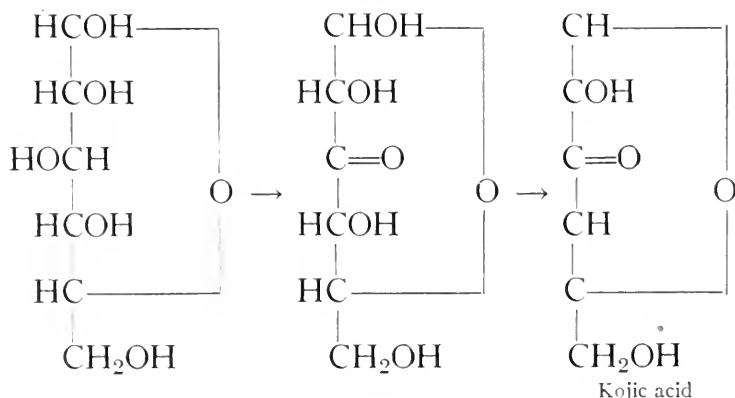

MANNITOL. Several workers have reported the occurrence of the hexahydric alcohol, mannitol, within the tissues of molds, and it has been regarded as a reserve product. Raistrick *et al.* (1931), however, established that mannitol can be formed in Czapek-Dox glucose solution, where it appears as a product of fermentation. *Aspergillus elegans*, *A. nidulans*, *A. wentii*, *Penicillium chrysogenum*, and *Helminthosporium geniculatum* were the organisms concerned in their experiments. Coyne and Raistrick (1931) found that *Aspergillus* can ferment glucose, mannose, and galactose with the production of mannitol, and that the pentoses, xylose and arabinose, can likewise be fermented in the same manner. For some reason not understood, *Aspergillus* did not form mannitol from fructose.

POLYSACCHARIDES

Many fungus structures have long been known to become blue when stained with iodine, a reaction used to establish the presence of "mold starch." Presumably the term mold starch applies to a group of closely related substances rather than to a single one. Boas (1917, 1922) found that *Aspergillus niger* can utilize various sugars, glycerol, mannitol, and several organic acids, such as citric, malic, oxalic, and tartaric, in producing mold starch, provided that high temperatures are maintained and free acids are present in the culture solution.

Chrzaszcz and Tiukow (1929, 1929a) observed that many species of *Penicillium* produce mold starch.

Dox and Neidig (1914) grew *Penicillium expansum* on Raulin's solution containing *d*-glucose. From the mycelium they isolated a polysaccharide which they named mycodextran. From *Aspergillus niger* grown on the same medium they isolated both mycodextran and another polysaccharide that they called mycogalactan.

Several other polysaccharides have been isolated [Raistrick (1938)], including luteic acid elaborated by *Penicillium luteum*, mannocarolose and galactocarolose by *P. charlesii*, and varianose by *P. varians*.

FATS

It is well known that many species of fungi store globules of fats within their spores and that fats may be present also within

the mycelia. According to Pearson and Raper (1927), the fresh mycelium of *Aspergillus niger* contains 2.4% fat and that of *Rhizopus nigricans* 5%. These fats in *Penicillium aurantio-brunneum* were studied by Strong and Peterson (1934) and were found to resemble butterfat. The analyses showed them to contain 40.2% oleic acid, 31.2% linoleic acid, 8.6% palmitic acid, and 5.3% stearic acid; the remainder consisted of 9.1% glycerol, 1.9% ergosterol, and a non-fatty residue of 4.5%. Their analysis of the fats of *Aspergillus sydowii* showed 8.8% palmitic acid, 11% stearic acid, 29.6% oleic acid, 16.3% linoleic acid, and a small percentage of higher unsaturated acids. Analysis of the fats of *Penicillium javanicum* by Ward and Jamieson (1934) revealed them to consist of 69.5% palmitic acid, 28% stearic acid, and 2.5% *n*-tetracosic acid. Nord and Mull (1945) indicated that *Fusarium gramineum* forms fats similar to those produced by yeasts.

The factors that influence the amount of fat produced have been investigated by Lockwood *et al.* (1934) and Ward *et al.* (1934, 1935) in a goodly number of species of molds. They secured best production with *Penicillium javanicum* when it was grown on a medium containing 40% glucose. Sucrose, xylose, and glycerol also served well as carbon sources. These workers found that the mycelium contained up to 41.5% fat in old cultures. The studies of Prill, Wenck, and Peterson (1935), using *Aspergillus fischeri*, showed increased fat production with higher pH within the range 2.0 to 8.0, along with greater concentration of glucose.

Even though the syntheses are not understood, the procedures are now so well known that they could be utilized industrially if a supply of animal fats could not be procured. In fact, one of the Endomycetales, *Endomyces vernalis*, has been used for some time in the commercial production of fats.

Various hypotheses, briefly considered by Smedley-McLean (1936), have been proposed to explain the mechanisms involved in the transformation of a carbohydrate into a fatty acid. Condensation of three hexose molecules to give the stem of stearic acid or of two pentose molecules and one hexose molecule to give palmitic acid has been suggested. In support of this hypothesis attention may be directed to the fact that in many naturally occurring fatty acids the number of carbon atoms is a multiple of six.

Another hypothesis is that acetaldehyde is produced from lactic acid as an intermediate substance and that by its repeated condensation the series of fatty acids from butyric upward is produced. The culturing of fungi on solutions of acetaldehydes has not strongly supported this hypothesis.

Another hypothesis, which is looked upon with favor but has not been elucidated, is that the hexose is fermented to pyruvic acid, from which the fatty acid is formed.

STEROLS AND VITAMINS

Within the past few years an appreciation has been developing that sterols and vitamins occur in fungi. This recognition has come in part from the therapeutic use of yeast to correct dietary deficiencies. The dietetic value of yeast becomes all the more remarkable when it is remembered that the yeast plant, cultured on hexose solution containing ammonium chloride together with a few drops of wort in which yeasts have previously been grown, is able to synthesize not only a goodly complement of vitamins but also all the amino acids. All these syntheses by a simple plant! To date the function of sterols (ergosterol, $C_{28}H_{44}O_5$, is the precursor of vitamin D) and vitamins in fungi remains largely unknown. The studies have centered largely on the occurrence of these substances and on their employment in animal feeding. Evidently they are of wide occurrence among fungi. The factors which condition their formation were studied by Birkinshaw, Callow, and Fischmann (1931). In 1929 Heiduschka and Lindner [Birkinshaw (1937)] determined the ergosterol content of *Dematium pullulans* to be 0.3% of the dry weight; of *Penicillium glaucum*, 0.75%; and of *Aspergillus oryzae*, 0.46%. Bernhauer and Potzelt (1935) found a variation in sterol content of 0.23 to 1.16% among 16 strains of *A. niger*.

Preuss *et al.* (1931, 1932, 1932a) studied the sterol content of 30 species of *Aspergillus*, 20 of *Penicillium*, and 15 of other species of fungi when grown on a synthetic medium containing 4% glucose. The difference in sterol content among species is shown by the occurrence of 0.98% in *Aspergillus oryzae*, 0.4% in *A. niger*, 0.35% in *Penicillium expansum*, and 0.16% in *P. janthivellum*. They found that different strains of the same species vary in

ability to produce sterol since, other conditions being uniform, 4 strains of *A. oryzae* yielded 0.54, 0.63, 0.76, and 0.98%. The duration of the period of cultivation was also found by these workers to influence the yield, since a given strain of *A. oryzae* after 10 days had produced 0.63%, and after about 50 days 1.07%. Reindel, Niederlander, and Pfundt (1937) found that best yields from *Torula* were produced in a molasses medium, increased yields being correlated with increased sugar concentration. Preuss *et al.* (1931) also administered in daily doses 10 mg of dried, finely ground fungus material to rachitic rats. They used *A. niger*, *A. oryzae*, *Marasmius oreades*, *Hypholoma incertum*, and *Secotium acuminatum*, with the result that each manifested antirachitic action. Among other of the higher fungi that have been found to contain vitamin D are *Psalliota campestris*, *Helvella esculenta*, *Boletus edulis*, *Cantharellus cibarius*, *C. clavatus*, *Hydnum imbricatum*, and *Ganoderma lucidum* [Iwanoff and Zwetkoff (1936)].

Evidence has also been accumulated to show that other vitamins are present in fungi and that some of them can be employed to enrich animal diets. Gorcica, Peterson, and Steenbock (1934) found vitamins B₁ (thiamin), B₂ (riboflavin), and B₄ in *Aspergillus sydowii*. Scheunert and Reschke [Iwanoff and Zwetkoff (1933)] found that *Cantharellus cibarius* is unusually rich in vitamin A (C₂₀H₃₀O). Lederer [Iwanoff and Zwetkoff (1936)] studied the carotene (provitamin A) content of many yeasts and fungi. Its wide distribution among fungi is indicated by his finding it in the slime mold, *Lycogala epidendrum*, in the rust, *Puccinia coronifera*, in the jelly fungus, *Tremella mesenterica*, and in the near yeast, *Torula rubra*.

Much interest also centers on the occurrence of growth substances, notably heteroauxin, in yeasts and certain fungi. An introduction to this subject can be obtained from Kögl and Kostermans' report (1934) of the existence of heteroauxin in *Rhizopus nigricans* and *Aspergillus niger*. It appears to be formed in the breakdown of tryptophane, since none is produced in mineral-nutrient solutions.

According to Nord and Mull (1945), a diet containing 10% *Fusarium lini* as a source of vitamins, with crystalline vitamin B₁ added, and 37% proteins from the same fungus serves excellently for growth, reproduction, and lactation by mice.

AMINO ACIDS

Apparently many fungi are able to synthesize their amino acids from inorganic nitrogen. Such synthesis may not be sufficiently rapid, however, for optimum growth, as is indicated by the fact that more rapid growth occurs after amino acids are added to the substrate.

Steinberg (1942) studied the utilization of amino acids as carbon and nitrogen sources for *Aspergillus niger* and interpreted his experiments as showing that amino acids may be formed from and reconverted to sugars. A mixture of proline, glutamic acid, and ornithine provided carbon and nitrogen almost as satisfactorily as did sucrose and ammonium salts.

Biogenesis of specific amino acids, as of arginine and tryptophane, especially by *Neurospora crassa*, has been given consideration [Tatum (1944)]. From such investigations the accumulated evidence indicates that the formation of primary amino acids involves oxidation of the α -hydroxy acid and amination of the keto acid.

PIGMENTS OF FUNGI

To almost any question regarding the pigments of fungi the mycologist makes the embarrassed answer, "I don't know." Many species are beautifully pigmented, and use is made of this fact in classification. Almost surely pigments serve some essential function in the metabolic activities of fungi, presumably in respiration, but this field of physiology remains quite wholly unexplored. To date the studies on such pigments deal mainly with their chemical nature.

CITROMYCETIN AND CITRININ. These two pigments were isolated by Raistrick and his associates (1931), citromycetin being obtained from *Penicillium glabrum* and citrinin from *P. citrinum*. The organisms were grown on modified Czapek-Dox medium (NaNO₃, 2 grams; KH₂PO₄, 1 gram; KCl, 0.5 gram; MgSO₄·7H₂O, 0.5 gram; FeSO₄·7H₂O, 0.02 gram; water, 1 liter; glucose, 50 grams). From *P. glabrum* Hetherington and Raistrick [Raistrick (1931)] extracted in 50% alcohol a substance that crystallized into lemon-yellow needle crystals, citromycetin, which is intensely olive green with ferric chloride. The reactions of this

dye indicate that it is related to the xanthone and flavone group. Its empirical formula is $C_{14}H_{10}O_7 \cdot 2H_2O$, with the following structural constitution:

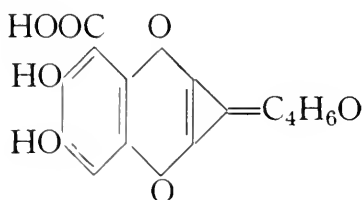

The other pigment, citrinin, also crystallizes as yellow crystals but is iodine brown in ferric chloride and discolors instantly in potassium permanganate. Its empirical formula is given as $C_{13}H_{14}O_5$, with the following structural constitution:

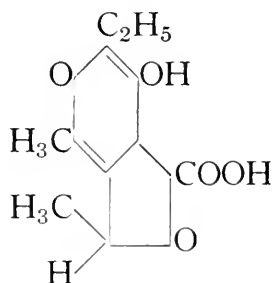

CAROTENE. Certain *Phycomycetes*, such as *Phycomyces blakesleanus*, *Mucor hiemalis*, and *Allomyces javanicus*, contain β -carotene, the precursor of vitamin A. The gametes of *Allomyces macrogyna* and *A. moniliformis* contain γ -carotene [Emerson and Fox (1940)]. Carotene occurs also in *Pilobolus* and is not uncommon among *Ascomycetes* and *Basidiomycetes*, especially rusts and jelly fungi.

OTHER PIGMENTS. Clutterbuck *et al.* (1932) isolated from *Penicillium chrysogenum* a yellow pigment whose empirical formula is $C_{15}H_{22}O_6$. From *Monascus purpureus* two pigments, monascorubrin, $C_{22}H_{24}O_5$, and monascoflavin, $C_{17}H_{22}O_4$, have been obtained. Monascorubrin is red and may be converted by hydrogen peroxide into monascoflavin, which is yellow [Birkinshaw (1937)]. Two pigments, oosporin, $C_{10}H_{14}O_6$, and aurantin, $C_{16}H_{22}O_3$, have been obtained from *Oospora aurantia*.

Gould and Raistrick (1934) isolated from members of the *Aspergillus glaucus* group three pigments; flavoglaucin, $C_{19}H_{28}O_3$, auroglaucin, $C_{19}H_{22}O_3$, and rubroglaucin, $C_{16}H_{12}O_5$.

Kögl and Erxleben [Iwanoff (1932)] have extracted pigments from a number of the higher fungi. From *Amanita muscaria* they extracted a red crystalline glucoside, muscarufin, $C_{25}H_{16}O_9$. From *Hydnum ferrugineum* and species of *Thelephora* they got thelephoric acid, $C_{20}H_{12}O_6$, whose crystals resemble in color potassium permanganate.

A group of interesting pigmented compounds is produced by each of the more commonly known species of *Helminthosporium* pathogenic to grasses, some compounds being obtained from more than one species. Raistrick (1937) and his associates cultured these species of *Helminthosporium* on Czapek-Dox solutions. From such cultures of *H. gramineum*, *H. cynodontis*, *H. catenarium*, and *H. tritici-vulgaris* they isolated helminthosporin, $C_{15}H_{10}O_5$, consisting of very dark maroon crystals. From cultures of *H. cynodontis*, *H. euchlaenae*, and *H. avenae*, cynodontin, $C_{15}H_{10}O_6$, consisting of bronze leaf-like crystals, was obtained. From cultures of *H. tritici-vulgaris*, tritispurin, $C_{15}H_{10}O_7$, consisting of reddish brown platelets, was obtained. Cultures of *H. ravenelii*, a fungus widely present in the southeastern United States on smut grass, *Sporobolus* sp., yielded ravenelin, $C_{14}H_{10}O_5$, an intensely yellow pigment. The following constitutions are assigned to these four pigments from *Helminthosporium* [Birkinshaw (1937)]:

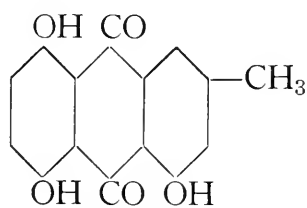

Helminthosporin

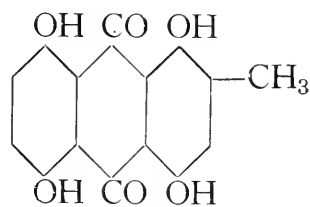

Cynodontin

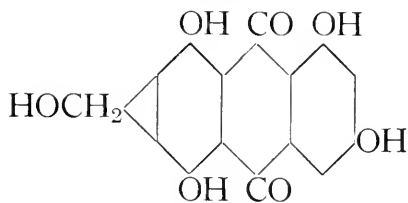

Tritispurin

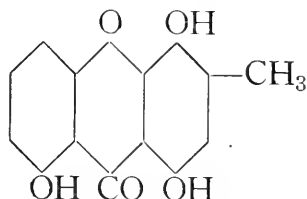

Ravenelin

Wood lying in moist situations may be discolored by *Chlorosplenium aeruginosum*. The pigment concerned is sylindein, and such wood, because of its beautiful verdigris-green stain, is utilized in making ornaments and souvenirs.

Quite a goodly number of other pigments have been isolated and studied, but the functions of most of them have not been given any consideration. Some of them catalyze oxidations, as does a red pigment, phoenicin, found in *Penicillium phoenicum* and also in the bacterium, *Pseudomonas aeruginosa*. This oxidative function may be exercised by pigments that are associated with the discoloration of agarics and boletes that have been injured. Strobilomycol, a red pigment that turns black in the presence of the oxidizing enzyme laccase, has been isolated from *Boletus (Strobilomyces) strobilaceus*. From *B. satanus* and *B. luridus* [Iwanoff and Zwetkoff (1930)] crystals of boletol have been obtained. These crystals become blue on oxidation as they are transformed into isoboletol in the following manner:

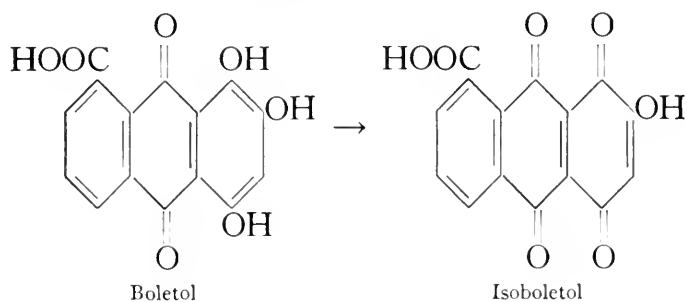

Evidence is being accumulated, furthermore, that many molds and yeasts contain glutathione, which can function in respiratory processes as an oxidation-reduction system, perhaps in conjunction with pigments. Miller and Stone (1938) record the occurrence of glutathione in *Monilia sitophila* and in species of *Penicillium*, *Aspergillus*, and *Rhizopus*.

OTHER METABOLIC PRODUCTS

Among the products of outstanding interest produced by a species of *Penicillium*, presumably *P. notatum*, is a bactericidal substance. Attention was called by Fleming (1929) to this property of culture solutions in which an unnamed species of *Penicillium* had been grown. This solution inhibited the growth of various organisms taken from the throat and favored the growth and isolation of *Hemophilus influenzae*. Reid (1935) investigated the properties of this germicidal substance, now known as penicillin. Later Chain and his associates (1940) reported its thera-

peutic action against *Streptococcus*, *Staphylococcus*, and *Clostridium septicum* in laboratory animals. From the same laboratory Abraham *et al.* (1941) purified penicillin and determined its action against body cells and against bacteria, indicating its therapeutic potentialities to replace sulfonamides. In fact, it was found to operate when sulfonamides are ineffective and to be without toxic effect against body tissues. It is bacteriostatic to *Staphylococcus* and *Streptococcus in vitro* in dilutions of one to a million. Its chemical formula, according to Meyer *et al.* (1942), is $C_{14}H_{19}NO_6$.

In a series of reports additional important findings by Raistrick and Smith (1941), Oxford, Raistrick, and Smith (1942), Oxford and Raistrick (1942), and Oxford (1942) were announced on the production by fungi of substances that inhibit the growth of pathogenic bacteria. From *Penicillium citrinum* these workers obtained penicillin, and from *P. cyclopium* penicillic acid. Both substances are bacteriostatic to *Staphylococcus aureus*, and penicillic acid is inhibitory also to the typhoid and paratyphoid bacteria. They isolated spinulosin from *Penicillium spinulosum* and fumigatin from *Aspergillus fumigatus*. Fumigatin is especially potent against *Bacillus anthracis*, *Staphylococcus aureus*, and *Vibrio cholerae*. The same workers synthesized both spinulosin and fumigatin.

Waksman and Schatz (1943) found that *Aspergillus clavatus* produces a potent bacteriostatic substance designated clavacin; differing amounts are produced by different strains.

Kochalaty (1943) purified an antibacterial substance called penatin, produced by *Penicillium notatum*, to the extent that it inhibited growth of 50 species of pathogenic and non-pathogenic bacteria in dilutions of one to ten millions or more.

Waksman and Bugie (1943) concluded that the antibiotic activity of *Aspergillus flavus* is due to two substances: (1) aspergillic acid, which is active against both Gram-positive and Gram-negative bacteria, and (2) flavacin, which is active against Gram-negative bacteria and may be identical with penicillin. In the production of these antibacterial substances three factors are involved: (1) differences in strains of *A. flavus*, (2) the composition of the substrate, and (3) the conditions of growth, especially aeration.

Bergel *et al.* (1943) isolated clavatin (identical with clavacin) from solutions in which *Aspergillus clavatus* had been grown. Their analyses indicated for clavatin the empirical formula

$C_7H_6O_4$. Furthermore they were able to show that this antibacterial substance is probably identical with claviformin, isolated from *Penicillium claviforme* by Chain and his associates, and also with patulin, isolated from *P. patulum* by Raistrick and his associates. *Trichoderma viride* has been shown to produce a very potent pigment called viridin [Brian *et al.* (1946)]. Surveys reveal that many fungi produce antibiotics [Wilkins and Harris (1942, 1943, 1945)].

Growing *Penicillium charlesii* on Czapek-Dox nutrient with glucose added, Clutterbuck *et al.* (1934) isolated a group of related substances. These included carolic acid, $C_9H_{10}O_4$, carolinic acid, $C_9H_{12}O_7$, carlic acid, $C_{10}H_{10}O_6$, carlosic acid, $C_{10}H_{12}O_6$, ramigenic acid, $C_{16}H_{20}O_3$, and verticillic acid, $C_{26}H_{32}O_{12}$. Penicillic acid, $C_8H_{10}O_4$, has been isolated from *P. puberulum* and *P. cyclopium*. Puberulic acid, $C_8H_6O_6$, has been obtained from *P. puberulum*. Mycophenolic acid is formed by both *P. glaucum* and *P. stoloniferum*.

The ability of molds, especially *P. brevicaulis* and *Aspergillus sydowii*, to react with arsenicals is of peculiar interest. These organisms liberate volatile arsenical products when growing on arsenic-containing wallpaper or when inoculated into the stomach contents of persons who have succumbed to arsenical poisoning. Challenger *et al.* (1933) found that trimethylarsine, which has a very pungent odor reminiscent of garlic, is produced in this reaction. Among other fungi capable of producing a similar reaction are *Aspergillus niger*, *A. virescens*, *Mucor mucedo* and *M. racemosus*.

IMPLICATIONS

Manifestly many problems in mycological chemistry await solution. In some instances, at least, it seems unfortunate that the details involved in the utilization of molds in industrial processes have remained trade secrets. In this period when vitamin deficiencies are so widely encountered, more should be known regarding the possibilities of utilizing fungi as sources of vitamins. The extent to which vitamins are essential in the metabolism of fungi themselves is also deserving of further elucidation.

The manufacture of citric acid and gluconic acid by mold fermentation has already been industrialized. Doubtless, when more is known regarding the fermentations which give rise to other organic acids, molds will come to be used in their commer-

cial production. Scarcely more than a beginning seems to have been made in the study of fungus pigments and of their uses to man and to the mold itself.

The study of toxin production by fungi is still in its infancy. Fungus toxins may eventually come to have an important place in therapy against pathogenic bacteria. The production of sera containing fungus antitoxins is deserving of more consideration.

Lastly, the physiology of molds should be studied in quite the same manner as has been done with bacteria. A few studies of this kind, typified by that of Martin and Jones (1940), in which carbohydrate fermentations and colony characteristics were employed to distinguish species of *Candida*, indicate the potentialities of these procedures. By such studies and by the refinement of techniques a better understanding may be reached regarding the protein metabolism of fungi and the mechanism by which they are able to elaborate mannose, glycogen, toxins, and many other substances.

LITERATURE CITED

- ABRAHAM, E. P., E. CHAIN, C. M. FLETCHER, A. D. GARDNER, N. G. HEATLEY, AND M. A. JENNINGS, "Further observations on penicillin," *Lancet*, 2: 7, 177-188, 1941.
- BERGEL, F., A. L. MORRISON, A. R. MOSS, R. KLEIN, H. RINDERKNECHT, AND J. L. WARD, "An antibacterial substance from *Aspergillus clavatus* and *Penicillium claviforme* and its probable identity with patulin," *Nature*, 152: 750, 1943.
- BERNHAEUER, K., "Zum Problem der Säurebildung durch *Aspergillus niger*," *Biochem. Z.*, 153: 517-521, 1924.
- "Über die Säurebildung durch *Aspergillus niger*. Allgemeines und methodisches bei der Untersuchung des Säurebildungsvorgange," *Biochem. Z.*, 172: 296-312, 1926.
- BERNHAEUER, K., AND N. BÖCKL, "Zum Chemismus der durch *Aspergillus niger* bewirkten Säurebildungsvorgänge. VII. Über die Umwandlung von Alkohol in Citronensäure," *Biochem. Z.*, 253: 16-24, 1932.
- VIII. "Über die Umwandlung von Aconitsäure in Citronensäure und weiteres über die Abbau der Essigsäure," *Biochem. Z.*, 253: 25-29, 1932a.
- BERNHAEUER, K., AND G. POTZELT, "Über Schimmelpilz-sterine. I. Die Sterinbildung bei *Aspergillus niger*," *Biochem. Z.*, 280: 388-393, 1935.
- BERNHAEUER, K., AND Z. SCHEUER, "Zum Chemismus der durch *Aspergillus niger* bewirkten Säurebildungsvorgänge. VII. Über die Bildung der Glykol und Glykolsäure aus essigsäuren Salzen," *Biochem. Z.*, 253: 11-15, 1932.
- BERNHAEUER, K., AND H. SIEBENÄUGER, "Zum Chemismus der Citronensäurebildung durch Pilze. V. Die Citronensäurebildung aus Essigsäure," *Biochem. Z.*, 240: 232-244, 1931.

- BERNHAUER, K., AND H. THELEN, "Zum Chemismus der durch *Aspergillus niger* bewirkten Säurebildungsvorgänge. IX. Über die Abfangung von Acetaldehyd in den Pilzkulturen," *Biochem. Z.*, 253: 30-36, 1932.
- BIRKINSHAW, J. H., "Biochemistry of the lower fungi," *Biol. Rev.*, 12: 357-392, 1937.
- BIRKINSHAW, J. H., R. K. CALLOW, AND C. F. FISCHMANN, "The isolation and characterization of ergosterol from *Penicillium puberulum* Bainier, grown on synthetic medium with glucose as sole source of carbon," *Biochem. J.*, 25: 1777-1980, 1931.
- BIRKINSHAW, J. H., AND H. RAISTRICK, "Studies in the biochemistry of micro-organisms. XXIII. Puberulic acid $C_5H_6O_6$ and an acid $C_5H_4O_6$, new products of the metabolism of glucose by *Penicillium puberulum* Bainier and *Penicillium aurantio-virens* Biourge," *Biochem. J.*, 26: 441-450, 1932.
- BOAS, F., "Stärkebildung bei Schimmelpilzen," *Biochem. Z.*, 78: 308-312, 1917.
- "Weitere Untersuchungen über die Bildung stärkeähnlicher Substanzen bei Schimmelpilzen," *Biochem. Z.*, 81: 80-86, 1917a.
- "Untersuchungen über Stärkewirkung und Bildung löslicher Stärke bei Schimmelpilzen. II," *Zentral. Bakt. Parasitenk., II Abt.*, 56: 7-11, 1922.
- BRIAN, P. W., P. J. CURTIS, H. G. HEMMING, AND J. C. MCGOWAN, "The production of viridin by pigment-forming strains of *Trichoderma viride*," *Ann. Appl. Biol.*, 33: 190-200, 1946.
- BUTKEWITSCH, W. S., "Über die Bildung der Citronensäure aus Zucker in Kulturen von *Penicillium glaucum* und *Aspergillus niger*," *Biochem. Z.*, 136: 224-237, 1923.
- BUTKEWITSCH, W. S., AND M. W. FEDOROFF, "Über Bildung von Fumarsäure in den Zuckerkulturen von *Mucor stolonifer* (*Rhizopus nigricans*), und sein Verhalten zur Bernsteinsäure," *Biochem. Z.*, 206: 440-456, 1929.
- "Über die Umwandlung der Essigsäure durch *Mucor stolonifer* in Bernstein- und Fumarsäure und das Verfahren zur Trennung und qualitativen Bestimmung dieser Säuren," *Biochem. Z.*, 207: 302-318, 1929a.
- "Über die Verhältnisse zwischen Essig-, Bernstein-, Fumar-, und Oxal-säure in den Kulturen von *Mucor stolonifer* und einigen anderen Pilzen," *Biochem. Z.*, 219: 87-102, 1930.
- "Über die Umwandlung des Äthylalkohol in den Kulturen von *Mucor stolonifer*," *Biochem. Z.*, 219: 103-121, 1930a.
- BUTKEWITSCH, W. S., AND A. G. TIMOFEEVA, "Einfluss einzelner mineralischer Elemente des Nährmediums auf die Säurebildung bei *Aspergillus niger*," *Biochem. Z.*, 275: 405-415, 1935.
- CHAIN, E., *et al.*, "Penicillium as a chemotherapeutic agent," *Lancet*, 2: 226-228, 1940.
- CHALLENGER, F., C. HIGGINBOTTOM, AND L. ELLIS, "The formation of organo-metalloid compounds by micro-organisms. I. Trimethylarsine and dimethylethylarsine," *J. Chem. Soc.*, 1933: 95-101, 1933.
- CHRZASZCZ, T., AND D. TUCROW, "Über die Säurebildung der Penicilliumarten (Link)," *Biochem. Z.*, 204: 106-124, 1929.
- "Die Stärkebildung bei den Schimmelpilzen (*Penicillium* Link), wie auch

- ihr Zusammenhang mit der Säurebildung," *Biochem. Z.*, 207: 39-52, 1929a.
- CHRZASZCZ, T., AND D. TIUKOW, "Oxalsäure in Schimmelpilzkulturen," *Biochem. Z.*, 218: 73-85, 1930.
- "Biochemische Umbildung der Essigsäure durch Schimmelpilze und über den Chemismus der Citronensäurebildung," *Biochem. Z.*, 229: 343-357, 1930a.
- "Der Zusammenhang der Stärkebildung mit der Säureanhaftung bei den Schimmelpilzen (*Penicillium*)," *Biochem. Z.*, 222: 243-258, 1936.
- CLUTTERBUCK, P. W., W. N. HAWORTH, H. RAISTRICK, G. SMITH, AND M. STACEY, "The metabolic products of *Penicillium charlesii* G. Smith," *Biochem. J.*, 28: 94-110, 1934.
- CLUTTERBUCK, P. W., A. E. OXFORD, H. RAISTRICK, AND G. SMITH, "Studies in the biochemistry of micro-organisms. XXIV. The metabolic products of the *Penicillium brevi-compactum* series," *Biochem. J.*, 26: 1441-1458, 1932.
- COHEN, CLARA, "Über die Bildung von Acetaldehyd bei den Umsetzungen von Zucker durch Pilze," *Biochem. Z.*, 112: 139-143, 1920.
- CONNSTEIN, W., AND K. LÜDECKE, "Über Glycerin Gewinnung durch Gärung," *Ber. deut. chem. Ges.*, 52: 1385-1391, 1919.
- COYNE, F. P., AND H. RAISTRICK, "Studies in the biochemistry of micro-organisms. XX. On the production of manitol from hexoses and pentoses by white species of *Aspergillus*," *Biochem. J.*, 25: 1513-1521, 1931.
- CURRIE, J. N., "The citic acid fermentation of *Aspergillus niger*," *J. Biol. Chem.*, 31: 15-37, 1917.
- CURRIE, J. N., AND C. THOM, "An oxalic acid-producing *Penicillium*," *J. Biol. Chem.*, 22: 287-293, 1915.
- DOX, A. W., AND R. E. NEIDIG, "The soluble polysaccharides of lower fungi. I. Myxodextran, a new polysaccharide in *Penicillium expansum*," *J. Biol. Chem.*, 18: 167-175, 1914.
- EMERSON, R., AND D. L. FOX, "Carotene in the sexual phase of the aquatic fungus *Allomyces*," *Proc. Roy. Soc. London, B*, 128: 275-293, 1940.
- EMMERLING, O., "Über Schimmelpilzgärung," *Ber. deut. chem. Ges.*, 30: 454-455, 1897.
- FITZ, A., "Über alkoholische Gärung durch *Mucor mucedo*," *Ber. deut. chem. Ges.*, 6: 48-58, 1873.
- "Über alkoholische Gärung," *Ber. deut. chem. Ges.*, 9: 1352-1355, 1876.
- FLEMING, A., "On the antibacterial action of cultures of a *Penicillium*, with special reference to their use in the isolation of *B. influenzae*," *Brit. J. Expt. Path.*, 10: 226-236, 1929.
- GORCICA, H. J., W. H. PETERSON, AND H. STEENBOCK, "The chemistry of mould tissue. V. Fractionation of the nitrogen in the mycelium of *Aspergillus fischeri*," *Biochem. J.*, 28: 504-511, 1934.
- GOTTSCHALK, A., "Biochemische Synthese von Fumarsäure aus Brenztaubensäure," *Höppe-Seyler's Z. physiol. Chem.*, 152: 136-143, 1926.
- GOULD, B. S., AND H. RAISTRICK, "Studies in the biochemistry of micro-organisms. XL. The crystalline pigments of species in the *Aspergillus glaucus* series," *Biochem. J.*, 28: 1640-1656, 1934.

- HERRICK, H. T., AND O. E. MAY, "The production of gluconic acid by the *Penicillium luteum-purpurogenum* group. II. Some optimal conditions for acid formation," *J. Biol. Chem.*, 77: 185-195, 1928.
- IWANOFF, N. M., "The biochemistry of the fungi," *Ann. Rev. Biochem.*, 1: 675-697, 1932.
- IWANOFF, N. M., AND E. S. ZWETKOFF, "The biochemistry of the fungi," *Ann. Rev. Biochem.*, 2: 521-540, 1933; 5: 585-612, 1936.
- KARDO-SSYSOJEW, E., "Über die Bildung von Gluconsäure durch *Aspergillus niger*," *Biochem. Z.*, 266: 337-351, 1933.
- KOCHALATY, W., "Purification and properties of the second antibacterial substance produced by *Penicillium notatum*," *Science*, 94: 186-187, 1943.
- KÖGL, F., AND D. G. KOSTERMANS, "Hetero-auxin als Stoffwechselprodukt niederer pflanzlicher organismen. Isolierung aus Hefe," *Höppe-Seyler's Z. physiol. Chem.*, 228: 113-121, 1934.
- KOSTYTCHEW, S., "Der Einfluss des Substrates auf die anaërobe Atmung der Schimmelpilze," *Ber. deut. botan. Ges.*, 20: 327-334, 1902.
- "Über die alkoholgärung von *Aspergillus niger*," *Ber. deut. botan. Ges.*, 25: 44-50, 1907; 25: 188-191, 1907a.
- KOSTYTCHEW, S., AND W. TSCHESNOKOW, "Bildung von Citronensäure und Oxalsäure durch *Aspergillus niger*," *Planta*, 4: 181-200, 1927.
- LETCHER, H., AND J. J. WILLAMAN, "Biochemistry of plant diseases. VIII. Alcoholic fermentation of *Fusarium lini*," *Phytopathology*, 16: 941-949, 1926.
- LOCKWOOD, L. B., AND A. J. MOYER, "The production of chemicals by filamentous fungi," *Botan. Rev.*, 4: 140-164, 1938.
- LOCKWOOD, L. B., G. E. WARD, O. E. MAY, H. T. HERRICK, AND H. T. O'NEILL, "Production of fat by *Penicillium javanicum* von Beijma," *Zentr. Bakt. Parasitenk., II Abt.*, 411-425, 1934.
- MARTIN, D. S., AND C. P. JONES, "Further studies on the practical classification of the Monilias," *J. Bact.*, 39: 609-630, 1940.
- MAY, O. E., H. T. HERRICK, A. J. MOYER, R. HELLBACH, "Semi-plant-scale production of gluconic acid by mold fermentation," *Ind. Eng. Chem.*, 21: 1198-1203, 1929.
- MAY, O. E., H. T. HERRICK, C. THOM, AND M. B. CHURCH, "The production of gluconic acid by the *Penicillium luteum-purpurogenum* group. I," *J. Biol. Chem.*, 75: 417-422, 1927.
- MAY, O. E., A. J. MOYER, P. A. WELLS, AND H. T. HERRICK, "The production of kojic acid by *Aspergillus flavus*," *J. Am. Chem. Soc.*, 53: 774-782, 1931.
- MEYER, KARL, *et al.*, "On Penicillin," *Science*, 96: 20-21, 1942.
- MILLER, T. E., AND R. W. STONE, "Occurrence of glutathione in micro-organisms," *J. Bact.*, 36: 248-249, 1938.
- MOLLARD, M., "Sur une nouvelle fermentation acide produite par le *Sterigmatocystis nigra*," *Comp. rend.*, 174: 881, 1922.
- MOYER, A. J., O. E. MAY, AND H. T. HERRICK, "Production of gluconic acid by *Penicillium chrysogenum*," *Zentr. Bakt. Parasitenk., II Abt.*, 95: 311-324, 1936.

- NEUBERG, C., AND CLARA COHEN, "Über die Bildung von Acetaldehyd und die Verwicklichung der zweiten Vergärungsform bei verschiedenen Pilzen," *Biochem. Z.*, 122: 204-224, 1921.
- NORD, F. F., AND ROBERT P. MULL, "Recent progress in the biochemistry of *Fusaria*," *Advances in Enzymol.*, 5: 165-205, 1945.
- OXFORD, A. E., "Antibacterial substances from moulds. Part III. Some observations on the bacteriostatic powers of the mould products citrinin and penicillic acid," *Chemistry & Industry*, 61: 48-51, 1942.
- "Part V. The bacteriostatic powers of the methyl ethers of fumigatin and spinulosin and other hydroxy-, methoxy-, and hydroxymethoxy derivatives of toluquinone and benzoquinone," *Chemistry & Industry*, 61: 189-192, 1942.
- OXFORD, A. E., H. RAISTRICK, AND G. SMITH, "Part II. Penicillic acid, a metabolic product of *Penicillium puberulum* Bainier and *Penicillium cyclopium* Westling," *Chemistry & Industry*, 61: 22-24, 1942.
- OXFORD, A. E., AND H. RAISTRICK, "Part IV. Spinosin and fumigatin, metabolic products of *Penicillium spinulosum* Thom and *Aspergillus fumigatus* Fresenius," *Chemistry & Industry*, 61: 128-129, 1942.
- PEARSON, L. K., AND K. B. RAPER, "The influence of temperature on the nature of the fat formed by living organisms," *Biochem. J.*, 21: 875-879, 1927.
- PORGES, N., "Citric acid production by *Aspergillus niger*," *Am. J. Botany*, 19: 559-567, 1932.
- PREUSS, L. M., H. J. GORCICA, H. C. GREENE, AND W. H. PETERSON, "Wachstum und Steringehalt gewisser Schimmelpilze," *Biochem. Z.*, 246: 401-413, 1932.
- PREUSS, L. M., W. H. PETERSON, AND E. B. FRED, "Isolation and identification of ergosterol and mannitol from *Aspergillus fischeri*," *J. Biol. Chem.*, 97: 483-489, 1932a.
- PREUSS, L. M., W. H. PETERSON, H. STEENBOCK, AND E. B. FRED, "Sterol content and antirachitic activatibility of mold mycelia," *J. Biol. Chem.*, 90: 369-384, 1931.
- PRILL, E. A., P. R. WENCK, AND W. H. PETERSON, "The chemistry of mould tissue. VI. Factors influencing the amount and nature of the fat produced by *Aspergillus fischeri*," *Biochem. J.*, 29: 21-33, 1935.
- RAISTRICK, H., "Biochemistry of the lower fungi," *Ergeb. Enzymforsch.*, 1: 345-363, 1931.
- "Certain aspects of the biochemistry of the lower fungi (moulds)," *Ergeb. Enzymforsch.*, 7: 316-348, 1938.
- "Biochemistry of the lower fungi," *Ann. Rev. Biochem.*, 9: 571-592, 1940.
- RAISTRICK, H., *et al.*, "Studies in the biochemistry of micro-organisms," *Trans. Roy. Soc. London*, B, 220: 367 pp., 1931.
- RAISTRICK, H., AND A. B. CLARK, "On the mechanism of oxalic acid formation by *Aspergillus niger*," *Biochem. J.*, 13: 329-344, 1919.
- RAISTRICK, H., AND P. SIMONART, "Studies in the biochemistry of micro-organisms. XXIV. 2:5-Dihydroxybenzoic acid (gentisic acid), a new product of the metabolism of glucose by *Penicillium griseofulvum* Dierckx," *Biochem. J.*, 27: 628-633, 1933.

- RAISTRICK, H., AND G. SMITH, "Studies in the biochemistry of micro-organisms. XXXV. The metabolic products of *Byssoclamlmys fulva* Olliver and Smith," *Biochem. J.*, 27: 1814-1819, 1935.
- "Antibacterial substances from moulds. Part I. Citrinin, a metabolic product of *Penicillium citrinum* Thom," *Chemistry & Industry*, 60: 828-830, 1941.
- REID, R. D., "Some principles of a bacterial inhibitory substance produced by a mold," *J. Bact.*, 29: 215-221, 1935.
- REINDEL, F., K. NIEDERLANDER, AND R. PFUNDT, "Die Sterinproduktion der Hefe bei Züchtung nach dem Zulauf- und Luftungsverfahren," *Biochem. Z.*, 291: 1-6, 1937.
- SMEDLEY-MCLEAN, IDA, "The biochemical synthesis of fat from carbohydrate," *Ergeb. Enzymforsch.*, 5: 285-304, 1936.
- STEINBERG, R. A., "The process of amino acid formation from sugars in *Aspergillus niger*," *J. Agr. Research*, 64: 618-633, 1942.
- STRONG, F. M., AND W. H. PETERSON, "Chemistry of mould tissue. IV. Lipides of *Aspergillus sydowii*," *J. Am. Chem. Soc.*, 56: 592-595, 1934.
- TATUM, E. L., "Biochemistry of fungi," *Ann. Rev. Biochem.*, 13: 667-764, 1944.
- WAKSMAN, S. A., AND ELIZABETH BUGIE, "Strain specificity and production of antibiotic substances. II. *Aspergillus flavus-oryzae* group," *Proc. Nat. Acad. Sci.*, 29: 282-288, 1943.
- WAKSMAN, S. A., AND J. W. FOSTER, "Respiration and lactic acid production by a fungus of the genus *Rhizopus*," *J. Agr. Research*, 57: 873-900, 1938.
- WAKSMAN, S. A., AND ALBERT SCHATZ, "Strain specificity and production of antibiotic substances," *Proc. Nat. Acad. Sci.*, 29: 74-79, 1943.
- WARD, G. E., AND S. G. JAMIESON, "The chemical composition of the fat produced by *Penicillium javanicum* von Beijma," *J. Am. Chem. Soc.*, 56: 973-975, 1934.
- WARD, G. E., L. B. LOCKWOOD, O. E. MAY, AND H. T. HERRICK, "Production of fat from glucose by moulds. Cultivation of *Penicillium javanicum* von Beijma in large-scale laboratory apparatus," *Ind. Eng. Chem.*, 27: 318-322, 1935.
- WEHMER, C., "Entstehung und physiologische Bedeutung der Oxalsäure im Stoffwechsel einiger Pilze," *Botan. Z.*, 49: 233-238, 1891.
- "Über oxalsäure Bildung durch Pilze," *Ber. deut. chem. Ges.*, 25: 647-648, 1892.
- "Über Fumarsäure-gärung des Zuckers," *Ber. deut. chem. Ges.*, 51: 1663-1668, 1918.
- "Abnahme des Säuerungsvermögens und Änderung der Säure bei einem Pilze," *Biochem. Z.*, 197: 418-432, 1928.
- WHITE, MOLLIE G., AND J. J. WILLAMAN, "Biochemistry of plant diseases. X. Fermentation of pentoses by *Fusarium lini*," *Biochem. J.*, 22: 583-591, 1928.
- WILKINS, W. H., AND G. C. M. HARRIS, "Investigation into the production of bacteriostatic substances by fungi. I. Preliminary examination of 100 fungal species," *Brit. J. Expt. Path.*, 23: 166-169, 1942.

- WILKINS, W. H., AND G. C. M. HARRIS, "Investigation into the production of bacteriostatic substances by fungi. III. Preliminary examination of a second 100 fungal species," *Brit. J. Expt. Path.*, 24: 141-143, 1943.
- V. "Preliminary examination of the third 100 fungi, with special reference to strain variation among species of *Aspergillus*," *Trans. Brit. Mycol. Soc.*, 27: 113-118, 1945.
- YULL, J. L., "Alcoholic fermentation by *Aspergillus flavus* Brefeld," *Biochem. J.*, 22: 1504-1507, 1928.

Chapter 5

EFFECTS OF TEMPERATURE ON FUNGI

Temperature is one of the most important environmental factors affecting the metabolic activities of fungi. Since this fact is generally appreciated, many workers have concerned themselves with problems involving the influence of temperature upon selected species of fungi. These studies have dealt with temperature as a factor in spore germination, mycelial growth, and reproduction of the chosen organisms; with determinations of their cardinal temperatures, temperature coefficients, and lethal temperatures; with attempts to correlate temperatures that are favorable or inhibitory to infection and the subsequent development of disease or decay with those that are favorable or inhibitory to the growth of the pathogens; and with attempts to establish a rational basis to account for the geographical distribution and seasonal incidence of fungi. In the aggregate the reports of these studies contain a large volume of data together with varied interpretations of them. In the account that follows an attempt has been made to select from these numerous reports representative materials that will aid in evaluating the effects of temperature on fungi.

It does not seem to be possible completely to isolate temperature as an environmental factor in studies with fungi. Such non-temperature factors as relative humidity, rate of accumulation and concentration of staling products and other by-products, character of the substrate, initial reaction and rate of change of reaction of the medium, and aeration of the medium, as well as factors internal to the fungus, such as strain differences and age of the mycelium, exert an influence, whether the fungus is being grown on artificial media or on the natural substrate.

Furthermore in experimental conditions temperatures are either maintained continuously or else fluctuate to only a small degree, whereas in nature they vary continually. Whether all metabolic activities can be maintained at a constant optimal level over indefi-

nite periods or whether one activity is favored by a given temperature whereas another is adversely affected by the same temperature is none too well known at present. The investigator is led to suspect, however, that physiologic unbalance results if temperatures are maintained, because at a constant level a single temperature may not necessarily be optimum for the germination, the mycelial development, and the reproduction of all species.

The duration of exposure of a fungus to a given temperature should also be taken into consideration. This factor becomes important in a study of the rate of growth, which varies within the culture period, there being a lag at the initiation of growth, followed by a period of acceleration and eventually terminated by a period of deceleration. These facts are expressed in the well-known sigmoid growth curve, characteristic of all organisms.

Another difficulty that presents itself, as has been indicated in Chapter 1, is the inadequacy of methods for measuring growth. In nearly all reports use is made of the diameter of colonies or of the amount of surface area of colonies, when as a matter of fact growth is three-dimensional. These two criteria are of value in comparing the growth of an organism at different constant temperatures on the same medium, but they largely lose their value when a comparison is made of the same or different organisms grown on different media. In studying the rate of growth of *Verticillium albo-atrum*, Chaudhuri (1923) was led to conclude that the "rate of spread" on different media may be associated with extremely different rates of mycelial production.

CARDINAL TEMPERATURES

Each fungus may be presumed to possess a minimum, an optimum, and a maximum temperature. The minimum and the maximum limit growth at low and high temperatures, respectively. These values are difficult to fix absolutely and usually are only closely approximated. The optimum temperature is that which permits greatest metabolic activity; it is usually based upon measurement of the greatest increment of growth during some definite time interval. Respiratory activity and mycelial extension, however, may be correlated with one optimum, whereas, as has been indicated and will be discussed subsequently, conidial production may occur at a different optimum. Observations by

Fawcett (1921) indicate that the optimum cannot be considered apart from the time factor.

The temperature range within which fungi are active is rather limited in comparison to that of bacteria. At 0° C their growth is completely checked, and relatively few are active at 42° C. The optimum temperature is not median in any instance between the minimum and the maximum temperatures. In other words, temperature does not increase the rate of fungus activity uniformly from the minimum to the optimum, and decrease it uniformly from the optimum to the maximum.

In connection with the rate of reaction (physiological processes) in fungi, the generalized rule of van't Hoff, which states that for every rise of 10° C the reaction rate is doubled or trebled, holds true, within the range approximating 10° C to 30° C. At high temperatures, however, as Blackman (1905) has indicated, this rule is modified by a time factor, for ". . . when the process is conditioned as to its rapidity by a number of separate factors, the rate of the process is limited by the pace of the 'slowest factor.'" Such controlling factors are sometimes spoken of as "pace-makers." Their influence is universally demonstrated in graphs showing cardinal temperatures in all fungi studied. The growth curve is observed to decline sharply and precipitously from the optimum to the maximum. In Table 8 are assembled the cardinal temperatures for a few representative species grown on semisolid media.

The most extensive study to date involving temperature in relation to the growth of fungi capable of producing decay of wood is that of Cartwright and Findlay (1934). They measured the diameter of colonies grown on 2% malt agar, using the average daily increment of growth of five colonies as an index. Their observations are summarized in Table 9.

From these data it is apparent, first of all, that the temperature requirements of species within the families Thelephoraceae, Polyporaceae, and Agaricaceae are variable between species, even within the same genus.

Cartwright and Findlay (1934) indicate that comparative growth rates on malt agar may not necessarily indicate the growth rates on timber in the forest. *Stereum purpureum*, for example, grows rapidly on malt agar but slowly on wood. Nevertheless a given wood-destroying species, such as *S. frustulosum* on oak,

TABLE 8

CARDINAL TEMPERATURES OF VARIOUS FUNGI

Fungus	Source of Data	Temperatures (degrees C)		
		Mini- mum	Opti- mum	Maxi- mum
<i>Fusarium coeruleum</i>	Edson and Shapovalov (1920)	5	25	35
<i>Fusarium eumartii</i>	Edson and Shapovalov (1920)	5	25	35
<i>Fusarium discolor</i> var. <i>sulphureum</i>	Edson and Shapovalov (1920)	5	25	35
<i>Fusarium oxysporum</i>	Edson and Shapovalov (1920)	5	30	
<i>Fusarium radicum</i>	Edson and Shapovalov (1920)	5	30	
<i>Fusarium trichothecioides</i>	Edson and Shapovalov (1920)	5	25	35
<i>Verticillium albo-atrum</i>	Edson and Shapovalov (1920)	5	25	35
<i>Verticillium albo-atrum</i>	Chaudhuri (1923)	10	22.5	30
<i>Rhizoctonia solani</i>	Lauritzen (1929)	2	23	34.5
<i>Merulius silvestris</i>	Falck (1907)	3	25	30
<i>Merulius domesticus</i>	Falck (1907)	3	22	30
<i>Merulius sclerotiorum</i>	Falck (1907)	3	25	30
<i>Polyporus vaporarius spumarius</i>	Falck (1907)	3	25	30
<i>Verpa bohemica</i>	Falck (1907)	3	22	30
<i>Lenzites saepiaria</i>	Lindgren (1933)	5	32-35	45
<i>Polyporus versicolor</i>	Lindgren (1933)	0	27-32	40
<i>Lenzites tigrinus</i>	Lindgren (1933)	7	32-35	43
<i>Gloeosporium musarum</i>	Edgerton (1915)		29-30	37.5
<i>Glomerella cingulata</i>	Edgerton (1915)		27-29	37.5
<i>Glomerella gossypii</i>	Edgerton (1915)		27-29	37.5
<i>Gloeosporium fructigenum</i>	Edgerton (1915)		24-25	34-35
<i>Colletotrichum lagenarium</i>	Edgerton (1915)		24	35
<i>Colletotrichum lindemuthianum</i>	Edgerton (1915)		21-23	30-31
<i>Magnusia nitida</i>	Sweet (1941)	5	32	43
<i>Magnusia brachytrichia</i>	Sweet (1941)	5	32	43
<i>Pythiacystis citrophthora</i>	Fawcett (1921)	8.7	26.5	31.9
<i>Phytophthora terrestris</i>	Fawcett (1921)	12.0	31.5	36.1
<i>Phomopsis citri</i>	Fawcett (1921)	9.1	27.0	31.4
<i>Diplodia natalensis</i>	Fawcett (1921)	8.4	28.0	36.0
<i>Ceratostomella pilifera</i>	Lindgren (1942)	4	28-29	34-35
<i>Ceratostomella coerulea</i>	Lindgren (1942)	3	25-27	32-34
<i>Ceratostomella pluriannulata</i>	Lindgren (1942)	4	28-29	34-35
<i>Ceratostomella ips</i>	Lindgren (1942)	6-8	30-32	37-39

TABLE 9
 AVERAGE DAILY GROWTH OF DIAMETER (IN MILLIMETERS) OF COLONIES OF WOOD-ROTTING FUNGI GROWN ON MALT AGAR AT VARIOUS TEMPERATURES

Organism	Temperature (degrees C) and Diameter of Colonies																						
	3	5	8	9	10	14	15	16	17	20	23	24	25	27	30	33	34	35	37	38	40	41	
<i>Stereum frustulosum</i>					0.6		1.1			2.0	2.8		3.2	2.9	2.1			1.2					
<i>Stereum hirsutum</i>	1.2	4.0					12.5		16.5				19.9	19.5	14.9	6.3		0.8					
<i>Stereum purpureum</i>	0.5	4.3					11.0		14.8				20.6	22.3	17.5	2.0		0.45					
<i>Stereum rugosum</i>					5.2	7.1			12.6	11.6			10.3	6.9	1.5			0					
<i>Stereum spadicium</i>		0.5			3.1	5.7			8.4	10.2			11.4	9.0	2.9			0					
<i>Contiophora cerebella</i>			1.5			4.3			8.6	10.4			10.0	7.8	2.9			0					
<i>Merulius lacrymans</i>			1.5		2.2	5.4			6.9	7.9			1.5	0	0								
<i>Merulius silvestris</i>					1.8	4.9			6.7	6.9			6.1	5.8	4.2			1.0					

may completely invade the wood to the exclusion of all other Thelephoraceae and Polyporaceae. Conceivably the temperature differential may be an important factor when two or more species are competing for occupancy of a given piece of wood, but it may not necessarily constitute the controlling factor.

Another inference from the data of Cartwright and Findlay (1934) involves temperature as an ecological factor affecting the geographical distribution of fungi. It is well known that certain species, just as is true also of seed plants, are quite sharply restricted in their natural habitat to Arctic regions, to temperate regions, or to the tropics. In pathogens this distribution might be anticipated to be coextensive with that of the susceptibles and therefore not necessarily governed primarily by temperature. In saprophytic species, temperature might not be expected to be as potent a factor as the kind of substrate, and saprophytes might be anticipated to be cosmopolitan in distribution. Nevertheless, many saprophytes are restricted in distribution, but evidence indicates that with them temperature is a major factor. This conclusion finds support in Weimer and Harter's (1923) studies on the temperature relations among species of *Rhizopus*. They found that *R. chinensis* is distinctly more tolerant of high temperature than any of the other ten species tested.

Humphrey and Siggers (1933) made an extensive study of temperatures favorable to the growth of wood-rotting fungi in culture, and on this basis were able to arrange them into three groups: (1) a low-temperature group (20° to 24° C), (2) an intermediate-temperature group (24° to 32° C), and (3) a high-temperature group (above 32° C).

In the first group are included *Coniophora cerebella*, *Stereum gausapatum*, *Merulius lacrymans*, *Phlebia merismoides*, *Polyporus abietinus*, *P. schweinitzii*, *Fomes annosus*, *F. officinalis*, *F. nigroligneatus*, *Trametes pini*, and *Collybia velutipes*. In the second group Humphrey and Siggers placed *Merulius silvestris*, *M. tremellosus*, *Corticium chrysocreas*, *C. effuscatum*, *Peniophora gigantea*, *Stereum frustulosum*, *S. fasciatum*, *S. rameale*, *Poria incrassata*, *P. subacida*, *P. xantha*, *Polyporus radiatus*, *P. robinophilus*, *P. sinuosus*, *P. sulphureus*, *P. versicolor*, *Daedalea ambigua*, *D. quercina*, *D. unicolor*, *Trametes serialis*, *Fomes everhartii*, *F. ignarius*, *F. marmoratus*, *F. pinicola*, *F. rimosus*, *F. subroseus*, *Ganoderma applanatum*, *Lenzites berkeleyi*, *Irpex mollis*, *Hydnum ochraceum*,

H. pulcherrimum, *Lentinus lepideus*, *Schizophyllum commune*, and *Pleurotus ostreatus*. The third group comprises *Phlebia strigosazonata*, *Stereum fuscum*, *Polyporus hirsutus*, *Ganoderma lucidum*, *Lenzites saepiaria*, *L. trabea*, and *Panus rudis*.

Studies to date on the temperature relations of wood-destroying fungi have involved their growth on artificial media rather than on wood [Herrick (1939)]. It is conceivable that there may be little, if any, correlation of growth rates on such different substrates. Lindgren (1933) indicated that two reasons may be assigned for a lack of correlation: (1) the chemical and physical differences between nutrient agar and wood; and (2) the time factor, cultivation on agar being confined to periods of short duration and on wood in nature to long periods. These reasons appear to be sufficient to render unreliable any predictions of the rate of decay of timber on the basis of the rate of growth on agar of the causal fungus.

RESISTANCE TO LOW TEMPERATURES AND HIGH TEMPERATURES

Experiments to determine the ability of fungi to survive when subjected to temperatures in excess of those known to inhibit growth and reproduction are meager. The results of these experiments, however, show that fungi are much more tolerant of low than of high temperatures. Evidently, as the temperature is elevated above the maximum for growth, desiccation and coagulation of proteins occur, and these reactions become the proximate cause of death. At low temperatures, on the other hand, these profound changes in proteins may not be accomplished, and other explanations are needed to account for the death of the fungus.

LOW TEMPERATURES. The temperatures employed in ordinary refrigeration and cold storage are very effective in inhibiting the growth of such fungi as those causing decay of meats, fruits, vegetables, and other foodstuffs.

Lauritzen (1929) found that a storage temperature of less than 2° C is required to prevent decay of turnips, induced by *Rhizoctonia solani*. At a maintained temperature of 8° to 10° C this fungus caused 62 to 87% decay within a period of 2 years.

Brooks and Cooley (1917) stored apples inoculated with various decay-producing fungi at 0° C with the result that the rots

developed. The organisms involved included *Alternaria* sp., *Botrytis cinerea*, *Cephalothecium roseum*, *Neofabrea malicorticis*, *Penicillium expansum*, *Sclerotinia cinerea*, *Sphaeropsis malorum*.

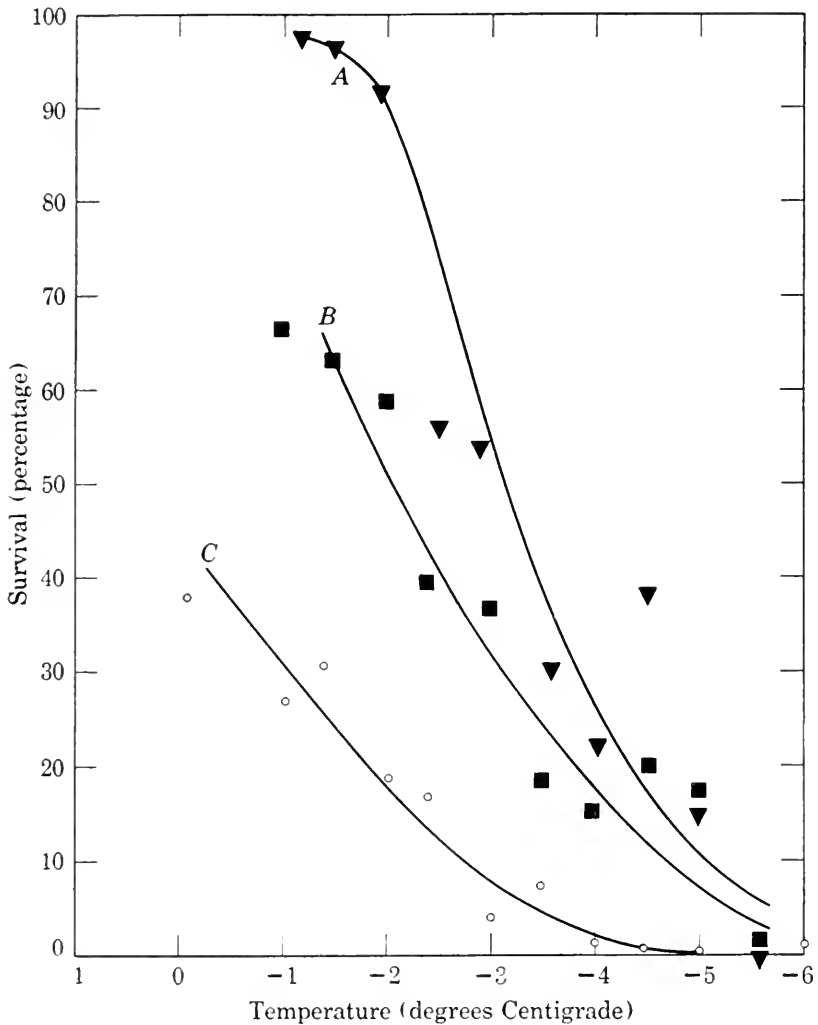

FIG. 4. Effect of cold upon survival of *Aethalium septicum*. A. Slow cooling, followed by exposure for 10 minutes at the given temperatures. B. Rapid cooling, followed by exposure for 5 seconds. C. Rapid cooling, followed by exposure for 10 minutes. (After Gehenio and Luyet.)

and *Volutella fructi*. Storage at 10° C inhibited *Glomerella cinzulata*; at 15° C, *Fusarium radiculicola*. These results support the observations of Schneider-Orelli (1912), who grew on gelatin the following species at maintained temperatures of 0° C, 4.5° C, and 9.5° C: *Botrytis cinerea*, *Fusarium putrefaciens*, *Gloeosporium album*, *G. herbarum*, *Monilia fructigena*, *Mucor piriformis*, and

Penicillium glaucum. Neither *Gloeosporium fructigenum* nor *Rhizopus nigricans*, however, grew at 0°C , although meager colonies of these organisms developed at 4.5°C . Since so many decay-inducing fungi are able to grow at or near 0°C , it is essential that subzero conditions be provided for many readily perishable foods that must be kept for months before they normally reach the consumer. Consequently storage in dry ice has been employed effectively to meet these conditions.

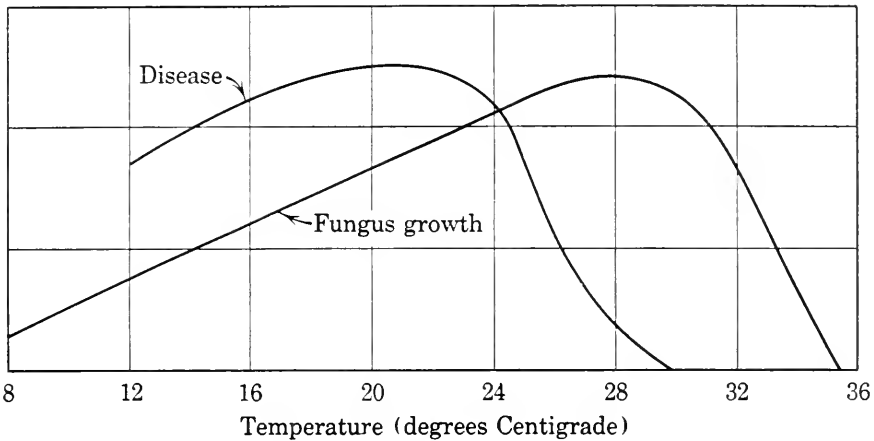

FIG. 5. Comparison under controlled conditions of temperatures favorable for the development of tobacco-root rot with those favorable for the growth of the causal fungus. Tobacco-root rot develops best at temperatures below those optimum for the pathogen. (After Jones.)

Numerous species of fungi are able to survive subzero weather, as their going into dormancy in fall and their reappearance in spring indicate. The cold of winter may decimate the fungus population, but it does not cause the extinction within a given area of any considerable number of species.

Buller and Cameron (1913) exposed the fructifications of *Schizophyllum commune* for several winter months to temperatures that ranged between -15°C and -40°C . After the fructifications had been brought inside for a few hours, they resumed casting their spores. Moreover, when fructifications that were actively discharging spores were quickly frozen at -31°C , they still retained their viability.

Bennett (1931) subjected the vegetative and perithecial stages of *Gibberella saubinetii* to -20°C every third day for 45 days, permitting the temperature at no time to reach zero. Afterwards the

cultures were more vigorous and produced perithecia more abundantly than similar cultures that had been kept at normal temperatures.

The ability of fungi to tolerate extreme cold is illustrated by Buller's (1913) findings with *Schizophyllum commune* and by Faull's (1930) findings with *Neurospora crassa*. Buller exposed the fructifications of *S. commune* to -190° C for 3 weeks without apparent injury, and Faull subjected the ascospores of *N. crassa* to temperatures from -170° to -190° C for 24 to 48 hours without delaying their germination. When wet, the conidia of this species were unimpaired by exposure to -80° C for 1 hour; when dry, to -170° to -190° C for an equal period. Toleration of these extremely low temperatures leads the investigator to anticipate that the spores of certain species will be found to survive at absolute zero (-273° C), the point at which all reactions and hence all biological processes are theoretically supposed to be inhibited, provided, of course, that the period of exposure is not too protracted.

Becquerel (1910) dried the conidia of *Mucor*, *Rhizopus*, *Aspergillus*, and *Sterigmatocystis*, sealed them in tubes under vacuum in which the pressure was reduced to 10^{-4} cm of mercury, and exposed them at -190° C for 77 hours; after 2 years' storage, they germinated normally.

In the experiments of Kadisch (1931) with several dermatophytes, *Achorion gypseum* survived 3 hours' exposure to -252° C in one instance, and in another withstood 2 hours at -268° C, followed by 4 hours at -268.8° C and then $1\frac{1}{2}$ hours at -272° C.

It would be anticipated that mycelia cannot tolerate as extreme temperatures as can spores. Evidence in support of this supposition has been presented by Bartetzko (1910), Lindner (1915), and Lipman (1937). Bartetzko (1910) subjected germinating spores of *Aspergillus*, *Penicillium*, *Botrytis*, and *Phycomyces* in liquid nutrient media to -14° for 2 hours without injury. When the young hyphae of *Aspergillus* in 1% glucose solution were exposed to -12° for 2 hours, they were killed, whereas in 5% glucose solution there was no apparent injury at -26° for an equal period. The other species exhibited similar differences in glucose solutions of different concentrations.

Lindner (1915) exposed *Aspergillus niger* and *Penicillium glaucum*, growing on 3% gelatin, to -10° to -13° C. Age of the

hyphae and duration of exposure were found to be important factors. Twenty-four-hour-old cultures were more easily killed than 48-hour-old cultures. Aerial hyphae were more easily killed than submerged hyphae.

Lipman (1937) employed 12 species of fungi, cultured for 24 hours on synthetic agar or on potato agar. After gradual cooling he immersed them in sealed tubes for 48 hours in liquid air; he then gradually warmed them. Of the 12 species, belonging in *Aspergillus*, *Penicillium*, *Rhizopus*, *Mucor*, *Absidia*, *Mortierella*, *Rhizoctonia*, *Armillaria*, *Trichoderma*, *Pythium*, and *Fusarium*, 8 survived. As an explanation Lipman hypothesizes that this extraordinary tolerance may be causally related to the tiny spaces that exist between the colloidal micelles, which because of their small size prevent dehydration through ice formation.

Not all fungi are capable of tolerating the extremes of temperature which have been mentioned. Gehenio and Luyet (1939) exposed the plasmodium of *Aethalium septicum* so as to study the effect of cold on vitality and the influence of the duration of exposure, as well as to determine whether cold *per se* or the suddenness of the temperature change is responsible for injury. They found, first of all, that there may be marked injury at temperatures of freezing or slightly above if the plasmodia are cooled abruptly, whereas with slow cooling the injury may not be appreciable until the temperature descends to about -2.5°C . They also noted that the plasmodia may be killed after exposure of only 5 seconds to temperatures of -1° or -2°C . This sensitivity to cold finds support in the observations that some tropical species of seed plants are killed if exposed to temperatures above 0°C . In these cases death cannot be attributed to the formation of ice crystals. Here the mechanism of death, as postulated by Gehenio and Luyet, consists of gelation of the protoplasmic sol under the action of cold, the gelation being accompanied by syneresis. The squeezing out of the dispersion medium, if gelation is complete, is not a reversible process and hence is lethal.

The problem of the causes of death by low temperatures in fungi, in other plants, and in animals is summarized in the monograph by Luyet and Gehenio (1940). Their summary indicates that death from cold has been attributed to the following causes: (1) bursting of the cells by expansion in ice formation, with consequent mechanical injury; (2) destruction of the fine structure

of the protoplasm by ice crystals; (3) crushing between the ice masses as freezing progresses; (4) thawing at too rapid a rate; (5) dehydration of protoplasm, resulting in increased permeability, increased viscosity, coagulation of proteins, ionic dissociation, loss of water-binding properties of cytoplasm, and/or synergetic release of water.

HIGH TEMPERATURES. Fungi, it has been pointed out, generally are unable to tolerate exposure to high temperatures. The decline in ability to germinate or to grow is normally very sharp in the zone beyond the optimal.

The lethal effects of temperature on germination of spores is considered in Chapter 9 and therefore need not be discussed here. In many instances such temperatures as inhibit germination and growth or are lethal are not excessive. For example, Wolf *et al.* (1934) found that sporangia of *Peronospora tabacina* exposed to 85° F for 1 hour are incapable of germination.

Fawcett and Barger (1927) observed that oranges kept at 90.5° F, which is above the maximal limit for *Penicillium italicum* and *P. digitatum*, are not decayed during 28 days' exposure. On the other hand, Faull (1930) noted that the ascospores of *Neurospora crassa*, when heated for more than 1 hour at 50° C, retain their ability to grow.

In the fermentation of cigar tobaccos, temperatures of 140° to 150° F are not unusual. *Aspergillus niger*, commonly present on the cured leaves, is unable to develop at these temperatures but may induce spoilage if too much time elapses for the bulk to become hot or to cool after fermentation. Temperatures near 100° F approximate the optimum for this mold.

Treatment with hot water has been employed to free seed oats from loose smut, caused by *Ustilago avenae*, and wheat from naked smut, caused by *U. tritici*. Such treatment is practicable because the temperature lethal for the smut fungi is lower than that which kills the cereal embryos. Similarly, cotton seed, if slowly desiccated, can be rendered free from viable external conidia and internal mycelium of the anthracnose fungus, *Glomerella gossypii*. Lehman (1925) predried cotton seeds at 50° C. for 36 hours or at 60° C for 18 to 24 hours and then heated them to 95° C for 10 to 12 hours, without reducing their percentage germination and with complete elimination of the anthracnose fungus.

In some cases seed disinfection does not require exposure to excessive temperatures. Edgerton (1915) found that 30° to 31° C is maximum for the growth in culture of *Colletotrichum lindemuthianum* and has been able to produce in Louisiana, during summer, anthracnose-free bean seed from a crop planted with infected seed.

INFLUENCE OF TEMPERATURE ON INFECTION

The severity of certain soil-borne diseases, especially those caused by *Fusarium*, *Verticillium*, *Rhizoctonia*, *Sclerotinia*, and *Thielaviopsis*, is known to be correlated with temperature. Data bearing on this matter have been amassed from the use of soil-temperature tanks equipped with thermostatic controls. Plans for the construction and operation of this type of apparatus are described by Jones, Johnson, and Dickson (1926). Their account should be carefully read to obtain an appreciation of the problems relating to the influence of temperature in the development of plant diseases and to the construction and operation of ecostats. These workers conclude that disease is the resultant of the "interaction of the plastic host and a plastic parasite under the play of variable environment." Temperature, as a variable, modifies the metabolic activity not only of the host but also of the parasite, and it may happen that such temperatures as approximate optimum for the one may exercise an adverse influence upon the other.

By means of soil-temperature tanks Gilman (1916) determined that symptoms of cabbage yellows, caused by *Fusarium conglutinans*, are absent at maintained soil temperatures between 12° and 16° C, but that characteristic symptoms appear within the range 17° to 22° C. When this organism is grown in culture, its optimum, indicated by a daily increase in the diameter of colonies, approximates 25° C.

Johnson and Hartman (1919), also using soil-temperature tanks, found that soil temperatures of 17° to 23° C are most favorable for the development of tobacco-root rot. The disease gradually diminished in severity above 26° C and was absent at 29° to 30° C. As they indicate, account must be taken in experimentation of such other factors as soil moisture, soil reaction, supply of nutrients in the soil, and amount of infestation, none of which can be isolated and evaluated completely. The sum total of all these

factors, whether favorable or unfavorable to the development of the disease, determines the severity of the attack.

The destruction of stem tissues of potato and injury to the growing points by *Corticium vagum* are limited within the range 9° to 27° C, [Richards (1921)], with greatest damage between 15° and 21° C. The severity of attack decreases very rapidly above 21° C, and damage is minor at 24° C and above.

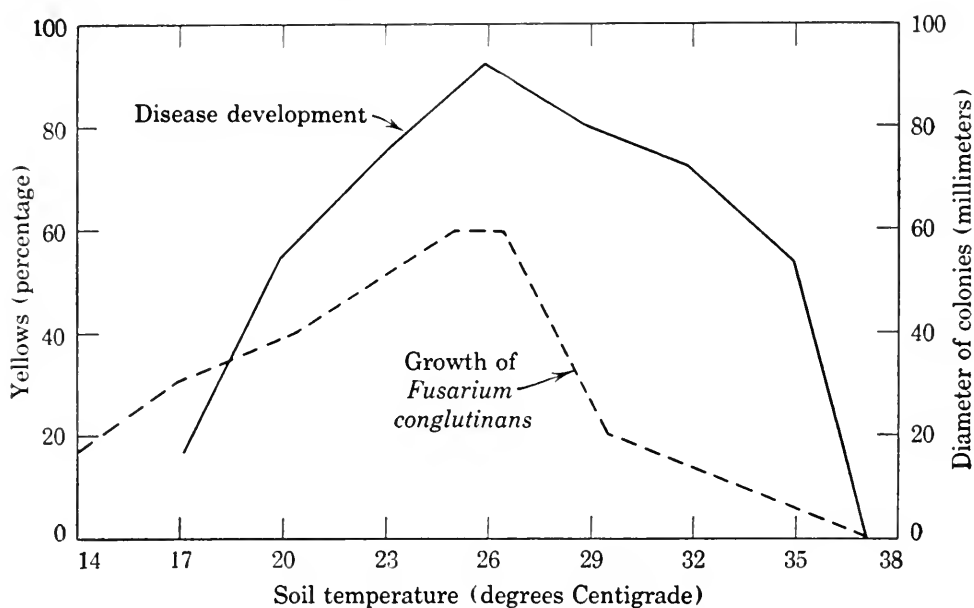

FIG. 6. Relation of the growth rate of *Fusarium conglutinans* and the development of cabbage yellows at various controlled soil temperatures. Both have quite the same optima. (After Jones, Johnson, and Dickson.)

Infection of onions by *Urocystis cepulae* is governed by soil temperature [Walker and Wellman (1926)]. Abundant infection by this smut fungus occurs at temperatures as low as 10° to 12° C, which is about the minimum permitting germination and growth of onions. Temperatures extending up to 25° C favor infection, but above this point the amount of infection is rapidly decreased. At 29° C and above, the onion seedlings remain free from infection.

Observations of the foregoing type afford a basis in accounting for the seasonal incidence of certain plant diseases and for their geographical distribution. Jones (1924) pointed out that onion smut does not occur in southern Texas, although the pathogen has been repeatedly introduced into this region. The soil temper-

ature is above that lethal to the smut fungus during the period when the seedlings are being grown in seed beds and are being transplanted. The prevalence of peach-leaf curl and apple scab is correlated with cold, wet spring weather. Late blight of potatoes is entirely absent, or at least never epiphytotic, in the Coastal Plains area of the southeastern United States if the crop matures in late May or in June, when summer temperatures prevail. The fungus which causes downy mildew of tobacco disappears rather quickly after a few warm days with temperatures in excess of 85° F [Dixon, McLean, and Wolf (1936)]. The observations of Stevens (1917) led him to conclude that temperature is the chief climatic influence in the growth of the chestnut-blight fungus, *Endothia parasitica*. *Sclerotium rolfsii* is limited to warm regions and becomes of importance only during hot weather.

TEMPERATURE AND REPRODUCTION

There is abundant evidence that temperatures favorable for germination or for growth of fungi may be slightly lower than those favorable for reproduction. In some instances mycelial growth occurs at high temperatures that are inhibitory to reproduction. Ames (1915) determined that the spores of *Thielaviopsis paradoxa* germinate at 5° to 6° C, and, although there is slight growth at 10° C, this organism must be provided with temperatures in excess of 10° C to induce fruiting. If the temperature is elevated to 36° C, however, the mycelium develops, but conidia are not produced. Similar differences were noted at both the upper and lower limits for *Glomerella rufomaculans*, which germinates at 4° C, but requires a minimum of 12° C to produce spores. *Penicillium digitatum* is able to germinate and grow at 30° C, but no conidia are formed at this temperature.

Sweet (1941) recorded that the formation of cleistothecia by *Magnusia nitida* and *M. brachytrichia* occurs throughout the range 16° to 38° C, although conidial germination is secured throughout the range 1.5° to 43° C. Production of conidia, however, is limited to the range 10° to 38° C in *M. nitida*, and 16° to 40.5° C in *M. brachytrichia*.

Sporulation by *Peronospora tabacina* occurs within a range of temperature from 42° to 63° F and is most abundant at 56° F

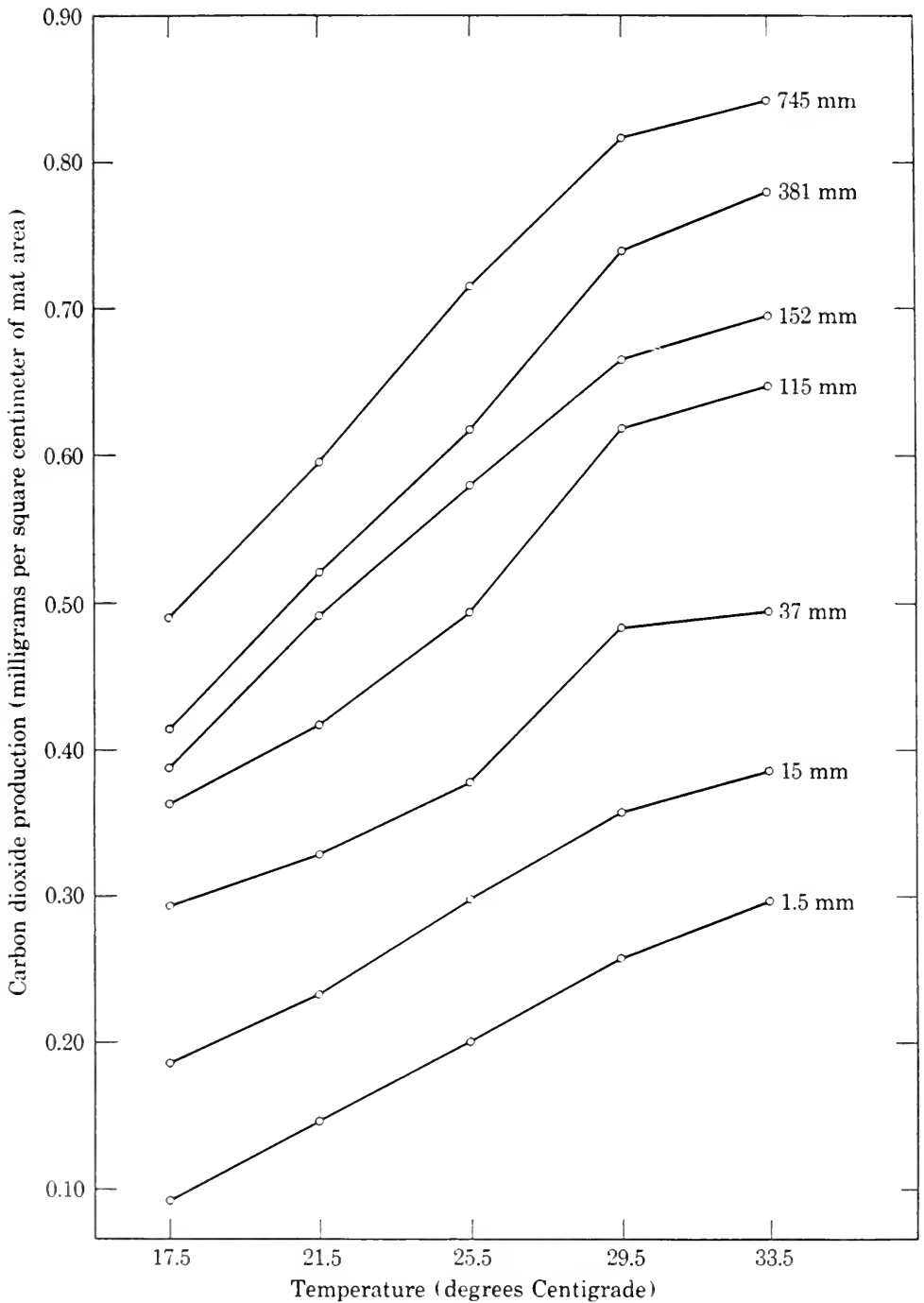

FIG. 7. Relation of CO_2 production per unit weight of mycelial mat to temperature for *Polystictus versicolor*, and of O_2 tension, CO_2 production, and temperature. (After Scheffer and Livingston.)

[Dixon, McLean, and Wolf (1936)]. Mycelial growth, however, may occur at temperatures either below or above this range.

Sawyer (1929) found that a temperature of approximately 21° C is most favorable for growth and reproduction by *Entomoph-*

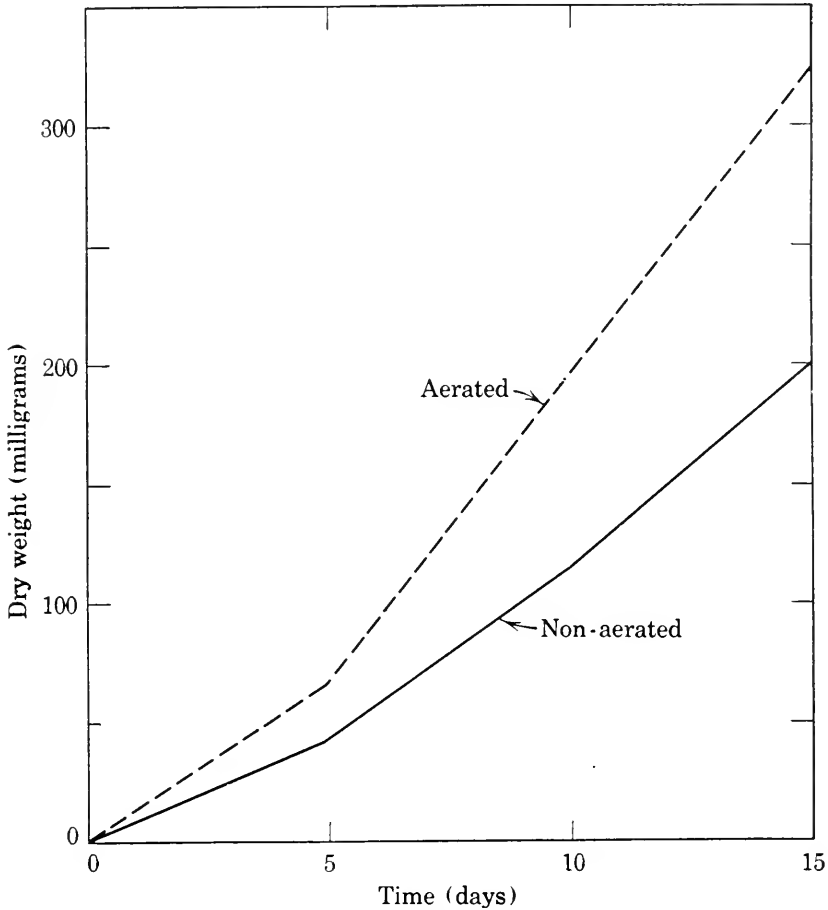

FIG. 8. Effect of aeration of liquid media on the dry weight of mycelial mat produced by *Verticillium albo-atrum*. (After Chaudhuri.)

thora sphaerosperma. Although growth occurs at 12° C, conidia are not formed.

Temperatures within the range 21° to 25° C were observed by Longrée (1939) to be optimum for sporulation of *Sphaerotheca pamosa* var. *rosae*, but mycelial growth occurs well beyond both of these limits. Crosier (1933) reported 21° C as optimum for sporangial production by *Phytophthora infestans*. Krause (1930) concluded that perithecial formation by *Neocosmospora vasinfecta* and *Nectria coccinea* is markedly influenced by temperature. At 7° C *Nectria coccinea* requires 45 days to produce perithecia;

at 22.5° C, 30 days; and at 30° C, 17 days. At 22.5° C *Neocosmospora vasinfecta* requires 45 days; at 28.5° C, 30 days; and at 31.5° C, 17 days. Undoubtedly low temperature is a primary factor in the formation of sporophores by many Thelephoraceae and Polyporaceae, but not all species. This statement is substantiated by the occurrence in North Carolina of fresh sporophores of *Fomes amosus*, *Polyporus abietinus*, *P. sanguineus*, *Stereum lobatum*, and *S. fasciatum* at any time in the interval from October to March.

TEMPERATURE AND ZONATION

Alternation of light and darkness is known to stimulate the production of daily bands of conidia and hence of zonation in various fungi grown in Petri dishes, as described in Chapter 6. Temperature may also play an important role in zonation. Bisby (1925) made the observation that *Fusarium discolor sulphureum*, which forms zones in response to alternating light and darkness, can be induced to form zones in constant darkness provided that temperature is favorable. At a temperature of 16° to 18° C zonation does not occur, even though the cultures are exposed to alternate light and darkness. At 21° C zones can be formed under the stimulus of light, but similar cultures in constant darkness are without zones. At 30° C, however, rings were formed when the cultures were maintained in constant darkness.

TEMPERATURE COEFFICIENTS

By temperature coefficient is meant the ratio of the rate of a given physiological process, for example, respiration, at any given temperature to the rate at which this process proceeds at another temperature. Temperature coefficient is frequently represented by the symbol Q_{10} , meaning that the interval is 10° and that the rate at the given higher temperature is divided by the rate at the temperature 10° lower. Biologists well appreciate the fact that within a range which approximates the minimal and maximal temperature limits for the given organism, the reaction-velocity changes follow van't Hoff's rule. According to this rule, Q_{10} for the physiological process in question should lie between 2 and 3 as a minimum.

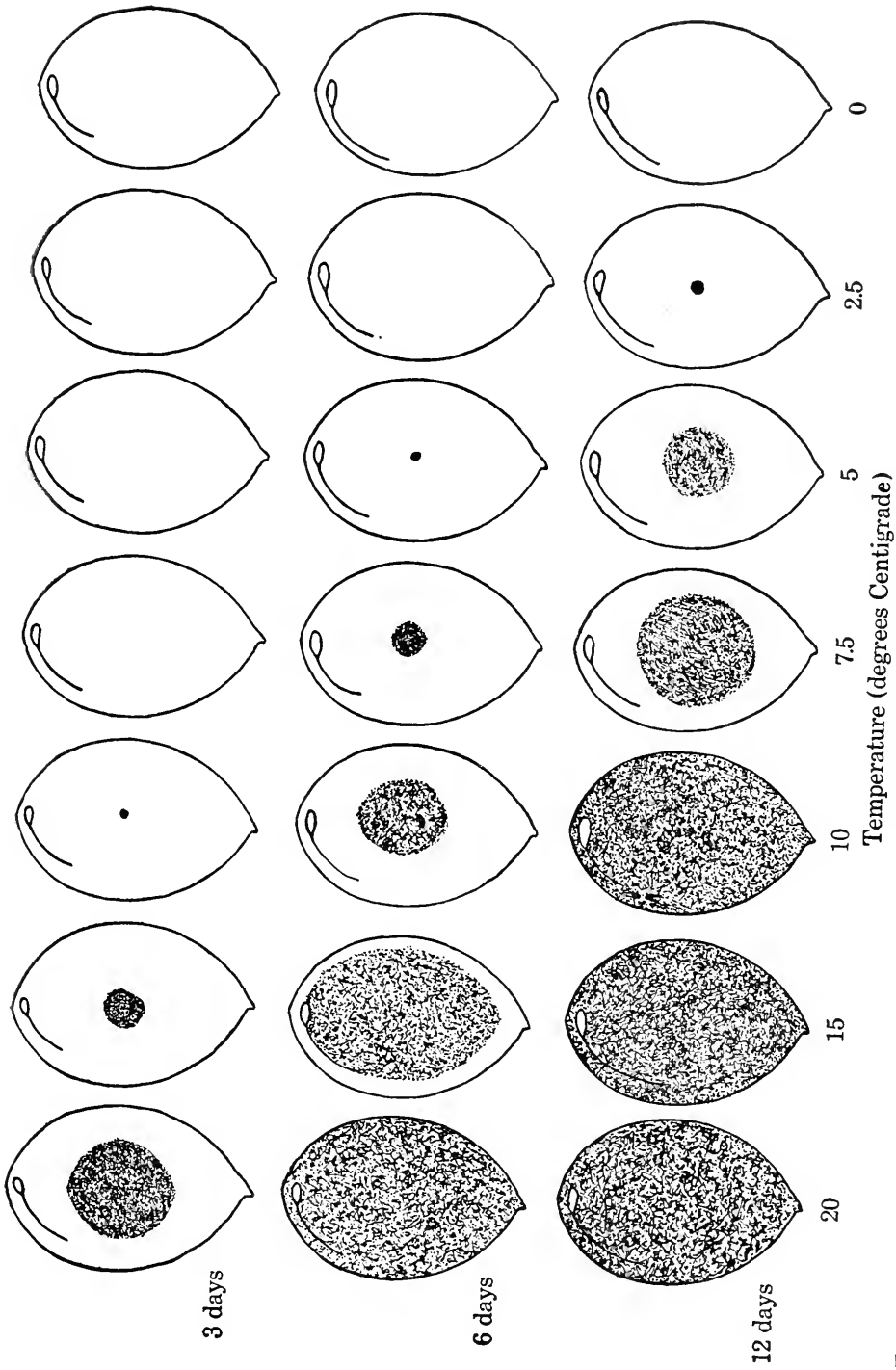

FIG. 9. Graphic representation of the influence of maintained temperature upon the development of brown rot on peaches. The shaded areas indicate decay. (After Brooks and Cooley.)

Temperature coefficients have been abundantly determined and interpreted. Fawcett (1921) measured the growth-temperature coefficients of *Pythiacystis citrophthora* and *Phytophthora terrestris* within the range 8° to 36° C, of *Phomopsis citri* within the range 8° to 32° C, and of *Diplodia natalensis* within the range 8° to 45° C. He found that for each 24-hour observation period, the

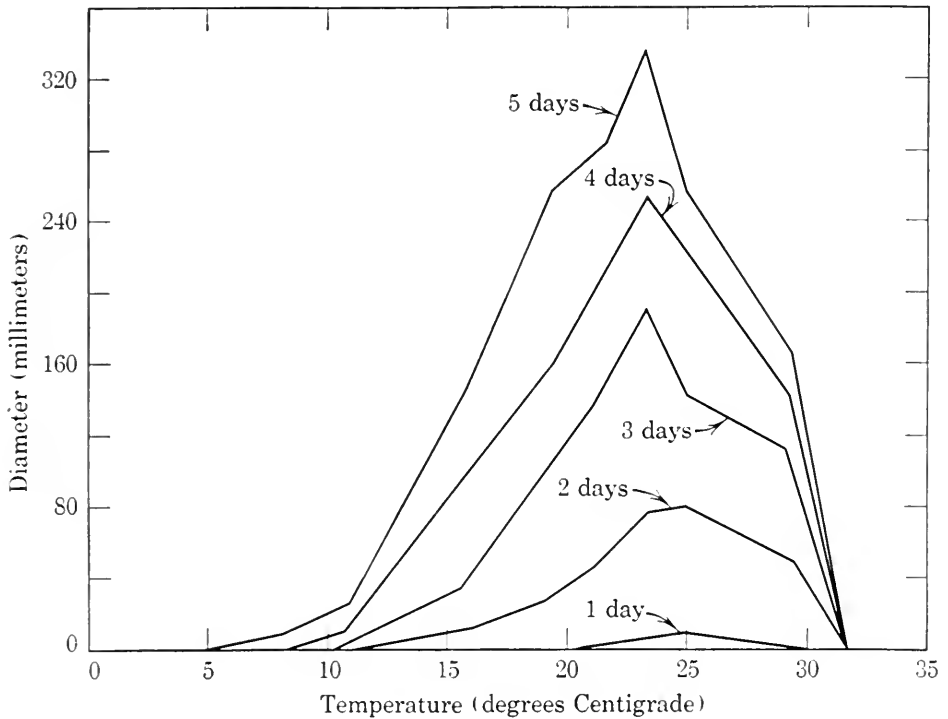

FIG. 10. The extent of decay, measured in terms of diameter of lesions, induced in turnips by *Rhizoctonia solani* at various maintained temperatures. (After Lauritzen.)

Q_{10} for mycelial growth is greatest for the lowest temperature shown and becomes smallest for the highest temperatures. At 8° to 18° C *Phytophthora terrestris* showed a coefficient of 30, and at 26° to 36° C a coefficient of 0.47. For the 8° to 18° C range the Q_{10} of *Phomopsis citri* was 4.0; for the 21° to 31° C range, 0.5. Within the range investigated, the coefficient of *Pythiacystis citrophthora* was 12.3 for the lowest temperature and 0.05 for the highest; that of *Diplodia natalensis* was 16.7 for the lowest temperature and 0.05 for the highest.

Scheffer (1936) determined the rate of carbon dioxide production by *Polystictus versicolor*. He found that production was

greater as temperature was increased, and at 29.5° C was critical. The loss of carbon (as CO₂) was least within the range 25.5° to 29.5° C; it was relatively great at 17.5° and at 33.5° C. Moreover the rate of CO₂ production per unit of mycelial area and the rate of growth were quite alike within the range 17.5° to 29.5° C.

TEMPERATURE AND OXYGEN TENSION

In the light of findings that the respiratory quotient is highest at the lowest temperatures and, conversely, lowest at the highest temperature, it would be expected that oxygen tension would also modify physiological processes. Evidence of such modifying effect has been presented by Scheffer and Livingston (1937). They grew *Polystictus versicolor* on malt agar in special tubes, by means of which they could modify the oxygen tensions and then keep them at constant levels. At the same time they maintained constant temperatures by means of thermostatically controlled incubators. By these procedures they found that CO₂ production per unit area of mycelial mat was always most rapid as O₂ pressure became greater. At 33.5° C with 745-mm pressure of O₂, CO₂ production was most rapid; it was least rapid at 17.5° C with zero O₂ pressure. Mycelial growth, however, was most rapid at the optimum temperature for *P. versicolor*, that is, at 29.5° C, at all O₂ pressures from 16 mm to 745 mm. When CO₂ production in atmospheres of pure O₂ was compared with that in pure N₂, Scheffer and Livingston noted that the rate per unit of mycelial area was two to five times as rapid in oxygen as in nitrogen.

The availability of O₂ is known to operate in another manner, as has been demonstrated by Chaudhuri (1923). He aerated liquid nutrient media on which *Verticillium albo-atrum* was being grown at different temperatures, employing rate of spread as a measure of yield of fungus material. His data show that aeration markedly increases both the rate of growth and the total amount of growth in a given volume of liquid media. Since *V. albo-atrum* is known to produce staling products, Chaudhuri postulates that these increases are to be attributed to the oxidation of waste products.

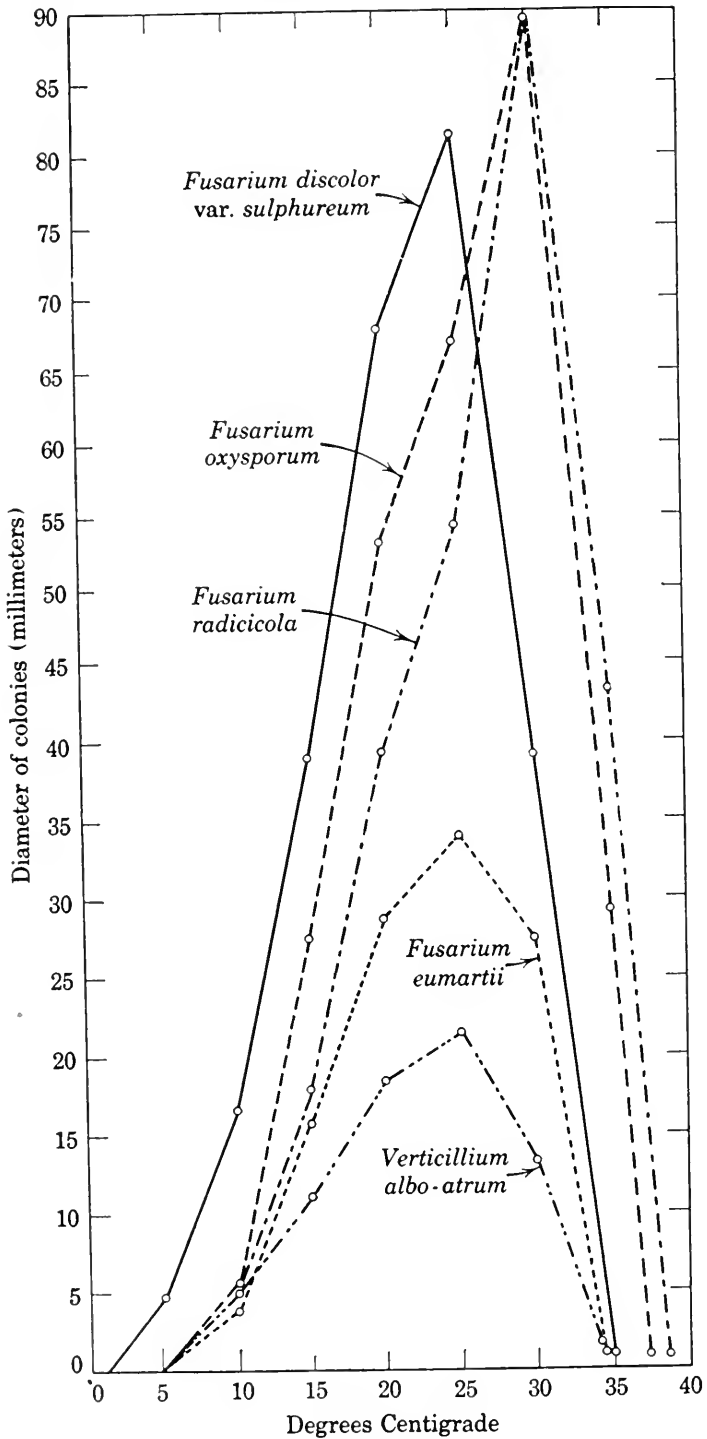

FIG. 11. The growth, measured in terms of diameter of colonies, of soil-inhabiting pathogens as influenced by temperature. *Verticillium albo-atrum* has the slowest growth rate; 25° C is the optimum temperature. (After Edson and Shapovalov.)

IMPLICATIONS

Experiments involving the maintenance of fungi in culture at a given constant temperature for considerable periods have a limited usefulness. This conclusion finds support in the fact that in nature fungi do not encounter constant temperature. Experiments with controlled temperature have demonstrated, it appears, that optimal temperature requirements exist for each metabolic activity of a given fungus and for each phase in its developmental cycle. It is desirable therefore that a much larger body of data showing these facts be accumulated, for from such experiments would certainly come increased understanding of temperature as an environmental factor in fungus activities.

Some persons are inclined to make light of the popular idea that "diseases are caused by weather." Indeed, such persons may with fairness be accused of overemphasizing the "germ theory." They are content to stress the primary cause of disease and to overlook secondary or attendant causes. Since temperature is one of the components of weather, it cannot be ignored in its influence, among pathogenic fungi, upon such sequential phenomena as spore dispersal, spore germination, incubation and severity of the resultant disease, and, finally, the development of reproductive elements by the pathogen.

LITERATURE CITED

- AMES, A., "The temperature relations of some fungi causing storage rots," *Phytopathology*, 5: 11-19, 1915.
- BARTETZKO, H., "Untersuchungen über das Erfrieren von Schimmelpilzen," *Jahrb. wiss. Botan.*, 47: 57-98, 1910.
- BECQUEREL, P., "Recherches experimentales sur la vie latente des spores des Mucorinées et des Ascomycètes," *Comp. rend.*, 150: 1437-1439, 1910.
- BENNETT, F. T., "*Gibberella saubinettii* (Mont.) Sacc. on British cereals. II. Physiological and pathological studies," *Ann. Applied Biol.*, 18: 158-177, 1931.
- BISBY, G. R., "Zonation in cultures of *Fusarium discolor sulphureum*," *Mycol.*, 17: 89-97, 1925.
- BLACKMAN, F. F., "Optima and limiting factors," *Ann. Botany*, 19: 281-295, 1905.
- BROOKS, CHARLES, AND J. S. COOLEY, "Temperature relations of apple-rot fungi," *J. Agr. Research*, 8: 139-164, 1917.

- BROOKS, CHARLES, AND J. S. COOLEY, "Temperature relations of stone-fruit fungi," *J. Agr. Research*, 22: 451-465, 1922.
- "Time-temperature relations in different types of peach-rot infection," *J. Agr. Research*, 37: 507-543, 1928.
- BULLER, A. H. R., "Upon the retention of vitality by dried fruit bodies of certain Hymenomycetes, including an account of an experiment with liquid air," *Trans. Brit. Mycol. Soc.*, 4: 106-112, 1913.
- BULLER, A. H. R., AND A. T. CAMERON, "On the temporary suspension of vitality in the fruit bodies of certain Hymenomycetes," *Proc. Trans. Roy. Soc. Canada*, 6: 73-78, 1913.
- CARTWRIGHT, K. ST. G., AND W. P. K. FINDLAY, "Studies in the physiology of wood-destroying fungi. II. Temperature and the rate of growth," *Ann. Botany*, 48: 481-495, 1934.
- CHAUDHURI, H., "A study of the growth in culture of *Verticillium albo-atrum* B. and Br.," *Ann. Botany*, 37: 519-539, 1923.
- CROSIER, WILLARD, "Studies in the biology of *Phytophthora infestans* (Mont.) de Bary," *Cornell Agr. Expt. Sta. Mem.*, 155: 40 pp. 1933.
- DICKSON, J. G., "Influence of soil temperature and moisture on the development of the seedling blight of wheat and corn caused by *Gibberella saubinetii*," *J. Agr. Research*, 23: 830-870, 1923.
- DIXON, L. F., RUTH A. MCLEAN, AND F. A. WOLF, "Relation of climatological conditions to tobacco downy mildew," *Phytopathology*, 26: 735-759, 1936.
- EDGERTON, C. W., "Effect of temperature on *Glomerella*," *Phytopathology*, 5: 247-259, 1915.
- EDSON, H. A., AND M. SHAPOVALOV, "Temperature relations of certain potato-rot and wilt-producing fungi," *J. Agr. Research*, 18: 511-524, 1920.
- FALCK, R., "Wachstumsgesetze, Wachstumsfaktoren, und Temperaturwerte der holzzerstörenden Mycelien," *Möller's Hausschwammforschungen*, Hefte 1: 53-152, 1907.
- FAULL, J. H., "On the resistance of *Neurospora crassa*," *Mycol.*, 22: 288-303, 1930.
- FAWCETT, H. S., "The temperature relations of growth in certain parasitic fungi," *Univ. Calif. Pub. Agr. Sci.*, 4: 183-232, 1921.
- FAWCETT, H. S., AND W. R. BARGER, "Relation of temperature to growth of *Penicillium italicum* and *P. digitatum* and to citrus-fruit decay produced by these fungi," *J. Agr. Research*, 35: 925-931, 1927.
- GEHENIO, P. M., AND B. F. LUYET, "A study of the mechanism of death in the plasmodium of Myxomycetes," *Biodynamica*, no. 55: 1-22, 1939.
- GILMAN, J. C., "Cabbage yellows and the relation of temperature to its occurrence," *Ann. Mo. Botan. Garden*, 3: 25-82, 1916.
- HERRICK, J. A., "The growth of *Stereum gausapatium* Fries in relation to temperature and acidity," *Ohio J. Sci.*, 39: 254-258, 1939.
- HUMPHREY, C. J., AND P. V. SIGGERS, "Temperature relations of wood-destroying fungi," *J. Agr. Research*, 47: 997-1008, 1933.
- JOHNSON, JAMES, AND R. E. HARTMAN, "Influence of soil environment on the root rot of tobacco," *J. Agr. Research*, 17: 41-86, 1919.

- JONES, L. R., "The relation of environment to disease in plants," *Am. J. Botany*, 11: 605-609, 1924.
- JONES, L. R., JAMES JOHNSON, AND J. G. DICKSON, "Wisconsin studies upon the relation of soil temperature to plant disease," *Wis. Agr. Expt. Sta. Bull.*, 71: 144 pp. 1926.
- KADISCH, E., "Beiträge zur Wirkung der Kalte auf pathogene Fadenpilze, Hefen, und Bakterien. Ausdehnung dieser Versuche bis in die Nahe des absoluten Nullpunktes (bis -272° C)," *Med. Klin.*, 27th year: 1074-1078, 1109-1112, 1931.
- KRAUSE, A. W., "Untersuchungen über den Einfluss der Ernährung, Belichtung, und Temperatur auf die Peritheciengproduktion einiger Hypocreaceen. Beitrag zur Kulturmethodik einiger parasitischer und saprophytischer Pilze," *Z. Parasitenk.*, 2: 419-476, 1930.
- LAURITZEN, J. I., "Rhizoctonia rot of turnips in storage," *J. Agr. Research*, 38: 93-108, 1929.
- LEHMAN, S. G., "Studies on treatment of cotton seed," *N. C. Agr. Expt. Sta. Tech. Bull.*, 26: 71 pp. 1925.
- LINDGREN, R. M., "Decay of wood and growth of some Hymenomycetes as affected by temperature," *Phytopathology*, 23: 73-81, 1933.
- "Temperature, moisture, and penetration studies of wood-staining *Ceratomyces* in relation to their control," *U. S. Dept. Agr. Tech. Bull.*, 807: 35 pp. 1942.
- LINDNER, J., "Über den Einfluss günstiger Temperaturen auf gefrorene Schimmelpilze. Zur Kenntnis der Kaltresistenz von *Aspergillus niger*," *Jahrb. wiss. Botan.*, 55: 1-52, 1915.
- LIPMAN, C. B., "Tolerance of liquid air temperatures by spore-free and very young cultures of fungi and bacteria growing on agar media," *Bull. Torrey Botan. Club*, 64: 537-546, 1937.
- LONGRÉE, K., "The effect of temperature and relative humidity on the powdery mildew of roses," *Cornell Agr. Expt. Sta. Mem.*, 223: 43 pp. 1939.
- LUYET, B. F., AND P. M. GEHENIO, *Life and death at low temperatures*. 341 pp. Biodynamica, Normandy, Mo. 1940.
- RICHARDS, B. L., "Pathogenicity of *Corticium vagum* on the potato as affected by soil temperatures," *J. Agr. Research*, 21: 459-482, 1921.
- SAWYER, W. H., "Observations on some entomogenous members of the Entomophthoraceae in artificial culture," *Am. J. Botany*, 16: 87-121, 1929.
- SCHEFFER, T. C., "Relation of temperature and time to carbon dioxide production and growth in continuously aerated malt-agar cultures of *Polystrictus versicolor*," *Plant Physiol.*, 11: 535-564, 1936.
- SCHEFFER, T. C., AND B. E. LIVINGSTON, "Relation of oxygen pressure and temperature to growth and carbon dioxide production in the fungus *Polystrictus versicolor*," *Am. J. Botany*, 24: 109-119, 1937.
- SCHNEIDER-ORELLI, OTTO, "Versuche über die Wachstumbedingungen und Verbreitung der Faulnispilze des Lagerobstes," *Zentr. Bakt., Parasitenk.*, II Abt., 32: 161-169, 1912.

- STEVENS, N. E., "The influence of temperature on the growth of *Endothia parasitica*," *Am. J. Botany*, 4: 112-118, 1917.
- SWEET, H. R., "Studies on the biology of two species of *Magnusia*. I. Effect of temperature on germination of spores and on growth and reproduction," *Am. J. Botany*, 28: 150-161, 1941.
- WALKER, J. C., AND F. L. WELLMAN, "Relation of temperature to spore germination and growth of *Urocystis cepulae*," *J. Agr. Research*, 32: 133-146, 1926.
- WEIMER, J. L., AND L. L. HARTER, "Temperature relations of eleven species of *Rhizopus*," *J. Agr. Research*, 24: 1-40, 1923.
- WOLF, F. A., L. F. DIXON, RUTH McLEAN, AND F. R. DARKIS, "Downy mildew of tobacco," *Phytopathology*, 24: 337-363, 1934.

Chapter 6

EFFECTS OF RADIATION ON FUNGI

Although students of fungi have long been interested in the reactions to light of this group of organisms, little progress in this field was made until after the beginning of the present century. The primary reason for this state of affairs is that the existence of radiations other than visible light was unknown until approximately 1900. From physical researches it is now known that radiations of the following groups exist, some of them possessing wavelengths in excess of those of visible light and others being shorter.

1. *Hertzian rays*, the wavelengths of which range from 1×10^6 to 3×10^{14} Angstrom units, an Angstrom unit (A) being 1/10,000,000 of a millimeter. Those waves in the upper portion of the range between 1×10^{11} and 3×10^{14} A are used in radio communication.

2. *Infrared or heat rays*, the wavelengths of which range from 8000 to 4×10^6 A, thus overlapping the lower end of the range of Hertzian waves.

3. *Visible light rays*, the wavelengths of which range from approximately 4000 to 8000 A.

4. *Ultraviolet rays*, the wavelengths of which range from 136 to 4000 A.

5. *X-rays*, the wavelengths of which range from 0.06 to 1000 A, thus overlapping the lower end of the ultraviolet range.

6. *Gamma-rays*, the wavelengths of which range from 0.01 to 1.4 A.

7. *Cosmic rays*, the wavelengths of which range down to 1/10,000 A.

Of these groups, infrared rays, visible light rays, ultraviolet rays, and X-rays have been used in experimentation with fungi. Such studies have been concerned mainly with the morphogenic effects of radiation, the fungicidal effects, and the modifying

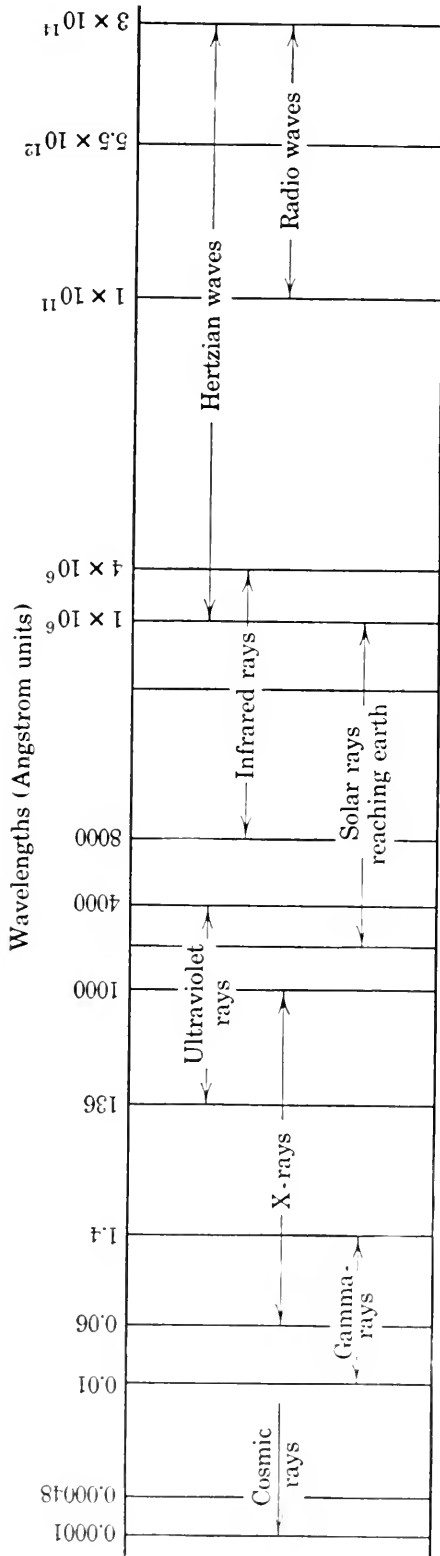

FIG. 12. Schematic representation showing relationship of wavelengths of radiations. Visible light ranges from 4000 to 8000 Angstrom units. An Angstrom unit equals 1 ten-millionth of a millimeter.

effects upon reproduction. Unfortunately many of the results, especially those with visible light, are not reproducible because account has not been taken of three correlated factors: (a) quantity or intensity of light, (b) quality of light or wavelength of radiations, and (c) duration of exposure or total radiation. Even in some studies employing monochromators intensity was not kept constant or was not measured when quality was changed. It is all too apparent, furthermore, that such other factors as age of the culture, hydrogen-ion concentration, temperature, and screening effects from the culture media and from the massing of hyphae must be considered in experimentation on the reactivity of fungi to radiation. Since this has not always been done, a barrage of criticisms may be levelled against the experimental procedures and consequently against the conclusions. In the account that follows some of the extensive publications in this field are brought together, but many meritorious ones have been excluded from the discussion. Although certain generalizations may be drawn from these publications, none appears to rest on too secure a basis, and the only broad statement warranted appears to be that much further work is needed. Such studies should be attempted, however, only by mycologists well grounded in the physical principles of light and other radiations. Much of value on the effects of radiation will be found in the summary by Smith (1936).

MORPHOGENIC REACTIONS

A survey of studies to determine whether light is required for the development of fructifications by fungi reveals that light exerts a profound influence upon some species but that others appear to be completely indifferent to it. Several early mycologists noted that in the complete absence of light the stipes of some species of Hymenomycetes are longer than normal, that other species, normally sessile, develop stipes, and that other species, normally pileate, branch in clavarioid fashion. *Coprinus stercorarius*, in darkness, has been observed to grow stipes 2 to 3 ft long. Buller (1906) noted that *Polyporus squamosus*, kept in the dark, developed coal-black stag-horn-shaped sterile stromata, 15 cm tall and having white tips, in place of normal stalked pilei. The formation of the pileus is entirely conditioned by the

presence of daylight, exposure for a single hour, even if followed by return to the darkroom, being sufficient to result in the production of pilei. Likewise in *Lentinus lepideus* [Buller (1905)] the stimulus of light is necessary for formation of the pileus. Fruiting bodies grown in weak light have grotesque shapes. Although stipes are at first positively heliotropic and indifferent to

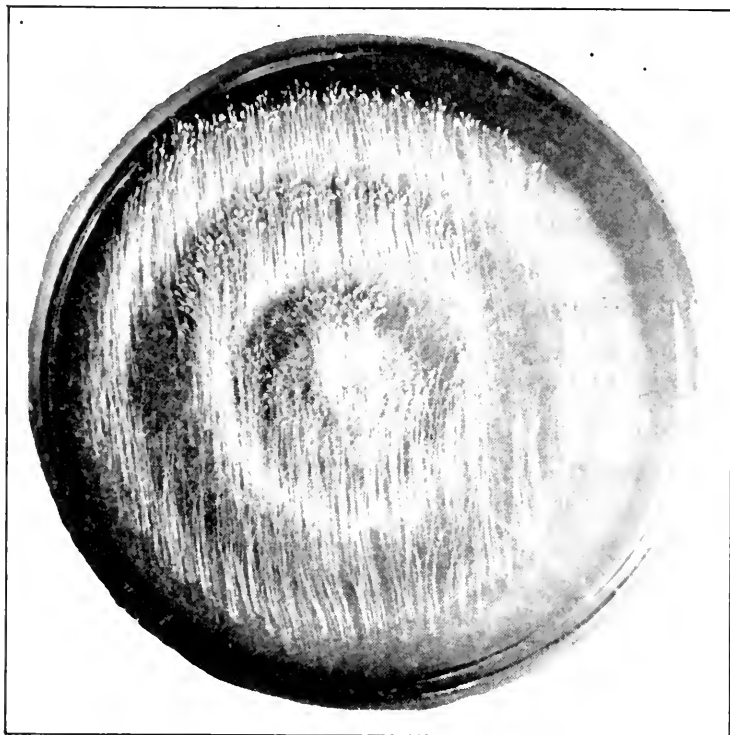

FIG. 13. Petri-dish culture of *Aspergillus clavatus* in ordinary diffuse light.

geotropism, by the time pilei begin to form they lose this reactivity to light, and negative geotropism dominates pilear development. *Aspergillus clavatus* forms short conidiophores when grown in total darkness, whereas conidiophores of two lengths, one short and the other an inch or more long, are produced on exposure to diffuse daylight [Wolf (1938)]. The colonies produced under these considerations might be suspected to belong to two distinct species of *Aspergillus*.

Psalliota campestris, the cultivated mushroom, when grown in caves or cellars that are illuminated only to permit gathering the crop, is completely indifferent to light. Many subterranean fungi, as would be anticipated, are unaffected by light. Evidence has accumulated, moreover, that a considerable number of slime

molds, Hyphomycetes, Pyrenomycetes, and Basidiomycetes can develop in the absence of light. Long and Harsch (1918), for example, found that sporophores of *Polyporus cinnabarinus*, *P. farlowii*, and *Trametes serialis* develop in culture in absolute darkness.

ZONATION. A variety of morphogenic effects may be expressed by those species that respond to light. Perhaps the most striking

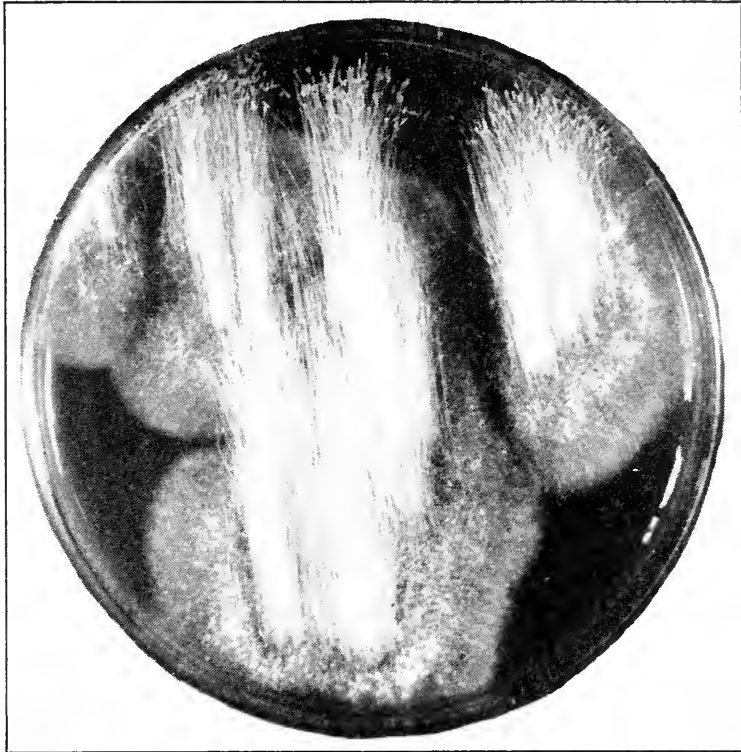

FIG. 14. Culture of *Aspergillus clavatus* grown in blue light.

is zonation, resulting from alternation of day and night, for it has been encountered by all who have cultivated fungi. Moreau (1912) observed the zone of conidia, produced daily, in *Penicillium glaucum*, Hedgcock (1906) in *Cephalothecium roseum*, and Bisby (1925) in *Fusarium discolor sulphureum*. Bisby reported that exposure of the cultures to bright daylight for a period of $\frac{1}{4}$ to $\frac{1}{2}$ second was sufficient to produce a ring of conidia. As a more accurate measure, he noted that exposure to a 25-candle-power tungsten light for 2 to 2 $\frac{1}{2}$ minutes was sufficient.

In order to relate zonation to radiation of certain wavelengths, Hedgcock (1906) subjected *Cephalothecium roseum* and Reide-

meister (1909) exposed *Botrytis cinerea* to illumination in which portions of the spectrum were screened out. The results of their studies and those of others are contradictory. In red light and in darkness few conidia of *B. cinerea* were noted by Reidemeister (1909), but they formed abundantly in blue light. Colonies of *Aspergillus clavatus* grown in blue light produced tall conidio-

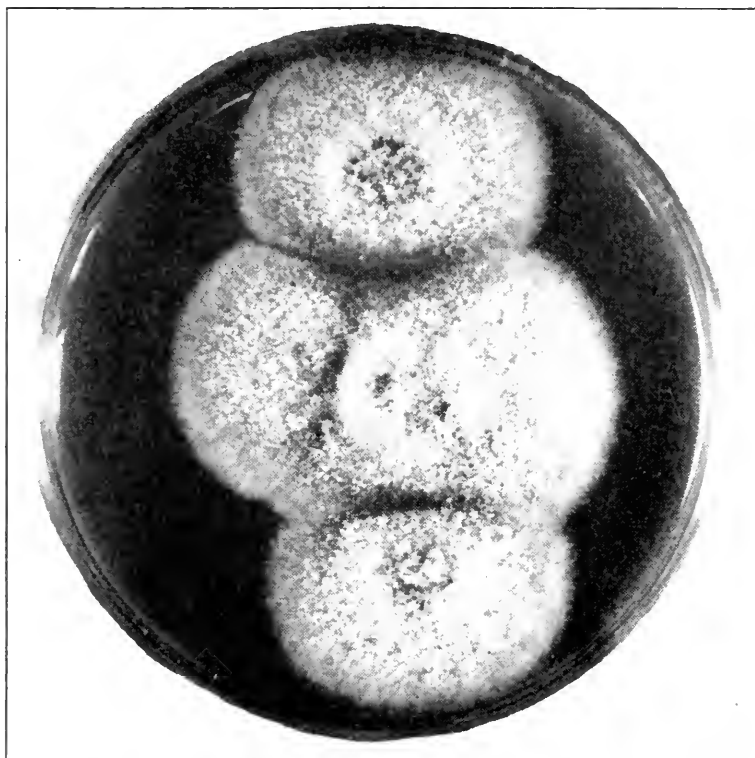

FIG. 15. Culture of *Aspergillus clavatus* grown in total darkness or in red light.

phores with a few short ones, whereas in red light and in darkness all were short [Wolf (1938)].

Since some fungi produce concentric zones in total darkness, the alternation of day and night must be regarded as only one of the complex factors involved in this phenomenon. Bisby (1925) induced zonation in *Fusarium discolor sulphureum* in total darkness if the temperature was alternated. The effect of temperature has been substantiated by more recent studies with other species. In an analysis of his studies on *Fusarium* and *Monilia fructigena* Brown (1925) showed that zonation in response to light changes is correlated with the following factors: (1) the capacity of the

species to react to light in the matter of sporulation, (2) staling produced by mycelial growth, provided that the amount of staling does not in any way impede the extension of the mycelium, and (3) the concentration of nutrients available, which should not permit of sporulation so intense as to interfere with the production of successive daily zones.

PHOTOTROPISM

The fact that fungi lack chlorophyll and that certain species are capable of completing their entire developmental cycle in the absence of light might at first thought incline the student to the belief that they would not react phototropically. On the other hand, it might be anticipated that radiant energy would influence rate of growth, and that consequently species in which growth or elongation is localized might respond to differences in the intensity of light. Species with long sporangiophores, such as *Pilobolus* or *Phycomyces nitens*, or with long conidiophores, such as *Aspergillus clavatus*, should be especially suited for studies of this sort, since they respond to unilateral illumination. It should be possible with such species to determine the minimal amount of light required to stimulate a phototactic response and to establish that quality, quantity, and duration of exposure are functions of each other. In *P. nitens* it has been found that response follows a change of $\frac{1}{4}$ to $\frac{1}{2}$ candlepower per meter per second. Response may not occur immediately, so that reaction time may be said to consist of an exposure and a latent period. The duration of this latent period is constant for any particular intensity unless the exposure time is reduced below the minimum threshold; below this minimum the reaction time increases progressively as the duration of exposure decreases.

AMONG PHYCOMYCETES. In response to light, *Phycomyces nitens* has long been known to bend in a zone just beneath the sporangium. Blaauw (1914), who investigated the phototropic response of this fungus by use of physical methods, regarded the sporangiophore as a cylindrical lens which concentrates the light on the cell wall opposite the source, causing greater photochemical activity in this area. The net result of this photochemical action is bending of the sporangiophore, a response to unequal

rates of growth on opposite sides of the growing zone. This explanation is not entirely satisfactory if it is borne in mind that the sporangiophores are radially symmetrical and that the regions of sensitivity and of growth coincide.

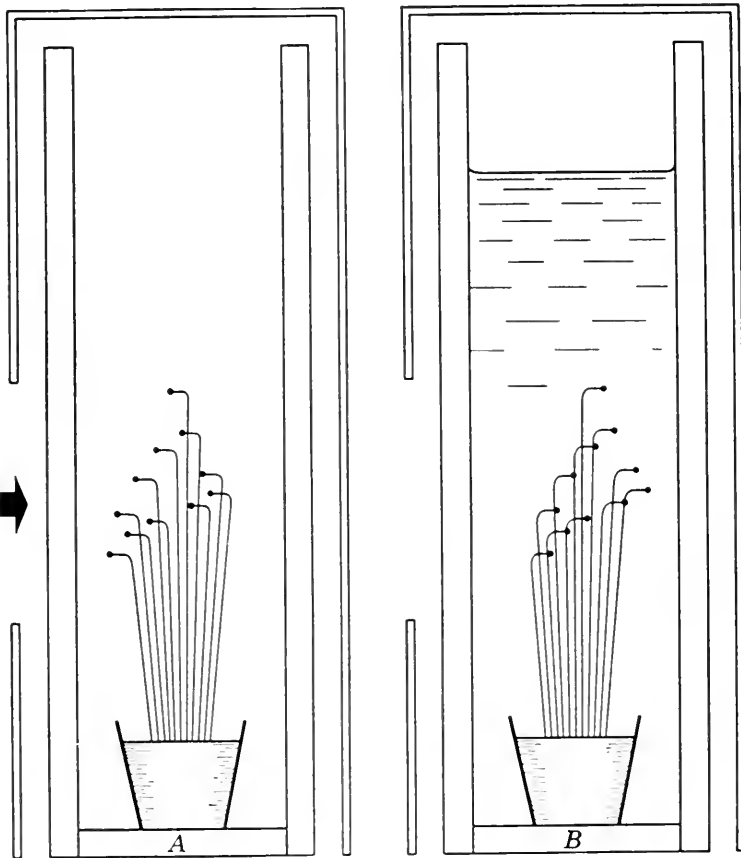

FIG. 16. Response of *Phycomyces* to incident light. In *A*, grown in air, the sporangiophores bend to direct the sporangia toward the light. In *B*, the sporangia are surrounded with paraffin oil and have turned away from the source of light. Density of the surrounding medium conditions the direction of refraction of light. (After Buder.)

Further evidence to clarify this problem was presented by Buder (1918). He grew *P. nitens*, with the sporangiophores directed vertically, in chambers whose vertical sides were parallel. He then immersed the sporangiophores in one chamber in paraffin oil; in the control chamber the sporangiophores were surrounded by air. Illuminating both unilaterally, he found that those in oil were negatively phototropic, whereas those in air were positively phototropic. In explanation Buder pointed out

that, since air is a less dense medium than is the content of the sporangiophore, the rays of light refracted from the front half of the cylindrical cell converge on the side opposite the source of light. Similarly, the oil is a more dense medium than is the content of the sporangiophore, and hence the rays of light after refraction diverge from one another. When air is the medium, the back half of the growing zone is lighted the more intensely; when oil is the medium, the front half. The growth response is therefore in opposite directions in the two cases.

Castle (1933) has also contributed to an understanding of the response of *P. nitens* to light. His solution of the problem is based upon three assumptions: (1) bending is a resultant of unequal absorption of light by the two halves of the cell (the half toward the source of light and the half most distant from the source); (2) the primary action of light is upon the protoplasm; and (3) the absorption of light is brought about by a substance or substances (pigment) equally distributed within the cell. From these reasonable assumptions he deduces that the factors which govern the unequal action of light in the two halves of the cell are the following: (1) the refractive index of the cell, (2) the size of the cell, more specifically its radius, and (3) the coefficient of absorption possessed by the intracellular pigment.

All known species of *Pilobolus*, which commonly occur on the fresh dung of herbivores when it is kept in a moist chamber, exhibit photic reactions. Among those who have investigated the response of these species to light are Allen and Jolivette (1914), Parr (1918), Pringsheim and Czurda (1927), van der Wey (1929), and Buller (1934). Allen and Jolivette admitted light through a pinhole and found that *Pilobolus* aimed point-blank at the light. The accuracy of the aiming was remarkable, for when the culture was 20 cm distant from the opening, 95% of the sporangia struck within a ring 4 cm in diameter, the remaining 5% being within the next 1 or 2 cm. A greater degree of precision was obtained with white or blue light and less accuracy with yellow light; the aiming was very inaccurate with red light. Of course the distance that the sporangia needed to travel modified the precision. Allen and Jolivette also made the interesting observation that, when *Pilobolus* was exposed to two equal beams of white light with the angle between them greater than 10° of arc,

the aiming was as accurate as if one source of light was nonexistent. The sporangia were aimed at one or the other source of light, not midway between the two. Allen and Jolivette were unable to explain how this result was achieved, but Buller (1934) later found the mechanical basis to reside in the ocellar structure of the subsporangial swelling.

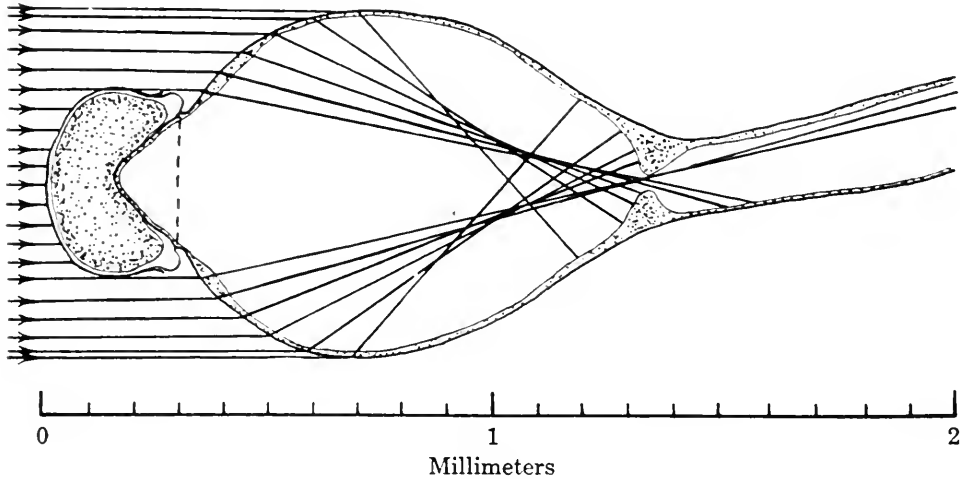

FIG. 17. Median longitudinal section of *Pilobolus kleimii*. The fructification is directed toward the source of light. The basal sporangial wall has gelatinized, and the broken line indicates where the sporangium has separated from its attachment. Certain rays cannot penetrate the black sporangium, which fits as a cap at the apex of the subsporangium. The rays which penetrate the upper sporangial wall converge at the basal perforated septum, which is red. The photochemical changes induced by converged light within the subsporangium induce swelling and eventual bursting at the tip. The sporangium is carried away *in toto* with the squirt. (After Buller.)

Later Parr (1918) concerned herself with precise measurements of the responses of *Pilobolus* to wavelengths of the different regions of the spectrum, to the presentation time, and to the energy values involved. Her important conclusions include the following: (1) *Pilobolus* responds phototropically to light in all regions of the spectrum. (2) The presentation time required to react phototropically increases gradually from the red rays to the violet; that is, *Pilobolus* is more sensitive to violet than to red. (3) The presentation time varies in inverse ratio to the square root of the wave frequency. (4) For any given light source the total energy value may be expressed as the product of the square root of the wave frequency multiplied by the presentation time.

This value decreases with a decrease in energy value of the spectral regions.

The method by which *Pilobolus* aims and discharges its sporangia toward the source of light was elucidated by Buller in a series of observations that began in 1919. He discovered that

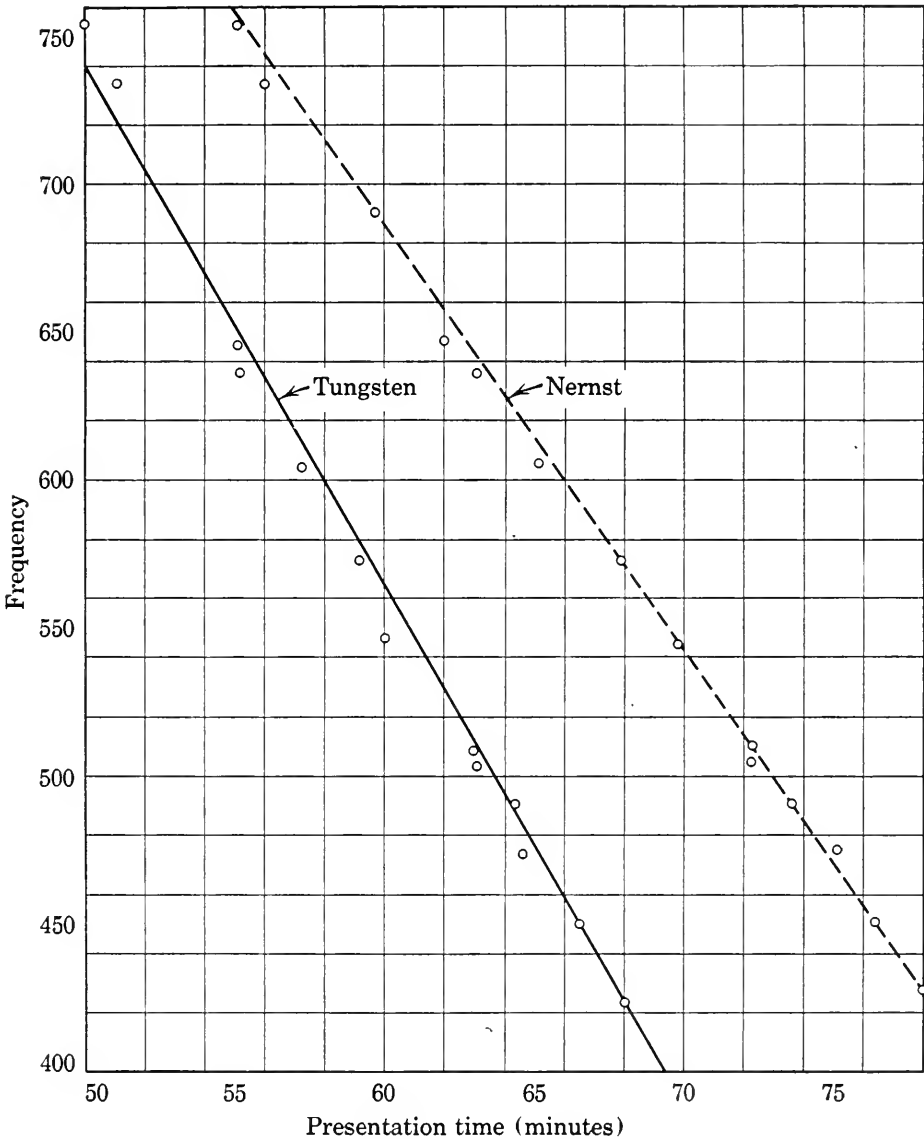

FIG. 18. Response of *Pilobolus* to light from two sources to show relation of presentation time to frequency of light. Presentation time is regarded as the time required for one-half of the sporangiophores to respond. The time required for heliotropic response is seen to decrease progressively from red light waves (those with low frequency) through yellow, green, blue, violet, and indigo (those with high frequency). (After Parr.)

the subsporangial swelling is an ocellus which acts as a lens. When the fruiting structures are in heliotropic equilibrium, the light is focussed on a red perforate septum at the base of each subsporangium. The red color is imparted by a carotinoid pigment. The sporangium itself is black and hence casts a shadow on some part of the subsporangium beneath. According to Buller (1934), the sequence of events is somewhat as follows: Light strikes the upper end of the fruiting body, and the incident rays enter the part of the upper wall of the subsporangium that bulges around the sporangium. They are focussed on the wall below, where a region of greater photochemical activity is thereby produced. The stimulus is thus transmitted to the motor region of the stipe (stalk of sporangiophore), and in response differential growth occurs. Most rapid growth, as has been discussed in *Phycomyces nitens*, occurs on the side of the stipe nearest the area where the light is focussed. As a consequence the ocellar mechanism is tilted until the rays fall symmetrically upon the red perforate ring at the base of the subsporangium. In this position a state of physiological equilibrium becomes established, and the sporangium is directed head on toward the light. Some appreciation of the rate of response may be gained from Buller's observation on *P. longipes*, in which he found the stipe capable of turning through an angle of 90° and of completely orienting the sporangium in about an hour.

The discharge of the sporangium is also the result of photic effects. When the rays are properly centered, the photochemical reactions on the protoplasmic content of the subsporangium result in increased osmotic pressure. Eventually the pressure is sufficient to separate the subsporangial and sporangial walls, the rupture beginning as a collar around the periphery of their zone of contact. When this release of tension occurs, the subsporangial wall, being weakest beneath the sporangium, bursts. The sporangium is thus carried away by a squirting process.

Among the striking observations on *Pilobolus* made by Allen and Jolivette (1914), as has been mentioned, was that, if two equal beams of white light are converged upon the fruiting bodies, with an angle of convergence greater than 10° , the sporangiophores direct the sporangia toward one or the other of the two sources of light. Contrary to expectations, the aim of the sporangiophores is therefore not in the direction of the resultant of

these two forces. The explanation for this response occurs in the accounts of Pringsheim and Czurda (1927) and van der Wey (1929) and has been confirmed by Buller (1934). All are in accord that this response may be explained by these assumptions: (1) the subsporangium acts as an ocellus, and (2) the red annular area in the base of the subsporangium is the region for light perception. Then, when two spots of light become focussed along the basal wall, the one nearest the annular area gives the greater stimulus to the motor region of the stipe. In consequence the stipe bends, and when the nearest spot comes to rest directly on the annular area, heliotropic equilibrium becomes established.

AMONG ASCOMYCETES. The position of the fruiting bodies of many Discomycetes and Pyrenomycetes within or on the substratum and the orientation of their asci may be presumed to be governed by phototropism or by geotropism. Some of these fungi, for example, subterranean species, may be wholly unaffected. In fact, little is known about the specific effect of either of these tropic forces on Ascomycetes. This subject constitutes a fertile field for study, especially in connection with leaf-inhabiting species.

As long ago as 1890 the tips of the asci of *Ascobolus denudatus* were known to bend phototropically. The meager studies subsequently made on phototropic responses among disk fungi are assembled and interpreted by Buller (1934). Discomycetes possess hymenia that are plane, concave, or convex. If the hymenia are plane, no structural adaptations are required to enable the ascospores to be discharged without striking some part of the hymenial surface. In certain species with concave or convex hymenia it has been shown that the ends of the asci may be curved phototropically, or else the opercula of the asci may be asymmetrically situated near the apices. By this means ascospores are ejected into the environment and do not lodge on the opposing walls of the fruit bodies.

In *Ascobolus magnificus* and *A. stercorarius* [Buller (1934)] the tip of the ascus protrudes above the hymenium. This tip, containing the ascospores, curves toward the source of light, and eventually the ascospores are discharged toward the light. In *Ciliaria (Lachnea) scutellata*, which normally is plane and normally possesses straight asci, curvature may be induced by unilateral illumination. In *Aleuria vesiculosa* both asci and pa-

raphyses are positively phototropic. Since its hymenial surface is hemispherical, the amount of bending of the ascus tip is related to the position of the ascus. Asci near the center are straight, whereas those near the periphery may be bent through an angle of 45° . In *Morchella conica*, *M. crassipes*, and *Ptychoverpa (Verpa) bohemica* the fertile portions of the fruit bodies may be regarded as compound disks. The asci are phototropic and behave as though each alveolus were a disk. The stipes of some of

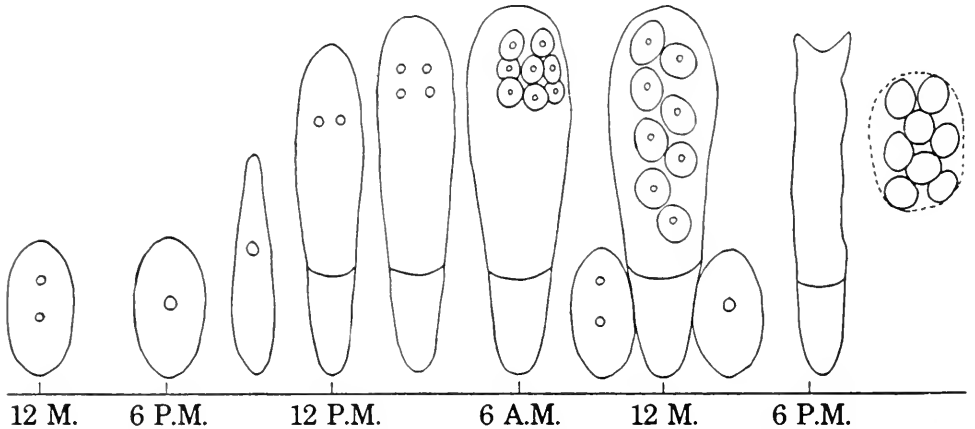

FIG. 19. Diurnal cycle of development of asci by *Taphrina deformans*. (After Yarwood.)

these stalked species bend in response to light, thus carrying the fertile tissues into the position most favorable for ascospore discharge and dissemination.

A diurnal rhythm in the discharge of ascospores is known to exist in certain species. Ingold (1939) observed that *Hypoxyylon fuscum* discharges its spores nightly during the approximate period between 9 P.M. and 5 A.M. In *Nectria cinnabarina* and *Podospora curvula*, however, ascospore discharge occurs in the daytime.

By direct microscopic examination and by use of spore traps, Yarwood (1941) found that in *Taphrina deformans* the ascogenous cells give rise to asci in the evening and that nuclear division and increase in size of asci occur throughout the night. During the following daylight period the ascospores become morphologically mature, and maximum discharge occurs during the early portion of the succeeding night. This rhythm is attributed to alternating light and darkness, but the significant effect of light

is not understood. In *T. deformans* discharge at night appears to be an adaptation favoring infection.

The perithecial beaks of *Neurospora sitophila* have been shown [Backus (1937)] to be positively phototropic and to discharge their spores toward the light. Observations indicate also that the beaks of such rostrate fungi as *Gnomonia*, *Ceratostomella*, and *Diaporthe* are positively phototropic. The phototropic responses of such genera as *Linospora* and *Ophiodothella*, whose perithecia

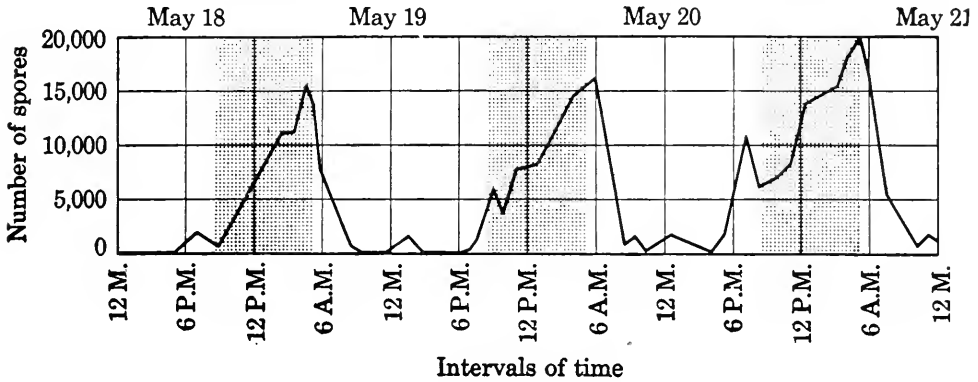

FIG. 20. Period of ascospore output from a stroma of *Hypoxylon fuscum* at a temperature within the range 17 to 19.5° C. (After Ingold.)

and asci lie horizontally and whose beaks stand vertically, should constitute an interesting subject of study.

LUMINESCENCE

Nearly everyone has noted that old stumps, decaying logs, and leaf mold may emit a weird glow at night. This phenomenon, which has been called "fox fire," is usually caused by luminous fungi, most of which are Hymenomycetes. Various other organisms, including species of bacteria, flagellates, sponges, jellyfish, hydroids, bryozoans, marine worms, earthworms, crustacea, myriapods, insects, molluscs, squids, and fish, are known to emit light. An informative treatment of this general subject is given in Harvey's (1940) *Living Light*. Buller (1924, 1934) studied luminescence in *Panus stipticus* and *Omphalia flavida*, and his account of this phenomenon among fungi will be found very stimulating.

According to Buller's list (1924), the pilei of the following species are luminous: *Clitocybe illudens*, *Panus incandescens*, *P.*

stipticus, *Pleurotus incandescens*, *P. facifer*, *P. gardneri*, *P. igneus*, *P. noctilucens*, *P. olearius*, *P. phosphoreus*, *P. prometheus*. The rhizomorphs of *Armillaria mellea* and the sclerotia of *Collybia tuberosa* and *C. cirrhata* are luminescent. Among other species claimed to be luminous are *Fomes annosus*, *Polyporus sulphureus*, *Fomes pini*, *Collybia longipes*, *Corticium coeruleum*, *Dictyophora phalloides*, and *Xylaria hypoxylon*.

The mycelium and pilei of *Panus stipticus* in North America are luminous, whereas those in England are non-luminous [Buller (1924)]. Dried fruit bodies do not glow, but, if revived by moistening, they again emit light. Not only moisture but also favorable temperature relations are necessary for luminescence. The minimum temperature for *P. stipticus* is -2° to -4° C, the maximum 35° to 37° C, and the optimum 10° to 25° C.

Omphalia flavida is of special interest because it has long been known to be the cause of a serious leaf disease of the coffee tree in the American tropics. Buller (1934) discovered that the lesions induced by *O. flavida* are luminous and reported that they may be seen in the dark at a distance of 6 to 10 ft. In culture the mycelium too is luminous. This organism is capable of forming peculiar structures called gemmifers and gemmae if the stimulus of alternating day and night is provided.

Luminosity in these fungi, as in other luminous organisms, is the result of an oxidative change within the cells, luciferin being acted upon by the enzyme luciferase in the presence of oxygen. Apparently this enzyme has not been extracted from fungi, nor has it been demonstrated to be capable of functioning apart from living cells.

INHIBITORY EFFECTS

Exposure of fungi to sunlight has long been known to modify their rate of growth. If the total illumination is small, growth may be retarded, but with larger amounts death may ensue. This matter appears to have been given rather extensive study, as Smith (1936) has indicated.

It would be anticipated that not all species of fungi are equally sensitive to sunlight. Abundant evidence in support of this conclusion from comparative studies is not available. Fromme (1915) noted that the germ tubes of urediniospores of *Puccinia rhamni* are negatively phototropic and mentioned that a similar reaction

for those of *P. dispersa* had earlier been recorded. The germ tubes of several other fungi, cited in his report, are indifferent in their reaction to light. It would seem that the restriction of some pathogens to the lower leaf surface instead of both leaf surfaces may be, in part at least, a light response. For example, the downy

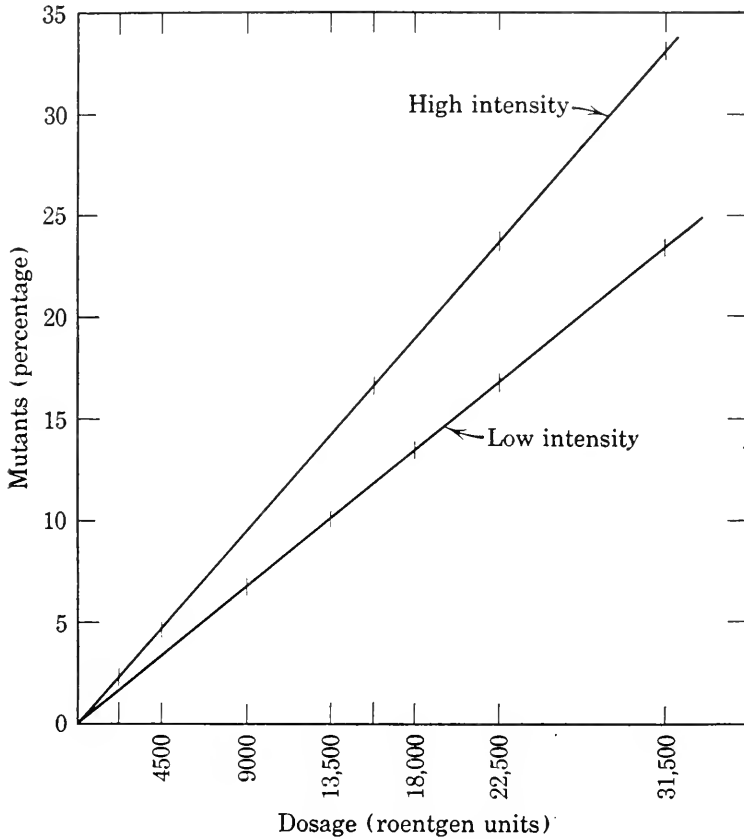

FIG. 21. Effect of dosage on mutation rate at low intensity (240 r per minute) and at high intensity (5400 r per minute). (From Sansome, Demerec, and Hollaender.)

mildews fructify quite commonly on unexposed surfaces, whereas powdery mildews behave in this respect as though quite indifferent to sunlight.

Numerous studies have been made to determine which portions of the spectrum are most injurious or possibly lethal. As might be anticipated, it has been found that radiations with shortest wavelengths are most effective in retarding growth. It has been noted furthermore that the ultraviolet regions are more effective than the blue, but in many of these studies intensities are not measured, and consequently the results cannot be satisfactorily

evaluated. The methods employed by Oster (1934) in his study of *Saccharomyces cerevisiae* appear to be well suited to similar studies of other fungi. He used monochromatic light and found that inhibition of colony size could be obtained at a low energy level. Under such conditions few new buds were formed, giant cells were sometimes produced, and the metabolic functions were retarded, as was shown by lowered O₂ consumption. At a wavelength of 2652 Å, 457 ergs/mm² were required to kill 50% of the cells, but at 3022 Å, 23,500 ergs/mm² were necessary. The shape of the curves for lethal action at different wavelengths suggests that more factors than single quantum hits on a sensitive region, that is, adsorption of energy by the nucleoproteins, are responsible for these effects. Oster suggests that the age of the cells at the time of exposure is also a factor in the energy relations involved. The effect of temperature must always be taken into consideration in experiments of this type.

Ultraviolet radiations of wavelengths between 2537 and 2650 Å were found most effective in killing *Trichophyton mentagrophytes* [Hollaender and Emmons (1939)]. They suspended the spores in physiological salt solution, using wavelengths in the range 2280 to 2950 Å in measured quantities. In a subsequent report these investigators [Emmons and Hollaender (1939)] correlated time of exposure of spores of this same species to monochromatic light of 2650 Å with energy required to cause death and with percentage survival. Their experimental data on these points are contained in Table 10.

TABLE 10

EFFECT OF ULTRAVIOLET LIGHT ON *Trichophyton mentagrophytes*

<i>Duration of Exposure (minutes)</i>	<i>Energy (ergs per spore in ten thousandths)</i>	<i>Survival Ratio (percentage)</i>
5	7.25	81.0
15.5	22.7	53.0
34.0	50.2	42.5
53	78.7	16.4
78	116.7	7.7
101	151.7	3.93
132	200.0	1.03
162	247.4	0.61
198	304.4	0.24
280	436.4	0.153

Dimond and Duggar (1941) determined the lethal effects of monochromatic ultraviolet radiations 2650 Å in wavelength on *Aspergillus melleus*, *Rhizopus suinus*, and *Mucor dispersus*. They correlated ergs of energy required with volume of the spores, using the volume of *A. melleus* as unity. Their data, which are presented in Table 11, indicate that resistance is not directly cor-

TABLE 11

LETHAL EFFECT OF ULTRAVIOLET RADIATIONS ON THREE SPECIES OF FUNGI

<i>Species</i>	<i>Ergs per Spore for 50% Killing</i>	<i>Ratio</i>	<i>Mean Volume of Spore, μ^3</i>	<i>Ratio</i>
<i>Aspergillus melleus</i>	0.0064	1.0	8	1.0
<i>Rhizopus suinus</i>	0.088	13.7	28	3.4
<i>Mucor dispersus</i>	0.12	17.5	113	14.1

related with the volume of the spore. Pigmentation of spores and differences in the number of spore nuclei are employed as additional factors in accounting for differences in the action of radiations.

Recently Sharp (1938) made certain refinements in methods of studying the effect of ultraviolet light on bacteria that would appear to be adaptable for use with fungi. In attempts to eliminate the shielding or screening effects of masses of bacteria and of the medium he atomized broth cultures into the air, passed the bacteria-laden air through a tube where they were exposed to monochromatic ultraviolet light, and then captured the treated bacteria at the exit on culture media. It should be possible to substitute suspensions of spores in water for broth cultures of bacteria in such an apparatus.

Several investigators have been concerned with the use of ultraviolet rays as a potential fungicide. Fulton and Coblenz (1929) tested a group of pathogens by use of a 110-volt quartz lamp with a mercury cathode and a tungsten anode operated on 320 watts (80 volts, 4 amp). The spores of all organisms were at the surface of the agar plates. The investigators eliminated temperature effects and found that the following survived exposure for one minute: *Helminthosporium* sp., *Alternaria* sp., *Cladosporium* sp.,

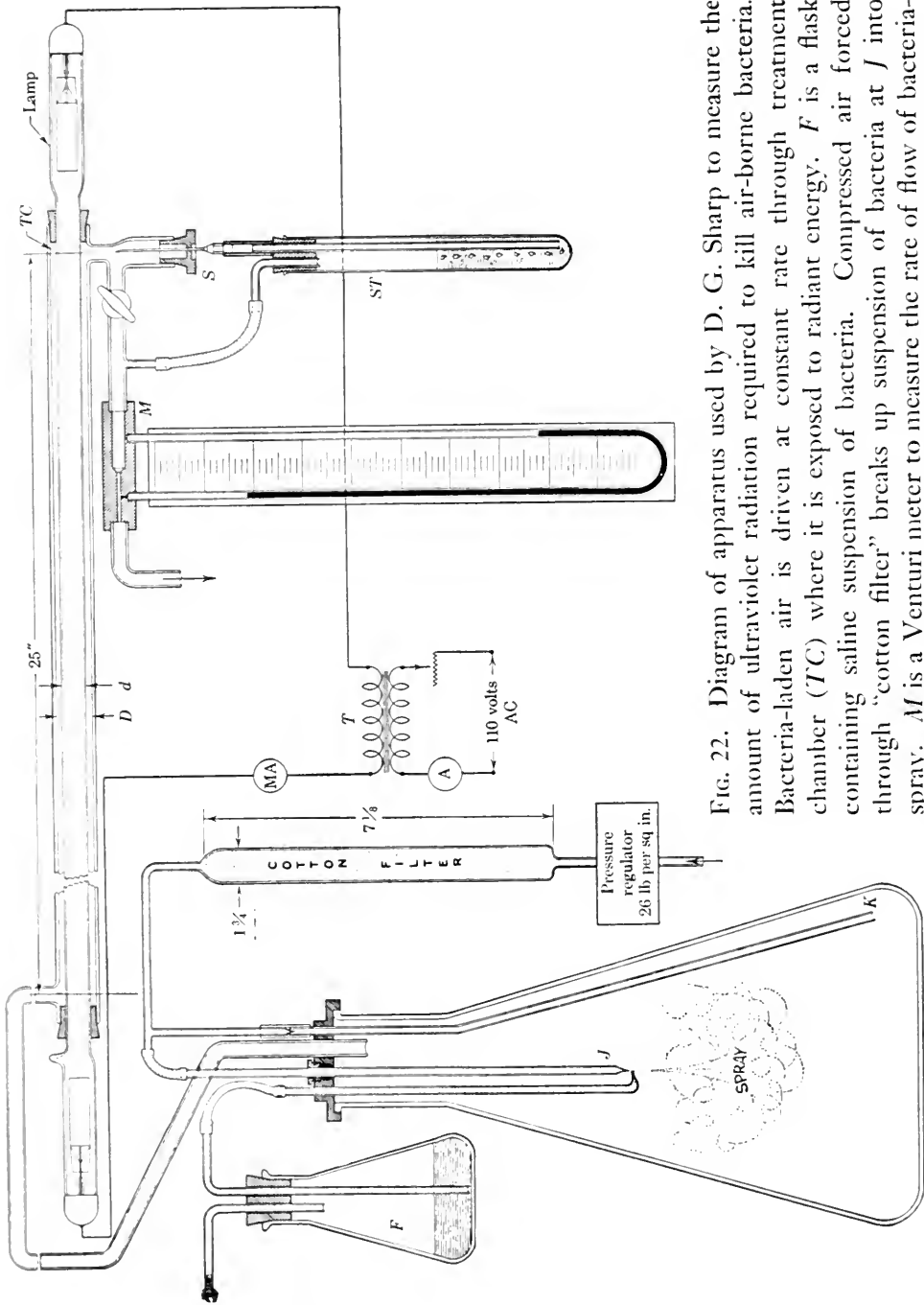

FIG. 22. Diagram of apparatus used by D. G. Sharp to measure the amount of ultraviolet radiation required to kill air-borne bacteria. Bacteria-laden air is driven at constant rate through treatment chamber (*TC*) where it is exposed to radiant energy. *F* is a flask containing saline suspension of bacteria. Compressed air forced through "cotton filter" breaks up suspension of bacteria at *J* into spray. *M* is a Venturi meter to measure the rate of flow of bacteria-laden air through *TC*. *ST* is a sterile tube of broth into which part of the air is admitted through a hypodermic needle; the remainder may escape through the side arm. (Courtesy of D. G. Sharp.)

Pestalozzia sp., Chaetomella sp. (all from cranberry), Diplodia sp. (from lime fruit), *Aspergillus niger*, *Penicillium italicum*, *Colletotrichum gloeosporioides*, and *Ceuthospora limitata*. The following species, however, were killed by this treatment: *Rhizopus nigricans*, *Penicillium digitatum*, *P. expansum*, *Phomopsis citri*, *Glomerella rufo-maculans*, *Gloeosporium limeticolum*, *Anthrostromella destruens*, *Acanthorhynchus vaccinii*, *Gloeosporium minus*, *Melanconium* sp. (from grape), *Fusarium* sp. (from orange), *Botrytis* sp. (from apple), *Phytophthora* sp. (from orange), and *Guignardia* sp. (from cranberry). Similar studies by Landen (1939) were concerned primarily with attempts to destroy the viability of chlamydospores and sporidia of *Ustilago zaeae*. Employing a large crystal-quartz monochromator, he found that sporidia are more sensitive than chlamydospores. Long ultraviolet rays between 3022 and 3130 Å required a dosage of 1.5×10^6 ergs/mm² to be lethal. Dillon-Weston and Halnan (1930) irradiated cultures of several species, including *Rhizopus nigricans*, *Dematium pullulans*, *Neurospora sitophila*, and *Sclerotinia trifoliorum*. They employed daily exposures with low intensities and therewith merely modified the rate of growth.

Germination of the urediniospores of *Puccinia graminis tritici* was inhibited if they were floated on the surface of water during exposure to sunlight, but if they were placed in the dark under otherwise similar conditions, they germinated readily [Dillon-Weston (1931)]. Similar results followed if he exposed them to a mercury-vapor lamp for ultraviolet radiations.

STIMULATORY EFFECTS

The evidence on stimulation of fungi by ultraviolet light is contradictory. The results of studies by a number of workers indicate that exposure to such light is followed by an increased growth rate. Using *Fusarium eumartii*, Smith (1935) found that irradiated cultures were at first retarded, but that the rate of growth was increased after the period of retardation. In such cultures the total growth was never greater than that in the controls. Since temperature and the accumulation of labile nutritive products also favored an increased rate of growth, Smith regarded stimulation as an indirect effect of radiation. This interpretation is not in accord with the results of Hutchinson and Newton

(1930), who obtained most stimulation in slow-growing cultures of yeast. They also conclude that some wavelengths result in stimulation, others in retardation, of growth. Since they did not take into consideration differences in total energy in the different wavelengths that they used, however, their conclusions cannot be accepted with finality.

EFFECT ON SPORULATION

Among other effects of ultraviolet irradiation is modification in spore production. Ramsey and Bailey (1930), using a quartz-mercury-vapor arc with filters to screen out radiations below a certain wavelength, and exposing for 15 to 30 minutes at a distance of 60 cm, found the greatest production of conidia by *Macrosporium tomato* and *Fusarium cepae* within the range 2535 to 2800 Å. Radiations within this range could also be used to inhibit the growth of these organisms or to kill them. Their evidence indicates that increased sporulation was not the result of increased temperature nor modification of the medium, as was suggested by Smith (1935) from her studies of *F. eumartii*. When the filters employed by Ramsey and Bailey permitted the transmission only of radiations of wavelengths greater than 3120 Å, there was slight stimulation in spore production. Radiations of wavelengths greater than 3334 Å, however, were without appreciable effect in this respect. They also noted that the minimum duration of exposure for stimulation was 30 seconds and that several exposures at short intervals were more effective than a single exposure equal in duration to the sum of the several short exposures. When irradiated, their cultures of *F. coeruleum* formed conidia, whereas this strain was never observed to do so in non-irradiated cultures. On the other hand, their cultures of *F. argillaceum*, when irradiated, failed to form conidia, producing only chlamydospores.

Stevens (1928, 1930, 1931) exposed *Glomerella cingulata* and a species of *Coniothyrium* to a Cooper-Hewett quartz-mercury-vapor arc operated at 4.5 amp and 66 volts. The agar plates were uncovered during exposure at a distance of 21 cm from the source of light. With exposures at less than 1 min, perithecia were formed in abundance by *G. cingulata* and pycnidia by *Coniothyrium*. In both species these structures normally appeared on the

same medium but were always sparse. Stevens (1931) induced *Colletotrichum lagenarium* to form the perithecial stage in culture, whereas this stage had never been observed previously under any conditions. Although he did not regard temperature as a significant factor, he noted that the presence in the medium of such sugars as favor growth also favors increased spore production after irradiation.

There is evidence that ultraviolet radiation may hasten sporulation [Hutchinson and Ashton (1930)]. Short exposures induced *Colletotrichum phomoides* to sporulate earlier, and long exposures delayed sporulation. Hutchinson and Ashton concluded that within certain limits the time of sporulation is an inverse expression of the rate of growth.

EFFECT OF X-RAYS

Both ultraviolet and X-rays have been used as therapeutic agents, especially in dermatomycosis and actinomycosis. The medical aspects of their use appear to be better known than their general effects on fungi. The evidence concerning X-rays indicates that fungi are rather insensitive to their action but that large dosages are lethal. Haskins and Moore (1934) found that soft X-rays were 2.1 times as potent in killing conidia of *Penicillium* as were hard X-rays. The soft X-rays used by them had a wavelength of 1.3 to 1.5 A; the hard ones, from 0.18 to 0.21 A. Lethal action of X-rays against plant pathogens was earlier reported by Pichler and Wöber (1922), who successfully freed wheat seed from *Ustilago tritici*, barley seed from *U. nuda*, and potato tubers from *Synchytrium (Chrysophlyctis) endobioticum*.

Nadson and Philippov (1925) suppressed the formation of zygotes in *Mucor genevensis* and *Zygorhynchus moelleri* by exposure of cultures to X-rays. Marked changes in protoplasmic structure resulted in *Saccharomyces cerevisiae* and *Nadsonia fulvescens* after exposure to X-rays [Nadson (1937)].

INDUCTION OF SALTATIONS

None of the effects of radiation which have thus far been given consideration in the present account can be regarded as mutations, for evidence is lacking that they are heritable. Radia-

tions of short wavelengths, however, have been used to produce heritable mutations with many biological materials, as is well known, and a voluminous literature on this subject exists. Relatively few studies have been made of induction of heritable mutations in fungi. Dickson (1932, 1933) exposed malt-agar cultures of *Mucor genevensis*, *Phycomyces blakesleeanus*, and the ascospores of seven species of *Chaetomium* to X-rays for 50 minutes at a distance of 26 cm. Changes in color and amount of mycelium were induced in colonies arising as subcultures from the irradiated materials, and these changes were manifest by sectoring. Stevens (1930) obtained sectoring in cultures of *Glomerella cingulata* exposed to ultraviolet radiation. Greaney and Machacek (1933) exposed cultures of *Helminthosporium sativum* to a mercury-arc lamp (110 volts, 60 cycles) for 4 minutes on each of 3 successive days. During exposure the cultures were placed at a distance of 35 cm from the arc. As a result of this treatment a saltant having hyaline mycelium and almost colorless conidia appeared. In all these cases the saltants remained constant in subcultures through succeeding generations.

Lockwood and associates (1945) irradiated 217 isolates of *Aspergillus terreus* with ultraviolet rays, and as a consequence 141 were changed morphologically. Among the 76 that were unchanged morphologically, 59 were found capable of producing more itaconic acid than the parent strains. None of the 141 strains that were altered morphologically, on the other hand, was found capable of this increased production of itaconic acid.

Emmons and Hollaender (1939) irradiated the dermatophyte, *Trichophyton mentagrophytes*, and thereby induced the production of mutants. This organism lacks a sexual stage, and consequently the investigators were unable to make a genetical analysis of the mutants. By use of *Neurospora crassa* [Sansome *et al.* (1945)], however, it was found that two types of mutants could be induced, one of which was caused by chromosomal aberration. They varied dosage and intensity and noted that increase in intensity resulted in increase in mutation rate. At low dosage there was a straight-line relationship between increase in mutation rate and increase in energy.

MODE OF ACTION OF SHORT RADIATIONS

When the percentage of survivors is plotted against the total energy used to kill yeast, typical S-shaped curves are secured from the data of Wyckoff and Luyet (1931) and Oster (1934). Several different explanations of why curves of this type should be obtained have been offered. Some workers regard them merely as expressions of normal probability of survival of the individuals. Others attribute the form of the curve to multiple quantum hits on a sensitive region of the cell, presumably on the nucleus or certain of its constituent elements. A single hit is regarded as the adsorption, by the sensitive region, of 1 quantum. The adherents of the multiple-quantum theory, knowing the amount of energy and the survival percentage, calculate the number of hits required to kill. Needless to say there is little accord in observations on the number of quanta required. The significance of this fact is not clear, but the situation might be clarified if the influence of age, nutrition, acidity, temperature, and such factors was taken into consideration. In conclusion, it is apparent that many phenomena attributed to the action of radiation are not caused by light alone but are correlated in a causal relationship with other factors.

IMPLICATIONS

It appears that the present-day mycologist and physicist, each in his own field, can do little more to extend knowledge of the effects of radiations on fungi. Conceivably they might achieve results were they to collaborate. In lieu of such collaboration, advances in knowledge will be conditional upon the presence of workers who may properly be termed bio-physicists. This name connotes possession of basic training in both biology and physics and, what is more important, a consuming zeal to apply this training to explorations leading to the furtherance and dissemination of knowledge in mycology. Such "myco-physicists" should be able to correct or clarify many of the contradictory conclusions and concepts now extant.

LITERATURE CITED

- ALLEN, RUTH F., AND H. D. JOLIVETTE, "A study of the light reactions of *Philobolus*," *Trans. Wis. Acad. Sci.*, 17: 533-598, 1914.
- BACKUS, M. P., "Phototropic response of perithecial necks in *Neurospora*," *Mycol.*, 29: 383-386, 1937.
- BISBY, G. R., "Zonation in cultures of *Fusarium discolor sulphureum*," *Mycol.*, 17: 89-97, 1925.
- BLAAUW, A. H., "Licht und Wachstum," *Z. Botan.*, 6: 641-703, 1914.
- BROWN, W., "Studies in the genus *Fusarium*. II. An analysis of factors which determine the growth forms of certain strains," *Ann. Botany*, 39: 375-408, 1925.
- BUDER, J., "Die Inversion des Phototropism bei *Phycomyces*," *Ber. deut. botan. Ges.*, 36: 104-105, 1918.
- BULLER, A. H. R., "The reactions of the fruit bodies of *Lentinus lepideus* to external stimuli," *Ann. Botany*, 19: 427-438, 1905.
- "The biology of *Polyporus squamosus*, a timber-destroying fungus," *J. Econ. Biol.*, 1: 101-138, 1906.
- Researches on fungi*, Vol. 1: pp. 47-78, 120-121, 1909; vol. 3: 357-411, 1924; Vol. 6: 36-45, 90-130, 264-324, 397-454, 1934. Longmans, Green, London.
- CASTLE, E. S., "The physical basis of the positive phototropism of *Phycomyces*," *J. Gen. Physiol.*, 17: 49-62, 1933.
- DICKSON, HUGH, "The effect of x-rays, ultra-violet light, and heat in producing saltants in *Chaetomium cochliodes* and other fungi," *Ann. Botany*, 46: 389-404, 1932.
- "Saltation induced by x-rays in seven species of *Chaetomium*," *Ann. Botany*, 47: 735-754, 1933.
- DILLON-WESTON, W. A. R., "Effect of light on urediniospores of the black-stem rust of wheat, *Puccinia graminis tritici*," *Nature*, 128: 67-68, 1931.
- DILLON-WESTON, W. A. R., AND E. T. HALNAN, "The fungicidal action of ultra-violet radiation," *Phytopathology*, 20: 959-965, 1930.
- DIMOND, ALBERT, AND B. M. DUGGAR, "Some lethal effects of ultra-violet radiation on fungus spores," *Proc. Nat. Acad. Sci.*, 27: 459-468, 1941.
- EMMONS, C. W., AND HOLLAENDER, A., "The action of ultraviolet radiation on dermatophytes. II. Mutations induced in cultures of dermatophytes by exposure of spores to monochromatic ultraviolet radiation," *Am. J. Botany.*, 26: 467-475, 1939.
- FROMME, F. D., "Negative heliotropism of urediniospore germ tubes," *Am. J. Botany*, 2: 82-85, 1915.
- FULTON, H. R., AND W. W. COBLENTZ, "The fungicidal action of ultra-violet radiation," *J. Agr. Research*, 38: 159-168, 1929.
- GREANEY, F. J., AND J. E. MACHACEK, "The production of a white fertile saltant of *Helminthosporium sativum* by means of ultra-violet radiation," *Phytopathology*, 23: 379-383, 1933.
- HARVEY, E. NEWTON, *Living light*. 328 pp. Princeton University Press. 1940. (Cf. pp. 37-42.)

- HASKINS, C. P., AND C. N. MOORE, "The inhibition of growth in pollen and mold under x-ray and cathode-ray exposure," *Radiology*, 23: 710-719, 1934.
- HEDGCOCK, G. G., "Zonation in artificial culture of *Cephalothecium* and other fungi," *Mo. Botan. Garden, Ann. Rept.*, 1906: 115-117, 1906.
- HOLLAENDER, A., AND C. W. EMMONS, "The action of ultraviolet radiation on dermatophytes. I. The fungicidal effect of monochromatic ultraviolet radiation on the spores of *Trichophyton mentagrophytes*," *J. Cellular Comp. Physiol.*, 13: 391-402, 1939.
- HUTCHINSON, A. H., AND M. R. ASHTON, "The effect of radiant energy in growth and sporulation in *Colletotrichum phomoides*," *Can. J. Research*, 3: 187-198, 1930.
- HUTCHINSON, A. H., AND D. NEWTON, "The specific effects of monochromatic light on the growth of yeast," *Can. J. Research*, 2: 249-263, 1930.
- INGOLD, C. T., *Spore discharge in land plants*. 178 pp. Clarendon Press, Oxford. 1939.
- LANDEN, E. W., "Spectral sensitivity of spores and sporidia of *Ustilago zea* to monochromatic ultra-violet light," *J. Cellular Comp. Physiol.*, 14: 217-226, 1939.
- LOCKWOOD, L. B., K. B. RAPER, A. J. MOYER, AND R. D. COGHILL, "The production and characterization of ultraviolet-induced mutations in *Aspergillus terreus*. III. Biochemical characteristics of the mutations," *Ann. J. Botany*, 32: 214-217, 1945.
- LONG, W. H., AND R. M. HARSCH, "Cultures of wood-rotting fungi on artificial media," *J. Agr. Research*, 12: 33-82, 1918.
- MOREAU, F., "Sur les zones concentriques que forment dans la cultures les spores de *Penicillium glaucum*," *Bull. soc. bot. France*, 59: 491-495, 1912.
- NADSON, G. A., "De certaines irregularités des changements de la 'matière vivante' sans l'influence des facteurs externes, principalement des rayons X et du radium," *Actualites Sci. Ind.*, 513: 1-26, 1937.
- NADSON, G. A., AND G. PHILIPPOV, "Influence des rayons X sur la sexualité et la formation des mutantes chez les champignons inférieurs (Mucorinées)," *Compt. rend. soc. biol.*, 93: 473-475, 1925.
- OSTER, R. H., "Results of irradiating *Saccharomyces* with monochromatic ultra-violet light," *J. Gen. Physiol.*, 18: 71-88, 1934.
- PARR, ROSALIE, "The response of *Pilobolus* to light," *Ann. Botany*, 32: 177-205, 1918.
- PICHLER, F., AND A. WÖBER, "Bestrahlungsversuche mit ultraviolettem Licht, Röntgenstrahlen, und Radium zur Bekämpfung von Pflanzenkrankheiten," *Zentr. Bakt., Parasitenk., II Abt.*, 57: 319-327, 1922.
- PRINGSHEIM, E. G., AND V. CZURDA, "Phototropische und ballistische Probleme bei *Pilobolus*," *Jahrb. wiss. Botan.*, 66: 869-872, 1927.
- RAMSEY, G. B., AND A. A. BAILEY, "Effects of ultra-violet radiation on sporulation in *Macrosporium* and *Fusarium*," *Botan. Gaz.*, 89: 113-136, 1930.
- REIDEMEISTER, W., "Die Bedingungen der Sklerotien und Sklerotienringbildung von *Botrytis cinerea* auf kunstlichen Nährboden," *Ann. Mycol.*, 7: 19-44, 1909.

- SANSOME, E. R., M. DEMEREC, AND A. HOLLAENDER, "Quantitative irradiation experiments with *Neurospora crassa*. I. Experiments with X-rays," *Am. J. Botany*, 32: 218-226, 1945.
- SHARP, D. G., "A quantitative method of determining the lethal effect of ultra-violet light on bacteria suspended in air," *J. Bact.*, 35: 589-599, 1938.
- SMITH, ELIZABETH C., "Effects of ultra-violet radiation and temperature on *Fusarium*. II. Stimulation," *Bull. Torrey Botan. Club*, 62: 151-164, 1935.
- "Effects of radiation on fungi." In *Biological effects of radiation*, II: 889-918, 1936.
- STEVENS, F. L., "Effect of ultra-violet radiation on various fungi," *Botan. Gaz.*, 86: 210-225, 1928.
- "The response to ultra-violet irradiation shown by various races of *Glomerella cingulata*," *Am. J. Botany*, 17: 870-881, 1930.
- "The ascigerous stage of *Colletotrichum lagenarium* induced by ultra-violet irradiation," *Mycol.*, 23: 134-139, 1931.
- WEY, H. G. VAN DER, "Über die phototropische Reaction von *Pilobolus*," *Proc. konink. Akad. Wetenschappen Amsterdam*, 32: 4-13, 1929.
- WOLF, FREDERICK A., "Fungal flora of Yucatan caves," *Carnegie Inst. Washington Pub.*, 491: 19-21, 1938.
- WYCKOFF, R. W. G., AND B. F. LUYET, "The effects of x-rays, cathode, and ultra-violet rays on yeast," *Radiology*, 17: 1171-1175, 1931.
- YARWOOD, C. E., "Diurnal cycle of ascus maturation of *Taphrina deformans*," *Am. J. Botany*, 28: 355-357, 1941.

Chapter 7

EFFECTS OF REACTION OF SUBSTRATE ON FUNGI

Among the chemical environmental influences to which fungi are generally known to respond is the reaction of the substrate. Long ago the theory was advanced that the chemical activities of acids, bases, and salts may be attributed chiefly to the ionized portions. Abundant experience has shown that fungi are more tolerant of acid ions [H^+] than of basic ions [OH^-]. If, for example, it becomes necessary to separate mixed cultures of fungi and bacteria, the growth of bacteria may be inhibited by the addition of lactic acid in the proportion of 1 drop of 50% lactic acid to 10 ml of agar in making the poured plates that are to be planted with the mixed cultures.

Many fundamental facts regarding the effects of the ionized portions were established before the differences between *total acidity* (titratable acidity) and *active acidity* (hydrogen-ion-concentration) were appreciated. The work of Clark (1899) is notable in this connection. He studied the effects of the concentration of a variety of mineral and organic acids upon the germination of spores and mycelial development of *Sterigmatocystis nigra*, *Oedocephalum albidum*, *Penicillium glaucum*, and *Botrytis cinerea*. As a result he found that the OH^- group is rather more toxic to all species than the H^+ ions and that molds differ specifically in tolerance. Furthermore, to inhibit the germination of these molds, a concentration of the mineral acids 200 to 400 times that fatal to higher plants is required.

Subsequently the classical studies of Michaelis and Sørensen on the theory of the hydrogen ion and its measurement laid the foundations of present-day knowledge. These matters, an understanding of which is essential to all biologists regardless of their special field of interests, are summarized and elucidated in a volume by Clark (1928). With the help of this book the student can learn the fundamentals of ionization, conductivity, and use of indicators, at least to a sufficient degree to be able to measure hydro-

gen-ion concentration, without mastering the underlying theories and principles.

MEANING OF HYDROGEN-ION CONCENTRATION. Substances are conceived to be aggregates of molecules; a molecule is the smallest unit of mass that possesses the characteristics of the given substance. A molecule is, however, conceived to be an aggregate of atoms, which, if all alike, constitute an element.

Included in atomic structure are positive electric units or charges (protons) and negative units (electrons). In each element protons and electrons are arranged according to a definite configuration, which is concerned with the behavior of the atoms. A complete atom may be deprived of one or more positively charged electrons, whereupon the remaining particle is a positively charged ion and is designated a cation. Some atoms, however, are able to acquire extra electrons, thereby becoming negatively charged ions which are designated anions.

The behavior of acids, bases, and salts in water solutions is attributed to the activities of their constituent ions. If, for example, an acid (base or salt) is dissolved in water, its molecules become dissociated to a certain amount. The radical of the molecule acquires an electron from the acid hydrogen atom, becoming a negatively charged ion and leaving the nucleus of the hydrogen atom positively charged. This hydrogen ion is designated as H^+ to distinguish it from the complete atom H; the remainder of the molecule may be symbolized by A^- . Dissociation of an acid may therefore be formally expressed as follows: $[HA] \rightleftharpoons [H^+] + [A^-]$. This reaction is shown to be reversible, but if temperature is kept constant, equilibrium will eventually become established. Then

$$\frac{[H^+] \times [A^-]}{[HA]} = K_a,$$

meaning that the product of the number of positively charged ions and negatively charged ions, divided by the number of undissociated molecules, is a constant for each given acid. It follows from this concept that if the value of K is large, the numerator must be large in proportion to the denominator. Such acids are strong acids. If, on the other hand, the numerator is small in proportion to the denominator, the acid is a weak acid. The intensity of reaction of an acid therefore depends upon the hydrogen-ion concentration.

MEASUREMENT OF HYDROGEN-ION CONCENTRATION. The concentration of hydrogen ions is expressed numerically in terms of a normal solution. A normal hydrogen-ion solution contains 1 gram of hydrogen ions or the equivalent per liter. Normal solutions are therefore made up on the basis of molecular weight to secure a solution containing 1 gram of hydrogen or the equivalent per liter. The dissociation constant of a 1 *N* solution of the strongest acid, HCl, at 25° C is essentially 1. The dissociation constant of the weakest acid, pure water, has been determined to be 1/10,000,000 *N*, which constitutes neutrality. It follows therefore that the dissociation constants of all other acids are fractions that range between these extremes.

The dissociation of pure water at 25° C, if expressed formally, would be written

$$\frac{[\text{H}^+] \times [\text{OH}^-]}{[\text{HOH}]} = K_w.$$

If the concentration of hydrogen ions in water is 1/10,000,000 gram (or 10^{-7} , if expressed logarithmically) and water is neutral, then the concentration of hydroxyl ions is also 1/10,000,000 gram (or 10^{-7}). The number of molecules of water dissociated is so small in comparison with the total number that [HOH] may be considered unity and omitted, making the formal equation $[\text{H}^+] \times [\text{OH}^-] = K_w$, or $[\text{H}^+] (10^{-7}) \times [\text{OH}^-] (10^{-7}) = K_w (10^{-14})$.

SIGNIFICANCE OF THE SYMBOL pH. Since the hydrogen-ion concentration of a solution is, with few exceptions, a fraction of the normal, it may be expressed as $\frac{1}{[\text{H}^+]}$, that is, the reciprocal of [H⁺]. By use of the reciprocal the negative exponent is avoided. The symbol pH is therefore used to designate the logarithm of the reciprocal of the hydrogen-ion concentration. The hydrogen-ion concentration of pure water, for example, is 1/10,000,000 *N*. Expressed otherwise,

$$[\text{H}^+] = 1 \times 10^{-7},$$

or

$$\log [\text{H}^+] = -7,$$

or

$$-\log [\text{H}^+] = +7,$$

or

$$\log \frac{1}{[\text{H}^+]} = 7,$$

or

$$\text{pH} = 7.$$

The *pH* of a solution is rarely an even decimal fraction of normal. For this reason the quantity between two succeeding fractions may be indicated by a multiplying factor. If, for instance, the concentration of ions is 0.000273 *N*, it may be written 2.73×10^{-4} . By the use of the logarithm table, it will be found that the logarithm of 2.73 = +0.434 and that of 10^{-4} = -4.000. Since the logs are added when multiplying, +0.434 + (-4.000) = -3.566. Therefore $\log \frac{1}{[H^+]} = 3.566$, or *pH* = 3.566.

If the actual figure for the hydrogen-ion concentration is sought when the *pH* value is given, it can be determined by the reverse of the procedure of calculation just described. Suppose that the given *pH* value is 9.63, which may be expressed thus: $[H^+] = 1 \times 10^{-9.63}$. The exponent -9.63 = -10 plus +0.37; or, otherwise stated, it equals $10^{-10} \times 10^{+0.37}$. The logarithm table shows that +0.37 corresponds with the number 2.34. Substitution of this number in the original equation, $[H^+] = 1 \times 10^{-9.63}$, gives the identity $[H^+] = 2.34 \times 10^{-10}$.

In acids dissociated in water, the concentration of hydrogen ions must be greater than that of the water itself and therefore must range between *pH* 7.0 (the hydrogen-ion concentration of water) and *pH* 0. Likewise, bases dissociated in water have a hydroxyl-ion concentration greater than that of water itself, so that this concentration can range between *pOH* 7.0 (the hydroxyl-ion concentration of water) and *pOH* 0 (the hydroxyl-ion concentration of a normal basic solution). Since the acid or base was dissociated in water, $[OH^-]$ ions are always present in acid solutions and $[H^+]$ ions in basic solutions. The concentration of hydrogen ions therefore varies inversely as the concentration of hydroxyl ions, and vice versa, the product of the concentration of both kinds being always 1×10^{-14} . From this relation it is evident that, if the concentration of either ion is known, that of the other can be readily computed. Thus if the *pH* of a solution is 10^{-4} , the *pOH* is 10^{-10} . From the foregoing discussion it is apparent that any *pH* value between 0 and 7 indicates an acid solution, with decreasing acidity as the number increases. Similarly, any *pH* value between 7.0 and 14.0 indicates a basic solution with increasing basicity (decreasing acidity) as the number increases.

MEASUREMENT OF *pH*. Two methods are employed in measuring hydrogen-ion concentration, one electrometric, the other colorimetric. The electrometric method is the more accurate and

requires the more expensive and elaborate apparatus. The colorimetric method yields approximate measurements that can be simply and quickly achieved. The electrometric method depends upon the ability of solutions of acids, bases, and salts to conduct an electrical current, differences being attributable to concentration; the colorimetric method involves changes in the colors of indicators, each within a given range of pH, and the matching of colors with standards.

pH AND GROWTH. Hydrogen-ion concentration does not equally influence all the vital processes or activities of fungi, as might be anticipated. Much of what has been learned about the effects of pH and pOH on fungi has come from studies on the influence of reaction upon growth rather than upon individual processes,

TABLE 12

RANGE OF HYDROGEN-ION CONCENTRATION PERMITTING GROWTH OF VARIOUS FUNGI

Authority	Organism	Range within Which Growth Occurred
Sherwood (1923)	<i>Fusarium lycopersici</i>	2.8 and 8.4
Herrick (1939)	<i>Stereum gausapatum</i>	2.0 and 8.2
Johnson (1923)	<i>Mucor glomerula</i>	3.2-3.4 and 8.7-9.2
Johnson (1923)	<i>Fusarium bullatum</i>	2.3-2.2 and 9.2-11.2
Johnson (1923)	<i>Aspergillus oryzae</i>	1.6-1.8 and 9.0-9.3
Johnson (1923)	<i>Aspergillus terricola</i>	1.6-1.8 and 9.0-9.3
Johnson (1923)	<i>Penicillium italicum</i>	1.9-2.2 and 9.1-9.3
Johnson (1923)	<i>Penicillium variabile</i>	1.6-1.8 and 10.1-11.1
Meacham (1918)	<i>Lenzites saepiaria</i>	1.9 (optimum, 3.0)
Meacham (1918)	<i>Fomes roseus</i>	1.9 (optimum, 3.0)
Meacham (1918)	<i>Merulius lacrymans</i>	1.0 (optimum, 3.0)
Meacham (1918)	<i>Coniophora cerebella</i>	1.9 (optimum, 3.0)
Webb (1919)	<i>Lenzites saepiaria</i>	Below 2.8 and 7.4
Webb (1919)	<i>Aspergillus niger</i>	2.8 and 7.4-8.8
Webb (1919)	<i>Penicillium cyclopium</i>	Below 2.8 and approximately 9.6
Webb (1919)	<i>Botrytis cinerea</i>	Below 2.8 and 7.4
Jackson (1940)	<i>Pythium</i> sp.	2.5-3.5 and 8.5
Jackson (1940)	<i>Rhizoctonia solani</i>	2.5 and 7.5-8.5
Wolpert (1924)	<i>Lenzites saepiaria</i>	3.4 and 7.3
Wolpert (1924)	<i>Daedalea confragosa</i>	3.5 and 7.2
Wolpert (1924)	<i>Polystictus versicolor</i>	2.5 and 7.6
Wolpert (1924)	<i>Armillaria mellea</i>	2.9 and 7.4
Wolpert (1924)	<i>Pholiota adiposa</i>	2.8 and 7.0
Wolpert (1924)	<i>Polyporus adustus</i>	3.5 and 7.6
Wolpert (1924)	<i>Pleurotus ostreatus</i>	3.0 and 7.5
Wolpert (1924)	<i>Schizophyllum commune</i>	3.4 and 7.0

such as reproduction, respiration, and enzyme production. In general, these studies have been concerned with establishing the range of pH within which growth can be accomplished. All show that optimum growth occurs if the media are acid, and there is abundant evidence to indicate that the range of pH that will permit growth varies with the species, with the composition and

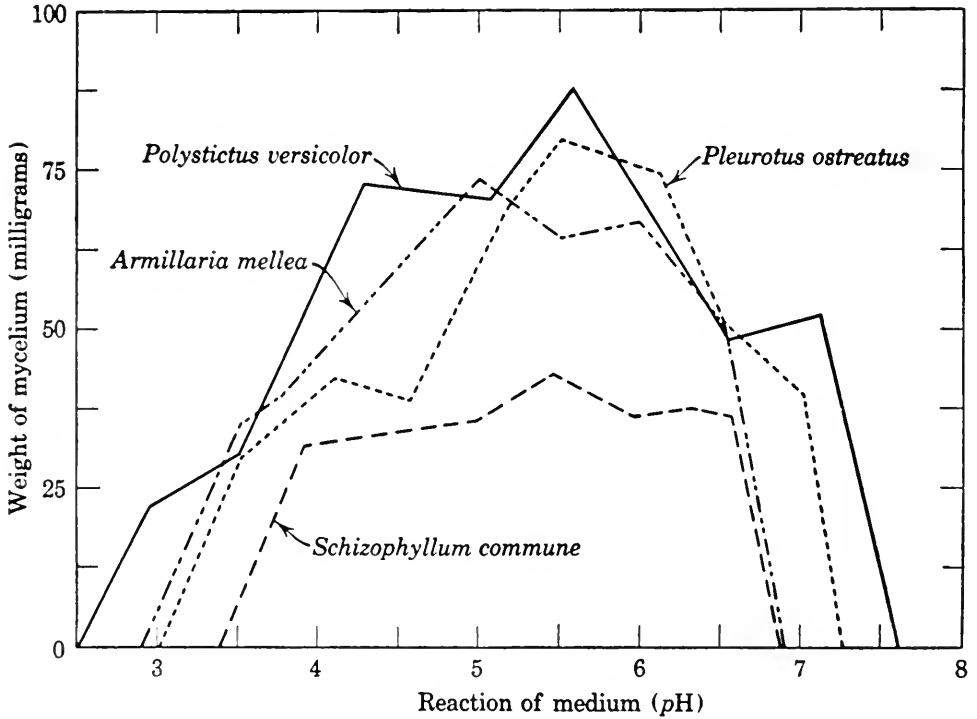

FIG. 23. Growth of certain Basidiomycetes in Richards' solution adjusted to different initial degrees of acidity. Cultures maintained at 25° C. (After Wolpert.)

the initial reaction of the culture medium, and with temperature. Representative results of the influence of reaction upon growth of fungi are assembled in Table 12.

The most significant feature indicated by Table 12 is that essentially all the region of pH permitting growth lies within the acid range. As a secondary feature it is apparent that each species may differ in the limits of this range. It should be indicated that the optimum pH does not occur at the midpoint. The underlying reasons for these facts seem to rest upon the isoelectric points of the constituent proteins of the different species, as shown by Robbins (1924). In *Rhizopus nigricans* and *Fusarium lycopersici*

the isoelectric points of the proteins were shown to be in the vicinity of pH 5.0 and 5.5, respectively. When Robbins stained the mycelial mat of *R. nigricans* with an acid dye, it retained the dye on the acid side of the isoelectric point, but the mycelium was unstained on the basic side. This result was determined by washing mycelia stained with eosin, for example, with solutions of pH 3.5, 3.9, 4.5, 5.7, 5.8 and 6.9. These solutions were made with appropriate mixtures of 0.1 M phosphoric acid and of 0.1 M sodium hydroxide. After thorough washing with a buffer solution of pH 3.5 or 3.9, the mycelia were bright red; with a solution of pH 4.5, intermediate red; with a solution of pH 5.7 or 5.8, pink; with a solution of pH 6.9, hyaline.

VARIATION OF pH RANGE WITH MEDIA. Failure of various workers to agree on the pH range that will support growth in a given fungus may be attributed to differences in culture media. These differences involve kind and proportion of nutrients, buffering, and initial reaction. The influence of the composite of these factors is illustrated by the work of Wolpert (1924). He employed a modified Richards' solution, on the one hand, and a 2.5% peptone-mineral nutrient, on the other, with the results shown in Table 13.

TABLE 13

COMPARISON OF pH RANGE OF CERTAIN BASIDIOMYCETES ON TWO DIFFERENT MEDIA

Organisms	pH Range That Inhibits Growth	
	Richards' solution	Peptone solution
<i>Lenzites saepiaria</i>	3.4 and 7.3	2.8 and 7.5
<i>Daedalea confragosa</i>	3.5 and 7.2	2.8 and 7.6
<i>Polystictus versicolor</i>	2.5 and 7.6	2.5 and 7.5
<i>Armillaria mellea</i>	2.9 and 7.4	2.0 and 7.8
<i>Pholiota adiposa</i>	2.8 and 7.0	2.8 and 7.8
<i>Pleurotus ostreatus</i>	3.0 and 7.5	3.0 and 8.5
<i>Schizophyllum commune</i>	3.4 and 7.0	2.8 and 8.5

During growth each species increased the acidity in Richards' solution, *Lenzites saepiaria* being the most active acid-producer. All of them except *L. saepiaria* and *Pleurotus ostreatus* decreased the acidity in peptone solution when the initial reaction was less than pH 6.0 and increased it when the initial reaction was greater than pH 6.0.

As is well-known, temperature modifies the rate of growth, but it is also an important factor in modifying the pH range. Temperatures favorable for optimal development tend to be correlated with the widest pH range. Wolpert (1924) grew each of the species listed in Table 13 at 15° C, 25° C, and 35° C, all other factors being identical. *Lenzites saepiaria*, *Pleurotus ostreatus*, and *Armillaria mellea* have high optimal temperatures, *Schizophyllum commune* has a low one, and the remainder have intermediate optimal temperature requirements.

The comparative growth of *Ophiobolus graminis* on Czapek's nutrient fortified with cane sugar and on corn-meal decoction led Webb and Fellows (1936) to conclude that the nutritional and physical nature of the media, irrespective of all other factors, greatly modifies the influence exerted by free hydrogen or hydroxyl ions on the growth of fungi.

pH OF FUNGUS TISSUES. Essentially nothing is known about the hydrogen-ion concentration of fungus tissues. Armstrong (1929) measured the reaction of the juice of crushed stipes and pilei of certain fleshy fungi, with the results shown in Table 14.

TABLE 14

HYDROGEN-ION CONCENTRATION OF FUNGUS TISSUES

Fungus	pH
<i>Agaricus campestris</i>	Ca. 5.9
<i>Amanita muscaria</i>	6.2
<i>Armillaria mellea</i>	5.6-5.9
<i>Clavaria rugosa</i>	Ca. 6.2
<i>Clavaria corniculatus</i>	Ca. 6.2
<i>Clitocybe laccata</i>	6.2
<i>Collybia radicata</i>	5.9
<i>Coprinus atramentarius</i>	6.2-6.8
<i>Coprinus micaceus</i>	5.6-5.9
<i>Cortinarius violaceus</i>	6.2
<i>Helvella crispa</i>	6.2
<i>Hypoholoma fasciculare</i>	Ca. 5.9
<i>Lactarius blennius</i>	Ca. 5.6
<i>Leotia chlorocephala</i>	5.6-6.2
<i>Mycena pura</i>	Ca. 5.9
<i>Mycena vulgare</i>	Ca. 5.9
<i>Panus torulosus</i>	5.6-5.9
<i>Polystictus versicolor</i>	5.9
<i>Typhula incarnata</i>	Ca. 5.9

These determinations of pH may not necessarily be those of the vacuolar sap, just as the pH of the crushed tissues of green plants may not be that of the cell sap. They appear of interest in indicating that fungus tissues are acid. Recognition of their significance, however, awaits the development of methods for determining true pH values of fungus-cell sap.

pH AND PIGMENTATION. The pigments in many species of fungi may function as natural indicators that change color with a change of reaction. One factor that controls the development of pigment, moreover, is the reaction of the medium. The presence of appropriate carbohydrates may also constitute a controlling factor. These relationships with species of *Fusarium* were studied by Sideris (1925). If he employed dextrose solutions and made no attempt to control the changes in reaction during growth, pigment was produced within the range pH 3.0 to 7.5. If the pH was kept constant, pigment was produced only within the range 3.5 to 5.5.

pH AND ENZYMIC ACTIVITY. The effect of pH on enzymic activity was mentioned in Chapter 2. Evidently the effect of reaction upon individual metabolic processes in fungi has not been the subject of much study. Karrer (1921) recorded that *Fusarium* sp. from cotton, when grown in nutrient solution, yield the greatest total amount of amylase if the initial reaction is pH 4.5 and the final reaction is pH 7.8; *Colletotrichum gossypii*, if the initial reaction is pH 7.0 and the final is pH 7.9. For *Penicillium italicum* pH 3.0 and pH 4.5 are equally favorable. Amylase accumulation is completely inhibited within the range pH 9.0 to 11.0 in *Fusarium* sp. and in *C. gossypii*, and at pH 9.0 in *P. italicum*. Further evidence of the influence of hydrogen-ion concentration upon the activity of amylase was presented by Sherman, Thomas, and Baldwin (1919). They showed that pancreatic amylase is active within the range pH 4.0 to 10, pH 7.0 being optimum; malt amylase within the range pH 2.5 to 9.0, pH 4.4 to 4.5 being optimum; and amylase from *Aspergillus oryzae* within the range pH 2.6 to 8.0, pH 4.8 being optimum.

CORRELATION OF REACTION OF THE SOIL, OPTIMUM pH OF THE PATHOGEN, AND INCIDENCE OF DISEASE. Experimentation involving these matters in connection with soil-borne pathogens has engaged the attention of certain plant pathologists, notably Chupp

(1928), MacInnes (1922), Schaffnit and Meyer-Hermann (1930), Sherwood (1923), and Sideris (1929).

Schaffnit and Meyer-Hermann (1930) determined the pH optima for growth of a group of soil-borne fungi as a basis for

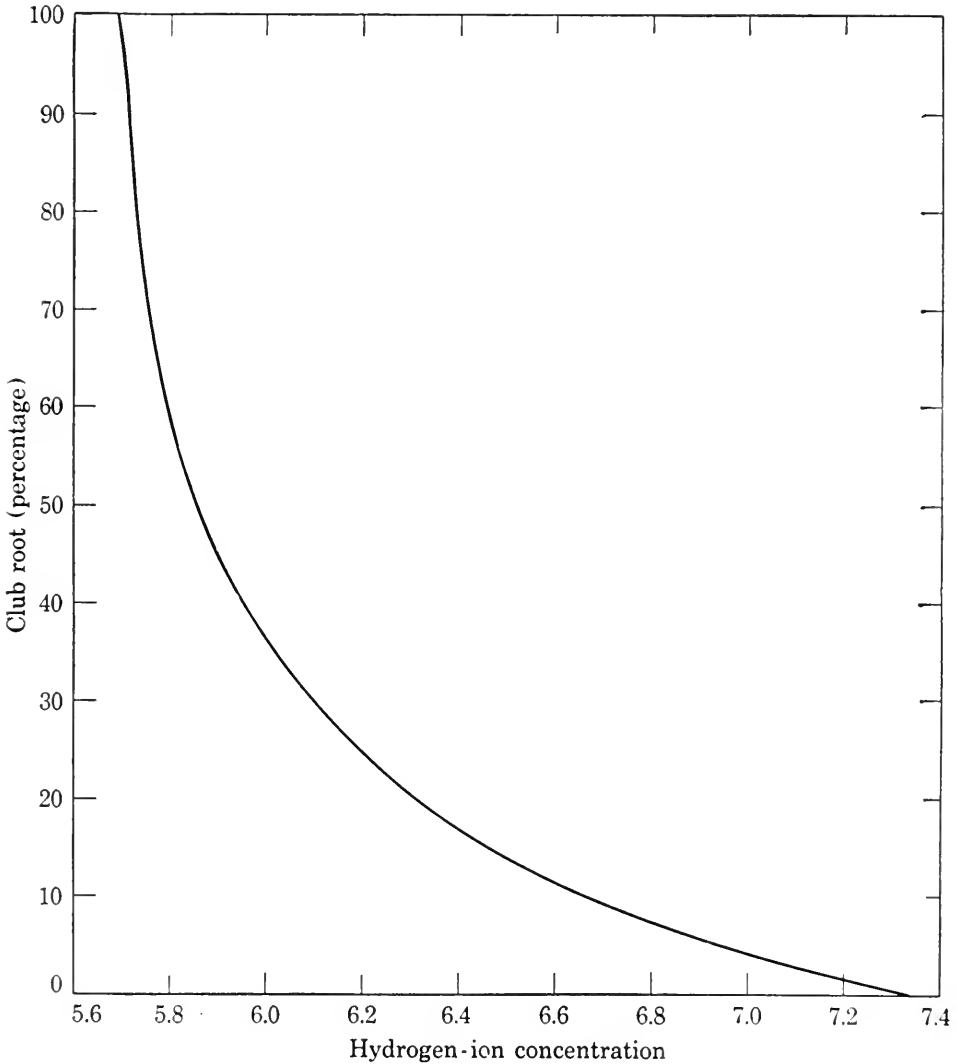

FIG. 24. Relation of hydrogen-ion concentration to infection of cabbage by *Plasmodiophora brassicae*. Infection is inhibited as alkalinity is approached. (After Chupp.)

their field trials. From these results they concluded that such organisms may be grouped as follows:

1. *Litrophilic*: those that prefer alkaline soils, including *Pythium de baryanum*, *Moniliopsis aderholdii*, *Fusarium nivale*, *F. equiseti*, *Ophiobolus graminis*, and *Typhula gramineum*. If the soils are

made acid, *F. nivale*, *O. graminis*, and *T. gramineum* may disappear.

2. *Mesanthrophilic*: those that thrive best in neutral soils, including *Fusarium aurantiacum*, *F. avenaceum*, *F. herbarum*, *Phoma betae*, and *Thielavia basicola*.

3. *Oxyphilic*: those that thrive best in acid soils, including *Plasmodiophora brassicae* and *Rhizoctonia violacea*. If the soil reaction reaches pH 7.5, *P. brassicae* is checked. *Synchytrium endobioticum* may also be placed within the oxyphilic group, but it is actually intermediate between this group and the astatic group.

4. *Astatic*: those that possess the ability to thrive in a wide range of soil reactions, including *Fusarium culmorum*, *F. polymorphum*, *Helminthosporium sativum*, *Ophiobolus herpotrichus*, and *Rhizoctonia solani*.

Schaffnit and Meyer-Hermann (1930) indicate that not only is the reaction changed by the addition of acid or basic materials to soil but also that such changes are always accompanied by changes in the physical properties of the soil. Furthermore it has become a matter of common knowledge that changes in reaction may not be permanent and that changed availability of minerals to growing crops accompanies changes in soil reactions.

Chupp (1928) noted that pH 7.2 to 7.4 is the upper limit at which *Plasmodiophora brassicae* causes club root of crucifers and that in the range more acid than pH 6.0 all the plants may be affected.

In black-root rot of tobacco, soil reaction and soil temperature are correlated factors. Doran (1929) observed that this disease does not develop at any temperature provided that the pH of the soil is 5.6 or lower. Marked injury is apparent, however, at 15° C with pH 5.7; at 18° C with pH 5.7 to 5.8; at 21° C with pH 5.8; at 27° C with pH 5.8 to 5.9. At 30° C there was little, if any, injury with pH values of 6.0 to 6.9.

That acid soils yield a scab-free crop of potatoes, unless lime is applied, is the common experience of potato growers. Studies by Gillispie (1918) on the scab organism, *Actinomyces chromogenus*, showed that it is inhibited at pH 4.8 to 5.2, varying with the isolates. He correlated these results with the fact that the acidity of Caribou loam of Maine ranges from 4.9 to 5.5 and hence may restrain the growth of the scab organism.

ALKALINE FUNGICIDES. In the light of observations that fungi generally grow better in acid than in basic media, various attempts have been made to utilize this fact in wood preservation and the

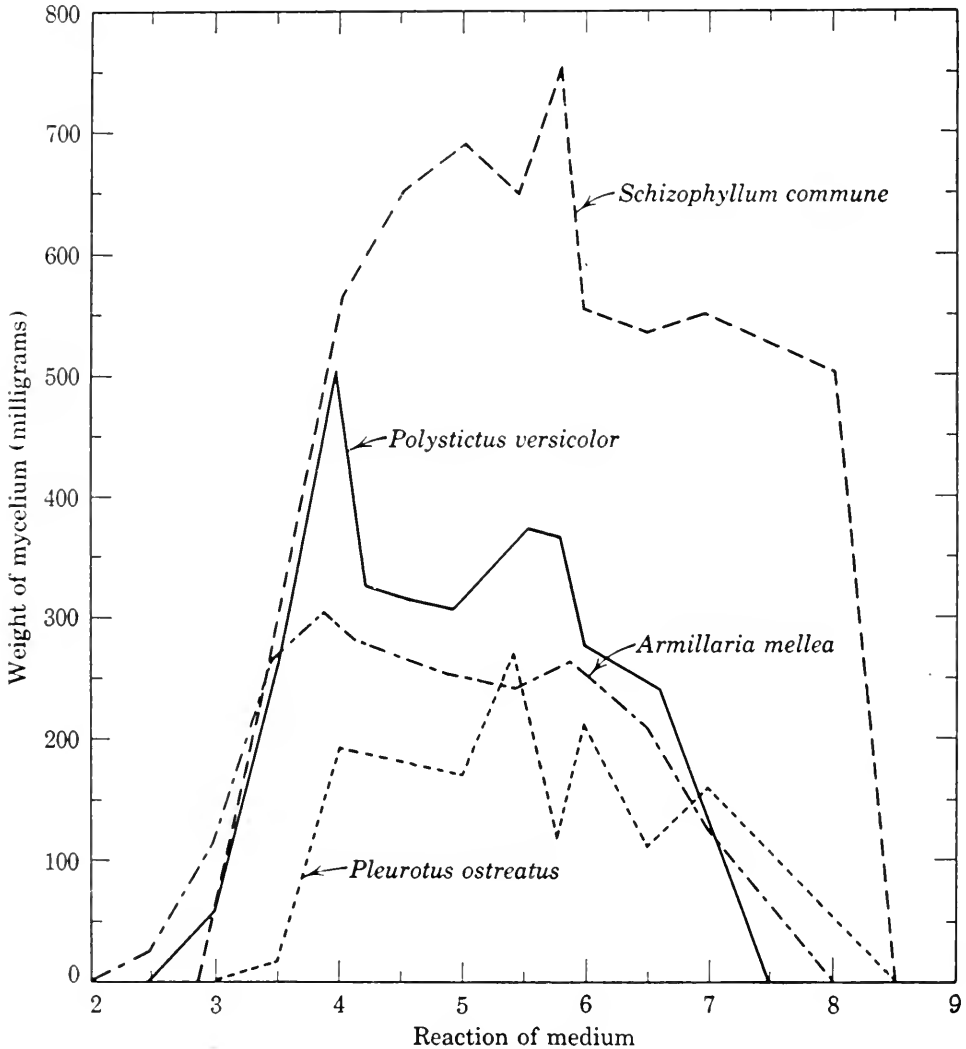

FIG. 25. Growth of certain Basidiomycetes at 25° C in peptone nutrient solutions with varying initial reactions. Comparison with Fig. 23 shows that nutrition is also a factor in growth. (After Wolpert.)

prevention of decay in fruits. Stains of sapwood can be largely prevented if the lumber is dipped into an alkaline bath immediately after it is sawn [Scheffer and Lindgren (1940)]. Such treatment gives protection until the water content of the lumber can be reduced to 20% or less, at which point lack of moisture inhibits the growth of sapwood-staining species.

Attempts to prevent the decay of apples and oranges by use of alkaline dips have been less successful. Marloth (1931) recorded that sodium tetraborate is more toxic to *Penicillium digitatum* than to *P. italicum*, but that sodium bicarbonate is more toxic to *P. italicum*. Attempts to prevent decay of citrus fruits by these molds and by *Phomopsis citri* and *Diplodia natalensis* have not been uniformly successful, presumably because the mycelia early become internal to the "buttons" or cut pedicels and because the spores of *Penicillium* are difficult to wet.

IMPLICATIONS. The totality of evidence from studies of the effects of reaction on fungi shows convincingly that *pH* is an environmental factor of enormous consequence in modifying their metabolic activities. There is specificity of minimal, optimal, and maximal *pH* requirements, but it must not be overlooked that the effects of the concentration of hydrogen ions cannot be isolated completely from those induced by other ions. These effects are always intricately correlated. For this reason it is not unlikely that in the past too much consideration has been given to the influence of the hydrogen ion and too little to that of other ions. No doubt this situation prompted the supercilious suggestion that doctoral dissertations dealing with these problems may be regarded as fulfilling requirements for the "*pH D.*"

So long as growth continues in a fungus culture, the reaction of the medium continues to change, although the changes may be masked by relatively large amounts of buffer substances present in the medium. In other words, the analytic and synthetic processes that occur during utilization of organic substrates result in the production of many kinds of organic acids and such other products as pigments, polysaccharides, sterols, and vitamins (see Chapter 4). Among the acids known to be produced by fungi are aconitic, carlic, carlosic, carolic, dimethylpyruvic, fulvic, fumaric, gallic, glycolic, glycuronic, itaconic, kojic, malic, *d*-mannonic, mycophenolic, oxalic, penicillic, puberulic, pyruvic, spiculisporic, succinic, and terrestric. It would seem that determination of the kinds of acids produced in fungus metabolism and the conditions influencing their production should be given increasing consideration, rather than devoting so much attention to accumulation of data on *pH* changes during growth.

LITERATURE CITED

- ARMSTRONG, J. I., "Hydrogen-ion phenomena in plants. I. Hydrion concentration and buffers in fungi," *Protoplasma*, 8: 222-260, 1929.
- CHUPP, C., "Club root in relation to soil alkalinity," *Phytopathology*, 18: 301-306, 1928.
- CLARK, W. M., *The determination of hydrogen ions*, 3rd ed. xvi + 717 pp. Williams and Wilkins Co., Baltimore. 1928.
- CLARK, J. F., "On the toxic effect of deleterious agents on the germination and development of certain filamentous fungi," *Botan. Gaz.*, 28: 289-327, 378-404, 1899.
- DORAN, W. L., "Effects of soil temperature and reaction on growth of tobacco infected and uninfected with black-root rot," *J. Agr. Research*, 39: 853-872, 1929.
- GILLISPIE, J. L., "The growth of the potato-scab organism at various hydrogen-ion concentrations as related to the comparative freedom of acid soils from potato scab," *Phytopathology*, 8: 257-269, 1918.
- HERRICK, J. A., "Growth and variability of *Stereum gausapatum* in culture," *Phytopathology*, 19: 504-511, 1939.
- JACKSON, L. W. R., "Effects of H-ion and Al-ion concentrations on damping-off of conifers and certain causative fungi," *Phytopathology*, 30: 563-579, 1940.
- JOHNSON, H. W., "Relationships between hydrogen-ion, hydroxyl-ion, and salt concentrations, and the growth of seven soil moulds," *Iowa Agr. Expt. Sta. Research Bull.*, 76: 307-344, 1923.
- KARRER, JOANNE L., "Studies in the physiology of the fungi. XIII. The effect of hydrogen-ion concentration on amylase produced by certain fungi," *Ann. Mo. Botan. Garden*, 8: 63-96, 1921.
- MACINNES, JEAN, "The growth of the wheat-scab organism in relation to hydrogen-ion concentration," *Phytopathology*, 12: 290-294, 1922.
- MARLOTH, R. H., "The influence of hydrogen-ion concentration and of sodium bicarbonate and related substances on *Penicillium italicum* and *P. digitatum*," *Phytopathology*, 21: 169-198, 1931.
- MEACHAM, M. R., "Note upon the hydrogen-ion concentration necessary to inhibit the growth of four wood-destroying fungi," *Science*, 48: 499-500, 1918.
- ROBBINS, W. J., "Isoelectric points for the mycelium of fungi," *J. Gen. Physiol.*, 6: 259-271, 1924.
- SCHAFFNIT, E., AND K. MEYER-HERMANN, "Über den Einfluss der Bodenreaktion auf der Lebensweise von Pilzparasiten und das Verhalten ihrer Wirtspflanzen," *Phytopath. Z.*, 2: 99-166, 1930.
- SCHEFFER, T. C., AND R. M. LINDGREN, "Stains of sapwood and sapwood products and their control," *U. S. Dept. Agr. Tech. Bull.*, 714: 124 pp. 1940.
- SHERMAN, H. C., A. C. THOMAS, AND M. E. BALDWIN, "Influence of hydrogen-ion concentration upon enzymic activity of three typical amylases," *Am. Chem. Soc. J.*, 41: 181-239, 1919.

- SHERWOOD, E., "Hydrogen-ion concentration as related to the Fusarium wilt of tomato seedlings," *Am. J. Botany*, 10: 537-553, 1923.
- SIDERIS, C. P., "The role of the hydrogen-ion concentration on the development of pigment in Fusaria," *J. Agr. Research*, 30: 1011-1019, 1925.
- "The effect of the H-ion concentration of the culture solution on the behavior of *Fusarium chromophythoron* and *Allium cepa* and the development of pink-rot-disease symptoms," *Phytopathology*, 19: 233-268, 1929.
- WEBB, R. W., "Studies in the physiology of the fungi. X. Germination of the spores of certain fungi in relation to hydrogen-ion concentration," *Ann. Mo. Bot. Garden*, 6: 201-222, 1919.
- WEBB, R. W., AND H. FELLOWS, "The growth of *Ophiobolus graminis* Sacc. in relation to hydrogen-ion concentration," *J. Agr. Research*, 33: 845-872, 1936.
- WOLPERT, F. S., "Studies in the physiology of the fungi. XVII. The growth of certain wood-destroying fungi in relation to the H-ion concentration of the media," *Ann. Mo. Bot. Garden*, 11: 48-96, 1924.

Chapter 8

SPORE DISSEMINATION

All students of fungi are impressed with the seemingly limitless profligacy of these organisms in the production of spores. Arthur (1929) records that more than 2 billion sporidia may be formed by a single gall of *Gymnosporangium juniperi-virginianae*. *Fomes applanatus*, which may attain a size of 0.75×0.5 meters, may have an annual production of 5 million million spores. The crop of aeciospores from a single barberry bush was found by careful computation to be 64,512,000,000. The pileus of *Psalliota campestris* may produce 1,800,000,000 basidiospores, that of *Coprinus comatus* 5 billion, and that of *Polyporus squamosus* 11 billion.

Meyer (1936) reported that a sporophore of *Fomes fomentarius* shed 1115 grams of spores in a period of 20 days. Each spore had a computed weight of 0.000,000,000,146 gram. The calculated number of spores produced by this sporophore, therefore, was 7,636,986,301,369.

Moss (1940) estimated the number of spores formed by *Calvatia gigantea* as 20 million million. This ability to produce spores in abundance is made possible among many Basidiomycetes by the large size of the fructifications and by such structural modifications as gills and pores that increase the spore-bearing surface. Certain leathery and woody polypores have been found to be capable of shedding spores continuously for 6 months or longer. Organisms in other groups may shed spores in abundance only under special conditions. *Monilia sitophila*, for example, may cover burned sugar-cane stubbles to the extent that acres of landscape look pink. The metallic-lustered *Blakeslea trispora* may be equally widely prevalent on mowed, withered *Sida spinosa* and other weeds in orange groves. Heald (1937) states that *Tilletia tritici* may be so abundant during the threshing season in eastern

Washington that over 5 million smut spores lodge on each square foot of soil.

Of much more interest than the ability of fungi to produce spores in abundance is the development of mechanisms or devices that serve to provide maximum distribution of these spores. Survival of given species may in large part be conditioned by dispersal into habitats where food is available. In most species of fungi special mechanisms are lacking, and hence distribution, among both aquatic and terrestrial forms, appears to be largely fortuitous.

DISTRIBUTION OF SPORES

AQUATIC FUNGI. The environment in which aquatic species exist is more constant than the habitat of terrestrial species, and correlated with this fact is the possibility that a larger proportion of their spores may germinate and develop into new individuals. For these reasons problems of dissemination of aquatic fungi might not be expected to stimulate as much interest as similar problems involving terrestrial fungi. Nearly all aquatic fungi are among the Phycomycetes, the spores of many of which are motile (planetic). The most primitive of these are holocarpic. Each such plant produces 20 to 30 spores, each of which possesses a single flagellum. After a brief period of motility, which rather closely restricts the distance that the spore may migrate from the parent plant, the spore initiates the assimilatory phase of the cycle of development. After a few days the sporangium is again mature, and conditions for dispersal have once more been prepared.

Other more highly specialized species possess differentiated sporangia or other sporiferous cells, from which cells having two flagella are liberated. Evidence is lacking that biflagellate species are significantly better able to disseminate themselves and to compete to greater advantage than monoflagellate ones. Undoubtedly diplanetism, that is, two morphologically distinct motile stages that always occur sequentially, so highly developed among the Saprolegniales, must be regarded as an evolutionary advance over monoplanetism. In the Saprolegniales diplanetism is accompanied by certain morphological differences in spores whose significances are wholly unknown. Typically, on first escaping from the sporangium the swarm spores are pear-shaped and terminally biflagellate. After swarming for a brief period, they encyst and then

escape from the cyst as reniform, laterally biflagellate swimmers. Encystment follows; after this stage they give rise to germ tubes. This pattern of behavior varies in the different genera. Sometimes polyplanetism occurs as reported by Weston (1919) in *Dicthyuchus*, by Höhnk (1933) in *Saprolegnia torulosa* and *Achlya racemosa*, and by Salvin (1940) in *Achlya*, the number of swarmings being controlled by reserve food in the swarm spore and by unknown environmental factors.

TERRESTRIAL FUNGI. Various adaptations occur among terrestrial fungi to aid in their geographic distribution. The spores of many are pulverulent, so that dissemination by air currents is favored. Others accumulate in a mucous matrix that is water soluble, the occurrence of dews and rains being required for spore dissemination. Some become wet with ease, others with difficulty; some have thin walls, others very thick, resistant walls; some are smooth, others are armed with spines, tubercles, or echinulations. The fructifications of some species are malodorous, encouraging visitation by flies, bees, ants, and other insects, whereas others are attractive to mycophagous animals, such as nematodes, beetles, snails, slugs, and rodents.

For convenience of discussion the dissemination or dispersal of fungi may be considered to be accomplished by (*a*) agencies related to the environment of the species and (*b*) the fungus itself through structural adaptations.

The environmental agencies include movement of air as convection currents and winds, movement of water, occurring as dew, rains, and streams, and transport by insects and other animals, including man. Many species are dispersed on seed, fruits, cuttings, seedlings, and transplants.

AIR CURRENTS AS A FACTOR IN DISPERSAL. For nearly 150 years it has been taken for granted from observational evidence that the spores of fungi are wind-borne. Proof that wind is an important agency in the spread of pathogenic fungi has been forthcoming only in recent years. It arose from attempts to explain the occurrence of epidemics, especially of rusts. According to Arthur (1929), Marshall reported the following observations made in 1782 upon the results of planting a barberry bush in a field of wheat: "About the barberry bush there appeared a long but somewhat oval-shaped stripe of a dark livid color, obvious to a person riding on the road at a considerable distance. The part

affected resembled the tail of a comet, the host itself representing the nucleus, on one side of which the sensible effect reached about twelve yards, the tail pointing toward the southwest, so that probably the effect took place during a northeast wind. . . . As the distance from the bush increased, the effect was less discernible, until it vanished imperceptibly." Ward (1882), in connection with studies on *Hemileia vastatrix* in Ceylon, was among the first to demonstrate that rusts are wind-borne; he trapped the urediniospores on slides coated with glycerin. Klebahn (1904) believed wind responsible for bringing grain-rust spores to Germany, because during a dust storm which swept from northern Africa to northern Europe, he caught 3800 spores of *Puccinia graminis* at Hamburg and 5600 at Thüringen in cotton-batting spore traps, 4 in. in diameter.

Within the United States a volume of evidence has been accumulated to show that the grain rusts are unable to survive the winter in the cold climates of the central part of the Cereal Belt, where the alternate host is absent, and that urediniospores are carried northward from Mexico and Texas toward Canada. By means of aeroplanes, Stakman and his associates (1923) entrapped viable rust spores during April over Waco, Texas, at various altitudes ranging from 1000 to 16,500 ft. In late summer in Manitoba at an altitude of 5000 feet, 259 urediniospores were entrapped on 2 sq in. of surface in one instance, and 116 urediniospores in another.

The later work of Stakman *et al.* (1940) showed that the teliospores of *Puccinia graminis* are of no consequence in the annual cycle of this rust in the South. The uredinial stage does not survive the winters north of Texas or the summers in Texas and areas southward. In the North rust is dependent on barberry and on urediniospores blown in from farther south. Toward the end of summer and in the fall urediniospores are blown southward, and the rust survives the winter in fields of early-sown wheat in Texas and northern Mexico.

Observations by Pennington (1924) indicate that aeciospores of *Cronartium ribicola*, while usually carried only a few hundred feet, may under exceptional conditions be transported 150 to 200 miles and then cause infection. *Gymnosporangium juniperi-virginianae* was found by Schneiderhan (1926) to have produced

11.5 spots per leaf on apple trees $1\frac{1}{2}$ miles away from infected cedars and 0.32 spot per leaf on trees 3 miles distant.

The foregoing evidence regarding dispersal of rusts by air currents is representative for this group of fungi but is inadequate in indicating the importance of this agency for other groups of fungi. Stakman and his coworkers (1923) identified other genera, such as *Alternaria*, *Helminthosporium*, *Cladosporium*, *Cephalothecium*, and *Ustilago*, on their spore traps. Heald *et al.* (1915) found that

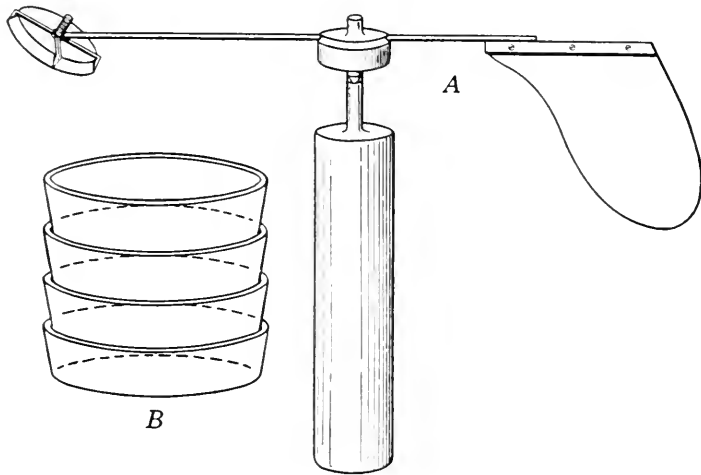

FIG. 26. Spore trap of weather-vane type. *A*. The dish whose inner surface is coated with glycerin remains directed toward the wind. *B*. Dishes may be stacked during transport.

ascospores of *Endothia parasitica* may be entrapped in the air in considerable numbers 300 to 400 ft. from diseased chestnuts, substantiating the observations of others. Many similar observations have been recorded for *Venturia inaequalis*. Burrill and Barrett (1909) showed that *Diplodia zeae* is distributed by winds; Wolf (1916) made the same observation for *Cercospora personata*. *Peronospora tabacina* is very quickly dispersed from infected tobacco seed beds to healthy ones several miles distant [Wolf *et al.* (1934)], and it is reasonable to assume that its introduction into New England and Canada was the result of the carriage of sporangia several hundred miles through the air.

The aerial dissemination of plant pathogens is briefly treated in a recent report by Craigie (1939). His studies show that the fungi causing stem rust of cereals, leaf rust of wheat, and crown rust of oats are air-borne in western Canada, being carried several

hundred miles from their place of origin. In conclusion it may be said that ample evidence has shown that fungus spores “fly through the air with the greatest of ease” [Keitt (1942), Christiansen (1942), Durham (1942)].

SPORE-TRAPPING DEVICES. Various devices for determining the presence and movement of wind-borne spores have been employed. These techniques were described and illustrated in a report by the Committee on Apparatus in Aerobiology (1941). The simplest method consists of exposing a surface coated with vaseline, glycerin, gelatin, or agar.

Rittenberg (1939) exposed agar plates on shipboard during cruises in the Pacific in the area from Monterey to the Cedros Islands and extending seaward 400 miles. He entrapped such soil-borne organisms as *Alternaria*, *Catenularia*, *Cephalosporium*, *Cladosporium*, *Penicillium*, *Spicaria*, *Sporotrichum*, *Stemphylium*, and *Trichoderma*.

Some workers have employed aspirators, by means of which a definite volume of spore-laden air is drawn through a filter of sterilized cotton or sugar crystals. Others expose dishes containing water or cotton batting. All devices are serviceable. In order to keep the sticky surface directed toward the wind, the exposure plates may be fastened to a weather vane or may be inclined from the vertical for protection from rains. The most ingenious apparatus used is the “sky hook,” as employed by Meier and Lind-

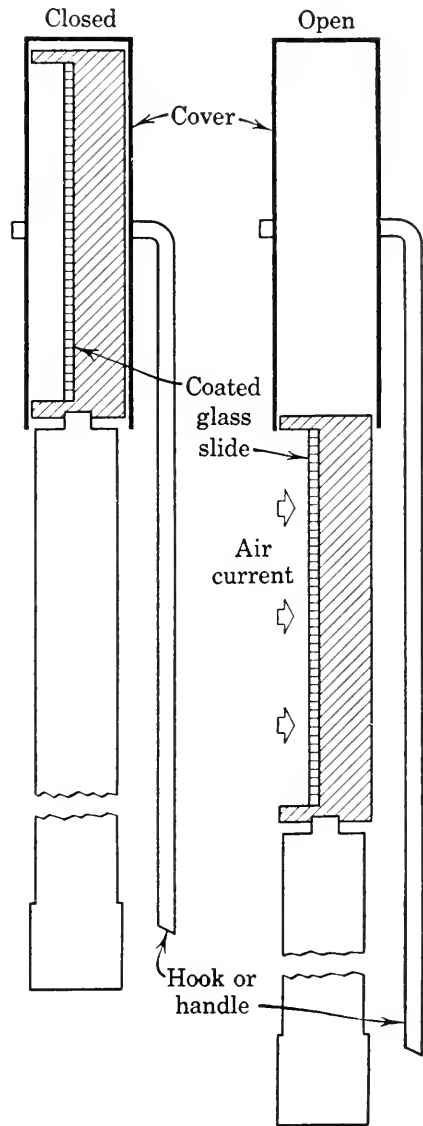

FIG. 27. Schematic representation of “sky-hook” type of spore trap. (Adapted from Meier and Lindberg.)

berg (1935) in their aerobiological studies in the Arctic. Proctor (1934) at the Massachusetts Institute of Technology used an ingenious automatic device.

RATE OF FALL OF SPORES. Rate of fall of spores in still air has been given consideration by a number of investigators, including Buller (1909), Ukkleberg (1933), Stephanov (1935), and Gregory (1945). In general the terminal velocity has been found to be of the order expected from Stokes' law. According to this law,

$$V = \frac{2}{9} \left(\frac{\rho - \sigma}{\mu} \right) gr^2,$$

where V = terminal velocity, ρ = density of the spore, σ = density of the medium, g = acceleration due to gravity, r = radius of the spore, and μ = viscosity of the medium. Deviations from the expected rate may be ascribed to the following factors: (1) shape of spore; that is, they are seldom ideal spheres; (2) irregularities in outer surface of spore wall; (3) rapid desiccation during falling; and (4) inaccuracy in determining the density of the spores.

Buller (1909) found that the rate of fall of basidiospores of *Collybia dryophila* is 0.49 mm per second and of *Coprinus plicatilis* 4.29 mm per second. Ukkleberg (1933) determined that the rate of fall of urediniospores of *Puccinia graminis tritici* is 11.57 mm, of *P. graminis secalis* 10.58 mm, of *P. coronata avenae* 10.00 mm, and of *P. triticina* 12.62 mm per second. He found that the rate of fall of aeciospores of *P. graminis tritici* is 10.56 mm, and of *P. graminis secalis* 10.20 mm per second.

INSECTS AS VECTORS OF FUNGI. It is well known that such insects and arachnids as ticks, fleas, flies, mosquitoes, lice, bees, wasps, beetles, and mites are capable of transmitting microorganisms, especially species responsible for important diseases of man and various animals. Much less is known, however, regarding the role that animals play in the transmission of species pathogenic to plants. Although the presence of certain virus diseases of plants appears to require the presence of specific insects as vectors, for instance, aster yellows, carried by *Cicadula sexnotata*, curly top of beets, carried by *Eutetix tenella*, and kroepoek of tobacco, carried by *Bemisia gossipiperda*, no portion of the life cycle of the pathogen, whether virus, bacterium, or fungus, appears to develop within the body of the vector. Instead the infective agent is

merely taken into the body of the insect and passes unharmed through the alimentary tract, or is regurgitated or accidentally adheres at the surface, or is mechanically transferred to the host plant. The relation of insects to disease in plants is therefore less spectacular than in animals but is none the less quite as important.

Rand and Pierce (1920) are among the first to bring together from widely scattered sources the information extant on insects as agents in the transmission of fungi. The later accounts of Rand, Ball, Caesar, and Gardner (1922) and the comprehensive works of Leach (1935, 1940) describe the present status of this topic. In the appendix to the volume by Leach (1940) is a long list of insect-transmitted fungi.

Abundant evidence is at hand to show that the brown-rot fungus of stone fruits, *Sclerotinia fructicola*, is transported by bees, wasps, May beetles, and squash bugs at the season when the fruit is ripening. Heald [Arthur (1929)] demonstrated that mites are carriers of *Sporetrichum anthophilum*, the cause of bud rot of carnations. Punctures made by the cabbage maggot, *Pegomya brassicae*, afford portals of entry for *Phoma oleracea*, the cause of cabbage blackleg. The woolly aphis, *Schizoneura lanigera*, is associated with the spread of the apple-canker fungus, *Nectria ditissima*. Similarly Ehrlich (1934) showed that *N. coccinea* infects beech, but only if the bark is infested with *Cryptococcus fagi*. Initial infection is possible provided that the living tissues of the bark have been injured by the insect while feeding. The fungus then grows parasitically and kills the beeches within 2 or 3 years.

Certain species of Orthoptera, Lepidoptera, Coleoptera, and Hemiptera were found by Wolf (1916) to distribute *Cercospora personata* on peanuts. Among these orders grasshoppers, because of their powers of flight, were regarded as especially important vectors of this peanut-leaf-spot fungus. A single longicorn beetle, *Leptostylus maculata*, was found to transport 320,000 spores of *Endothia parasitica* and, according to Studhalter and Ruggles (1915), 19 other insect species also act as carriers of this fungus.

The larval forms of many species find rust spores to be suitable food, and they effectively aid in distributing them. Arthur (1929) records that the larvae of *Smyrithurus* sp., a neuropterous insect, carries *Puccinia rubigo-vera tritici*, and the larvae of *Diplosis* sp.,

a cecidomyid, transports *Uromyces bidenticola*. Honeybees distribute the urediniospores of rust on *Populus* and the aeciospores of *Caecoma nitens*. The scarabeid beetle, *Serica sericea*, is among many species that transport *Cronartium ribicola*. *Basidiobolus ranarum* is carried to frogs and salamanders within the bodies of various beetles. Gypsy-moth larvae, *Porthetria dispar*, have been found by actual count to bear from 1120 to 23,320 aeciospores of *Cronartium ribicola*. Arthur (1929) records that Rathay noted 135 species of Coleoptera, Hymenoptera, Hemiptera, and Diptera as carriers of rust spores, Diptera being especially attracted to the saccharine exudate of pycnia. Doubtless they are important agents in the spermatization of rusts.

The Dutch elm pathogen, *Ceratostomella ulmi*, is transported by bark beetles, *Scolytus scolytus* and *S. multistriatus*. Several species of *Ips* and *Dendroctonus* are known to be capable of disseminating spores of fungi (various species of *Ceratostomella*) associated with blue stain of logs and lumber.

The spore dispersion of Phallales appears to be dependent upon sarcophagid and muscid flies. The sporiferous tissue of Phallales becomes slimy at maturity and is nauseatingly putrid. This penetrating odor is attractive to flies, and in consequence they carry the spores externally and also void them intact in their excreta. *Ithyphallus coralloides*, suspected of causing root rot of sugar cane, is so attractive to flies that they can be driven away from the fructifications only with difficulty. Various ants and beetles are also attracted to this species and no doubt carry the spores underground to situations favorable for germination and development. Various flies are also attracted to the saccharine exudate containing conidia of the sphaelial (conidial) stage of *Claviceps*, especially *C. purpurea* and *C. paspali*.

Brodie (1931) has shown that flies transport the conidia of *Coprinus lagopus*, as a result of which the mycelia become diploidized. Similarly the transfer of pycniospores of *Puccinia graminis* and *P. helianthi* by flies and other insects attracted to the sugary exudate has been demonstrated [Craigie (1931)].

The tree cricket, *Oecanthus niveus*, actively transports the spores of *Leptosphaeria coniothyrium*, the cause of canker on apple trees.

The flea beetle, *Epitrix cucumeris*, the Colorado potato beetle, *Leptinotarsa decemlineata*, and the horn worm, *Protoparce caro-*

lina, have been found to have conidia of *Alternaria solani* and of *Septoria lycopersici* on their bodies.

Hendree (1933) isolated from the fecal pellets of termites and from the frass and wood enclosing their burrows 33 genera of fungi, among them *Trichoderma* and *Penicillium*. In her opinion these fungi are a common dietary element of the termites *Reticulitermes hesperus*, *Zootermopsis angusticollis*, and *Kalotermes minor*.

Such insect visitors as honeybees, bumblebees, carpenter bees, thrips, and ants were found [Smith and Weiss (1942)] to be capable of transporting spores of *Ovulinia azaleae*, causing flower spot on cultivated azaleas.

It has been noted that the females of certain woodwasps, *Sirex gigas* and *S. cyaneus*, always have elements of the wood-rotting fungus, *Stereum sanguineolentum*, in the pouches at the anterior end of the ovipositor. Whether this association is symbiotic is not known.

The only conclusion warranted from the foregoing discussion, which is representative of a large volume of reports of insects as disseminating agents, is that many species of insects are concerned. Furthermore, many fungi, both pathogenic and saprogenic, are insect-borne. It remains to be determined whether virulence in fungi is modified by passage through the alimentary tract. It is known that some species have already germinated when the fecal pellets are voided, although essentially nothing is known about the effects of digestive enzymes on germination.

More attention should be given also to the necessity of host injuries by the insect for inoculation and infection. In this connection there is evidence that sugar cane injured by the sugar-cane borer, *Spenophorus obscurus*, is more subject to attack by *Colletotrichum falcatum*. Moreover, onions infested with thrips are predisposed to infection by *Peronospora destructior*, and grasses punctured by aphids are more susceptible to *Erysiphe graminis*.

Leach (1935) has expressed the opinion that insects are not merely disseminators of inoculum in the case of pathogenic fungi, but that the insect-fungi relationship is highly organized and has broad biologic and evolutionary significance.

OTHER ANIMALS AS VECTORS OF FUNGI. Besides insects, many other animals transport fungi, but usually dissemination by them is entirely fortuitous. Among the animals known to be or sus-

pected of being carriers are slugs, snails, sow bugs, various rodents, birds, and domestic animals. Slugs and snails feed upon a large variety of fungi, especially powdery mildews, discomycetes, rusts, mushrooms, polypores, and leathery fungi [Buller (1922), Wolf and Wolf (1940)]. The spores either are voided or are dragged along and scattered by the migrations of these animals in search of food. Fleshy Hymenomycetes appear to be especially attractive. Poisonous species are devoured with impunity. The possession of a highly developed olfactory sense guides the animals in the location of the fruit bodies of these species. Gravatt and Marshall (1917) made the observation that slugs (*Agriolimax agrestis*), snails (*Sabulina octona*), and sow bugs (*Armadillidium vulgare*) eat and distribute spores of *Cronartium ribicola*. Heald and Studhalter (1914) found that birds, especially woodpeckers, are of importance in the dissemination of *Endothia parasitica*. An estimate of the numbers of spores of this fungus carried by two downy woodpeckers (*Dryobates pubescens medianus*) was 757,074 and 624,341 and by a brown creeper (*Certhia familiaris americana*), 254,019.

A number of fungi, notably species of *Pilobolus*, *Sordaria*, *Panaeolus*, *Anellaria*, and *Coprinus*, normally occur on dung and are regarded as coprophilous. Their spores are distributed by such herbivorous animals as horses, cattle, sheep, goats, rabbits, and geese. These animals swallow the spores and herbage together, and either the spores pass undamaged through the alimentary tract or else their germination is favored by the digestive enzymes which they encounter en route. After having been eaten, the spores of these coprophilous species may remain for hours within the alimentary tract before being voided in the feces. Meanwhile the animal may transport them for miles. Soon after discharge from the animal's body the spores will develop into new plants, and their fruiting bodies will mature. Some dung-fungi are especially adapted to such habitats. Buller (1934) has shown, for example, that the sporangia of *Pilobolus*, on being shot away, adhere to herbage 3 to 8 ft. distant from the dung heap. The sporangia cling by virtue of the gelatinous material that arose by dissolution when the sporangium separated from the swollen subsporangium. Since these sporangia cannot be wet, they are not affected by rains and in consequence may adhere intact to the

vegetation for several weeks. Moreover the sporangial wall is black, so that injurious radiations are screened out.

There is no evidence that certain other coprophilous species, for example, *Lachnea stercorea* and *Humaria granulata*, have any structural adaptations for such habitats. Undoubtedly many species grow in dung quite by accident. At any rate, mycologists have come to recognize that herbivorous animals are excellent collectors of fungi.

THE HUMAN AGENCY. Man, unwittingly and wittingly in the distribution of seed, seedlings, cuttings, nursery stock, bulbs, and roots, has spread and will continue to spread fungi of economic importance throughout the world. Many of these fungi have caused him enormous financial losses. To relieve and prevent this situation, both state and federal inspection services have been instituted and quarantines established.

In North America alien or exotic species appear to be much more destructive than indigenous ones, as is evident from the ravages of chestnut blight (*Endothia parasitica*), blister rust of white pines (*Cronartium ribicola*), Dutch elm disease (*Ceratostomella ulmi*), late blight of potato (*Phytophthora infestans*), downy mildew of tobacco (*Peronospora tabacina*), and willow scab (*Fusicladium saliciperdum*). Furthermore, there is evidence that pathogens introduced from one continent into another may find conditions in the new land more favorable for development in epidemic proportions, as did grape mildew (*Plasmopara viticola*) and late blight of potato (*Phytophthora infestans*), introduced into Europe from the New World, and coffee rust (*Hemileia vastatrix*), introduced into Ceylon, presumably from Africa. A list of rusts [Arthur (1929)] in Australia in 1906, comprising 161 species, is said to contain 30 species that are not indigenous. Arthur also lists 41 species of rusts that have been introduced into North America, including such important ones as *Cronartium ribicola*, *Uromyces appendiculatus phaseoli*, *U. appendiculatus vignae*, *U. betae*, *U. caryophyllinus*, *U. trifolii*, *Puccinia arachidis*, *P. asparagi*, *P. chrysanthemi*, *P. glumarum*, *P. graminis phlei pratensis*, *P. graminis tritici*, and *P. malvacearum*. Undoubtedly man distributes many fungi that cling to hands and clothing and are inoculated onto healthy plants inadvertently as he passes to them after handling diseased plants.

SEED-BORNE FUNGI. In 1733 Jethro Tull recorded seed disinfection by the use of brine. Wheat being shipped to England became wet in the hold. Some of it was planted, and the resulting crop was observed to be free from stinking smut. From this observation came the use of salt-water steepers to prevent seed-borne diseases. Moreover, before this early period some of the tribes in Asia Minor passed their seed grain through flames and thereby removed the highly inflammable smut spores. They did this, however, as a religious ritual, because fire has long been regarded as a means of purification.

Subsequent studies have shown that many grass smuts are seed-borne. In addition, such other pathogenic agencies as certain viruses, bacteria, many fungi from nearly every important taxonomic group, nematodes, and insects are known to be carried with the seed. Orton (1931) assembled a bibliography of seed-borne diseases which should serve as a basis for studies by others. In his long list are such important pathogens as *Gibberella saubinetii*, *Colletotrichum lindemuthianum*, *Phoma lingam*, *Septoria apii*, *Diplodia zaeae*, *Glomerella gossypii*, *Colletotrichum lagenarium*, *Phomopsis vexans*, *Sclerospora graminicola*, *Urocystis cepulae*, *Ascochyta pisi*, *Tilletia tritici*, and *Ustilago avenae*.

SOIL-BORNE FUNGI. Vascular and root-rot parasites, including species of *Fusarium*, *Verticillium*, *Cephalosporium*, *Thielaviopsis*, *Sclerotium*, *Phytophthora*, *Pythium*, and *Rhizoctonia*, commonly persist in the soil and are distributed by numerous agencies. These include movement of the infested soil by washing rains or its transport by streams, carriage of infested soil on seedlings, rooted cuttings, bulbs, corms, or roots, and transport on implements, machinery, tools, hoofs of farm animals, and shoes of man.

Observations in the East Indies and in the United States leave little doubt that fields which are flooded or overflowed after rains may become infested with *Phytophthora nicotianae*, causing tobacco black-shank. The rowward spread of *Fusarium* wilts is a matter of common observation. Carriage of fungi with soil or on seedlings may not be an unmixed evil. Evidence assembled by Hatch (1936) shows that in afforestation the planting of seed may fail, whereas the transplanting of seedlings may succeed. The reason for this anomaly is the dependence of tree species upon certain fungi which become associated in the mycorrhizal relationship.

WATER AS A VECTOR OF FUNGI. Water may sometimes serve as an important agency for dissemination of fungi, although there is a dearth of direct data on this point. Rain splash is known to be responsible for the spread of conidia of apple bitter-rot (*Glomerella rufo-maculans*), cotton anthracnose (*G. gossypii*), bean anthracnose (*Colletotrichum lindemuthianum*), and brown-spot needle disease of pines (*Systremma acicola*). The conidia of these fungi and of many others are produced in a matrix that is corneous when dry but that dissolves when moist. Such fungi are adapted for distribution at times favorable for spore germination and infection. Others are mechanically transported by dews or rains and thus find lodgment on new substrata. In Colorado years ago *Cercospora beticola* was found to be present in water in irrigation ditches and to be spread to non-infected beets by irrigation. Arthur (1929) mentions an outbreak of *Puccinia sorghi* on *Oxalis* in a corn-field that was overflowed.

STRUCTURAL ADAPTATIONS FOR EXPULSION OF SPORES

At maturity or soon thereafter the spores of many species of fungi are forcibly discharged. Expulsion of spores from the structures within which they are delimited or upon which they are borne must be regarded as a device to further the geographical distribution of the particular species.

HYGROSCOPIC MECHANISM IN MYXOMYCETES

Within the sporangia of certain slime molds, notably *Trichia* and *Hemitrichia*, the capillitial threads are thickened in spiral bands. When the sporangial wall is ruptured as the result of drying, the tangled capillitia may be noted to be interspersed among the spores. As the capillitia dry, they writhe and twist by virtue of the unequal thickenings of the wall. As the ends of the threads spring free, they fling adhering spores into the air. This behavior is, therefore, quite like that in the liverwort, *Marchantia*, and is very efficient in conjunction with air currents in causing the spores to be widely disseminated. Dissemination of other species, however, appears to be wholly fortuitous.

The mechanisms involved in spore discharge are quite different and need not indicate phylogenetic relationships.

SPORE EXPULSION AMONG PHYCOMYCETES

Among some aquatic fungi, such as the Chytridiales and Saprolegniales, sporangiospores are merely ejected to the exterior of the sporangium, where, by virtue of their flagella, they become rather widely distributed. Members of these orders generally possess an exit tube or papilla. As the result of increased turgor after delimitation of sporangiospores, the sporangium opens at the exit tube or papilla, and the sporangiospores are rapidly ejected, either *en masse* or singly. In *Achlya* and *Aphanomyces* they are quiescent on expulsion and collect in a hollow sphere at the orifice. In *Saprolegnia* and *Leptolegnia* they emerge in an actively motile condition. In the related *Aplanes* they are retained within the sporangium. In *Dictyuchus* the sporangial content is cleaved into segments, a pore is developed from each segment, and the protoplast escapes from each segment as a motile spore, leaving behind a reticulum of empty cells. In *Saprolegnia* two planetic (motile) stages normally occur, a phenomenon no doubt well adapted for increased dissemination of the species.

Apparently none of the *Peronosporales*, except species of *Sclerospora*, forcibly expels its sporangia. As observed by Weston (1919), *S. philippinensis* and *S. graminis*, occurring on maize, possess a double wall separating the tip of the sterigma and the sporangium. At first these two walls in contact with each other are plane. As the sporangium grows and turgor increases, these membranes tend to bulge outward, and this tendency is restrained by adhesion of the two surfaces in contact. Eventually adhesion is overcome by the stress from increased turgor, and with a sudden snap both membranes bulge outward, catapulting the sporangium away. It can then be caught by air currents and transported to near-by maize plants.

In *Peronospora tabacina* and certain other species of *Peronospora* the sporangia are effectively liberated, but by an entirely different mechanism. The sporangiophores grow closely crowded. Each sporangiophore looks like a little tree, and together the sporangiophores constitute a miniature forest with interlocking branches. The entire tree, including its twig tips, sterigmata, is a single, inflated coenocytic cell. A slight change in relative humidity in the immediate environment of the sporan-

giophore occasioned by air currents or increased temperature causes the crown of the little tree to swirl and twist. In conse-

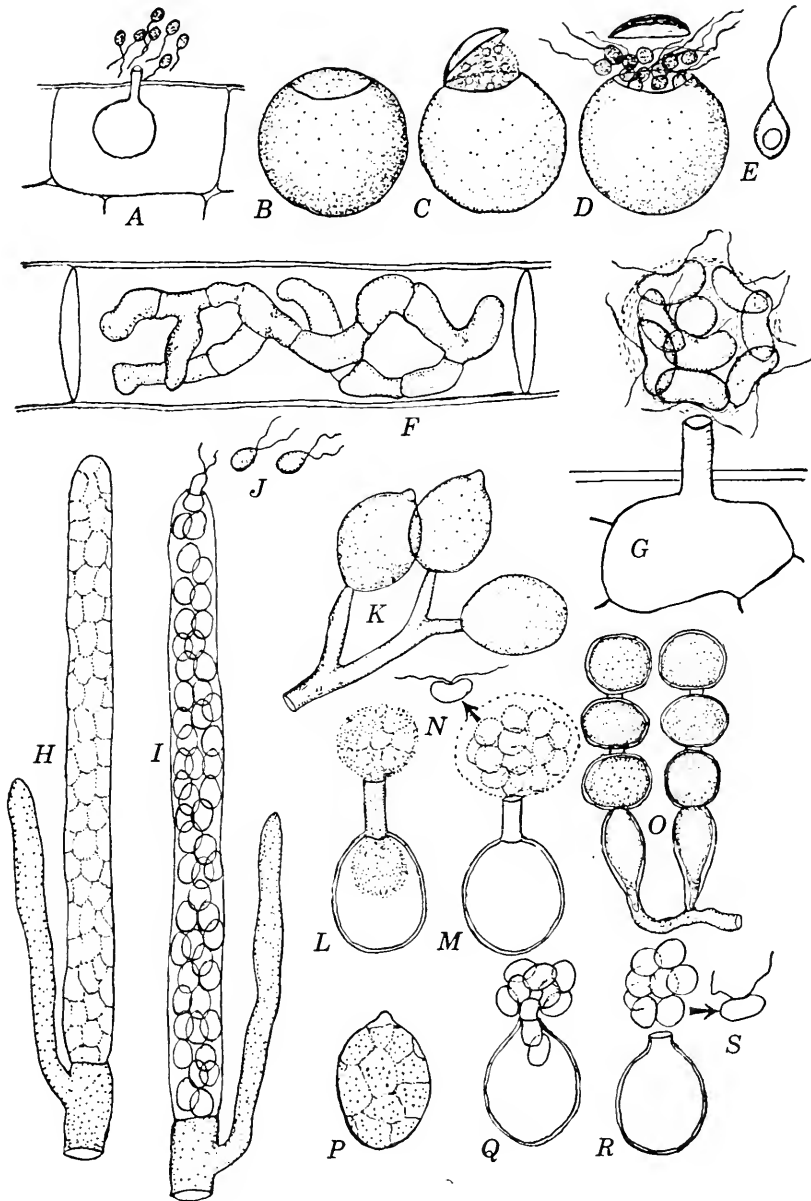

FIG. 28. Discharges of spores by various Phycomycetes. A. *Olpidium brassicae*. B, C, D, E. *Physoderma maydis*. F, G. *Lagenidium rabenhorstii*. H, I, J. *Saprolegnia* sp. K, L, M. *Pythium de Baryanum*. O, P, Q, R. *Albugo candida*.

quence of these hygroscopic movements the sporangia are dislodged [Pinckard (1942)]. Long ago attention was called to this phenomenon by de Bary (1887), who stated from his ob-

servations on *Peronospora*, *Phytophthora infestans*, and *Botrytis*, "The slightest change in the humidity of the surrounding air, such for instance as may be caused by the breath of the observer, at once produces changes in their turgescence and torsion; the latter give a twirling motion to the extremity of the gonidiophore and the ripe spores are thereby thrown in every direction."

Link, in 1809, was among the earliest observers to consider the problem of discharge of sporangia by *Pilobolus*. Since then many others have recorded their studies of this phenomenon, and gradually a clear conception of the mechanism involved has evolved. The ingenious experimentation by Buller is especially pertinent and illuminating. Members of this genus are coprophilous and can best be studied by cultivation on fresh dung of herbivorous animals, collected and placed in the laboratory in moist chambers. After a few days a crop of sporangia should have formed, and new crops may form each day for several successive days. Each sporangiophore consists of a hat-shaped, black sporangium that surmounts a bulbous subsporangial swelling, the upper portion of the stipe. This subsporangial swelling functions both as an ocellus that causes the stipe to direct its free end toward the source of light and as a part of the squirting apparatus that propels the sporangium.

A layer containing bright red pigment, carotene, is formed in the basal wall of the subsporangial swelling. This layer extends partly across the stipe and forms a centrally perforate, biconcave septum. Immediately beneath this perforate septum is the motor region, which responds in such fashion as to direct the sporangium head on toward the light, when heliotropic equilibrium is established. In this position the incident light is centered on the perforation of the septum. Bending is a photochemical response, as is also the increased pressure of turgor in the subsporangium that follows when the sporangium faces the light. At the time of expulsion this pressure in *Pilobolus longipes* may be equivalent to approximately 5.5 atm.

While these phototropic reactions are taking place, the sporangium wall splits into two layers, the inner of which remains intact to enclose the spores. The expansion of the columella, which presses upward against the sporangium, together with the liquefaction of the outer wall circumferentially around the base of the sporangium, results in fissuring of the outer wall. The

upper portion persists as a convex cap over the sporangium; the lower portion remains attached to the base of the sporangium with the jelly-like mass formed around the fissure. The sporangium is now ready for discharge, and this phenomenon occurs as soon as the swelling of the subsporangium reaches the limits of extensibility. Since the papillar area constitutes the weakest portion of the wall, the subsporangium opens at this point, squirts away about one-half the fluid content of the subsporangium and stipe, and carries along the sporangium with the jet of sap. The gelatinous mass present around the base of the sporangium before discharge is carried along with the sporangium and sticks it to vegetation. When the plants are eaten, the spores pass through the alimentary tract and are evacuated, undigested and unharmed.

The initial velocity of the sporangia of *P. longipes* and *P. kleini* approximates 20 ft. per second. Buller's observations showed that the explosive force is sufficient to carry sporangia to a vertical height of 72.5 in. and a horizontal distance of 91.5 in. in *P. longipes* and 90.5 in. in *P. kleini*. When he prepared a special drum with tissue paper as the membrane forming its head, the impingement of sporangia was audible at a distance of 21 ft. Moreover the sporangia are discharged with sufficient force to be felt when they strike the face.

Nearly everyone has observed that flies may become attached to windows in attics and other little-used rooms. Upon closer observation a whitish halo may be noted to surround such flies. This halo, 2 or 3 cm in diameter, is produced by discharged

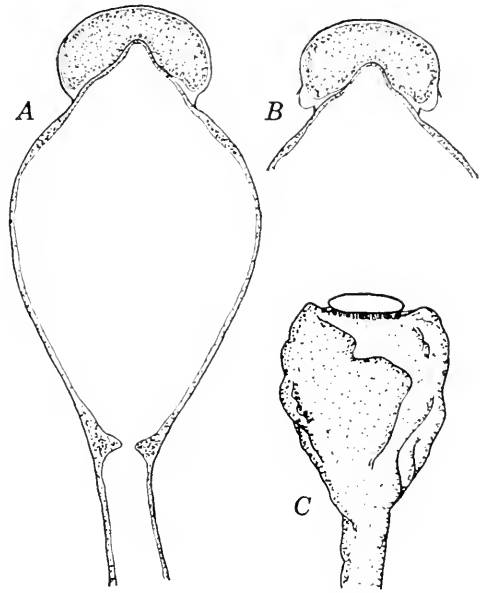

FIG. 29. Stages in discharge of sporangia by *Pilobolus*. A. Mature sporangium atop the subsporangial swelling. B. Circumscissile rupture of outer membrane of sporangium and liquefaction around base of sporangium. C. Collapsed subsporangium after discharge. (After Buller.)

conidia of the entomogenous fungus, *Entomophthora muscae*. When the fly, sluggish because of the infection, succumbs, rhizoidal hyphae grow out from crevices between the sclerites and anchor the fly to the pane. Expulsion of conidia by this fungus and most other species of *Entomophthora* is accomplished by the same mechanism. In a report Sawyer (1931) described this type of spore discharge in *Entomophthora sphaerosperma*, parasitic on

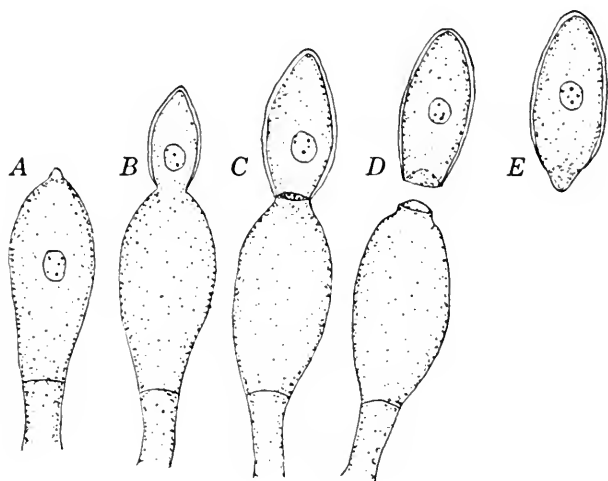

FIG. 30. Stages in spore discharge by *Entomophthora sphaerosperma*. A. Conidiophore with papillar apex. B. Bud-like enlargement at the apex of conidiophore. C. The conidium has been delimited by a septum, and there occur two closely opposed membranes. D. The conidiophore tip impinges into the conidium that has just been freed. E. The tip of the conidium becomes everted after release of pressure from conidiophore. (After Sawyer.)

the larvae of *Rhopobota vacciniana*, attacking cranberries, *Vaccinium macrocarpon*. He noted that a bud, the initial of the conidium, forms at the blunt apical portion of the conidiophore. Into this developing conidium a nucleus passes, the conidial wall thickens, and a short neck becomes differentiated between conidium and conidiophore. A septum then forms across the base of the spore. This septum consists of two membranes in close apposition, one being the basal wall of the conidium, the other the apical wall of the conidiophore. As growth continues, the greater hydrostatic pressure within the conidiophore forces the opposed walls to bulge convexly into the conidium. Eventually the pressure becomes so great that the attachment between the conidium and the conidiophore is ruptured circumferentially.

The recoil of the basal wall of the conidium against the impinging apical wall of the conidiophore acts as a spring, and in consequence the conidium is violently pushed into space. Its passage through the field, when material in the humid atmosphere of a Van Tieghem cell is viewed with a microscope, appears like a

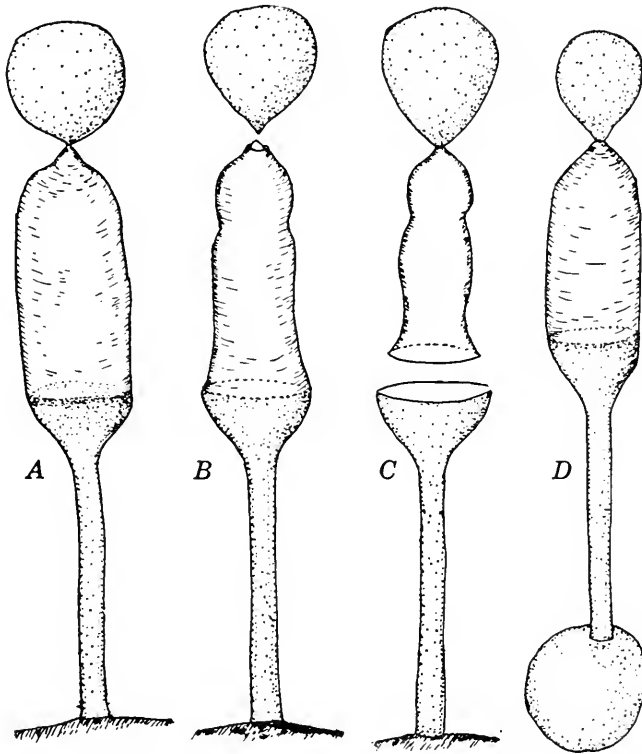

FIG. 31. Schematic diagrams showing stages in sporangial (conidial) discharge in *Basidiobolus ranarum*. (After Ingold.) A. Zone of weakness apparent near base of subsporangial swelling. B. Sporangium liberated from upper part of subsporangium. C. Sporangium freed, but with empty, thimble-like subsporangium attached. D. Germination of conidium with secondary discharge in progress, a repetitional phenomenon.

streak of light. The roughened ring, marking where the conidium was torn from its attachment of the conidiophore, can also be observed readily, the end of the conidium being normally everted on lodging.

The accounts by Levisohn (1927) and Ingold (1934) of the mechanism in *Basidiobolus ranarum* indicate that it is quite different from that in *Entomophthora*, being more nearly like that in *Pilobolus*. *Basidiobolus ranarum* occurs in frog excreta and can readily be made to develop and discharge its conidia on ab-

sorbent paper in a moist chamber. This fungus possesses a subconidial bulb, and a line of dehiscence consisting of two membranes in apposition develops toward the base of this bulb. The upper membrane is the more elastic. When, with increased turgor inside, the rupture of the conidiophore takes place along the line of separation, the upper part of the bulb, which is least extensible, contracts, and the basal septum bursts. The effect is that the sap is squirted backward, carrying away all parts above the line of dehiscence on the recoil. During the rocket-like flight the conidium may become separated from the adhering upper part of the subconidial bulb or may fail to separate. The conidiophore tip pushes into the conidium at the juncture to effect separation, just as it does in *Entomophthora*.

Evidently all *Entomophthorales*, except perhaps *Massospora*, are capable of forcibly liberating their spores.

SPORE DISCHARGE AMONG ASCOMYCETES

SPORE DISCHARGE AMONG ERYSIPTACEAE. As might be anticipated, cleistocarpous fungi, such as the powdery mildews, require a mechanism to liberate their spores that is quite unlike that of *Pyrenomycetes* and *Discomycetes*. Ingold (1939) has assembled the observations made on spore liberation among the *Erysiphaceae*. According to him, there are two types of spore liberation in this family. In *Sphaerotheca mors-uvae*, which illustrates one type, the cleistothecium remains dormant throughout winter, but in spring the single ascus swells to the extent of causing the cleistocarp wall to rupture, permitting the ascus to protrude through the fissure. The protruded ascus continues to swell, finally bursting in a thin region at the tip and squirting out the ascospores.

In 1884 the other type of discharge was graphically described for *Erysiphe* by W. G. Smith [Ingold (1939)] as follows: "When they [the cleistocarps] burst, the contained bladders or asci often burst at the same time, and the living sporidia, after their six months' rest, fly into the air. At other times the bladders or asci themselves fly out of the perithecia, and sail, each with its little load of eight sporidia, through the air. When in the air, the asci burst, and the spores are set free into the atmosphere." This type might well be called the rocket type of discharge. The operation

of this mechanism, as it applies to *Podosphaera leucotricha*, has been confirmed by Woodward [Ingold (1939)].

DISCHARGE AMONG OTHER ASCOMYCETES. It is a matter of common knowledge among those who have studied Ascomycetes that many species of this class forcibly expel their ascospores [Ziegen-speck (1926)]. Even though this phenomenon has been observed in connection with a relatively small proportion of the vast assemblage of widely different species that constitute the Ascomycetes, undoubtedly most of them will be found capable of such forcible discharge. Many of those who attempt to isolate Ascomycetes in pure culture utilize the phenomenon of expulsion. They have found that the simplest procedure to employ in isolating is to place inverted agar-poured plates above mature perithecia at a suitable height. If favorable moisture conditions are then provided, an abundance of ascospores will be found to have been ejected onto the surface of the agar after a few hours.

The height to which the ascospores are propelled varies with the species, being governed by the size of the spores or of the spore mass as one of the correlated factors. *Hypomyces lactifluorum* has been found to shoot its spores to a height of 10 mm, *Endothia parasitica*, 22 mm, *Sordaria fimicola*, 60 mm, *Podospora fimiseda*, 300 mm, and *P. curvicola*, 450 mm. In *P. curvicola* Weimer (1917) found that the spore mass of approximately 500 spores, held together in a gelatinous matrix, had a diameter of 168 to 266 μ and that they were hurled up into the necks of 2-liter culture flasks.

RATE OF ASCOSPORE DISCHARGE. The rate of ascospore discharge from perithecia is controlled by the external factors of moisture, temperature, and light. These factors are interdependent, and in no species does discharge occur unless the water content of perithecial tissues approximates the maximum. As may be expected, the output of spores is low at low temperature and increases to a maximum with a rise in temperature. With further increase there is a very rapid decline in the rate of discharge. As far as light is concerned, some species are stimulated by it, such as *Nectria cinnabarina* and *Podospora curvula*, whereas others are inhibited, for example, *Hypoxylon fuscum* [Ingold (1939)].

For a few species the rate of discharge has been recorded. Ingold (1939) has assembled certain data on this point; they are shown in Table 15.

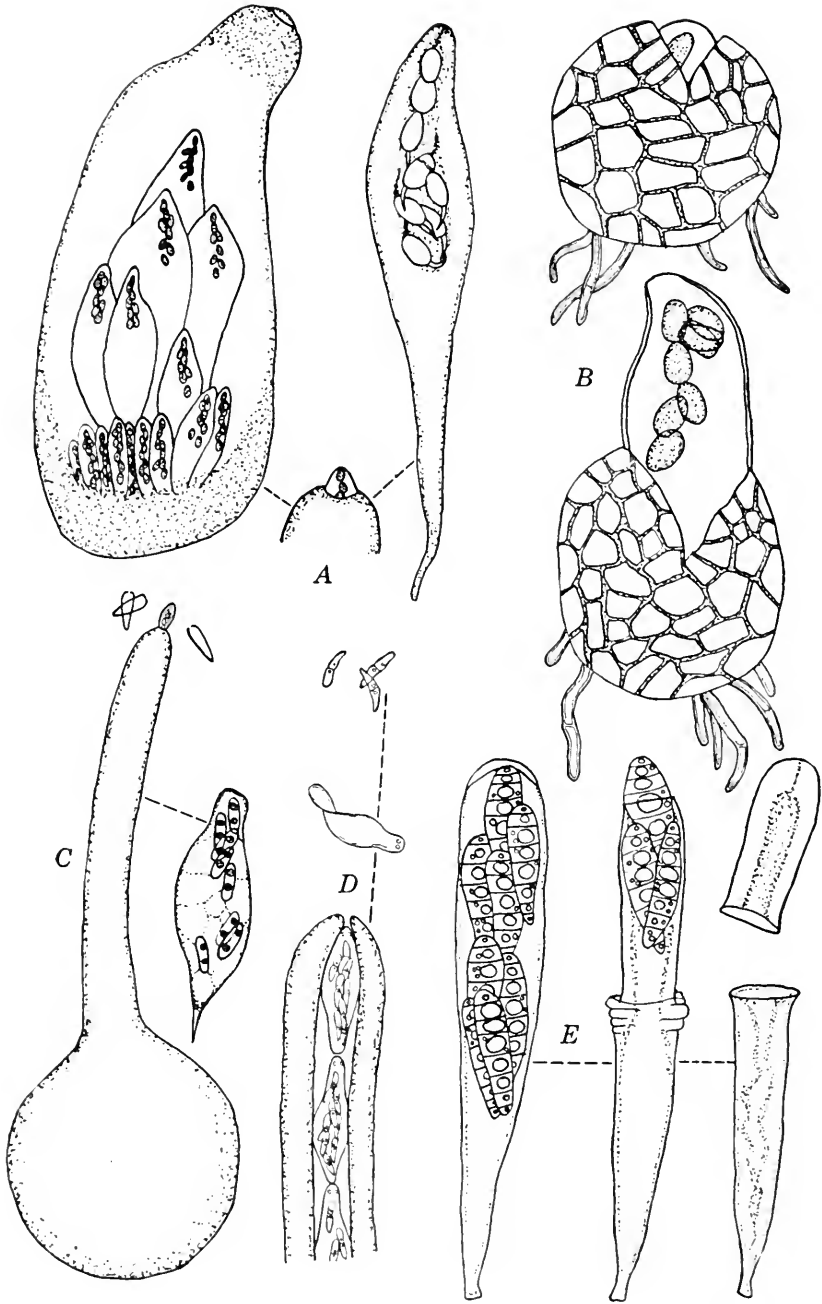

FIG. 32. Types of spore discharge among Ascomycetes. *A. Podospora curvula* (adapted from Ingold). *B. Sphaerotheca mors-uvae* (adapted from Salmon). *C* and *D. Ceratostomella ampullacea* (adapted from Ingold). *E. Lecanidion atratum* (adapted from Butler).

TABLE 15

RATE OF ASCOSPORE DISCHARGE BY SEVERAL ASCOMYCETES

<i>Species</i>	<i>Spore Output per Perithecium per Hour</i>
<i>Podospora minuta</i>	24
<i>Podospora curvula</i>	40
<i>Sporormia intermedia</i>	184
<i>Hypoxyton coccineum</i>	1,800
<i>Diatrype disciformis</i>	23,000
<i>Endothia parasitica</i>	14,000

SPORE DISCHARGE AMONG DISCOMYCETES. Evidently the earliest observations of ascospore discharge were made upon the larger Discomycetes. Micheli (1729) described spore ejection of *Peziza* as being "like smoke." Bulliard (1791) recorded that "their seeds ascend like steam," if the observer shakes the fructifications or blows his breath upon them. De Albertini and de Schweinitz (1805) saw "clouds of smoke" in *Rhytisma salicinum*. A very graphic account of spore discharge by *Morchella gigas* is given by Plowright (1880-81), who observed the spore cloud as seen against a dark background with the aid of a beam of light: "When acted upon by a gentle current of air such as would be produced by gently waving the hand, it swayed to and fro without manifesting any tendency to become dispersed. The component sporidia were in constant motion, rising and falling and circling about, as if the law of gravity were a myth, existing only in the imagination of philosophers. When the cloud was quite blown away by a more powerful air current, it, in the course of a few seconds, reformed." In his chapter on the liberation or puffing of spores by Discomycetes Buller (1934) assembled many interesting features from the accounts of early observers and added the results of his own observation and experimentation and those of his contemporaries [Falck (1916), (1923)].

Dickson and Fisher (1923) described a technique for photographing discharge by *Sclerotinia libertiana* that is applicable to other large Discomycetes. Buller's (1934) observations show that *Sarcoscypha protracta* can become a miniature geyser, hurling a column of spores to a height of about 3 in. before the spores lose their vertical momentum and begin to be dispersed into a cloud. The puffing by *Urnula geaster*, having ascomata which,

before dehiscence, are brown and cigar-shaped, has earned for this fungus the common name, "devil's cigar." Discharge by these larger disk fungi creates a blast of air that carries along the spores, so that they appear like a cloud.

Among the Discomycetes spore discharge is not only visible but also audible. An easily perceptible hissing sound is emitted by many species. The noise is best heard if the fruit bodies that have been maintained in a moist chamber are held near the ear. As indicated by Buller (1934), Desmazieres noted the emission of sound by *Helvella ephippium* nearly 100 years ago. De Bary noted it in *Peziza acetabulum* and *Helvella crispa*, Stone in *H. elastica*, Johnstone in *Otidea leporina*, and Buller in *Aleuria repanda*, *A. vesiculosa*, *Ascobolus stercorarius*, *Caloscypha fulgens*, *Ciliaria scutellata*, *Galactinia badia*, *Peziza aurantia*, *Pseudoplectania nigrella*, *Pustularia catinus*, *Pyronema confluens*, *Rhizina inflata*, *Sarcoscypha protracta*, *S. coronaria*, *Urnula craterium*, and *U. geaster*. The sound produced resembles most nearly the fizzing of a freshly drawn carbonated drink. The "effervescence" of some species, especially the larger ones, is protracted, lasting for several minutes; in others it can be heard for a few seconds only.

Among the Discomycetes known to puff [Buller (1934)] are *Arachnopeziza aurata*, *Ascobolus crouani*, *Chlorosplenium aeruginosum*, *Dasyscypha virginea*, *Helotium scutula*, *Lachnea setosa*, *Mollisia cinerea*, *Orbilia xanthostigma*, and *Rhytisma acerinum*. The writers have noted its occurrence in *Diplocarpon earliana*, *D. rosae*, *Peziza repanda*, *Sclerotinia fructicola*, and *S. trifolium*.

SPORE DISCHARGE AMONG PYRENOMYCETES. De Bary (1887) was among the first to assemble the extant information regarding spore ejection among Pyrenomycetes. He pointed out that there are two types of expulsion: simultaneous and successive. In the first type all the spores and much of the fluid content of the ascus are ejected as a unit; in the second, each ascospore is discharged separately. De Bary augmented his account with his own observations. Subsequently many other investigators have noted forcible spore liberation and have reported their findings with particular species. Much of our knowledge of this phenomenon comes from the recent studies by Buller (1933) and Ingold (1933, 1939).

Among Pyrenomycetes the spores of most genera, but not all, are forcibly liberated. These fungi may, for convenience, be

arranged into spore-liberation types [Ingold (1933)]. In the first type are species of *Chaetomium*, *Ascotricha*, *Daldinia*, and *Diatrype* and *Ceratostomella fimbriata*. Their ascus wall is very delicate and ephemeral, and as a consequence the ascospores are freed and lie intermixed with gelatinous material within the perithecial cavity. The gelatinous material absorbs water readily and swells, and the spore mass is squeezed out through the ostiole, like tooth-paste from a tube.

The second type, first correctly described by Zopf [de Bary (1887)], occurs in *Sordaria* and *Podospora* and certain other coprophilous species, which develop on the dung of herbivorous animals [Griffiths (1901)]. The perithecia are pear-shaped, and the ostiolar canal is lined with hyphae directed toward the opening. The perithecial walls are thin enough for spore discharge to be satisfactorily observed. Ingold (1939) mounted entire perithecia of *Podospora curvula* in water in a hanging drop and noted that they contain asci in different stages of maturity. The asci and interspersed paraphyses are attached to a stroma occupying the bottom of the perithecium and remain attached to this stroma during discharge. On looking through the perithecial wall, the observer may note that mature asci elongate by growth and by the pressure exerted by the surrounding cells. The greatly distended elastic ascus extends into the neck canal, and the ascus tip slips through, being "lubricated" by the hyphae within the canal, until it protrudes slightly beyond the ostiole. At this stage the tip of the ascus opens by a circumscissile rupture, and the cap formed, together with the mass of 8 ascospores and much of the ascus-sap, is shot upward. Immediately after discharge the empty ascus, being attached to the basal stroma, snaps back inside the perithecium, and another ascus elongates, opens, discharges, and is withdrawn seriatim, until the perithecial content is exhausted. Since each ascospore of *P. curvula* possesses two terminal gelatinous appendages that become entwined, the spore mass is a rather large projectile and can be hurled for a distance of 20 cm or more. The neck of the perithecium being phototropic, the ascus content is discharged directly toward the source of light.

The third type has asci of "jack-in-the-box" construction, as aptly designated by Ingold (1933). This type has many variants, but in each kind the elongated ascus extends to the exterior of the

perithecium. It was first correctly described by Pringsheim (1858) from observations on *Pleospora scirpicola* (*Sphaeria scirpi*). Since then this type of discharge has been observed by numerous mycologists in various genera, and the accounts of Hodgetts (1917), Weimer (1920), Atanasoff (1919), Ingold (1933, 1939), and Butler (1939) may well be consulted. In her account Butler lists the following fungi as having jack-in-the-box dehiscence: *Ascospora beijerinckii*, *A. ruborum*, *Cucurbitaria laburni*, *Lecanidion atratum*, *Leptosphaeria acuta*, *Metasphaeria asparagi*, *Mycosphaerella rubina*, *Pleospora herbarum*, *Plowrightia ribesia*, *Physalospora malorum*, *Sphaeria inquinana*, *S. ellipsocarpa*, *S. lanada*, *S. lemaneae*, *Sporormia bipartis*, and *Venturia inaequalis*. Such dehiscence has been noted in many other pyrenomycetous genera and also in several discomycetous ones.

The essential structure that makes this type of discharge possible is the double ascus wall, consisting of an outer, thick, fairly rigid, inextensible membrane, sometimes called the ectoascus, and an inner, thin, elastic membrane, the endoascus. It may be impossible to distinguish the membranes as entities until the moment discharge is begun. At maturity the ascus imbibes water as the result of transformation of stored glycogen into osmotically active compounds. Endosmosis occurs, but the outer ascus membrane does not permit any considerable stretching to increase the diameter. Enlargement proceeds to the point where the ectoascus is ruptured, whereupon the endoascus suddenly elongates to one to three times its original intact length.

There are several types of rupture of the ectoascus. In *Lecanidion atratum* the tip of the ascus is lifted off, forming a thimble-like cap at the tip of the endoascus. The remainder of the ectoascus slips down toward the base of the ascus, or its edge is folded or rolled as stockings are by some wearers.

In *Mycosphaerella* a thin place may appear in the ectoascus wall, in some species near the tip, in others well down along the side. Rupture takes place at this thin area when sufficient internal pressure has been developed, and the ectoascus tip persists as a flap at the side of the extended endoascus. At any rate, the sudden release of the endoascus permits its apex to spring through the ostiole. If, as in *Sporormia*, the ascospores are to be discharged simultaneously, the further increased pressure ruptures the ascus tip, and the spores are squirted *en masse*. If, as is more

common, the spores are to be discharged successively, they become compressed into a single row with long diameters lying in the direction of the longitudinal axis of the ascus. Then a contractile pore forms in the apex, and each spore is ejected endwise. Discharge of the 8 spores requires a period of a few seconds to a minute or two. While the first half of the ascospore of *Mycosphaerella* is passing through the contractile pore, its velocity is diminished, and it has been observed to stop momentarily at the constriction. Its rate of ejection increases as the second half passes through the pore, and the spore is snapped into space, somewhat after the fashion of a watermelon seed when compressed between the fingers. The next spore in line instantly plugs the pore, and the process is repeated until all 8 are ejected. The empty ascus then contracts, and its place is taken by another mature ascus or complement of mature asci.

A fourth type of discharge is exhibited, especially by long-necked or rostrate Pyrenomycetes. In this type, as illustrated by *Gnomonia rubi*, *Ophiobolus careciti*, *Endothia parasitica*, and *Ceratostomella ampullacea* [Ingold (1939)], the asci at maturity become detached and for a time remain free and intact within the perithecial cavity. As more asci are formed from the stromatic tissue within the basal portion of the perithecium, they become freed and displace those first detached. As a consequence a stream of asci is squeezed into the long neck canal, the asci passing up in single file. In *Ceratostomella ampullacea* the asci swell quickly as soon as they protrude from the ostiole, the lower end being firmly held by the rigid jaws of the ostiole. The ascospores are dispelled by the bursting of the ascus, and the empty ascus is pushed out by the next ascus in the series, and so on. In some rostrate species, such as *Linospora gleditsiae*, the asci collect in a mucoid droplet at the orifice of the ostiole and must be disseminated by water.

Still another structural mechanism has been described in other Pyrenomycetes. In *Glomerella*, for example, the ascus is apically thickened, and exit is provided through a papillar perforation. The ectoascus remains intact. As the intra-ascal pressure increases, the thickened pore resists stretching, but the ascospores are squeezed through the perforation. As each emerges at the tip of the pore, it is snapped into space.

SPORE DISCHARGE AMONG BASIDIOMYCETES

Most of our knowledge of spore discharge among the Basidiomycetes comes from the painstaking researches of Buller (1924, 1933). Throughout this entire group with its numerous species, except for the Gastromycetes, which is constituted of relatively few species, essentially the same mechanism of discharge prevails. This generalized mechanism has been termed the "drop-excretion mechanism." As a matter of fact, no satisfactory explanation of how this mechanism causes the spores to be forcibly expelled is as yet forthcoming, but the problem can be properly appreciated if the structure of the basidium is first learned and is kept clearly in mind. The hymenium, whether plane or having pores, gills, teeth, or other modification to increase the spore-bearing surface, is composed of a palisade of basidia. In some species sterile cells (paraphyses or cystidia) are interspersed among the basidia. Each basidium is a turgid clavate to saccate cell. Apically on this cell are formed typically four conical projections, the sterigmata. The tip of each sterigma soon becomes slightly bulbous, and the inflated portion increases, simulating the appearance of a soap bubble being blown. These portions are the basidiospores, which vary in shape and surface markings among the different species. Mature basidiospores are always inequilateral, with the more plane surfaces of the quartet of spores directed toward each other. The hilum of each points inward and is thus asymmetrically placed. Presumably a wall eventually forms to separate the basidiospore from the tip of the sterigma.

As far as the structural features just recounted are concerned, all investigators are in accord. In connection with discharge itself and the forces involved, however, there remain unexplored possibilities. For a long time it was generally believed that a water-squirting mechanism somewhat comparable to that in *Pilobolus* causes discharge. This would be expected to operate most effectively if all 4 spores of a basidium were discharged simultaneously. As a matter of fact, the basidiospores are discharged successively one at a time. Of course this type of mechanism might still be capable of operating to discharge the spores successively if the tip of the sterigma were to be sealed before appreciable loss of turgor within the basidium. That there is actually no

loss of turgor of the basidium which can be recognized by change in shape and size is shown by Buller's observations on a rather large number of species. He found in all cases that the spores

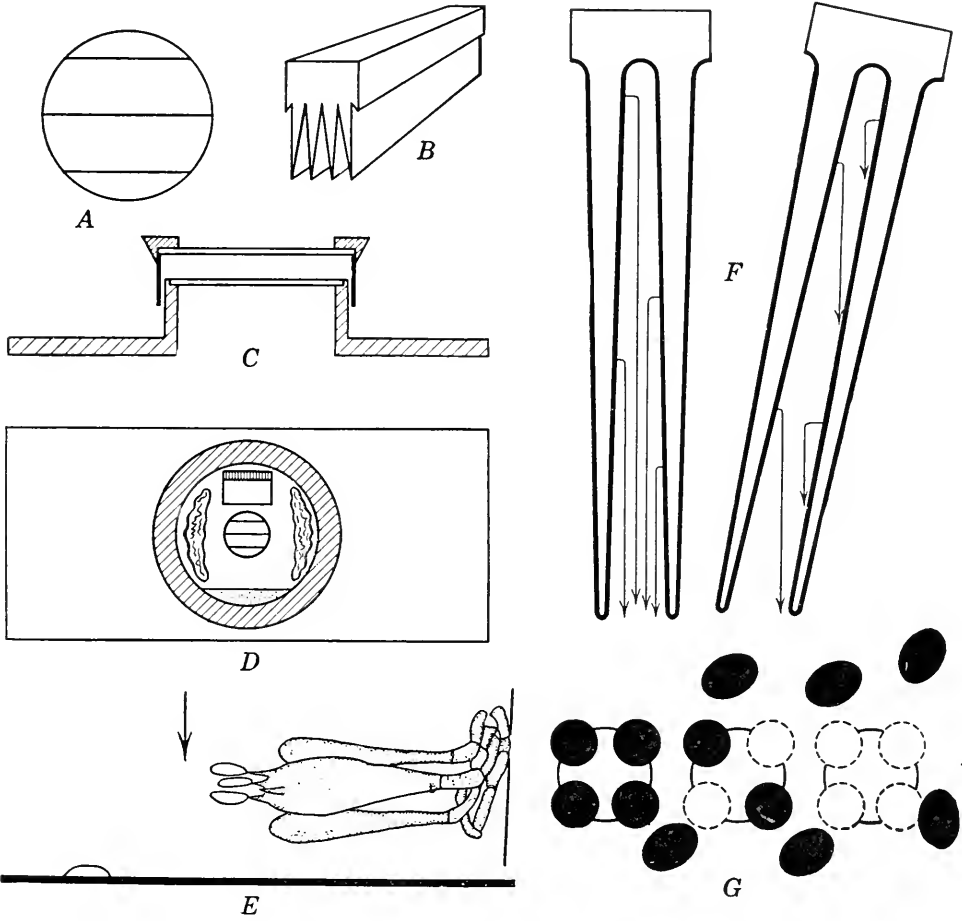

FIG. 33. Diagrams of apparatus and materials used by Buller to secure evidence of forcible discharge of basidiospores by Hymenomycetes. *A.* Threads in ocular of microscope. *B.* Section of pileus to be mounted in compressor cell; *C.*, shown in sectional view. *D.* Compressor cell in vertical position as seen through a horizontally placed microscope. There is a bit of pileus near the top of the cell, moist paper at either side, and water at the bottom. *E.* Basidium as seen with such a horizontal microscope, one spore discharged. *F.* Diagram showing paths of discharged basidiospores (indicated by arrows) and the necessity of vertical arrangement of gills if spores are to fall unimpeded. *G.* Stages in basidiospore discharge as seen when viewed from hymenial surface. (After Buller.)

are violently discharged from the basidium in succession. Moreover, just before each spore is expelled, a drop of liquid exudes at the hilum. During a period of a few seconds this drop increases

in volume, and when it reaches a definite size, the spore is shot away, carrying the drop with it. Drop excretion may begin at the hilum of one or more of the other members of the quartet before the first spore is discharged, and only a few seconds or minutes elapse between successive discharge of each member. The sterigmata are turgid after discharge, and apparently the tips

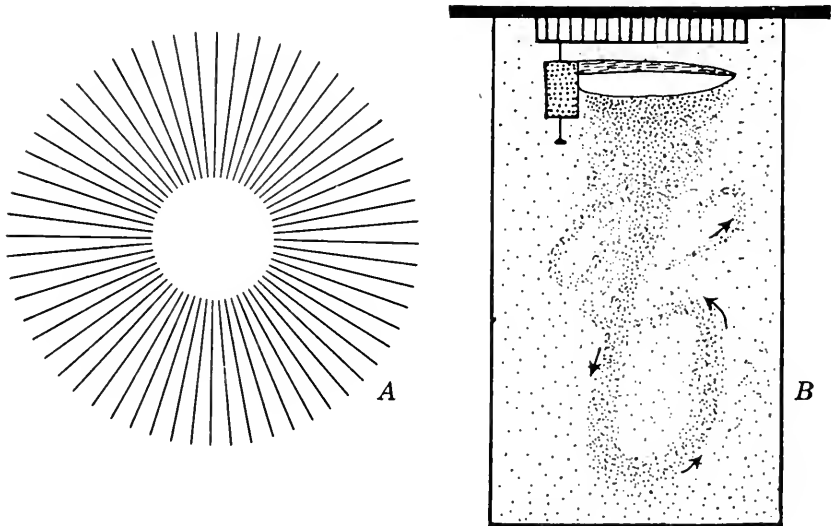

FIG. 34. Two types of evidence of spore discharge among Hymenomycetes. *A.* Diagram of a spore print of an agaric, made by placing the ventral surface of the pileus horizontally on white paper in a moist chamber. *B.* Diagram to indicate how spore discharge may be observed in a beam of light. A fragment of pileus is attached to cork, fastened to cover of vessel. Basidiospores are circulated by convection currents.

are sealed. Afterward the basidia may slowly lose turgor, but they collapse only when death occurs.

This description of the structures involved and the sequence of events does not offer any explanation to account for the asymmetrical position of the spore on its sterigma, as Ingold (1939) points out, nor does it explain how the drops are excreted. Concerning the force employed to discharge each spore, Buller (1922) believes that it is caused by surface tension energy. From ingenious experiments and from calculations he found that the surface energy on a drop of exudate on the spore of *Psalliota campestris* is 0.000012 erg. To derive this figure the value of surface tension is considered as 72 on a drop 2.3 μ in diameter with a surface area of 0.000000166 sq cm. Not all this energy is available for dis-

charge, because the drop is a hemispherical mass in contact with the spore. If the surface tension between the surface of the spore and the drop is considered negligible, the surface energy of the hemispherical drop is 0.0000095 erg. Then the difference between 0.000012 erg and 0.0000095 erg is 0.0000025 erg. This energy is calculated to be seven times that necessary for the actual initial velocity of the spore when it is liberated. Ingold (1939) explains how this energy is mobilized to break the connection of the spore with the sterigma and to discharge it as follows: "At the moment of spore discharge the drop excreted at the hilum flows to the side of the spore, and, while this is happening, the spore will tend to move in the opposite direction. This would involve pressure of the spore on the end of the sterigma. This pressure, suddenly exerted, might lead to the springing of the spore into the air just as one jumps from the ground by pressing suddenly downward. . . . Only a small fraction of the available surface-tension energy is required to impart the necessary initial velocity to the spore, and the remainder is available for breaking the connection between the spore and its sterigma."

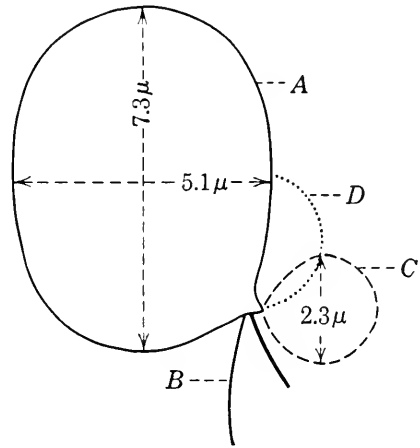

FIG. 35. Spore discharge, in diagram, of *Psalliota campestris*. (After Ingold.) A, spore on sterigma, B, just before discharge. The exuded droplet of liquid, C, is of full size. During discharge the drop, C, takes up position, D, and is carried away on the side of the basidiospore.

SPORE DISCHARGE IN SMUTS. The chlamydospores of smuts are pulverulent, except in a few species. Air currents constitute the primary factor in the dispersal of these spores. Forcible expulsion of sporidia has not been noted among the Ustilaginaceae. Among the Tilletiaceae, however, Buller (1933) and his associates have studied violent spore discharge in *Tilletia tritici*, *T. laevis*, *T. horrida*, *T. holci*, *T. asperifolia*, *Entyloma menispermi*, *E. lobeliae*, and *E. linariae*. When a chlamydospore of these species germinates, a short mycelium, generally regarded as the basidium, is produced. At the tip of this mycelium a cluster of about a dozen

filiform cells, which have generally been regarded as basidiospores, is formed. Buller, however, regards them as sterigmata of a highly specialized type for two reasons: (1) they are never shot away and therefore do not serve to disseminate the fungus, and

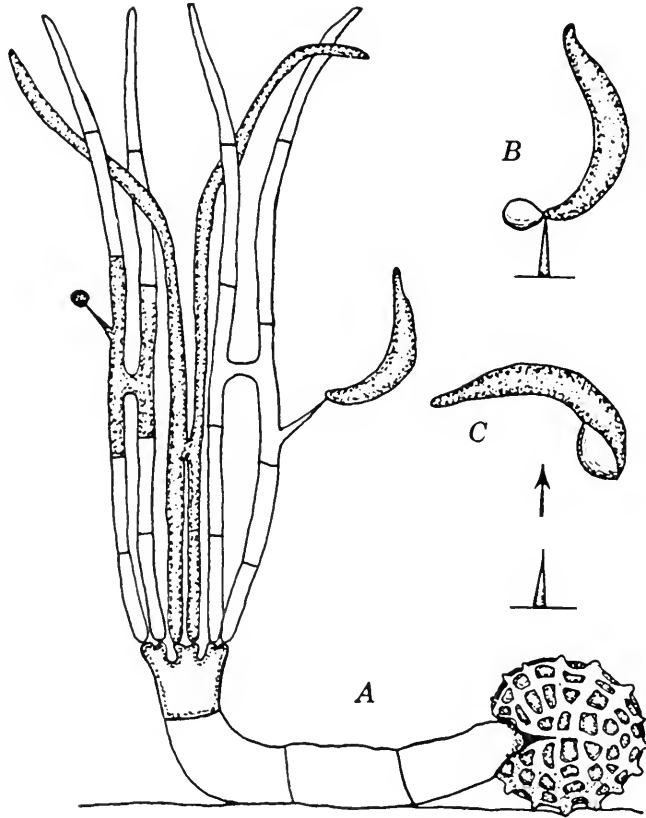

FIG. 36. Spore discharge by *Tilletia tritici*. A. Germination of chlamydo-spore, formation of special sterigmata that have fused in H-shaped fashion, and stages in formation of true basidiospores or sporidia. B. Tip of sterigma with mature basidiospore and a droplet of fluid that serves in forcible discharge. C. Basidiospore that has just been discharged with droplet clinging to base of basidiospore. (After Buller.)

(2) while still attached to the basidium, they give rise to sickle-shaped spores, asymmetrically placed, that are forcibly expelled. These spores may cause infection, and Buller consequently regards them as the true basidiospores of the Tilletiaceae.

As has often been observed, the specialized sterigmata may form H-shaped conjugations. Either from these pairs or from a single unpaired member, a septate hypha may arise, from which the sickle-shaped basidiospores are abstricted. In *T. tritici* these

basidiospores are propelled to a vertical height of 1.0 mm and to a horizontal distance of 1.4 mm.

SPORE DISCHARGE IN RUSTS. Klebahn (1904) is the first investigator to point out that the basidiospores of rusts are forcibly discharged. Dietel (1912) later recorded the same phenomenon in connection with *Puccinia malvacearum*, *P. glechomatis*, *P. annularis*, *Coleosporium campanulae*, *C. petasitidis*, and *Cronartium asclepiadeum*. In some instances he observed that a tiny droplet of water appears at the tip of the sterigma immediately before discharge. He determined that under normal conditions basidiospores may be shot about 0.3 mm vertically and 0.6 mm horizontally. For *Gymnosporangium juniperi-virginianae* Coons (1912) recorded a horizontal distance of discharge of 0.26 to 0.36 mm. Shortly thereafter Buller (1924) made a detailed study of spore discharge, especially in *Puccinia graminis* and *Endophyllum euphorbiae-sylvaticae*. In all essential features the phenomena of discharge among the Hymenomycetes, which he had previously studied, and those in the Uredinales are alike. As differences between the two groups, he notes that the rust basidiospores are larger and are usually shot farther, the distances being 0.4 to 0.85 mm in the rusts and 0.05 to 0.2 mm in the fleshy Hymenomycetes. In correlation with these differences he noted that the droplet of water exuded at the spore hilum in Uredinales is somewhat larger and requires from 10 to 40 seconds to form, whereas in Hymenomycetes only 5 to 10 seconds is usually required.

Later Prince (1943) reported that expulsion of basidiospores by *Gymnosporangium nidus-avis* is accomplished by a different mechanism from that described by Buller for other rusts. Prince concluded that the mechanism is quite like that among Entomophthoraceae. The basidiospore arises as an enlargement of the apex of the sterigma, so that the primary membrane is common to the spore and the sterigma. When the spore attains mature size, a septum is formed in the sterigma that delimits the spore and leaves an apiculus at its base. Next a wall is laid down inside the spore and also one below the septum. Pressures built up in the apiculus of the basidiospore and in the apex of the sterigma rupture the primary membrane at the septum, and the instantaneous opposed bulging of the end of the apiculus and of the sterigma results in forcible discharge of the spore.

From the evidence it seems entirely probable that Uredinales generally are capable of violently discharging their basidiospores. The urediniospores are powdery and are disseminated by wind. Evidently aeciospores in many species are projected out of the aecia with considerable force. Attention was first directed to the matter of forcible ejection of aeciospores by Zalewski (1883) from observations on *Uromyces pisi*, whose aecia are borne on Euphorbia. He also showed from experiments that *Puccinia graminis*, *P. calystegia*, *P. coronata*, and *Aecidium symphyti* discharge their aeciospores, the oldest, outermost aeciospores of the chain being discharged first. Dodge (1924) observed the same phenomenon in *Gymnotelium myricatum* and *Puccinia podophylli*. From similar studies Buller (1924) recorded its occurrence in *Uromyces poae*, *Puccinia clematidis*, *P. fraxinata*, *P. grosulariae*, *P. graminis*, *P. hieraciata*, *P. impatientis*, *P. poarum*, *P. pulverulenta*, and *P. urticata*. The mechanism by which expulsion is made possible consists of thickenings of the spore walls, which push into the spore wall opposite. These thickenings serve as fulcra, against which the elastic spore walls react. As the uppermost cells approach maturity, the pressure may be suddenly released above, whereupon the aeciospore is shot out. Sometimes masses of spores are expelled. The aeciospores of *P. graminis* may be discharged to a height of 7 to 8 mm, of *Uromyces pisi*, 15 to 20 mm. Thus far observations have dealt with cupulate and caecomoid aecia, no studies having been made of rostelloid and peridermioid aecia, in some of which the peridial layer reacts to moisture, and the hygroscopic movements of peridial segments expel the aeciospores.

SPORE DISCHARGE AMONG HYMENOMYCETES. Of course the simplest procedure to demonstrate that Hymenomycetes shed their spores is to place the pilei with undersurface downward on a piece of white paper to secure a spore print or to focus a beam of light below the fruit body suspended in a closed glass vessel. Practically all our knowledge of violent spore discharge among Hymenomycetes has come from the studies by Buller, conducted over a period of about 30 years and recorded in his *Researches on Fungi*. In this period he examined numerous genera and species, including such well-known and widely distributed species as *Psalliota campestris*, *Coprinus comatus*, *C. atramentarius*, *Polyporus squamosus*, *Lentinus lepideus*, *Psathyrella disseminata*, *Ar-*

millaria mellea, *Amanitopsis vaginata*, *Russula emetica*, *Panus stipiticus*, and *Pleurotus ostreatus*. All exhibit the following features during basidiospore discharge: (1) the four spores are discharged in succession, not simultaneously; (2) a droplet of exudate appears at the hilum of the basidiospore just before discharge and is absent on the sterigma after discharge. It is carried along with the spore and disappears as the spore strikes, causing it to adhere; (3) the sterigmata and basidium do not collapse as the spores disappear.

Violent basidiospore discharge is an important phenomenon in this group because the spores, when liberated into the space between gills or spines or into pores, are prevented by the position of the pileus from touching each other or the hymenial surface. They thus escape from the pilei. Each is shot horizontally for a short distance, the motion being rapidly terminated because of resistance of the air. In *Amanitopsis vaginata* horizontal movement of the spore is completed in 1/400 second [Buller (1909)], and the initial velocity approximates 40 cm per second. When horizontal movement is at an end, the spores react in response to gravity. Buller observed the rate of fall of basidiospores by use of a horizontally placed microscope. He mounted sections of hymenium in a chamber and placed the chamber on the microscope stage. The hymenium was thus vertically disposed. Three silk threads were then attached to the eyepiece at equal distances from each other across the field of view. Records of the velocity of spores passing through the field of view could then be made on an electrically rotated drum connected with a tapping key that could be depressed by the observer. By this means Buller (1909) found that the velocity of fall in millimeters per second for *Collybia dryophila* was 0.37, for *Pluteus cervinus*, 0.67, for *Psalliota campestris*, 1.61, for *Polyporus squamosus*, 1.03, for *Boletus felleus*, 1.22, for *Russula emetica*, 1.64, for *Amanitopsis vaginata*, 2.95, and for *Coprinus commatus*, 3.96. Small spores fell at a slower rate than larger spores. These rates of fall were found to be considerably greater than expected from calculation by Stokes' law, a discrepancy for which Buller was unable to offer a satisfactory explanation. Presumably it is in part related to diminution in volume of the mass (spore plus droplet) as fall proceeds.

Among other interesting facts established by these studies on violent spore discharge among Hymenomycetes is that, so long as corky and woody pilei have sufficient moisture, they may con-

tinue to shed spores. Species of *Lenzites*, *Daldalea*, *Schizophyllum*, *Polystictus*, and *Stereum*, after having been dried for as long as a year or two, may be revived in the presence of moisture, whereupon spore discharge is renewed. In the presence of vapors of ether or chloroform spore discharge ceases. Such reactions leave no doubt that discharge is a vital phenomenon.

The pilei of species of *Coprinus* are bell- or thimble-shaped. Their gills undergo autodigestion, commonly regarded as deliquescence. This process is a very important adaptation to insure escape of the spores into the air, which is accomplished because the spores on each gill mature and are discharged progressively from the outer edge of the gill toward the stipe. Those portions of the gills from which the spores have been shed are digested and removed soon after discharge, and in consequence space is provided for the shedding of spores just above, as the pilei continue to open outward like the opening of an umbrella.

SPORE DISCHARGE AMONG GASTROMYCETES. The *Gastromycetes* include a group of species whose best-known members are called "puffballs" or "snuffboxes." The spore mass of the larger proportion of species in this subclass is dry and powdery and therefore admirably adapted for dissemination by air currents. The hygroscopic movement of capillitia aids in spore expulsion in certain species. Some few are subterranean, and their spores are scattered by rodents or burrowing animals that find the fruit bodies attractive as food. Another group, the stinkhorns, possesses a glebal or spore-bearing portion which is attractive to carrion flies because of its putrid odor. These stinkhorns appear to develop overnight, but actually the "eggs," encased in a protective membrane or volva, have gradually been developing in the decaying leaf mold. When the volva is ruptured, the spongy stalk or receptacle, capped with the gleba, rather suddenly elongates in a jack-in-the-box fashion. De Bary thought that this straightening out or elongation of the stalk was caused by inflation from gas within the tissues. Burt (1897) determined, however, that the stretching is an osmotic phenomenon and that it occurs coincident with the disappearance of a reserve of glycogen in and about the receptacle, whose cells merely increased rapidly in size.

These modifications in stinkhorns to insure spore dispersal are much less spectacular and remarkable than those in *Sphaerobolus*. Members of this genus occur on rotten wood and on the dung of

such herbivores as rabbit, horse, cow, and elephant. In 1729 Micheli in his *Nova Plantarum Genera* first described and illustrated *Sphaerobolus stellatus* in his Plate 86, but he employed for it the name "carpobolus." Fischer (1884) gave an account of the struc-

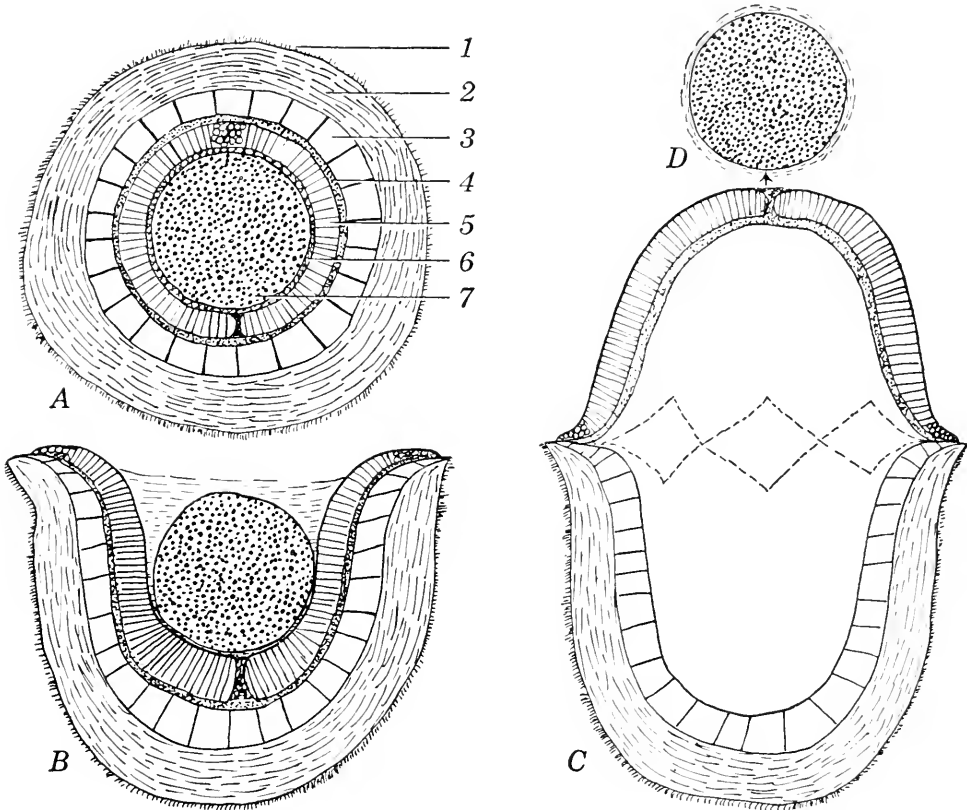

FIG. 37. Structure of *Sphaerobolus stellatus* in diagram. A. Section of mature sporocarp, with six (1-6) layers that invest the central peridiole (7). B. Dehiscence of sporocarp at apex. The inner membrane has liquefied. C. Eversion of the remaining two inner layers, by which the peridiole, D, is hurled away.

tural mechanism by means of which the gleba, about the size of a BB shot, is discharged. Later Walker (1927), Walker and Andersen (1925), and Buller (1933) have painstakingly and graphically worked out the details of the mechanism of this veritable fungus "trench mortar."

The peridium or wall consists of six layers: (a) an outer layer of loosely interwoven hyphae, (b) a gelatinous layer penetrated by hyphae, (c) a compact pseudoparenchymatous layer, (d) a narrow layer of tangentially ramifying threads, (e) a layer of

radially arranged pseudoparenchyma, and finally (f) a thin layer of small-celled pseudoparenchyma.

Within this multiple peridium is the glebal mass. At maturity the peridium splits and bends outward to expose the gleba. The fruit body now consists of two tooth-rimmed cups, one fitting inside the other and the two joined at the tips of the teeth. The outer cup consists of the three outermost layers. The innermost

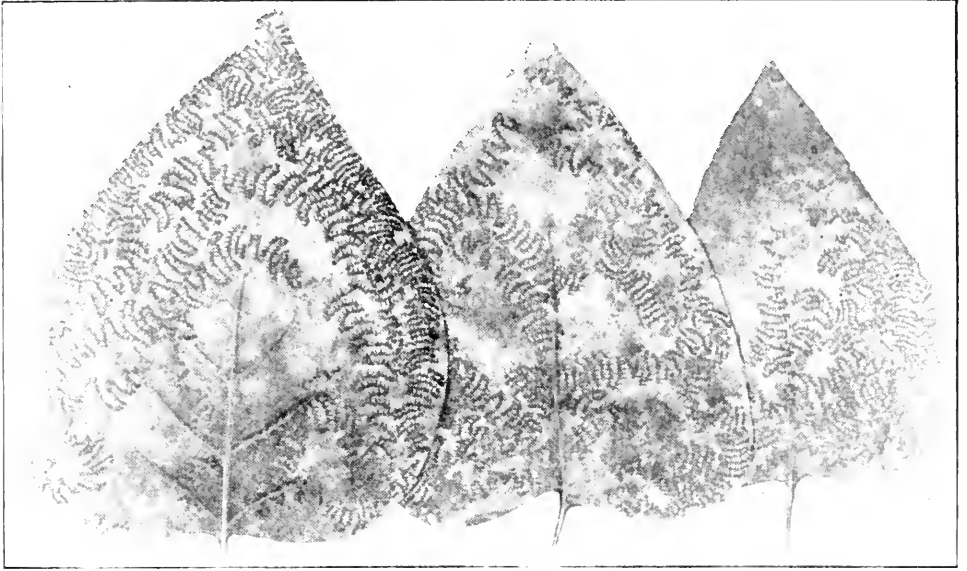

FIG. 38. Feeding tracks made by the snail *Polygyra thyroideus* on lilac leaves infected with powdery mildew.

layer liquefies, and this liquid accumulates around the spherical glebal mass, which is now free and can be rolled around in the cup. The tangentially arranged layer and the radially elongated layer are left to constitute the inner cup. Everything is now ready for discharge, provided that there is light, a temperature approximating 90° F, and high relative humidity. If these conditions prevail, the inner cup suddenly everts itself and in so doing hurls the gleba away. If the fruit body is tilted to get the most suitable trajectory, the gleba may be projected a horizontal distance of 546 cm. *Sphaerobolus* holds the long-distance record among fungi for spore projection.

The inner cup may be ejected along with the glebal mass, but more often it remains as a glistening dome. After a time it may assume its original position. Wax or plasticine spheres can then

be substituted for the natural projectiles, and the "trench mortars" can be repeatedly operated with these artificial projectiles.

The tensions that are responsible for eversion of the inner cup arise from transformation of glycogen [Errera (1885), Walker and Andersen (1925)] into reducing sugars. Up to the time that the peridium splits open, the radially arranged palisade tissues are filled with glycogen, but it has all been digested by the time discharge takes place. In conclusion it may be mentioned that species of *Sphaerobolus* are to be regarded as among the most fascinating objects of study among fungi.

Evidence indicates that the peridioles of Nidulariaceae are disseminated by rain splash and adhere to near-by objects by means of their glutinous coating, as was noted by Diehl (1941). He found that the lower leaves of camellia bushes beneath which *Cyathus pallidus* was fruiting on fragments of wood were studded with black, button-shaped peridioles. More remarkable, perhaps, is Diehl's (1941) re-examination of specimens of a fungus on camellia leaves collected over 100 years ago and identified as *Leptostroma camelliae*. This fungus proved to be not a pycnidial form but the peridioles of *Cyathus stercoreus*.

IMPLICATIONS

The studies that have been made on dissemination of fungus spores are essentially of two types: (1) those that deal with the structural mechanisms involved and with the manner in which these mechanisms function; and (2) those that deal with the vectors or agencies of dissemination. Spore dissemination is of consequence to each particular fungus because the perpetuation of that species requires that spores be dispersed. Perpetuity is insured, all other factors being favorable, if spores are brought into contact with new sources of food.

A study of spore dissemination becomes meaningful mainly in relation to the occurrence and relative abundance of diseases of plants and animals and in relation to the geographical distribution of the given fungus. The student may even wonder why plant and animal diseases are not more prevalent and why more fungi are not ubiquitous in distribution, when once he appreciates that many species are incredibly profligate in the production of spores.

LITERATURE CITED

- ALBERTINI, J. B. DE, AND L. D. DE SCHWEINITZ, *Conspectus fungorum in Lusatae superioris agro niskiensis crescentium*, p. 62. Lipsiae, 1805.
- ARTHUR, J. C., *The Plant Rusts*. 466 pp. 1929.
- ATANASOFF, D., "A novel method of ascospore discharge," *Mycol.*, 11: 125-128, 1919.
- BARY, A. DE, *Comparative morphology and biology of fungi, mycetozoa, and bacteria*. Oxford. 1887. (See p. 72.)
- BRODIE, H. J., "The oidia of *Coprinus lagopus* and their relation to insects," *Ann. Botany*, 45: 315-344, 1931.
- BULLER, A. H. R., *Researches on fungi*, Vol. I: 287 pp., 1909. Vol. II: viii + 492 pp., 1922. Vol. III: xii + 611 pp., 1924. Vol. V: xiii + 416 pp., 1933 (see Chap. III). Vol. VI: xii + 513 pp., 1934.
- BULLIARD, P., *Histoire des champignons de la France*. Pp. 51-52, pl. II, fig. 6. Paris. 1791.
- BURRILL, T. J., AND T. J. BARRETT, "Ear rots of corn," *Ill. Agr. Expt. Sta. Bull.*, 133: 63-109, 1909.
- BURT, E. A., "The Phalloideae of the United States. III. On the physiology of elongation of the receptaculum," *Botan. Gaz.*, 24: 73-92, 1897.
- BUTLER, ELLYS T., "Ascus dehiscence in *Lecanidion atratum* and its significance," *Mycol.*, 31: 612-622, 1939.
- CHRISTIANSEN, J. J., "Long-distance dissemination of plant pathogens," *Aerobiology, Am. Assoc. Adv. Sci. Pub.*, 17: 78-85, 1942.
- COMMITTEE ON APPARATUS IN AEROBIOLOGY, NATIONAL RESEARCH COUNCIL, "Techniques for appraising air-borne populations of microorganisms, pollen, and insects," *Phytopathology*, 31: 201-225, 1941.
- COONS, G. H., "Some investigations of the cedar-rust fungus, *Gymnosporangium juniperi-virginianae*," *Nebr. Agr. Expt. Sta. Ann. Rept.*, 25: 217-242, 1912.
- CRAIGIE, J. H., "An experimental investigation of sex in the rust fungi," *Phytopathology*, 21: 1001-1040, 1931.
- "Aerial dissemination of plant pathogens," *Proc. Sixth Pacific Sci. Cong.*, 4: 753-767, 1939.
- DICKSON, L. F., AND W. R. FISHER, "A method of photographing spore discharge from apothecia," *Phytopathology*, 13: 30-32, 1923.
- DIEHL, W. W., "The taxonomy of Zenker's *Leptostroma camelliae*," *Mycol.*, 33: 215-219, 1941.
- DIETEL, P., "Über die Abschleuderung der Sporidien bei der Uredineen," *Mycol. Zentr.*, 1: 355-359, 1912.
- DODGE, B. O., "Acciospore discharge as related to the character of the spore wall," *J. Agr. Research*, 27: 749-756, 1924.
- DURHAM, O. C., "Air-borne fungus spores as allergens," *Aerobiology, Am. Assoc. Adv. Sci. Pub.*, 17: 32-47, 1942.
- EHRlich, JOHN, "The beech-bark disease. A Nectria disease of *Fagus*, following *Cryptococcus fagi* (Baer.)," *Can. J. Research*, 10: 393-692, 1934.

- ERRERA, L., "Sur le glycogene chez les Basidiomycetes," *Rec. l'inst. bot. Bruxelles*, 1: 95, 1885.
- FALCK, R., "Über die Sporenverbreitung bei den Ascomyceten. I. Die radio-sensiblen Diskomyceten," *Mykol. Untersuchungen Berichte*, 2: 77-144, 1916.
- II. "Die taktiosensiblen Diskomyceten," *Mykol. Untersuchungen Berichte*, 3: 370-403, 1923.
- FISCHER, E., "Die Entwicklungsgeschichte der Gastromyceten," *Botan. Z.*, 42: 433-443, 449-462, 465-470, 1884.
- GRAVATT, G. F., AND R. P. MARSHALL, "Arthropods and Gastropods as carriers of *Cronartium ribicola* in greenhouses," *Phytopathology*, 7: 368-373, 1917.
- GREGORY, P. H., "The dispersion of air-borne spores," *Trans. Brit. Mycol. Soc.*, 28: 26-72, 1945.
- GRIFFITHS, D., "The North American Sordariaceae," *Mem. Torrey Botan. Club*, 11: 1-134, 1901.
- HATCH, A. B., "The role of mycorrhizae in afforestation," *J. Forestry*, 34: 22-29, 1936.
- HEALD, F. D., *Introduction to Plant Pathology*. 579 pp. McGraw-Hill Book Co., New York. 1937.
- HEALD, F. D., M. W. GARDNER, AND R. A. STUDHALTER, "Air and wind dissemination of ascospores of the chestnut-blight fungus," *J. Agr. Research*, 3: 443-526, 1915.
- HEALD, F. D., AND R. A. STUDHALTER, "Birds as carriers of the chestnut-blight fungus," *J. Agr. Research*, 2: 405-422, 1914.
- HEALD, F. D., AND R. C. WALTON, "The expulsion of ascospores from the perithecia of the chestnut-blight fungus, *Endothia parasitica* (Murr.) And.," *Am. J. Botany*, 1: 499-521, 1914.
- HENDREE, ESTHER C., "The association of termites with fungi," *Science*, 77: 212-213, 1933.
- HODGETTS, W. J., "On the forcible discharge of spores of *Leptosphaeria acuta*," *New Phytol.*, 16: 139-146, 1917.
- HÖHNK, W., "Polyplanetism and zoospore germination in Saprolegniaceae and Pythium," *Am. J. Botany*, 20: 45-62, 1933.
- INGOLD, C. T., "Spore discharge in the Ascomycetes," *New Phytol.*, 32: 178-196, 1933.
- "The spore-discharge mechanism in *Basidiobolus ranarum*," *New Phytol.*, 33: 274-277, 1934.
- Spore discharge in land plants*. 178 pp. Clarendon Press, Oxford. 1939.
- KEITT, G. W., "Local aerial dissemination of plant pathogens," *Aerobiology, Am. Assoc. Adv. Sci. Pub.*, 17: 69-77, 1942.
- KLEBAHN, H., *Die wirtwechselnden Rostpilze*. 447 pp. Gebrüder Borntrager, Berlin. 1904.
- LEACH, J. G., "Insects in relation to plant diseases," *Botan. Rev.*, 1: 448-466, 1935.
- Insect transmission of plant diseases*. 615 pp. McGraw-Hill Book Co., New York. 1940.

- LEVISOHN, I., "Beitrag zur Entwicklungsgeschichte und Biologie von *Basidiobolus ranarum* Eidam," *Jahrb. wiss. Botan.*, 66: 513-555, 1927.
- LINK, H. F., "Observationes in Ordines plantarum naturales," *Magaz. ges. naturf. freunde Berlin*, 3: p. 32, 1809.
- MEIER, F. C., AND CHARLES A. LINDBERG, "Collecting micro-organisms from the arctic atmosphere, with field notes and material," *Sci. Monthly*, 40: 5-20, 1935.
- MEYER, HELEN, "Spore formation and discharge in *Fomes fomentarius*," *Phytopathology*, 26: 1155-1156, 1936.
- MOSS, E. H., "Overwintered giant puffballs in Alberta," *Mycol.*, 271-273, 1940.
- ORTON, C. R., "Seed-borne parasites. A bibliography," *West Va. Agr. Expt. Sta. Bull.*, 245: 47 pp. 1931.
- PENNINGTON, L. H., "Wind dissemination of aeciospores of *Cronartium ribicola* Fischer," *Phytopathology*, 14: 32-53, 1924.
- MICHELI, P. A., *Nova plantarum genera*. P. 204, pl. 86, fig. 17. Florentiae, 1929.
- PINCKARD, J. A., "The mechanism of spore dispersal in *Peronospora tabacina* and certain other downy mildew fungi," *Phytopathology*, 32: 505-511, 1942.
- PLOWRIGHT, C. B., "On spore diffusion in the larger Elvellacei," *Grevillea*, 9: 47, 1880-81.
- PRINCE, A. E., "Basidium formation and spore discharge in *Gymnosporangium nidus-avis*," *Farlowia*, 1: 79-90, 1943.
- PRINGSHEIM, N., "Über das Austreten der Sporen von *Sphaeria scirpi* aus ihren Schlauchen," *Jahrb. wiss. Botan.*, 1: 189, 1858.
- PROCTOR, B. E., "The microbiology of the upper air. I," *Proc. Am. Acad. Arts, Sci.*, 69: 315-340, 1934.
- RAND, F. V., E. D. BALL, L. CAESAR, AND M. W. GARDNER, "Insects as disseminators of plant diseases," *Phytopathology*, 12: 225-240, 1922.
- RAND, F. V., AND W. D. PIERCE, "A coordination of our knowledge of insect transmission of plant and animal diseases," *Phytopathology*, 10: 189-231, 1920.
- RITTENBERG, S. C., "Investigations of the microbiology of marine air," *J. Marine Research*, 2: 208-217, 1939.
- SALVIN, S. B., "The occurrence of five successive swarming stages in a non-sexual Achlya," *Mycol.*, 32: 148-154, 1940.
- SAWYER, W. H., "Studies on the morphology and development of an insect-destroying fungus, *Entomophthora sphaerosperma*," *Mycol.*, 23: 411-432, 1931.
- SCHNEIDERHAN, F. J., "Apple diseases in northern Virginia," *Va. Agr. Expt. Sta. Bull.*, 245: 35 pp. 1926.
- SMITH, F. F., AND FREEMAN WEISS, "Relationship of insects to the spread of azalea-flower spot," *U. S. Dept. Agr. Tech. Bull.*, 798: 43 pp. 1942.
- STAKMAN, E. C., A. W. HENRY, G. C. CURRAN, AND W. N. CHRISTOPHER, "Spores in the upper air," *J. Agr. Research*, 24: 599-605, 1923.
- STAKMAN, E. C., W. L. POPHAM, AND R. S. CASSELL, "Observations on stem-rust epidermiology in Mexico," *Am. J. Botany*, 27: 90-99, 1940.

- STEPHANOV, K. M., "Dissemination of infective diseases of plants by air currents," *Bull. Plant Prot. Leningrad*, Ser. 2, *Phytopathology*, 8: 1-68, 1935.
- STUDHALTER, R. A., AND A. G. RUGGLES, "Insects as carriers of the chestnut-blight fungus," *Pa. Dept. Agr. Forestry Bull.*, 12. 34 pp. 1915.
- UKKLEBERG, H. G., "The rate of fall of spores in relation to the epidemiology of black-stem rust," *Bull. Torrey Botan. Club*, 60: 211-228, 1933.
- WALKER, LEVA B., "Development and mechanism of discharge in *Sphaerobolus iowensis*, n. sp., and *S. stellatus* Tode," *J. Elisha Mitchell Sci. Soc.*, 42: 151-178, 1927.
- WALKER, LEVA B., AND EMMA N. ANDERSEN, "Relation of glycogen to spore ejection," *Mycol.*, 17: 154-159, 1925.
- WARD, H. M., "Researches on the life history of *Hemileia vastatrix*, the fungus of the coffee-leaf disease," *J. Linn. Soc. Bot.*, 19: 299-335, 1882.
- WEIMIER, J. L., "Some observations on the spore discharge of *Pleuraea curvica* (Wint.) Kuntze," *Am. J. Botany*, 7: 75-77, 1920.
- WESTON, W. H., JR., "Repeated zoospore emergence in *Dictyuchus*," *Botan. Gaz.*, 68: 287-296, 1919.
- "Production and dispersal of conidia in the Philippine *Sclerosporas* of maize," *J. Agr. Research*, 23: 239-284, 1923.
- WOLF, F. A., "Further studies on peanut leaf spot," *J. Agr. Research*, 5: 891-902, 1916.
- WOLF, F. A., L. F. DIXON, RUTH McLEAN, AND F. R. DARKIS, "Downy mildew of tobacco," *Phytopathology*, 24: 337-363, 1934.
- WOLF, F. T., AND F. A. WOLF, "The snail *Polygyra thyroidus* as a mycophagist," *Bull. Torrey Botan. Club*, 66: 1-5, 1940.
- ZALEWSKI, A., "Über Sporenabschnurung und Sporenabfallen bei den Pilzen," *Flora*, 66: 268-270, 1883.
- ZIEGENSPECK, H., "Schleudermechanismen von Ascomyceten," *Botan. Arch.*, 13: 341-381, 1926.

Chapter 9

GERMINATION OF SPORES

The process of germination of spores is generally regarded as belonging among growth phenomena and hence being subject to modification by all those factors that influence growth. Spore germination has much in common with seed germination, as might be anticipated, and much of value has been learned by mycologists from the techniques and interpretations of those who have studied the germination of seeds. Manifestly the factors that affect the germination of spores, just as that of seeds, are of two types: hereditary or internal, and environmental or external. Hereditary factors include the maturity, longevity, dormancy, and vitality of spores. The environmental factors include the influence of moisture, temperature, pH, kind and concentration of nutrients, light, and the presence of oxygen and carbon dioxide.

Both saprophytic and parasitic fungi have been used in spore-germination studies, more especially the parasitic, because weather conditions are known to influence the incidence and relative prevalence of plant-disease outbreaks. In attempts to evaluate the relative importance of environmental factors to plant diseases, the pathogens have been grown in culture, and, as an incidental result, our knowledge of spore germination has been increased.

GERMINATION TYPES

Different kinds of spores germinate differently. Sometimes the type of germination is characteristic of a large number of closely related species. In other cases environmental factors exert a controlling influence on the type of germination within the same species. Among the aquatic Phycomycetes each propagative element is at first a mother cell whose content breaks up into intracellular units of protoplasm, which, after escape from

the mother cell and after one or more motile stages, become transformed into the assimilatory phase or thallus. In the simplest Phycomycetes this transformation is accomplished by the imbibition of water, after which the protoplast increases in volume, although remaining within the stretched parent-cell membrane; more nuclei and more protoplasm are then formed. The spore thus becomes the unicellular, coenocytic, spherical thallus. The transition from germination to subsequent growth is so imperceptible that there is little or no evidence of delimitation of the two. Among the higher Phycomycetes, for example, species of *Albugo*, *Phytophthora*, *Plasmopara*, and *Sclerospora*, the content of the mother cell (sporangium) may break up into intrasporangial elements (spores), or the sporangium may germinate by the production of a germ tube, depending upon temperature, as one of the controlling factors.

All spores absorb water and swell as an initial step in germination. In most species a germ tube, the primordium of the mycelium, is then formed. In some, however, reserve food in the form of droplets of oil can be noted to disappear as the protoplasm moves into the developing germ tube. If the spore contents in their entirety migrate into the hypha, an empty spore cavity devoid of living content is formed.

In the Erysiphaceae, Peronosporaceae, and Uredinales the germ tube ceases to grow as soon as the reserve food is exhausted unless a nutritive relationship with an appropriate host plant has been established. If nutrient is available, either from the host tissues or from the culture medium, the germ tube continues to grow, becomes branched, and otherwise assumes the characteristics of the parent thallus.

The germ tube of the chlamydospores of Ustilaginales and of the teliospores of the Uredinales is, however, a promycelium or basidium. Its growth is determinate. The promycelium produces sporidia which may germinate by tube formation. Among the Ustilaginaceae the sporidia may germinate by budding. Among the Tilletiaceae the thread-like elements (so-called sporidia) are regarded by Buller as sterigmata of a specialized type, which produce the true sporidia. In species of *Taphrina* and in *Gloeosporium aridum*, *Microstroma juglandis*, *Protocoronospora* (*Kabatella*) *nigricans*, *Catenophora pruni*, *Dematium pullulans*, *Poly-*

spora liri, and many other fungi, the spores may germinate by budding and may continue to grow by budding. In a goodly number of species the spores first form a tube, and subsequent growth is wholly or in large part by budding.

Some spores require both water and a supply of nutrient substances before they can be made to germinate. A lining of protoplasm remains in their spore cavity, and the spore becomes an integral part of the mycelium.

Spores seldom form more than a single germ tube or at most a few. Exceptions are the multicellular spores or large spores. Each cell of a multicellular spore normally behaves as an entity. Large spores, such as those of *Pertusaria* and *Megalospora*, may develop simultaneously fifty or more germ tubes. The tubes in these genera are emitted through pores in the thick wall, but they possess no other peculiarities.

METHODS OF TESTING SPORE GERMINATION

Hoffman (1860) initiated the hanging-drop technique, which now employs Van Tieghem cells and which is now widely used in spore-germination tests. It is employed successfully not only with liquid but also with semisolid media. This method has certain obvious advantages over the use of drops of water containing spores and placed on microscopic slides and over the implanting of spores on media in Petri dishes. None of these features seems to be so important as an understanding of how to secure reproducible results of germination trials. It is quite apparent that there is little accord among the results of investigations on spore germination. As McCallan and Wilcoxon (1932) have shown, the variations in spore germination that have been reported may be attributed to two causes: faulty technique and variation in sampling. Among the common errors which McCallan and Wilcoxon enumerate are: (a) failure to state the number of spores counted, either germinated or not germinated, making it impossible to determine from statistical analysis the degree of significance to attach to the results; (b) counting the control germination as 100% and adjusting the treatments accordingly, thus preventing adequate comparison, because small differences between controls will result in large differences between treatments; (c)

expressing the results of progressively changing treatments plotted against germination of spores as a jagged curve, whereas this curve should be smooth if a sufficient number of spores has been counted.

In regard to faulty technique it is essential that such environmental factors as temperature, time, nature of the medium used in germination, and cleanliness of glassware be controlled. Moreover, uniformity of source and age of spores and density of spore suspension should be given attention. Repetitions of tests on different days may yield variations whose causes are not well understood.

In connection with differences in results between duplicated germination tests, it is possible to determine whether these differences are real and also to compute the degree of significance of differences. Differences attributable to variations in sampling have been found to follow a mathematical law. By use of a formula, that is, by making the Chi-square test (X^2), and by reference to the tables of Fisher (1930, pp. 75-98), which give the probability of occurrence of such values of X^2 , the variations caused by errors in sampling can be evaluated. The procedures involved in these computations are not complicated, although detailed explanation of them is wholly beside the purpose of this chapter.

Some fungi do not seem to require that energy-yielding materials be present for germination, as noted by Lin (1940), using conidia of *Sclerotinia fructicola*. Other species, however, are found dependent upon the presence of sugars and minerals. Lin (1945) demonstrated that the conidia of *Glomerella cingulata* require carbon, magnesium, nitrogen, and phosphorus. He supplied carbon as dextrose in 0.01% solution and minerals in 1.0 millimols with the results shown in Table 16.

TABLE 16

NUTRITIONAL REQUIREMENTS FOR GERMINATION OF *Glomerella cingulata*

<i>Substance Supplied</i>	<i>Element Lacking</i>	<i>Percentage of Germination</i>
Redistilled water	Carbon and minerals	0.0
Dextrose	Minerals	0.0
KNO ₃ + KH ₂ PO ₄ + MgSO ₄	Carbon	0.7
Dextrose + KNO ₃ + KH ₂ PO ₄ + Na ₂ SO ₄	Magnesium	0.9
Dextrose + KNO ₃ + KCl + MgSO ₄	Phosphorus	1.5
Dextrose + KCl + KH ₂ PO ₄ + MgSO ₄	Nitrogen	3.9
Dextrose + KNO ₃ + KH ₂ PO ₄ + MgSO ₄	None	92.8

HEREDITARY FACTORS AND GERMINATION

Many observations on the maturity, longevity, dormancy, and vitality of spores as factors in germination have been recorded, but very little of a fundamental nature is known regarding them. In general, conidia are capable of germination as soon as they are abstracted from the parent cell, just as many seeds may be germinated as soon as they are mature. The zygospores and oospores of Phycomycetes, the chlamydospores of many smuts, and the teliospores of certain species of rusts, however, are known to require a period of dormancy, which, as in seeds, is characterized by thick, hard, protective walls that are presumably quite impervious to water and oxygen.

It may well be that some spores must undergo a period of after-ripening also, as has been reported in connection with *Ustilago longissima*, *U. striaeformis*, *Urocystis anemones*, and *U. cepulae*. Davis (1924) stored spores of *U. striaeformis* in the laboratory in a damp atmosphere at 20° C for about 240 days before he could secure germination. About 265 days were required if the material was stored out of doors. Davis was able to hasten after-ripening by exposing fresh smut spores to fumes of chloroform for 1 minute, then submerging them for 5 minutes in a 10% solution of citric acid, and washing them before placing them in storage.

The oospores of certain Peronosporaceae, for example, *Plasmopara viticola* and *Sclerospora graminicola*, and the teliospores of certain rusts that normally hibernate and then germinate in spring may be induced to germinate during the preceding autumn. By floating teliospores on water or by alternate wetting and drying, Maneval (1922) was able to secure germination during November and December. As the season advanced, there was a marked increase in the percentage germination and a decrease in the time necessary for germination to begin. He used *Puccinia asparagi*, *P. helianthi*, *P. menthae*, *P. peridermiospora*, *P. ruelliae*, *P. sorghi*, *P. sydowiana*, *P. windsoriae*, and *Phragmidium potentillae*. Still other species appear completely to lack a more or less fixed period of dormancy. Spaulding and Rathbun-Gravatt (1925) noted that under outdoor conditions one collection of teliospores of *Cronartium ribicola* from *Ribes rotundifolium* retained longevity for 19 days, and one from *R. nigrum* for 87 days, and that urediniospores

accompanying the teliospores remained viable for a maximum period of 59 days.

Horner (1921) attempted to germinate the aeciospores of *Puccinia coronata avenae* on leaves of *Rhamnus* kept in the herbarium and found them non-viable 167 days after collection, whereas urediniospores on *Avena sativa*, under the same conditions of storage, were viable 87 days after collection. He also placed rust-infected oat leaves in Petri dishes and stored them as follows: Five collections were stored outdoors under a thick covering of leaves and snow, at a temperature range of 27° to 42° F. Two of these collections showed viable urediniospores after 44 days. Of four collections placed unprotected outdoors, none showed viable spores after 22 days. Both of the collections wrapped in paper and stored in the dark at temperatures ranging from 29° to 86° F had viable urediniospores after 79 days. Neither of two collections exposed to sunlight at 29° to 86° F had viable spores after 23 days. The urediniospores of this species kept outdoors in Arkansas under the natural variations of temperatures and humidity succumbed in 15 days [Rosen and Weetman (1940)]. Under controlled conditions Rosen and Weetman found that spores were short-lived at relative humidities below 25% or above 50%, irrespective of temperature. At higher temperatures and humidities viability was lost in 15 days, and at lower temperatures and humidities the spores survived for over 300 days. These results with crown rust of oats and other similar ones with *Puccinia graminis tritici*, both heteroecious species, have an important bearing on the problem of the source of inoculum in spring for infections on these cereals.

Hart (1926) found a similar relationship between temperature and humidity in the retention of viability of urediniospores of *Melampsora lini*. They retained ability to germinate for almost 3 months at favorable temperature and humidity. At relative humidities of 40% and 60% they were viable longer than at 20% or 80%. When stored at high temperatures, they lost viability more rapidly than when kept at low temperatures.

Raeder and Bever (1931) recorded that urediniospores of *Puccinia glumarum*, *P. graminis phlei-pratensis*, and *P. graminis tritici* remained germinable 88, 120, and 128 days, respectively, when kept at a relative humidity of 49% and at a temperature range between 9° and 13° C. At the same relative humidity and at

temperatures between 3° and 11° C, *P. triticina* remained viable 124 days.

Smut fungi are known to retain their viability for long periods. McAlpine found *Tolyposporium bursum* on kangaroo grass viable after 4 years' storage in the laboratory. Long ago Brefeld noted that *Tilletia tritici*, when kept dry in the herbarium for 8½ years, was still germinable. *Urocystis cepulae* is reported to remain viable in the soil for at least 5 years. Many root-invading pathogens are well known to persist in the soil not only from one year to the next but also for a term of years.

It has been indicated that, as teliospores of certain rusts become older, less time may be necessary for their germination, especially in species in which the teliospores constitute the overwintering stage. The converse is true in many conidial forms. Brown (1922) observed that 6-week-old conidia of *Botrytis cinerea*, for instance, require twice as long to germinate as do 10-day-old ones. On the other hand, a larger percentage of conidia of *Phyllosticta solitaria* are capable of germination 10 to 14 days after they are of mature size than can germinate immediately after they have attained this size [Burgert (1934)]. It thus appears that an interval may exist between morphological and physiological maturity of spores.

The retention of viability by spores is in some instances related to their separation from the parent cell and from the host tissues and to their isolation from each other. The ascospores of bark-inhabiting and leaf-inhabiting species are known to retain their ability to germinate for a longer time if they remain within the host tissues than if they are removed. Similarly, the conidia of *Gloeosporium*, *Colletotrichum*, *Lecanosticta*, and other genera in which a mucilaginous matrix holds the conidia together in mucoid masses succumb much more quickly after they have been dispersed by contact with water. Desiccation is undoubtedly the primary cause of loss of viability in such cases.

The studies by Goddard (1935) and Goddard and Smith (1938) constitute an interesting approach to the problem of dormancy in spores. Goddard (1935) induced the dormant ascospores of *Neurospora tetrasperma* to germinate by heating them for a few minutes at temperatures of 50° C or higher. Germination occurred within 2 or 3 hours if such heat-treated spores were placed in water at room temperature. If the spores were stored under

anaerobic conditions for a few hours after treatment and then placed under conditions favorable for germination, however, they failed to grow. Activation and deactivation were therefore reversible reactions. In later work Goddard and Smith (1938) sought to explain what portion of the respiratory mechanism is activated by heat and what constitutes the respiratory block in dormant spores. By subjecting spores to various partial pressures of oxygen and carbon dioxide, they determined that the respiratory rates are not limited by permeability of the spore membranes to passage of these gases. Under anaerobic conditions carbon dioxide was not evolved by dormant spores, an observation which led Goddard and Smith to suggest that active carboxylase is not present in such spores. On heating, however, this enzyme is reversibly activated. They interpreted their results to show that two qualitatively different respiratory systems are present in the ascospores of *N. tetrasperma*, the dormant system which func-

TABLE 17

VIABILITY OF SPORES OF MYXOMYCETES

<i>Species</i>	<i>Germinated at Indicated Interval after Collection (approximate number of years)</i>
<i>Stemonitis favogenita</i>	5
<i>Fuligo septica</i>	6
<i>Reticularia lycoperdon</i>	10
<i>Lamproderma violaceum</i>	13
<i>Trichia favoginea</i>	16
<i>Enteridium olivaceum</i>	17
<i>Badhamia utricularia</i>	20
<i>Stemonitis ferruginea</i>	21
<i>Dictydiaethalium plumbeum</i>	22
<i>Badhamia panicea</i>	23
<i>Trichia botrytis</i>	26
<i>Lepidoderma tigrinum</i>	26
<i>Physarum straminipes</i>	26
<i>Trichia scabra</i>	27
<i>Trichia lateritia</i>	28
<i>Physarum cinereum</i>	29
<i>Didymium squamulosum</i>	30
<i>Fuligo septica</i>	30
<i>Diachea leucopoda</i>	30
<i>Hemitrichia clavata</i>	32
<i>Stemonitis ferruginea</i>	32

tions in the absence of the enzyme carboxylase, and a second system which is active in heated spores. Inactivity of carboxylase thus constitutes the respiratory block.

The age of spores of *Myxomycetes* has been shown by Smith (1929) to be of little significance in germination. Using herbarium specimens, he secured germination in spores from 5 to 32 years after collection, as is shown in Table 17.

WATER RELATIONS AFFECTING GERMINATION

Since water is profoundly important in all vital phenomena, it may be anticipated that its presence is a primary requirement in initiating spore germination. Spores, like seeds, do not all become wet with equal facility, an observation that has been made by everyone who has attempted to suspend spores in water for use as inoculum. Ziegenspeck (1934) has clarified the physico-chemical principles involved in the problem of wetting spores. Wetting must be regarded as the displacement of a gas film at the surface of a solid (spore) by a liquid (water). It implies an affinity of the solid for the liquid and is governed by solid-liquid, solid-gas, and liquid-gas tensions. The resultant forces are measurable in terms of the angle of contact made by the solid with the liquid, as Ziegenspeck shows.

An examination of the literature on moisture requirements for germinating spores shows conflicting results concerning whether a film of water is necessary, since at high relative humidity a slight decrease in temperature causes condensation. Experimentation becomes difficult if the effects of an aqueous film and of humidity are to be distinguished. Far too little careful work has been done on this problem.

Doran (1922, pp. 334-335) recorded that *Sclerotinia fructigena*, *Peronospora pygmaea*, *Phyllosticta antirrhini*, *Cylindrocladium scoparium*, and urediniospores of *Puccinia coronata* germinate only when in direct contact with water. On the other hand, his observations show that aeciospores of *Gymnosporangium clavipes* and conidia of *Alternaria solani* and *Venturia inaequalis* may germinate in moist air. Stock (1931) failed to secure germination of urediniospores of *Puccinia graminis* and *P. coronata* when the spores were dusted on glass slides at relative humidities of 99% or below.

Hemmi and Abe (1933) controlled humidity by exposure over varying concentrations of sulphuric acid with the results shown in Table 18 for urediniospores of *P. glumarum*.

TABLE 18

GERMINATION OF *Puccinia glumarum* AS MODIFIED BY VARIOUS RELATIVE HUMIDITIES

Relative Humidity	H ₂ SO ₄ (specific gravity)	Condition of Spores	Number of Spores	Percentage of Germination
100	1.0	In drops	1247	44.5
100	1.0	Dry	684	12.4
99	1.020	Dry	646	1.5
95	1.090	Dry	739	0
90	1.158	Dry	904	0

Although fungi generally respond to humidity in a manner similar to that shown by *P. glumarum* in Table 18, certain of them germinate independently of the moisture content of the surrounding air. The conidia of *Erysiphe polygoni*, for instance, were found by Brodie and Neufeld (1942) to germinate through a range of relative humidity from approximately zero to 100%. These observations find support in the fact that powdery mildews are known to grow luxuriantly in areas where low relative humidities prevail.

By means of apparatus in which he was able to control relative humidities accurately, Clayton (1942) found that the mean percentage germination of urediniospores of *Puccinia coronata*, *P. graminis tritici*, and *P. graminis avenae* was lower at a relative humidity of 100% than in water, was considerably less at 99% relative humidity, and was practically nonexistent at 98%. The conidia and ascospores of *Venturia inaequalis* germinated on dry glass if the relative humidity was 99 to 100%. When chlamydo-spores of *Ustilago hordei* and *U. nuda* were similarly placed on dry glass, they germinated at relative humidities of 95 to 100% but not at 93% or below. Furthermore he was able to germinate the conidia of *Erysiphe polygoni* on dry glass at relative humidities of zero to 100%, thus verifying the results of Brodie and Neufeld (1942).

Rippel (1933) presented evidence in connection with his studies on the germination of conidia of *Cladosporium fulvum* that the

humidity gradient between the air and the spore membrane is a more decisive factor than relative humidity in influencing germination. In *C. fulvum* moisture content of the spores is low. He concluded that the higher is the gradient, the better are the chances of germination.

In many of the studies concerned with germination of rusts, infected host tissues or the spores themselves are floated on water. Blackman (1903) noted that the submerged germ tubes (promycelium) of *Uromyces fabae*, *Puccinia graminis*, and *Phragmidium rubi* grew to considerable length with the protoplasm collected near the apex and that basidiospores were not formed unless the tube reached the air, whereas in moist air the tubes were short and 4-celled, and each cell possessed a sterigma upon which a basidiospore was borne. This morphological modification in type of germination is now known to be related to the fact that rusts forcibly expel their basidiospores, which are adapted for dispersal by air.

Evidently alternate wetting and drying play an important part in the spore germination of some species. Jahn (1905) stated this to be true of certain slime molds. Alternate wetting and drying, he believed, activated the glycogen-cleaving enzymes, thus causing glycogen in the spore to be converted into maltose with resultant increase of osmotic pressure. This explanation may well apply to other kinds of fungi, but it is conceivable that modification of the spore wall itself may result from alternate wetting and drying and that this change is an important factor in germination.

Little is known concerning the application of findings from laboratory studies on the relation of moisture to spore germination. A body of data is much needed, especially on the relation of moisture to germination and infection by plant pathogens. Observational evidence, which is insufficient and which may indeed be misleading, has led to the conclusion that outbreaks of some plant diseases are caused by dry weather, others by wet weather. Among studies of this kind is that of Jones (1923), who attempted to correlate the moisture-holding capacity of the soil with germination by *Ustilago avenae*. She placed chlamydospores on agar between filter papers and then placed them in soils containing 30, 60, or 80% of their water-holding capacity. At favorable temperatures germination was highest at 30%, slightly less at 60%, and markedly less at 80%. At 80%, which is also unfavorable for in-

fection, lack of sufficient oxygen, as Jones points out, is undoubtedly a controlling factor.

Heavy water, deuterium oxide, as it affects germination of conidia of *Erysiphe graminis tritici*, was studied by Pratt (1936). He varied the concentrations of D₂O from 0.02 to 100%, with phosphates as buffers. Conidia germinated in all concentrations, but the rate of elongation of the germ tube and its final length were found to be inversely proportional to the concentration of D₂O. Deuterium oxide seems to limit the amount of solutes and colloids within the conidia that is utilizable in growth.

EFFECTS OF TEMPERATURE ON GERMINATION

Temperature is known to be one of the factors that modify the severity of plant diseases. It may also be the limiting factor in the prevalence of diseases of crop plants in certain areas. As examples it may be recalled that apple scab and late blight of potatoes are of rare occurrence and are never of consequence in the Coastal Plain area of the southeastern United States. Anthracnose-free bean seed can be produced in portions of this area by planting at such seasons that high temperatures will prevail at the critical period during maturing of the crop. Blue-staining fungi are an important cause of the degrading of lumber in the warmer parts of the United States.

For every fungus there is a minimum, an optimum, and a maximum temperature, the cardinal temperatures, for germination and for subsequent growth of the fungus. The metabolic activities or rate of reaction of each species increases with an increase of temperature up to a certain limit. These cardinal temperatures must be understood to mean both the extreme temperature limits of metabolic activity, all other factors being kept constant, and the temperature at which metabolism proceeds at the best rate.

The effect of temperature on germination of urediniospores of *Puccinia coronata* and on rate of growth of the germ tube is shown by the work of Melhus and Durrell (1919), the rate being greatest at the optimum temperature. At either extreme, there is no growth. Rate of growth may, therefore, be regarded as a direct function of $(t - t^0)$, if t represents any particular temperature, and t^0 , the minimum temperature. In some instances, as could be expected, the temperature which is optimum for germination

of spores may not be optimum for subsequent development. These adaptations may be hereditary and may account for the geographical distribution of the organisms concerned and for their seasonal incidence.

One type of influence of temperature upon the method of spore germination was shown by Melhus (1915). He noted that the sporangia of *Phytophthora infestans* germinated by either formation of a tube or formation of swarm spores. A temperature of

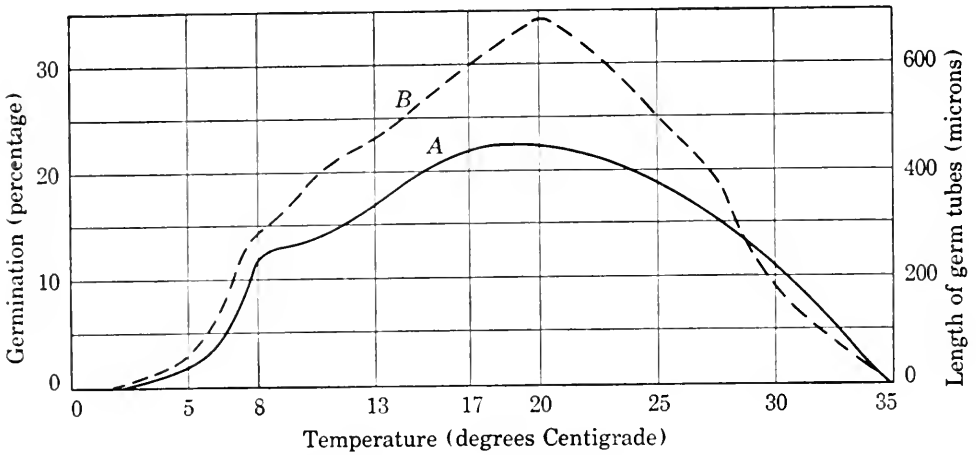

FIG. 39. Effect of temperature upon percentage of germination and upon length of germ tubes in urediniospores of *Puccinia coronata*. (After Melhus and Durrell.) A. Percentage of germination. B. Length of germ tubes in microns. A close correlation is shown.

23° C was optimum for tube formation and of 13° C for production of swarm spores. These critical temperatures, as given by Crozier (1933), were 24° C and 12° C, respectively. Other Peronosporales, notably *Peronoplasmopara cubensis*, are known to behave similarly.

CARDINAL TEMPERATURES FOR GERMINATION. From his own observations and those of other workers, Doran (1922) assembled in tabular form data on the influence of temperature on spore germination among a variety of pathogenic fungi. These data constitute the bases from which Table 19, supplemented by more recent observations, has been prepared. No generalizations appear warranted from these data, except perhaps that the temperatures which normally prevail when the spores of these species are being dispersed are favorable for germination. The data have a direct bearing, however, on problems that concern the relation

TABLE 19
CARDINAL TEMPERATURE AND SPORE GERMINATION

Organism	Cardinal Temperatures		
	Mini- mum (° C)	Opti- mum (° C)	Maxi- mum (° C)
<i>Plasmodiophora brassicae</i>	27-30
<i>Plasmopara viticola</i> (sporangia)	25-35
<i>Cystopus candidus</i> (sporangia)	0	10	25
<i>Phytophthora infestans</i> (sporangia)			
(indirect method)	2-3	12-13	24-25
(direct method)	12-13	24	30
<i>Peronospora parasitica</i> (sporangia)	8-12	29
<i>Sclerospora graminicola</i>			
(sporangia) [Tsaugi (1933)]	5	17.5	33.5
(oospores) [Tsaugi (1933)]	11.5	20-23.5	35
<i>Rhizopus nigricans</i> [Ames (1915)]	5	36
<i>Glomerella ruformaculans</i>	5	30
<i>Gymnosporangium clavipes</i> (aeciospores)	8	14	25
<i>Gymnosporangium juniperi-virginianae</i>			
(teliospores)	11	15	29
(teliospores)	7	23-24	29
<i>Cronartium ribicola</i>			
(aeciospores)	5	12	19
(urediniospores)	8	14	25
<i>Melampsora lini</i> (urediniospores) [Hart (1926)]	0	6-23	26
<i>Puccinia antirrhini</i> (urediniospores)	5	10	20
<i>Puccinia coronifera</i> (urediniospores) [Stock (1931)]	5	14-25.5	32.5
<i>Puccinia coronata</i>			
(urediniospores)	18	30
(urediniospores)	7	30
(urediniospores)	1	17-22	35
(urediniospores) [Stock (1931)]	7-8	12-17	30
<i>Puccinia dispersa</i> (urediniospores)	10-12	18-20	25-27
<i>Puccinia graminis</i> (basidiospores)	15-20
(urediniospores)	2	31
(urediniospores) [Stock (1931)]	2-3	5-20	29-30
(teliospores)	9	22	23
<i>Puccinia malvacearum</i> (teliospores)	3	14	30
<i>Puccinia phlei-pratensis</i> (urediniospores)	18	30
<i>Puccinia rubigo-vera</i> (urediniospores)	2	31
(urediniospores) [Johnson (1912)]	2	12-17	30
<i>Puccinia sorghi</i> (urediniospores)	4	14	25
<i>Puccinia triticina</i> (urediniospores) [Stock (1931)]	2-3	5-20	29-30
<i>Uromyces carophyllinus</i> (urediniospores)	4	14	29
<i>Uromyces trifolii</i> (urediniospores)	16	34
<i>Ustilago avenae</i> [Jones (1924)]	4-5	15-28	29-30
<i>Ustilago striaeformis</i> [Davis (1924)]	7	22	35
<i>Urocystis cepulae</i> [Walker and Wellman (1926)]	9	15-22	29
<i>Urocystis tritici</i> [Noble (1923)]	5	24	32
<i>Urocystis occulta</i> [Ling (1940)]	5	15	30
<i>Alternaria solani</i> [Doran (1919), p. 392]	1-3	26-28	37-45
<i>Colletotrichum lagenarium</i>	7	22-27
<i>Cylindrocladium scoparium</i> [Doran (1919), p. 392]	8	12-30	36
<i>Phyllosticta solitaria</i> [Burgert (1934)]	5	23	39
<i>Monilia fructigena</i> [Ames (1917)]	0	25
<i>Cephalothecium roseum</i> [Ames (1917)]	5	30
<i>Penicillium digitatum</i> [Ames (1917)]	0	25

of temperature to infection, escape from infection, resistance, and cardinal temperatures of the host. Such matters are beside the present purpose but are comprehensively dealt with by Lauritzen (1919) in his studies of *Ascochyta fagopyrum* on buckwheat, *Colletotrichum lindemuthianum* on bean, and *Puccinia graminis* on wheat. It may be mentioned, however, that temperatures permitting spore germination generally also permit infection. In soil-borne pathogens and smuts that infect seedlings, temperature interacts with soil moisture and soil reaction, and each factor is interdependent.

The temperature relations of those fungi that produce decay, especially of fruits and vegetables, have been extensively studied because of their bearing on problems of storage and refrigeration. Weimer and Harter (1923) determined the cardinal temperatures of several species of *Rhizopus*, all of which cause decay of sweet potatoes in storage, to be as shown in Table 20. The first four

TABLE 20

CARDINAL TEMPERATURES OF SPECIES OF RHIZOPUS ASSOCIATED WITH SOFT ROT OF SWEET POTATOES

Species	Temperature (degrees C)		
	Minimum	Optimum	Maximum
<i>R. artocarp</i>	1.5	26-29	33.5
<i>R. nigricans</i>	1.5	26-28	33.0
<i>R. reflexus</i>	1.5	30-32	36.6
<i>R. microsporus</i>	1.5	26-28	33.0
<i>R. tritici</i>	1.5	36-38	44.0
<i>R. delemar</i>	8.7	36-38	44.0
<i>R. nodosus</i>	1.5	36-38	44.0
<i>R. oryzae</i>	9.0	36-38	44.0
<i>R. arrhizus</i>	1.5	36-38	43.6
<i>R. chinensis</i>	10.0	43-45	51.0

species in the list may be set apart as a low-temperature group, *R. chinensis* is a high-temperature species, and the others are intermediate.

In general, the studies on minimal temperatures that prevent germination and growth of species causing decay of perishable foods show that storage temperatures near 0° C must be maintained if losses are to be prevented. Hoffman (1860) found that conidia of *Penicillium glaucum*, *Botrytis vulgaris*, and *Trichothec-*

cium roseum, all essentially omnivorous species, germinate very near the freezing point. In similar studies Ames (1915) employed *Glomerella rufomaculans* and *Cephalothecium roseum* from apple, *Thielaviopsis paradoxa* from pineapple, *Penicillium digitatum* from

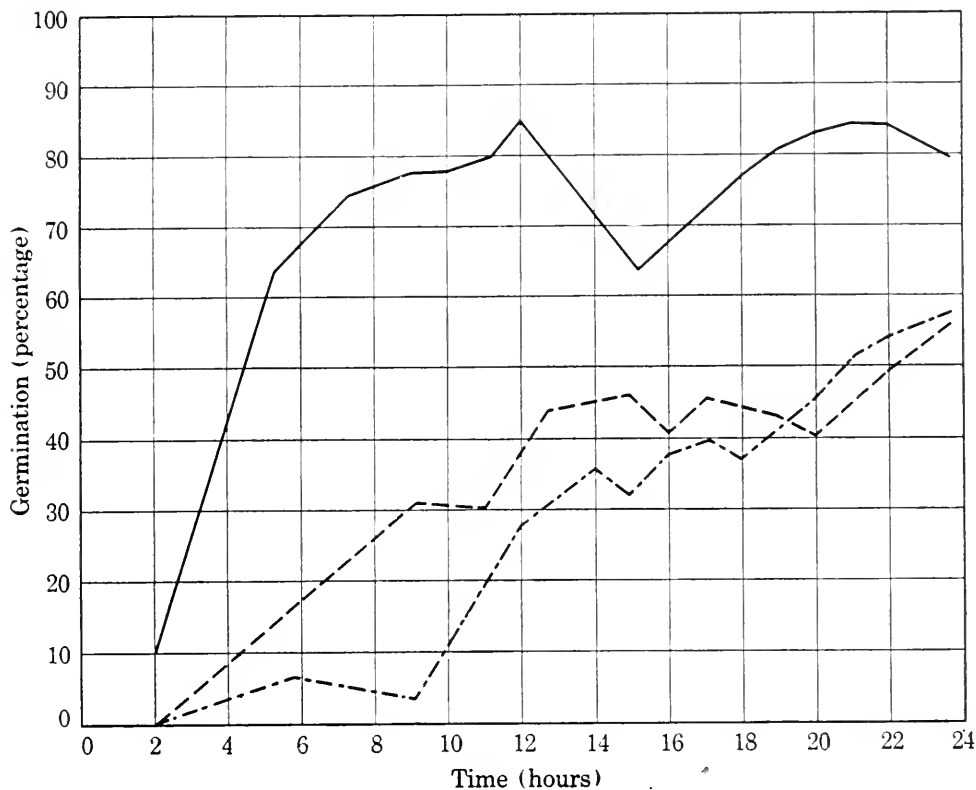

FIG. 40. Effect of storage indoors for different periods on germination of teliospores of *Cronartium ribicola*. The curves are based on 3-hour moving averages. Solid line, from teliospores taken from *Ribes nigrum* and stored for 5 days; dash line, from teliospores taken from *R. americanum* and stored for 15 days; dot-dash line, from teliospores taken from *R. nigrum* and stored for 25 days. (After Spaulding and Rathbun-Gravatt.)

orange, *Rhizopus nigricans* from sweet potato, and *Monilia fructicola* from plums and found that near-freezing temperatures must be maintained in storage if germination of these species is to be prevented and development of decay by them entirely avoided.

The most extensive data on cardinal temperatures among Myxomycetes are those of Smart (1937). He germinated the spores of 70 species, finding that the range 22° to 30° C is optimum for all. At 10° C or lower and above 30° C percentage germination

and rate of germination are greatly reduced. The temperature range for germination extends from 2° to 36° C.

THERMAL DEATH POINT. In bacteriology the term thermal death point or, more appropriately, thermal death time has been employed to express that minimal temperature fatal to all bacteria after exposure for 10 minutes. The method used is to subject a suspension of bacteria to a series of selected temperatures and at definite intervals to plant out portions to determine the number of survivors. If the operation is repeated sufficiently often, it will be found that at a particular temperature all organisms are dead after an exposure of 10 minutes. All other factors must be identical in thermal-death-time measurements, because age of organisms, concentration of organisms, and pH are modifying factors. Essentially the same method, using suspensions of spores, may be employed for fungi. Smith (1923) made such a study with conidia of *Botrytis cinerea* exposed at a range of temperatures between 31° and 50.3° C. When he plotted the proportion surviving at different times for each temperature, he got a series of approximately symmetrical sigmoid curves all exactly alike except for the rate of speed of killing at different temperatures. If the observations at each temperature employed by Smith are plotted, they will be seen to fall closely on a typical frequency-distribution curve.

Spores retain their viability at higher temperatures when subjected to dry heat than to moist heat. These differences in tolerance become greater if the temperature is very slowly elevated during dry heating. In explanation it may be pointed out that heat coagulates proteins more readily when the moisture content is high than when a small percentage of water is present. The observations of Tsaugi (1933) on retention of germinability by oospores of *Sclerospora graminicola* are concerned with this point. Those subjected to dry heat at 50° C, 55° C, and 60° C remained viable, whereas moist heat at these temperatures was lethal.

Ames (1915) determined that the thermal death point of *Thielaviopsis paradoxa* is 52.5° to 53.5° C, of *Rhizopus nigricans*, 60° C, of *Monilia fructicola*, 52.0° to 52.5° C, of *Glomerella rufomaculans*, 53.0° to 53.5° C, of *Cephalothecium roseum*, 47° to 48° C, and of *Penicillium digitatum*, 58.0° to 58.5° C.

The tolerance of fungus spores to low temperatures should be subjected to study by methods patterned after those dealing with thermal death points. Such studies appear not to have been accomplished, except for relatively few species. This topic is summarized by Luyet and Gehenio (1941) and is briefly discussed in Chapter 5. Investigations of the effects of cold on fungi, especially rusts, have been largely concerned with overwintering, as related to the source of inoculum for the development of disease outbreaks. Christman (1905) and Horner (1921) are among

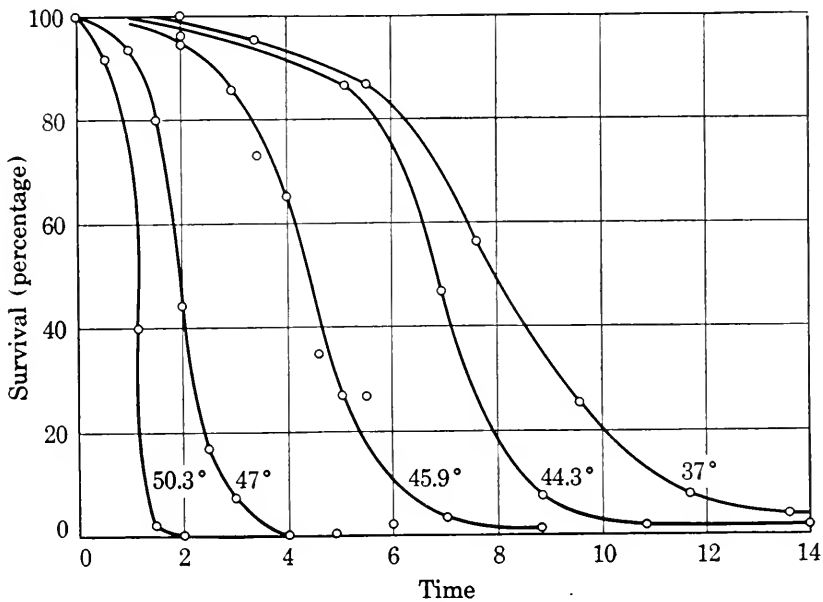

FIG. 41. Effect of temperature upon survival of *Botrytis cinerea*. Percentage surviving plotted against time in minutes, except for the 37° C curve, the intervals of which are 30 minutes. (After J. H. Smith.)

those who have investigated survival of urediniospores of cereal rusts. Ewert (1910) noted that a small proportion of conidia of *Pseudopeziza ribis* survived the winter when exposed to outdoor temperatures as low as -22°C . Several exposures of *Fusicladium dendriticum* and *F. pirinum* to freezing greatly reduced their percentage of germination. The conidia of *Mycosphaerella sentina*, however, artificially subjected to alternate freezing at temperatures as low as -16°C and thawing, retained germinability as well as did untreated ones.

Many Ascomycetes known to possess a conidial stage can overwinter in this stage. The ascospores of others are mature in fall

and remain dormant throughout winter. The ascogenous stage of a third group develops slowly during winter and matures in spring. In any event the overwintering of conidia of a species not known to possess an ascogenous stage is not a criterion upon which to predicate the possession of such a stage.

TEMPERATURE AND PERCENTAGE GERMINATION. Obviously the proportion of the total number of spores of a given species which germinate is correlated with temperature and with time as external factors of primary importance. Temperature as a correlated factor in percentage germination is illustrated by the observations of Kaufmann (1934), presented in Table 21. Germination was

TABLE 21

PROPORTION OF SPORES OF CERTAIN BASIDIOMYCETES THAT GERMINATE AT DIFFERENT TEMPERATURES

Organism	Percentage of Germination at						
	15° C	20° C	25° C	30° C	35° C	40° C	45° C
<i>Coprinus micaceus</i>	1.72	3.30	15.09	15.05	77.73	39.54	27.48
<i>Coprinus comatus</i>	3.37	6.72	12.69	17.18	16.29	14.38	7.58
<i>Lepiota cepaestipes</i>	0	0	3.39	8.97	2.71	0	0
<i>Cyathus olla</i>	0	2.59	4.26	10.52	4.53	0	0
<i>Cyathus striatus</i>	0	1.99	3.93	7.65	3.19	0	0

relatively poor with each of these species, so that the relationship is not so striking as may have been desired. Doran's (1922) results with a series of trials employing conidia of *Venturia inaequalis* are more representative. The averages of his tests are 0% at 2° C, 3% at 5° C, 21.5% at 8° C, 56.2% at 10° C, 76.5% at 12° C, 100% at 15° C, 77.2% at 18° C, 56.5% at 20° C, 41.5% at 24° C, 22.2% at 28° C, 11% at 30° C, and 0% at 32° C.

TIME REQUIRED FOR GERMINATION AT DIFFERENT TEMPERATURES. As has previously been stated, the spores of some fungi are capable of germination as soon as they are produced, whereas others undergo a period of dormancy. In any event temperature is a factor correlated with the time required for spore germination. In some species germination can be secured within an hour; at the opposite extreme, others may require exposure for several weeks to conditions favoring germination. The time-temperature relationships in spore germination are illustrated by Ames's (1915) results of studies on fruit-rotting fungi and are shown in Table 22.

TABLE 22

TIME (HOURS) REQUIRED FOR GERMINATION OF SPORES AT DIFFERENT TEMPERATURES

Fungus	1° C	5°-6° C	10°-12° C	15° C	20° C	25° C	30° C
<i>Thielaviopsis paradoxa</i>	1	168	23	13	8	8	8
<i>Rhizopus nigricans</i>	1	168	43	36	16	13	16
<i>Monilia fructigena (fructicola)</i>	245	100	7	7	7	7	7
<i>Penicillium digitatum</i>	120	48	15	8	8	8	8
<i>Glomerella ruformaculans</i>	1	174	15	8	7	7	7
<i>Cephalothecium roseum</i>	1	1	24	15	7	7	7

¹ Failed to germinate.

INFLUENCE OF REACTION ON GERMINATION

The pH which limits germination has been determined for many species of fungi. A divergence of opinion exists concerning the proper appraisal of the value of such knowledge. No such disagreement exists, however, regarding the usefulness of data involving the influence of reaction on mycelial development of fungi in cultures or in soil and other natural habitats.

Most fungi germinate and develop best in acid media. The kind of nutrient, however, exerts a profound influence upon the response to the reaction of the medium. Webb (1921) made a comparative study of the effects of hydrogen- and hydroxyl-ion concentration upon the germination of *Botrytis cinerea*, *Aspergillus niger*, *Penicillium italicum*, *P. cyclopium*, *Lenzites saepiaria*, *Puccinia graminis*, *Fusarium* sp., and *Colletotrichum gossypii* in four liquid media, namely, solutions of mannite and of peptone, Czapek's nutrient, and sugar-beet decoction. All except *Fusarium* sp. and *C. gossypii* responded favorably to successively increasing concentrations of hydrogen ions in all media within the range pH 7.0 to 3.0-4.0. *Colletotrichum gossypii* responded best within the alkaline range. Specificity of response in each nutrient is illustrated by the fact that *Botrytis cinerea* germinated in mannite from pH 1.6 to 6.9, but did best at pH 3.0; in Czapek's nutrient from pH 2.5 to 9.6, but best at pH 3.0 to 3.6; in peptone from pH 2.1 to 8.7, but best at pH 4.0 to 5.3; and in beet decoction from pH 2.0 to 9.8, but best at pH 4.0 to 7.0.

Similar studies on other organisms show that pH 6.86 is optimum for germination of *Urocystis occulta*, with no germination

at pH 3.80 and sparse germination at pH 8.95 [Ling (1940)]. Tsaugi (1933) secured best germination of oospores of *Sclerospora graminicola* at pH 2.9 to 3.1, with very little germination at pH 9.3. Kaufmann (1934) found pH 7.5 optimum for *Coprinus micaceus*, *C. comatus*, and *Cyathus olla*, pH 7.0 optimum for *Lepiota cepaestipes*, and pH 6.5 optimum for *Armillaria mellea*. Smart (1937) made a study involving the effect of reaction on the germination of 70 species of slime molds. All species germinated within the range pH 4.0 to 8.0. *Fuligo septica* germinated within the range pH 2.0 to 10, and *Physarum serpula*, pH 2.0 to 8.5. The optimum pH for germination in all species was 4.5 to 7.0.

INFLUENCE OF OXYGEN ON GERMINATION

De Bary (1887) noted that spores in a drop of water between the cover glass and slide germinate better near the periphery of the cover glass than near the center. He attributed this effect to the relative amounts of air available. This observation has been verified by everyone who has attempted to repeat the experiment. Duggar (1901) gave special consideration to reduced O₂ tension as a factor in retarding germination. Blackman (1903) pointed out the occurrence of morphological differences in germination of teliospores in water and in air. Melhus and Durrell (1919) recorded that few urediniospores of *Puccinia coronata* germinate if submerged in comparison with the number germinating if they float at the surface. Abundant evidence shows that a smaller percentage of germination is secured in drops of water containing many spores than in those containing few. Oxygen relations must therefore be considered in studies of spore germination, and they may be expected to be correlated with the ability to become wet and with the specific gravity of the spores.

The absence of oxygen may not inhibit germination, as is shown by Uppal's (1926) studies on certain Peronosporales. When he removed the oxygen (by a vacuum pump or by alkaline solutions of pyrogallie acid) from the environment in which sporangia of *Phytophthora colocasiae*, *P. infestans*, *P. parasitica*, and *P. palmivora* were placed for germination, these species germinated by formation of swarm spores. On the other hand, *Albugo candida*, *Plasmopara viticola*, and *Sclerospora graminicola*, which germinate in the same manner, require the presence of oxygen

for germination, as do also *Peronospora parasitica* and *P. trifoliorum*, which germinate by formation of germ tubes.

INFLUENCE OF CARBON DIOXIDE ON GERMINATION

The observations of Brown (1922) on volatile materials produced by apples and potatoes in storage led him to conclude that volatile substances may have considerable influence in control of organisms which produce decay. Ethyl acetate, a common fruity ester evolved by apples, exerted either a stimulatory or an inhibitory effect on the germination of *Botrytis cinerea*, depending upon the concentration. Volatile substances from leaves of apple, Ruta, Eucalyptus and other aromatic plants increased germination of this fungus, whereas vapors from potato tubers and onions were inhibitory. Platz, Durrell, and Howe (1934) concluded that stimulation of germination of *Ustilago zae* in the presence of plant tissues is the result of increased carbon dioxide tension, the carbon dioxide being generated by the plant tissues. The presence of corn leaves in their germination chambers increased the carbon dioxide content to 15%, the optimum for germination of the corn smut. Platz, Durrell, and Howe reported that carbon dioxide acts by changing the reaction, and that 15% carbon dioxide in the air produces hydrogen-ion concentrations ranging from pH 4.9 to 5.6, which is optimum for *U. zae*.

INFLUENCE OF LIGHT ON GERMINATION

Too little is known regarding the effect of radiations on the germination of fungi, and published reports frequently contain conflicting conclusions. De Bary [Doran (1922), p. 333] and Farlow [Doran (1922), p. 333] state that light inhibits germination of spores of Oomycetes. Melhus (1915), on the other hand, found that light does not inhibit germination of sporangia of *Phytophthora infestans*. Doran (1922) noted that *Alternaria solani* and conidia of *Sclerotinia fructigena* germinate equally well in direct light, diffuse light, or darkness. Dillon-Weston (1932) germinated urediniospores of *Puccinia graminis avenae*, *P. graminis tritici*, and *P. coronata* under standardized Wratten green and blue filters, which permit the passage of wavelengths of 450 to 555 m μ ,

but germination was inhibited under the red, orange, yellow, and purple filters.

INFLUENCE OF NUTRITION ON GERMINATION

As has been emphasized, the intake of water by the spore is the *sine qua non* for the initiation of germination. Apparently, however, not all species can be made to germinate in pure water. Since water is a universal solvent, spores do not come in contact with pure water under natural conditions. Whether they lodge on living plants or animals, on decaying tissues, on the soil, or in water, they come in contact with soluble organic materials. Advantage may be taken of this fact in germination trials, especially with species that thus far have proved impossible to grow in artificial culture, for example, Peronosporaceae, Erysiphaceae, and Hypodermataceae. The germination of some species in those families appears to be hastened by the presence of the green tissues of their appropriate hosts. Similar experiences have also been recorded with *Rhizytisma acerinum*, *Gnomonia ulmea*, *Cymadothea trifolii*, *Diplocarpon rosae*, and *Linospora gleditsiae*. Germination of the spores of *Merulius lacrymans* is hastened by the presence of urine. In general, with species whose germination is attended with difficulty in potable water, an attempt should be made to approximate natural conditions of germination.

RÉSUMÉ

It is plainly apparent from the foregoing discussion that both hereditary and environmental factors influence the germination of fungus spores. It is not evident, however, that anything of fundamental importance is likely to be established by additional studies of this sort involving either these same species or other species. Perhaps attention might better be centered on determining the causes of dormancy in spores and the means whereby dormancy may be broken. Such inquiries are likely to be most fruitful if they are patterned after studies on the germination of seed.

Studies involving the presence of growth factors to hasten or to increase germination might conceivably yield results of value, especially with species that require the given growth factor for

mycelial development. Conceivably such information might have a bearing on problems of obligate parasitism.

LITERATURE CITED

- AMES, ADELINE, "The temperature relations of some fungi causing storage rots," *Phytopathology*, 5: 11-19, 1915.
- BARY, ANTON DE, *Comparative morphology and biology of the fungi, mycetozoa, and bacteria*. Oxford Press, 1887.
- BLACKMAN, V. H., "Conditions of teleutospore germination and of sporidia formation in the Uredinales," *New Phytol.*, 2: 10-14, 1903.
- BRODIE, H. J., AND C. C. NEUFELD, "The development and structure of the conidia of *Erysiphe polygoni* DC and their germination at low humidity," *Can. J. Research*, 20: 41-61, 1942.
- BROWN, WILLIAM, "On the germination and growth of fungi at various concentrations of oxygen and of carbon dioxide," *Ann. Botany*, 36: 257-283, 1922.
- "Studies in the physiology of parasitism. IX. The effect on the germination of fungal spores of volatile substances arising from plant tissues," *Ann. Botany*, 36: 285-300, 1922a.
- BURGERT, IRMA A., "Some factors influencing germination of spores of *Phyllosticta solitaria*," *Phytopathology*, 24: 384-396, 1934.
- CHRISTMAN, A. H., "Observations on the overwintering of grain rusts," *Trans. Wis. Acad. Sci.*, 15: 98-107, 1905.
- CLAYTON, C. N., "The germination of fungous spores in relation to controlled humidity," *Phytopathology*, 32: 921-943, 1942.
- CROZIER, WILLARD, "Studies in the biology of *Phytophthora infestans* (Mont.) de Bary," *Cornell Agr. Expt. Sta. Mem.*, 155: 40 pp. 1933.
- DAVIS, W. H., "Spore germination of *Ustilago striaeformis*," *Phytopathology*, 14: 251-267, 1924.
- DILLON-WESTON, W. A. R., "The reaction of disease organisms to certain wavelengths in the visible and invisible spectrum," *Phytopath. Z.*, 4: 229-246, 1932.
- DORAN, W. L., "The minimum, optimum, and maximum temperatures of spore germination in some Uredinales," *Phytopathology*, 9: 391-402, 1919.
- "Effect of external and internal factors on the germination of fungous spores," *Bull. Torrey Botan. Club*, 49: 313-336, 1922.
- DUGGAR, B. M., "Physiological studies with reference to the germination of certain fungous spores," *Botan. Gaz.*, 31: 38-66, 1901.
- EWERT, R., "Die Überwinterung von Sommerkonidien pathogener Ascomyceten und die Widerstandfähigkeit derselben gegen Kälte," *Z. Pflanzenk.*, 22: 129-141, 1910.
- FISHER, R. A., *Statistical methods for research workers* 3rd ed. 283 pp. Oliver and Boyd, Edinburgh. 1930.

- GODDARD, D. R., "The reversible heat activation inducing germination and increased respiration in the ascospores of *Neurospora tetrasperma*," *J. Gen. Physiol.*, 19: 45-60, 1935.
- GODDARD, D. R., AND P. E. SMITH, "Respiratory block in the dormant spores of *Neurospora tetrasperma*," *Plant Physiol.*, 13: 241-264, 1938.
- HART, HELEN, "Factors affecting the development of flax rust, *Melampsora lini* (Pers.) Lév.," *Phytopathology*, 16: 185-205, 1926.
- HEMMI, H., AND T. ABE, "On the relation of air humidity to germination of urediniospores of some species of *Puccinia* parasitic on cereals," *Forsch. Gebiete Pflanzenk.*, 2: 1-10, 1933.
- HOFFMAN, H., "Untersuchungen über Keimung der Pilzsporen," *Jahrb. wiss. Botan.*, 2: 267-297, 1860.
- HORNER, G. R., "Germination of aeciospores, urediniospores, and teliospores of *Puccinia coronata*," *Botan. Gaz.*, 72: 173-177, 1921.
- JAHN, E., "Myxomycetenstudien 4. Die Keimung der Sporen," *Ber. deut. botan. Ges.*, 23: 489-497, 1905.
- JOHNSON, E. C., "Cardinal temperatures for the germination of urediniospores of cereal rusts (abst.)," *Phytopathology*, 2: 47-48, 1912.
- JONES, EDITH S., "Influence of temperature, moisture, and oxygen on spore germination of *Ustilago avenae*," *J. Agr. Research*, 24: 577-590, 1923.
- KAUFMANN, F. H. O., "Studies on the germination of the spores of certain Basidiomycetes," *Botan. Gaz.*, 96: 282-297, 1934.
- LAURITZEN, J. I., "Relation of temperatures and humidity to infection by certain fungi," *Phytopathology*, 9: 7-35, 1919.
- LIN, C. K., "Germination of the conidia of *Sclerotinia fructicola*, with special reference to the toxicity of copper," *Cornell Agr. Expt. Sta. Mem.*, 233: 1-33, 1940.
- "Nutrient requirements in the germination of the conidia of *Glomerella cingulata*," *Am. J. Botany*, 32: 296-298, 1945.
- LING, LEE, "Factors affecting spore germination and growth of *Urocystis occulta* in culture," *Phytopathology*, 30: 579-591, 1940.
- LUYET, B. F., AND P. M. GEHENIO, *Life and death at low temperatures*. 341 pp. Biodynamica, Normandy, Mo. 1941.
- MANEVAL, W. E., "Germination of teliospores of rusts at Columbia, Missouri," *Phytopathology*, 12: 471-488, 1922.
- MCCALLAN, S. E. A., AND FRANK WILCOXON, "The precision of spore-germination tests," *Contrib. Boyce Thompson Inst.*, 4: 233-243, 1932.
- MELIUS, I. E., "Experiments on spore germination and infection in certain species of Oomycetes," *Wis. Agr. Expt. Sta. Research Bull.*, 15: 25-91, 1911.
- "Germination and infection with the fungus of the late blight of potato," *Wis. Agr. Expt. Sta. Research Bull.*, 37: 64 pp. 1915.
- MELIUS, I. E., AND L. W. DURRELL, "Studies on the crown rust of oats," *Iowa Agr. Expt. Sta. Research Bull.*, 49: 115-144, 1919.
- NOBLE, R. J., "Studies on *Urocystis tritici* Koern., the organism causing flag smut of wheat," *Phytopathology*, 13: 127-139, 1923.
- PLATZ, G. A., L. W. DURRELL, AND MARY E. HOWE, "Effect of carbon dioxide

- upon the germination of chlamydospores of *Ustilago zaeae* (Beckm.) Ung.," *J. Agr. Research*, 34: 137-147, 1927.
- PRATT, R., "Growth of germ tubes of *Erysiphe* spores in deuterium oxide," *Am. J. Botany*, 23: 422-431, 1936.
- "The influence of the proportions of KH_2PO_4 , MgSO_4 , and NaNO_3 in the nutrient solution on the production of penicillin in surface cultures," *Am. J. Botany*, 32: 528-535, 1945.
- RAEDER, J. M., AND W. M. BEVER, "Spore germination in *Puccinia glumarum* with notes on related species," *Phytopathology*, 21: 767-789, 1931.
- RIPPEL, K., "Untersuchungen über die Abhängigkeit der Sporenkeimung vom Wassergehalt der Luft bei *Cladosporium fulvum* Cooke und anderen Pilzen," *Arch. Mikrobiol.*, 4: 530-542, 1933.
- ROSEN, H. R., AND L. M. WEETMAN, "Longevity of urediospores of crown rust of oats," *Ark. Agr. Expt. Sta. Bull.*, 391: 3-20, 1940.
- SMART, R. F., "Influence of external factors on spore germination in the Myxomycetes," *Am. J. Botany*, 24: 145-159, 1937.
- SMITH, E. C., "The longevity of myxomycete spores," *Mycol.*, 21: 321-323, 1929.
- SMITH, J. H., "The killing of *Botrytis cinerea* by heat, with a note on the determination of temperature coefficients," *Ann. Appl. Biol.*, 10: 335-347, 1923.
- SPAULDING, P., AND A. RATHBUN-GRAVATT, "Longevity of the teliospores and accompanying urediospores of *Cronartium ribicola* in 1923," *J. Agr. Research*, 31: 901-916, 1925.
- STOCK, F., "Untersuchungen über Keimung und Keimwachstum der Urediosporen einiger Getreideroste," *Phytopath. Z.*, 3: 231-280, 1931.
- TSUJIGI, H., "Studies on the physiology of the conidiospores, conidia, and oospores of *Sclerospora graminicola* (Sacc.) Schroet. on the Japanese millet [*Setaria italica* (L.) Beauv.]," *J. Imp. Agr. Expt. Sta.*, 2: 225-252, 1933.
- UPPAL, B. N., "Relation of oxygen to spore germination in some species of Peronosporales," *Phytopathology*, 16: 285-292, 1926.
- WALKER, J. C., AND F. L. WELLMAN, "Relation of temperature to spore germination and growth of *Urocystis cepulae*," *J. Agr. Research*, 32: 133-146, 1926.
- WEBB, R. W., "Studies in the physiology of fungi. XV. Germination of the spores of certain fungi in relation to hydrogen-ion concentration," *Ann. Mo. Bot. Garden*, 8: 282-341, 1921.
- WEIMER, J. L., AND L. L. HARTER, "Temperature relations of eleven species of *Rhizopus*," *J. Agr. Research*, 24: 1-39, 1923.
- ZIEGENSPECK, H., "Die physikalische Chemie der zwar benetzbaren Sporen und sägespanförmigen Samen," *Biol. Generalis*, 10: 615-656, 1934.

Chapter 10

HOST PENETRATION

The production of disease by pathogenic fungi involves the following sequential processes: inoculation, incubation, and infection. In the first process is included distribution of the pathogen by any agencies whatsoever that bring into contact inoculum and suscept. The inoculum may take an active part in this process, as occurs among swarm spores of certain Phycomycetes and among ascospores and basidiospores that are forcibly expelled. On the other hand, the inoculum may be entirely passive and therefore be dependent upon water, currents of air, and insects or other biological agencies. In incubation are included penetration of the tissues of suscept by germination and growth of the inoculum to set up the parasitic relationship. Penetration may be accomplished by entrance through natural openings, such as stomata, lenticels, and hydathodes, by direct passage through cuticle and epidermal walls, or by entrance through wounds. Length of the incubation stage is definite for each specific pathogen and terminates when symptoms appear. All of those physiologic and morphologic responses (symptoms) that express the interaction of pathogen and suscept are infection phenomena, and they constitute a continuous process. It may be impossible to determine when the incubation stage ends and the infection stage begins, the disturbances being imperceptible when first initiated.

In the present instance concern centers upon the beginning of the incubation stage, especially upon the phenomena of penetration and the subsequent relationship of the fungus to the invaded tissues. Numerous studies have been made of this complex problem, beginning with those by de Bary (1886) and carried forward by Ward (1888) and later by Blackman and by Brown and his associates. The status of this problem has been summarized by Blackman (1924) and Brown (1936).

DIRECT PENETRATION

Pioneer work on the initiation of attack by direct penetration was done by de Bary (1886) in a study dealing with invasion by *Sclerotinia libertiana*. He maintained that, when he applied ascospores in drops of nutrient solution to suitable intact plant tissues, they were able to penetrate directly; whereas, if ascospores were placed in drops of water, they formed organs of attachment by means of which they intimately applied themselves to the surface of the host. These organs of attachment secreted a principle which killed the underlying cells, and in consequence nutrients diffused from the dead cells. As a parasite, therefore, *S. libertiana* was able to penetrate directly, and as a saprophyte it must first kill the underlying host cells. When he prepared an extract from infected tissues, he was able to demonstrate that this extract could cause the cells to fall apart, that is, to rot, and could kill the protoplasts. Boiling destroyed the activity of the extract; from this fact he concluded that rotting was caused by an enzyme, but he was unable to determine the nature of the lethal substance. Although he expressed the opinion that oxalic acid produced by the fungus killed the cells, he did not know whether this acid was solely responsible for the death of the tissues. Several reports have subsequently appeared, the authors of which accepted the de Bary hypothesis that parasitic fungi and bacteria secrete a ferment that enables them to penetrate cell walls. Ward (1888) expressed this opinion regarding *Botrytis cinerea*, the cause of a disease of lilies.

In regard to the cause of killing in advance of penetration, Smith (1902) found in connection with *Botrytis cinerea*, parasitic on lettuce, that it produced a thermostable toxic substance and expressed the opinion that this substance was oxalic acid. Peltier (1912), on the other hand, in a study involving presumably the same fungus on pepper and lettuce, concluded that the toxic thermostable substance was not oxalic acid but some other organic acid or acids. Higgins (1927) demonstrated production by *Sclerotium rolfsii* of oxalic acid in certain nutrient solutions. Considerable quantities of oxalates were also found in the dead cells underlying the holdfasts of soybeans and peppers, but none occurred in healthy cells of the same hosts. Moreover, the tox-

icity of filtrates from cultures in which *S. rolfsii* had been grown became greater with increase in oxalic acid content. For these reasons Higgins stated that the evidence appears conclusive in showing that oxalic acid, secreted by fungus hyphae, causes death of cells in advance of actual penetration.

Other pertinent evidence was presented by Brown (1915) from his experiments with extracts from germ tubes of *Botrytis cinerea*. These extracts are highly active in decomposing parenchymatous tissues of many kinds of vegetables and fruits. Heating to 60° to 70° C inactivated this extract, and he was unable to separate enzyme from toxic principle. Drops of extract, when placed on delicate rose petals, were quite innocuous, provided that the cuticle was intact. Brown found no oxalic acid in the extract and was forced to conclude as follows: (a) that the only active constituent of the extract was pectinase, and (b) that he had failed to extract a toxic principle, leaving unfounded the killing in advance of penetration described by de Bary.

In early stages of invasion by *Diplocarpon rosae*, browning of the host cells has been observed [Aronescu (1934)], but the immediate cause has not been determined.

When Blackman and Welsford (1916) and Boyle (1921) made cytological examination of tissues attacked by *Botrytis cinerea* and by *Sclerotinia libertiana*, they noted that the staining reactions of the host cell beneath the germ tube were early modified and that a very slender "infection hypha" always penetrated the cells in advance of killing. Once this had been established, Brown (1922) determined by conductivity tests that rapid exosmosis of solutes from the tissues does not occur unless the infection hyphae have penetrated, and thus he was able to establish with some degree of finality how facultative parasites are able to attack host cells.

THE ROLE OF APPRESSORIA. Certain pathogenic fungi, notably of the genera *Colletotrichum*, *Gloeosporium*, and *Marssonina*, form peculiar structures called appressoria, which function in penetration of the suscept. Frank (1883) first recognized the true nature of appressoria in connection with observations on *Fusicladium tremulae*, *Polystigma rubrum*, and *Colletotrichum lindemuthianum*. He interpreted them to be adhesion disks which applied themselves closely to the surface to be penetrated and there served to anchor the pathogen while the membranes immediately beneath

were being pierced by the infection hypha. Büsgen (1893) verified Frank's observations and concluded that appressorium formation results in response to contact of germ tubes or hyphae with a solid body. In hanging drops or in drops of liquid on glass slides, appressoria generally form as soon as the tube emerges.

Hasselbring (1906) noted the existence of appressoria 12 to 18 hours after inoculation in *Gloeosporium fructigenum*, Allen (1923) on the day after inoculation with wheat rust, and Aronescu (1934) as early as the ninth hour after inoculation with *Diplocarpon rosae*. Appressoria become separated from the tube by a septum, their wall thickens, and eventually they become circular in outline, being flattened, however, on the side in contact with the solid body. These characteristics led various American workers who early studied the organisms causing cotton anthracnose, apple bitter-rot, ripe-rot of grapes, and pepper anthracnose to regard appressoria as secondary spores. Attention was directed to this error and to their true function among anthracnose-producing species by Hasselbring (1906). He also observed that lack of food is a factor in their formation, since they may not develop in the presence of a supply of nutrients. Similar studies involving appressoria of *Colletotrichum lindemuthianum* and *C. gloeosporioides* were made by Dey (1919, 1933). His evidence indicated that appressoria can withstand drying and that they give rise to the penetration tube only when nutrients are available. It is indicated that substances diffuse out through the cuticle to stimulate germination.

In 1886 de Bary described organs of attachment that facilitated penetration among species of *Sclerotinia*. Details of the penetration by *S. libertiana* were presented by Boyle (1921). When this fungus was placed on bean leaves, appressoria formed near the hypha tips. They became fixed to the leaf surface by means of a mucilaginous sheath. From beneath the appressoria a very slender "infection hypha" then developed, which indented the cuticle at the point of contact. There was no evidence of dissolution of the cuticle, but eventually the infection hypha penetrated this membrane by mechanical pressure.

Diplocarpon rosae pierces rose cuticle wholly by mechanical pressure, but the enlargement of the infection peg into an infection hyphae is interpreted by Aronescu (1934) to indicate that further penetration occurs in a different manner.

Penetration by infection hyphae of the same type is known among other pathogenic fungi. Blackman and Welsford (1916) noted that *Botrytis cinerea* pierces the cuticle of *Vicia faba* by mechanical pressure exerted on a narrow outgrowth from the germ tube. Waterhouse (1921) recorded the occurrence of a mucilaginous envelope on the germ tubes of sporidia of *Puccinia graminis* germinating on leaves of *Berberis vulgaris*. The mucilaginous matrix fixed the sporidium and germ tube to the leaf. Penetration of the cuticle was accomplished by mechanical pressure exerted upon a beak-like outgrowth from beneath the sporidium or upon a very tenuous style-like hypha beneath the germ tube. After penetration the tip of the infection tube swells into a vesicle, and from it the mycelium forms.

Penetration by boring through the host-cell membranes has been observed and described in several Phycomycetous species. Curtis (1921) noted entrance of zoospores that had come to rest and of young zygotes of *Synchytrium endobioticum* into potato tissues. A small protuberance develops on the side in contact with the host, which eventually perforates the wall. The tip of the tube then enlarges into a vesicle within the lumen of the host cell, into which the entire protoplast flows, leaving the empty wall of the resting cell or of the zygote outside the host. Similarly Tisdale (1919) noted migration of the content of erstwhile zoospores of *Physoderma zeae-maydis* through narrow bore tubes into the epidermal cells of corn. Among certain higher Phycomycetes, such as *Peronospora tabacina*, entrance may be effected with apparently equal facility either by direct penetration or by entrance through stomata.

Among hyperparasites the hyphae of the one species may penetrate the walls of a second and grow within them, and others merely entwine themselves closely around the host species. An unusual type of hyperparasite and of direct penetration is presented in *Parasitella (Mucor) parasiticus* and in *Chaetocladium*, both of which are parasitic upon other Mucoraceae. Burgeff (1924) described this relationship, pointing out that the sequence of events is as follows: The hypha tip of the parasitic species, after contact with the host hypha, cuts off a buffer cell. The wall between this buffer cell and the host is then dissolved, effecting a direct connection between them. The buffer cell then enlarges, and hypha branches are developed from it. Meanwhile

host and parasite nuclei and protoplasm freely intermingle with each other.

THE STIMULUS CAUSING PENETRATION. The observations of Pfeffer that chemotropic stimuli are responsible for the migration of antherozoids of mosses and ferns to the archegones furnished the stimulus for similar studies involving the proximate cause of penetration by fungi. Miyoshi, working under Pfeffer's direction, published two reports (1894, 1895), in which he con-

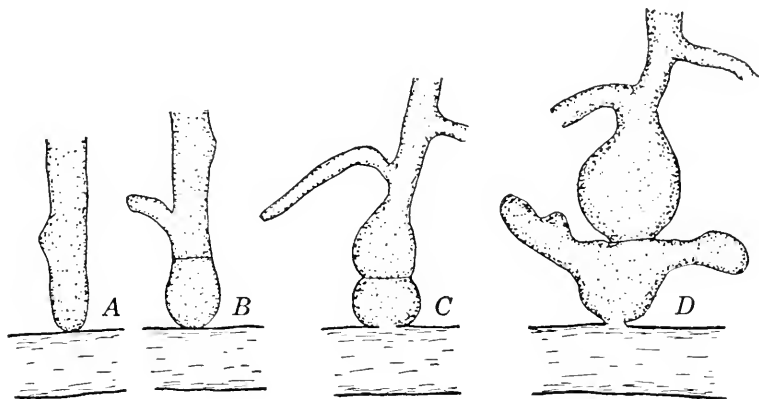

FIG. 42. Stages in penetration by the hyperparasite *Parasitella (Mucor) parasiticus* into the hypha of *Mucor*. The buffer cell is cut off in B. In C the wall between buffer cell and host has been dissolved, permitting direct protoplasmic contact. In D branches are developing from the buffer cell. (After Burgeff.)

cludes that membranes are penetrated by germ tubes or hyphae only when a certain concentration of an attractive substance (chemical attractant) is present on the opposite side. According to this theory, concentration of the chemical must exceed a specific threshold value if it is to attract; but, if a certain maximum concentration is employed, the result is repellent action. He dealt with penetration of collodion films, parchment, gold leaf, cellulose films, and the epidermis of onion scales. The spores of the various species used were placed in films of agar that were separated from the chemical to be tested by perforated sheets of mica. He also injected with water leaves of *Begonia* and *Tradescantia* to which spores were applied, but no penetration resulted, whereas active penetration followed injection with cane sugar. Admittedly his conclusion that chemotropic factors are fundamental in determining whether germ tubes penetrate is supported by quite convincing evidence.

A different point of view, however, results from the experiments of Fulton (1906). He followed the same techniques as Miyoshi, using among others the following fungi: *Botrytis vulgaris*, *Penicillium glaucum*, *Sterigmatocystis nigra*, *Mucor mucedo*, *Monilia sitophila*, *M. fructigena*, and *Sphaeropsis malorum*. Fulton postulated a negative chemotropism, resulting from metabolic staling products produced by the fungus itself. The germ tubes showed quite as much turning toward pure water and non-nutrient solutions as toward substances that were presumed to act as attractants.

Graves (1916) reinvestigated the problem of chemotropism, using reactions of germinating spores of *Rhizopus nigricans* and *Botrytis cinerea*. He too employed the perforated mica-plate technique. His evidence inclined him toward the negative-chemotropism hypothesis of Fulton for these reasons: (a) the germ tubes and hyphae turn away from the layer on the opposite side of the mica plate if it is already well occupied by hyphae or already contains their own staling products; (b) the germ tubes and hyphae turn toward the layer on the opposite side of the mica plate if it is free of hyphae and staling products, unless it contains some other substance capable of evoking a negative chemotropic reaction; (c) the germ tubes and hyphae, when present in equal amounts on both sides of the mica plate, exhibit no turning from one side to the other. Nevertheless, Graves found justification also for the views of Miyoshi. In his general conclusion he took the position that positive chemotropism is to be regarded as one of the factors that govern penetration, but that negative chemotropism is the major factor.

It becomes of interest to follow the implications that logically follow the acceptance of these conclusions. Susceptibility could be attributed to the possession by the host tissues of substances that attract and, conversely, resistance to substances that repel. A specialized pathogen, then, is one which would react to one particular substance only, whereas a generalized pathogen would react to a variety of substances. That such is not the situation is shown by the work of Johnson (1932) in his studies with *Colletotrichum circinans*. He found that this organism is capable of penetrating such widely unrelated species as buckwheat, bean, cotton, tomato, cucumber, tobacco, cabbage, castor bean, and morning glory. It was unable to produce lesions, to be sure, but

the organism could be isolated from the interior of these host species several days after inoculation. Similarly Young (1926), using *Diplodia zaeae*, *Cephalosporium acremonium*, *Colletotrichum nigrum*, *Helminthosporium gramineum*, and other fungi, was able to produce lesions or callosities on many kinds of plants not normally infected by these fungi. Since the spores of a multitude of different fungi must find lodgment at the surface of every green plant, it is reasonable to expect that their hyphae may gain entrance yet be unable to establish a pathogenic relationship. That this occurs is, moreover, attested by the experiences of everyone who has attempted to isolate fungi by using bits of host tissues as inocula. It is not surprising, therefore, to find many adherents to the viewpoint voiced by Brown (1934) that neither positive chemotropism nor negative chemotropism plays any significant role in penetration.

Further examination of the perforated mica-plate method as a working model to represent host tissue with its natural openings appears pertinent. Without the arguments being followed out, this analogy would appear to be in the same category as the substitution of glass slides sprayed with fungicides for the surface of leaves and fruits in tests to determine the value of fungicides. Studies on the toxicity of Bordeaux by Yarwood (1943) show that it is more active on bean leaves against the urediniospores of *Uromyces phaseoli* than it is on glass slides. These results serve to bring into sharp perspective the differences between *in vitro* and *in vivo* tests for the toxicity of fungicides.

Brown and Harvey (1927) got ready penetration by germ tubes of *Botrytis cinerea* of epidermis from onion scales and of Eucharis leaves, either inward or outward, if the membranes were washed to remove diffusible substances. Similar results followed the substitution of membranes made of paraffin. These results and a mass of similar ones by other workers show that penetration may be independent of any chemotropic stimulus.

Failure to establish response to chemotropic stimuli as a satisfactory explanation for penetration has focussed attention on the role of the stimulus of contact, haptotropism. It may be recalled that certain species of *Botrytis*, *Sclerotinia*, *Colletotrichum*, *Gloeosporium*, and *Marssonina* show their reaction to contact by forming attachment organs. The best evidence in favor of haptotropism as a factor in penetration comes from experiments with

species that produce appressoria or other means of attachment that function in the same manner as appressoria. Here again evidence and opinion are divided, since some workers maintain that the penetration tube enters only in conjunction with the dissolution of the cuticle to prepare the way, and others that the cuticle is pierced by a mechanical thrust. Brown (1915) made extracts

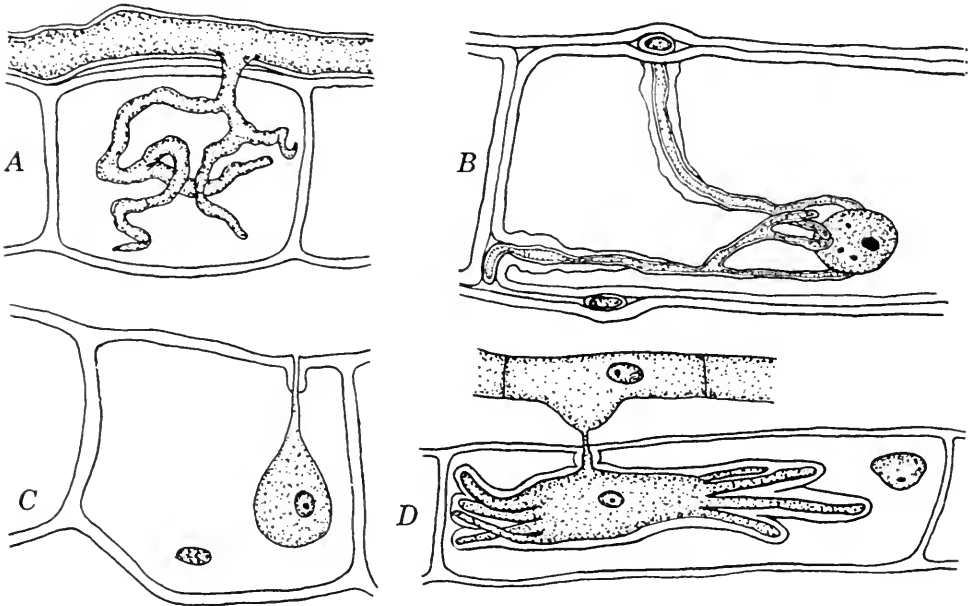

FIG. 43. Haustorial types. A. Branched haustorium of *Peronospora calothecae*. (After de Bary.) B. Haustoria of *Puccinia adoxae*. A sheath partly invests the haustorium. (After Guttenberg.) C. A bulbous haustorium of *Erysiphe communis*. (After Smith.) D. Digitate, sheathed haustorium of *Erysiphe graminis*. (After Smith.)

of *Botrytis cinerea*, as has been stated, which were capable of digesting tissues very rapidly when injected into them, but which, if placed at the surface of delicate rose petals, caused no injury within a period of approximately 24 hours. His lack of evidence of solvent effect to aid penetration is substantiated by the results of Boyle (1921), Waterhouse (1921), Dey (1919, 1933) and many others. Instead they adhere to the mechanical theory of penetration. In the experiments of Brown and Harvey (1927) cells of *Eucharis* and other plants were readily penetrated if they had previously been plasmolyzed, but no penetration took place if the cells were turgid. It becomes difficult to understand how rigidity of the host cells could inhibit the production of wall-dissolving enzymes.

The work of Link and his associates (1929) involving the inhibitory activity of specific chemicals is of special interest. They noted that white onions are subject to attack by *Colletotrichum* (*Vermicularia*) *circinans*, which causes the disease known as smudge, and that pigmented onions are disease-free. From these onions they isolated protocatechuic acid, which was found to inhibit the growth of the pathogen. This organic complex, furthermore, does not occur in white-scaled onions. Inhibition of penetration by the smudge fungus and disease resistance, therefore, are caused by protocatechuic acid. Presumably this is the first chemical substance isolated that has been demonstrated to render plants immune from infection.

In connection with mechanical penetration it may be recalled that a mucilaginous matrix aids in sticking the spore, appressorium, or germ tube to the cuticle, thus providing anchorage against the force of the thrust required to pierce the cuticle. The small diameter of the infection hypha minimizes this required force, which attempts have been made to measure by mechanical devices. Hawkins and Harvey (1919) studied penetration of potato by the rot-producing fungus, *Pythium de baryanum*. They employed a modified Joly balance with a needle having a point of definite area to test resistance of potato tissues to puncture. Potatoes of the McCormick variety, resistant to attack by this organism, were found to require more pressure to puncture than was required for Bliss Triumph or Green Mountain, varieties susceptible to decay. Rosenbaum and Sando (1920), using the same appliance, correlated resistance of tomatoes to puncture with resistance to penetration by *Macrosporium tomato*. Certain of their data are presented in Table 23. These data show that, as tomato fruits increase in age, they also increase in ability to inhibit penetration and consequent infection by this fungus. Thickness of the cuticular layer also increases with the age of the tomato fruit, but, as Rosenbaum and Sando point out, these results do not prove that inhibition of penetration is purely a matter of resistance to mechanical pressure.

Epidermal resistance of barberry to puncture was measured with a mechanical device by Melander and Craigie (1927), and they correlated their measurements with resistance to penetration by germinating basidiospores of *Puccinia graminis*. They con-

TABLE 23

RELATION OF RESISTANCE OF TOMATO FRUITS TO PUNCTURE AND TO PENETRATION
BY *Macrosporium tomato*

<i>Age of Fruit</i> (days)	<i>Diameter</i> <i>of Fruit</i> (centimeters)	<i>Average Pressure</i> <i>Necessary to</i> <i>Puncture (grams)</i>	<i>Infection</i> <i>of Fruit</i> (percentage)
7	0.70	0.97	100
14	2.30	2.99	100
21	5.18	4.21	85
28	5.40	4.90	49
35	5.46	5.08	23.3
41	6.55	5.96	0
48	6.92	6.74	0
55	5.56	0

cluded that species of *Berberis* which are resistant to puncture are usually resistant to rust, but the converse is not usually true.

Pioneer work on the correlation of structure of plant tissues and inhibition of penetration by fungi into plant tissues was instituted by Valteau (1915). Thickness of the skin of plums was found correlated with resistance to the brown-rot fungus. Valteau also found that the cells lining substomatal cavities possessed corky walls and that the stomata were very commonly completely occluded with corky cells. By and large, Curtis (1928) verified Valteau's findings but believed that cuticular resistance to penetration by the brown-rot pathogen was equally as important as the presence of corky tissue in natural openings, if not more important. It might be expected that varieties of stone fruits lacking stomata or lenticels would be immune. Curtis did not find this to be true, however, since in the varieties which he investigated the germ tubes entered through the stomata in plums, through the cuticle in cherries, and down the hair sockets in peaches, and penetrated either through the cuticle or the stomata in apricots.

In varieties of tobacco resistant to invasion by the black root-rot fungus, *Thielaviopsis basicola*, Conant (1927) found that resistance to infection is correlated with the ability of the host rapidly to develop a corky layer to inhibit the spread of the pathogen.

The short period of time required for penetration of the cell wall by *Pythium de baryanum* [Hawkins and Harvey (1919)] also constitutes evidence of mechanical puncture. They observed

penetration to be accomplished within approximately 5 minutes. They also found the hyphae to possess an osmotic pressure sufficient to penetrate turgid potato cells. Few measurements of osmotic pressure in fungi have been made; they might be found valuable in an interpretation of factors concerned in penetration.

Studies of this type were conducted by Thatcher (1939, 1942). He used the plasmolytic method in osmotic pressure and permeability determinations and was able to show that certain parasitic fungi increase the permeability of the plasma membrane of the host cells. His measurements of the osmotic pressure of parasite and host are shown in Table 24. In each fungus the osmotic

TABLE 24

RESULTS OF MEASUREMENTS OF OSMOTIC PRESSURE IN PARASITE AND HOST

<i>Parasite</i>	<i>Average Osmotic Pressure (atmospheres)</i>	<i>Host</i>	<i>Average Osmotic Pressure (atmospheres)</i>
<i>Uromyces fabae</i>		<i>Pisum sativum</i>	
germ tubes	44.25	leaf	9.15
haustoria	21.90	petiole	10.10
<i>Uromyces caryophyllinus</i>		Dianthus	
haustoria	18.6	leaf base	11.2
<i>Puccinia graminis</i>		Mindum wheat	
haustoria	18.9	leaf	9.4
<i>Erysiphe polygoni</i>		Brassica	
hyphae	18.0	leaf	10.6
<i>Botrytis cinerea</i>		<i>Apium graveolens</i>	
hyphae	29.8	petiole	8.3
<i>Sclerotinia sclerotiorum</i>		<i>Apium graveolens</i>	
hyphae	23.5	petiole	13.4
<i>Phoma lingam</i>		Brassica	
hyphae	41.3	root	11.3

pressure of the parasite is greater than that of its host. Moreover, Thatcher was able to demonstrate an increased permeability in diseased tissues over healthy tissues, indicating that the parasite causes certain substances to leach from the host cells and thus to lower their osmotic pressure.

Although these data as a whole have a bearing on the problem of penetration and might be taken to prove that penetration is the result of mechanical pressure in certain species of fungi, it does not necessarily follow that all species which effect their own

entrance do so by the same means. Aronescu (1934) concluded that both chemical action and mechanical pressure are necessary for penetration by the fungus causing black spot of roses. There may exist only the two general means of penetration that have been discussed, but perhaps each pathogen has made such modifications and adaptations as are suited to its own requirements.

STOMATAL PENETRATION

Stomata constitute normal portals for entrance by a large number of pathogenic species. Observations on penetration through stomata have been recorded for many different fungi. Such observations may be made by one of three methods: (*a*) epidermal stripping, (*b*) sections of fixed, embedded material, and (*c*) use of a stomatoscope. Certain advantages and disadvantages attend the use of each.

If spores are sown in drops of water on leaves and chalk is added to indicate the site of the drops, it is not difficult to strip off epidermis in the areas marked by deposits of chalk, mount it in water with the exterior surface upward, and examine it under the microscope. With a little practice the investigator can learn to tear the leaf and thus strip off the epidermis, or to cut it off by holding the leaf taut over the end of the finger and slicing parallel to the leaf surface. By this method many examinations can be made in a comparatively short time, and the time interval involved in penetration can thus be determined. Mounting specimens in cotton blue * instead of water may aid in differentiating the hyphae and in clearing the host tissues.

The merit of fixing, at known intervals after inoculation, tissues which have had spores applied to their surfaces has the feature of permanency to recommend its use. These tissues may be embedded, sectioned, stained, and examined whenever time is available and may be kept indefinitely. This method, however, is obviously both laborious and time-consuming.

Direct examination with an apparatus known as the stomatoscope requires familiarity with the operation of an apparatus that has been available to only a few investigators. Pool and McKay (1916) used such an appliance in their studies of penetration of

* Use 0.1% cotton blue in lactophenol, which contains equal parts of phenol, lactic acid, glycerin, and distilled water.

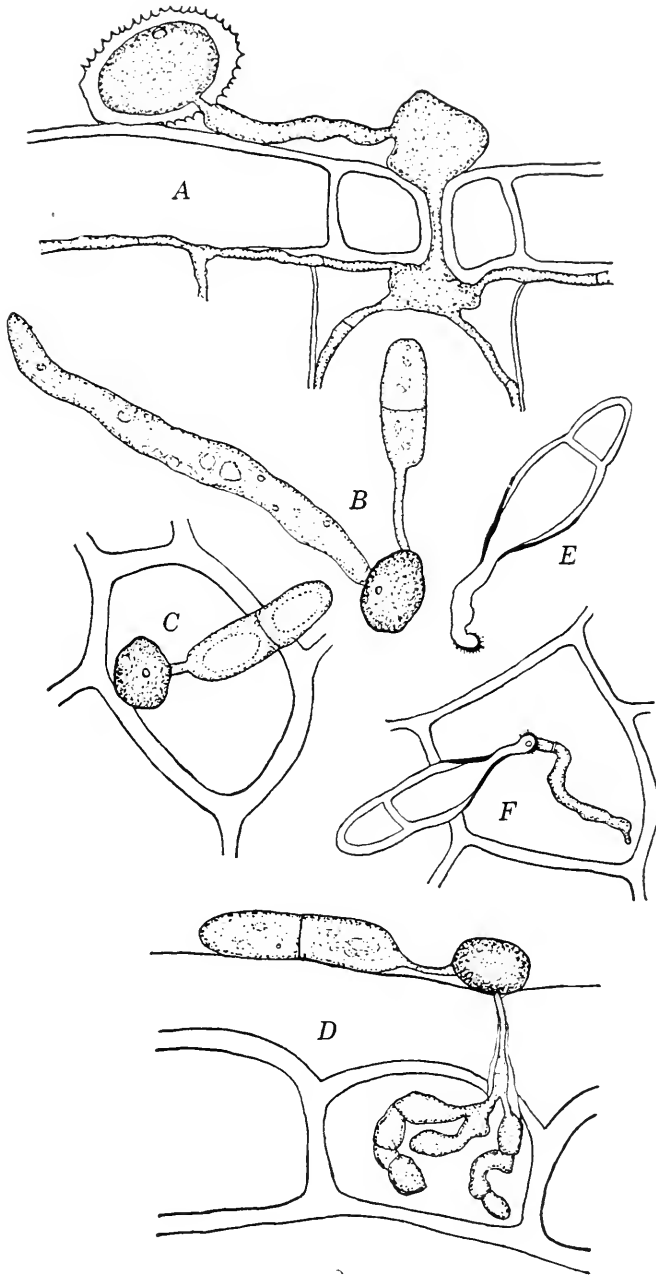

FIG. 44. Types of appressoria. *A*. Appressorium of urediniospore at stomatal aperture. *B*, *C*, and *D*. Appressoria formed by one of the anthracnoses, as an early stage in germination. *B*. In culture a hypha arises from the appressorium. *C*. In the host the appressorium anchors the organism, and the slender penetration tube arises from beneath the appressorium. *E* and *F*. Appressoria formed by *Diplocarpon rosae*. (After Aronescu.)

sugar-beet leaves by germ tubes of *Cercospora beticola*. They observed that this organism is unable to penetrate at night when stomata are closed but can do so during daytime when the opening of the stomata permits the entrance of germ tubes into substomatal cavities. No doubt many fungi among those that penetrate through natural openings are able to do so only during daylight hours. This factor must be borne in mind in tests involving the pathogenicity of a given fungus.

The germ tubes of aeciospores and urediniospores of rusts very commonly enter through stomata, although the germ tubes of the basidiospores of these same species may penetrate directly. Pady (1935) noted that germinating aeciospores of *Gymnoconia interstitialis* enter blackberry leaves not through the stomata but by direct penetration. The urediniospores of many species are known to produce a special appressorium, which functions in the mechanism of entrance. The sequence of events in penetration is as follows: When the tip of the germ tube comes to lie immediately above a stoma, the protoplasm accumulates in the tip. This apical region then swells, and the end cell is delimited by a cross-septum to become the appressorium. By nuclear division two or more pairs of nuclei form within the appressorium. Then a hypha develops from the lower side of the appressorium and forces its way between the guard cells into the substomatal cavity; once inside, its tip swells to form a vesicle into which the protoplast of the appressorium migrates. Meanwhile more conjugate nuclear divisions occur, and hyphae, whose cells contain paired nuclei, grow radiately from this substomatal vesicle. These hyphae course between the host cells and establish intimate contact with them by forming haustoria.

Opinions differ as to whether the appressoria of rusts adhere by means of a mucilaginous matrix. Rice (1927) saw no evidence of such a matrix in *Puccinia sorghi*.

Study of penetration by *Puccinia graminis tritici* into resistant Khapli emmer by Allen (1926) indicates that the appressoria secrete a toxin upon the guard cells. This observation led her to opine that ". . . the appressorial secretion is a survival from an earlier period in the evolution of the fungus when it did dissolve its way into the host."

The time required for penetration is correlated with temperature, as has been capably shown by Peltier in studies with *Puccinia*

graminis tritici. When he inoculated 7-day-old wheat seedlings with urediniospores within the range optimum for germination, he found that maximum infection required at least 36 hours [Peltier (1925)]. This period was determined by use of a series of plants inoculated at the same time by a suspension of urediniospores. After definite intervals the surfaces of some of the plants were permitted to become dry. An arbitrary scale to show severity of infection was then employed as a basis of comparison. Leaves on which 5 or fewer rust pustules developed were regarded as in class 1; those with 6 to 10, in class 2; and those with 11 to 25, in class 3. Certain of Peltier's data are shown in Table 25. Ap-

TABLE 25

TIME REQUIRED FOR INFECTION BY *Puccinia graminis tritici*

<i>Definite Intervals after Which Leaves Dried (hours)</i>	<i>Plants Infected (percentage)</i>	<i>Severity of Infection (class)</i>
2	0	0
3	1.7	1
6	17.0	1
12	28.0	1
16	33.0	1
20	59.0	1
24	89.0	2
30	98.0	2
36	100.0	3

parently the minimum time required by the wheat stem-rust fungus for actual entrance through the stomatal aperture is between 2 and 3 hours.

PENETRATION THROUGH WOUNDS

There is a large group of facultative parasites that lack ability to produce disease or decay in intact tissues but can establish themselves in wounds and thence spread to normal tissues. The heartwood and sapwood rots of trees are notable in this respect. Many of these fungi gain entrance through branch stubs or scars left in pruning, through fire scars, through abrasions from contact of limbs, or through injuries by other fungi, insects, or rodents.

Little is known about the fundamental differences between these so-called facultative parasites and true parasites or about actual

changes in aggressiveness or pathogenicity which they may undergo as the result of growth on wounded tissues. This matter has been the subject of experimentation and speculation by many students of fungi. Salmon (1905) made the observation that races of *Erysiphe graminis* occurring on various genera of grasses are morphologically indistinguishable yet cannot be made to infect reciprocally when cross-inoculated from one genus to another. If, however, he wounded the leaf by cutting away a small piece of tissue or by applying a hot needle to its surface and then placed the spores on the surface opposite the wound, ready infection resulted.

Many have concerned themselves with what may be a closely related problem in trying to account for the inability among heteroecious rusts of basidiospores to infect the telial host. The mere generalization that aggressiveness is enhanced or rejuvenated by sexuality does not appear to constitute a satisfactory explanation.

HAUSTORIA AND THEIR SIGNIFICANCE

Penetration of tissues by fungi is also concerned with host-parasite relations after the pathogen has pierced the cuticle or epidermis, the first line of defence. Some species remain entirely intercellular; others are intercellular but possess intracellular haustoria; and in others the mycelium itself courses intracellularly from cell to cell. Our immediate interest is in the haustorium-forming species. This group includes such obligate parasites as the downy mildews, powdery mildews, rusts, and smuts but is not confined to obligate parasites, since haustoria have been observed in *Coccomyces*, *Diplocarpon*, and other genera. Among the rusts, intracellular mycelium has been observed in one species only, namely, the short-cycled form of *Gymnoconia interstitialis*. In this species, which is systemic, Pady (1935) described peculiar intracellular elements which functioned to establish the fungus in the host. They were therefore interpreted as being haustorial in nature. An elaborate account by Rice (1927), dealing especially with haustoria of rusts, contains much of value regarding the structure and function of haustoria in general.

Haustoria vary in form among the different species of fungi, being spherical in the simplest forms and variously branched and lobulate in the most complex ones. Their size indicates conform-

ity to that necessary to maintain a delicate nutritional balance. Haustoria may be uninucleate, may contain a pair of nuclei, or may be multinucleate. They possess a conspicuous sheath that is deposited by and is continuous with the host-cell wall, as generally believed. In *Diplocarpon rosae* the sheath does not extend completely around the haustorium [Aronescu (1934)], as has been described for many parasitic fungi. In Erysiphaceae, however, staining reactions indicate that haustorial sheaths are chitinous. More should be known regarding the chemical nature of the sheath as an aid in understanding how the sheath modifies absorption and passage of food.

Haustoria are always connected with the intercellular hyphae by narrow tubes of a length slightly in excess of the thickness of the host-cell membrane. These constrictions facilitate penetration. Presumably both mechanical pressure and dissolution of the wall are involved in haustorial penetration. Allen (1923) found no evidence of enzyme secretion in connection with haustorial penetration by *Puccinia graminia tritici*, but the walls beneath the appressoria appeared to be altered during initiation of infection.

PENETRATION BY ECTOPARASITES

Several distinct types of host-parasite relationships occur among fungi possessing mycelium which remains wholly external to the infected plant organs. One type is represented by the powdery mildews, all of which, except *Phyllactinia corylea* and *Leveillula (Erysiphe) taurica*, are ectophytic. In *P. corylea* both internal and external mycelium is produced; in *L. taurica* the mycelium is wholly internal, an adaptation to xerophytic environment. All parts of all other powdery mildews, except the haustoria, are borne externally.

A very unusual type of ectoparasitism is exhibited by *Cercospora rubi*, the cause of rosette and double blossom of blackberries and dewberries. Plakidas (1937) found that the mycelium of this fungus occurs in buds between the embryonic leaves. If the buds are opened at any time during summer, fall, winter, or early spring, a delicate arachnoid web will be observed to be present between the young leaves. The fungus at no time actually penetrates the young branch buds and flower buds but absorbs its nourishment directly through the thin walls of the embryonic

cells. Transfer of food from host to parasite does not require, in this species, the production of specialized organs of penetration.

A third type of ectoparasitism is exhibited by the Meliolaceae and Capnodiaceae, which apply themselves to the surface of plant tissues by means of hyphopodia. Graff (1932) found that, although some species of *Meliola* form haustorial vesicles within the epidermal cells, *M. circinans* is entirely superficial. Its cell walls are in intimate contact with the host epidermis and are thinner wherever contact is maintained. The epidermal cell walls are more or less corroded at these points of contact, and evidence of degeneration products was noted within them.

Internal mycelium is wanting or scanty in many Microthyriaceae and Hemisphaeriaceae. Luttrell (1940) concluded that *Morenoella quercina*, one of the Microthyriaceae, absorbs its nutrients through the intact host cuticle at first, and later certain hyphae penetrate only to the extent of becoming subcuticular.

IMPLICATIONS

Problems of host penetration remain of utmost importance in spite of the large number of studies that have been devoted to this phenomenon and in spite of the conflict among observations and the interpretations of them. They should continue to receive unstinted attention because of their bearing on matters of tolerance or resistance to disease, on studies involving the causes of natural immunity, and on production of races of disease-resistant crop plants.

LITERATURE CITED

- ALLEN, RUTH F., "A cytological study of infection of Baart and Kanred wheats by *Puccinia graminis tritici*," *J. Agr. Research*, 23: 131-151, 1923.
- "Cytological studies of forms IX, XXI, XXVII of *Puccinia graminis tritici* on Khalpi emmer," *J. Agr. Research*, 32: 701-725, 1926.
- ARONESCU, ALICE, "*Diplocarpon rosae*: from spore germination to haustorium formation," *Bull. Torrey Botan. Club*, 61: 291-329, 1934.
- BARY, A. DE, "Über einige Sclerotinien und Sclerotienkrankheiten," *Botan. Z.*, 44: 377-387, 393-404, 409-426, 433-441, 449-461, 465-474, 1886.
- BLACKMAN, V. H., "Physiological aspects of parasitism," *Proc. Brit. Assoc. Bot. Toronto*, 233-246, 1924.
- BLACKMAN, V. H., AND E. J. WELSFORD, "Studies in the physiology of parasitism. II. Infection by *Botrytis cinerea*," *Ann. Botany*, 30: 389-398, 1916.

- BOYLE, C., "Studies in the physiology of parasitism. VI. Infection by *Sclerotinia libertiana*," *Ann. Botany*, 35: 337-347, 1921.
- BROWN, W., "Studies on the physiology of parasitism. I. The action of *Botrytis cinerea*," *Ann. Botany*, 29: 313-348, 1915.
- VIII. "On the exosmosis of nutrient substances from the host tissue into the infection drop," *Ann. Botany*, 36: 285-300, 1922.
- "Mechanism of disease resistance in plants," *Trans. Brit. Mycol. Soc.*, 19: 11-33, 1934.
- "The physiology of host-parasite relation," *Botan. Rev.*, 2: 236-281, 1936.
- BROWN, W., AND C. C. HARVEY, "Studies in the physiology of parasitism. X. On the entrance of parasite fungi into the host plant," *Ann. Botany*, 41: 643-662, 1927.
- BURGEFF, H., "Untersuchungen über Sexualität und Parasitismus bei den Mucorineen," *Botan. Abhandl. (Herausgeg. von Goebel)*, 4: 1-135, 1924.
- BÜSGEN, M., "Über einige Eigenschaften der Keimlinge parasitischer Pilze," *Botan. Z.*, 51: 53-72, 1893.
- CONANT, G. H., "Histological studies of resistance in tobacco to *Thielavia basicola*," *Am. J. Botany*, 14: 457-480, 1927.
- CURTIS, K. M., "The life history and cytology of *Synchytrium endobioticum*," *Phil. Trans. Roy. Soc. London, Ser. B*, 210: 409-478, 1921.
- "The morphological aspect of resistance to brown rot in stone fruit," *Ann. Botany*, 42: 39-68, 1928.
- DEY, P. K., "Studies in the physiology of parasitism. V. Infection by *Colletotrichum lindemuthianum*," *Ann. Botany*, 33: 305-312, 1919.
- "Studies in the physiology of the appressorium of *Colletotrichum gloeosporioides*," *Ann. Botany*, 47: 305-312, 1933.
- FRANK, A. B., "Über einige neue und weniger bekannte Pflanzenkrankheiten," *Ber. deut. botan. Ges.*, 1: 29-34, 58-63, 1883.
- FULTON, H. R., "Chemotropism of fungi," *Botan. Gaz.*, 41: 81-108, 1906.
- GRAFF, P. W., "The morphological and cytological development of *Meliola circinans*," *Bull. Torrey Botan. Club*, 59: 241-266, 1932.
- GRAVES, A. H., "Chemotropism in *Rhizopus nigricans*," *Botan. Gaz.*, 62: 337-369, 1916.
- HASSELBRING, H., "The appressoria of the anthracnoses," *Botan. Gaz.*, 42: 135-142, 1906.
- HAWKINS, L. A., AND R. B. HARVEY, "Physiological study of the parasitism of *Pythium de Baryanum* Hesse on the potato tuber," *J. Agr. Research*, 18: 275-297, 1919.
- HIGGINS, B. B., "Physiology and parasitism of *Sclerotium rolfsii*," *Phytopathology*, 17: 417-448, 1927.
- JOHNSON, BURT, "Specificity to penetration of the epidermis of a plant by the hyphae of a pathogenic fungus," *Am. J. Botany*, 19: 12-31, 1932.
- LINK, K. P., H. R. ANGELL, AND J. C. WALKER, "The isolation of protocatechuic acid from pigmented onion scales and its significance in relation to disease resistance in onion," *J. Biol. Chem.*, 81: 369-375, 1929.
- LUTTRELL, E. S., "*Moronoella quercina*, cause of leaf spot of oaks," *Mycol.*, 32: 652-666, 1940.

- MELANDER, L. W., AND J. H. CRAIGIE, "Nature of resistance of *Berberis* spp. to *Puccinia graminis*," *Phytopathology*, 17: 95-114, 1927.
- MIYOSHI, M., "Über Chemotropismus der Pilze," *Botan. Z.*, 52: 1-28, 1894.
 "Die Durchbohrung von Membranen durch Pilzfäden," *Jahrb. wiss. Botan.*, 28: 269-289, 1895.
- PADY, S. M., "Aeciospore infection in *Gymnoconia interstitialis* by penetration of the cuticle," *Phytopathology*, 25: 453-474, 1935.
 "The role of intracellular mycelium in systemic infections of *Rubus* with the orange rust," *Mycol.*, 27: 618-637, 1935a.
- PELTIER, G. L., "A consideration of the physiology and life history of a parasitic *Botrytis* on pepper and lettuce," *Mo. Botan. Garden Rept.*, 23: 41-74, 1912.
 "A study of the environmental conditions influencing the development of stem rust of wheat in the absence of an alternate host," *Nebr. Agr. Expt. Sta. Research Bull.*, 35. 11 pp. 1925.
- PLAKIDAS, A. G., "The rosette disease of blackberries and dewberries," *J. Agr. Research*, 54: 275-303, 1937.
- POOL, V. W., AND M. B. MCKAY, "Relation of stomatal movement to infection by *Cercospora beticola*," *J. Agr. Research*, 5: 1011-1038, 1916.
- RICE, MABEL A., "The haustoria of certain rusts and the relation between host and pathogen," *Bull. Torrey Botan. Club*, 54: 63-153, 1927.
- ROSENBAUM, J., AND C. E. SANDO, "Correlation between size of the fruit and the resistance of the tomato skin to puncture and its relation to infection with *Macrosporium tomato* Cooke," *Am. J. Botany*, 7: 78-82, 1920.
- SALMON, E. S., "Cultural experiments with biologic forms of the Erysiphaceae," *Phil. Trans. Roy. Soc.*, Ser. B, 197: 107-122, 1905.
- SMITH, R. E., "The parasitism of *Botrytis cinerea*," *Botan. Gaz.*, 23: 421-436, 1902.
- THATCHER, F. S., "Osmotic and permeability relations in the nutrition of fungus parasites," *Am. J. Botany*, 26: 849-858, 1939.
 "Further studies of osmotic and permeability relations in parasitism," *Can. J. Research*, 20: 283-311, 1942.
- TISDALE, W. H., "Physodermia disease of corn," *J. Agr. Research*, 16: 137-154, 1919.
- VALLEAU, W. D., "Varietal resistance of plums to brown rot," *J. Agr. Research*, 5: 365-396, 1915.
- WARD, H. MARSHALL, "A lily disease," *Ann. Botany*, 2: 319-382, 1888.
- WATERHOUSE, W. L., "Studies in the physiology of parasitism. VII. Infection of *Berberis vulgaris* by sporidia of *Puccinia graminis*," *Ann. Botany*, 35: 557-564, 1921.
- YARWOOD, C. E., "The function of lime and host leaves in the action of Bordeaux mixture," *Phytopathology*, 33: 1146-1156, 1943.
- YOUNG, P. A., "Penetration phenomena and facultative parasitism in *Alternaria*, *Diplodia*, and other fungi," *Botan. Gaz.*, 81: 258-279, 1926.

Chapter 11

PHYSIOLOGIC SPECIALIZATION AND VARIATION AMONG FUNGI

The concept that physiological differences exist between the members that together constitute a given species of fungus probably has its origin in bacteriology. In the early years of bacteriology there were two opposing schools of thought, one of which held to the monomorphic hypothesis and the other to the polymorphic or pleomorphic hypothesis. Adherents of the monomorphic hypothesis believed in fixity and immutability of species; adherents of the polymorphic hypothesis, in variability in morphological and physiological characteristics. Billroth (1874), representing an extreme of the polymorphic group, for example, believed that only one species of bacteria, "*Coccobacteria septica*," existed.

To the person who compares a considerable number of isolates of any one fungus, especially when grown on artificial media, it quickly becomes apparent that the species is variable and that differences exist between the several isolates. Although these differences may be so minute as to be morphologically indistinguishable, they are none the less real and of tremendous importance, especially as they concern pathogenic species. In fact, problems of virulence of species, of their aggressiveness, of the outbreak of epidemics, and of the breeding of crop plants that are resistant or immune to attack, all hinge upon the fact that these differences are meaningful and must be taken into account. Questions concerning the origin of these differences have been regarded too largely as of only academic interest. Actually no useful purpose is served by assigning them to the academician.

DEFINITION OF TERMS. The concept embodied in the term physiologic species has changed since Schroeter (1879) first suggested that physiologic specialization in fungi exists. He observed that *Puccinia graminis*, growing on wheat, failed to produce in-

fection if inoculated onto other grass hosts, such as rye, oats, timothy, and blue grass, whereas under the same environmental conditions wheat readily became infected. Similarly *Puccinia graminis* from any of the other grasses produced infection on the host species from which the inoculum was taken, but reciprocal inoculations always failed to cause infection. Further work of the same nature by Eriksson (1894) led to the division of *Puccinia graminis* into the following groups, which he called "formae speciales": *Puccinia graminis tritici*, *P. graminis secalis*, *P. graminis avenae*, *P. graminis phlei-pratensis*, *P. graminis agrostidis*, and *P. graminis poae*. He also showed that subdivisions can similarly be made of *P. glumarum*, *P. dispersa*, and *P. coronata*. He recognized five specialized forms, *tritici*, *secalis*, *elymi*, *agropyri*, and *hordei*, of *P. glumarum*. Four specialized forms, *secalis*, *agropyri*, *bromi* and *tritici*, comprise *P. dispersa*; and *P. coronata* consists of six, *avenae*, *alopecuri*, *festucae*, *lolii*, *calamagrostis*, and *melicae*. To these groupings within the species the terms biologic forms, biologic races, physiologic forms, biologic species, physiologic species, physiologic races, parasitic strains, sister species, and specialized varieties have been applied. They are now generally regarded as varieties, and many workers designate them as of varietal rank. Their pathogenic behavior thus serves as the basis for the varietal separations. Within the past 25 years it has been found that many parasitic strains or biotypes comprise a given variety and that some of these strains can be isolated by their pathological effects on appropriate susceptible species, and others by cultural characteristics. It is to these strain groupings that the term physiologic specialization is properly applied.

Some mycologists maintain that it is impossible to establish varieties among pathogenic fungi, as in *Puccinia graminis*, on the basis of morphologic differences. If this be true, there is little justification for the use of varietal names. Minute yet recognizable differences are indicated by others to exist, and they therefore find it convenient to employ varietal names. Without the threadbare problem of what constitutes a variety or physiologic species being raised again, it is clearly established by students of rusts and smuts that secondary groupings within the variety may be made on the basis of pathogenicity on selected susceptibles. These secondary groupings are called physiologic strains. They

are not sufficiently distinct morphologically to entitle them to specific rank but must be distinguished from each other by pathogenic reactions.

If the worker is dealing with fungi that can be cultivated on artificial media, he may employ differences in cultural characteristics, for example, in color of mycelial mat, shape of colonies, surface markings, size of colonies, branching of hyphae, and abundance of conidia, to distinguish physiologic forms. This situation is typified by the cultural differences noted by Christiansen (1932) in the 15 races of *Pestalozzia funerea* that he isolated from needles of longleaf pine. These races differed in abundance, color, and zonation of surface and aerial mycelium, in abundance, distribution, and size of acervuli, and in size, shape, and color of spores.

Several other terms, including variation, mutation, saltation, and dissociation, have been more or less loosely used in connection with the phenomenon of differences among the members that comprise a given species of fungi. For clarity these terms may at this point be defined. *Variation* is applied to divergences, whether morphological or physiological, from the observed characteristics of the usual or normal condition. They are regarded as non-hereditary. *Variation* is usually regarded as synonymous with *dissociation*. *Mutation*, as originally employed by de Vries, refers to sudden variations, the offspring differing from the parents in one or more clearly defined characteristics. Mutation is to be distinguished from gradual variation, such as may occur during the course of countless generations. Furthermore mutations are hereditary, since once they appear, they can be transmitted to the progeny. *Saltation* may be defined as a type of mutation that appears in artificial cultures. Saltations may be maintained indefinitely in subcultures if conidia or hyphae are used in transplantation. Sports, as the term is applied to seed plants that can be propagated by cutting or other vegetative structures, correspond to saltants among fungi.

IN WHAT FUNGI HAS PHYSIOLOGIC SPECIALIZATION BEEN OBSERVED? Numerous species of pathogenic fungi are known to consist of many physiologic forms. Presumably all do. At least, it would be scientific news if after extensive study one was found that was not comprised of numerous physiologic forms.

TABLE 26

FUNGI REPORTED TO EXHIBIT PHYSIOLOGIC SPECIALIZATION

Name of Fungi	Authority for Report
<i>Rhizopus nigricans</i>	Harter and Weimer (1923)
<i>Albugo candida</i>	Togashi and Shibusaki (1934)
<i>Albugo ipomoeae-panduranae</i>	Ciferri (1928)
<i>Albugo tragopogonis</i>	Pfister (1927)
<i>Phytophthora parasitica</i> var. <i>rhei</i>	Leonian (1926)
<i>Peronospora</i> spp.	Gäumann (1923)
<i>Erysiphe communis</i>	Hammarlund (1925)
<i>Erysiphe graminis</i>	Reed (1918), Salmon (1904), Marchal (1903)
<i>Erysiphe graminis hordei</i>	Mains and Dietz (1930)
<i>Erysiphe graminis tritici</i>	Mains (1933)
<i>Erysiphe horridula</i>	Blumer (1922)
<i>Phyllactinia guttata</i>	Hammarlund (1925)
<i>Sphaerotheca humuli</i>	Steiner (1908)
<i>Claviceps purpurea</i>	Stäger (1903), Stakman (1926)
<i>Pleospora</i> spp.	Diedicke (1902)
<i>Ploerightia morbosa</i>	Gilbert (1913)
<i>Puccinia anomala</i>	Mains (1933a), Hey (1931)
<i>Puccinia coronata avenae</i>	Hoerner (1919), Peturson (1930), Frenzel (1930)
<i>Puccinia glumarum</i>	Eriksson (1894), Allison and Isenbeck (1930), Wilhelm (1931)
<i>Puccinia graminis avenae</i>	Eriksson (1894), Stakman, Levine, and Bailey (1923), Bailey (1925), Waterhouse (1929), Gordon (1933)
<i>Puccinia graminis secalis</i>	Cotter and Levine (1932)
<i>Puccinia graminis tritici</i>	Eriksson (1894), Stakman and Piemeisel (1917), Stakman and Levine (1922), Waterhouse (1929), Stakman, Levine, and Hines (1934), Newton and Johnson (1927)
<i>Puccinia rubigo-vera tritici</i>	Mains and Jackson (1926), Waterhouse (1929), Johnson and Mains (1932), Mains (1933), Radulescu (1932)
<i>Puccinia sorghi</i>	Stakman <i>et al.</i> (1928)
<i>Sphaecelotheca sorghi</i>	Tisdale, Melchers, and Clemmer (1927), Melchers, Fricke, and Johnston (1932)
<i>Sorosporium reilianum</i>	Reed, Swabey, and Kolk (1927), Stakman (1926)
<i>Tilletia laevis</i> , <i>T. tritici</i>	Rodenheiser and Stakman (1927), Reed (1928), Gaines (1928), Holton (1931), Bressman (1931)
<i>Ustilago avenae</i> , <i>U. levis</i>	Reed (1924, 1927, 1929, 1940), Reed and Stanton (1932), Aamodt (1931), Flor (1933), Melchers (1934)
<i>Ustilago hordei</i>	Faris (1924)
<i>Ustilago tritici</i>	Stakman (1926), Grevel (1930)
<i>Ustilago violacea</i>	Zillig (1921), Goldschmidt (1928)
<i>Ustilago zeae</i>	Christiansen and Stakman (1926), Stakman <i>et al.</i> (1929)
<i>Septoria</i> spp.	Beach (1919)
<i>Pestalozzia guelpini</i>	LaRue and Bartlett (1922)
<i>Pestalozzia funerea</i>	Christiansen (1932)
<i>Colletotrichum lindemuthianum</i>	Barrus (1918), Burkholder (1923), Leach (1922), Budde (1928), Penser (1931), Schreiber (1932)
<i>Helminthosporium gramineum</i>	Christiansen and Graham (1934)
<i>Helminthosporium sativum</i>	Christiansen (1922)
<i>Polyspora lini</i>	Stakman (1926)
<i>Fusarium lini</i>	Stakman (1926)
<i>Rhizoctonia solani</i>	Matsumoto (1921), Briton-Jones (1924)

Although the list in Table 26 is by no means complete, it indicates that physiologic specialization occurs among all the major groups of fungi. A survey of accounts from which this list was compiled shows that in the recognition of physiologic forms four criteria were employed: (a) pathogenicity on special hosts, (b) differences in artificial culture, (c) minor morphological differ-

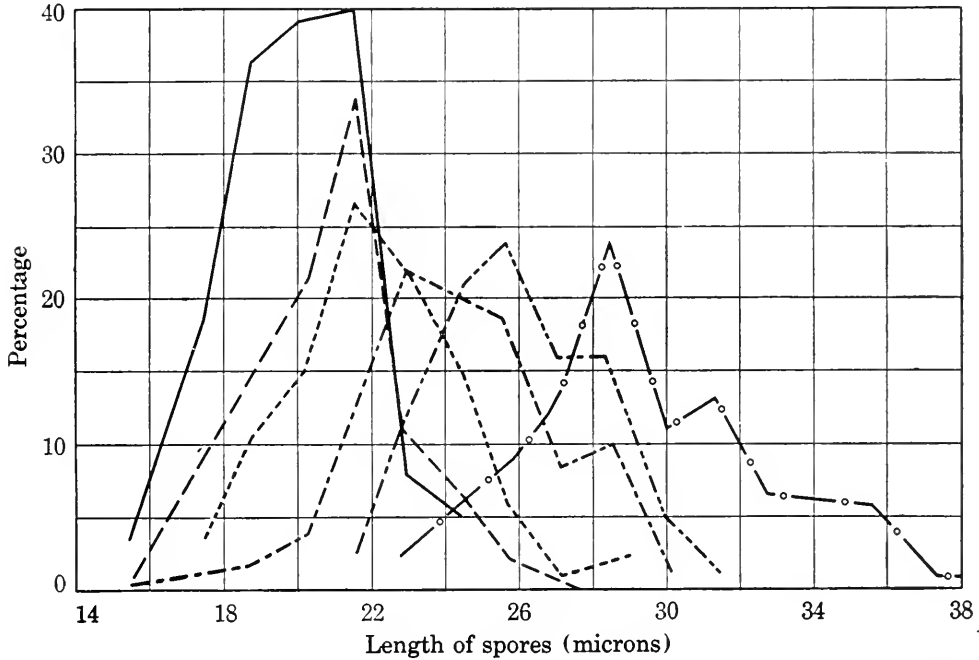

FIG. 45. Variation in length of spores of six strains of *Pestalozzia guepini*, plotted as length of spores in microns against percentage of the total number measured. (After LaRue.)

ences, and (d) physico-chemical reactions. Each will be given further consideration.

PATHOGENICITY TESTS. Concerning the pathogenic potentialities of disease-producing fungi, two diametrically opposed theories have been advanced. One is that disease-producing potentialities are inherent in the fungus itself and therefore are hereditary. The other is that the pathogens become adapted, modified, or "educated" under the influence of the host or of other environmental factors. According to the first view, the physiologic forms are true-breeding entities that maintain a uniform potentiality to produce disease throughout many generations or over a long period of years. The weight of evidence in recent years favors this viewpoint, since physiologic characteristics appear to

be governed by genetic factors in the same way as morphologic characteristics are governed. Nevertheless the idea of adaptation is maintained to be operative, and it has the support of a certain group who believe in evolution through adaptative modifications. Attention was directed to this point of view by the results of Ward (1903) on *Puccinia dispersa* on brome grasses and of Salmon (1904) on various powdery mildews, especially *Erysiphe graminis* on grasses. Ward maintained that this rust could acquire the ability to attack a resistant host if it were first transferred to another host with lesser resistance. After repeated transfers on this less resistant host, it acquired the ability to attack the resistant one. The less resistant variety, therefore, served as a "bridge." Similarly, Salmon maintained that *E. graminis* from barley could not infect wheat unless the leaves were injured. When grown on injured wheat leaves for several transfers, it acquired the ability to infect intact ones. From this type of results he concluded, "The restriction in power of infection characteristic of biologic forms breaks down if the vitality of the leaf on which the conidia are sown is interfered with in certain ways." He also noted that the powdery mildew from *Bromus racemosus* did not infect *B. commutatus* in 12 trials, but that it infected *B. hordeaceus* in each of 36 trials. Furthermore failure of infection resulted in 36 attempts when conidia from *B. commutatus* were applied to *B. racemosus*, and infection occurred in 40 out of 49 trials in which conidia from *B. hordeaceus* were applied to *B. commutatus*. From these experiments *B. hordeaceus* was concluded to act as a bridging species for powdery mildews on *B. racemosus* and *B. commutatus*.

Hammarlund (1925) attempted to repeat Salmon's work, using *Erysiphe communis tritici* cultivated for 37 generations on wounded leaves of *Hordeum europaeum*, with the result that there was no increasing tendency to become adapted to barley. He also employed *E. graminis tritici* cultivated on wounded leaves of *Hordeum vulgare* for 128 generations. In this experiment likewise there was no evidence at the end that the powdery mildew had acquired the ability to infect intact barley leaves.

Stakman and his associates (1926) attempted to adapt *Erysiphe graminis tritici* to grow on barley, rye, and oats. They subjected the plants to "every conceivable form of torture," but all refused to become infected.

The existence of adaptation and "bridging" among pathogens remains questionable in the light of these experiments. That the pathogenicity of specialized races is hereditary and therefore constant, on the other hand, has volumes of evidence in its support. Those who have studied the rusts over a period of years, as have

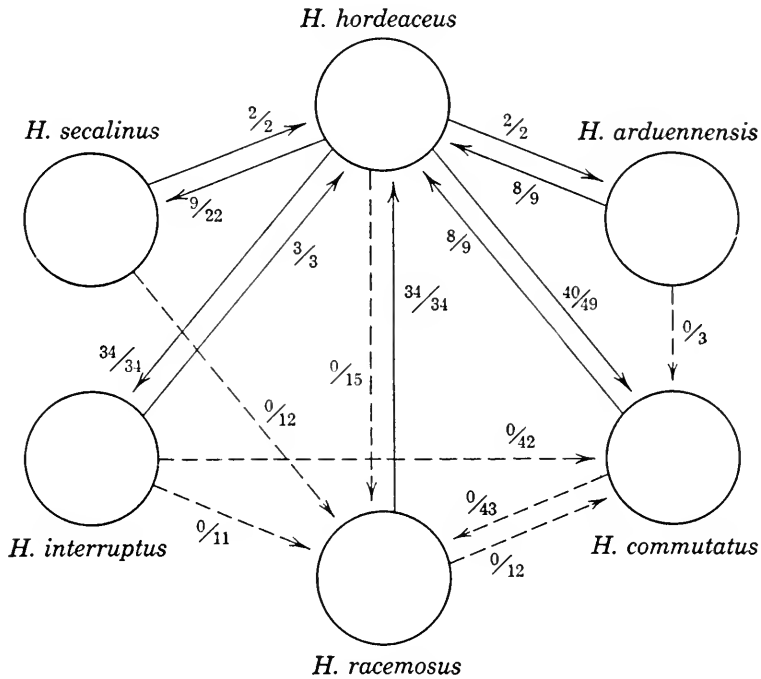

FIG. 46. Reciprocal inoculation of species of *Hordeum* with conidia of powdery mildew. Solid lines show successful transfer with resultant infection in direction indicated by arrow; broken lines, failure of infection after transfer of conidia. The numerator indicates the number of successful trials; the denominator, the number of attempts made to secure infection. The species *hordeaceus* is a "bridging species" for *Erysiphe graminis*. (After Salmon.)

Stakman and his associates, or the smuts, as have Reed and his associates, are able to isolate the same physiologic forms year after year. These identical forms may range widely in one area or country or may even be found in different continents.

DIFFERENCES IN ARTIFICIAL CULTURE. Macroscopic or microscopic differences between strains isolated from monosporous cultures have been reported for numerous species of fungi. From our knowledge of genetics these strain differences may have arisen either through hybridization or through mutation.

From the voluminous literature on plus and minus strains within

a given species, it would be anticipated that new forms are being produced constantly. There is abundant evidence that this is the situation, especially among rusts and smuts [Christiansen and Stakman (1926), Newton and Johnson (1927), Christiansen (1929), Flor (1932)].

SECTORING. Sometimes differences appear as sectors in the colonies on Petri dishes. These sectors may appear as wedge-shaped areas of different color, of different compactness of mycelial growth, with less profuse sporulation, or of some other very marked difference. Christiansen and Stakman (1926) and Stakman, Tyler, and Hafstad (1933) noted sectoring in *Ustilago zaeae*. In their report Stakman, Tyler, and Hafstad (1933) recorded the isolation of 14 variant lines of *U. zaeae* from a single monosporidial cell that sectoried in culture. Each line maintained distinctive cultural characteristics for 5 years. Evidently each was a distinct biotype, and each arose as a mutation.

Dodge (1931) isolated an albino strain of *Neurospora sitophila* that produced few conidia. Johnson and Valleau (1935) isolated from a sector an albino strain of *Thielaviopsis basicola*. Leonian (1930) observed sectoring in *Fusarium moniliforme*, and it appears to be of rather common occurrence among *Fusaria* in the section *Elegans*. Hansen and Smith (1932) recorded sectoring in *Botrytis cinerea*, and Wolf and Wolf (1939) in *Botryosphaeria ribis*. *Pestalozzia funerea* sectoried, giving rise to conidia with only a single seta [Christiansen (1932)], which is characteristic of the genus *Monochaetia*.

The occurrence of dissociation with the production of albinistic mutants has been noted in *Brachysporium trifolii* [Bonar (1922)] and among sclerotia in *Botrytis cinerea*.

Brierley (1920) and Christiansen (1922) secured evidence that some of the mutations of *Helminthosporium sativum* were more virulent, and others less virulent, than their parents. *Ustilago zaeae* from purplish sectors was more virulent than that from tan sectors [Christiansen and Stakman (1926)]. Newton and Johnson (1927) isolated a bright orange and a greyish strain of *Puccinia graminis tritici* from form species 9. Both seemed identical in pathogenicity, however, with the normal form.

Sectoring among fungi has been compared with "bud sporting" among seed plants. The causes of sectoring are not understood, although certain factors are known to exert an influence. These

include kind and amount of nutrients, temperature, light and other radiations, pH, staling products, and the addition of certain salts and toxic substances, a subject briefly summarized by Christiansen (1940).

Sectoring could be expected to take place among fungi in which hyphal fusions occur or in those with multinucleate spores, as in *Botrytis cinerea*. Hansen and Smith (1932) have shown that the propagative elements of this fungus are heterocaryotic, resulting from anastomoses that permit the migration of nuclei from one cell to another. In *Botryosphaeria ribis*, which has multinucleate ascospores and conidia, however, all the nuclei within any ascospore or conidium have the same origin and hence are homocaryotic [Wolf and Wolf (1939)]. The causes of sectoring in this species are unknown, and the phenomenon may be wholly spontaneous.

Normally when a culture originates from a single conidium it is regarded as clonal and is presumed to be genetically pure. Variations occur in the colonies from these clones, as has been shown by LaRue (1922) in *Pestalozzia guepini*, by Christiansen (1932) in *Pestalozzia funerea*, and by Leonian (1929) in many species and varieties of *Fusarium*. Sometimes the variants in subcultures of *Fusarium* remained different from the parent type and that of the variant biotype that arose by sectoring. Leonian (1929) concluded, "The presence of distinct strains and variants within the same species and their decidedly different reactions (to various acids and toxic substances) seem to indicate that the concept of the species must not be that of a single organism but that of a group of many organisms having in general the same principal characters."

Brierley (1929) summarized his observations on variation of fungi in cultures, especially of *Botrytis cinerea*, by stating that his distinct monosporial isolates of *B. cinerea* remained stable for long periods of time when cultivated under different nutritional and environmental conditions, both *in vitro* and *in vivo*. When the different isolates were then brought back to the common standardized environment, all immediately reverted in their conidial dimensions to a common original condition. This phenomenon shows genotypic fixity within the species, which has been repeatedly demonstrated to occur in other organisms.

Four variant strains of *Hypomyces ipomoeae*—purple, alba, convoluta, and reverta—were isolated by Dimock (1939). They originated by gene mutations. None of them appeared to be capable of perpetuating themselves in competition with the normal type, because all had growth rates slower than the normal, produced conidia less abundantly, and were quite incapable of inbreeding.

The causes underlying these variational phenomena are undoubtedly diverse. In some cases they have been shown to be genetic, but in others a different explanation must be sought. Dodge (1942) noted increased vigor of growth and production of conidia in *Neurospora tetrasperma* when he crossed a dwarf race of this fungus with a normal one of opposite sex or else with one of the same sex with resultant mycelial fusions. The cells of these mycelia, containing nuclei of both races, grew two or three times as fast as those of normal ones. He ascribed increased vigor to synthesis of vitamins by the heterocaryotic mycelium.

HYBRIDIZATION. Stakman, Levine, and Cotter (1930) crossed *Puccinia graminis tritici* form 36 with *Puccinia graminis agrostidis*. When segregation occurred in the progeny, 3 new form species were isolated that had previously not been encountered among the numerous form species of *tritici*. Stakman, Levine, Cotter, and Hines (1934) segregated over 20 different races of wheat-stem rust from aecial collections and 80 from uredinial collections. In the Mississippi Valley, where barberry occurs, there is ample opportunity for hybridization to occur, whereas in Australia, where barberry is absent, as was pointed out by Waterhouse (1929), there are few races of wheat-stem rust. In consequence, an abundance of races can exist, and new ones can continue to arise naturally by segregation and recombination of factors for differences in pathogenicity wherever the barberry host thrives. Emphasis was also placed on hybridization as a means of securing new races of stem rust by Craigie (1940) in his summary of studies conducted at the Dominion Rust Research Laboratory, Winnipeg, Canada.

Similarly Tisdale, Melchers, and Clemmer (1927) found in Kansas, New Mexico, and Texas a new kernel smut that infects milo and hegari but is non-infectious to feteretia, and presented evidence that it arose as a hybrid between *Sphacelotheca sorghi*

and *S. cruenta*. The phenotypes obtained had characters common to both parents. Other interspecific smut hybrids, such as those between *Ustilago avenae* and *U. levis*, and between *U. hordei* and *U. medians*, have been produced that are intermediate in the F₁ generation but segregate in the F₂ generation. The status of present knowledge of genetic factors as applied to hybridization in smuts, and especially to the origin of physiologic races by this means, is summarized by Rodenheiser (1940). New specialized races of smuts are known to arise in nature, presumably by hybridization. Reed (1935) isolated from a collection of loose smut of oats from Texas two distinct new races, one capable of infecting Red Rustproof oat and the other Fulgum oat.

It should be recalled that in some species of smuts infection and production of chlamydospores occur only if there has been fusion of lines of opposite sex. In such species hybridization between biotypes undoubtedly is of common occurrence. Moreover, interspecific hybrids between *Ustilago hordei* and *U. medians*, *U. levis* and *U. avenae*, *Tilletia levis* and *T. tritici*, and *Sphacelotheca cruenta* and *S. sorghi* have been produced. Certain intergeneric crosses, as between *Sorosporium reilianum* × *Sphacelotheca sorghi*, and *Sorosporium reilianum* × *Sphacelotheca cruenta*, have also been effected [Tyler and Shumway (1935), Christiansen and Rodenheiser (1940)].

MORPHOLOGICAL DIFFERENCES BETWEEN PHYSIOLOGIC SPECIES. It has been pointed out that minor morphologic differences have been noted between urediniospores of varieties of *Puccinia graminis*. This observation has led to a search for distinctive differences by means of which to separate specialized races of this rust as it occurs on wheat. The outstanding of these attempts is that of Levine (1928), who by the aid of biometrical methods was able to show minor differences in size and shape of spores between the several physiologic forms. Newton and Johnson (1927) were able to show that a bright orange form species and a greyish brown one can be distinguished from the normal form 9 of *P. graminis tritici*. Similar segregation of species followed from monographic studies on *Peronospora* by Gäumann (1923). By making numerous measurements of the lengths and widths of sporangia of *Peronospora parasitica* and then plotting these data as population curves, he was able to separate the species into a number of distinct groups.

Savulescu and Rayss (1930) found minor differences in the sporangia of *Albugo candida* and used them as a basis to divide it into 8 form species. Togashi and Shibasaki (1934) were able, by means of a large series of measurements of sporangia, to divide this species into 2 varieties, *microspora* and *macrospora*, and then to separate *microspora* into 3 form species and *macrospora* into 2 form species.

Leonian (1925) isolated from *Phytophthora parasitica rhei* 5 types of colonies that were so different no one would regard them as members of the same species. For a long time mycologists have placed great emphasis upon the host species as an aid in identifying rusts, smuts, downy mildews, powdery mildews, and other obligate parasites. Undoubtedly some so-called species are in reality only form species. The converse may, of course, be found to be equally true, with changes in concepts of what constitutes the species.

PHYSICO-CHEMICAL DIFFERENCES AMONG SPECIALIZED RACES. In the light of statements already made, it would seem possible to isolate races that possessed more marked ability than other isolates to produce a given by-product as the result of their metabolic activity. This is true in the case of the groups, baker's yeasts and brewer's yeasts, that have been selected from the complex known as *Saccharomyces cerevisiae*. Growth of the baker's yeasts is inhibited in wort in which the alcohol content has accumulated to a concentration of 4 to 5%, and of the brewer's yeast, at an alcohol concentration of 14 to 17%. Similarly races of molds, especially of *Penicillium*, *Rhizopus*, and *Aspergillus*, differing in fermentative ability in the formation of oxalic acid, acetic acid, lactic acid, and other products, have been isolated. It would seem that these races are merely selections within the species. This interpretation has direct bearing on the "species concept." The degree of difference requisite in separating species and varieties, and sometimes genera, of fungi is not fixed. Morphology is agreed to be the primary basis of specific distinctions. In some genera, such as *Botrytis*, *Fusarium*, and *Phytophthora*, morphologic differences are either minute or non-existent and hence a source of confusion. Physiologic differences among them are, therefore, employed as a convenient basis for specific taxonomic units. If physiologic differences were employed among rusts, precise means of cleaving species exist that are more

distinctive than morphologic differences between accepted species in certain other genera. Similarly constant physico-chemical differences among fungi can be demonstrated to exist. Their taxonomic value, like that of other bases, however, remains a matter of dispute.

INFLUENCE OF ENVIRONMENTAL FACTORS ON PHYSIOLOGIC SPECIES. The pathogenic potentialities of fungi are modified by environmental factors, as has been demonstrated to the satisfaction of everyone who has worked with plant pathogens. There is evidence also that the specialized races that together constitute a species respond differently to a single factor. For example, Waterhouse (1929) has shown that certain physiologic forms of *Puccinia graminis tritici*, *P. graminis avenae*, *P. triticina*, and *P. simplex* are pathogenic to a particular host variety in summer but not in winter. Waterhouse reported that *P. simplex* was capable of infecting 14 varieties of barley equally potently in winter and in summer, but 8 varieties were resistant under winter weather conditions and susceptible in summer. A similar response to weather was noted by Peturson (1930) in *P. coronata avenae*. At 57° F Red Rust-proof oats were resistant, but at 70° F or higher this variety was susceptible. Ruakura oats were resistant within the range 57° to 77° F, whereas the varieties Green Mountain, White Tartar, and Green Russian were susceptible within this range. Susceptibility to form species 21 of *P. graminis tritici* was dominant at high temperature in the cross between Marquillo and Marquis wheat, but at low temperature resistance was dominant [Harrington (1931)]. Presumably these effects of temperature, representative of similar observations on other pathogenic fungi, involve the metabolic activities of both interacting organisms and are to be regarded as quantitative rather than qualitative.

It is well known that certain diseases involve only mature plants or plant parts, whereas others are limited to seedlings or to young tissues. *Fomes pini*, for example, causes disease of mature conifers and becomes a very important cause of decay in overmature stands. Again, the leaves and fruits of grapefruit and orange are subject to melanose, caused by *Diaporthe citri*, and to scab, caused by *Sphaceloma fawcetti*, in the period of 4 to 6 weeks after the petals have fallen but become highly resistant thereafter. The fundamental causes of differences between young and old tissues in susceptibility to infection by fungi are little understood. Further-

more, that such differences may be correlated with the existence of physiologic races of the particular species is shown by the experiments of Goulden, Newton, and Brown (1930). Among the 16 form species of *Puccinia graminis tritici* that they used some were more pathogenic on wheat in the seedling stage than on the same variety in the mature condition.

ENVIRONMENTAL FACTORS AND VARIATION AMONG SAPROPHYTES. Variations among saprophytic fungi, in relation to their production by such factors as temperature, chemicals, kind and amount of food, and effects of radiations, have also been given due consideration. An appreciation of the influence of environmental factors is shown in the report by Barnes (1936). In it he states that Hansen, in his work with yeasts in 1883, was the first to induce variation in a fungus. He secured an anascosporous yeast by use of high temperature. In Barnes' own studies, involving *Eurotium herbariorum*, *Botrytis cinerea*, and *Thamnidium elegans*, he secured variants by exposure to temperatures just insufficient to kill. These variations were manifest by reduced fertility or less vigorous vegetative development. Barnes judiciously indicates the need for distinguishing between modifications that are temporary in nature and variants characterized by permanency. Both modificatory types appeared in his own experiments and in those of certain others. Barnes' (1936) discussion involves the possibility that wounding which results from breaking the hyphae while making transfer from one medium to another may induce variation. He would not attribute all variation to nuclear changes, since physiological processes might conceivably be deranged without nuclear derangement. Barnes concludes by saying, "Variants are damaged versions of the normal stocks . . . and the evolutionary process may depend in part on the running down of the biological machine."

Evidence presented by Barnes (1928, 1930) shows that variation can be induced in *Eurotium herbariorum* and *Botrytis cinerea* by subjecting the spores to high temperatures. In *E. herbariorum* these variations are manifest by differences in amount of aerial mycelium, density of growth, color of conidia, and abundance of perithecial formation; in *B. cinerea*, by the change in color and density of the mycelium and by abnormalities in abundance of conidia and sclerotia. Certain variants that arose by high-temperature treatment seemed capable of retaining these characteristic

differences even after repeated transfer, whereas others reverted to the normal.

IMPORTANCE OF PHYSIOLOGIC SPECIALIZATION AND VARIATION. Thus far emphasis has been placed upon the fact that specialized races exist, and their possible origin has been considered. The significance and practical application of these facts and theories cannot have been kept from mind during the perusal of this discussion. Their importance in the field of plant pathology is not believed to be properly appreciated; indeed, it can scarcely be overestimated. For a period of years these problems have engaged the attention of many students of the rusts and smuts, especially Stakman and his associates. In a report Stakman (1936) has summarized them in their application to the need for plant quarantines and to the breeding of varieties resistant to disease.

Investigations at the Minnesota Agricultural Experiment Station, at the Dominion Rust Research Laboratory, and in Australia [Waterhouse (1929)] are in accord in showing the relationship between the presence of barberry and the existence of numerous races of *Puccinia graminis tritici*. Race 34 seems to be the only one present in quantity in Australia, whereas in the wheat-growing belt of North America approximately 150 races are known to exist. In addition, new races are continuously being developed as the result of hybridization on the barberry. The unrestricted introduction of the North American races into Australia or other continents might easily result in epidemics of rust on varieties of wheat that are highly resistant to races of rusts already present in these countries. This supposition is supported by Stakman's (1936) observations on the rust epidemic on the varieties Ceres and Thatcher in 1935. Both had previously rather uniformly resisted rust for a term of years. It should be added that in 1935 no races of rust capable of infecting Vernal emmer were isolated from uredinial collections made in regions where barberries are absent, whereas three capable of infecting this variety of emmer were isolated from barberries or from grain growing near them. Several of the races isolated that year from barberries were new biotypes, showing that hybridization and segregation in rusts are taking place in nature. Experiences of this sort should convince the most hard-headed unbeliever that barberries should be eradicated.

The recent work of Reed (1940) serves to emphasize the importance of physiologic races in the breeding of oats resistant to smuts. He differentiated 29 races of *Ustilago avenae* and 14 of *U. levis* by their pathogenic behavior on strains and varieties of 9 species of *Avena*. *Avena barbata* was susceptible to all races of smuts. The variety Canadian was susceptible to all physiologic races of these smuts except one of each. The varieties Markton, Victoria, and Navarro proved to be highly resistant to many races of both loose and covered smuts.

Literature on plant pathology contains many accounts of varieties of crop plants that are resistant to a specific pathogen when grown in one region but are susceptible when grown in another region. Of course this apparent breakdown of resistance cannot be attributed to one cause in every case, but the existence of different specialized races in different regions is no doubt frequently the primary cause. For example, it is a common observation that durum wheats in the United States are more resistant to stinking smut than are vulgare wheats. The opposite situation has been observed in Palestine. Abundant evidence is now at hand that these conflicting observations can be explained by the existence of different physiologic races of *Tilletia tritici* and *T. levis* in these two regions. It is to be expected that hybridization is less important in breeding crops resistant to smuts if the smuts belong to the group in which the promycelium or its branches directly penetrate the host tissues. Even in these species fusions between different promycelia could occur, and new races could be formed.

From the numerous examples of interracial and interspecific hybridization and of variation by sectoring that have been observed, it is apparent, as has been indicated, that new forms are continuously being produced in nature. The plant pathologist must therefore first know the pathogen thoroughly, if the breeding or selecting of resistant host varieties is to be successful.

LITERATURE CITED

- AAMODT, O. S., "Varietal trials, physiologic specialization, and breeding spring wheats for resistance to *Tilletia tritici* and *T. levis*," *Can. J. Research*, 5: 501-528, 1931.
- ALLISON, C. C., AND K. ISENBECK, "Biologisches Specialisierung von *Puccinia glumarum tritici* Eriksson and Henning," *Phytopath. Z.*, 2: 87-98, 1930.

- BAILEY, D. L., "Physiologic specialization in *Puccinia graminis avenae* Erikss. and Henn.," *Minn. Agr. Expt. Sta. Tech. Bull.*, 35: 36 pp. 1925.
- BARNES, B., "Variations in *Eurotium herbariorum* (Wigg) Link, induced by the action of high temperatures," *Ann. Botany*, 42: 783-812, 1928.
- "Variations in *Botrytis cinerea* Pers., induced by the action of high temperatures," *Ann. Botany*, 44: 825-858, 1930.
- "Induced variation," *Trans. Brit. Mycol. Soc.*, 20: 17-32, 1936.
- BARRUS, M. F., "Varietal susceptibility of beans to strains of *Colletotrichum lindemuthianum* (Sacc. et Magn.) B. and C.," *Phytopathology*, 8: 589-614, 1918.
- BEACH, W. S., "Biologic specialization in the genus *Septoria*," *Am. J. Botany*, 6: 1-33, 1919.
- BILLROTH, T., *Untersuchungen über die Vegetationsformen von Cocco-bacteria septica*. Berlin. 1874.
- BLUMER, B., "Beiträge zur Specialisation der *Erysiphe horridula* Lé. auf Boraginaceen," *Zentr. Bakt., Parasitenk., II Abt.*, 55: 480-506, 1922.
- BONAR, L., "An albino mutation of the dematiaceous fungus *Brachysporium trifolii*," *Science*, 56: 226-227, 1922.
- BRESSMAN, E. N., "Varietal resistance, physiologic specialization, and inheritance studies in bunt of wheat," *Ore. Agr. Expt. Sta. Bull.*, 281: 1-44, 1931.
- BRIERLEY, W. B., "On a form of *Botrytis cinerea* with colorless sclerotia," *Phil. Trans. Roy. Soc. London, Ser. B*, 210: 83-114, 1920.
- "Variation in fungi and bacteria," *Proc. Intern. Congr. Plant Sci. Ithaca*, 2: 1629-1654, 1929.
- "Biological races in fungi and their significance in evolution," *Ann. Appl. Biol.*, 18: 420-434, 1931.
- BRITON-JONES, H. R., "Strains of *Rhizoctonia solani* (*Corticium vagum* Berk. and Curt.)," *Trans. Brit. Mycol. Soc.*, 9: 200-210, 1924.
- BUDDE, A., "Über Rasenbildung parasitischer Pilze unter besonderer Berücksichtigung von *Colletotrichum lindemuthianum* (Sacc. et Magn.) Bri. et Cav. in Deutschland," *Forsch. Gebiete Pflanzenkr. Immunität im Pflanzenreich*, 5: 115-147, 1928.
- BURKHOLDER, W. H., "The gamma strain of *Colletotrichum lindemuthianum* (Sacc. and Magn.) B. and C.," *Phytopathology*, 13: 316-323, 1923.
- CHRISTIANSEN, C., "Cultural races and the production of variants in *Pestalozzia funerea*," *Bull. Torrey Botan. Club*, 59: 525-544, 1932.
- CHRISTIANSEN, J. J., "Studies on the parasitism of *Helminthosporium sativum*," *Minn. Agr. Expt. Sta. Tech. Bull.*, 11: 3-42, 1922.
- "Mutation and hybridization in *Ustilago zaeae*. Part II. Hybridization," *Minn. Agr. Expt. Sta. Tech. Bull.*, 65: 85-108, 1929.
- "Studies on the genetics of *Ustilago zaeae*," *Phytopath. Z.*, 4: 129-188, 1931.
- "The origin of parasitic races of phytopathogenic fungi through mutation," *Genetics of Pathogenic Organisms, Am. Assoc. Adv. Sci.*, 77-82, 1940.
- CHRISTIANSEN, J. J., AND T. W. GRAHAM, "Physiologic specialization and variation in *Helminthosporium gramineum* Rab.," *Minn. Agr. Expt. Sta. Tech. Bull.*, 95: 1-40, 1934.

- CHRISTIANSEN, J. J., AND H. A. RODENHEISER, "Physiologic specialization and genetics of the smut fungi," *Botan. Rev.*, 6: 389-425, 1940.
- CHRISTIANSEN, J. J., AND E. C. STAKMAN, "Physiologic specialization and mutation in *Ustilago zea*," *Phytopathology*, 16: 979-999, 1926.
- CIFERRI, R., "Osservazioni sulla specializzazione dell' *Albugo ipomoeae-panduranae* (Schw.) Sw., *Nuov. giorn. Ital.*, 35: 112-134, 1928.
- COTTER, R. U., AND M. N. LEVINE, "Physiologic specialization in *Puccinia graminis secalis*," *J. Agr. Research*, 45: 297-315, 1932.
- CRAIGIE, J. H., "The origin of physiologic races of rust fungi through hybridization," *Genetics of Pathogenic organisms, Am. Assoc. Adv. Sci.*, 66-72, 1940.
- DIEDICKE, H., "Über den Zusammenhang zwischen Pleospora und Helminthosporium-arten," *Zentr. Bakt., Parasitenk., II Abt.*, 9: 317-329, 1902.
- DIMOCK, A. W., "Studies of ascospore variants of *Hypomyces ipomoeae*," *Mycol.*, 31: 709-727, 1939.
- DODGE, B. O., "Inheritance of the albinistic non-conidial character in interspecific hybrids in *Neurospora*," *Mycol.*, 23: 1-50, 1931.
- "Heterocaryotic vigor in *Neurospora*," *Bull. Torrey Botan. Club*, 69: 75-91, 1942.
- ERIKSSON, J., "Über die Specialisierung des Parasitismus bei den Getreiderostpilzen," *Ber. deut. botan. Ges.*, 12: 292-331, 1894.
- FARIS, J. A., "Physiologic specialization of *Ustilago hordei*," *Phytopathology*, 14: 537-557, 1924.
- "Factors influencing infection of *Hordeum sativum* by *Ustilago hordei*," *Am. J. Botany*, 11: 189-214, 1924a.
- FLOR, H. H., "Heterothallism and hybridization in *Tilletia tritici* and *T. levis*," *J. Agr. Research*, 44: 49-58, 1932.
- "Studies on physiologic specialization in *Tilletia tritici* and *T. levis* in the Pacific Northwest," *J. Agr. Research*, 47: 193-213, 1933.
- FRENZEL, H., "Beiträge zur Spezialisierung des Haferkronenrostes *Puccinia coronifera*, f. sp., *avenae* Kleb.," *Arb. biol. Reichs. Land-u. Forstw. Berlin-Dahlem*, 18: 153-176, 1930.
- GAINES, E. F., "New physiological forms of *Tilletia levis* and *T. tritici*," *Phytopathology*, 18: 579-588, 1928.
- GÄUMANN, E., "Beiträge zu einer Monographie der Gattung *Peronospora* Corda," *Beitr. Kryptogmenflora*, 5: 1-360, 1923.
- GILBERT, E. M., "Biologic forms of black knot," *Phytopathology*, 3: 246-247, 1913.
- GOLDSCHMIDT, V., "Vererbungsversuche mit den biologischen Arten der Antherenbrandes (*Ustilago violacea* Pers.)," *Z. Botan.*, 21: 1-90, 1928.
- GORDON, W. L., "Effect of temperature on host reaction to physiologic forms of *Puccinia graminis avenae* Erikss. and Henn.," *Sci. Agr.*, 11: 95-103, 1930.
- "A study of the relation of environment to the development of the uredinial and telial stages of the physiologic forms of *Puccinia graminis avenae* Erikss. and Henn.," *Sci. Agr.*, 14: 184-237, 1933.
- GOULDEN, C. H., M. NEWTON, AND A. M. BROWN, "The reaction of wheat

- varieties at two stages of maturity to sixteen physiologic forms of *Puccinia graminis tritici*," *Sci. Agr.*, 11: 9-25, 1930.
- GREVEL, F. K., "Untersuchungen über das Vorhandensein biologischer Rassen des Flugbrandes des Weizens (*Ustilago tritici*)," *Phytopath. Z.*, 2: 209-234, 1930.
- HAMMARLUND, C., "Zur Genetik, Biologie, und Physiologie einiger Erysiphaceen," *Hereditas*, 6: 1-126, 1925.
- HANSEN, H. N., AND R. E. SMITH, "The mechanism of variation in imperfect fungi: *Botrytis cinerea*," *Phytopathology*, 22: 953-964, 1932.
- HARRINGTON, J. B., "The effect of temperature on the expression of factors governing rust reaction in a cross between two varieties of *Triticum vulgare*," *Can. J. Research*, 5: 200-207, 1931.
- HARTER, L. L., AND J. L. WEIMER, "Some physiological variations in strains of *Rhizopus nigricans*," *J. Agr. Research*, 26: 363-371, 1923.
- HEY, A., "Beiträge zur Spezialisierung des Gerstenzwergrostes, *Puccinia simplex* Eriksson et Henning," *Arb. biol. Reichs. Land-u. Forstw. Berlin-Dahlem*, 19: 227-261, 1931.
- HOERNER, G. R., "Biologic forms of *Puccinia coronata* on oats," *Phytopathology*, 9: 309-314, 1919.
- HOLTON, C. S., "The relation of physiologic specialization in *Tilletia* to recent epiphytotics of bunt in Durum and Marquis wheats," *Phytopathology*, 21: 687-694, 1931.
- JOHNSON, C. O., "An aberrant physiologic form of *Puccinia triticina* Erikss.," *Phytopathology*, 20: 609-620, 1930.
- JOHNSON, C. O., AND E. B. MAINS, "Studies on physiologic specialization in *Puccinia triticina*," *U. S. Dept. Agr. Tech. Bull.*, 313: 1-23, 1932.
- JOHNSON, E. M., AND W. D. VALLEAU, "Cultural variations of *Thielaviopsis basicola*," *Phytopathology*, 25: 1011-1018, 1935.
- LARUE, C. D., "The results of selection within pure lines of *Pestalozzia guepini*," *Genetics*, 7: 142-183, 1922.
- LARUE, C. D., AND H. H. BARTLETT, "A demonstration of numerous distinct strains within the nominal species *Pestalozzia guepini* Desm.," *Am. J. Botany*, 9: 79-92, 1922.
- LEACH, J. G., "The parasitism of *Colletotrichum lindemuthianum*," *Minn. Agr. Expt. Sta. Tech. Bull.*, 14: 39 pp. 1922.
- LEONIAN, L. H., "Physiological studies on the genus *Phytophthora*," *Am. J. Botany*, 12: 444-498, 1925.
- "The morphology and pathogenicity of some *Phytophthora* mutations," *Phytopathology*, 16: 723-731, 1926.
- "Studies on the variability and dissociation in the genus *Fusarium*," *Phytopathology*, 19: 753-868, 1929.
- "Attempts to induce 'mixochimaera' in *Fusarium moniliforme*," *Phytopathology*, 20: 895-901, 1930.
- LEVINE, M. N., "Biometrical studies on the variation of physiologic forms of *Puccinia graminis tritici* and the effects of ecological factors on the susceptibility of wheat varieties," *Phytopathology*, 18: 7-126, 1928.
- MAINS, E. B., "Host specialization of barley rust, *Puccinia anomala*," *Phytopathology*, 20: 875-882, 1930.

- MAINS, E. B., "Host specialization of *Erysiphe graminis tritici*," *Proc. Nat. Acad. Sci.*, 19: 49-53, 1933.
- "Host specialization in the leaf rust of grasses, *Puccinia rubigo-vera*," *Mich. Acad. Sci. Papers*, 17: 289-394, 1933a.
- MAINS, E. B., AND S. M. DIETZ, "Physiologic forms of barley mildew, *Erysiphe graminis hordei* Marchal," *Phytopathology*, 20: 229-239, 1930.
- MAINS, E. B., AND H. S. JACKSON, "Physiologic specialization in the leaf rust of wheat, *Puccinia graminis* Erikss.," *Phytopathology*, 16: 89-120, 1926.
- MARCHAL, E., "De la specialization du parasitisme chez l'*Erysiphe graminis* DC." *Comp. rend.*, 135: 210-212, 1902; 136: 1280-1281, 1903.
- MATSUMOTO, T., "Studies in the physiology of fungi. XII. Physiological specialization in *Rhizoctonia solani* Kühn," *Ann. Mo. Botan. Garden*, 8: 1-62, 1921.
- MELCHERS, L. E., "Investigations on physiologic specialization of *Tilletia laevis* in Kansas," *Phytopathology*, 24: 1203-1226, 1934.
- MELCHERS, L. E., C. H. FRICKE, AND C. O. JOHNSTON, "A study of physiologic forms of kernel smut (*Sphacelotheca sorghi*) of sorghum," *J. Agr. Research*, 44: 1-11, 1932.
- NEWTON, M., AND T. JOHNSON, "Color mutations in *Puccinia graminis tritici* (Pers.) Erikss. and Henn.," *Phytopathology*, 17: 711-725, 1927.
- "Specialization and hybridization of wheat-stem rust, *Puccinia graminis tritici*, in Canada," *Dom. Canada Dept. Agr. Bull.*, 160: 1-60, 1932.
- NEWTON, M., T. JOHNSON, AND A. M. BROWN, "A preliminary study of the hybridization of physiologic forms of *Puccinia graminis tritici*," *Sci. Agr.*, 10: 721-731, 1930.
- PENSER, H., "Fortgesetzte Untersuchungen über das Vorkommen biologischer Rassen von *Colletotrichum lindemuthianum* (Sacc. et Magn.) Bri. et Cav.," *Phytopath. Z.*, 4: 83-112, 1931.
- PETURSON, B., "Effect of temperature on host reactions to physiologic forms of *Puccinia coronata avenae*," *Sci. Agr.*, 11: 104-110, 1930.
- PFISTER, R., "Zur Biologie von *Cystopus tragopogonis* Pers.," *Zentr. Bakt., Parasitenk., II Abt.*, 71: 312-313, 1927.
- RADULESCU, E., "Zur physiologischen Spezialisierung des Weizenbraunrostes (*Puccinia triticina* Erikss.)," *Kühn-Arch.*, 33: 195-205, 1932.
- REED, G. M., "Physiological specialization of parasitic fungi," *Brooklyn Botan. Garden Mem.*, 1: 348-409, 1918.
- "Physiologic races of oat smuts," *Am. J. Botany*, 11: 483-492, 1924.
- "Further evidence of physiologic races of oat smuts," *Mycol.*, 19: 21-28, 1927.
- "Physiologic races of bunt of wheat," *Am. J. Botany*, 15: 157-170, 1928.
- "New physiologic races of oat smuts," *Bull. Torrey Botan. Club*, 56: 449-470, 1929.
- "Physiologic specialization of the parasitic fungi," *Botan. Rev.*, 1: 119-137, 1935.
- "Physiologic races of oat smuts," *Am. J. Botany*, 27: 135-143, 1940.
- REED, G. M., AND T. R. STANTON, "Physiologic races of *Ustilago levis* and *U. avenae* on red oats," *J. Agr. Research*, 44: 147-153, 1932.

- REED, G. M., MARJORIE SWABEY, AND LAURA A. KOLK, "Experimental studies of head smut of corn and sorghum," *Bull. Torrey Botan. Club*, 54: 295-320, 1927.
- RODENHEISER, H. A., "Physiologic specialization in some cereal smuts," *Phytopathology*, 18: 955-1003, 1928.
- "The origin of physiologic races in the smut fungi by hybridization," *Genetics of Pathogenic Organisms, Am. Assoc. Adv. Sci.*, 73-76, 1940.
- RODENHEISER, H. A., AND E. C. STAKMAN, "Physiologic specialization in *Tilletia levis* and *Tilletia tritici*," *Phytopathology*, 17: 247-253, 1927.
- SALMON, E. S., "On *Erysiphe graminis* DC, and its adaptive parasitism within the genus *Bromus*," *Ann. Mycol.*, 2: 255-267, 307-343, 1904.
- "Cultural experiments with biologic forms of the Erysiphaceae," *Phil. Trans. Roy. Soc. London, Ser. B.*, 197: 107-122, 1904a.
- "Recent researches on the specialization of parasitism in the Erysiphaceae," *New Phytopathologist*, 3: 55-60, 1904.
- SAVULESCU, T., AND T. RAYSS, "Contribution à la connaissance des Péronosporacées de Roumaine," *Ann. Mycol.*, 28: 297-320, 1930.
- SCHREIBER, F., "Resistenzzüchtung bei *Phaseolus vulgaris*," *Phytopath. Z.*, 4: 415-454, 1932.
- SCHRÖETER, J., "Entwicklung einiger Rostpilze," *Beitr. Biol. Pflanzen*, 3: 69-70, 1879.
- STÄGER, R., "Infectionsversuche mit Gramineen-bewohnenden Clavicepsarten," *Botan. Z.*, 61: 111-158, 1903.
- STAKMAN, E. C., "Physiologic specialization in pathogenic fungi," *Proc. Intern. Congr. Plant Sci. Ithaca*, 2: 1312-1330, 1926.
- "The problem of specialization and variation in phytopathogenic fungi," *Genetica*, 18: 372-389, 1936.
- STAKMAN, E. C., J. J. CHRISTIANSEN, AND H. E. BREWBAKER, "Physiologic specialization in *Puccinia sorgbi*," *Phytopathology*, 18: 345-354, 1928.
- STAKMAN, E. C., J. J. CHRISTIANSEN, C. J. EIDE, AND B. PETURSON, "Mutation and hybridization in *Ustilago zaeae*," *Minn. Agr. Expt. Sta. Tech. Bull.*, 65: 108 pp. 1929.
- STAKMAN, E. C., AND M. N. LEVINE, "The determination of biologic forms of *Puccinia graminis* on *Triticum* spp.," *Minn. Agr. Expt. Sta. Tech. Bull.*, 8: 1-10, 1922.
- STAKMAN, E. C., M. N. LEVINE, AND D. L. BAILEY, "Biologic forms of *Puccinia graminis* on varieties of *Avena* spp.," *J. Agr. Research*, 24: 1013-1018, 1923.
- STAKMAN, E. C., M. N. LEVINE, AND R. U. COTTER, "Origin of physiologic forms of *Puccinia graminis* through hybridization and mutation," *Sci. Agr.*, 10: 707-720, 1930.
- STAKMAN, E. C., M. N. LEVINE, R. U. COTTER, AND L. HINES, "Relation of barberry to the origin and persistence of physiologic forms of *Puccinia graminis*," *J. Agr. Research*, 48: 953-969, 1934.
- STAKMAN, E. C., M. N. LEVINE, AND L. HINES, "Relation of barberry to the origin and persistence of physiologic forms of *Puccinia graminis*," *J. Agr. Research*, 48: 953-969, 1934.

- STAKMAN, E. C., AND F. J. PIEMEISEL, "A new strain of *Puccinia graminis*," *Phytopathology*, 7: 73, 1917.
- STAKMAN, E. C., L. J. TYLER, AND G. E. HAFSTAD, "The constancy of cultural characters and pathogenicity in variant lines of *Ustilago zeae*," *Bull. Torrey Botan. Club*, 60: 565-572, 1933.
- STEINER, J. A., "Die Spezialisierung der Alchenillen-bewohnenden *Sphaerotheca humuli* (DC) Burrill," *Zentr. Bakt., Parasitenk., II Abt.*, 21: 677-736, 1908.
- TISDALE, W. H., L. E. MELCHERS, AND H. J. CLEMMER, "Strains of kernel smuts of sorghum, *Sphacelotheca sorghi* and *S. cruenta*," *J. Agr. Research*, 34: 825-838, 1927.
- TOGASHI, K., AND Y. SHIBASAKI, "Biometrical and biological studies of *Albugo candida* (Pers.) O. Kuntze, in connection with its specialization," *Imp. Coll. Agr. Forestry, Morioka, Bull.*, 18: 1-88, 1934.
- TYLER, L. J., AND C. P. SHUMWAY, "Hybridization between *Sphacelotheca cruenta* and *Sorosporium reilianum*," *Phytopathology*, 25: 375-376, 1935.
- WARD, H. MARSHALL, "Further observations on the brown rust of bromes, *Puccinia dispersa* (Erikss.), and its adaptive parasitism," *Ann. Mycol.*, 1: 132-151, 1903.
- WATERHOUSE, W. L., "A preliminary account of the origin of two new Australian physiologic forms of *Puccinia graminis tritici*," *Proc. Linnean Soc. N.S. Wales*, 54: 96-106, 1929.
- "Australian rust studies. I," *Proc. Linnean Soc. N.S. Wales*, 54: 615-680, 1929a.
- WILHELM, P., "Studien zur Spezialisierung-weise des Weizengelbrostes, *Puccinia glumarum*, f. sp., *tritici* (Schmidt) Eriksson et Henning und zur Keimungsphysiologie seiner Uredosporen," *Arb. biol. Reichs. Land-u. Forstw. Berlin-Dahlem*, 19: 95-133, 1931.
- WOLF, F. T., AND F. A. WOLF, "A study of *Botryosphaeria ribis* on willow," *Mycol.*, 31: 217-227, 1939.
- ZILLIG, H., "Über spezialisierte Formen beim Antherbrand *Ustilago violacea* (Pers.) Fekl.," *Zentr. Bakt., Parasitenk., II Abt.*, 53: 33-74, 1921.

Chapter 12

ASSOCIATIVE EFFECTS AMONG FUNGI

In this chapter it is proposed to consider those phenomena manifest as a result of different species of fungi living together in close proximity. It is essentially an ecological study of fungi and corresponds in some measure to a consideration of associations among seed plants. Of course, a great deal has been learned regarding the influence of one species of seed plant upon another growing in close juxtaposition. Our knowledge of similar associative relationships among fungi is strikingly much more meager and fragmentary, and the data are rather widely dispersed in the literature. Such facts regarding fungi appear none the less important, however, and they may be found to possess interesting applications and economic potentialities.

For convenience, the effects of interaction of fungi, one upon the other, may be divided into the following categories: antibiotic, symbiotic, and synergetic. The associative relationships have been designated antagonism, symbiosis, and synergism, respectively. In antibiotic effects are included those antagonistic, competitive, or harmful effects that result to organisms from their growth in close proximity. Effects resulting from parasitism are among those included in this classification. In symbiotic effects are included mutualistic advantages that result from the living together of two or more species. In synergetic effects are included those in which two or more species through their combined action produce effects or changes that neither could produce alone.

It becomes apparent immediately that these categories are arbitrary, and that evidence might be found to show that they intergrade. Indeed, such evidence is at hand. Among the factors studied that have to do with intergradation and with associative effects generally are competition for food, modification of food supply by the metabolism of one or the other of the associated species, relative availability of food constituents, changes in re-

action of the medium, production of inhibitory toxic products, production of stimulatory or growth-controlling substances, such as vitamins, auxins and hormones, and variation in temperature and in O₂ tension. These matters, as they apply to associative effects, have been capably reviewed by Waksman (1937), Porter and Carter (1938), Weindling (1938), D'Aeth (1939), and Waksman (1941), each of whose summaries should be carefully perused.

ANTAGONISM

In our social organization the human race may be spoken of as constituted of two groups, producers and consumers, and if this analogy is applied to fungi, all of them, by virtue of their lack of chlorophyll, are perforce in the consumer grouping. They not only are largely dependent upon other organisms, living or dead, as sources of food, but also the "struggle for existence" is just as acute among them, with resultant "survival of the fittest," as it is among any other type of organism. This associative interaction exists not only among the fungi themselves but between bacteria and fungi, slime molds and fungi, actinomycetes and fungi, protozoa and fungi, and also various other organisms and fungi. In fact, it is doubtful if any chlorophyll-bearing species of plant is free from attack by fungi, and, moreover, records of hyperparasitism among fungi are not infrequent.

EVIDENCE OF ANTAGONISM FROM CULTURES. One of the essential techniques in the study of fungi is their isolation in pure culture. These procedures are based upon the use of semisolid media, first utilized by Koch to isolate bacteria in pure culture. All mycologists have come to place enormous importance upon the use of pure cultures, although they know full well that in nature pure cultures are either non-existent or else occur as miraculous oddities. In consequence of insistence upon use of pure cultures, too little attention has been given to studies of known mixtures of fungi [Fawcett (1931)].

It has long been known that microorganisms in culture produce substances that limit their own period of growth. As evidence the production of alcohol by yeasts, of citric acid by *Aspergillus niger*, and of lactic acid by *Rhizopus* sp. may be cited. These growth-inhibiting substances have been regarded as aids in the struggle for existence of microorganisms.

All who have studied microorganisms on artificial media have noted evidence of this antagonism between the colonies of different species. An explanation for this phenomenon was first sought by Raulin in 1869 [D'Aeth (1939)] in experiments involving the growth of *A. niger* on liquid synthetic media. He removed the mycelial mat by filtration at intervals of 3 days and determined the amount of growth during each successive 3-day period. Most growth occurred in the first period, with less in each period thereafter. From these results it was concluded that growth-affecting substances are excreted by *A. niger* and that they remain in the filtrate. The reciprocal influence of the simultaneous production of such substances upon paired organisms in the same culture was first studied by Reinhart in 1892 [D'Aeth (1939)]. Since then similar studies have been made by, among others, Zeller and Schmitz (1919), Porter (1924), Sanford and Broadfoot (1931), Endo (1931, 1932, 1932a), Weindling (1932), Broadfoot (1933), and Arrillaga (1935).

Porter (1924) used 80 species of fungi and bacteria grown in pairs on corn-meal agar. The fungi employed included *Penicillium glaucum*, *P. italicum*, *Rhizopus nigricans*, *Fusarium lini*, *F. culmorum*, *F. coeruleum*, *Gloeosporium piperatum*, *Colletotrichum nigrum*, *C. lindemuthianum*, and *Helminthosporium sativum*. He classified their interactions into five groups, four of which are antagonistic, showing differences in degree of inhibitory action as follows:

1. One species overgrows and inhibits the other.
2. Each member of the pair exerts a slight mutual inhibition.
3. One of the pair grows close to but around the other.
4. Mutual inhibition is exhibited at a considerable distance, and the two remain separate.

Endo (1931, 1932, 1932a) found that *Hypochnus centrifugus*, *H. sasakii*, and *Sclerotium oryzae-sativae*, causing root-rot diseases of rice, are indifferent to certain other fungi, and antagonism was exhibited in other combinations.

Broadfoot (1933) studied the interaction of 66 species of microorganisms, many of them bacteria, with special consideration to their antagonisms toward *Ophiobolus graminis*. Among the fungi that he found to be antagonistic to *O. graminis* are *Ascochyta graminis*, *Botrytis cinerea*, *Helminthosporium sativum*, *Lepto-*

sphaeria herpotrichoides, *Plenodomus meliloti*, and *Wojnowicia graminis*.

Arrillaga (1935) made all possible combinations on potato dextrose agar of 12 species of fungi associated with disease or decay of Citrus fruits, with the result that *Diaporthe citri* checked the growth, especially of *Phytophthora parasitica* and *P. citrophthora*.

CAUSES OF ANTAGONISM. It is apparent from the reports of these studies that the range of interaction between fungi extends from complete indifference of both members of the pair on the one extreme to very active inhibition on the other. Since these effects are manifest indifferently between members of all classes of fungi, it appears improbable that one and the same proximate cause is responsible for all. Instead a variety of causes has been suggested, and evidence in their support has been submitted. Some of these causes are exhaustion of nutrients, modification of their balance or concentration, differential in optimal pH, which may be the result of metabolic products formed by one of the species, differential in optimal temperature, production of excretory products, which cause staling, production of toxic substances, and aversion. Not all need be considered in this discussion, nor need evidence in their support be reviewed.

The term staling is applied to the well-known phenomenon in which the growth rate of a fungus on an artificial medium gradually decreases and eventually ceases. This phenomenon is not the result of an exhaustion of nutriment but of the presence of a progressive increase in amount of products of metabolism. Nikitinsky (1904) grew on liquid media repeated crops of *Penicillium glaucum*, *P. griseum*, *Mucor stolonifer*, *Aspergillus flavus*, *Saccharomyces cerevisiae*, and *S. rosaceus*. At intervals the mycelial mat was removed by filtration, dried, and weighed. The medium was then sown with the same or a different species, and the mat was again removed. This procedure was repeated until the medium would no longer support growth. He observed that, when ammonium chloride was used as the source of nitrogen, the inhibition set in quickly, and the medium became increasingly more acid. To such media he then added alkali, and the media again supported good growth. When he employed ammonium tartrate as the source of nitrogen, the medium became stale less quickly, the NH_3 being used as the source of nitrogen and the tartrate radical as the source of carbon. When peptone was used, the media

quickly became alkaline, and good growth could again be promoted by the addition of acid.

From similar studies with *Aspergillus niger*, *Botrytis cinerea*, *Cladosporium herbarum*, *Fusarium solani*, *Mucor mucedo*, *Penicillium glaucum*, and *Rhizopus nigricans* Lutz (1909) concluded that a variety of materials cause staling. Although he was unable to indentify any of them, he determined that some filtrates were free from growth-inhibiting substances after passage through a porcelain filter, whereas in others the staling products passed readily through such filters. In some instances, moreover, heating to 80° C destroyed the inhibitory properties, indicating a relationship to enzymes. Even after dilution with 20 volumes of water the filtrates still greatly inhibited growth.

Boyle (1924) grew *Botrytis cinerea* and *Fusarium* sp., isolated from apple, on Richards' solution, potato extract, and apple extract. On each medium these organisms caused increased alkalinity, which if eliminated in slightly stale media by addition of acid, caused growth to be restored. At a later stage of staling, however, adjustment of reaction did not correct conditions. He concluded from these results that change in reaction is not *per se* the limiting factor but that it accompanies the accumulation of other inhibitory metabolic products. Filtration through a colodion membrane removed part of the inhibitory properties. Boiling of the staled medium also resulted in improved growth but indicated that both thermolabile and thermostable products were present.

Pratt (1924, 1924a), using a species of *Fusarium* that rapidly staled Richards' solution and *Botrytis cinerea*, which had little staling properties, noted that hydrogen peroxide added to the staled medium removes staleness, as does charcoal also, provided that the alkalinity is first removed. Her chemical tests of media staled by *Fusarium* indicate that ammonia, alcohol, and salts of acetic, propionic, butyric, valeric, and lactic acids are produced. Her general conclusion is that alkaline staling is caused by the production of bicarbonates from the carbon dioxide of respiration whenever basic radicals are set free.

From the foregoing accounts it is clear that a variety of inhibitory staling products are elaborated and that different species of fungi may produce different products. Some of them may be either simple or complex, some either heat-labile or heat-stable,

some either filterable or non-filterable. There may also exist intergradations between slight inhibition of growth and marked toxic action, and in consequence it becomes practically impossible to separate staling products from toxic products. Much has been written regarding these toxins, since they have been employed to explain the proximate cause of wilting by pathogenic, vascular-tissue-invading species of *Fusarium*. The chemical constitution of many definitely toxic products has been determined. Some appreciation of the extent of our knowledge on this matter may be gained from the excellent summaries of Raistrick (1932, 1938). Clutterbuck, Lowell, and Raistrick (1932) isolated one such toxic substance, a yellow pigment, chrysogenin, with the empirical formula $C_8H_{22}O_6$. It is formed by one of the *Penicillium chrysogenum* group on a synthetic medium containing glucose. Tests showed it to possess very powerful antibacterial properties, especially against the pyogenic cocci and the diphtheria group, but it was ineffective against the colon-typhoid organisms. Weindling and Emerson (1936) isolated a proteinaceous toxin with the formula $C_{14}H_{16}N_2S_2O_4$ from *Gliocladium fimbriatum*, whereas Dutcher (1941) determined its formula to be $C_{13}H_{14}O_4N_2S_2$. In concentration of 2.5 mg per milliliter it was bactericidal to *Staphylococcus albus*, and of 1.0 mg per milliliter to *S. aureus* and *Streptococcus viridans*.

Recently Abraham and associates (1941) isolated penicillin, presumably from *Penicillium notatum*, finding that it was very potent against several species of bacteria pathogenic to man. Penicillin appears to have therapeutic value when used in place of sulfonamides, as is indicated in Chapter 4. In some cases the toxic principles appear, from their extractability by ether or chloroform, to be lipoidal in nature.

A very different type of antagonism, in which the cause is associated with sex, has been encountered among all the principal groups of fungi. It has been widely studied in connection with the phenomenon of heterothallism, which need not be discussed at this time. Suffice it to say that, when the mycelia of monosporic cultures are grown in the same Petri-dish culture, mutual aversion may be manifest by sexual incompatibility. Cayley (1923, 1931) has given special consideration to aversion, primarily as it concerns *Diaporthe pernicioso*, the cause of wilt of plums in Europe. In cultures of this organism, the isolates may

exhibit mutual aversion at their line of contact, evidenced by killing of the hyphal tips. This property is heritable but is not influenced by sex. Hoppe (1936) noted a similar aversion in the conidial fungus, *Diplodia zae*, pathogenic to maize, and the property remained fixed as shown by repeated inoculation into the living host and reisolation.

EVIDENCE OF ANTAGONISM FROM GROWTH IN HOST TISSUES. Clear-cut evidence of antagonism between microorganisms when associated within green host plants is lacking or meager. Bamberg (1931) found that several species of unidentified bacteria reduced the virulence of *Ustilago zae* and prevented the formation of smut galls when injected into maize coincidentally with smut sporidia or even 3 days later. After smut galls $\frac{1}{2}$ in. in diameter had developed, injection of bacteria was followed by disintegration of the gall and failure of chlamydospores to form. Johnson (1931) found that certain bacteria produced enzymes capable of dissolving the cell walls of sporidia of several smuts and that others with the same enzymes were unable to attack the sporidia. From these results she concluded that the antagonistic principle was not an enzyme.

Savastano and Fawcett (1929) inoculated citrus fruits with combinations of various fungi normally associated with decays of such fruit. In some combinations the rate of decay was slower than that produced by the slower-growing component by itself. These investigators conclude that the cause of modification of rate of decay is correlated with specific food requirements of the respective species and with the competition for these foods that must occur. The two common molds, *Penicillium italicum* and *P. digitatum*, that attack citrus fruits are antagonistic, *P. digitatum* being able to grow with greater rapidity and to surround the area decayed by *P. italicum*.

Perhaps the best evidence in hand of antagonism between fungi is exhibited by the numerous instances of hyperparasitism familiar to every mycologist. Among the better known are *Cicinnobolus cesatii*, parasitic on various Erysiphaceae, *Darluca filum* on the uredinia and telia of rusts, *Tuberculina maxima* on the pycnia and aecia of various blister rusts, including *Cronartium ribicola*, *Mycogyne pernicioso* on mushrooms, *Hypomyces* sp. on *Russula*, *Lactarius*, and other Hymenomycetes, and *Sclerotinia fructicola* on hypertrophies induced by *Tapbrina mirabilis*.

Buller (1924) has compiled a list of hyperparasites of more than 50 species. They include members in the Chytridiaceae, Mucoraceae, Pyrenomycetes, Agaricaceae, Polyporaceae, and Fungi Imperfecti. Little of a fundamental nature is known about the antagonisms in any of them.

EVIDENCE OF ANTAGONISM BETWEEN FUNGI IN SOILS. The soil constitutes the normal habitat of many species of fungi. Such factors as texture, organic content, acidity, moisture, temperature, and character of the vegetational cover, are known to influence the presence or absence of a particular species and its relative abundance. How these interrelated factors influence competition between soil fungi remains largely unknown, but undoubtedly the fungus flora is never in equilibrium. The type of observations that have been made on these problems is indicated in the following discussion. Millard and Taylor (1927) observed that potato scab, caused by *Actinomyces scabies*, was eliminated in fields containing large amounts of organic matter resulting from green manuring. Under these conditions the development of a saprophytic species, *A. precox*, was favored, and it was able to suppress the pathogen. A proximate cause appears from the studies by Sanford (1926). He noted in cultures that the limiting acidity for germination of *A. scabies* was about pH 5.3 and that the optimum reaction was pH 8.5. From these results it may be anticipated that acidity from decomposition of green crops that have been plowed under would be unfavorable for the scab pathogen but might be favorable for other microorganisms to the extent that they would predominate and manifest their antibiosis.

Fungi causing root rots are known to survive in the soil for varying periods in the absence of their host plants. Supposedly they live under these conditions as saprophytes. Hence it follows that the incorporation of organic matter should increase their incidence, but this anticipated result is not invariable. Other soil-inhabiting species have been shown to modify prevalence of the root-invading pathogens, as the work of Sanford and Broadfoot (1931, 1934) on *Ophiobolus graminis*, *Helminthosporium sativum*, and *Fusarium culmorum* illustrates. Not only were soil-inhabiting saprophytes able to modify pathogenicity in their pot cultures but also similar effects were secured by the use of filtrates from cultures of the saprophytes. Presumably toxic products caused this inhibitory action against the pathogens. Similarly

Greaney and Machacek (1935) were able to demonstrate that *Cephalothecium roseum* inhibits *Helminthosporium sativum*.

Garrett (1936) explains somewhat differently the relative incidence of *Ophiobolus graminis* in soils. His observations led him to conclude that *O. graminis* increases in amount only so long as there are living host roots, along which it spreads. Its rate of spread is hypothesized to be related to the carbon dioxide content arising from respiratory processes in the microclimate along the root. The presence of alkaline receptors for carbon dioxide in the soil stimulates spread of the pathogen. Decline of *O. graminis* occurs in its saprophytic phase at which time the mycelium is being decomposed by other soil-inhabiting species.

Recently Weindling (1932, 1934, 1938) found that *Trichoderma lignorum* and *Gliocladium fimbriatum* penetrate the hyphae of such soil-borne parasites of seed plants as *Rhizoctonia solani*, *Sclerotium rolfsii*, and *Phytophthora parasitica*. Undoubtedly antagonisms of this sort are not uncommon in the fungus flora of soil, and such relationships are factors in the control of diseases of cultivated plants. Evidence in support of this type of antagonistic action by *Trichoderma* against fungi that cause damping-off of cucumber seedlings is derived from the experiments of Allen and Haenseler (1935). They applied cultures of *Trichoderma* to the soil with the result that damping-off was apparently checked.

It would appear to be feasible to evaluate the several factors previously mentioned that are known to influence the incidence of fungi in soil generally. This field of research certainly offers many possibilities. As is indicated by the rate at which invasion of heat-sterilized soils is accomplished, for example, by *Pyronema confluens*, more attention should be devoted to such problems as they relate to culture of plants in cold frames, hotbeds, and greenhouses.

STIMULATION BY ASSOCIATIVE INTERACTION

Apparently one fungus may be stimulated by the presence of another in either of two ways: increased assimilatory or vegetative activity or else reproductive activity. The proximate cause of these responses need not be the same metabolic product but may be different specific entities. Much interest in recent years has

centered around the complex problem of factors regulating growth and reproduction in plants and animals. The terms auxins, hormones, and vitamins, applied to stimulatory and regulatory substances, are commonly used not only by the biologist but also by the man in the street.

STIMULATION OF VEGETATIVE ACTIVITY. Wildiers (1901) first established that *Saccharomyces cerevisiae* will not grow in a synthetic medium consisting of ammonium chloride and sugar unless some substance essential for growth is added. This result revived an old controversy that existed years before between Pasteur and Liebig. Pasteur claimed that yeasts made abundant growth on a nutrient medium containing sugar, ammonium salts, and the ashes of yeast. Liebig was unable to grow yeast successfully on this formula, whereupon Pasteur offered to produce for him "all the yeast he could require." Liebig declined the challenge, and in consequence Pasteur was considered to have won the scientific argument. Wildiers noted that, when he placed a single yeast cell or a few cells only in this medium, little or no growth took place. If, however, he introduced as many yeast cells as were contained in two drops of beer wort from a vat in which yeast was being grown, abundant growth resulted. He also induced growth by the addition of a few cubic centimeters of boiled yeasts. His results were so striking that he assumed some hypothetical substance that he called "bios" to be essential for growth. He extracted this bios from yeasts by boiling. It was dialyzable from a watery extract; it was not present in yeast ashes. Of course, the results of Wildiers attracted wide attention and were sharply criticized. They were substantiated, however, and with the discovery of vitamins and the flood of investigation that followed, it became apparent that bios and vitamins are similar. In fact, bios is now known to be a complex consisting of a number of components identified as vitamin B₁ (thiamin), biotin, *i*-inositol, and additional factors [Eastcott (1928)].

Conflicting evidence exists regarding the necessity of the addition of growth factors to culture media used to grow other fungi. Kögl and Fries (1937) have shown that *Polystictus adustus* grown on a synthetic medium requires the addition of thiamin, and *Nematospora gossypii* requires biotin. *Polystictus adustus* is capable of producing biotin, and *N. gossypii* thiamin, so that they can supply their mutual needs when they are grown in association.

These two growth factors appear to be necessary for a large number of fungi, as is indicated by rather numerous reports of trials.

Schopmeyer and Fulmer (1931) indicated that bios is produced by *Aspergillus niger*, *A. clavatus*, and *Trichoderma lignorum*, as judged by the ability to stimulate the growth of yeast. On the other hand, Williams and Honn (1932) have shown distinct stimulation in growth by the addition of yeast extract to media on which *Aspergillus niger*, *Mucor racemosus*, *Microsporium fulvum*, *Monilia metalondinensis*, and *M. macedoniensis* were grown. They called these stimulatory substances "nutrilites." A recent summary by Williams (1941) reviews pertinent literature on nutrilites, which have been identified as biotin, inositol, pantothenic acid, pyridoxin, and thiamin.

Leonian and Lilly (1940) have shown that certain thiamin-requiring fungi are greatly influenced by specific amino acids and by zinc, iron, and other minor elements.

Extracts from different fungi and from bacteria have been used experimentally to stimulate the growth of fungi, but in most cases little is known of the nature and properties of the extracted substances. Such studies are worth while, but the value of similar investigations will be greatly enhanced if, in the future, more attention is devoted to analyses to determine the identities of the extracted materials. Evidence is given in one study [du Vigneaud *et al.* (1940)] of the identity of biotin and vitamin H.

Both growth-stimulating and growth-inhibiting factors would be expected to be present in extracts from fungi. Such a situation was encountered by Satoh (1931) with *Ophiobolus miyabeanus*. When the liquid on which this fungus had been grown was passed through a Chamberland (F) filter, a material stimulatory to *Aspergillus niger* was contained in the filtrate, and one inhibitory to the same fungus was retained on the filter. The stimulatory component proved to be thermostable and the inhibitory one thermolabile.

STIMULATION OF REPRODUCTIVE ACTIVITY. The opinion was long ago voiced that some chemical attractant aids in bringing together plant sex cells of opposite potentialities. De Bary (1881) supposed that this was true of fungi and also that such substances were operative in stimulating the production of antheridial and oogonial branches among certain Phycomycetes. Ever since the discovery of heterothallism the same opinion has been entertained

generally in connection with reproductive activities among heterothallic fungi. Recently Moreau and Moruzi (1931) claimed that perithecia of *Neurospora* are produced if two strains are grown in opposite ends of a U-tube, and that this response is the result of diffusion of a hypothetical hormone through the medium from one arm of the tube to the other. Dodge (1931) attempted to repeat their experiments with *Neurospora sitophila* and *N. tetrasperma* but did not succeed in obtaining perithecia unless and until the hyphae of opposite colonies were in contact. Raper (1939, 1939a, 1940) presented evidence that the sexual reactions in *Achlya bisexualis* and *A. ambisexualis* are controlled by four specific substances, two produced by the male mycelia and two by the female. Responses are evident when the mycelia are 6 mm apart, if mated on agar. Both sex strains are activated when grown on opposite sides of a cellophane membrane. Male plants form antheridial branches when placed in water in which female plants have previously been grown. Furthermore, female plants produce oogonial initials when placed in water in which male plants have been grown and have formed antheridial branches, although there is no such activation in water in which a vegetative male has been grown. Of the two hormones produced by the female plant, one initiates the formation of antheridial branches, and the other, in connection with a thigmotropic response, induces the delimitation of antheridia. Of the two hormones produced by the male plant, one initiates the formation of oogonial branches, and the other brings about the delimitation of the oogonium. The chemical constitution of none of the hormones is yet known.

The filtrate of old cultures of *Aspergillus niger* contains a principle that promotes conjugation of *Zygosaccharomyces acidifaciens* [Nickerson and Thimann (1943)]. This principle, on being fractionated, appears to consist of an organic acid and a member of the vitamin B complex, neither fraction having much activity by itself. Nickerson and Thimann were unable to identify these constituents with certainty, but when they imitated the principle by a mixture of glutaric acid and riboflavin, conjugation was promoted.

SYNERGETIC REACTIONS. Synergism or synergetic reaction logically appears to be a form of stimulation, the term applying, however, only to cooperative phenomena that might not be produced

by either of the associated organisms acting alone. Molliard (1903) first recorded the influence of one microorganism in stimulating sporulation by another. He secured apothecia of *Ascobolus* on carrot only when a bacterial contaminant was present. The same sort of influence between species of fungi associated in the same culture was first described by Heald and Pool (1908). They secured an abundance of perithecia of *Melanospora pampeana* grown in a mixture with *Fusarium moniliforme*, *Melanospora culmorum*, or *Basisporium gallarum*. Similar reactions occurred if *M. pampeana* was planted on the media after these fungi had grown on them and they had been sterilized.

McCormick (1925) secured perithecia from monoconidial cultures of *Thielavia basicola*, grown mixed with *Cladosporium fulvum*, *Aspergillus umbrosus*, *A. glaucus*, *Eurotium amstelodami*, or *Fusicladium pirinum*. If aqueous extracts of these fungi were passed through a Berkefeld filter, the filtrate retained its effectiveness in stimulating perithecial production. Asthana and Hawker (1936) got active stimulation of fruiting in *Melanospora destruens* and other Ascomycetes by the addition to the culture medium of the ether-insoluble fraction of nutrient solutions "staled" by *Fusarium*, *Botrytis*, or *Melanospora* itself. Arrillaga (1935) noted that the presence of *Diaporthe citri* stimulated the formation of reproductive structures by *Phytophthora citrophthora*.

Evidence of synergetic effects is not confined to responses in cultures. It appears also to be manifest when a mixture of organisms is grown in tissues. Fawcett (1931) employed combinations of several pathogens of citrus to inoculate into the bark of citrus trees, with the result that lesions developed more rapidly than when one organism alone comprised the inoculum. Fawcett used in these experiments *Diplodia natalensis*, *Colletotrichum gloeosporioides*, *Diaporthe citri*, *Sphaceloma fawcetti*, and *Phytophthora citrophthora*. Savastano and Fawcett (1929) found that *Oospora citri-aurantii* accelerated the rate of decay of citrus fruits when, as inoculum, it was mixed with other organisms of decay.

More attention should be given to the synergetic reactions involved in the production of lesions on plant parts. Once a lesion has been initiated by the primary organism, it soon becomes invaded by secondary organisms. These secondary species may be found in some instances to play an important role in the pro-

duction of mature lesions. Evidence strengthening this supposition is found in the frequent occupancy of lesions by secondary invaders.

Wolf (1916) found fungi belonging to *Gloeosporium*, *Fusarium*, and *Phoma* associated with citrus canker, whose primary cause is *Phytophthora citri*. Of these fungi a species of *Phoma* was noted to be capable of secreting cellulase, invertase, diastase, and maltase, and from this fact it was concluded that this *Phoma* is actively associated with processes involved in the destruction of citrus tissues.

GENERAL CONSIDERATIONS

The numerous observations cited in the foregoing account may be assumed to prove the obvious fact that fungi interact, but the assumption is not warranted that certain combinations are always antagonistic or stimulatory, as the case may be, under all conditions. Combinations that are antagonistic in culture may not be so under natural conditions, as Broadfoot's (1933) experiences with *Ophiobolus graminis* and certain other soil-borne organisms indicate. Whether an associative interaction is beneficial or injurious may prove to be a matter of adjustment of climatic, edaphic, and biotic factors whose balance is delicately poised.

The possibility that fungi occur within plants that appear to be entirely normal is worthy of consideration, and it is indicated that systematic attempts should be made to isolate fungi from "normal tissues." If this were done, it should not come as a surprise to discover that certain fungi may prove capable under some environmental conditions of producing serious diseases, under others of being benign, and under still others of inducing no evidence of abnormality. No doubt many of the fungus associations in the soil are intricately complex. Whether stability is ever attained among soil fungi or whether a condition approximating such a vegetational climax as a prairie or a hardwood forest ever obtains among fungi is extremely doubtful.

Attention has been centered in this account on the effect of one fungus on another, to the almost complete exclusion of the interaction of bacteria, protozoa, and green plants with fungi. Much has been learned from studies of these problems, but these topics are regarded as outside the scope of the present summary.

Interactions between parasites and saprophytes on living host

plants appear to be less complex than interactions between microorganisms in the soil, primarily because a smaller number of species is involved. Undoubtedly the spores of many species germinate at the surface of the plant, but only those of the pathogenic species succeed in producing infections. Once the lesions are formed, however, saprophytes may enter. In some instances tissue plantings from young lesions are found to yield pure cultures of the pathogen, but at a later date the tissues always yield a mixture of the pathogen and one or more secondary invaders. Still later it may be impossible to isolate the primary fungus, the secondary ones may also have been eliminated, and the tissues may be completely occupied by tertiary species. It is highly probable that successions of this sort do not result simply from exhaustion of specific food materials by the several organisms concerned. A solution of the problem of these interactions must be based upon an understanding of the physiology of each organism concerned, especially of their enzyme-producing abilities and the metabolic products they form. Only a beginning has as yet been made in this field of research.

The existence of several species of fungi in the same lesion may also be interpreted to indicate that the conception of monoeiology of disease in plants, as in animals, is altogether too narrow and may actually lead to misinterpretations.

LITERATURE CITED

- ABRAHAM, E. P., E. CHAIN, C. M. FLETCHER, A. D. GARDNER, N. G. HEATLEY, AND M. A. JENNINGS, "Further observations on penicillin," *Lancet*, 2: 7, 177-188, 1941.
- ALLEN, M. C., AND C. M. HAENSELER, "Antagonistic action of *Trichoderma* on *Rhizoctonia* and other soil fungi," *Phytopathology*, 25: 244-252, 1935.
- ARRILLAGA, J. G., "The nature of inhibition between certain fungi parasitic on citrus," *Phytopathology*, 25: 763-775, 1935.
- ASTHANA, R. P., AND L. E. HAWKER, "Influence of certain fungi on the sporulation of *Melanospora destruens* Shear and of some other Ascomycetes," *Ann. Botany*, 50: 325-343, 1936.
- BAMBERG, R. H., "Bacteria antibiotic to *Ustilago zaeae*," *Phytopathology*, 21: 881-890, 1931.
- BARY, A. DE, *Beiträge zur Morphologie und Physiologie der Pilze*, 4: 85, 1881.
- BOYLE, C., "Studies on the physiology of parasitism. X. The growth reactions of certain fungi to their staling products," *Ann. Botany*, 38: 113-135, 1924.

- BROADFOOT, W. C., "Studies on foot and root rot of wheat. II. Cultural relationships on solid media of certain microorganisms in association with *Ophiobolus graminis* Sacc.," *Can. J. Research*, 8: 545-552, 1933.
- BULLER, A. H. R., *Researches on fungi*, Vol. 3. Longmans, Green and Co., London. 1924. (Cf. 432-473.)
- CALEY, D. M., "The phenomenon of mutual aversion between monospore mycelia of the same fungus (*Diaporthe pernicioso* Marchal) with a discussion of sex heterothallism in fungi," *J. Genetics*, 13: 353-370, 1923.
- "The inheritance of the capacity for showing mutual aversion between monospore mycelia of *Diaporthe pernicioso* Marchal," *J. Genetics*, 24: 1-63, 1931.
- CLUTTERBUCK, P. W., R. LOWELL, AND H. RAISTRICK, "Studies in the biochemistry of microorganisms. XXVI. The formation from glucose by members of the *Penicillium chrysogenum* series of a pigment, an alkali-soluble protein, and penicillin—the antibiotic substance of Fleming," *Biochem. J.*, 26: 1901-1918, 1932.
- D'AETH, H. R. X., "A survey of interaction between fungi," *Biol. Rev. Cambridge Philos. Soc.*, 14: 103-131, 1939.
- DODGE, B. O., "Heterothallism and hypothetical hormones in *Neurospora*," *Bull. Torrey Botan. Club*, 58: 517-522, 1931.
- DUTCHER, J. D., "The chemical nature of gliotoxin: a microbial compound produced by the fungus *Gliocladium fimbriatum*," *J. Bact.*, 42: 815-816, 1941.
- EASTCOTT, E. V., "Wildiers' bios. The isolation and identification of bios. I," *J. Physiol. Chem.*, 32: 1093-1111, 1928.
- ENDO, S., "Studies on antagonism of microorganisms. I. Growth of *Hypochmus centrifugus* (Lév.) Tul. as influenced by the antagonistic action of other microorganisms," *Miyazaki Coll. Agr. Forestry Bull.*, 3: 95-118, 1931.
- II. "Growth of *Hypochmus sasakii* Shirai as influenced by the antagonistic action of other microorganisms," *Miyazaki Coll. Agr. Forestry Bull.*, 4: 133-158, 1932.
- III. "Pathogenicity of *Hypochmus centrifugus* (Lév.) Tul. and *Hypochmus sasakii* Shirai in the presence of other microorganisms," *Miyazaki Coll. Agr. Forestry Bull.*, 4: 159-184, 1932a.
- FAWCETT, H. S., "The importance of investigations on the effects of known mixtures of microorganisms," *Phytopathology*, 21: 545-550, 1931.
- GARRETT, S. D., "Soil conditions and the take-all disease of wheat," *Ann. Appl. Biol.*, 23: 667-699, 1936.
- GREANEY, F. J., AND J. E. MACHACEK, "Studies on the control of root-rot disease of cereals caused by *Fusarium culmorum* (W. G. Smith) Sacc. and *Helminthosporium sativum* P. K. and B. II. Pathogenicity of *Helminthosporium sativum* as influenced by *Cephalothecium roseum* Corda in greenhouse pot tests," *Sci. Agr.*, 15: 377-386, 1935.
- HEALD, F. D., AND V. W. POOL, "The influence of chemical stimulation upon the production of perithecia of *Melanospora pampeana* Speg," *Nebr. Agr. Expt. Sta. Ann. Rept.*, 22: 130-134, 1908.

- HOPPE, P. E., "Intraspecific and interspecific aversion in *Diplodia*," *J. Agr. Research*, 53: 671-680, 1936.
- JOHNSON, DELIA, "The antibiosis of certain bacteria to smuts and some other fungi," *Phytopathology*, 21: 843-863, 1931.
- KÖGL, F., AND N. FRIES, "Über den Einfluss von biotin, aneurin und meso-inosit auf das Wachstum verschiedener Pilzarten," *Hoppe-Seyler's Z. physiol. Chem.*, 249: 93-110, 1937.
- LEONIAN, L. H., AND V. G. LILLY, "Studies on the nutrition of fungi. IV. Factors influencing the growth of some thiamin-requiring fungi," *Ann. J. Botany*, 27: 18-26, 1940.
- LUTZ, O., "Über den Einfluss gebrauchter Nährslösung auf Keimung und Entwicklung einiger Schimmelpilze," *Ann. Mycol.*, 7: 91-133, 1909.
- MACHACEK, J. E., "Studies on the association of certain phytopathogens," *McDonald College Tech. Bull.*, 7: 1928.
- MCCORMICK, F. A., "Perithecia of *Thielavia basicola* Zopf in culture and the stimulation of their production by extracts from other fungi," *Cornell Agr. Expt. Sta. Bull.*, 269: 539-554, 1925.
- MILLARD, W. A., AND C. B. TAYLOR, "Antagonism of microorganisms as the controlling factor in the inhibition of scab by green manuring," *Ann. Appl. Biol.*, 14: 202-216, 1927.
- MOLLIARD, M., "Rôle des bactéries dans la production des périthèces des *Ascobolus*," *Compt. rend.*, 136: 899-901, 1903.
- MOREAU, F., AND M. C. MORUZI, "Recherches expérimentales sur la formation des périthèces chez les 'Neurospora,'" *Comp. rend.*, 192: 1476-1478, 1931.
- NICKERSON, W. J., AND K. V. THIMANN, "The chemical control of conjugation in *Zygosaccharomyces*. II," *Am. J. Botany*, 30: 94-100, 1943.
- NIKITINSKY, J., "Über die Beeinflussung der Entwicklung einiger Schimmelpilze durch ihre Stoffwechselprodukte," *Jahrb. wiss. Botan.*, 40: 1-93, 1904.
- PORTER, C. L., "Concerning the characters of certain fungi as exhibited by their growth in the presence of other fungi," *Am. J. Botany*, 11: 168-188, 1924.
- PORTER, C. L., AND J. C. CARTER, "Competition among fungi," *Botan. Rev.*, 4: 165-182, 1938.
- PRATT, CLARA A., "The staling of fungal cultures. I. General and chemical investigation of staling by *Fusarium*," *Ann. Botany*, 38: 563-595, 1924.
- II. "The alkaline metabolic products and their effect on the growth of fungal spores," *Ann. Botany*, 38: 599-615, 1924a.
- RAISTRICK, H., "Biochemistry of the lower fungi," *Ergeb. Enzymforsch.*, 1: 345-363, 1932.
- "Certain aspects of the biochemistry of the lower fungi (moulds)," *Ergeb. Enzymforsch.*, 7: 316-349, 1938.
- RAPER, J. R., "Role of hormones in the sexual reaction of heterothallic *Achylya*," *Science*, n.s., 89: 321-322, 1939.
- "Sexual hormones in *Achylya*. I. Indicative evidence for a hormonal coordinating mechanism," *Am. J. Botany*, 26: 639-650, 1939a.

- RAPER, J. R., "Sexual hormones in *Achylya*. II. Distance reactions, conclusive evidence for a hormonal coordinating mechanism," *Am. J. Botany*, 27: 162-173, 1940.
- SANFORD, G. B., "Some factors affecting the pathogenicity of *Actinomyces scabies*," *Phytopathology*, 16: 525-547, 1926.
- SANFORD, G. B., AND W. C. BROADFOOT, "Studies on the effects of other soil-inhabiting microorganisms on the virulence of *Ophiobolus graminis* Sacc.," *Sci. Agr.*, 11: 512-528, 1931.
- "On the prevalence of pathogenic forms of *Helminthosporium sativum* and *Fusarium culmorum* in the soil of wheat fields and its relation to the root-rot problem," *Can. J. Research*, 10: 264-274, 1934.
- SATOH, S., "Studies on the effects of nutrient solutions used by *Ophiobolus niyabeanus* on the germination and development of another fungus," *Forsch. Gebeite Pflanzenk.*, 1: 71-83, 1931.
- SAVASTANO, G., AND H. S. FAWCETT, "A study of decay in Citrus fruits produced by inoculations with known mixtures of fungi at different constant temperatures," *J. Agr. Research*, 39: 163-198, 1929.
- SCHOPMEYER, H., AND E. J. FULMER, "The production of yeast-growth stimulants by the molds. I. *Aspergillus niger*, *Trichoderma lignorum*, and *Aspergillus clavatus*," *J. Bact.*, 22: 23-28, 1931.
- VIGNEAUD, V. DU, D. B. MELVILLE, PAUL GYÖRY, AND C. S. ROSE, "On the identity of vitamin H with biotin," *Science*, 92: 62-63, 1940.
- WAKSMAN, S. A., "Associative and antagonistic effects of microorganisms. I. Historical review of antagonistic relationships," *Soil Sci.*, 43: 51-68, 1937.
- "Antagonistic relations of microorganisms," *Bact. Rev.*, 5: 231-291, 1941.
- WEINDLING, R., "*Trichoderma lignorum* as a parasite of other soil fungi," *Phytopathology*, 22: 837-845, 1932.
- "Studies on a lethal principle effective in the parasitic action of *Trichoderma lignorum* on *Rhizoctonia solani* and of other soil fungi," *Phytopathology*, 24: 1153-1179, 1934.
- "Isolation of toxic substances from the culture filtrates of *Trichoderma* and *Gliocladium*," *Phytopathology*, 27: 1175-1177, 1937.
- "Association effects of fungi," *Botan. Rev.*, 4: 475-496, 1938.
- WEINDLING, R., AND O. H. EMERSON, "The isolation of a toxic substance from the culture filtrate of *Trichoderma*," *Phytopathology*, 26: 1068-1070, 1936.
- WILDIERS, E., "Nouvelle substance indispensable au developpement de la levure," *Cellule*, 18: 313-333, 1901.
- WILLIAMS, R. J., "Growth-promoting nutrilites for yeast," *Biol. Rev.*, 16: 49-80, 1941.
- WILLIAMS, R. J., AND J. M. HONN, "Role of 'nutrilites' in the nutrition of molds and other fungi," *Plant Physiol.*, 7: 629-641, 1932.
- WOLF, FREDERICK A., "Citrus canker," *J. Agr. Research*, 6: 69-100, 1916.
- ZELLER, S. M., AND H. SCHMITZ, "Studies in the physiology of fungi. VIII. Mixed cultures," *Ann. Mo. Botan. Garden*, 6: 183-192, 1919.

Chapter 13

MYCORRHIZAE AND MYCOTROPHY

Our knowledge of the existence of a dual relationship of fungi with the roots of green plants begins with the classic work of Frank (1885). He regarded mycorrhizae* (literally, fungus roots) as compound structures constituted of two components, a fungus and a root. These components are associated in a nutritional or mycotrophic relationship, and the structure produced by their association is morphologically distinct, in the same sense that a lichen is distinct from the alga and the fungus composing it. These findings by Frank immediately stimulated others to undertake studies on mycorrhizae, and interest in the problems that have arisen has not flagged to the present day. Nevertheless no problem involving fungi is so little appreciated and understood by mycologists today, and there does not appear to be any of greater significance. Much of the work on mycorrhizae has been done by persons with such divergent interests as foresters, silviculturists, physiologists, morphologists, pathologists, and cytologists, and in consequence an overwhelmingly voluminous literature on mycorrhizae has accumulated. An invaluable bibliography on the subject, covering more than 900 typed pages, was prepared by Kelly (1932). As a consequence of the numerous publications it might be supposed that mycorrhizae are thoroughly understood, but many phases of this subject still remain controversial. The conflict of observations, opinions, and conclusions may be attributed in part to the dangerous habit, even among scientists, of making generalizations. Interested students and investigators will find the monographs by Rayner (1927), Hatch (1937), and Björk-

* Frank (1885, p. 129): "Die ganze Körper ist also weder Baumwurzel noch Pilze allein, sondern ähnlich wie die Thallus von Flechten, eine Vereinigung zweier verschiedener Wesen zu einem einheitlichen morphologischen Organ, welches vielleicht passend also Pilzwurzel, Mycorrhiza, bezeichnet werden kann."

man (1942) indispensable in providing a knowledge of the present status of studies on mycorrhizae.

OCCURRENCE OF MYCORRHIZAE. Formerly it was generally believed that relatively few species of plants possess mycorrhizae. Mycorrhizal species were then regarded as objects of scientific interest or even of curiosity. It is becoming more and more apparent from cumulative records, however, that they involve a wide variety of plants and that they occur widely throughout the world. Mycorrhizae occur on trees, shrubs, and herbs on essentially all kinds of soils ranging from the Arctic regions to the tropics. In 1934 Asai [Burgess (1936)] examined members of 134 families of plants in Japan and found mycorrhizae associated with 82% of them. McDougall and Glasgow (1929) found mycorrhizae in 28 species of composites. Samuel [Burgess (1936)] recorded the occurrence of mycorrhizae in Australia on Euphorbiaceae, Geraniaceae, Graminiaceae, Leguminosae, Liliaceae, Myrtaceae, Plantaginaceae, Ranunculaceae, Rosaceae, and Violaceae. They have also been noted on members of the Burmanniaceae, Cunoniaceae, Ericaceae, Epicridaceae, Lauraceae, Orchidaceae, Pyrolaceae, Rutaceae, and Sapindaceae [Burgess (1936)]. Nearly all species of coniferous and hardwood trees examined have proved to be mycotrophic. Moreover, an ever-increasing number of crop plants are being found to possess mycorrhizae.

The mycorrhizal habit is not restricted to the seed plants. Fungal threads were noticed in the thalli of the liverwort, *Preissia*, nearly 100 years ago. Since then, principally from the observations of Nemec in 1899, Galenkin in 1902, and Cavers in 1903 [Rayner (1927)], intracellular hyphae are of rather common occurrence within the rhizoids and ventral parts of the thalli in both Jungermanniaceae and Marchantiaceae. Convincing proof of the functional nature of this association, however, is lacking. Several investigators have attempted to isolate each constituent in pure culture in order to learn of the possible interdependence among them. Such experiments have been uniformly unsuccessful, because it has been impossible to isolate the fungus on artificial media. In consequence the opinion has been expressed that in the Hepaticae mycorrhizae may be lacking and the associated fungi may indeed be highly specialized parasites.

Among Bryophyta internal mycelium has been found of common occurrence in certain genera, such as *Buxbaumia* and *Tetraplodon*, but whether this is a mutualistic relation is a point still lacking experimental proof.

In regard to mycotrophy among Pteridophyta there is also a conflict of opinion. A *Pythium*-like fungus has been found in the prothalli of several species of *Lycopodium*. Mycorrhizae have been described as occurring in the root cortex of *Ophioglossum* and *Botrychium*. The endophytic mycelium from certain marattiaceous ferns is claimed to sporulate when isolated in pure culture, an indication that the fungus may not be the true symbiont. Rayner (1927) records the presence in *Pteridium aquilinum*, a true fern, of typical endophytic mycorrhizae, with arbuscules and sporangioles occurring within the root cortex. The evidence that ferns are absolutely dependent upon the fungal associate, in any case, may fairly be said to be not too convincing.

KINDS OF MYCORRHIZAE. Various characteristics have been employed as bases of distinction in efforts to classify mycorrhizae. Most commonly mycorrhizae are spoken of as either ectotrophic or endotrophic. The ectotrophic group comprises those in which the fungus remains in large part as a mantle over the exterior of the roots, whereas the endotrophic group comprises those in which the hyphae are within the host cells. In Frank's original descriptions (1885) he directed attention to intercellular hyphae beneath the mantle. These intercellular hyphae invest the cortical cells and have been called the "Hartig-net." As might be expected, forms intermediate between the true ectotrophic and the true endotrophic exist. Such forms have been termed ectendotrophic. Hatch and Doak (1933), however, include the ectendotrophic forms among the ectotrophic as transitional stages between endotrophic and ectotrophic.

Melin (1925) described three types of mycorrhizae on Scots pine, the external form constituting the basis of separation. He designated them as follows: (a) "Gabelmykorrhiza" (forked), (b) "Knollenmykorrhiza" (knotted), and (c) "einfach Mykorrhiza" (simple). The first type is most common in nature, especially in woodland soils having an abundant layer of raw humus. It is characterized by the possession of short, dichotomously branched roots invested with mantles of various colors, the color being determined by the species of fungus involved in its pro-

duction. The second type he noted to occur under the same conditions as the first, but the fusion of mantles merged clusters of forked roots and thereby produced knots or tuber-like growths. The third type is constituted of long, thin, unbranched structures, which occur upon the roots of heath-inhabiting species and are believed to be conditioned by decreased "virulence" of the fun-

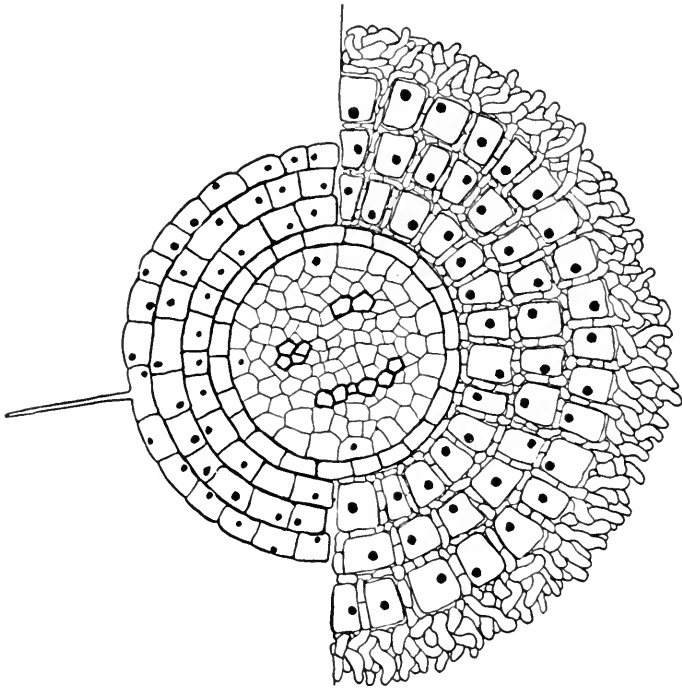

FIG. 47. Diagram of root in cross-sections, one-half being normal, the other mycorrhizal. The cells of the cortex are hypertrophic, and all are enveloped by fungus filaments, forming a mycorrhiza of the ectotrophic type. (After Hatch and Doak.)

gus. Decreased virulence, in turn, is the result of growth in the more acid soils whose mineral content is relatively unavailable. Melin's observations, involving mycorrhizae on pine, spruce, and larch, led him to conclude that mycorrhizal types represent phases or stages in development. The endotrophic condition is transitional to the ectendotrophic, which finally becomes transformed into a typical ectotrophic type. During this transition the invading hyphae are gradually digested and eliminated by the host cells.

No doubt a great deal of the confusion in understanding the structure and function of mycorrhizal associations arises from

failure to distinguish between "long roots" and "short roots," as pointed out by Hatch and Doak (1933). Frank (1885) and most European investigators, including Melin (1925), are in accord that "short roots" are invariably mycorrhizal roots. Observations by Noelle (1910) on the anatomical differences between long roots (Bereicherungswurzel) and short roots (Ernährungswurzel) of pine, confirmed by Hatch and Doak (1933), are summarized as follows:

<i>Long Roots</i>	<i>Short Roots</i>
Root cap present.	Root cap absent.
Diarch or polyarch.	Monarch.
Have secondary growth.	Lack secondary growth.
Root hairs arise from second or third layer of cortical cells.	Root hairs arise from epidermal cells.
Branch racemosely.	Branch dichotomously.
Ratio of stele diameter to total diameter high.	Ratio of stele diameter to total diameter low.

These anatomical differences support the theory that mycorrhizae are distinct morphological structures, as Frank (1885) first maintained. They also indicate that long roots are permanent structures, whereas short ones are ephemeral, lasting at most throughout one season.

Hatch and Doak (1933), like earlier workers, distinguish three kinds of short roots: (1) uninfected short roots, (2) pseudomycorrhizal roots, and (3) mycorrhizal roots.

The first kind is exceedingly rare and is characterized by the following features: (*a*) formation of root hairs from epidermal cells, (*b*) continuous slow elongation, (*c*) no hypertrophy of cortical cells, (*d*) complete lack of fungal hyphae, and (*e*) dichotomous branching.

The second type, called pseudomycorrhizae by Melin, may be differentiated by these characteristics: (*a*) absence of root hairs, (*b*) early cessation of elongation, (*c*) complete absence of hypertrophy of root cortex, (*d*) lack of intercellular fungal net, (*e*) occasional dichotomous branching, and (*f*) intracellular invasion by soil-inhabiting fungi.

Endotrophic mycorrhizae, such as occur among Ericaceae and Orchidaceae, are not to be confounded with the intracellular hyphae in pseudomycorrhizal roots. These hyphae do not occur in masses but may penetrate the cells in small numbers, involving

even the parenchyma cells of the central cylinder. One or more distinct species may be involved in one and the same pseudomycorrhiza.

In the third kind the following features are noteworthy: (a) presence of intercellular web or Hartig net, (b) presence of a fungal mantle, (c) hypertrophy of cortical cells, (d) occasional intracellular hyphae in cortical cells, (e) profuse dichotomous branching, and (f) continued elongation during one growing season.

FUNGI INVOLVED IN MYCORRHIZAL FORMATION. Numerous species of fungi have been found to be associated with mycorrhizae, and it is not the present purpose to list all of them but merely to indicate their number and taxonomic diversity. In short, members of each of the three large classes, Phycomycetes, Ascomycetes, and Basidiomycetes, enter into mycorrhizal formation. The most extensive lists assembled appear to be those of the Italian mycologist Peyronel [Rayner (1927)], who designates the following species:

1. On *Fagus sylvatica*, *Cortinarius proteus*, *C. bivexus*, *Boletus cyanescens*, *B. chrysenteron*, *Hypochnus cyanescens*, *Scleroderma vulgare*, *Amanita rubescens*, *Lactarius subdulcis*, *L. blechnius*, *Russula emetica*, and *R. nigricans*.

2. On *Corylus avellana*, *Lactarius coryli*, *L. subdulcis*, *Boletus chrysenteron*, *Strobilomyces strobilaceus*, *Hypochnus cyanescens*, *Amanita rubescens*, *Rhodopaxillus nudus*, *Cortinarius proteus*, *C. multiformis*, *C. violaceus*, and *Hydnum repandum*.

3. On *Betula alba*, *Amanita muscaria*, *Amanitopsis vaginata*, *Lactarius necator*, *L. torminosus*, *Boletus scaber*, *Scleroderma vulgare*, *Russula rhodoxantha*, and *Trichoderma flavobrunneum*.

4. On *Larix decidua*, *Amanita muscaria*, *Russula laricina*, *Hygrophorus bresadolae*, *H. lucorum*, *Scleroderma vulgare*, *Lactarius rufus*, *Gomphidius gracilis*, and *Paxillus lateralis*.

5. On *Populus tremella*, *Cortinarius collinitus*.

6. On *Quercus robur*, *Amanita citrina*, *Lactarius subdulcis*, and *Russula cyanoxantha*.

7. On *Castanea vesca*, *Amanita rubescens*, *Russula lepida*, *R. rubra*, and *Scleroderma vulgare*.

Mycologists have long known that certain Hymenomycetes are restricted to the area beneath particular species of trees and are never collected under other kinds of trees. In Sweden *Boletus*

luteus, for example, occurs constantly on the litter under *Pinus montana*. Elsewhere in Europe it has been found under *P. montana*, *P. austriaca*, and *P. sylvestris* and is presumed to be responsible for mycorrhizae. Similarly *Boletus elegans* occurs under *Larix* and is supposed to be restricted to larches. Noack (1889) observed that *Geaster fimbriatus*, *G. fornicatus*, and *Cortinarius calisteus* form mycorrhizae on pine, and *Tricholoma terreus* on spruce. Masui (1926) observed *Cantharellus floccosus* as the mycorrhizal associate on *Abies firma* in Japan. Melin (1925) regarded *Boletus luteus*, *B. granulatus*, *B. variegatus*, and *B. badius* as responsible for the production of "Knollenmykorrhiza" on *Pinus sylvestris* in Sweden. His "Gabelmykorrhiza" on pine, fungal components of which he identified as *Mycelium radices sylvestris* β , and *M. radices sylvestris* γ , have features resembling the mycelia of species of *Tricholoma* and *Cortinarius*, respectively.

Certain hypogean Ascomycetes, including *Elaphomyces granulatus*, *Terfezia leonis*, and *Tuber* sp., form mycorrhizae on hardwoods. The evidence that species of *Penicillium* can produce mycorrhizae appears to be unconvincing.

The mycorrhizal associates in liverworts and in many herbaceous seed plants are Pythium-like or Phytophthora-like in aspect.

A Rhizoctonia type of fungus is the common endophyte of orchids. Organisms of similar appearance have been isolated from the roots of wheat, corn, barley, potatoes, tobacco, carrots, and other flowering plants.

Peyronel has attributed the cause of confusion in the identity of the fungal constituent of mycorrhiza to the coincidental invasion of the roots by two distinct fungi, one a Phycomycete, the other a Rhizoctonia-like species. The Phycomycete produces vesicles and arbuscles that may eventually be digested by the host cells, and it is overgrown by the second species. In 1924 Peyronel published a list of species, distributed among 37 families, that possessed this dual type of invasion [Rayner (1927)]. It may be inferred from his observations that the presence of two mycorrhizal associates in one and the same host root occurs widely among seed plants.

Several endophytes of orchids have been specifically identified by Bernard. From *Cattleya* and *Cypripedium* he isolated *Rhi-*

zoctonia repens; from *Phalaenopsis* and *Vanda*, *R. mucoroides*; from *Odontoglossum*, *R. lanuginosa*.

Fundamental knowledge regarding endotrophic mycorrhizae in Ericaceae comes from the studies of Ternetz published in 1907 [Rayner (1927)]. Ternetz became interested in the possibility of nitrogen fixation by the endophytes that she invariably found in Ericaceae growing in peaty soils. From 5 ericaceous species she isolated pycnidium-forming fungi, to which she gave the names *Phoma radialis oxycocci*, *P. radialis andromedae*, *P. radialis vaccinii*, *P. radialis tetralicis*, and *P. radialis ericae*. She was able to show that each, when grown in a liquid nitrogen-free medium, was capable of fixing appreciable quantities of nitrogen. From these results, obligatory symbiosis among Ericaceae has been inferred to exist, as Rayner has claimed, in a series of studies involving *Calluna vulgaris*. In this species the endophyte occurs within the seed and permeates the entire plant. Rayner also found (1929) that the endophytic mycelium ramifies throughout the stem tissues of *Vaccinium oxycoccus* and *V. macrocarpon* and that ovarian infection occurs in *V. vitisidaea*, *V. myrtillus*, *V. pennsylvanicum*, *V. ovatum*, *V. vacillans*, and *V. corymbosum*. Rayner's claims, however, have been disputed. There exists a body of evidence that ericaceous species, notably cranberries, have been grown successfully for a term of years, apart from the endophyte. Significance must be attached, however, to the fact that in nature certain species always possess endotrophic mycorrhizae and that vigorous growth is promoted by the presence of the fungus. Recent studies by Barrows (1941) show that an endophyte occurs within the roots, stems, flowers, ovules, and fruits of trailing arbutus, *Epigaea repens*.

A most unusual kind of mycorrhizal relationship exists between the tuberous, non-chlorophyllous orchid, *Gastroidea elata*, and *Armillaria mellea* [Kusano (1911)]. The rhizomorphs of this fungus, which is widely known because of its ability to destroy forest trees, attack the tubers in such a way that the outer layers contain a dense mass of thick-walled hyphae; beneath it occurs a region containing thin-walled hyphae, and the innermost layer contains a few slender hyphae. Tubers associated with rhizomorphs produce offsets which remain dormant during the winter and develop flowers in the following summer. If mycorrhizae are not formed, flowers are not developed.

Another endotrophic mycorrhizal relationship, which is of unusual interest and has been studied rather extensively, involves the grasses, *Lolium perenne* and *L. temulentum*. The fungus invades the growing point, penetrates the carpels, and has been demonstrated to occupy the ovules and embryo. Sampson (1935) called attention to the fact that fungus-free seed can be made to produce fungus-free plants that set seed. On the other hand, seed containing the endophyte may produce plants that again are mycorrhizal. This fungus is not identified, but there are reasons for believing it may be a smut.

FUNCTION OF MYCORRHIZAE. Although knowledge of the existence of mycorrhizae dates back at least to the fourth century B.C. [Kelly (1932)], definite information concerning their true structural nature may be said to begin with Frank's observations in 1885. In the years that followed, conjecture as to their function was rife, and from the publication of Frank's classical studies to the present, numerous theories on this subject have been advanced. Of these only two have been accorded general acceptance. In one theory mycorrhizae are regarded as pathological structures induced by the parasitic action of the fungus upon the root tissues. The other theory is that mycorrhizae are symbiotic structures that facilitate the absorption and utilization of organic materials, especially of organic nitrogen, contained in humus. It appears that evidence in support of these theories may be best presented by a brief review of a few of the numerous publications on mycorrhizae.

Over 100 years ago the mode of nutrition of *Monotropa hypopitys*, a flowering plant lacking chlorophyll, attracted the attention of botanists. This curious plant, classed as a saprophyte in modern botanical textbooks, grows with its roots intermingled with those of beeches, spruces, and other species of trees. In consequence some workers regarded the *Monotropa* as a root parasite, and they noted that its roots were covered with "a whitish, silky, somewhat fibrous material, connected with the decaying leaves." The fungal nature of this material was first recognized in 1832 by Elias Fries. Several early workers demonstrated that *Monotropa* is not a root parasite by the simple expedient of transplanting and maintaining it apart from tree roots. In spite of this fact, final settlement of the mode of its nutrition was deferred until 1881, when Kamiensky (1881, 1882) again showed that

Monotropa will grow independently of tree roots and that the roots of both the tree and the *Monotropa* are invested with a similar fungus mantle. Furthermore this mantle is organically connected with hyphae that course between the cells of the root cortex. In criticism of Kamiensky's work, however, it may be indicated that he did not present experimental evidence that either the trees or the *Monotropa* are dependent upon the fungus.

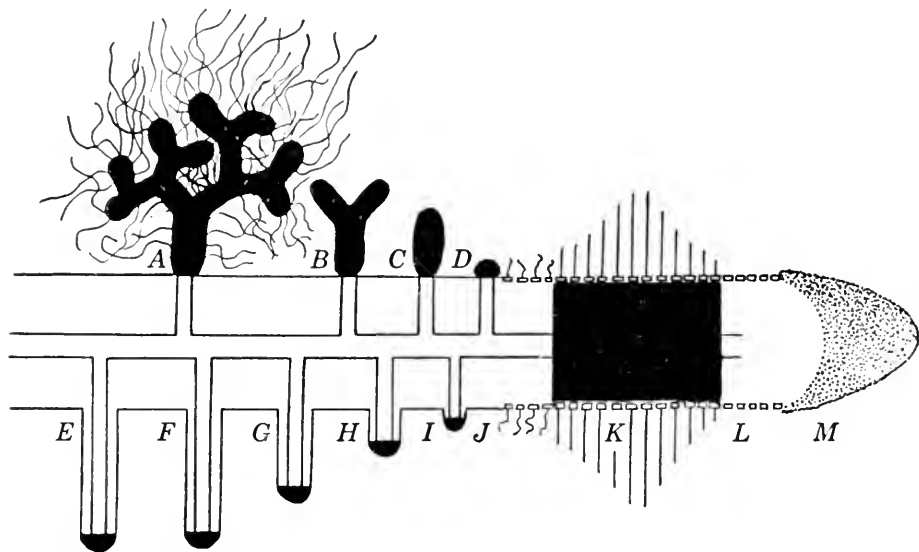

FIG. 48. Diagram of young root, the upper side mycorrhizal, the lower normal. The root-hair zone, *K* (in black), occurs near the root tip, *M*. The increased absorbing surface in *A*, *B*, *C*, and *D* (in black) is to be compared with that in *E*, *F*, *G*, and *H*. The surface area active in absorption in mycorrhizal roots must also take account of the surface area of the fungus filaments. (After Hatch.)

From about 1840 the association of truffles, especially with oak, beech, and hornbeam, attracted botanical attention. Certain early students of this problem definitely established that the mycelia of truffles are connected with the roots of these trees, but the relationship was supposed to be parasitic. At first Frank's interest in the matter was centered upon the possibility of cultivating truffles and other hypogeous fungi, especially *Elaphomyces granulatus*, in the forest. As an outgrowth of this interest he established the fact that the roots of certain trees, especially members of the Cupulifereae, are invariably invaded by fungi. Moreover, he was led to formulate the theory that the relationship is not one of parasitism but of definite beneficial symbiosis, in which the fungal

component, in lieu of root hairs, functions to absorb water and mineral salts from the soil. Some of Frank's experiments involved growing seedlings in culture solutions free from mycorrhizae. He found that such trees made entirely satisfactory growth, a result that has been repeatedly verified by others. Frank's interpretations immediately created a great deal of interest throughout Europe, and from the investigations that were undertaken in the next few years a barrage of criticism arose. The net result of these studies was the general admission that mycorrhizae are of widespread occurrence in nature, but many workers questioned the mycotrophic relationship.

Stahl's comprehensive study (1900) of mycorrhizae is a landmark among contributions to the literature of this subject. In it he elaborated the thesis that the incidence of mycorrhizal development is correlated inversely with soil fertility. Supporting evidence for this thesis rests in part upon the assumption, since confirmed by a host of investigators, that in the keen competition between vascular plants and soil fungi for essential minerals, the fungus mycelium possesses superior mechanism. Presumably the basis for this superiority is that the ratio of surface area to volume is vastly greater in fungus hyphae than in roots. For this reason non-mycorrhizal plants, such as *Sambucus nigra*, Cyperaceae, and various ferns, are at a disadvantage when growing on infertile soils in competition with mycorrhiza-formers.

Stahl's observations also bore out his assumption that different species of plants differ in the extensiveness of their root systems and their rates of transpiration. Species with extensive root systems and with the capability of losing water rapidly might be expected to be best fitted for competition. Actually Stahl found that the reverse is true, for the reason that species possessing extensive root systems and being capable of transpiring rapidly tend to be autotrophic, whereas those with restricted root systems and slow transpiration rates are mycotrophic.

Rayner (1934) concluded from researches involving pines that there is a "direct causal relation between mycorrhiza development and the thrifty growth in seedlings of various species of *Pinus*." Further evidence in support of Stahl's mineral-nutrition theory is advanced by Hatch (1937) in an extensive series of experiments. He emphasizes that the absorbing surface area of short roots is increased through the presence of mycorrhizae by the following:

(*a*) continued elongation, (*b*) increased diameter, (*c*) dichotomous branching, (*d*) delay in suberization of cortex, and (*e*) acquisition of additional surface area, the composite of that of the hyphae. His three interpretations made in conclusion are: (1) that mycotrophic relationship is a symbiotic mechanism to increase the absorption of soil nutrients; (2) that the extent of the surface area of short roots is determined by the availability of minerals, mycorrhizal roots being rarely formed in fertile soils but produced in abundance in infertile soils; and (3) that trees are dependent upon symbiotic association with mycorrhizal fungi for all their mineral nutrients and therefore for their ability to exist in all except the most fertile soils. Experiments by Mitchell, Finn, and Rosendahl (1937) on mycorrhizae as related to mineral absorption by coniferous seedlings led them to arrive at conclusions similar in all essentials to those of Hatch. Björkman (1942) found that light, nitrogen, and phosphorus are each decisive factors governing the formation of mycorrhizae.

Burges (1936) postulated that the higher plants benefit from association with fungi by absorbing the nutrients made soluble as a result of decomposition by the soil fungi. He does not believe that there is any mutualistic relationship between tree roots and fungi but that mycorrhizae represent a controlled parasitic attack. Some support of this idea appears from Rayner's (1934, 1936) experiments, in which, after inoculation with mycorrhizal fungi, she noted markedly improved growth of pine seedlings at a period in advance of the actual formation of mycorrhizae. She attributed this stimulation to the elaboration of growth-promoting substances by the fungus and to the nutrients liberated to the seedlings by the activity of the fungus. In view of the body of evidence that is being accumulated on the elaboration of auxins by fungi, these substances may well be important factors in increasing the growth of plants possessing mycorrhizae.

Much has been written to indicate that mycorrhizal fungi are parasitic and that the balance may be easily tipped toward one or the other partner in the relationship. The observations of Masui (1926, 1927) in Japan and of McDougall (1914) in this country inclined them to regard the association as one of parasitism by the fungus.

Bernard's experiments (1909), summarized in her "L'évolution dans la symbiose des Orchidées," are fundamental to an apprecia-

tion of the nature of endotrophic mycorrhizae. In an early report* she concluded that the fungal component is a benign parasite causing chronic pathogenesis. She became interested in this problem because of the difficulty that orchid growers were experiencing in germinating seed and raising seedlings. In the green-

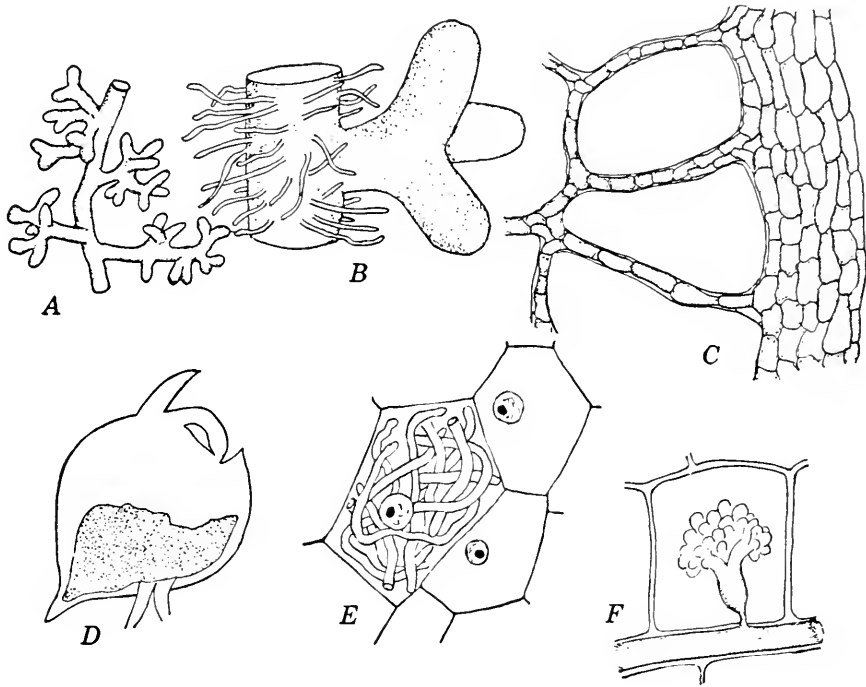

FIG. 49. *A.* Short, lateral roots dichotomously branched, typical of mycorrhizae on pine. *B.* Somewhat enlarged mycorrhizae on pine. (After Hatch.) *C.* Sketch of ectotrophic mycorrhiza on pine, showing mantle and "Hartig net." (After Doak.) *D.* Locus of endotrophic mycorrhiza (stippled area) in germinating orchid seed, *Odontoglossum*. *E.* Cell from stippled area showing hyphae of *Rhizoctonia lanuginosa*. (After Bernard.) *F.* Ectendotrophic mycorrhiza in cell of strawberry root. (After O'Brien and McNaughton.)

houses of successful growers she noted that certain fungi were present in the soil around the roots and that endotrophic mycelium occurred within the tissues. If seed were sown near parent plants, germination resulted. If the seed were grown aseptically, germination failed. These observations led her to believe that the presence of the endophyte was essential for germination and

* She considered orchids, "comme les plantes atteintes d'une maladie parasitaire chronique qui commence à la germination et persiste en général jusqu'à l'état adulte; maladie benigne en un certain sens. . . ."

growth. She isolated the endophyte from several genera, getting organisms that were morphologically similar but were dissimilar in action when used reciprocally to inoculate seedlings. If, for example, she inoculated seed of *Phalaenopsis* with the fungus isolated from the same host, normal germination followed, and the mycelium was kept in bounds by the digestive activity of the cells of the embryo. If instead she used the fungus isolated from *Odontoglossum*, germination stopped short at an early stage, and intracellular digestion of the fungus was excessive. In certain other orchids, such as *Bletilla hyacinthia*, the seed germinated even when the fungus was absent, but the seedlings did not survive beyond the first leaf stage.

Bernard was able to grow seedlings to a size suitable for transplanting in the absence of the endophyte, if she supplied sugar solutions and salep of varying concentrations. She interpreted this ability to germinate in the absence of the endophyte to be caused by a physico-chemical stimulus of the sugar and not to be produced by the sugar as a food.

More recently Knudson (1929) summarized a series of studies (1922, 1925) on the food relationship in these non-symbiotic germinations. He found that the embryos of *Cymbidium*, *Vanda*, *Ophrys*, and *Epipactis* lack chlorophyll for the first 5 or 6 weeks. They must, therefore, obtain soluble food from the substratum in which they are grown. When Knudson supplied *Cattleya* embryos with sugar for the period of a month and then removed them to a medium lacking sugar, the seedlings continued to make good growth for 5 or more years. Sugar concentrations in pure cultures as low as 0.02% yielded good germinations. Knudson was also able, in Pfeffer's solution fortified with a mixture of peat and sphagnum and adjusted to pH 4.6, to germinate embryos just as rapidly as occurs in the presence of the endophyte. Moreover, he was able successfully to substitute a species of *Phytophthora* isolated from lilies for the true endophytic *Rhizoctonia*. He concluded from these extensive studies that the unusual requirements of orchid seed for germination must be explained by their inability to synthesize food. The embryos must therefore be regarded as saprotrophic in early development and the associated fungus as mildly pathogenic, pathogenicity being controlled by the physiological condition of the orchid. In criticism it may be noted that the universal occurrence of the endophyte in orchid roots in

nature is not satisfactorily explained by these experiments of Knudson.

IMPORTANCE OF MYCORRHIZAE TO FORESTRY. Evidence from observations extending over a period of years has been accumulating which tends to show that mycorrhizae play an important role in reforestation and afforestation. As long ago as 1917 [Hatch (1937)] Melin noticed that seedlings of pine and spruce, started from wind-distributed seed in recently drained peat bogs, exhibited nitrogen starvation and eventually died unless they became invaded with mycorrhizal fungi. Seedlings in entire nurseries in Australia, southern Rhodesia, the Netherlands East Indies, and the Philippines remained unthrifty when the nurseries were located outside the natural range of the species being grown [Hatch (1936)]. When soil from established nurseries or from sites where the species was endemic was incorporated as inoculum in these seed beds, however, the seedlings recovered and grew normally. Similarly, non-mycorrhizal seedlings made poor growth in plantations until they were inoculated with small quantities of soil containing mycorrhizal fungi.

More convincing evidence of the beneficial nature of mycorrhizae has been supplied by Rayner (1934, 1936, 1939), Hatch (1936, 1937), and Young (1940). Rayner reported experiments in which she applied pure cultures of mycorrhizal fungi to soils in which seedlings were making poor growth and in which mycorrhizae were infrequent. As a result of such inoculations, seedling growth was markedly stimulated, and correlated mycorrhizal formation was abundant.

Since transplants in the Prairie States grew poorly, Hatch planted *Pinus strobus* seed in pots of prairie soil in an effort to determine the cause. The seedlings grew poorly, and mycorrhizae were lacking. He then inoculated a portion of the pots with pure cultures of mycorrhizal fungi. The inoculated seedlings responded by increased growth over the uninoculated ones to the extent that, after two months, analyses showed the inoculated seedlings had 75% more potassium, 86% more nitrogen, and 234% more phosphorus than the uninoculated. Young grew 1600 *Pinus caribaea* in soil that had never grown pines. He mixed manure and pine needles with the soil to supply organic materials. As inoculum he used 7 mycorrhizal fungi. In all cases the uninoculated controls made the poorest growth, with best growth

in those inoculated with *Boletus viscidus*. The differences would no doubt have been greater if he had not used manure. Australian mycorrhizal fungi might also be expected to have been better suited as inoculum.

These observations and experiments, although not numerous, indicate several very obvious conclusions. In the first place, attempts to exclude diseases and pests from prairie or other treeless regions by starting nurseries from seed are doomed to failure unless suitable mycorrhizae producers are introduced. Second, mycorrhizal fungi perish in areas that have been long denuded, and they must be reintroduced if the areas are to be reforested. Third, planting failure can result if the environment of the planting site is unfavorable for the growth of the fungal component. This conclusion is supported by the experiments of Romell [Hatch (1937)], who found that mycorrhizal fungi may be more exacting in their site requirements than are the trees with which they became established in this mycorrhizal relationship.

In the light of these studies on mycorrhizae, the fleshy fungi growing on the forest floor have uses aside from supplying the mycologist with objects with which he may occupy his time, or the layman with victims against which he may employ his toe to vent his pent-up emotions.

For use in silviculture further knowledge should be sought by attempting to synthesize mycorrhizae from fleshy fungi and forest trees. Studies of this sort are still too limited in number and scope. The value of such work is indicated by Modess (1941). He employed pure cultures of Hymenomycetes and Gastromycetes with pines and spruce, finding that Scots pine developed mycorrhizae with *Amanita mappa*, *A. muscaria*, *A. pantherina*, *Boletus flavidus*, *Entoloma rhodopolum*, *Lactarius helvus*, *Paxillus prunulus*, *Rhizopogon luteolus*, *R. roseolus*, *Scleroderma aurantium*, *Tricholoma albobrunneum*, *T. imbricatum*, *T. pessundatum*, and *T. vaccinium*, and that *Picea abies* synthesized mycorrhizae with each of the species of *Amanita*, *Boletus*, *Lactarius*, *Tricholoma*, and *Scleroderma* that has been mentioned.

TUBERIZATION. From time to time evidence has been presented which indicates that tuberization in certain plants may be induced by mycorrhizal fungi. In this connection the work of Bernard on the group of tuberous orchids is of especial significance. She found that the seeds of *Bletilla*, sown aseptically, develop into

seedlings with slender stems and with leaves borne at distinct internodes, whereas in the presence of the endophyte the axes of the seedlings are thick, the internodes short, and the leaves crowded. These observations led her to conclude that a causal relationship between invasion by the endophyte and tuberization exists and also induced her to explore the possibility that fungi are the cause of tuberization in *Ranunculus ficariae* and *Solanum tuberosum* [Bernard (1911), Bernard and Magrou (1911)]. After Bernard's untimely death the experiments were continued by Magrou (1921, 1924). He observed mycorrhizae in *Solanum magia*, presumably an ancestor of the cultivated potato, and *S. dulcamara* and named the associated fungus *Mucor solani*. He reported that this fungus was capable of infecting *Solanum tuberosum* raised from sterilized seed. His observations and conclusions have not remained unchallenged, however, and in fairness may be said to require confirmation by the performance of a series of synthetic experiments. Only on the basis of such experiments can his findings be accepted or discarded. There still remains the interesting possibility that the endophyte may provide the stimulus that initiates tuberization, and that it may be entirely digested by the host cells by the time the tuber is mature.

Constantin (1922) summarized his studies of tuberization as follows: "The association of perennial species of plants with soil fungi has brought about a permanent symbiosis—a condition which does not occur with annual species. Since the perennial character in plants is due to the low temperatures of high altitudes and latitudes, cold climates may be considered as favorable to the establishment of symbiosis. Cultivated potatoes have lost the mycorrhizal relations of the primitive forms to which tuberization was due, and in order to produce tubers without this relationship they must be grown in cold climates."

The recent report of Lutman (1945) directs attention to Actinomycetes within tubers of potato and the roots of artichoke, parsnip, carrot, and beet. The filaments, demonstrable by special stains, pass between the cells and are intimately applied to them. Their role remains unknown, but Lutman concludes, "The effects of actinomyces filaments surrounding every cell cannot, at this time, be even estimated, but the materials which they withdraw from the cells and the products which they excrete and which

must be absorbed by the cells cannot fail to change the characteristics of the cells."

IMPLICATIONS. The classical interpretations of the mechanisms involved in absorption of water and mineral nutrients by seed plants must be modified somewhat or must, in some measure, be supplanted by a more complicated system in the light of the foregoing consideration of mycorrhizae. Certain seed plants, especially trees, and certain fungi have been demonstrated to be nutritionally interdependent. This interdependence is a partnership, and, as in any partnership, both members may profit mutually or one member may exploit the other. Apparently the advantages that accrue to each member of the partnership outweigh the disadvantages when environmental factors are normal, but this balance may become upset in times of stress. The mycologist may speculate to the satisfaction of his scientific soul on how and why such a relationship between totally unrelated organisms ever became established, only to arrive eventually at the unsatisfactory conclusion that living things are interdependent.

LITERATURE CITED

- BARROWS, FLORENCE L., "Propagation of *Epigaea repens*. II. The endophytic fungus," *Contrib. Boyce Thompson Inst.*, 11: 431-440, 1941.
- BERNARD, N., "L'évolution dans la symbiose des Orchidées et leur champignons commensaux," *Ann. sci. nat. Botan.*, 9: 1-96, 1909.
- "Les mycorrhizes des Solanum," *Ann. sci. nat. Botan.*, 14: 235-252, 1911.
- BERNARD, N., AND J. MAGROU, "Sur les mycorrhizes des Pomme de terre sauvage," *Ann. sci. nat. Botan.*, 9 me. sér., 14: 252-258, 1911.
- BJORKMAN, ERIK, "Über die Bedingungen der Mykorrhizabildung bei Kiefer und Fichte," *Symbolae Botan. Upsalensis*, 6, No. 2, 1942.
- BURGES, A., "On the significance of mycorrhiza," *New Phytol.*, 35: 117-131, 1936.
- CONSTANTIN, J., "Sur l'hérédité acquise," *Comp. rend.*, 174: 1659-1662, 1922.
- FRANK, A. B., "Über die auf Wurzelsymbiose beruhende Ernährung gewisser Bäume durch unterirdische Pilze," *Ber. deut. botan. Ges.*, 3: 128-145, 1885.
- HATCH, A. B., "The role of mycorrhizae in afforestation," *J. Forestry*, 34: 22-29, 1936.
- "The physical basis of mycotrophy in Pinus," *Black Rock Forest Bull.*, 6. 168 pp. 1937.
- HATCH, A. B., AND K. D. DOAK, "Mycorrhizal and other features of the root systems of Pinus," *Arnold Arboretum J.*, 14: 85-99, 1933.
- KAMIENSKY, F., "Die Vegetationsorganen der *Monotropa hypopitys* L.," *Botan. Z.*, 39: 458-461, 1881.

- KAMIENSKY, F., "Les organes vegetatifs du *Monotropa hypopitys* L.," *Ext. Mem. soc. nationale sci. nat. math. Cherbourg*, 24: 5-40, 1882.
- KELLY, A. P., "The literature of mycorrhizae" (manuscript 948 pp.), Library, U. S. Dept. Agr., Washington, D. C. 1932.
- KNUDSON, L., "Nonsymbiotic germination of orchid seeds," *Botan. Gaz.*, 73: 1-25, 1922.
- "Physiological study of the symbiotic germination of orchid seeds," *Botan. Gaz.*, 79: 345-379, 1925.
- "Physiological investigations on orchid-seed germination," *Proc. Intern. Congr. Plant Sci. Ithaca*, 2: 1183-1189, 1929.
- KUSANO, S., "*Gastroidia elata* and its symbiotic association with *Armillaria mellea*," *J. Coll. Agr., Imp. Univ. Tokyo*, 4: 1-66, 1911.
- LUTMAN, B. F., "Actinomycetes in various parts of the potato and other plants," *Vt. Agr. Expt. Sta. Bull.*, 522. 72 pp. 1945.
- MCDUGALL, W. B., "On the mycorrhizas of forest trees," *Ann. J. Botany*, 1: 51-74, 1914.
- MCDUGALL, W. B., AND O. E. GLASGOW, "Mycorrhizas of the Compositae," *Am. J. Botany*, 16: 224-228, 1929.
- MAGROU, J., "Symbiose et tuberization," *Ann. sci. nat. Botan.*, 10 me. ser., 3: 181-273, 1921.
- "Remarques sur les cultures experimentales de pomme de terre avec endophyte," *Ann. sci. nat. Botan.*, 10 me. ser., 6: 285-288, 1924.
- MASUI, KOKI, "A study of the mycorrhiza of *Abies firma* S. et Z., with special reference to its mycorrhizal fungus, *Cantharellus floccosus* Schw.," *Mem. Coll. Sci., Kyoto Imp. Univ.*, Ser. B., 2: 16-84, 1926.
- "A study of the ectotrophic mycorrhizas of woody plants," *Mem. Coll. Sci., Kyoto Imp. Univ.*, Ser. B., 3: 149-279, 1927.
- MELIN, ELIAS, *Untersuchungen über die Bedeutung der Baummycorrhiza, eine ökologisch-physiologische Studie*. 152 pp. G. Fischer, Jena. 1925.
- MITCHELL, H. F., R. F. FINN, AND R. O. ROSENDAHL, "The relation between mycorrhizae and the growth and nutrient absorption of conifer seedlings in nursery beds," *Black Rock Forest Paper*, 1: 58-73, 1937.
- MODESS, O., "Zur Kenntnis der Mykorrhizabildner von Kiefer und Fichte," *Symbolae Botan. Upsalienses*, 5: 3-147, 1941.
- NOACK, R., "Über Mycorrhizenbildene Pilze," *Botan. Z.*, 47: 389-397, 1889.
- NOELLE, W., "Studien zur vergleichenden Anatomie und Morphologie der Koniferenwurzeln mit Rücksicht auf die Systematik," *Botan. Z.*, 68: 169-266, 1910.
- RAYNER, M. C., *Mycorrhiza, an account of non-pathogenic infection by fungi in vascular plants and Bryophytes*. 246 pp. Weldon & Wesley, Ltd., London. 1927.
- "The biology of fungus infection in the genus *Vaccinium*," *Ann. Botany*, 43: 55-70, 1929.
- "Mycorrhiza in relation to forestry. I. Researches on the genus *Pinus*, with an account of experimental work in a selected area," *Forestry*, 8: 96-125, 1934.
- "The mycorrhizal habit in relation to forestry. II. Organic composts and the growth of trees," *Forestry*, 10: 1-22, 1936.

- RAYNER, M. C., "The mycorrhizal habit in relation to forestry. III. Organic composts and the growth of young trees," *Forestry*, 13: 19-35, 1939.
- SAMPSON, K., "The presence and absence of an endophytic fungus in *Lolium temulentum* and *L. perenne*," *Trans. Brit. Mycol. Soc.*, 19: 337-343, 1935.
- STAHL, E., "Der Sinn der Mycorrhizenbildung," *Jahrb. wiss. Botan.*, 34: 534-688, 1900.
- YOUNG, H. E., "Mycorrhizae and growth of *Pinus* and *Araucaria*. The influence of different species of mycorrhiza-forming fungi on seedling growth," *J. Australian Inst. Agr. Sci.*, 6: 21-25, 1940.

Chapter 14

GENETICS OF FUNGI

The principles upon which the science of genetics rests were established by Mendel in 1865 but remained unrecognized until the beginning of the present century. He determined from hybridization experiments with peas that heritable characters behave as units. These characters may be allelomorphic, that is, they may operate as pairs, one member of which is dominant, the other recessive. The characters must therefore be controlled by factors or determiners which maintain their individuality throughout the developmental cycle and are transmitted from generation to generation. Moreover, in the second hybrid generation or later these characters segregate or become assorted in definite numerical ratios.

With the rediscovery of Mendelism at the beginning of the twentieth century attention turned largely to studies of genetics of seed plants and higher animals. The application of Mendelism to fungi has constituted a neglected field of inquiry until the past few years. Some of the reasons will become apparent in the account that follows. Not the least of them is the small size of nuclei and chromosomes and their constituents. These facts militate seriously against the procurement of microscopic evidence to substantiate macroscopic evidence of inheritance.

SEXUAL AND ASEXUAL STAGES OF FUNGI

In order to appreciate and properly evaluate genetic studies of fungi it is necessary to recall certain knowledge that is fundamentally axiomatic. In the normal life cycle of fungi generally there occur fusions between pairs of gametes. This phase is called the sexual stage in contrast to the asexual stage, in which vegetative units are capable independently of propagating the fungus. The fusion of gametes, called fertilization, produces a

one-celled structure called the zygote. The most important part of each gamete is the nucleus. Gametes of fungi are not known to possess any appreciable or functional cytoplasm, such as is known to occur among seed plants. Undoubtedly gametes of fungi possess functional cytoplasm, but as yet proof of cytoplasmic inheritance either is not forthcoming or is meager.

Each gametic nucleus is constituted of chromatic materials, the chromosomes. Each zygote contains $2n$ chromosomes and is therefore diploid. As a rule, however, among the Basidiomycetes and Ascomycetes, when the two gametic nuclei are brought into juxtaposition, they do not fuse immediately but remain as a pair. Then the two divide at one and the same time, the process being called conjugate nuclear division and giving rise to two daughter pairs. Hundreds or even thousands of successive conjugate nuclear divisions may follow, extending in time over a period of weeks or months. Finally two such paired nuclei come to lie in special cells (basidia in the Basidiomycetes, teliospores in the Uredinales, chlamydospores in the Ustilaginales, young asci, ascogonia, or ascogenous hyphae in the Ascomycetes), where they actually fuse.

The fusion nucleus resulting contains $2n$ chromosomes and is thus diploid. Shortly after fertilization the fusion nucleus divides twice. The processes involved in these two divisions constitute meiosis. In one of the divisions the number of chromosomes is reduced to n , and the other division is homotypic (equational). Sex factors are segregated during meiosis. Each of the four nuclei resulting from meiosis contains n chromosomes, the haploid number. In the Basidiomycetes each of the four nuclei migrates into a developing basidiospore, which is a haploid cell. When these basidiospores germinate, they produce haploid mycelia; if two such mycelia or their equivalents of opposite sex fuse, cells again containing a conjugate pair of nuclei arise. In the Ascomycetes each of the four haploid nuclei again undergoes a mitotic division, whereupon each of the eight haploid nuclei becomes invested with a wall and is an ascospore. The germination of ascospores gives rise to haploid mycelia, and the nuclei may again become paired in preparation for fusion within the ascogonium, young asci, or ascogenous hyphae, as the case may be.

HOMOTHALLISM AND HETEROTHALLISM

From the above generalizations we may pass on to their significance. For a long time it was held that the spore or the individual derived from any spore is totipotent. This concept, it may be interjected, as employed in studies of monosporous cultures, has been both a great deterrent to progress and a potent factor in promoting progress in the acquisition of knowledge of fungi. It has hindered progress because many workers have regarded a monosporous culture of a fungus as a whole organism, whereas it may be, as we now know, only a "hemi-organism." On the other hand, the concept has promoted knowledge because by use of mated monosporous cultures it has been possible to learn that each individual may not be totipotent but may require another complementary culture. In 1904 Blakeslee (1904) first proved, for a number of species of Zygomycetes, that zygospores can be obtained only when mycelia of opposite sex are mated. If he grew mycelium from a single conidium, sporangia and conidia were formed in abundance, but gametangia and zygospores were not produced. To those organisms requiring two thalli of opposite sex potentialities for fertilization, he applied the term heterothallic. One strain or race he called plus (+), and the other minus (-). Sex in these species is segregated in bipolar fashion at meiosis. On the other hand, in *Sporodinia grandis* mycelia from single conidia produce zygospores and are therefore hermaphroditic, and sex segregation is entirely lacking. Subsequently both heterothallism and homothallism have been found to occur side by side in genera in all the larger groups of fungi.

IN PHYCOMYCETES. Burgeff (1928) isolated from *Phycomyces blakesleeanus* a number of variant or mutant races to which he gave such form names as *arbusculus*, *mucoroides*, *gracilis*, and *pallens*. When various crosses between the original *P. blakesleeanus* and any one of the forms were made, the progeny appeared like that of the original except in the crosses with *mucoroides*. The type of progeny, therefore, is determined by a single factor that is recessive in the form and dominant in the original; this was true in all crosses with mutants except in the form *mucoroides*. Burgeff also noted certain linkages with the factor for sex. For example, in his crosses of *arbuscula* with the normal,

the heterozygous zygospores were (*Arb arb* + -). When these were germinated, half of them gave four different haploid derivatives with the respective constitutions (*Arb* +), (*Arb* -), (*arb* +), and (*arb* -). The other half yielded only two different

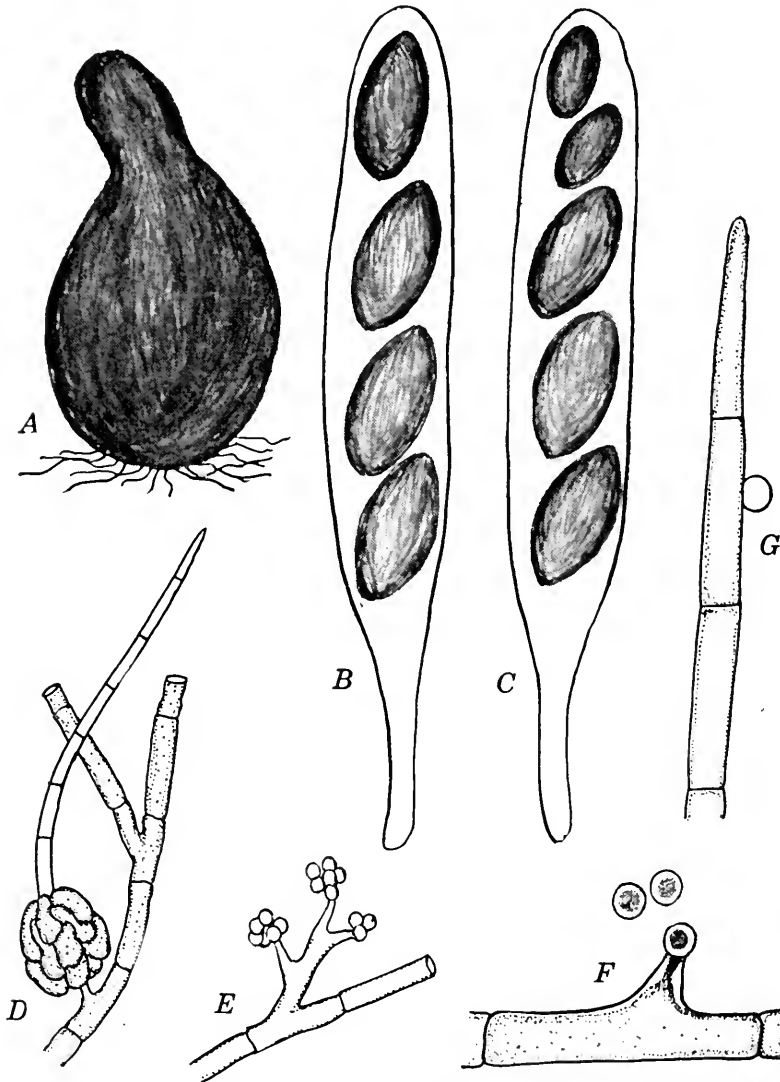

FIG. 50. *Pleurage anserina*. A. Normal perithecium, external appearance. B. Normal ascus, bearing four ascospores. C. Occasionally asci are found bearing five ascospores, two of which are smaller than normal. Mycelium from small ones bear ascogonia, D, and spermatia. E. The mycelium from normal spores can produce perithecia; the spermatia and ascogonia borne on mycelia from small spores are self-incompatible and hence self-sterile, but compatible and fertile if reciprocally crossed. F. Spermatia borne by phialide-like lateral branches. G. Trichogyne with empty spermatium attached. (Adapted from Ames.)

types, either (*Arb* +) and (*arb* -) or (*Arb* -) and (*arb* +). To explain this condition Burgeff assumed properly that one or both factor pairs must segregate at the second division. If both pairs of factors had segregated at the first division, there would have been only two haploid types, either (*Arb* +) and (*arb* -) or (*Arb* -) and (*arb* +).

IN ASCOMYCETES. The most illuminating genetical studies among Ascomycetes have concerned *Neurospora* [Shear and Dodge (1927), Dodge (1927, 1928, 1930, 1931, 1940), Wilcox (1928), Lindegren (1929, 1933, 1936, 1939)]. The best-known species of this genus is *N. sitophila*, known as the pink bakery mold, which is cosmopolitan in distribution. It has a *Monilia* conidial stage. Some of the species, represented by *N. sitophila* and *N. crassa*, are eight-spored and obligately heterothallic. Each spore is uninucleate and unisexual, four spores being of (+) sex reaction and four of (-) sex reaction. Other species, such as *N. tetrasperma*, are normally four-spored, each spore being binucleate and bisexual. Occasionally in this species one or more of the spores are giants or dwarfs, as occurs also in *Pleuroge anserina*, a widely distributed dung-fungus [Wolf (1912), Dowding (1931), Ames (1934)]. Usually the giant spore replaces two normal spores. The dwarf spores occur in pairs, each containing a single nucleus. In *N. tetrasperma* [Dodge (1927)] all eight of the nuclei may occasionally occur within one giant spore.

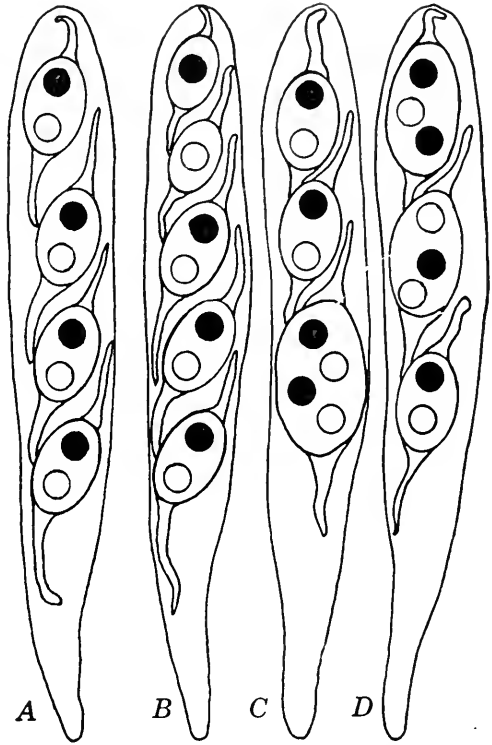

FIG. 51. Schematic representation of potentialities of ascospores of *Pleuroge anserina*. Circles represent nuclei of one sex, and black dots nuclei of the opposite sex. Although the asci always have eight nuclei, the ascospores may be uninucleate, binucleate, trinucleate, or quadrinucleate.

In order to learn something of sex segregation Shear and Dodge

(1927) and Dodge (1927, 1928) isolated each of the eight ascospores of *N. crassa* and found that four are (+) and the other four (-). This discovery left unanswered the question of when segregation of sex factors occurs. Manifestly it might be possible

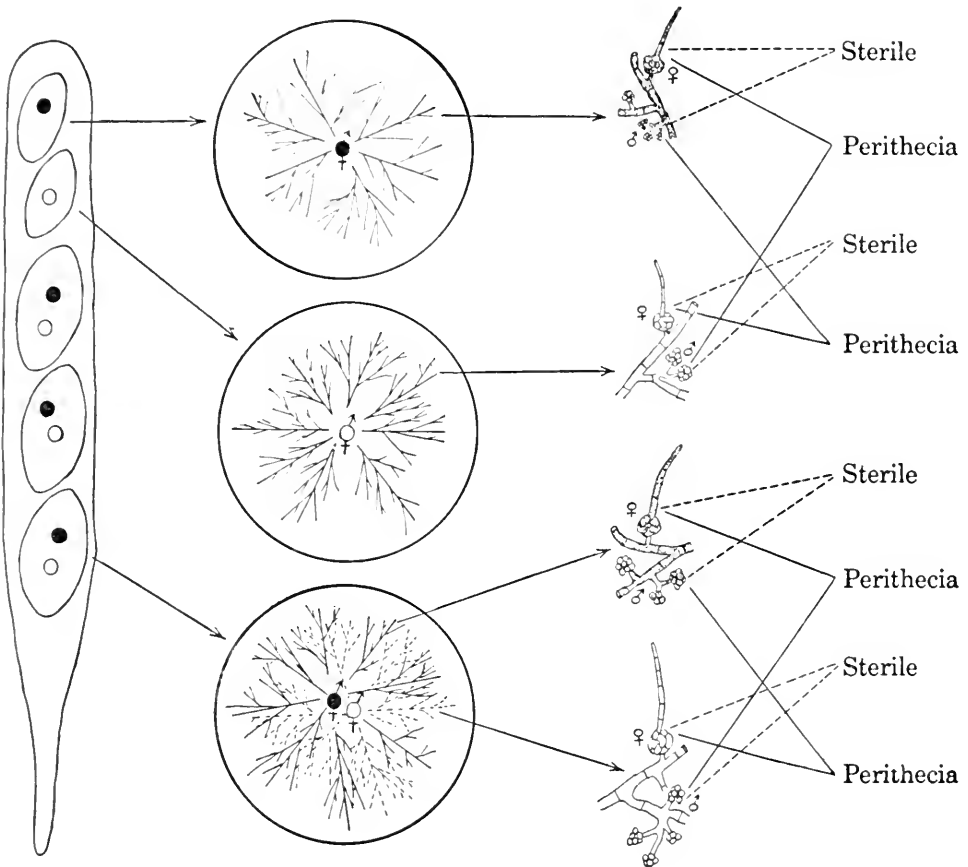

FIG. 52. Schematic representation of a five-spored ascus of *Pleurage anserina*. The small spores are of opposite sex, the large spores of both sexes. If planted on agar plates, the mycelium of each bears both ascogonia and spermatia. The conditions of fertility and sterility are indicated by the matings in each culture. (After Ames.)

to determine this question if each of the ascospores was isolated and it were known what position within the ascus each occupies. Colonies from each could then be mated reciprocally with each of the others. Accordingly Wilcox (1928) employed *N. sitophila* in such experiments, finding that (+) and (-) ascospores alternate in pairs in the series of eight. This discovery indicates that the sex factors are segregated at the second division of the fused nucleus of the primary ascus.

Another type of evidence has been provided by Dodge (1927) from cytological study of *N. tetrasperma*. In this species the spindle of the first nuclear division is longitudinal with respect to the ascus, and the two daughter nuclei come to lie one above the other in the ascus. At the second division two types of position and orientation of the spindle may occur. The spindles may lie approximately parallel, perhaps just slightly oblique to the long axis, or else are again longitudinal. The spindles of the third division are nearly transversely oriented, bringing non-sister nuclei into symmetrical arrangement. On delimitation of the spores two non-sister nuclei are included in each ascospore, whether segregation takes place in the first, second, or third division.

A somewhat different explanation may account for the situation in *Pleurage anserina* [Dowding (1931)]. She found that the paired dwarf spores are always of opposite sex. This discovery, together with the fact that normal spores are always bisexual, indicates that the (+) and (-) nuclei are arranged alternately at time of spore formation. This alternate arrangement might be taken as *prima facie* evidence that sex segregation occurs at the third division. Dowding indicates, however, that the ascus is so wide that there is opportunity for the nuclei or even the young spores to slip by each other, so that the final arrangement of (+) and (-) nuclei could permit segregation of sex factors at any of the divisions.

Lindegren (1929) found that the ratio of first-division to second-division segregation of sex in *Neurospora crassa* is 8:15. Later (1936, 1939) he determined that the gene for sex is linked with other factors and, by determining crossing-over percentages, was able, for the first time with fungi, to construct chromosome maps. These data provide an explanation of the mechanism involved and appear to prove that the chromosomes disjoin at the first division and that the factors are segregated at the second division. Lindegren also emphasizes that pure lines of fungi must be obtained by inbreeding as stock for genetical studies. Such stocks also serve best for experimentation on interspecific hybrids, one of which was secured by Dodge (1928) by crossing the eight-spored *N. sitophila* with the four-spored *N. tetrasperma*.

Dimock (1939) hybridized strains of *Hypomyces ipomoeae* obtained by isolating single ascospores. From these isolations

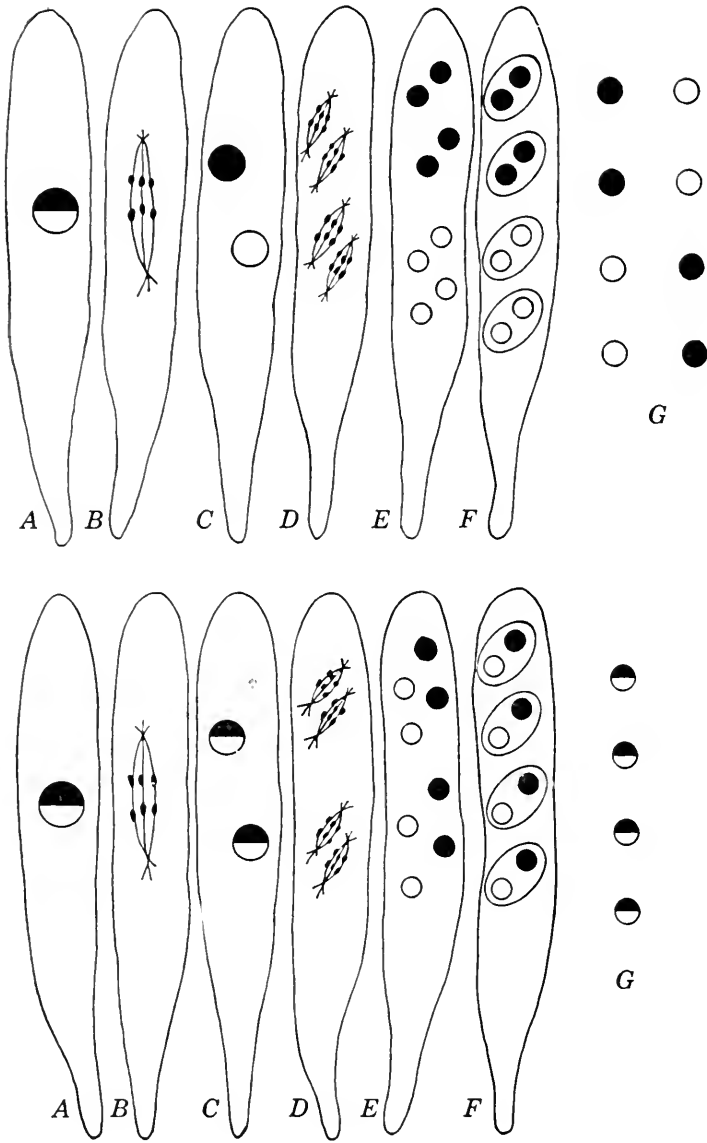

FIG. 53. Diagrams to illustrate sex of ascospores of *Neurospora tetrasperma*, conditioned by whether sex is segregated at the first division of the primary ascus nucleus or at the second nuclear division. *Above*. Segregation at the first division, C, resulting in four free nuclei of one sex after the third division, and four nuclei of the other sex, E. Two of the four spores formed are therefore of one sex, F, and two of the other. The two upper ascospores may both be + (G) with the lower pair, or the pairs may occupy the reverse positions. *Below*. Sex not separated in C at the first division of the fusion nucleus, but separated in the second division. When ascospores are delimited, each contains part + and -, F, or else sex may not segregate at all, and each nucleus is as shown in G. (Adapted from Dodge.)

he obtained four strain groups, which he designated *purple*, *alba*, *revoluta*, and *reverta*. When he attempted to inbreed by mating within each of these strains, perithecia were not produced except in one *purple* \times *purple* mating. When back-crossed to normal, all had low fertility except the *alba* strains. The evidence, he believes, indicates that these variants in *H. ipomoeae* arise by gene mutation.

Edgerton and his associates (1945) employed, in crosses, strains of *Glomerella*, isolated from *Ipomoea*, that differed only in that some were (+) and the others (-). In certain of these crosses each ascus contained four ascospores of the (+) type and four of the (-) type. In others all ascospores were of the (-) type. Some (+) strains originating from single ascospores segregated into two strains, but no explanation of this phenomenon based on nuclear constitution has been forthcoming.

The synthesis of vitamins and amino acids may be gene controlled, and loss of such synthetic ability has been induced by treatment of *Neurospora crassa* with X-rays and ultraviolet light. Tatum (1944) secured approximately 400 mutant strains from 60,000 single-spore cultures. Among these mutants were strains which required each of the B vitamins except folic acid and riboflavin. Others required most of the amino acids. These mutations involved only a single gene. One strain was unable to complete the synthesis when supplied with β -alanine and pantooyl-lactone. It required that pantothenic acid be supplied as such from an exogenous source [Tatum (1944)]. From the results of such differences among strains of *N. crassa* the question arises of why some are able to synthesize their required vitamins and what the mechanism is for loss of such ability by other strains.

Lindegren (1945) in an extended study of cultivated yeast demonstrated (+) and (-) races that must be mated to secure ascospores.

IN BASIDIOMYCETES. Two investigators, Bensaude (1918) and Kniep (1919), working independently, called attention to the fact that heterothallism occurs among Hymenomycetes and that it is correlated with the presence of long-known mycelial structures called clamp connections. Since then a large number of other workers have contributed to our knowledge of sexuality and genetics of Basidiomycetes, those dealing mostly with Hymenomycetes having come from Buller and his students and those

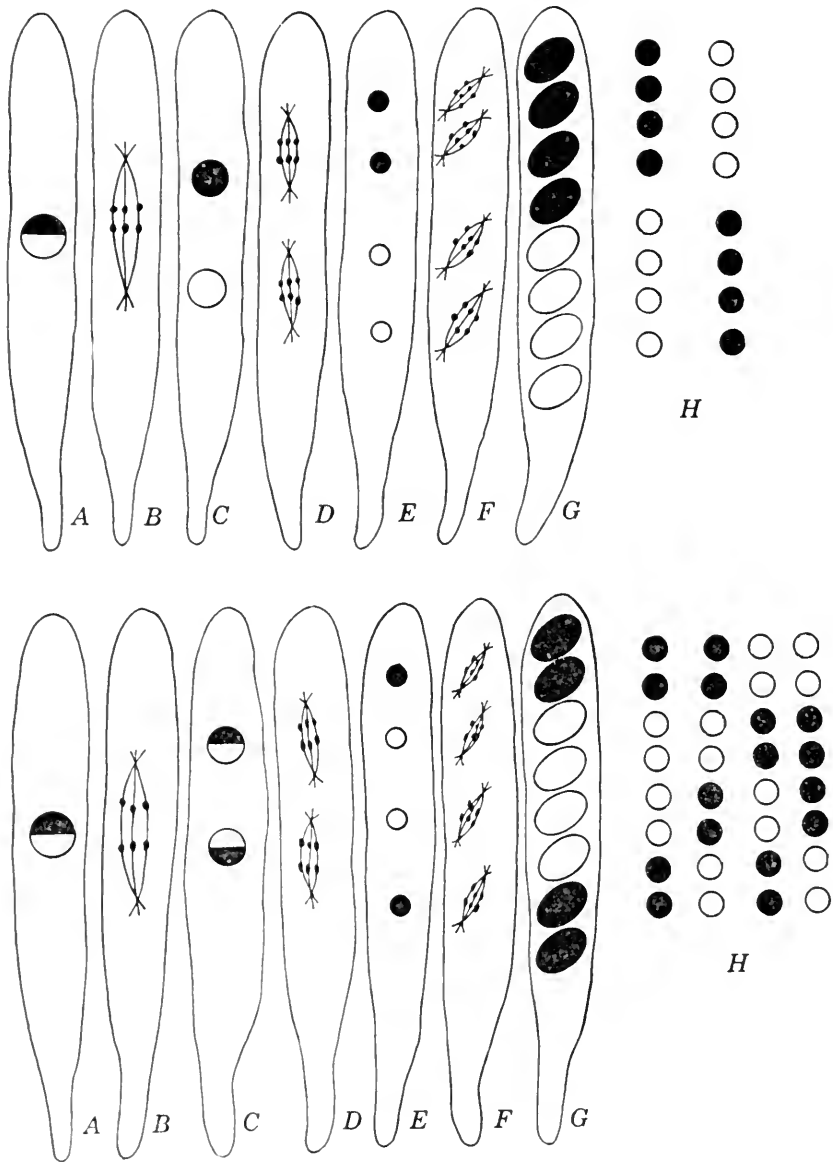

FIG. 54. *Above.* Schematic representation of sex segregation at the first nuclear division in *Neurospora sitophila*. There result two possible arrangements of the ascospores with regard to sex, as shown in *H*. Either the four spores at the upper end of the ascus are + and the four at the lower end —, or else the fours are in reverse position. (After Dodge.) *Below.* Schematic representation of sex segregation at the second nuclear division in *Neurospora sitophila*. There result four possible arrangements of ascospores with regard to sex, as shown in *H*.

dealing with rusts and smuts from Stakman and his students. It should be kept clearly in mind that the Hymenomycetes do not possess sexual organs, although they occur in the Uredinales, nor

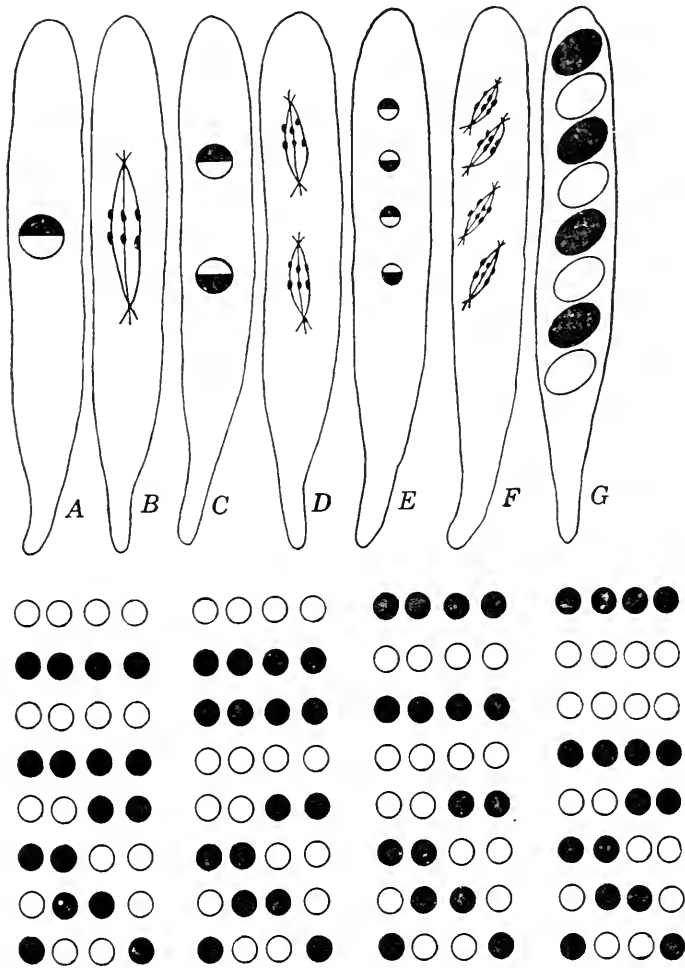

FIG. 55. Schematic representation of sex segregation at the third nuclear division in *Neurospora sitophila*. Each of the pair at C, the first division, and each of the pair at F, the second division, is + -, but at the third division + and - segregate. There result 16 possible arrangements of the ascospores with regard to sex potentialities, as shown by the series of rings below. (After Dodge.)

do they produce definitive sex cells. Instead sexual functions are carried out by paired nuclei. Nevertheless most of the species are heterothallic and exhibit a definite sexual process. The basidiospores, whether of a homothallic or a heterothallic species, are haploid; that is, their nuclei contain n chromosomes. When two haploid mycelia of opposite sex of a heterothallic species grow

in contact, hyphal fusions occur, and the mycelia become, in consequence, dicaryotic (two-nucleate). The nuclei become associated in conjugate pairs of $(n) + (n)$ chromosomes. Then, as the dicaryotic mycelium continues to grow, conjugate nuclear divisions occur, but with each conjugate division a clamp connection separates the two pairs of daughter nuclei. Finally a conjugate pair is delimited in each basidium. Here they fuse, whereupon meiosis occurs, and each resulting haploid nucleus migrates into a developing basidiospore.

Up to this point observations are quite in accord. Kniep (1919, 1922) found in *Schizophyllum commune* and *Aleurodiscus polygonius* that sometimes two of the tetrad of basidiospores were of one sex and two of the other sex, although each species is normally quadrisexual, that is, quadripolar or quadripotential. In explanation he proposed that, when the abnormal situation obtained, disjunction of sex occurred in the first division. The quadrisexual situation he explained by assuming that sex is determined by two pairs of allelomorphous factors, which segregate independently of each other during the second division.

In *Coprinus rostrupianus* Newton (1926) found only two kinds of spores in each basidium, two (*A*) spores and two (*a*) spores, in which case sex is determined by one set of factors. In *C. lagopus* she (1926) found, however, as had Kniep, that sex is determined by two pairs of linked factors, so that the nucleus of the primary basidium has the constitution *AaBb*. The basidiospores then can be (1) *AB*, *Ab*, *aB*, and *ab*; or (2) two *AB* and two *ab*; or (3) two *Ab* and two *aB*. Similar results have been obtained by others with *Hypholoma fasciculare* and *Collybia velutipes*. Newton analyzed 42 tetrads, 25 of which were of the first of the 3 types, 9 of the second, and 8 of the third.

Brunswik (1924) analyzed 93 tetrads of *Coprinus fimetarius* (*lagopus*) with these findings: 37 gave all four types of spores *AB*, *Ab*, *aB* and *ab*; 29 gave the two types *AB* and *ab*; 27 gave the two types *Ab* and *aB*.

These data, together with those of other observers [Buller (1931)], show that sexuality is both bipolar and tetrapolar among Basidiomycetes. The mechanism of these patterns of behavior, as Dodge (1940) indicates, is readily explainable if we assume that the genotypes of the parental nuclei in the matings made by Newton and by Brunswik were either *AB X ab* or *Ab X aB*. This

assumption would account for the presence of two types of bipolar basidia in equal proportions, if reduction (segregation) occurred in the first division and there was random segregation without genetic linkage. With such genotypes a simple crossing-over during meiosis would account for the tetrapolar basidia.

Further light on this problem was shed by the studies of Sass (1929). He found four-spored and two-spored forms of each of the three species *Coprinus ephemerus*, *Naucoria semiorbiculatus*, and *Galera tenera*. The two-spored form of each is normally homothallic. The four-spored forms are heterothallic and bisexual, and sex is determined by one pair of Mendelian factors.

Panus stipticus from Europe is non-luminous, but the same species from North America is luminous. Studies by Macrae (1942) of both European and North American strains of this fungus show that each strain is heterothallic and tetrapolar. When she crossed a luminous with a non-luminous one, the haploid mycelium of the F_1 generation was luminescent. Luminosity is therefore dominant and is governed by a single pair of factors.

In Ustilaginales. Some of the more important contributions to the genetics of smut fungi are those of Stakman and Christiansen (1927), Christiansen (1929), Hanna (1929), Dickinson (1931), Flor (1932), Allison (1937), Kernkamp (1939), and Schmitt (1940). The smuts constitute a group of destructive plant parasites which, in regard to their sexual process, resemble the other Basidiomycetes generally in that they lack sexual organs and definitive gametes. Their most distinctive feature, the mature chlamydospore or smut spore, is unincucate. Its nucleus is a $2n$ structure. At germination meiosis occurs, and each haploid nucleus finds its way into a basidiospore or sporidium. According to Hanna (1929), infection of maize by *Ustilago zaeae* is accomplished by haploid mycelia, and the chance meeting of two haploid mycelia of opposite sex within the host tissues is followed by hyphal fusions, whereupon the mycelial cells are dicaryotic. Previously Stakman and Christiansen (1927) had failed to obtain fusions in artificial cultures between strains of opposite sex but had found hyphal fusions and clamp connections in hyphae within the maize tissues. Moreover, infections from monosporidial cultures failed to result in the production of smut galls and of chlamydospores. When dicaryotic mycelium eventually becomes

transformed into young chlamydo-spores, the conjugate nuclear condition still obtains, and actual fusion takes place only within the maturing chlamydo-spore.

Stakman and Christiansen (1927), by isolating the individual sporidia, were able to show that *U. zeae* is heterothallic, and by

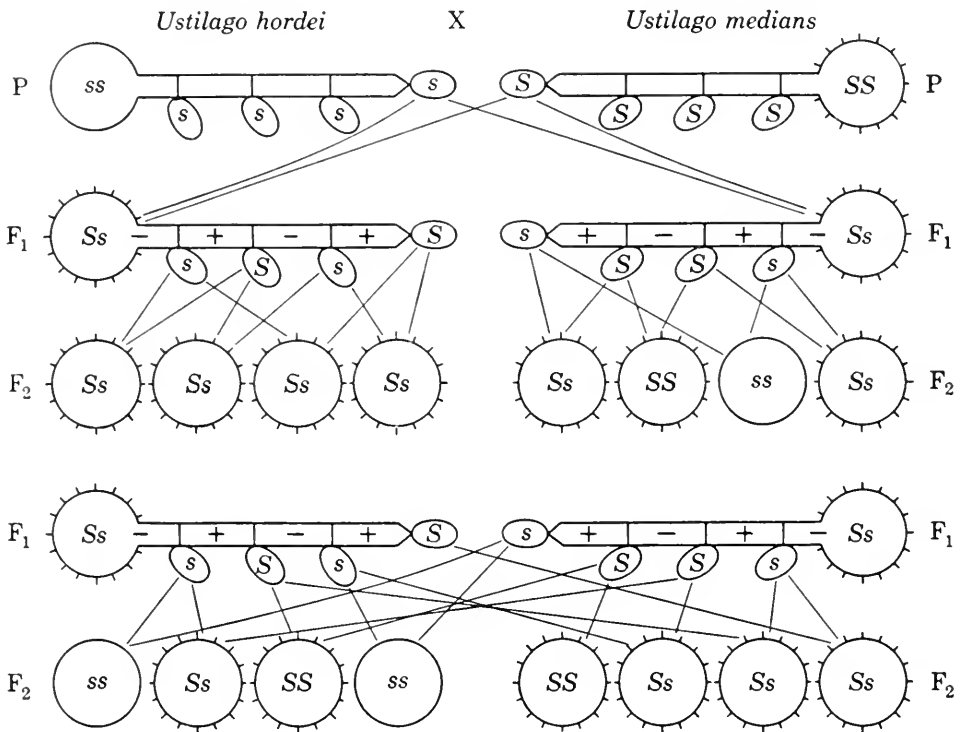

FIG. 56. Schematic representation of hybridization of two species of smuts, one smooth-walled and one rough-walled. P represents parents. The sex factor, + or -, segregates independently of the chlamydo-spore-wall character. S in sporidia represents spiny walls; s in sporidia represents smooth walls with S dominant. In the F₁ generation all spore walls are spiny. In the F₂ generation the ratio of spiny-walled spores to smooth-walled spores is 4:0, 3:1, and 2:2, if all possible combinations are made.

the same techniques Flor (1932) showed that this situation exists also in *Tilletia tritici* and *T. levis*.

Working with oat smut, *Ustilago levis*, Dickinson (1931), considered that the two pairs of factors *Aa* and *Bb*, representing sex and color, were additive in their effect, *AB* causing brown color, *ab* causing cream color, and either *Ab* or *aB* causing yellow color. He isolated the four sporidia of known position. It was apparent that the haploid parental mating was *AB* X *ab*, that is brown X cream. Out of this mating came tetrads of sporidia of three

groups in the proportion of: (1) two *AB* and two *ab*, (2) two *Ab* and *aB*, (3) one each of *AB*, *ab*, *aB*, and *Ab*. Segregation would appear therefore to occur in the fashion described by Newton (1926) and Brunswik (1924) in *Coprinus lagopus*, with the linkage and crossing-over mechanisms as interpreted by Dodge (1940). These observations by Dickinson (1931) are further substantiated by the findings of Schmitt (1940) on *Ustilago zaeae*. The segregations of factors for colony color, sex, and type of growth (sporidial or mycelial) occurred in both the first and the second divisions. For each of these characters numerical ratios of 1:1, 3:1, and 1:3, were found, with a 4:0 segregation for sex in one case among several thousand.

Smuts constitute especially favorable material for genetical studies for the reason that all the sporidia from a promycelium can be isolated and can then be propagated in culture. Each sporidium by budding can be made to form numerous haploid individuals that can be mated under controlled conditions. Genetic studies of smuts have been concerned with colony characters and tendency to sector. Other studies have included such factors as color of the peridium of sori, pathogenicity, sex compatibility, color of the chlamydospores and the nature of their walls, and tendency to be myceloid or to form buds [Christiansen and Rodenheiser (1940)].

Kernkamp (1942) isolated monosporidial lines of *U. zaeae* to study the effects of genetic and environmental factors on types of colonial growth. Some isolates were entirely sporidial, some entirely mycelial, and some intermediate. Strictly sporidial lines could not be mated and could not infect maize. The growth types of sporidial or of mycelial lines could not be modified by changes in concentration of food or by addition of certain vitamins, poisons, amino acids, or other substances. The growth type of intermediate lines, however, could be modified for increased sporidial production by the presence of dextrose or for mycelial production by unfavorable growth conditions.

Stakman and his associates (1943) found that mutation is unbelievably common in *U. zaeae*. In this smut mutability and constancy are governed by genetic factors, as has been determined from the results of numerous crosses between monosporidial lines of opposite sex. Stakman and his associates conclude, "*Ustilago zaeae* definitely comprises an indefinite number of biotypes that

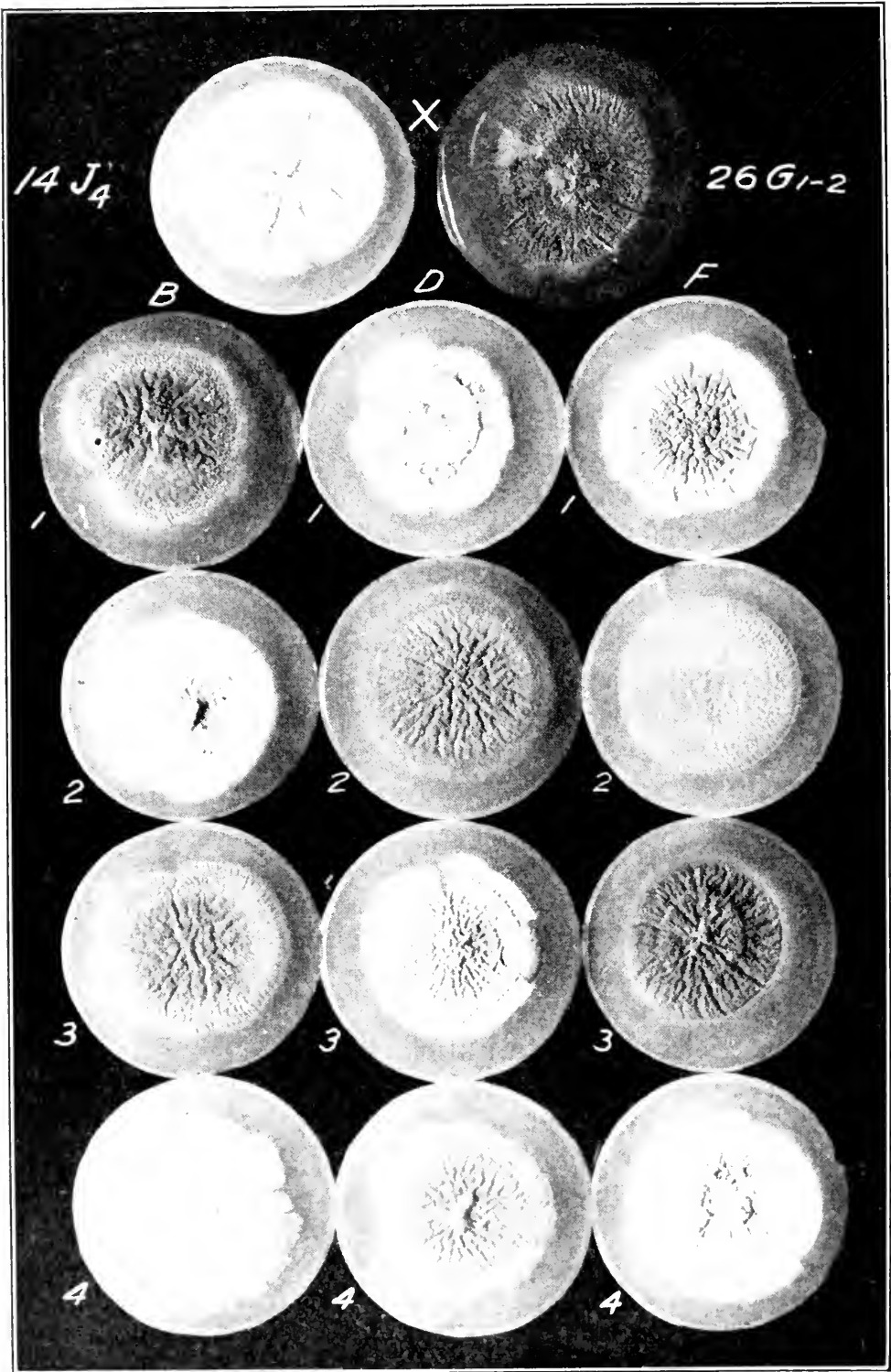

FIG. 57. Hybrids between monosporidial lines of *Ustilago zaeae*. Progeny of the four primary sporidia from each of three chlamydozoospores. Note recombination of characters. (Courtesy of E. C. Stakman.)

differ either widely or slightly in every observable character or combination of characters. New ones are continually being produced as a result of mutation and of recombinations resulting from interbiotypic hybridization.”

In Uredinales. The Uredinales, or rust fungi, are a group of obligate parasites of enormous economic importance, because many of them attack crop plants. Although many studies, from which have come a number of fundamental concepts, have been concerned with their sexuality, an understanding of this subject was first established by the investigations of Craigie (1927, 1927a, 1928). He showed that the pycnia are functional structures and that the pycniospores are essential in diploidization.

Undoubtedly many rusts are heterothallic, for Craigie's studies have shown that such is the situation in *Puccinia graminis*, *P. helianthi*, *P. coronata*, *P. pringsheimiana*, and *Gymnosporangium* sp. At germination of the teliospore, whose mature cells are uninucleate, the nucleus divides meiotically within the promycelium, the homologue of the basidium, and the four resultant nuclei are haploid. Each migrates through a sterigma into the basidiospore that arises at the apex of a sterigma. Craigie found that these basidiospores are of either (+) or (-) potentialities. If monosporidial inoculations are made, pycnia containing pycniospores are developed. However, aecia never develop in association with such pycnia unless pycniospores from a pycnium of opposite sex are applied. In nature this interchange of pycniospores is accomplished either by insects attracted to the sugary exudate in which pycniospores are embedded or by water. Buller (1940) has shown that flexuous hyphae extend from the orifices of the pycnia and that pycniospores fuse with these flexuous hyphae. The pycniospores are thus spermatia, and the flexuous hyphae are receptive surfaces comparable to trichogynes. Buller (1940) has observed flexuous hyphae in 21 species belonging in *Coleosporium*, *Cronartium*, *Gymnoconia*, *Gymnosporangium*, *Melampsora*, *Melampsorella*, *Milesia*, *Phragmidium*, *Pucciniastrum*, *Puccinia*, and *Uromyces*.

If spermatization is accomplished, aecia bearing dicaryotic aeciospores with conjugate, (n) + (n), nuclei are developed.

In full-cycled rusts, not only the aeciospores but also the mycelia arising when they germinate, the urediniospores and the mycelia arising from their germination, and the young teliospores

are dicaryotic. The thousands of nuclear divisions that occur meanwhile are conjugate, and the complete cycle from the monocaryotic to the dicaryotic condition and back again to the monocaryotic may require a period of, at one extreme, only a few days to, at the other, 5 to 7 years, as in *Cronartium ribicola*.

Inability to grow rusts on artificial media has no doubt interfered to some extent with genetical studies of them. Nevertheless such studies have been energetically pursued, especially by Stakman and his associates at the Minnesota Experiment Station and by a group at the Dominion Cereal Rust Laboratory in Canada. The presence of barberry bushes in areas devoted to cereal crops permits the development in nature of new races or strains of rusts by hybridization. There is abundant evidence that such new hybrid rusts are continuously being developed and that their presence accounts for the breaking down of resistance in cereal varieties that possess a high degree of resistance to old strains of rusts. The production of new strains of rusts tends to nullify the laborious efforts of plant breeders to develop resistant varieties of cereals and to control cereal rusts by use of these resistant varieties.

Newton and Johnson (1940) crossed *Puccinia graminis tritici* and *P. graminis avenae*, finding them completely interfertile. These workers were concerned primarily with pathogenic potentialities. Crosses within the *avenae* variety showed that the less virulent pustule type is dominant over the more virulent type, whereas within the *tritici* variety the less virulent type is dominant in some crosses but recessive in others. In reciprocal crosses between these two varieties the maternal cytoplasm appears to exercise the controlling influence. A cross between a variant whose urediniospores were orange and a variant whose urediniospores were grayish-brown gave all normal red color in the F_1 generation. When selfed, four different colors—red, orange, grayish-brown, and white—appeared in the F_2 generation, with a distribution ratio suggesting 9:3:3:1, respectively.

In experiments with physiologic races of *P. graminis tritici*, Johnson and Newton (1940) found that absence of pustules, which they called O type, was dominant over large pustules (+ type) on Kanred wheat. When this hybrid was selfed, the O type was approximately 3 times as abundant in the F_2 generation as the + type. In this instance pathogenic behavior is governed by

a single factor pair. On Mindum wheat the 4 type was dominant over very small pustules (1 type) with a 3:1 ratio in the F_2 generation. On the other hand, when the emmer variety, Vernal, served as the host, the 1 type was 15 times as abundant as the 4 type in the F_2 generation. Pathogenic behavior on Vernal emmer appears therefore to be governed by duplicate factors. Johnson and Newton conclude that the genes in the binucleate urediniospores function as if they occurred in a single diploid nucleus.

DOMINANCE AND LETHAL FACTORS

The existence of dominance and recessiveness among fungi would appear to have been amply demonstrated in the studies described, which are representative of experiments among the larger groupings of fungi. This Mendelian principle can be demonstrated for interested students, however, by hybridizing an eight-spored *Neurospora* with a four-spored *Neurospora*. All the F_1 progeny will be found to be eight-spored. Similarly, when a rough-spored race of smut is crossed with a smooth-spored one, all the F_1 are rough.

Lethal factors exist among fungi, just as they are known to occur among seed plants. Dodge (1934) reported the results of studies on *N. tetrasperma*, known to possess bisexual ascospores. After treatment with X-rays a strain appeared that was practically self-sterile, as manifest by ascus abortion. When this strain was mated with a normal one, the F_1 generation gave asci that formed spores normally. Further results showed that at meiosis the lethal factor was segregated, so that each bisexual ascospore contained a normal nucleus and one with the lethal factor. This situation insured the transmission from generation to generation of the lethal factor.

More recently Fischer (1940) noted a haplo-lethal factor in five collections of *Ustilago bullata* on species of *Agropyron*, *Bromus*, *Elymus*, and *Festuca*. When he germinated the chlamydospores and isolated the basidiospores in monosporidial cultures, he found that approximately half yielded typical colonies, and in the remainder the basidiospores budded a few times and then underwent complete lysis. Fischer was able to show that the lethal factor was sex-linked in four of the five collections.

RÉSUMÉ

Mendelian principles apply in genetical studies of fungi, just as in similar studies involving other living organisms. By means of hybridization evidence has been obtained of dominance and recessiveness, of segregation in predictable numerical ratios, of sex linkage, of lethal factors, of mutations, of crossing-over at reduction division, and of other genetic features. As Dodge (1940) has aptly said, "The fungi in their reproduction and inheritance follow exactly the same laws that govern these activities in higher plants and animals." The practical consideration to be kept in mind, a conclusion that follows from these facts, is that new races of fungi are continually arising by hybridization. This fact must be taken into account in breeding plants for disease resistance.

LITERATURE CITED

- ALLISON, C. C., "Studies on the genetics of smuts of barley and oats in relation to pathogenicity," *Minn. Agr. Expt. Sta. Tech. Bull.*, 119: 1-34, 1937.
- AMES, L. M., "Hermaphroditism involving self-sterility and cross-fertility in the ascomycete *Pleurage anserina*," *Mycol.*, 26: 392-414, 1934.
- BENSAUDE, M., "Recherches sur le cycle évolutif et la sexualité chez la Basidiomycetes," Thèse (Paris), Nemours. 153 pp. 1918.
- BLAKESLEE, A. F., "Sexual reproduction in the Mucorineae," *Proc. Am. Acad. Sci.*, 40: 205-319, 1904.
- BRUNSWIK, H., "Untersuchungen über die Geschlechts- und Kern-verhältnisse bei der Hymenomyzetengattung *Coprinus*," *Bot. Abhandlung. herausg. K. von Goebel*, 5: 1-152, 1924.
- BULLER, A. H. R., *Researches on Fungi*, Vol. IV. 329 pp. Longmans, Green & Co., London. 1931.
- "The flexuous hyphae of *Puccinia graminis* and of other rust fungi," *Proc. 3rd Intern. Congr. Microbiol.*, p. 534, 1930.
- BURGEFF, H., "Variabilität, Vererbung und mutation bei *Phycomyces blakesleeanus* Egff.," *Z. Indukt. Abstam. Vererb.*, 49: 26-94, 1928.
- CHRISTIANSEN, J. J., "Mutation and hybridization in *Ustilago zeae*. Part II. Hybridization," *Minn. Agr. Expt. Sta. Tech. Bull.*, 65: 85-108, 1929.
- CHRISTIANSEN, J. J., AND H. A. RODENHEISER, "Physiologic specialization and genetics of the smut fungi," *Botan. Rev.*, 6: 389-425, 1940.
- CRAIGIE, J. H., "Experiments on sex in rust fungi," *Nature*, 120: 116-117, 1927.
- "Discovery of the function of pycnia and aecia in certain rust fungi," *Nature*, 120: 765-767, 1927a.
- "On the occurrence of pycnia and aecia in certain rust fungi," *Phytopathology*, 18: 1005-1015, 1928.

- DICKINSON, S., "Experiments on the physiology and genetics of the smut fungi. Cultural characters. II. The effect of certain external conditions on their segregation," *Proc. Roy. Soc. B*, 108: 395-423, 1931.
- DIMOCK, A. W., "Studies on ascospore variants of *Hypomyces ipomoeae*," *Mycol.*, 31: 709-727, 1939.
- DODGE, B. O., "Nuclear phenomena associated with heterothallism and homothallism in the ascomycete *Neurospora*," *J. Agr. Research*, 35: 289-305, 1927.
- "Production of fertile hybrids in the ascomycete *Neurospora*," *J. Agr. Research*, 36: 1-14, 1928.
- "Breeding albinistic strains of the *Monilia* bread mold," *Mycol.*, 22: 9-38, 1930.
- "Inheritance of the albinistic non-conidial characters in inter-specific hybrids in *Neurospora*," *Mycol.*, 23: 1-50, 1931.
- "A lethal for ascus abortion in *Neurospora*," *Mycol.*, 26: 360-376, 1934.
- "Second-division segregation and crossing-over in the fungi," *Bull. Torrey Botan. Club*, 67: 467-476, 1940.
- DOWDING, E. S., "The sexuality of the normal, giant, and dwarf spores of *Pleurage anserina* (Ces.) Kuntze," *Ann. Botany*, 45: 1-15, 1931.
- EDGERTON, C. W., S. J. P. CHILTON, AND G. B. LUCAS, "Genetics of *Glomerella*. II. Fertilization between strains," *Ann. J. Botany*, 32: 115-118, 1945.
- FISCHER, G. W., "Two cases of haplo-lethal deficiency in *Ustilago bullata* operative against saprophytism," *Mycol.*, 32: 275-289, 1940.
- FLOR, H. H., "Heterothallism and hybridization in *Tilletia tritici* and *T. levis*," *J. Agr. Research*, 44: 49-58, 1932.
- HANNA, W. F., "The problem of sex in *Coprinus lagopus*," *Ann. Botany*, 39: 431-457, 1925.
- "Studies in the physiology and cytology of *Ustilago zaeae* and *Sorosporium reilianum*," *Phytopathology*, 19: 415-442, 1929.
- JOHNSON, T., AND M. NEWTON, "Mendelian inheritance of certain pathogenic characters of *Puccinia graminis tritici*," *Can. J. Research*, 18: 599-611, 1940.
- KERNKAMP, M. F., "Genetic and environmental factors affecting growth types of *Ustilago zaeae*," *Phytopathology*, 29: 473-484, 1939.
- "The relative effect of environmental and genetic factors on growth types of *Ustilago zaeae*," *Phytopathology*, 32: 554-567, 1942.
- KNIEP, H., "Über morphologische und physiologische Geschlechtsdifferenzierung," *Verhandl. physik.-med. Ges. Würzburg*, 46: 1-18, 1919.
- "Über Schlechtsbestimmung und Reduktionsteilung," *Verhandl. physik.-med. Ges. Würzburg*, 47: 1-29, 1922.
- "Verehrungserscheinungen bei Pilzen," *Bibliogr. Genet.*, 5: 371-478, 1929.
- LINDEGREN, C. C., "The genetics of *Neurospora*. II. The segregation of sex factors in asci of *N. crassa*, *N. sitophila*, and *N. tetrasperma*," *Bull. Torrey Botan. Club*, 59: 119-138, 1929; III, 60: 133-154, 1933.
- "A six-point map of the sex chromosome of *Neurospora crassa*," *J. Genetics*, 32: 234-256, 1936.

- LINDEGREN, C. C., "Non-random crossing-over in the second chromosome of *Neurospora crassa*," *Genetics*, 24: 1-7, 1939.
- "Yeast genetics: life cycles, hybridization, vitamin synthesis, and adaptive enzymes," *Bact. Rev.*, 9: 111-170, 1945.
- MACRAE, RUTH, "Interfertility studies and inheritance of luminosity in *Panus stipticus*," *Can. J. Research*, 20: 411-434, 1942.
- NEWTON, D. E., "Bisexuality of individual strains of *Coprinus rostrupianus*," *Ann. Botany*, 40: 105-128, 1926.
- "The distribution of spores of diverse sex on the hymenium of *Coprinus lagopus*," *Ann. Botany*, 40: 891-917, 1926a.
- NEWTON, D. E., AND T. JOHNSON, "Variation and hybridization in *Puccinia graminis*," *Proc. 3rd Intern. Congr. Microbiol.*, p. 544, 1940.
- SASS, J. E., "The cytological basis for homothallism and heterothallism in the Agaricaceae," *Am. J. Botany*, 16: 663-701, 1929.
- SCHMITT, C. G., "Cultural and genetic studies on *Ustilago zaeae*," *Phytopathology*, 30: 381-398, 1940.
- SHEAR, C. L., AND B. O. DODGE, "Red bread-mold fungi of the *Monilia sitophila* group, life histories and heterothallism," *J. Agr. Research*, 34: 1019-1042, 1927.
- STAKMAN, E. C., AND J. J. CHRISTIANSEN, "Heterothallism in *Ustilago zaeae*," *Phytopathology*, 17: 827-834, 1927.
- STAKMAN, E. C., M. F. KERNKAMP, T. H. KING, AND W. J. MARTIN, "Genetic factors for mutability and mutant characters in *Ustilago zaeae*," *Am. J. Botany*, 30: 37-48, 1943.
- TATUM, E. L., "Nutrition, genetics, and 'Neurospora,'" *Stanford Med. Bull.*, 2: 1-4, 1944.
- "Biochemistry of fungi," *Ann. Review Biochem.*, 13: 667-704, 1944a.
- WILCOX, M. S., "The sexuality and arrangement of the spores in the ascus of *Neurospora sitophila*," *Mycol.*, 20: 3-16, 1928.
- WOLF, F. A., "Spore formation in *Podospora anserina* (Rabh.) Winter," *Ann. Mycol.*, 10: 60-64, 1912.

Chapter 15

POISONOUS AND EDIBLE FUNGI

When mention is made of poisonous fungi, most persons immediately think of toadstools, regarding them as comprising all the poisonous forms. These persons separate toadstools (*Todes Stuhl*) from mushrooms, placing all poisonous species in the toadstool group and all edible ones in the mushroom group. Such a distinction is unwarranted and mycologically meaningless. In the present account, which is by no means comprehensive, consideration will be given to certain fleshy fungi and also to other well-known species that are poisonous, especially to humans.

POISONOUS FLESHY FUNGI

Fleshy fungi have long been employed for food, and it has as long been known that some species are extremely poisonous. Thousands of species are edible, however, whereas relatively few are toxic to man. Sickness and fatalities from eating mushrooms can be attributed only to lack of knowledge. Anyone can learn to recognize the poisonous species, and it cannot be too strongly emphasized that such knowledge constitutes the only safe guide to determining which species are to be avoided. A beginner can soon learn to recognize a few of the choicest and most common edible species and can confine his collections for the table to these species, which include the common mushroom, *Psalliota campestris*, the shaggy mane, *Coprinus comatus*, the common ink cap, *C. atramentarius*, the glistening ink cap, *C. micaceus*, the oyster mushroom, *Pleurotus ostreatus*, the parasol mushroom, *Lepiota procera*, the honey agaric, *Armillaria mellea*, the velvet-stemmed mushroom, *Collybia velutipes*, the morel, *Morchella esculenta*, all coral fungi, and all puffballs that are pure white in section. While gathering these, the student will gradually become acquainted with the poisonous ones.

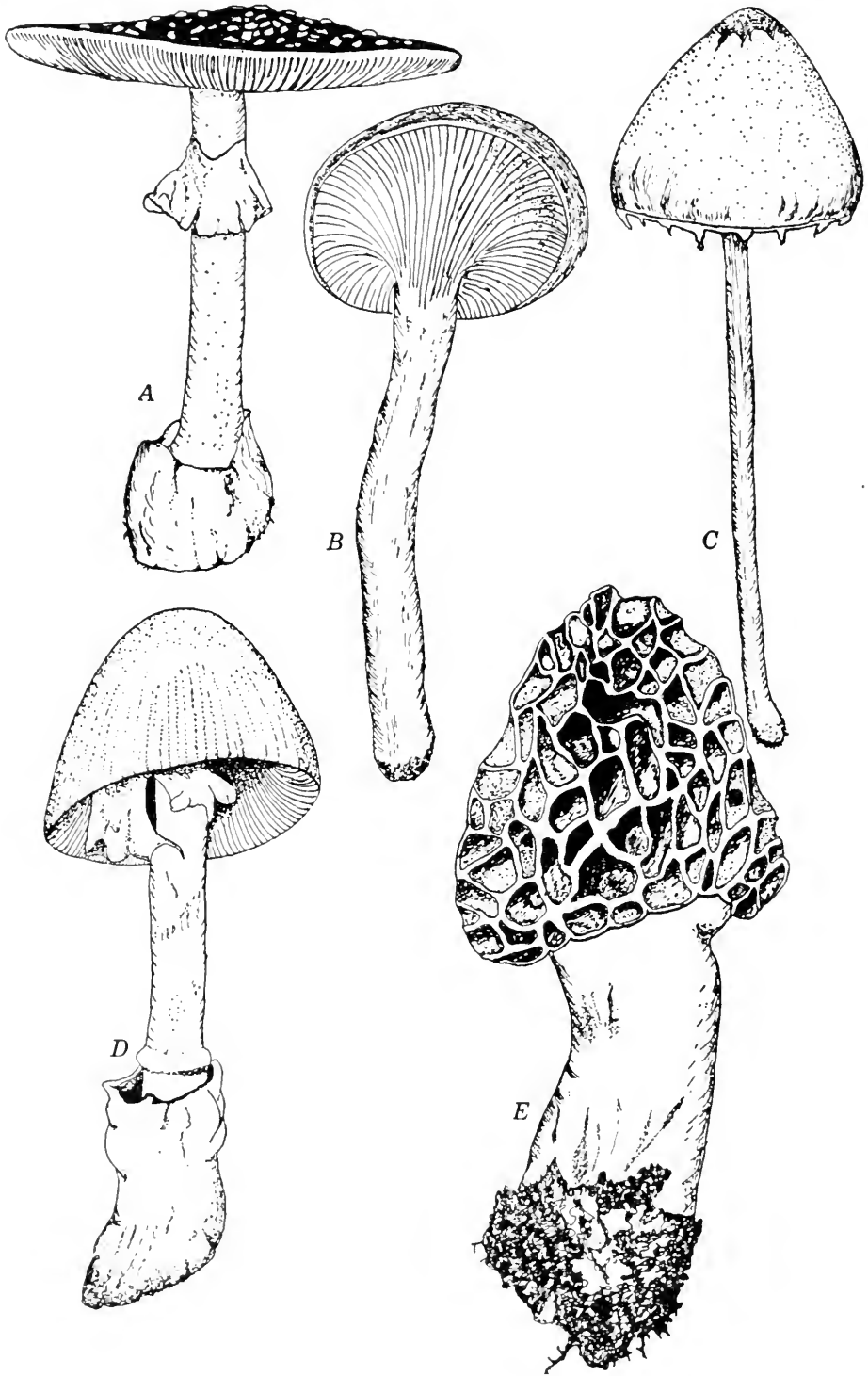

FIG. 58. Some common poisonous fungi. A. *Amanita phalloides*. B. *Clitocybe illudens*. C. *Panaeolus retirugis*. D. *Amanita caesarea*. E. *Morchella esculenta*.

A compendium by Dujarrac de la Riviere and Heim (1938) constitutes an invaluable source of information about poisonous fungi. The earlier series of researches on poisonous mushrooms and their toxic properties by Ford and his associates (1906, 1906a, 1907, 1907a, 1911, 1913, 1914, and 1926) should also be read by all mycologists and laymen who collect fungi for food.

It appears that in ancient times the Babylonians, Romans, and Greeks, both those of high estate and of the lower classes, employed mushrooms in season as delicacies and as daily food. The fact that deaths from poisoning occurred among their notables may be regarded as evidence that the ancients were not able to distinguish between noxious and harmless species. History records that such outstanding civic and political leaders as Pope Clement VII, Emperor Jovian, Emperor Charles VI, Emperor Claudius (his wife Agrippina is said to have added poison to his dish of boleti), the widow of Czar Alexis, and the wife, two sons, and a daughter of the Greek poet Euripides were among the victims of poisonous mushrooms. Galen cautioned his patients against using mushrooms, stating, "Few of them are good to be eaten, and most of them do suffocate and strangle the eater," although his "Amanitae" almost certainly were *Psalliota campestris*. The renowned Greek physician Dioscorides states, "Fungi have a two-fold difference, for they are either good for food, or are poisonous; their poisonous nature depends on various causes, for such fungi grow amongst rusty nails, or rotten rags, or near serpents' holes, or on trees producing noxious fruits."

Some appreciation of the number of fatalities from mushroom poisoning can be gained from Ford and Clark's (1914) report assembled from various sources. In the Les Vosges area of southwestern France the annual death toll is about 100, and in Japan 480 deaths occurred in 8 years. Sartory [Ford and Clark (1914), p. 169] lists 153 fatal cases in a 2-week period in 1912 in France. In 1911 there were 22 deaths in the vicinity of New York City within a 10-day period. Throughout the world a large number of fatalities undoubtedly are due to poisonous mushrooms every year. A vast majority is caused by the "death angel," *Amanita phalloides*. Rolfe (1928, p. 232) has expressed the opinion, "This inglorious trio [*Amanita phalloides*, *A. virosa*, and *A. verna*] is responsible for fully ninety per cent of the deaths from fungus poisoning."

CLASSIFICATION OF FLESHY FUNGI ACCORDING TO TOXIC EFFECT. Toxicologists have classified poisonous fleshy fungi according to the effects that they produce upon the human system [Ford (1926)]. On this basis they may be divided into the following groups:

1. Fungi whose toxicity is first manifest 6 to 15 hours after ingestion and that cause degeneration of the nervous tissues and glandular parenchymatous tissues, especially the liver. The clinical

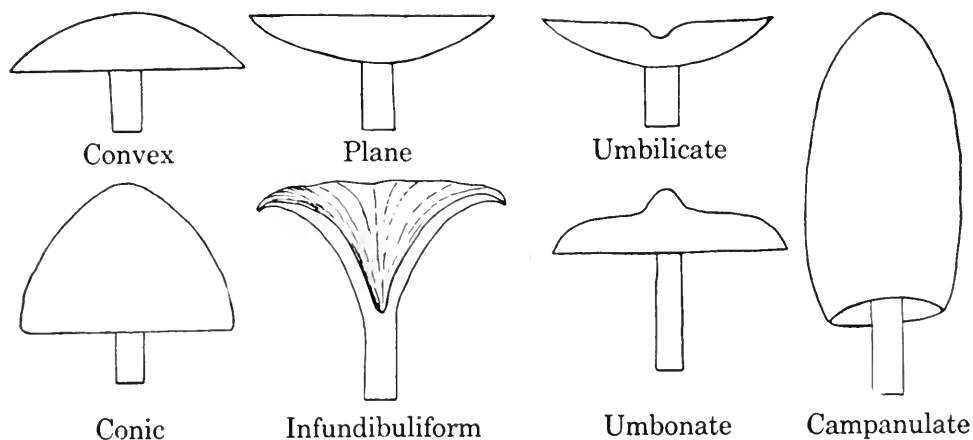

FIG. 59. Types of pilei of agarics in diagram, indicating variation in form used in generic determinations.

cal symptoms consist of sudden seizure by severe abdominal pains, accompanied by vomiting and diarrhoea. Abundant blood and mucus appears in the vomitus and stools. The victim loses weight rapidly, passes into a coma after 2 to 5 days, and succumbs. Recovery is very rare. Poisoning of this type is caused by ingestion of *Amanita phalloides*, *A. virosa*, and *A. verna*, more rarely by *Pholiota autumnalis* and *Hygrophorus conicus*.

2. Fungi whose poisonous effects appear soon after ingestion and that act chiefly by stimulating and then paralyzing the central nervous system. Poisoning is manifest by profuse perspiration and salivation, retching, and diarrhoea, accompanied by delirium, hallucinations, and convulsions. The patient may die from paralysis of respiration. This complex is caused mainly by *Amanita muscaria*. Similar clinical symptoms may be induced by *A. pantherina*, *Inocybe infelix*, *I. infida*, and *Clitocybe illudens*. In Siberia decoctions of dried *A. muscaria* are sometimes used to

induce orgies of intoxication somewhat similar to those from hashish.

3. Fungi whose irritant principles act on the mucous membranes of the gastrointestinal tract soon after the fungi are eaten. The clinical symptoms, consisting of griping pains in the stomach, dizziness, nausea, vomiting, and diarrhoea, subside rather abruptly, and recovery proceeds rapidly. This type of poisoning is induced by *Russula emetica*, *Lactarius torminosus*, *Lepiota morgani*, *Entoloma lividum*, *Boletus satanus*, *B. mineato-olivaceus*, and some of the species of *Amanita*.

4. Fungi that contain hemolytic principles. The symptoms are abdominal distress, dizziness, and vomiting. The vomitus contains blood. The victim may have convulsions and may pass into profound sleep. During convalescence mild jaundice develops. The ingestion of *Helvella esculenta* commonly causes this type of poisoning, which may also be induced by other species of *Helvella* and by *Amanita rubescens*.

5. Fungi that stimulate the central nervous system in a manner somewhat like alcoholic intoxicants. The victim feels greatly exhilarated and laughs immoderately. His gait is staggering, and he has the feeling that he is walking on air. This type of intoxication lasts for 24 to 48 hours after the ingestion of *Panaeolus papilionaceus* or *P. campanulatus*.

IDENTIFICATION OF POISONOUS MUSHROOMS. As has previously been stated, a person can learn to recognize the poisonous fleshy mushrooms if he applies himself to the task. In order to do so, he must become familiar with the salient structural features that are employed by the mycologist in identifying mushrooms. Relatively few species will be found to be poisonous. Each of the more common poisonous species will be briefly characterized in the following account.

Amanita phalloides. The fructifications of this species vary in color, being white, green, olive, amber, and rarely yellowish. They grow singly and are 5 to 7 in. tall. The pileus or cap is white, viscid, and convex, with or without scales at the surface. The stipe or stem is smooth and of the same color as the pileus. The gills are white and free from the stipe. The annulus or veil breaks at the margin of the cap and clings skirt-like near the top of the stipe. The volva or cup is variable because of the manner

in which it ruptures. It may be cup-like or appear as a bulbous expansion at the base of the stipe. Since the volva may be deeply buried in the leaf mold, care must be exercised while collecting to remove the entire fructification. This is of special importance, because *A. phalloides* may be mistaken for *Lepiota naucina*, a common edible species.

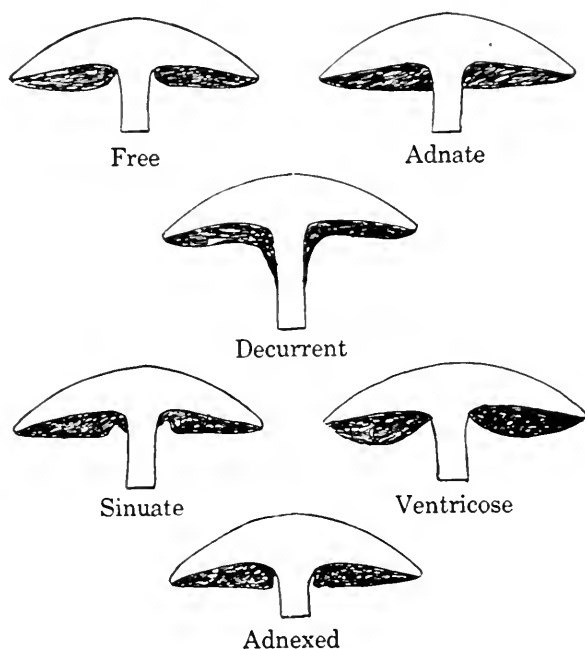

FIG. 60. Diagrams illustrating types of attachment of gills to the stipe, a character used in determination of genera among agarics.

Amanita muscaria. This fungus, called the fly agaric because it has been used as a fly poison, grows in fields or open woods. The striking yellow to orange and even red color of the fructifications characterizes this species, which is 4 to 6 in. tall. The pileus is 3 to 5 in. broad. Prominent warty scales cover the pileus. The gills are white. The veil remains around the stem as a large, membranous, pendent collar. The base of the stipe is bulbous.

Other white species of Amanita. Several other typically white species of *Amanita*, including *A. verna*, *A. virosa*, and *A. spreata*, are as deadly poisonous as is *A. phalloides*. All possess a volva, an annulus, and white gills and have scales on the expanded pileus. The possession of these characters positively identifies the fungus as a species of *Amanita*. Since nearly all species of *Amanita*,

whether white or some color, are known to be poisonous, it is prudent sedulously to avoid all of them.

Lepiota morgani. The genus *Lepiota* lacks the volva but in other features looks like *Amanita*. *Lepiota morgani* grows in fields and open woods, especially in the Ohio Valley, and is not uncommon in the vicinity of Durham, North Carolina. The fruc-

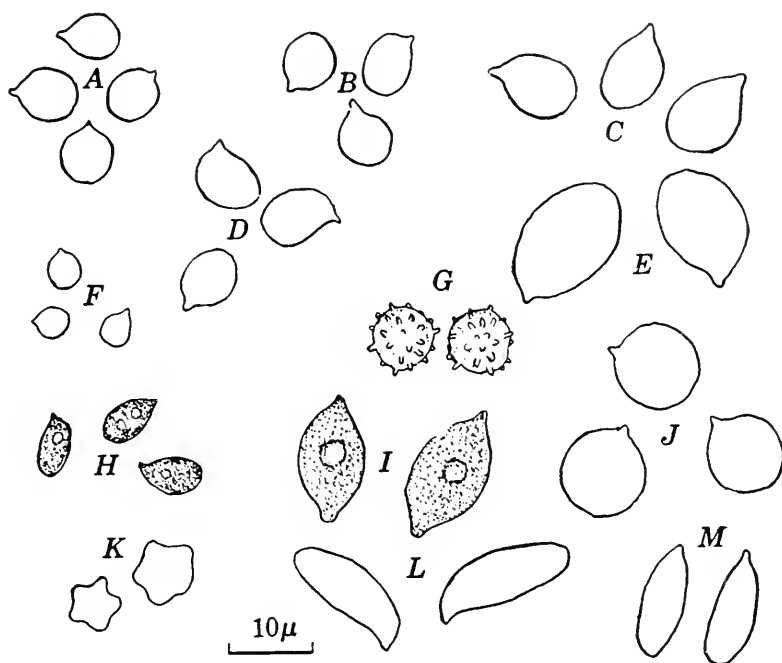

FIG. 61. Shapes of spores in outline. A. *Amanita phalloides*. B. *Amanita verna*. C. *Lepiota morgani*. D. *Amanita muscaria*. E. *Lepiota procera*. F. *Clitocybe illudens*. G. *Russula emetica*. H. *Psalliota campestris*. I. *Panaeolus retirugis*. J. *Amanitopsis strangulata*. K. *Entoloma* sp. L. *Boletinus* sp. M. *Hebeloma crustuliforme*.

tifications are 4 to 8 in. tall, and the convex-to-flat cap may be equally broad. The stipe has a club-shaped base. The color varies from grayish white to buff or pale amber. Irregular scales or patches occur on the cap. The annulus is large, thick, and movable. The gills are free, rather broad, ventricose, and white at first, changing to bright green and then to dull green. The color is so striking as to prevent this species from being mistaken for any edible one.

Clitocybe illudens. The fructifications of this fungus occur in dense clusters, each being 3 to 7 in. tall and 2 to 5 in. broad. They are luminescent, hence the common name jack-o'-lantern. The

color ranges from saffron yellow to orange. The caps are plane to centrally depressed. The gills are decurrent, of the same color as the cap, and narrowed at each end. The stipes are firm, smooth, and solid, tend to be excentric, and are darker near the base.

Clitocybe dealbata var. *sudorifica*. Clusters of fructifications of this fungus, also called *C. sudorifica*, occur on lawns or on other grassy sites. They are $\frac{3}{8}$ to $1\frac{1}{8}$ in. tall, and the caps are $\frac{3}{4}$ to $1\frac{1}{2}$ in. broad. The color throughout is grayish white. The caps are plane, depressed, or umbilicate, and the margin splits irregularly. The stipes have a spongy center. The gills are thin, narrow, and adnate or slightly decurrent. A few cases of poisoning have also been attributed to *C. morbifera* and *C. nebulosus*.

Lactarius torminosus. When the fructifications of *Lactarius* are broken, a milky or colored juice exudes. This characteristic serves to distinguish *Lactarius* from all other gill-bearing fungi. The flesh is always very brittle. *Lactarius torminosus* occurs on the ground in woods in late summer. The fructifications occur singly. They are 2 to 4 in. tall with a pileus of approximately the same breadth. They are convex and depressed in the center. The gills are crowded, thin, and whitish. The stipe is cylindrical, even, and hollow. The milk is white, unchangeable, and acrid. The pilei have an uneven mixture of pink and ochre colors and are very hairy at the margins.

Russula emetica. Species of *Russula* are at once separated from *Lactarius* by the absence of milky juice, although they resemble *Lactarius* in all other respects. *Russula emetica* fruits during summer and autumn. It is a very beautiful and very fragile species. The fructifications are 2 to 4 in. tall, and the cap is equally broad. They are pink when young and darker red when older. The stipes are stout and spongy within. The caps are plane to depressed and are furrowed near the margin. The gills are free, broad, not crowded, and white.

Pholiota autumnalis. Species of *Pholiota* are ochre-spored. They possess an annulus, and the gills are adnate. *Pholiota autumnalis* fruits on decaying wood. The fructifications are clustered and are 1 to 2 in. tall. The caps are convex, cinnamon-rufous to dingy yellow, and striate on the margin. The stipes are slender, fibrillose, hollow, and somewhat paler than the cap.

Inocybe infida. Ochre-spored species with a fibrillose universal veil are included in *Inocybe*. *Inocybe infida* occurs on

mossy ground during autumn. The fructifications are 1 to 2 in. tall. The caps are $\frac{5}{8}$ to 1 in. broad, campanulate, and whitish with a brownish umbo. The gills are annexed, close, narrow, and cinnamon-colored. The stipes are slender, hollow, and white.

Inocybe infelix. This species occurs throughout summer among mosses or on bare soil. Its size agrees with that of *I. infida*. The campanulate pilei are floccosely squamulose and grayish brown or

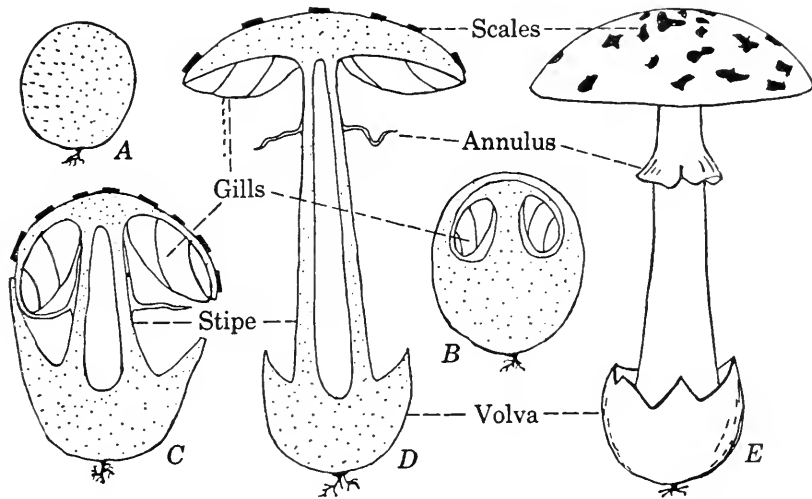

FIG. 62. Relationship of structural features in *Amanita*. A. Undifferentiated "egg." B. Button stage, in which the gills are differentiating in the upper portion. C. Opening of the pileus, showing at one side the ruptured universal veil and annulus. D. Expanded pileus, in section, with scales on the pileus and volva surrounding the base of the stipe. Both structures are remains of the universal veil.

amber. The gills are adnexed, close, broad, ventricose, and rusty. The stipes are equal, solid, silky fibrillose, whitish above and brownish below.

Hebeloma crustuliforme. In *Hebeloma* are placed ochre-spored species with adnate gills and with a delicate fibrillose veil that is present only on the young caps. All species are unwholesome. *Hebloma crustuliforme* appears on lawns in autumn. It is 2 to 3 in. tall, and the caps are equally broad. The caps are convex to umbonate, tan-colored, darker over the center, and viscid. The gills are adnate but rounded near the stem, and their edge is white and irregular. The stipe is stuffed, enlarged below, and whitish. It is reported that *H. fastibile* causes the same type of symptoms as does *Amanita muscaria*.

Entoloma lividum and *E. sinuatum*. *Entoloma* is characterized by being pink-spored with gills that are adnate to sinuate. All the species should be avoided. *Entoloma lividum* and *E. sinuatum* have been proved to be poisonous. They differ mainly in that the stipe of *E. lividum* is solid and of *E. sinuatum* hollow. They grow gregariously in the woods. The fructifications are 3 to 5 in. tall. The caps are 2 to 3 in. broad, convex, becoming centrally depressed, moist, even, and yellowish white, with a wavy margin and sulcate surface.

Panaeolus papilionaceus and *P. retirugis*. In *Panaeolus* are included black-spored agarics that grow on dung or on grassy, manured ground. The pilei are thin, with even margins that extend beyond the gills. The gills are spotted with brown and black; the stipes are long and slender. The pilei of both *P. papilionaceus* and *P. retirugis* are conic and grayish to smoky, with fragments of veil attached around the margin. The centers of the pilei are commonly darker than the margins. The gills are adnate and, as the caps expand, tend to separate more and more from the stipe.

Boletus satanus, *B. luridus*, and *B. mineato-olivaceus*. In *Boletus* are placed fleshy, central-stalked polypores. The caps are convex, and the pore layer is quite readily separable from the substance of the cap. Many discolor immediately on being bruised. Some persons maintain that none of the species should be eaten. Many are bitter and possess disagreeable odors. *Boletus mineato-olivaceus* possesses caps 2 to 6 in. broad. They are red, becoming ochre-red with age. The flesh is yellow but instantly becomes blackish blue when bruised.

The caps of *B. luridus*, about 8 in. across, are dirty olivaceous yellow; the flesh is yellowish, becoming blue. The tubes are yellowish, becoming green. The stipes are approximately 6 in. long and yellowish above and blackish at the base.

Hygrophorus conicus. *Hygrophorus* contains the white-spored species in which the tissue of the cap is continuous with that of the stem. The gills are distant, the edge being acute at the margin, are gradually thickened toward the stipe, and are characteristically waxy, appearing to be sodden. *Hygrophorus conicus* grows in woods in mossy or grassy situations. It has conic pilei, about 2 in. broad, fragile, slightly viscid, and red, orange, or yellow, blackening when bruised. Gills are close, ventricose, almost free, and yellowish. Stipes are yellow, fibrous, equal, and striate.

Morchella esculenta. The morels are disk fungi that appear in late spring in damp situations. Morel fruits possess a distinct cap and stalk. The cap varies in shape with the species, being spherical, ovate, cylindrical, or conic. A network of ridges and pits covers the outer surface. The stipe is stout and irregularly wrinkled. All species are buff to light ochre. The fructifications of *M. esculenta* may be as high as 6 in. tall. The cap is oval in outline, and the pits are irregularly arranged.

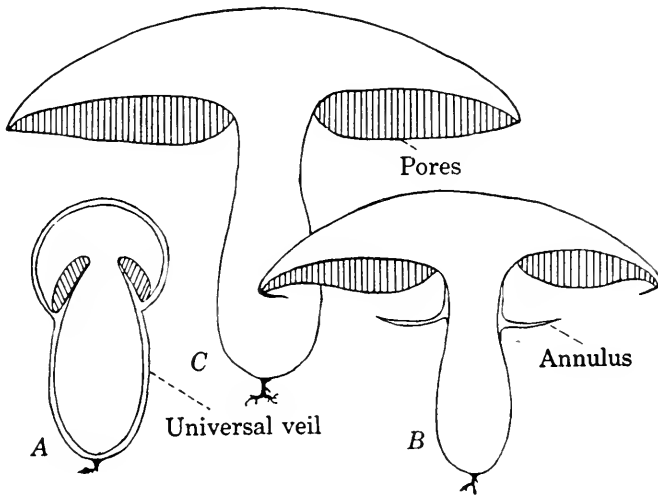

FIG. 63. Structural diagrams of *Boletus*. *A*. Young unopened pileus in which the entire fructification is still enclosed within the universal veil. *B*. Expanded pileus, showing the annulus and remnants attached to the rim of the pileus. *C*. Opened, mature pileus with stipe, cap, and pore surface.

Persons who gather mushrooms should learn to recognize the foregoing poisonous species and should sedulously avoid eating them. Although the judicious use of such knowledge constitutes the best and only safeguard, many other so-called tests to determine whether a given form is poisonous may be mentioned. Silver spoons or coins are said to turn black when dipped into a dish of cooked poisonous mushrooms. Poisonous species are said to peel with readiness. Species that are bright colored, that have undesirable odors, or that have a bitter taste when freshly gathered are claimed to be toxic. The reliability of these and similar tests is vouched for by the world-famous authority, "They say." All such tests are without foundation and must be regarded as sheer nonsense.

TOXICOLOGY. The vast amount of experimentation that has been conducted to determine the nature of the toxic principles in poisonous fleshy fungi can be appreciated from Ford and Clark's report (1914). They indicate that in 1826 Letellier extracted from *Amanita phalloides* a heat-stable substance that he called amanitin. Later he found, in addition to this thermostable substance that he thought to be a glucosidal alkaloid, a substance capable of attacking mucous membranes. In 1877 Ore [Ford and Clark (1914), p. 171] ascribed poisoning by *A. phalloides* to a hypothetical alkaloid that he named phalloidin. In 1891 Kobert [Ford and Clark (1914), p. 177] extracted from *A. phalloides* a hemolytic substance, readily destroyed by heat, which he named phallin. At first he believed it to be the essential poison, but he later extracted an alcohol-soluble alkaloid that was extremely poisonous to his experimental animals.

The analyses by Ford (1906) showed that *A. phalloides* contains, besides phallin, the hemolytic principle of Kobert, another substance of toxic nature. Ford verified the thermolabile nature of phallin and found that the other substance was heat-stable and resistant to digestion by pepsin and pancreatin. He also prepared antiserum that was effective against the stable substance but had no neutralizing effect on phallin. To this stable extractive Ford gave the name amanita-toxin.

Schlesinger and Ford (1907) purified amanita-toxin to the extent that it did not give the reactions of proteins, glucosides, or alkaloids, and concluded that it ". . . appears to be an aromatic phenol so combined with an amine group that it readily forms an indol or pyrrol ring."

Since *Amanita virosa*, *A. verna*, *Pholiota autumnalis*, and *Hygrophorus conicus* induce similar clinical symptoms, they may be assumed to contain the same amanita-toxin as does *A. phalloides*. Other species which contain amanita-toxin are *A. porphyria*, *A. strobiliformis*, *A. radicata*, *A. chlorinosoma*, *A. mappa*, *A. morrisii*, *A. citrina*, *A. crenulata*, and *Amanitopsis volvata*.

The toxic principle in *Amanita muscaria* was isolated by Schmiedeberg and Koppe [Ford and Clark (1914), p. 177] in 1869 and given the name muscarine. There was also isolated from this same species the alkaloid choline, which, on uniting with oxygen, as it does when the fly agaric decays, becomes muscarine. Kobert [Ford and Clark (1914), p. 177] maintained that this

fungus contains a third alkaloid, which he called "pilz-atropin." Muscarine depresses the same nerves that are stimulated by "pilz-atropin" and atropin, both of which therefore are physiological antitodes for muscarine. Persons who have been poisoned by *A. muscaria* and whose heart has nearly ceased pulsating may be given atropin, with the result that heart action will again become strong.

Studies on muscarine indicate that it is not a chemical entity but a group of at least five substances, having the empirical formula $C_5H_{15}NO_2$. Muscarine occurs in *Amanita pantherina*, *Boletus satanus*, *B. luridus*, and *Russula emetica*. *Clitocybe illudens*, *Lactarius torminosus*, *Inocybe infida*, and *I. decipiens* contain a muscarine-like principle that may be similar to that in *Amanita muscaria*.

There occurs in *Helvella esculenta* a water-soluble, heat-labile, hemolytic principle that has been identified as helvellic acid, $C_{12}H_{20}O_7$. It is generally agreed that fresh specimens are free from this poison but that it occurs in old or decaying morels.

FOOD VALUE OF FLESHY FUNGI

The food value of mushrooms is indicated by analyses made years ago by Mendel (1898). Certain of his data are presented in Table 27. Mendel pointed out that these percentages do not represent the digestible fraction. For example, he found that only about one-seventh of the total nitrogen in *Coprinus comatus* is actually digestible. No determinations were made of the nutritive value of the ether extract, that is, the fatty substances, but Mendel assumed that the digestible portion of this fraction must be similar to that of the total-nitrogen fraction.

TABLE 27
COMPOSITION OF CERTAIN EDIBLE FUNGI

Species	Dry Matter (percentage)	Constituents (percentage on dry-weight basis)			
		Total N	Protein N	Ether extract	Ash
<i>Coprinus comatus</i>	7.81	5.79	1.92	3.3	12.5
<i>Morchella esculenta</i>	10.46	4.66	3.49	29.3	10.4
<i>Pleurotus ostreatus</i>	26.30	2.40	1.13	31.5	6.1
<i>Psalliota campestris</i>	8.20	4.75	3.57	11.6

Mendel concluded that mushrooms have a low caloric value. Nevertheless he properly regarded them as being among the most appetizing of culinary delicacies and as adding greatly to the palatability of many foods when cooked as savories with them.

Later workers are inclined to regard mushrooms as having amounts of nitrogenous substances, carbohydrates, and fats that would rank them, in regard to nutritive value, along with fresh vegetables. Data of Sabalitschka [Ivanoff and Zwetkoff (1932)] showed that *Psalliota campestris* and *Boletus edulis* have a high protein content. This finding was confirmed by Saburow and Wasiliew [Ivanoff and Zwetkoff (1932)], who recorded the protein content of these two species as 32.06% and 31.25%, respectively, these figures being based on the weight of dry substance. On the other hand, other edible species may be low in proteins, since Saburow and Wasiliew found in *Collybia velutipes* 8.87% and in *Tricholoma portentosum* 10.50%. They also reported large variation in fat content between species, *Boletus edulis* having 1.6% and *B. scaber* 9.69%. Since the proportions of proteins, carbohydrates, and fats that are digestible by man remain unknown, the true nutritive value of mushrooms likewise remains a mystery.

FLESHY SPECIES MOST USED AS FOOD. The fleshy fruit-bodies of fungi that are used as food in most parts of the world are not cultivated but occur in forests, mainly on the forest floor. The choicest species include *Psalliota (Agaricus) campestris*, *P. arvensis*, *Boletus edulis*, *Lepiota procera*, *Lactarius deliciosus*, *Coprinus comatus*, *Cantharellus cibarius*, *Pleurotus ostreatus*, and *Fistulina hepatica*. Among other highly prized species are the morels, including *Morchella esculenta*, *M. conica*, *Gyromitra gigas*, and *G. esculenta*, the truffles, especially *Tuber aestivum* and *T. melanospermum*, and certain puffballs. In parts of Australia and Tasmania use is made of the large sclerotia of *Polyporus mylittae*, which are called "native bread" and "black-fellow's bread." The natives in Tierra del Fuego eat large quantities of *Cyttaria*, especially *C. gummii*, *C. hookeri*, *C. darwinii*, and *C. harti*, which grow parasitically on the branches of *Nothofagus*.

ARTIFICIAL CULTIVATION OF FLESHY FUNGI. In light of the fact that the excellence of certain species has long been appreciated, it is not surprising to find that attempts were made by the ancients to cultivate them. At present, however, few species are culti-

vated in any country. *Psalliota campestris*, the common mushroom, is apparently the species most widely grown under artificial conditions. Precise directions for the commercial growing of this mushroom are available but are not relevant to this account. A few of the general features involved in its culture, however, seem pertinent. Caves, cellars, abandoned mines, and special types of glasshouses are suitable for growing mushrooms, provided that temperature, moisture, and ventilation are properly controlled. Of these factors, temperature is perhaps the most vital; it should be kept within the range 53° to 63° F. High relative humidity is required, but the site should not be wet.

Mushroom growers attach great emphasis to proper preparation of the manure. Stable manure, including the litter used for bedding, is piled deeply, mixed with loam, and turned and re-piled until a suitable compost is formed. The compost is then placed in beds and is implanted with spawn, that is, with blocks of humus permeated with the mycelium of the mushroom. After several weeks the beds are cased. This process consists in covering the beds to a depth of 1 or 2 in. with a layer of loam. The beds then require occasional sprinkling to keep them moist. The mushrooms should soon begin to appear. In France morels are grown in much the same way, except that bits of fruit bodies are used as spawn.

In parts of China *Hirneola polytricha*, under the Chinese name *Mu Erh*, is grown under semiartificial conditions. Sapling oaks (*Quercus variabilis*) are cut into poles, allowed to lie on the ground for several months, and then stacked in small piles in moist places. The gelatinous fruit bodies are developed the following year. The Chinese similarly grow the large sclerotia of *Poria cocos* on partly buried pine poles.

The fruit bodies of *Armillaria shii-take* are produced artificially on a large scale in Japan and are marketed under the name *shii-take*. The name *shii* applies to an evergreen oak, *Quercus cuspidata*. Recently cut logs of this oak are soaked in water, and the bark is loosened by pounding; holes are then made in the logs, and pieces of wood decayed by the fungus are placed therein. After about 2 years the mushrooms appear. By proper management of cutting, the coppice growth from the stumps attain cutting size in about 20 years. Tracts are thus reforested to continue the production of crops of *shii-take*.

ERGOT AND ERGOTISM

The name ergot, which is properly applied to the sclerotial stage of *Claviceps purpurea*, is derived from the old French *argot* and refers to the resemblance of the sclerotium to a cock's spur. Ergot, when ingested by man and various animals, has long been known to be poisonous, causing a disease known as ergotism. Both the disease and its cause have come to be well known and have attracted the attention of a large number of investigators. Two monographic treatises on this subject, one by Atanasoff (1920) and the other by Barger (1931), are especially noteworthy. That by Atanasoff is concerned primarily with matters of plant-pathological and mycological interest, whereas that by Barger deals primarily with ergotism. Barger's interests were centered on this problem for more than 20 years, and his comprehensive report, although intended primarily for the student and the practitioner of medicine, is also of wide general usefulness.

HISTORICAL ACCOUNT. It becomes apparent from the account by Barger (1931) that the antiquity of ergotism cannot be established with certainty. There is little likelihood that the ancient Greeks and Romans knew this disease, as is maintained by Kobert [Barger (1931), pp. 40-42]. Certain diseases mentioned by Hippocrates and Galen and interpreted by Kobert and others to be ergotism seem to have been some other disorder. It seems highly probable that an outbreak of ergotism was first chronicled by some unknown writer in the *Annales Xanthensis* in A.D. 857. Translated, his statement is: "A great plague of swollen blisters consumed the people by a loathesome rot, so that their limbs were loosened and fell off before death." Confusion also exists regarding the cause of the epidemics called "holy fire" (*ignis sacer*) that occurred throughout the succeeding period of about 800 years. The gangrenous condition of limbs, resulting in death or the loss of hands and feet, undoubtedly was ergotism, although anthrax, erysipelas, scurvy, and plague may have accounted for a portion of the mortality.

The modern history of ergotism begins with an account by Dodart [Barger (1931), pp. 59-60] of an epidemic in the Sologne district of France in 1676. In 1777, in this same district, about 8000 persons are said to have succumbed from ergotism. In 1770

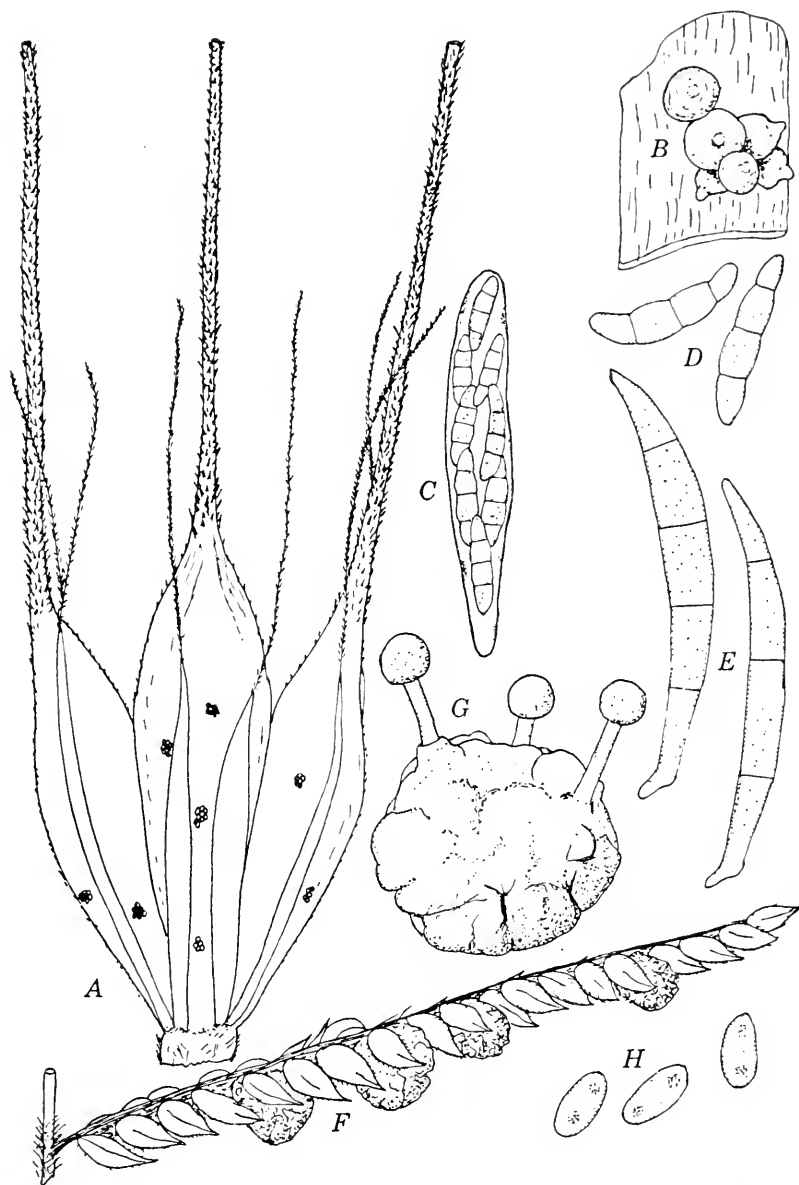

FIG. 64. Poisonous Ascomycetes on grasses. A. *Gibberella saubinettii* (*G. zae*) in small clusters on barley glumes. B. Cluster of perithecia of *G. saubinettii*. D. Ascospores. E. Conidia of the Fusarium stage. F. Branch of panicle of *Paspalum laeve*, certain of the ovaries having been replaced by sclerotia of *Claviceps paspali*. G. Sclerotium of *C. paspali* that has hibernated, after which three perithecial stromata developed. H. The conidia of *C. paspali* belong to the form Genus Sphacelia and occur on the surface of the stromata that later become sclerotia.

an outbreak involved the inhabitants of several European countries, and subsequently there have been many epidemics throughout the whole of Europe, some of them widespread and all of them producing horrible suffering and disfigurement.

The date of the first use of ergot as a drug cannot be fixed, but the first published mention of its use to induce uterine contractions occurs in Adam Lonicer's *Kreuterbuch* in 1582. The ergot grains are therein described as "long, black, hard, narrow corn pegs, internally white, protruding like long nails from between the grains in the ear," and three sclerotia are designated as constituting a dose. Subsequently for a period extending throughout the eighteenth century midwives in various European countries used ergot to expedite lingering parturition. Its use did not enter into pharmaceutical practice, however, nor was it employed by the medical practitioner. In the United States ergot was medically introduced under the name of *pulvis parturiens* early in the nineteenth century.

Early writers were not in accord on the true nature of ergot. Caspar Bauhin refers to it as *Secale luxurians* in his *Phytopynax*, published in 1596 [Barger (1931), p. 10]. Until the middle of the nineteenth century many writers regarded ergot grains as degenerated kernels. Among the causes assigned for this degeneration were improper nutrition, failure of the flowers to become fertilized, injury from insects, and excessive rainfall. Fries (1822) considered the ergot grain as a fungus structure; he gave it the name *Spermoedia clavus* but later (1849) changed this name to *Claviceps purpurea*. Lévillé (1827) observed that the sugary secretions on young sclerotia contained conidia. Thinking that the conidia were reproductive structures belonging to a fungus parasitizing the sclerotia, he named this supposed parasite *Sphacelia segetum*. He (1842) maintained that the ergot itself was a degenerated kernel. Meyen's observations (1841) on ergot led him to conclude that the sclerotium is an early stage of the *Sphacelia segetum* that Lévillé had described nearly 15 years before. The chapter on the nature of ergot was finally concluded by Tulasne (1853), who established that the conidia, sclerotia, and perithecial stromata constitute developmental stages of one and the same fungus, which he called *Claviceps purpurea* (Fr.).

The structure and development of *Claviceps purpurea* have been recounted in some detail [Falck (1911), Stäger (1903), Zimmerman (1906), Kirchhoff (1929), Killian (1919)]. This fungus at-

tacks various cereal and forage grasses. It is most commonly known in the sclerotial or ergot stage as it occurs on rye. The rye grain is replaced by the ergot "grain" or sclerotium. The fungus may first be noted at the time of the flowering of the rye,

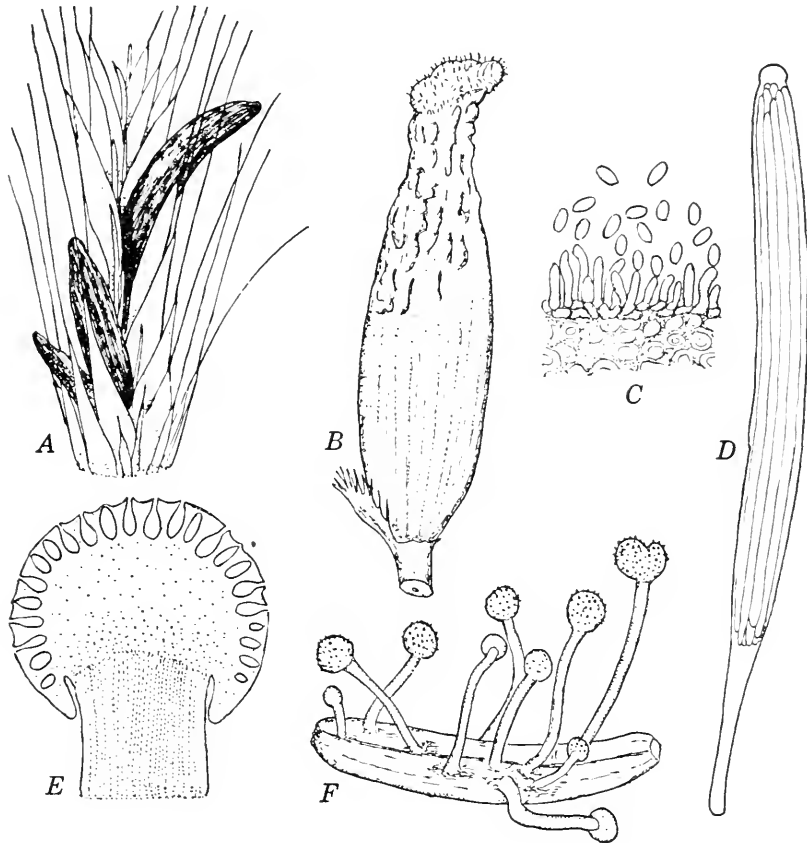

FIG. 65. Stages in the development of ergot, *Claviceps purpurea*, on rye. *A*. Ergot grains (sclerotia) appearing as dark spurs and replacing the rye grains. *B*. Young infected rye ovary, at whose surface conidia are formed. *C*. Detail of surface of young infected ovary. *D*. Mature ascus of *C. purpurea*, bearing eight thread-like ascospores. *E*. Diagram of apex of perithecial stroma, showing perithecia arranged near the periphery. *F*. Sclerotium in spring, bearing several club-shaped perithecial stromata.

when the young rye ovaries are covered with masses of conidia that collect in droplets. These droplets ("honey dew") are dispersed by insects. By the time the normal grain is ripe, the ergot grains are also mature. When the grain is threshed, the ergot grains are admixed with the rye.

ERGOTISM IN LIVESTOCK. There is reason to believe that sclerotia from all species of *Claviceps* are poisonous. From various parts of the world have come reports of the poisonous effect of ergotized

pasture grasses and of ergotized hay when consumed by domestic animals. The fungi involved are mainly *Claviceps purpurea* and *C. paspali*. Poisoning from *C. purpurea* occurs when animals are fed rye as grain or are pastured on ergot-infected *Lolium perenne*, *Poa pratensis*, or *Agrostis alba*. Several serious outbreaks of ergotism among cattle and horses, caused by *C. purpurea* on *Elymus canadensis*, fed as hay, have been reported from the prairie regions of the central United States. *Claviceps paspali*, occurring on several species of *Paspalum* used as forage grasses, is known to cause poisoning of cattle in the Argentine, Natal, and the southern United States.

Poisoning by *C. purpurea* causes lameness and swelling of one or more limbs; in severe cases, as the result of impairment of circulation, the extremities may become gangrenous. Ears, horns, hoofs, toes, feet, and tails may become necrotic and may slough off. The loss to stockmen from abortion by cows and mares is heavy when ergot is abundant. Gastric disturbances and varying degrees of paralysis are other symptoms of ergot poisoning in horses and cattle.

An epidemic of poisoning by *C. paspali* in Mississippi was studied by Brown and Ranck (1915) and Brown (1916). Their feeding trials involved guinea pigs, young calves, and more mature young cattle. They noted that affected animals are highly nervous and are unable to coordinate their movements. Paralysis may ensue, and in consequence affected cattle are unable to reach water to drink. If ergotized grass was kept from the sick animal, and water and feed were given after the administration of a purgative, recovery followed.

TOXICOLOGY. Many painstaking chemical analyses have been made to isolate and identify the active principle in ergot, as is apparent from Barger's (1931) monograph. In 1875 Tanret [Barger (1931)] isolated what he regarded as a pure alkaloidal substance and as the active principle, and called it ergotinine. In 1884 Kobert [Barger (1931)] identified three substances, ergotinic acid, sphacelic acid, and cornutine. Ergotinic acid is a nitrogenous glucoside that causes inflammation of mucous membranes and hemolysis. Kobert first thought sphacelic acid caused uterine contractions but later attributed this action to cornutine. At first cornutine was thought to cause convulsions and paralysis. In 1897 Jacoby isolated a phenol-like substance that he called

sphacelotoxin. When acted upon by an alkaloidal base, sphacelotoxin became secalintoxin, and when purified, it became the ergotinine of Tanret. Analysis by Kraft in 1901 yielded two alkaloids, Tanret's crystalline ergotinine and an amorphous hydroergotinine. In 1906 Barger and Dale [Barger (1931)] maintained that Kraft's hydroergotinine is ergotoxin, $C_{35}H_{41}O_6N_5$, an alkaloid capable of increasing blood pressure, of causing gangrene on the combs of hens, and of inducing uterine contractions. Tanret, who first gave the formula of his ergotinine as $C_{35}H_{40}O_6N_4$, later changed it to $C_{35}H_{40}O_5N_5$. After years of study Barger concluded that the correct formula of ergotinine is $C_{33}H_{35}O_5N_5$.

Reports of studies on the nature of the toxic principle in ergot appeared almost simultaneously from several laboratories. Stoll and Burkhart (1935) called their purified alkaloid ergobasine; Thompson (1935) called his ergostetrine. Dudley and Moir (1935) named their substance ergometrine. Kharasch and Legault (1935) called their product ergotocin. They got 0.1 to 0.3 mg of ergotocin from 3 to 4 grams of ergot grains, an amount held to constitute a dose. Kharasch, King, Stoll, and Thompson (1936) compared the melting points of the four alkaloids, ergobasine, ergostetrine, ergometrine, and ergotocin, and those of certain of their salts, and also the optical properties of each in different solvents, and came to the conclusion that the four names are synonymous.

The alkaloidal content of ergot varies with the year and with the locality. Spanish and Portuguese ergot assays 0.05 to 0.30%, whereas ergot from Russia and Poland varies from 0.02 to 0.10%. The superiority of the Spanish and Portuguese ergots may be causally related to moisture. When stored at high humidities, ergot deteriorates, deterioration being correlated with increased histamine content. When stored dry, it keeps for long periods, although pharmaceutical supply manufacturers avoid buying ergot that is more than a year old.

TOXICITY OF *GIBBERELLA SAUBINETTII* (*G. ZEAE*) AND *FUSARIUM* SPP.

The heads or inflorescences of various grasses may be parasitized by a polymorphic ascomycetous fungus, *Gibberella saubinetii*, that is especially destructive to barley, oats, rye, wheat, and

corn. On small grains the disease is known by the common name scab. The causal fungus is most frequently encountered in its conidial stage, which is of the *Fusarium* type. As the cereal crop approaches maturity, conidia of the *Fusarium* stage are present in profusion at the surface of the grains and glumes. This fungus, especially as it occurs on barley, has long been known to be poisonous. The status of present-day knowledge of its toxicity in connection with scabby barley is summarized in a report by Christiansen and Kernkamp (1936).

Long ago peasants in Russia found that scabby barley, when used in bread-making or when fed to livestock, is toxic. In northern Russia this toxicity came to be attributed to *Fusarium avenaceum* (Fr.) Sacc., and in southern Russia, to *Fusarium gramineum* Schwabe. In the United States about a dozen species of *Fusarium* are known to be associated with barley scab.

Barley scab was unusually abundant in 1928 in the Upper Mississippi Valley. Much of this diseased barley was used to feed swine, and in consequence of complaints of sickness in the herds, special efforts were made to learn more about the poisonous properties of *Fusarium*-affected barley. Some of the diseased crop was exported to Europe, where similar complaints arose from its use as feed for swine. The results of experimentation that was initiated in the United States and in Europe leave no doubt that the feeding of scabby barley is responsible for sickness among domestic animals. In their entirety these experiments showed that such barley is poisonous to horses, cattle, sheep, pigs, chickens, and dogs, ruminants being able to tolerate greater proportions of affected grains.

Christiansen and Kernkamp (1936) observed that pigs refuse to eat scabby barley unless they can get nothing else. If the proportion of affected kernels is as much as 16%, it is extremely toxic, and if as much as 32%, the pigs refuse to eat it. Poisoning is manifested by loss of appetite, listlessness, and weakness and nausea; death may ensue. These investigators found that the poisonous principle is water-soluble and heat-stable. An aqueous extract from 15 grams of scabby barley, when administered orally through a stomach tube to a pig weighing 100 lb, caused vomiting. An overdose of extract from *Fusarium*-infected corn caused death.

Christiansen and Kernkamp isolated several species of *Fusarium* from affected barley kernels, *F. gramineum* being most common. Extracts from pure cultures of these species did not prove toxic to pigs, although they refused to eat barley that had been used as a culture medium unless it was masked by mixture with a sufficient quantity of other feed. When Christiansen and Kernkamp inoculated wheat, barley, and corn with *F. gramineum* at a time when the grain was developing, the ripened kernels were found to contain the toxic principle. Moreover, affected grain retained its toxicity for long periods, at least 3 years. Affected kernels tend to float at the surface of water; this fact can be utilized in separating normal and scabby grains.

Concerning the chemical nature of the toxic principle little has been established to date, except that it is water-soluble and thermostable. Schroeter and Strassberger (1931) found large quantities of choline and fatty acid esters of choline in *Fusarium*-affected grain and expressed the opinion that these substances constitute the toxic principle.

It may be recalled that the proximate cause of wilting in vascular diseases of crop plants associated with species of *Fusarium* is commonly regarded as a toxin. The experiments with *Fusarium*-affected grain indicate, as a line of departure, the employment of animals in studies involving the nature of such toxins in *Fusaria* causing vascular-wilt diseases.

IMPLICATIONS

In the past, studies of poisonous fungi have been concerned mainly with the identity of the poisonous fungus, with the nature of its toxic principle, and with the effects of this principle upon animals and man. Too little is yet known about fungi poisonous to seed plants. It is indicated that future studies should stress plant toxemias to a greater extent than have those of the past, in order to account for the disease syndrome. By the use of plant toxins as antigens, it should be possible to produce specific antitoxins. Furthermore the ultracentrifuge and electron microscope should enable the worker to purify fungus toxins and antitoxins and thus to learn something more of their physical properties and eventually of their chemical constitution.

LITERATURE CITED

- ATANASOFF, D., "Ergot of grains and grasses" (stenciled copy, 107 pp.). U. S. Dept. Agr., Bur. Plant Industry. 1920.
- BARGER, G., "Ergot and ergotism," a monograph based on the Dohme lectures delivered in Johns Hopkins University. 279 pp. Gurney and Jackson, London. 1931.
- BROWN, H. B., "Life history and poisonous properties of *Claviceps paspali*," *J. Agr. Research*, 7: 401-406, 1916.
- BROWN, H. B., AND E. M. RANCK, "Forage poisoning due to *Claviceps paspali* on Paspalum," *Miss. Agr. Expt. Sta. Tech. Bull.*, 6: 3-35, 1915.
- CHRISTIANSEN, J. J., AND H. C. H. KERNKAMP, "Studies on the toxicity of blighted barley to swine," *Minn. Agr. Expt. Sta. Tech. Bull.*, 113. 38 p. 1936.
- DUDLEY, H. W., AND J. C. MOIR, "The new active principle of ergot," *Science*, 81: 559-560, 1935.
- DUJARRAC DE LA RIVIERE, D., AND ROGER HEIM, *Les champignons toxiques*. Paris. 1938.
- FALCK, R., "Über die Luftinfektion des Mutterkorns (*Claviceps purpurea* Tul.) und die Verbreitung pflanzlicher Infektionskrankheiten durch Temperaturströmungen." *Z. Forst- und Jagdwesen*, 43: 202-227, 1911.
- FORD, W. W., "The toxicological constitution of *Amanita phalloides*," *J. Expt. Med.*, 8: 437-450, 1906.
- "The toxins and antitoxins of poisonous mushrooms," *J. Infectious Diseases*, 3: 191-224, 1906a.
- "On the presence of hemolytic substances in edible fungi," *J. Infectious Diseases*, 4: 434-439, 1907.
- "A clinical study of mushroom intoxication," *Johns Hopkins Hosp. Bull.*, 18: 1-21, 1907a.
- "The distribution of haemolysins, agglutinins, and poisons in fungi, especially the Amanitas, the Entolomas, the Lactarius, and the Inocybes," *J. Pharmacol.*, 2: 285-318, 1911.
- "A new classification of mycetismus (mushroom poisoning)," *J. Pharmacol.*, 29: 305-309, 1926.
- FORD, W. W., AND E. D. CLARK, "A consideration of the properties of poisonous fungi," *Mycol.*, 6: 167-191, 1914.
- FORD, W. W., AND J. L. SHERRICK, "On the properties of several species of the Polyporaceae and of a new variety of Clitocybe, *Clitocybe dealbata sudorifica* Peck," *J. Pharmacol.*, 2: 549-558, 1911.
- "Further observations of fungi, particularly *Clitocybe sudorifica* Peck, *Pholiota autumnalis* Peck, and *Inocybe decipiens* Bresadola," *J. Pharmacol.*, 4: 321-332, 1913.
- FRIES, ELIAS M., *Systema Mycologicum*, 2: p. 268. 1822.
Summa vegetabilium Scandinaviae, p. 381. 1849.
- IWANOFF, N. N., AND E. S. ZWETKOFF, "The biochemistry of fungi," *Ann. Rev. Biochem.*, 2: 521-540, 1932.

- KHARASCH, M. S., H. KING, A. STOLL, AND M. R. THOMPSON, "The new ergot alkaloid," *Science*, 83: 206-207, 1936.
- KHARASCH, M. S., AND R. R. LEGAULT, "Ergotocin," *Science*, 81: 388, 1935.
- KILLIAN, CHARLES, "Sur la sexualite de l'ergot de Seigle, le *Claviceps purpurea* Tulasne," *Bull. soc. mycol. France*, 25: 182-197, 1919.
- KIRCHHOFF, H., "Beiträge zur Biologie und Physiologie des Mutterkornpilzes," *Zentr. Bakt., Parasitenk., II Abt.*, 77: 310-369, 1929.
- LÉVEILLÉ, J. H., "Memoire sur le genre *Sclerotium*," *Comp. rend.*, 14: 446-448, 1842.
- "Memoire sur l'ergot, an nouvelles recherches sur la cause et les effets de l'ergot, considere sous le triple rapport botanique, agricole et medical," *Mem. Soc. Linn. Paris*, 5: 565-569, 1927.
- MENDEL, L. B., "The chemical composition and nutritive value of some edible American fungi," *Am. J. Physiol.*, 1: 225-238, 1898.
- MEYEN, F. J. B., *Pflanzenpathologie*. p. 192. 1841.
- ROLFE, R. T., AND F. W. ROLFE, *The romance of the fungus world*. 309 pp. J. B. Lippincott Co., Philadelphia. 1928.
- SCHLESINGER, H., AND W. W. FORD, "On the chemical properties of Amanita toxin," *J. Biol. Chem.*, 3: 279-383, 1907.
- SCHROETER, G., AND L. STRASSBERGER, "Cholin als Schadstoff in kranker Gerste," *Biochem. Z.*, 232: 452-458, 1931.
- STÄGER, R., "Infektionsversuche mit Gramineen bewohnenden *Claviceps*-Arten," *Botan. Z.*, 61: 111-158, 1903.
- STOLL, A., AND E. BURKHARDT, "L'ergobasine, nouvel alcaloïde de l'ergot de seigle, soluble dans l'eau," *Compt. rend.*, 200: 1680-1682, 1935.
- THOMPSON, M. R., "The new active principle of ergot," *Science*, 81: 636-638, 1935.
- TULASNE, L. R., "Memoire sur l'ergot des Glumacées," *Ann. soc. nat. botan.*, 3 ser., 20: 5-56, 1853.
- ZIMMERMAN, A., "Ergänzende Versuche zur Feststellung der Keimfähigkeit ältere Sklerotien von *Claviceps purpurea*," *Z. Pflanzenkr.*, 16: 129-131, 1906.

Chapter 16

MEDICAL MYCOLOGY

The fungi which are pathogenic to man occupy a position which may well be designated as a "no man's land" for both the mycologist and the medical practitioner. Even well-trained mycologists have no first-hand knowledge of humanly pathogenic fungi, and these organisms remain quite unknown to the physician, since they are given little, if any, attention in the curricula of our best medical schools. Lack of proper appreciation of these fungi may also be attributed in part to the fact that the mycologist is quite unacquainted with the clinical aspects or clinical variations and pathological anatomy of the diseases which they produce and that the physician is lost in the maze of controversial taxonomic and cultural difficulties which both he and the mycologist have fostered. Some of these problems have arisen because the pathogenic fungi exhibit so much variation in appearance when in lesions and when grown on various culture media. In addition, some confusion may be attributed to difficulties in interpreting many of the studies and descriptions of the pathogens. Experienced, well-trained mycologists with the organisms available for critical study find these taxonomic problems very puzzling and time-consuming. As a consequence a confusion has developed which will depend for clarification upon collaborative studies among clinicians, pathologists, taxonomists, serologists, biochemists, and epidemiologists. No single investigator, working independently, can hope to establish order in a field so chaotic. Thousands of papers on medical mycology, many of them case reports, have been published since 1900. An appreciation of the status and scope of this subject can be gained from Dodge's (1935) *Medical Mycology* and from the excellent recent summaries by Tate (1929), Ramsbottom (1931), Gregory (1935) and Emmons (1940). The medical practitioner will find the volume by Lewis

and Hopper (1939) especially helpful in diagnosis and in identification.

Similarly the physician will find the *Manual of Clinical Mycology* by Conant, Martin, Smith, Baker, and Callaway (1944) indispensable in dealing with mycotic diseases. It discusses systematically and briefly symptoms, differential diagnosis, prognosis, immunology, etiology, identification, isolation and cultivation of the fungus, and range of the disease.

It would seem that medical mycology is not surpassed by any other field of mycological study in potential importance and in appeal to the scientific imagination of the young investigator seeking new and difficult problems whose solution means much to the welfare of the human race.

On the basis of present-day knowledge certain general statements regarding fungi pathogenic to man appear to be warranted. These statements are therefore categorically presented in the following introductory paragraphs. In the first place the number of species known to be pathogenic to man is limited. These are mostly imperfect fungi; a few are Ascomycetes, closely related to the yeasts, and a few are Actinomycetes, whose systematic position is still a matter of dispute.

Little is definitely known about their source in nature except that circumstantial evidence indicates that some of them originate on plants. Some species, especially among the Trichophytoneae, occur also on wild and domestic animals and are transmitted to man only by being implanted.

Entrance to the body is gained (*a*) through hair follicles, but never through sweat glands, (*b*) through the nasal passages and thence into the lungs, and (*c*) through abrasions or injuries, as through scratches or wounds made by thorns or splinters. In a few species entrance appears to be gained through the enteron.

The types of tissue reactions induced in man by fungi are extremely variable. Some species remain quite superficial in their effect, whereas others produce deep lesions or involve such internal organs as the lungs, spleen, and liver. Some are local, and some systemic. Among the common tissue changes are congestion, edema, exudation, hyperplasia, necrosis, scar-tissue formation, and suppuration with accompanying migration of polymorphonuclear cells.

In artificial culture many of these pathogens have a very different appearance from the way they look in tissues. Some of them are filamentous when grown at room temperature but under otherwise similar conditions are yeast-like in appearance when cultivated at incubator temperature, 37.5° C.

HISTORICAL MATERIAL

Medical mycology may be said to begin with Schoenlein, who in 1839 associated a fungus with favus, a form of ringworm characterized by lesions and having bright yellow crusts composed of small cup-like scales. The causal organism was given the name *Achorion schoenleini* by Remak 6 years later. In the same year Malmsten employed the generic name Trichophyton for the ringworm pathogen. The deeply seated, suppurative form of ringworm known as kerion was shown in 1856 to be induced by a Trichophyton originating from animals. Further proof of transmission from animal to animal followed, as well as demonstration by various workers that ringworm can be transmitted to man from horse, cow, dog, or cat. All in all, however, little important work in this field was accomplished until Sabouraud began his studies in the early 1890's. The publication of his monumental *Les Teignes* (1910) constitutes the beginning of the modern era of investigation and is the foundation upon which all present-day studies in medical mycology are based.

The medical worker has found it convenient to designate by the term "mycoses" (literally "filled with, or full of, fungi") the diseases of man and animals caused by fungi. This terminology has a definite significance for the mycologist, since the generic name of the pathogen and the suffix "osis" are combined, as in Actinomycosis, Torulosis, Histoplasmosis, and Blastomycosis, and it will be employed in the discussion that follows. Confusion arises, however, when "osis" and "mycosis" are applied to clinically distinct mycoses, such as may be produced by one and the same fungus involving different organs and tissues, for example, "onchomycosis" when the nails are involved, "sychosis" when the beard is involved, and "dermatomycosis" when the glabrous skin is involved. Similarly, the wisdom of retaining the name "dermatophytes" or "dermatomycetes" for those fungi that invade the keratinized layers of the epidermis and such appendages or

modifications as the hair, nails, hooves, feathers, and horns may be questioned. One might with equal reason indicate by the term "caulophytes" those fungi involving plant stems, "fructophytes," those involving fruits, and "phyllophytes," those attacking foliage!

The account that follows is intended as an introduction to the mycologic features of some of the better-known human pathogens. The scope of the field can be appreciated only by consultation of certain voluminous monographic studies, such as those of Sabouraud (1910), Brumpt (1935), and Dodge (1935). It is also quite apparent that all too little is as yet known of the mycotic flora of the surface of the normal body and of the protective mechanisms which the skin affords to invasion by fungus pathogens.

COCCIDIOIDES IMMITIS

This organism, which causes a highly fatal disease, was first reported in Argentina but is best known in California, Arizona, and Texas. The disease is commonly known in its acute form as valley fever; the medical profession calls it coccidioidal granuloma. It has been reported to occur among cattle, sheep, and dogs, but as yet there is little evidence of transmission from animals to man or man to animals. Emmons (1942) reported that the pathogen occurs in rodents, including deer mice, pocket mice, kangaroo rats, and ground squirrels, in Arizona and also that he was able to isolate it from soil.

The early history of coccidioidomycosis is summarized in an account by Rixford, Dickson, and Beck (1931). The disease

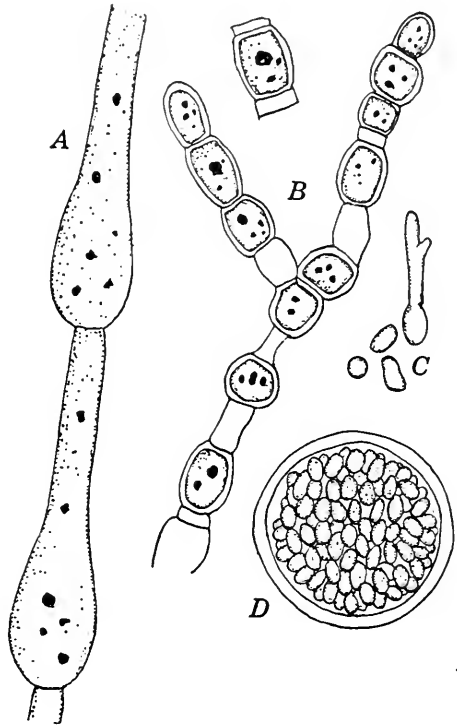

FIG. 66. *Coccidioides immitis*. A. Hypha from nutrient agar, tending to be racket-shaped. B. Arthrospores from culture. C. Spores, one of them germinating from globular sporangium-like cell, which contains numerous spores. (After Moore.)

may be manifest as a mild, pleurisy-like, respiratory infection, with chills, night sweats, and headache. After 2 or 3 weeks papillomatous eruptions appear on the arms, thighs, and scalp, and occasionally the knee and ankle joints are arthritic. Examination by X-ray may reveal pulmonary nodules resembling primary tuberculosis. The sputum is mucopurulent and may contain blood.

Ulcerative lesions on the face and neck may characterize another form of the disease. Such lesions slowly become subcutaneous and may spread to the meninges and spinal cord. If the miliary type of involvement develops, the fever is high, prostration is marked, and death occurs after a few weeks.

When present in the tissues, *Coccidioides immitis*, described by Stiles in a report by Rixford and Gilchrist (1896), consists of large, thick-walled, spherical cells that may reach a diameter of 50 to 70 μ . At maturity these cells function as sporangia, although they have been misinterpreted by some to be asci. By cleavage their content gives rise to a large number of spores, which escape by rupture of the sporangial wall. From a comparative study of 15 strains by Baker, Mrak, and Smith (1943) it has been concluded that the organism is a Phycomycete.

This fungus in cultures on semisolid media forms creamy white, cottony mycelium. By fragmentation chlamyospore-like oidia are produced. Sporangia and sporangiospores are developed, however, if cultured under reduced oxygen tension in the presence of egg albumen or serum.

The acute type of the disease probably enters through the pulmonary route. The pathogen has been isolated from the soil, but soil may not constitute its natural habitat. In patients who recover spontaneously, and among residents of the San Joaquin Valley generally, intradermal injection of killed cultures of the fungus results in rather severe skin reactions.

CRYPTOCOCCUS HISTOLYTICUS

Approximately 30 species of *Cryptococcus* are reported to be pathogenic to man, *Cryptococcus histolyticus*, a cause of blastomycosis, being perhaps the best known. Reports of blastomycosis include a disease which in the United States manifests itself by a disturbance of the central nervous system, clinically like

chronic meningitis, whereas in Europe ulcerative lesions of the skin and underlying tissues are a more common manifestation. The evidence by Benham (1934) indicates that European blastomycosis and American torulosis are identical. Freeman's (1931) account of clinical appearance and pathology shows that there may be chronic respiratory involvement which leads to a diagnosis of tuberculous meningitis. The pathogen is presumed to enter through the respiratory tract.

The etiology of this disease remains confused. Freeman (1931) indicates that several organisms may produce the same disease complex.

The pathogen is usually known as *Torula histolytica* or *Cryptococcus hominis*. It is one of the Saccharomycetaceae, having ovoid to elliptical cells occurring singly or in groups and invested by a thick gelatinous capsule. It forms white to yellowish white, pasty, opaque colonies on agar. Its only known method of reproduction is by buds, unless the researches of Todd and Hermann (1936) are confirmed. Their study of the developmental cycle shows endospore formation of the type found in *Debaryomyces*, in consequence of which they referred the pathogen to *D. hominis*. It has been suggested, on the basis of priority, that the proper binomial is *D. neoformans*.

A generalized blastomycosis, manifest as cutaneous abscesses, is caused by the closely related *Blastomyces dermatitidis*, also known as *Gilchristia dermatitidis* or *Zymonema dermatitidis*.

HISTOPLASMA CAPSULATUM

Approximately 30 years ago Darling reported the occurrence among the natives of Panama of a disease characterized clinically by fever, emaciation, anemia, splenomegaly, leucopenia, and ulceration of the nose, throat, and intestines. He was not able to isolate the etiologic agent but believed it was a protozoan, to which he gave the name *Histoplasma capsulatum*. Subsequently other cases of histoplasmosis were recorded in widely separated places, and in 1932 de Monbreun (1934) isolated and described the causal fungus. In the mononuclear blood cells and lymph vessels it exists as yeast-like cells with thick capsules. When the organism is kept at body temperature on blood or serum media, this form of the pathogen persists. When grown on other agar media, however, it

is filamentous and produces peculiar spherical conidia or chlamydospores, covered with finger-like outgrowths, 10 to 25 μ in diameter.

Its relationship to other fungi is not clearly established. It has been interpreted to be related to *Coccidioides* and placed in the Genus *Posadasia* among the Endomycetaceae. Studies by Howell (1939), however, in which *Histoplasma* was compared with *Sepe-*

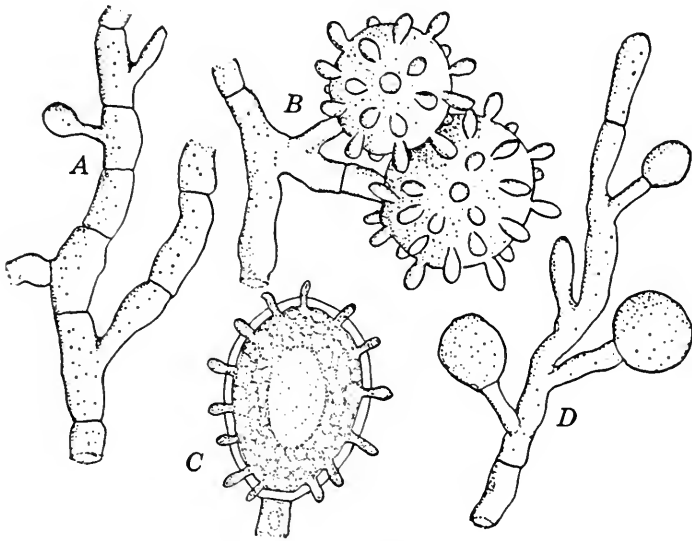

FIG. 67. *Histoplasma capsulatum*. A. Mycelium from culture. B. Aleurospores that form on aerial mycelium, showing characteristic protrusions. C. Aleurospore in optical section. D. Aleurospores that form submerged. Their walls are smooth.

donium and other fungi related to *Sepedonium* show that these two genera are closely related Fungi Imperfecti. *Sepedonium* is never yeast-like, however, and it may produce phialospores, which are not known to be developed among species of *Histoplasma*. Conant (1941) reported that in its parasitic form within tissues *Histoplasma* is always yeast-like with thick capsules. On blood agar incubated at 37° C it buds, yeast-like, but at room temperature it is myceloid and forms tuberculate chlamydospores. Conant too regards it as closely related to *Sepedonium*.

PHIALOPHORA VERRUCOSA

This is among the organisms involved in a chronic infection of the skin and subcutaneous tissues, characterized by the presence

of warty or cauliflower-like excrescences. Usually the hands are involved; the feet are especially susceptible to infection. Other parts also are known to bear the nodular ulcers. The disease has a wide geographical distribution [Emmons (1940)] in the tropics of both hemispheres, especially among laborers who work bare-footed. There is no evidence of spread from person to person. The pathogen appears to enter through injuries, such as those from thorns or splinters.

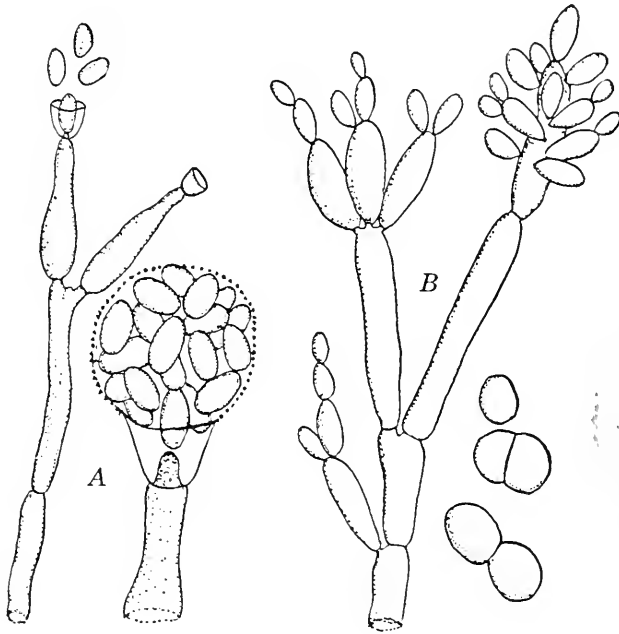

FIG. 68. A. *Phialophora verrucosa*, the spores borne in a phial and adhering in a mass at the opening of the phial. B. *Hormodendron pedrosoi*, conidiophores and chains of conidia that arise as buds.

Two names, *chromoblastomycosis* and *dermatitis verrucosa*, both of which have been criticized, have been applied to the disease. The name *chromoblastomycosis* is criticized on the grounds that the fungus cells within the tissues, although pigmented, do not bud in yeast-like fashion but divide by septation. The roughening of the skin indicated by the name *dermatitis verrucosa* does not give an adequate clinical picture, since other tissues and related conditions are included in the disease complex.

The causal agency was first described by Medlar (1915) as *Phialophora verrucosa*, one of the Dematiaceae, although the disease was first observed by Pedroso in Brazil 4 years earlier. *Phialophora*, when seen in scrapings or in biopsied dermal papillae, con-

sists of thick-walled, brown, spherical cells or two or three closely associated cells. In its saprophytic phase on agar it is myceloid and grayish black. Sporulation occurs from lateral conidiophores, which are phial-like or cup-like with funnel-shaped mouths. The small spores are formed in the base of the cup and are extruded but adhere in a spherical mass at the mouth of the cup.

The natural habitat of *P. verrucosa* is revealed by the work of Conant (1937). He found that *Cadophora americana*, one of several species that cause a blueing of wood pulp, is morphologically and culturally identical with *P. verrucosa*. Further evidence of their identity comes from their antigenic similarity, established by Martin (1938).

Another closely related species, *Hormodendrum pedrosoi*, described by Brumpt in 1922 [Brumpt (1935)], causes an involvement whose clinical aspects cannot be distinguished from those induced by *P. verrucosa*. This fact has been established by several investigators, among whom are Emmons (1936) and Martin, Baker, and Conant (1936). Further evidence adduced by Emmons and Carrión (1937) showed that some strains of *H. pedrosoi* may form phialospores in culture. Not only have morphologic relationships been established between these two fungi that produce chromoblastomycosis, but also serologic evidence of Martin, Baker and Conant (1936) and Conant and Martin (1937) shows a very close relationship. These workers found that *H. pedrosoi* causes specific complement-fixing antibodies to form in the patients' serum and that there is a cross-antigenic relationship between strains of *Hormodendrum* and *Phialophora*. The taxonomic difficulties that have arisen in this complex are indicated by combinations which have placed the pathogen in such genera as *Gomphinarina*, *Fonsecaea*, *Carrionia*, *Acrotheca*, and *Trichosporium*. Presumably one variable species only is involved in the production of chromoblastomycosis, as is indicated in the brief but comprehensive account by Carrión (1942).

MALASSEZIA OVALIS

Approximately 75 years ago Malassez reported the occurrence of an organism, *Pityrosporum ovale*, in the squamae, follicles, and sebaceous glands of the scalp. Since then many papers have been published, interest in this organism being centered on its possible

relationship to baldness. Some workers have maintained that this organism is the cause of dandruff and seborrheic dermatitis; others, that it is a harmless saprophyte. Unna, one of the foremost students of this problem, is among those who believe that *P. ovale*, which he called the "bottle bacillus" because of the shape of the cells, is the etiologic agent in this scaly condition of the scalp; he designated the disease "pityriasis capitis."

Among the recent workers who regard this organism as pathogenic is Moore (1935), Ota and Huang (1933), on the other hand, concluded that their yeast-like isolates from seborrheic dermatitis, belonging to *Pityrosporum*, were saprophytes. The most critical study of this whole problem is that of MacKee and his associates (1938). They made direct examination of the scrapings of normal and diseased scalps and in one series found *P. ovale* in 86 of the 100 cases examined, prevalence being little different on the normal and on the diseased scalps. From these scrapings they also cultured species of molds belonging to *Aspergillus*, *Rhizopus*, *Alternaria*, *Chaetomium*, *Torula*, *Dematium*, and *Mycoderma*, and in addition several species of *Staphylococcus*. MacKee and his associates conclude: "The occurrence at times of the organism [*P. ovale*] on all types of scalps and the fact that it may occasionally be found in as large numbers on the normal scalp as on one with severe dandruff leads one to consider the possibility that this yeast is a saprophyte, and grows well in the presence of scaling or in sebaceous material but is not responsible for the presence of these findings."

ACTINOMYCES BOVIS

Bacteriologists and mycologists are not in accord on the systematic position of *Actinomyces*, bacteriologists regarding it as among the Schizomycetes, and mycologists including it among the Hyphomycetes. *Actinomyces* is a large genus and includes not only many species that are pathogenic to man and other animals, but also a few plant pathogens and many species that are normal inhabitants of the soil.

The mycelium of *Actinomyces* consists of very slender, branched hyphae, commonly about $1\ \mu$ in diameter. More or less specialized branches become sporogenous and by segmentation

form chains of spores. These sporogenous hyphae are coiled, the rotation of the helix and the type of coiling being characteristic of the species.

The best known of the species pathogenic to man is *Actinomyces bovis*, described by Harz (1879) in 1879. It causes a chronic disease known to the medical profession as actinomycosis and characterized by the formation of suppurative tumors.

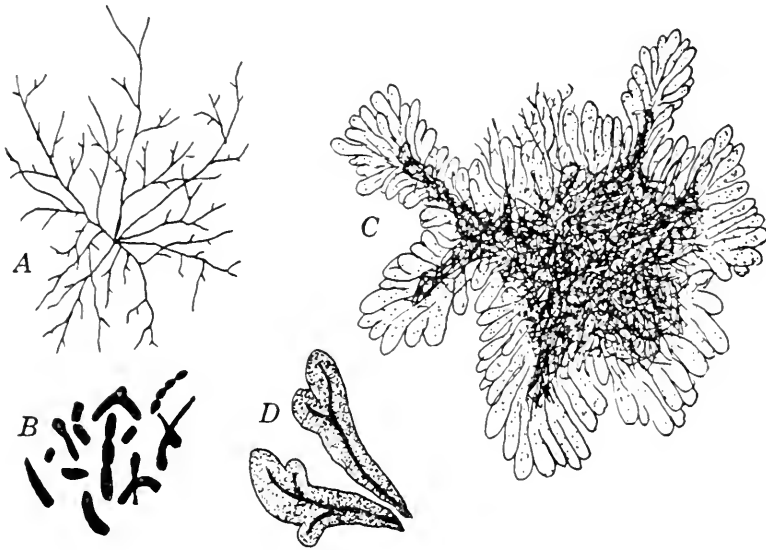

FIG. 69. *Actinomyces bovis*. A. Filamentous appearance of colony in culture. B. The hyphae from culture when smeared on microscopic slide fragment to become bacteria-like. C. "Sulphur granule" taken from abscess and stained to show peripheral clubs. D. View of clubs with magnification slightly increased over that in C.

Farmers and cattlemen are more commonly afflicted than are persons in other occupations. The disease involves not only man but also such other animals as horses, cows, sheep, and pigs, as well as many species of wild animals. In cattle the disease is called "lumpy jaw," "wooden tongue," or "sarcoma of the jaw." In man *A. bovis* may involve any part of the body but is most common on the head and neck. About 60% of all cases are cervico-facial, 14% are thoracic, and 8 to 18% involve the abdominal organs.

Many cervico-facial cases arise from dental defects or after the extraction of teeth. Studies by Emmons (1935) show that in a high percentage of instances the causal fungus can be isolated from the normal mouth, carious teeth, tonsillar crypts, or drain-

ing sinuses. He found it in 47% of extirpated tonsils in Puerto Rico.

Meningitis and endocarditis are among the occasional manifestations of actinomycosis. In generalized actinomycosis evidence indicates that the pathogen is spread through the blood stream.

Emmons (1935) has shown that some of the confusion regarding the causal fungus has arisen because it is a microaerophilic species and must not be confused with aerobic contaminants. It appears to be widespread on vegetation, so that it is inadvisable to chew straws, sticks, weeds, or plant stems. Slight wounds appear to serve as portals of entry for the fungus into the tissues. Further confusion in etiology arises because the aerobic species, *Actinomyces hominis*, is primary in approximately 10% of Actinomyces cases.

Such generic names as *Nocardia*, *Streptothrix*, *Oospora*, and *Discomyces* have been applied to this fungus. Some workers prefer to use for it the name *Actinomyces israeli*. An extensive bibliography on actinomycosis exists. In a publication by Musgrave and his associates (1908) that appeared in 1908 more than 1500 titles of papers on this disease are assembled.

In the diagnosis of actinomycosis the presence of granulation tissue and of pus-containing "sulphur granules" should be sought. These granules are composed of radially arranged hyphae, which are terminated peripherally by eosin-staining clubs, the clubs being sheathed hyphal tips. Emmons (1935) states that these clubs are not formed within tonsillar tissues. Observations by Lentze (1938), involving 55 cases of true actinomycosis, showed that granules can be demonstrated in 80% of the cases. He placed the pus in a drop of methylene blue and noted that the leucocytes which take the methylene blue invest a cauliflower-shaped meshwork of threads whose periphery consists of bluish-green clubs.

SPOROTRICHUM SCHENCKII

A comprehensive account of the Genus *Sporotrichum* and the clinical aspects of diseases it induces are contained in the monographic treatise by Beurmann and Gougerot (1912). One species, *S. schenckii*, first described by Schenck in the United States in 1898 [Emmons (1940)] is definitely pathogenic to man. Certain other species, including *S. beurmanni* and *S. equi*, are believed to

be specifically identical with *S. schenckii*. This organism commonly enters through some minor injury, such as a barberry, rose, or bramble puncture. Evidence also points to inoculation from splinters or into abrasions incurred in the work of clearing land. An ulcerative lesion that fails to heal develops. Gradually subcutaneous abscesses form that spread along the lymphatics, dissemination apparently being hematogenous. Once the disease becomes

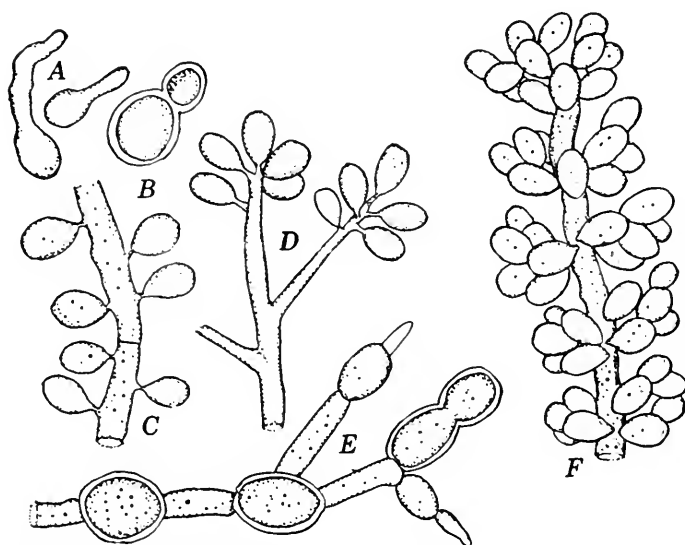

FIG. 70. *Sporotrichum schenckii*. (Adapted from Moore.) A. Germinating spores. B. Yeast-like spores. C. Aleurospores laterally formed in culture. D. Terminally formed spores that may become chlamydo-spore-like. E. Both intercalary and terminal chlamydo-spores may form in culture. F. Conidia formed abundantly.

systemic, various organs, muscles, bones, lungs, joints, and other tissues, including the brain and viscera, become involved.

Sporotrichosis may occur spontaneously in horses, dogs, cats and rabbits. Attention was called by du Toit (1942) to the occurrence of *S. beurmanni* on wood, mud, and other materials in a mine in the Transvaal, where an outbreak of sporotrichosis involved 650 among 2500 native miners. The organism was introduced by a worker. Sterilized wood and mud constituted good substrata for the cultivation of *S. beurmanni*.

On agar the fungus forms white colonies that may become brownish with age. Temperatures within the range 30° to 38° C are optimum. The hyphae are much branched, and chlamydo-spores appear on media poor in nutrients. Conidiophores are not

differentiated, but profuse clusters of ovoid hyaline conidia arise laterally or terminally on short branches.

Beurmann and Gougerot isolated from various plants species of *Sporotrichum* that they believed were pathogenic. Further evidence in support of its occurrence on vegetation is supplied by Benham and Kesten (1932). They inoculated carnation buds with *S. schenckii*, and a bud rot resembling the well-known bud-rot disease caused by *S. poae* developed. When reisolated, it was still virulent for man. These experiments are especially noteworthy, because they constitute the first successful transmission of a human disease to a plant.

This fungus is among the few that produce specific agglutinins when spores are used as antigens. Spores may be agglutinated in high dilutions, indicating strong antigenic properties.

MONILIA (CANDIDA) SPP.

Within the Genus *Monilia*, as used in a medical sense, are included those fungi having sparse mycelial development and reproducing by budding to form white, smooth colonies on agar. The numerous species in this genus rather readily dissociate into rough and smooth colonies on artificial media; they vary in virulence. Some of them are filamentous at room temperature but yeast-like at body temperature, and others are filamentous on ordinary agars and yeast-like on blood agar. They are entirely distinct from *Monilia* as used by the plant pathologist to designate conidial stages of *Sclerotinia*. Dodge (1935) places them in the *Eremasaceae Imperfectae*.

Manifestly a number of generic types are represented among the medical *Monilias*, and accord has not been reached on their proper binomials. These taxonomic problems are set forth clearly in a recent report by Conant (1940); it is apparent that for final agreement action by the International Botanical Congress will be necessary. Among those who have studied the classification of this group are Benham (1931), Langeron and Talice (1932), Shrewsbury (1934), Lamb and Lamb (1935), Dodge (1935), Martin and his associates (1937), and Langeron and Guerra (1938). The generic name *Candida* seems to be the preferred one for medical species of *Monilia*.

Morphologic bases for separating species seem to be inadequate, since clinically similar cases in the hands of a single investigator have yielded organisms that have been placed in as many as a half-dozen different species. This fact induced Benham (1931) to supplement morphologic differences with variations in fermentative ability and serologic characteristics. Lamb and Lamb (1935) used fermentation and precipitation reactions in specific

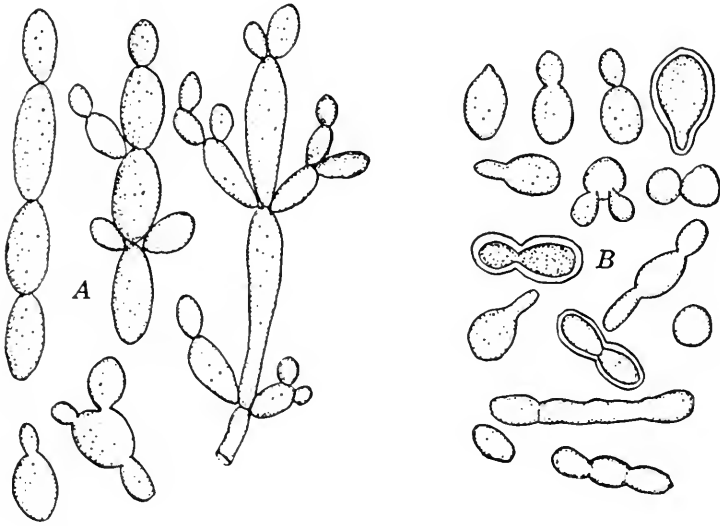

FIG. 71. *A.* Hyphal elements and budding spores of *Candida albicans*. *B.* *Malassezia ovalis*, showing thin-walled and thick-walled spores. Growth usually results in buds, but short hyphae may be formed.

separation. Martin and his associates (1937) employed differences in growth habits on blood agar, corn-meal agar, and Sabouraud's agar, together with fermentation reactions, in their identification of species. All students of the group clearly recognize the inherent variability and dissociative potentialities of *Monilia*.

Two species of *Monilia* are singled out from this aggregate as being of most interest. These include *M. albicans* (*Candida tropicalis*) and *M. psilosis* (*Syringospora albicans* and *S. psilosis*, respectively, according to Dodge).

Monilia albicans is best known in connection with thrush, a disease of the throat and mouth of children; rarely it occurs also in old or debilitated persons. In addition it is of importance as an etiologic agent in pulmonary moniliasis and may also attack the nails, producing chronic paronychia, may involve the mucous membranes of the genitalia, or may cause skin lesions on the palmar

and interdigital surfaces. It may establish secondary infection in pulmonary tuberculosis and has been recorded to be present in the mouths of normal, healthy persons in the proportion of 3 to 24%.

Monilia psilosis is associated with sprue, a disease primarily of the tropics, which involves the intestinal tract. Prolonged diarrhoea and anemia are the most outstanding symptoms. Change of climate and vitamin deficiency have also been assigned etiologic roles in sprue, and *M. psilosis* is now generally believed to be a secondary cause of the disease.

ASPERGILLUS FUMIGATUS

Species of *Aspergillus* are predominantly saprophytes, but Dodge (1935) has assembled published reports showing that approximately 30 species may at times be pathogenic. *Aspergillus fumigatus* is among those that are regularly pathogenic. It attacks man, particularly in humid regions, most commonly producing symptoms that clinically resemble those of pulmonary tuberculosis. If the sputum is examined, conidia will be found, but no trace of *Mycobacterium tuberculosis*. Neither are tubercles formed in the lungs, and upon treatment with potassium iodide the lung involvement usually clears promptly.

Aspergillosis may be regarded as an occupational disease for the reason that it is most prevalent among those who work with abrasives, force-feed fowls, or prepare furs or feathers for use as wearing apparel. The same species involves the lungs of birds, especially quails and grouse, and may cause severe epizootics among them.

Some of the other pathogenic species quite regularly involve the auditory passages or the nails or are associated with abscesses or asthma.

THE TRICHOPHYTONEAE OR RINGWORM FUNGI

The Trichophytoneae constitute a group of 100 to 200 species of Fungi Imperfecti that parasitize man and various animals by invading the keratinized layers of the skin and its modifications, such as hair, nails, feathers, hooves, and horns. The resulting dermatomycoses are commonly known as ringworm, tinea, dhobie

itch, barber's itch, athlete's foot, herpes, favus, or kerion. Nearly all these fungi grow readily on any common culture medium, but most laboratories employ the standard media of Sabouraud to cultivate them. On his "proof medium," containing sugars, growth is especially luxuriant, and the various species exhibit their characteristic cultural aspects. On his "preserving medium," high in peptone and lacking sugars, growth is less rapid in most species, and pleomorphic changes are inhibited.

There is nothing about their mycelium to enable the worker to differentiate the Trichophytoneae from many fungi commonly encountered in the laboratory. Various hyphal structures and various types of spores which develop in culture are employed, however, to identify and classify the numerous species. They may be briefly described, without reference to any particular genus or species, as follows:

a. RACKET-SHAPED HYPHAE. Sabouraud applied the term "raquette cells" to hyphae each of whose cells is of considerably greater diameter at one end than at the other. When these hyphae occur in series, they have somewhat the appearance of tennis rackets placed end to end.

b. TERMINAL CLUBS. When the apices of hyphae were variously enlarged, they were called "terminal clubs" by Sabouraud.

c. PECTINATE HYPHAE. Hyphae bearing short, denticulate projections along one side are called "pectinate hyphae." Usually this portion of the hypha is curved, and the projections form on the convex surface. If the projections appear as short hyphae, they are termed "nodular organs."

d. SPIRAL HYPHAE. In certain species the terminal hyphae are coiled into a rather tight spiral, making up the so-called "spiral hyphae." These structures are regarded by some workers as comparable with the hyphal ornamentations on the peridia of certain Gymnoascaceae and as an indication of relationship with this family.

e. ARTHROSPORES. In the parasitic stage the terminal hyphae become closely segmented, and the segments round up and become separate cells. These are the arthrospores, which constitute the sole means of reproduction in nature, if the possible existence of an ascial stage is disregarded.

f. CHLAMYDOSPORES. If chlamydospores are classified on the basis of their point of origin, there are three types, terminal,

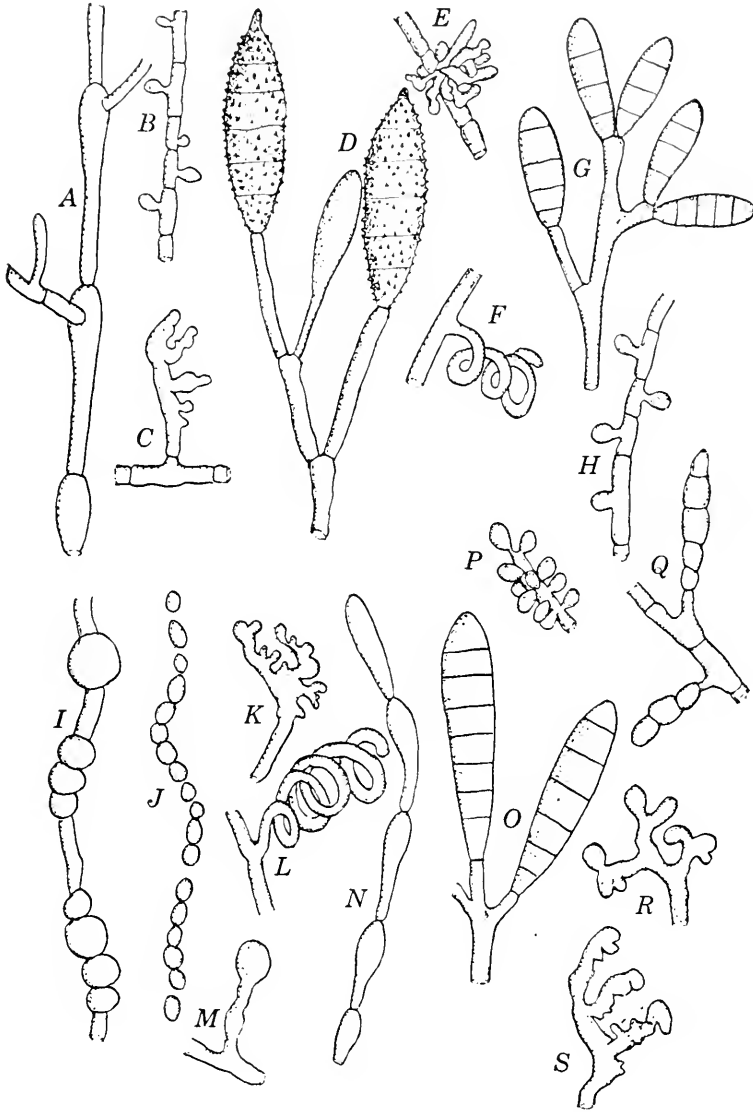

FIG. 72. Types of reproductive cells produced by Dermatophytes. *A-F* apply to *Microsporum*; *G*, to *Epidermophyton*; *H-O*, to *Trichophyton*; *P-S*, to *Achorion*. *A*. Racket cells of *Microsporum*. *B*. Aleurospores. *C*. Pectinate hypha. *D*. Macroconidia or fuseaux. *E*. Nodular organ. *F*. Spiral hypha. *G*. *Epidermophyton* macroconidia. *H*. Aleurospores budding from hyphae of *Trichophyton* in culture. *I*. Intercalary chlamydospores. *J*. Arthrospores. *K*. Pectinate hypha. *L*. Spiral hypha. *M*. Pedicellate chlamydospores. *N*. Racket cells in series. *O*. Fuseaux or macrosprores. *P*. Aleurospores of *Achorion*. *Q*. Chlamydospores. *R* and *S*. Pectinate hypha.

lateral, and intercalary. When the chlamydospores are large and spindle-shaped, they are known as fuseaux, according to the terminology of Sabouraud. Fuseaux may be borne terminally or laterally; they occur singly.

They may be smooth, or the entire surface or a portion of it may be covered with projections. They may consist of one cell or be septate. In some instances lateral chlamydospores are borne on a pedicel and hence are called "pedicellate chlamydospores." This type of chlamydospore may be separate from the parent hypha or may lack a septation.

g. ALEURIES OR ALEUROSPORES. Spores that develop by migration of protoplasts from the hyphal cell into the developing spores, leaving the hyphal cell empty, are known as aleuries or aleurospores. They may not be abstricted and may remain attached, or a septum may be laid down. The hyphae that bear aleuries may be simple or copiously branched. The aleuries of copiously branched hyphae may adhere in grape-like bunches.

CLASSIFICATION. The classification of the members of

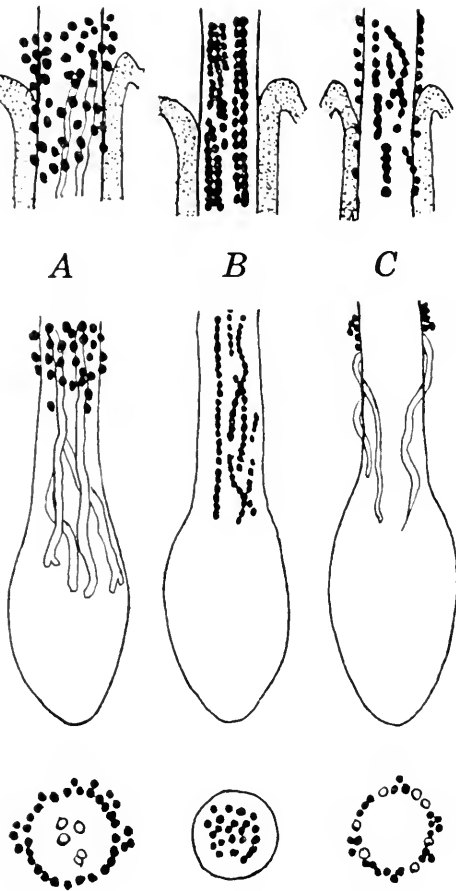

FIG. 73. Diagrams illustrating the relationship of the fungi to hairs in: A. *Microsporium*. B. *Endothrix Trichophyton*. C. *Ectothrix Trichophyton*. Spores arise at or near the opening of the hair follicle. (After Henrici.)

this group is a difficult task, and considerable disagreement exists concerning what characteristics constitute an adequate basis for distinguishing genera and species. Clinical aspects of the disease complex have been given precedence by some workers, purely mycological features by others, cultural characters by others, and host relations by others. This situation may be illustrated by the delimitation of the Genus *Achorion* to include fungi which

cause favus, whereas it is known that this disease may be caused by some species of *Trichophyton* (*Trichophyton*) and *Microsporum* (*Microsporon*) as well. Again *Microsporum* is understood to include those species which produce a sheath of closely aggregated tiny spores, never in chains, around the basal part of the hair. In *Trichophyton*, on the other hand, the infecting hyphae are intrapilar and become closely segmented, appearing as chains of spores. The spores, however, arise in chains from a circumpilar sheath. In some species the circumpilar portion disappears; these were regarded by Sabouraud as "endothrix." In others the circumpilar sheath is the most prominent feature; hence these species are termed "ectothrix." The transition group between these two constitute Sabouraud's "neoendothrix" species.

Species of *Epidermophyton* and *Endodermophyton* are understood to be limited to the glabrous skin. The only kind of spores formed in culture by *Epidermophyton* are separate fuseaux; by *Endodermophyton*, arthrospores.

Several systems of classification have been proposed, including those by Sabouraud (1910) and its modifications (1929), by Ota and Langeron (1923), by Langeron (1926), by Grigoraki (1925, 1929), by Langeron and Milochevitch (1930), and by Dodge (1935). The system of Sabouraud is fundamental and is in general usage among students of this group, since it has the merit of being workable. A comparison of his larger groupings with those employed by Dodge is shown in Table 28.

Emmons (1934) found by a study of representative members of this group that botanical characteristics exist as means for classifying them and that such characteristics should replace clinical ones. He employed shape, size, and method of formation of conidia to separate *Trichophyton*, *Microsporum*, and *Epidermophyton*. *Trichophyton* possesses clavate conidia that are thin-walled and have few septations; *Epidermophyton*, conidia that are clavate to ovate and are thick-walled with few septations; and *Microsporum*, conidia that are spindle-shaped, thick-walled, and frequently septate. Emmons regarded spirals, chlamydo-spores, and nodular organs as of little value in classification.

In separating species Dodge (1935) based his key largely on cultural characteristics of giant colonies. This means of identification becomes increasingly useful as the student gains experience

TABLE 28

CLASSIFICATION OF TRICHOPHYTONEAE, AS USED BY SABOURAUD AND BY DODGE

<i>Sabouraud's Classification</i>	<i>Dodge's Classification</i>	<i>Synonyms</i>	<i>Type Species</i>
Trichophyton	Trichophyton		<i>T. tonsurans</i>
Endothrix	Endothrix		
	Malstenia		<i>T. tonsurans</i>
	Sabouraudia		<i>T. sabouraudia</i>
Neoendothrix	Neoendothrix	Neotrichophyton Cast.	
Ectothrix		Ectotrichophyton Cast.	
Megaspores	Megatrichophyton	Enutotrichophyton	<i>M. roseum</i>
Faviformes	Favotrichophyton		
	Eufavotrichophyton	Grubyella (pro parte)	<i>F. ochraceum</i>
	Bodinia	Bodinia Ota et Lang.	<i>F. violaceum</i>
Microides	Ectotrichophyton		<i>E. mentagrophytes</i>
gypseums		Spiralia Grig.	<i>E. mentagrophytes</i>
niveums		Microtrichophyton N.	<i>E. felinum</i>
Microsporium	Microsporium	Sabouraudites Ota et Lang.	
Neomicrosporium	Neomicrosporium		
Eumicrosporium	Eumicrosporium		
Achorion	Achorion	Grubyella Ota et Lang.	
Neoachorion	Lophophyton		
Euachorion	Euachorion		
Epidermophyton	Epidermophyton		<i>E. floccosum</i>
	Endodermophyton		<i>E. concentricum</i>

with cultures and becomes more and more familiar with them in the laboratory routine.

Studies of the type conducted by Conant (1936, 1936a, and 1937), in which the investigator has at his disposal a large number of species and strains, offers the best means of solving the confusing taxonomic problems of the Trichophytoneae. Conant made biometric studies but may not have had a sufficient number of strains of each species to become familiar with the extremes of variation within a given species. In criticizing these studies, Emmons (1940) pointed out that, if Conant had examined more strains of *Microsporium fulvum* and *M. gypseum*, he probably would have regarded them as specifically identical. At any rate it must be emphasized that the inherent tendency of all species to vary must never be lost sight of by students of this group nor of any other group of fungi.

The difficulties attendant on making specific identification by clinical aspects are illustrated by the experiments of Dowding and Orr (1937). They isolated *Trichophytum gypseum* from three clinically distinct diseases, namely kerion, tinea circinata, and vesicular lesions on feet.

Another technique for identification arises from the work of Davidson, Dowding, and Buller (1932). They observed that hyphal fusions or anastomoses occur between hyphae of the same mycelium or between mycelia of different origin but of the same species, and that no hyphal fusions form between mycelia of different species. If, then, the investigator has stock cultures whose identity is known, it becomes possible by suitable pairings to establish the identity of unknown isolates. In their studies Davidson, Dowding, and Buller employed *Microsporium audouini*, *M. lanosum*, and *Trichophyllum gypseum*.

RELATIONSHIP OF RINGWORM FUNGI WITH OTHER FUNGI. Evidence has been presented to show that the ringworm fungi are conidial forms of Gymnoascaceae and that they have lost their ability to produce asci. Some of this evidence includes the fact that *Ctenomyces serratus*, growing naturally on feathers, possesses as peridial ornaments spiral hyphae that are like those of certain species of small-spored Trichophyton, and that it forms aleurospores and spindles in culture. Nannizzi (1926) is among those who would classify the ringworm fungi with the Gymnoascaceae. He maintained that they should be grown on hair, feathers, horn, or skin and that the morphologic structures developed on synthetic media are all abnormalities. When he cultivated *Achorion gypseum* on these animal decidua, he reported the development of asci and ascospores like those of *Gymnoascus*. Tate (1929) was unable, however, to confirm Nannizzi's findings; moreover they remain without confirmation for other species, and hence it must be concluded that all these problems of relationships require further study.

PLEOMORPHISM. The phenomena of production of physiological species by fungi and of sectoring, saltation, and mutation were discussed in Chapter 7. The term pleomorphism is not to be associated with these phenomena; it applies to a peculiar and confusing change that is especially prevalent among ringworm fungi. When these fungi are grown on sugar-containing media and have reached their maximum development, which is usually attained after 4 to 6 weeks, white, downy tufts suddenly appear on the surface of the mature colonies, suggesting the presence of a surface contaminant. These tufts grow rapidly, enveloping the whole surface and spreading beyond the margin of the primary colony, until a mantle of pure white, downy mycelium envelops

the entire surface. If a fragment of this pleomorphic mycelium is planted on a fresh medium, the cultures obtained are like the pleomorphic mycelium, and these characteristics are retained on subsequent repeated transfer. Pleomorphic forms do not revert to the normal once they have been isolated.

The most striking feature of these pleomorphic colonies is that the majority of them remain completely sterile, whereas other species may form chlamydospores or may bear small, little differentiated, lateral spores. For this reason pleomorphic forms of the different species are very similar to each other, and identification has been difficult and very confusing. Many are so similar, in fact, that some workers question the plurality of species among ringworm fungi.

Variation in this tendency to produce pleomorphic forms exists among these fungi. Pleomorphism is common among small-spored, animal-infecting species of *Trichophyton* and among species of *Microsporon* from animals but is rare or non-existent among species of *Trichophyton* attacking man. Tate (1929) states that it is not known to occur in *Microsporon audouini* or in *Trichophyton radicans* and *T. denticulatum*.

According to Sabouraud, nutritional and temperature factors most favorable for growth are also most favorable for the development of pleomorphic forms. The presence of about 4% of carbohydrates in the medium and constant temperatures of 30° to 37° C induced pleomorphic changes, whereas media with 3% of peptone and no carbohydrates tended to prevent pleomorphic development.

When Langeron and Milochevitch (1930) grew *Sabouraudites asteroides* (the generic termination *ites* should be limited to genera of fossils), *S. granulosis*, *S. lacticolor*, and *S. gypseus*, all of which are pleomorphic on sugars, on cereals, straw, dung, or synthetic media enriched with dextrin or soluble starch, pleomorphic forms did not appear. They concluded that monosaccharides and disaccharides are toxic and that these sugars induce pleomorphic change, whereas polysaccharides and the colloidal complexes of the natural substrata are not toxic and may be used without first being cleaved.

Emmons (1932) cultured *Achorion gypseum* on horn, starting with a single aleurospore. Six distinct pleomorphic variants arose from the progeny, and all were so different that, if they had been

isolated from lesions on patients, they might have been regarded as distinct species. When subcultures were isolated, using aleurospores or fuseaux from these variants, each produced a culture like those from the particular variant from which it originated. Furthermore none of the variants reverted to the parent form. Three different kinds of pleomorphic forms are also known for *Microsporum lanosum*, and all are reversible to each other but not to the primary form. The three include a coarse, shaggy, downy form (the most common one), a white, downy form, and an immersed, glabrous, brown form.

The most remarkable feature of pleomorphism is exhibited by the results of animal inoculations. When used as inoculum, the pleomorphic forms produce lesions that are indistinguishable from those arising from inoculum with the primary or normal form. When the fungus is reisolated from the infected hairs or scales, it invariably grows like the pleomorphic form. Langeron and Talice (1930) used the pleomorphic form of *Sabouraudites felinus* as inoculum, obtained a typical lesion on guinea pig, and were able to reisolate only pleomorphic mycelium. In its normal parasitic phase this fungus consists of an ectothrix sheath of spores surrounding the infected hair and of hyphae internal to the hair. In the pleomorphic form the ectothrix sheath was without spores. If the pleomorphic culture used as inoculum is completely pleomorphic and quite sterile, the cultures reisolated from scales and hairs are likewise quite sterile.

MYCIDES. In 1912 Jadassohn made the interesting observation that primary localized infections (mycoses) by species of Trichophytoneae may be accompanied by secondary lesions (mycides) on distant parts of the body in which no fungus can be found. These mycides have come to be designated as trichophytides, epidermophytides, microsporides, etc., depending upon the genus responsible for the primary lesions. Jadassohn [Gregory (1935)] explained this phenomenon as an allergic reaction, since he found that secondary lesions could be produced by rubbing the spores into the skin of other children. This external origin of mycides, however, has not been substantiated in subsequent investigations. Instead they have been determined to arise from spores or toxic products of the pathogen liberated in the primary lesions and disseminated by the blood stream. The reaction appears, therefore, to result from hypersensitivity to the fungus protein. Evidence

in support of internal origin comes from the symmetrical distribution of rashes or eruptions (the "id" lesions) on the body surface and from the isolation of spores from the circulating blood. Gregory (1935) summarized the findings of various workers regarding the isolation of fungi from the blood. He noted that among the fungi isolated are *Trichophyton interdigitale*, *T. granulosum*, *T. gypseum*, *T. cerebriforme*, *Achorion schoerleini*, *A. quinckeanum*, and *Microsporum audouini*.

Wise and Wolf (1936) pointed out that the vesicular eruptions on the hands of patients with primary mycotic infections on the feet may not necessarily be ids. In their opinion, however, such eruptions, except in persons with occupational eczema or eczema of unknown cause nearly always occur coincidentally with infection of the feet.

Species other than Trichophytoneae may evoke the formation of ids, as *Monilia* [Hopkins (1932)] and *Sporotrichum* are known to do. Evidence presented by Hopkins shows that *Monilia* in the alimentary tract may produce substances which induce skin lesions in the sensitized person.

Some persons possess a related allergy to such common fungi as *Cladosporium*, *Penicillium*, and *Aspergillus*, present in household dust or in clothing. Consideration of this subject is outside the province of this book; the student may introduce himself to this problem by consulting the report by Rackemann, Randolph, and Guba (1937-38). They found that the tomato-mold fungus, *Cladosporium fulvum*, may irritate the nasal mucosa and eyes, producing asthma.

Ids may also appear on sensitized animals. De Lamater and Benham (1938) inoculated *Trichophyton gypseum* through the skin and into the blood stream of guinea pigs, whereupon widely disseminated fungus-free lesions developed.

FLUORESCENCE. Margarot and Devès (1924-25) made the interesting observation that the affected hairs of patients with *Microsporum* ringworm or with favus and also cultures of the causal fungi exhibit a greenish fluorescence if examined with ultraviolet light filtered through Wood's nickel oxide glass. This discovery has proved a useful tool in diagnosis. Others have confirmed and extended these observations and have sought an explanation of the source of these fluorescent properties. Kinnear (1931) concluded that fluorescence is resident in the fungus itself in the case of

Microsporum audouini, *Trichophyton crateriforme*, *T. acuminatum*, *T. sulfureum*, and *T. polygonum* and that it is retained in the hairs when treated with potassium hydroxide for indefinite periods. In endothrix trichophyta and in favus, however, fluorescence was attributed to keratin of the hairs.

Davidson and Gregory (1932) noted that the ectothrix trichophyta, *Trichophyton gypseum* and *T. album*, do not exhibit greenish fluorescence, but with certain species with endothrix hyphae, such as *Achorion schoenleini*, fluorescence resides in the hair, as Kinnear (1931) maintained. They extended their observations by defatting, in warm water or in ether, hairs infected by *Microsporum audouini*, *M. felinum*, or *Achorion schoenleini* and then extracting with potash and secured a fluorescent extract. The hairs so treated were no longer fluorescent. Normal hairs and *Trichophyton*-infected hairs, moreover, did not yield a fluorescent substance by this same procedure. These results may be regarded as proof that the invading fungus produces some hydrolytic change in the hair substance and that this product has fluorescent properties. The exact nature of the substance still remains unknown.

PHYSIOLOGIC ACTIVITIES. Both Tate (1929) and Dodge (1935) have briefly reviewed the publications dealing with the physiology of the Trichophytoneae that are peculiarly adapted to living on keratinized tissues. Since the early studies of Verujsky (1887) on the activities of *Trichophyton tonsurans* and *Achorion schoenleini* many investigators have been concerned with the physiology of this group of fungi. Verujsky found that both species grow best in neutral or slightly acid media, with 33° C the optimum temperature. Both produce proteolytic enzymes, as is evidenced by the liquefaction of gelatin. *Trichophyton tonsurans* can utilize glucose and maltose, but *A. schoenleini* does not possess the ability to ferment these sugars.

A considerable number of these fungi have been grown in pure culture for periods varying from a few months to two years without loss of virulence, such substrates as feathers, horn, leather, silk, straw, and wood [Dodge (1935)] being employed. The organisms tested include *Trichophyton flavum*, *T. floccosum*, *T. granulatum*, *T. interdigitale*, *T. mentagrophytes*, *Achorion gypseum*, and *A. muris*.

Roberts (1894) tried unsuccessfully to demonstrate a "kerolytic" enzyme by growing certain species on hairs as a substrate. Later Tate (1929a) failed to demonstrate a keratin-cleaving enzyme in *Trichophyton radiolatum*, *T. tonsurans*, *Microsporium lanosum*, *M. audouini*, or *Achorion schoenleini*. All species were capable of utilizing maltose, starch, casein, and tributyrin and, except for *T. tonsurans*, urea. None, however, produced peptase, invertase, lactase, zymase, and inulase.

Goddard (1934), employing *Trichophyton interdigitale* and *Microsporium lanosum*, found that both showed increased growth in media containing glucose, mannose, fructose, and arabinose. There was a slight increase with sucrose, but not with lactose. Casein and peptone were hydrolyzed to amino acid and ammonia, with a sparing action in the presence of glucose.

The production of pigments among Trichophytoneae and the properties of these pigments have been given consideration by Tate (1929a) and others. Such species as *Trichophyton acuminatum*, *T. magnini*, *T. vinosum*, *Sabouraudites ruber*, and *S. radiolatus* form red to reddish brown pigments, which are soluble in dilute acids and acid alcohol. In these solvents the color is yellow, changing to a reddish hue if alkali is added. Reversal of color change may be accomplished repeatedly. Evidence indicates that these are anthracene pigments like those in *Physcia* and certain other lichens.

IMPLICATIONS

Medical mycology is still in its infancy. This conclusion is evident to staff members of hospitals where there are practitioners trained to recognize and diagnose mycoses. In hospitals not so staffed the etiologic role of fungi is not even suspected in many instances. This condition will continue to exist until this subject receives proper consideration in the curricula of medical schools.

A "run-of-the-mine" mycologist could not expect to contribute materially to medical mycology. To become a medical mycologist, he should supplement his training by the usual courses required for a degree in medicine, with additional special training in bacteriology, biochemistry, pathology, and immunology. Finally, his laboratory should be so located as to insure ready contact with the clinical aspects of fungus diseases.

LITERATURE CITED

- BAKER, E. E., E. M. MRAK, AND C. E. SMITH, "The morphology, taxonomy, and distribution of *Coccidioides immitis* Rixford and Gilchrist 1896," *Farlowia*, 1: 199-229, 1943.
- BENHAM, RHODA W., "Certain Monilias parasitic on man, their identification by agglutination," *J. Infectious Diseases*, 49: 183-215, 1931.
- "The fungi of blastomycosis and coccidioidal granuloma," *Arch. Dermatol. Syphilol.*, 30: 385-400, 1934.
- BENHAM, RHODA W., AND BEATRICE KESTEN, "Sporotrichosis, its transmission to plants and animals," *J. Infectious Diseases*, 50: 437-458, 1932.
- BEURMANN, L., AND H. GOUGEROT, *Les Sporotrichosis*. 825 pp. Felix Alcan, Paris, 1912.
- BRUMPT, E., *Précis de parasitologie*. Masson et Cie, Paris. 1935.
- CARRIÓN, A. L., "Chromoblastomycosis," *Mycol.*, 34: 424-441, 1942.
- CONANT, N. F., "Studies in the genus *Microsporium*. I. Cultural studies," *Arch. Dermatol. Syphilol.*, 33: 665-683, 1936.
- II. "Biometric studies," *Arch. Dermatol. Syphilol.*, 34: 79-89, 1936a.
- III. "Taxonomic studies," *Arch. Dermatol. Syphilol.*, 36: 781-808, 1937.
- "The occurrence of a human pathogenic fungus as a saprophyte in nature," *Mycol.*, 29: 597-598, 1937a.
- "The taxonomy of anascosporous yeast-like fungi," *Mycopathologia*, 2: 255-266, 1940.
- "A cultural study of the life cycle of *Histoplasma capsulatum* Darling 1906," *J. Bact.*, 41: 563-578, 1941.
- CONANT, N. F., AND D. S. MARTIN, "The morphologic and serologic relationships of the various fungi causing dermatitis verrucosa (chromoblastomycosis)," *Am. J. Trop. Med.*, 17: 553-577, 1937.
- CONANT, N. F., D. S. MARTIN, D. T. SMITH, R. D. BAKER, AND J. L. CALLOWAY, *Manual of clinical mycology*. 348 pp. W. B. Saunders Co., Philadelphia. 1944.
- DAVIDSON, A. M., ELEANOR S. DOWDING, AND A. H. R. BULLER, "Hyphal fusions in dermatophytes," *Can. J. Research*, 6: 1-20, 1932.
- DAVIDSON, A. M., AND P. H. GREGORY, "Note on an investigation into the fluorescence of hairs infected by certain fungi," *Can. J. Research*, 7: 378-385, 1932.
- DODGE, C. W., *Medical mycology. Fungous diseases of man and other animals*. 900 pp. C. V. Mosby Co., St. Louis. 1935.
- DOWDING, ELEANOR S., AND H. ORR, "Three clinical types of ringworm due to *Trichophyton gypseum*," *Brit. J. Dermatol. Syphilis*, 49: 298-307, 1937.
- EMMONS, C. W., "Pleomorphism and variation in the dermatophytes," *Arch. Dermatol. Syphilol.*, 25: 987-1001, 1932.
- "Dermatophytes: a natural grouping based on the form of the spores and accessory organs," *Arch. Dermatol. Syphilol.*, 30: 337-362, 1934.
- "Actinomyces and actinomycosis," *Puerto Rico J. Pub. Health Trop. Med.*, 11: 63-76, 1935.

- EMMONS, C. W., "*Hormodendron pedrosoi*, an etiologic agent in chromoblastomycosis," *Puerto Rico J. Pub. Health Trop. Med.*, 11: 639-650, 1936.
- "Medical mycology," *Botan. Rev.*, 6: 474-514, 1940.
- "Isolation of *Coccidioides* from the soil and rodents," *U. S. Pub. Health Rept.*, 57: 109-111, 1942.
- EMMONS, C. W., AND A. L. CARRIÓN, "Sporulation of the *Phialophora* type in *Hormodendrum*," *Mycol.*, 29: 327-333, 1937.
- FREEMAN, WALTER, "Torula infection of the central nervous system," *J. Psych. Neur.*, 43: 236-345, 1931.
- GODDARD, D. R., "Phases of the metabolism of *Trichophyton interdigitale* Priestley," *J. Infectious Diseases*, 54: 149-163, 1934.
- GREGORY, P. H., "The dermatophytes," *Biol. Rev.*, 10: 208-233, 1935.
- GRIGORAKI, L., "Recherches cytologiques et taxonomiques sur les dermatophytes et autres champignons parasites," *Ann. sci. nat. Botan.*, Ser. 10, 7: 165-444, 1925.
- "Dermatophytes et dermatomycoses," *Ann. Derm. Syphiligr.*, VI, 10: 18-53, 1929.
- HARZ, C. O., "*Actinomyces bovis*, ein neuer Schimmel in den Geweben des Rindes," *Deut. Z. Tiermed.*, Suppl. to Bd. 5 (*Jahresber. Central-Tierarznei Schule in München*, 1877-78), pp. 125-140, 1879.
- HOPKINS, J. G., "Moniliasis and moniliids," *Arch. Derm. Syphilol.*, 25: 599-614, 1932.
- HOWELL, ARDEN, "Studies on *Histoplasma capsulatum* and similar form species. I. Morphology and development," *Mycologia*, 31: 191-216, 1939.
- KINNEAR, J., "Wood's glass in the diagnosis of ringworm," *Brit. Med. J.*, 1: 791-793, 1931.
- LAMATER, E. D. DE, AND R. W. BENHAM, "Experimental studies with dermatophytes," *J. Investigative Dermatol.*, 1: 451-488, 1938.
- LAMB, J. H., AND MARGARET L., "A grouping of the *Monilias* by fermentation and precipitation reactions," *J. Infectious Diseases*, 56: 8-20, 1935.
- LANGERON, M., "Travaux recents sur la classification des dermatophytes," *Ann. parasitol. humaine comparee*, 4: 193-198, 1926.
- LANGERON, M., AND P. GUERRA, "Nouvelles recherches de zymologie medicale," *Ann. parasitol.*, 16: 36-84, 162-179, 429-478, 481-525, 1938.
- LANGERON, M., AND S. MILOCHEVITCH, "Morphologie des dermatophytes sur milieux naturels et milieux à base de polysaccharides. Essai de classification," *Ann. parasitol. humaine comparee*, 8: 465-508, 1930.
- LANGERON, M., AND R. V. TALICE, "Nouveau type de lésion pileaire expérimentale produite par la culture purement pleomorphique du *Sabouraudites felinus*," *Ann. parasitol. humaine comparee*, 8: 419-421, 1930.
- "Nouvelles methodes d'étude et essai de classification des champignons levuriformes," *Ann. parasitol. humaine comparee*, 10: 1-89, 1932.
- LENTZE, F. A., "Zur Bakteriologie und Vakzintherapie der aktinomykose," *Zentr. Bakt. Parasitenk.*, Orig., 141: 21-36, 1938.
- LEWIS, GEORGE M., AND MARY E. HOPPER, *An introduction to medical mycology*. 342 pp. The Year Book Publishers, Inc., Chicago. 1943.

- MACKEE, G. M., AND G. M. LEWIS, "Dandruff and seborrhea. I. Flora of normal and diseased scalps," *J. Investigative Dermatol.*, 1: 131-139, 1938.
- MARGAROT, J., AND P. DEVÈSE, "Aspect de quelques dermatoses en lumière ultrapara-violette," *Bull. soc. sci. med. biol. Montpellier*, 6: 375-378, 1924-25.
- MARTIN, D. S., "The antigenic similarity of a fungus, *Cadophora americana*, isolated from wood pulp to *Phialophora verrucosa* isolated from patients with dermatitis verrucosa (chromoblastomycosis)," *Am. J. Trop. Med.*, 18: 421-426, 1938.
- MARTIN, D. S., R. D. BAKER, AND N. F. CONANT, "A case of verrucous dermatitis caused by *Hormodendrum pedrosoi* (chromoblastomycosis) in North Carolina," *Am. J. Trop. Med.*, 16: 593-618, 1936.
- MARTIN, D. S., C. P. JONES, K. F. YAO, AND L. E. LEE, "A practical classification of the Monilias," *J. Bact.*, 34: 99-130, 1937.
- MEDLAR, E. M., "A new fungus, *Phialophora verrucosa*, pathogenic for man," *Mycol.*, 7: 200-203, 1915.
- MONBREUN, W. A. DE, "The cultivation and cultural characteristics of Darling's *Histoplasma capsulatum*," *Am. J. Trop. Med.*, 14: 93-125, 1934.
- MOORE, M., "Cultivation and study of *Pityrosporum ovale*, the so-called bottle bacillus of Unna," *Arch. Dermatol. Syphilol.*, 31: 661-671, 1935.
- MUSGRAVE, W. E., M. T. CLEGG, AND M. POLK, "Streptothricosis with special reference to the etiology and classification of mycetoma," *Philip. J. Sci.*, Ser. B, 3: 447-544, 1908.
- NANNIZZI, A., "Ricerca sui rapporti morfologici e biologici tra Gymnoascee e Dermatomiceti," *Ann. mycol.*, 24: 85-129, 1926.
- OTA, M., AND P. T. HUANG, "Sur les champignons du genre *Pityrosporum* Sabouraud," *Ann. parasitol. humaine comparee*, 11: 49-69, 1933.
- OTA, M., AND M. LANGERON, "Nouvelle classification des dermatophytes," *Ann. parasitol. humaine comparee*, 1: 305-336, 1923.
- RACKEMANN, F. M., T. G. RANDOLPH, AND E. F. GUBA, "The specificity of fungous allergy," *J. Allergy*, 9: 447-453, 1937-38.
- RAMSBOTTOM, J., "Fungi pathogenic to man." In *A system of bacteriology in relation to medicine*, Chap. I, pp. 11-70. H. M. Stationery Office, London. 1931.
- RIXFORD, E., E. C. DICKSON, AND M. DOROTHY BECK, "Coccidioidal granuloma," *Calif. Dept. Pub. Health, Spec. Bull.*, 57. 1931.
- RIXFORD, E., AND T. C. GILCHRIST, "Two cases of Protozoan (Coccidioidal) infection of the skin and other organs," *Johns Hopkins Hosp. Rept.*, 1: 209-268, 1896.
- ROBERTS, L., "The physiology of the Trichophyton," *J. Path. Bact.*, 3: 300-309, 1894.
- SABOURAUD, A., *Les teignes*. 855 pp. Masson et Cie., Paris. 1910.
- "Generalities concernant les dermatophytes. II. La classification naturelle des dermatophytes," *Ann. Derm. Syphiligr.*, VI, 10: 569-580, 1929.
- SHREWSBURY, J. F. D., "The genus *Monilia*," *J. Path. Bact.*, 38: 313-354, 1934.
- TATE, P., "The dermatophytes or ringworm fungi," *Biol. Rev.*, 4: 41-75, 1929.
- "On the enzymes of certain dermatophytes or ringworm fungi," *Parasitol.*, 21: 31-54, 1929a.

- TODD, R. A., AND W. W. HERMANN, "The life cycle of the organism causing yeast meningitis." *J. Bact.*, 32: 89-104, 1936.
- TOIT, C. J. DU, "Sporotrichosis on the Witwatersrand," *Proc. Transvaal Mine Med. Officers' Assoc.*, 22: 111-126, 1942.
- VERUJSKY, D., "Recherches sur la morphologie et la biologie du *Trichophyton tonsurans* et de l'*Achorion schoenleini*," *Ann. inst. Pasteur*, 1: 369-391, 1887.
- WISE, FRED, AND JACK WOLF, "Dermatophytosis and dermatophytids," *Arch. Dermatol. Syphilol.*, 34: 1-14, 1936.

Chapter 17

GEOGRAPHICAL DISTRIBUTION OF FUNGI

Plant geography is admittedly a tremendously valuable branch of botanical knowledge, and its fundamentals, in relation to mosses, ferns, and especially seed plants, are now relatively well understood. Apparently, however, for reasons that will become manifest in the discussion which follows, any consideration of the geographical distribution of fungi at this stage of mycological development has a limited usefulness, partly because to date this phase of inquiry has received little attention. Nevertheless it should eventually come to be recognized as having a very practical and very general interest.

Bisby (1933) has said, "Mycologists have been able to map with accuracy the geographic distribution of comparatively few fungi." The worker who turns his attention to this subject is early impressed with the fact that vast portions of the earth's surface remain completely unexplored for fungi and hence are literally *terrae incognitae fungorum*. Such distributional data as are contained in monographs on special groups of fungi or in accounts of species of economic importance afford a basis for certain generalizations. Much additional pertinent information has been catalogued in herbaria but remains unpublished and hence quite unavailable.

In a report Bisby and Ainsworth (1943) state that the exact distribution of but few of the 3600 genera including 37,000 "good" species of known fungi has been determined. Distribution of genera by continents, as given by Bisby (1943), is as follows: Europe 1800, North America 1700, South America 1100, Asia 1100, Africa 800, and Australia-New Zealand 600.

On first thought it might appear that the nutritional factor should be all important in determining the distributional range of fungi for the reason that they are either saprotrophic or parasitrophic in food habits. Food is not, however, the sole factor, for, just as with holophytic plants, natural distribution has been found

to be governed by the interaction of interrelated and interdependent factors, climatic, edaphic, and biotic.

The validity of this conclusion becomes apparent if, for example, an attempt is made to deduce the probable distributional range of certain parasitic fungi from knowledge of the range of their hosts. The student may think that each parasite should be coextensive in range with its host (suscept), only to discover that, although such is the situation among certain species, it is not among others. Such observations lead to the conclusion that endemism exists, that is, certain fungi are indigenous on native species within particular areas where they have become dispersed by natural agencies. These certain species may eventually be spread to areas outside their natural range, but only as a result of "artificial" introduction, chiefly by man. In a very real sense man has interfered in no small measure with the natural factors that influence the distribution of fungi. To retard or prevent artificial dissemination of pathogenic species, quarantines have been instituted, eradication campaigns have been organized and conducted, inspection procedures have become compulsory in connection with shipment of plants or plant parts from one locality to another, and researches have been and are being made to produce hosts that are resistant to disease. Problems which have arisen as a result of disturbance of biological balance by man and of his attempts to rectify them, therefore, constitute an interesting and important phase of the geography of fungi.

For a discussion of the structural features possessed by certain species that aid in their geographical distribution the reader is referred to Chapter 8, Spore Dissemination. In this chapter information will also be found on such natural agencies as air currents, rains, streams, floodwaters, and insects and various other animals as factors in distribution. In a very real sense fungi tend continually to extend their range, some behaving as settlers and others as tourists.

In the account that follows, greatest emphasis will be placed on the geographic distribution of fungi as modified by man through the introduction and cultivation of exotic plants of economic importance. The presentation will not follow the logical arrangement based on the distribution of fungi as governed by climatic, edaphic, and biotic factors, but will be artificial and will be based on fungus groupings.

DISTRIBUTION OF MYXOMYCETES

Collectors of Myxomycetes are quite universally inclined to the opinion that this group is among the most ubiquitous and cosmopolitan of organisms. Intensive collecting, even in restricted areas at widely distant points, has yielded for each locality only from one-third to one-half of all the species known throughout the world. Nevertheless the geographical distribution of slime molds is not fortuitous but depends upon such dominant factors in each locality and for each species as temperature, moisture, kind of substrate and its acidity or alkalinity, and other factors.

More species of slime molds have been recorded for temperate regions than for the tropics, but this phenomenon appears to be causally related to the greater interest in collecting in the temperate zones. Some species, however, are limited to temperate regions; others, such as *Trichamphora pezizoides* and *Alwisia bombardata*, to tropical or subtropical regions [Martin (1940)]. This observation need not necessarily be interpreted as proof that temperature is the primary and controlling factor in determining the range of slime molds in general. Otherwise it becomes difficult to explain numerous observations like those of Smith (1931), who noted that in Colorado species of *Badhamia* prefer decaying aspen or cottonwood logs, whereas species of *Cribraria* are restricted to coniferous wood. As a result of several years' experience in collecting slime molds, Smith (1931) concluded that moisture, especially adequate rainfall for considerable periods, is the primary desideratum for their growth, the proper kind of decaying vegetable matter being secondary. He correlated the greater rainfall at elevations of 8000 to 9000 feet in Colorado with the greater abundance of species. Even though he collected *Stemonitis fusca*, *Comatrichia nigra*, and several species of *Cribraria* and *Arcyria* on dry exposed slopes, they invariably were found only on the lower side of logs kept moist by melting snow. The fact that the lower side of logs is preferred by slime molds is not regarded as a response to gravity, an opinion on which there is general accord. Smith (1931) and MacBride (1914) do not contend that any of the species they collected in the high mountains near the timber line are alpine.

The constant occurrence of lime granules as a constituent part of the fructifications among species of *Badhamia*, *Craterium*, *Diderma*, *Diachea*, *Didymium*, *Fuligo*, *Leocarpus*, *Mucilago*, and *Physarum* and their absence in others, for example, among *Comatrichia* and *Stemonitis*, are not without significance. Carr (1939) reported that 90% of the species on sandstone soils in a region in Virginia are "non-lime species" and 88% of those on limestone soils in this same region are "lime species." From comparison of collections made in Sweden with those made along the border between Bolivia and Argentina, Fries (1903) concluded that lime-containing species predominate over non-lime-containing species in the tropics, but that the reverse is true in temperate regions. That regional distribution is not determined entirely by the calcareousness of soils is borne out by the findings of other collectors, as Martin (1940) has indicated.

Thom and Raper (1930) found that numerous species may be isolated from arable soils, where they occur in the plant debris and litter. Abundant evidence is at hand to show that they subsist upon various fungi and bacteria that decompose plant remains. The influence of food in distribution is further evidenced by the rather constant occurrence of certain species among mosses, of others on decaying coniferous leaves, and of others on decaying leaves of hardwoods.

Some slime molds may develop well above the ground. Smith (1931) collected *Lycogala fusco-flavum* and *Mucilago spongiosa* var. *solida* 8 to 10 feet up on exposed, heart-rotted trunks of cottonwood. The plasmodium of some species, such as *Physarum cinereum*, may climb upon blades of grass or other vegetation immediately before becoming transformed into sporangia.

Plasmodiophora brassicae is now essentially world-wide in distribution. Its wide host range among cruciferous species and its preference for acid soils constitute the important factors that have contributed to this broad range. Evidence indicates that for over 200 years market gardeners have contended with club-root disease, which it causes on cabbage, radishes, and turnips. In Europe it is most destructive in the northern portions of the continent. It has been reported from nearly all parts of the United States and from Alaska and Canada. A monograph on Plasmodiophorales by Karling (1942) contains an extensive bibliography on the range of this organism and on other features.

Spongospora subterranea, causing powdery scab of potato, appears to be endemic to Equador and Peru. It has become established throughout the British Isles, continental Europe, Madagascar, the area bordering the Mediterranean Sea on the east and south, South Africa, New Zealand, and Tasmania. The shipment of infected tubers from one region to another undoubtedly is the primary means of dispersal of this organism.

DISTRIBUTION OF PHYCOMYCETES

The lists of Bisby and his associates (1929) and of Bisby (1933) indicate that 85% of all Phycomycetes present in Manitoba and 40% of those in India occur also in Europe. Of 35 species, mostly Mucorales, present in soil in North America 26 are also European. The significance of nutrition as a factor in distribution among Phycomycetes is apparent when the Peronosporales are considered in contrast to other phycomycetous orders. The distribution of Peronosporales, all obligate parasites, is definitely limited by that of the hosts.

Less is known regarding the distributional range of saprophytic species of Phycomycetes in general than that of pathogenic species, but *Rhizopus nigricans* and *Mucor mucedo*, both cosmopolitan species, are notable exceptions. Seemingly both can thrive wherever man lives, and both utilize the remains of numerous kinds of plants as food.

Students of soil fungi have shown that species of *Mucor* are universally present in arable soils and also in many virgin soils. Another soil-borne genus is *Allomyces*, which is peculiarly suited to wet sites, its members being commonly regarded as "water molds." *Allomyces arbuscula*, representative of this genus, has been collected in wet soil on all continents. Since water molds do not thrive in the oceans and since *A. arbuscula* is unable to tolerate salinity, no explanation of its wide geographical range is forthcoming.

The distribution of coprophilous Phycomycetes, such as species of *Pilobolus*, is conditioned, not by climate and soil, but only by the migration of the herbivor. Browsing animals eat the sporangia that are lodged on vegetation near dung piles. The spores germinate when voided with the feces, and within a few days *Pilobolus* will mature a crop of sporangia and discharge them.

ENDEMIC SPECIES, ARTIFICIALLY DISPERSED. The existence of endemism among pathogenic Phycomycetes can be shown by numerous examples. Among them is *Physoderma zae-maydis*, which is known to have existed for about 40 years in the southeastern United States, throughout the area south of the Ohio River and east of the Mississippi River. It is, however, found sparingly in the Corn Belt north and west of this range, but here it occurs sporadically. It produces serious losses within its normal range, especially in low, poorly drained lands during seasons of abundant and frequent rains. This fungus has been dispersed widely outside the United States, as is shown by records of collections in India, China, Japan, Rhodesia, Sierra Leone, Guatemala, and Mexico. It would be expected to occur wherever corn has been introduced, provided that moisture and temperature are favorable.

Another example of this kind is the organism that causes potato wart, *Synchytrium endobioticum*, first described from Hungary in 1896. Soon thereafter it was encountered in other portions of central Europe, where it is presumably indigenous, for example, in Czechoslovakia, Poland, Silesia, Austria, and Germany. In 1902 it was reported in the British Isles, in 1912 in Canada, in 1918 in the United States, in 1922 in South Africa, and in 1929 in Peru and Russia. Meantime stringent quarantines were established in many countries to prevent the introduction and spread of this organism.

Among the classic examples of a pathogenic species that has been artificially dispersed is *Phytophthora infestans*. This fungus, native of the northern Andes, home of the potato, was introduced into Europe and North America between 1830 and 1840. In 1845 and 1846 an epiphytotic so severe as to cause failure of the potato crop occurred throughout northern Europe, especially in Ireland, where famine resulted. This pathogen was introduced into India between 1870 and 1880 and into Australia and South Africa between 1900 and 1910.

North America has contributed an organism, *Plasmopara viticola*, which becomes notoriously destructive when introduced into new areas. This downy mildew was first described in 1834 and was transplanted into France with grape nursery stock early in the 1870's. There it produced an epiphytotic in 1879 and rapidly spread throughout the vineyards of France and Italy. Efforts to check this grape disease led to the discovery and use of

Bordeaux mixture as a fungicide. By 1907 the malady had reached South Africa, and in 1917 it caused the first severe outbreak in the vineyards of Australia.

The tobacco downy mildew, *Peronospora tabacina*, endemic to Australia, seemingly has been introduced both into North America and South America, and there seems no reason for supposing it will not spread eventually to other continents or countries. Evidence indicates that it has been known in Australia for more than 50 years. It first appeared in Florida in 1921 and in Rio Grande do Sul, Brazil, in 1938. Apparently it was eradicated from Florida in the first season of its introduction, but it reappeared in 1931. Since then it has gradually spread northward in the United States, reaching Connecticut and Massachusetts in 1937 and southern Ontario, Canada, in 1938. Clayton and Stevenson (1943) are of the opinion, however, that this fungus is native to all temperate regions having an indigenous *Nicotiana* flora.

INFLUENCE OF LATITUDE. Meager data are available on latitude as a factor in limiting the range of Phycomycetes, but it is apparent that climatic zonation occurs. *Phytophthora parasitica* var. *nicotianae*, for example, is regarded as tropical and subtropical and was first recorded on tobacco from the East Indies in 1896. Since then it has been found to occur on this crop in India, Japan, Indo-China, the Philippine Islands, Nyasaland, Cameroons, Uganda, Rhodesia, Puerto Rico, Jamaica, and Guatemala. More recently the disease appeared in Florida, North Carolina, Virginia, and Kentucky and in Greece, Rumania, and Bulgaria, all of which are in the North Temperate Zone. In tropical regions tobacco plants of all ages are subject to attack, whereas in more northerly areas infection does not occur until the warmest weather, at which season the plants are essentially mature.

Choanephora cucurbitarum grows most abundantly in tropical and subtropical regions but extends into adjacent temperate zones. Collections of it have been reported throughout the East Indies, Malaya, Burma, India, the Gold Coast, Sierra Leone, the West Indies, and the southern United States, commonly on fading flowers of cotton, okra, althea, squash, watermelon, cowpea, chili, cassava, papaw, peanut, hibiscus, and dahlia. The closely related *Blakeslea trispora* is quite restricted to tropical and subtropical areas having abundant and frequent rains. During 1942, which

was a very wet season, however, this fungus was noted on tobacco flowers in the vicinity of Durham, North Carolina.

DISTRIBUTION OF ASCOMYCETES

This discussion of the distribution of Ascomycetes must of necessity be fragmentary and is in no sense proportional to the vast body of data on this group that has been accumulated. Nevertheless the material is believed to be representative for the group as a whole. Many species of great economic importance have been spread by man to the extent that they now occur in all countries where the hosts are cultivated. The severity of the diseases which they cause is modified, to be sure, by latitude, by seasonal differences in climate, or by application of palliative or control measures. Fungi of this kind include *Taphrina deformans* and *Sclerotinia fructicola* on peach and *Venturia inaequalis* on apple. *Venturia inaequalis* occurs throughout the United States, Mexico, and Canada, but it rarely is found in the Coastal Plains of the southeastern United States. In Europe it has been noted in the British Isles, Belgium, Netherlands, Portugal, France, Switzerland, Norway, Sweden, Denmark, Germany, Austria, Czechoslovakia, Russia, Greece, and Bulgaria. Moreover it is reported from India, New Zealand, Tasmania, Rhodesia, Morocco, Argentina, and Peru and may therefore be presumed to be global in distribution.

The observations of Fawcett and Lee (1926) show that *Diaporthe citri* on citrus is another in the same group of organisms. This fungus was first studied in Florida in 1892 and was subsequently found in Brazil, Argentina, Mexico, the West Indies, China, Japan, Palestine, Algeria, South Africa, and South Australia. Its symptom-complex includes dying bark of twigs, stem-end rot of ripe fruits, and melanose markings on leaves, twigs, and fruits. The melanose form of the disease does not occur in California or at least is very rare, whereas it is always very abundant in central Florida.

The fact that pathogenic species, especially, are capable of maintaining themselves for indefinite periods saprogenically, as is *Thielavia basicola* (*Thielaviopsis basicola*), constitutes a complicating factor in distribution. *Thielavia basicola* attacks many species of legumes, especially beans, clovers, lupins, peas, soybeans,

and vetches, but may also seriously involve tobacco, flax, cotton, and watermelon. Collection records indicate its presence in Central Asia, the Philippine Islands, Queensland and New South Wales in Australia, the British Isles, Russia, Turkey, Rumania, Hungary, Czechoslovakia, Germany, France, Switzerland, Italy, Puerto Rico, the United States, and Canada.

DISTRIBUTION OF POWDERY MILDEWS. Of the 60 species and varieties of Erysiphaceae listed by Salmon (1900), 22 are confined to the Old World and 19 to the New World, leaving 19 that are common to both hemispheres. This situation is accounted for in part by the limitation of certain mildews to particular hosts and to the seemingly almost complete lack of specialization in other species. *Erysiphe tortilis*, confined to *Cornus sanguinea*, *Uncinula geniculata*, to *Morus rubra*, and *Podosphaera biuncinata*, to *Hammamelis virginiana*, are examples of highly restricted species. *Uncinula aceris* is limited to species of Acer, *U. flexuosa* to Aesculus, and *Sphaerotheca lanestrus* to Quercus. Less restriction is exhibited by *Erysiphe graminis*, which occurs only on various Gramineae, by *Uncinula salicis* on Salicaceae, and by *Sphaerotheca pannosa* on Rosaceae. On the other hand, *Erysiphe cichoracearum*, *E. polygoni*, and *Phyllactinia corylea* are world-wide and attack a wide range of hosts. *Phyllactinia corylea*, for example, is recorded on 48 host-genera in 27 families of plants. Continental distribution of powdery mildews has been summarized by Salmon (1900) as shown in Table 29.

TABLE 29

DISTRIBUTION OF POWDERY MILDEWS BY CONTINENTS

Country	Total Number	Number of Endemics
Europe	32	12
Africa	8	..
Asia	28	5
Australia and New Zealand	5	1
America	28	19

DISTRIBUTION OF PYRENOMYCETES AND DISCOMYCETES. Bisby (1933) indicates that about half of the species of Pyrenomyces listed from Manitoba [Bisby *et al.* (1929)] are known to occur in Europe. Moreover, only about 12% of those in the list from

India [Butler and Bisby (1931)] occur in Europe. Seemingly this group contains members that are restricted in range, and many of them are confined to the tropics or subtropics.

Of the operculate discomycetes listed in Seaver's monograph (1928) 35% are limited to North America and 61% are common to both North America and Europe. This group, which is almost wholly saprophytic, is thus quite cosmopolitan.

DISTRIBUTION OF EXOTICS. *Endothia parasitica*, the chestnut-blight fungus, is the best known and also the most destructive ascomycete introduced into the United States. It was first noted by Merkel in the New York Zoological Park in 1904 and thence spread with alarming rapidity throughout the entire Appalachian region where *Castanea dentata* is native. In 1913 Meyer found that this organism is endemic on *Castanea mollissima* in northern China.

Ceratostomella ulmi, causing the so-called Dutch elm disease [Clinton and McCormick (1936)], appeared in Holland in 1919, spread throughout continental Europe and the British Isles, and was first found in the United States in 1930. It is presumed to have been introduced into the United States on burl elm logs. Now it is gradually spreading on American elms in northern New Jersey and other localities in the vicinity of New York City.

Dasyscypha ellisiana, widely prevalent in the eastern United States on the bark of pines, is a much less spectacular exotic. It was first collected by de Schweinitz in 1931 and does not injure pines in any way. Only recently, however, it was found capable of attacking *Pseudotsuga taxifolia* [Hahn and Ayers (1934)], a species that does not grow in the natural range of *D. ellisiana*.

SPECIES WITH ERRATIC DISTRIBUTION. Plausible explanations are lacking to account for the peculiar distributional range of many Ascomycetes. For example, *Uromyces geaster*, first collected near Austin, Texas, in 1893, was known only from that location until 1938, when it was found in Japan. So large and so striking a disk fungus could scarcely have escaped observation elsewhere had it been present. A similar opinion is held regarding *Sarcoscypha minuscula*, occurring on dead cedar foliage, which is known only from Portugal, Bermuda, and the Yosemite National Park [Seaver (1942)]. Furthermore, *Poronia leporina*, which is abundant on rabbit dung in Bermuda [Seaver (1942)], has been collected in North America only three times during a period of over 50 years.

Also, *Ophionectria cylindrothecia* is abundant on stems of palmetto palm in Bermuda [Seaver (1942)] and has been found on cornstalks in Ohio.

Many fungi are limited to particular substrata, but the underlying reasons for this limitation are unknown. None of the species of *Melanconis*, *Pseudovalsa*, *Prosthecium*, and *Titania* occurs on coniferous wood [Wehmeyer (1941)], whereas each species of *Keithia* is limited to a certain conifer. *Keithia tetraspora* occurs on *Juniperus communis*, *K. juniperi* on *Juniperus virginiana*, *K. tsugae* on *Tsuga canadensis*, *K. thujina* on *Thuja occidentalis*, and *K. chamaecyparissi* on *Chamaecyparis thyoides*.

Until more is known about the reasons for differences between host species and varieties in susceptibility to a given fungus and about the influence of environment on the aggressiveness or virulence of pathogenic fungi, no one can prophesy the probable outcome of their introduction into new areas. *Lophodermium pinastri*, for instance, has long been known in Europe as a serious menace in pine-seedling nurseries, but, although this fungus is not uncommon in the United States, it is as yet nowhere a major problem.

DISTRIBUTION OF BASIDIOMYCETES

Obligate parasitism, as correlated with host range, is a primary factor in accounting for the distribution of the smuts and rusts. This is not so, however, among Hymenomycetes and Gymnomyces generally, even among those that are not saprophytic.

DISTRIBUTION OF SMUTS. The monograph by Clinton (1906) contains 206 species of smuts, of which 114 are strictly North American. Several of the smuts, including *Ustilago zaeae* on maize and the stinking smuts of wheat, *Tilletia foetans* and *T. tritici* [Holton and Heald (1941)], are now and have been for a considerable period essentially coextensive in range with that of their host. Certain others are less widely dispersed. These include *Tilletia horrida* on rice, which is endemic in China and is known also from Indo-China, Burma, the Philippine Islands, and adjacent tropical and subtropical areas. It was first introduced during the late 1890's into South Carolina with seed rice sent from China [Anderson (1899)]. Subsequently it has spread to Louisiana and Arkansas. Another smut, alien to the United States, is *Urocystis tritici*, causing flag smut of wheat. In all likelihood this smut is

endemic to the Mediterranean area. It was first noted in the United States in 1919 and was early studied by Tisdale, Dugan, and Leighty (1923) and Griffiths (1924). It has been recorded from China, Japan, India, Australia, Tasmania, South Africa, Egypt, Tunis, Italy, Cyprus, and Spain. Dissemination in Australia is attributed to horses that are permitted to forage on wheat straw; the smut spores pass intact through the alimentary tract and then grow in the droppings.

DISTRIBUTION OF RUSTS. More is known about the distribution of rusts than that of any other basidiomycetous group. Arthur (1929) considers Europe and North America as the best-explored regions of the earth for rusts, and he states that, as far as their rust flora is concerned, vast areas of other continents remain almost wholly unknown. The Genus *Melampsora*, according to Cunningham (1931), constitutes the only member of the Melampsoraceae that is world-wide, most other rusts of this family being confined to Europe, Asia, and America. *Milesia* also is regarded as world-wide by Faull (1932). Another distributional peculiarity noted by Cunningham (1931) is that species of *Milesia* and *Pucciniastrum*, but none of *Cronartium*, are found in New Zealand, whereas species of *Cronartium*, but none of *Milesia* nor of *Pucciniastrum*, thrive in Australia. In connection with *Uredinopsis*, attacking ferns and firs, Faull (1938) states that 13 species occur in the Western Hemisphere north of Mexico, 3 in Europe, 12 in Asia, and 1 in Africa. *Uredinopsis macrosperma* is the most widely dispersed one, but strangely it is entirely absent in many regions where its fern host, *Pteridium latiusculum*, thrives. Some species have very limited ranges, such as *U. adianti* in northeastern Asia and *U. investita* in the mountains of Guatemala, both on *Adiantum*. However, although *U. mayoriana* is known from Colombia, far from the range of fir, it is capable of producing accia when artificially inoculated on fir.

Of the 33 species and 2 varieties of *Milesia*, also fir-fern rusts, recognized by Faull (1932), only one, *Milesia vogesiaca*, is common to both the Old World and the New World. Nine species have been taken in the United States and Canada, 7 in Central America, northern South America, and the West Indies, 13 in Asia, 11 in Europe, 2 in Africa, and 1 in Australia. Many species of *Milesia* have the ability to perpetuate themselves for years in the entire absence of species of *Abies*, which are the accial hosts.

Furthermore many of them produce new crops of uredinospores in the spring before the old fern leaves die.

Among the Pucciniaceae, the distribution of *Puccinia*, *Uromyces*, and *Phragmidium* is global [Cunningham (1931)]. *Transchelia pruni-spinosae* occurs throughout the world wherever peaches and plums are grown, and *Phragmidium disciflorum* is found wherever cultivated roses can flourish. Other limitations imposed by host are exhibited by *Uromycladium*, confined to acacias in Australia and the East Indies, and by *Phragmidium*, confined to Rosaceae. Except for a few, all species of *Gymnosporangium* have Rosaceae as aecial hosts. *Ravenelia* typically occurs on leguminous hosts, but a few of its approximately 100 species attack Euphorbiaceae and Tiliaceae.

Influence of climate on rust distribution. From the many surveys that have been made of whether the short-cycled rusts and long-cycled ones are proportionally alike in all regions of the world, it appears that short-cycled species are relatively more abundant in mountainous regions and in northern areas than they are in lowlands and in the tropics. This fact indicates that, just as temperature is a limiting factor in latitudinal and altitudinal distribution of seed plants, so it is similarly operative among rusts. In his summary of this subject as it pertains to North America, Arthur (1929) divided the continent into the boreal zone, in which 23% of the total rust population is short-cycled, the temperate zone, in which 19% is short-cycled, and the tropic zone, in which 15% is short-cycled.

Latitudinal zonation of rusts is strikingly indicated by Arthur (1929) as shown in Table 30. Some of these genera are plainly more northern than others, and *Ravenelia* and *Uropyxis* are to be considered tropical and subtropical. In fact, only 3 species of *Ravenelia*, namely, *R. opaca*, *R. cassiaecola*, and *R. epiphylla*, range north of 40° north latitude.

ENDEMISM AMONG RUSTS. Since so many rusts attack plants of economic importance, it would be anticipated that each area into which alien plants or plant parts have been introduced would contain non-native species of rusts. That such is the case is shown by the work of Arthur (1929). Of approximately 1000 species of North American rusts, only about 600 are held to be endemic. McAlpine (1906) regards 31 of the 161 rusts in Australia as aliens.

TABLE 30

LATITUDINAL ZONATION OF NORTH AMERICAN RUST GENERA

Genus	Boreal Area	Temperate Area	Tropical Area
<i>Coleosporium</i>	1	21	16
<i>Melampsora</i>	8	12	3
<i>Pucciniastrum</i>	7	10	2
<i>Cronartium</i>	4	6	2
<i>Uredinopsis</i>	3	6	1
<i>Hyalospora</i>	1	4	0
<i>Milesia</i>	2	2	3
<i>Puccinia</i>	130	358	261
<i>Uromyces</i>	28	108	70
<i>Ravenelia</i>	0	22	44
<i>Gymnosporangium</i>	5	33	2
<i>Phragmidium</i>	13	16	2
<i>Uropyxis</i>	0	6	5
Total	202	604	411

The list of rusts introduced into North America, in the account by Arthur (1929), contains such important species as *Cronartium ribicola*, *Uromyces appendiculatus phaseoli*, *U. appendiculatus vignae*, *U. betae*, *U. caryophyllinus*, *U. trifolii*, *Puccinia arachidis*, *P. asparagi*, *P. chrysanthemi*, *P. glumarum*, *P. malvacearum*, *P. rubigo-vera secalis*, and *P. rubigo-vera tritici*.

Cronartium ribicola was first known from collections made in Russia before 1856. In 1861 it was noted in Finland; in 1871, in East Prussia; in 1880, in Sweden; in 1885, in Norway; in 1889, in France; in 1892, in the British Isles; and in 1906, in the United States.

Puccinia malvacearum is endemic in Chile, where it was first noted in 1852. It did not reach North America until 34 years later. Meantime it spread to Australia in 1857, to Spain in 1869, to France in 1872, to Germany and the British Isles in 1873, to Italy in 1874, to Switzerland in 1875, to Greece in 1877, to Sweden in 1887, and to Finland in 1890.

DISTRIBUTION OF SEPTOBASIDIUM. The symbiotic relationship between *Septobasidium* and scale insects, clarified by the work of Couch (1938), serves as the most potent factor in accounting for the distribution of members of this genus. If, for example, the symbiotic scale insect is limited to the tropics, then the particular

species of *Septobasidium* is likewise restricted to the tropics. Couch (1938) found that species occurring in the southeastern United States are entirely different from those in the West Indies. Moreover, some West Indian species are not found in Central America and northern South America. Again, all those in Cuba are distinct from those in Jamaica, except for *S. rhobarbarinum*. This species is indicated to be widely dispersed in Central America, tropical Africa, and the Orient.

There is evidence that *S. pseudopedicellatum* and *S. curtisii*, common on many native species of trees and on cultivated ones as well throughout the southeastern United States, may have been introduced into other lands with shipments of trees.

DISTRIBUTION OF OTHER BASIDIOMYCETES. Some impressions have been recorded of comparative distribution of agarics in North America and Europe by Lange (1934) and of the polypores in these countries by Overholts (1939). Lange (1934) states that 70% of the species that he encountered on a tour across North America were known also in Europe. He mentions certain species that are common to both continents, such as *Psalliota silvicola* (*P. arvensis*), *Lactarius deliciosus*, *Panus stipticus*, *Amanita muscaria*, *A. caesarea*, *Hypholoma fasciculare*, *Inocybe geophylla*, *Laccaria laccata*, *Stropharia psathyroides* and *Lepiota cygnea*. The difference between the agaric floras of the two continents is in no wise as striking as are differences on each continent due to latitude. *Stropharia depilata* is a boreal species ranging from the Rocky Mountains to the Scandinavian subarctic zone [Lange (1934)]. *Amanita caesarea* is a temperate species and extends northward to southern Denmark and northern Germany. Lange (1934) also states that certain species in Europe are limited to the Mediterranean region and rarely, if ever, extend beyond the Alps. Species of *Marasmius*, some of which cause thread blights, and *Lentinus* abound in the subtropics and tropics.

Several well-known agarics, such as *Clitocybe illudens*, *Armillaria mucida*, *Collybia radicata*, and *Lepiota procera*, were noted by Bisby (1933) as being absent from Manitoba for some unknown reason.

Certain agarics and Boletaceae are mycorrhizal, and some of them are known to be restricted to certain species of trees. In such cases the range of the tree is the factor which governs the distributional range of the particular fungus. (See Chapter 13.)

Another feature regarding the distribution of Basidiomycetes that has impressed every mycologist who has intensively collected in a given area for a period of years is that certain species found one season may be entirely absent in succeeding years.

The extensive studies of Overholts (1939) led him to conclude that of the 227 species of North American pileate Polyporaceae at least 43% occur in the Eastern Hemisphere. Of the more common genera, he found that 54% of *Fomes* and of *Trametes* species, 50% of *Daedalea* and of *Lenzites* species, and 44% of *Polyporus* species are common to North America and the Old World. Certain of them, such as *Polyporus conchifer* and *P. texanus*, are limited in range to that of their hosts, *Ulmus americana* and *Prosopis juliflora*, respectively. *Fomes applanatus* is a cosmopolitan species. *Polyporus abietinus* can utilize all species of conifers; *P. versicolor*, *P. pargamensis*, and *Lenzites betulina*, many kinds of hardwoods; and all are widely distributed. *Fomes pini* and *Polyporus schweinitzii*, both capable of causing heart rots of conifers, are widely present throughout the United States and Canada.

The Gastromycetes are widely dispersed, with little evidence of being affected by latitude. An exception is the Phallales, which are mostly tropical, whereas the Lycoperdales are temperate.

DISTRIBUTION OF DEUTEROMYCETES

The imperfect fungi of most economic importance are either seed-borne or soil-borne or else are dispersed with nursery stock.

DISTRIBUTION OF SEED-BORNE SPECIES. Many pathogenic imperfect fungi, particularly those of cultivated plants, have been demonstrated to be seed-borne [Orton (1931)]. This fact accounts for the wide distribution and establishment of such fungi as *Ascochyta pisi*, leaf and pod blight of pea; *Cercospora beticola*, leaf spot of beet; *Cercospora daizu*, frog-eye leaf spot of soybean; *Colletotrichum gossypii*, cotton anthracnose; *C. lagenarium*, watermelon anthracnose; *C. lindemuthianum*, bean anthracnose; *Cladosporium fulvum*, leaf mold of tomato; *Diplodia zaeae*, ear rot of corn; *Kabatiella caulivora*, anthracnose of clover; *Helminthosporium gramineum*, barley stripe; *Phoma lingam*, cabbage blackleg; *Polyspora lini*, flax-stem break; *Septoria apii*, celery blight; *Septoria lycopersici*, leaf spot of tomato. Presumably each of these fungi occurs wherever its hosts are cultivated, and com-

petent collectors would no doubt find them all in regions from which there are now no collection records. To mention a few ranges, *Cercospora beticola* is known to be present in Korea, Japan, Czechoslovakia, Hungary, Ukraine, Jugoslavia, Rumania, Germany, Austria, Italy, Poland, Latvia, Lithuania, France, Spain, Holland, Belgium, Ireland, Morocco, Mauritius, Bermuda, Cuba, Dominican Republic, the United States, and Canada. *Polyspora lini* has been noted on flax in Ireland, Holland, Sweden, Denmark, Germany, Poland, Latvia, Russia, Italy, New Zealand, Canada, and the United States. *Septoria lycopersici* is known to occur in the United States, Canada, Great Britain, France, Denmark, Germany, Norway, Esthonia, Lithuania, Russia, Rumania, middle Asia, Ceylon, southern Australia, Fiji, Mauritius, Kenya, Morocco, east Africa, Rhodesia, Argentina, Brazil, Trinidad, Guatemala, Bermuda, and Hawaii.

DISTRIBUTION OF SPECIES DISPERSED WITH NURSERY STOCK. Some very important imperfect fungi have been widely disseminated with shipments of nursery stock, for example, *Cladosporium carpophilium*, causing scab and freckle of stone fruits, *Phyllosticta solitaria*, causing canker, blotch, and leaf spot of apple, and *Sphaceloma fawcetti*, causing citrus scab. Data on the occurrence of *Cladosporium carpophilium* outside the United States and southern Canada are not abundant; nevertheless Keitt (1917) is of the opinion that this species is present in all countries where peach, nectarine, and cherry are grown. Austria, Germany, Bulgaria, Holland, South Africa, New South Wales, and Brazil are among the regions where *C. carpophilium* is known to occur.

Phyllosticta solitaria has not been given serious attention outside the central and eastern United States. Guba (1925) suspected that wild crabapple, *Pyrus coronaria*, is the original host and source of inoculum. This fungus has been reported from Argentina, Rhodesia, Spain, and Holland.

Sphaceloma fawcetti is believed [Fawcett (1926)] to have been present in Japan since ancient times, but it was given little attention until its discovery in Florida about 1886. It occurs also in China, India, the East Indies, Australia, New Zealand, Hawaii, Brazil, and Argentina.

DISTRIBUTION OF SOIL-BORNE SPECIES. Many of the Moniliales are soil-borne. The outstanding representative of this group of imperfect fungi is *Phymatotrichum omnivorum*, commonly called

the Texas root-rot fungus. The appropriateness of its specific name is indicated by the fact that it is known to attack more than 1700 species of flowering plants, more than does any other known pathogen. An appreciation of the destructiveness of *P. omnivorum* can be gained from the fact that a complete bibliography of it would include about 300 titles, and annual losses which it occasions are estimated to approximate one hundred million dollars.

Its range extends throughout the greater part of Texas and contiguous parts of Arkansas, Oklahoma, New Mexico, and Mexico. It also occupies areas in Arizona, California, Nevada, and Utah. Its existence outside this range has been noted in the Dominican Republic, Hawaii, and (doubtfully) Russia.

Active dissemination is accomplished largely by growth of the fungus through the soil, where it may hibernate by means of sclerotia.

Various species of *Fusarium* that live saprophytically in the soil for long periods and cause wilt diseases when the appropriate crop is planted on such a soil are also included in this group. Among them are *Fusarium vasinfectum* on cotton, *F. cubense* on banana, *F. oxysporum* on potato, *F. lycopersici* on tomato, *F. nivveum* on watermelon, and *F. lini* on flax. All are widely dispersed in any region where these crops are grown.

IMPLICATIONS

It is quite apparent that no comprehensive information regarding fungus floras throughout the world is available at this time. Many additional monographic studies of fungal groups must first be made, and also many more lists of the type of the *Host Index of the Fungi of North America* [Seymour (1929)], *The Fungi of Manitoba* [Bisby, Buller, and Dearness (1929)], *The Fungi of India* [Butler and Bisby (1931)], and *British Stem and Leaf Fungi* [Grove (1935, 1937)] must be prepared. Seymour's book includes about half of all the known species of fungi, and about 60% of the Canadian species listed by Bisby *et al.* (1929) are also known to occur in Europe.

Students of the geographic distribution of fungi seem agreed that climate has a controlling effect [Bisby (1943)], Diehl (1937), Lind (1934). Diehl (1937) concluded that the life zones of

fungus vegetation are bounded or delimited by climatic lines or factors. These climatic factors operate by controlling the distribution of the particular substrata, for both endemic and exotic species. The provinces of fungi are delimited by such natural barriers as climate, oceans, mountains, deserts, wind direction, and vectors, but man has operated to break down these barriers and to carry the fungi over them into new sites.

Lind (1934) has also emphasized the influence of climate as a factor in distribution.

Of the 422 species collected in the Arctic, Lind indicates that many occur also in the Alps and are otherwise widespread and that no genus in these collections is endemic to the northern polar region.

Bisby's (1943) opinion is: "There are perhaps three times as many [species of] phanerogams as fungi on earth." Moreover saprophytic species generally have a wider distribution than do parasitic ones, although distribution of substrata and hosts is of primary importance as a control factor.

The natural ranges and habitats of fungi tend toward the establishment of stability and biological balance. Man has always upset this stability by intensive cultivation of a given species of host in a limited area, by constructing artificial environments such as cold frames and greenhouses, in which to grow plants, by attempts to grow crops in new areas, and by introducing fungi into areas where the environment unfortunately has too frequently proved more favorable for the fungi than did their natural range. In regard to the results of man's activities upon the distribution of fungi, it is apparent that he has indeed made his own difficulties and problems; nevertheless he seems to thrive in spite of his tendency to learn things the hard way.

There are good reasons for believing that some so-called new diseases of cultivated plants are not caused by new species of fungi but by old ones long present in a particular locality. As a result of the conditions that obtain under cultivation, the host may succumb to attack, whereas it might be immune in its natural or native habitat. Of course, it must always be remembered that both the susceptibility of the host and the aggressiveness of the parasite are influenced by environmental factors which may eventuate in a modification of the distributional range both of the host and of the parasite.

Because of the enormous financial outlay that has become necessary in connection with quarantines and with the control and eradication of fungi already introduced, all exotics should perforce be regarded as potentially undesirable aliens and should be so treated. Some fungi are closely restricted in range and are very complacently provincial, some can be widely transplanted without becoming obnoxious, some are exceedingly noisome when transported to new environments, and some are naturally cosmopolitan and international and, in consequence, have become widely established.

LITERATURE CITED

- ANDERSON, A. P., "A new *Tilletia* parasitic on *Oryza sativa*," *Botan. Gaz.*, 27: 467-472, 1899.
- ARTHUR, J. C., *et al.*, *The plant rusts (Uredinales)*. 446 pp. John Wiley and Sons, New York. 1929. (See Chap. V, pp. 161-205.)
- BISBY, G. R., "The distribution of fungi as compared with that of phanero-gams," *Am. J. Botany*, 20: 246-254, 1933.
- "Geographical distribution of fungi," *Botan. Rev.*, 9: 466-482, 1943.
- BISBY, G. R., AND G. C. AINSWORTH, "The numbers of fungi," *Trans. Brit. Mycol. Soc.*, 26: 16-19, 1943.
- BISBY, G. R., A. H. R. BULLER, AND J. DEARNESS, *The fungi of Manitoba*. viii + 194 pp. Longmans, Green, and Co., London. 1929.
- BUTLER, E. J., AND G. R. BISBY, *The fungi of India*, Imper. Counc. Agr. Research, Sci. Monograph I. xviii + 237 pp. 1931.
- CARR, L. G., "A comparison of Mycetozoa found in sandstone and limestone regions of Augusta County, Virginia," *Mycol.*, 31: 157-160, 1939.
- CLAYTON, E. E., AND J. A. STEVENSON, "*Peronospora tabacina* Adam, the organism causing blue-mold (downy-mildew) disease of tobacco," *Phytopathology*, 33: 101-113, 1943.
- CLINTON, G. P., "Ustilaginales," *North Am. Flora*, 7: 1-82, 1906.
- CLINTON, G. P., AND F. A. McCORMICK, "Dutch elm disease, *Graphium ulmi*," *Conn. Agr. Expt. Sta. Bull.*, 389: 707-752, 1936.
- COUCH, J. N., *The genus Septobasidium*. 480 pp. University of North Carolina Press. 1938.
- CUNNINGHAM, G. H., *The rust fungi of New Zealand, together with the biology, cytology, and therapeutics of the Uredinales*. xx + 261 pp. J. McIndoe, Dunedin, New Zealand. 1931.
- DIEHL, W. W., "A basis for mycogeography," *J. Washington Acad. Sci.*, 27: 244-254, 1937.
- FAULL, J. H., "Taxonomy and geographical distribution of the genus *Milesia*," *Contrib. Arnold Arboretum*, 2: 5-138, 1932.
- "Taxonomy and geographical distribution of the genus *Uredinopsis*," *Contrib. Arnold Arboretum*, 11: 5-120, 1938.

- FAWCETT, H. S., AND H. A. LEE, *Citrus diseases and their control*. xii + 582 pp. McGraw-Hill Book Co., New York. 1926.
- FRIES, R. E., "Myxomyceten von Argentinien und Bolivia," *Ark. Bot.*, 1: 57-70, 1903.
- GRIFFITHS, MARION A., "Experiments with flag smut of wheat and the causal fungus, *Urocystis tritici* Kcke," *J. Agr. Research*, 27: 425-449, 1924.
- GROVE, W. B., *British stem and leaf fungi (Coelomycetes)*, 1: xx + 488 pp., 1935; 2: xi + 406 pp., 1937. Cambridge University Press.
- GUBA, E. F., "Phyllosticta leaf spot, fruit blotch and canker of the apple: etiology and control," *Ill. Agr. Expt. Sta. Bull.*, 256: 481-557, 1925.
- HAHN, G. G., AND T. T. AYERS, "Dasyscyphae on conifers in North America II. *Dasyscypha ellisiana*," *Mycol.*, 26: 167-180, 1934.
- HOLTON, C. S., AND F. D. HEALD, *Bunt or stinking smut of wheat (a world problem)*. ii + 211 pp. Burgess Publishing Co., Minneapolis. 1941.
- KARLING, J. S., *Plasmodiophorales*. ix + 144 pp. Published by the author, New York. 1942.
- KEITT, G. W., "Peach scab and its control," *U. S. Dept. Agr. Bull.*, 395: 1-66, 1917.
- LANGE, J. E., "Mycofloristic impressions of a European mycologist in America," *Mycol.*, 26: 1-12, 1934.
- LIND, J., "Studies on the geographical distribution of arctic circumpolar micromycetes," *Kgl. Danske Videnskab. Selskab Biol. Medd.*, 11 (12): 1-152, 1934.
- MACBRIDE, T. H., "Mountain Myxomycetes," *Mycol.*, 6: 146-149, 1914.
- MARTIN, G. W., "The Myxomycetes," *Botan. Rev.*, 6: 356-388, 1940.
- MCALPINE, D., *The rusts of Australia*. 349 pp. 1906.
- ORTON, C. R., "Seed-borne parasites, a bibliography," *West Va. Agr. Expt. Sta. Bull.*, 245: 3-47, 1931.
- OVERHOLTS, L. O., "Geographical distribution of some American Polyporaceae," *Mycol.*, 31: 629-652, 1939.
- SALMON, E. S., "A monograph of the Erysiphaceae," *Mem. Torrey Botan. Club*, 9. 292 pp. 1900.
- SEAVER, F. J., *The North American cup fungi (Operculates)*. 284 pp. Published by the author, New York. 1928.
- "The mycoflora of Bermuda," *Science*, 96: 462-463, 1942.
- SEYMOUR, A. B., *Host index of the fungi of North America*. xiii + 732 pp. Harvard University Press. 1929.
- SMITH, E. C., "Ecological observations on Colorado Myxomycetes," *Torreyana*, 31: 42-44, 1931.
- THOM, C., AND K. B. RAPER, "Myxamoebae in soil and decomposing crop residues," *J. Wash. Acad. Sci.*, 20: 362-370, 1930.
- TISDALE, W. H., G. H. DUGAN, AND C. E. LEIGHTY, "Flag smut of wheat with special reference to varietal resistance," *Ill. Agr. Expt. Sta. Bull.*, 242: 511-537, 1923.
- WEHMEYER, L. E., "A revision of *Melanconis*, *Pseudovalsa*, *Prosthecium*, and *Titania*," *Univ. Mich. Studies*, 14. 161 pp. 1941.

Chapter 18

MYCOLOGY IN RELATION TO PLANT PATHOLOGY

Plant materials constitute the substrate on which nearly all fungi thrive in their natural habitats. Relatively few utilize animals or animal tissues as substrates of first choice. Furthermore many fungi, whether saprogenic or pathogenic, are quite closely restricted to a particular plant species. The fundamental reasons for these idiosyncrasies in the choice of food are not without significance, but they remain quite unknown beyond the point that there is a correlation between the enzyme-producing abilities of each fungus and the kind of substrate on which it grows.

The idea that all fungi are either parasitic or saprophytic has had far-reaching consequences. It has had a deleterious effect primarily on understanding the activities of fungi and secondarily on appreciating the intimate interdependence of mycology and plant pathology. It is not uncommon for a plant pathologist to remark that parasitic fungi are of interest to him but that saprophytic species are of no concern. He chooses to entrust saprophytic species to the tender care of a mycologist! In so doing he may overlook the fact that a particular species may have both a parasitic and a saprophytic phase. Perhaps the terms parasitic and saprophytic have outlived a measure of their usefulness.

Much information regarding the natural habitats of fungi has come from studies, not of saprogenic species, but of pathogenic ones and has therefore been contributed by plant pathologists. In so far as such studies have emphasized the disease aspect, including disease prevention and control, they properly constitute the subject matter of phytopathology. On the other hand, in so far as such studies pertain to the etiologic agent itself, they belong to mycology. The two fields are therefore closely interrelated, as may be brought out by consideration of their parallel development, but they have grown to be quite distinct. In fact, some workers regard mycology as the parent science and phytopathol-

ogy as the offspring. The purpose of this discussion is to bring these interrelations into perspective. To anyone who attempts to do this properly, it soon becomes apparent that the task is herculean, for the reason that the subject matter of each field of science is dispersed in a bewildering array of books, technical reports, and bulletins. Manifestly it is impossible to accomplish such a task within the scope of a single chapter. Moreover, to date no one has attempted a comprehensive interpretative history of mycologic and phytopathologic development. Little more can be attempted in this discussion than to point out a few of the landmarks along the pathway, beginning with the completely unscientific era from which both mycology and plant pathology emerged and ending with present-day concepts. Both fields, as was briefly indicated in Chapter 1, Vol. I, had their beginnings in the dim, distant past, long before the period of recorded history. The development of each has been dependent, as would be expected, upon advances in such fields as bacteriology, medicine, animal pathology, physics, and chemistry, and especially upon the improvisation of new methods or techniques.

EARLY CONCEPTS OF DISEASE IN PLANTS

Some appreciation of the ideas concerning disease in plants that prevailed before 1807 may be gained from a treatise by Ré (1807). Later Smith (1902, 1929), Arthur (1906), and Whetzel (1918) sketched the background against which present-day ideas can be interestingly evaluated. As these writers point out, man long recognized the existence of disease, especially among cultivated plants, but from earliest times such diseases were uniformly interpreted as supernatural phenomena and ascribed to offended deities. Later came the belief, generally accepted among scientists, that fungi were generated by the host or suscept on which they occurred. The works of Unger, Meyen, and Hallier [Whetzel (1918)] are based on this concept.

Certain other contemporary writers, however, held a different opinion, as is shown by the observations of Fontana, published in 1767, in which he made the following statement regarding grain rust: "We are dealing with a great number of hungry and insatiable plants that live by violence, feeding at the expense of the tender green plant; they grow rapidly, thanks to the food that

they steal from the grain, feeding in a great number of places, stopping entirely the flow of the already prepared and digested juice, which is to nourish the grain and to be converted into pulp and flour."

The mystical and ethereal nature of the cause of disease in plants was also refuted by Fabricius in a treatise published in 1774, in which he maintained that smut is caused by "something organized," that is, something living, and by Prévost in a dissertation published in 1807, in which he concluded that rust and smut diseases are produced by "internal parasitic plants." These ideas did not gain acceptance among scientists, however, and the real turning point in progress on the nature of disease in plants came with the publication in 1853 of *Die Brand Pilze*, based on experimentation by de Bary. He showed that the rust and smut fungi are entities that induce disease by growth within the host tissues, with resultant modification of the structure and the function of the infected plants.

CONTRIBUTORY ADVANCES IN BACTERIOLOGY

The impact of such conclusions from the work of de Bary upon mycology and plant pathology can be appreciated only if considered in connection with discoveries that had already been made or were made soon thereafter in other fields, especially bacteriology. It should be remembered that for a long time scientific thought was permeated with the concept that many kinds of living things, especially those of microscopic proportions, originated by spontaneous generation. Using goose-necked flasks containing fermentable fluids, Pasteur demonstrated with finality that fermentations may be induced by air-borne bacteria and that during fermentation these bacteria generate other bacteria like themselves. This discovery led to his subsequent studies, which served as the basis for the establishment of the germ theory of disease in animals, a theory that soon came to pervade the entire field of medicine. Concurrently came the development of laboratory methods for the isolation and cultivation of organisms in pure culture, notably (1) the use of semisolid media, originating with the work of Koch on the anthrax bacillus; (2) the use of cotton stoppers, interposed between the medium and the open air to strain out organisms floating in the air, first employed by

Schroder and Dusch; and (3) the establishment of pathogenicity by compliance with axiomatic rules of proof, called Koch's rules. Gradually other techniques from procedures developed in bacteriology were adapted for use in studying fungi. These techniques involve the influence of such environmental factors as temperature, food requirements, and hydrogen-ion concentration of the medium and the complex reactions involved in studies of antigenic properties of fungi.

SIGNPOSTS ALONG THE PHYTOPATHOLOGICAL PATH

Certain outstanding events and discoveries indicate the course of development in any field of science. Those in phytopathology, as has been stated, have been very directly and quite uniformly related to mycology. The most significant are categorically listed as follows:

1. The epiphytotics of late blight of potatoes in 1843, 1844, and 1845 in northern Europe and the British Isles. The destruction of the potato crop was so complete that in Ireland alone approximately a quarter of a million persons died of famine. As a secondary consequence of the catastrophe, attempts were made to determine the cause and control of this potato disease, and plant pathology, as a science, may properly be concluded to have originated with these studies. For the first time the public appreciated the significance and the necessity of plant pathological investigations.

2. The publication in 1853 of the first textbook of plant pathology by Julius Kühn, who is generally regarded as the father of plant pathology. In this book considerable emphasis is placed on the disease itself rather than on its cause. This is true also of important books that followed, such as those by Berkeley, Cooke, Hartig, Sorauer, W. G. Smith, Tubeuf, Kirchner, Ward, Comes, Prillieux, Masee, and Viala; all of these, however, are preponderantly mycologic.

3. The establishment of proof of the heteroecism of rusts by de Bary in 1864 to 1865. The relationship between rust on wheat and that on barberry had long been suspected by farmers. In fact, they had compelled the enactment of legislation providing for the eradication of barberry as early as 1660 in France and as early as 1726 in the state of Connecticut.

4. Outbreaks of downy mildew on grapes in Europe, especially in the vineyards of France and Italy. The causal fungus, *Plasmopora viticola*, indigenous in the United States, had been introduced into Europe in 1878. In order to prevent pilfering of his grapes, a grower sprinkled his vines with a mixture of lime and copper sulphate. Millardet noted that the grapes so treated remained free from downy mildew, and as an eventual result the world's best-known fungicide, Bordeaux mixture, was developed.

5. The establishment of the Office of Vegetable Pathology in the United States Department of Agriculture and the organization of the state agricultural experiment stations under the Hatch act, both in 1887. Provision was thus made for the first time for the initiation of organized research on diseases of crop plants. In the beginning only meager financial support was forthcoming for this work, but the appropriation has increased throughout the years in proportion to needs and to growing appreciation of the importance of such studies.

6. The publication of Saccardo's *Sylloge Fungorum*, a compendium containing descriptions of all known species of fungi. This monumental work, the first volume of which appeared in 1882, now contains twenty-five volumes. It is truly a requisite for the mycologist and phytopathologist.

7. The introduction of two species of alien fungi, *Endothia parasitica*, causing chestnut blight, and *Cronartium ribicola*, causing blister rust of five-needle pines. *Endothia parasitica* was first noted in the United States in 1904 and *Cronartium ribicola* in 1906. These two organisms became widely dispersed with rapidity, and their ravages stimulated the general public to an appreciation of the destructiveness of plant diseases and to an interest in problems of disease prevention and control.

8. The establishment of the Federal Plant Quarantine Law in 1912. The enactment of this law was the outgrowth of experiences with chestnut blight and with blister rust of white pines. Moreover it was the first legalized effort by a nation to exclude foreign pests and plant diseases.

9. The organization of departments of plant pathology at Cornell University in 1907 and at the University of Wisconsin in 1909 for the training of specialists in research and the teaching of plant pathology. The emphasis on instruction in so-called plant

pathology up to that time had been largely taxonomic mycology, and in fact it remains all too much so to this day.

10. The organization of the American Phytopathological Society in 1909 and the publication of *Phytopathology*, the official organ of this society, beginning in 1911. The charter membership included 130 names, but the membership has now grown to well over 1000 persons. These two agencies, the society and the journal, have been potent factors in stimulating interest and in directing the trend of phytopathologic development not only throughout the United States but also throughout the world.

11. The initiation of the abstract journal, *Review of Applied Mycology*, at the Kew Gardens in 1922. This journal, published at regular intervals throughout the year, contains complete references to all current publications on plant pathology, together with a summary of the content of each report. It is absolutely indispensable as a tool in keeping abreast of developments in mycology and plant pathology.

DEVELOPMENTS IN TERMINOLOGY

Correct terminology is essential properly to express concepts in any field of learning. Certain terms have been used both in mycology and in phytopathology without regard to precision of expression, and, as a consequence, confusion and inaccuracies have appeared. Fortunately some of these inaccuracies have been rectified, as inevitably occurs during the course of the normal development of a science. The terminology in both fields could be expected to have much in common, especially during their formative periods. In fact, in the beginning the terminology of mycology and phytopathology reflected the influence of animal pathology and medicine, since many of the early workers in the newer fields were medical practitioners or at least had been trained in medicine. This fact is demonstrated by the use in Fabricius' treatise of 1774 of such terms as anasarca, gangraena, tabes, exulceratio, polysarcia, and carcinoma. Moreover, in the period before 1850, the employment of such names in connection with diseases of plants as icterus, anemia, phlegmasia, fluxion or bleeding, verrucosis, and exanthema is further confirmation of the influence of medical terminology.

During the latter half of the nineteenth century the overwhelming interest in plant diseases centered around etiology. In the textbooks of this period, as in nearly all recent textbooks, plant diseases are arranged on the basis of the classification of the etiologic agent. The reasons for this situation are numerous and include the following:

1. The period of 50 years after the overthrow of the theory of spontaneous generation, now regarded as the "golden age of discovery" in bacteriology, was also the golden age of discovery in fields pertaining to bacteria and fungi as causes of disease in plants. In this period the cause of a disease and the disease itself were all too commonly regarded as synonymous. The connotation host-parasite, which indicates a food relationship, became a commonplace and was used instead of pathogen-suscept, which indicates the disease relationship. Writers spoke of "spread of disease" and "spread of infection" when they meant spread of inoculum or of pathogenic agents. These examples indicate the confusion of ideas that have been carried over from mycology to phytopathology.

2. The emphasis in studies of plant-pathogenic fungi has remained so overwhelmingly etiologic that even at the present time too little recognition is being given to the influence of "predisposing factors," as stressed by Sorauer, and to the morbid anatomy of diseased plants, as stressed by Küster (1925) in his first edition of *Phytopathologische Pflanzenanatomie*, which appeared in 1903. That plant diseases should be classified on the basis of the disease processes themselves is cogently argued by Whetzel (1929). It is becoming increasingly apparent that instead of stating that a given fungus is *the* cause of a particular disease one should state that it is *one of the causes*, because environmental factors may exert a controlling influence. It is also apparent that the classifications of disease by Küster are fundamental, and future developments must be built on his scheme.

3. The investigators of this period lacked training in phytopathology, and in consequence their attention was centered primarily on the pathogen, with only passing consideration being given the diseased plant. In their scientific writings they employed terms from fields of knowledge with which they were familiar. As soon as interest shifted, a distinctive terminology, applicable only to plant pathology, began to develop, as exempli-

fied by such common terms as wilt, scorch, blight, scald, stripe, die-back, shot hole, leak, damping-off, chlorosis, stunt, dwarf, drop, russet, intumescence, curl, gall, and scab, all of which indicate characteristic symptoms of disease. With the increase in knowledge of changes in cellular structure and function induced by pathogenic fungi, technical terms have been and are being introduced, just as they were in the field of animal pathology. Also there is an increasing tendency among plant pathologists to classify diseases as root-rot diseases, fruit diseases, leaf diseases, seedling diseases, etc., terms analogous to respiratory diseases, gastrointestinal diseases, skin diseases, etc., as used by the medical worker. There is now a growing tendency to clarify terminology as belonging to mycology or to phytopathology and to employ terms that are distinctive in each field.

FUNGI AS ANTIGENS AND PLANT PATHOLOGY

A very extensive literature on studies of resistance to disease among plants exists and has been recently reviewed by Wingard (1941). Nearly all such studies deal with natural immunity, as opposed to acquired immunity. Experimental evidence that plants may acquire immunity after being "vaccinated" and that antibody formation results was first submitted approximately 40 years ago. Plant pathologists generally have not reacted favorably to this type of research and have given it little credence for the reason that plants lack a tissue system comparable with the circulatory system in animals. Nevertheless additional reports have appeared from time to time of studies that tend to support the possibility of acquired immunity in plants. An excellent monographic review of such studies, together with a summary of their own work, was prepared by Carbone and Arnaudi (1930). The "vaccines" used were either injected into plants or applied to the surface of seeds before planting. Arnaudi (1933) prepared vaccine of *Thielaviopsis basicola* from dried powdered mycelial mat or from fresh mycelial mat mixed with sand and triturated in a mortar. These vaccines were applied to the tobacco seed or to the soil with apparent protection of the seedlings.

Series of studies on immune reactions in plants were conducted by Chester (1932) and by Chester and Whitaker (1933), which showed that the so-called "plant precipitins" are in fact non-

protein precipitates arising from a reaction between oxalates and calcium. Their results led them to conclude, "The published immunological reactions in plants are rendered untenable because of lack of homology between the animal and plant reactions, and because of the wide-spread occurrence in plants heretofore used of simple non-protein reactions." Even though the weight of evidence is against the existence of acquired immunity against pathogenic fungi in plants, ample evidence has been accumulated to show that fungi pathogenic to man and animals have antigenic properties.

PRESENT TRENDS IN MYCOLOGIC AND PHYTOPATHOLOGIC WORK

Since the turn of the present century marked changes have taken place in the prescribed disciplines for the training of teachers and investigators of mycology and plant pathology and in the kinds of research involving plant-pathogenic fungi. It is difficult at this time to determine or to decide whether these changes have always tended in the direction of improvement over previous studies, mainly for the reasons that not enough time has elapsed to appraise them disinterestedly and without bias and to view such matters in perspective. Improvement should have been made because, as must be admitted, present-day students of fungi are better trained for their tasks than were their elders. Additional support for this conclusion is found in the fact that during the first quarter of the present century undue attention was devoted to projects involving "spray schedules" and "spray calendars." This kind of project was not sponsored by so-called plant pathologists and mycologists alone, but also by horticulturists, agronomists, entomologists, and botanists, all of whom vied with each other to acquire direction of such projects. Sprays were all too commonly applied, not at critical times in the development of the pathogen, but on planned and prearranged dates. Indeed, basic knowledge about the pathogens involved was extremely meager, and efforts to gain such knowledge were regarded by some workers as a "not practical" expenditure of time. Determination of not only the most effective times to spray but also the proper fungicidal concentrations was sought by empirical methods. Needless to say, a body of contradictory and inexplicable data was

assembled from such experimentation, and it is not surprising that the epithet "squirt-gun pathologists" came to be applied to such workers.

Although plant pathologists have gradually assumed charge of studies on the prevention and control of plant diseases, some still fail to acquire or to utilize knowledge of the seasonal cycle of development of the pathogen, of its epiphytology, and of agencies of its dissemination as a basis for instituting experiments on how best to control the given disease. Two obvious reasons may be offered for this situation. It may arise from lack of adequate mycological training or else from pressure exerted by administrative officials for the publication of experimental findings. In any event the net result is reflected in the content of published reports and of papers presented at conferences or meetings. It is apparent in many cases that too little cognizance has been taken of existing knowledge of the disease and that the materials presented are preliminary and are fragmentary rather than comprehensive in scope. For these reasons they are intrinsically limited in application and in usefulness. The validity of these criticisms is supported by the fact that many papers presented at meetings are not deemed of sufficient merit for publication.

At present, plant pathologists do not occupy positions of respect and honor in society comparable with those held by medical practitioners. Of course, the difference in age of the two professions is a causal factor, but several other reasons, such as the following, seem equally plausible and more fundamental in accounting for this state of affairs.

1. Remuneration for services rendered by plant pathologists is made from funds raised by taxation. Plant pathologists are therefore public servants whose help and advice on the problems of diagnosis and treatment of plant diseases must be given gratuitously to all who request aid. The public has ironically come to feel that the cost of things and their real value to them as individuals are either identical or at least closely correlated.

2. Reports, both those dealing with very meritorious research on pathogenic fungi and those having little or no value, are alike published and distributed free of charge. The public is not always able to differentiate between these two types of reports nor to evaluate them, and they are, in consequence, appraised as though of equal value. It is unfortunate that they should be simi-

larly publicized or perhaps that either should be given any popular publicity, for they thereby partake all too much of the nature of nostrums for the cure of human ailments, as advertised in newspapers and popular magazines or over the radio. It should be remembered that reputable physicians never sponsor the dissemination of panaceas for human diseases. Neither do they make diagnoses nor prescribe treatment without first-hand knowledge of the patient. It seems altogether probable, therefore, that the plant pathologist could raise the esteem and respect with which he is regarded by emulating the medical practitioner in these respects.

3. It is patently a mistake for the student of fungi to confine himself to his armchair or to the four walls of his laboratory or greenhouse. It is equally fatal for best results if he depends entirely upon observations made in the field. Laboratory experiments with fungi and observations on them in the field each have a limited usefulness, but they can be used to complement each other. Results of laboratory experiments are intended to serve as a basis for field trials but should never be translated into definite recommendations for field practice until after they have been adequately tested under conditions that obtain in the field. To do otherwise might cause the reputation of the plant pathologist to suffer a serious decline; furthermore the mistakes of an individual sometimes reflect discredit to his associates and colleagues as well. Unfortunately scientific theory, as developed from experiments under controlled conditions existing in the laboratory, and field practice may prove to be miles apart. All in all, there clearly exists a real need among plant pathologists and mycologists for better acquaintance with both saprogenic and pathogenic fungi as they occur in garden, orchard, field, and forest. Such meetings with fungi in their natural haunts would serve the same function to students of mycology as does the holding of clinics to the physician.

Gradually the interests of students of fungi have become more sharply delimited, one group being concerned primarily with taxonomic problems and the other with disease problems. This specialization has been carried to the extent that it is unusual for a mycologist to do research in plant pathology and for a phytopathologist to do research in mycology. The underlying reasons are not difficult to discern. They may most charitably be attributed to the frailties and limitations of the human mind and to the fact that specialization in training and interest has become

compulsory as a consequence of competition and the desire to gain recognition in a chosen field.

The control of plant diseases is based mainly upon (1) prevention and (2) natural resistance. Prevention may be accomplished by attention to sanitary measures, rotation of crops, seed treatment, establishment of quarantines, application of fungicidal sprays and dusts, and other means. Natural resistance is sought and isolated by selection and hybridization. Little has been done in the field of chemotherapy, or the cure of plant diseases by chemical agencies, especially by the use of vaporous substances, although this field of inquiry seems to offer inviting possibilities for development. The principle involved in the use of chemicals as therapeutic agents is the existence of a differential between pathogen and suscept in tolerance for the chemical or drug. That such studies have merit is indicated by results from the use of benzol and related compounds in the cure of tobacco downy mildew. Similarly the vapors of ethyl mercury chloride and ethyl mercury phosphate have been found effective against *Glomerella gossypii* in cotton-seed treatment [Lehman (1943)]. It is of more than passing interest to note that studies of chemotherapy in human diseases, beginning with the work of Ehrlich, resulted in the discovery of only a few specifics until the recent introduction of the use of sulphonamides and antibiotics produced by certain fungi and bacteria.

IMPLICATIONS

Mycology and phytopathology, parent and offspring, respectively, have not always worked together harmoniously. Seemingly, parents have not learned to accept gracefully the counsel and dictation of their children! The offspring have become numerically larger than the parent, and as an outcome the irritating question of their relative importance has been raised. If their relation were to become synergetic rather than antagonistic, both mycology and phytopathology would profit. It is indicated that such a development is in process of accomplishment. This end could be attained most effectively and most rapidly if teachers earnestly strove to impart instruction that not only embodied all tradition, theories, and useful truth about fungi but also indicated the relation of such knowledge to a balanced, well-rounded education. Moreover, teachers with this viewpoint are true scientists and cannot be nationalistic, for science, like literature, music, and

art, is international. Scientists contribute their efforts and findings for the betterment of mankind everywhere, without regard to race, creed, or political and social affiliations. Such scientists, as teachers, are not unduly concerned with the degree of esteem and respect accorded them by the public. They are true humanists, servants of their times, and this in itself is their all-sufficient and soul-satisfying reward.

LITERATURE CITED

- ARNAUDI, C., "On the vaccination of the tobacco plant against *Thielaviopsis basicola*," *Bull. Torrey Botan. Club*, 60: 583-597, 1933.
- ARTHUR, J. C., "History and scope of plant pathology," *Congr. Arts Sci., St. Louis*, 5: 149-164, 1906.
- CARBONE, D., AND C. ARNAUDI, *L'immunità nelle piante*. Monographie dell'Inst. Sieroterapico Milanese. 271 pp. 1930.
- CHESTER, K. S., "Studies on the precipitin reaction in plants. I. The specificity of the normal precipitin reaction," *J. Arnold Arboretum*, 13: 52-74, 1932.
- CHESTER, K. S., AND T. W. WHITAKER, "Studies on the precipitin reaction in plants. III. A biochemical analysis of the 'normal' precipitin reaction," *J. Arnold Arboretum*, 14: 118-197, 1933.
- FABRICIUS, J. C., "Attempt at a dissertation on the diseases of plants," *Phytopath. Classics*, 1. 66 pp. 1926. (Translated by Margaret K. Raven.)
- FONTANA, FELICE, "Observations on the rust of grain," *Phytopath. Classics*, 2. 40 pp. 1932. (Translated by P. P. Pirone.)
- KÜSTER, ERNST, *Phytopathologische Pflanzenanatomie*, 3rd ed. xii + 558 pp. G. Fischer, Jena. 1925.
- LEHMAN, S. G., "Vapor action of certain fungicidal materials prepared for dusting cotton," *Phytopathology*, 33: 431-448, 1943.
- PRÉVOST, BÉNÉDICT, "Mémorial on the immediate cause of bunt or smut of wheat, and of several other diseases of plants, and on preventives of bunt," *Phytopath. Classics*, 6. 94 pp. 1939. (Translated by G. W. Keitt.)
- RÉ FILLIPO, *Saggio teorico-pratico sulle malattie delle piante*. 1-437. Venezia. 1807.
- SMITH, E. F., "Plant pathology: a retrospect and prospect," *Science*, 15: 601-612, 1902.
- "Fifty years of pathology," *Proc. Intern. Congr. Plant Sci. Ithaca*, 1: 13-46, 1929.
- WHETZEL, H. H., *An outline of the history of phytopathology*. 130 pp. W. B. Saunders Co. 1918.
- "The terminology of phytopathology," *Proc. Intern. Congr. Plant Sci. Ithaca*, 2: 1204-1215, 1929.
- WINGARD, S. A., "The nature of disease resistance in plants," *Botan. Rev.*, 7: 59-109, 1941.

Chapter 19

SOIL FUNGI

In studies of soil fertility much emphasis has been placed upon mineral composition, and all too little attention has been given to microbial composition of soils. Indeed Boussingault and Lewy (1853) long ago showed that the nitrate content of soils, if left fallow, increased, but the causal relation of biologic factors was not recognized at that time, nor was it definitely established until 1877. Then Schloesing and Müntz (1877), in epoch-making studies involving the purification of sewage, established the foundations of nitrification and soil fertility, and their findings constitute the basis for present-day knowledge of relationships between biologic factors and soil fertility. An appreciation of these matters can best be gained from reading *The Microorganisms of the Soil* [Russell *et al.* (1923)], *Principles of Soil Microbiology* [Waksman (1927)], and *Die microscopischen Boden-Pilze* [Niethammer (1937)].

A proper appraisal of the composition of soil must take into account its content of microbes, including bacteria, protozoa, blue-green algae, green algae, and fungi. It appears that Adametz (1886) was the first to isolate fungi from the soil. No real interest in the fungus flora of the soil was manifest, however, until nearly 20 years later, when Oudemans and Köning (1902) isolated and described 45 species of soil fungi. Subsequent studies on this subject may be grouped into three essential types: (1) taxonomic, those concerned with the kind and number of fungi in soils; (2) biochemic, those dealing with the physiological activities of soil fungi; and (3) epidemiologic, those dealing with soil-borne plant and animal pathogens.

TAXONOMIC STUDIES

METHODS. As might be anticipated, various techniques for isolating and culturing soil fungi have been employed. Oudemans

and Köning (1902) placed a fragment of humus in a small vessel containing 1 ml of sterilized water. After the humus has been thoroughly triturated, a platinum loopful of suspension was introduced into 10 ml of sterilized water. A small quantity of this dilute suspension was then poured upon the surface of poured plates of media, consisting of agar 1.5%, gelatin 10%, and sucrose 2%, with an added quantity of wort.

Hagem (1910) sprinkled small amounts of soil on the surface of poured plates in attempts to isolate Mucorales. By repeated transfer of mycelium and spores to new substrates he secured pure cultures. Lendner (1908) employed tubes or flasks of wort gelatin or of moist bread on which small amounts of soil were planted. Several other workers have used a filtrate of soil, suspended in water for 24 hours, to enrich the media. Matters involving media and methods of sampling and of isolating soil fungi are discussed in an outline by Waksman and Fred (1922). They recommend the use of sodium albuminate agar, sodium caseinate agar, or soil-extract agar and gelatin.

Since fungi are tolerant of acid substrates, whereas bacteria and actinomycetes grow best on neutral or alkaline media, a reaction of pH 4.0 to 5.0 is preferable in the isolation of fungi.

Conn (1922) proposed the use of a technique by means of which the presence of fungus hyphae in soils could be demonstrated by direct microscopic examination.

In isolating "water molds," a small quantity of soil, along with some sterilized water, is first placed in a Petri dish, and then boiled hemp seeds are introduced as "bait." Many workers, beginning with Harvey (1925), have employed this technique.

KINDS OF FUNGI ISOLATED. Opinion was divided among earlier students on whether fungi are normal inhabitants of the soil. The weight of evidence, however, has gradually favored the existence of a true fungus flora of the soil. The isolations of Adametz (1886) yielded 11 species of fungi, among which were *Aspergillus glaucus*, *Penicillium glaucum*, *Mucor mucedo*, *M. racemosus*, and *M. stolonifer*. These species have been quite commonly found by all whose interest has centered on the problem of kinds of soil fungi. These investigators have included Oudemans and Köning (1902), Lendner (1908), Hagem (1910), Beckwith (1911), Dale (1912, 1914), Jensen (1912), Goddard (1913), Werkenthin (1916), Paine (1927), Gilman and Abbott (1927),

LeClerc and Smith (1928), Jensen (1931), Cobb (1932), and Gillman (1944).

The list of Oudemans and Köning (1902), from Netherlands includes 45 species, 9 of which are Mucorales. Lendner (1908) described 9 new species of Mucorales among the fungi which he isolated from soils in Switzerland. Hagem (1910) isolated 18 species of Mucorales from field, meadow, forest, and garden soils in Norway, 9 of them being new species.

Dale (1912, 1914) isolated more than 100 species of fungi from soils in England. Jensen (1912) isolated 35 species in New York state. Waksman (1917) obtained from different sections of the United States and Hawaii 25 soil samples, from which he isolated more than 200 species, 137 of which he was able to identify. Among the genera represented were *Absidia*, *Mucor*, *Rhizopus*, *Zygorhynchus*, *Saccharomyces*, *Hypoderma*, *Sordaria*, *Sphaeronema*, *Monilia*, *Oidium*, *Papulospora*, *Aspergillus*, *Penicillium*, *Scopulariopsis*, *Rhinotrichum*, *Sepedonium*, *Botrytis*, *Verticillium*, *Acrostalagmus*, *Cephalothecium*, *Stachybotrys*, *Dematium*, *Cladosporium*, *Alternaria*, *Macrosporium*, *Helminthosporium*, *Stysanus*, and *Fusarium*. The summary by Brierley (1923) in 1923 indicated that up to that time there had been recorded from isolations from soils 56 species in 11 genera of Phycomycetes, 12 species in 8 genera of Ascomycetes, and 197 species in 62 genera of Fungi Imperfecti, including Actinomycetes. This did not include, of course, the startling multitude of species of Basidiomycetes that grow especially in forest soils. Later the report by Gilman and Abbott (1927) listed a total of 61 genera, including 242 species from Iowa soils. A later, more comprehensive report by Gilman (1944) contained a list of 198 species of Phycomycetes, 30 Ascomycetes, and 383 Fungi Imperfecti. Paine (1927) described as new 5 among the 31 species isolated.

Beginning with the studies of Harvey (1925), there has been a lively interest in the occurrence of Phycomycetes, especially water molds in soils. Harvey isolated the following species: *Brevilegnia declina*, *Geolegnia inflata*, *G. septisporangia*, *Leptolegnia subterranea*, *Saprolegnia ferax*, *Isoachlya eccentrica*, and *Achlya caroliniana*. Among other soil-inhabiting species are *Allomyces arbuscula*, *A. javanicus*, *A. cystogenus* and *A. moniliformis*. These species, especially *A. arbuscula*, appear to be widely distributed

throughout the world, according to Emerson (1941) and Wolf (1941).

NUMBER OF FUNGI IN SOILS AND FACTORS INFLUENCING PREVALENCE. The quantitative determinations of fungi in soils have been made by use of dilution-poured plates, and the results obtained do not constitute an entirely satisfactory estimation. Among the factors that are known to influence the results are: (1) dilution of soil suspension, (2) kind of culture medium, (3) reaction of medium, (4) kind of soil, (5) soil reaction, (6) depth at which sample was taken, (7) moisture, (8) season of the year, (9) tillage, (10) manuring practices.

If the soil fungi are sporulating in the sample being examined, the number of colonies will be large; if they are merely vegetating, the investigator may get a small count and as a result may infer that few fungi are present.

Data presented by Brierley (1923) show that portions of the same soil suspension plated on different media yield strikingly different numbers of colonies! Furthermore, when the same soil suspension is plated on the same medium, adjusted to different initial hydrogen-ion concentrations, the number of colonies developing is very different. Brierley's observations from monthly plate counts of fungi in soils at the Rothamsted Experiment Station led him to conclude that there is a seasonal rhythm in the number of soil fungi, ranging from approximately 200,000 to 1,600,000 per gram. Jensen (1931), using European soils from fields, meadows, forests, heaths, moors, and marshes, secured counts ranging from 24,300 to 46,000 per gram of soil.

Accord exists among all investigators that fungi are most abundant near the surface of the soil and that the number decreases with depth. LeClerc and Smith (1928) found *Aspergillus niger* and *Trichoderma lignorum* in Colorado soils only at the surface. Russell (1923) isolated 30 species at a depth of 1 in. from the surface of an unmanured grass plot, 19 species at 6 in., and 11 species at 12 in. Goddard (1913) in Michigan and Werkenthin (1916) in Texas found quite the same uniform distribution of species to a depth of approximately 4 in. Waksman (1916) found *Zygorhynchus vuilleminii* most often in subsoil at depths of 12 to 20 in. Cobb (1932) recorded that fungi are 10 times as abundant in the top soil under hemlock trees as in the subsoil. The data of Takahashi (1919) showed 590,000 fungi per gram of soil

at a depth of 2 cm and 160,000 at 8 cm. He found *Zygorhynchus mölleri* and *Trichoderma köningii* at the lower depths.

Since the soil is such a complex environment, there are abundant reasons for differences of opinion regarding kinds of soil fungi in different soils. Goddard (1913) and Werkenthin (1916) found a constant and characteristic fungus flora of soils, regardless of tillage, soil type, and manuring. Dale (1912, 1914) found certain species common to chalky, peaty, and black earth soils in England. Waksman (1916) obtained the same species from cultivated and uncultivated soils in New Jersey but concluded that each soil possesses a more or less characteristic fungus flora. Brown (1917) expressed a similar opinion by stating that different soils have different fungus floras. Hagem (1910) isolated Mucorales from the soil of meadows, gardens, forests, and cultivated fields but observed that they are most abundant in forest soils. On the other hand, Jensen (1931) found that Mucorales are most abundant in field and garden soil, whereas species of *Trichoderma* are most common in virgin soils, such as those of forests, moors, and heaths.

Cobb (1932) was led to conclude that species of *Mucor* and *Aspergillus* are scarce in forest soils. She also reported differences in abundance between soils under hemlock trees and under deciduous trees, there being twice as many in the top soil under hemlocks as in that under deciduous species. Other observations on factors that modify the presence of specific fungi in soils include those of LeClerc and Smith (1928). Their evidence showed that *Rhizopus nigricans* and *Trichoderma lignorum* occur most abundantly in soils of low mineral and low moisture content and that *Penicillium expansum* is not limited by soil moisture and occurs abundantly, as does *P. lilacinum*, in soils of high mineral content.

Experimentation involving the influence of each of the several factors that modify the activities of soil fungi has been limited. Coleman (1916) employed sterilized soils, with *Aspergillus niger*, *Trichoderma köningii*, and *Zygorhynchus vuilleminii* among the test organisms on which to study the effects of temperature, aeration, and food supply. All grew best at approximately 30° C, but the species differed in their oxygen and food requirements. At any rate, there was no interaction of one species with another nor with the numerous species of soil microorganisms that occur in

unsterilized soil, so that the application of Coleman's findings to conditions in the field is difficult or even impossible of accomplishment.

Waksman (1922) applied several treatments to soils to determine their influence upon the numbers of fungi and obtained the results shown in Table 31.

TABLE 31

THE INFLUENCE OF SOIL AMENDMENTS UPON THE NUMBERS OF SOIL FUNGI

<i>Substance Applied</i>	<i>Soil Reaction (pH)</i>	<i>Number of Fungi per Gram of Soil</i>
Minerals only	5.6	37,300
Heavy supply of manure	5.8	73,000
Sodium nitrate	5.8	46,000
Ammonium sulphate	4.0	110,000
Minerals and lime	6.6	26,000
Ammonium sulphate and lime	6.2	39,100

In general, it would be expected that soils rich in organic matter would support the most abundant fungus population. Jensen (1931) is among those who hold this belief, for he concluded that the application of barnyard manure to soils results in increased numbers of fungi.

The kind of organic matter, through its correlation with the kind of cleavage products resultant from decomposition, may well be a factor of consequence in determining the kind of fungi that predominate. Species of *Penicillium* and *Trichoderma* were noted by Jensen (1931) to prevail in acid soils. In this instance carbohydrates may have constituted the source from which the acids were derived. On the other hand, Jensen (1931) also made the observation that *Mycogone nigra* and *Coccospora agricola* prevailed in alkaline soils that may be assumed to have derived their alkalinity by ammonification of proteins.

BIOCHEMICAL ACTIVITIES OF SOIL FUNGI

The purpose of this discussion is to stress the role that soil fungi play in the transformation of organic matter into humus and into other material necessary for the nutrition of green plants. The impact of bacteriologic study and teaching has resulted in establishing the impression that bacteria constitute the organisms most

concerned in these important changes, when, as a matter of fact, soil fungi are also vitally concerned in these processes. An attempt will be made to show that these fungi function in three interrelated ways: (1) in decomposing carbohydrates, (2) in ammonifying proteins, and (3) in producing mineral transformations.

DECOMPOSITION OF CARBOHYDRATES. Both simple and complex carbohydrates are now known to be fermented by various fungi. It may be recalled that Höpfe-Seyler (1886) long ago secured evidence that filter paper is digested in the presence of a little sewage slime. He placed 25.773 grams of filter paper in a flask, so constructed that he could lead off the gases for analyses. After 4 years 15 grams of the cellulose had been digested, with the production of 3281 cc of carbon dioxide and 2571 cc of methane. This decomposition was established to be induced by anaerobic bacteria. Evidence that fungi can also function in the decomposition of cellulose was first presented by van Iterson (1904) in 1904. His experiments were performed not with pure cultures but with soil as inoculum. The medium consisted of filter paper moistened with tap water in which small amounts of ammonium nitrate and monopotassium phosphate had been dissolved. By this procedure evidence was secured to show that certain fungi, including *Chaetomium kunzeanum*, *Trichocladium asperum*, *Stachybotrys alternans*, *Sporotrichum bombycinum*, *S. roseolum*, *S. griseolum*, *Botrytis sporoides*, *Mycogone puccinioides*, and *Cladosporium herbarum*, digest cellulose. Van Iterson's observations initiated a series of studies on cellulose digestion by fungi, among them those by Kellerman and McBeth (1912), Daszewska (1913), Scales (1916), Waksman (1918), and Henkelekian and Waksman (1925). Kellerman and McBeth (1912) made use of cellulose agar, the preparation of which they describe, and established that many species of *Aspergillus*, *Fusarium*, *Penicillium*, and *Sporotrichum* utilize cellulose as nutrient in pure cultures. Daszewska (1913) found that *Sporotrichum olivaceum*, *Verticillium glaucum*, *V. cellulosa*, and various other Hyphomycetes are more important in cellulose decomposition than are bacteria and that the color of the humus formed is related to that of mycelium and conidia. Among 22 species of soil fungi tested by Waksman (1916), 15 were able to decompose cellulose.

Henkelekian and Waksman (1925) have shown that *Trichoderma* and *Penicillium* possess the ability to decompose cellulose

completely, with carbon dioxide as the only waste product. Moreover a considerable proportion of the carbon in cellulose may be reassimilated by the fungus in building protoplasm. This observation on the utilization of carbon dioxide is elaborated by Foster *et al.* (1941) in their recent studies on this subject.

Abundant evidence, some of which is summarized in Chapter 3, has been secured that many Basidiomycetes, especially wood-rotting species, are capable of utilizing cellulose. Phycomycetes are generally regarded as incapable of digesting cellulose. The work of Whiffen (1941), however, shows that certain chytrids possess this ability.

Many fungi are known to be capable of utilizing starch. Among 22 species of soil fungi tested by Waksman (1916) for diastatic ability, 6 proved capable of using starch. The Mucorales have been shown to utilize many monosaccharides, disaccharides, and also pectins.

DECOMPOSITION OF PROTEINS. That fungi differ in ability to use elemental nitrogen and nitrogen complexes was given consideration in Chapter 2, where it was pointed out that some few species can assimilate atmospheric nitrogen but that most of them prefer amino acids, nitrate nitrogen, or else ammonium salts. That soil fungi have the power of ammonifying proteins was first demonstrated in 1893 by Müntz and Coudon (1893), using *Mucor racemosus* and *Fusarium mützii*, and by Marchal (1893), using *Aspergillus terricola* and *Cephalothecium roseum*. Numerous investigations of this problem followed, including those of McLean and Wilson (1914), Waksman (1916), and Henkelekian and Waksman (1925).

McLean and Wilson (1914) employed members of the Mucoraceae, Aspergillaceae, Dematiaceae, and Moniliaceae, finding that all could produce ammonia either from dried blood or from cottonseed meal. It was observed that some species are more active than others, but of much more interest was the finding that soil fungi exceed bacteria in ammonifying power. Waksman (1916) showed that *Trichoderma köningii* is an especially potent ammonifier. Evidence is lacking that any species of soil fungi takes part in nitrification.

Henkelekian and Waksman (1925) observed a direct correlation between the amount of nitrogen transformed into ammonia

by species of *Penicillium* and *Trichoderma* and the amount of cellulose decomposed.

The abundance of studies on protein decomposition by soil fungi has yielded data on the various factors that modify the accumulation of ammonia. These factors are known to include aeration, soil moisture, soil type, soil reaction, duration of the incubation period, temperature, nature of the protein complex, and presence of soil minerals, especially phosphates.

SOIL-BORNE PATHOGENS

No attempt can be made adequately to summarize the vast literature on the relation of soil-inhabiting fungi to disease in plants. Species of *Pythium*, *Phytophthora*, *Aphanomyces*, *Thielaviopsis*, *Fusarium*, *Sclerotinia*, *Colletotrichum*, *Gloeosporium*, *Botrytis*, *Rhizoctonia*, *Sclerotium*, and *Phymatotrichum* are among those well-known to be soil-borne and to cause serious destruction of crops. Some of them occur in virgin soils, and others are introduced with the culture of the host species. Unfortunately many of them, when once introduced into a field, persist for years, even when susceptible hosts are not planted in these fields for long periods. Pratt (1918) isolated *Fusarium radicicola*, *F. trichothecioides*, and *Rhizoctonia solani* from soils in southern Idaho that had never been cropped to potatoes. Rathbun (1918) found *Fusarium*, a cause of damping-off of coniferous seedlings, in virgin seed-bed soils. Soils that are "crop sick," on the other hand, may contain a variety of species capable of producing infection [Beckwith (1911)].

Infection by soil-inhabiting fungi has been shown to be controlled by such factors as temperature, reaction, and interaction, subjects given consideration in Chapters 5, 7, and 12.

Few cases involving soil-borne human pathogens have been proved. Emmons (1942) determined that *Coccidioides immitis*, the cause of "valley fever," may be isolated from the soil in regions where this disease is endemic.

IMPLICATIONS

As a result of the transformation of organic materials into humus by soil fungi, organic acids are produced, and these acids

have properly been assumed to account for soil acidity. Hagem (1910) concluded that inorganic soil constituents containing such minerals as calcium, magnesium, and phosphorus are dissolved by these organic acids and thereby made available for green plants. Soil fungi are therefore to be regarded as important in soil fertility. Much remains to be determined, however, concerning the indirect role of fungi in making available iron, sulphur, and the many other elements that green plants require in small amounts.

Many soil fungi, as grown on artificial media or on sterilized soil, should be studied intensively to increase our knowledge of their biochemical activities. Similarly two or more species, if grown in association in the same culture, might yield valuable data. The application of these findings in explaining the activities of fungi in normal soils would require the exercise of incisive thinking and well-balanced judgment. Success would be most likely attained if such studies were undertaken by a corps of workers, including microbiologists, chemists, and physicists, working in collaboration.

Means for measuring soil fertility continue to be sought because in the future an adequate supply of food and feed crops will come more and more to depend upon a better knowledge of soil fertility. Partly for this reason the use of *Aspergillus niger* to test the soil-potassium needs of a given crop, as was proposed by Mehlich *et al.* (1933), has intriguing possibilities for application to requirements for other minerals.

Undoubtedly soil fungi perform an important role in producing growth-promoting substances that are utilized by green plants. It is a well-established fact that crop plants do not grow as well on infertile soil if the fields are enriched with mineral fertilizers as if they are enriched with manure or organic material containing equivalent amounts of minerals. The relationship of soil fungi to the production of growth regulators should be further elucidated.

The results of researches on soil fungi, if viewed in perspective, emphasize that soils are not static, but dynamic. The ever-changing balance between each kind of soil microbe and the mineral and non-living organic content of soils still remains largely unknown. A concise summary of these subjects, together with an excellent bibliography, is to be found in a paper by Waksman (1944).

LITERATURE CITED

- ADAMETZ, L., "Untersuchungen über die niederen Pilze der Ackerkrume," Inaugural dissertation. 78 pp. Leipzig. 1886.
- BECKWITH, T. D., "Root and culm infections of wheat by soil fungi in North Dakota," *Phytopathology*, 1: 169-176, 1911.
- BOUSSINGAULT, J. B., AND LEWY, "Sur la composition de l'air confiné dans de terre végétale," *Ann. chim. phys.*, Troisième Serie, 37: 5-50, 1853.
- BRIERLEY, W. B., "The occurrence of fungi in the soil." In E. J. Russell, *Microorganisms of the Soil*, pp. 118-146. 1923.
- BROWN, P. E., "Importance of mold action in soils," *Science*, 46: 171-175, 1917.
- COBB, MARY JO, "A quantitative study of the microorganic population of a hemlock and a deciduous forest soil," *Soil Sci.*, 33: 325-345, 1932.
- COLEMAN, D. A., "Environmental factors influencing the activity of soil fungi," *Soil Sci.*, 2: 1-65, 1916.
- CONN, H. J., "A microscopic method for demonstrating fungi and actinomycetes in soil," *Soil Sci.*, 14: 149-152, 1922.
- DALE, E., "On the fungi of the soil," *Ann. Mycol.*, 10: 452-477, 1912; 12: 33-62, 1914.
- DASZEWSKA, W., "Étude sur la désagregation de la cellulose dans la terre de bruyere et la trube," *Bull. soc. botan. Genève*, Ser. 8, fasc. 8: 255-316, 1913.
- EMERSON, RALPH, "An experimental study of the life cycles and taxonomy of Allomyces," *Lloydia*, 4: 77-144, 1941.
- EMMONS, C. W., "Isolation of Coccidioides from soil and rodents," *U. S. Pub. Health Rept.*, 57: 109-111, 1942.
- FOSTER, J. W., S. F. CARSON, S. RUBEN, AND M. D. KAMEN, "Radioactive carbon dioxide utilization. VII. The assimilation of carbon dioxide by molds," *Proc. Nat. Acad. Sci.*, 27: 590-596, 1941.
- GILMAN, J. C., *A manual of soil fungi*. 392 pp. Iowa State College Press, Ames, Iowa. 1944.
- GILMAN, J. C., AND E. V. ABBOTT, "A summary of the soil fungi," *Iowa State Coll. J. Sci.*, 1: 225-343, 1927.
- GODDARD, H. M., "Can fungi living in agricultural soil assimilate free nitrogen?" *Botan. Gaz.*, 56: 249-305, 1913.
- HAGEM, O., "Untersuchungen über Norwegische Mucorineen. I," *Videnskapselskaps-Skrifter Mat.-naturv. Klasse Kristiania*, 7: 1-50, 1907; II, 4: 1-152, 1910.
- "Neue Untersuchungen über Norwegische Mucorineen," *Ann. Mycol.*, 8: 265-286, 1910a.
- HARVEY, J. V., "A survey of the water molds and Pythium occurring in the soils of Chapel Hill," *J. Elisha Mitchell Sci. Soc.*, 41: 151-164, 1925.
- HENKELEKIAN, H., AND S. A. WAKSMAN, "Carbon and nitrogen transformation in the decomposition of cellulose by filamentous fungi," *J. Biol. Chem.*, 66: 323-342, 1925.

- HÖPPE-SEYLER, F., "Über Gährung der Cellulose mit Bildung von Methan und Kohlensäure," *Höppe-Seyler's Z. physiol. Chem.*, 10: 201-217; 401-440, 1886.
- ITERSON, C. VAN, "Die Zersetzung von Cellulose durch acrobe Mikroorganismen," *Zentr. Bakt. Parasitenk., II Abt.*, 11: 689-698, 1904.
- JENSEN, C. N., "Fungus flora of the soil," *Cornell Agr. Expt. Sta. Bull.*, 315: 415-501, 1912.
- JENSEN, H. L., "The fungus flora of the soil," *Soil Sci.*, 31: 123-158, 1931.
- KELLERMAN, K. F., AND I. G. MCBETH, "The fermentation of cellulose," *Zentr. Bakt. Parasitenk., II Abt.*, 34: 485-494, 1912.
- LECLERG, E. L., AND F. B. SMITH, "Fungi in some Colorado soils," *Soil Sci.*, 25: 433-441, 1928.
- LENDNER, A., *Les Mucorinées de la Suisse*. 180 pp. Berne. 1908.
- MARCHAL, E., "Sur la production de l'ammonique dans le sol par les microbes," *Bull. acad. sci. Belg.*, 25: 727-771, 1893.
- MCLEAN, H. C., AND G. W. WILSON, "Ammonification studies with soil fungi," *N. J. Agr. Expt. Sta. Bull.*, 270. 39 pp. 1914.
- MEHLICH, A., E. TRUOG, AND E. B. FRED, "The *Aspergillus niger* method of measuring available potassium in soil," *Soil Sci.*, 35: 259-276, 1933.
- MÜNTZ, A., AND H. COUDON, "La fermentation ammoniacale de la terre," *Compt. rend.*, 116: 395-398, 1893.
- NIETHAMMER, A., *Die microscopischen Boden-Pilze, ihr Leben, ihre Verbreitung, sowie ihre oeconomische und pathogene Bedeutung*. 193 pp. W. Junk, The Hague. 1937.
- OUDEMANS, C. A. J. A., AND C. J. KÖNING, "Prodrome d'une flore mycologique, obtenue par la culture sur gelatin préparée de la terre humeuse du Spanderswoud près de Bussum," *Arch. néerland. sci.*, 7: 266-298, 1902.
- PAINE, F. S., "Studies of the fungous flora of virgin soils," *Mycol.*, 19: 248-267, 1927.
- PRATT, O. A., "Soil fungi in relation to diseases of the Irish potato in southern Idaho," *J. Agr. Research*, 13: 73-100, 1918.
- RATHBUN, ANNIE E., "The fungous flora of pine seed beds. I," *Phytopathology*, 8: 469-483, 1918.
- RUSSELL, E. J., *et al.* *The microorganisms of the soil*. 188 pp. Longmans, Green and Co., London. 1923.
- SCALES, F. M., "Studies on the decomposition of cellulose in soils," *Soil Sci.*, 1: 437-487, 1916.
- SCHLOESING, T., AND A. MÜNTZ, "Sur la nitrification par les ferments organisés," *Compt. rend.*, 84: 301-303, 1877; 85: 1018-1020, 1877.
- TAKAHASHI, R., "On the fungus flora of the soil," *Ann. Phytopath. Soc. Japan*, 12: 17-22, 1919.
- WAKSMAN, S. A., "Soil fungi and their activities," *Soil Sci.*, 2: 103-155, 1916.
 "Is there any fungus flora of the soil?" *Soil Sci.*, 3: 565-589, 1917.
 "The importance of mold action in the soil," *Soil Sci.*, 6: 137-155, 1918.
 "The growth of fungi in the soil," *Soil Sci.*, 14: 153-158, 1922.
- Principles of soil microbiology*. xix + 897 pp. Williams and Wilkins Co., Baltimore. 1927.

- WAKSMAN, S. A., "Three decades with soil fungi," *Soil Sci.*, 58: 89-114, 1944.
- WAKSMAN, S. A., AND E. B. FRED, "A tentative outline of the plate method for determining the number of microorganisms in the soil," *Soil Sci.*, 14: 27-28, 1922.
- WERKENTHIN, F. C., "Fungus flora of Texas soils," *Phytopathology*, 6: 241-253, 1916.
- WHIFFEN, ALMA J., "Cellulose decomposition by the saprophytic chytrids," *J. Elisha Mitchell Sci. Soc.*, 57: 321-329, 1941.
- WOLF, FRED T., "A contribution to the life history and geographical distribution of Allomyces," *Mycol.*, 33: 158-173, 1941.

Chapter 20

FUNGUS-INSECT INTERRELATIONSHIPS

The studies to date on the interrelationships of fungi and insects may be placed largely in one or the other of five categories: (1) those dealing with insects as vectors of plant-pathogenic fungi, (2) those concerned with fungi that produce diseases of insects, (3) those involving fungi as agencies in the biological control of insects injurious to crops, (4) those dealing with insects that make it possible for certain species of fungi to undergo their cyclical changes or developmental processes, and (5) those involving fungi that are cultivated by insects for food. These studies deal with a large number of species in each group of organisms. For this reason any account that attempts a complete review of the literature and a discussion of it would of necessity be voluminous, and such an undertaking is beside the present purpose. Instead an attempt will be made by the use of representative examples to introduce each of these important fields of interest. A much more comprehensive account of these subjects, to which the student is referred, is contained in a volume by Leach (1940).

INSECTS AS VECTORS OF PLANT-PATHOGENIC FUNGI

This subject was briefly considered in Chapter 8, and to avoid repetition some details are omitted at this point. Attention may well be directed, however, to certain general features of this phase of the fungus-insect relationship. It should be appreciated, first of all, that a background of related evidence facilitated acceptance of the fact that insects are instrumental in dispersing certain pathogenic fungi and in implanting them within host tissues. Before 1900 it had been established that certain mosquitoes are vectors of the nematode worm, *Wuchereria bancrofti*,

causing elephantiasis of man, that the malaria-producing protozoa are transmitted by mosquitoes, and that ticks transmit the Texas cattle-fever organism. Furthermore it had been established that the bacterium responsible for fire blight of pears and apples may be dispersed by bees and wasps. From such basic observations on insect transmission of nematodes, protozoa, and bacteria responsible for animal and plant diseases, interest in insects as vectors increased. As an outcome, instances were found and convincing proofs were submitted that viruses and plant-pathogenic fungi may also be dispersed by insects.

The dispersal of plant-pathogenic fungi by insects is accomplished quite fortuitously. Spores that adhere to the body of the vector may become dislodged on a near-by host. Leaf-eating insects quite generally consume diseased and non-diseased tissues indiscriminately, and the spores may pass intact through the alimentary tract. Such spores in the fecal matter can then serve as inoculum. Again, spores may be introduced or may gain entrance into plant tissues, especially of fruits and twigs, through incisions made in connection with oviposition.

In general, all the dispersal of spores of a given fungus is not accomplished by one species of insect. Rather several species of insects serve as vectors; they may belong to entirely different groups. Among the kinds of insects known to be vectors of plant-disease-producing fungi are grasshoppers, crickets, aphids, scale insects, beetles, true bugs, flies, wasps, and bees.

As might be anticipated, abundance of a given vector may be directly correlated with the severity of an outbreak of disease among plants. For this reason insect control and plant-disease control sometimes become mutually interdependent.

Among important plant-pathogenic fungi known to be transported by insects are the following: *Endothia parasitica*, the chestnut-blight fungus, *Claviceps purpurea*, the ergot-producing organism, *Phoma lingam*, the cause of cabbage blackleg, *Nematospora phaseoli*, the cause of pod spot of Lima bean, *Septoria lycopersici*, the cause of a leaf spot of tomato, *Sclerotinia fructicola*, the brown-rot fungus of stone fruits, *Botrytis anthophila*, the cause of clover-blossom blight, *Ceratostomella ulmi*, the Dutch elm pathogen, and *C. pilifera* and related blue-stain-producing species on coniferous wood.

FUNGI OCCURRING ON OR WITHIN INSECTS

The entomogenous fungi, or fungi that naturally occur on or within the bodies of insects, vary greatly in food habits. Some utilize only living insects, whereas others subsist entirely as scavengers. Some exhibit a high degree of specialization; others are quite generalized. Furthermore, with the exception of the Laboulbeniales and nearly all the Entomophthorales and species of Cordyceps, the entomogenous habit is not a characteristic possessed by any large group of closely related species. All seem markedly influenced in their food habits both by biotic and environmental factors.

Much of our knowledge of these fungi comes from the investigations of Thaxter (1888, 1896, 1908, 1924, 1926) and Petch (1914, 1921, 1924, 1925, 1926, 1931, 1932, 1935, 1939). Thaxter devoted his attention to the Entomophthorales and Laboulbeniales; Petch, to various others, principally to Ascomycetes belonging to Cordyceps, Hypocrella, Sphaerostilbe, Myriangium, Podonectria, and Nectria, and to members of the Fungi Imperfecti belonging to Aspergillus, Penicillium, Spicaria (Isaria), Aschersonia, Microcera, Verticillium, Acremonium, Cephalosporium, Rhinotrichum, Cladobotryum, and Beauveria. The student of entomogenous fungi should also acquaint himself with the check lists by Seymour (1929, pp. 698-718) and Charles (1941) to gain some appreciation of the large number of species of fungi and insects involved. In the following account mention will be made only of a few of the better-known ones.

In 1921 Keilin (1921) described as *Coelomyces stegomyiae* an organism parasitizing the larvae of the mosquito, *Stegomyia scutellaris*. Later Couch (1945) found additional species of *Coelomyces* in larvae of other mosquitoes, *Culex* and *Anopheles*, in Georgia, and determined that the parasites belong among the Blastocladales.

Among the better-known species of Entomophthora may be mentioned *E. muscae* on houseflies, *E. gryllii* on crickets, and *E. sphaerosperma* on the caterpillars of cabbage butterflies. *Entomophthora sphaerosperma* was reported by Sawyer (1929) as parasitizing *Rhopobota vacciniana*, which attacks cranberry vines. Speare (1912) described *E. pseudococci* as parasitic on mealy bugs,

Pseudococcus calceolariae, on sugar cane in Hawaii. Petch (1926b) lists, from Mysore, *E. (Empusa) lecanii* as the first member of this genus found attacking a scale insect.

The "seventeen-year locust," *Tibicinia septendecem*, is very commonly attacked by a peculiar fungus, *Massospora cicadina* [Speare (1921)]. This organism grows within the insect's body and causes the posterior segments to drop off while the cicada is still alive. The conidia and resting spores are then dispersed as the cicada crawls or flies.

In the American tropics *Metarrhizium anisopliae*, called the green muscardine fungus, is known to be destructive to approximately 60 species of insects. Some of these insects are of importance, including the sugar-cane froghopper, *Tomaspis varia*, and May beetles, because they normally cause appreciable damage to crops.

Beauveria bassiana is another generalized species, best known from its occurrence on chinch bug, *Blissus leucopterus*, and corn borer, *Pyrausta nubilalis*. It was first described as a parasite of silk-worm larvae and given the name *Botrytis bassiana* [Petch (1914)]. Previously another species, *Beauveria globulifera*, which has been confused with *B. bassiana*, was described from France and from South America. In South America it was identified as *Sporotrichum globuliferum*. However, Lefebvre (1931) regards *B. bassiana* and *B. globulifera* as distinct species, and his evidence indicates that *B. globulifera* is the more virulent as a pathogen on corn borer.

Sorosporella uvella, a hyphomycete pathogenic to certain cutworms and to larvae of the sugar-beet curculio, *Cleonus punctiventris*, is of peculiar interest because there is no external evidence of its presence in host larvae [Speare (1920)]. The fungus is an obligate parasite. Its resting spores are formed internally to the body wall and come to fill the body cavity with a brick-red powdery mass. This organism was first described from Russia, where it was given the name *Tarichium uvella*.

The generic name *Isaria* has come to be widely known among mycologists in connection with conidial stages of *Cordyceps* that parasitize various beetles and other insects. Petch (1934) proposed, however, that the name *Isaria* be discarded in favor of *Spicaria*. Then the name *Isaria farinosa*, as the type, becomes

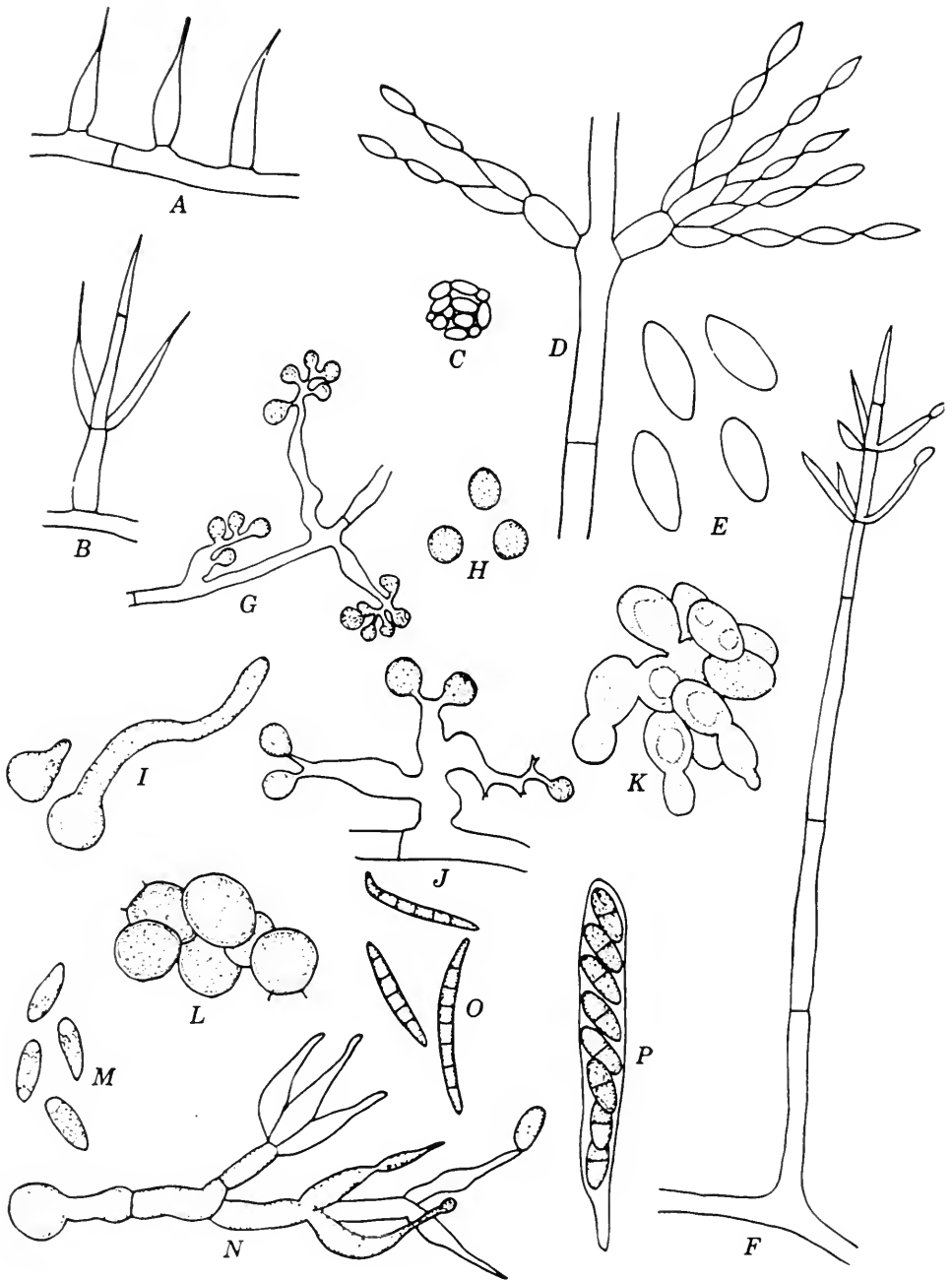

FIG. 74. Various entomogenous fungi. A. Simple conidiophores of *Cephalosporium lecanii* on *Lecanium viride* on coffee. B. Branched conidiophore of *C. lecanii*. C. A lead of conidia of *C. lecanii*. D. Conidiophore. E. Conidia. F. Conidiophore. G. Conidiophore. H. Conidia. I. Conidia. J. Conidiophore. K. Conidia. L. Conidia. M. Conidia. N. Conidiophore. O. Conidia. P. Conidia.

Spicaria farinosa. *Spicaria javanica* attacks the cottony cushion scale, *Icerya purchasi*, in Puerto Rico.

According to Petch (1921), there are about 50 valid species of *Hypocrella*, most of them parasitic on scale insects. A considerable number possess a pycnidial stage belonging to *Aschersonia*. The first *Aschersonia* to be described was *A. aleyrodis* on *Aleyrodes citri*, collected in Florida, in 1894.

Other parasites of scales are mostly species of *Myriangium*, *Sphaerostilbe*, *Nectria*, and *Podonectria*. Of the 15 species of *Myriangium* recognized by Petch (1924a), 4 are entomogenous, namely *M. duriaei*, *M. curtisii*, *M. montagnei*, and *M. thwaitesii*.

Apparently the first entomogenous fungus on scales was collected in Normandy and given the name *Microcera coccophila* by Desmazières in 1848 [Petch (1921)]. This is a conidial stage, and soon thereafter the Tulasne brothers wrongly attached this name to *Sphaerostilbe coccophila*. Petch, however, maintains that *S. flammea* is the correct perithecial-stage name for *Microcera coccophila*, which is a widely distributed fungus on scales in North America. The next scale parasite to be recognized was collected on orange twigs in Ceylon and identified as *Nectria aurantiicola*. Later Luttrell (1944) studied the development of this species, using the name *Sphaerostilbe aurantiicola*, which is widely present in the Orient and in the southeastern United States. Like *S. flammea*, it possesses a similar conidial (*Microcera*) stage.

Perhaps the most remarkable of the fungi that attack insects

of *Spicaria javanica* with phialides and conidia. E. Conidia of *S. javanica*. F. Conidiophore and conidia of *Verticillium heterocladium*, parasitic on *Aleyrodes*. G. Botryoid clusters of conidiophores of *Beauveria bassiana*, bearing conidia. H. Mature conidia of *B. bassiana*. I. Germinating conidia of *B. bassiana*. J. Flask-shaped phialides terminating conidiophore branches of *B. bassiana*. K. Colony of young resting spores of *Sorospora uvella* from diseased cutworm, showing budding. L. Mature resting spores of *S. uvella* with remains of walls of cohering spores. M. Mature conidia (secondary) of *S. uvella*. N. Verticillate conidiophore of *S. uvella*, bearing secondary conidia. O. Conidia (*Microcera*) of *Sphaerostilbe aurantiicola*. P. Ascus of *S. aurantiicola*. (A, B, C, D, and E after Petch, F after Fawcett, G, H, I and J after Lefebvre, K, L, M and N after Speare, and O and P after Luttrell.)

are species of *Septobasidium*, a genus monographically treated by Couch (1938). Its members live in mutualistic association with colonies of scale insects, using some individuals for food and giving shelter and protection to others.

BIOLOGICAL CONTROL OF INSECTS

That competition between organisms exists everywhere throughout nature is clearly appreciated by biologists. This concept was crystallized from observations and incisive analyses by Darwin, and he expressed it by the connotation "the struggle for existence." The discussion that follows is intended merely to direct attention to man's efforts to intervene in a struggle between fungi and insects in order to suppress epidemics of insect pests, at least to the extent of bringing them under control.

The basic principles of biological control of noxious insects by microorganisms (fungi, bacteria, viruses, and protozoa) have been given consideration by Sweetman (1936). He indicates that the following factors should be given particular attention: (1) the differences in receptivity or susceptibility of the insect at different stages of development; (2) the environment most favorable to the pathogenic agent; (3) the virulence of the pathogen as modified by environment; and (4) the necessity of having the optimum conditions for attack by the pathogen coincide with the occurrence of favorable abundance and developmental stage of the insect to be controlled.

Upon contemplation of these factors it will become apparent that little hope of success should be expected in controlling a particular insect pest by use of a given entomogenous fungus unless and until an understanding has been gained of the aggressiveness or virulence of the fungus. For example, some fungi, such as species of *Penicillium*, *Alternaria*, and *Cladosporium*, whose members rarely attack living organisms, may be presumed when present to have invaded the bodies of insects after they have died. At the opposite extreme in intergradation of parasitism are such obligate parasites as *Entomophthora* and *Sorosporella*, which thrive only while the insect remains alive. Such fungi produce spores during a brief period before the death of their victim or immediately thereafter, and the spores remain dormant or fail to germinate unless they come in contact with another living insect.

Furthermore weather factors are known to influence the aggressiveness of entomogenous fungi. Most of them, especially species of *Sphaerostilbe*, *Aegerita*, *Aschersonia*, and *Beauveria*, are favored by wet weather or periods of high humidity coupled with high temperature. If dense populations of insects occur at such times, these fungi spread with great rapidity, and the insects become diseased in epidemic proportions. These factors may therefore become limiting in man's efforts toward artificial control.

Beauveria bassiana, first observed in 1835 by Bassi di Lodi as pathogenic to silk-worm larvae, is among the better-known species that have been used in efforts to secure control of insects. Attempts extending over several seasons were made to control flea beetles (*Haltica*) in Algeria, with the result that the adult stage readily became infected, but the larvae seemed quite resistant. Attempts were also made over the period 1888 to 1896 to control chinch bug, *Blissus leucopterus*, in Illinois by use of the related *Beauveria globulifera*. A measure of success was obtained in these trials but only when the insects were present in excessive abundance and when hot, wet weather prevailed.

Extensive attempts have been made in Florida to utilize naturally occurring entomogenous fungi against white flies and scale insects in citrus groves [Fawcett (1907, 1908), Berger (1909, 1910), Morrill and Back (1912)]. In Florida citrus groves, several species, including *Aegerita webberi*, *Aschersonia aleyrodinis*, *A. goldiana*, *Verticillium cinnamomeum*, *Sphaerostilbe aurantiicola*, and *Podonectria coccicola*, are of importance and have been used artificially. Increase of white flies and scale insects has been stimulated there by the use of Bordeaux mixture to control citrus scab, *Sphaceloma fawcetti*, and citrus melanose, *Diaporthe citri*.

The inoculum for these entomogenous species consisted of spore suspensions sprayed upon insect-infested trees or of fungus-bearing leaves or twigs tied to such trees. In some instances the spore suspensions were prepared from pure cultures and in others from fungi removed from infested leaves.

Under some conditions the results in Florida and elsewhere show that the artificial introduction of fungi has very materially aided in the destruction of insects [Picard (1914), Berger (1921, 1932), and Watson and Berger (1937)].

Morrill and Back (1912) concluded, however, that *Aegerita*

webberi is so effective in controlling white fly in low-lying hammock groves that artificial measures are unnecessary.

Aspergillus parasiticus has been found effective against various mealy bugs in Hawaii [Speare (1912)], Puerto Rico [Johnston (1910)], and California [Smith and Armitage (1931)].

Species of *Entomophthora* are not easily cultivated in pure culture but, if artificially disseminated, may aid in bringing epidemics of plant lice under control. *Entomophthora sphaerosperma*, for example, caused considerable reduction in the population of apple sucker, *Psyllia mali* [Sweetman (1936), p. 71], in Nova Scotia and in parts of Europe. Another species, *E. chromaphidis*, was found very destructive to walnut aphid, *Chromaphis juglandicola*, in California. In some seasons in Florida *E. fresenii* becomes an important factor in the control of *Aphis spiraecola*, especially on tangerines.

Metarrhizium anisopliae, when artificially applied in some localities to corn leaves, has been found very destructive to corn borer [Sweetman (1936), p. 75].

It becomes apparent to anyone who critically reads accounts dealing with attempts to use fungi to control insect pests that the results are not always in accord, and the conclusions are often contradictory. Petch (1921) summarized his pertinent experiences as follows: "The problem which has yet to be solved by those who wish to control insects by means of fungi is to create an epidemic at a time when such an epidemic would not occur naturally." On the basis of the relatively few cases in which outstanding control has been accomplished Fawcett (1944) suggests that more attention should be given to the artificial spreading of entomogenous fungi and to more efficient ways of increasing their use.

INSECTS IN RELATION TO REPRODUCTION OF FUNGI

It has long been known that insects carry pollen and that the setting of seed and the development of certain fruits, for example, clovers, apples, and peaches, is conditioned by insect pollination. Similarly insects disperse reproductive elements (spermatia) among fungi. In support of this conclusion, Brodie (1931) found that flies are agents of diploidization of *Coprinus lagopus*, a heterothallic species. The fruit bodies of this mushroom do not form unless oidia from the plus mycelium are transported to the minus

mycelium, or vice versa, whereupon they germinate, the hyphae fuse, diploidization results, and mushrooms are developed.

Craigie (1931) showed that *Puccinia helianthi* and *P. graminis* may be diploidized by the agency of insects. The pycniospores of these rusts are haploid. Diploidization occurs only if pycniospores from one pycnium are transferred to another of opposite sex, whereupon the process is initiated by fusion of a germinating pycniospore with a receptive (flexuous) hypha that projects from the pycnium. Insects may be essential agents in the transfer of pycniospores, and such transfer is an essential condition in the development of dicaryotic aeciospores. Subsequent findings with other rust fungi substantiate these observations. Spermatization of certain ascomycetes also is known to result from insect transfer of spermatia.

FUNGI CULTIVATED BY INSECTS

Much of our knowledge on this topic involves "ambrosia" beetles (timber-boring Scolytidae, including engraver beetles and bark beetles that tunnel and breed in bark and sapwood), leaf-cutting ants, and termites. Such relationship of insect and fungus is termed an ectosymbiotic one by Buchner (1930). By ectosymbiosis, in this instance, is meant an association in which the fungus occurs chiefly outside the body of the insect.

BEETLES AND FUNGI. Many species of Scolytid beetles are associated with fungi; the better-known ones belong to *Scolytus*, *Dendroctonus*, *Ips*, and *Hylurgopinus*. Their relationship with specific fungi seems none too well understood in most cases, although the phenomenon of fungus-insect association was first observed about a hundred years ago. As indicated in Buchner's treatise (1930), Thomas Hartig in 1844 recognized that the ambrosia of *Xyleborus dispar* in *Alnus cordata* is a fungus, which he named *Monilia candida*. Subsequent investigations have shown that there are many other species of ambrosia fungi. Leach (1940) emphasizes, however, that ". . . taxonomic studies of ambrosia fungi are conspicuous by their absence."

Ambrosia fungi in general permeate the wood and enter into the burrows and brood galleries made by the beetles. The mycelium and spores that protrude into the galleries are eaten by the

beetles, and spores either may be regurgitated or may resist digestion and then be voided in the excrement.

A great deal of interest in ambrosia fungi has centered on those species associated with the staining of wood, since such wood staining is of so much economic importance to the lumber industry. The work of Rumbold (1936) shows that *Ceratostomella ips*, *C. pilifera*, and *C. pini* occur in pines, *C. piceaperda* in spruce in eastern Canada, *C. pseudotsugae* in Douglas fir and larch in the Northwest, and *C. pluriannulata* in hardwoods. In white fir damaged by several species of *Scolytus*, Wright (1935, 1938) noted two wood-staining species, *Trichosporium symbioticum* and *Spicaria anomala*.

Ceratostomella ulmi, which attacks elms, is always associated with galleries produced by *Scolytus scolytus* and *S. multistriatus*.

Several other species of fungi are associated with wood staining, but their relationship to insects remains unknown. These species include *Endoconidiophora coerulescens*, *E. moniliformis*, *Diplodia natalensis*, *Graphium rigidum*, *Lasiochaeria pezizula*, *Penicillium dicaricatum*, *P. roseum*, *P. aureum*, *Chlorosplenium aeruginosum*, *Fusarium moniliforme*, *F. viride*, *F. roseum*, *Dematium pullulans*, and several species of *Cadophora*, *Hormodendrum*, and *Alternaria*. It seems probable that all of them are not cultivated by wood-boring beetles.

ANTS AND FUNGI. Approximately a hundred species of tropical and subtropical myrmicine ants have the remarkable habit of cultivating and feeding upon fungi. These ants live in large colonies in underground nests. They cut out bits of leaves and carry them into these nests. The plant tissues are then built into spongy masses that serve as a culture medium upon which the ants implant spores and mycelium. Such inoculum is transported within the infrabuccal pouch, especially by the queens. The fungi grow in these "ant gardens" and produce bromatia, swollen, roundish hyphal tips, which are consumed by the ants. New crops of bromatia continue to replace those that have been eaten.

Divergent opinions have been expressed on the identity of the fungi involved. Möller (1893) found in the nests of *Acromyrex disciger* a gill fungus that he named *Rozites gonglyophora* (the termination "ites" should be reserved for fossil fungi). *Xylaria micrura* was identified in the nest of *Acromyrex lundii* by Spegazzini. *Cladosporium myrmecophilum* is cultivated by *Lasius fulig-*

imosus, and *Hormiscium pithyophilum* by *Lasius umbratus*. The fungus cultivated by *Atta cephalotes* was identified by Weber (1938) as *Lentinus atticolus*. Spores of several unidentified species from infrabuccal pouches are represented in the illustrations that accompany the report by Bailey (1920).

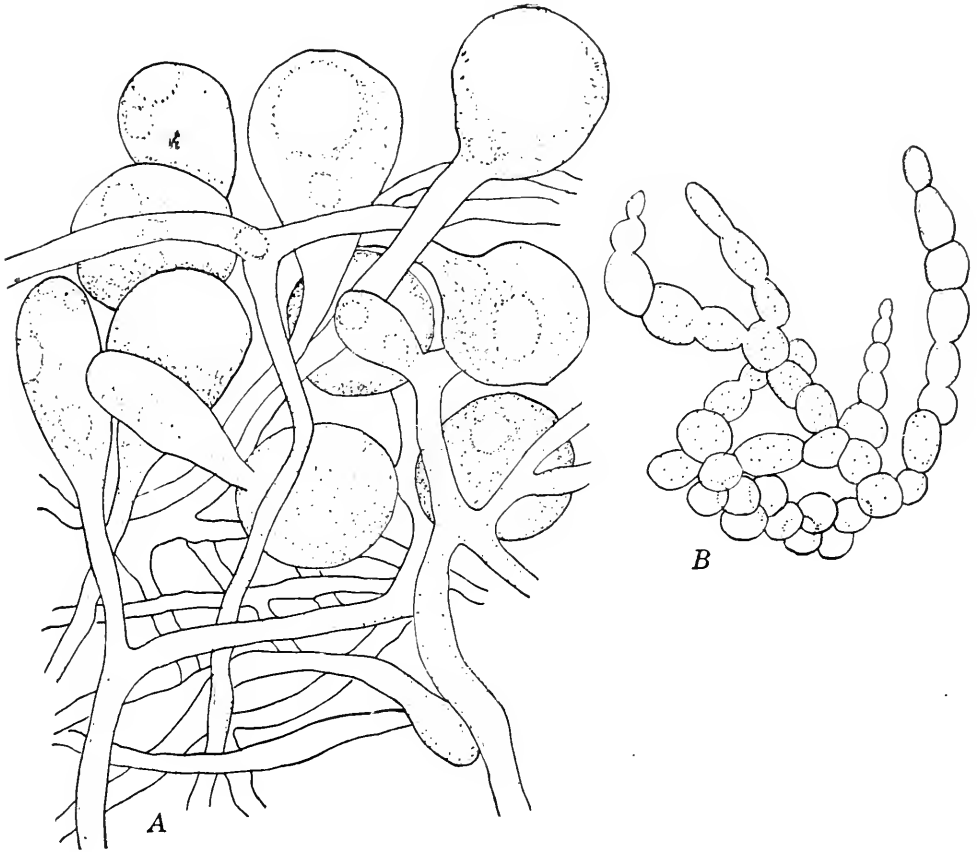

FIG. 75. Fungi used as food by insects. *A*. Globular hyphal tips (bromatia) of a fungus cultivated by ants. (Adapted from Wheeler.) *B*. Monilioid fungus in artificial culture. The ambrosia beetle, *Trypodendron betulae*, uses this fungus. (Adapted from Leach, Hodson, Christiansen, and Chilton.)

Some workers have maintained that the associated fungus occurs in "pure culture," a claim which is denied by Goetsch and Stoppel [Uphof (1942), p. 584]. These investigators isolated the following fungi from the nests of *Atta sexdens*: *Hypomyces ipomoeae*, *Fusarium oxysporum*, *F. angustum*, *F. equiseti*, *Verticillium candidum*, and *Clonostachys araucariae*; from nests of *Acromyrex* they isolated *Mucor racemosus*, *Actinomucor repens*, *Moniliopsis aderholdii*, *Rhizopus nigricans*, *Trichoderma* sp., and *Penicillium* sp.

Interest in such problems involving ants as growers of fungi should be stimulated by perusal of the reports of Möller (1893), Wheeler (1907), Elliott (1915), Bailey (1920), Spegazzini (1922), and Weber (1938).

TERMITES AND FUNGI. One group of the termites cultivates fungi in "gardens" for use as food. Such termites are colonial and live either in large nests (termitaria) built underground or in mounds above ground. Within these nests are compartments in which the fungi are cultivated on termite excrement. The fungi grown are eaten by the young and constitute essentially the only food used. In spite of the fact that naturalists found fungi in termite nests nearly 200 years ago, little is yet known regarding the identity of such fungi, as is indicated by the accounts of Holtermann (1898), Petch (1906, 1913), Brown (1918), Bose (1923), and Uphof (1942). Uphof states that Berkeley in 1869 described a fungus taken from white-ant nests as *Agaricus termitigina*, probably identical with *Lentinus cartilagineus*. He further states that Cesati in 1870 regarded *Tricholoma subgambosum*, which occurs in Ceylon, Java, Singapore, and Borneo as a termite fungus. Fungi identified as *Pluteus termitus* and *Xylaria nigripes* have been taken from termite nests in Brazil. In India Bose (1923) found that termites cultivate *Collybia albuminosa* but "weed out" the stromata of *Xylaria nigripes*. Petch (1906) made the observation that *Agaricus* sp. does not grow in the soil surrounding the nest but only on the "comb" in compartments while the nests are inhabited. After the nests have been abandoned, *Peziza epispartia*, *Podaxon* sp., and other fungi develop on the comb.

In addition to the cases of ectosymbiosis involving fungi and insects which have been enumerated, attention may be directed to the existence of endosymbiosis. The best known of these endobiotic relations involve termites that digest wood but are able to do so only through the agency of symbiotic protozoa that live within their intestines. The claim has been made by Koch (1931) that an unnamed fungus, which is endobiotic, lives in the fat bodies of the saw-tooth grain weevil, *Oryzaephilus surinamensis*, and in some manner contributes to fat metabolism. This relationship is maintained from generation to generation by invasion of the eggs.

IMPLICATIONS

It appears that problems of interrelationship of fungi and insects are basically ecological, and more emphasis should be placed on approaching them from this viewpoint. To this end closer co-operation between mycologists and entomologists is required. The usefulness of these scientists' findings should be enhanced if natural rather than artificial environments can be employed for their experimentation. The resistance of seed plants to attack by the noxious insect should in any event be regarded as an essential phase of such ecologic problems.

LITERATURE CITED

- BAILEY, I., "Some relations between ants and fungi," *Ecology*, 1: 174-189, 1920.
- BERGER, E. W., "White fly studies in 1908," *Fla. Agr. Expt. Sta. Bull.* 97: 43-71, 1909.
- "White fly control," *Fla. Agr. Expt. Sta. Bull.*, 103: 1-28, 1910.
- "Natural enemies of scale insects and white flies in Florida," *Fla. Sta. Plant Bd. Quart. Bull.*, 5: 141-154, 1921.
- "The latest concerning natural enemies of citrus insects," *Fla. State Hort. Soc. Proc.*, 45: 131-136, 1932.
- BOSE, S. R., "The fungi cultivated by the termites of Barkuda," *Rec. Indian Mus.*, 25: 253-258, 1923.
- BRODIE, H. J., "The oidia of *Coprinus lagopus* and their relation with insects," *Ann. Botany*, 45: 315-344, 1931.
- BROWN, W. H., "The fungi cultivated by termites in the vicinity of Manila and Los Baños," *Philip. J. Sci., Ser. C. (Bot.)*, 13: 223-231, 1918.
- BUCHNER, P., *Tier und Pflanze in Symbiose*. Gebrüder Bornträger, Berlin. 1930.
- CHARLES, VERA K., "A preliminary check list of the entomogenous fungi of North America," *U. S. Dept. Agr., Bur. Plant Indus., Insect Pest Survey Bull.*, 21: 770-785, 1941.
- COUCH, J. N., *The genus Septobasidium*. 480 pp. Chapel Hill, N. C. 1938.
- "Revision of the genus *Coelomyces*, parasitic in insect larvae," *J. Elisba Mitchell Sci. Soc.*, 61: 124-136, 1945.
- CRAIGIE, J. H., "An experimental investigation of sex in the rust fungi," *Phytopathology*, 21: 1001-1040, 1931.
- ELLIOTT, J. S., "Fungi in the nests of ants," *Trans. Brit. Mycol. Soc.*, 5: 138-142, 1915.
- FAWCETT, H. S., "Fungi parasitic on the Citrus white fly," *Fla. Agr. Expt. Sta. Rept.*, 1907: 47-49, 1907.

- FAWCETT, H. S., "Fungi parasitic upon *Aleyrodes citri*," *Univ. Fla. Spec. Studies*, 1: 1-41, 1908.
- "Fungus and bacterial diseases of insects as factors in biological control," *Botan. Rev.*, 10: 327-348, 1944.
- HOLTERMAN, C., *Mykologische Untersuchungen aus den Tropen*. 107 pp. 1898.
- JOHNSTON, J. R., "The entomogenous fungi of Porto Rico," *Porto Rico Bd. Comm. Agr. Bull.*, 10: 1-33, 1910.
- KEILIN, D., "On a new type of fungus, *Coelomyces stegomyiae*, n.g., n.sp., parasitic in the body cavity of the larva of *Stegomyia scutellaris* Walker," *Parasitology*, 13: 225-234, 1921.
- KOCH, A., "Die Symbiose von *Oryzaephilus surinamensis* L. (Cucujidae, Coleoptera)," *Z. Morphol. Ökol. Tiere*, 23: 389-424, 1931.
- LEACH, J. G., *Insect transmission of plant diseases*. ix + 615 pp. McGraw-Hill Co., New York. 1940.
- LEFEBVRE, C. L., "Preliminary observations on two species of *Beauveria* attacking the corn borer, *Pyrausta nubilalis* Hübner," *Phytopathology*, 21: 1115-1128, 1931.
- LUTTRELL, E. S., "The morphology of *Sphaerostilbe aurantiicola* (B. and Br.) Petch," *Bull. Torrey Botan. Club*, 21: 599-619, 1944.
- MÖLLER, A., "Die Pilzgarten einiger Südamerikanischen Ameisen," *Schimper's Bot. Mitt. aus Tropen.*, 6: 1-127, 1893.
- MORRILL, A. W., AND E. A. BACK, "Natural control of white flies in Florida," *U. S. Dept. Agr., Bur. Entom. Bull.*, 102: 1-73, 1912.
- PETCH, T., "The fungi of certain termite nests," *Ann. Roy. Botan. Garden, Peradeniya*, 3: 185-270, 1906.
- "Termite fungi, a résumé," *Ann. Roy. Botan. Garden, Peradeniya*, 5: 303-341, 1913.
- "The genera *Hypocrella* and *Aschersonia*," *Ann. Roy. Botan. Garden, Peradeniya*, 5: 521-537, 1914.
- "Fungi parasitic on scale insects," *Trans. Brit. Mycol. Soc.*, 7: 18-40, 1921.
- "Studies in entomogenous fungi. I. The *Nectriae* parasitic on scale insects," *Trans. Brit. Mycol. Soc.*, 7: 89-167, 1921a.
- II. "The genera *Hypocrella* and *Aschersonia*," *Ann. Roy. Botan. Garden, Peradeniya*, 7: 167-278, 1921b.
- IV. "Some Ceylon *Cordyceps*," *Trans. Brit. Mycol. Soc.*, 10: 28-45, 1924.
- V. "Myriangium," *Trans. Brit. Mycol. Soc.*, 10: 45-80, 1924a.
- VI. "Cephalosporium and associated fungi," *Trans. Brit. Mycol. Soc.*, 10: 152-182, 1925.
- VII. "Spicaria," *Trans. Brit. Mycol. Soc.*, 10: 183-189, 1925a.
- VIII. "Notes on *Beauveria*," *Trans. Brit. Mycol. Soc.*, 10: 244-271, 1926.
- IX. "Aegerita," *Trans. Brit. Mycol. Soc.*, 11: 50-66, 1926a.
- XI. "*Empusa lecanii* Zimm," *Trans. Brit. Mycol. Soc.*, 11: 254-258, 1926b.
- "Notes on entomogenous fungi," *Trans. Brit. Mycol. Soc.*, 16: 55-75, 1931; 16: 209-245, 1932; 18: 48-75, 1933; 19: 34-38, 1934; 20: 161-194, 1935; 23: 127-148, 1939.
- PICARD, F., "Les champignons parasites des insectes et leur utilization agricole," *Ann. école nat. agr. Montpellier*, 13: 121-248, 1914.

- RUMBOLD, CAROLINE T., "Three blue-staining fungi, including two new species associated with bark beetles," *J. Agr. Research*, 53: 419-437, 1936.
- SAWYER, W. H., "Observations on some entomogenous members of the Entomophthoraceae in artificial culture," *Ann. J. Botany*, 16: 87-121, 1929.
- SEYMOUR, A. B., *Host index of the fungi of North America*. xiii + 718 pp. Cambridge, Mass. 1929.
- SMITH, H. S., AND H. M. ARMITAGE, "The biological control of mealy bugs attacking citrus," *Calif. Agr. Expt. Sta. Bull.*, 509: 1-74, 1931.
- SPEARE, A. T., "Fungi parasitic upon insects injurious to sugar cane," *Hawaiian Sugar Planters Assoc., Expt. Sta. Bull.*, 12: 1-62, 1912.
- "Further studies of *Sorospora uvella*, a fungous parasite of noctuid larvae," *J. Agr. Research*, 18: 399-440, 1920.
- "*Massospora cicadina* Peck, a fungus parasite of the periodical cicada," *Mycol.*, 13: 72-82, 1921.
- SPEGAZZINI, C., "Description de Hongos Mirmecofilos," *Rev. museo de la Plata*, 26: 166-173, 1922.
- SWEETMAN, H. L., *The biological control of insects*. 461 pp. Comstock Publishing Co., Ithaca, N. Y. 1936.
- THAXTER, R., "The Entomophthoraceae of the United States," *Mem. Boston Soc. Nat. Hist.*, 4: 133-201, 1888.
- "Contributions toward a monograph of the Laboulbeniaceae. I," *Mem. Am. Acad. Arts Sci.*, 12: 189-429, 1896; II, 13: 219-469, 1908; III, 14: 313-414, 1924; IV, 15: 431-580, 1926.
- UPHOF, J. C. Th., "Ecological relations of plants with ants and termites," *Botan. Rev.*, 8: 563-598, 1942.
- WATSON, J. R., AND E. W. BERGER, "Citrus insects and their control," *Univ. Fla. Agr. Ext. Bull.*, 88: 1-135, 1937.
- WEBER, N. A., "The biology of the fungus-growing ants. III. The sporophore of the fungus grown by *Atta cephalotes* and a review of other reported sporophores," *Rev. Entomologia*, 8: 265-272, 1938.
- WHEELER, W. M., "The fungus-growing ants of North America," *Bull. Am. Mus. Nat. Hist.*, 23: 669-807, 1907.
- WRIGHT, ERNEST, "*Trichosporium symbioticum*, n.sp.: a wood-staining fungus associated with *Scolytus ventralis*," *J. Agr. Research*, 50: 525-538, 1935.
- "Further investigations of brown-staining fungi associated with engraver beetles (*Scolytus*) in white fir," *J. Agr. Research*, 57: 759-774, 1938.

Chapter 21

MARINE FUNGI

Among students of fungi and of marine biology generally, a knowledge of marine fungi is largely non-existent. The underlying reasons for this strange state of affairs are not apparent in view of the enormous volume of work dealing with marine life that has been accomplished. Biologists quite generally concede that the ocean is the ancestral home of life and that the progenitors of present-day land animals and plants came from the ocean. With similar reasoning fungi may be assumed to have originated within the ocean. It might be anticipated, moreover, that marine fungi would constitute favorable materials for studies on phylogeny and on the place which such organisms occupy in the economy of life in oceans.

Terrestrial fungi and bacteria are well known to be responsible for the decomposition of organic debris of all sorts, and it may reasonably be assumed therefore that organisms of these types play a similar role in the ocean. This assumption is not supported, however, by any body of observational and experimental data of appreciable magnitude. Similarly, relatively little appears to be known about the activities and life histories of any species of marine fungi and bacteria, although marine bacteria have been studied somewhat intensively and extensively.

Students of the phylogeny of the fungi regard the Archimycetes as the ancestral and the most primitive group. Among Archimycetes the asexual spores and both kinds of gametes or those of one sex only may be motile, whereas among present-day, higher, terrestrial Phycomycetes and among all Ascomycetes and all Basidiomycetes motility is lacking. This fact might be interpreted to indicate that all these present-day, non-motile forms were derived in a monophyletic line from terrestrial progenitors after the land habit had once become established. It is conceivable too that the higher marine fungi of the present day may

have evolved on land and thereafter migrated from the land to the ocean. On the other hand, those who would derive the Ascomycetes from Florideae regard the fungi as polyphyletic. They emphasize as a basis of relationship similarities between sexual reproductive structures rather than the phenomenon of motility. Regardless of whether fungi are mono- or polyphyletic, there do not seem to be adequate explanations to account for the paucity of Phycomycetes and Ascomycetes within the oceans. There should be an abundant population of marine fungi, primarily because the ocean constitutes a relatively stable environment which should be favorable for the continuous maintenance of species, without major adaptative modification, even of those whose origin dates back into remote geologic time. This environmental stability may in itself be used to account for the lack of evolutionary development of new or different species. If numerous kinds of marine fungi exist, the fact is not revealed by publications. Instead the literature on marine fungi conveys the definite impression that the oceans do not constitute the natural habitat of diverse fungi, nor are they at any place densely populated by any given species.

HISTORICAL BACKGROUND

Evidently many of the early students of marine animals and plants failed to recognize the presence of fungi among their collections or else interpreted the fungi as structures possessed by the animals or plants themselves. Nevertheless occasional observers noted hyaline objects which were interpreted to be fungoid. In 1858 Wedl [Bornet and Flahault (1889)] observed that corals from the littoral zone down to a depth of 1095 fathoms are frequently invaded by filaments that lack septations and are terminated by clavate cells resembling sporangia of the Saprolegniaceae. Kölliker (1859–1860) made similar observations in his examination of animals possessing calcareous shells. Stirrup (1872) observed fungoid growths within the shells of molluscs, and Duncan (1876–1877) identified as *Achlya penetrans* and *Saprolegnia ferax* two water molds within the canals of *Caryophyllia smithii*, one of the Madreporia. Since these two species have not been found subsequently in salt water, their identification must be questioned. The solvent action of carbon dioxide produced by the hyphal tips made possible the penetration of the shells. Bornet and Flahault

(1889) identified the fungi which they found in molluscan shells as *Ostracoblade implexa*, presumably a saprolegniaceous form, and *Lithopythium gangliiforme*, a pythiaceous species.

Evidently non-filamentous Phycomycetes are more abundant among marine species than are Saprolegniaceae and Pythiaceae. The work of Petersen (1905) in Denmark and the more recent studies by Sparrow in Denmark and along the New England coast (1934, 1936) on marine Chytridiales should be considered in orienting one's knowledge of this group.

Barghoorn and Linder (1944) and Linder (1944) gave special consideration to marine fungi on wood and cordage. Nearly all of the 10 imperfect species and 18 Pyrenomycetes which they isolated had not been described previously. Seven of the Pyrenomycetes tolerated well the salinity of sea water and were able to utilize cellulose, pectin, and starch.

For a period of years no one seems to have devoted himself to a study of marine Ascomycetes. The reports by Reed (1902) from collections on the California coast and of Cotton (1907) and Sutherland (1914, 1915, and 1915a) on the English coast are among those of most importance.

Knowledge of the imperfect fungi of the sea is very meager, as is that of the Myxomycetes, except for a few species in the aberrant order Labyrinthulales. The best known of these is *Labyrinthula macroystis*, associated with the "wasting disease" of eel grass, *Zostera* spp.

In the account that follows each of these four major groups of fungi will be considered to a degree consonant with available knowledge and with its importance.

MARINE PHYCOMYCETES

One of the first chytrids to be studied is *Eurychasma dicksonii*, parasitic upon *Ectocarpus*. Wright (1879) named this parasite *Rhizophyidium dicksonii*, a name which was subsequently changed to *Olpidium dicksonii* by the algologist Wille and then to *Eurychasma dicksonii* by Mangnus. Information on its structure and parasitism appears in the accounts by Löwenthal (1905) and Dangeard (1934). Löwenthal (1905) states that at maturity the thallus contains a large vacuole with a peripheral segmentation of this layer. Petersen (1905) traced zoosporogenesis also and

found that numerous vacuoles, separated by thin layers of cytoplasm, function in zoospore formation. Once formed, they are active for a brief period and then encyst within the sporangium, giving it a reticulate appearance. Encystment within the sporangium seems, however, to be abnormal. Scherffel (1925) believes that these methods of zoosporogenesis in *Eurychasma* are not those of true chytrids but of Saprolegniaceae, and he would therefore place it in this group.

Reports of chytrids from the Pacific coast briefly describe *Chytridium alarium* [Kibbe (1916)] on *Alaria fistulosa* and *C. codicola* and *Rhizophyidium codicola* on *Codium mucronatum* [Zeller (1918)]. In a brief note Martin (1922) calls attention to the fact that *Polysiphonia* sp. along the New Jersey coast is parasitized by *Chytridium* (*Rhizophyidium*) *polysiphoniae*, and Sparrow (1936) records the occurrence of this same chytrid on *Polysiphonia fibrillosa* and *Ceramium rubrum* in the vicinity of Woods Hole, Massachusetts. This pathogen is in turn parasitized by the chytrid *Pleolpidium* (*Rozella*) *marinum* [Sparrow (1936)]. All other known species of this genus occur in fresh water.

Among the 15 species of chytrids collected by Sparrow (1936) in the waters near Woods Hole, 2 are especially noteworthy. One, *Petersenia* (*Olpidiopsis*) *andréei*, occurs on *Ectocarpus siliculosus*, upon which it may be pathogenic. Its zoospores are laterally biciliate, as was first pointed out by Petersen (1905) and confirmed by Sparrow (1936). The other species, *Thraustochytridium proliferum*, occurring saprophytically upon *Ceramium diaphanum* and *Bryopsis plumosa*, is described as a new generic type. Its sporangia are Thraustotheca-like in their discharge of zoospores and sporangial proliferation. At the time of discharge the zoospores lack cilia, but each may later come to have a single anterior flagellum.

In Karling's (1943) account mention is made of an organism collected near Beaufort, North Carolina, which is parasitic on *Ectocarpus mitchellae* and *E. siliculosus* and is *Olpidium*-like in structure and development but possesses anteriorly uniflagellate zoospores. Karling described it as *Anisolpidium ectocarpii* and placed it in the family Anisolpidiaceae, which was to include 2 other genera and 5 other species, each having zoospores with a single flagellum that rises anteriorly. Furthermore he believed that the members of this family and those of the Rhizidiomyce-

taceae and Hyphochytriaceae should together be placed in the new order Anisochytridiales.

Among the collections by Petersen (1905) and Sparrow (1934) from the coast of Denmark are listed 22 species of chytrids. Their studies indicate that chytrids are the most abundant members of the marine fungus flora.

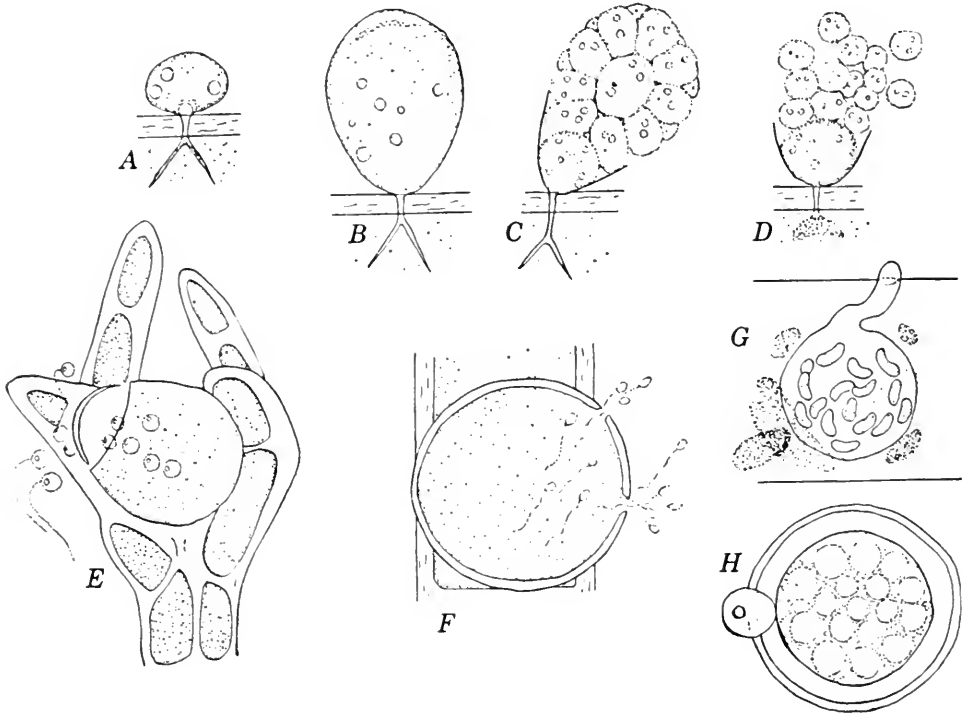

FIG. 76. Various marine chytrids. (After Sparrow.) A-D. Developmental stages of *Thraustochytridium proliferum* on *Bryopsis plumosa*. E. *Chytridium polysiphoneae* in thallus of *Polysiphonia*. F. *Pleolpidium* (*Rozella*) *marinum*, discharging its spores within the thallus of *Chytridium polysiphoniae*. G. Sporangium of *Petersenia andreei* in *Ectocarpus*. H. *P. andreei*, mature resting spore with empty male cyst attached.

Perhaps the most singular member of this group that has been described is *Ichthyophonus hoferi*, first mentioned in 1904 as a parasite of certain fishes by Hofer and later studied by Plehn and Mulow (1911) and Daniel (1933). This species causes enormous losses to marine fish, particularly herring and trout. Plehn and Mulow (1911) described and named the organism, placing it among the Chytridiales. Daniel (1933) made a rather detailed study of the pathogen as it occurs in the sea herring, *Clupea harengus*. The spores are non-motile and usually multinucleate

and escape from the apex of a thick exit-tube-like hypha. During transformation of the spore into a globular thallus nuclear division is accompanied by an increase in the volume of the thallus.

An earlier account by Neresheimer and Clodi (1914) deals comprehensively with the morphology, life history, and pathogenicity of *Ichthyophonus hoferi*. The later study by Fish (1934) em-

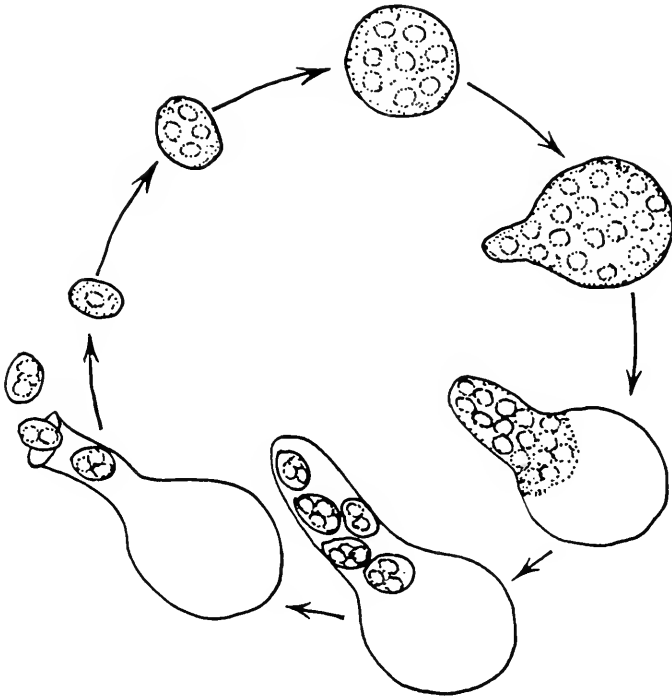

FIG. 77. Schematic life cycle of *Ichthyophonus hoferi*, which parasitizes fishes. (Adapted from Daniel.)

plies the name *Ichthyosporidium hoferi* for the pathogen, which Fish encountered in sea herring, alewife (*Pomobolus pseudo-harengus*), and flounder (*Pseudopleuronectes americanus*) throughout the Gulf of Maine. He concluded that fishes become infected by way of the alimentary canal. Association of these species and cannibalistic food habits, especially of flounder, which eats herring, account for acquisition of the pathogen.

Several saprolegniaceous parasites of marine animals have been observed. Apstein (1910) noted that *Synchaeta monopus*, a rotifer occurring in brackish waters along the Baltic Sea, may be invaded by mycelia of an organism that he named *Synchaetophagus balticus*. The hyphae may more or less completely occupy the body cavity, destroying the organs and leaving only the outer

body membrane. Eventually an isolated branch or the entire mycelium is transformed into sporangia that liberate motile zoospores 5 to 8 μ in diameter. Apstein also observed structures which he doubtfully referred to as oogonia.

In England Atkins (1929) found that pea crabs (Pinnotheres) are killed by one of the Saprolegniaceae. Infection is indicated by whitish patches that show through the body wall in the region of the gills and along the junctions of the abdominal segments. Intricately branched hyphae occupy the tissues of the gills and those between the gill chamber and the dorsal surface of the carapace. Hyphae do not appear at the exterior. The sporangia, which are confined to the gills and pleopods, form at hyphal tips and are cut off by septa. They are of the same diameter as the assimilatory hyphae. The zoospores are pyriform and biciliate. After a brief period of motility they encyst and may undergo a second motile phase. Atkins' evidence for diplanetism, however, is not conclusive. Its identity among Saprolegniaceae is not established beyond the fact that it differs from all other members of this family, mainly in its occurrence wholly within the body of the animal.

Two other parasites of marine animals, described by Niezabitowski (1913), are of interest, *Thalassomyces spizakovii* and *T. batei*. He placed them in the new family, Thalassomycetinae, among the Oomycetes. *Thalassomyces spizakovii* occurs on the deep-sea decapod, *Pasiphaea sivado*, in the Mediterranean, and *T. batei* on *P. cristata* on the coast of the Fiji Islands. Evidence of infection is the presence of clusters of colorless hyphae on the underside of the crustacean's body. Apparently the assimilatory mycelium lives wholly within the interior of the body, and the reproductive hyphae constitute the external hyphal tufts. The non-septate, external hyphae consist of a stalk cell that divides dichotomously one or more times, and each tip eventually becomes segmented to form a row of three cells, which are liberated as conidia. Niezabitowski (1913) places *Thalassomyces* near the Saprolegniaceae and Monoblepharidaceae.

In the vicinity of Beaufort, North Carolina, mud crabs, *Panopeus herbstii*, and mole crabs, *Emerita talpoida*, are commonly parasitized by a species of *Enterobryus*, apparently unnamed. The organism consists of thick-walled, cylindrical filaments of uniform diameter that are about 2 to 3 mm long and 15 to 20 μ wide.

These filaments are straight or coiled and are non-septate. They are attached by disk-shaped holdfasts to the intestinal wall and project as a tuft of white hairs from the anal opening. At maturity a series of three or four cylindrical cells of the same diameter as the hypha is formed. These cells appear to be spores. When

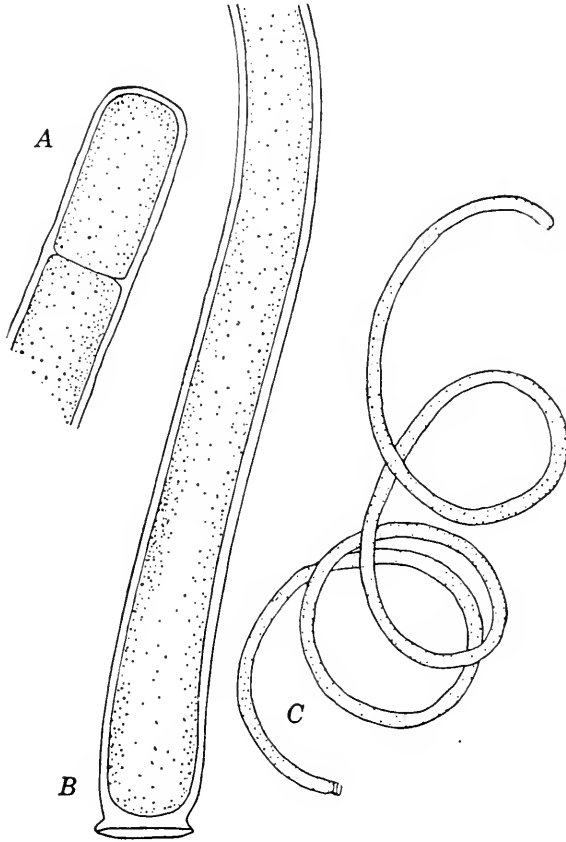

FIG. 78. An eccrinid, presumably a species of *Enterobryus* from mud crab, *Panopeus herbstii*. A. Apex of hypha, showing endogenously formed spore. B. Basal portion of hypha with disk, by means of which the eccrinid is attached to intestinal wall. C. Entire plant, unbranched and unsegmented.

the apex of the hypha ruptures, the spores are freed seriatim by growth and pressure from below. All efforts to cultivate this organism on artificial media have failed. It is strictly parasitic, as are related species.

Little is known about the taxonomy and systematic position of *Enterobryus*, and it is not included in Saccardo's *Sylogae Fungorum*, even though a considerable number of species have been described. The Genus *Enterobryus* was founded by Leidy (1849, 1853) from observations of several entophytous species.

In 1895 Hauptfleisch (1895) described as a new genus and species *Astreptonema longispora*, occurring in the intestine of *Gammarus locusta*. He regarded it as among the Saprolegniaceae, but Saccardo (*Sylloge Fungorum*, 14: 446) placed it among the chytrids. In 1920 Thaxter (1920) found a closely related organism growing exposed on the anal plates of beetle, *Passalus* sp., and properly assigned it the name *Enterobryus compressus*. He was of the opinion that the organism described by Hauptfleisch is an *Enterobryus* and that it belongs among the Phycomycetes, near the Saprolegniaceae.

The ordinal name Eccrinales has been employed to include *Enterobryus* and several related genera, all of which have the same growth habit and form endogenous non-motile spores. None of them is genuinely aquatic, although some species, such as *Eccrinopsis hydropilorum*, parasitize aquatic beetles. No accord has been reached on the relationship of the Eccrinales to other fungi, but presumably they are related to the Saprolegniales. The reports by Léger and Duboscq (1916) and Poisson (1929) will introduce the reader to the status of this strange order of fungi.

Only one species of *Pythium* having a marine habitat has been recorded. Sparrow (1934) obtained it from *Ceramium rubrum* and described it as *Pythium marinum*.

MARINE ASCOMYCETES

Representatives of the Sphaeriales, Dothidiales, and Hysteriales have been found on marine plants and animals. Most of the known species occur on marine algae. Among the 35 species of marine seed plants, included in 8 genera, all monocotyledonous, only *Zostera* and *Posidonia* are known to serve as hosts for ascomycetous fungi. *Ophiobolus halimus* on *Zostera marina* is associated with the so-called "wasting disease," which has wrought so much havoc with this valuable marine species. *Amphisphaeria posidoniae* has long been known on *Posidonia oceanica*.

Of most interest, perhaps, are those species that are thought to be symbiotic. Reed (1902) found that the *Guignardia alaskana-Prasiola borealis* complex approaches that of an ordinary terrestrial lichen. The fronds are entirely dissimilar to those of normal *Prasiola*. In the *Ulva californica-Guignardia ulvae* complex, however, thickenings appear in the tissues surrounding the

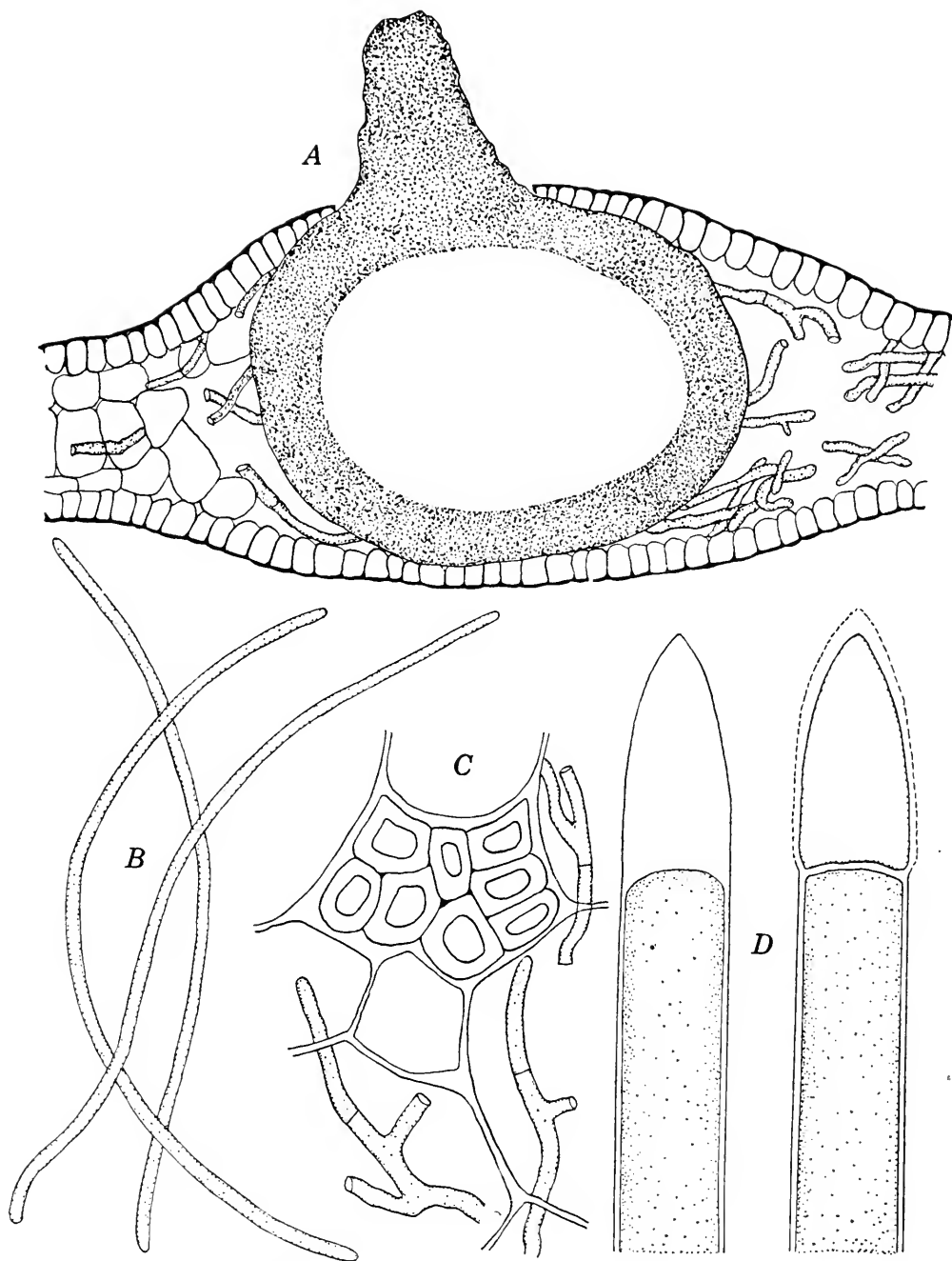

FIG. 79. *Ophiobolus balimus* on *Zostera marina*. A. Perithecium in vertical section. B. Ascospores. C. Hyphae in tissue of rhizome. D. Appendaged tips of ascospores.

perithecia, but they are otherwise quite normal, although *Ulva* does not fruit.

Sutherland (1915) regards *Mycosphaerella pelvetiae* as a symbiont with *Pelvetia*. In this case the perithecia and the host conceptacles mature coincidentally.

Didymella conchae is of particular interest because of its ability to decalcify the shells of certain limpets, molluscs, and barnacles,

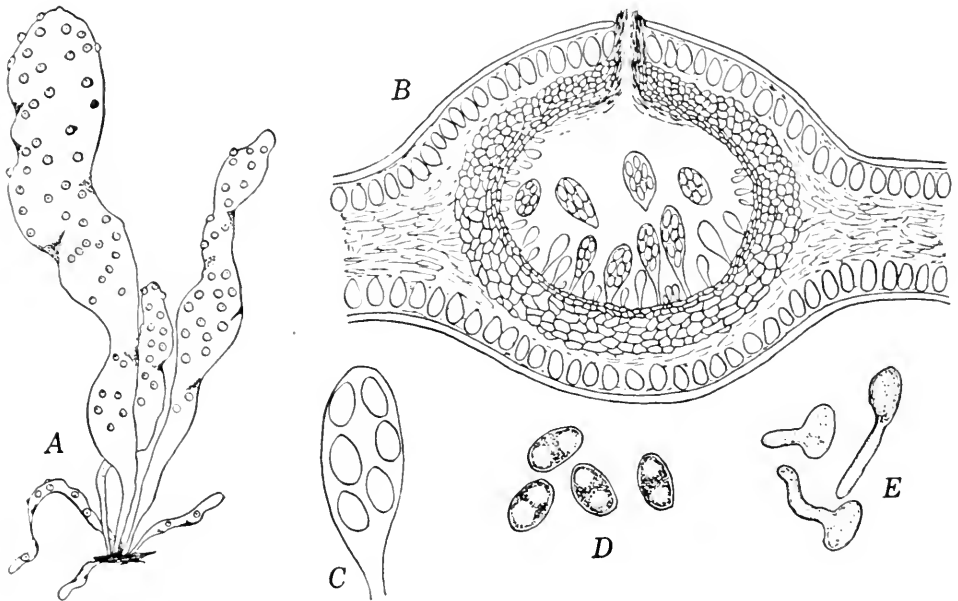

FIG. 80. *Guignardia ulvae* on *Ulva californica*. (After Reed.) A. Habit sketch, indicating swollen areas in which the perithecia are embedded. B. Section of thallus and perithecium. C. Ascus of *G. ulvae*. D. Ascospores. E. Germination of ascospores.

including *Acmea digitalis*, *A. fenestrata*, *A. limatula*, *A. peltata*, *A. scabra*, *A. scutum*, *Balanus glandulosa*, *Littorina planaxis*, *Mitella polymerus*, and *Tegula funebris* [Bonar (1931)].

If further acquaintance with this group is sought, it may be obtained by study of the species assembled in Table 32. This list, however, does not include all the Ascomycetes found on marine algae and seed plants.

MARINE FUNGI IMPERFECTI

Knowledge of these fungi, which is limited to a few saprophytic species, has come from direct examination of decaying algae and

TABLE 32

SOME ASCOMYCETES FORMED ON MARINE PLANTS

<i>Organisms</i>	<i>Hosts</i>	<i>Authority for Name of Fungus</i>
<i>Amphisphaeria posidoniae</i>	<i>Posidonia oceania</i>	Cesati and de Notrais (1863)*
<i>Didymella conchae</i>	Acmea, Balanus, Littorina, Mitella, Tegula	Bonar (1931)
<i>Didymosphaeria fucicola</i>	<i>Fucus vesiculosus</i>	Sutherland (1915)
<i>Didymosphaeria pelvetiana</i>	<i>Pelvetia canaliculata</i>	Sutherland (1915)
<i>Dothidella laminariae</i>	Laminaria sp.	Rostrup (1891)*
<i>Dothidella pelvetiae</i>	<i>Pelvetia canaliculata</i>	Sutherland (1914)
<i>Guignardia alaskana</i>	<i>Prasiola borealis</i>	Reed (1902)
<i>Guignardia (Sphaerella) chondri</i>	<i>Chondrus crispus</i>	Jones (1898)
<i>Guignardia irritans</i>	<i>Cystoseira osmundacea</i> , <i>Halidrys dioica</i>	Estee (1913)
<i>Guignardia ulvae</i>	<i>Ulva californica</i> , <i>Enteromorpha mimima</i>	Reed (1902)
<i>Hypoderma laminariae</i>	<i>Laminaria saccharina</i>	Sutherland (1914)
<i>Leptosphaeria chondri</i> (identical with <i>Sphaerella chondri</i>)	<i>Chondrus crispus</i>	Cotton (1907)
<i>Maireomyces peyssonelia</i>	<i>Peyssonelia squamaria</i>	Feldmann (1940)
<i>Mycaureola dilseae</i>	<i>Dilsea edulis</i>	Maire and Chemin (1922)
<i>Mycosphaerella ascophylli</i>	<i>Ascophyllum nodosum</i>	Cotton (1908)
<i>Mycosphaerella pelvetiae</i>	<i>Pelvetia</i> spp.	Sutherland (1915)
<i>Ophiobolus halimus</i>	<i>Zostera marina</i>	Mounce and Diehl (1934)
<i>Ophiobolus laminariae</i>	<i>Laminaria digitata</i>	Sutherland (1914)
<i>Orcadia ascophylli</i>	<i>Ascophyllum nodosum</i>	Sutherland (1914)
<i>Orcadia pelvetiana</i>	<i>Pelvetia canaliculata</i>	Sutherland (1915)
<i>Pharcidia pelvetiae</i>	<i>Pelvetia</i> spp.	Sutherland (1915)
<i>Phyllachorella oceanica</i>	Sargassum sp.	Ferdinandson and Winge (1920)
<i>Pleospora pelvetiae</i>	<i>Pelvetia</i> spp.	Sutherland (1915)
<i>Stigmatea pelvetiae</i>	<i>Pelvetia</i> spp.	Sutherland (1915)
<i>Trailia ascophylli</i>	<i>Ascophyllum nodosum</i>	Sutherland (1914)
<i>Zignoella calospora</i>	<i>Castagnea chordariaeformis</i>	Patouillard (1897)
<i>Zignoella enormis</i>	<i>Styptocaulon scoparium</i>	Patouillard and Hariot (1903)

* See Saccardo, *Sylloge Fungorum*, 1: 729 (1882).

from attempts to isolate in culture fungi obtained in samples of mud from the ocean bottom at various depths. This second procedure has yielded no typically marine species, all isolates being common species of *Aspergillus*, *Penicillium*, and similar genera [Sparrow (1937)]. By direct examination of decaying algae, largely through the work of Sutherland (1916), however, a number of species have been identified. These include *Alternaria maritima*, *Blodgettia confervoides*, *Cladosporium algarum*, *Cercospora salina*, *Diplodina laminariana*, *Epicoccum maritimum*, *Macrosporium laminarium*, *Monosporium maritimum*, *Sporotrichum maritimum*, and *Stemphylium codii*. Feldmann (1940) described *Macrophoma gymnogongri* as a parasite on *Gymnogongrus norvegicus*.

MARINE SLIME MOLDS

The most important among the several species of marine slime molds is that within diseased leaves of *Zostera marina*. It has, with uncertainty, been identified as *Labyrinthula macrocystis*, an organism consisting of net-like aggregates of individuals connected by pseudopodia. The individuals are spindle-shaped and glide along this interconnecting pseudopodial network.

Affected leaves of *Zostera* bear dark streaks and splotches. Often the cuticle and cortex of the stems are also irregularly spotted with dark brown or black areas. Affected leaves slough off; the stem may persist for a year or two and form new shoots, but eventually the reserve food is exhausted, the plants waste away, and the roots decompose.

Among those who have studied this eel-grass disease are Petersen (1935), Renn (1936, 1937), and Young (1938). Accord has not been reached concerning its etiology, but Renn and Young interpret their evidence as showing that *Labyrinthula* is the pathogenic agent. Among the causes assigned by others are the pyrenomycete *Ophiobolus halimus*, bacteria, unfavorable light, unfavorable temperature, and accumulation of industrial wastes and oil.

IMPLICATIONS

It is of more than passing interest to note that, with the exception of the disease on *Zostera*, fungus diseases of marine plants sufficiently abundant and widespread to be regarded as epidemics

are unknown. If a plausible reason assigned by investigators or arising from contemplation of the data is sought, nothing significant comes to light.

Again, all the known marine fungi are quite like those occurring in fresh water or on land. None appears to have any structural modifications of either the assimilatory or the reproductive parts that can be correlated with adaptation to halophytism. On the other hand, they cannot be regarded as "living fossils," nor as evidence either for or against the concept that the ocean is the ancestral home of the Fungi.

Since the ocean is so stable an environment and contains so many plants and animals that might serve as food, it becomes of interest to speculate on the reasons for the paucity of species among marine fungi.

The role of marine fungi in the decomposition of seaweeds constitutes an almost completely neglected field of inquiry. In all likelihood some of them are capable of digesting agar and chitin, as marine bacteria are known to do [Stanier (1941)]. Seaweeds cast up on beaches no doubt serve as food for both terrestrial and marine fungi.

LITERATURE CITED

- APSTEIN, C., "*Synchaetophagus balticus*, ein in *Synchaeta lebender* Pilz," *Wiss. Meeresuntersuchungen, Abt. Kiel*, n.f., 12: 163-166, 1910.
- ATKINS, D., "On a fungus allied to the Saprolegniaceae found in the pea crab, *Pinnotheres*," *J. Marine Biol. Ass. United Kingdom*, 16: 203-219, 1929.
- BARGHOORN, E. S., AND D. H. LINDER, "Marine fungi: their taxonomy and biology," *Farlowia*, 1: 395-401, 1944.
- BONAR, L., "An unusual Ascomycete in the shells of marine animals," *Univ. Calif. Pub. Bot.*, 19: 187-194, 1936.
- BORNET, E., AND C. FLAHAULT, "Sur quelques plants vivant dans le test calcaire des Mollusques," *Bull. soc. bot. France*, 36: cxlvii-clxxvii, 1889.
- COTTON, A. D., "Notes on marine Pyrenomycetes," *Trans. Brit. Mycol. Soc.*, 3: 92-99, 1907.
- DANGEARD, P., "Sur la presence a Roscoff d'une chytridiale parasite des Ectocarpées, l'*Eurychasma dicksonii* (Wright) Magnus," *Ann. Protoplastenk.*, 4: 69-72, 1934.
- DANIEL, G. E., "Studies on *Ichthyophomus hoferi*, a parasitic fungus of the herring, *Clupea harengus*. I. The parasite as it is found in the herring," *Am. J. Hyg.*, 17: 262-276, 1933.

- DUNCAN, P. MARTIN, "On some thallophytes parasitic within Madreporia," *Proc. Roy. Soc. London*, 25: 238-257, 1876-1877.
- ESTEE, LULA M., "Fungus galls on Cystoseira and Halidrys," *Univ. Calif. Pub. Bot.*, 4: 305-316, 1913.
- FELDMANN, JEAN, "Maireomyces, nouveau genre du Pyrenomycete marin," *Bull. soc. hist. nat. Afrique du Nord*, 31: 163-166, 1940.
- "Une nouvelle espèce de Sphéropsidée parasite d'une algue marin," *Bull. soc. hist. nat. Afrique du Nord*, 31: 167-169, 1940.
- FERDINANDSEN, C., AND O. WINGE, "A Phyllachorella parasitic on Sargassum," *Mycol.*, 12: 102-103, 1920.
- FISH, F. T., "A fungus disease in fishes of the Gulf of Maine," *Parasit.*, 26: 1-16, 1934.
- HAUPTFLEISCH, P., "*Astreptonema longispora*, n. g., n. sp., eine neue Saproleginacee," *Ber. deutsch. botan. Ges.*, 13: 83-88, 1895.
- JONES, HERBERT L., "A new species of Pyrenomycete parasitic on an alga," *Bull. Oberlin Coll. Lab.*, 9: 3, 1898.
- KARLING, J. S., "The life history of *Anisopidium ectocarpii*, gen. nov. et sp. nov., and a synopsis and classification of other fungi with anteriorly uniflagellate zoospores," *Am. J. Botany*, 30: 637-648, 1943.
- KIBBE, ALICE, "*Chytridium alarium* on *Alaria fistulosa*," *Pub. Puget Sound Marine Sta.*, 1: 221-226, 1916.
- KÖLLIKER, A., "On the frequent occurrence of vegetable parasites in the hard structure of animals," *Proc. Roy. Soc. London*, 10: 95-99, 1859-1860.
- LÉGER, L., AND O. DUBOSCQ, "Sur les Eccrinides des Hydrophilides," *Arch. zool. expt. gén.*, 56: 21-31, 1916.
- LEIDY, JOSEPH, "On the existence of Entophyta in healthy animals as a natural condition," *Proc. Acad. Nat. Sci. Phila.*, 4: 225-233, 1849.
- "A flora and fauna within living animals," *Pub. Smithsonian Inst.*, 5: 2-67, 1853.
- LINDER, D. H., "I. Classification of the marine fungi," *Farlowia*, 1: 401-420, 1944.
- LÖWENTHAL, W., "Weitere Untersuchungen an Chytridiaceen," *Arch. Protistenk.*, 5: 221-239, 1905.
- MAIRE, R., AND E. CHEMIN, "Un nouveau pyrenomycete marin," *Compt. rend.*, 175: 319-321, 1922.
- MARTIN, G. W., "*Rhizopidium polysiphoniae* in the United States," *Botan. Gaz.*, 73: 236-238, 1922.
- MOUNCE, I., AND W. W. DIEHL, "A new Ophiobolus on eel grass," *Can. J. Research*, 11: 242-256, 1934.
- NERESHEIMER, F., AND C. CLODI, "*Ichthyophonus hoferi* Plehn und Mulsow, der Erreger der Traummelkrankheit der Salmoiden," *Arch. Protistenk.*, 34: 217-248, 1914.
- NIEZABITOWSKI, E. L., "Die pflanzlichen Parasiten der Tiefsee-Decapodengattung Pasiphaera," *Kosmos (Lwow)*, 38: 1563-1572, 1913.
- PATOUILLARD, N., "*Zignoella calospora*," *J. Bot.*, 11: 242, 1897.
- PATOUILLARD, N., AND P. HARIOT, "Une algue parasitée par une Sphaeriacee," *J. Bot.*, 17: 228, 1903.

- PETERSEN, H. E., "Contributions à la connaissance des Phycomycetes marins (Chytridinae Fischer)," *Oversigt, Kgl. Danske Videnskab. Selskab Forhandl.*, 1905: 440-488, 1905.
- "Preliminary report on the disease of eel grass (*Zostera marina* L.)," *Rept. Danish Biol. Sta.*, 40: 1-8, 1935.
- PLEHN, M., AND M. MULSOW, "Der Erreger der 'Taumelkrankheit' der Salmoniden," *Zentr. Bakt. Parasitenk.*, 59: 63-68, 1911.
- POISSON, R., "Recherches sur quelques Eccrinides parasites de Crustaces, Amphipodes et Isopodes," *Arch. zool. expt. gén.*, 69: 179-216, 1929.
- REED, MINNIE, "Two new ascomycetous fungi parasitic on marine algae," *Univ. Calif. Pub. Bot.*, 1: 141-164, 1902.
- RENN, C. E., "The wasting disease of *Zostera marina*. I. A phytological investigation of the diseased plant," *Biol. Bull.*, 70: 148-158, 1936.
- "The eel-grass situation along the middle Atlantic coast," *Ecology*, 18: 323-325, 1937.
- SCHERFFEL, A., "Zur Sexualität der Chytrideen," *Arch. Protistenk.*, 53: 1-58, 1925.
- SPARROW, F. K., "Observations on marine phycomycetes collected in Denmark," *Dansk Bot. Arkiv*, 8: 1-24, 1934.
- "Biological observations on the marine fungi of Woods Hole waters," *Biol. Bull.*, 70: 236-263, 1936.
- "The occurrence of saprophytic fungi in marine muds," *Biol. Bull.*, 73: 242-248, 1937.
- STANIER, R. Y., "Studies on marine agar-digesting bacteria," *J. Bact.*, 42: 527-560, 1941.
- STIRRUP, M., "On shells of mollusca showing so-called fungoid growths," *Proc. Lit. Phil. Soc. Manchester*, 11: 173, 1872.
- SUTHERLAND, G. K., "New marine Pyrenomycetes," *Trans. Brit. Mycol. Soc.*, 5: 147-154, 1914.
- "New marine fungi on *Pelvetia*," *New Phytol.*, 14: 33-42, 1915.
- "Additional notes on marine Pyrenomycetes," *New Phytol.*, 14: 183-193, 1915a.
- "Marine Fungi Imperfecti," *New Phytol.*, 15: 35-48, 1916.
- THAXTER, R., "Second note on certain peculiar fungus parasites of living insects," *Botan. Gaz.*, 69: 1-27, 1920.
- WRIGHT, E. P., "On a species of Rhizophydium parasitic on a species of *Ectocarpus*, with notes on the fructification of the ectocarpi," *Trans. Roy. Irish Acad. Sci.*, 26: 369-379, 1879.
- YOUNG, E. L., "Labyrinthula on Pacific coast eel grass," *Can. J. Research*, 16: 115-117, 1938.
- ZELLER, S. M., "Fungi found on *Codium mucronatum*," *Pub. Puget Sound Marine Sta.*, 2: 121-126, 1918.

Chapter 22

FOSSIL FUNGI

At first thought fossil fungi might be regarded as outside the field of interest of the student of fungi and of little, if any, innate value to him. It must be admitted that in the past few contributions to our knowledge of fossil fungi have been made by mycologists. This field of inquiry has been left to geologists, whose knowledge of fungi, it is to be hoped, exceeds the mycologists' acquaintance with geology. There are doubtless few mycologists who have ever seen any fossil fungi, and until an occasional worker comes to have some first-hand knowledge of them, there can be no lively interest in objects so long dead and buried. The reason for discussing fossil fungi in this work is that a better acquaintance with the geological history of fungi will, it is hoped, contribute to a greater appreciation of the present place of these plants in the economy of nature.

GEOLOGICAL TIME

Rocks have been truly said to constitute the documentary source books of geological history. By using the evidence exhibited by rocks, that is, their kind, their composition, their position, and their content of minerals and fossils, geologists are able to interpret the past developmental history of the earth and to forecast the future. In so doing they denote segments of geological time as eras, periods, epochs, and stages, which in point of view of time are not sharply delimited one from the other. If, since the beginning of geological time, there had not been inequalities in the amount of heat received from the sun by different regions of the earth's surface, and if rock formation had everywhere proceeded uniformly and without interruption, a geologist could examine a vertical section of the earth's crust anywhere, and the whole monotonous course of events would be in evidence. Cli-

mate, however, must always have been zonal, as it now is. Furthermore the earth's crust was not uniformly constructed nor is it uniformly constituted, as is shown by its stratification. It becomes necessary therefore to segment geological time into intervals to indicate the periods during which the different strata were formed. It would also be anticipated that under these conditions the same kinds of strata would not be encountered everywhere that examination was made of a vertical section of the earth's crust.

The student must also be prepared to accept the conclusion that the same kinds of strata do not occur everywhere in the same relative positions. Evidence is furnished by exposed rocks in such situations as mountainsides, canyon walls, mine shafts, escarpments, and tunnels. Here the strata may be observed to be variously folded, buckled, and jumbled. Moreover, sedimentary rocks are found in some places to be deeply covered by basaltic lava and volcanic ash. In certain localities layers of rock have slipped past each other and been reshuffled in the reverse order of that in which they were formed. In others great beds of coal, lignite, or peat occur. Extensive deposits of salt, sulphur, gypsum, limestone, phosphate, and various minerals are found in other localities. There is evidence that certain parts of the earth were inundated for long periods and that long ago these areas were raised up out of the sea. Faunas and floras existed that were very different from those present anywhere today. Catastrophic changes in climate evidently occurred. The earth's crust must have been in convulsion when the mountains were formed. It is from evidence of this kind, gathered from various localities, that geologists have been able to piece together and to formulate a plausible conception of the sequence of geological events and to approximate the duration of the different segments of geological time.

Estimates of the age of the earth do not agree closely, partly because they are based upon different kinds of evidence. From Biblical evidence Archbishop Ussher placed the age of the earth at approximately 4000 years. If calculations of the duration of geological time are based upon the rate of dissipation of the earth's initial store of heat energy, however, a figure of about 100 million years is deduced.

Several years ago a more exact method of estimating the earth's age was provided from observations involving radioactive rocks, which showed that atoms of uranium spontaneously decompose into atoms of lead and helium, thus liberating radiations. By de-

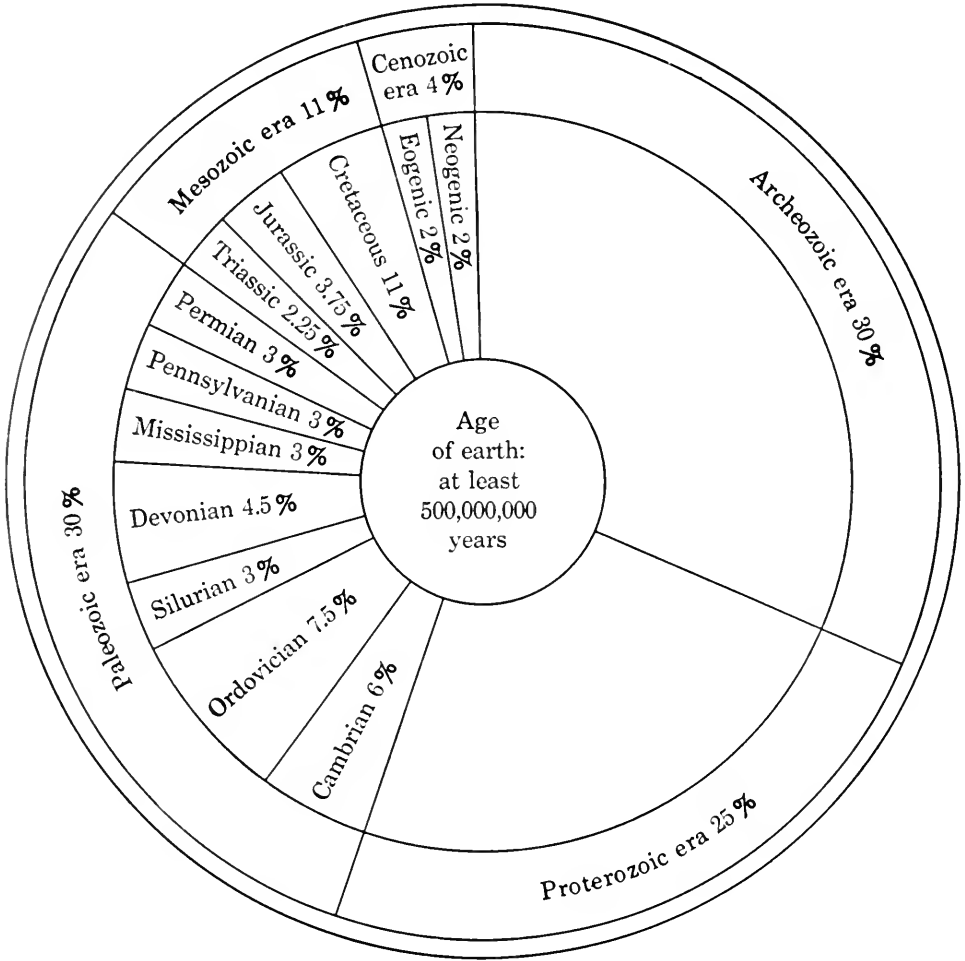

FIG. 81. Dial of geologic time clock. The proportion of time in each era and of the most important divisions of each is indicated.

termining the amount of uranium in uranium-containing rocks, together with the amount of lead associated, Professor A. Holmes concluded that the Pre-Cambrian period began 1580 million years ago. The primeval crust of the earth was formed earlier; hence it may be concluded that 2000 million years constitutes a conservative estimate of the earth's antiquity. As shown by the geological time clock, the age of the earth has been set at 500 million years as a minimum. Whether the earth's age is assumed

to be 500 million years or 2000 million years is certainly of little consequence to the mycologist.

AGE OF FOSSIL FUNGI

Seward (1933), one of the world's foremost students of fossil plants, writes as follows on this subject: "One thing is certain: from the Devonian period onwards and even from a more remote age there were parasitic and saprophytic fungi . . . which so far as we can tell differed in no essential respects from living representatives of this class. We can safely assume that bacteria and many other fungi are entitled to be included among the most ancient members of the plant kingdom." James (1893) has expressed the opinion that evidences of fungi need not be looked for until the Devonian period.

Indirect evidence must be employed in determining how long before the Devonian period plants could have existed. The seas during the Cambrian period contained an abundance of animals, and fossils in Cambrian rocks reveal something of the multitude and variety of these animals. Since fossil plants are lacking, however, it must be assumed that plants existed to serve as food for the multitude of animals. Then, as one descends in time toward and into the Pre-Cambrian period in an effort to find a common "dawn of life" for plants and animals, the tracery terminates, and he is compelled, as Seward (1933) has been, to the following conclusion: "We do not know when and how life began; we cannot measure the rate of the early stages of evolution, nor can we accept as proof of the existence of plants much of the evidence that has been adduced, and not infrequently presented with a confidence worthy of a better cause."

If one ascends in time from the Devonian period, fossil plants, including fungi, would be anticipated in all subsequent periods. They have been found to exist, perhaps most abundantly in Carboniferous rocks formed during the Pennsylvanian and Permian periods, when ferns, fern allies, and pteridosperms flourished. Fossil plants occur throughout the rocks of the Triassic and Jurassic periods, when gymnosperms predominated, and throughout the Cretaceous and Tertiary periods, when angiosperms came into ascendancy. Species from the early Mesozoic period survived and developed, as is indicated by fossils in all subsequent

periods, and their offspring persisted to become the varied assemblage of species that constitute our present living fungi.

In the ascending order the Tertiary period includes the Eocene, Oligocene, and Miocene and grades into the Quaternary, including the Pliocene and Recent Glacial. The Tertiary and Quaternary comprise the Cenozoic era.

THE NATURE OF FOSSILIZED FUNGI

It has been possible with a considerable degree of certitude to relate fossil fungi with members of each of the classes employed in classification of present-day forms. Some fungi, as is well known, are extremely ephemeral; others, because of their corky, leathery, or woody texture, can be kept indefinitely. Since fossils both of ephemeral species, for example, phycomycetous forms, and of resistant species, resembling *Polyporus*, occur, the paucity of fossil fungi cannot be attributed solely to the constitution of the fungi themselves.

The fossilization of fungi is in no way different from that of other plants. Ordinarily the term fossil implies that petrification, a process in which living tissues are replaced by mineral matter, has taken place. Sometimes in fossilization the replacement is made with calcareous materials, as is the case with fossils found in so-called "coal balls." These nodular concretions, sometimes several inches in diameter, consist mainly of carbonates of calcium and magnesium, together with oxides and sulphides of iron.

Carbonaceous matter may also replace the original tissues in the formation of fossils.

Perhaps the most common kind of fossil is formed by incrustation with calcium carbonate. Sometimes leaves and stems, together with the fungi which inhabit them, leave impressions in argillaceous or arenaceous shales or in travertine. These impressions begin to form when the plant part is deposited in the siliceous or calcareous matrix while it is still soft. Gradually the matrix hardens and sets, and the impressions often portray the tissues in great delicacy of detail.

Sometimes fungi are found sealed up in masses of Baltic amber and are thus preserved in a high degree of perfection. Baltic amber, also called true amber, consists of hardened resinous secretions that exuded from conifers and other trees during the Oligo-

cene era. Other kinds of amber are more recent and may contain the remains of various fungi.

PREPARATION OF FOSSILS FOR STUDY

Several methods have been developed for the study of fossilized fungi. The choice of method, as Seward (1933) has indicated, depends upon the nature of the fossil. Sometimes fossil leaves and fructifications of fungi growing upon them are preserved in carbonized films, especially on the surface of hardened mud. If fragments of these carbonized films can be peeled off, they may be bleached in potassium chlorate and nitric acid, washed in ammonia, and then mounted in Canada balsam for direct examination. If the carbonized film cannot be detached, the specimen is first covered with cellulose acetate dissolved in amyl acetate. After this solution has dried, the specimen is covered with hot Canada balsam and then with melted paraffin, after which it is placed in hydrofluoric acid. This acid dissolves the matrix and leaves the fossil intact. If the paraffin is then removed, the fossil can be examined directly.

In preparing fossils in coal balls, either thin sections are cut by special machinery, or else sections can be ground down to a suitable thinness. As an alternative, the smooth, cut surface of the coal ball may be etched by immersion in hydrofluoric acid, whereupon the actual plant substance is left in relief. After the etched surface has been washed and dried, a film of gelatin or of some cellulose ester is poured over it; when this film hardens, it may be peeled off and mounted. This simple method makes it possible to get a score or more of reproductions from the same etched surface.

CLASSIFICATION OF FOSSIL FUNGI

It is apparent that fossil fungi cannot be classified on the basis of developmental morphology, as can living species. Their fossilized remains must therefore be compared structurally with present-day forms and, on the basis of evidence which is at best merely fragmentary, must be placed in modern families. When this is done, some appear to resemble living forms closely, and others, as might be expected, do not exhibit such affinities. By use of the generic termination "ites" the resemblance of fossils

to present-day genera may be indicated. If this were the sole difficulty in classification, a fairly stable taxonomic status might be achieved. There remains, however, the vexatious and ever-present problem of specific identity. Are specimens in rocks from one locality identical with those from another? Are specimens in non-contemporaneous rocks specifically alike? Are specimens on different hosts specifically distinct? These are only typical of the questions that arise and cannot be answered satisfactorily. Other difficulties just as serious will appear in the account that follows.

Several extensive classifications of fossil fungi have appeared, including Meschinelli's (1892) "Fungi Fossiles" in 1892 in Saccardo's *Sylloge Fungorum*. It contains a list of slightly more than 300 named species and, as maintained by Seward (1898), ". . . includes certain species which . . . should have no place in any list that claims to be authentic." Meschinelli's *Iconographia* (1902), which appeared 10 years later, is to be regarded as the most useful, complete, and well-illustrated compilation up to that date.

The most comprehensive modern treatise on fossil fungi is that by Pia in Hirmer's *Handbuch der Palaobotanik* (1927). Pia's compilation recognizes fossil fungi that bear resemblance to members of 39 present-day families. The account that follows is taken from Pia's report with certain additions and omissions and with comments and criticisms.

I. MYXOMYCETES

A single species of slime mold, *Myxomycetes mangini* Renault, in the cortex of some vascular plant in the Coal Measures has been described.

II. PHYCOMYCETES

Eleven species of Phycomycetes are mentioned in Meschinelli's *Iconographia*, and Ellis (1915, 1918) is authority for the statement that four have been described since: *Palaeomyces bacilloides*, among the Saproleginaceae, and *Phycomycites frodinghamii* by Ellis, *Urophlyctites stigmariae* by Weiss (1904), and *Peronosporites palmi* by Berry (1916). Porter and Zebrowski (1937) identified fungi occurring in sands from Australia, China, Africa, Texas, North Carolina, and the West Indies as Phycomy-

cetes in the Cladochytriaceae. These fungi occurred in shell fragments of Mollusca, Foraminifera, and Ostracoda and in sponge spicules of species that date back to the Cambrian. Renault and Bertrand (1885) would include their chytridiaceous *Grilletia sphaerospermii* in this class.

1. Oochytriaceae

Oochytrium * *lepidodendri* Renault, in twigs of *Lepidodendron*, like the present-day chytrid genus *Urophlyctites oliverianus* Magnus (1903), is parasitic in leaves of *Alethopteris aquilina*. *Urophlyctites stigmariae* Weiss is parasitic in rootlets of *Stigmaria*.

2. Pythiaceae

Pythites dysodilis Pamp., fossil remains from the Miocene, show mycelia and spores.

3. Peronosporaceae

Peronosporites antiquarius W. Smith, in tracheids of *Lepidodendron* from the English Coal Measures, is one of the best-known fossil fungi. *Peronosporites gracilis* Renault was first described as *Palaeomyces gracilis*. Ellis (1918) noted its intracellular hyphae in parenchyma cells of stem and roots of *Lepidodendron aculeatum* and *Lyginodendron oldhamium*. *Peronosporites miocaenicus* Pamp. and *P. siculus* Pamp. are from the Miocene.

4. Mucoraceae

Mucorites cambrensis Renault from the Paleozoic lacks reproductive structures; hence its relationship is unsatisfactorily known.

Phycomycites frodinghamii Ellis from the Jurassic is interpreted as having had a chemotactic affinity for iron, as have modern iron bacteria.

III. ASCOMYCETES

Approximately 100 species of Sphaerites are included in Meschinelli's "Fungi Fossiles," a fact which gives an indication of the abundance of fossil Ascomycetes and at the same time may be presumed to demonstrate the difficulty of making specific identifications. It is reasonable to assume that certain of this assemblage may not be distinct species. There is reason to believe also that

* Some palaeontologists have not chosen to employ the termination "ites."

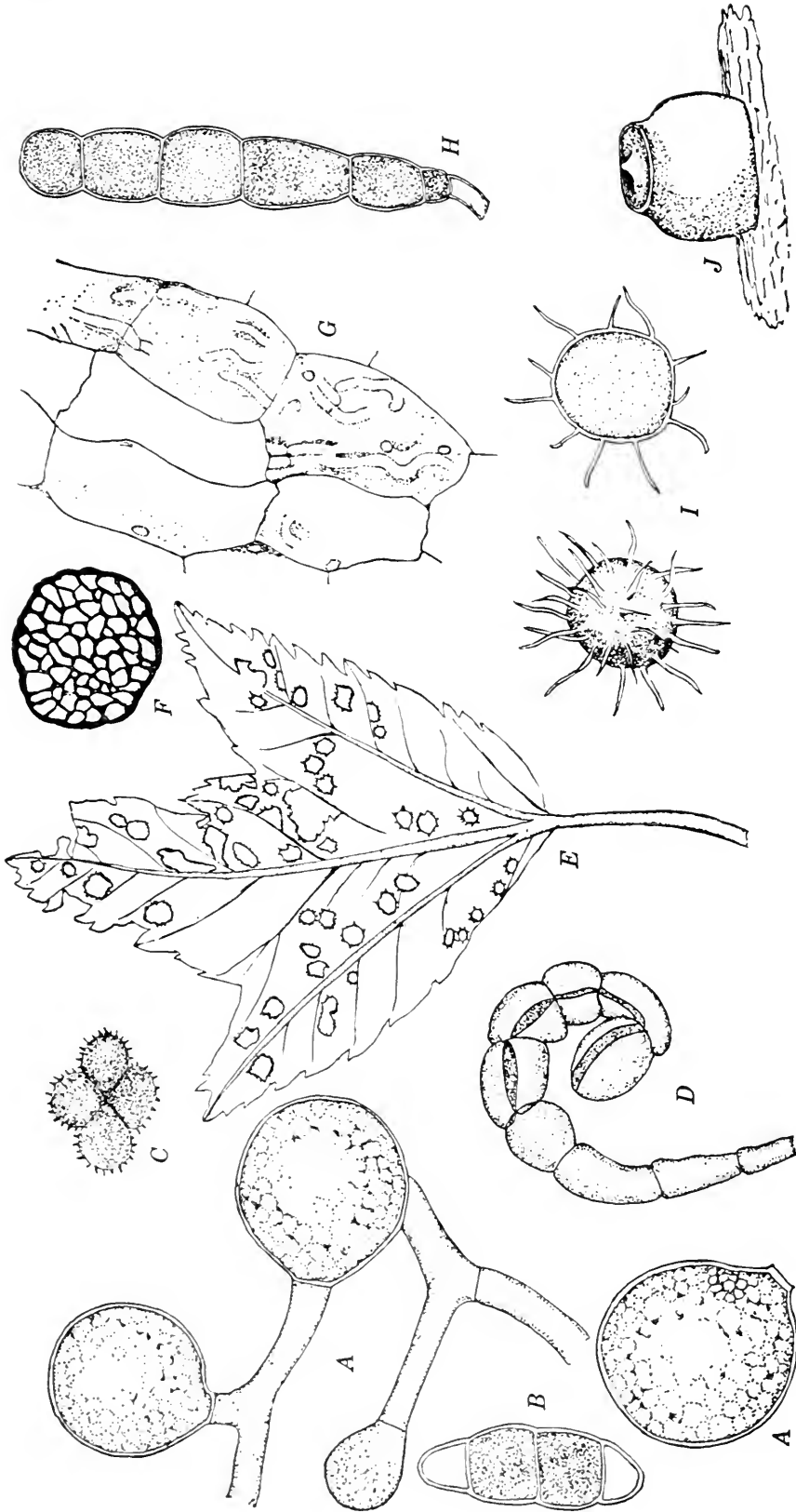

FIG. 82. Representative fossil fungi. *A*, *Peronosporites antiquarius* W. G. Smith. (After Smith.) *B*, *Chaetosphaerites bilychnis* Felix. (After Heer.) *C*, *Speqazzinites cruciformis* Felix. (After Felix.) *D*, *Helicoma* sp. (After Kräusel.) *E*, *Depazites picta* Heer on *Acer trilobatum*. (After Heer.) *F*, *Sclerotites bradonianus* Jeffrey and Chrysler from Tertiary dicotyledonous wood. (After Jeffrey and Chrysler.) *G*, *Mycorrhiza* in *Amyelon radicans* Will. (After Osborn.) *H*, *Cercosporites* sp. (After Salmon.) *I*, *Uncinulites baccharini* Pampaloni. (After Salmon.) *J*, *Rosellinites congregatus* Beek. (After Engchart.)

structures interpreted to be fossil perithecia may not be perithecia, since asci and paraphyses are rarely preserved. This fact is illustrated by Salmon's (1903) comments. He stated that the globoid bodies which Pampaloni (1902) described as appendaged perithecia of *Uncinulites* and *Erysiphites*, and which he examined, are merely spiny spores.

1. Protomycetaceae

Protomycites protogenes W. Smith occurs on *Lepidodendron* roots from the Coal Measures.

2. Erysiphaceae

Erysiphites metilli Pamp., *E. protogaeus* Schmalhausen, and *Uncinulites baccarinii* Pamp. are said to occur in the Miocene, but Salmon (1902) thinks they are from the Eocene.

3. Perisporiaceae

The Genus *Perisporites*, with three species, was created by Felix from Eocene and Miocene rocks.

4. Microthyriaceae

Phragmothyrites eocenica Edwards, *Microthyrites dysodilis* Pamp., which looks like an *Asterina*, and *Xylomites asteriformis* Braun, occurring on some cycad-like plant, represent this family.

5. Aspergillaceae

Penicillites curtipes Berk. occurs as a well-preserved fungus in amber from the Eocene.

6. Hysteriaceae

This family is represented by *Hysterites ancinitis* Matth. from the upper Devonian and *H. cordatis* Matth. from the Permian and Carboniferous.

7. Phacidiaceae

Approximately 50 species of leaf-inhabiting species assigned to Meschinelli's genera *Phacidites* and *Rhytismites* from the Tertiary and Quaternary have been described.

8. Stictidiaceae

Stegites poacitum A. Br., described from the Miocene, occurs in flecks on grass leaves.

9. Pezizaceae

Pezizites candidus Göpp et Ber. occurs as well-preserved material on insects in amber.

10. Cenangiaceae

Cenangites piri Ludw. from the Miocene externally resembles modern *Cenangium*.

11. Hypocreaceae

Melanosporites stefani Pamp. from the Miocene consists of perithecia and ascospores.

12. Dothideaceae

Included in this family are 8 species of leaf-inhabiting fungi belonging to *Dothidites* Bur. et Pot.

13. Chaetomiaceae

Chaetomites intricatus Pamp. from the Miocene shows hairy perithecia like those of *Chaetomium*.

14. Sordariaceae

From the Miocene came fossilized ascospores resembling those of *Sordaria*.

15. Sphaeriaceae

A large number of leaf- and bark-inhabiting species representing this family from the Permian have been described in *Sphaerites*, established by Unger. Representative forms include *Sphaerites suessi* Ettingh. on *Rhamnus*, *Rosellinites Beyschlagii* Pot., *R. congestus* Beck, *R. schusteri* Rehm., *Petrosphaeria japonica* Stopes et Fujii, and *Chaetosphaerites bilychnis* Felix.

16. Amphisphaeriaceae

Trematosphaerites lignitum is from the Oligocene.

17. Mycosphaerellaceae

Laestadites nathorstii Mesch. is from the Quaternary.

18. Pleosporiaceae

On the leaves of *Cryptomeriopsis mesozoica* occurs a species, that shows perithecia containing asci and paraphyses and that has

been identified as *Pleosporites shirianus* Suzuki. Other representatives include *Didymosphaerites bethelii* Cockerell on Typha leaves from the Miocene and *Leptosphaerites lemoinii* Richon.

IV. BASIDIOMYCETES

Among the fossilized Basidiomycetes are two of outstanding interest. One was described by Conwentz [Seward (1898)] from petrified wood preserved in amber and identified as *Polyporus vaporarius* Fr. f. *succinea*. The other, a beautifully silicified shelf fungus, was collected in the site of the dinosaur beds from the lower Cretaceous of Montana by Wieland (1934) and identified by him as *Polyporites brownii*.

As is the situation in other classes of fossil fungi, identifications have been questioned. *Polyporites bowmanii* Lindley et Hutton from the Carboniferous of England may be a ganoid fish scale. James (1893) suggests that *Rhizomorpha sigillariae* Lesquereux bears a strong resemblance to insect burrows, like those of *Bostrychus*. Renault's *Teleutosporites milloti* from the Permo-Carboniferous, in the macrospores of *Lepidodendron*, is rejected by Seward (1898) as a fossil Puccinia.

1. Tilletiaceae

Spores from coal resemble those of modern *Tilletia* and *Urocystis*.

2. Coleosporiaceae

Coleosporium-like spores have been identified in coal.

3. Pucciniaceae

From the upper Cretaceous come *Puccinities lanceolatus* Ettingsh., *P. cretaceous* Velen., and *P. Whitfordi* Knowlt. Whitford (1916) described *P. cretaceum* from Cretaceous leaf tissue as new.

4. Hypochnaceae

Meschinelli has described a species of *Hypochnites* on wood overlain with amber.

5. Clavariaceae

From the Quaternary has been described the little-known species *Clavaria turbinata* Murr.

6. Hydnaceae

Only a single species, *Hydnites argillae* Ludw., has been listed.

7. Polyporaceae

Fossil polypores include *Polyporites foliatus* Ludw. on Tertiary wood, *P. brownii* Wieland from the lower Cretaceous, *Pseudopolyporus carbonicus* [Hollick (1910)] from the Carboniferous, and *Lenzites gastaldii* Heer from the Tertiary.

8. Agaricaceae

Agaricites Wardianus Mesch. is a representative agaric.

9. Lycoperdaceae

From the Miocene in Colorado comes *Geasterites florissantensis* Cockerell, an earth-star-like species.

V. DEUTEROMYCETES (FUNGI IMPERFECTI)

A rather wide range of fossilized Deuteromycetes, many from amber, have been discovered.

1. Sphaerioidaceae

Depazites rabenhorsti Gein. occurs on Carboniferous fern leaf.

2. Melanconiaceae

Pestalozzites sabalana Berry is found on palm leaves.

3. Mucedinaceae

In amber have been found *Acremonites succineus* Gasp., *Gonatotrytis primigennis* Gasp., *Monilites albida* Pamp., *Ramularites oblongisporus* Gasp., and *Sporotrichites heterospermus* Göpp. *Ocularites barbouri* Whit. occurs in leaf tissue from the Cretaceous [Whitford (1916)].

4. Dematiaceae

Among dark-spored Moniliales are *Cladospites bipartitus* Felix, *C. fasciculatus* Berry, *C. oligocaenicum* Berry, *Macrosporites ropaloides* Ren., *M. subtrichellus* Ren., and *Torulites moniliformis* Menge.

5. Stilbaceae

Stilbites conwentzi Felix is among the coremioid species.

6. Tuberculariaceae

On Tertiary wood occurs a form identified as *Spegazzinites cruciformis* Felix.

At the end of his list of classified fossils Pia has assembled a group that does not fit among present-day genera, and therefore, their classification is uncertain. This list includes *Palaeomyces gordonii* Kidst., *P. majus* Ren., *Fungites jenensis* Hallier on mussels, *Xylomites polaris* Heer from the upper Triassic, *X. zamitae* Göpp. from the Carboniferous, *Caenomyces sapotae* Berry from the Eocene, *Nyctomyces entoxylinus* Ung., *Anthracomyces camallensis* Ren., *A. rochei* Ren., *Sclerotites brandonianus* Jeffr. et Chrysl. in Tertiary lignite, *Phellomyces dubius* Ren., *Rhizomorphytes intertextus* Sternb., and *R. polymorphus* Matth.

FOSSIL MYCORRHIZAE

Seward (1933) expressed the opinion, "From very early times there have been two kinds of associations between higher plants and fungi: fungi preying upon their hosts and others beneficial to the hosts in which they lived." In the beneficial category are the mycorrhizal associates. It is exceedingly interesting that this peculiar symbiotic relationship extends so far into antiquity as the lower Coal-Measures period. Some appreciation of the mycorrhizal habit can be obtained from the accounts of Weiss (1904), Lignier (1906), and Osborn (1909). Weiss (1904) observed mycorrhizae in coal balls. He says of them, "The excellent preservation of both the fungus and the host and the specialization of the cortex into two layers comparable with similar structures in recent mycorrhizae suggest that, as in the case of the latter, the host plant is deriving some benefit from the presence of the fungus." Lignier (1906) identified the fungal component on some Sequoia-like tree root as *Radiculites reticulatus*. The mycorrhizae observed by Osborn (1909) involved the roots of *Amyelon radicans*.

IMPLICATIONS

The habit of procuring a livelihood by appropriating it from other organisms or by scavenging is usually considered to be degrading to both the individual and the race, and it may lead to extinction. The habit of obtaining food by parasitism, saprophytism, or symbiosis among fungi therefore becomes of interest because of its antiquity. In spite of this habit the race has survived with little modification, as is shown by the resemblance between fossilized species and present-day forms. In contrast, vast faunas and autotrophic floras have been unable to survive competition and the vicissitudes of geological climatic changes. The extinction of dinosaurs and of the progenitors of modern seed plants bears witness to this fact. No evidence is at hand to show that the rapacity of parasitic fungi can be used to account for the disappearance of any races of plants or animals. From the beginning their motto seems to have been, "Live and let live." This adjustment by fungi to their environment, therefore, must be pronounced a successful one of a high order by any standard of measurement that can be applied.

The antiquity of fungi also raises again the question of their origin, whether they came from the Algae or from one or more separate and distinct phylogenetic lines. The sum of geological evidence appears to favor the conclusion that they have been distinct from the beginning and should not be placed in the same phylum with the algae.

LITERATURE CITED

- BERRY, E. W., "Remarkable fossil fungi," *Mycol.*, 8: 73-79, 1916.
- ELLIS, D., "Fossil micro-organisms from the Jurassic and Cretaceous rocks of Great Britain," *Proc. Roy. Soc. Edinburgh*, 35: 110-132, 1915.
- "Phycomycetous fungi from the English Lower Coal Measures," *Proc. Roy. Soc. Edinburgh*, 38: 130-145, 1918.
- HIRMER, MAX (with the collaboration of JULIUS PIA AND WILLIAM TROLL), *Handbuch der Palaobotanik*, Vol. I. 708 pp. 1927. (Vide pp. 43, 112-131.)
- HOLLICK, A., "A new fossil polypore, *Pseudopolyporus carbonicus*, gen. et sp. nov.," *Mycol.*, 2: 93-94, 1910.
- JAMES, J. F., "Notes on fossil fungi," *J. Mycol.*, 7: 268-273, 1893.

- LIGNIER, O., "*Radiculites reticulatus*, radicle fossile de Sequoïnée," *Bull. soc. bot. France*, 53: 193-201, 1906.
- MAGNUS, P., "Ein von F. W. Oliver nachwiesener parasitischer Pilz," *Ber. deut. botan. Ges.*, 21: 248-250, 1903.
- MESCHINELLI, A., "Fungi fossiles." In Saccardo's *Sylloge fungorum omnium hucusque cognitorum*, 10: 741-805, 1892.
Fungorum fossilium omnium hucusque cognitorum, *Iconographia*. 144 pp. 1902. (Vicetia.)
- OSBORN, T. G. B., "Lateral roots of *Amyelon radicans* and their mycorrhiza," *Ann. Botany*, 23: 603-611, 1909.
- PAMPALONI, L., "Microflora e microfauna nel disodile di Melille in Sicilia," *Atti. accad. Lincei*, 11: sem. 2, 248-251, 1902.
- PORTER, C. L., AND GEORGE ZEBROWSKI, "Linie-loving molds from Australian sands," *Mycol.*, 29: 252-257, 1937.
- RENAULT, B., AND C. E. BERTRAND, "*Grilletia sphaerospermii*, Chytridiacée fossile du terrain houiller supérieur," *Compt. rend.*, 100: 1306-1308, 1885.
- SALMON, E. S., "Cercosporoites spec., a new fossil fungus," *J. Botany*, 41: 127-130, 1903.
- SEWARD, A. C., *Fossil plants*, Vol. 1, pp. 207-222. Cambridge University Press. 1898.
Plant life through the ages, a geological and botanical retrospect. 603 pp. Cambridge University Press. 1933.
- WEISS, F. E., "A probable parasite of Stigmarian rootlets," *New Phytol.*, 3: 63-68, 1904.
"Mycorrhiza from the Lower Coal Measures," *Ann. Botany*, 18: 255-265, 1904a.
- WHITFORD, A. C., "A description of two new fossil fungi," *Nebr. Geol. Survey*, 7: 85-92, 1916.
- WIELAND, G. R., "A silicified shelf fungus from the lower Cretaceous of Montana," *Am. Museum Novitates*, 725: 1-13, 1934.

AUTHOR INDEX

- Aamodt, O. S., 260, 272
Abbott, E. V., 430, 439
Abe, T., 219, 234
Abraham, E. P., 87, 89, 284, 293
Adametz, L., 429, 430, 439
Ainsworth, C. G., 395, 397, 403, 414
Albertini, J. B. de, 189, 206
Allen, M. C., 287, 293
Allen, Ruth F., 131, 134, 148, 239, 250, 253, 254
Allison, C. C., 260, 272, 329, 336
Allison, F. E., 24, 31
Ames, Adeline, 111, 119, 223, 225, 226, 228, 233
Ames, L. M., 320, 321, 322, 336
Andersen, Emma N., 203, 205, 209
Anderson, A. P., 405, 414
Angell, H. R., 245, 255
Apstein, C., 463, 464, 471
Armitage, H. M., 450, 457
Armstrong, G. M., 4, 31
Armstrong, J. I., 158, 164
Arnaudi, C., 423, 428
Aronescu, Alice, 238, 239, 248, 249, 253, 254
Arrillaga, J. G., 281, 282, 291, 293
Arthur, J. C., 166, 168, 173, 174, 177, 179, 206, 406, 407, 408, 414, 417, 428
Ashton, M. R., 145, 149
Aso, K., 11, 31
Asthana, R. P., 291, 293
Atanasoff, D., 192, 206, 354, 362
Atkins, D., 464, 471
Ayers, T. T., 404, 415

Back, E. A., 445, 456
Backus, M. P., 137, 148
Bailey, A. A., 144, 149
Bailey, D. L., 260, 273, 277
Bailey, L., 453, 454, 455
Baker, E. E., 368, 391
Baker, R. D., 365, 372, 391, 393
Baldwin, M. E., 159, 164

Ball, E. D., 173, 208
Bamberg, R. H., 285, 293
Barger, G., 354, 356, 358, 362
Barger, W. R., 108, 120
Barghoorn, E. S., 460, 471
Barnes, B., 270, 273
Barrett, J. T., 170, 206
Barrows, Florence L., 304, 314
Barrus, M. F., 260, 273
Bartetzko, H., 106, 119
Bartlett, H. H., 260, 275
Bary, A. de, 181, 190, 191, 202, 206, 230, 231, 233, 236, 237, 238, 239, 254, 289, 293
Bavendamm, W., 44, 51
Bayliss, J. S., 46, 51
Beach, W. S., 260, 273
Beck, M. Dorothy, 367, 393
Beckwith, T. D., 430, 437, 439
Becquerel, P., 106, 119
Benecke, W., 2, 3, 13, 31
Benham, Rhoda W., 369, 377, 378, 388, 391, 392
Bennett, C. W., 4, 7, 22, 36
Bennett, F. T., 105, 119
Bensaude, M., 325, 336
Bergel, F., 87, 89
Berger, E. W., 449, 454, 457
Bernard, N., 308, 309, 310, 312, 313, 314
Bernhauer, K., 15, 31, 70, 72, 73, 74, 81, 89, 90
Berry, E. W., 480, 488
Bertrand, C. E., 481, 489
Beurmann, L., 375, 377, 397
Bever, W. M., 215, 235
Bilbroth, T., 257, 273
Birkinshaw, J. H., 70, 76, 78, 81, 84, 85, 90
Bisby, G. R., 114, 119, 128, 148, 395, 399, 403, 404, 409, 412, 413, 414
Bjorkman, Erik, 297, 308, 314
Blaauw, A. H., 129, 148
Blackman, F. F., 98, 119

- Blackman, V. H., 220, 230, 233, 238,
 240, 254
 Blakeslee, A. F., 319, 336
 Blank, L. M., 7, 35
 Blumer, B., 260, 273
 Boas, F., 22, 31, 79, 90
 Böckl, N., 73, 89
 Böseken, J., 16, 31
 Bonar, L., 264, 273, 468, 469, 471
 Bonner, James, 27, 31
 Bornet, E., 459, 471
 Bortels, H., 11, 13, 15, 31
 Bose, S. R., 43, 46, 51, 454, 455
 Bourquelot, E., 43, 51
 Boussingault, J. B., 429, 439
 Boyle, C., 238, 239, 244, 255, 283,
 293
 Brannon, J. M., 18, 31
 Bressman, E. N., 260, 273
 Brewbaker, H. E., 260, 277
 Brian, P. W., 88, 90
 Bricley, W. B., 264, 265, 273, 431,
 432, 439
 Briton-Jones, H. R., 260, 273
 Broadfoot, W. C., 281, 286, 292, 293,
 296
 Brodie, H. J., 174, 206, 219, 233, 450,
 455
 Brooks, Charles, 103, 115, 119, 120
 Brown, A. M., 270, 274, 276
 Brown, H. B., 358, 362
 Brown, P. E., 433, 439
 Brown, W. H., 454, 455
 Brown, William, 128, 148, 216, 231,
 233, 236, 237, 238, 243, 244, 255
 Brumpt, E., 367, 372, 391
 Brunswik, H., 328, 331, 336
 Buchner, P., 451, 455
 Budde, A., 260, 273
 Buder, J., 130, 148
 Bugie, Elizabeth, 87, 94
 Buller, A. H. R., 46, 51, 105, 106,
 120, 125, 126, 131, 132, 133, 135,
 137, 138, 148, 172, 176, 182, 183,
 189, 190, 194, 195, 196, 197, 198,
 199, 200, 201, 203, 206, 286, 294,
 328, 333, 336, 385, 391, 397, 403,
 412, 414
 Bulliard, P., 189, 206
 Bulloch, William, 54, 55, 67
 Bunker, H. J., 50, 52
 Burgeff, H., 240, 241, 255, 319, 336
 Burgert, Irma A., 216, 223, 233
 Burges, A., 298, 308, 314
 Burkhardt, E., 359, 363
 Burkholder, P. R., 27, 28, 31
 Burkholder, W. H., 260, 273
 Burrill, T. J., 170, 206
 Burt, E. A., 202, 206
 Büsgen, M., 239, 255
 Butkewitsch, W. S., 70, 71, 72, 73,
 75, 90
 Butler, E. J., 404, 412, 414
 Butler, Ellys T., 188, 192, 206
 Caesar, L., 173, 208
 Cagniard-Latour, Charles, 54, 67
 Caley, D. M., 284, 294
 Calfee, R. K., 13, 14, 33
 Callow, R. K., 81, 90
 Calloway, J. L., 365, 391
 Calvery, H. O., 41, 51
 Cameron, A. T., 105, 120
 Camp, A. F., 19, 31
 Campbell, W. G., 44, 51
 Carbone, D., 423, 428
 Carr, L. G., 398, 414
 Carrión, A. L., 372, 391, 392
 Carson, S. F., 19, 32, 463, 439
 Carter, J. C., 280, 295
 Cartwright, K. St. G., 98, 102, 120
 Cassell, R. S., 169, 208
 Castle, E. S., 131, 148
 Chain, E., 86, 87, 89, 90, 284, 293
 Challenger, F., 88, 90
 Charles, Vera K., 444, 455
 Chaudhuri, H., 97, 99, 113, 117, 120
 Chemin, E., 469, 472
 Chester, K. S., 423, 428
 Chibnall, A. C., 21, 32
 Chilton, S. J. P., 325, 337
 Christiansen, C., 259, 265, 273
 Christiansen, J. J., 171, 206, 260, 264,
 265, 267, 273, 274, 277, 321, 336,
 327, 329, 330, 338, 360, 361, 362
 Christman, A. H., 227, 233
 Christopher, W. N., 169, 208
 Chrzaszcz, T., 13, 15, 31, 70, 71, 73,
 79, 90, 91
 Chupp, C., 159, 161, 164
 Church, M. B., 74, 92
 Ciferri, R., 260, 274
 Clark, A. B., 74, 93
 Clark, E. D., 341, 350, 362
 Clark, J. F., 151, 164
 Clark, W. M., 151, 164

- Clayton, C. N., 219, 233
 Clayton, E. E., 401, 414
 Clegg, M. T., 375, 393
 Clemmer, H. J., 260, 266, 279
 Clinton, G. P., 404, 405, 414
 Clodi, C., 463, 472
 Clutterbuck, P. W., 84, 88, 90, 284, 294
 Cobb, Mary Jo, 431, 432, 433, 439
 Coblentz, W. W., 141, 148
 Coghill, R. D., 146, 149
 Cohen, Clara, 70, 91, 93
 Coleman, D. A., 433, 434, 439
 Committee on apparatus in aerobiology, 171, 206
 Conant, G. H., 246, 255
 Conant, N. F., 365, 370, 372, 384, 391, 393
 Conn, H. J., 430, 439
 Connstein, W., 77, 91
 Constintin, J., 313, 314
 Cooley, J. S., 103, 115, 119, 120
 Coons, G. H., 199, 206
 Copping, Alice M., 25, 31
 Cotter, R. U., 260, 266, 274, 277
 Cotton, A. D., 460, 469, 471
 Couch, J. N., 409, 414, 444, 448, 455
 Coudon, H., 436, 440
 Coyne, F. P., 79, 91
 Crabill, C. H., 43, 51
 Craigie, J. H., 170, 174, 206, 245, 256, 266, 274, 333, 336, 451, 455
 Crosier, Willard, 113, 120, 222, 233
 Cunningham, G. H., 406, 407, 414
 Curran, C. G., 169, 208
 Currie, J. N., 71, 72, 91
 Curtis, K. M., 240, 246, 255
 Curtis, P. J., 88, 90
 Czapek, F., 21, 31, 43, 51
 Czurda, V., 131, 135, 149

 D'Aeth, H. R. X., 280, 281, 294
 Dale, E., 430, 431, 433, 439
 Dammann, E., 66, 67
 Dangeard, P., 460, 471
 Daniel, G. E., 462, 471
 Darkis, F. R., 108, 122, 170, 209
 Daszewska, W., 435, 439
 Davidson, A. M., 385, 389, 391
 Davis, A. R., 23, 24, 31
 Davis, W. H., 214, 223, 233
 Davison, F. R., 48, 51
 Davison, W. C., 38, 52

 Dearness, J., 397, 403, 412, 414
 Demerec, M., 139, 140, 146, 150
 Devèse, P., 388, 393
 Dey, P. K., 239, 244, 255
 Dickson, E. C., 367, 393
 Dickson, Hugh, 146, 148
 Dickson, J. G., 109, 120, 121
 Dickson, S., 329, 330, 331, 337
 Diedicke, H., 260, 274
 Diehl, W. W., 205, 206, 412, 414, 469, 472
 Dietel, P., 199, 206
 Dietz, S. M., 260, 276
 Dillon-Weston, W. A. R., 143, 148, 231, 233
 Dimock, A. W., 266, 274, 323, 337
 Dimond, Albert, 141, 148
 Dixon, L. F., 108, 111, 113, 122, 170, 189, 206, 209
 Doak, K. D., 299, 300, 301, 309, 314
 Dodge, B. O., 200, 206, 264, 266, 274, 290, 294, 321, 322, 323, 324, 326, 327, 331, 335, 336, 337, 338
 Dodge, C. W., 364, 367, 377, 379, 383, 384, 389, 391
 Doran, W. L., 161, 164, 218, 223, 228, 231, 233
 Dowding, E. S., 321, 323, 337, 384, 385, 391
 Dox, A. W., 79, 91
 Duboscq, O., 466, 472
 Dudley, H. W., 359, 362
 Dugan, G. H., 406, 415
 Duggar, B. M., 23, 24, 31, 141, 148, 230, 233
 Dujarrac de la Riviere, D., 341, 362
 Duncan, P. Martin, 459, 472
 Durham, O. C., 171, 206
 Durrell, L. W., 221, 222, 230, 231, 234
 Dutcher, J. D., 284, 294

 Eakin, R. E., 28, 36
 Eastcott, E. V., 288, 294
 Edgerton, C. W., 99, 109, 120, 325, 337
 Edson, H. A., 99, 118, 120
 Ehrlich, John, 173, 206
 Eide, C. J., 260, 277
 Elliott, J. S., 454, 455
 Ellis, D., 480, 481, 488
 Ellis, L., 88, 90
 Emerson, O. H., 284, 296

- Emerson, Ralph, 84, 91, 432, 439
 Emmerie, A., 11, 14, 36
 Emmerling, O., 78, 91
 Emmons, C. W., 140, 146, 148, 149,
 371, 373, 374, 377, 383, 384, 386,
 391, 392, 437, 439
 Endo, S., 281, 294
 Erickson, James, 26, 31
 Eriksson, J., 258, 260, 274
 Errera, L., 205, 207
 Estee, Lula M., 469, 472
 Ewert, R., 227, 233
- Fabbrioni, Adamo, 53, 55, 67
 Fabricius, J. C., 418, 421, 428
 Falck, R., 99, 120, 189, 207, 356, 362
 Faris, J. A., 260, 274
 Faull, J. H., 106, 108, 120, 406, 414
 Fawcett, H. S., 98, 99, 108, 116, 120,
 280, 285, 291, 294, 296, 402, 411,
 415, 447, 449, 450, 455, 456
 Fedoroff, M. W., 71, 73, 75, 90
 Feldmann, Jean, 469, 470, 472
 Fellows, H., 22, 31, 158, 165
 Ferdinandsen, C., 469, 472
 Findlay, W. P. K., 98, 102, 120
 Finn, R. F., 308, 315
 Fischer, E., 203, 207
 Fischer, G. W., 335, 337
 Fischmann, C. F., 81, 90
 Fish, F. T., 463, 472
 Fisher, R. A., 213, 233
 Fisher, W. R., 189, 206
 Fitz, A., 76, 77, 91
 Flahault, C., 459, 471
 Fleming, A., 86, 91
 Fletcher, C. M., 87, 89, 284, 293
 Flor, H. H., 260, 264, 274, 329, 330,
 337
 Folkers, K., 28, 32
 Fontana, Felice, 417, 428
 Ford, W. W., 341, 342, 350, 362, 363
 Foster, J. W., 11, 13, 14, 16, 19, 32,
 36, 76, 94, 436, 439
 Fox, D. L., 84, 91
 Frank, A. B., 238, 255, 297, 299, 301,
 305, 306, 314
 Fred, E. B., 19, 22, 36, 81, 82, 93,
 430, 438, 440, 441
 Freeman, Walter, 369, 392
 Frenzel, H., 260, 274
 Fricke, C. H., 260, 276
 Fries, Elias, 356, 362
- Fries, N., 26, 32, 288, 295
 Fries, R. E., 398, 415
 Fromme, F. D., 138, 148
 Fulmer, E. J., 289, 296
 Fulton, H. R., 141, 148, 242, 255
 Funke, G. L., 48, 51
- Gaines, E. F., 260, 274
 Gardner, A. D., 87, 89, 284, 293
 Gardner, M. W., 173, 176, 207, 208
 Garren, K. H., 47, 51
 Garrett, S. D., 287, 294
 Gäumann, E., 260, 267, 274
 Gehenio, P. M., 107, 120, 121, 227,
 234
 Gilbert, E. M., 260, 274
 Gilchrist, T. C., 368, 393
 Gillispie, J. L., 161, 164
 Gilman, J. C., 109, 120, 430, 431, 439
 Glasgow, O. E., 298, 315
 Goddard, D. R., 216, 217, 234, 390,
 392
 Goddard, H. M., 430, 432, 433, 439
 Goldschmidt, V., 260, 274
 Gorcica, H. J., 82, 91, 93
 Gordon, W. L., 260, 274
 Gottschalk, A., 58, 67, 74, 91
 Gougerot, H., 375, 377, 391
 Gould, B. S., 84, 91
 Goulden, C. H., 270, 274
 Graff, P. W., 254, 255
 Graham, T. W., 260, 273
 Gravatt, G. F., 176, 207
 Graves, A. H., 242, 255
 Greaney, F. J., 146, 148, 287, 294
 Greene, H. C., 82, 93
 Gregory, P. H., 172, 207, 364, 387,
 388, 389, 391, 392
 Grevel, F. K., 260, 275
 Griffiths, D., 191, 207
 Griffiths, Marion A., 406, 415
 Grigoraki, L., 383, 392
 Grove, W. B., 412, 415
 Guba, E. F., 388, 393, 411, 415
 Guerra, P., 377, 392
 György, Paul, 289, 296
- Haenseler, C. M., 5, 12, 32, 287, 293
 Hafstad, G. E., 264, 278
 Hagem, O., 430, 431, 433, 438, 439
 Hahn, G. G., 404, 415
 Halnan, E. T., 143, 148
 Hammarlund, C., 260, 262, 275

- Hanna, W. F., 329, 337
 Hansen, H. N., 264, 265, 275
 Harden, A., 58, 67
 Hariot, P., 469, 472
 Harrington, J. B., 269, 275
 Harris, G. C. M., 88, 94, 95
 Harris, S. A., 28, 32
 Harsch, R. M., 127, 149
 Hart, Helen, 215, 223, 234
 Hartelius, V., 23, 33
 Harter, L. L., 18, 36, 48, 51, 102,
 122, 224, 235, 260, 275
 Hartman, R. E., 109, 120
 Harvey, C. C., 243, 244, 255
 Harvey, E. Newton, 137, 148
 Harvey, J. V., 430, 431, 439
 Harvey, R. B., 245, 246, 255
 Harz, C. O., 374, 392
 Haskins, C. P., 145, 149
 Hasselbring, H., 239, 255
 Hatch, A. B., 178, 207, 297, 299, 300,
 301, 306, 307, 308, 311, 312, 314
 Hauptfleisch, P., 466, 472
 Hawker, Lilian E., 25, 26, 32, 66, 67,
 291, 293
 Hawkins, L. A., 18, 29, 32, 245, 246,
 255
 Haworth, W. N., 88, 90
 Heald, F. D., 29, 32, 167, 170, 173,
 176, 207, 291, 294, 405, 415
 Heatley, N. G., 87, 89, 284, 293
 Hedgcock, G. G., 127, 149
 Heim, Roger, 341, 362
 Hellback, R., 74, 92
 Hemmi, H., 219, 234
 Henning, H. G., 88, 90
 Hendree, Esther C., 175, 207
 Henkelekian, H., 435, 436, 439
 Henry, A. W., 169, 208
 Hérissey, H., 43, 51
 Hermann, W. W., 369, 373
 Herrick, H. T., 16, 32, 74, 75, 78, 92,
 94
 Herrick, J. A., 103, 120, 155, 164
 Herriott, R. M., 41, 51
 Hey, A., 260, 275
 Higginbottom, C., 88, 90
 Higgins, B. B., 49, 52, 237, 238, 255
 Hines, L., 260, 266, 277
 Hirmer, Max, 480, 488
 Hodgetts, W. J., 192, 207
 Hoerner, G. R., 260, 275
 Hoffman, H., 212, 224, 234
 Höhnk, W., 168, 207
 Hollaender, A., 139, 146, 150
 Hollick, A., 486, 488
 Holterman, C., 454, 456
 Holton, C. S., 260, 275, 405, 415
 Honn, J. M., 289, 296
 Hoover, S. R., 24, 31
 Hopkins, J. G., 388, 392
 Hopkins, S. J., 21, 32
 Hoppe, P. E., 285, 295
 Hösche-Seyler, F., 435, 440
 Hopper, Mary E., 365, 392
 Horner, G. R., 215, 227, 234
 Horr, W. W., 18, 32
 Howe, Mary E., 231, 234
 Howell, Arden, 370, 392
 Huang, P. T., 373, 393
 Humphrey, C. J., 102, 120
 Hutchinson, A. H., 143, 145, 149
 Ingold, C. T., 136, 137, 149, 185, 186,
 187, 188, 190, 191, 192, 193, 196,
 197, 207
 Isenbeck, K., 260, 272
 Iterson, C. van, 435, 440
 Iwanoff, N. M., 69, 73, 82, 85, 86,
 92, 352, 362
 Jackson, H. S., 260, 276
 Jackson, L. W. R., 155, 164
 Jahn, E., 220, 234
 James, J. F., 477, 488
 Jamieson, S. G., 80, 94
 Javillier, M., 11, 16, 32
 Jennings, M. A., 87, 89, 284, 293
 Jensen, C. N., 430, 431, 440
 Jensen, H. L., 431, 432, 433, 434,
 440
 Johnson, Burt, 242, 255
 Johnson, C. O., 260, 275, 276
 Johnson, Delia, 285, 295
 Johnson, E. C., 223, 234
 Johnson, E. M., 264, 275
 Johnson, H. W., 155, 164
 Johnson, James, 109, 120, 121
 Johnson, T., 260, 264, 267, 276, 328,
 331, 334, 337, 338
 Johnston, J. R., 450, 456
 Jolivet, H. D., 131, 134, 148
 Jones, C. P., 89, 92, 377, 378, 393
 Jones, Edith S., 220, 221, 223, 234
 Jones, Herbert L., 469, 472
 Jones, L. R., 105, 109, 110, 121

- Kadisch, E., 106, 121
 Kamen, M. D., 19, 32, 436, 439
 Kardo-Ssysojewa, E., 75, 92
 Karling, J. S., 398, 415, 461, 472
 Karrer, Joanne L., 159, 164
 Kavanaugh, F., 26, 27, 28, 34
 Keilin, D., 444, 456
 Keitt, G. W., 171, 207, 411, 415
 Kellerman, K. F., 435, 440
 Kelly, A. P., 305, 315
 Kernkamp, H. C. H., 360, 361, 362
 Kernkamp, M. F., 329, 331, 337
 Kersten, Beatrice, 375, 391
 Kharasch, M. S., 359, 363
 Kibbe, Alice, 461, 472
 Kiessling, W., 58, 61, 67
 Killian, Charles, 356, 363
 King, H., 359, 363
 King, T. H., 331, 338
 Kingery, L. K., 4, 15, 19, 25, 33
 Kinnear, J., 389, 392
 Kirchhoff, H., 356, 363
 Klebahn, H., 169, 199, 207
 Klein, R., 87, 89
 Klotz, L. J., 22, 32
 Kniep, H., 325, 328, 337
 Knudson, L., 310, 311, 315
 Koch, A., 454, 456
 Kocholaty, W., 87, 92
 Kögl, F., 26, 32, 82, 92, 288, 295
 Kolk, Laura A., 260, 277
 Kölliker, A., 459, 472
 Köning, C. J., 429, 430, 431, 440
 Kostermans, D. G., 82, 92
 Kostytchew, S., 57, 58, 67, 72, 92
 Krause, A. W., 113, 121
 Kusano, S., 304, 315
 Küster, Ernst, 422, 428

 LaFuze, H. H., 45, 52
 Lamater, E. D. de, 388, 392
 Lamb, J. H., 377, 378, 392
 Lamb, Margaret L., 377, 378, 392
 Landen, E. W., 143, 149
 Lange, J. E., 409, 415
 Langeron, M., 377, 383, 386, 387, 392, 393
 Lanphere, W. M., 47, 52
 LaRue, C. D., 260, 261, 265, 275
 Latham, M. E., 23, 32
 Lauritzen, J. I., 99, 103, 121, 224, 234
 Lavoisier, A. L., 54, 67

 Leach, J. G., 173, 175, 207, 260, 275, 442, 451, 456
 LeClerg, E. L., 431, 432, 433, 440
 Lee, H. A., 402, 415
 Lee, L. E., 377, 378, 393
 Lefebvre, C. L., 445, 447, 456
 Legault, R. R., 359, 363
 Léger, L., 466, 472
 Lehman, S. G., 108, 121, 427, 428
 Leidy, Joseph, 465, 472
 Leighty, C. E., 406, 415
 Lendner, A., 430, 431, 440
 Lentze, F. A., 375, 392
 Leonian, L. H., 4, 22, 27, 32, 260, 265, 268, 275, 289, 295
 Letcher, H., 77, 92
 Léveillé, J. H., 356, 363
 Levine, M. N., 260, 266, 267, 274, 275, 277
 Levisohn, I., 185, 208
 Lewis, George M., 364, 373, 392
 Liebig, J. von, 54, 55, 67
 Lignier, O., 487, 489
 Lilly, V. G., 4, 22, 27, 32, 289, 295
 Lin, C. K., 213, 234
 Lind, J., 412, 413, 415
 Lindberg, Charles A., 171, 208
 Lindegren, C. C., 321, 323, 325, 337, 338
 Linder, D. H., 460, 471
 Lindgren, R. M., 99, 121, 162, 164
 Lindner, J., 106, 121
 Ling, Lee, 223, 230, 234
 Link, H. F., 182, 208
 Link, K. P., 245, 255
 Lipman, C. B., 106, 107, 121
 Livingston, B. E., 112, 117, 121
 Lockwood, L. B., 15, 16, 32, 70, 80, 92, 94, 146, 149
 Long, W. H., 127, 149
 Longrée, K., 113, 121
 Lowell, R., 284, 294
 Löwenthal, W., 460, 472
 Lucas, G. B., 325, 337
 Lüdecke, K., 77, 91
 Lutman, B. F., 61, 63, 67, 313, 315
 Luttrell, E. S., 254, 255, 447, 456
 Lutz, O., 283, 295
 Luyet, B. F., 107, 120, 121, 146, 150, 227, 234

 Ma, Roberta, 25, 28, 34
 MacBride, T. H., 397, 415

- Machacek, J. E., 146, 148, 287, 294, 295
 MacInnes, Jean, 160, 164
 MacKee, G. M., 373, 392
 Mackinnon, J. E., 25, 34
 Macrae, Ruth, 329, 338
 Magnus, P., 481, 489
 Magrou, J., 313, 314, 315
 Mains, E. B., 260, 275, 276
 Maire, E., 469, 472
 Maneval, W. E., 214, 234
 Mann, Mary L., 7, 32
 Marchal, E., 260, 276, 436, 440
 Marczynski, M., 26, 33
 Margarot, J., 388, 393
 Marloth, R. H., 163, 164
 Marshall, R. P., 176, 207
 Martin, D. S., 89, 92, 365, 372, 377, 378, 391, 393
 Martin, G. W., 397, 415, 461, 472
 Martin, W. J., 331, 338
 Masui, Koki, 303, 308, 315
 Matsumoto, T., 260, 276
 May, O. E., 15, 16, 32, 74, 75, 78, 92, 94
 Mayo, J. K., 47, 52
 McAlpine, D., 407, 415
 McBeth, I. G., 435, 440
 McCallan, S. E. A., 212, 234
 McCormick, Florence A., 291, 295, 404, 414
 McDonald, J. A., 47, 52
 McDougall, W. B., 298, 308, 315
 McGowan, J. C., 88, 90
 McHargue, J. S., 13, 14, 33
 McKay, M. B., 248, 256
 McLean, H. C., 436, 440
 McLean, Ruth, 108, 111, 113, 122, 170, 209
 McVeigh, Ilda, 27, 28, 31
 Meacham, M. R., 155, 164
 Medlar, E. M., 371, 393
 Meier, F. C., 171, 208
 Melander, L. W., 245, 256
 Melchers, L. E., 260, 266, 276, 279
 Melhus, I. E., 221, 222, 230, 231, 234
 Melich, A. E., 438, 440
 Melin, Elias, 299, 301, 303, 311, 315
 Melville, D. B., 289, 296
 Mendel, L. B., 351, 352, 363
 Menon, K. P. V., 48, 52
 Meschinelli, A., 480, 481, 489
 Metz, O., 14, 15, 33
 Meyen, F. J. B., 356, 363
 Meyer, Helen, 166, 208
 Meyer, Karl, 87, 92
 Meyer-Hermann, K., 160, 161, 164
 Meyerhoff, O., 58, 61, 67
 Micheli, P. A., 189, 203, 207, 208
 Milchochevitch, S., 383, 386, 392
 Millard, W. A., 286, 295
 Miller, T. E., 86, 92
 Mitchell, H. F., 308, 315
 Miyoshi, M., 241, 256
 Modess, O., 312, 315
 Moir, J. C., 359, 362
 Molisch, H., 3, 4, 13, 33
 Möller, A., 452, 454, 456
 Molliard, M., 18, 29, 33, 72, 92, 291, 295
 Monbreun, W. A. de, 369, 393
 Montgomery, H. B. S., 47, 52
 Moore, C. N., 145, 149
 Moore, Elizabeth J., 19, 33
 Moore, M., 367, 373, 376, 393
 Moreau, F., 127, 149, 290, 295
 Morrill, A. W., 449, 456
 Morris, H. J., 24, 31
 Morrison, A. L., 87, 89
 Moruzi, M. C., 290, 295
 Moss, A. R., 87, 89
 Moss, E. H., 166, 208
 Mosher, W. A., 4, 15, 19, 25, 33
 Mounce, I., 469, 472
 Moyer, A. J., 70, 74, 78, 92, 146, 149
 Mozingo, R., 28, 32
 Mrak, E. M., 368, 391
 Muhleman, G. W., 48, 52
 Mull, Robert P., 80, 82, 93
 Mulsow, M., 462, 473
 Müntz, A., 429, 436, 440
 Musgrove, W. E., 375, 393
 Nadson, G. A., 145, 149
 Naegeli, C. von, 2, 3, 19, 33
 Nannizzi, A., 385, 393
 Neidig, R. E., 79, 91
 Nerescheimer, E., 463, 472
 Neuberg, C., 58, 67, 70, 93
 Neufeld, C. C., 219, 233
 Newton, D., 143, 149
 Newton, M., 260, 264, 267, 270, 274, 276, 328, 331, 334, 337, 338
 Nickerson, W. J., 290, 295
 Niederlander, K., 82, 94
 Nielsen, E., 23, 28, 33

- Niethammer, A., 15, 33, 429, 440
 Niezabitowski, E. L., 464, 472
 Nikitinsky, J., 282, 295
 Niklas, H., 30, 33
 Noack, R., 303, 315
 Noble, R. J., 223, 234
 Noecker, N. L., 26, 33
 Noelle, W., 301, 315
 Nord, F. F., 38, 39, 52, 63, 67, 80, 82, 93
 Northrop, J. L., 41, 51, 52
 Nutman, F. J., 45, 47, 52

 O'Neill, H. T., 16, 32, 80, 92
 Orr, H., 384, 391
 Orton, C. R., 178, 208, 410, 415
 Osborn, T. C. B., 487, 489
 Oster, R. H., 140, 147, 149
 Ota, M., 373, 383, 393
 Oudemans, C. A. J. A., 429, 430, 431, 440
 Overholts, L. O., 409, 410, 415
 Oxford, A. E., 87, 91, 93

 Pady, S. M., 252, 256
 Paine, F. S., 430, 431, 440
 Palladin, W., 58, 67
 Pampaloni, L., 483, 489
 Parr, Rosalie, 131, 132, 149
 Pasteur, Louis, 55, 67, 68
 Patouillard, N., 469, 472
 Pearson, L. K., 80, 93
 Peltier, G. L., 237, 250, 251, 256
 Pennington, L. H., 23, 33, 169, 208
 Penser, H., 260, 276
 Petch, T., 444, 445, 447, 450, 454, 456
 Petersen, H. E., 460, 462, 470, 473
 Peterson, W. H., 19, 22, 36, 80, 82, 91, 93, 94
 Peturson, B., 260, 269, 276, 277
 Peyros, E., 13, 15, 31
 Pfeffer, W., 16, 33
 Pfister, R., 260, 276
 Pfundt, R., 82, 94
 Philippov, G., 145, 149
 Pichler, F., 145, 149
 Pickard, F., 449, 456
 Piemeisel, F. J., 260, 278
 Pierce, W. D., 173, 208
 Pieters, A. J., 19, 33
 Pinckard, J. A., 181, 208
 Pirschle, K., 16, 23, 33, 34
 Plakidas, A. G., 253, 256

 Platz, G. A., 231, 234
 Plehn, M., 462, 473
 Plowright, C. B., 189, 208
 Poisson, R., 466, 473
 Polk, M., 375, 393
 Pool, V. W., 29, 32, 248, 256, 291, 294
 Popham, W. L., 169, 208
 Porges, N., 15, 34, 72, 93
 Porter, C. L., 280, 281, 295, 480, 489
 Potzelt, G., 81, 89
 Pratt, Clara A., 283, 295
 Pratt, E. F., 66, 68
 Pratt, O. A., 437, 440
 Pratt, R., 9, 34, 221, 235
 Preuss, L. M., 81, 93
 Prévost, Benedict, 418, 428
 Prill, E. A., 80, 93
 Prince, A. E., 199, 208
 Pringsheim, E. G., 131, 135, 149
 Pringsheim, N., 192, 208
 Proctor, B. E., 172, 208

 Quantz, L., 26, 27, 34

 Raciborski, H., 29, 34
 Rackemann, F. M., 388, 393
 Radulescu, E., 260, 276
 Raeder, J. M., 215, 235
 Raistrick, H., 18, 34, 69, 70, 74, 75, 76, 77, 78, 79, 83, 84, 85, 87, 88, 90, 91, 93, 94, 284, 294, 295
 Ramsbottom, J., 364, 393
 Ramsey, G. B., 144, 149
 Ranck, E. M., 358, 362
 Rand, F. V., 173, 208
 Randolph, T. G., 388, 393
 Raper, K. B., 80, 93, 146, 149, 398, 415
 Raper, J. R., 290, 295, 296
 Rathbun, Annie E., 437, 440
 Rathbun-Gravatt, A., 214, 225, 235
 Raulin, J., 2, 3, 10, 13, 34
 Rayner, M. C., 297, 298, 299, 302, 303, 304, 307, 308, 311, 315, 316
 Rayss, T., 268, 277
 Ré, Fillipo, 417, 428
 Reed, G. M., 260, 263, 267, 272, 276, 277
 Reed, H. S., 43, 48, 51, 52
 Reed, Merton, 26, 33
 Reed, Minnie, 460, 466, 468, 469, 473
 Reid, R. D., 86, 94

- Reidemeister, W., 127, 128, 149
 Reindel, F., 82, 94
 Renault, B., 481, 489
 Renn, C. E., 470, 473
 Rice, Mabel A., 250, 252, 256
 Richards, B. L., 110, 121
 Richards, H. M., 13, 15, 34
 Richter, Andreas, 62, 63, 68
 Rinderknecht, H., 87, 89
 Rippel, K., 23, 34, 219, 235
 Rittenberg, S. C., 171, 208
 Rixford, E. E., 365, 368, 393
 Robbins, W. J., 21, 22, 25, 26, 27, 28,
 34, 156, 157, 164
 Roberg, Max, 10, 11, 13, 15, 24, 34
 Roberts, L., 390, 393
 Rodenheiser, H. A., 260, 267, 274,
 277, 321, 336
 Rohrman, E., 25, 36
 Rolfe, F. W., 341, 363
 Rolfe, R. T., 341, 363
 Rose, C. S., 289, 296
 Rosen, H. R., 215, 235
 Rosenbaum, J., 245, 256
 Rosendahl, R. O., 308, 315
 Rotini, O. T., 66, 67
 Ruben, S., 19, 32, 436, 439
 Ruggles, A. G., 173, 209
 Rumbold, Caroline T., 452, 457
 Russell, E. J., 429, 432, 440

 Sabouraud, A., 366, 367, 380, 382,
 383, 384, 393
 Saccardo, 420
 Salmon, E. S., 252, 256, 260, 262, 263,
 277, 483, 489, 403, 415
 Salvin, S. B., 168, 208
 Sampson, K., 305, 316
 Sando, C. E., 245, 256
 Sanford, G. B., 281, 286, 296
 Sansome, E. R., 139, 146, 150
 Sarkar, S. N., 46, 51
 Sass, J. E., 328, 329
 Satoh, S., 289, 296
 Saunders, D. H., 4, 15, 19, 25, 33
 Savastano, G., 285, 291, 296
 Savulescu, T., 268, 277
 Sawyer, W. H., 113, 121, 184, 208,
 444, 457
 Scales, F. M., 435, 440
 Schade, A. L., 4, 19, 20, 22, 34
 Schaffnit, E., 160, 161, 164
 Schatz, Albert, 87, 94
 Scheffer, T. C., 112, 116, 117, 121,
 162, 164
 Scherfel, A., 461, 473
 Scheuer, Z., 8, 9
 Schleisinger, H., 350, 363
 Schloesing, T., 429, 440
 Schmitt, C. G., 328, 329, 331
 Schmitz, H., 47, 52, 281, 291
 Schneiderhahn, F. J., 169, 208
 Schneider-Orelli, Otto, 104, 121
 Schober, R., 24, 34
 Schopfer, W. H., 26, 28, 34
 Schopmeyer, H., 289, 296
 Schreiber, F., 260, 277
 Schroeter, G., 361, 363
 Schröter, J., 257, 275, 277
 Schwann, Theodor, 54, 68
 Schweinitz, L. D. de, 189, 206
 Seaver, F. J., 404, 405, 415
 Seward, A. C., 477, 479, 480, 485,
 487, 489
 Seymour, A. B., 412, 415, 444, 457
 Shapovalov, M., 99, 118, 120
 Sharp, D. G., 141, 142, 150
 Shear, C. L., 321, 338
 Sherman, H. C., 159, 164
 Sherrick, J. L., 341, 362
 Sherwood, E., 155, 165
 Shibasaki, Y., 260, 268, 278
 Shoup, C. S., 19, 23, 36, 64, 68
 Shrewsbury, J. F. D., 377, 393
 Shumway, C. P., 267, 278
 Sideris, C. P., 159, 165
 Siebenäuger, H., 73, 89
 Siggers, P. V., 102, 120
 Simonart, P., 75, 93
 Sing-Fang, F., 28, 33
 Smart, R. F., 225, 285
 Smedley-McLean, Ida, 80, 94
 Smith, C. E., 368, 391
 Smith, D. T., 365, 391
 Smith, E. F., 417, 428
 Smith, Elizabeth C., 125, 138, 143
 150, 218, 235, 397, 398, 415
 Smith, F. B., 431, 432, 433, 440
 Smith, F. F., 175, 208
 Smith, G., 76, 87, 88, 91, 93, 94
 Smith, H. S., 450, 457
 Smith, J. Henderson, 45, 52, 226, 235
 Smith, P. E., 216, 217, 234
 Smith, R. E., 237, 256, 264, 265
 Snell, E. S., 28, 36

- Sparrow, F. K., 460, 461, 462, 466,
 470, 473
 Spaulding, P., 214, 225, 235
 Speare, A. T., 444, 445, 450, 457
 Spegazzini, C., 454, 457
 Stacey, M., 88, 91
 Stäger, R., 260, 277, 356, 363
 Stahl, E., 307, 316
 Stakman, E. C., 169, 170, 208, 260,
 262, 265, 271, 274, 277, 278, 327,
 329, 330, 331, 332, 338
 Stanier, R. Y., 471, 473
 Stanton, T. R., 260, 276
 Steenbock, H., 81, 82, 91, 93
 Steinberg, R. A., 4, 10, 11, 13, 14, 15,
 16, 18, 21, 22, 35, 83, 94
 Steiner, J. A., 260, 278
 Stephanov, K. M., 172, 209
 Stern, K. G., 11, 35
 Stevens, F. L., 144, 146, 150
 Stevens, N. E., 111, 122
 Stevenson, J. A., 401, 414
 Stirrup, M., 459, 473
 Stock, F., 218, 223, 235
 Stoll, A., 359, 363
 Stone, R. W., 86, 92
 Strassberger, L., 361, 363
 Strong, F. M., 80, 94
 Studhalter, R. A., 173, 209
 Sutherland, G. K., 460, 468, 469,
 470, 473
 Swabey, Marjorie, 260, 277
 Sweet, H. R., 99, 111, 122
 Sweetman, H. L., 448, 450, 457

 Takahashi, R., 432, 440
 Talice, R. V., 377, 387, 392
 Talley, P. J., 7, 35
 Tamiya, H., 20, 35, 65, 68
 Tate, P., 364, 385, 386, 389, 390, 393
 Tatum, E. L., 70, 83, 94, 325, 338
 Tauber, H., 28, 52
 Tausson, W. O., 21, 35
 Taylor, C. B., 286, 295
 Ternetz, C., 24, 35
 Thatcher, F. S., 247, 256
 Thaxter, R., 444, 457, 466, 473
 Thaysen, A. C., 50, 52
 Thelen, H., 70, 90
 Thenard, Louis Jacques, 54, 68
 Thimann, K. V., 290, 295
 Thom, Charles, 71, 74, 91, 92, 398,
 415
 Thomas, A. C., 159, 164
 Thompson, M. R., 359, 363
 Timofeeva, A. G., 73, 90
 Tisdale, W. H., 240, 256, 260, 266,
 279, 406, 415
 Tiukow, D., 71, 73, 79, 90, 91
 Tochinai, Y., 18, 35
 Todd, R. A., 369, 393
 Togashi, K., 260, 268, 278
 Toit, C. J. du, 376, 394
 Toursel, D., 30, 33
 Truog, E., 438, 440
 Tsaugi, H., 223, 226, 230, 235
 Tschesnokow, W., 72, 92
 Tulasne, M. R., 356, 363
 Tyler, L. J., 264, 278

 Ukkelberg, H. G., 172, 209
 Uphof, J. C. Th., 453, 454, 457
 Uppal, B. N., 230, 235

 Valteau, W. D., 246, 256, 264, 275
 Verujsky, D., 388, 394
 Vigneaud, V. du, 289, 296
 Volkonsky, M., 4, 36

 Waksman, S. A., 16, 36, 38, 52, 76,
 87, 94, 280, 296, 429, 430, 431, 432,
 433, 434, 435, 436, 439, 440, 441
 Walker, J. C., 110, 122, 223, 235,
 245, 255
 Walker, Leva B., 203, 205, 209
 Ward, G. E., 15, 16, 32, 80, 92, 94
 Ward, H. Marshall, 169, 209, 236,
 256, 262, 278
 Ward, J. L., 87, 89
 Wassiljew, G., 15, 36
 Waterhouse, W. L., 240, 244, 256,
 260, 266, 269, 271, 278
 Waterman, H. I., 16, 31
 Watson, J. R., 449, 457
 Watterson, A., 15, 36
 Webb, R. W., 155, 158, 165, 229, 235
 Weber, N. A., 453, 454, 457
 Weetman, L. M., 215, 235
 Wehmer, C., 3, 13, 36, 70, 71, 72, 75,
 76, 94
 Wehmeyer, L. E., 405, 415
 Weidenhagen, R., 38, 52, 63, 67
 Weimer, J. L., 18, 36, 48, 51, 102,
 122, 187, 192, 209, 224, 235, 260, 275
 Weindling, R., 280, 281, 284, 287,
 296

- Weiss, F. E., 480, 487, 489
Weiss, Freeman, 175, 208
Wellman, F. L., 110, 122, 223, 235
Wells, P. A., 78, 92
Welsford, E. J., 238, 240, 254
Wenck, P. R., 19, 22, 36, 80, 93
Werkenthin, F. C., 430, 433, 441
Werkman, C. H., 39, 52
Weston, W. H., Jr., 168, 180, 209
Wey, H. G. van der, 131, 135, 150
Wheeler, W. M., 454, 457
Whetzel, H. H., 417, 422, 428
Whiffen, Alma J., 436, 441
Whitaker, T. W., 423, 428
White, Mollie G., 77, 94
Whitford, A. C., 485, 486, 489
Wieland, G. R., 485, 489
Wilcox, M. S., 321, 322, 338
Wilcoxon, Frank, 212, 234
Wildiers, E., 24, 36, 288, 296
Wilhelm, P., 260, 278
Wilkins, W. H., 88, 94, 95
Willaman, J. J., 48, 51, 77, 92, 94
Williams, R. J., 4, 15, 19, 25, 27, 28,
33, 36, 66, 68, 289, 296
Wilson, G. W., 436, 440
Wingard, S. A., 423, 428
Winge, O., 469, 472
Wise, Fred, 388, 394
Wöber, A., 145, 149
Wolf, D. E., 28, 32
Wolf, Frederick A., 108, 111, 113,
122, 126, 128, 150, 170, 173, 176,
209, 264, 265, 278, 292, 296, 321,
338
Wolf, Fred T., 19, 23, 36, 64, 68,
176, 209, 264, 265, 278, 432, 441
Wolf, Jack, 388, 394
Wolff, L. K., 11, 14, 36
Wolpert, S., 155, 156, 157, 158, 162,
165
Worley, C. L., 12, 13, 36
Wright, Ernest, 452, 457
Wright, E. P., 460, 473
Wyckoff, R. W. G., 146, 150
Yao, K. F., 377, 378, 393
Yarwood, C. E., 136, 150, 243, 256
Young, E. L., 470, 473
Young, H. C., 4, 7, 22, 36
Young, H. E., 311, 316
Young, P. A., 243, 256
Yuill, J. L., 77, 95
Zalewski, A., 200, 209
Zebrowski, George, 480, 489
Zeller, S. M., 47, 52, 281, 296, 461,
473
Ziegenspeck, H., 187, 209, 218, 235
Zillig, H., 260, 278
Zimmerman, A., 356, 363
Zvetkoff, E. S., 69, 73, 82, 86, 92,
352, 362

SUBJECT INDEX

- Abies*, 406
 firma, 303, 315
 Abortion, 358
Absidia, 107, 431
 ramosa, 26
 Acacia, 407
Acanthorhynchus vaccinii, 143
Acer, 403
 trilobatum, 482 *
 Acetaldehyde, 58, 59, 60, 62, 77, 81
 Acetic acid, 49, 55, 56, 60, 71, 73, 74,
 75, 268, 283
Achlya, 4, 180
 ambisexualis, 290
 bisexualis, 290
 caroliniana, 431
 conspicua, 4
 penetrans, 459
 prolifera, 18
 racemosa, 18, 168
Achrorion, 381, 382
 gypseum, 106, 385, 386, 389
 muris, 389
 quinckeianum, 388
 schoenleinii, 366, 388, 389, 390, 394
 Acidity, 151
Acmea, 469
 digitalis, 468
 fenestrata, 468
 limatula, 468
 peltata, 468
 scabra, 468
 scutum, 468
 Aconitic acid, 73, 163
Acremonites succineus, 486
 Acremonium, 444
Acromyces, 453
 disciger, 452
 lundii, 452
 Acrostalagmus, 431
 Acrotheca, 372
Actinomucor repens, 453
Actinomyces
 bovis, 373-375, 374, 392
 chromogenus, 161
 hominis, 375
 israeli, 375
 praecox, 286
 scabies, 286, 296
 Actinomycetes, 280, 313, 365, 430,
 431
 Actinomycosis, 145, 366, 373-375
 Activated hexoses, 59
 Active acidity, 151
Aecidium symphyti, 200
Aegerita, 449
 webberi, 449, 450
 Aerobic respiration, 56, 58
 Aesculus, 403
 Astatic fungi, 161
Aethalium septicum, 104, 107
 Agar, 471
 Agaricaceae, 98, 286, 486
Agaricites Wardianus, 486
 Agarics, 86, 408
Agaricus, 454
 campestris, 58, 158, 352
 termitigina, 454
 Age of fossil fungi, 477-478
Agriolimax agrestis, 176
 Agropyron, 335
Agrostis alba, 358
 Air currents in spore dispersal, 168-
 171
 Alanine, 22, 23, 64
 β -Alanine, 25, 325
Alaria fistulosa, 461, 472
 Albinism, 264
Albugo, 211
 candida, 181, 223, 230, 260, 268, 278
 candida macrospora, 268
 candida microspora, 268

* An italic numeral indicates that the page contains an illustration or a table.

- Albugo*
ipomoeae-panduranae, 260, 274
tragopogonis, 260
 Alcohol, 20, 54, 55, 56, 58, 59, 60, 61,
 62, 63, 69, 72, 75, 77, 268, 280,
 283
Alethopteris aquilina, 481
Aleuria
repanda, 190
vesiculosa, 135, 190
Aleurodiscus polygonius, 328
 Aleurospores, 381, 382
 Alewife, 463
Aleyrodes citri, 447, 456
 Algae, 468, 488
 blue-green, 429
 green, 429
 Alkaloids, 45, 350, 358, 359
Allium cepa, 165
Allomyces
arbuscula, 19, 22, 64, 399, 431
cystogenus, 19, 64, 431
javanicus, 19, 64, 84, 431
knipii, 26, 27, 34
moniliformis, 19, 64, 84, 431
Alms cordata, 451
Alternaria, 104, 141, 170, 171, 373,
 431, 448, 452
 citri, 20
 maritima, 470
 solani, 175, 218, 223, 231
 tenuis, 23
 Althea, 401
Alwisia bombardata, 397
Amanita, 343, 347
 caesarea, 340, 409
 chlorinosoma, 350
 citrina, 302, 350
 crenulata, 350
 mappa, 312, 350
 morrisii, 350
 muscaria, 85, 158, 302, 312, 342,
 344, 345, 347, 350, 351, 409
 pantherina, 312, 342, 351
 phalloides, 340, 341, 342, 343, 344,
 345, 350, 362
 porphyria, 350
 radicata, 350
 rubescens, 302, 343
 spretta, 344
 strobiliformis, 350
 verna, 341, 342, 344, 345, 350
 virosa, 341, 342, 344, 350
Amanita-toxin, 350
 Amanitin, 350
Amanitopsis
 strangulata, 345
 vaginata, 201, 302
 volvata, 350
 Amber, 478, 479, 483, 484, 485, 486
 Ambrosia beetles, 451
 Ambrosia fungi, 451-452
 American Phytopathological Soci-
 ety, 421
 Amidase, 48
 Amino acids, 22, 83, 289, 325, 331,
 390, 436
 Ammonia, 21, 22, 23, 283, 390, 436,
 437
 Ammonification, 436
 Ammonium chloride, 282, 288
 Ammonium tartrate, 282
Amphisphaeria posidoniae, 466, 469
 Amphisphaeriaceae, 484
Amyelon radicans, 482, 487, 489
 Amygdalase, 40
 Amygdalin, 49
 Amylase, 38, 42, 45, 46, 47, 159
 Anaerobic respiration, 56-62
 Anellaria, 176
 Angiosperms, 477
 Angstrom unit, 123
 Anisochytridiales, 462
 Anisopodiaceae, 461
Anisopodium ectocarpii, 461, 472
 Annulus, 343, 344, 347
 Anopheles, 444
 Antagonism, 279, 280-287
Anthostromella destruens, 143
 Anthracene pigments, 390
 Anthracnose, 108, 109, 179
 bean, 179, 221, 410
 clover, 410
 cotton, 179, 239, 410
 pepper, 239
 watermelon, 410
Anthracomyces
 cannallensis, 487
 rochei, 487
 Anthrax, 354, 418
 Antibiotic, 279, 427
 Antigens, 423-424
 Antisera, 350
 Ants, 168, 174, 175, 452-454
 leaf-cutting, 451

- Aphanomyces*, 180, 437
 camptostylus, 4
 Aphids, 175, 443
 Aphis, walnut, 450
 woolly, 173
Aphis spiraeicola, 450
Apium graveolens, 247
 Aplanes, 180
Apodachlya brachynema, 4, 19, 20,
 22
 Apple, 48, 54, 103, 143, 163, 170, 225,
 231, 239, 283, 402, 443, 450
 Apple bitter-rot, 179
 Apple blotch, 411
 Apple canker, 173, 174, 411
 Apple-leaf spot, 411
 Apple scab, 111, 221
 Apple sucker, 450
 Appressorium, 238-241, 245, 249, 250,
 253
 Apricot, 246
 Aquatic fungi, 167-168
 Arabinose, 18, 19, 65, 75, 79, 390
 Arachnids, 172
Arachnopeziza aurata, 190
 Arbuscules, 299, 303
 Arbutus, trailing, 304
 Archimycetes, 458
 Areyria, 397
 Arginine, 22, 23, 41, 64, 83
Armadillidium vulgare, 176
Armillaria, 107
 mellea, 44, 47, 51, 52, 138, 155, 156,
 157, 158, 162, 200-201, 230,
 304, 315, 339
 nucida, 409
 shii-take, 353
 Arsenic, 49, 50, 88
 Arthrospores, 380, 381
 Artichoke, 313
Aschersonia, 444, 449
 aleyrodidis, 447, 449
 goldiana, 449
Ascobolus, 291
 crouani, 190
 demidatus, 135
 magnificus, 135
 stercorarius, 135, 190
Ascochyta, 4
 fagopyrum, 224
 graminis, 281
 pisi, 178, 410
 Ascomycetes, 186-193, 227, 302, 303,
 318, 321-325, 365, 402-405, 431,
 444, 451, 458, 459, 460, 466-
 468, 481-485
Ascophyllum nodosum, 469
Ascospora
 beijerinckii, 192
 ruborum, 192
 Ascotricha, 191
 Asparaginase, 46, 47
 Asparagine, 22, 23, 64
 Aspartic acid, 22, 23, 25, 41, 64
 Aspen, 397
 Aspergillaceae, 436, 483
 Aspergillic acid, 87
 Aspergillois, 379
Aspergillus, 3, 50, 86, 107, 268, 373,
 388, 431, 435, 444, 470
 cinnamomeus, 74
 clavatus, 72, 87, 89, 126, 127, 128,
 129, 289, 296
 effusus, 78
 elegans, 79
 fischeri, 19, 22, 36, 80, 91, 93
 flavus, 14, 21, 33, 49, 77, 78, 87, 92,
 95, 282
 flavus-oryzae, 77, 94
 fumaricus, 75, 76
 fumigatus, 87, 93, 379
 glaucus, 77, 84, 91, 291, 430
 itaconicus, 73
 melleus, 141
 nidulans, 79
 niger, 2, 4, 5, 6, 11, 13, 14, 15, 16,
 17, 18, 21, 22, 23, 24, 29, 31, 32,
 33, 34, 35, 36, 45, 50, 51, 58,
 70, 72, 74, 75, 77, 79, 80, 81,
 82, 83, 88, 89, 90, 91, 92, 93,
 94, 106, 108, 121, 143, 155, 229,
 280, 281, 283, 289, 290, 296,
 432, 433, 438, 440
 ochraceus, 71
 oryzae, 11, 20, 31, 35, 49, 65, 78,
 81, 82, 155, 159
 parasiticus, 72, 78, 450
 sydowii, 80, 82, 88, 94
 tamarii, 77-78
 terreus, 76, 146, 149
 terricola, 155, 436
 umbrosus, 291
 versicolor, 21, 32
 violaceus-fuscus, 71
 virescens, 88

- Aspergillus wentii*, 78, 79
 Associative effects among fungi,
 279-296
 antagonism, 280-287
 causes, 282-285
 evidence from cultures, 280-282
 evidence from growth in host
 tissues, 285-286
 evidence in soils, 286-287
 general considerations, 292-293
 stimulation, by associative inter-
 action, 287-292
 of reproductive activity, 289-
 290
 of vegetative activity, 288-289
 synergetic reactions, 290-292
 Aster yellows, 172
 Asterina, 483
Astreptonema longispora, 466, 472
 Athlete's foot, 380
 Atropin, 351
Atta
 cephalotes, 453, 457
 sexdens, 453
 Aurantin, 84
 Auroglaucin, 84
 Autodigestion, 50, 202
 Auxins, 280, 288, 308
Avena
 barbata, 272
 sativa, 215
 Canadian, 272
 Markton, 272
 Navarro, 272
 Victoria, 272
 Aversion, 282, 284
 Azalea, 175
Azotobacter chroococcum, 24

Bacillus anthracis, 87
 Bacteria, 280, 281, 292, 398, 429, 430,
 434, 448, 458, 470, 471, 477
Badhamia, 397, 398
 panicea, 217
 utricularia, 217
Balanus, 469
 glandulosa, 468
 Baltic amber, 478
 Banana, 412
 Barberry, 166, 169, 245, 266, 271,
 334, 376, 419
 Barber's itch, 380
 Barium, 3
 Barley, 145, 262, 263, 269, 303, 355,
 359, 360, 361
 scab, 359-361
 stripe, 410
 Barnacles, 468
Basidiobolus ranarum, 22, 174, 185,
 207, 208
 Basidiomycetes, 194-205, 302, 318,
 325-335, 405-410, 431, 436, 458,
 485-486
Basisporium gallarum, 291
 Beans, 109, 221, 224, 239, 242, 243,
 402, 410
Beauveria, 444
 bassiana, 445, 446-447, 449
 globulifera, 445, 449
 Beech, 173, 305, 307
 Beer, 54
 Bees, 168, 173, 443
 bumblebees, 175
 carpenter, 175
 honey, 174, 175
 Beetles, 168, 172, 443, 445, 466
 ambrosia, 451
 and fungi, 451-452
 bark, 451
 Colorado potato, 174
 engraver, 451
 flea, 174, 449
 longicorn, 173
 May, 173, 445
 scarabeid, 174
 Beets, 172, 179, 313
 curly top, 172
 leaf spot, 410
 sugar, 179
 Begonia, 241
Bemesia gossiperda, 172
 Benzol, 427
Berberis, 246
 vulgaris, 240, 256
 Beryllium, 16
Betula alba, 302
 Bicarbonates, 283
 Biocatalysts, 11
 Biochemistry, 69-95
 amino acids, 83
 citric acid, 71-74
 ethyl acetate, 77
 ethyl alcohol, 77
 fats, 79-81
 fumaric acid, 75
 gluconic acid, 74-75

- Biochemistry, glycerol, 77-78
 implications, 88-89
 kojic acid, 78
 lactic acid, 76-77
 malic acid, 76
 mannitol, 79
 organic acids, 70-79
 other metabolic products, 86-88
 oxalic acid, 70-71
 pigments, 83-86
 polysaccharides, 79
 sterols and vitamins, 81-82
 succinic acid, 76
- Biological control of insects, 442, 448-450
- "Bios," 24, 25, 288, 289
- Biotic factors in geographic distribution, 396
- Biotin, 25, 26, 28, 288, 289
- Birds, 176
- Bitter-rot of apple, 239
- Black root-rot of tobacco, 105, 109, 161, 246
- Black-shank of tobacco, 178
- Black spot of roses, 248
- Blackberry, 250, 253
- "Black-fellow's bread," 352
- Blakeslea trispora*, 166, 401
- Blastocladales, 444
- Blastocladiella variabilis*, 26, 27, 34
- Blastomyces dermatitidis*, 369
- Blastomycosis, 366, 368, 369
- Bletilla*, 312
hyacinthia, 310
- Blissus leucopterus*, 445, 449
- Blister rust, 285, 420
- Blodgettia confervoides*, 470
- Blue grass, 258
- Blue stain, 162, 174, 372, 443
- Bodinia, 384
- Boletaceae, 409
- Boletes, 86
- Boletol, 86
- Boletus*, 341, 349
badius, 303
chryserveron, 302
cyanesces, 302
edulis, 82, 352
elegans, 303
felleus, 201
flavidus, 312
granulatus, 303
luridus, 86, 348, 351
- Boletus*
luteus, 302, 303
mineato-olivaceus, 343, 348
satanus, 86, 343, 348, 351
scaber, 302, 352
strobilaceus, 86
variegatus, 303
viscidus, 312
- Bordeaux mixture, 243, 401, 420, 449
- Boron, 10
- Bostrychus, 485
- Botrychium, 299
- Botryosphaeria ribis*, 264, 265, 278
- Botrytis*, 15, 48, 106, 143, 182, 216, 243, 268, 291, 431, 437
anthopila, 443
bassiana, 445
cinerea, 4, 18, 25, 29, 45, 48, 104, 128, 149, 151, 155, 226, 227, 229, 231, 235, 237, 238, 240, 242-244, 247, 254-256, 264, 265, 270, 273, 275, 281, 283
sporoideum, 435
vulgaris, 224, 242
- Brachysporium trifolii*, 264, 273
- Brassica, 247
- Brevilegnia dielina*, 431
- "Bridging host," 262, 263
- Bromatia, 452, 453
- Brome grasses, 262
- Bromus*, 335
commutatus, 262
hordeaceus, 262
racemosus, 262
- Brown rot, of peaches, 115, 173, 246
 of stone fruits, 443
- Brown spot of pines, 179
- Brown rot of woods, 44
- Bryophyta, 299
- Bryopsis plumosa*, 461, 462
- Bryozoans, 137
- Buckwheat, 224, 242
- Budding, 211, 212
- Bugs, 443
- Burmanniaceae, 298
- Butterflies, cabbage, 444
- Butyric acid, 49, 55, 283
- Buxbaumia, 299
- Byssoclamlmys fulva*, 94
- Cabbage, 242, 398
 blackleg, 173, 410, 443
 club root, 160, 161

- Cabbage, maggot, 173
 yellows, 109, 110
Cadophora, 452
 americana, 372, 393
Caenomyces sapotae, 487
Caecoma nitens, 174
 Caesium, 3
 Calcium, 3, 4-5, 7, 10, 438
 Calcium carbonate, 10, 11, 70, 71, 75,
 76, 478
 Calcium oxalate, 71
Calluna vulgaris, 304
Caloscypha fulgens, 190
Calvatia gigantea, 166
 Cambrian period, 477, 481
 Camellia, 205
 Camembert cheese, 49
 Canada balsam, 479
Candida, 89, 377-379
 albicans, 378
 tropicalis, 378
 Cannizzaro reaction, 59, 77
Cantharellus
 cibarius, 82, 352
 clavatus, 82
 floccosus, 303, 315
 Capnodiaceae, 254
 Capric acid, 20, 49
 Caproic acid, 49
 Carbohydrases, 50
 Carbon dioxide, 53, 54, 55, 59, 60,
 61, 62, 69, 116-117, 210, 231,
 435, 436, 459
 Carbon monoxide, 65
 Carbon requirements, 17-21, 213
 Carboniferous period, 477, 483, 485,
 486, 487
 Carboxylase, 57, 59, 217, 218
 Carboxypolypeptidase, 41
 Cardinal temperatures, 96, 97-103,
 221, 222, 223, 224, 225, 226
 Carlic acid, 88, 163
 Carlosic acid, 88, 163
 Carnation-bud rot, 173, 377
 Carolic acid, 88, 163
 Carolinic acid, 88
 Carotene, 82, 84, 182
 Carotinoid pigment, 134
 Carrionia, 372
 Carrots, 303, 313
Caryophyllia smithii, 459
 Casein, 390
 Cassava, 401
Castagnea chordariaeformis, 469
Castanea
 dentata, 404
 mollissima, 404
 vesca, 302
 Castor bean, 242
 Catalase, 12, 40, 41, 45, 46, 47
 Catalysts, 37-38, 61
 Catechol, 44
Catenophora pruni, 211
 Catenularia, 171
 Caterpillars, 444
 Cats, 366, 376
 Cattle, 176, 366, 367, 374
 Cattleya, 303, 310
 Cecidomyid, 174
 Cedar, 170, 404
 Celery blight, 410
 Cellobiose, 19, 65
 Cellulase, 40, 45, 46, 47, 292
 Cellulose, 19, 44, 50, 435, 436, 437, 460
 Cellulose acetate, 479
 Cenangiaceae, 484
Cenangites piri, 484
 Cenangium, 484
 Cenozoic era, 478
Cephalosporium, 171, 178, 444
 acremonium, 243
 lecanii, 446-447
Cephalothecium, 170, 431
 roseum, 104, 127, 223, 225, 226,
 229, 287, 294, 436
Ceramium
 diaphanum, 461
 rubrum, 461, 466
Ceratostomella, 137
 ampullacea, 188, 193
 coerulea, 99
 imbriata, 191
 ips, 99, 452
 piceaperda, 452
 pilifera, 99, 443, 452
 pini, 452
 pluriammulata, 99, 452
 pseudotsugae, 452
 ulmi, 174, 177, 404, 443, 452
Cercospora, 4
 beticola, 179, 250, 256, 410, 411
 daizu, 410
 personata, 170, 173
 salinia, 470
Cercospora rubi, 253
 Cercosporites, 482

- Cereals, 334, 386
Certhia familiaris americana, 176
Ceuthospora limitata, 143
Chaetocladium, 240
 brefeldii, 26
 Chaetomella, 143
 Chaetomiaceae, 484
Chaetomites intricatus, 484
Chaetomium, 50, 146, 191, 373, 484
 cochlioides, 148
 kunzeanum, 435
Chaetosphaerites bilychnis, 482, 484
Chamaecyparis thuyoides, 405
 Charcoal, 283
 Chemotherapy, 427
 Chemotropism, 241, 242, 243
 Cherries, 54, 246, 411
 Chestnut blight, 111, 170, 177, 404,
 420, 443
 Chili, 401
 Chinch bug, 445, 449
 Chi-square test, 213
Chitin, 253, 471
Chlamydozozores, 329, 330, 380, 381,
 382
 Chloroform, 214
Chlorosplenium aeruginosum, 85,
 190, 452
Choanephora cucurbitarum, 26, 401
 Choline, 350, 361
Chondrus crispus, 469
Chromaphis juglandicola, 450
 Chromium, 16
 Chromoblastomycosis, 370-372
 Chromosome maps, 323
 Chrysogenin, 284
Chrysophlyctis endobioticum, 145
 Chymotrypsin, 41
 Chytridiaceae, 286
 Chytridiales, 180, 460, 462
Chytridium
 alarium, 461, 472
 codicola, 461
 polysiphoniae, 461, 462
 Chytrids, 436, 460, 461, 462, 466, 481
 Cicada, 445
Cicadula sexnotata, 172
Cicinnobolus cesatii, 285
Ciliaria scutellata, 135, 190
 Citric acid, 13, 15, 19, 20, 69, 71-74,
 75, 76, 79, 88, 214, 280
 Citrinin, 83-84
Citromyces
 glaber, 71
 pfefferianum, 71
 Citromycetin, 83-84
 Citrus, 20, 49, 77, 163, 282, 285, 291,
 292, 402, 449
 melanose, 269, 402, 449
 scab, 269, 411
 Cladobotryum, 444
 Cladochytriaceae, 481
Cladospites
 bipartitus, 486
 fasciculatus, 486
 oligocaenicum, 486
Cladosporium, 141, 170, 171, 388,
 431, 448
 algarum, 470
 carpophilum, 411
 fulvum, 219, 220, 235, 291, 388,
 410
 herbarum, 283, 435
 myrmecophilum, 452
 Clamp connections, 325, 328
 Clasterosporium, 76, 78
 Clavacin, 87
Clavaria
 corniculatus, 158
 rugosa, 158
 turbinata, 485
 Clavariaceae, 485
 Clavatin, 87
Claviceps
 paspali, 174, 355, 358, 362
 purpurea, 174, 260, 354, 356, 357,
 358, 362, 363, 443
 Claviformin, 88
Cleonus punctiventris, 445
 Climatic factors in geographic dis-
 tribution, 396
Clitocybe
 dealbata var. *sudorifica*, 346, 362
 illudens, 137, 340, 342, 345, 351
 409
 laccata, 158
 morbifera, 346
 nebulosus, 346
 sudorifica, 346, 362
Clonostachys araucariae, 453
Clostridium
 pastorianum, 24
 septique, 87
 Clover, 402, 450
 anthracnose, 410

- Clover-blossom blight, 443
 Club root of crucifers, 160, 161, 398
Clupea harengus, 462, 471
 Coal, 485
 "Coal balls," 478, 479, 487
 Coal Measures, 480, 483, 487
 Cobalt, 16
 Cocarboxylase, 41
 Cocci, pyogenic, 284
 Coccidioidal granuloma, 367
Coccidioides, 370
 immitis, 367, 368, 391, 437
Coccobacteria septica, 257, 273
 Coccomyces, 49, 252
Coccospora agricola, 434
Codium mucronatum, 461, 473
Coelomyces stegomyiae, 444, 456
 Coenzymes, 41-42, 57, 61
 Coffee, 138
 Coffee rust, 177
 Coleoptera, 173, 174
 Coleosporiaceae, 485
Coleosporium, 333, 408, 485
 campanulae, 199
 petasitidis, 199
Colletotrichum, 4, 216, 238, 243, 437
 circinans, 242, 245
 falcatum, 175
 gloeosporioides, 143, 239, 255, 291
 gossypii, 159, 229, 410
 lagenarium, 99, 145, 150, 178, 223, 410
 lindemuthianum, 99, 109, 178, 179, 224, 238, 239, 255, 260, 273, 275, 276, 281, 410
 lini, 35
 nigrum, 243, 281
 phomoides, 145, 149
Collybia
 albuminosa, 454
 cirrhatta, 138
 dryophila, 172, 201
 longipes, 138
 radicata, 158, 409
 tuberosa, 138
 velutipes, 26, 33, 102, 328, 339, 352
 Colon-typhoid organisms, 284
 Colorimetric method of pH measurement, 154-155
 Columbium, 16
Comatrichia, 398
 nigra, 397
 Compositae, 298
 Conifers, 269, 308, 397, 398, 405, 410, 437, 443, 478
Coniophora cerebella, 44, 100, 102, 155
 Coniothyrium, 144
 Conjugate nuclear division, 318
 Copper, 10, 11, 13, 14, 15
Coprinus, 176, 202
 atramentarius, 158, 200, 339
 comatus, 166, 200, 228, 230, 339, 351, 352
 ephemerus, 329
 finetarius, 328
 lagopus, 174, 206, 328, 330, 337, 338, 450, 455
 micaceus, 158, 228, 230, 339
 plicatilis, 172
 rostrupianus, 328, 338
 Coprophilous fungi, 176, 177, 182, 191, 203, 321, 399, 404
 Coral fungi, 339
 Corals, 459
 Cordyceps, 444, 445
 Corky tissue, 247
 Corn, 240, 303, 360, 399, 405
 borer, 445, 450
 ear rot, 410
 smut, 231
 Cornell University, 420
Cornus sanguinea, 403
 Cornutine, 358
Corticium
 chrysocreas, 102
 coeruleum, 138
 effusatum, 102
 vagum, 110, 121, 273
Cortinarius
 bivelus, 302
 calisteus, 303
 collinitus, 302
 multiformis, 302
 proteus, 302
 violaceus, 158, 302
Corylus avellana, 302
 Cosmic rays, 123, 124
 Cotton, 49, 108, 239, 242, 401, 403, 410, 412
 Cotton blue, 248
 Cottonwood, 397, 398
 Cottony cushion scale, 447
 Covered smuts, 272
 Cowpea, 401
 Cozymase, 41

- Crab, mole, 464
 mud, 464
 pea, 464
 Crabapple, 411
 Cranberry, 143, 184, 304, 444
 Craterium, 398
 Creeper, brown, 176
 Cretaceous period, 477, 485, 486
 Cribraria, 397
 Cricket, 443, 444
 tree, 174
Cronartium, 333, 406, 408
asclepiadeum, 199
ribicola, 169, 174, 176, 177, 207,
 208, 214, 223, 225, 235, 285,
 334, 408, 420
 Crop rotation, 427
 Crossing-over percentages, 323
 Crown rust of oats, 170, 215
 Crucifers, 398
 Crustacea, 137, 464
Cryptococcus
fagi, 173, 206
histolyticus, 368-369
Cryptomeriopsis mesozoica, 484
Ctenomyces serratus, 385
 Cucumber, 242
Cucurbitaria laburni, 192
 Culex, 444
 Cultivation of fungi, 352-353
 by insects, 451-454
 Cunoniaceae, 298
 Cupuliferae, 306
 Curculio, sugar-beet, 445
 Curly top of beets, 172
 Cuticle, 236, 237, 239, 244, 246, 252
 Cutworms, 445
 Cyanide, 65, 66
Cyathus
olla, 228, 230
pallidus, 205
stercoreus, 205
striatus, 228
 Cycad, 483
Cylindrocladium scoparium, 218, 223
Cymadothea trifolii, 232
 Cymbidium, 310
 Cynodontin, 85
 Cyripedium, 303
 Cystine, 4, 22, 41, 64
Cystopus candidus, 223
Cystoseira osmundacea, 469
 Cytase, 40
 Cytochrome, 12, 58, 63
Cyttaria
darwinii, 352
gummi, 352
harioti, 352
hookeri, 352
 Czapek-Dox solution, 79, 83, 85, 88
 Czapek's solution, 3, 229
Daedalea, 202, 410
ambigua, 102
confragosa, 47, 52, 155, 157
flavida, 46
quercina, 102
unicolor, 102
 Dahlia, 401
 Daldinia, 191
Darlucia filum, 285
Dasyscypha
ellisiana, 404, 415
virginea, 190
 "Death angel," 341
Debaryomyces
hominis, 369
neoformans, 369
 Decapods, 464
 Dehydrogenase, 58, 59, 63
 Dematiaceae, 371, 436, 486
Dematiium, 373, 431
pullulans, 81, 143, 211, 452
Dendroctonus, 174, 451
Depazites
picta, 482
rabenhorsti, 486
Dermatitis verrucosa, 371
Dermatomycetes, 366
Dermatomyces, 145, 366, 379-390
 Dermatophytes, 106, 366
 Deuterium oxide, 221
Deuteromycetes, 410-412, 486-487
 "Devil's cigar," 190
 Devonian period, 477, 483
 Dewberries, 253
 Dextrin, 19, 64, 386
 Dextrose, 18, 19, 20, 213, 331
 Dhobie itch, 379-380
Diachea, 398
leucopoda, 217
Dianthus, 247
Diaporthe, 137
citri, 269, 282, 291, 402, 449
perniciosa, 284, 294
 Diastase, 38, 40, 48, 49, 292

- Diatrype*, 191
 disciformis, 189
Dicaryotic mycelium, 328, 329
Dicranophora fulva, 26
Dictydiaethalium plumbeum, 217
Dictyophora phalloides, 138
 Dictyuchus, 4, 168, 180
 Diderma, 398
Didymella conchae, 468, 469
Didymium, 398
 squamulosum, 217
Didymosphaeria
 fucicola, 469
 pelvetiana, 469
Didymosphaerites bethelii, 485
 Diketoadipic acid, 74
Dilsea edulis, 469
 Dimethylpyruvic acid, 163
 Dinosaur, 485, 488
Diplocarpon, 252
 earliana, 190
 rosae, 190, 232, 238, 239, 249, 253,
 254
Diplodia, 143
 natalensis, 20, 22, 99, 116, 291, 452
 tubericola, 18, 29
 zeae, 170, 178, 243, 285, 410
Diplodina laminariana, 470
 Diploidization, 333, 450, 451
 Diploisis, 173
 Diptera, 174
 Direct penetration, 237-248
 Disaccharides, 386, 436
 Discomyces, 375, 403, 404
 Discomycetes, 135, 176, 186, 189-190
 Dissemination of spores, 166-209
 Dissociation, 259
 Dogs, 366, 367, 376
 Domestic animals, 360, 366, 367
 Dominant characters, 317, 335
 Dormancy, 214, 216
 Dothideaceae, 484
 Dothideales, 466
Dothidella
 laminariae, 469
 pelvetiae, 469
 Dothidites, 484
 Dothiorella, 4
 Douglas fir, 452
 Down mildew, 252, 268, 400
 of grapes, 420
 of tobacco, 111, 177, 401, 427
 "Drop-excretion mechanism," 194
Dryobates pubescens medianus, 176
 Dulcitol, 78
 Dutch elm disease, 174, 177, 404,
 443
 Earth, age of, 475, 476
 Earthworms, 137
 Eccrinales, 466
 Eccrinid, 465
Eccrinopsis hydropilorum, 466
Echinodontium tinctorium, 47, 52
 Ecology, 279
 Ectoascus, 192
Ectocarpus, 460
 mitchellae, 461
 siliculosus, 461
 Ectoparasites, 253-254
 Ectosymbiosis, 451, 454
Ectotrichophyton, 384
 felineum, 384
 mentagrophytes, 384
 Ectotrophic mycorrhiza, 299, 300,
 309
 Edaphic factors in geographic dis-
 tribution, 396
 Edible fungi, 339-363
 Eel grass, 460, 470
Eidamia
 catemulata, 77
 viridescens, 77
 "Einfach Mykorrhiza," 299
Elaphomyces granulatus, 303, 307
 Electrometric measurement of pH,
 154-155
Elegans, section of *Fusarium*, 264
 Elephantiasis, 443
 Elm, 404, 452
Elymus, 335
 canadensis, 358
Emerita talpoida, 464
 Emmer, 250
 Vernal, 271, 335
Empusa lecanii, 445, 456
 Emulsin, 40, 42, 45, 46, 47, 48
 Endemism, 396, 400-401, 402-408
 Endoascus, 192
 Endocarditis, 375
Endoconidiophora
 coerulescens, 452
 moniliformis, 452
Endodermophyton, 383, 384
 concentricum, 384
Endomyces vernalis, 80

- Endomycetaceae, 370
 Endomycetales, 80
Endophyllum euphorbiae-sylvaticae, 199
 Endosymbiosis, 454
Endothia parasitica, 111, 122, 170, 173, 176, 177, 187, 189, 193, 207, 404, 420, 443
 Endotrophic mycorrhiza, 299, 301, 304, 309
Enteridium olivaceum, 217
Enterobryus, 464, 465
 compressus, 466
Enteromorpha minima, 469
Entoloma, 345
 lividum, 343, 348
 rhodopolium, 312
 sinuatum, 348
 Entomogenous fungi, 444-448
Entomophthora, 185, 448
 chromaphidis, 450
 fresenii, 450
 gryllii, 444
 lecanii, 445
 muscae, 184, 444
 pseudococci, 444
 sphaerosperma, 113, 184, 208, 444, 450
 Entomophthorales, 185, 444
Entyloma
 linariae, 197
 lobeliae, 197
 menispermi, 197
 Enutotrichophyton, 384
 Enzymes, 37-52, 55, 159, 237, 238, 283, 285, 389, 416
 chemical properties, 39-41
 classification, 39
 coenzymes, 41-42
 general considerations, 50
 in decay of fruits and vegetables, 48
 influence of reaction, temperature, and time, 42
 methods for detection, 43
 of wood-destroying fungi, 43-48
 other activities, 49-50
 production by fungi, 43
 specificity, 42
 Eocene period, 478, 483, 487
Epicoecium maritimum, 470
 Epiceridaceae, 298
 Epidermis, 252
 Epidermophytid, 387
Epidermophyton, 381, 383, 384
 floccosum, 384
Epigaea repens, 304, 314
 Epipactis, 310
Epitrix cucumeris, 174
 Eremascaceae Imperfectae, 377
 Erepsin, 40, 46, 47
 Ereptase, 48
 Ergobasine, 359
 Ergometrine, 359
 Ergosterol, 80, 81
 Ergostetrine, 359
 Ergot, 354-359, 443
 Ergotinic acid, 358
 Ergotinine, 358, 359
 Ergotism, 354-359
 Ergotocin, 359
 Ergotoxin, 359
 Ericaceae, 298, 301, 304
 Erysiphaceae, 1, 186-187, 211, 232, 253, 285, 483
Erysiphe, 186
 cichoracearum, 402
 communis, 244, 260
 communis tritici, 262
 graminis, 175, 244, 252, 262, 277, 402
 graminis hordei, 260, 276
 graminis tritici, 221, 260, 276
 horridula, 260, 273
 polygoni, 219, 233, 247, 402
 taurica, 253
 tortilis, 402
Erysiphites
 metilli, 483
 protogalus, 483
 Essential elements, 10
 Esterase, 40
 Ethyl acetate, 77, 231
 Ethyl alcohol, 77
 Ethyl mercury chloride, 427
 Ethyl mercury phosphate, 427
 Euachorion, 384
 Eucalyptus, 231
 Fucharis, 243, 244
 Eufavotrichophyton, 384
Eumicrosporium, 384
 Euphorbia, 200
 Euphorbiaceae, 298, 407
Eurotium
 amstelodami, 291
 herbariorum, 270, 273

- Eurychasma*, 461
 dicksonii, 460, 471
Eutetix tenella, 172
 Exosmosis, 238
 Exotics, 404
- Facultative anaerobes, 56
Fagus sylvatica, 302
 Fats and oils, 21, 62, 67, 79-81
 Faviformes, 384
Favotrichophyton, 384
 ochraceum, 384
 violaceum, 384
 Favus, 366, 380, 382, 388
 Feathers, 367, 379, 385, 389
 Federal Plant Quarantine Law, 420
 Fenn respirometer, 64, 65
 Fermentation, 43, 53, 54, 55, 58-62,
 69, 418
 Fern allies, 477
 Ferns, 406, 477, 486
 Fertilization, 317
 Festuca, 335
 Feteretia, 266
 Filters, Berkefeld, 291
 Chamberland, 289
 porcelain, 283
 Fire blight of pears and apples, 443
 Firs, 406
 Douglas, 452
 white, 452
 First-division segregation, 326
 Fish, 137, 462
 ganoid, 485
Fistulina hepatica, 352
 Flagellates, 137
 Flavacin, 87
 Flavoglucin, 84
 Flavone, 84
 Flax, 77, 403, 411, 412
 stem break, 410
 Fleas, 172
 Flexuous hyphae, 333
 Flies, 168, 172, 183, 184, 443, 450
 carrion, 202
 house, 444
 muscid, 174
 sarcophagid, 174
 Florideae, 459
 Flounder, 463
 Fluorescence, 388-389
 Fly agaric, 344, 350
 Folic acid, 325
- Fomes*
 annosus, 101, 102, 114, 138
 applanatus, 166, 410
 cryptarum, 101
 everhartii, 102
 fomentarius, 51, 166, 208
 fraxineus, 47, 52
 igniarius, 47, 52, 102
 marmoratus, 102
 nigrolineatus, 102
 officinalis, 102
 pini, 44, 138, 269, 410
 pinicola, 26, 45, 47, 52, 102
 rimosus, 102
 roseus, 155
 subroseus, 102
Fonsecaea, 372
 Food value of fleshy fungi, 351-353
 Foraminifera, 481
 Forestry, 311-312
 Formic acid, 20
 Fossil fungi, 474-489
 age, 477-478
 classification, 479-487
 Myxomycetes, 480
 Phycomycetes, 480-481
 Ascomycetes, 481-485
 Basidiomycetes, 485-486
 Deuteromycetes (Fungi imper-
 fecti), 486-487
 fossil mycorrhizae, 487
 geological time, 474-477
 implications, 488
 nature, 478-479
 preparation, for study, 479
 "Fox fire," 137
 Frogs, 174, 185
 Frog hopper, sugar-cane, 445
 Fructose, 42, 74, 75, 390
 γ -Fructose, 59
Fucus vesiculosus, 469
Fuligo, 398
 septica, 217, 230
 Fulvic acid, 163
Fumago vagans, 74, 76
 Fumarase, 40
 Fumaric acid, 19, 71, 73, 75, 76, 163
 Fumigatin, 87
 Fungi Imperfecti, 286, 379, 431, 460,
 468-470, 486-487
 Fungicides, 162, 163, 243, 401, 420,
 427
Fungites jenensis, 487

- Fungus-insect interrelationships, 442-457
 biological control of insects, 448-450
 fungi cultivated by insects, 451-454
 ants, 452-454
 beetles, 451-452
 fungi occurring on or within insects, 444-448
 implications, 455
 insects as vectors of plant-pathogenic fungi, 442-443
 insects in relation to reproduction of fungi, 450-451
- Fusarium*, 107, 109, 143, 159, 178, 229, 265, 268, 284, 292, 355, 359, 361, 431, 435, 437
acuminatum, 18
angustum, 453
argillaceum, 144
aurantiacum, 161
avenacearum, 161, 360
avenaceum, 28, 34
bullatum, 155
cepae, 144
chromophythoron, 165
coeruleum, 99, 144, 281
conglutinans, 109, 110
cubense, 412
culmorum, 161, 281, 286, 294, 296
discolor var. *sulphureum*, 99, 114, 118, 119, 127, 128, 148
equiseti, 161, 453
eumartii, 99, 118, 143, 144
graminacearum, 67
gramineum, 80, 360, 361
herbarum, 161
lini, 18, 35, 77, 82, 92, 94, 260, 281, 412
lycopersici, 155, 156, 412
moniliforme, 264, 275, 291, 452
niützii, 436
nivale, 160, 161
niveum, 27, 28, 412
oxysporum, 4, 5, 7, 15, 29, 99, 118, 412, 453
polymorphum, 161
putrefaciens, 104
radicicola, 29, 99, 104, 118, 437
roseum, 452
solani, 283
trichothecioides, 99, 437
- Fusarium*
vasinfectum, 412
viride, 452
- Fuseaux, 381, 382
- Fusicladium*
dendriticum, 227
pirinum, 227, 291
saliciperdatum, 177
tremulae, 238
- "Gabelmykorrhiza," 299, 303
- Galactinia badia*, 190
- Galactocarolose, 79
- Galactose, 18, 19, 21, 42, 45, 65, 75, 79
- Galera tenera*, 329
- Gallic acid, 44, 163
- Gallium, 16
- Gamma rays, 123, 124
- Gammarus locusta*, 466
- Gangrene, 354, 358, 359
- Ganoderma*
applanatum, 44, 51, 101, 102
lucidum, 82, 103
- Garlic, 50, 88
- Gastroidea elata*, 304, 315
- Gastrointestinal tract, effect of fungi, 343
- Gastromycetes, 194, 202-205, 312, 406, 410
- Geaster*
fimbriatus, 303
fornicatus, 303
- Geasterites florissantensis*, 486
- Geese, 176
- Gelatin, 389, 430
- Genetics, 317-338
 Dominance and lethal factors, 335
 homothallism and heterothallism, 319-335
 in Phycomycetes, 319-321
 in Ascomycetes, 321-325
 in Basidiomycetes, 325-335
 in Ustilaginales, 329-333
 in Uredinales, 333-335
 résumé, 336
 sexual and asexual stages, 317-318
- Geographical distribution of fungi, 96, 102, 395-415
- Myxomycetes, 397-399
- Phycomycetes, 399-402
 endemic species artificially dispersed, 400-401
 influence of latitude, 401-402

- Geographical distribution of fungi,
 Ascomycetes, 402-405
 exotics, 404
 powdery mildews, 403
 Pyrenomycetes and Discomy-
 cetes, 403-404
 species with erratic distribu-
 tion, 404-405
 Basidiomycetes, 405-410
 smuts, 405-406
 rusts, 406-407
 endemism in, 407-408
 septobasidium, 408-409
 other Basidiomycetes, 409-410
 Deuteromycetes, 410-412
 seed-borne, 410-411
 nursery stock, 411
 soil-borne, 411-412
 implications, 412-414
Geolegnia
inflata, 431
septisporangia, 431
 Geological time, 474-477, 476
Geraniaceae, 298
 Germ theory of disease, 418
 Germination of spores, 210-235
 carbon dioxide, 231
 germination types, 210-212
 hereditary factors and, 214-218
 light, 231-232
 methods of testing, 212-213
 nutrition, 232
 oxygen, 230-231
 reaction, 229-230
 résumé, 232-233
 temperature, 221-229
 water relations, 218-221
 Giant colonies, 383
Gibberella
saubinettii, 66, 67, 105, 119, 120,
 178, 355, 359-361
zeae, 355, 359-361
Gilchristia dermatitidis, 369
 Gills, attachment of, 344
Gliocladium fimbriatum, 284, 287,
 294
Gloeosporium, 216, 237, 243, 292, 437
album, 104
aridum, 211
fructigenum, 25, 99, 104, 239
herbarum, 104
limeticolum, 143
minus, 143
Gloeosporium
musarum, 99
piperatum, 281
Glomerella, 48, 193, 325
cingulata, 18, 32, 99, 104, 144, 146,
 150, 213, 234
gossypii, 24, 99, 108, 178, 179, 427
rufomaculans, 48, 111, 143, 179,
 223, 225, 226, 229
 Gluconic acid, 16, 74-75, 76, 88
 Glucose, 18, 19, 42, 49, 65, 74, 79, 80,
 81, 389, 390
 γ -Glucose, 59
 Glucose diphosphate, 61
 Glucose monophosphate, 61
 Glucosidase, 40
 Glucosides, 45
 Glutamic acid, 22, 23, 41, 64, 83
 Glutaric acid, 290
 Glutathione, 41, 63, 86
 Glyceric aldehyde, 60, 61
 Glycerol, 18, 19, 21, 59, 60, 61, 74,
 77-78, 79, 80
 Glycine, 22, 23, 65
 Glycogen, 67, 192, 202, 205, 220
 Glycolase, 40, 57, 59
 Glycolic acid, 71, 163
 Glycuronic acid, 163
 Glyoxalic acid, 71
Gnomonia, 137
rubi, 193
ulmea, 232
 Goats, 176
Gomphidius gracilis, 302
 Gomphinarina, 372
Gonatobotrytis primigenis, 486
 Gooseberries, 54
 Gramineae, 403
 Graminiaceae, 298
 Grapefruit, 269
 Grapes, 53, 143, 239, 400
 mildew, 177, 420
Graphium
rigidum, 452
ulmi, 28, 414
 Grass, 85, 252, 258, 262, 305, 357,
 358, 398, 483
 blue, 258
 brome, 262
 kangaroo, 216
 Grasshoppers, 443
Grilletia sphaerospermii, 481, 489
 Growth, measurement of, 12, 13, 96,
 97, 155-157

- Growth-inhibiting substances, 280, 289
- Growth-stimulating substances, 280, 289, 308
- Grubyella, 384
- Guaiacol, 44, 45
- Guignardia, 143
alaskana, 466, 469
chondri, 469
irritans, 469
ulvae, 466, 469
- Guinea pig, 387, 388
- Gums, 50
- Gymnoascaceae, 385
- Gymnoconia*, 333
interstitialis, 250, 252, 256
- Gymnogongrus norvegicus*, 470
- Gymnosperms, 477
- Gymnosporangium*, 333, 407, 408
clavipes, 218, 223
juniperi-virginianae, 166, 169, 199, 206, 223
nidus-avis, 199, 208
- Gymnotelium myricatum*, 200
- Gyromitra*
esculenta, 352
gigas, 352
- Hadromase, 44
- Hair, 367, 379, 389, 390
- Halidrys dioica*, 469
- Haltica, 449
- Hamanelis virginiana*, 403
- Haptotropism, 243
- Harden theory of fermentation, 58
- Hardwoods, 398, 410, 452
- "Hartig-net," 299, 302, 309
- Hashish, 343
- Hatch Act, 420
- Haustoria, 244, 252-253
- Heartwood rots, 251, 410
- Heavy metals, 10, 11
- Heavy water, 221
- Hebeloma*
crustuliforme, 345
fastibile, 347
- Hegari, 266
- Helicoma, 482
- Helium, 476
- Helminthosporin, 85
- Helminthosporium*, 141, 170
avenae, 85
- Helminthosporium*
catenarium, 85
cynodontis, 85
euchlaenae, 85
geniculatum, 77, 78, 79, 431
gramineum, 85, 243, 260, 273, 410
ravenelii, 85
sativum, 146, 148, 161, 260, 264, 273, 281, 286, 287, 294, 296
tritici-vulgaris, 85
- Helotium scutula*, 190
- Helvella*
crispa, 158, 190
elastica, 190
epibippium, 190
esculenta, 82, 343, 351
- Helvetic acid*, 351
- Hematin, 41
- Hemicellulase, 46, 47
- Hemicellulose, 50
- Hemileia vastatrix*, 169, 177, 209
- Hemiptera, 173, 174
- Hemisphaeriaceae, 254
- Hemitrichia*, 179
clavata, 217
- Hemlock, 432-433
- Hemolysis, 343, 350, 351, 358
- Hemophilus influenzae*, 86
- Hemp seed, 430
- Hepaticae, 298
- Hereditary factors and germination, 214-218
- Hermaphroditism, 319
- Herpes, 380
- Herring, sea, 462, 463
- Hertzian rays, 123, 124
- Heteroauxin, 82
- Heterocaryosis, 265, 266
- Heteroecism, 419
- Heterothallism, 284, 289, 290, 319-335
- γ -Hexoses, 59
- Hexose phosphate theory of fermentation, 58, 61
- Hibiscus, 401
- High temperatures, 108-109
- Hirneola polytricha*, 353
- Histidine, 40
- Histoplasma capsulatum*, 369-370, 391, 392, 393
- Histoplasmosis, 366, 369-370
- "Holy fire," 354
- Homothallism, 319-335

- Honey agaric, 339
 "Honey dew," 357
 Hooves, 367, 379
Hordeum
 arduennensis, 263
 commutatus, 263
 europaeum, 262
 hordeaceus, 263
 interruptus, 263
 racemosus, 263
 sativum, 274
 secalinus, 263
 vulgare, 262
Hormiscium pithyophilum, 453
Hormodendron cladosporioides, 23
Hormodendrum, 452
 pedrosoi, 371, 372, 392, 393
 Hormones, 280, 288, 290
 Hornbeam, 306
 Horns, 367, 379, 386, 389
 Horses, 176, 366, 374, 376, 406
 Host penetration, 236-256
 by ectoparasites, 252-253
 direct, 237-248
 haustoria and their significance,
 252-253
 implications, 254
 stomatal, 248-251
 wound, 251-252
Humaria granulata, 177
 Humidity, 215, 218
 Humus, 50, 305, 430, 434, 435
 Hyalospora, 408
 Hybridization, 263, 266-267, 272,
 317, 334, 427
 Hydathodes, 236
 Hydnaeae, 486
Hydmites argillae, 486
Hydnum
 ferrugineum, 85
 imbricatum, 82
 ochraceum, 102
 pulcherrimum, 103
 repandum, 302
 Hydroergotinine, 359
 Hydrofluoric acid, 479
 Hydrogen acceptor, 58
 Hydrogen peroxide, 283
 Hydrogen-ion concentration, 151-
 164
 Hydroids, 137
 Hydroquinone, 44
 Hydroxyl ions, 151, 154
Hygrophorus
 bresadolae, 302
 conicus, 342, 348, 350
 lucorum, 302
 Hylurgopinus, 451
 Hymenomyces, 125, 137, 176, 195,
 196, 199, 200-202, 285, 302, 312,
 325, 327, 405
 Hymenoptera, 174
 Hyperparasite, 240, 280, 285, 286
 Hyphal anastomosis, 385
 Hyphal fusions, 265
 Hyphochytriaceae, 462
Hypholoma
 fasciculare, 158, 328, 409
 incertum, 82
 Hyphomyces, 373, 435, 445
 Hyphopodia, 254
 Hypochneae, 485
Hypochnus
 centrifugus, 281, 294
 cyanescens, 302
 sasakii, 281, 294
Hypochnites, 485
 Hypocreaceae, 484
 Hypocrella, 444, 447
Hypoderma, 431
 laminariae, 469
 Hypodermataceae, 232
Hypomyces, 285
 ipomoeae, 266, 274, 323, 337, 453
 ipomoeae alba, 325
 ipomoeae purple, 325
 ipomoeae revecta, 325
 ipomoeae revoluta, 325
 lactiflorum, 187
Hypoxydon
 coccineum, 189
 fuscum, 136, 137, 187
 Hysteriaceae, 483
 Hysteriales, 466
Hysterites
 ancinitis, 483
 cordiatis, 483
Icerya purchasi, 447
Ichthyophonus boferi, 462, 463, 471,
 472
Ichthyosporidium boferi, 463
 Identification of poisonous mush-
 rooms, 343-349

- Ids, 388
 Immunity, 423, 424
 Impurities in C.P. reagents, 10, 11
 Incubation, 236
 Indicators, 151, 155
 Infection, 236
 and temperature, 96, 109-111
 "Infection hypha," 238, 239, 245
 Infrared rays, 123, 124
 Inhibitors of respiration, 65-66
 Ink cap, common, 339
 glistening, 339
 Inoculation, 236
Inocybe
 decipiens, 351, 362
 geophylla, 409
 infelix, 342, 347
 infida, 342, 346, 347, 351
i-Inositol, 25, 26, 28, 288, 289
 Insect diseases, 442
 Insects, 137, 168, 172-175, 236, 251,
 442-457, 484, 485
 Intercellular parasites, 252
 Intoxication from eating fungi, 343
 Intracellular parasites, 252
 Inulase, 40, 46, 47, 390
 Inulin, 19, 78
 Invertase, 40, 42, 48, 292, 390
 Iodine, 79
 Ionization, 152
 Ipomoea, 325
 Ips, 174, 451
 Iron, 3, 10, 11, 13, 14, 16, 289, 438,
 478, 481
Irpex mollis, 102
Isaria, 444, 445
 farinosa, 445
Isoachlya, 4
 eccentrica, 431
 monilifera, 4
 Isoboletol, 86
 Isoelectric point, 156, 157
 Itaconic acid, 73, 163
Ithyphallus coralloides, 174

 Jack bean, 41
 "Jack-in-the-box" dehiscence, 191,
 192
 Jack-o'-lantern, 345
 Jelly fish, 137
 Jelly fungi, 84
 Jungermanniaceae, 298

Juniperus
 communis, 405
 virginiana, 405
Jurassic period, 477, 481

Kabatiella
 caulivora, 410
 nigricans, 211
Kaloterms minor, 175
Keithia
 chamaecyparissi, 405
 juniperi, 405
 tetraspora, 405
 thujina, 405
 tsugae, 405
 Keratin, 366, 379, 389, 390
 Kerion, 380, 384
 Ketosuccinic acid, 71
 Khapli emmer, 250
 "Knollenmykorrhiza," 299, 303
 Koch's rules, 419
 Kojic acid, 78, 163
 Kroepoek of tobacco, 172

 Laboulbeniales, 444
 Labyrinthula macrocystis, 460, 470
 Labyrinthulales, 460
Laccaria laccata, 409
 Laccase, 46, 47, 86
Lachnea
 scutellata, 135
 setosa, 190
 stercorea, 177
Lactarius, 285, 346
 blennius, 158, 302
 coryli, 302
 deliciosus, 352, 409
 helvus, 312
 necator, 302
 rufus, 302
 subdulcis, 302
 torminosus, 302, 343, 346, 351
 Lactase, 40, 46, 47, 390
 Lactic acid, 20, 55, 56, 76, 81, 248,
 268, 280, 283
Lactobacillus
 acidophilus, 76
 bulgaricus, 76
 Lactophenol, 248
 Lactose, 18, 19, 21, 74, 390
Laestadites nathorstii, 484
Lagenidium rabenhorstii, 181

- Laminaria*, 469
 digitata, 469
 saccharina, 469
Lamproderma violaceum, 217
 Larch, 300, 303, 452
Larix, 303
 decidua, 302
Lasiosphaeria pezizula, 452
Lasius
 fuliginosus, 452, 453
 umbratus, 453
 Late blight of potato, 111, 177, 221, 419
 Latitude and geographic distribution, 401-402, 407, 408, 409
Lauraceae, 298
 Lead, 476
 Leaf rust of wheat, 170
 Leather, 389
 Leathery fungi, 176
Lecanidium atratum, 188, 192, 206
Lecanium viride, 446-447
Lecanosticta, 216
 Lecithinase, 40
 Leguminosae, 298, 402, 407
 Lenticels, 236, 246
Lentinus, 409
 aticolus, 453
 cartilagineus, 454
 lepideus, 101, 103, 126, 148, 200
Lenzites, 202
 berkeleyi, 102
 betulina, 101, 410
 saepiaria, 26, 47, 52, 99, 103, 155, 157, 158, 229
 tigrinus, 99
 trabea, 101, 103
Lenzites gastaldii, 486
 Leocarpus, 398
Leotia chlorocephala, 158
Lepidodendron, 481, 483, 485
 aculeatum, 481
Lepidoderma tigrinum, 217
 Lepidoptera, 173
Lepiota
 cepaestipes, 228, 230
 cygnea, 409
 morgani, 343, 345
 naucina, 344
 procera, 339, 345, 352, 409
Leptinotarsa decemlineata, 174
Leptolegnia, 4, 180
 subterranea, 431
Leptonitus lacteus, 4, 19, 20, 22
Leptosphaeria
 acuta, 192, 207
 chondri, 469
 coniothyrium, 174
 herpotrichoides, 281-282
Leptosphaerites lemoinii, 485
Leptostroma camelliae, 205, 206
Leptostylus maculata, 173
 Lethal factors, 335
 Lettuce, 237
 Leucine, 22, 23
Leveillula taurica, 253
Levulose, 18, 19, 42, 65
 Lice, 172
 Lichens, 297, 390, 466
 Light, 210, 231-232, 308, 470
 Lignin, 43, 44, 50
 Ligninase, 46, 47
 Lilac, 203
 Liliaceae, 298
 Lilies, 237
 Lima-bean-pod spot, 443
 Lime, 143, 398
 Limpets, 468
 Lineolic acid, 80
Linospora, 137
 gleditsiae, 193, 232
 Lipase, 40, 41, 46, 47, 48, 50
Lithopythium gangliiforme, 460
 Litrophilic fungi, 160-161
Littorina, 469
 planaxis, 468
 Liverworts, 298
Lolium
 perenne, 305, 316, 358
 temulentum, 305, 316
 "Long roots," 301
 Long-cycled rusts, 407
 Longleaf pine, 258
 Loose smuts, 272
Lophodermium pinastri, 26, 405
Lophophyton, 384
 Low temperatures, 103-108, 227
 Luciferase, 40, 138
 Luciferin, 138
 Luminescence, 137-138, 329, 345
 "Lumpy jaw," 374
 Lupine, 402
 Luteic acid, 79
Lycogala
 epidendrum, 82
 fusco-flavum, 398

- Lycoperdaceae, 486
 Lycoperdadales, 1, 410
 Lycopodium, 299
Lyginodendron oldhamium, 481
 Lysine, 23, 41
 Lysis, 335

 Macroconidia, 381
Macrophoma gymnogongri, 470
Macrosporites
 ropaloides, 486
 subtrichellus, 486
Macrosporium, 4, 15, 431
 commune, 24
 laminarium, 470
 sarcinaeforme, 7
 tomato, 144, 245, 246, 256
 Madreporia, 459
 Magnesium, 3, 4, 7, 10, 213, 438, 478
Magnusia
 brachytrichia, 99, 111
 nitida, 99, 111
Maireomyces peyssonelia, 469
 Maize, 285, 329, 331, 405
 Malaria, 443
Malassezia ovalis, 372-373, 378
 Malic acid, 20, 71, 73, 75, 76, 79, 163
 Malstenia, 384
 Maltase, 40, 42, 45, 46, 47, 292
 Maltose, 19, 64, 74, 78, 220, 389, 390
 Man as vector, 177
 Manganese, 10, 11, 14
 Mannitol, 19, 21, 65, 79, 229
 Mannocarolose, 79
d-Mannonic acid, 163
 Mannose, 18, 42, 79, 390
 Mantle, 306, 309
Marasmius, 409
 oreades, 82
 Marattiaceae, 299
 Marchantia, 179
 Marchantiaceae, 298
 Marine fungi, 458-473
 historical background, 459-460
 implications, 470
 Phycomycetes, 460-466
 Ascomycetes, 466-468
 Fungi Imperfecti, 468-470
 slime molds, 470
 Marine worms, 137
 Marssonina, 238, 243
Massospora, 186
 cicadina, 445, 457

 Mealy bugs, 444, 450
 Medical mycology, 364-394
 Actinomyces bovis, 373-375
 Aspergillus fumigatus, 379
 Coccidioides immitis, 367-368
 Cryptococcus histolyticus, 368-369
 Histoplasma capsulatum, 369-370
 historical, 366-367
 implications, 390
 Malassezia ovalis, 372-373
 Monilia (candida) spp., 377-379
 Phialophora verrucosa, 370-372
 physiologic activities, 389-390
 Sporotrichum schenckii, 375-377
 Trichophytonaceae or ringworm
 fungi, 379-390
 classification, 382-385
 fluorescence, 388-389
 mycides, 387-388
 pleomorphism, 385-387
 relationship with other fungi,
 385
 Megalospora, 212
 Megaspores, 384
Megatrachophyton, 384
 roseum, 384
 Meiosis, 318, 328
Melampsora, 333, 406, 408
 lini, 215, 223, 234
 Melampsoraceae, 406
 Melampsorella, 333
 Melanconiaceae, 486
 Melanconis, 405
 Melanconium, 143
 Melanose of citrus, 269, 402, 449
Melanospora
 culmorum, 291
 destruens, 26, 32, 66, 67, 291, 293
 pampeana, 291, 294
Melanosporites stefani, 484
 Melibiose, 42
 Meliolaceae, 254
Meliola circinans, 254, 255
 Membranes, collodion, 283
 Meningitis, 369, 375
Merulius
 domesticus, 99
 lacrymans, 43, 44, 100, 102, 155,
 232
 sclerotiorum, 99
 silvestris, 99, 100, 102
 tremellosus, 102
 Mesanthrophilic fungi, 161

- Mesozoic period, 477
Metarrhizium anisopliae, 445, 450
Metasphaeria asparagi, 192
 Methane, 435
 Methylarsine, 50
 Methylglucosides, 42
 Methylglyoxal, 57, 59, 60, 62
 Mice, 367
 Microbial composition of soils, 429
Microcera, 444, 446-447
 coccophila, 447
 Microides, 384
 Microsporid, 387
Microsporium, 381, 382, 383, 388
 audouini, 385, 386, 388, 389, 390
 felineum, 389
 fulvum, 289, 384
 gypseum, 384
 lanosum, 385, 387, 390
Microstroma juglandis, 211
 Microthyriaceae, 254, 483
Microthyrites dysodilis, 483
 Microtrichophyton, 384
 Middle lamella, 48
Milesia, 333, 406, 408
 vogesiaca, 406
 Milo, 266
 Mineral nutrition of fungi, 2-16
 Miocene period, 478, 481, 483, 484,
 485, 486
Mitella, 469
 polymerus, 468
 Mites, 172, 173
 Moisture, 210, 220
 Molasses, 74, 82
 "Mold starch," 79
Mollisia cinerea, 190
 Molluscs, 137, 459, 460, 468, 481
 Molybdenum, 16
 Monascoflavin, 84
 Monascorubrin, 84
Monascus purpureus, 84
Monilia, 321, 377-379, 388, 431
 albicans, 378
 candida, 451
 fructicola, 225, 226, 229
 fructigena, 48, 104, 128, 223, 229,
 242
 macedoniensis, 289
 metalondinensis, 289
 oregonensis, 48
 psilosis, 378
 sitophila, 86, 166, 242
Moniliaceae, 436
 Moniliales, 411, 486
 Moniliasis, 378
Moniliopsis aderholdii, 160, 453
Monilites albida, 486
 Monoblepharidaceae, 464
 Monocaryotic mycelium, 334
 Monochaetia, 264
 Monochromator, 125, 140, 143
 Monosaccharides, 386, 436
Monosporium maritimum, 470
 Monosporous cultures, 319
Monotropa, 306
 hypopitys, 305, 314, 315
Morchella
 conica, 136, 352
 crassipes, 136
 esculenta, 339, 340, 349, 531, 352
 gigas, 189
 Morel, 339, 349, 351, 352, 353
Morenoella quercina, 254, 255
 Morning glory, 243
 Morphogenesis, 125-129
 Mortierella, 107
Morus rubra, 403
 Mosquitoes, 172, 442, 443, 444
 Mosses, 398
 Moth, gypsy, 174
Mu Erb, 353
 Mucedinaceae, 486
Mucilago, 398
 spongiosa var. *solida*, 398
Mucor, 13, 106, 107, 431, 433
 christianensis, 22
 dispersus, 141
 genevensis, 145, 146
 glomerula, 155
 griseocyanus, 22
 hiemalis, 84
 mucedo, 76, 78, 88, 91, 242, 283,
 399, 430
 parasiticus, 240, 241
 piriformis, 104
 racemosus, 18, 22, 77, 88, 289, 430,
 436, 453
 rannamianus, 26, 27, 28
 solani, 313
 sphaerospora, 22
 spinosus, 22
 stolonifer, 23, 71, 90, 282, 430
 Mucoraceae, 240, 286, 436, 481
 Mucorales, 399, 430, 431, 433, 436
Mucorites cambrensis, 481

- Muscardine fungus, 445
 Muscarine, 350
 Muscarufin, 85
 Mushrooms, 176, 285
 edible, 339
 Mussels, 487
 Mutations, 259, 262, 264, 331, 385
 radiation and, 139
Mycaureola dilseae, 469
Mycelium radidis sylvestris β , 303
Mycelium radidis sylvestris γ , 303
Mycena
 pura, 158
 vulgare, 158
Mycides, 377-388
Mycobacterium tuberculosis, 379
Mycoderma, 373
 vini, 55
 Mycodextran, 79
 Mycogalactan, 79
Mycogone
 nigra, 434
 perniciosa, 285
 puccinioides, 435
 Mycology in relation to plant pathology, 416-428
 contributory advances in bacteriology, 418-419
 developments in terminology, 421-423
 early concepts of plant disease, 417-418
 fungi as antigens and plant pathology, 423-424
 implications, 427-428
 present trends, 424-427
 signposts along the phytopathological trail, 419-422
 Mycophenolic acid, 88, 163
 Mycorrhiza, 178, 409, 482, 487
 Mycorrhizae and mycotrophy, 297-316
 function, 305-311
 fungi involved, 302-305
 implications, 314
 importance to forestry, 311-312
 kinds, 299-302
 occurrence, 298-299
 tuberization, 312-314
Mycosphaerella, 193
 ascophylli, 469
 pelvetiae, 468, 469
 rubina, 192
Mycosphaerella sentina, 192
 Mycosphaerellaceae, 484
 Mycotrophy, 297-316
Myriangium, 444
 curtisii, 447
 duriaei, 447
 montagnei, 447
 thwaitesii, 447
 Myriapods, 137
 Myrmicine ants, 452
 Myrtaceae, 298
 Myxomycetes, 39, 217, 218, 225, 397-399, 460, 480
Myxomycetes mangini, 480

Nadsonia fulvescens, 145
 Nails, 367, 379
 "Native bread," 352
Naucoria semiorbiculatus, 329
 Nectarine, 411
Nectria, 444
 aurantiicola, 447
 cinnabarina, 136, 173, 187
 coccinea, 26, 113, 173
 ditissima, 173
 Nematodes, 168, 178, 442, 443
Nematospora
 gossypii, 26, 288
 phaseoli, 443
 Neoachorion, 384
Neocosmospora vasinfecta, 113, 114
Neofabrea malicorticis, 104
 Neomicrosporium, 384
 Neotrichophyton, 384
 Nervous system, effect of poisonous fungi on, 342, 343
 Neuroptera, 173
Neurospora
 crassa, 83, 106, 108, 120, 146, 150, 321, 323, 325, 337, 338
 sitophila, 137, 143, 264, 290, 321, 322, 323, 326, 327, 337, 338
 tetrasperma, 216, 217, 234, 266, 290, 321, 323, 324, 335, 337
 Nicotiana, 401
 Nicotinic acid, 41
 Nidulariaceae, 205
 Nitrate nitrogen, 21, 22, 429, 436
 Nitrification, 429, 436
 Nitrogen fixation, 23, 24, 304
 Nitrogen requirements, 21-24, 213, 308, 311

- Nocardia, 375
 "Nodular organs," 380, 381, 383
 Nucleoproteins, 140
 Nursery stock, 410, 411
 "Nutrilites," 289
 Nutrition, 1-36, 210, 232, 265, 282
 growth factors, 24-28
 implications, 29-31
 mineral, 2-16
 calcium, 4-5
 concentration and proportion, 5-10
 copper, 13-14
 difficulties, 10-13
 iron, 13
 manganese, 14
 other elements, 16
 sulphur, 4
 zinc, 14-16
 organic nutrients, 16-24
 carbon requirements, 17-21
 nitrogen requirements, 21-24
Nyctomyces entoxylimus, 487

 Oak, 98, 306
 Oats, 108, 258, 262, 272, 359
 Fulgum, 267
 Green Mountain, 269
 Green Russian, 269
 loose smut, 267
 Red Rustproof, 267, 269
 Ruakura, 269
 White Tartar, 269
 Ocellus, 134, 135, 182
 Odontoglossum, 304, 309, 310
Oecanthus niveus, 174
Oedocephalum albidum, 151
 Oidium, 431
 Oils, 45
 Okra, 401
 Oleic acid, 80
 Oligocene period, 478, 479, 484
Olpidiopsis andréei, 461
Olpidium, 461
 brassicae, 181
 dicksonii, 460
Omphalia flavida, 137, 138
 Onion smudge, 245
 Onions, 110, 175, 231, 241, 243, 245
 Onychomycosis, 366
Oochytriceae, 481
Oochytrium lepidodendri, 481

Oomycetes, 231, 464
Oospora, 375
 aurantia, 84
 citri-aurantii, 20, 291
Oosporin, 84
Ophiobolus
 careciti, 193
 balinnus, 466, 467, 469, 470
 herpotrichus, 161
 graminis, 22, 31, 158, 160, 161, 165,
 281, 286, 287, 292, 294, 296
 laminariae, 469
 miyabeanus, 289, 296
Ophiodothella, 137
Ophioglossum, 299
Ophionectria cylindrothecia, 405
 Ophrys, 310
 Oranges, 108, 143, 163, 225, 269
Orbilia xanthostigma, 190
Orcadia
 ascophylli, 469
 pelvetiana, 469
 Orchidaceae, 298, 301, 308
 Orchids, 303, 304, 309, 310, 312
 Ornithine, 83
 Orthoptera, 173
Oryza sativa, 414
Oryzaephilus surinamensis, 454, 456
 Osmotic pressure, 5, 7, 29, 220, 247
Ostracoblade implexa, 460
 Ostracoda, 481
Otidea leporina, 190
Ovularites barbouri, 486
Ovulinia azaleae, 175
 Oxalacetic acid, 71, 74
 Oxalic acid, 13, 15, 62, 69, 70-71, 75,
 79, 163, 237, 238, 268
 Oxaloacetate, 19
 Oxidase, 48, 50, 58, 63
 Oxidation-reduction systems, 63-64
 Oxygen, 210, 230-231, 280
 Oxygenase, 46, 47
 Oxyphilic fungi, 161
 Oyster mushroom, 339

 "Pacemakers," 98
Palaeomyces
 bacilloides, 480
 gordoni, 487
 gracilis, 481
 majus, 487
 Paleozoic period, 481
 Palm, 405, 486

- Palmitic acid, 80
Panaeolus, 176
 campanulatus, 343
 papilionaceus, 343, 348
 retirugis, 340, 345, 348
Panopeus herbstii, 464, 465
 Pantothenic acid, 25, 26, 28, 66, 289,
 325
 Pantoyl-lactone, 325
Panus
 incandescens, 137
 rudis, 103
 stripticus, 137, 138, 201, 329, 337,
 409
 torulosis, 158
 Papain, 41
 Papaw, 401
 Papulospora, 431
 Paraffin, 479
Parasitella
 parasiticus, 240, 241
 simplex, 26
 Parasol mushroom, 339
 Paratrophic fungi, 1, 30, 295
 Paratyphoid, 87
 Paronychia, 378
 Parsnip, 313
Pasiphaea
 cristata, 464
 sivado, 464
Paspalum, 358
 laeve, 355
 Passalus, 466
 Pathogen, 422, 437
 Pathogenicity, 261-263
 Patulin, 88
Paxillus
 lateralis, 302
 panuoides, 101
 prunulus, 312
 Pea crab, 464
 Peach, 246, 402, 407, 411, 453
 Peach-leaf curl, 111
 Peanut, 401
 leaf spot, 173
 Pears, 443
 Peas, 317, 402
 leaf and pod blight, 410
 Peat, 310, 311
 Pectase, 40, 48
 Pectic acid, 48
 Pectin, 48, 49, 50, 436, 460
 Pectinase, 46, 47, 48, 238
 Pectinate hyphae, 380, 381
Pegomya brassicae, 173
Pelvetia, 468
 canaliculata, 469
 Penatin, 87
 Penicillic acid, 87, 88, 163
 Penicillin, 9, 86, 87, 171, 284
Penicillites curtipes, 483
Penicillium, 3, 13, 15, 17, 77, 107,
 145, 175, 268, 303, 388, 431,
 434, 435, 437, 444, 448, 453,
 470
 aurantio-brunneum, 80
 aurantio-virens, 76, 90
 aureum, 452
 brevicaule, 49, 88
 brevi-compactum, 90
 canemberti, 18
 charlesii, 79, 88, 90
 chrysogenum, 74, 79, 84, 92, 284,
 294
 citrinum, 72, 83, 87, 94
 claviforme, 88, 89
 cyclopium, 87, 88, 93, 155, 229
 daleae, 78
 digitatum, 20, 77, 108, 111, 120,
 143, 163, 164, 223, 225, 226,
 229, 285
 divaricatum, 72, 452
 expansum, 24, 45, 72, 79, 81, 91,
 104, 143, 433
 glaber, 74
 glabrum, 83
 glaucum, 4, 13, 16, 18, 29, 31, 32,
 50, 55, 70, 72, 74, 81, 88, 90,
 105, 106, 127, 149, 151, 224,
 242, 281, 282, 283, 430
 globosum, 54
 griseo-fulvum, 75, 93
 griseum, 282
 italicum, 108, 120, 143, 155, 159,
 163, 164, 229, 281, 285
 janthivellum, 81
 javanicum, 16, 32, 80, 92, 94
 lilacinum, 433
 luteum, 72, 79, 92
 notatum, 9, 86, 92, 284
 oxalicum, 71
 patulum, 88
 phoenicum, 86
 puberulum, 88, 90, 93
 purpurogenum var. *rubriscleroti-*
 um, 74

- Penicillium*
roquefortii, 49
roseum, 452
spinulosum, 72, 87, 93
stoloniferum, 20, 88
variable, 155
varians, 79
- Peniophora gigantea*, 102
- Pennsylvanian period, 477
- Pentosans, 44, 45
- Pentoses, 18, 45, 77
- Pepper, 237, 239
- Pepsin, 10, 41, 46, 47
- Peptase, 390
- Peptone, 64, 282, 386, 390
- Perisporiaceae, 483
- Perisporites, 843
- Permian period, 477, 483, 484, 485
- Peronoplasmopara cubensis*, 222
- Peronospora*, 182, 260
calothecae, 244
destructor, 175
parasitica, 223, 231, 267
pygmaea, 218
tabacina, 108, 111, 170, 177, 180,
208, 240, 401, 414
trifoliorum, 231
- Peronosporaceae, 1, 211, 214, 232, 481
- Peronosporales, 180, 222, 230, 399
- Peronosporites*
antiquarius, 481, 482
gracilis, 481
miocaemicus, 481
palni, 480
siculus, 481
- Peroxidase, 12, 40, 46, 47
- Pertusaria, 212
- Pestalozzia*, 143
funerea, 259, 260, 264, 265, 273
guepini, 260, 261, 265, 275
- Pestalozzites sabalana*, 486
- Petersenia andréei*, 461, 462
- Petrification, 478
- Petrosphaeria japonica*, 484
- Peyssonelia squamaria*, 469
- Peziza*, 189
acetabulum, 190
aurantia, 190
repanda, 190
epispartia, 454
- Pezizaceae, 484
- Pezizites candidus*, 484
- Pfeffer's solution, 3, 7, 310
- pH, 42, 151-164, 210, 226, 229-230,
265, 282, 286, 310
- Phacidiaceae, 483
- Phacidites, 483
- Phalaenopsis, 304, 310
- Phallales, 1, 174, 410
- Phallin, 350
- Phalloidin, 350
- Pharcidia pelvetiae*, 469
- Phaseolus vulgaris*, 277
- Phellomyces dubius*, 487
- Phenol, 248
- Phenolase, 40
- Phenolic compounds, 45
- Phialophora verrucosa*, 370-372, 371,
393
- Phlebia*
merismoides, 102
strigosa-zonata, 103
- Phioroglucinol, 44
- Phoenicin, 86
- Pholiota*
adiposa, 155, 157
autumnalis, 342, 346, 350, 362
- Phoma*, 4, 292
apiicola, 7
betae, 23, 24, 161
lingam, 178, 247, 410, 443
oleracea, 173
radicis, 24
radicis andromedae, 304
radicis ericae, 304
radicis oxycocci, 304
radicis tetralicis, 304
radicis vaccinii, 304
- Phomopsis*
citri, 20, 99, 116, 143, 163
vexans, 178
- Phosphate, 61
- Phosphorus, 3, 4, 8, 10, 213, 308, 311,
438
- Photosynthesis, 56
- Phototropism, 129-137, 138, 182
- Phragmidium*, 333, 408
disciflorum, 407
potentillae, 214
rubi, 220
- Phragmothyrites eocenica*, 483
- Phycomyces*, 27, 106
blakesleeanus, 26, 27, 84, 146, 319,
336
blakesleeanus arbusculus, 319
blakesleeanus gracilis, 319

- Phycomyces*
blakesleeanus mucoroides, 319
blakesleeanus pallens, 319
longipes, 134
nitens, 17, 26, 27, 129, 130, 134
- Phycomycetes, 167-168, 180-186,
 210-211, 214, 236, 240, 289, 302,
 319-321, 368, 399-402, 431, 436,
 458-459, 460-466, 478, 480-481
- Phycomycites frodinghamii*, 480, 481
- Phyllachorella oceanica*, 469
- Phyllactinia*
corylea, 253, 403
guttata, 260
- Phyllosticta*
antirrhini, 218
solitaria, 216, 223, 233, 411
- Phymatotrichum*, 437
omnicorum, 7, 8, 19, 33, 35, 411,
 412
- Physalospora malorum*, 192
- Physarium*, 398
cinereum, 217, 398
serpula, 230
straminipes, 217
- Physcia*, 390
- Physiologic specialization and vari-
 ation, 257-278
 definition of terms, 257-259
 differences in artificial culture,
 263-264
 fungi having physiological spe-
 cialization, 259-261
 hybridization, 266-267
 importance, 271-272
 influence of environmental fac-
 tors, 269-271
 morphological differences between
 physiological species, 267-268
 pathogenicity tests, 261-263
 physico-chemical differences
 among specialized races, 268-
 269
 sectoring, 264-266
- Physoderma*
maydis, 181
zcae-maydis, 240, 400
- Phytomonas citri*, 292
- Phytopathology, 421
- Phytophthora*, 143, 178, 211, 268, 303,
 310, 437
boehmeriae, 26
cactorum, 26
- Phytophthora*
cambivora, 26
capsici, 26
cinnamomi, 26
citrophthora, 282, 291
colocasiae, 230
cryptogea, 26
drechsleri, 26
fagopyri, 27
infestans, 113, 120, 177, 182, 222,
 223, 230, 231, 233, 400
nicotianae, 178
palmivora, 26, 230
parasitica, 26, 45, 230, 282, 287
parasitica var. *rhei*, 260, 268
parasitica var. *nicotianae*, 401
terrestris, 99, 116
- Picea abies*, 312
- Pigments, 83-86, 159, 390
- Pigs, 374
- Pilaira anomala*, 26
- Pileus*, 342
- Pilobolus*, 84, 129, 131, 133, 176, 182,
 185, 194, 399
kleinii, 132, 182
longipes, 182
 "Pilz-atropin," 351
- Pineapple, 225
- Pines, 300, 301, 303, 307, 309, 311,
 312, 404, 405, 452
 brown-spot disease, 179
 five-needle, 420
 longleaf, 259
 Scots, 312
 white, 420
- Pink bakery mold, 321
- Pinnotheres, 464
- Pinus*, 307
austriaca, 303
caribaea, 311
montana, 303
strobis, 311
sylvestris, 303
- Pisum sativum*, 247
- Pityrosporium ovale*, 372-373, 393
- Plant lice, 450
- Plant pathology, 416-428, 442-443
- Plantaginaceae, 298
- Plasmodiophora brassicae*, 160, 161,
 223, 398
- Plasmodiophorales, 398

- Plasmolysis, 244
Plasmopara, 211
 viticola, 177, 214, 223, 230, 400, 420
Plenodomus meliloti, 282
Pleolpidium marinum, 461, 462
Pleomorphism, 50, 257, 385-387
Pleospora, 260
 herbarum, 192
 scirpicola, 192
Pleosporaceae, 484
Pleosporites shirianus, 485
Pleurage
 anserina, 320, 321, 322, 323, 336, 337
 curvicola, 209
Pleurotus
 facifer, 138
 gardneri, 138
 igneus, 138
 incandescens, 138
 noctilucens, 138
 olearius, 138
 ostreatus, 44, 51, 101, 103, 155, 156, 157, 158, 162, 201, 339, 351, 352
 phosphoreus, 138
 prometheus, 138
Pliocene period, 478
Plowrightia
 morbosa, 260
 ribesia, 192
Plums, 225, 246, 284, 407
Pluteus
 cervinus, 201
 termitus, 454
Poa pratensis, 358
Podonectria, 444, 447
 coccicola, 449
Podosphaera
 biuncinata, 403
 leucotricha, 187
Podospora
 anserina, 338
 curvicola, 187
 curvula, 136, 188, 189, 191
 fimiseda, 187
 minuta, 189
Poisonous and edible fungi, 176, 339-363
 ergot and ergotism, 354-359
 ergotism in livestock, 357-358
 historical, 354-357
 toxicology, 358-359
Poisonous and edible fungi, food value of fleshy fungi, 351-353
 artificial cultivation of fleshy fungi, 352-353
 implications, 361
 poisonous fleshy fungi, 339-351
 classification by toxic effect, 342-343
 identification of poisonous mushrooms, 343-349
 toxicology, 350-351
 toxicity of *Gibberella saubinetii* (*G. zeae*) and *Fusarium* spp., 359-361
Polygyra thyroideus, 203, 209
Polyporaceae, 98, 102, 114, 286, 410, 486
Polypores, 176, 408
Polyporites
 foliatus, 486
 bowmanii, 485
 brownii, 485, 486
Polyporus, 478
 abietinus, 26, 47, 51, 102, 114, 410
 adustus, 26, 44, 155
 betulinus, 47, 52
 cinnabarinus, 127
 conchifer, 410
 farlowii, 127
 fumosus, 101
 hirsutus, 103
 hispidus, 52
 lucidus, 47, 52
 mylittae, 352
 ostreiformis, 46
 parganemus, 410
 radiatus, 102
 robimophilus, 102
 sanguineus, 114
 schweinitzii, 44, 102, 410
 sinuosus, 102
 squamosus, 46, 51, 125, 148, 166, 200, 201
 sulphureus, 43, 51, 102, 138
 texanus, 410
 vaporarius spumarius, 99
 vaporarius succinea, 485
 versicolor, 99, 102, 410
 volvatus, 47, 52
 zonalis, 46
Polysaccharides, 79, 386

- Polysiphonia*, 461
 fibrillosa, 461
Polyspora lini, 211–212, 260, 410, 411
Polystictus, 202
 adustus, 101, 288
 hirsutus, 46
 leoninus, 46
 sanguineus, 46
 versicolor, 44, 45, 46, 51, 52, 101, 112, 116, 117, 121, 155, 156, 157, 158, 162
Polystigma rubrum, 238
Pomobolus pseudobarengus, 463
Populus, 174
 tremella, 302
Poria
 cocos, 353
 incrassata, 102
 subacida, 102
 vaporaria, 101
 xantha, 102
Poronia leporina, 404
Portbetria dispar, 174
Posadasia, 370
Posidonia oceania, 466, 469
Potassium, 3, 4, 8, 10, 311, 438
Potassium hydroxide, 389
Potassium iodide, 379
Potato, 110, 145, 161, 231, 240, 245, 303, 313, 400, 412, 437
 powdery scab, 399
Potato scab, 161, 286
Potato wart, 399
Powdery mildews, 176, 186, 203, 252, 253, 262, 268, 403
Powdery scab of potato, 399
Prasiola borealis, 466, 469
Pre-Cambrian period, 476, 477
Predisposing factors in infection, 422
Preissia, 298
Proline, 83
Propionic acid, 20, 283
Prosopis juliflora, 410
Prosthecium, 405
Protease, 48
Proteolytic enzymes, 389
Protocatechuic acid, 245
Protocoronospora nigricans, 211
Protomycetaceae, 483
Protomycites protogenes, 483
Protopectin, 48
Protopectinase, 48
Protoparce carolina, 174–175
Protozoa, 280, 292, 429, 443, 448, 454
Prunus, 49
Psalliota
 arvensis, 352, 409
 campestris, 82, 126, 166, 196, 197, 200, 201, 339, 341, 345, 351, 352, 353
 silvicola, 409
Psathyrella disseminata, 200
Pseudococcus calceolariae, 445
Pseudomonas aeruginosa, 86
Pseudomycorrhiza, 301, 302
Pseudopeziza ribis, 227
Pseudoplectania nigrella, 190
Pseudopleuronectes americanus, 463
Pseudopolyporus carbonicus, 486, 488
Pseudotsuga taxifolia, 404
Pseudozalsa, 405
Psyllia mali, 450
Pteridium
 aquilinum, 299
 latiusculum, 406
Pteridophyta, 299
Pteridosperms, 477
Ptychoverpa bohémica, 136
Puberulic acid, 88, 163
Puccinia, 407, 408, 485
 adoxae, 244
 annularis, 199
 anomala, 260, 275
 antirrhini, 223
 arachidis, 177, 408
 asparagi, 177, 214, 408
 calystegia, 200
 chrysanthemi, 177, 408
 clematidis, 200
 coronata, 200, 218, 219, 222, 223, 230, 231, 234, 275, 333
 coronata alopecuri, 258
 coronata avenae, 172, 215, 258, 260, 269, 276
 coronata calamagrostis, 258
 coronata festucae, 258
 coronata lolii, 258
 coronata melicae, 258
 coronifera, 82, 223
 coronifera avenae, 274
 dispersa, 139, 223, 258, 262, 278
 dispersa agropyri, 258

- Puccinia*
dispersa bromi, 258
dispersa secalis, 258
dispersa tritici, 258
fraxinata, 200
gleckomatis, 199
glumarum, 177, 215, 219, 235, 258, 260, 408
glumarum agropyri, 258
glumarum elymi, 258
glumarum hordei, 258
glumarum secalis, 258
glumarum tritici, 258, 272, 278
graminis, 199, 200, 218, 220, 223, 224, 229, 239, 245, 247, 256, 257, 258, 267, 276, 277, 278, 333, 336, 337, 338, 451
graminis agrostidis, 258, 266
graminis avenae, 258, 219, 231, 260, 269, 272, 274, 334
graminis phlei-pratensis, 177, 215, 258
graminis poae, 258
graminis secalis, 172, 258, 260, 274
graminis tritici, 143, 148, 169, 172, 174, 177, 215, 219, 231, 250, 251, 253, 254, 258, 260, 264, 266, 267, 269, 270, 271, 275, 276, 278, 334
grossulariae, 200
helianthi, 174, 214, 333, 451
hieraciata, 200
impatiens, 200
malvacearum, 177, 199, 223, 408
menthae, 214
peridermiospora, 214
phlei-pratensis, 223
poarum, 200
pringsheimiana, 333
pulverulenta, 200
rhamni, 138
rubigo-vera, 223, 276
rubigo-vera secalis, 408
rubigo-vera tritici, 173, 260, 408
ruelliae, 214
simplex, 269, 275
sorgbi, 179, 214, 223, 250, 260, 277
sydowiana, 214
triticea, 172, 216, 223, 269, 275, 276
urticata, 200
windsoriae, 214
- Pucciniaceae, 407, 485
 Pucciniastrum, 333, 406, 408
Puccinmites
cretaceus, 485
cretaceum, 485
lanceolatus, 485
Whitfordi, 485
 Puffballs, 202, 339, 352
Pulvis parturiens, 356
 Pure cultures, 280
Pustularia catinus, 190
 Pycniospores, 333
Pyrausta nubilalis, 445, 456
 Pyrenomycetes, 135, 186, 190-193, 285, 403, 404, 460
 Pyridoxine, 25, 26, 28, 289
 Pyrimidine, 27, 28
 Pyrogallic acid, 230
 Pyrogallol, 44
 Pyrolaceae, 298
Pyronema confluens, 45, 190, 287
Pyrus coronaria, 411
 Pyruvate, 19, 20
 Pyruvic acid, 59, 60, 62, 81, 163
 Pyruvic acid theory of fermentation, 58, 59
 Pythiaceae, 460, 481
Pythiacystis citrophthora, 99, 116
Pythiomorpha gonapodioides, 27, 28
Pythites dysodilis, 481
Pythium, 107, 155, 178, 299, 303, 437
arrhenomanes, 26
butleri, 27
de baryanum, 160, 181, 245, 246, 255
marimum, 466
polycladon, 26, 27
- Quadripolar sexuality, 328
 Quarantine, 420, 427
 Quaternary period, 478, 483, 484, 485
Quercus, 403
cuspidata, 353
robur, 302
varibilis, 353
- Quinol, 45
 Quotient, respiratory, 62
- Rabbits, 176, 376, 404
 Radiation, 123-150, 265, 270
 effect, of X-rays, 145
 on sporulation, 144

- Radiation, implications, 147
 induction of saltations, 145-146
 inhibitory effects, 138-143
 luminescence, 137-138
 mode of action, 147
 morphogenic reactions, 125-129
 phototropism, 129-137
 stimulatory effects, 143-144
- Radiculites reticulatus*, 487, 489
- Radioactive carbon, 19
- Radioactivity, 476
- Radish, 398
- Raffinase, 40, 46, 47
- Raffinose, 42
- Ramigenic acid, 88
- Ramularites oblongisporus*, 486
- Ranunculaceae, 298
- Ranunculus ficariae*, 313
- "Raquette cells," 380, 381
- Rats, 367
- Raulin's solution, 2, 79
- Ravenelia*, 408
cassiaeicola, 407
epiphylla, 407
opaca, 407
- Ravenelin, 85
- Reaction of substrate, 151-164, 229-230, 280
 alkaline fungicides, 162-163
 H⁺ concentration, meaning of, 152
 measurement of, 153
 implications, 163
 pH, and enzymatic activity, 159
 and growth, 155-157
 and media, 157-158
 and pigmentation, 159
 and plant disease, 159-161
 measurement of, 154-155
 of fungus tissues, 158-159
 significance of, 153-154
- Recent Glacial period, 478
- Recessive characters, 317
- Reductases, 50
- Relative humidity, 215, 218
- Rennetase, 46, 47
- Rennin, 40
- Resins, 45
- Resorcinol, 44, 45
- Respiration, 53-68, 83
 aerobic, mechanism, 58
 anaerobic mechanism, 58-62
- Respiration, historical, 53-55
 implications, 66, 67
 inhibition, 65-66
 interrelations of aerobic and anaerobic, 57-58
 respiratory quotient, 62-63, 117
 respiratory systems, 63-64
 respirometer techniques, 64-65
 stimulation, 66
 types, 56-62
- Respiratory enzymes, 11
- Respiratory pigments, 58
- Reticularia lycoperdon*, 217
- Reticulotermes hesperus*, 175
- Rhamnus, 215
- Rhinotrichum, 431, 444
- Rhizidiomycetaceae, 461, 462
- Rhizina inflata*, 190
- Rhizoctonia*, 4, 107, 109, 178, 303, 310, 437
lanuginosa, 304, 309
minoroides, 304
repens, 303-304
solani, 45, 99, 103, 116, 155, 161, 260, 273, 276, 287, 296, 437
violacea, 161
- Rhizomorpha sigillariae*, 485
- Rhizomorpha*
intertextus, 487
polymorphus, 487
- Rhizophyctis rosea*, 34
- Rhizophydium*
codicola, 461
dicksonii, 460
polysiphoniae, 461, 472
- Rhizopogon*
luteolus, 312
roseolus, 312
- Rhizopus*, 16, 48, 86, 106, 107, 268, 280, 373, 431
arrhizus, 76, 77, 224
artocarpi, 224
chinensis, 76, 102, 224
delemar, 224
elegans, 76
japonicus, 76
microsporus, 224
nigricans, 4, 5, 14, 33, 45, 50, 75, 77, 80, 82, 90, 104, 143, 156, 157, 223, 224, 225, 226, 229, 242, 255, 260, 281, 283, 399, 433, 453

- Rhizopus*
nodosus, 224
oryzae, 32, 75-77, 224
reflexus, 224
suinus, 27-28, 141
tritici, 18, 48, 51, 75-77, 224
Rhodopaxillus nudus, 302
Rhopobota vacciniiana, 184, 444
Rhytisma
acerinum, 190, 232
salicinum, 189
Rhytismites, 483
Ribes
americanum, 225
nigrum, 214, 225
rotundifolium, 214
Riboflavin, 25, 26, 41, 82, 290, 325
Rice, 49, 281, 405
Richards' solution, 3, 5, 156, 157, 283
Rickets, 82
Ringworm, 366, 379-390
Ripe rot of grapes, 239
Rocks, 474
 sedimentary, 475
Rodents, 168, 176, 202, 251, 367
Root, mycorrhizal, 306, 309
Roquefort cheese, 49
Rosaceae, 298, 403, 407
Rosellinia necatrix, 26
Rosellinites
Beyschlagii, 484
congestus, 484
congregatus, 482
schusteri, 481
Roses, 238, 239, 244, 376, 407
 black spot, 248
Rotifer, 463
Rozella marimum, 461, 462
Rozites gonglyophora, 452
Rubidium, 3
Rubroglaucin, 84
Russula, 285
 cyanoxantha, 302
 emetica, 201, 302, 343, 345, 346, 351
 laricina, 302
 lepida, 302
 nigricans, 302
 rhodoxantha, 302
 rubra, 302
Rusts, 84, 168, 169, 170, 176, 177,
 199-200, 214, 252, 263, 264,
 268, 271, 285, 327, 405, 406-
 408, 417, 418, 419, 451
Rusts, blister, 285, 420
Ruta, 231
Rutaceae, 298
Rye, 258, 262, 357, 358, 359
Sabouraud's media, 380
Sabouraudia, 384
Sabouraudites, 384
 asteroides, 386
 felineus, 387, 392
 granulosus, 386
 gypseus, 386
 lacticolor, 386
 radiolatus, 390
 ruber, 390
Sabulina octona, 176
Saccharomyces, 431
 cerevisiae, 28, 60, 63, 77, 140, 145,
 268, 282, 288
 rosaceus, 282
Saccharomycetaceae, 369
Saké, 49
Salamander, 174
Salep, 310
Salicaceae, 403
Saltations, 145-146, 259, 385
Sambucus nigra, 307
Sanitary measures in disease pre-
 vention, 427
Sapindaceae, 298
Saprolegnia, 180, 181
 ferax, 19, 431, 459
 mixta, 4
 monoica, 19
 parasitica, 22
 torulosa, 168
Saprolegniaceae, 459, 460, 461, 463,
 464, 466, 480
Saprolegniales, 167, 180
Saprotrophic fungi, 1, 30, 295
Sapwood rots, 251
Sarcoscypha
 coronaria, 190
 minuscula, 404
 protracta, 189, 190
Sargassum, 469
Scab, of barley, 360-361
 of citrus, 269, 411, 449
 of potatoes, 161, 286
 of stone fruits, 411
Scale insects, 408, 443, 445, 447, 448,
 449

- Schizomycetes, 373
Schizoneura lanigera, 173
Schizophyllum, 202
 commune, 26, 101, 103, 105, 106,
 155, 156, 157, 158, 162, 328
Scleroderma
 aurantium, 312
 vulgare, 302
Sclerospora, 211
 graminicola, 178, 214, 223, 226,
 230, 235
 graminis, 180
 philippinensis, 180
Sclerotinia, 4, 5, 48, 109, 243, 377,
 437
 cinerea, 26, 29, 48, 52, 104
 fructicola, 173, 190, 213, 234, 285,
 402, 443
 fructigena, 218, 231
 libertiana, 20, 189, 237, 238, 239,
 254
 sclerotiorum, 247
 trifoliorum, 143, 190
Sclerotites brandonianus, 482, 487
Sclerotium, 178, 437
 bataicola, 18
 delphinii, 26, 27
 oryzae-sativae, 281
 rolfsii, 26, 27, 111, 237, 238, 255,
 287
Scolytidae, 451
Scolytus, 451
 multistriatus, 174, 452
 scolytus, 174, 452
 ventralis, 457
Scopulariopsis, 431
 Seaweed, 471
Secale luxurians, 356
 Secalintoxin, 359
 Second-division segregation, 321,
 322, 323, 326
Secotium acuminatum, 82
 Sectoring, 264-266, 272, 385
 Sedimentary rocks, 475
 Seed treatment, 427
 Seed-borne fungi, 178, 410-411
 Selection, 427
 Semisolid media, 418
Sepedonium, 370, 431
Septobasidium, 408, 448
 curtisii, 409
 pseudopedicellatum, 409
Septobasidium rhobarbarinum, 409
Septoria, 260
 apii, 178, 410
 lycopersici, 175, 410, 411,
 443
Sequoia, 487
Serica sericea, 174
Setaria italica, 235
 Seventeen-year locust, 445
 Sex linkage, 336
 Shaggy mane, 339
 Sheep, 176, 367, 374
Shii-take, 353
 Short-cycled rusts, 407
 "Short roots," 301
 "Shot hole," 49
Sida spinosa, 166
 Silk, 389
 Silk-worm larva, 445, 449
Sirex
 cyaneus, 175
 gigas, 175
 "Sky-hook," 171
 Slime molds, 280, 470, 480
 Slugs, 168, 176
 Smut grass, 85
 Smuts, 108, 110, 176, 197-199, 214,
 216, 224, 252, 263, 264, 268,
 271, 305, 327, 329-333, 335,
 405-406, 418
 corn, 231
 covered, 272
 flag, 405
 kernel, 266
 loose, 272
 stinking, 405
Smyrithurus, 173
 Snails, 168, 176
 Sodium albuminate agar, 430
 Sodium bicarbonate, 163
 Sodium caseinate agar, 430
 Sodium sulphite, 60, 78
 Sodium tetraborate, 163
 Soil fungi, 178, 286-287, 410-412,
 429-441
 biochemical activities, 434-437
 decomposition of carbohy-
 drates, 435-436
 decomposition of proteins, 436-
 437
 implications, 437-438
 soil-borne pathogens, 437

- Soil fungi, taxonomic studies, 429-434
 kinds of fungi isolated, 430-432
 methods, 429-430
 number of fungi in soils and factors influencing prevalence, 432-434, 434
- Solanum*
dulcamara, 313
magia, 313
tuberosum, 313
- Sorbose, 18
- Sordaria*, 176, 191, 431, 484
fimicola, 26, 187
- Sordariaceae, 484
- Sorospora*, 448
ucella, 445, 446-447, 457
- Sorosporium reilianum*, 260, 267, 278, 337
- Sow bugs, 176
- Soya sauce, 49
- Soybean, 237, 402
 frog-eye leaf spot, 410
- Spawn, 353
- Spegazzinites cruciformis*, 482, 487
- Spermoedia clavus*, 356
- Sphacelia*, 355
segetum, 356
- Sphacelic acid, 358
- Sphaceloma farwetti*, 269, 291, 411, 449
- Sphacelotheca*
cruenta, 267, 278
sorghii, 260, 266, 267, 276, 278
- Sphacelotoxin, 359
- Sphaerella chondri*, 469
- Sphaeria*
ellipsocarpa, 192
inquinana, 192
lanada, 192
lemanaeae, 192
scirpi, 192
- Sphaeriaceae, 484
- Sphaeriales, 466
- Sphaerioidaceae, 486
- Sphaerites*, 481
suessi, 484
- Sphaerobolus*, 202, 204, 205
iowensis, 209
stellatus, 203, 209
- Sphaeronema*, 430
fimbriatum, 18
- Sphaeropsis*, 5
malorum, 22, 29, 104, 242
- Sphaerostilbe*, 444, 449
auranticola, 446-447, 449, 456
coccophila, 447
flammea, 447
- Sphaerotheca*
humuli, 260, 278
lanestrus, 403
mors-urvae, 186, 188
pamosa, 403
pamosa var. *rosae*, 113
- Sphaerulina trifolii*, 26, 27
- Sphagnum, 310
- Sphenophorus obscurus*, 175
- Spicaria*, 171, 444, 445
anomala, 452
farinosa, 447
javanica, 446-447
- Spiculisporic acid, 163
- Spinulosin, 85
- Spiral hyphae, 380, 381, 383
- Spiralia, 384
- Sponges, 137
 spicules, 481
- Spongospora subterranea*, 399
- Spontaneous generation, 417, 418, 422
- Sporangioles, 299
- Spore dissemination, 166-209
 distribution of spores, 167-179
 air currents, 168-171
 animals as vectors, 175-177
 aquatic fungi, 167-168
 insects as vectors, 172-175
 rate of fall of spores, 172
 seed-borne fungi, 178
 soil-borne fungi, 178
 spore traps, 171-172
 terrestrial fungi, 168
 the human agency, 177
 water, 179
 hygroscopic mechanism in Myxomycetes, 179
 implications, 205
 spore discharge among Ascomycetes, 186-193
 spore discharge among Basidiomycetes, 194-205
 spore expulsion among Phycomycetes, 180-186
 structural adaptation, 179
- Spore germination, 96, 210-235

- Spore traps, 170, 171
 Sporobolus, 85
 Sporodinia grandis, 319
 Sporormia
 bipartis, 192
 intermedia, 189
 Sporotrichites heterospermus, 486
 Sporotrichum, 171, 388
 anthophilum, 173
 beurmanni, 375, 376
 bombycinum, 435
 equi, 375
 globuliferum, 445
 griseolum, 435
 maritimum, 470
 olivaceum, 435
 poae, 377
 roseolum, 435
 schenckii, 375-377, 376
 Spruce, 300, 303, 305, 311, 312, 452
 Sprue, 379
 Squash, 401
 Squash bugs, 173
 Squids, 137
 Squirrel, ground, 367
 Stachybotrys, 431
 alternans, 435
 Staining of wood, 162, 174, 372, 443, 452
 Staling products, 242, 265, 282, 283
 Staphylococcus, 87, 373
 albus, 284
 aureus, 87, 284
 Starch, 19, 74, 390, 436, 460
 soluble, 65, 386
 State agricultural experiment stations, 420
 Stearic acid, 80
 Stegites poacitum, 483
 Stegomyia scutellaris, 444, 456
 Stem rust of cereals, 170, 266
 Stemonitis, 398
 favogenita, 217
 ferruginea, 217
 fusca, 397
 Stemphylium, 171
 codii, 470
 Stereum, 202
 fasciatum, 102, 114
 frustulosum, 26, 33, 98, 44, 100, 102
 fuscum, 103
 gausapatum, 102, 120, 155, 164
 hirsutum, 100
 lobatum, 114
 purpureum, 44, 47, 52, 98, 100
 rameale, 102
 rugosum, 100
 sanguineolentum, 175
 spadiaceum, 100
 Sterigmatocystis, 106
 nigra, 29, 32, 33, 92, 151, 242
 Sterols, 25, 81-82
 Stictidiaceae, 483
 Stigmara, 481
 Stigmatea pelvetiae, 469
 Stilbaceae, 487
 Stilbites conwentzi, 487
 Stinkhorns, 202
 Stinking smut, 176, 405
 Stokes' law, 172, 201
 Stomata, 236, 240, 246, 248-251
 Stomatoscope, 248
 Straw, 389
 Strawberry, 309
 Streptococcus, 87
 lactis, 76
 viridans, 284
 Streptothrix, 375
 Strobilomyces strobilaceus, 86, 302
 Strobilomycol, 86
 Strontium, 3
 Stropharia
 depilata, 409
 psathyroides, 409
 Stypocaulon scoparum, 469
 Stymanus, 431
 Succinic acid, 19, 20, 61, 71, 73, 75, 76, 78, 163
 Sucrase, 39, 40, 45, 46, 47
 Sucrose, 18, 19, 42, 45, 61, 64, 74, 80, 390, 430
 Sugar beet, 229, 250
 Sugar cane, 166, 174, 445
 Sugar-cane borer, 175
 Sulfonamides, 284, 427
 Sulphur, 3, 4, 10, 438, 478
 "Sulphur granules," 375
 Surface tension, 196-197
 Suscept, 422
 Sweet potato, 224, 225
 Sychosis, 366
 Sylenein, 85
 Symbiosis, 279, 304, 305, 306, 313, 466, 488
 Synchaeta monopus, 463

- Synchaetophagus balticus*, 463, 471
Synchytrium endobioticum, 145,
 161, 240, 255, 400
 Synergism, 279, 290-292
Syringospora
 albicans, 378
 psilosis, 378
 Syrups, 49
Systemma acicola, 179

 Tangerines, 450
 Tannase, 40, 46, 47
 Tannic acid, 44
 Tannin, 45
Taphrina, 211
 deformans, 136, 137, 150, 402
 mirabilis, 285
Tarichium uvella, 445
 Tartaric acid, 79
 Teeth, 374
Tegula, 469
 funeralis, 468
Teleutosporites milloti, 485
 Temperature, 96-122, 210, 221-229,
 265, 269, 270, 280, 282, 313,
 389, 470
 and reproduction, 111-114
 cardinal, 97-103
 implications, 119
 influence, on infection, 109-111
 oxygen tension, 117
 resistance to low and high, 103-
 109
 zonation, 114
 Temperature coefficients, 96, 114-
 117
Terfezia leonis, 303
 Terminal clubs, 380
 Termites, 175, 451, 454
 Terpenes, 45
 Terrestrial acid, 163
 Tertiary period, 477, 483, 485, 487
n-Tetracosic acid, 80
 Tetraplodon, 299
 Tetrapolar sexuality, 328, 329
 Texas cattle fever, 443
 Texas root-rot fungus, 412
 Textiles, 49
Thalassomyces
 batei, 464
 spizakovii, 464
 Thalassomycetinae, 464
Thamnidium elegans, 270

Thelephora, 85
 Thelephoraceae, 98, 102, 114
 Thelephoric acid, 85
 Thermal death point, 226-228
 Thermolabile metabolic products,
 283, 289
 Thermostable metabolic products,
 283, 289, 350
 Thiamin, 25, 26, 27, 28, 41, 66, 82,
 288, 289
 Thiazole, 27, 28
Thielavia basicola, 161, 255, 291,
 295, 402
Thielaviopsis, 109, 178, 437
 basicola, 246, 264, 275, 402, 423,
 428
 paradoxa, 111, 225, 226, 229
Thraustochytridium proliferum, 461,
 462
 Thraustotheca, 461
 Thread blight, 409
 Thrips, 175
 Thrush, 378
Thuja occidentalis, 405
Tibicina septendecem, 445
 Ticks, 172, 443
 Tiliaceae, 407
Tilletia, 485
 asperifolia, 197
 foetans, 405
 holci, 197
 horrida, 405
 levis, 197, 260, 267, 272, 274, 276,
 277, 330, 337
 tritici, 166, 178, 197, 198, 216, 260,
 267, 272, 274, 277, 330, 337,
 405
 Tilletiaceae, 197, 198, 211, 485
 Timothy, 256
 Tinea, 379, 384
 Titania, 405
 Titrable acidity, 151
 Toadstools, 339
 Tobacco, 108, 242, 246, 303, 401-
 403, 427
 Tobacco black-shank, 178
 Tobacco downy mildew, 111, 177,
 401
 Tobacco kroepoek, 172
 Tobacco root-rot, 105, 109, 161, 246
Tolyposporium bursum, 216
Tomaspis varia, 445
 Tomato, 242, 246, 412

- Tomato-leaf mold, 410
 Tomato-leaf spot, 410, 443
 Tonsils, 374, 375
Torula, 29, 82, 373
 cerevisiae, 55
 histolytica, 369
 rubra, 82
 saccharina, 29
Torulites moniliformis, 486
 Torulosis, 366, 368-369
 Total acidity, 151
 Toxicology, 350-351
 Toxins, 89, 237, 238, 250, 280, 282, 284, 286
Tradescantia, 241
Trailia ascophylli, 469
Trametes, 410
 cingulata, 46
 gibbosa, 101
 lactinea, 46
 pini, 51, 102
 radiciperda, 44
 serialis, 101, 102, 127
 Transpiration, 307
Tranzschelia pruni-spinosae, 407
 Trehalase, 40
Trematosphaerites lignitum, 484
Tremella mesenterica, 82
 Triangle system, 7, 9, 12
 Triassic period, 477, 487
 Tributyrin, 390
Trichamphora pezizoides, 397
Trichia, 179
 botrytis, 217
 favoginea, 217
 lateritia, 217
 scabia, 217
Trichocladium asperum, 435
Trichoderma, 50, 107, 171, 175, 434, 435, 437, 453
 flavobrunneum, 302
 königii, 15, 433, 436
 lignorum, 77, 287, 289, 296, 432, 433
 viride, 88, 90
Tricholoma
 albobrunneum, 312
 imbricatum, 312
 pessundatum, 312
 portentosum, 352
 subgambosum, 454
 terreus, 303
 vaccinum, 312
Trichophytids, 387
Trichophyton, 366, 381, 383
 acuminatum, 389, 390
 album, 389
 cerebriforme, 388
 crateriforme, 389
 denticulatum, 386
 discoides, 25, 34
 ectothrix, 382, 383, 384, 389
 endothrix, 382, 383, 384, 389
 flavum, 389
 floccosum, 389
 granulosum, 388, 389
 gypseum, 384, 385, 388, 389, 391
 interdigitale, 4, 15, 19, 25, 33, 388, 389, 390, 392
 magnini, 390
 mentagrophytes, 140, 146, 149, 389
 neoendothrix, 383, 384
 polygonum, 389
 radians, 386
 radiolatum, 390
 sabouraudia, 384
 sulfureum, 389
 tonsurans, 384, 389, 390, 394
 vinosum, 390
Trichophytoneae, 365, 379-390, 384
Trichosporium, 372
 symbioticum, 452, 457
Trichothecium roseum, 224-225
Trimethylarsine, 88
 Tripalmitin, 62
Triticum vulgare, 275
 Tritisporin, 85
 Trout, 462
 Truffles, 306, 352
Trypodendron betulae, 453
 Trypsin, 40, 41, 46, 47
 Tryptophanase, 42, 82, 83
 Tryptophane, 40
Tsuga canadensis, 405
Tuber, 303
 aesticum, 352
 melanospermum, 352
 Tuberculariaceae, 487
Tuberculina maxima, 285
 Tuberculosis, 368, 379
 Tuberization, 312-314
 Tungsten, 16
 Turnips, 103, 116, 398
 Typha, 485
 Typhoid, 87

- Typhula*
gramineum, 160, 161
incarnata, 158
 Tyrosinase, 40, 46, 47
 Tyrosine, 23, 41, 44, 45, 65

Ulmus americana, 410
 Ultraviolet, 123, 124, 139, 142, 143,
 146, 325, 388
Ulex, 468
californica, 466, 469
Uncinula
aceris, 403
flexuosa, 403
geniculata, 403
salicis, 403
Uncinulites baccharini, 482, 483
 United States Department of Agriculture, 420
 University of Wisconsin, 420
 Uranium, 16, 476
 Urea, 55, 390
 Urease, 40, 41, 46, 47
 Uredinales, 1, 211, 318, 327, 333-335
Uredinopsis, 406, 408
adianti, 406
inestita, 406
macrosperma, 406
mayoriana, 406
Urnula
craterium, 190
geaster, 189, 190, 404
Urocystis, 485
anemones, 214
cephulae, 110, 122, 178, 214, 216,
 223, 235
occulta, 223, 229, 234
tritici, 223, 234, 405, 415
Uromyces, 333, 407, 408
appendiculatus phaseoli, 177, 408
appendiculatus vignae, 177, 408
betae, 177, 408
bidenticola, 174
caryophyllinus, 177, 223, 247, 408
fabae, 220, 247
phaseoli, 242
pisi, 200
poae, 200
trifolii, 177, 223, 408
Uromycladium, 407
Urophlyctites
oliverianus, 481
stigmariae, 480, 481

Uropyxis, 407, 408
 Uschinsky's solution, 3
 Ustilaginaceae, 197
 Ustilaginales, 211, 318, 329-333
Ustilago, 170
avenae, 108, 178, 220, 223, 234,
 260, 267, 272, 276
bullata, 335, 337
hordei, 219, 260, 267, 274, 330
levis, 260, 267, 272, 276, 330
longissima, 214
medians, 267, 330
nuda, 145, 219
striaeformis, 214, 223, 233
tritici, 108, 145, 260, 275
violacea, 260, 274, 278
zeae, 143, 149, 231, 235, 264, 273,
 274, 277, 278, 285, 293, 329,
 330, 331, 332, 336, 337, 338,
 405
 Uterine contraction, 356, 358, 359

 Vaccines, 423
Vaccinium
corymbosum, 304
macrocarpon, 184, 304
myrtillus, 304
ovatum, 304
oxycoccus, 304
pennsylvanicum, 304
racillans, 304
vitisidaea, 304
 Valeric acid, 283
 Valley fever, 367, 437
 Van Tieghem cells, 212
 Vanda, 304, 310
 van't Hoff's rule, 98, 114
 Varianose, 79
 Variation, 257, 259
 Vectors of fungi, 172-179, 442, 443
 Velvet-stemmed mushroom, 339
Venturia inaequalis, 170, 192, 218,
 219, 228, 402
Vermicularia, 5
circinans, 245
Verpa bohemica, 99, 136
 Verticillic acid, 88
Verticillium, 109, 178, 431, 444
albo-atrum, 97, 99, 113, 117, 118,
 120
candidum, 453
cellulosae, 435

- Verticillium*
cinnamomeum, 449
glaucum, 435
heterocladium, 446-447
 Vesicle, 303
 Vetch, 403
Vibrio cholerae, 87
Vicia faba, 240
 Violaceae, 298
 Viridin, 88
 Viruses, 443, 448
 Vitamins, 81-82, 88, 266, 280, 288,
 325, 331, 379
 Vitamin A, 82
 Vitamin B complex, 325
 Vitamin B₁, 25, 26, 27, 28, 41, 66,
 82, 288
 Vitamin B₄, 82
 Vitamin D, 81
 Vitamin H, 289
Volutella fructi, 104
 Volva, 343, 344, 347

 Warburg respirometer, 64, 66
 Wasps, 172, 173, 175, 443
 Wasting disease of *Zostera*, 460,
 466
 Water, 211, 218-221
 "Water molds," 430, 431
 Watermelon, 401, 403, 410, 412
 Weather, 210
 Weevil, 454
 Wheat, 108, 145, 168, 169, 257, 267,
 270, 271, 303, 359, 405, 419
 Ceres, 271
 durum, 271
 flag smut, 405
 Kanred, 334
 Marquillo, 269
 Marquis, 269
 Mindum, 247, 335
 rust, 239, 251
 stem rust, 266
 Thatcher, 271
 vulgare, 272
 White ants, 454
 White flies, 449, 450
 White-pine blister rust, 177

 White rot of woods, 44
 Willow scab, 177
 Wilting, 361
 Wine, 53, 54
 Wood-destroying fungi, 98-103,
 436
 enzymes, 43-48
 Woodpeckers, 176
 Worm, horn, 174
 Wort, 430
 Wound penetration, 251-252
Wojnowicia graminis, 282
Wuchereria bancrofti, 442

 Xanthone, 84
 X-rays, 123, 124, 145, 146, 325, 335
Xylaria
 hypoxylon, 138
 micrura, 452
 nigripes, 454
Xyleborus dispar, 451
Xylomites
 asteriformis, 483
 polaris, 487
 samitae, 487
Xylose, 18, 21, 79, 80

 Yeast, 27, 28, 43, 54, 55, 61, 62, 66,
 69, 76, 77, 82, 144, 147, 270,
 288, 289, 325, 365
 baker's, 268
 brewer's, 268

Zignoella
 calospora, 469, 472
 enormis, 469
 Zinc, 3, 7, 10, 11, 14-16, 289
 Zonation, 114, 127-129
Zootermopsis angusticollis, 175
Zostera, 460
 marina, 466, 467, 469, 470, 473
Zygorhynchus, 431
 möllerii, 26, 145, 433
 cuillenini, 432, 433
Zygosaccharomyces acidifaciens, 290
 Zygote, 318
 Zymase, 40, 42, 57, 58, 390
Zymonema dermatitidis, 369

